

Yellow
9/2 x 6 1/4
inside
9/4 x 6

Q151
.A721
v.10
1914

JOURNAL & PROCEEDINGS
OF THE
ASIATIC SOCIETY OF BENGAL.

New Series, Vol. X
1914.



CALCUTTA:

PRINTED AT THE BAPTIST MISSION PRESS, AND PUBLISHED BY
THE ASIATIC SOCIETY, 1, PARK STREET, CALCUTTA.
1918.



Q 151
A 721
v. 10
1914

DATES OF PUBLICATION.

Journal, pp.	1-42	Proceedings, pp.	i-ii	29th April	1914.
„ „	43-84	„ „	iii-lxxx	18th June	„
„ „	85-106	„ „	lxxxv-lxxxvi	30th „	„
„ „	107-120	„ „	lxxxvii-xciv	1st July	„
„ „	121-200	„ „	xcv-xcvi	20th Aug.	„
„ „	201-256	„ „	xcvii-cii	21st Oct.	„
„ „	257-294	„ „	ciii-civ	9th Dec.	„
„ „	295-372	„ „	cv-cviii	30th Jany.	1915.
„ „	373-488	„ „		26th May	„

DIRECTIONS FOR BINDING.

The pages of the Journal should be bound first after the list of papers; they are numbered in Arabic numerals. The pages of the Proceedings should follow them; they are paged consecutively in Roman numerals. The Index is paged in continuation of the Proceedings.

Plate	i	to follow	page	110
„	ii	„	„	176
„	iii-iv	„	„	50
„	v-vi	„	„	64
„	vii	face	„	197
„	viii	„	„	92
„	ix-xi	follow	„	172
„	xii-xiv	face	„	115
„	xv-xvii	follow	„	120
„	xviii-xx	„	„	130
„	xxi	„	„	250
„	xxii	„	„	244
„	xxiii	„	„	240
„	xxiv	„	„	210
„	xxv-xxx	„	„	274
„	xxxi	„	„	420
„	xxxii	„	„	424
„	xxxiii	„	„	484

ERRATA.

In Journal, Vol. X, p. 102.—Edilpur Grant of Keśavasena,
eighth line from top :—

Read

34 थिवीमिमां प्रथितवीरवर्गाग्रणीः सगर्गं यवनान्वय प्रलयकाल
instead of

34. थिवीमिमां प्रथितवीरवर्गाग्रणीः सगन्ध यवनान्वय प्रलयकाल ।

LIST OF PAPERS AND ABSTRACTS

ARRANGED ACCORDING TO AUTHORSHIP.

	<i>Page</i>
ALLAN, J.	
The Legend of Samudragupta's Aśvamedha Coin Type ..	255
ANNANDALE, N., and MAHAMAHOPADHYAYA HARAPRASAD SHASTRI.	
Relics of the Worship of Mud-Turtles (Trionychidae) in India and Burma	131
BANERJI, R. D.	
Edilpur Grant of Kesavasena	97
The Belabo Grant of Bhojavarman	121
Four Forged Grants from Faridpur	425
A New Type of Audambara Coinage	247
Silver Coins of the Chandella, Madanavarman	199
BEVERIDGE, H.	
The Date of the Death of Shah Beg Arghūn, the Ruler of Sind ..	283
Sirhind or Sehrind	281
BHATTASALI, NALINI KANTA.	
A Forgotten Kingdom of East Bengal	85
BISHWESHWAR NATH, SHASTRI.	
Jhalrapatan Stone Inscription of Udayaditya [Vikrama] Samvat 1143 (1086 A.D.)	241
BOTHAM, A. W.	
The Ahom Coins of A.D. 1648	457
Chronology of the Jaintia Kings	459
BROWN, C. J.	
Note on some Copper Coins discovered in Balaghat, C. P. ..	481
On Two Finds of Bahmani Coins	196
On Four Rare Mughal Coins	197
BROWN, J. COGGIN.	
Further Descriptions of Stone Implements from Yünnan ..	265
Grooved Stone Hammers from Assam and the Distribution of Similar Forms in Eastern Asia	107
BURKILL, I. H. : See PRAIN, D., and I. H. BURKILL.	
CALDWELL, KENNETH SOMERVILLE.	
An Improved Method of using Oil Gas	215
CAMPBELL, W. E. M.	
Gupta Gold Coins found in the Ballia District	174
Nepalese War Medals	195

	<i>Page</i>
CHAKRAVARTI, NILMANI.	
Spirit Belief in the Jātaka Stories	257
CHAKRAVARTTI, VANAMALI.	
The Nature of <i>mokṣa</i> in the <i>nyāya</i> and <i>vaiśeṣika</i> systems ..	93
CHATTERJEE, GOURIPATI.	
On a Demonstration Apparatus for determining Young's Modulus	51
CLEGHORN, MAUDE L.	
A Note on the Floral Mechanism of <i>Typhonium trilobatum</i> ..	421
DEY, NUNDOLAL.	
Notes on Ancient Aṅga or the District of Bhagalpur ..	317
DUTT, BARUN CHANDRA, and SURYA NARAYAN SEN.	
The Action of Nitric Oxide on Metallic Peroxides suspended in Water. Part I	287
EKENDRANATH GHOSH: <i>See</i> GHOSH, EKENDRANATH.	
GHOSH, EKENDRANATH.	
On the Reproductive System of <i>Atopos</i> , Simroth	111
GOURIPATI CHATTERJEE: <i>See</i> CHATTERJEE, GOURIPATI.	
GRAVELY, F. H.	
The Evolution and Distribution of certain Indo-Australian Passalid Coleoptera	201
The Evolution and Distribution of Indian Spiders belonging to the Subfamily Aviculariinae	411
GUPTA, B. A.	
Kāthkari	105
HARAPRASAD SHASTRI, MAHAMAHOPADHYAYA, and N. ANNANDALE: <i>See</i> ANNANDALE, N., and MAHAMAHOPADHYAYA HARAPRASAD SHASTRI.	
HAYDEN, H. H.	
Note on the Application of the Principle of Isostatic Compensation to the Conditions prevailing beneath the Indo-Gangetic Alluvium	275
HENDERSON, J. R.	
Note on the Dates of the Maulūdī Era of Tipu Sultan of Mysore	251
HIDAYET HOSAIN, M.: <i>See</i> HOSAIN, M. HIDAYET.	
HOSAIN, M. HIDAYET.	
Note on a History of Firuz Shah called Sirat-i-Firuz Shahi ..	xcviii

	<i>Page</i>
HOSTEN, REV. H.	
Fr. Jerome Xavier's Persian Lives of the Apostles ..	65
IVANOW, W.	
On the Language of the Gypsies of Qainat (in Eastern Persia) ..	439
IYER, L. K. ANANTHA KRISHNA.	
A Comparative Study of the Marriage Customs of the Cochin Castes	295
JACKSON, V. H., and A. T. MUKERJEE.	
Improvements in Measurements with Quadrant Electrometers ..	227
KANITKAR, N. V.: <i>See</i> MANN, HAROLD H., and N. V. KANITKAR.	
KIEFFER, J. J.	
Chironomides du Lac de Tibériade	369
LALL, PANNA.	
A New Coin of Shah Alam II	246
LLOYD, R. E.	
Presence and Absence of the Gall-bladder in certain Rodents ..	211
MAJUMDAR, RAMESH CHANDRA.	
The Date of Chashtana	223
MANN, HAROLD H., and N. V. KANITKAR.	
Notes on the Fat of <i>Garcinia indica</i> , the so-called <i>kokam</i> butter	293
MASTER, A.	
The Gujrāt Mahmūdi	463
Note upon the Eponym of Changīzī	470
The Post-Mughal Coins of Ahmadābād, or a Study in Mint- marks	153
MRITYUNJOY ROYCHOWDHURI: <i>See</i> ROYCHOWDHURI, MRITYUNJOY.	
NALINI KANTA BHATTASALI: <i>See</i> BHATTASALI, NALINI KANTA.	
NATH, BISHWESHWAR, SHASTRI: <i>See</i> BISHWESHWAR NATH, SHASTRI.	
NILMANI CHAKRAVARTI: <i>See</i> CHAKRAVARTI, NILMANI.	
NUNDOLAL DEY: <i>See</i> DEY, NUNDOLAL.	
D'ORCHYMONT, A.	
Hydrophilidae from the Lake of Tiberias	357
PANNA LALL: <i>See</i> LALL, PANNA.	
PRAIN, D., and I. H. BURKILL.	
A Synopsis of the Dioscoreas of the Old World, Africa excluded, with Descriptions of New Species and of Varieties ..	5

	<i>Page</i>
RAMANUJASWAMI, S. P. V.	
Jayamangala	1
RAMASWAMI, M. S.	
A new species of <i>Diospyros</i> from the Tinnevelly Hills ..	47
Note on Leaf Variation in <i>Heptapleurum venulosum</i> , Seem ..	115
Studies on the Leaf Structure of <i>Zoysia pungens</i> , Willd ..	57
RAMESH CHANDRA MAJUMDAR: <i>See MAJUMDAR, RAMESH CHANDRA.</i>	
ROY, SARAT CHANDRA.	
Magic and Witchcraft on the Chota Nagpur Plateau ..	349
ROYCHOWDHURI, MRITYUNJOY.	
A Gold Coin of Croesus	486
SARAT CHANDRA ROY: <i>See ROY, SARAT CHANDRA.</i>	
SATIS CHANDRA VIDYABHUSANA: <i>See VIDYABHUSANA, SATIS CHANDRA.</i>	
SCHULTEN, C.	
Hot Springs in Raj Darbhanga, Khargpore Hills, District Monghyr	147
SEN, SURYA NABAYAN: <i>See DUTT, BABUN CHANDRA, and SURYA NABAYAN SEN.</i>	
SMITH, LIEUT.-COL. J. MANNERS.	
The "Shous" or Bighorned Deer of Tibet	117
SOUTHWELL, T.	
A Short Account of Our Present Knowledge of the Cestode Fauna of British India and Ceylon	139
SUBOOR, M. A.	
A Note on the Babylonian Seal in the Central Museum, Nagpur	461
TATTERSALL, WALTER M.	
Amphipoda and Isopoda from the Lake of Tiberias.. .. .	361
TAYLOR, G. P.	
A Copper Coin from the Nahrwāla Shahr Pattan Mint ..	479
List Complementary to Mr. Whitehead's "Mint Towns of the Mughal Emperors of India"	178
An Unissued Rupee of Edward VII	245
Review. R. B. Whitehead: Catalogue of the Coins in the Punjab Museum, Lahore. Vol. II. Coins of the Mughal Emperors	471
Review. W. H. Valentine: The Copper Coins of India. Part I. Bengal and United Provinces	477
TESSITORI, L. P.	
A Scheme for the Bardic and Historical Survey of Rajputana ..	373
VANAMALI CHAKRAVARTTI: <i>See CHAKRAVARTTI, VANAMALI.</i>	

	<i>Page</i>
VIDYABHUSANA, SATIS CHANDRA.	
The Localization of certain Hymns of the Rigveda 43
WRIGHT, H. NELSON.	
Bairāta or Barār 250



NOTICE.

Foreign Societies who favour the Asiatic Society of Bengal with their publications are informed that they may be sent either to the address of the Society at Calcutta, or to the Agent of the Society in London, Mr. Bernard Quaritch, 11, Grafton Street, New Bond Street.

AVIS.

Les Sociétés étrangères qui honorent la Société Asiatique de Bengale de ses publications, sont priées de les envoyer ou directement à l'adresse de la Société, 1, Park Street, Calcutta, ou à l'agent de la Société à Londres, Mr. Bernard Quaritch, 11, Grafton Street, New Bond Street.

ANZEIGE.

Ansländische Gesellschaften welche die Asiatische Gesellschaft von Bengalen mit ihren Publicationen beehren, werden hierdurch ersucht dieselben entweder direkt an die Adresse der Gesellschaft, 1, Park Street, Calcutta, oder an den Agenten in London, Mr. Bernard Quaritch, 11, Grafton Street, New Bond Street, zu senden.

JOURNAL
OF THE
ASIATIC SOCIETY OF BENGAL.

New Series.

Vol. X.—1914.



I. Jayamangalā.

By S. P. V. RĀMĀNUJASWĀMI, B.A., *Vizagapatam.*

In the paper on “The real author of Jayamangalā” by Pandit Chandradhar Guleri, B.A., of Ajmer, in the issue for July 1913 of the Indian Antiquary, the author came to the conclusion that the Jayamangalā on Kāmasūtra was composed by Śankarārya, the author of the commentary of the same name on the Nītisāra of Kāmandaka. I am one with him in so far as he says that the commentary was not composed by Yaśodhara, but was simply copied by him after the text when he was too idle for more important work on account of his sorrow for the death of his cultured friend. The commentary on the last book which accompanied the second edition of Kāmasūtra, which Mr. Guleri thinks to belong to Vijayanagaram, but which was really copied from the Grantha manuscript of the Government Oriental Library, Mysore, by my brother, S. P. V. Ranganāthasvāmi Aryavaraguru, and lent to the Editor, does not mention Yaśodhara as its author. There is another copy of the same work in that library in Canarese characters which too does not mention the name of Yaśodhara. Again the Malayalam manuscript of Jayamangalā belonging to the Adyar Library, Madras, does not make mention of Yaśodhara. The colophon in these manuscripts is simply

समाप्तं च वात्स्यायनीयकामसूत्रटीकायां जयमंगलाख्याया or समाप्तं
चेदं वात्स्यायनीयकामसूत्रटीकायां..... अधिकरणं समाप्तम् ॥

The phrase about Yaśodhara, viz. विदग्धाङ्गनाविरहकावरेण
गुणदत्तेन्द्रपादाभिधानेन यशोधरेणैकत्रकृतसूत्रभाष्यायां, obtains only

in the printed edition brought forth by Mahāmahopādhyāya Pandita Durgā Prasāda. After the above colophon in some manuscript he consulted, at the end of the sixth chapter, where it comes to a close, the following few lines are found:—

इत्यपरार्जुनभुजबलमल्लराजनारायण महाराजाधिराज चौलुक्य-
चूडामणि श्रीमद्वीरसलदेवस्य भारतीभाण्डागारे श्रीवात्स्यायनीयकामसूत्र
टीकायां जयमङ्गलाभिधानायां वैशिकमधिकरणं समाप्तम् ॥

This latter alone is found in the manuscript belonging to Jambūnātha Bhatta of Tanjore (Report on Sanskrit manuscripts in Southern India by E. Hultzsch, Ph.D., Government Epigraphist, Madras, No III), and several others noticed by Prof. S. R. Bhandarkar, M.A., in Rajputana (Report of second tour in 1904-5, 1905-6, page 48). As the latter part of the colophon is found in many manuscripts in which the name of Yaśodhara is not mentioned, the probable conclusion appears to be the Kāmasūtra was for the first time copied with the Jayamangalā for the Bhāratī Bhāndāgāra of Srī Viśaladeva by Yaśodhara, a scribe attached to that library, while before that the text and the commentary were separate.

Now, Mr. Guleri has proved beyond all doubt that the author of Jayamangalā on Kāmasūtra was the same as the author of Jayamangalā on the Nitisāra of Kāmandaka—whatever be his name. But there is another Jayamangalā which he has lost sight of, viz. the commentary on Bhattikāvya. Long before the publication of Nitisāra of Kāmandaka in the Trivandrum Sanskrit Series, Mr. Ranganāthasvāmi pointed out in his paper on Jayamangalā in the Mitragoshthī¹ (and all I have done in this paper is simply to combine the two papers on the same subject), that the author of Jayamangalā on Bhattikāvya is identical with the author of the commentary on Kāmasūtra. The similarities of style pointed out by him are striking. Compare, for instance, the introductory verses of the three Jayamangalas.

- वात्स्यायनायं किल कामसूत्रं प्रस्तावितं कैश्चिदिहान्यधैव ।
[M] तस्माद्विधाप्ये जयमङ्गलाख्यां टीकामहं सर्वविदं प्रणम्य ॥
कामन्दकौये किल नौतिशास्त्रे प्रायेण नास्मिन् सुगमाः पदार्थाः ।
[M] तस्माद्विधास्ये जयमङ्गलाख्यां तत्पञ्जिकां सर्वविदं प्रणम्य ॥
प्रणिपत्य सकलवेदिनमतिदुस्तरमट्टिकाव्यसलिलनिधेः ।
[M] जयमङ्गलेति नम्रा नौकेव विरच्यते टीका ॥

¹ A monthly paper edited formerly by Pāndeya Srīrāmāvatārasarma, M.A., &c., and Sri Vidhusekharabhattachārya at Benares, now no longer issued. The paper on Jayamangalā appeared on page 338, No. 12, Vol. II for 1904-5.

Mr. Guleri has pointed to two passages in the two Jayamangalas which show a close resemblance. Compare with these the following note from the Jayamangalā on Bhattikāvya on the same subject.

दण्डको नाम ऋषिर्भागवकन्यामहरत् । तच्छापात् पांसुवधेणाक्रान्तः
सबन्धुराष्ट्रविनाशो यस्मिन् स्थाने तत्वोपलक्षितं शक्यमभूत् तदोयिवान् ॥

It, therefore, comes upon us as a natural conclusion that one and the same person commented on the three works, Kāmasūtra, Nitisāra and Bhattikāvya. The conclusion is strengthened by the fact that the commentator on Bhattikāvya calls himself अनेकशास्त्राख्यानुक्तो .

Well, then, what is the name of this commentator? He calls himself Śankarārya in the Jayamangalā on Nitisāra, and Jatisvara, Jayadeva and Jayamangala in the commentary on Bhattikāvya. The paradox is only apparent. Śankara is none else than Jatisvara, the ārya being only an honorific suffix, and there is not much difference between Jayadeva and Jayamangala. His original name appears to have been Jayamangala, as he called his works after that name. Moreover, in the complete copy of the commentary on Kāmasūtra found in the Library of the Bombay Branch, Royal Asiatic Society (cf. Catalogue No. 1, the Pandit Bhagavānlāl Indraji collection, published 1903, page 2), the name of the author is given as Jayamangala. Thus there is at least one manuscript which notes the correct name of the author. Jayamangala appears to have been a Buddhist by religion as in his three works he makes obeisance to सर्ववित् and सकलवेदिन्, synonyms of Buddha.

In conclusion, I may mention that it is on a consideration of these points, that, in the edition of Kāmasūtra of Vātsyāyana recently brought forth together with the Jayamangalā by the Proprietor of the Chowkhamba Sanskrit Book Depot, under the general supervision of Bibu Govinda Dāsa of Benares, the name of the commentator is given as Jayamangala and the colophon changed into जयमङ्गलरचितायाम्, etc. But a critical edition of the Kāmasūtra and the Jayamangalā, which is the best of the commentaries on it, is still a want requiring fulfilment. Dr. R. Schmidt of Germany, I learn, brought forth an edition of the work, but in that too, the commentary is attributed to Yaśodhara. It, therefore, appears that Dr. Schmidt also overlooked the force of the expressive एकत्रकृत-
सूत्रभाष्यायाम् .

2. A Synopsis of the Dioscoreas of the Old World,
Africa excluded, with descriptions of new
species and of varieties.

By D. PRAIN and I. H. BURKILL.

The paper on Dioscorea, here offered, is intended to serve two purposes: (1) to publish in the requisite form diagnoses of certain new species and varieties, and (2) to make immediately available a key to this difficult genus. In the Annals of the Royal Botanic Gardens, Calcutta, our detailed monograph will appear, with rather more than one hundred plates and a full account of the synonymy, distribution, uses and relationship of the species here briefly enumerated.

The reader will observe that this paper anticipates the publication, in Mr. Elmer's Leaflets of Philippine Botany, of several diagnoses¹: he may also note that the correct positions of *Dioscorea polystachya*, Turcz., *D. deleteria*, Noronha, *D. goeringiana*, Kunth, and *D. vilis*, Kunth, are not given as we have not decided what they are. *D. polystachya* is presumedly near to *D. japonica*: it was imperfectly described by Turczaninow: but his type is preserved in the St. Petersburg herbarium, and we trust that we may shortly be able to examine it. *D. goeringiana* was described from inadequate material (now apparently lost): we think that it belongs to the section Stenophora. *D. vilis*, described from immature material, is one of the section Enantiophyllum.

PART I.

A KEY TO THE SPECIES.

Section 1. BORDEREA.—Tuber globular, crowned with a dense tuft of scales, apparently growing very slowly forward, and dying behind, but its exact nature has not been investigated. Stem short, not supporting itself by twining, but sometimes flexuous. Leaves simple, entire. Male-flowers in spreading racemes: perianth-members just united: the stamens inserted on the bases of the perianth-lobes: filaments simple. Female flowers 1—2 together. Seeds without wings, in abbreviated erect capsules.

Only species 1. *pyrenaica*.

¹ These were published on May 5th, 1913 on pages 1589-1599 of Volume V of Mr. Elmer's Leaflets of Philippine Botany.

Section 2. STENOPHORA. Rhizome horizontal, inedible. Stem twining to the left. Leaves simple, but often lobed. Male flowers in small irregular cymes, or in groups of 2–5, or sometimes solitary, along racemose axes: perianth cup- or saucer-shaped, the stamens inserted on the margin of its tube: filaments simple. Seeds winged all round, often unequally so, in abbreviated reflexed capsules.

Male flowers not in sessile clusters.

Male flowers not in a thyrsoïd panicle.

Leaves not lobed.

Flowers in small inflorescences and 1–2 together.

Leaves exactly cordate 2. *flabellifolia*.

Leaves lanceolate-ovate-sagittate 3. *daunaea*.

Leaves ovate-deltoid 4. *cambodiana*.

(Probably allied to the above, but the male flowers unknown) 5. *Ridleyi*.

Flowers in robust inflorescences and as many as six together 6. *birmanica*.

Leaves lobed.

Leaves trifid 8. *membranacea*.

Leaves with many small lobes 9. *nipponica*.

Male flowers in thyrsoïd panicles.

Panicles and pedicels relatively short.

Leaves lobed deeply.

Leaves with sharp lobes, drying black .. 10. *septemloba*.

Leaves with blunt lobes, not drying black 11. *quinqueloba*.

Leaves with very slight lobes, narrowed abruptly from the auricles, bright green .. 12. *Tokoro*.

Panicles elongated and pedicels relatively long. 13. *tenuipes*.

Leaves usually 7-nerved.

Leaves 9-nerved, dull, not narrowed abruptly above the auricles 14. *enneaneura*.

Male flowers in very contracted scorpioid cymes, very small 15. *tentaculigera*.

Male flowers in sessile clusters (sub-sessile in *D. sikkimensis*).

Stamens 6.

Plants not drying black.

Lower leaves 4 together 16. *villosa*.

Lower leaves not 4 together.

Leaves smooth beneath.

Male flowers strictly sessile .. 17. *Prazeri*.

(Certainly allied to the above, differing in the shape of the capsules; but male flowers unknown) .. 18. *Clarkei*.

Male flowers with very short pedicels .. 19. *sikkimensis*

Leaves with papillæ beneath.

Tubular part of male flower as wide as long; sepals obtuse 20. *deltoides*.

Tubular part of male flower narrow at the mouth; sepals acute .. 21. *caucasica*

Plant drying blackish; leaves from a cordate base triangular-acuminate 22. *panthaica*.

Plant drying black; leaves abruptly and shortly acuminate.

Leaves not peltate 23. *oenea*.

Leaves slightly peltate 24. *zingiberensis*.

Stamens 3 only fertile.

Plant drying black 25. *Colletti*.

Plant not drying black.

Edge of leaves not wavy.

- | | |
|--------------------------------|------------------------|
| Leaves relatively small | 26. <i>Morsei.</i> |
| Leaves up to 20 cm. long | 27. <i>hypoglauca.</i> |
| Edge of leaves very wavy | 28. <i>gracillima.</i> |

Section 3. SHANNICOREA. Tubers as far as known descending vertically. Stem twining to the left. Leaves simple, cordate. Male flowers in abbreviated distorted racemes which look like small scorpioid cymes, placed along the axis of a spike-like raceme: perianth saucer-shaped, the stamens inserted near the margin of its tubular part: filaments simple. Seeds with the wing developed on one side only, in elongated reflexed capsules.

Leaves as broad as or broader than long.

Leaves with numerous hairs.

- | | |
|--|-------------------------|
| Leaves larger, with white tomentum | 29. <i>yunnanensis.</i> |
| Leaves smaller, with brown hairs | 30. <i>Hemsleyi.</i> |
| Leaves with no hairs | 31. <i>subcalva.</i> |

Leaves elongated so that they are longer than broad.

- | | |
|--|-----------------------|
| Plant with very sparse hairs | 32. <i>nitens.</i> |
| Plant with rather abundant white hairs | 33. <i>Martini.</i> |
| Plant with plentiful tawny hairs | 34. <i>velutipes.</i> |

Section 4. COMBILIUM. Tubers produced in a bunch, spreading, edible. Stem twining to the left. Leaves simple, cordate. Male flowers 1-2 together on a long spike-like raceme (when the second flower is present it is placed cymosely on the pedicel of the first): perianth saucer-shaped, the stamens inserted near its margin. Seeds unknown.

- | | |
|--------------------|----------------------|
| Only species | 35. <i>aculeata.</i> |
|--------------------|----------------------|

Section 5. LASIOPHYTON. Tubers vertical, containing dioscorine in varying quantity. Stem twining to the left. Leaves generally compound, but not always. Male flowers in spikes or spike-like racemes which are generally compound: perianth-lobes just united at the base, with the stamens inserted on them: filaments simple. Seeds winged on one side only, in elongated reflexed or horizontal capsules.

Male flowers not very densely packed: stamens 3.

- | | |
|--|-----------------------|
| Leaves simple | 36. <i>Kerrii.</i> |
| Leaves simple and compound: hair as abundant grey tomentum | 37. <i>tomentosa.</i> |

Leaves compound or if any simple leaves are present, they are small ones among the flowers.

Capsules at maturity reflexed on the pendulous axis.

Capsule not more than 18 mm. long.

Leaflets relatively small, up to 10 cm. long.

- | | |
|---|-----------------------|
| Tubers several, on long slender rather divergent stalks | 38. <i>Arachidna.</i> |
|---|-----------------------|

Tubers single or few, not on long stalks.

Leaflets narrow	39. <i>melanophyma.</i>
Leaflets broader	40. <i>kamoonensis.</i>
Leaflets broadly ovate	41. <i>tamarisciflora.</i>
Leaflets relatively large.	
Plant hispidly hairy	42. <i>Pierrei.</i>
Plant not hispidly hairy.	
Leaflets 3 or 5	43. <i>pentaphylla.</i>
Leaflets 5 or 6 or 7, often irregularly divided; tubers descending rather deeply	44. <i>Kalkapershadii.</i>
Capsules 25 mm. long or longer	45. <i>Elmeri.</i>
Capsules at maturity standing at a right angle to the dependent axis.	
Leaflets not truncate under the acumen.	
Capsules with margins rounded	46. <i>inaequifolia.</i>
Capsules with margins rather rectangular	47. <i>Cumingii.</i>
Leaflets truncate under the acumen: capsules unknown in <i>D. Blumei</i> , rectangular in <i>D. Scortechinii</i> .	
Lower surface of leaf with a few hairs and petiole bristly	49. <i>Blumei.</i>
Lower surface of leaf and petiole glabrous	50. <i>Scortechinii.</i>
Male flowers densely packed: stamens 6	51. <i>triphylla.</i>

Section 6. OPSOPHYTON. Tubers vertical, containing dioscorine in varying quantity. Stems twining to the left. Leaves simple, cordate. Male flowers in characteristic dependent spikes: perianth-lobes free, with the stamens inserted at their bases: filaments simple. Seeds with the wing developed on one side only, in elongated reflexed capsules.

Leaves alternate.

Leaves ovate-cordate, drying green; flower-spikes long.	
Tuber not or little elongated	52. <i>bulbifera.</i>
Tuber much elongated	53. <i>Rogersii.</i>
Leaves deltoid: flower-spikes shorter, much branched; tuber unknown	54. <i>Brandisii.</i>
Leaves apposite; tuber unknown	55. <i>punctata.</i>

Section 7. ENANTIOPHYLLUM. Tuber vertical, usually edible. Stems twining to the right. Leaves simple. Male flowers sessile on short axes, opening but a little way: perianth-lobes free, with the stamens inserted at their bases: filaments simple. Seeds winged all round, in capsules which are not reflexed, but face forwards.

Male flowers in axillary spikes and not on special leafless branches (Nos. 56 to 69).

Auricles of the leaves set on obliquely, so that the margin of the leaf presents a sinus above them.

Auricles very oblique.	
Leaves relatively large	56. <i>Batatas.</i>
Leaves smaller	57. <i>doryophora.</i>
Auricles slightly oblique	58. <i>japonica.</i>
Auricles of the leaves not set on obliquely, or only inconsistently so.	

Flowers large	59. <i>luzonensis</i> .
Flowers small.	
Leaves almost as broad as long, cordate.	
Buds sessile on a broad base.	
Capsules truncate above	60. <i>peperoides</i> .
Capsules obtuse above	61. <i>bicolor</i> .
Buds with a narrow base	62. <i>aspersa</i> .
Leaves longer than broad.	
Network of veins very prominent.	
Leaves with the first pair of nerves near the midrib	63. <i>spicata</i> .
Leaves with the first pair of nerves remote from the midrib	64. <i>intermedia</i> .
Network of veins not prominent.	
Leaves ovate-cordate, drying dark	65. <i>Trimenii</i> .
Leaves triangular-cordate	66. <i>Wightii</i> .
Leaves ovate-elliptic with horn-coloured margins	67. <i>oppositifolia</i> .
Leaves linear-hastate	69. <i>hastifolia</i> .
Male flowers in spikes simple in the weaker leaf axils, but in the stronger axils disposed in pyramidal panicles.	
Plant of moderate growth; flowers also of moderate size; root edible	70. <i>transversa</i> .
Plant of large growth, with large flowers; root inedible	71. <i>cirrhusa</i> .
Male flowers in spikes arranged on elongated leafless branches (Nos. 72 to 106).	
Spikes of male not strongly negatively geotropic, but taking a position at a right angle or slightly less to the leafless branch.	
Flowers on male plant on axes which are never zig-zag alive or dry; buds generally flattened at the base (Nos. 72 to 96).	
Special flowering branches conspicuously shorter than the leaves (unknown in <i>D. pulvereae</i>).	
Capsules not very oblique, often rather glaucous	72. <i>Wallichii</i> .
Capsules very oblique and very glaucous	73. <i>pulvereae</i> .
Special flowering branches, when well grown, longer than the leaves.	
Pubescence of the plant abundant on the leafless axes which bear the spikes of male flowers.	
Stamens 3	74. <i>decipiens</i> .
Stamens 6	
Male flowers 1—2 mm. apart.	
Leaves with floccose hairs below	75. <i>orbiculata</i> .
Leaves without floccose hairs below	76. <i>Zollingeriana</i> .
Male flowers closely packed, touching or almost touching (unknown in <i>D. Listeri</i>).	
Hairs enwrapping the male flowers.	
Capsule wings 22 by 14 mm.	77. <i>anguina</i> .
Capsule wings 36 by 30 mm.	
Pubescence rather restricted; large bulbils produced	78. <i>Listeri</i>
Pubescence general	79. <i>polyclades</i> .
Hairs not enwrapping the male flowers.	

- Leaves thin, hair white.
- Leaf rather elongated, drying red-brown; first pair of lateral veins rather near the margin 80. *trinervia*.
- Leaf rather shorter, not drying red-brown; first pair of lateral veins more remote from the margin .. 67. *oppositifolia*.
- Leaves rather thick; hairs brown .. 81. *pyrifolia*.
- Pubescence absent, but a very few hairs present at the base of the male inflorescence.
- Leaves hastate, the uppermost losing the auricles 82. *Loheri*.
- Leaves sagittate.
- Leaves moderately firm .. 83. *Soror*.
- Leaves tender 84. *Foxworthyi*.
- Leaves ovate or ovate-cordate.
- Leaves very thin; stems with fine prickles below 85. *Seemannii*.
- Leaves firm.
- First lateral nerves in the first part of their course rather close to the midrib 86. *nummularia*
- First lateral nerves in the first part of their course more remote from the midrib; leaves rather narrower than in *D. nummularia* .. 81. *pyrifolia*.
- Leaves firm, with, when dry, the network standing out on the lower surface 87. *Merrillii*.
- Pubescence absent entirely.
- Leaves linear-lanceolate: ♂ bud rose-coloured 88. *grata*.
- Leaves broader.
- Base of leaf commonly obtuse or rounded only in the very largest, cordate in *D. Wattii*.
- Plant wide climbing, with large leaves and large capsules .. 89. *Wattii*.
- Plant of lesser dimensions with smaller capsules; leaves ovate .. 67. *oppositifolia*.
- Plant very slender; leaves obtuse .. 68. *obcuneata*.
- Base of leaf cordate or hastate or subsagittate.
- Leaves 5 times as long as broad .. 90. *gibbiflora*.
- Leaves only about twice or thrice as long as broad.
- Leaves hastate; flowers closely packed.
- Network not conspicuous .. 91. *Fordii*.
- Network conspicuous below.
- Leaves rarely more than twice as long as broad .. 92. *belophylla*.
- Leaves three times as long as broad; buds more elongated than in *D. belophylla* .. 93. *belophylloides*.
- Leaves cordate or ovate-cordate.
- Veins in the exactly cordate leaves very inconspicuous .. 94. *Lepcharum*.

- Veins not inconspicuous: the first lateral pair of nerves rather close to the midrib; leaves thin curling up on the midrib in drying .. 95. *glabra*.
- Veins not inconspicuous; the first lateral pair of nerves remote from the midrib .. 96. *vexans*.
- Flowers of the male plant on axes which become zig zag either in life or when dry.
- Stems rough with numerous warts; petiole short .. 97. *brevipetiolata*.
- Stems not rough; petioles of moderate length.
- Buds large; leaves ovate-elliptic .. 98. *Benthamii*.
- Buds small; leaves cordate.
- Leaves with the basal sinus rounded as if bitten out; axes of the spikes very thin; buds often elongated .. 99. *myriantha*.
- Leaves with the basal sinus more or less acute.
- Stems hardly winged, reddish when dry; root deeply penetrating.
- Network rather distinct on the under surface of the leaf: capsules equaling those of *D. alata* .. 100. *persimilis*.
- Network not so distinct on the under surface of the leaf: capsules larger than those of *D. alata* .. 101. *Hamiltonii*.
- Stems winged; rarely the wings much reduced but then the root not deeply penetrating .. 102. *alata*.
- Spikes with a very pronounced negative geotropism.
- Buds rather small.
- Leaves thin but the network becoming just prominent below when they are dry .. 103. *laurifolia*.
- Leaves subcoriaceous.
- Leaves not much longer than broad: network distinct .. 104. *Havilandii*.
- Leaves more elongated; spikes long .. 105. *Waburgiana*.
- Buds larger, leaves thin .. 106. *deflexa*.

Section 8. STENOCOREA. Tubers unknown. Stem twining to the right. Leaves simple. Male flowers in racemes. Perianth tubular, opening wide: stamens 6, inserted in the upper part of the tube, constructed like the stamens of *Stenomeres* i.e. swollen below and horned at the back. Female flowers also tubular. Seeds unknown, but 2 ovules present in each locus.

- Only species 107. *stenomeriflora*.

PART 2.

ENUMERATION WITH DIAGNOSES.

Section 1.—BORDEREA.

1. *D. PYRENAICA*, Bubani et Bordère ex Grenier, in Bull. Soc. Bot. France, xiii. (1866), p. 380. *Borderea pyrenaica*,

Miégeville, loc. cit., p. 374. Central and Eastern Pyrenees. A relic of the Tertiary Flora of Europe, very local and very interesting on account of its wingless seeds. The structure of the tubers deserves investigation.

Section 2.—STENOPHORA.

2. *D. FLABELLIFOLIA*, Prain et Burkill, in Elmer, Leaflets of Philippine Botany, v. (1913), p. 1593. Luzon in the latitude of Manila. There is considerable doubt in regard to the position of this species, of which the capsules and underground parts are unknown. It has been obtained by three collectors in the Island of Luzon, Philippines (*Elmer*, 9095! *Loher*, 6907! 7027! *McGregor*, 14381!)

3. *D. DAUNAEA*, Prain et Burkill, in Journ. Asiatic Soc. Bengal, iv. (1908), p. 450. Dawna Hills of Tenasserim. The female plant is at present unknown.

4. *D. CAMBODIANA*. This is the third plant of the section *Stenophora* of which the male only is known. It was collected by the late M. Pierre in Cambodia, and is described here.

DIOSCOREA CAMBODIANA. *Tuber* ignotum. *Planta* omnino glabra. *Caules* superiores siccitate flavi, leviter striati, sinistrorsim volubiles. *Folia* alterna, ovato-deltaidea, abrupte et breviter acuminata, tenuissima, ad 5 cm. longa, 5 cm. lata, 7-nervia: area media a nervorum lateralium primo pare terminata late oblanceolata: nervi extimi bifidi: venæ secundariæ inter venulas indistinctæ: petiolus ad 5 cm. longus. *Flores* maris singuli in racemum spiciformem dispositi: axis tenuissimus, triangularis: pedicelli 1.5 mm. longi: bractea late lanceolata, acuminato-acutæ, subscariosæ: bracteolæ similes, minores. *Perianthii* maris lobi biseriati, ovati, obtusissimi, apice rotundati, 1-nervii, floribus expansis paullulo recurvati: tubus crateriformis, externe costatus, 1 mm. longus. *Stamina* 6, in marginem tubi inserta: filamenta .25 mm. longa, antheribus æquilonga. *Planta* fœminea ignota.

CAMBODIA.—In Monte Kereer: *Pierre*, 6673! Typus in herbario Horti Botanici ad Lutetias Parisiorum conservatur.

5. *D. RIDLEYI*. Sarawak in Borneo. As the male plant is unknown its position is somewhat doubtful: but we expect that it will be found to have the saucer-shaped perianth of the *Stenophoras*, and that the male flowers are single to each bract as in *D. daunæa* and *D. cambodiana*. It is interesting to observe that this is characteristic of the southernmost species of the section.

DIOSCOREA RIDLEYI. *Rhizoma* ignotum. *Caules* tenues, inermes, teretes. *Folia* alterna, ovata, acuminata, basi tantum cordata, glabra, ad 10 cm. longa, ad 4.5 cm. lata, 5-nervia: area media a nervorum lateralium pare primo terminata elliptica: venæ secundariæ inter se fenestratæ nec trajectæ: petiolus ad 3 cm. longus, glaber, angulatus. *Capsulæ* irregulariter reflexæ, vix imbricatæ, basi ad 8 mm. longa

inclusa ad 30 mm. longæ, supra truncatæ: alæ obliquæ 20—22 mm. longæ, 17—18 mm. latæ. *Semina* pallida membrana circumcirca alata.

BORNEO.—In principatu Sarawak ad Bau, *Ridley*, 11710! sine loco, mercenarius *Merrillii*, 1278! Typi conservantur in Herbariis Horti Botanici ad Singapur et Scientiæ Conservatorii ad Manilam.

6. *D. BIRMANICA*, Prain et Burkill, in Journ. Asiatic Soc. Bengal, lxxiii. (1904), p. 185. Common in the forest-clad parts of Burma, except the Arakan coast, and extending thence into Yunnan and Northern Siam.

7. *D. SP.*, Prain et Burkill, in Journ. Asiatic Soc. Bengal, lxxiii. (1904), p. 186: *Ridley*, Mat. Flor. Malay Penins., ii. (1907), p. 84. "Tuba ubi," *Ridley*, in Agric. Bull. Straits Settlements and F. M. States, 1908, p. 444. Perak in the Malay Peninsula.

8. *D. MEMBRANACEA*, Pierre MS. A very marked species occurring in three isolated localities in Burma, Northern Siam and near the Gulf of Siam.

DIOSCOREA MEMBRANACEA. *Rhizoma* horizontale, externe atro-castaneum. *Caules* siccitate flavescentes, longitudinaliter striati, ad bases foliorum nonnullorum inferiorum bispinosi, supra inermes, glabri. *Folia* alterna, ex basi cordata trifida, ad 26 cm. longa et 21 cm. lata, glabra, 9 nervia, nervis tribus in apicem lobi medii incurventibus et aream internerviæ elliptico-ovatae includentibus, nervorum paribus secundis et tertiis in apices loborum lateralium incurventibus; nervorum pari quarto tenue et in fornice effoeto: venæ secundariæ aliquomodo irregulares, supra subdistinctæ, infra distinctissimæ; petiolus canaliculatus, ad 18 cm. longus. *Flores maris* singuli vel bini in racemos spiciformes dispositi (si bini sint junior in pedicello vetustioris insidens): pedicelli 5 mm. longi: bracteæ singulæ vel binæ, glabræ, tenuissimæ, basalis ovato-acuminata, superior minor obtusior: bracteolæ minimæ. *Perianthi maris* laciniæ 1 mm. longæ, subligulatæ, obtusæ: tubus campanulatus, glaber, 1 mm. longus, intra quinque-costatus ob filamentis adnatis. *Stamina* 6: filamenta in marginem tubi inserta, 3 mm. longa. *Flores feminei* in spicas dependentes ad 20 cm. longas dispositi: bracteæ ovatæ, acutæ, tenuissimæ, 1.5 mm. longæ; bracteolæ similes, minores. *Sepala* obovata, obtusa, carinata, glabra, 1 mm. longa et ultra. *Petala* lanceolato-acuta, sepalis breviora. *Staminodia* minuta. *Capsulæ* reflexæ, ad 18 mm. longæ, apice subtruncatæ: alæ paullulo latiores quam semicirculares, 12 mm. latæ.

BURMA ET SIAM ET INDO-CHINA.—Ad Gangaw in districtu Pakokku Burmæ superioris, *Millar* in Mus. R. E. P., 20632! 20633! 20634! In monte Dinh præfecturæ cambodianæ Baria, *Pierre*, 7017! Ad Vatou in litore maris Siamensis, *Pierre*, 7018, 205! Prope Chengmai ad Meh-hia, *Kerr*, 1951! et in monte Doi Sutep, ad 1200 ped. alt., *Kerr*, 1245! Typi Pierreani in Herbario Horti Botanici ad Lutetias Parisiorum conservantur: exempla omnia masculina. Flores feminei in herbario Kewensi conservantur ex collectione Kerriana. Radix nobis nota est ex exemplis vivis ad Hortum Botanicum Calcuttensem a Millar benevolenter missis.

9. *D. NIPPONICA*, Makino, Illustr. Flor. Jap. 1. (1891) t. 45. *D. acerifolia*, Uline ex Diels, in Engl. Bot. Jahrb., xxix. (1900), p. 261: Prain et Burkill, in Journ. Asiatic Soc.

Bengal, lxxiii. (1904), suppl. p. 7. *D. quinqueloba*, Maximowicz, Fl. Pekin in Primit. Flor. Amur. (1859), p. 478. A widespread species occurring from Kwei-chow and Hupeh in Central China northwards into Russian territory on the Amur river and found in Corea and Japan as far north as 40°N.

Following Maximowicz this species is almost invariably called *D. quinqueloba* by Russian botanists.

Variat:—

Var. VERA. *Folia* infra setulosa, supra glabrescentia. *Perianthii tubus* floris masculini vix 1 mm. longus, sed ob pedicello ad basin tubi ampliato longior esse videtur.

Var. ROSTHORNII. *Folia* infra admodum setulosa, supra etiam subsetulosa, cinerascens. *Perianthii tubus* floris masculini ei varietatis veræ similis

Var. JAMESII. *Folia* subglabra *Perianthii tubus* quam tubus varietatum præcedentium paullulo brevior: lobi apice rotundati.

Varietas VERA reperitur in provinciis sinensibus Szechuan, (*Farges*, 227!), Hupeh (*Henry*, 105! 4769! 5870! 5870B! 7358!), Pechili (*David*, 961!), et in Corea (*Faurie*, 675! 859! *Mills*, 293!), et in Mongolia (*Komarov*!), et in Japonia (*Makino*! *Faurie*, 2373!). Varietas ROSTHORNII reperitur in provinciis sinensibus Shensi (*Giraldi*!), et Kwei-chow (*Rosthorn*, 2127), et Pechili (*David*, 14560!), etiamque in Corea (*Mills*!), in Manchuria (*James*! *Maack*! *Maximowicz*! *Komarov*! *Karo*!). Varietas JAMESII reperitur in Manchuria inter Mukden et Kirin (*James*!). Secunda a cel. Diels sub nomine *Dioscoreæ acerifoliæ* var. *Rosthornii* descripta est.

10. *D. SEPTEMLOBA*, Thunb., Flor. Jap., (1784), p. 149: Makino, Ill. Flor. Jap., i (1889), p. 27: Prain et Burkill, in Journ. Asiatic Soc. Bengal, lxxiii. (1904), suppl. p. 8. *D. quinqueloba*, Miq., Prolusio Flor. Jap., (1865), p. 150, in part: Franchet et Savatier, Enum. Flor. Jap., ii. (1879), p. 46. Japan as far north as Lat. 37°N:

11. *D. QUINQUELOBA*, Thunb., Flor. Jap., (1784), p. 150: Kaempfer, Ic. Sel., (1791), t. 15: Makino, Ill. Flor. Jap., i. (1889), t. 26: Prain et Burkill, in Journ. Asiatic Soc. Bengal, lxxiii. (1904), suppl. p. 9. Corea, and Japan as far north as Lat. 37°N.

12. *D. TOKORO*, Makino, in Tokyo Bot. Mag., iii. (1889), p. 112 and Ill. Flor. Jap., (1889) t. 24. *D. sativa*, Miq., Prolusio Flor. Jap., (1865), p. 323, in part: Franchet et Savatier, Enum. Pl. Jap., ii. (1879), p. 47, in part. *D. Yokusai*, Prain et Burkill, in Journ. Asiatic Soc. Bengal, lxxiii. (1904), suppl. p. 10. Japan as far north as Lat. 41°30' N., on Quelpart, off the coast of Corea, and in Northern Formosa. This species is very closely allied to *D. tenuipes*.

13. *D. TENUIPES*, Franchet et Savatier, Enum. Flor. Jap., ii (1879), pp. 48, 525: Maximowicz, in Engl. Bot. Jahrb.,

vi. (1885) p. 52: Makino, Ill. Flor. Jap., i. (1889), t. 6: Prain et Burkill, in Journ. Asiatic Soc. Bengal, lxxiii. (1904), suppl. p. 9. Japan as far north as Lat. 38° N.

14. *D. ENNEANEURA*, Prain et Burkill, in Journ. Asiatic Soc. Bengal, lxxiii. (1904), suppl. p. 11. *D. Buergeri*, var. *enneaneura*, Uline ex Diels, in Engl. Bot. Jahrb., xxix. (1900), p. 260. Central China, in the Province of Hupeh.

15. *D. TENTACULIGERA*. A very curious plant of the Shan Hills, with minute crowded flowers.

DIOSCOREA TENTACULIGERA. *Radix* ignota. *Caules* teretiusculi, inermes, glabri, castanei, sinistrorsim volubiles. *Folia* alterna, ovato-cordata, tenuia, omnino glabra acuminata vel acuta, apice mucronulata, ad 7 cm. longa, ad 5 cm. lata 7-nervia; area media in parte primo nervorum lateralium terminata ovata; nervi extremi bifidi; venae secundariae paucae, irregulares, supra indistinctae; petiolus glaber, supra canaliculatus, ad 3.5 mm. longus. *Flores* masculinae 3-6 in cymas breves densas dispositi, albidi; cymae in axin singularem minutissime papillatam 20 cm. longam subsparse; bractea ovatae, subacuminatae, incurvae, scariosae, glabrae, 5 mm. longae. *Perianthii* masculini lacinae aequales, apice incurvae; tubus 35 mm. profundus. *Stamina* 6, ad basin tubi inserta; filamenta tubo aequilonga; antherae parvae, introsciae. *Flores* femineae 8-16 in spicis pendulis ad 6 cm. longis; bractea late lanceolatae, acuminatae, 5 mm. longae. *Perianthii* feminei lobi biseriati, ovati, apice incurvi, exteriores paululo majores; tubus perbrevis. *Staminodia* minuta. *Capsulae* recurvae, ad 16 mm. longae, vel paululo longiores, apice subretusae, pallide castaneae; ala semi-ellipticae. *Semina* circumcirca alata.

MONTES SHANNORUM.—Prope Maymyo ad 3500 ped. alt., Lace, 4102! ad Laikaw et Inde in principatu Yaunghwe, Abdul Khalil! Typi in Herbariis Hortorum Regalium ad Kew et Calcuttam conservantur.

16. *D. VILLOSA*, Linn., Spec. Plant., (1753), p. 1033. Jacquin, Ic. Plant. Rar., (1793), t. 626. *D. sp.*, C. H. Wright, in Journ. Linn. Soc. Bot., xxxv. (1903), p. 94: Nakai, in Journ. Coll. Sci. Tokyo, xxxi. (1911), p. 235.

Variat:—

Var. *VERA*. *Capsula* maculata.

Var. *COREANA*. *Capsula* immaculata, laete polita.

Varietas *VERA* americana est. Varietas *COREANA* in Corea media adhuc reperta est a Carles (sub numero 78!) et Faurie (sub numero 697!) et Uchiyama. Radix ejus ignota manet, quod dolendum est quandoquidem rhizoma *D. villosae* verae ab rhizomatibus specierum asiaticarum longe distat.

17. *D. PRAZERI*, Prain et Burkill, in Journ. Asiatic Soc. Bengal, lxxiii. (1904), suppl. p. 2. Northern Burma and the northern part of the Shan States. A species very nearly allied to *D. sikkimensis*.

18. *D. CLARKEI*. As the male is unknown, there is some slight doubt regarding the exact affinity of this species: it

may be a variety only of *D. Prazeri* or *D. sikkimensis*, differing in the shape of the capsules.

D. CLARKEI. *Radix* nobis ignota. *Caules* glabri, angulati, sinistrorsim volubiles. *Folia* opposita, glabra, cordata vel longe cordata, tenuiter acuminata, nec margine sinuosa, lobis basalibus subangulatis, ad 8 cm. longa, ad 6 cm. lata, 7-nervia: area media a parte primo nervorum lateralium terminata lanceolata acuminata; nervi extimi bifidi: venæ secundariæ reti venicularum paululo magis conspicuæ: petiolus ad 7 cm. longus, supra canaliculatus, dorso et lateribus angulatus. *Flores* ignoti. *Capsulæ* respicientes, 20 mm. longæ, apice retusæ, fuscæ, castaneo aspersæ: alæ semi-obcordatæ, 12 mm. latæ. *Semina* loculis conformia, circumcirca alata.

MONTES NAGARUM.—Kohima ad 5500 ped. alt., *C. B. Clarke*, 41018! Typus in herbario apud Calcuttam conservatur.

19. *D. SIKKIMENSIS.* Prain et Burkill, in *Journ. Asiatic Soc. Bengal*, lxxiii. (1904), suppl. p. 3. The Himalaya from the longitude of Khatmandu to Western Bhutan, and from the plains to 5000 ft.; it has occurred also in the districts of Champaran and Malda, but perhaps only as a casual, the root having been carried down some river and lodged on the river bank.

20. *D. DELTOIDEA*, Wall., *Cat. Lith.*, (1832), no. 5100: Kunth, *Enum.*, v. (1850), p. 340, in chief part: Stewart, in *Journ. Agri-Hort. Soc. India*, xiv. (1867), p. 37: Hook. f., *Flor. Brit. India*, vi. (1892), p. 291, in chief part: Prain et Burkill, in *Journ. Asiatic Soc. Bengal*, lxxiii. (1904), suppl. p. 5. *D. nepalensis*, Sweet, *Hort. Brit.*, 2nd ed. (1830) p. 522. *Tamnus nepalensis*, Jacquemont MS. The Himalaya eastward from the longitude of Khatmandu to the Afghan border, from 3000 to 8000 ft., and sometimes to 10,000 ft.: also occurring near Cherrapunji in the Khasia Hills, and on the Yunnan-Burma boundary.

21. *D. CAUCASICA*, Lipsky, in *Bull. Soc. Nat. Kieff*, 1893, p. 143: Alboff, in *Acta Hort. Petrop.*, xii. (1893), p. 439: Radde, *Sammlungen des Kaukasischen Museums*, ii. (1901), p. 166. The coast of the Black Sea in the lower Caucasus, where the annual rainfall is about 60 to 80 inches. The species differs very little from *D. deltoidea*.

22. *D. PANTHAICA*, Prain et Burkill, in *Journ. Asiatic Soc. Bengal*, lxxiii. (1904), suppl. p. 6. The Province of Yunnan in south-western China at 7000—9000 ft.

23. *D. OENEA*. The flowers of this species are unknown, but it undoubtedly has a close relationship to *D. zingiberensis*.

D. OENEA. *Tuber*, teste Farges, magnum et ligneum. *Caulis* glaber, colore cupreo-purpureus, striatus, sinistrorsim volubilis. *Folia* alterna,

late cordata, margine leviter sinuata, breviter acuminata, supra glabra, infra pilis rigidis parvis in nervis prominentibus induta, ad 7 cm. longa, ad 6 cm. lata, 7-nervia: area media a parte primo nervorum lateralium terminata oblanceolato obovata: venae secundariae in rete anastomosantes nec trajectae: petiolus folii laminae aequilongus. *Flores maris* ignoti. *Flores feminei* in spicas breves dependentes 5 cm. longas compositi: axes fusco-purpurei, angulati, pilis minutis induti: bractea fusco-rufae, ovato-lanceolatae, acutae, 1 mm. longae: bracteolae similes, minores. *Sepala* ovata, supra rotundata, tenuiora, 5 mm. longa. *Petala* breviora, basi angustata. *Staminodia* perminuta. *Capsulae* reflexae, cupreo-purpureae, apice rotundatae, infra in pedicellam angustatae: alae 14 mm. latae, margine plus minusve irregulares.

CHINA OCCIDENTALIS.—Ad Tchen-keou-tin in provincia Szechuan, alt. 1400 ped., *Farges*, 90! Typus in herbario Horti botanici ad Lutetias Parisiorum conservatur.

24. *D. ZINGIBERENSIS*, C. H. Wright, in Journ. Linn. Soc. Bot., xxxvi. (1903), p. 93. *D. Henryi*, Uline ex Diels, in Engl. Bot. Jahrb., xxix. (1900), p. 261. name only. The Provinces of Hupeh in central China and Yunnan in south-western China. A very well marked species.

25. *D. COLLETTII*, Hook. f., Flor. Brit. Ind., vi. (1892), p. 290. *D. sp.*, Collett et Hemsley, in Journ. Linn. Soc. Bot., xxviii. (1890), p. 137. Shan States and in China in the Provinces of Yunnan, Szechuan and Kweichow, apparently abundant.

26. *D. MORSEI*, Prain et Burkill, in Journ. Asiatic Soc. Bengal, iv. (1908), p. 454. Central China in the Province of Kiang-si. A plant as yet only found at the eastern end of the central mountain complex of China, but allied to the next.

27. *D. HYPOGLAUCA*, Palibin, in Bull. Herb. Boiss., ser. 2, vi. (1906), p. 21. Central China in the province of Fokien. This species and the preceding are certainly very closely allied.

28. *D. GRACILLIMA*, Miq., Prolusio Flor. Jap., (1865), p. 324: Franchet et Savatier, Enum. Flor. Jap., ii. (1879), p. 49: Makino, Ill. Flor. Jap., i. (1889), t. 25. Central Japan.

Section 3. SHANNICOREA.

29. *D. YUNNANENSIS*, Prain et Burkill, in Journ. Asiatic Soc. Bengal, lxxiii (1904), p. 186. The Chinese Provinces of Yunnan and Kweichow.

30. *D. HEMSLEYI*, Prain et Burkill, in Journ. Asiatic Soc. Bengal, iv. (1908), p. 451. *D. praecox*, Prain et Burkill,

loc. cit. p. 455. Shan Plateau and the Chinese Provinces of Yunnan and Kweichow.

31. *D. SUBCALVA.* Plentiful in Yunnan.

D. SUBCALVA. *Tuber* in terram descendens, longum, rufo-fuscum. *Caules* inermes, glabri, striati, alterni, sinistrorsim volubiles. *Folia* glabra, latissime cordata, abrupte cuneatim acuminata, ad 4 cm. longa, ad 6 cm. lata, 9-nervia: area media a pare primo nervorum lateralium terminata obovata, nervis extimis bifidis: venæ secundariæ subrectæ: petiolus ad 1 cm. longus, supra canaliculatus. *Flores maris* 1-7, in racemos breves secundarios unilateraliter congregati: racemi ipsi sparsim in axin tenuem angulatum ad 12 cm. longum admodum parce hirsutum dispositi: bracteæ ovatae, acutæ, 1 mm. longæ, glabræ, fulvæ atque rubro-maculatæ. *Perianthii maris* lobi ovati, ligulati, apice rotundati, 1.75 mm. longi, .5 mm. lati, flore aperto excurvati, rubro-maculati: tubus perbrevis. *Stamina* ad perianthii lobos basin supra affixa, lobis breviora. *Flores fæminei* singuli vel bini in spicis 9 cm. longis in axin angulatum glabrescentem positi: bracteæ lanceolatae, 2 mm. longæ. *Sepala* anguste ovata, obtusiuscula, 1.5 mm. longa, atro-rubra in siccitate. *Petala* similia, obtusiora. *Staminodia* minuta. *Capsulæ* respicientes, 25 mm. longæ, infra obtusæ, supra truncatæ et mucronatæ: alæ subrectangulares, 23 mm. longæ, 6 mm. latæ.

CHINA AUSTRALIS. In Provincia Yunnan ad Yunnan-fu (*Ducloux*, 107! 318!), in montibus supra Ta-pin-tze (*Delavay*, 374! 1826!), La-ko-chan prope Ta-pin-tze, (*Delavay*, 2834!), Pee-tsao-chan, (*Delavay*, 6654!), Kiao-che-tong prope fauces Hee chan-men (*Delavay*, 3853!). Sine locis (*Bons d'Anty*! *Wilson*, 4552!) Typi præcipue in Herbario Horti botanici ad Lutetias Parisiorum conservantur; at nonnulli in Herbario Kewensi conservantur.

32. *D. NITENS.* A species of Yunnan.

D. NITENS. *Radix* ignota. *Caules* juniores sparsissime hirsuti, vetustiores glabrescentes politi, leviter striati, sinistrorsim volubiles. *Folia* longe-cordata, acuminata, infra in nervis primariis perparce hirsuta, ad 10 cm. longa, ad 7 cm. lata, 7-nervia: area media a nervorum lateralium pare primo terminata lanceolata: nervi extremi bifidi: venæ secundariæ rectæ vel subrectæ, paucæ, supra indistinctæ: petiolus 35 cm. longus, glaber vel sparsissime hirsutus, supra canaliculatus, infra carinatus. *Flores maris* in racemos breves secundarios unilaterales 4 mm. longos aggregati: racemi ipsi parce in axes singulos vel binos vel ternos nunc simplices nunc compositos sparsim hirsutos dispositi: bracteæ ovatae, breviter acuminatae, glabræ vel fere glabræ, 1 mm. longæ. *Perianthii maris* lobi biseriati anguste ovati, subacuti, 1.5 mm. longi, 25 mm. lati, uninervii, sparsim rubro-punctati, exteriores interioribus paululo longiores: tubus .25 mm. longus. *Stamina* 6; filamenta ad perianthii lobos supra basin adnata. *Flores fæminei* in spicis elongatis, (capsulis maturis) ad 20 cm. longis. *Perianthii fæminei* lobi sparsim hirsuti, biseriati, exteriores late lanceolati acuti 1.5 mm. longi, interiores latiores rotundati. *Staminodia* minuta. *Capsulæ* respicientes, imbricantes, glabræ, glaucæ, apice retusæ, ad 25 mm. longæ; alæ fere subrectangulares, ad 22 mm. longæ et 7 mm. latæ. *Semina* (immatura solum visa) admodum inæqualiter alata.

CHINA AUSTRALIS.—In Provincia Yunnan, ad Yunnanfu (*Ducloux*, 784!), Mengtze ad 5000 ped. alt., (*Henry*, 10287 B!), Szemao, 4000—4500 ped. alt. (*Henry*, 12338! 12338B!). Sine loco, (*Bons d'Anty*, 430!). Typi præcipue in Herbario Kewensi conservantur.

33. *D. MARTINI.* A species of Yunnan and Kweichow.

D. MARTINI. *Radix ignota.* *Caules* sparsim pilis tortis albis tecti, longitudinaliter lineati, sinistrorsim volubiles. *Folia* cordata, acuminata, supra glabra, infra subaraneosa, ad 12 cm. longa, ad 6 cm. lata, 9-nervia: area media a parte primo nervorum lateralium terminata late ovata vel late obovata: nervi extremi bifidi: venæ secundariæ rectæ, paucae, supra distinctæ: petiolus ad 12 cm. longus, supra canaliculatus, sparsim hirsutus. *Flores maris* 1—4-ni in racemos breves 5 mm. longos aggregati: racemi ipsi in axin subaraneosum ad 18 cm. longum dispositi: bracteæ lineari-lanceolatae, acutæ, subaraneosæ, 2.5 mm. longæ. *Perianthii maris* lobi æquales, anguste ovati, rubro-maculati: tubus brevis, externe araneosus. *Stamina* 6, perianthii lobos vix æquantia: filamenta tenuia, paululo supra bases loborum inserta. *Flores feminei* ignoti. *Capsulae* respicientes, imbricantes, in spicas sparse araneosas ad 20 cm. longas dispositæ, basi supra pedicellam truncatæ, apice rotundæ: alæ sub-rectangulares, ad 28 mm. longæ, 8 mm. latæ, rubro-maculatæ. *Semina* inæqualiter alata: ala vix 1 mm. lata in latere angustiori, 20 mm. lata in latere latiori.

CHINA AUSTRALIS.—In Provinciis Kwei-chow et Yunnan, prope Tsin-tchen in silvis (*Martin et Bodinier*, 1865!), prope Gan-pin in silvis (*Martin et Bodinier*, 2517!), supra Ta-pin-tze (*Delavay*, 4524!). Typi in herbario Horti Botanici ad Lutetias Parisiorum conservantur.

34. D. VELUTIPES. A species of the Southern Shan States.

D. VELUTIPES. *Radix ignota.* *Caules* juniores pilis fuscis tortis vestiti, vetustiores glabrescentes, subconspicue lineati, siccitate castanei, sinistrorsim volubiles. *Folia* elongato-deltoideo-cordata, acuminata, juniora supra dense albo-pubescentia, vetustiora glabrescentia, infra juniora dense fulvo-pubescentia deinde sparsim pubescentia, ad 9 cm. longa, ad 5 cm. lata. 7-nervia: area media a nervorum lateralium parte primo terminata late lanceolata: venæ secundariæ rectæ, trajectæ, inconspicuæ. *Flores maris* 1—3-ni in racemos breves dispositi, ipsos in inflorescentiam spiciformem compositos: axis ad 16 cm. longus, angulatus, pilis albis tectus; bracteæ anguste ovato-acuminatæ, 1.5 mm. longæ. *Perianthium maris* crateriforme: lobi externi ad 3 mm. longi, albo-pubescentes: lobi interni obtusiores, paululo latiores. *Stamina* in lobos insidentia: filamenta 1 mm. longa: antheræ parvæ, introrsæ. *Flores feminei* in spicas dependentes ad 14 cm. longas dispositi: axis dense fulvo-pubescentis: bracteæ ovatæ, fulvo-pubescentes, 1.75 mm. longæ. *Sepala* triangulari-ovata, exteriora quam interiora paululo majora, 7.5 mm. longa, extus dense pubescentia. *Staminodia* minuta. *Capsulae* ignotæ.

MONTES SHANNORUM, versus austrum, loco non indicato. (*Macgregor*, 732! 738!) Typi in Herbario Horti Botanici regalis ad Calcuttam conservantur.

Section 4. COMBILIUM.

35. D. ACULEATA, Linn., *Amoen. Acad.*, iv. (1754), p. 131: and *Syst. Nat.*, ed. 13, ii. (1791) p. 582: Lam., *Encyc. Meth.*, iii. (1789), p. 232, in chief part: Willd., *Sp. Plant.*, iv. (1805), p. 792, in part: Graham, *Cat. Plants Bombay*, (1839), p. 218: Kunth, *Enum.*, v. (1850), p. 398, in part. *D. Combilium*, Ham. ex Wall., *Cat. Lith.*, (1832), No. 5103A. *D. diacantha*, Zippelius ex Spanoghe, in *Linnaea*, xx. (1841), p. 479. *D. echinata*, Ham. ex Wall., *Cat. Lith.*, (1832), No. 5103E. *D. fasciculata*, Roxb., *Hort. Beng.*, (1814), p. 72, name only, and *Flor. Ind.*, iii. (1832), p. 801: Kunth, *Enum.*, v. (1850),

p. 399: Hook. f., *Flor. Brit. Ind.*, vi. (1892), p. 296. *D. papuana*, Warb., in *Engl. Bot. Jahrb.*, xiii. (1891), p. 273. *D. sativa*, Linn., *Sp. Plant.*, (1753) p. 1033, in small part: Lam., *Ill.*, (1793), t. 818. *D. spinosa*, Roxb. ex Wall., *Cat. Lith.*, (1832), Nos. 5103A, 5103D, 5103E: C. H. Wright, in *Journ. Linn. Soc. Bot.*, xxxvi. (1903), p. 91: Safford, in *Contrib. U. S. Nat. Herb.*, ix. (1905), p. 68. *D. tiliaefolia*, Kunth, *Enum.*, v. (1850), p. 401. *D. tredecimnervis*, Pierre, in *Herb. propr. D. Tugui*, Blanco, *Flor. Filip.* (1839), p. 800. *Oncus esculentus*, Lour., *Flor. Cochinch.*, (1790), p. 194.

Variat:—

Var. **TILLÆFOLIA**. *Folia* magna. 13-nervia, pubescentia. *Flores* maris copiose producti. *Tubera* clavata, radiculosa, infra spinas horridas producta.

Var. **SPINOSA**. *Folia* paululo minora, plus minusve pubescentia. *Flores* raro producti. *Tubera* infra spinas producta.

Var. **FASCICULATA**. *Folia* minora, subglabra. *Flores* omnino desunt. *Tubera* ellipsoidea, congregata, espinosa.

Varietas **TILLÆFOLIA** est planta inculta insularum philippinensium et regionis istius. *Flores* maris copiose producti, et certe herbaria a nobis visa specimina plura praebent. Varietas **SPINOSA** culta est et inculta. Inter sylvas birmanicas agricolae varietatam hanc varietati **FASCICULATÆ** anteponunt propterea spinas feroces apri effodere non possunt. Varietas **FASCICULATA** colitur in India et in Java et in insulis aliis Malaicis.

Linnaeus in 1753 applied the name "aculeata" to a drawing in Rheede's *Hortus Malabaricus* which is too confused to serve as a substitute for a definition. He employed the name more satisfactorily in 1754: and we apply it as used in that year. This usage is that adopted by many French botanists and by the botanists who worked on the Western Coast of India.

Section 5. LASIOHPYTON.

36. **D. KERRII**. Northern Siam near Chengmai. A smaller plant than the allied *D. tomentosa*.

D. KERRII. *Tubera*, ut videtur, terram alte penetrantia. *Caulis* basi roseo-tinctus, inermis, parce pilis fulvis hirsutus. *Folia* alterna, cordata vel ovato-cordata, tenuia, acuminatuscula, ad 7.5 cm. longa, ad 4.5 cm. lata, 5-nervia, nervorum lateralium pare primo in parte superiori supra medium terminato, margine ciliata, supra fere glabra, infra pilis sparsis fuscis subpubescentia: petiolus fere hispidus, ad 3 cm. longus. *Flores* maris sessiles in spicas cylindricas ad 2 cm. longas singulas vel binas ad axillas foliorum dispositi: axis pubescens, angulatus: bractea ovata, acuminata, tenues, margine subhyalinae, glabrae: bracteolae similes, nisi minores et pro rata latiores. *Sepala* late ovata, obtusa, glabra, viridi-lutescentia, 1.5 mm. longa. *Petala* anguste elliptica, subobtusa, quam sepala paululo breviora, colore similia. *Stamina* 3, sepalis opposita, brevia: anthera tria ovata: staminodia 3 paululo longiora. *Flores* foeminei ignoti.

SIAM.—D. i Sutep prope Chengmai ad 1400 ped. alt. (*Kerr*, 1404!). Typus in herbario horti botanici Kewensis conservatur.

37. *D. TOMENTOSA*, Koenig ex Roxb., Hort. Beng., (1814), p. 105, name only: Heyne in Roth, Nov. Plant. Sp., (1821), p. 371: Hook. f., Flor. Brit. Ind., vi. (1892), p. 289. *D. triphylla*, Russ. ex Wall., Cat. Lith., (1832) No. 5101D. *D. nullica*, Ham. MS. *Helmia?* *tomentosa*, Kunth, Enum., v. (1850), p. 439. India south of the Gangetic Plain, and in Ceylon in damper parts.

38. *D. ARACHIDNA*. A small obscure species of the dense forests of Assam, north of the Cachar Hills. Its tubers are arranged somewhat like those of *D. aculeata*, but it is otherwise closely allied to *D. pentaphylla* and *D. melanophyma*.

D. ARACHIDNA. *Tubera* plura, ellipsoidea, lævia, carne alba tenera, ad 5 cm. longa, stolones oblique descendentes 5—20 cm. longas terminantia. *Caules* glabri, inermes, tenues, sinistrorsim volubiles. *Folia* alterna, ternata: foliola media elliptica, versus apicem basinque angustata, apice breviter acuminata, glabra, ad 7 cm. longa, ad 4 cm. lata, penninervia: foliola lateralia inæqualia, medio fere æquilonga, ad 4 cm. lata: petiolus ad 3.5 cm. longus: petioluli ad 5 mm. longi. *Flores* ignoti.

ASSAM. In sylvis districtu Nowgong prope Lumding (*Burkill!* *Kalka Pershad*, 35581!) *Tubera* edibilia cibo a Mikiris vulgo effodiuntur. Typi in herbariis ad Kew et Calcuttam conservantur.

39. *D. MELANOPHYMA*, Prain et Burkill, in Journ. Asiatic Soc. Bengal, iv. (1908), p. 452. *D. kamaonensis*, Collett, Fl. Simlensis, (1902), p. 518. *D. quinata*, Atkinson, Gazetteer N.W. Prov., x. (1882), p. 703, name only. *D. sp.* Griffith, Posthumous Papers, Journal, (1851), ii, p. 62. The Himalaya from 4000 to 6000 ft., from the eastern border of Kashmir to Sikkim; in the Khasia Hills, and in the Chinese Province of Yunnan.

40. *D. KAMOONENSIS*, Kunth, Enum., v. (1850), p. 395. *D. kamaonensis*, Hook. f., Flor. Brit. Ind., vi. (1892), p. 290. *D. Fargesii*, Franchet in Revue Hort., 1896, p. 541: Bois in Bull. Soc. Bot. France, xlvii. (1900), p. 49: Hackel in Bull. Soc. d'Acclim., (1901), p. 193. *D. pentaphylla*, Wall., Cat. Lith., (1832), No. 5098F: Diels in Engl. Bot. Jahrb., xxix. (1900), p. 260, presumably. *D. triphylla*, Wall., Cat. Lith., (1832), No. 5102D in part and 3102E. *D. sp.*, C. H. Wright in Journ. Linn. Soc. Bot., xxxvi. (1903), p. 91. The Himalaya from Kamaon to Sikkim, ascending from 3000 to 6500 ft.; in northern Siam, northern Burma and the Chinese Provinces of Yunnan, Szechuan, Kweichow and Hupeh.

Variet:—

Var. *VERA*. *Bracteæ* flores masculinos superantes, acuminatæ.

Var. *STRAMINEA*. *Bracteæ* floribus masculinis æquilongæ. *Folia* ad 6 cm. longa.

Var. *FARGESII*. *Bracteæ* floribus masculinis æquilongæ. *Folia* ad 10 cm. longa.

Var. DELAVAYI. *Bracteæ* perlatae, obtusae vel rotundatae, vel paulum mucronulatae, magnae. *Flores masculini* magni.

Var. HENRYI. *Bracteæ* perlatae, obtusae vel rotundatae vel paulum mucronulatae, parvae. *Flores masculini* parvi.

Varietas VERA himalaica est: varietas STRAMINEA austro-sinensis (ex provincia Yunnan attulit Henry, 9495 C! 11301! Delavay, 4816! necnon siamensis (Kerr, 1374!). Varietates FARGESII et DELAVAYI et HENRYI austro-sinenses sunt: var. FARGESII ex provinciis Yunnan (Forrest, 25666!), Szechuan (Henry, 7103! Farges!), Kwei-chow (Martin et Bodinier!), Hupeh (Henry, 266! 4486! 7501!): varietas DELAVAYI in provinciis Yunnan (Delavay, 563! 1825! 1828! 3318! 3833!), Szechuan (Farges, 227!), Kwei-chow (Chaffanjon et Bodinier! Bodinier, 2408!), Hupeh (Henry, 6419!): varietas HENRYI in provinciis Yunnan (Henry 9495! 9715!) et Kwei-chow (Chaffanjon and Bodinier!).

41. D. TAMARISCIFLORA. *D. pentaphylla*, var., Ridley, Mat. Flor. Malay Peninsula, ii. (1907), p. 81. *D. pentaphylla*, Ridley in Journ. Roy. Asiatic Soc., Straits Br., li. (1911), p. 206. The island of Lankawi off the northern part of the west coast of the Malay Peninsula. A species closely allied to *D. pentaphylla* and requiring further study.

D. TAMARISCIFLORA. *Tuber* ignotum. *Caulis* supra tenuis, pilis simplicibus hirsutus. *Folia* alterna, ternata, pilis sparsis supra induta, infra ad nervos majores rufo hirsuta, inter nervos fusco-hirsuta: foliolum medium anguste ellipticum, longe acuminatum, ad 6 cm. longum, ad 2.5 cm. latum, basi acutum venis lateralibus utrinque quinque: foliola lateralia asymmetrica, basi oblique acuta, apice quam medium minus acuminata, ad 5 cm. longa: petioli foliorum visorum ad 25 mm. longi: petioluli 2—3 mm. longi, rufo-hirsuti. *Flores maris* ad 45 in spicas singulas vel binas ad 4.5 mm. longas dispositi: spicae ipsae in inflorescentiam spithamæam compositae: axis triangularis, hirsutus: bracteae ovato-acuminatae, hirsutae, ad 1.25 mm. longae: bracteolae similes minores. *Sepala* lanceolato-ovata, extra hirsuta. 1 mm. longa. *Petala* spatulata, crassa, glabra. *Stamina* 3.

PENINSULA MALAICA. In principatus Kedah insula Langkawi (Curtis, 2539!). Typus in herbario Singaporense conservatus est. Species ob spicas longas inter affines distincta est.

42. D. PIERREI. A species of Lower Cochin-China, differing from *D. pentaphylla* notably in the thickness and stiffness of its felt of red-brown hairs.

D. PIERREI. *Tubera* ignota. *Caules* aculeati, pilis ferrugineis dense piloso-pubescentes, sinistrorsim volubiles. *Folia* alterna, 3—5-foliolata, supra pilis paucis rigidis induta, infra dense pubescentia: foliolum medium obovatum, acuminatum, basi acutum, ad 15 cm. latum, penninerve: foliola externa, minora, asymmetrica, 4—5-nervia, nervo in latere versus folium medium singulo, nervis 2—3-nis in latere exteriori: petiolus dense ferrugineo-pubescentis, ad 8 cm. longus: petioluli ad 5 mm. longi. *Flores maris* in racemos spiciformes 2 cm. longos dispositi: racemi ipsi in inflorescentias 20 cm. longas compositi: axis dense ferrugineo-pubescentis: bracteae spicarum lineari-lanceolatae: bracteae florum in pedicillis insidentes, ovatae, acutiusculae vel subacuminatae, extra dense tomentosae: bracteolae lanceolatae, acuminatae, bracteas longitudine fere æquantes. *Sepala* exacte ovata, obtusiuscula, extra pubescentia, 1 mm. longa. *Petala* anguste obovata, glabra obtusa, sepalis breviora. *Stamina* 3, brevia, antheris rotundatis. *Flores feminei* in spicas deflexas

[N.S.]

subrigidas 20 cm. longas dispositi: axis dense pubescens pilis rufo-griseis: bractæ lanceolatae, 8 cm. longæ, extra pubescentes. *Sepala* lineari-lanceolata, acuta, 6-7 mm. longa, extra pubescentia. *Petala* similia, minora. *Staminodia* perminuta. *Capsulae* reflexæ, versus maturitatem subglabrescentes, 22 mm. longæ, apice obtusissima, basi paulum retusæ: alæ semi-ovato-cordatæ, 7 mm. latæ. *Semina* altero latere alata.

COCHIN CHINA. In provincia Bien-hoa ad Thu-dau-mot et Ben-cat (*Pierre*, 7019!), ad Bao-chauh et Ton-man (*Pierre*, 7020!) ad Hauh-chui in ripis fluminis Mekong (*Harmand*, 92!), sine loco exacto (*Thorel*, 356! *Godefroy*!). Typi in Herbario ad Lutetias Parisiorum conservantur.

43. *D. PENTAPHYLLA*, Linn., *Sp. Plant.*, (1753), p. 1032: *Lam.*, *Encyc. Meth.*, iii (1789), p. 234: *Willd.*, *Sp. Plant.*, v. (1805), p. 789. *D. digitata*, Mill., *Gard. Dict.*, (1768), no. 6. *D. Jacquemontii*, Hook. f., *Flor. Brit. Ind.* vi. (1892), p. 290. *D. Kleiniana*, Kunth, *Enum.*, v. (1850), p. 394. *D. mollissima*, Hassk., *Cat. Hort. Bög.*, (1844), p. 33. *D. tomentosa*, var. *glabra*, Wight in Wall., *Cat. Lith.*, (1832), No. 5101C. *D. triphylla*, Linn., *Sp. Plant.*, (1753) p. 1032. *Botryosicyos pentaphyllus* Hochst., in *Flora*, xxvii. i. Beilage (1844), p. 3. *Hamatris triphylla*, Salisb., *Gen. Plant. Fragm.*, (1865) p. 12. *Ubiium scandens*, Jaume-Saint-Hilaire, *Expos. Fam. Nat.*, i. (1805), p. 106. From Western India to the remotest parts of the Pacific, from the Himalaya and Yunnan southwards to Ceylon and to the islands in the Torres Straits.

Variat:—

- Var. LINNÆI. *Tubera* elongata, carne albida sapida. *Planta* pilis albis præcipue in floribus masculinis plus minusve induta. *Folia* nitentia.
- Var. THWAITESII. Præcedenti similis, at folia tenuissima, fere glabra.
- Var. SULI. Præcedentibus similis at folia grisea nec nitentia.
- Var. JACQUEMONTII. *Tubera* elongata, carne albida sapida. *Pili* albi pauci in inflorescentia masculina, sed folia glabra. *Bulbillæ* rotundæ. *Flores* majores.
- Var. CARDONII. Præcedenti similis, sed folia parce pilis rufis induta et flores minores.
- Var. SIMPLICIFOLIA. Varietati *Cardonii* similis; differt foliis firmiter, ultimis magnis simplicibus.
- Var. RHEEDEI. *Tubera* elongata, carne albida sapida. *Folia* siccitate subnigrescentia. *Bulbillæ* magnopere elongatæ. *Inflorescentia* parce pilis albis induta.
- Var. MALAICA. *Tubera* breviuscula vel elongata, carne sapida. *Folia* rufo-pubescentia: foliola plerumque angustiora.
- Var. HORTORUM. *Tubera* rotundata, læviuscula, carne albida sapida. *Folia* tria, latiora, siccitate nigricantia.
- Var. COMMUNIS. *Tubera* brevia, radiculis rigidis horrentia, carne insipida firma. *Foliola* terna vel quinata, rufo-pubescentia.
- Var. KUSSOK. Præcedenti similis, differt foliis glabrescentibus.

Varietas LINNÆI reperitur in Zeylania et in India australi (*Wight* in *Herb. Wall.* No. 5102!). Varietas THWAITESII est *Thwaites* 2869! ex Zeylania centrali. Varietas SULI in montibus Himalaicis vulgaris est, nec non occurrit in montibus Khasianis et Nagensium. Varietas JACQUEMONTII vulgaris est in montibus supra litore occidentali Indiæ. Varietas CARDONII præcipue reperitur in montibus indicis regionis Chutia Nagpur. Varietas SIMPLICIFOLIA adhuc ex montibus Melghat

cognita. Varietas RHEEDEI in India australi satis repanda, ubi cibum præbet. Varietas MALAICA in insulis malaicis sparsim occurrit: in peninsula malaica colitur. Varietas HORRORUM in India colitur. Varietas COMMUNIS in tota regione Gangetica et in Burma vulgatissima, necnon aliis partibus occurrit. Varietas KUSSOK præcipue sikkimensis est.

44. *D. KALKAPERSHADII*. This has the appearance of being a hybrid between *D. pentaphylla* and *D. tomentosa*. It has been found, but only rarely, in the region common to both.

D. KALKAPERSHADII *Tuber* singulum, variabile, nunc tenerum carne album, nunc fibrosum carne fulvo luteum, itidem nunc radiculis plurimis tectum, nunc læve. *Caulis*, ut videtur, est *D. tomentosæ* æqualis, parce aculeatus, hirsuto-glabrescens. *Folia* alterna, foliolis 5—7 composita: foliola media obovata vel elliptica, basi acuta, apice acuminata, supra pilis perpaucis induta, infra albo-pubescentia, ad 25 cm. longa, ad 11 cm. lata: foliola extima asymmetrica, parva, pro ratione latiora: petiolus parce aculeatus, ad 24 cm. longus: petioluli ad 2 cm. longi. *Flores* maris in spicas singulas vel binas dispositi; spicæ in racemos longos rigidiusculos compositæ: axis fulvo-tomentosus atque parce nigro-setosus: bracteæ spicarum ovato-lanceolatæ, ad 2 mm. longæ, fulvo-tomentosæ: bracteæ florum late ovato-acuminatæ, floris basin amplectentes, subglabræ: bracteolæ similes, minores. *Sepala* ovata, acuta, 5 mm. longa. *Petala* ovata, obtusiuscula, 5 mm. longa. *Stamina* 3, sepalis breviora. *Flores* fæminei ignoti.

INDIA. In collibus Chutia-Nagpurensibus, Orixensibus, Shevaroi. Ad Rungarit et Biru in districtu Ranchi, (*Cardon*, 12! *Kalka Pershad*, 34389! 34390!), Patharchaki in districtu Balasore, (*Kalka Pershad*, 34323!), Baripada in principatu Mayurbhanj (*Holmes*, 34309! 33185! 33825!). In montibus Shevaroi in districtu Salem (*Perrottet*, 1! 334!). *D. Kalkapershadii* forsitan hybrida sit inter *D. pentaphyllum* et *D. tomentosam*.

45. *D. ELMERI*, Prain et Burkill, in Elmer, Leaflets of Philippine Botany, v. (1913), p. 1594. A species of the Philippine Islands, collected in Luzon in the latitude of Manila, and in Negros.

Variat:—

Var. VERA. *Folia* coriacea. *Capsularum* a'æ ad 25 mm. longæ.

Var. DUBIA. *Folia* admodum coriacea. *Capsulæ* paululo minores, densissime rufo-tomentosæ.

Varietas VERA in provincia Laguna reperitur (*Alberto*! *Elmer*, 8265!); etiamque in provincia Tayabas (*Elmer*, 9156!): varietas DUBIA in provincia Laguna (*Ramos*, 13520!).

46. *D. sp.* A fragment exists in the Kew Herbarium collected in the Chinese Province of Kwei-chow (*Esquirol*, 970!) which certainly represents a new species of the section Lasio-phyton. It has capsules like those of *D. inæquifolia*, but has a dense tomentum on the back of the leaves.

47. *D. INÆQUIFOLIA*, Elmer ex Prain et Burkill in Elmer, Leaflets of Philippine Botany, v. (1913), p. 1595. Philippine Islands: Batanes Islands (*Fenix*, 3659!), Mindoro (*Merritt*, 6796!), and Mindanao (*Elmer*, 10654!).

48. *D. CUMINGII*, Prain et Burkill, in Journ. Asiatic Soc. Bengal, iv. (1908), p. 459. Philippine Islands, rather widely distributed in Luzon.

49. *D. BLUMEI*. *D. pentaphylla*, Blume, Enum. Plant. Jav. i (1827), p. 20. Collected by Reinwardt in Java.

D. BLUMEI. *Tubera* ignota. *Caules* glabri, parce aculeati, sinistorsim volubiles. *Folia* alterna, 5-foliata, supra glabra, infra pilis parce in nervis majoribus induta: foliolum medium basi obtusum vel subrotundatum, apice abrupte acuminatum, venis pinnatis, ad 12 cm. longum, ad 6 cm. latum: foliola externa asymmetrica 3-nervia, nervis duobus parte externa versus medio currentibus: petiolus 5 cm. longus, sparsim hirsutus: petioluli ad 1 cm. longi. *Flores* maris in paniculam magnam bis et iterum ramosam dispositi: rami hirsuto-glabrescentes: racemi spiciformes ad 2 cm. longi axibus ferrugineo-hirsuti: bracteae in pedicellorum apicibus insidentes, late triangulari-ovatae, extra dense ferrugineo-pubescentes, acuminatiusculae, 1 mm. longae: bracteolae similes minores. *Sepala* ovata, obtusa, extra et marginibus pilis fulvo-rufis induta, 1 mm. longa. *Petala* elliptica, breviora, obtusa. *Stamina* 3, breviora: staminodia 3, petalis aequilonga. *Flores* feminei ignoti.

JAVA. Sine loco exacto, Reinwardt! Typus in Herbario Lugdunense conservatur.

50. *D. SCORTECHINII*, Prain et Burkill, in Journ. Asiatic Soc. Bengal, iv. (1908), p. 455. *D. pentaphylla*, Ridley et Curtis, in Journ. Roy. Asiatic Soc., Straits Br., (1902), p. 66, in part. Through the Malay Peninsula and in Tonkin. More material is wanted of it, of *D. Blumei* and of *D. Cumingii*, in order to define them better than we can do at present.

51. *D. TRIPHYLLA*, Linn., Amoen. Acad., iv. (1754), p. 131: Syst. Nat. ed. 13, ii. (1791), p. 581; Jacq. Collect., ii. (1788), p. 365: Lam., Encyc. Meth., iii. (1789), p. 234: Jacq., Ic. Plant. Rar., iii. (1790), p. 627. *D. amoena*, Wight (by error for *D. daemona*), Icones, (1840), t. 811. *D. altissima*, Roxb. MS. in Herb. propr. *D. daemona*, Roxb., Hort. Beng., (1814), p. 72, name only: and Flor. Ind., iii. (1832), p. 805: Hook. f., Flor. Brit. Ind., vi. (1892), p. 289. *D. daemonum*, Kurz, in Prelim. Rep. Pegu, (1875), appendix p. xxii. *D. hirsuta*, Roth, Nov. Plant. Sp., (1821), p. 370: Blume, Enum. Plant. Jav., i. (1827), p. 21. *D. hispida*, Dennst., Schlüss., (1818), p. 33. *D. lunata*, Roth, Nov. Plant. Sp., (1821), p. 370: Kunth, Enum., v. (1850), p. 397. *D. macrocarpa*, Wall., Cat. Lith., (1832), No. 5100. *D. mollissima*, Blume, Enum. Plant. Jav., i. (1827), p. 21. *D. pentaphylla*, Wall., Cat. Lith., (1832), No. 50891. *D. tomentosa*, Kurz, Prelim. Rep. Pegu, (1875), appendix p. xxii. *D. virosa*, Wall., Cat. Lith., (1832), No. 5099. *D. trinervia*, Roxb. ex Wall., Cat. Lith., (1832), No. 5099F. *Smilax altissima*, Roxb. ex Wall., Cat. Lith., (1832), No. 5099C. *S. narcotica*, Ham. ex Wall., Cat. Lith., (1832), No. 5099A. *Helmia?* *daemona*, Kunth, Enum., v. (1850), p. 439. *H. hirsuta*, Kunth, Enum. v. (1850), p. 438. *H. dumetorum*, Kunth, Enum. v. (1850),

p. 436. India to New Guinea, occurring just within South-western China, and in Formosa. Linnæus in 1753 applied the name "triphylla" to a form of *D. pentaphylla*: in 1754 he applied it as we use it here.

Variat:—

Var. DÆMONA. *Planta pubescens.*

Var. RETICULATA. *Planta hispido-pubescens.*

Var. MOLLISSIMA. *Planta albo-tomentosa.*

Varietas DÆMONA in India communis est, necnon in partibus minime pluviosis insulæ Javæ. Varietas RETICULATA in peninsula insulisque malaicis abundans. Varietas MOLLISSIMA reperitur in Burma orientali et australi, in regno Siamiensi, in insulis malaicis.

Section 6. OPSOPHYTON.

52. *D. BULBIFERA*, Linn., Sp. Plant., (1753), p. 1035: Lam., Encyc. Meth., iii. (1789), p. 232: Bailey, Queensland Flor., v. (1902), p. 1615: Prain, Bengal Plants, ii. (1903), p. 1066. *D. crispata*, Roxb., Hort. Beng., (1814), p. 72, name only: and Flor. Ind., iii. (1832), p. 802. *D. decemangularis*, Ham. ex Wall., Cat. Lith., (1832), no. 5106B. *D. heterophylla*, Roxb., Hort. Beng., (1814), p. 72, name only: and Flor. Ind., iii. (1832), p. 804. *D. japonica*, Thunb. in Herb. propr., in part: Wall., Cat. Lith., (1832), no. 5107C and 5107D in part. *D. oppositifolia*, Campbell, Econ. Prod. Chutia Nagpur sent to Col. & Ind. Exhib., (1886), p. 7. ? *D. papillaris*, Blanco, Flor. Filip., (1837), p. 552. *D. pulchella*, Roxb., Hort. Beng., (1814), p. 72, name only: and Flor. Ind., iii. (1832), p. 801. *D. sativa*, Thunb., Flor. Jap., (1784), p. 191: Kunth, Enum., v. (1850), p. 340, in part: Benth., Flor. Hongkong., (1861), p. 368; and Flor. Austral., vi. (1873), p. 460: Seemann, Flor. Vitiensis, (1873), p. 626: Hook. f., Flor. Brit. Ind., vi. (1892), p. 295. *D. tamnifolia* Salisb., Parad. Lond., (1806), t. 17. *D. Tunga*, Ham. ex Wall., Cat. Lith., (1832), no. 5107D. *Helmia bulbifera*, Kunth, Enum. v. (1850), p. 35. From India to the remotest parts of the Pacific, ascending the Himalaya to 5000 feet: and in Southern China, in Southern Japan, and in Northern Australia. Introduced into Tropical America and into Africa.

Variat:—

Var. VERA. *Tuber et bulbillæ acridæ, breves. Folia supra nitentia.*

Var. SIMBHA. *Præcedenti similis tubero bulbillisque. Folia longiora, infra nitentia. Flores maris magni.*

Var. KACHEO. *Tuber bulbillæque vix acridæ. Tuber magnum, nec elongatum, sparsim radicibus indutum.*

Var. SUAVIOR. *Præcedenti similis tubero. Bulbillæ admodum verrucosæ, subnigræ.*

Var. BIRMANICA. *Varietati suaviori similis; sed tuber æve, carne album.*

Var. SATIVA. *Tuber pœne deest. Bulbillæ magnæ, fere læves, viridi-fuscæ. Folia magna.*

Var. ELONGATA. *Tuber elongatum*

Var. DELTOIDEA. *Folia triangulari ovata.*

[N.S.]

Varietas VERA ubique vulgaris. Varietates SIMBHA et KACHEO in montibus sikkimensibus et in locis ab iis versus orientem tendentibus reperiuntur. Varietas SUAVIOR in India colitur. Varietas BIRMANICA in Burma et Assamia colitur. Varietas SATIVA in litoribus maris Pacifici colitur, necnon nuper in India. Varietas ELONGATA in Australia crescit: a clariss. Manson Bailey descripta, nobis parum nota est. Varietas DELTOIDEA in insula Hongkong reperitur (*Bodinier*, 1310!).

53. *D. ROGERSII*. This species, like *D. bulbifera*, var. *elongata*, has an elongated root. We think it possible that both may be hybrids of *D. bulbifera* with species of the section *Enantiophyllum*. *D. Rogersii* has been obtained in the Andaman islands.

D. ROGERSII. *Tuber* elongatum, carne album nec amarum. *Caulis* glaber, lævis, teres, purpureo-maculatus. *Folia* alterna, ovato-cordata, acuminata, ad 13 cm. longa, ad 11 cm. lata, glabra, 9-nervia: venæ secundariæ plus minusve oblique trajectæ. *Flores maris* vel in spicas dependentes 1--4-nas ad axillas foliorum vel racemosim in inflorescentias ad 20 cm. longas compositi: axis angularis: bractæ naviculari-ovatae, acuminatae, 1 mm. longæ: bracteolæ lineares, acuminatae, 5 mm. longæ. *Alabastra* elliptico ovoidea. *Perianthii maris* lobi 6, basi ipsa conjuncti, æquilongi, interiores exterioribus paululo angustiores, crassiores. *Stamina* 6, tria aliis paululo longiora, in basi perianthii loborum inserta. *Flos fæmineus* ignotus.

INSULÆ ANDAMANICÆ. Ad ripas fluminis Rablikchokal, *Rogers*, 37! Vix an ne vix *D. bulbifera* hybrida sit. Typus in herbario Horti Regii Calcuttensis conservatur.

54. *D. BRANDISII*. This appears to us to be a hybrid between *D. bulbifera* and *D. glabra*. It was obtained by the late Sir Dietrich Brandis in some unrecorded locality in Burma.

D. BRANDISII. *Tuber* ignotum. *Caulis* glaber, lævis, teres, sinistrorsim volubilis. *Folia* alterna, glabra, hastata, acuminata, ad 18 cm. longa, ad 7 cm. lata, 7-nervia: venæ secundariæ trajectæ, rectæ, vix conspicuæ. *Flores maris* in racemos spiciformes in inflorescentiam ad 12 cm. longam compositi: bractæ floris maris lanceolatae, acuminatae: bracteolæ similes minores: pedicellus bractea paululo brevior. *Perianthii* lobi 6, basi ipsa conjuncti æquilongi, obtusi, brunneo-maculati. *Stamina* 6: filamenta 1 mm. longa, in basi perianthii loborum inserta: antheræ subrotundatæ. *Flores fæminei* ignoti.

BURMA. In Burma inferiori, loco non indicato, *Brandis*! Typus in herbario horti botanici Calcuttensis conservatur.

55. *D. PUNCTATA*, R. Brown, Prod. Flor. Nov. Holl., (1810), p. 294, in part: Kunth, Enum., v. (1850), p. 390: Benth., Flor. Austral., vi. (1873), p. 46. Obtained in the northern part of Queensland more than a century ago, but not since. It may be a hybrid of *D. bulbifera* with *D. transversa*; and if so, a comparison may be made between it and *D. bulbifera*, var. *elongata*.

Section 7. ENANTIOPHYLLUM.

56. *D. BATATAS*, Decne., in Rev. Hort., Ser. 4, iii. (1854), p. 243, and iv. (1855) p. 69. *D. decaisneana*, Carrière,

in Rev. Horticult., 1865, p. 111. *D. glabra*, F. v. Muell., Select Plants for Extra-Trop. Countries, Ind. edit. (1880), p. 100. *D. japonica*, Pépin in Mém. Soc. Imp. et Cent. d'Agric. (1854), reprint. ? *D. opposita*, Thunb., Flor. Jap. (1784) p. 191. *D. opposita*, Siebold in Verhandl. Bat. Genootsch., xii. (1830), p. 14. *D. oppositifolia*, Kunth, Enum., v. (1850), p. 390, in part : Kawakami, List Plants Formosa, (1910), p. 122. China from Yunnan and Kwangtung to Pechili, generally cultivated; also in Formosa, the Island of Quelpart off Corea, and in Japan to 41° N. It has been experimentally grown in Europe and in India. Hackel has raised hybrids between it and *D. japonica*.

57. *D. DORYOPHORA*, Hance, in Ann. Sc. Nat., Ser. 5, v. (1866), p. 244: C. H. Wright, in Journ. Linn. Soc. Bot., xxxvi. (1903), p. 91. *D. Rosthornii*, Diels, in Engl. Bot. Jahrb., xxix. (1900), p. 261. *D. Swinhoei*, Rolfe, in Journ. Bot., xx. (1882), p. 359. Formosa and the Chinese Provinces of Kweichow and Hupeh. It seems probable that it may be a depauperate form of *D. Batatas*.

58. *D. JAPONICA*, Thunb., Flor. Jap., (1784), p. 51: Siebold in Verhandl. Bat. Genootsch., xxii. (1830), p. 14: Makino, Ill. Flor. Jap., i. (1889), t. 22. *D. Batatas*, Pailleux et Bois, Potager d'un Curieux, (1899), p. 231. Japan, commonly to Lat. 37° N., China in the south and west, and in the Naga Hills of India.

Variat :—

VAR. VERA. *Spicarum* axes tenues.

VAR. TENUAXON. *Spicarum* axes tenuissimi.

Varietatem TENUAXON ex monte Omei in Provincia Szechuen attulit Faber. Varietas VERA per regionem totam reperitur.

59. *D. LUZONENSIS*, Schauer in Nova Acta Nat. Cur., xix. suppl. i. (1843), p. 444. ? *D. divaricata*, Blanco, Flor. Filip., (1837), p. 797. Philippine islands: common in Central and Southern Luzon, and found also in the island of Palawan. A species well marked by the size of its flowers.

60. *D. PEPEROIDES*, Prain et Burkill in Elmer, Leaflets of Philippine Botany, v. (1913), p. 1597. Luzon and Tonkin. It is closely allied to *D. luzonensis*; but has much smaller flowers. Better material from Tonkin may show that the plant which we possess from thence, which we here call a variety of *D. peperoides*, may be a different species.

Variat :—

Var. VERA. *Folia* exacte cordata.

Var. SAGITTIFOLIA. *Folia* minora, ad 7 cm. longa, hastato-sagittata.

Var. ANGULATA. *Folia* cordato-sagittata.

[N.S.]

Varietas VERA reperitur in Insula Luzon, provinciis Rizal et Benguet (Loher, 1882! 7007! Merrill, 6512! Elmer, 6399! 6400!). Varietas SAGITTIFOLIA in provincia Nueva-Viscaya (Ramos, 8178!). Varietas ANGULATA in Tonkin (Balansa, 279!).

61. *D. BICOLOR*, Prain et Burkill, in Journ. Asiatic Soc. Bengal, iv. (1908), p. 449. China, in the province of Yunnan. The shape of the capsule is very unusual.

62. *D. ASPERSA*, Prain et Burkill, in Journ. Asiatic Soc. Bengal, iv. (1908), p. 447. China, in the province of Yunnan.

63. *D. SPICATA*, Roth, Nov. Spec. Plant., (1821), p. 571; Hook. f., Flor. Brit. Ind., vi. (1892), p. 291; and in Trimen, Handb. Flor. Ceylon, vi. (1898), p. 227, in chief part. Southern India and Ceylon.

Variat:—

Var. PARVIFOLIA. *Folia* parva, circiter 5 cm. longa.

Var. ANAMALLAYANA. *Folia* majora, ad 10 cm. longa.

Varietatem PARVIFOLIAM ex regione australi Zeylanicæ attulit Thwaites! Varietas ANAMALLAYANA reperitur in montibus zeylanicis et Travancoricis et in districtibus Cochin Coimbatoreque Tinnevellicis.

64. *D. INTERMEDIA*, Thwaites, Enum. Plant. Zeyl., (1864), p. 326. *D. spicata*, Hook. f., in Trimen, Handb. Flor. Ceylon, iv. (1898), p. 277, in part. Ceylon, Travancore, and the district of Malabar. This yam seems to be common in the parts of Ceylon near Kandy, and all the Peradeniya botanists have been familiar with it; but Trimen left notes on it in the Peradeniya herbarium under the name of *D. spicata* which were absorbed by Sir Joseph Hooker in his description of the allied *D. spicata*.

65. *D. TRIMENII*. *D. spicata*, var. β , Thwaites, Enum. Plant. Zeyl., (1864), p. 326. Collected in fruit by Thwaites in Central Ceylon.

D. TRIMENII. *Tuber* ignotum. *Caulis* glaber, tenuis, inermis. *Folia* opposita, longe hastato-cordata, acuminata, siccitate nigrescentia. auriculis rotundata, glabra, ad 8 cm. longa, ad 4 cm. lata, 7-nervia: area media a nervorum lateralium primo pare terminata oblanceolata: venæ secundariæ infra prominentes: rete distinctum: petiolus ad 4.5 cm. longus. *Flores* ignoti. *Capsulæ* basi acutæ, apice acuminatæ, 35 mm. longæ: alæ semicirculares, 25 mm. longæ, 15 mm. latæ, colore fulvæ. *Semina* circumcirca alata: ala fusco-castanea.

IN INSULA ZEYLANIA.—Ad Ambagamowa, Thwaites, 3119! et sine loco, Thwaites, 2872!

66. *D. WIGHTII*, Hook. f., Flor. Brit. Ind., vi. (1892), p. 291. In the extreme south of India in the district of Tinne-

velli. This and the three preceding species are all closely allied to *D. oppositifolia*, and may be regarded as sharing a common origin with it.

67. *D. OPPOSITIFOLIA*, Linn., Spec. Plant, (1753), p. 1033, and earlier in his Flor. Zeyl., (1747), no 361: Hook. f., Flor. Brit. Ind., vi. (1892), p. 292. *D. coriacea*, Wall. in Herb. propr. *D. elliptica*, Thunb. in Herb. propr. *D. ovata*, Thunb. in Herb. propr., in part. This species occurs commonly throughout India south of the Ganges, and in Ceylon. It varies in a way which makes it impossible to give to it a single place in our key (see above after no. 66, after no. 80, and after no. 89); for sometimes the inflorescence is pubescent, and sometimes not; sometimes the male spikes are axillary only, and sometimes in special leafless inflorescences. On one hand it finds close allies in *D. spicata*, *D. intermedia*, *D. Trimenii* and *D. Wightii*: on the other it approaches *D. trinervia*, and more remotely *D. pyrifolia*. We define three varieties.

Variet —

Var. THWAITESII. *Folia* pubescentia, lanceolato-ovata vel late ovata, siccitate brunnescentia. *Inflorescentiæ maris* axis copiose pubescens.

Var. LINNÆI. *Folia* glabra, late lanceolata vel ovata. *Inflorescentiæ maris* axis elongatus, brunneo-pubescens.

Var. DUKHUNENSIS. *Folia* glabra, late ovata. *Spicæ maris* axillares vel rarissime in inflorescentia aggregatæ, glabræ vel fere glabræ.

Varietas THWAITESII zeylanica (*Thunberg!* *Walker*, 147! 219! *Thwaites*, 2303! *Gardner*, 898!). Varietas LINNÆI reperitur in Zeylanica (*Walker*, 46! *Rottler!*) et in districtu Malabar (*Hohenacker*, 597!) et in districtu Tinneveli (*Wight*, 2824!). Varietas DUKHUNENSIS in omnibus partibus montanis humidis peninsulæ Indiæ reperitur.

68. *D. OBCUNEATA*, Hook. f., Flor. Brit. Ind., vi. (1892), p. 293. Ceylon, without precise locality. This species connects *D. spicata* with *D. oppositifolia*. Unlike the local varieties of the latter occurring in Ceylon, it is wholly glabrous. Its elongated inflorescences are such as are often to be found in *D. oppositifolia*, and its obtuse leaves are shaped as those of *D. spicata* sometimes are: but the leaves of *D. spicata* are much firmer. It has not been possible to give this species a natural place in the key.

69. *D. HASTIFOLIA*. Nees in Lehm., Plant. Preiss., ii. (1848), p. 33: Benth., Flor. Austral., vi. (1873), p. 461. Found near the western coast of Australia between lat. 33° and 27°S.

70. *D. TRANSVERSA*, R. Brown, Prod. Flor. Nov. Holl. (1810), p. 295: Benth., Flor. Austral., vi. (1873), p. 460. ? *D. punctata*, Thozet, Notes on roots used as food, (1866), pp. 7 and

12. Found near the eastern coast of Australia between Lat. 34°S and Torres Straits; and in northern Australia.

71. *D. CIRRHOSA*, Loureiro, Flor. Cochinch., (1790), p. 625: Kunth, Enum., v. (1850), p. 401. *D. rhipogonioides*, Oliv. in Ic. Plant., (1889), t. 1862: Henry, in Kew Bull., 1895, p. 230. *D. camphorifolia*, Uline MS. in herbariis nonnullis. Tonkin to Hong-Kong and in Formosa. A very marked species, peculiar in the colouring matter of its tubers. Loureiro's name, were it not for a specimen preserved in the British Museum, would be unrecognisable.

72. *D. WALLICHII*, Hook. f., Flor. Brit. Ind., vi. (1892), p. 295. *D. aculeata*, Linn., Sp. Plant., (1753), p. 1033, in small part. *D. sativa*, Wall., Cat. Lith., (1832) Nos. 5108A, 5108B, 5108F. India in the hills of the Malabar Coast, extending thence inland near the River Tapti to Chota Nagpur and the Circars, then occurring again through Burma and in the hills south of the Brahmaputra Valley.

Variat:—

Var. *VERA*. *Capsulae* vix glaucae.

Var. *CHRISTIEI*. *Capsulae* glaucae.

Varietas *VERA* occurrit in partibus Indiae peninsularis orientalibus: varietas *CHRISTIEI* in Burma.

73. *D. PULVEREA*. Yunnan, in south-western China. Perhaps this may prove to be no more than a variety of the last: but until more material is available, its oblique very glaucous capsules and rather firmer leaves render it desirable to separate it.

D. PULVEREA. *Tuber* ignotum. *Caules* robusti, glabri, inermes parte superiori, glauci. *Folia* pergamentacea, exacte cordata vel late cordata, apice acuminata, flavo-marginata, ad 13 cm. lata, ad 13 cm. longa vel pro ratione paululo angustiora, 9-nervia: area media a nervorum lateralium parte primo terminata anguste obovata: venae secundariae rectae, trajectae: petiolus ad 12 cm. longus, glaber. *Flores* ignoti. *Capsulae* in rhachei rigido deflexo ad 20 cm. longo profertae, admodum glaucae, rigidae, apice retusae, ad 30 mm. longae: ala semi-obcordata, 25 mm. longa, 12 mm. lata. *Semina* inaequaliter circumcirca alata, ala castanea.

CHINA AUSTRALIS. In Provincia Yunnan, ad Mengtze, alt. 4600 ped. (*Henry*, 9288!).

74. *D. DECIPIENS*, Hook. f., Flor. Brit. Ind., vi. (1892), p. 293. *D. glabra*, Wall., Cat. Lith., (1832), Nos. 5105G, 5105H. *D. rotundifolia*, Wall. MS. in Herb. propr. In the Naga Hills and through Burma to northern Siam and Laos; occurring just within the Chinese province of Yunnan.

75. *D. ORBICULATA*, Hook. f., Flor. Brit. Ind., vi. (1892), p. 292: Ridley, Mat. Flor. Malay Penins., ii. (1907),

p. 82. *D. glabra*, Ridley and Curtis, in Journ. Roy. Asiatic Soc., Straits Br., xxxviii. (1902), p. 66, in part. *D. sativa*, Wall., Cat. Lith., (1832) No. 5108C. Through the Malay Peninsula to Sumatra and Borneo. A species very well marked by the angle at which the male spikes stand.

76. *D. ZOLLINGERIANA*, Kunth, Enum., v. (1850), p. 384: Miq., Flor. Ind. Bat., suppl., (1860), pp. 229, 611. Nicobar Islands, the south of the Malay Peninsula, Sumatra, Java and perhaps in the Kei Islands. It is nearly allied to *D. orbiculata*.

77. *D. ANGUINA*, Roxb., Hort. Beng., (1814), p. 72, name only: and Flor. Ind., iii. (1832), p. 293. *D. Combilium*, Ham. in Herb. Wall. propr. *D. pubera*, Blume, Enum. Plant. Jav., i. (1827), p. 21, very inadequately described. *D. spinosa*, Wall., Cat. Lith., (1832), Nos. 5103G, 5103H. India, in the Himalaya from Central Nepal eastwards; general where the moisture is sufficient on the south of the Ganges as far as Travancore (but not in Ceylon); Assam, northern Burma, Sumatra and Java.

78. *D. LISTERI*, Prain et Burkill, in Journ. Asiatic Soc. Bengal, vi. (1908), p. 452. Upper Assam and the adjoining hills. A species very close to *D. anguina*.

79. *D. POLYCLADES*, Hook. f., Flor. Brit. Ind., vi. (1892), p. 294: Ridley, Mat. Flor. Malay Penins., ii. (1907), p. 81. *D. nummularia*, Moritzi, Syst. Verzeichn. d. v. Zollinger gesammelt. Pflanzen, (1846), p. 92: Zollinger, Syst. Verzeichn., (1854), p. 68. *D. pubera*, Prain et Burkill, ex Koorders-Schumacher, Syst. Verzeichn. Lief. 9, (1912), genus No. 1252. Malay Peninsula, Sumatra and Java.

80. *D. TRINERVIA*, Roxb. MS. in Herb. propr., but not ex Wall. *D. glabra*, Wall., Cat. Lith., (1832), Nos. 5105D, 5105E. *D. oppositifolia* Hook. f., Flor. Brit. Ind., vi. (1892), p. 292, in part.

D. TRINERVIA, Roxb. *Tuber* alte descendens, ad 1 m. longum, carne molle supra aurantiaca infra alba. *Caulis* tenuis, inermis, basi glaber, apice pubescens, dextrorsim volubilis. *Folia* alterna, vel suprema opposita, glabra, vel lanceolato-ovata basi obtusa, vel ovata basi rotundata, fulvo-marginata, apice acuminata, ad 15 cm. longa, ad 5 cm. vel ad 8 cm. lata, 5-nervia: area media a nervorum lateralium pare primo terminata late lanceolata: venæ secundariæ oblique trajectæ, paucæ, inconspiciæ: petiolus 2 cm. longus, pubescens. *Flores maris* 20—35 in spicas binas ad axillas bractearum oppositarum in inflorescentias ad 30 cm. longas dispositi: spicarum axes ad 20 cm. longi, pubescentes, angulati: bracteæ ovatæ, acuminatæ, subglabræ, 1 mm. longæ: bracteolæ similes, minores. *Sepala* triangulari-ovata,

obtusa, incurva, glabra, 1 mm. longa. *Petala* late elliptico-ovata, sepalis breviora, glabra. *Stamina* 6, brevia. *Flores* fariniferi 10—15 in spicas plerumque simplices ad 15 cm. longas dispositi: axis pubescens: bractea ovata, acuminata, fere glabra, 1 mm. longa. *Sepala* triangulari-ovata, obtusa, crassa, 75 mm. longa, glabra. *Petala* similia, minora. *Staminodia* minuta. *Capsula* griseo-fusca, rufo-maculata, glabra, pedicello incluso 15 mm. longa: ala latiores quam semicirculares, 15 mm. longa, 12 mm. lata.

INDIA ORIENTALIS: IN MONTIBUS ASSAMICIS ARAKANENSIBUSQUE. In districtu Nowgong ad Lunding, (*Burkill*, 35309! *Kalka Pershad*, 35575!). In districtu Cachar ad Alni in ripis fluminis Barak, (*Gage*!). In montibus Khasianis ad flumen Bor-Pani, (*Hooker f. & Thomson*!). sine loco, (*Mann*! *Griffith*, 5549!). In montibus cacharicis ad Haflong, (*Shaik Mokim*, 184! 273! *Ballantine*, 31830! *Craib*, 13! *Burkill*, 33011! 33022! 33024!), ad Damcherra, (*Keenan*!). In districtu Chittagong, sine loco, (*Bruce* in *Herb. Wall.* 5105D!). In districtu Sandoway, sine loco, (*Mus. R.E.P.* 15034!). Etiamque sine locis, (*Booth* in *Herb. Nuttall*! *Rorburgh*!).

81. *D. PYRIFOLIA*, Kunth, Enum., v. (1850), p. 384: Miq., Flor. Ind. Bat., iii. (1855), p. 571: Hook. f., Flor. Brit. Ind., vi (1892), p. 292: Ridley, Mat. Flor. Malay Penins., ii. (1907), p. 82. *D. cornifolia*, Kunth, Enum., v. (1850), p. 38: Ridley, Mat. Flor. Malay Penins., ii. (1907), p. 81, in chief part. *D. Diepenhorstii* Miq., Flor. Ind. Bat., suppl. (1860), p. 611. *D. ferruginea*, Thunb. in *Herb. propr.* *D. nummularia*, Blume, Enum. Plant. Jav., i. (1827), p. 21: Hassk. in *Tijds. Nat. Gesch.*, ix. (1842), p. 136. *D. ornata*, Wall. in *Herb. propr.* *D. preangeriana*, Uline ex Harms in *Herb. Lugd.* *D. repanda*, Hallier in *Herb. Lugd.* The commonest *Dioscorea* in the Malay Peninsula: in Sumatra, Java and Borneo; and occurring also in Cambodia and Timor-laut: erroneously recorded as having been obtained in the Philippine islands by Cuming. Cuming's plant came from Malacca.

Variat:—

Var. FERRUGINEA. *Folia* siccitate infra ferruginea, plerumque copiose fulvo-pubescentia.

Var. VERA. *Folia* siccitate infra grisea, venis castaneis plerumque copiose melleo-flavescentia.

Var. DIEPENHORSTII. *Folia* siccitate infra grisea, pilis fulvis nisi ad insertionem petioli absentibus.

Varietas FERRUGINEA frequens est per regionem: varietas GRISEA rarior: varietas DIEPENHORSTII reperitur in Sumatra et Borneo et Timorlaut, et Cambodia.

82. *D. LOHERI*. Found in the island of Luzon, in the districts about the latitude of Manila.

D. LOHERI. *Tubera* esculenta, a nobis haud visa. *Caules* aculeis armati, glabri. *Folia* opposita vel subopposita, glabra, hastata barbibus divergentibus vel hastato-cordata, vel subovata, plus minusve marginata, ad 9 cm. longa, ad 2 cm. lata supra barba, sed ex barba ad barbam 4 cm. lata, 7-nervia: area media a nervorum lateralium primo pare terminata oblanceolata: venae secundariae suboblique trajectae, inconspicuae: petiolus ad 4 cm. longus. *Flores* maris 40 in spicas patentes ad 4 cm. longas dispositi; spicae ipsae vel in ramos aphyllous vel ad

axillas foliorum compositæ: axis angulatus, glaber: bracteæ ovatæ, tenuissimæ, reflexæ, incurvatæ, rufo-lineolatæ, 1 mm. longæ: bracteolæ minores, similes. *Sepala* triangulari-ovata, obtusa, margine hyalina, 1.25 mm. longa. *Petala* sepalis breviora, obovata, crassa. *Stamina* 6: antheræ breviter ellipsoideæ, filamentis æquilongæ. *Flores fæminei* in spicas post anthesin ad 14 cm. longas compositi: axis glaber, angulatus: bracteæ ovato-acutæ. *Sepala* triangulari-ovata, crassa, ad 1 mm. longa. *Petala* similia, minora. *Capsulæ* immaturæ supra retusæ: alæ latiores quam semicirculares.

INSULA LUZON PHILIPPINENSIVM. Prope Mangilet in provincia Bataan, (*Curran*, 5465!). In provincia Rizal ad San Francisco del-Monte haud procul a Manila, (*Loher*, 1885! 1886!), atque ad Montalban, (*Loher*, 1899!). In provincia Morong ad Antipolo, (*Ramos*, 6!).

83. *D. SOROR*, Prain et Burkill in Elmer, Leaflets of Philippine Botany, v. (1913), p. 1598. A mountain species of the Philippine islands, found in Luzon.

Variat:—

Var. *VERA*. *Capsulæ* non glaucæ.

Var. *GLAUCA*. *Capsulæ* glaucæ.

Varietatem *GLAUCAM* collexit *Foder* haud procul a Nozogaray in provincia Bulacan.

84. *D. FOXWORTHYI*, an ally of the two preceding species and of the two following, which has only been collected in the Lamao Forest, Luzon.

D. FOXWORTHYI. *Tuber* esculentum, non visum. *Caules* 3—5 mm longi, parte superiori inermes, glabri, teretes, virides. *Folia* opposita vel subopposita, ovato-hastata vel subovata, acuminata, glabra, parum marginata, ad 13 cm. longa, ad 5 cm. lata et media parte et per barbas, 7-nervia: area media a nervorum lateralium primo pare terminata oblanceolata: venæ secundariæ suboblique trajectæ, inconspiciuæ: petiolus ad 5 cm. longus. *Flores maris* ad 25 in spicas patentes dispositi: spicæ ipsæ in ramos aphyllis ad 20 cm. longos compositæ: axis angulatus, glaber: bracteæ ovatæ, acuminatæ, tenuissimæ, reflexæ: bracteolæ similes minores. *Alabastra* conoidea ex basi triangulari. *Sepala* quadrato-ovata, obtusa, rufa, nec marginibus tenuia, 1 mm. longa. *Petala* obovata, sepalis minora. *Stamina* 6: antheræ subrotundæ, filamentis æquilongæ. *Flores fæminei* ignoti.

INSULA LUZON.—In sylvis ad Lamao provinciæ Bataan (*Foxworthy*, 1558!).

85. *D. SEEMANNII*. *D. nummularia*, Seemann, Flor. Vitiensis, (1873), p. 308. ? *D. divaricata* Naudeaud, Plantes Usuelles des Tahitiens, (1864), p. 10. ? *D. pirita*, Naudeaud, Enum. Pl. Tahiti, (1873), p. 35. "Tivoli yam," F. v. Mueller, Select Plants for extra tropical culture, Ind. Ed. (1880), p. 101, Fiji and perhaps Tahiti. Better material of this species is required in order to ascertain exactly how far it differs from *D. nummularia*.

D. SEEMANNII. *Tubera* esculenta, cylindrica, elongata, metralia vel ultra, brachio hominis crassa. *Caulis* basi copiose armatus, ad 4 mm. crassus, striatus, glaber. *Folia* opposita, glabra, ovato-cordata vel ovata, vel infera sagittato-cordata, acuminata, ad 11 cm. longa, ad 9 cm. lata, 7-nervia: area media a pare primo nervorum lateralium terminata elliptica,

acuminata: venæ secundariæ plus minusve regulariter trajectæ, sed parum conspicuæ in rete: margines tenues: petiolus glaber, ad 5 cm. longus. *Flores maris* in spicas aggregatas axillares 3—6-nas dispositi: spicæ ad 3 cm. longæ, circiter 25-floræ: axis glaber nisi basi, ubi pili perpauca: bracteæ ovatæ, acuminatæ, reflexæ, depressæ, 1 mm. longæ: bracteolæ similes, minores. *Sepala* fere rotunda, mucronulata, 1.25 mm. longa. *Petala* crassiora, elliptico-spathulata, 1 mm. longa. *Stamina* 6, petalis æquilongæ: antheræ filamentis æquilongæ. *Flores fœminei* ignoti.

INSULAE VITIENSES.—Frequens, (Seemann, 628! Græffe!). Forsan etiam in insula Tahiti.

86. *D. NUMMULARIA*, Lam., Encyc. Meth., iii. (1789), p. 231: Blume, Enum. Plant. Jav., i. (1827), p. 21 in part: Prain et Burkill in Elmer, Leaflets of Philippine Bot., v. (1913), p. 1599. *D. glabra*, Koorders in Mededeel. van s'Lands Plantentuin, xix. (1898), p. 312. Celebes, the Moluccas, Philippine islands, New Guinea, and across the Torres Straits to Prince-of-Wales Island. *D. nummularia* replaces *D. pyrifolia* in Eastern Malaya, apparently being as common there as *D. pyrifolia* is in Western Malaya. *D. pyrifolia* and *D. nummularia* for the most part are distinguished without difficulty by their leaves, having different venation.

Variat:—

Var. VERA. *Capsulæ* haud glaucæ.

Var. GLAUCA. *Capsulæ* plus minusve glaucæ.

Varietas VERA late repanda. Varietas GLAUCA reperitur in Luzon (Elmer, 5638! Hallier!).

87. *D. MERRILLII*, Prain et Burkill in Elmer, Leaflets of Philippine Bot., v. (1913), p. 1598. A species of the alliance of the preceding six, which has coriaceous leaves. It has been collected by Merrill on Mount Halcon in Mindoro, and by Elmer on Mount Apo in Mindanao, Philippine islands.

88. *D. GRATA*. A slender species of the Philippine islands, so far only collected by Loher at Montalban in Luzon.

D. GRATA. *Tuber* ignotum. *Caules* tenuissimi, glabri, parum striati, 1 mm. diametro. *Folia* alterna, lineari-lanceolata, æqualiter versus apicem attenuata, ad 8 cm. longa, ad 8 mm. lata, glabra, 5-nervia: area media a nervorum lateralium paræ primo terminata lineari-lanceolata: venæ secundariæ in rete indistinctæ; petiolus glaber, tenuis, 1.5 cm. longus. *Flores maris* ad 20 in spicas foliis breviores dispositi: axes rosei, parum angulati, glabri, ad 25 mm. longi: alabastro rosea, plus minusve triangulari-conoidea: bracteæ parvæ, 5 mm. longæ, reflexæ, ovatæ, acutæ. *Sepala* crassa, roseo-tincta, ovata, obtusa, 7.5 mm. longa. *Petala* minora, obovata, crassa. *Stamina* 6, petalis breviora: antheræ filamentis æquilongæ. *Flores fœminei* in spicas solitarias dispositi. *Capsulæ* apice truncatæ, basi attenuatæ, ad 25 mm. longæ: alæ latæ, oblique rotundatæ, 20 mm. longæ, 15 mm. latæ.

INSULA LUZON PHILIPPINENSIVM. Ad Montalban in provincia Rizal insulæ Luzon, (Loher, 7012! 7017!).

89. *D. WATTII*, Prain et Burkill, in Journ. Asiatic Soc. Bengal, iv. (1908), p. 457. A wide climbing species of the

forests of Assam, and of the hills on either side of the Brahmaputra valley, as far west as Sikkim.

90. *D. GIBBIFLORA*, Hook. f., *Flor. Brit. Ind.*, vi. (1892), p. 294: Ridley, *Mat. Flor. Malay Penins.*, ii. (1907), p. 82. *D. glabra*, Wall., *Cat. Lith.*, (1832), No. 5105B, in part. Malay Peninsula, Java, Celebes and the Moluccas.

91. *D. FORDII*, Prain et Burkill, in *Journ. Asiatic Soc. Bengal*, iv. (1908), p. 450. *D. Batatas*, Benth., *Flor. Hongkong.*, (1861), p. 368, in part: C. H. Wright in *Journ. Linn. Soc. Bot.*, xxxi. (1903), p. 91. *D. glabra*, C. H. Wright, loc. cit. Hongkong and adjacent mainland.

92. *D. BELOPHYLLA*, Voigt, *Hort. Suburb. Calc.*, (1845), p. 652: Prain, *Bengal Plants*, ii. (1903), p. 1067. *D. deltoidea*, Stewart, *Punjab Plants*, (1869), p. 128, in small part. *D. deltoidea*, Baden-Powell, *Punjab Products*, i. (1868), p. 259, in part. *D. glabra*, Hook. f., *Flor. Brit. Ind.*, vi. (1892), p. 294, in part: Collett, *Flor. Simlensis*, (1902), p. 519. *D. sagittata*, Royle ex Voigt, *Hort. Suburb. Calc.*, (1845), p. 653. *D. sp.*, Aitchison, *Cat. Punjab and Sind Plants*, (1869) p. 148. A species demanding less rain than most of the others: met with along the Himalaya towards the west as far as the vale of Kashmir, and found also in the Salt Range: eastwards its distribution, as far as is known, terminates in Sikkim: southwards it occurs on hill crests as far as the Nilgiri Hills: once it has been obtained in the Khasia Hills.

93. *D. BELOPHYILLOIDES*, Prain et Burkill, in *Journ. Asiatic Soc. Bengal*, iv. (1908), p. 448. The eastern parts of subtropical China.

94. *D. LEPCHARUM*. A curious species which the Lepchas of Sikkim value as food.

D. LEPCHARUM. *Tubera* 2—4, divergentia, ex parte basali vix 1 mm. diametro 5—19 cm. longa clavata, apice rotundata, grisea: caro mollis, alba, esculenta. *Caules* inermes, glabri, striati vel subteretes. *Bulbillæ* nuces *Juglandis* æquantur. *Folia* glabra, nec marginata, opposita vel alterna, sæpe exacte cordata vel raro auriculis extensis subcordata, tenuia, ad 13 cm. longa, ad 8 cm. lata (sæpissime 10 cm. longa, 6 cm. lata) 7-nervia: area media a nervorum lateralium pare primo terminata elliptico-ovata: venæ secundariæ irregulariter suboblique trajectæ, supra indistinctæ, infra satis distinctæ: petiolus ad 10 cm. longus, sæpissime folio æquilongus. *Flores* maris ad 40 in spicas 15—20 mm. longas binas ad axillas bractearum oppositarum dispositi: spicæ ipsæ in ramos aphyllis compositæ: axis conspicue angulatus, glaber: bracteæ triangulari-ovatae, reflexæ, acuminatae, longæ: bracteolæ similes nisi breviores. *Alabastra* obovoidea. *Sepala* obovata basi lata, crassa, 1.25 mm. longa. *Petala* obovata, basi angusta, sepalis paululo minora, crassa. *Stamina* 6: antheræ filamentis duplo mino-

res. *Flores* fœminei ad 20 in spicas dependentes ad 25 cm. longas dispositi: axis angulatus, glaber: bractee late ovate, tenues. *Sepala* triangularia, crassa, obtusa, 1.5 mm. longa. *Petala* obovata, apice rotundata. *Staminodia* minuta. *Capsula* pedicello 8 mm. longo incluso 22 mm. longa, apice retusæ: ala multo latiores quam semicirculares, 20 mm. longa, 18 mm. lata, pergamentacea, subgrisea. *Semina* loculo conformia: ala rufo-fumea

INDIA.—In montibus Himalaicis orientalibus ad 3000 ped. alt., in regionibus sub-montanis Bengalensibus Assamicisque Birmanicisque. In locis plurimis districtus Darjœling, e.g. Ryang (*Ribu!* *Kali!* *Russell!*). Rebong (*Kali!*), Silake (*Ribu!*), Mungpu, (*Hartless, 9!* *Gage, 34214!* 34216! *Ribu, 34207!*), Sureil (*Gage, 34207!*). Labdah (*Russell!*), Gielle Kola (*Russell!*), Pashok (*Lister!*), Tunkling (*Lister!*), Mungwa (*Lister!*). In montibus Aborum ad Sissin, Kekarmonnying, castra Rengging, ad flumina Yambung et Egar (*Burkill, 37680!*). In planitie districtus Jalpaiguri ad Madarihat, (*Burkill, 32352!* *Kalka Pershad, 33560!*). In districtu Nowgong, Noncurbit (*Simons!*), Lunding (*Burkill, 35304!*). In districtu Lakhimpur, ad Niagaon prope Dibrugarh, (*Burkill, 32611!*), ad Sadiya (*Burkill, 35769!* 32666!), ad Saikhowa (*Burkill, 35797!*), ad Kobo (*Burkill, 35905!* 35906!). In districtu Cachar prope Hafflong (*Ballantine, 31878!*). In districtu Bhamo, prope Bhamo (*Burkill, 22843!* 26538!).

Variat:—

Var. VERA. *Folia* tenuia. Alæ capsularum æqualiter rotundatæ. *Planta* sicca sine colore rubra. *Vide supra.*

Var. BHAMOICA. *Folia* paululo firmiora. Alæ capsularum obliquæ. *Planta* sicca rufescens.

Varietas BHAMOICA adhuc reperta est in districtu Bhamo, Burmæ boreali, prope Bhamo (*Burkill, 22808!* 22814! 22820! 22822! 22824! 22825! 22828! 22829! 22831! 22842!) ubi crescit cum *D. Hamiltonii*: et forsan ejusdem hybrida sit.

95. *D. GLABRA*, Roxb., Hort. Beng., (1814), p. 72, name only; and Flor. Ind., iii. (1832), p. 803: Hook. f., Flor. Brit. Ind., vi. (1892), p. 294, in chief part. *D. crepitans*, Ham. in Wall., Cat. Lith., (1832), No. 5105 F. *D. gracillima*, Ridley in Engl. Bot. Jahrb., xliv. (1910), p. 528. *D. laurifolia*, Curtis, Flowering Plants and Ferns of Penang, (1894), p. 83. *D. oppositifolia*, Ridley and Curtis, in Journ. Roy. Asiatic Soc., Straits Br., xxxviii. (1902), p. 66. *D. nummularia*, Roxb., Hort. Beng., (1814), p. 72, name only, and Flor. Ind., iii. (1832), p. 72. *D. salicifolia*, Blume, Enum. Plant. Jav., i. (1827), p. 23, inadequately described. *D. Wallichii*, Hook. f., Flor. Brit. Ind., vi. (1892), p. 295, in small part. India, south of the Ganges in the moister parts, the Himalaya from Central Nepal eastwards, the plains of Bengal, and Assam, in Burma, Siam. Indo-China, the Malay Peninsula and the Malay Islands eastward to Java.

Variat:—

Var. GRISEA. *Folia* ovata, siccitate infra grisea, velutina.

Var. SALICIFOLIA. *Folia* lineari-lanceolata vel lanceolato-sagittata, subcoriacea, siccitate infra grisea.

Var. HASTIFOLIA. *Folia* lineari-lanceolata, basi abrupte hastata, subcoriacea.

Var. VERA. *Folia* ovata, tenuia, infra glaucissima, siccitate rufescentia.

Var. LONGIFOLIA. *Folia* lanceolato-ovata, ad 12 cm. longa, ad 4 cm. lata.

Var. TENUIFOLIA. *Folia* lineari-lanceolata vel lanceolato-sagittata tenuissima.

Varietas GRISEA in Tenasserim, et per Peninsulam Malaicam et raro in insulis Sumatra Javaque reperitur, ubi versus *D. pyriformis* transitum præbet. Varietas SALICIFOLIA est *D. salicifolia*, Blume, et *D. gracillima*, Ridley: in iisdem regionibus reperitur, nec non in Borneo. Varietas HASTIFOLIA Andamanica est (Rogers, 278!). Varietas VERA per Indiam occurrit, nec non in Indo-China et regno Siam. Varietas LONGIFOLIA reperitur in China australi (Henry, 13540!), et in Indo-China (Balansa, 298! 301! Thorel, 287!). Varietas TENUIFOLIA burmanica est (Kurz, 2631! Burkill, 22656!).

96. *D. VEXANS*, Prain et Burkill, in Journ. Asiatic Soc. Bengal, iv (1908), p. 446. Andaman islands where it generally replaces the common Indian *D. glabra*.

97. *D. BREVIPETIOLATA*. Apparently common in Indo-China.

D. BREVIPETIOLATA. *Tuber* ignotum. *Caules* asperi, glabri, striati. *Folia* ovata, acuminata, opposita, glabra, marginata, ad 10 cm. longa, ad 3.5 cm. lata, 5-nervia: area media a nervorum lateralium parte primo terminata anguste obovato-elliptica: venæ secundariæ interrupte trajectæ, parum conspicuæ: petiolus brevis, 1 cm. longus. *Flores* maris in spicas 1 cm. longas dispositi: spicæ ipsæ in ramos aphyllous longos compositæ: axis zigzag, glaber, angulatus: bractæ ovatæ, acuminatæ, rufo maculatæ: bracteolæ similes, minores. *Alabastra* subglobosa. *Sepala* ovato-rotunda, obtusissima, 1.25 mm. longa, copiose rufo lineolata. *Petala* multo minora, crassiora, obovata, .75 mm longa. *Stamina* 6, petalis æqualia: antheræ filamenta æquantia. *Flores* femininæ in spicas singulas vel binas dispositi: spicæ ipsæ in ramos aphyllous breves compositæ: bractæ ovato-lanceolatæ, acutæ. *Sepala* triangulari-ovata, crassa. *Petala* suborbicularia, breviora. *Staminodia* perminuta. *Capsulæ* parvæ, glabræ, breviter pedicellatæ, supra cordatæ: alæ latiores quam semicirculares, 15 mm. longæ, 13 mm. latæ, pallide rufo-asperæ.

COCHIN-CHINA INFERIOR, ET CAMBODIA, ET SIAM. In provincia Bienhoa Cochinchinensi ad Vri-an, (Lecompte & Finet, 1982!), ad Cayiong, (Pierre, 7000!), ad Tay-ninh, (Pierre, 6697!). In provinciæ Baria monte Dinh, (Pierre, 6698!). Ad Phanrang, (Lecompte & Finet, 1485!), ad Ou-yiem, (Lecompte & Finet, 1926!). In insula Pulu Condore, (Germain, 49!). In insula Phu-quoë Cambodiensi ad Dabac, (Godefroy, 849!). Ad Nang-kaw, Sriracha, in litore siamensi, Kerr, 2047!). Typi præcipue in herbario ad Lutetias Parisiorum, necnon ad Kew conservantur.

98. *D. BENTHAMII*, Prain et Burkill, in Journ. Asiatic Soc. Bengal, iv. (1908), p. 449. Hongkong.

99. *D. MYRIANTHA*, Kunth, Enum., v. (1850), p. 382. *D. filiformis*, Blume, Enum. Plant. Jav., i. (1827), p. 22, very inadequately described. *D. salicifolia*, Uline in Mededeel. van s' Lands Plantentuin, xix. (1908), p. 312. Java, Celebes, the Moluccas and the Philippine islands.

100. *D. PERSIMILIS*, Prain et Burkill, in Journ. Asiatic Soc. Bengal, iv. (1908), p. 454. South-western China, south-eastern China and Tonkin.

101. *D. HAMILTONII*, Hook. f., Flor. Brit. Ind., iv. (1892), p. 295, in chief part: Prain, Bengal Plants, ii. (1903), p. 1067. *D. acutangula*, Ham. in Herb. Wall. *D. acutanguliflora*, Steud. in Herb. Ind. Or. Hohenacker. *D. Hookeri*, Prain in Records Bot. Survey Ind., ii. (1902), p. 143. In the moister parts of India, e.g. Sikkim, Assam, northern Burma, Arakan, the Shan plateau and Tenasserim, also in the Circars and Orissa and in the Western Ghats from North Kanara to Travancore. In the Flora of British India it has not been clearly distinguished from the following species.

102. *D. ALATA*, Linn., Spec. Plant., (1753), p. 1033. *D. atropurpurea*, *D. globosa*, *D. purpurea* and *D. rubella*, Roxb., Flor. Ind., iii. (1832), pp. 797-800. *D. Bicantaca*, *D. Devipata*, *D. Hurchusia* and *D. octangularis*, Ham. in Herb. Wall. Cultivated throughout the Tropics, wherever the rainfall is sufficient. It is certainly of eastern origin and was perhaps derived from *D. Hamiltonii*. In the Western Himalaya races exist, here classed under var. *Tarri*, which appear as if *D. belophylla* may possibly enter their composition. A plant widely cultivated is commonly polymorphic as regards the parts subjected to man's influence; and *D. alata* is no exception: it shows a great variety of forms of tuber. Roxburgh sub-divided the species by the shape of the tuber and by their colour, knowing only those which are commonly cultivated in Lower Bengal: and Hamilton followed Roxburgh's lead. Wider knowledge makes it inconvenient to maintain Roxburgh's and Hamilton's species even as varieties. *D. alata* sometimes flowers and very rarely fruits. It readily persists in a wild state in moist regions after the desultory cultivation of jungle tribes, maintaining itself by means of its tubers: naturally it is the deeper rooting races which most of all persist, the others being soon grubbed up by wild animals.

Variat:—

Var. *TARRI*. *Venæ* in pagina inferiore foliorum conspicuæ.

Var. *VERA*. *Venæ* minus conspicuæ.

Varietas *TARRI* colitur in Kamaon et in partibus adjacentibus montium Himalaicorum.

103. *D. LAURIFOLIA*, Wall., Cat. Lith., (1832), no. 4111: Hook. f., Flor. Brit. Ind., vi. (1892), p. 293. *D. oppositifolia*, Curtis, Flowering Plants and Ferns Penang, (1894), p. 83. Malay Peninsula, being common in the island of Singapore.

104. *D. HAVILANDII*. *D. cornifolia*, Ridley, Mat. Flor. Malay Penins., ii. (1907), p. 81, as regards the fruit only.

Borneo, in Sarawak. A coriaceous ally of the preceding species.

D. HAVILANDII. *Tubera* ignota. *Caules* glabri, nisi basi inermes, obtuse angulati, virides vel rufo-virides, dextrorsim volubiles. *Folia* alterna, glabra, satis coriacea, latissime elliptica vel fere orbiculata, apice abrupte acuminata, basi plus minusve cordata, supra nitentia nervis venisque modice prominentibus, infra nervis modice prominentibus, ad 10 cm. longa, ad 7 cm. lata, 5-nervia: area media a parte primo nervorum lateralium terminata late obovata: venæ secundariæ trajectæ, sed inter rete parum conspicuæ: petiolus ad 5 cm. longus. *Flores maris* in spicas erectas 6 cm. longas fasciculatas dispositi: spicæ ipsæ in ramos aphyllis dependentes ad 70 cm. longos productæ: axis angulatus, glaber: bracteæ ovatæ, acuminatæ, ad axin repressæ, deinde ecurvatæ: bracteolæ similes, multo minores. *Alabastra* subovoidea. *Sepala* basi lata ovata, apice rotundata, rufo-brunnea, 1 mm. longa. *Petala* satis crassa, carinata, sepalis paululo breviora. *Stamina* 6, biserialim in basin floris inserta: filamenta 3 mm. longa: antheræ paululo longiores. *Flores feminei* ignoti.

INSULÆ MALAICÆ OCCIDENTALES.—Borneo, haud procul a Kuching in principatu Sarawak, (*Haviland*, 1816!), et sine loco, (*Ridleyi mercenarius*, 154! *Merrillii mercenarius*, 310! 386! 842!). Billiton, (*Riedel*!) Banca, (*Horsfield*!).

105. *D. WARBURGIANA*, Uline ex Koorders, in Mededeel. van s'Lands Plantentuin, xix. (1898), p. 313, name only: Prain et Burkill, in Journ. Asiatic Soc. Bengal, iv. (1908), p. 456. Celebes.

106. *D. DEFLEXA*, Hook. f., Flor. Brit. Ind., vi. (1892), p. 293: Ridley, Mat. Flor. Malay Penins., ii. (1907), p. 83. ? *D. repanda*, Blume, Enum. Plant. Jav., i. (1827), p. 22. Malay Peninsula, Sumatra and Java.

Section 8.—STENOCOREA.

107. *D. STENOMERIFLORA.* A curious species occurring in the Malay Peninsula, with stamens showing an obvious affinity to the genus *Stenomeris*. The only male plant seen by us is preserved in the British Museum of Natural History, South Kensington. Another bridge between *Dioscorea* and *Stenomeris* seems to be found in the climbing species of the latter genus described by Taubert in Engl. Bot Jahrb. Beibl. no. 38 as of uncertain origin, but most probably obtained in the Philippine islands.

D. STENOMERIFLORA. *Tuber* ignotum. *Caulis* glaber, inermis nisi basi, crassiusculus, striatus, purpureo-viridis, scandens ad 80 ped. alt., dextrorsim volubilis. *Folia* alterna, coriacea, glabra, elliptica, apice abrupte acuminata, infra modice cordata vel majora sagittata barbibus rotundatis, ad 28 cm. longa, ad 11 cm. lata, 5-nervia: area media a parte primo nervorum lateralium terminata fere conformis folio ob propinquitate nervorum ad margines: venæ secundariæ oblique trajectæ, tere rectæ: margines plus minusve indurati: petiolus crassus, supra canaliculatus, ad 5 cm. longus. *Flores maris* in racemos spithameos

nunc axillares simplices solitarios vel binos nunc in ramos breves aphyllolos producti: axis glaber: bracteæ ovato-lanceolatae, 1 mm. longæ. *Perianthii maris* tubus 1 mm. longus. *Sepala* triangulari-ovata, obtusa, rufo-maculata. *Petala* sepalis æquilonga, ovata, obtusa, rufo-maculata. *Stamina* 6: filamenta supra basin multum incrassata, dein incurvata: antheræ introrsæ, fere didymæ. *Flores fœminei* in racemos dependentes 30 cm. longos singulos vel binos vel ternos axillares dispositi: axis glaber, conspicue angulatus: bracteæ lanceolato-ovatae, scariæ, rufo-brunnæ, ad 1.5 mm. longi: pedicelli 5 mm. longi. *Perianthium* viridiluteum: tubus 1 mm. longus, externe 6-carinatus. *Sepala* 3 mm. longa, anguste ovata, subacuta, apice patula rufo-maculata. *Petala* lanceolata, sepalis paululo breviora, colore similia. *Staminodia* biserialim in basin floris inserta, majora ante petala, minora ante sepala: filamenta infra manifeste incrassata, apice supra antheras steriles in acumine breve producta. *Capsula* in æstivatione 5 mm. longæ: loculi 2-ovulati.

PENINSULA MALAICA.—Perak, Larut ad 2000 ped. alt., (*mercenarius Kingii*, 4160! 5152! 6693! 6746!). Selangor, Batu Tiga, (*Ridley*!). Singapore Island, Changi, (*Ridley*!). Species distinctissima, propter antheras cornutas inter genera *Dioscoream* et *Stenomeredem* quasi medians. *Perianthii* tubus floris fœminei inter *Dioscoreas* orientales notabilis est.

UNPLACED.

DIOSCOREA DELETERIA, Noronha in Verh. Bat. Genootsch., v. (1790) ed. 1, art. 4, p. 13

DIOSCOREA GOERINGIANA, Kunth, Enum., v. (1850) p. 402.

DIOSCOREA POLYSTACHYA, Turcz. in Bull. Soc. Nat. Mosc. 1837, No. vii., p. 158.

DIOSCOREA VILIS, Kunth, Enum. v. (1850), p. 400.

3. The Localisation of certain Hymns of the Rigveda.

By MAHĀMAHOPĀDHYĀYA SATIS CHANDRA VIDYĀBHŪṢANA,
M.A., PH.D.

It is generally held that the hymns of the Rigveda were composed while the Aryans, in the course of their south-eastern journey, still lingered in Eastern Kabul and the Punjab. We must modify this theory in the light of some verses of the Rigveda which refer to the old kingdom of Videha comprising the modern district of Darbhāngā. It is stated in the verses that a certain natural well was bodily transplanted by the Marut-gods and placed before a thirsty sage named Gotama. The water gushing out from the well is said to have quenched the sage's thirst, and formed itself into a river, the source of which was the seat of the original well. One of the verses referred to runs as follows :—

जिह्वं नुनुद्रेऽवतं तथा दिशासिंचन्नुत्सं गोतमाय तृष्णजे ।

आगच्छन्तीमवसा चित्रभानवः कामं विप्रस्य तर्पयन्त धामभिः ॥ ११ ॥

(Rigveda, maṇḍala 1, sūkta 85).

It has been translated by Wilson¹ thus :—

They brought the crooked well to the place (where the *muni* was), and sprinkled the water upon the thirsty Gotama. The variously radiant (Maruts) come to his succour, gratifying the desire of the sage with life-sustaining (waters).

In the commentary on the Rigveda (maṇḍala 1, sūkta 85, verse 10), Sāyaṇa relates the story of the well in a passage quoted below :—

अत्रेयमाख्यायिका । गोतम ऋषिः पीपासया पीडितः सन् मरुत उदकं यथाचे । तदनन्तरं मरुतोऽदूरस्थं कूपमुद्भृत्य यत्र स गोतम ऋषि-
न्तिष्ठति तां दिशं नीत्वा ऋषिसमीपे कूपमवस्थाप्य तत् पार्श्वं आहावं
च कृत्वा तस्मिन्नाहावे कूपमुत्सिच्य तमृषिं तेनोदकेन तर्पयांचक्रुः ॥
अथमर्थोऽनया उत्तरया च प्रतिपाद्यते ॥

The passage may be translated as follows :—

“The sage Gotama afflicted with thirst prayed for water of the Maruts who raising aloft a well from a little distance carried the same to the place where the sage resided. They caused delight to the sage by preparing a reservoir which

¹ Wilson's translation of the Rigveda, page 221.

was filled with water flowing from the well placed before him.”

This natural well of the vedic verse tallies accurately with an actual well called Gotama-kunḍa which is situated 28 miles north-east of the modern town of Darbhāṅgā in Behar. I visited it in October last. It feeds a perennial rivulet called Kṣirodadhi (generally called Khiroi) which issues from the gorges in the Nepal terai. A mud-hill called Gotama-sthāna, in the vicinity of the well, represents the place where Gotama of the vedic verse, resided.

Another verse of the Rigveda mentions four rivers, which are Indra's special gifts to the sons of Gotama. The verse runs thus :—

तदु प्रयत्नतमस्य कर्म दस्यस्य चाहृतममस्ति दंसः ।

उपह्वरे यदुपरा अपिन्वन्मध्वर्णसो नद्यश्चतस्रः ॥ ६ ॥

(Rigveda, maṇḍala 1, sūkta 62).

“The deeds of that graceful Indra are most admirable; his exploits are most glorious, in that he has replenished the four rivers of sweet water, spread over the land.”¹

The four rivers mentioned in the vedic verse seem to correspond to the Kauśiki, Vāṅmatī, Kamalā and Gaṇḍaka which intersect the district of Dār bhāṅgā.

It is further stated in the Rigveda that Gotama was the priest² of the royal family of Kuru-srñjaya for whose victory in battle he prayed to Indra. This statement harmonises well with the account of a certain member of the Gotama family named Śatānanda,³ priest of the royal family of Janaka in Mithilā (Dār bhāṅgā).

¹ Here “land” is substituted for “surface of the earth” in Wilson's translation.

² रङ्गमणुषो गीतमः कुरुसृञ्जयानां राज्ञां पुरोहित आसौत् । तेषां राज्ञां परैः सह यद्दे सति स ऋषिरनेन हृत्तेन इन्द्रं सुत्वा स्वकीयानां जयं प्रार्थयामासेति । तस्य च पुरोहितत्वं वाजसनेयिभिरान्नातम् । गीतम इ वै रङ्गमण उभवेषां कुरुसृञ्जयानां पुरोहित आसौत् ॥

(Rigveda, maṇḍala 1, sūkta 81, verse 3, Sāyaṇa's Commentary).

विदेषो च माथवोऽग्निं वैश्वानरं मुखे वभार ।

तस्य गीतमो रङ्गमण ऋषिः पुरोहित आस ॥

(Śatapatha Brāhmaṇa of the White Yajurveda, Kāṇḍa 1, adhyāya, Mādhyandiniya recension).

³ शतानन्दः पुरस्कृत्य पुरोहितमनिन्दितः ।

प्रतिगृह्य तु तां पूजां जनकस्य महात्मनः ॥

(Rāmāyaṇa, ādikāṇḍa, sarga 50).

गीतमस्य शतानन्दो जनकानां पुरोहितः । (Uttara-Rāmacaritam).

The fields waving with paddy plants which greet the eyes of a modern traveller near and round Gotama-sthāna in Dār-bhāngā bear testimony to Agni's gift of rice and cattle in abundance to the family of Gotama described in the Rigveda.¹

The above facts lead me to conclude that the hymns of the Rigveda continued to be composed even while the Aryans advanced to the east as far as the river Kauśikī at the eastern boundary of Dār-bhāngā included in the ancient kingdom of Videgha or Videha with its capital at Mithilā.

¹ त सुत्वा मोतमो गिरा रायस्कामो दुवस्यति । द्युञ्जैरभि प्र णोनुमः ॥ २ ॥
(Rigveda, maṇḍala 1, sūkta 78.)

4. A new species of *Diospyros* from the Tinnevelly Hills.

By M. S. RAMASWAMI, M.A. (formerly Government Postgraduate Research Scholar in Botany, Presidency College, Madras); Officiating Curator of the Herbarium, Royal Botanic Garden, Calcutta.

[With Plates III-IV.]

In February 1913, in accordance with instructions from Major A. T. Gage, I.M.S., Director of the Botanical Survey of India, a Botanical collection was made by Mr. D. Hooper and myself in the Tinnevelly hills. In working out this collection at the Calcutta Herbarium, I had occasion to examine all the Herbarium specimens of *Diospyros* and discovered that two sheets marked simply '*Diospyros*' (Kannikatti, Tinnevelly. Nos. 2951, 2960, Barber) exactly matched one of my numbers in the present collection. These sheets, as the records in the Calcutta Herbarium show, were sent for comparison to Kew by Mr. W. W. Smith, formerly Curator of the Calcutta Herbarium, and were declared there to be unmatched ones. As my specimens contained only female flowers, and the two sheets were incomplete, I was anxious to obtain fuller material. I therefore requested Mr. K. Rangachari of the Madras Agricultural College, Coimbatore, to send me on loan the original sheets corresponding with the two duplicates above mentioned. He very kindly acceded to my request. On examination of all these sheets, I concluded that a fairly distinct and hitherto undescribed species existed, a description of which I proceed to give below:—

DIOSPYROS BARBERI, *Ramaswami*, sp. nov. Species *D. foliolosa*, *Wall.* et *D. Ebenum*, *Koenig.* affinis; Calycis late crateriformis, lobis subito-acutus in fructu late triangularis distinguenda.

Arbor; ramuli teretes, juniores puberuli; *Folia* alterna, densissima, oblonga vel oblongo-lanceolata, apice obtusa, caudato-acuminata, basi cuneata vel rotundata, 3.17 cm.—8.25 cm. longa, 1.27 cm.—2.22 cm. lata, margine integra, coriacea, glabra, subtus puncticulata; nervis primariis 6—9 paribus, obliquis, distincte reticulatis; *Fl.* ♂ 2—3 fasciculati, sub-sessiles, pedunculi 5.1 mm.—6.3 mm. longi. *Calyx* campanulato-tubulosus, 3.2 mm.—4.2 mm. longus, rugulosus sub-truncatus supra sparsus; *Dentes* 4, breves, obtusi, ciliolati. *Corollae* tubus, 6.3 mm. longus, glaber; lobi 4, 3 mm. longi, carnosii, dextrorsum contorti; *Antherae* geminae, 16, plus minus lineares glabrae, filamenta breviora, connectivo apiculatae. *Fl.* ♀ solitarii,

pedunculi 9·5 mm.—14·3 mm. longi, apice crasse articulati. *Calyx* magnus, late crateriformis, lobi 4, late triangulares, 4·2 mm. longi, 6·3 mm. lati. *Staminodia* 4, apice crasse. *Ovarium* 4-loculare, 4-ovulatum; stylus brevissimis stigmatibus 4-lobatus; lobi calycis in fructu 16·9 mm. lati, 10·5 mm. longi. Fructus imperfectus.

A tree. *Bark* greyish-black, rough. *Young branches* puberulous. *Leaves* alternate, close-set, oblong or oblong-lanceolate, apex obtusely caudate-acuminate, base cuneate or rounded, $1\frac{1}{4}$ in.— $3\frac{1}{4}$ in. long, $\frac{1}{2}$ in.— $\frac{7}{8}$ in. broad, entire, coriaceous, glabrous, under-surface punctulate. Primary nerves 6 to 9 pairs, oblique, those of the upper half reaching the apex, reticulations distinct on both sides, faint only on the under surface in small leaves. *Petiole* $\frac{1}{8}$ in.— $\frac{1}{2}$ in. long, wrinkled. *Male flowers*. 2—3 together, almost sessile, articulate with and fascicled on, short axillary peduncles $\frac{1}{3}$ in.— $\frac{1}{2}$ in. long. *Calyx* campanulate-tubular, $\frac{1}{2}$ in.— $\frac{1}{3}$ in. long, rugulose, nearly truncate, 4-toothed, sparsely hairy without and on the margins. Teeth obtuse, ciliolate. *Corolla buds* narrow, tubular, $\frac{1}{2}$ in. long, covered half-way by the calyx, glabrous. Lobes 4, reaching half-way down, $\frac{1}{2}$ in. long, fleshy, twisted to the right. *Anthers* paired, 16, more or less linear, glabrous, filaments very short, connective produced. *Female flowers* solitary, peduncled, peduncle $\frac{3}{8}$ in.— $\frac{1}{2}$ in. long, thickened and articulate at the top. *Calyx* considerably larger than the male one, broadly crateriform, 4-lobed, lobes reaching half-way down, broadly triangular and abruptly acute, $\frac{1}{2}$ in. long, $\frac{1}{2}$ in. broad. *Corolla* nearly as in ♂. *Staminodes* 4, thickened towards the top. *Ovary*, when young, covered with brown powdery excrescences, completely concealed by the calyx, 4-celled, cells 1-ovuled. *Style* very short. *Stigmas* 4. *Fruiting calyx* much enlarged, lobes $\frac{1}{2}$ in. long, $\frac{2}{3}$ in. broad. *Fruit* imperfect.

TINNEVELLY HILLS: Kannikatti, Nos. 2946, 2948, 2951 and 2960, 2500 ft., Barber; Kannikatti, towards Agastiyamalai, No. 39438, 2650 ft., Hooper and Ramaswami.

This species appears to occupy an intermediate position between *D. foliolosa*, Wall. and *D. Ebenum*, Koenig. It differs from *D. foliolosa*, Wall. in the almost sessile, smaller male flowers fascicled on short peduncles and in the broadly crateriform calyx with much shorter and broader triangular lobes while it also differs from *D. Ebenum*, Koenig, in its larger pedicelled female flowers, 4-celled and 4-ovuled ovary and in the form and disposition of the lobes of the fruiting calyx.

So far as known at present, the plant appears to be restricted to the Tinnevelly hills. The specific name is given in honour of Dr. C. A. Barber who collected this plant in 1901, and who has made several botanical collections in Sou-

thern India. My sincere thanks are due to Mr. C. C. Calder, Officiating Director of the Botanical Survey of India, for having checked my Latin diagnosis, and also to Mr. K. Rangachari, for having supplied me with the desired specimens.

EXPLANATION OF PLATES.

PLATE III.

Diospyros Barberi, <i>Ramas.</i> , sp. nov. ♂	
A. Part of plant, nat. size.	
B. Flower-bud,	× 2
C. Calyx, spread out,	× 3
D. Corolla, with stamens,	× 3
E. & F. Stamens,	× 3
G. A single anther,	× 6

PLATE IV.

Diospyros Barberi, <i>Ramas.</i> , sp. nov., ♀	
H. Part of plant, nat. size.	
I. Ovary and Staminodes,	× 2
J. & K. Fruiting Calyx,	× 2
L. Transverse section of Ovary,	× 4

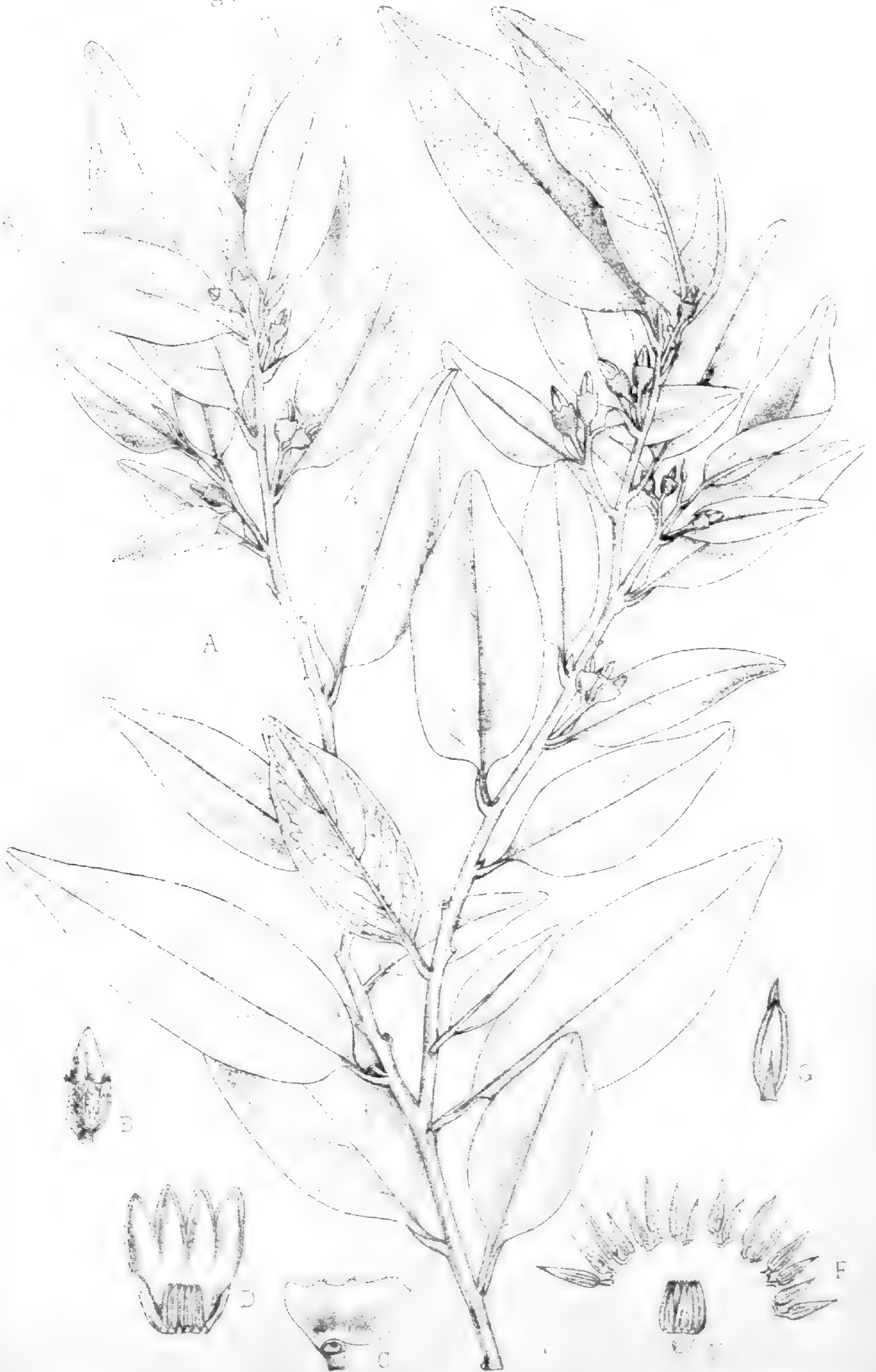

A N B del

A C Chowdhary, lith.

DIOSPYROS BARBERI Ramas. sp. nov. ♂





A.N.B. del.

A.C. Chowdhary, lith.

DIOSPYROS BARBERI Ramas- sp. nov. ♀

5. On a Demonstration Apparatus for determining Young's Modulus.

By GOURIPATI CHATTERJEE.

This apparatus was primarily designed for showing qualitatively to a class the elongation of metallic wires when loaded. Later on it was found to be sufficiently accurate for use as a demonstration apparatus with which load-elongation curves could be actually plotted before an audience, and values of Young's Modulus obtained rapidly to within 1%, provided the radius of the wire was determined with the usual precautions. The use of an optical method for finding Young's Modulus is not new and was used by Bottomley,¹ Ewing, and others, but the apparatus designed by those observers was very much more elaborate than the one here described and was intended for accurate laboratory determinations.

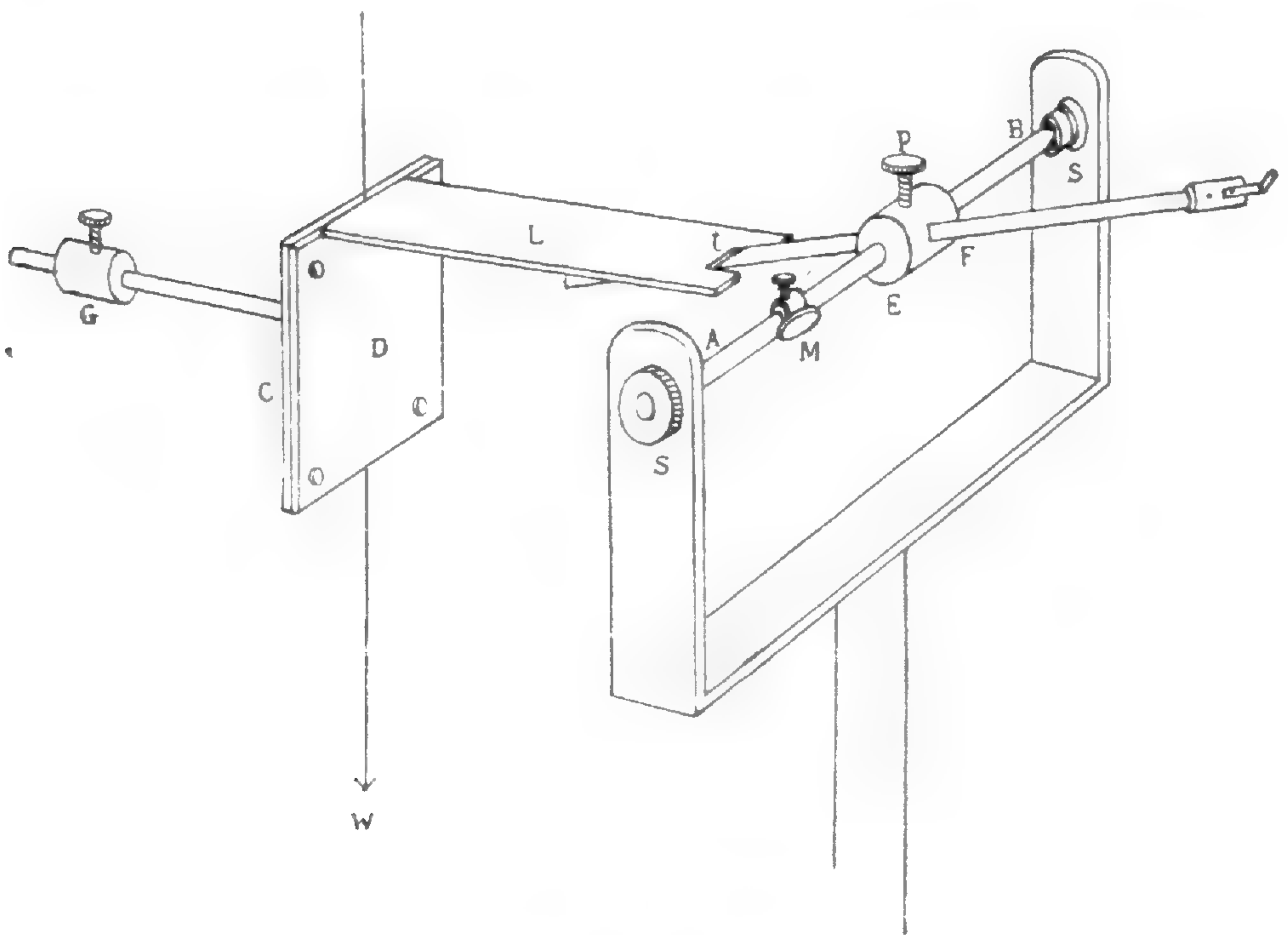

FIG. I.

¹ Phil. Mag. 889, Vol. 28, p. 94.

Description of the Apparatus.

The rod AB (Fig. I) which is of greater diameter between E and F is capable of turning with as little friction as possible between two screw bearings S, S'. In the middle of the portion EF is drilled centrally a hole through which passes a glass rod which can be clamped by means of the screw P. Between E and A is a collar which can be clamped in any position, and carries a concave mirror which throws an image of a spot of light on a distant vertical scale.

The left-hand portion of the apparatus (Fig. I) is the part which is clamped to the experimental wire. It consists of two brass plates C and D which can be fixed firmly to the wire by means of four screws. The plate D carries at right angles (as shown in the figure) a plate L. To the centre of the plate C and at right angles to it is soldered a rod carrying a sliding weight G which can be adjusted in any desired position on the rod and serves as a counterpoise. On the inner surface of the plate D is cut a very fine vertical groove in such a position that when C is clamped and G properly adjusted, the centre of gravity of the whole system lies in this groove. The groove is such that the wire passing along it is rigidly clamped when the four screws are made tight, but on loosening the screws the plates can be made to slide along the wire with just sufficient friction to support them, the groove guiding the plates vertically.

The glass rod is either clamped at a point some distance from its centre or is slightly weighted at one end, so that its centre of gravity lies to the right-hand side of P. Thus it always presses against a steel knife edge fixed at the edge of a slit *t*. As the wire elongates under a load *W*, the clamped plates descend, and the projecting piece descending vertically with them turns the rod about the axis S S', thereby rotating the mirror M. The spot of light which is received on a vertical scale is thus displaced upwards. (The magnification that can be obtained is as much as 200).

Uniformity of Magnification.

Preliminary experiments were made, to test whether the magnification was uniform over the scale. The clamped plates, detached from the wire, were made to descend vertically by a micrometer screw fixed relatively to the ground, thus turning the rod as in the previous case; the amount of descent being read off from the graduations of the screw and the deflection of the spot of light on the scale being noted, the magnification of the instrument could be determined. It was found by this method that when the scale is about two metres from the

[N.S.]

mirror the shift of the spot of light is nearly¹ proportional to the descent of the plates, through a fairly wide range of the scale, say from 10 to 90 cms, as shown in Table I. This proves that it is legitimate to use the apparatus for quantitative measurements so far as constancy of magnification is concerned.

TABLE I.

Descent of the plate L as measured by the micrometer screw.	Position of the spot of light on the scale.	Magnification.
0	7.9	0
.0484	15.0	146.7
.0968	22.1	146.7
.1452	29.2	146.7
.1936	36.3	146.7
.2420	43.4	146.7
.2904	50.55	146.8
.3388	57.60	146.7
.3872	64.8	146.9
.4356	72.0	147.1
.4840	79.1	147.1
.5324	86.4	147.4
.5808	93.8	147.8

Determination of the Magnification.

In determining the load-elongation curve for a metal and finding the value of Young's Modulus from the curve, the magnification of the instrument was found by a slightly different process to that described in the preceding paragraph. A length of wire is taken such that for the greatest elongation to be plotted the spot of light remains on the scale. The wire is suspended from a heavy rigid stand. At the other end of the wire is fixed a scale pan to carry weights, and vanes are attached to a length of thick wire which in turn is fastened underneath the scale pan, and dips into a vessel of water with the object of damping the oscillations of the system. The apparatus CD is lightly clamped to the wire, as described above, and the rest of the apparatus adjusted. The position of the spot of light is then noted, the plates made to descend through a known distance by sliding them down the wire² and the position of the spot of light again noted. This gives the magnification which can be determined easily to 1%. The plates are then clamped tightly in their former position, and readings of the spot on the scale taken for different loads in the pan.

¹ To 1% or 2%.

² This can be effected either by means of a reading microscope or by direct measurement with a pair of dividers.

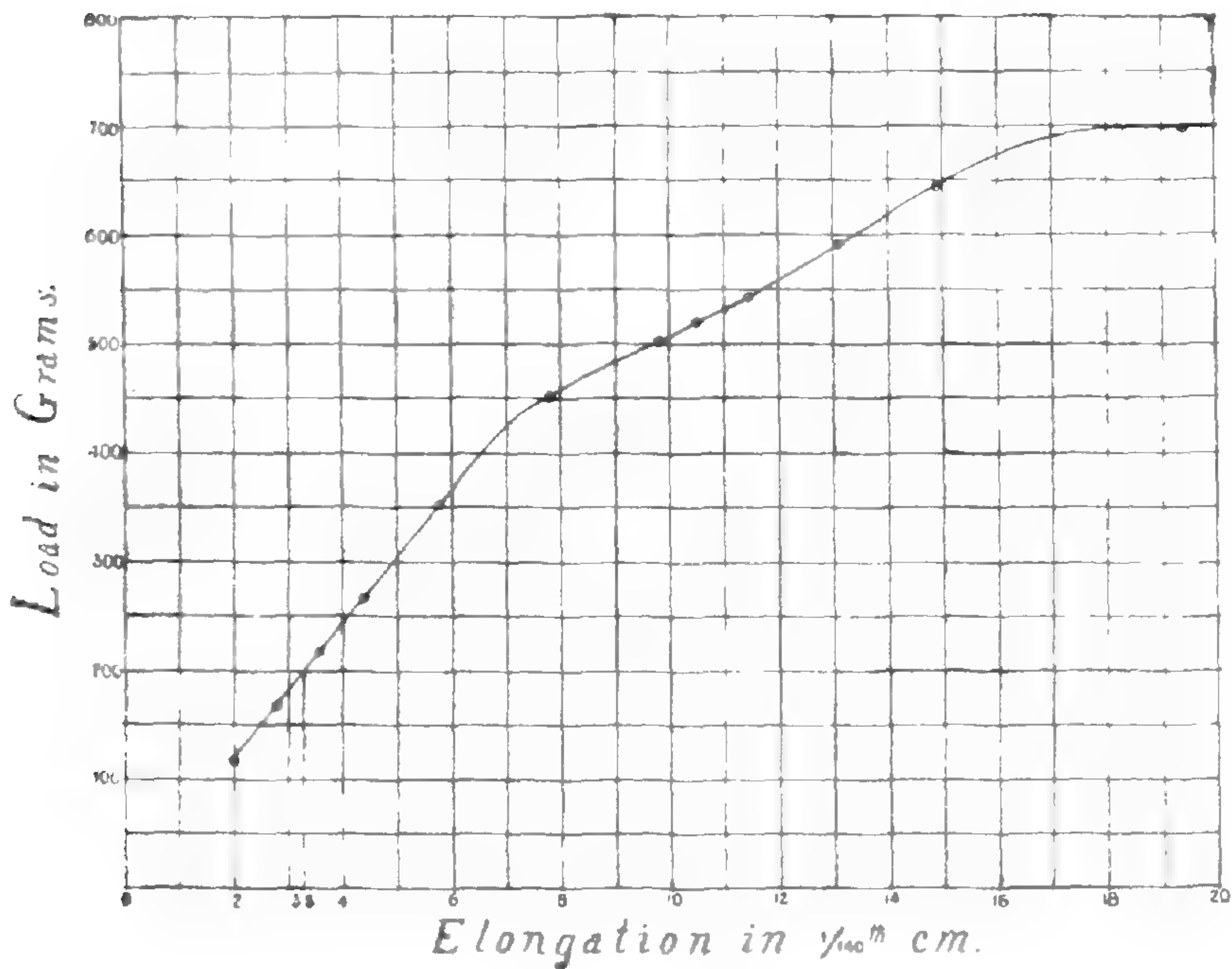

FIG. II.

Example of an Experiment.

The following are the observations made in determining the load-elongation curve of copper:—

Length of copper wire No. 30 B.W.G. ..	88.5 cms.
Diameter of the wire031 cm.
Magnification of the apparatus as arranged ..	140.

Load in grams.	Elongation \times 140 in cms.
118	2.0
168	2.8
218	3.6
268	4.4
352	5.8
452	7.8— (elastic limit exceeded)
502	9.8
522	10.5
542	11.5
592	13.1
644	14.9
700	18.2— (secular change begins)

The curve Fig. II shows the load-elongation curve for the specimen of copper wire, as obtained from the above observations. From the straight portion of the curve it is found that when the load is 200 grams the elongation is 3.3, 140 cm., whence the value of Young's modulus is found to be equal to $.94 \times 10^{12}$ dynes cm.^2 . The value obtained for the same specimen by the ordinary laboratory method (scale and vernier) was $.89 \times 10^{12}$ dynes/ cm.^2 .

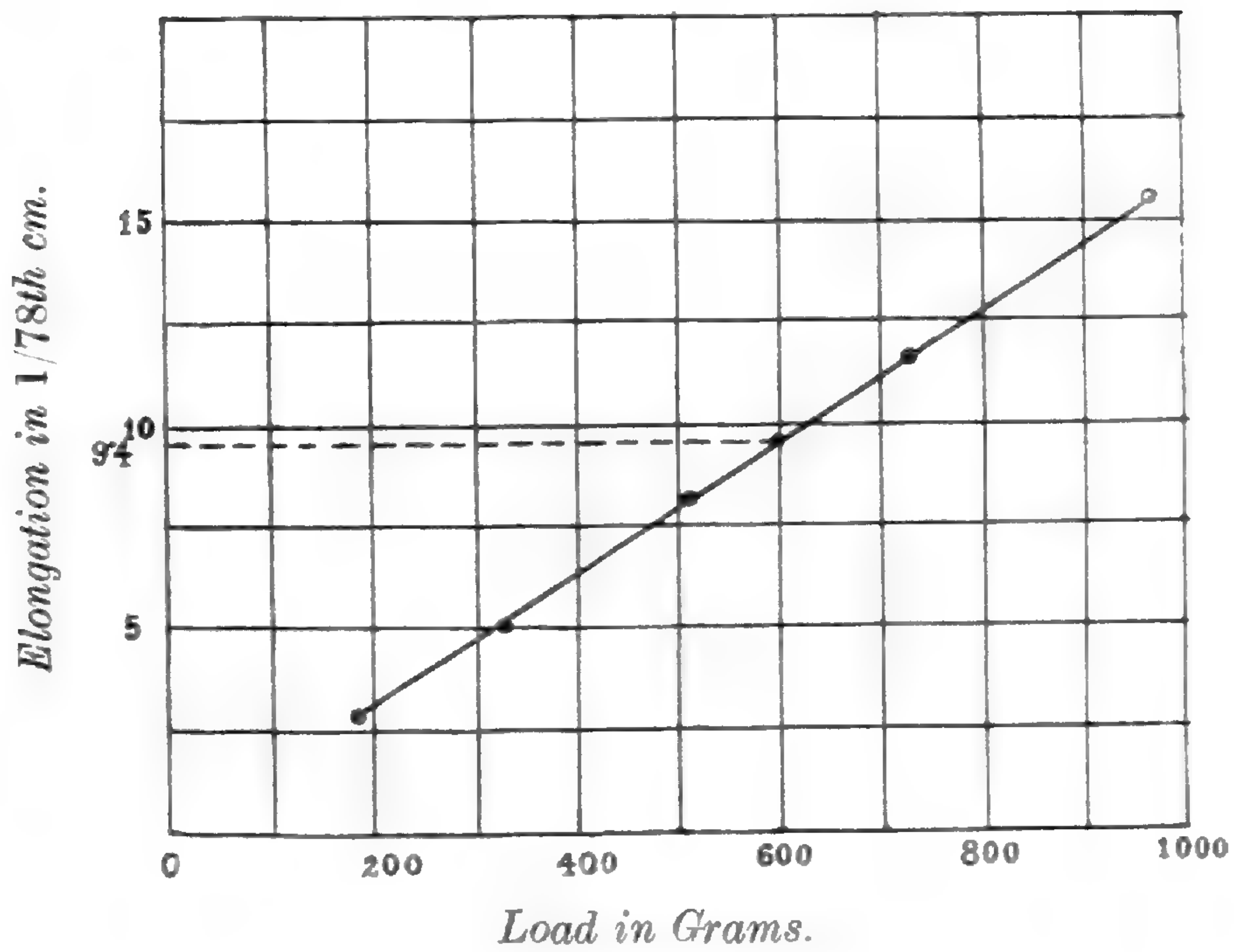

FIG. III.

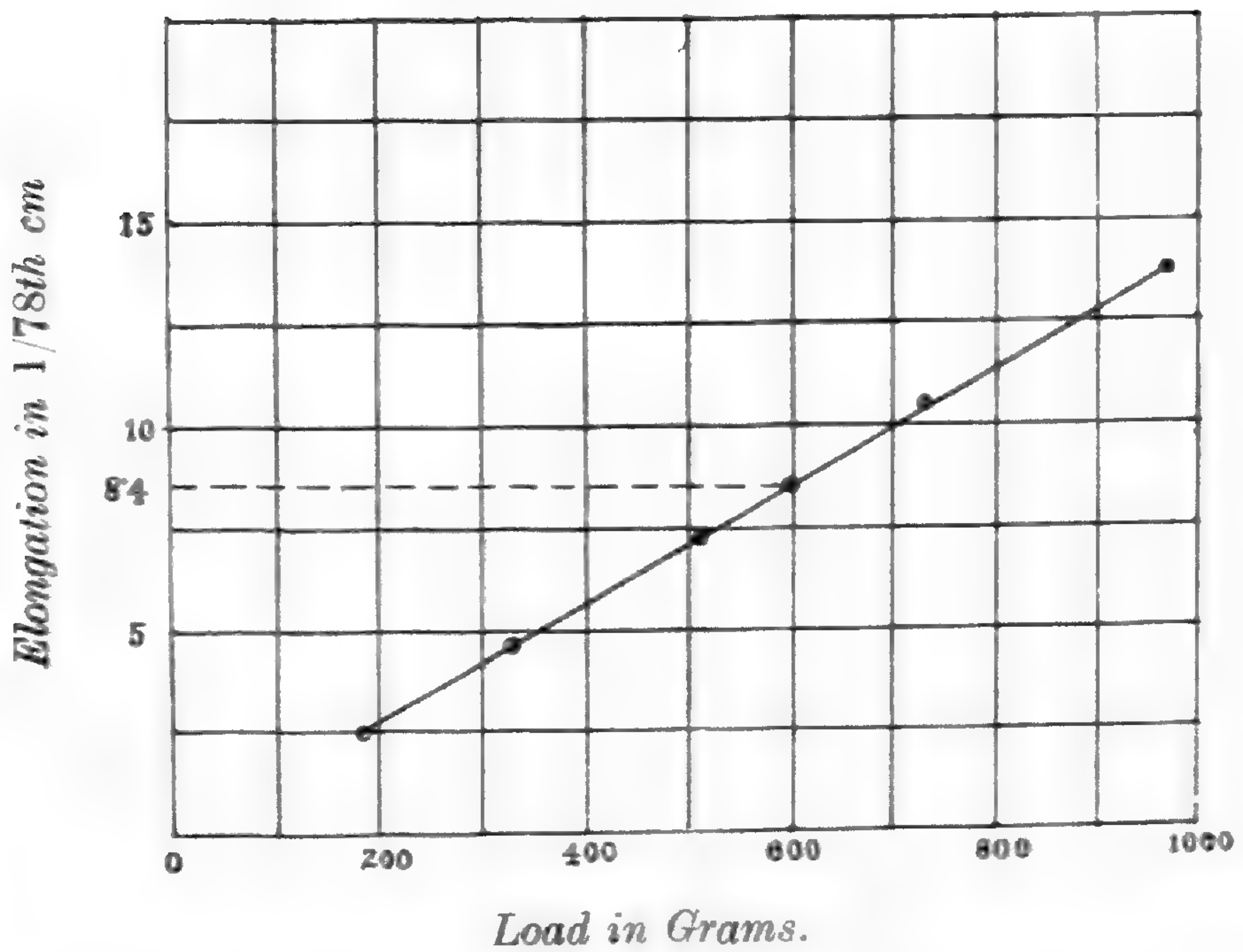

FIG. IV.

In using the apparatus for experiments with a long wire, the magnification can be diminished by making the length of the rod between P and the edge of the slit t (Fig. I) sufficiently long so that the spot of light may remain on the scale for the greatest elongation to be plotted. Figures III and IV are the curves for brass and steel respectively. They are plotted by observations on lengths of over 3 metres of wire, the magnification of the instrument in each case being 78.

Length of brass wire 333 cms. Diameter of the wire .045 cm. From Fig. III it is found that when the load is equal to 600 grams the elongation is $9.4/78$ cm., whence the value of Young's modulus for the specimen is found to be 10.2×10^{11} dynes cm.² The value obtained by the ordinary laboratory method was 10.61×10^{11} dynes cm.²

Length of steel wire used 333 cms. Diameter .034 cm. From the curve when the load is 600 grams the elongation is found to be $8.4/78$ cm., whence the value of Young's modulus is found to be 20×10^{11} dynes cm.² The value obtained by the ordinary laboratory method was 19.9×10^{11} .

This apparatus is described not because its value as an accurate scientific instrument is emphasized, but because it forms a very convenient arrangement for demonstration purposes and is believed to supply what has long been wanted among lecturers in Elementary Physics. Judging from the degree of accuracy which it affords in determining Young's modulus it appears that its use may not be altogether precluded in the laboratory, especially for the investigation of those portions of the load-elongation curve for the soft metals, which are beyond the elastic limit.

In conclusion, I take this opportunity of expressing my gratitude to Professor E. P. Harrison who has given me the necessary facilities in the Physical Laboratory of Presidency College and has encouraged me with his valuable advice.



6. Studies on the Leaf Structure of *Zoysia pungens*,
Willd.

By M. S. RAMASWAMI, M.A. (formerly Government Postgraduate
Research Scholar in Botany, Presidency College, Madras);
Officiating Curator of the Herbarium, Royal Botanic Garden,
Calcutta.

(With Plates V—VI.)

The subject of this paper forms really one of a series of investigations on the comparative anatomy of the leaves of South Indian grasses undertaken by me from 1909 onwards, at the suggestion of Prof. P. F. Fyson, to whom I desire to express my thanks for the facilities afforded at the beginning of this study.

Four species of the Natural Order Gramineae are known to me as occurring on the sands opposite the City of Madras within a distance of 150 yards from the sea. They are—

1. *Zoysia pungens*, Willd.
2. *Sporobolus virginicus*, Kunth.
3. *Spinifex squarrosus*, Linn.
4. *Trachys mucronata*, Pers.

Plants other than grasses noticed in this area were *Ipomœa biloba*, Forsk, *Launea pinnatifida* Cass, and *Cyperus arenarius*, Retz. These were long known as maritime sand-binding plants on account of the useful purpose they serve by the extensive and interlacing nature of their shoot and root systems in protecting lands from the encroachment of sand blown continually by sea winds. Although the root system of *Zoysia pungens* is not so extensive as to entitle it to be called a sand-binder, yet, when we consider the smallness of its stem and leaves, we are at once struck by the wonderful extensiveness of the root-stock and its branches. We may, then, safely say that *Zoysia pungens*, though not an effective sand-binder by itself, forms a valuable aid to the others mentioned above, in accomplishing their purpose. The four grasses enumerated above are not to be regarded as the only ones of their kind found along the sea-shore at Madras, but merely represent those species which are almost always found exclusively growing on maritime sands and which were collected and studied by me. I propose, in this paper, to discuss some of the structural adaptations noticeable in the leaf of *Zoysia pungens*, due in great part to the peculiar habitat of the plant. *Zoysia pungens*, Willd., is a native of the sea-shores of the South-Eastern Asia, Australia and Mauritius. Before beginning to study the peculiarities of its leaf-structure, it will be appropriate to give a

Botanical description of the plant, as found on the Madras Coast—special attention being paid to the leaf.

Zoysia pungens, Willd., is a small much-branched rigid glabrous grass with a very long, slender, wiry, creeping root-stock usually 2 to 3 ft. long, occasionally even 5 ft. long, with interlaced branches, giving off at definite intervals, short, stiff, leafy stems 4 to 8 in. high above the ground, and long thin filiform roots usually nearly a foot long below the ground. *Leaves* $\frac{3}{4}$ – $1\frac{1}{2}$ in. long, spreading dorsally rounded, margins, strongly incurved, subulate, pungent, glaucous-green, quite smooth. *Sheath* very short. *Ligule* a very narrow, abundantly ciliolate membrane. *Racemes* 1– $1\frac{1}{2}$ in. long, strict, erect. *Spikelets* red brown, shining $\frac{1}{10}$ th in. long, erect.

In order to find out what exactly are the structural adaptations found in the leaf of *Zoysia pungens* on account of its curious habitat, let us roughly examine the actual state of the surrounding environment under which it has to maintain successfully its survival in the struggle for existence. It will be convenient to consider the nature of the surroundings under the following heads:—

Soil.—It is a matter of common knowledge that the soil near the sea is sandy, dry and poor in humus. The subsoil may, of course, be permeable and may also admit of being thoroughly soaked to some depth at each fall of rain, but unfortunately dries very quickly when the rain is over. In addition to this, the soil of these sandy regions contain always an excess of mineral salts derived from the sea in spray or by percolation. These two factors, *viz.* scarcity of water in the soil and excess of mineral salts in it, are quite enough to reduce considerably the absorption of water by the roots. In fact, they render absorption of water and food-material by osmosis extremely difficult. How exactly then can our plant flourish in such a place? It is clear that it must have armed itself with certain devices, whereby it remains satisfied with the limited supply of water and also counteracts the injurious influence of the concentrated mineral solutions in the soil, managing at the same time to take in its necessary food.

Temperature.—The influence of temperature on plants has been recognized as a very important one from early days. Every plant can live only at temperatures lying between two extreme degrees which are termed respectively its maximum and minimum points. The over-stepping of either of these limits sooner or later results in the death of the plant. But these two points vary for different species and even for different functions. Consequently, it is not possible to give any absolute figures for maximum and minimum points. However, we may say approximately that the average points of minimum, optimum and maximum temperatures in the case of metabolism of plants are about 10 C, 30 C and 50°C respectively.

The temperature of the sandy beach at Madras may be taken as 90 F or 32°C roughly on an average. When dealing with temperature, we should also consider the temperature of the particular soil. Under the influence of the sun's rays, the temperature of at least the superficial layers of the soil rises to somewhere near the maximum limit. This intense surrounding heat is not altogether favourable to the well-being of the plant. Vegetable physiologists have experimentally proved that warming the soil is attended by an increase in the absorption of water and transpiration. Protective contrivances are therefore called for and an investigation shows their actual existence.

Light.—This is one of the most important external factors affecting plant form and structure. Whilst temperature has no great influence in determining a plant's conformation, light on the other hand plays a prominent part in controlling the structure of plants. The effects of light depend not on the amount but on the degree of its intensity. For instance, very intense light acts fatally on the protoplasm, while subdued, diffuse light acts somewhat beneficially to it. In vegetable organisms, death occurs from too intense a light indirectly owing to the decomposition of pigments primarily associated with assimilation, but at any rate land plants, owing to intense illumination, suffer from a considerable disintegration of their chlorophyll. The importance of the chlorophyll corpuscles to plant-life is too well known to be mentioned here. These chlorophyll corpuscles are so extremely sensitive to varying degrees of light that they frequently rearrange themselves. The slightest variation in the light affects them considerably. On the sea-shore, the plant is actually exposed to a glaring sunlight nearly throughout the day. How then are the chlorophyll corpuscles carrying on their work? The answer is simply that there must be certain adaptive structures playing the part of light-regulators.

Air.—The influence of the wind on plants is partly direct by its stretching action and by pressure and partly indirect by increasing transpiration. It may of course be doubted whether these will affect such small creeping plants as the present one. The injury, in this case, will not be much by stress, or pressure, but the continuously blowing wind will cause an excessive increase of transpiration. Again, the purely mechanical disturbance of shaking, due to winds, stimulates the protoplasm in such a way as to increase transpiration. On the sea-shore, continuous and violent winds are constantly occurring. Consequently, the plants growing there freely should possess some adaptations to combat successfully with the above-mentioned injurious influences.

Peculiarities due to the action of the agencies indicated above next claim our attention. Adaptations in relation to the above environmental conditions are combined in the

clearest manner in *Zoysia pungens*, Willd. I shall first very briefly indicate the adaptations in the general configuration of the plant and then pass on to examine in detail the structural peculiarities in the leaf.

To begin with, the prostrate attitude of the plant (Plate V, Fig. A) appears to be solely due to the action of high winds prevalent on the sea-shore. The presence of numerous long adventitious roots with an interlacing system of rootlets helps to anchor the plant firmly in the loose shifting substratum and thus offers a protection against violent winds. The very short, stiff, leafy stems do not offer much resistance to the blowing wind. The growing tip of the plant (Plate V, Fig. B) is so finely pointed that it quite easily pierces the sand. Moreover, as pointed out by Schimper, these plants have the wonderful faculty of again growing out of the sand after having been covered by it. A tendency to diminish the evaporating surface and to conserve the stock of water is also shown by the rigid, subulate leaf, hard in consistency and with a spiny apex. The dull light green colour of the leaf is also an adaptation, which this plant possesses in common with other sand plants, to ward off the great intensity of light on the sea-shore. Having briefly outlined the general adaptations, I now proceed to point out the various structural adaptations found in the tissues composing the leaf of *Zoysia pungens*, Willd.

Epidermis.—Under this heading, we have to consider not only the ordinary epidermal cells but also the “motor cells” and the stomata. The epidermal cells appear more or less square in transverse section, while in longitudinal section they appear rectangular. They are, as usual, arranged along the long axis of the leaf. As regards their form, the outer walls of the upper epidermal cells are conspicuously arched outwards, while those of the lower are much flatter. In the former, the arching of the outer walls has taken place to such an extent, as to make the cells distinctly papillose. The purpose of these papillae will be referred to later. Both the upper and the lower epidermis are much thickened, but the difference between them in the amount of thickening is very marked. The lower epidermis is much more thickened than the upper. This is explained by the fact that the upper epidermis in these grasses almost always remains protected by the rolling or folding of the leaf, which not infrequently happens in grasses enduring a long season of drought. Consequently, the upper epidermis does not stand in need of much thickening, whereas the lower epidermis is constantly exposed and therefore requires to be considerably thickened. This exceptionally strong cuticularisation of the lower epidermis, then, is an adaptation against excessive transpiration and excessive light, as the layers forming the cuticle are filled with air and act as bad conductors between the external atmosphere and the internal structures.

Motor cells.—These bands of cells, as their name indicates, serve the purpose of bringing about movement. They are generally found in grass leaves at the base of each groove, if the leaf is a ribbed one, or by the midrib, if the leaf is non-ribbed. The leaf of *Zoysia pungens* is very faintly ribbed. We find the motor cells here lying in layers at the base of each groove. They differ from the ordinary epidermal cells in their greater depth. As pointed out before, the leaves fold or roll themselves, when dryness prevails. This folding or rolling is brought about by an alteration in the turgidity of the motor cells, causing them to contract and thus shortening the upper surface of the leaf. When the motor cells contract, the ridges are brought closer and the whole leaf becomes a little more closely rolled. In this manner, the upper epidermis is completely shut off from the surrounding air. This is clearly an adaptation to prevent excessive loss of water by transpiration.

Stomata.—These are the respiratory organs of the plant and are usually arranged in grasses in longitudinal rows interspersed with the epidermal cells. Normally, stomata are found on both sides of grass leaves. But in *Zoysia pungens* they are entirely confined to the upper epidermis. This, in itself, is a very powerful adaptation against excessive transpiration, as we have already found the upper epidermis to be always protected. Even on the upper epidermis, they occupy good sheltered spots, for instance, on the flanks of the feeble ridges. We have already seen that these flanks contain a number of papillae. Their action is to hinder excessive transpiration by preventing a free circulation of air in the groove—the sides of which contain the stomata and represent the transpiring surface. Consequently, vigorous transpiration is checked. We may then say that in the epidermis there exist several protective devices purposely adapted to prevent excessive light and excessive transpiration.

Vascular bundles.—The vascular bundles of *Zoysia pungens*, in common with other grasses, enter the leaf separately and run parallel from base to apex of the blade along the ridges. Those met with in this leaf are of two kinds—one with two large lateral vessels which are characteristic of the monocotyledonous type, the other without them. In both types there are no intercellular spaces. In spite of the smallness of the leaf, there are a good number of vessels. Probably these are useful in conveying large quantities of water rapidly when there is an occasional increase of water-supply (e. g. after a sudden fall of rain) and thus fill the water cells which may afterwards yield their contents to the assimilating cells when the supply of water is reduced.

Bundle-sheaths.—In nearly all leaf-sections of grasses, each vascular bundle is seen to possess at least two conspicuous sheaths. The inner one is always thickwalled and the outer

thinwalled. In *Zoysia pungens*, two sheaths can be easily recognized. The inner sheath is not continuous in the smaller bundles but surrounds only the phloem. In the bigger ones, however, it is continuous. The function of this thickwalled inner sheath is simply that of mechanical protection to the soft-walled phloem.

The cells of the outer sheath however are very large and contain chlorophyll to some extent. In places where the inner sheath is joined to the epidermis by a sclerenchyma band, the outer sheath is not continuous. It then presents a V-shaped appearance. The function of this outer sheath in grasses generally, is supposed by some botanists to be conduction of water, serving as an auxiliary conducting system. But this view is negatived in *Zoysia pungens* by the fact that there is no necessity for an auxiliary conducting system. The vessels in themselves are more than enough for this purpose. Consequently, I am disposed to regard this sheath, which sometimes is called by the name of transfusion-tissue, as a special sort of water reservoir. It is I think in these cells that water is stored, which is sooner or later made use of by the abutting assimilating cells. Here again, we notice another adaptation in the direction of economizing the water-supply.

Mechanical tissue.—The mechanical tissue, or stereome, consists in grasses, as a general rule, of sclerenchyma fibres. These fibres are known to withstand wonderfully the strain of flexure, traction or pressure. The sole function of these fibres is support. Let us now consider how these bands of stereome are disposed in the leaf to the best advantage. On both ends near the margins the two big vascular bundles are girdered to the upper and lower epidermis by strong bands. It is the lower band that is larger and stronger. Along the two margins we also find a certain amount of mechanical tissue. Moreover three small bundles are girdered to the lower epidermis only. Thus the majority of the stereome is on the lower side. It will be noticed then that there is a marked tendency for the mechanical tissue to be stronger on the lower than on the upper side. What is the purpose of this arrangement? These maritime sand grasses are, as already stated above, constantly exposed to terrific storms and winds. Therefore, a firm support is needed and this is supplied by this great development of mechanical tissue. I say 'great' in comparison with the smallness of the leaf. Under dry conditions, which is almost always the case with these plants, the leaves remain rolled up and become cylindrical organs. Physical experiments have shown us that the mechanically best arrangement for supporting a cylindrical structure is to have a strengthening band at the periphery. This is exactly the case here. The bands of stereome are just below the lower

epidermis and thus form the strengthening agency at the periphery of the rolled-up leaf. Such is the nature of the adaptation for withstanding and warding off the injurious effects of storms and winds.

Chlorophyll-containing tissue.—This tissue is composed of a mass of closely packed, irregularly shaped, cells with very little intercellular spaces. By this reduction in the size of the intercellular spaces, the transpiring surface becomes smaller and, as a necessary consequence, transpiration itself is reduced. These cells lie between the vascular bundles, and the layers of motor cells in most cases forming nearly a ring round the former. This position is obviously of distinct advantage and, in addition to storing the water-supply brought up by the vascular bundles, serves to protect them from the intense glare of the sun. The chlorophyll tissue is also restricted in amount and the corpuscles are few in number. This accounts for the extreme scarcity of starch grains in the leaves.

To sum up, the leaf-structure of *Zoysia pungens* is remarkably modified to suit the surrounding environment and the main directions in which the adaptations have occurred are, the economic utilization of a very limited water-supply, the prevention of excessive transpiration, the withstanding of mechanical strain due to winds, and lastly the shutting off of the intense glare of the sun.

EXPLANATION OF PLATES.

PLATE V.

- A. Part of Plant (Natural size).
- B. Do. showing growing tip (Nat. size).
- C. A leaf and leaf-sheath $\times 4$.

PLATE VI.

(The leaves were fixed in Absolute Alcohol and sections cut by hand).

- D. Transverse section of the leaf \times about 100 diam.
(The crossed lines represent *stereome*, the circles with dots *vascular bundles*, and cones with horizontal and lateral lines, *Motor cells*.)
- E. Transverse section of the leaf \times about 300 diam.
(Ep¹, Lower Epidermis;
Ep², Upper Epidermis;
St., stomata; Ster., stereome.
C., Chlorophyll-containing tissue.
V. B., vascular bundles; I.S., inner sheath;
O. S., outer-sheath; M. C. Motor cells.)



K. P. Dass, del.

A. C. Chowdhary, lith.

LEAF STRUCTURE OF ZOYSIA PUNGENS, Willd.

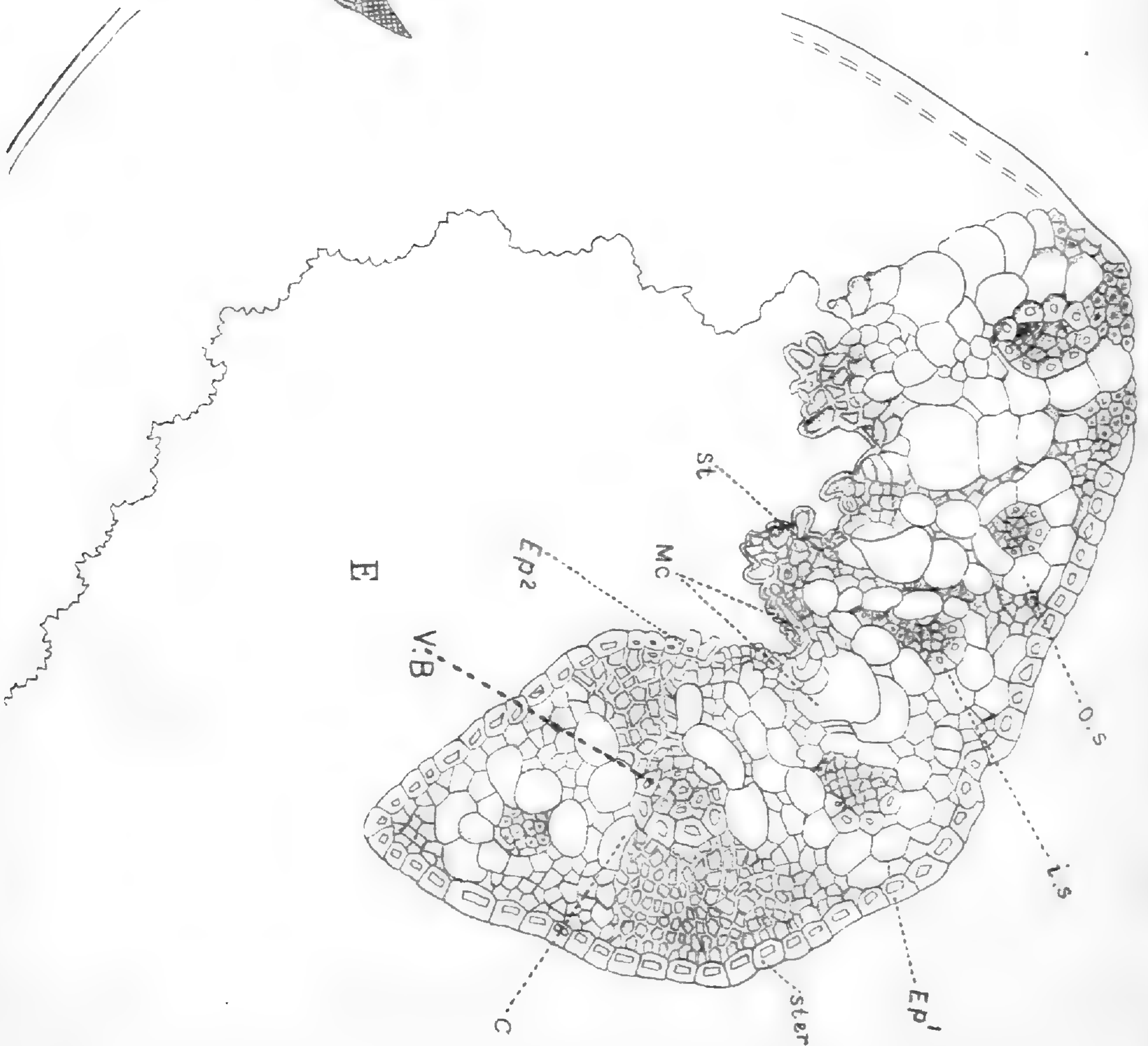
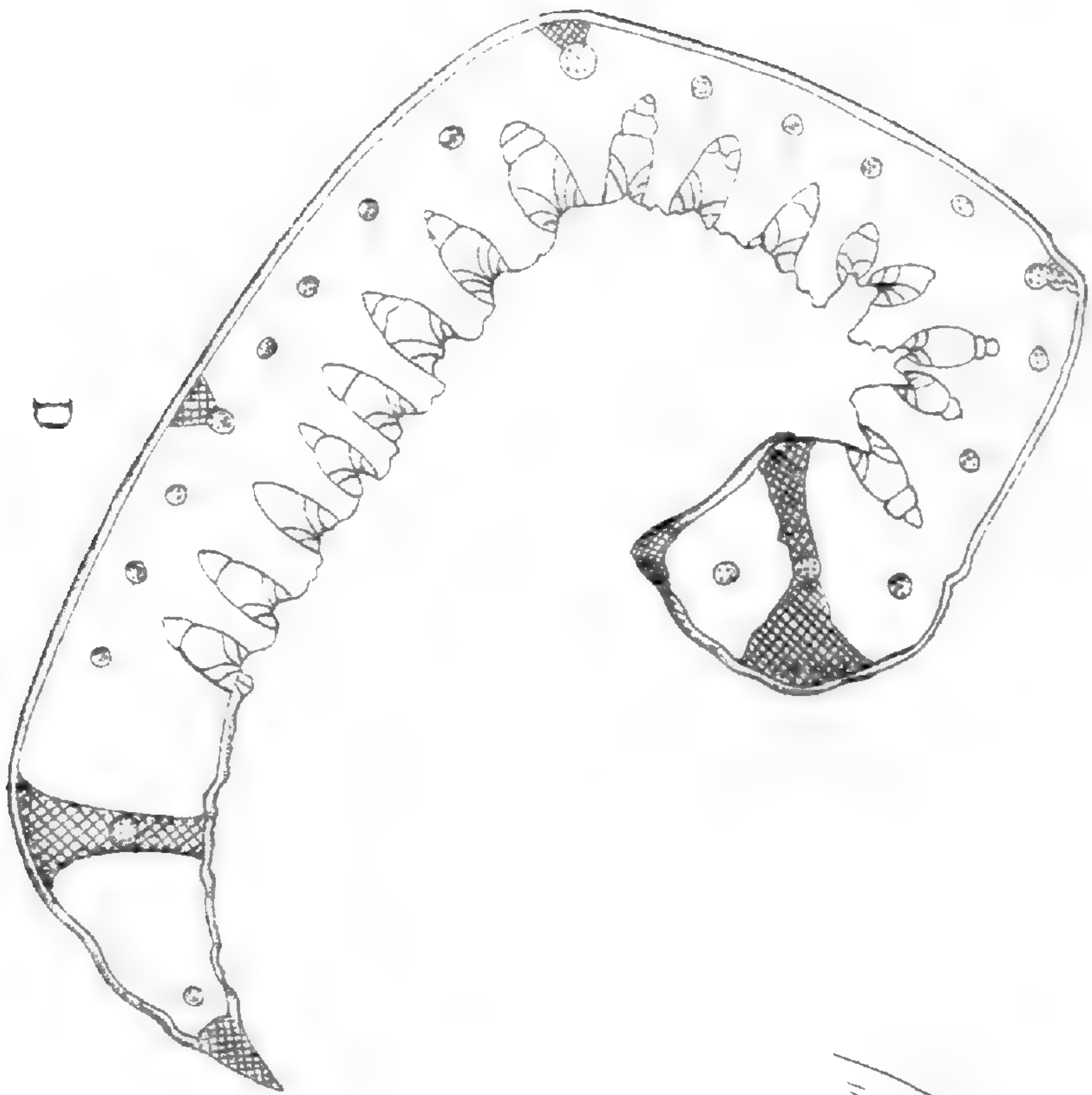

M.S. Ramaswami, del.

A.C. Chowdhary, lith.

LEAF STRUCTURE OF ZOYSIA PUNGENS, Willd.

7. Fr. Jerome Xavier's Persian *Lives of the Apostles*.

By the REV. H. HOSTEN, S.J.

At the end of 1912, the Rev. Fr J. De Smet, S J., drew my attention to the following passage in Edmund Mitchell's *Guide Book to Calcutta*, Thacker & Co., 1890, p. 105: "Serampur College There is a splendid Library, containing some rare works, among them being an account of the Apostles, drawn up by the Jesuits for the Emperor Akbar" I hastened to communicate with the Principal, Dr. George Howells, who at his next visit to Calcutta kindly brought the book with him for my inspection.

The result was as gratifying as expected. The book turned out to be a complete copy of J. Xavier's *Lives of the Apostles*, about the history of which I had collected some data.

"While Fr. Pigneiro was in the town of Agra [1602], Fr. Xavier, who was also there, presented to the King a treatise in Persian on the life, miracles, and doctrine of our Saviour Jesus Christ, which the King had himself asked, and which he longed to see. Hence, he showed that he esteemed it much and he had it often read by his great Captain Agiscoa ['Aziz Koka], who took so much pleasure in it that he asked the Father for another copy, and it was already so much talked of among the Grandees that there was hope God would by this means make known to those infidels and unbelievers His only Son our Lord After this, the King asked the Father for another book on the life of the Apostles." ¹

The first life in the Serampur MS, that of St. Peter, is identical with the one published in Persian, with a Latin translation and notes, by Louis de Dieu, a Professor of Oriental Languages at the University of Leyden, under the title: *Historia S. Petri | Persice | Conscripta, simulque multis notis | contaminata. | Latine | Reddita, & brevibus Animadversionibus notata, | a | Ludovico de Dieu, | Lugduni Batavorum, | Ex-officina Elseviriana, A° C/D MCCCXXXIX [1639] |* ²

At p. 108, Louis de Dieu remarks that the *Life of Christ*, written in 1602, had been preceded, two years before, by the *Life of St. Peter*. He refers evidently to a passage in the text

¹ Cf. du Jarric, *Histoire des choses plus memorables* III. 66-67: *J.A.S.B.*, 1896, p. 87; F. Guerreiro, S J., *Relaçam Annual de 602 & 603*, Lisboa. 1605 (*Moguer*, Ch. VI).

² See it fully described in de Backer. *Bibl. des Ecrivains de la C. de J.*, Série VII, Liège, 1861, p. 414: Sommervogel, VIII, s. v. Xavier, Jérôme.

of the *Life of St. Peter* at p. 94. “*Usque ad hodiernum diem qui annus millesimus sexcentusimū à Nativitate D. Jesu, & quadragesimus nonus sublimitatis Epochæ sessionis Majestatis Imperatoricæ [Akbar] est,*” i.e., “Until to-day, the year 1600 from the Birth of the Lord Jesus, and the 49th of the sublime Era of His Imperial Majesty’s enthronement.”¹ There is an evident discrepancy between these two ways of speaking, since the year 1600 makes the 45th, not the 49th, of the Ilāhī era. The Ilāhī year must be the correct one, no allusion to the *Lives of the Apostles* being found in the Jesuit Letters until 1602, when, as we saw, Akbar asked for it.

The *Life of St. Peter* may thus have been completed in the 49th year of Akbar’s reign or A.D. 1604. A note sent me by Mr. George Ranking would show that Akbar saw it before his death (1605), together with the lives of St. Andrew, St. James and St. Paul. The complete work was probably not finished till two years after Jahāngīr’s accession. From the preface of the Serampur MS., kindly translated for me by Mr. H. Beveridge, we gather that the *Lives of the Apostles* was undertaken at Akbar’s request after the completion of the *Mirātu-l-Quds* or *Life of Christ*, that it was dedicated to Jahāngīr, and translated by ‘Abdu-s-Sattār from the “*Firinghī*,” by which we should understand “Portuguese.”

A copy of the *Lives of the Apostles*, in the “National Library” of Paris, is described as “containing the life and the miracles of the twelve Apostles, translated from the Latin into Persian by Fr. Jerome Xavier, of the Society of Jesus, who dedicated it to Dgelal-Uddin Mohammad Akbar, Emperor of the Mngols.”² Similarly, John Ury’s *Bibl. Bodl. Cod. MSS. Orientalium*, Part I, Oxonii 1787. p. 270, No. VIII, describes one of J. Xavier’s works thus: “Codex bombycinus, perita manu, folia 215 efficiens. Complectitur opus, *Speculum Sanctitatis* inscriptum, ubi nimirum exhibentur vita et miracula duodecim Apostolorum, e Latina lingua in Persicam conversa, auctore Patre Hieronymo Xaverio Societatis Jesu, qui opus suum Gelaleddino Akbar, Mongolorum Imperatori nuncupavit. Præmittitur quinque paginarum præfatio [Laud. A. 125].” The title is given in Persian: *Mirātu-l-Quds*. This description is partly wrong. Either the book is the *Mirātu-l-Quds*, and then it is the *Life of Christ*; not the *Life of the Apostles*; or it is, more probably, the *Life of the Apostles*, since it is said to contain their lives, and miracles; but, then, Ury mistook for the title of it the words “*Mirātu-l-Quds*” mentioned in the

¹ Compare with the date of Xavier’s *Historia Christi* edited by L. de Dieu. p. 536: “[Hic liber] Anno millesimo sexcentesimo secundo à Nativitate D. Jesu, atq: quadragesimo septimo sublimitatis Sancti Imperatoris finem accepit.” 1602=47th year of the Ilāhī era, is correct.

² Cf. Sommervogel. *Bibl. de la C. de J.*, VIII, col. 1340, No. 9.

preface in connection with *The Life of Christ*, an earlier work dedicated to Akbar.

The Serampur MS. bears no date; but we find that a copy of the complete work was presented to Jahāngīr in 1607. "The King returning from the Kingdom of Cabul to the City of Lahor, the Fathers, hearing of his arrival, went to meet and welcome him two leagues out of the city. He received them with a mild countenance, and saluted them very lovingly. Stopping his horse for some time, he embraced them after his manner, by laying his hands on their shoulders, and asked them familiarly how they were. They also saluted His Majesty's children, and the chief personages of his suite, who returned the salute. Hereupon, they offered to the King a book in Persian, composed by them, of the life of the Apostles, *with several remarks on different passages of it, which they had inserted, in confirmation of our faith, and in refutation of the sect of Mahomet.*"¹

The passage we have just italicised was misunderstood by du Jarric. Guerreiro, whom he follows throughout, notes that the copy presented to Jahāngīr was interleaved with a number of paintings representing the Emperor's palaces, and that the Emperor showed himself extremely pleased with the Fathers' attention. "*Apresentarão lhe os Padres hũ liuro em Parsio, q̄ tinham feito das vidas dos Apostolos, cõ muitos registros de seus passos antresachados nelle, o qual mostrou estimar muito*"²

We may conclude from the foregoing to a chronological error in the *Bibliotheca Marsdeniana*, p. 305 (cf. *J.A.S.B.*, 1896, p. 113), where a copy of the *Lives of the Apostles* obtained by Marsden is said to have been "composed in Persian, by P. Jeronimo Xavier of the C. of J. at Agrah, at the Court of the Emperor Jahāngīr in the year 1609." The date, if it was correctly read, could mean only that a *transcript* of the work was completed in 1609.

Both the copy of the Bodleian and that of the National Library of Paris are said to have been dedicated to Akbar. Mr. G. Ranking's note about an incomplete copy once in Akbar's library might be taken to prove that what had been written until 1604, *viz.* 4 lives, was dedicated to Akbar. But, what of the copies in the Bodleian and the National Library of Paris? If they contain *all* the lives of the Apostles, as we suppose, we suspect a mistake in the description of them, even though we are in presence of two different catalogues describing two different copies. Our unpleasant experience of library catalogues is that, when a book has once been described in a catalogue, this description is generally transferred, mistakes

¹ Cf. du Jarric *Histoire*, III. 113.

² Guerreiro, *Relaçam Annal* de 606 & 607 Lisboa. MDCIX, fol. 158 r.

and all, to the catalogues of other libraries. We should judge differently if a *complete* copy of the *Lives of the Apostles* contained a clear, authenticated statement to the effect that it was dedicated to Akbar.

Again, we are told that the copy of the Bodleian and that of the National Library were translated from the Latin. On what is this based? Has not the word *Feringhī* been misunderstood to mean *Latin*? In the preface to his *Life of Christ*, as published by Louis de Dieu, J. Xavier says in one place (cf. *Proc. A. S. B.*, 1870, pp. 141-142, or Louis de Dieu, *Historia Christi*, p. 9) that on comparing the Persian translation *cum scriptis Latinis*, with the Latin (*Latīn*), he was repeatedly dissatisfied with his work, and kept polishing the translation until he judged it worthy of Akbar's acceptance. The phrase "*cum scriptis Latinis*" would not necessarily mean that 'Abdu-s-Sattār, J. Xavier's co-translator, who by Akbar's order had learned Portuguese under the Fathers, but had, apparently, no knowledge of Latin, was not given a Portuguese text to work from; else, how could he conveniently have assisted J. Xavier? Among the *scripta Latina* with which Xavier collated the Persian translation there must have been the Vulgate. A copy of the *Life of Christ* in the Harleian (Sommervogel, viii col. 1340, No. 8) is described as translated "from the Portuguese,"¹ but, the point has perhaps no other authority than a lucky (?) piece of guessing on the part of La Croze (*Hist. du Christian. des Indes*, 1758, II, 77-78), who sought to rob Xavier of the honour of knowing Persian. The fact is that the *Lives of the Apostles* was not the only book the original draft of which Xavier wrote in Portuguese. In a letter to the General, Lahore. Aug. 1, 1598, he announces his return from Kashmīr to Lahore: "We return to the study of the Persian language, and speak it still poorly (*mediocrement*). I take up again my work of translating into Persian a treatise I had made in Portuguese; I mean that I make it again, for the one I had made was stolen in Caximir, when they plundered our house." (*MS. letter unpublished*). The work in question must have been the *Aīna-i-Haqq Numā*.

Fr. Jerome Xavier, during 20 years the mainstay of the Mogor Mission, died at Goa (Rachol?) on June 17, 1617. His compositions, worthy monuments of his learning, continued to be sought after in the Mogor Mission and the Christians copied them or had them copied by the best calligraphers of the bazars.²

Pietro della Valle, that scholarly tourist, who visited Persia

¹ Cf. DE LA FIGANIERE. *Catalogo dos MSS. portuguezes existentes no Museu Britannico*, 1853, p. 39.

² A copy of the *Speculum Veritatis* or *Aīna-i-Haqq Numā*, dated 1678, was found in an obscure corner of the Kinawar Mts., and sent to Csoma de Körös. Cf. Th. Duka. *Life and Works of A. Csoma de Körös*, London, Trübner, 1885, p. 96. Another copy of the same dated 1740 was transcribed for Khwājah 'Abdu-l-Masih of Hamadan by Rāmg'hosan of

and India to satisfy his passion for Oriental studies, wrote that he met at Surat on March 7, 1623, a Jesuit lay-brother¹ who was going to Agra. He handed him a letter for the Fathers of Agra, reminding them that he had written to them a first time from Persia to ask for a correct copy of the Persian books written by the Fathers at the Moghul Court. His intention was to get them printed in Rome. It would seem that his request was not complied with. None of J. Xavier's writings appears in the list of Persian books brought by della Valle from India.²

I do not know of any other complete specimen of the *Lives of the Apostles* than the copy of Serampur. Those in the Marsden collection, the Bodleian (?) and the National Library, Paris, are perhaps complete, too.

The copy of the *Life of St. Peter* published by Louis de Dieu contained two other Persian treatises: viz., the death of Hussain, son of the *Khalif* 'Alī, and a fragment of Akbar's *Life*. It had been brought from Mogor with 8 or 9 other Persian books, one of which bore the note: "*Emptus in Agra, 16 Stuseris, 20 Octobris 1621. Ioannes Romanus Roterodamo Batavus.*" de Dieu concluded that John Romanus, a Doctor and Oriental scholar, had bought the *Life of St. Peter* during his travels in India. On his death, after his return to his country, these books fell into other hands, the *Life of St. Peter* and another passing into the possession of John Eligmannus, de Dieu's friend.³

Fourmont had already shown that de Dieu did not publish the whole of Xavier's *Lives of the Apostles*, his *Catalogus MSS. Bibl. Regiae, Codices Persici*, No. VI, pointing to a complete copy in 4° "translated from the Latin," in the "Royal Library" of Paris.⁴

Xavier's *Life of St. Peter*, as published by de Dieu, was placed on the Index, both on account of de Dieu's "heretical" notes, and certain unsafe or apocryphal sources made use of by the author.⁵

DESCRIPTION OF THE SERAMPUR MS.

The Serampur MS., a volume bound in brown leather on back and corners, measures 0 m.30 × 0 m.135 between the covers.

Saidābād, in the Dist. of Murshidābād, Bengal Cf. C. Rieu, *Cat. of the Persian MSS. in the Brit. Mus.*, 1879, p. 5.

¹ Probably Brother Manoel Marquez, who went to Tibet with Fr. A. de Andrade in 1624.

² Cf. *De' Viaggi di Pietro della Valle* Parte III, Roma, Mascardi, MDCLXIII, Letter from Surat, March 22, 1623, pp. 89-90. He obtained at Ispahan a Persian-Italian Vocabulary of the words in the *Christian Doctrine* composed by J. Xavier, as also a *Christian Doctrine* in Persian, probably by the same. Cf. Assemani, *Bibl. Orientalis*, I. 590, Nos. 48 and 49.

³ Cf. L. de Dieu, *Historia S. Petri*, pp. 120-121.

⁴ Cf. Sommervogel, *Op. cit.*, VIII, Col. 1340, No. 9.

⁵ Cf. *ibid.*

The title in gilt letters on the back is: *Jesus | and | His | People | Persian | MS. |*

At the end, pasted to the cover: *Serampore College | Library | Case G. Shelf 3. No. 6. |*

Condition of the MS.: complete; fairly well preserved; the worm-eaten passages have been carefully strengthened with tissue paper; legible throughout.

Writing: Nastāliq, in a fine clear hand.

Number of lines per page: 25.

Material of paper: country-made.

Pagination: pp. 262; the pagination, marked on recto and verso, being correct throughout. Catch-words at the end of each verso.

	<i>Pages.</i>
<i>Contents</i> : Preface	1-7.
1. St. Peter	7-57.
2. St. Paul	57-134.
3. St. Andrew	134-146.
4. St. James	146-177.
5. St. John	177-206.
6. St. Thomas	206-223.
7. St. James the Less	223-231.
8. St. Philip	231-234.
9. St. Bartholomew	234-242.
10. St. Matthew	242-250.
11. 12. Sts. Simon & Jude	250-257.
13. St. Mathias ¹	257-262.

Titles in red ink appear from the life of St. James. In the beginning of the first three lives, a line has been left blank, for the title.

¹ *Age*: No date can be found in the MS.

Pencil-notes: The MS. must have been carefully studied by an English scholar, as is clear from notes and marginal references to the scriptural texts quoted. Leaving aside the scriptural references, I remark the following pencil notes: (p. 3) Nabuchadnasar (?); (p. 6) Judas Iscariot; (p. 81) Tarsus; (p. 121) Galatians; (p. 146) St. James; (p. 156) France; (p. 162) Spain; (p. 177) St. John; (p. 178) Domitianus, (Petrus?); (p. 183) Rev.; (p. 215) Krisnu; (p. 217) Brahmana.

My ignorance of Persian precludes my diving deeper into the contents of the *Lives of the Apostles*. There would be little utility besides. Xavier's manner and style can be studied in *The Life of St. Peter*, and *The Life of Christ* published by L. de Dieu, copies of which exist in the library of our Society. I may refer in particular to the studies of Mr. Rehatsek (*Calcutta Review*, Jan. 1886, p. 18), Dr. C. Rieu (*Catal. of the Persian*

¹ *Acts* I. 26.

MSS. in the Brit. Mus.), Prof. Blochmann (*Proc. A S B.*, 1870, pp. 138-147, where the preface of the *Life of Christ* is translated, and a summary of Chap. I has been drawn up); Mr. H. Beveridge (*J.A.S.B.*, 1888, pp. 33-39); General R. Maclagan and his son, Sir E. D. Maclagan (*J.A.S.B.*, 1896, pp. 110-113), who quote all the above references, and indicate two other papers by Mr. A. Rogers, which I have not seen, viz., 'the Holy Mirror or the Gospel of Father Jerome Xavier' (*Asiatic Quarterly Review*, July 1890), and 'A Persian History of Christ and St. Peter by Jerome Xavier, S.J.' read before the Royal Asiatic Society on March 10, 1896.¹ Other notices are found in the Catalogues of Persian MSS. of the chief continental libraries.

Mr. George Ranking's Copy of J. Xavier's Persian Lives of the Apostles.

Mr. George Ranking, who for many years was Secretary to the Board of Examiners in Calcutta, has favoured me with the following valuable note (Beech Lawn, Park Town, Oxford. January 10, 1914):—

“ It will, perhaps, interest you to hear that I am in possession of a copy of Father Jerome Xavier's Persian *Lives of the Apostles*. I have had it for many years. It is, unfortunately, badly worm-eaten. It is 8vo.

It came, I believe, from Akbar's own library, as it bears his seal in several places, *Muhammad Akbar, Padishāh-i-Ghāzī*, 1013. This would be 1604, the year before his death.

It contains the following lives, in this order:—

1. *Life of St. Andrew* (foll. 1—12^r).—Foll. 12^v and 13^r are blank.

Foll. 13^v —24^v are occupied by a discourse which

begins ای عزیز من بخاطرم رسید

ends نا آنچه که از ما استماع نموده اید تجربه دریابید -

Fol. 25^r is blank.

2. *Life of St. James* (foll. 25^v —50^r).—Foll. 50^v and 51^r are blank.

Foll. 51^v - 65^r contain a discourse which

begins ای عزیزان دلنگ نباشید که ما را درین

ends لباس نظاره میکنید پس مرا ببخش و قبول کن -

¹ Where was this published? I do not find it in the Catal. of the R.A.S. publications. I may also refer to *Indo-European Correspondence*, Calcutta, 1870, pp. 311, 422.

و توفیق ده تا نیت درست را بعمل رفیق گودانم و مراد این
حاضران را مخصوص مراحم فرمای

Foll. 65^v —72^r contain philosophical reflections

beginning ای حیات معلوم نیست

ending ای صاحب من سعادتى همراه باشد —

Foll. 72^v is blank.

3. *Life of St. Peter* (foll. 73^r —86^v; in another handwriting).

4. *Life of St. Paul* (foll. 86^r, lower half, to 109^v). Here the MS. ends.

I have often intended taking this MS. in hand with a view to its publication, but some other work has always prevented me, and I fear I shall never do anything with it now, as I have so little leisure and less eyesight, and part of the MS. is very hard to read.”

Hindustānī Translation of the Lives of the Apostles.

The *Lives of the Apostles* is the only work of Xavier's which I know to have been translated in another Eastern language. I have lying before me a copy of a Hindostānī translation.

TITLE: *Nuskha-i Kitāb-i bārah Apustal | jis kā tarjuma Itāliyān zabān se | Urdū zabān meṁ kiyā giyā. | Bi yāzat-i Archbīshap Sāhib-i Āgra kī ma'rijat Pādri | Anglu Sāhib Kapūchin ne chhapwā,ī | Sardhana | Roman Kātūlik yatimōn ke chhape khāna meṁ. | San 1873 'īsawī.* [The book of the Twelve Apostles, translated from the Italian into Urdu, and published with the permission of the Archbishop of Agra by the Rev. Father Angelo of the Capuchin Order. Sardhana. Printed at the Roman Catholic Orphanage A.D. 1873].

(0^m. 23 × 0^m. 16); paper covers; Arabic characters; pp. 166. From p. 151 to 166 the first figure is a 2.

Contents: Preface pp. i-v, followed by 1 blank page.

1. St. Peter,	pp. 1-38.
2. St. Paul,	pp. 38-73.
3. St. Andrew,	pp. 73-83.
4. St. James,	pp. 83-107.
5. St. John,	pp. 108-128.
6. St. Thomas,	pp. 128-140.
7. St. James the Less,	pp. 140-143.
8. St. Philip,	pp. 143-145.
9. St. Bartholomew,	pp. 145-150.
10. St. Matthew,	pp. 251-257 [151]-[157].
11, 12. Sts. Simon & Jude,	pp. 257-262 [157]-[162].
13. St. Mathias,	pp. 263-266 [163]-[166].

The preface agrees in substance with the Persian original.

Though the title of the Sardhana translation gives 1873 as the year of printing, we find it stated at p. 266 [166] that the printing was completed on Dec. 1, 1894. The explanation sent me about this anomaly by Mr. S. W. Butler (Sept. 26, and Oct. 19, 1910, Kothi Bhagwat Dayal, Sardhana) would reveal, if correct, some primitive methods at the late Sardhana Press.

The Urdū translation, he writes, was not made directly from the Persian; it was a re-rendering of a former Urdū translation made itself in Delhi, which had remained in MS. The preface, however, was not rendered into Urdū at the time of the first translation, but was added to the newer one of 1894, when the book was really printed. A man, who was present at the printing of the book in 1894, told Mr. Butler that the Father in charge of the Press in 1894, not wishing to have his name put down on the title-page, asked the printer to ascribe the printing of the book to Fr. Angelo, in whose time, especially in 1873, many religious books were printed at Sardhana. "But you should not think that this Urdū translation was made from the Italian, as the title says."

The editor of the Urdū translation must have wrongly understood the term *Feringhī*, used in the Persian text. He translated boldly by "Italian." He may have been misled also by the fact that Bishop Pezzoni's *Lives of forty-four Saints*, published before 1853, in 1872, and 1882, was a translation from the Italian.

The anomaly of the double date would be minimized if the MS. of the Urdū translation printed in 1894 had been found among Fr. Angelo's papers, after his death. He had collected largely the writings of the old Missionaries, and had not seen them all through the press before he died.

Mr. Butler's explanations about the double date 1873 and 1894 may be correct. No earlier edition of 1873 is known to exist. I have my doubts, however, about the re-rendering of an earlier Urdū translation. If the preface was wanting to the first translation, how was it obtained for the second? The Urdū preface in the Sardhana edition agrees with the Persian of the Serampur MS. Must we suppose that the Persian original used for the first Urdū translation passed into the hands of the second translator about 1894? In that case, where is this Persian original, or where is the original of the first Urdū translation? At Sardhana? At Delhi? Mr. Butler vainly searched for them in both places.

If there was a first translation made in Delhi, I fancy it had the preface; and, if this translation was overhauled, this may have been done under the instructions of Fr. Angelo, or perhaps by Fr. William Keegan, who died at Delhi on May 1, 1885, after 28 years of missionary labours in the Agra Mission. He left behind him a number of Urdū books in MS. Cf. *Indo-Europ. Corresp.*, Calcutta, 1885, p. 434.

For the material description which I made of *The Lives of the Apostles* I am indebted to the help of Aga Muhammad Kāzim Shirāzī, the Persian Instructor of the Board of Examiners, Calcutta. It is also he who passed through the press the Persian text of the preface, and pointed out the textual errors. (Cf. *Appendix B.*)

As for the translation of the preface from the Persian (cf. *Appendix A*), it was kindly undertaken by Mr. H. Beveridge at my request. It is not the only service which Mr. Beveridge has rendered me. His letters on a variety of historical subjects connected with my researches have been accumulating to the size of a volume during the past six or seven years, and they will be invaluable guides to me in the future as they have been in the past. In connection with the preface to the *Lives of the Apostles*, he notes that the text is not always correct, and that the transitions from one subject to another are rather abrupt.

APPENDIX A.

PREFACE OF THE LIVES OF THE APOSTLES, TRANSLATED FROM THE PERSIAN BY H. BEVERIDGE.

Story of the Apostles of Hazrat Jesus, and description of their virtues.

Praise be to God! My physical body and my mental faculties have again become fit for service. In a fortunate hour, I have commenced the good design. May Almighty God grant its completion, and may the work find acceptance at His glorious Court!

In the Holy Mirror (*Mirātu-l-Qads*) an account was given of Hazrat Jesus our Lord, taken from the Gospels and other books. It happened, however, that though many wondrous doings of His were recorded therein, one marvel which, perhaps, may be called the greatest of all, was left unnoticed by me. This was due either to shortness of time, or because the lips of H.M. the Shadow of God (Akbar) were athirst for the new Learning,¹ or because the marvel in question was, from its greatness, deserving of a separate book. Now then, I desire that by the Divine help and by the Fortune of H.M. the Shāhinshāh I may write of the marvel, and so complete "*The Holy Mirror.*" The marvel in question is that, at a time

¹ [The new learning means, probably, the doctrine to be derived from the 'Holy Mirror.' In that case, Akbar would be represented as so anxious to get a look at the "Holy Mirror" that the author had no time to complete it as he intended.—H. H.]

when the world was given over to idolatry, and mankind had completely forgotten the sacred books and the sayings of the Prophets, and was devoted to sensual pleasures, many of them should have broken to pieces their idols, and have turned away from their old customs, and seized hold of the Gospel, so that they joyfully sacrificed kingdoms, and reputation, and property, and life in order that they might hold fast to the Faith.

Our Lord chose out from among them twelve persons, poor men and of low caste, unknown fishermen, and made them Apostles and the shewers forth of the great marvel. They entered upon their task without swords or other means of warfare.

The Prophet Samuel has recorded in his book that a tribe of Philistines, whose territory adjoined that of the children of Israel, led an army against Saul, the king of the Israelites, and that the children of Israel were terrified and unable to make resistance. They took refuge in mountains and caves, and disappeared. However much king Saul strove to encourage them, and to protect them, it was of no avail. Indeed, he himself became afraid and withdrew from the conflict. At this crisis, the power of God wrought a marvellous thing. It came into the heart of Jonathan, the king's son, that he should go out against the host of the Philistines. So he joined to himself one other person, and these two set out to slay the Philistines. They wrought such deeds that the enemy became afraid and confused, and warred with one another. Many were slain, and the children of Israel were victorious. Samuel says that on this occasion a wondrous thing was shown, namely, that two men attacked a great host and got the victory. Now what shall I say of the twelve Apostles? They, so poor and weak, and ignorant, took courage and came into the lands of the idolators, and were victorious over their men of power and learning. They prevailed over them, so that with their own hands they broke their idols, destroyed their temples and erected places of worship in the name of the true God, and, instead of their own idols, they set up the sacred Cross. In truth, this marvel is greater than the other marvels. God be praised! The poor attack, the rich oppose them; the fishermen rush on, and stand before princes; weak travellers and ignorant strangers make the assault, the powerful come forth to fight with them, and victory is on the side of the poor!

The Prophet Daniel says that Nebuchadnezzar, the Ruler of Babylon, saw (in a dream) a great image which was made of gold and silver, and other things, and, while he was beholding it, there came a stone from a mountain, cut out without hands, and it smote upon the feet of that image, and made it disappear. The same Prophet gave the interpretation of this dream. Now, I say that that image was idolatry, which is tricked out with silver and gold and the like, and the stone

was these twelve persons, who were weak and without power, but who cast out idolatry from the Earth. The reason of this was that, solely by the power of God, and without the help of man, that stone came rolling down. Nor was it without significance that Hazrat Jesus called Simon, who was the head of the twelve, Peden (Peter), that is, "stone." James and John were brothers, and they were called "Boanerges," that is, sons of thunder; that is, they were like lightning, and stones that fell from Heaven, and they broke stones and cast down lofty edifices. Thus did St. Peter and other vice-gerents (*Nāibān*) throw down in the city of Rome, which was the seat of the Cæsars, idol-worship, and the idols which had such power and such vogue. They also drove away the Cæsars from there, and made the city their own seat, so that the true Faith prevailed there, and the Gospel was established. These things were the result of Hazrat Jesus' power. This, then, is the miracle which is greater than all the other miracles which have astonished the wise. In truth it is very wonderful to think by what weapons these twelve men did these things. The power, it is clear, was the armour with which Hazrat Jesus bade them be clothed, *viz.*, poverty, patience, meekness, love, and devotion.¹ So also when Saul the king sent Hazrat David to fight with Goliath, whom they call Jālbūt,² of whom the children of Israel were sore afraid, David would not accept the royal armour. On the contrary, he relied solely on the protection of God, and was contented with a sling and five stones. With these he put an end to the enemy, to the astonishment of thousands who were present. So also Hazrat Jesus our Lord did not wish that they should have any other armour except that of poverty, meekness, humility, patience and love. He said, "Go ye into the parts of the Earth." "I am sending you. Take no money with you, and but one garment, for that is necessary (?). And take a staff (?), and be hopeful, for I am He Who shall defeat the enemies (?)." Provided with this armour, they went out into the world, and conquered, and made current the new Faith. The learned and far-seeing say that the hardest of all things is to win hearts, and these men so turned away mankind from their old ways and so enticed them, that they came to recognize that the idols which they worshipped as gods were devils, and that their belief in them was vain, and that what they had considered the path to Paradise was really the path to Hell. They also embraced with heart and soul the Way of the Cross, and the teaching of the crucified Messiah, whom at first they had considered as a mad-

¹ *T'aasab*, which, however, is generally used in the bad sense of bigotry.

² Johnson's ed. of Richardson gives Jālūt جالوت as the Arabic name of Goliath.

man, and joyfully gave their heads for the defence of this Faith. Verily, this victory which Hazrat Jesus won through the twelve over mankind is regarded by the wise as greater than making the blind from their birth to see, or giving life to the dead. Hence, I have judged it proper to adorn this account of these twelve heroes with the blessed name of His Majesty.¹ I relate this great marvel of my Lord, and I clearly show to what tribe they (the Apostles) belonged and what deeds they did, and to what degree of greatness they attained by their Faith in Christ.

As the story of Hazrat Jesus our Lord was written in the reign of Hazrat 'Arsh Āshayānī Jalālu-d-dīn wa daniyā Akbar Bādshāh, and was designated by that Hazrat Bādshāh by the great and honourable name of the Holy Mirror (*Mirātu-l-Qads*), justice and gratitude now require that the story of the twelve Apostles of that mighty one (Jesus), who sent them forth for the guidance of mankind, and for instruction in the religion of the Gospel, and who chose them from out of all his disciples and took them for His own children, should be inscribed with the name of that Hazrat who by auspicious Fortune is seated on the throne, and who is the rightful heir of that pardoned potentate who was the shining lamp of the spiritual and material sovereignty of the Lord of Conjunction [Timur].

Let it not be concealed that, at the time when Hazrat Jesus our Lord was engaged in this world in teaching the truth, He chose twelve persons and called them His Apostles, that is, Messengers. He also chose 72 persons and called them disciples, and He said to the Twelve, "Ye are the salt of the Earth, and the light of the World, and a city built upon the summit of a mountain," that is, you are the joy and the light and the ease of the peoples of the world, and He made His power specially visible in them. When they were poor and ignorant, of mean condition, and void of power, they brought over mankind to their own side, so that all might know that the works which they did were not done by their own power, but rather by the power which that Hazrat delivered to them.

It is proper to know that Hazrat Jesus our Lord gave them the title of His Apostles, that is "The Sent." In Arabic they are called Hawārī, that is, "regarded as friends." And there is no doubt that they were also His friends. Accordingly, from friendship and love to Him, they with all joyfulness gave their heads for Him, and they were beloved by Him, so that He gave them the power of working miracles, and sent them among mankind and made them exponents of marvels. Hence I in this book call them His Apostles. There were

¹ *Hazrat.* (Apparently what is meant is that the book was dedicated to Jahāngīr).

twelve of them and one of them was Judas Iscariot. He became rejected, and made over his Master to the Jews, as has been mentioned in the *Mirātu-l-Qads*. After the Hazrat had ascended into Heaven, another was, by His orders, appointed in the room of Judas, so that the number should be complete.

One year¹ after our Lord had ascended into Heaven, He one day descended and ordered that Saul, whose name was changed to St. Paul, should receive the lofty title of Apostle, as will shortly be stated. This man did such great things that in our books his name is always mentioned next to that of St. Peter. The word Saint is always prefixed to their names (*i.e.* the Apostles); this word means "Pure," and "Arrived at God." Though in the Christian books not much is said about the Apostles, either because the learned men of the Faith were always encompassed with troubles, and so were unable to write everything, or because what they wrote was destroyed in the turbulence of strife and opposition, yet what remains is sufficient to testify to the greatness which they had received from Hazrat Jesus. I have regarded this as sufficient, and have written accordingly. Prince Solomon has said that a wise son is the glory of his father. Also an object of Hazrat Jesus was that one of His marvels should be the purifying and doing good to His disciples. We have ascertained that H.M. [Jahāngīr] is a lover of Hazrat Jesus our Lord, and is favourable to the design of this well-wisher [the author]. So in the hope that this account of the wondrous deeds of these twelve persons, who were at once the children and the disciples of the Messiah, will be favourably received by H.M. the Shadow of God, I have ventured to write it, and hope that with the help of Maulānā 'Ābdu-s-Sitār it may be translated into a fortunate hour, from Feringhī [*i.e.* Portuguese] into Persian, and may be blessed by H.M. and other readers and hearers.²

¹ *U nīr u dah māh.* Unintelligible. Is it one year and ten months?

² [This wish, that the book might be translated into Persian, was natural in the Portuguese original, but it sounds curious after the translation was completed.—H. H.]

APPENDIX B.

THE PERSIAN TEXT OF THE PREFACE EDITED BY
AGA MUHAMMAD KĀZIM SHĪRĀZĪ.

داستان احوال حواریان حضرت عیسی و ذکر مناقب ایشان

المنتهی لایه که اعضای ظاهری و قوای باطنی از سر نو متوجه خدمت شدند و در ساعت مسعود و زمان خجسته آغاز این اصنیت شایسته شد - ایزد بیچون اختتامش کرامت کند و از درگاه خلافت عظاما قبولش دهد - و چون از مرآة القدس که در آن احوال خجسته حضرت عیسی خداوند ما از روی انجیل و دیگر کتب نگاشته رهای شد^۱ چنان واقع شد که اگرچه بسیاری از عجایب و غرایب و سرگذشت حضرت عیسی خداوند ما و از معجزه^۲ بزرگ قدر او در آن گذارش یافته بود - لیکن بیک معجزه که آنرا از همه معجزه توان عظیم تر گفت متعرض شده بودم * و این از تذکری وقت و تشنه لبی حضرت ظل الهی به پوشیدن^۳ تازة چیزها بوده یا از آنکه این معجزه جلیل القدر از بزرگی خویش کتاب جداگانه را شایستگی داشت * پس اکنون خواستم که بتوفیق الهی و بیاوری اقبال حضرت شاهنشاهی آنرا نیز نگاشته همان کتاب "مرآة القدس" را در معنی تمامت دهم - و آن معجزه اینست که در آن هنگام که عالم شیفته بت پرستی بود و مردم از کتابهای الهی و سخنان پیغمبران مطلق فراموش کرده خود را بآرزوهای جسمانی سپرده بودند بسیاری از ایشان بتان خود را شکسته آنچه از آئین قدیم خویش برگشتند و بدین انجیل گرویدند که جان و مال و ناموس و ملکها بزوق تمام و اذت جان گذاشتند تا این دین خود را نگاهدارند * و حضرت خداوند ما دوازده تن از

^۱ Error in the text.

معجزه‌های^۲

نوشیدن (۳)^۳

مردم فقیر و کهنتر و گمنام و ماهی گیر را برسالت برگزیده مظهر این معجزه بزرگ ساخته است بی آنکه جنگ و تیغ را درین دخل باشد *

شموئیل پیغمبر در کتاب خویش آورده که گروه فلسین^۱ که ولایت ایشان نزدیک بزمین بنی اسرائیل واقع است بر ساول نام پادشاه بنی اسرائیل لشکر کشید و بنی اسرائیل هراس خورده و تاب مقابله او نیاورده پناه بکوهها و غارها بردند - و برگزیده شدند - و چند آنکه ملک ساول ایشان را دل داد و در نگاهداشتن کوشید هیچ سود نکرد بلکه ترسید و خواست که از مقابله او کنار گیرد * درین هنگام قدرت ابزدی نیرنگی گیرد^۲ و پسران این ملک مذکور شوتمش نام را بخاطر افتاد که هرگونه خود را بران لشکر زند - پس یک نفر دیگر بخود متفق ساخته برو تاختن آورد و آنچنان این دو تن پای خود را در قتال ایشان فشردند و کارهای کردند که غنیمت از قوس فرو گرفت و برهم خورد بطوری که بهم دیگر بجنگ آویختند و بسیاری کشته شدند و فتح بنی اسرائیل شد * این شعمول^۳ میفرماید که درین ماجرا معجزه بزرگ ظاهر شد - و بزرگ بود که دو تن بر لشکر عظیم حمله کنند و فتح یابند - پس اکنون ازان دوازده تن چه گویم که با چندین ناتوانی و فقیر^۴ و مجهول خویش همت را پیشوای خود ساخته در ملکهای بت پرستان در آئید^۵ و بر دانایان و بر قادران ایشان غالب شوند و ایشان را برین بیارند که بدستهای خود بتها بشکنند و دیرهای خود خراب ساخته عبادت خانه بزم خدای حقیقی عمارت کنند و بجای معبود خویش صلیب مقدس را منصوب سازند * براسستی این معجزه از دیگر معجزهها بزرگتر است - سبحان الله! فقرا می نازند^۶ و دولتمدان بدیشان^۷ مقابله میکنند - ماهی گیران تاختن می آرند در برابر ایشان سلاطین می ایستند - مسافران ضعیف و بیگانگان نادان^۸ حمله می آرند و خداوندان زبر دست بجنگ ایشان آماده میشوند و فتح از جانب فقرا میشود *

۱ فلسین

۲ کود

۳ شموئیل

۴ فقر

۵ در آید

۶ می نازند

۷ بدیشان

۸ بیگانگان نادان

و دانیال پیغمبر می فرماید که بخت نصر والی بابل پیکری مهیب دید که از طلاء و نقره و دیگر چیزها بود و درین زمان که نظر آن شهریار بران پیکر بود سنگی از کوه بی واسطه دست جدا شد و در پای آن صورت خورد و آنرا نابود ساخت * و همان پیغمبر این خواب را تعبیر گفته است * اکنون میگوییم که آن پیکران کل^۱ بت پرستی بود که آراسته است از چندین قدرت^۲ از سیم و زر و آن سنگ این دوازده کس اند که ناتوان و ضعیف بوده اند که این بت پرستی را از عالم برانداخته اند و گم نشان کرده - و سببش این بود که بعضی قدرت خدا بی مدد آدمی این سنگ علقان آمده بودند^۳ - و گویا بی تقرب نبود که شمعون را که سرآمد این دوازده رسول بوده حضرت عیسی پیدار نماید یعنی سنگ * و یعقوب و یوحنا هر دو برادر بودند این هر دو را "برابرشش" خواند یعنی پسران رعد خواند یعنی همچنان که برق و سنگها که از آسمان می آیند سنگها را می شکنند و بناهای بلند بصدمة خود می اندازند * اینچنین سن پیدار و دیگر نائبان از شهر رومه که تخت گاه قیصره بود بت پرستی و بتها که چندان رواج و قوت داشت انداختند و قیصره را از آنجا رانده آن شهر را پای تخت خویش کردند که در آنجا بوده رواج دین حق انجیل و پند^۴ * این بقدرت و حقیقت حضرت عیسی بود * پس اینست آن معجزه بزرگتر از همه معجزات او که خردمندان را حیران و متعجب میسازد - و الحق بغایت شگفت می آرد که این دوازده تن بکدام سلاح مسلح شده این دعوت را آخر رسانیده اند * این قدر پیداست سلاخی که حضرت عیسی پوشیدن می فرمود فقر و صبر و حلم و نی^۵ و محبت و تعصب بوده است * همچنانکه هنگامی که ساور نام ملک حضرت دانیون^۶ را بجنگ گولیات که او را جابوت میگویند فرستاد که ازو بنی اسرائیل چندان قوس خورده بودند - و دانیون^۶ هیچ از اسلح بادشاهی قبول

۱ شکل

۴ دهزد

۳ Error in the text

۵ Error in the text.

۵ آمده بود

۶ داوود

زکرد بلکه یکنه ۱ بر حمایت ایوڑی کرده همان فلاخن و پنج سنگ را بستند ۲ -
 دانست - و بدان کار غنیم تمام ساخت و هزاران مردم درین کار او در عجب
 شدند * این چنین حضرت عیسی خداوند ما نخواست که سلاح دیگر پوشند
 مگر سلاح فقر و حلم و عجز و صبر و محبت * و فرمود که " شما یان در اقصای
 جهان بگردید " - و گفت منم آنکه شما را میفرستم - با خود را دو ۳ نقد بردارید
 بغیر یک جامه که آن ضروری است با شما نباشد ۴ - و یک عصا بستند دابند
 و امیدوار باشند ۵ که منم که شکست میدهم مخالفان را * باین سلاح ایشان
 مستعد بوده بعالم در آمدند و غالب شدند و دین نو رواج دادند * دانایان
 دیده‌ور میگویند که دشوارترین کارها گرد آیدن دل است و ایشان های ۶ مردم
 را انچنان از روش قدیم گرد آیدند و فریفته خویش کرده که معبودان خود را
 که بخدای می پرستیدند، شیطان و باطل اعتقاد کردند - و آنرا را که راه بهشت
 می پنداشتند راه دوزخ داشتند ۷ - و راه صلیب و تعلیم مسیح مصلوب را که
 نخستین آنرا دیوانگی خیال میکردند بدل و جان گرویدند و برای حفظ آن
 تمام خوشدلی سرهای خود دادند * بند حاصل که ۸ ابن فتح و فیروزی را که
 حضرت عیسی بواسطه ابن دوازده کس بر جهانیان یافته دانایان بزرگتر از پیدا
 ساختن کوران مادرزاد و زنده کردن مردگان اعتقاد کرده اند * بذاتین واجب
 دانستم که احوال ابن دوازده بزرگوار را بدام مبارک حضرت مزین ساخته این
 معجزه بزرگ خداوند خود بیان کنم - و خوب و انمایم که ایشان از کدام گروه
 و چکاره بوده اند - و بدولت ایمان و اعتقاد به مسیح بکدام پایه بزرگواری رسیدند *
 و چون داستان حضرت عیسی خداوند ما در عهد جهان آرای و فرمان
 فرمای حضرت عرش آشیانی جلال الدین و الدنیا اکبر بادشاه نگارش یافته
 بود - و از حضرت آن بادشاه مغفور بنام نامی و رسم گرامی " مرآة القدس "
 موسوم گشته * اکنون انصاف و شکر نعمت رسیدگی تقاضا فرمود که داستان
 احوال خیر مآل دوازده رسول آن بزرگوار (که برای هدایت عالمیان و تعلیم
 دین انجیل از حضرت او گماشته شده اند و ایشان را از جمله شاگردان خویش
 بجای پسران خود گرفته) بنام حضرت که بدولت و سعادت مسند نشین
 و خلف الصدق آن بادشاه غفران پناه و چراغ افروز خادواده سلطنت صوری

۱ تکیه

۲ بسفد

۳ با خود زاد و نقد

۴ باشد

۵ و یک عصا بردارید و امیدوار باشید

۶ ایشان

۷ دانستند

۸ حاصل اینکه

و معنوی حضرت صاحب قران اند نگارش یافته گلگونه شرف و عزت قبول
جاوید یابد و این نیز بنام نامی و رسم گرمی از حضرت ظل الهی
موسوم گردد *

پوشیده نماید که وقتی که حضرت عیسی خداوند ما درین دنیا بتعلیم
حق مشغول گردید دوازده کس را برگزید - و ایشان را اپوستلش خطاب کرد
یعنی فرستاده شدهگان و نیز هفتاد و دو کس انتخاب کرده شاگردان نامید -
و باین دوازده کس فرمود که " شما بنده¹ نمک زمین و نور عالم و شهری معهور
بر قلعه کوهی " - یعنی که ایشان لذت و نور و علاج عالمیان اند و در ایشان
قدرت خود بیشتر ظاهر ساخت که در دیگران برگزیده * ایشان را در آن هنگام
که فقیر و نادان و فرومایه و ناتوان بوده اند و عالمیان را برسالت ایشان
سوی خود آورده - تا معلوم همه باشد که این کارها که ایشان میکردند
بقدرت ایشان نبود بلکه بدان قدرت که آنحضرت در ایشان سپرد *

باید آنست² که حضرت عیسی خداوند ما ایشان را اپوستلش
خطاب کرده است یعنی فرستاده شده - و عرب ایشان را حواری میخوانند
یعنی دوست داشته شده * و شک نیست که ایشان هم دوست او بودند
چنانکه بدوستی و محبت او بذوق تمام سرهای خود داده اند - و هم محبوب او
چنانکه ایشان را قدرت خوارق و کرامت سپرده برسالت عالمیان فرستاده است
و مظهر عجایبات ساخته * بنابراین ایشان را درین کتاب اپوستلش می نویسم -
و ایشان دوازده کس بوده اند و یکی از ایشان یهودا بسخار پوتس نام - اگرچه
مردود شده - خداوند³ خود را به یهودان سپرده - چنانکه در صراة القدس گذارش
یافت * اما بعد از آنکه آن حضرت آسمانی شد بحکم او دیگری بجای او
برگزیده اند تا این عدد پوره گردد و نیز و ده صاع⁴ * بعد از يك سال آنکه
خداوند ما آسمانی شده است روزی نزول فرموده - ساول نام را که از
سن پاول تعبیر میروند باین خطاب اپوستلو بلند ساخته است - چنانکه بزودی
گذارش یابد * و این مرد چندان بزرگ گشته که نام او در کتب ما همه جا
پس از سن پیدرو مذکور می شود * و نیز پوشیده نماید که هرگاه نام یکی

¹ بنده

² باید دانست

³ چونکه خداوند خود

⁴ Error in the text: the expression پوره گردد is Urdu and not Persian.

از ایشان درین کتاب می گیریم کلمه سنت بآن پیوند می کنیم یعنی پاک و خدا رسیده - همین بجای دعاست بعد از ذکر ایشان * و اگرچه از احوال این برگزیدگان الهی در کتب عیسویان کمتر یافته میشود و این یا از جهت آن بود که چون علمای این امت دایم در تشاکش محبت و رنجی دایمی بوده اند توفیق نوشتن همه چیزها نیافتند یا از آنکه هرچه نوشته شده بود در شورش عداوت و استیلائی مخالفان بیشتری پامال حوالت گردید * اما آنچه مازده بود آنرا برای گواهی بزرگی ایشان که از حضرت عیسی یافته بودند بسند و گاهی دانسته نوشتیم * هرگاه مهتر سلیمان میفرماید که "پسر دانا عزت پدر است" * و نیز مراد حضرت عیسی آن بود که یکی از جمله معجزه های او پاکیزگی و نیکو کاری شاگردان او باشد * و ما دریافتیم که حضرت خلافت پناهی را محبت حضرت عیسی خداوند ما بر مراد این بندگان خیر اندیش است - پس بآید آنکه احوال عجیب و کارهای غریب این دوازده تن که هم پسران مسیح اند و هم شاگردان او حضرت ظل الهی را خواهد خوش افتاد جرأت کرده نوشتیم - و امید که بدست یاری مرلانا عبد الستار در ساعت مسعود از فرنگی بفارسی جلوه کند و بر حضرت و سایر خوانندگان و شنوندگان مبارک گردد *

8. A Forgotten Kingdom of East Bengal.

By NALINI KANTA BHATTASALI, M.A.

Communicated by SIR ASUTOSH MOOKERJEE, KT.

[With Plate VIII.]

It is now more than a quarter of a century that two copper-plate inscriptions of a Buddhist king named Deva Khadga, with a small bronze chaitya, were unearthed at Asrafpur,—a small village some miles north-east of Dacca. One of the plates was somewhat damaged at the edges, but the other plate was in a perfect state of preservation. Dr. Rajendra Lal Mitra published a reading of the first plate on pages 49-52 of the *Proceedings of the Asiatic Society of Bengal* for 1885. Short notices of the second plate and the chaitya were published in the *Proceedings for 1890*, p. 242 and 1891, p. 119. A photograph also of the chaitya was published with the notice of 1891. The only serious attempt of publishing a correct reading of the plates up to this time has been that of late Ganga Mohan Lashkar, M.A., who in 1904 read a paper on the plates in the Asiatic Society of Bengal. But neither his article nor those of his predecessors contain any attempt of determining the historical importance of the plates, or of identifying the city of Karmmanta from which the plates were issued. Though Khadga dynasty was undoubtedly a local dynasty, one may well ask whether it deserves the oblivion to which it has been consigned. Last year, while searching for objects of antiquarian interest in and near the town of Comilla, I chanced upon an inscribed image of Nataraj Shiva, and on examining the inscription I found that it was an inscription of a king of Karmmanta,—no doubt the same Karmmanta from which the Asrafpur plates were issued. The place near which the image was found is still called Kamta. It lies some twelve miles west of the town of Comilla. Imposing ruins of ancient buildings, temples and forts, large tanks apparently several hundred years old and innumerable stone images of Buddhist and Shaiva gods and goddesses testify most conspicuously to the antiquity and past greatness of the city of Karmmanta.

When did the Khadga dynasty of Karmmanta begin to rule? How far did their sway extend? How and when did the dynasty come to a close? These are the questions which we shall try to answer in the light of the new materials in our hands.

Mr. Lashkar in his article on the Asrafpur plates says—
“Paleographic considerations would lead us to place these

inscriptions in the eighth or ninth century A.D.’’ Dr. R. L. Mitra was also of the same opinion. But a careful comparison with some of the inscriptions of the seventh century A.D. would readily show that the plates must belong to that period. The characters of the Shahpur image inscription of Aditya Sena dated in the 66th year of the Harsha Era (672 A.D.)¹, and the Apsad inscription of the same king² are much more developed than the characters of the Asrafpur plates. Indeed, the characters of these plates are so akin to those of the Madhuban and the Banskera³ plates of Harsha that these four plates must belong to the same period. Further corroborations are not wanting.

We know from the Allahabad Pillar Inscription of Samudra Gupta that the kingdom of Samatata, Davaka, Kamarupa, Nepala, etc., were on the border of his empire. So we see that there were clearly defined kingdoms in East Bengal at this early period. We cease to hear any more of the kingdom of Davaka, but that the kingdom of Samatata continued to have an individual existence is clear from the accounts of Hiuen-Tsang, who visited the kingdom during his travels. It is to be regretted that he does not mention the name of the king of Samatata. From his description, it appears that there were thirty or more Sangharamas at Samatata with 2000 priests. The maintenance of thirty Sangharamas with 2000 priests seems to urge that the king belonged to the Buddhist creed. This is further corroborated by the assertion that Silabhadra, the teacher of Hiuen-Tsang, belonged to the Royal family of Samatata; moreover, It-Sing expressly mentions that the king of Samatata was a devout Buddhist.

What was this Buddhist Royal Family of Samatata that had given a principal to the University of Nalanda in the person of Shilavadra? We believe it was the Khadga family. The only difficulty in the way of the identification is the mention of Shilabhadra as a Brahmin by Hiuen-Tsang. The title of Khadga is avowedly a Kshatriya title. But Hiuen-Tsang also calls Bhashkara Varman, king of Kamrupa, a Brahmin. If Varman can be a brahmin, I do not see why a Khadga cannot.

I have already pointed out the close resemblance of the characters of the Asrafpur plates with those of the plates of Harsha. This itself, as we have already said, is a proof that the Buddhist Khadga family belongs to that period. The assertions of It-Sing (673 to 687 A.D.) dispel the least shade of doubt.

The first plate of Asrafpur states that it grants land to secure

¹ Fleet's "Gupta Inscription," pl. xxix.

² *Ibid.*, pl. xxviii.

³ *Epigraphia Indica*, Vol. I, p. 67, and Vol. IV, p. 210.

the longevity of Rajabhatta, and we know from the second plate that Rajabhatta was the son of Deva Khadga. In the second plate, Rajabhatta himself is the donor, and he gives land from his own private estates for the Triratna. Fortunately, this pious prince is mentioned by name by It-Sing.¹ It-Sing states that Rajabhatta king of Samatata was an enthusiastic adherent and patron of Buddhism, and that the number of the Buddhist Monks in the capital had risen from the 2000 of Hiuen-Tsang's time to 4000 in his time, who were all maintained by the king. Rajabhatta's munificence is apparent in his grant of land to the Triratna from his private estates, even while he was a crown prince, and we are glad to learn from It-Sing that he continued his charity even after coming to the throne. That the Khadga family was really a Brahmin family is apparent from the name of Rajabhatta.

It-Sing stayed in India from 673 to 687 A.D.² Rajabhatta therefore must have reigned in the last quarter of the seventh century A.D. The names of only four kings of this dynasty are known,—namely, Khadgodyama, his son Jatakhadga, his son Devakhadga, and his son Rajaraja Bhatta. The first king Khadgodyama therefore must have risen to power in the last quarter of the sixth century A.D., in the troubled period following the dismemberment of the Gupta empire.

The capital of the kingdom of Samatata in the time of the Khadga Kings was Karmmanta, modern Kamta near Comilla. It was the town of Karmmanta, therefore, which Hiuen-Tsang and It-Sing visited. The town was then nearly five miles in circuit. There were thirty Sangaramas in the capital in which nearly 2000 monks lived. Deva temples also were numerous, numbering nearly 100, and they belonged to all sects. The Nirgrantha Jaina Ascetics also lived in the capital in great numbers. In the suburbs of the city was a Buddhist Stupa said to have been built by Asoka Raja. Near the Stupa was a Sangarama containing an image of Buddha in green jade 8 feet in height. The ruins of the Stupa and the Sangharama may perhaps still be identified on a little search and excavation, for Mahomedan devastation did never reach up to Karmmanta. I personally have never had the opportunity of taking up the work seriously.³

¹ Watters' "Yuan Chwang," Vol. II, p. 188.

² It-Sing Takakusu's Translation, Introduction.

³ In December last I was deputed by the Dacca Shahitya Parisat (a Literary and Research Society of Dacca) to explore the site of the ancient Karmmanta. The stupa mentioned by Hiuen-Tsang still exists in the shape of a big mound on the east side of the modern village of Kamta. A mile to the north of Kamta lies the village of Behar mandal, which contains many ruins, and which, I believe, is the site of the sangharama with Buddha in green jade mentioned by Hiuen-Tsang. An image of the Buddhist god Jambhala is still worshipped in the village and he is locally known as the Krishnadeva of Beharmandal. A very

The kingdom of Samatata does not seem to have been a small one. That the kingdom extended up to a pretty distance westwards is shown by the grant of land by the kings of Karmmanta at Asrafpur in the Narayanagunge Subdivision of Dacca. The old Brahmaputra on which stands the Tirtha of Langalbandha seems to have marked the western boundary of the kingdom of Samatata. The kingdom seems to have included the districts of Tipperah, Noakhali, Barisal, Faridpur and the east half of the Dacca District.

Who reigned after Rajabhatta and how the kingdom fell are at present wrapped in obscurity. A little light is thrown as regards the state of Karmmanta after the fall of the Khadgas by the new Comilla inscription.

The inscription is at the pedestal of an eighteen-armed image of the God Shiva performing the Tandava dance. The inscription designates him as Nartteswara. The worship of Nartteswara seems to have been very current in India from the sixth century A.D. onwards. Images of the god are met with all over India. Four of these images are preserved in the Madras Museum, but all of them are four-handed. The images at Elephanta, Ellora¹ and Badami² have more than four hands; the Badami one in particular has eighteen hands and is quite like the Comilla image.

We give below a transcript of the new inscription and a translation of the same.

TEXT.

- (1) Srimallayaha Chandra Devapadi | ya Bijaya Rajye Asta : shna Chaturdasyam Tithau Brhaspati Bare Pushya Nakashatre | Karmmantapala Sri |
- (2) Kushumadeva Suta Sri Bharudeva | Karita Sri Nartteswara Bhatta | Ashadha Dine 14 Khanitancha Ratokena Sarbbaksharah | Kashanitancha Madhusudaneneti.

TRANSLATION.

- (1) In the eighteenth year of the victorious reign of his glorious majesty Layahachandradeva, on Thursday, in the dark Chaturdasi Tithi and in the star Pushya.

fine image of Dhyani-Buddha was removed from this village to a village near by where it receives worship as Basudeva. People around consider the name of Beharmandal as inauspicious. They never utter its name in the morning but always signify it by the terms,—east village, west village, north village or south village as the case may be. This is a curious remnant of the later Hindu hatred of Buddhism. The site of the palace of the kings of Karmmanta lies near by, surrounded by a broad ditch.

¹ Havell's "Ideals of Indian Art," pl. xxvii and xxix.

² Arch. Surv. of West India, Vol. I, by Burgess, pl. xvii.

[N.S.]

- (2) Bharudeva son of Kushumadeva Lord of Karmmanta made the Lord Nartteswara.....on the fourteenth day of Ashadhara All the letters engraved by Ratoka. Sculptured by Madhusudana.¹

In all probability the inscription had a date but the inscribed portion in the beginning of the third section has been broken away and lost, and some letters in the beginning of each line have been rendered illegible by the peeling off of stone. In spite of that the date might have been ascertained by astronomical calculation from the data available in the inscription. The question would be:—In what year did the dark Chaturdashi Tithi, the Pushya Nakshatra, Thursday and the fourteenth of Ashadha come together. We referred the question to eminent astronomers like Babu Jogesh Chandra Ray, M.A., of Cuttack and Babu Rajkumar Sen, M.A. late Professor of Dacca College, but they both assure us that the coincidence of Chaturdashi Tithi and Pushya Nakshatra is impossible. I am at a loss to account for this dilemma. On paleographical grounds the inscription cannot be put earlier than the tenth century A.D.

It will be seen from the inscription that the kings of Karmmanta had sunk to a very low position. The absence of any royal titles shows that they were mere local chiefs by this time and King Kushumadeva acknowledged the over-lordship of certain Layahachandradeva.

Up to this time we know of only two Chandra dynasties who might have acquired over-lordship over Karmmanta. These are the Chandra dynasty of Vikrampur and the Chandra dynasty of Arracan.

We came to know of the Chandra dynasty of Vikrampur only the other day.² Mr. Rankin has published in the *Dacca Review* of October, 1912, a note on the Idilpur plate of King Chandra, which was communicated to him some years ago by late Gangamohan Lashkara, M.A. Nothing can be said about it definitely until the publication of this plate in full with facsimile, but it is apparent from Gangamohan Babu's brief observations that King Chandra was a Buddhist king and that the characters of the plate are of the twelfth century type. Three Chandra Kings of Vikramapur are known from this plate. Namely, Subarna, Trailokya and Chandra, and there is no Layaha among them. We must look to Arracan for this Layahachandra.

¹ Rātoka was the engraver who engraved "all the letters." Madhusudana, therefore, must have been the sculptor. We are glad to learn that Dhiman and Bitapal of Barendri had their rivals in East Bengal.

² Recently a copperplate grant of Srichandradeva of Bikrampus has been published by Prof. R. G. Basak, M.A., in the *Bengali Magazine* "Shahitya."

The history of the Chandra Dynasty of Arracan is very imperfectly known. Mr. Phayre in his "History of Burma," p. 45, has recorded what little can be known of the kings of that dynasty from the Arracanese chronicles. They relate that King Maha-taing-tsandra was the first king of the dynasty. He ascended the throne in A.D. 788 and built a new Capital Wethali, i.e. Vaisali, soon after his accession. Nine kings of this dynasty reigned in this city in succession up to A.D. 957. The names of these kings are given in full in "Numismata Orientalia," Vol. II, Part I, p. 42, by Phayre, transcribed from the original Arracanese. These names sound so strange that it is difficult to say what their Sanskrit originals were.

Some coins of the Chandra Kings have also been found in Arracan, but it is very strange that the names found on them do not at all correspond to any of the names on the Arracanese lists. The names of Barmma Chandra, Priti Chandra and Bira Chandra are known from the coins, but none of them bear any resemblance to any name on the lists.¹

Under these circumstances it is very difficult to identify the Layahachandra of the Comilla inscription with any name of the Arracanese list. But the last king Tsu-la-taing-tsandra who reigned from A.D. 951 to 957 may be Srilayahachandra of the Comilla inscription, and the date of the king also is in keeping with the evidence of paleography.

If the identification be right, it may be surmised that the descendants of Rajabhatta continued to reign for 100 years more in Karmmanta and were at last swept away by the rise of the Chandra Kings of Arracan by the end of the eighth century A.D. They placed their minion on the throne of Karmmanta who began to rule as a vassal of the kings of Arracan. Mr. Phayre has suggested that the Chandra Kings were perhaps of foreign origin and that they brought about changes in religion by discarding the popular Buddhism and embracing Shaivism as is shown by the couchant bull and trident symbol on their coins.² We suspect that they came from Vaisali of India from their naming the new capital Vaisali, and the suspicion is confirmed by the fact that the mother of Kyansittha, King of Pegu, was said to have been a daughter of the King of Vaisali.³ The north-western origin of the Chandra King is also hinted at by their over-lordship over the Kings of Karmmanta. The couchant bull symbol of the Chandra Kings is strikingly similar to the couchant bull symbol of the Asrafpur plates, and this may point to some unknown relationship between the two dynasties. The supposition that the Chandra Kings were Shaivas is corroborated

¹ "Numismata Orientalia," Vol. II, Part I, pp. 28-29.

² "Numismata Orientalia," Vol. II, Part I, Intro., p. 4.

³ Phayre's "History of Burma," page 38.

by the Comilla inscription, which is on the pedestal of a Nartteswara Shiva.

The country round Kamta is at present known as the Purganah of Patikara. We learn from the Maharajaweng that there was still a royal dynasty reigning in those parts in the latter part of the eleventh century A.D. and in the beginning of the twelfth century A.D. A prince of Patikara was united to a daughter of Kyansittha king of Pegu, and king Alangsithu (A.D. 1035 to A.D. 1160), the fruit of this union, married a princess of Patikara. The existence of a royal dynasty in these parts in the twelfth century A.D. is further attested by a copperplate inscription of Ranabankamalla, which was found in 1803 in the Lalmai Hills midway between Comilla and Kamta and which was sent to the Asiatic Society of Bengal by Mr. Elliot, the then District Magistrate of Comilla. A reading of it was published by Mr. Colebrooke as early as 1807, in the Asiatic Researches, Vol. IX, p. 398, and it has been reprinted in Vol. II, p. 241, of his essays. A revised reading ought to be published by this time if the plate be still in the possession of the Society.





The Nartteswara image inscription of Bad Kamta (one fourth of the original).

9 The Nature of *mokṣa* in the *nyāya* and *vaiśeṣika* systems.

By VANAMALI CHAKRAVARTTI.

In an article headed “Optimism in ancient *nyāya*,” which I contributed to the Journal of the Asiatic Society of Bengal, December 1905, Vol. I, No. 10 (N.S.), it was pointed out that the conception of *mokṣa* (liberation, salvation) in ancient *nyāya* was to be distinguished from the *vaiśeṣika* and neo-*naiyāyika* conception of it, inasmuch as the former contained an element of pleasurable feeling, while the latter was utterly devoid of every element of consciousness. I had to support this view by a single passage¹ from the *Samkṣepa Śāṅkara Jaya* of *Mādhavācārya*. I have since come across three more passages to the same effect, and these I propose to bring together in this short note.

The first passage is from the *nyāya* section of the *सर्वदर्शन-सिद्धान्तसङ्ग्रह*, a work which is attributed to *Śāṅkarācārya* himself.¹

नित्यानन्दानुभूतिः स्यान्मोक्षे तु विषयादृते ॥

वरं वृन्दावने रम्ये ष्टगालत्वं वृणोम्यहम् ।

वैशेषिकोक्तमोक्षात् सुखलेशविवर्जितात् ॥

यो वेदविहितैर्यज्ञैरीश्वरस्य प्रसादतः ।

मूर्च्छा मिच्छति यत्नेन पाषाणवदवस्थितिम् ।

Chap. VIII, 41-43.

“In the condition of final release there will be the experience of eternal bliss without (any perception whatsoever of) sense-objects. I choose to be a fox in the beautiful *Vrindāvana* in preference to that altogether blissless soul-deliverance, which has been taught by the *vaiśeṣikas*, who by means of sacrifices, prescribed in the *vedas*, and by means of the grace of the

¹ अत्यन्तनाथे गुणसङ्घे यथा

स्थितिर्न भवति कष्टमक्षयपक्षे ।

मुक्तिस्त्वदौघे चरणाक्षयपक्षे

सानन्दसंवित्महिना विमुक्तिः ॥ १३ । १८

Lord¹, wishes to attain with great effort the altogether feelingless state of a swoon, a condition of existence similar to that of a stone.” (M. Raṅgācārya’s translation).

This passage not only states the *naiyāyika* conception of *mokṣa* as containing an element of agreeable feeling, it also distinguishes it clearly from the *vaiśeṣika* conception.

The second passage is from *Guṇaratna’s Tarka-Rahasya-Dīpikā*. It was originally brought to my notice by my revered teacher *Mahāmahopādhyāya* Haraprasāda Śāstri, C.I.E., M.A., F.A.S.B. It runs thus (Dr. Luigi Sualì’s edition of षड्दर्शनसमुच्चय, p. 188).

वरं वृन्दावने वासः षड्गालैश्च सहोषितम् ।
न तु वैशेषिकीं मुक्तिं गौतमो गन्तुमिच्छति ॥

Translation:—A follower of *Gotama* (i.e. a *naiyāyika*) would not like to attain such liberation as is taught by the *vaiśeṣikas*. He would prefer living in *Vṛindāvana* [though this might entail] living in company with [such creatures as] the jackals.

This passage also makes a clear distinction between the *vaiśeṣikas* and the *naiyāyikas*, with reference to the notion of *mokṣa* or liberation.

The third passage is from the well-known *Nyāya Sāra*. It is avowedly a *naiyāyika* work and its author *Bhāsarvajña* is mentioned as a leading authority on *nyāya*, along with *Akṣapāda*, *Vātsyāyana*, *Vācaspati*, etc., in *Guṇaratna’s Tarka-Rahasya-Dīpikā*. The following extract will show that at least one school of *naiyāyikas* (including *Bhāsarvajña*) allowed an element of agreeable feeling in the notion of *mokṣa*.

कः पुनरयं मोक्ष इति । एके तावद् वर्णयन्ति समस्तविशेषगुणोच्छेदे² संहारावस्थायामाकाशवदात्मनोऽत्यन्तावस्थानं मोक्ष इति । कस्मात् । सुखदुःखयोरविनाभावित्वाद् विवेकहानानुपपत्तेः । न च सुखार्थैव² प्रेक्षावतां प्रवृत्तिः कण्टकादिदुःखपरिहानार्थत्वेनापि प्रवृत्तेरुपलम्भात् इति । तत् सिद्धमेतत् नित्यसंवेद्यमानेन² सुखेन विशिष्टा आत्यन्तिकी दुःखनिवृत्तिः पुरुषस्य मोक्ष इति ।

Bibliotheca Indica ed., pp. 39-41.

¹ I would prefer to translate thus:—“who by means of the grace of the Lord, obtained by the performance of *vedic* sacrifices.”

² *Mahāmahopādhyāya* Satischandra Vidyabhusan, M.A., Ph.D., F.A.S.B., reads ‘समस्त गुणोच्छेदे’, ‘सुखार्थे च’ and ‘नित्यसंवेद्यम् । अनेन’.

I have accepted the above readings, however, on the strength of *Jayasimha Sūri’s* commentary.

Translation:—What is [the nature of] this liberation? Some¹ describe it thus:—the perpetual existence of the soul, with all its special qualities [such knowledge, pleasure, pain, etc.] extinguished, is called Liberation (*mokṣa*): it may be likened to the existence of ether (*ākāśa*) after the dissolution of the world.² How [is it possible that such an unconscious, pleasureless state should be regarded as the supreme object of human pursuit?] [The reply turns on the recognition of the fact that] pleasure is inseparable from pain, and hence it is not possible to shun all pain and enjoy pure pleasure. Moreover, pleasure is not the only object of human pursuit. Men are found to exert themselves for removal of pain as well, e.g. when they try to pull out a thorn from off their feet. [Here ends the statement of the *vaiśeṣika* and neo-*naiyāyika* position. The author now refutes this position and states his own, i.e. the really *naiyāyika* position and concludes]..... Thus we have proved that when a person fully and finally rids himself of all pain and gets into a state of perpetual pleasure, then he is said to attain liberation or *mokṣa*.

These several passages will make it abundantly clear that the *naiyāyika* conception of *mokṣa* had not always been identical with the *vaiśeṣika* conception, as is now almost universally supposed to be the case.

¹ This "some" probably refers to a school of *naiyāyikas*, who had adopted the teaching of the *vaiśeṣikas*. According to the commentator, some = the *vaiśeṣikas*. एके इति श्रीसुक्ताः ।

² An extract from the commentary will make the passage clear :

अथमर्थः । वैशेषिकाणां मते चतुर्दशगुणाधिकरण आत्मा । तत्र चतुर्दशानां गुणानां मध्ये पञ्च गुणाः सामान्याः बहुप्रादयो नव विशिष्टाः । यर्हि बहुप्रादयो नव विशिष्टा गुणाः समुच्छिद्यन्ते तदा शिलाशकलकल्पस्य आत्मनाऽत्यन्तावस्थानं मोक्षो भवति यथा प्रलयकाले विशिष्टगुणशब्दोच्छेदात् केवनस्याकाशस्यावस्थानं भवति तथैत्यर्थः ।

10. Edilpur Grant of Kesavasena.

By R. D. BANERJI, M.A.

The discovery of this inscription was announced by Prinsep in 1838, in which year it was presented to the Asiatic Society of Bengal by Babu Conoy Lal Tagore (i.e. Kānāi Lāla Thākura).

The plate was dug up on a river bank in the Pargana Edilpur in the Bākerganj district of Bengal. Prinsep published his reading in the 7th volume of the Journal of the Asiatic Society of Bengal.¹ He read the king's name *Kēśavasēna*. About sixty years afterwards Babu Nagendra Nāth Vasu, when editing the Madanapāda grant of Viśvarūpasēna, observed that the king's name should be read as *Viśvarūpa* and not *Kēśava*.² He relied on the reading of the last words of verse 10—

*Etasmāt kathamanyathā ripu-vadhū-vaidhavya-vaddha-vratō
vikhyātaḥ kshitipalāmaulir-abhavat śrī-Viśvarūpō nṛpaḥ*

which he correctly read as *Viśvarūpo nṛpaḥ*. His views were adopted by Dr. Kielhorn, in his list of Northern India Inscriptions,³ who states "This name was by Prinsep misread as *Kēśavasēna*"⁴.

In 1907 Dr. Sten Konow, the then Government Ephigraphist for India, enquired about the plate, and then the Society found out that the grant was missing. Subsequent enquiries produced no result. Some time ago I was engaged in studying the date of Lakshmanasēna and his successors. At that time I was struck by Dr. Kielhorn's statement, and on examining the facsimile found out that Prinsep's reading of the king's name is quite correct. In the absence of the original plate, which seems to be lost beyond all hope of recovery, I am obliged to rely on the facsimile published by Prinsep, which fortunately enough is not a drawing but a lithograph from a mechanical estampage. The lithograph is as good as that from which Dr. Kielhorn published the Mungir grant of Dēvapāla⁵, excepting the spots retouched by Prinsep.⁶

The subsequent discovery of the Madanapāda grant of Viśvarūpasēna has facilitated the revision, as all of the verses of the former are to be found in the latter. The king's name is undoubtedly *Kēśavasēna*. The word *Viśvarūpa* in the 17th line

¹ *Journ. Beng. As. Soc.*, Vol. VII, Pt. I, pp. 40ff.

² *Ib d.*, Vol. LXV, Ft. I, pp. 8ff.

³ *Ibid.*, Vol. V, App. p. 88, No. 649.

⁴ *Ibid.*, note 1.

⁵ *Ind. Ant.*, Vol. XXI, pp 254ff.

⁶ *Journ. Beng. As. Soc.*, Vol. VII, p. 40.

is a surname and not a proper name. If we take it to be a proper name, we shall have to acknowledge that the word *ētābhyām* in the 24th line refers to Viśvarūpa and Tādādēvi.¹ Consequently in the case of the Madanapāda grant we would have to admit that Viśvarūpasēna was the son of king Viśvarūpa and Tādādēvi. Therefore it is quite certain that the word *Viśvarūpa* in the 17th line is an epithet and not a proper name. The Edilpur grant contains several additional verses, consequently it might be stated that Viśvarūpasēna was Kēśavasēna's predecessor. They were not contemporary sovereigns, because both grants mention the *Vikramapurabhāga* or division. One peculiarity of the Madanapāda grant of Viśvarūpasēna has been overlooked by the learned Editor. The name *Viśvarūpa* occurs twice, and in each case it is evident that the engraver had run short of space. In the present grant the name of the king has been incised in the place of another name, which had been scratched off. But the space is quite sufficient for the new name. Evidently the former name consisted of three or more syllables. The space in the plate was insufficient for writing the king's name, Viśvarūpasēna, on it, and consequently the letters are very small. It may be that some name with three syllables was erased and *Kēśava* incised in its place, while in the Madanapāda grant a name with three syllables was erased and the name Viśvarūpa, with four syllables, substituted for it. The genealogy of the Sēna kings of Bengal would therefore be:—

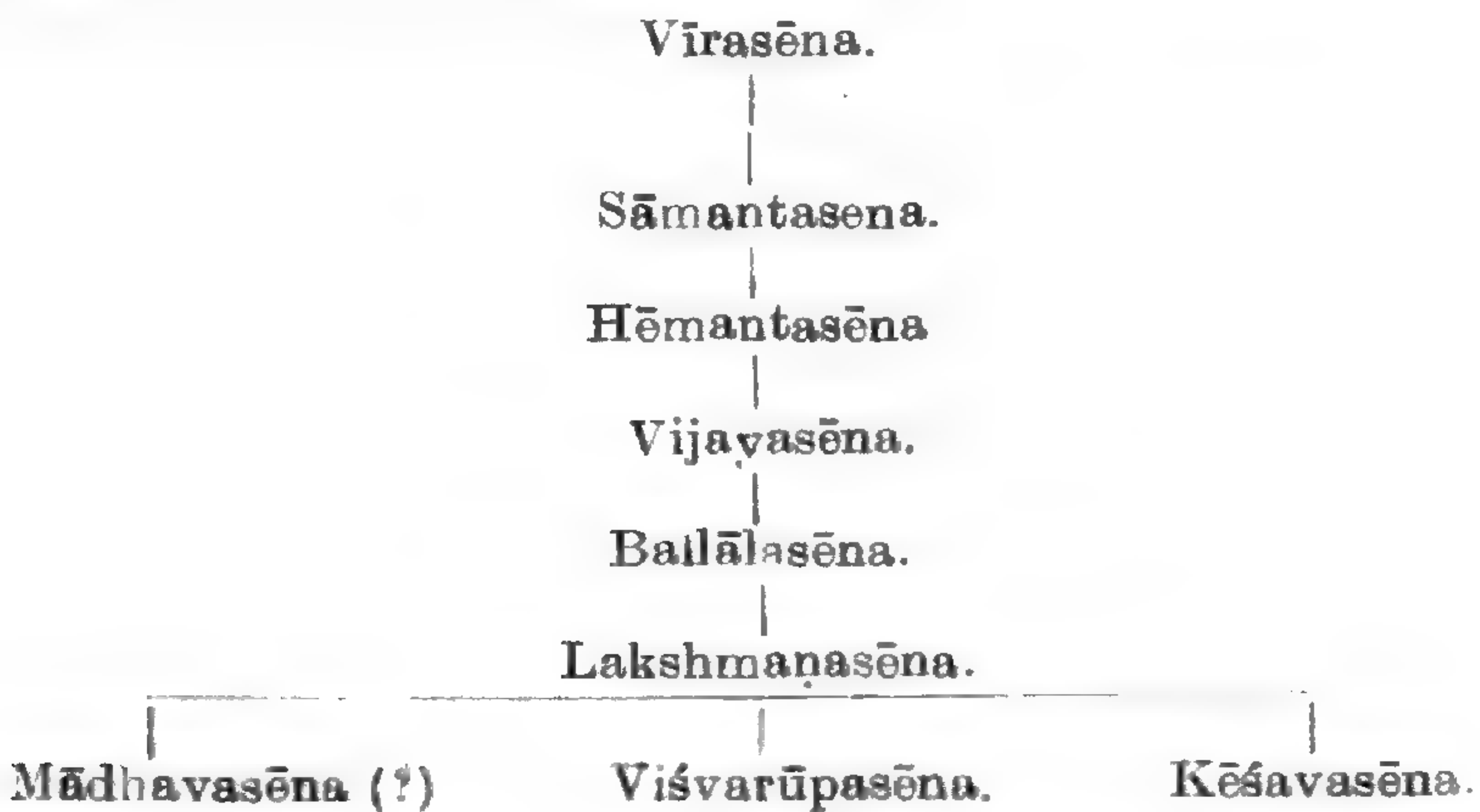

The inscription records the grant of a village in the *Paundravardhana-bhukti* and *Vikramapura bhāga*, by the *Paramēśvara paramabhattāraka*, the devout worshipper of the Sun god, the *Mahārājādhirāja Kēśavasēnadēva*, who meditated on the feet of the illustrious *Lakshmanasēnadēva*, who meditated on the feet of the illustrious *Ballālasēnadēva*, who meditated on the feet of the illustrious *Vijayasēnadēva*.

¹ This is clearly the reading of the plate, which, of course, should be corrected into *Tārādēvi* or *Chandradevi* as the case may be, because the verse occurs in both grants.

The grant was issued [l. 38] from the victorious camp at *Jamvugrāma* on the occasion of the king's birthday.¹

The recipient of the grant was a Brāhmana, named *Īsvara-dēvaśarman*, of the *Vatsa gōtra* and a reader of the *Vēdas (śrutipāthaka)*. The term *Sadāśiva-mudrayā mudrayitvā* requires some explanation. All copperplate inscriptions of the *Sēna* kings of Bengal bear a small ten-armed seated male figure at the top. Evidently this is the *lāñchana* of the *Sēna* dynasty, and the words quoted above show that it was commonly known as the *Sadāśivamudrā*. It may, of course, be taken to mean the very auspicious seal, but we find a description of *Sadāśiva*, a ten-armed form of *Śiva*, in the *Mahāparinirvāṇa Tantra*, and the coincidence is so remarkable that we certainly have to explain the expression *Sadāśiva-mudrayā mudrayitvā* as meaning "sealing it with the *Sadāśiva* seal.

TEXT.

First Vide.

1. ओं ओं नमो नारायणाय ॥ वन्देऽरविन्दवनवान्धवमन्धकारकारा-
निव(ब)द्धभुवनत्रयमुक्तिहेतुम् । पर्यायविस्तृतसितासितपक्षयुग्म-
मुद्यान्तम-
2. द्रुतखगं निगमद्रुमस्य ॥ [१] पर्यन्तस्फटिकाचला वसुमतौ विश्व-
गिवमुद्गीभवन्मुक्ताकुड्मलमब्धिमम्बरनदीवन्यावनडं नभः । उद्भिन्न-
स्मित-
3. मञ्जरीपरिचिता दिक्कामिनीः कल्पयन् प्रत्युन्मीलतु पुष्पसायकयशो-
जन्मान्तरञ्चन्द्रमाः । [२] एतस्मात् क्षितिभारनिःसहशिरोद-
4. वीकरग्रामणीविश्रामोत्सवदानदीक्षितभुजास्ते भूभुजो जज्ञिरे ।
येषामप्रतिमल्लविक्रमकथारब्धप्रबन्धाद्भूतव्याख्यानन्दवि-
5. निव्रसान्द्रपुलकैर्याप्ताः सदस्यैर्दिशः ॥ [३] 'अवातरदधान्वये महति
तत्र देवः स्वयं सुधाकिरणशेखरो विजयसेन इत्या-
6. ख्यया । यदंघ्रिनखधोरणिस्फुरितमौलयः क्षामुजो दशास्य-
नतिविभ्रमं विदधिरे किलैकैकशः ॥ [४] नीलाम्भोरुहसो-

¹ The actual wording of the plate, ll. 49f., is *śubhavarṣavṛddhan dīrghāyusth [ā] kāmanayā*. In Western Bengal, two words are used to denote a birthday—*śubhavarṣa-pūjā* and *janmatithi-pūjā*.

7. दरो ऽपि दलयन्मर्माणि कादम्बिनोकान्तो ऽपि ज्वलयन्मनांसि
मधुपस्त्रिग्धो ऽपि तन्वन्मयम् । निर्निक्ताञ्जनसन्नि-
8. भो ऽपि जनयन्नेत्रकमं वैरिणां यस्याशेषजनाद्भुताय समरे
कौक्षेयकः खेलति ॥ [५] भासन्निस्त्रि[]श निद्राविरहवि-
9. लसितैर्वैरिभूपालवंश्यानुच्छिद्योच्छिद्य मूलावधि भुवमखिलां
शासतो यस्य राज्ञः । आसीत्तेजोजिगीषा सह दि-
10. वसकरेणैव दोषस्तुलामूढुत्तैवाशीविषाणामजनि दिग्धिपै
रेव सौमाविवादः ॥ [६] खिलत् खङ्गलतापमार्जनक-
11. तप्रत्यर्थिदर्प्यज्वरस्तस्मादप्रतिमल्लकौर्त्तिरभवदल्लालसेनो
नृपः । यस्यायोधनसौमि शोणितसरिद्ःसञ्चरा-
12. यां हृताः संसक्तद्विपदन्तदण्डशिविकामारोप्य वैरिस्त्रियः ॥ [७]
श्रीकान्तो ऽपि न मायया वलिजयी वागीश्वरो ऽप्यक्ष-
13. रं वक्तुं नेत्य पटुः कलानिधिरपि प्रोन्मक्तदोषाग्रहः ।
भोगीन्द्रो ऽपि न जिह्मगैः परिवृतस्त्रैलोक्यरेखा-
14. द्रुतस्तस्माल्लक्ष्मणसेनभूपतिरमूढुलोककल्पद्रुमः ॥ [८]
प्रत्यूषे निगडस्वनैर्न्नियमितप्रत्यर्थिपृथ्वीभुजां ।
15. मध्याङ्गे जलपानमुक्तकरठिप्रोद्गोलघण्टारवैः । सायं
वेशविलासिनौ जनरगन्मञ्जौरमञ्जुस्वनैर्यनाका
16. रि विभिन्नशब्दघटनावन्ध्यं त्रिसन्ध्यं नभः ॥ [९] पूर्वं जन्मशतेषु
भूमिपतिना सन्त्यज्य मुक्तिग्रहं नूनं तेन सुतार्थिना सरधुनीतीरे
17. भवः प्रीणितः । एतस्मात् कथमन्यथा रिपुवधूवैधव्यवद्धव्रतो
विख्यातः क्षितिपालमौलिरभवत् श्रीविश्वरूपो नृपः ॥ [१०] न गग-
18. नतल एव शीतरश्मिर्न कनकभूधर एव कल्पशाखी । न विबुध-
पुर एव देवराजो विलसति यत्र धरावतारभाजि ॥ [११] वाहू

वारणह

19. स्तकाण्डसदृशौ वक्षः शिलासंहतं वाणाः प्राणहरा द्विषां मद-
जलप्रस्यन्दिनो दन्तिनः । यस्यैतां समराङ्गप्रणयिनीं कृत्वा
20. स्थितिं वेधसा को जानाति कुतः कृतो न वसुधा चक्रे ऽनुरूपो
रिपुः ॥ [१२]
वेलायां दक्षिणाब्धेर्मुसलधरगदापाणिसंवासवे-
21. द्यां क्षेत्रे विश्वेश्वरस्य स्फुरदसिवरणाश्लेषगङ्गोर्मिभाजि ।
तौरोत्सङ्गे त्रिवेण्याः कमलभवमखारम्भनिर्व्याजपूते ये-
22. नोच्चैर्यज्ञयूपैः सह समरजयस्तम्भमाला न्यधायि ॥ [१३] यान्निर्माय
पवित्रपाणिरभवद्देधाः सतीनां शिखारत्नं या किमपि
23. स्वरूपचरितैर्विश्वं ययालङ्कृतम् । लक्ष्मीभूरपि वाञ्छितानि
विदधे यस्याः सपत्न्यौ महाराज्ञी श्रीचान्द्रादेवी स्व (?) स्य महिषी
24. सामूत्तिवर्गोचिता ॥ [१४] एताभ्यां शशिशेखरगिरिजाभ्यामिव
वभूवशक्तिधरः । श्रीकेशवसेनदेवः प्रतिभटभूपालमुकुट
25. मणिः ॥ [१५] दृष्टिस्थानमवाप्य विश्वजयिनो यस्य द्विजानां पयः
पात्रैर्लौहमयैर्हिरण्यपदवी प्राप्तेति कोविस्मयः । एतस्मिन्नपतौ
26. प्रतापमहति प्रत्यर्थिपृथ्वीभुजां यत् पात्राणि हिरण्ययान्यपि
पुनः यातान्यथोवर्णताम् ॥ [१६] आकौमारमपारसङ्करहरव्यापार
27. ढष्णावश्वान्तस्यास्य निशम्य वीर परिषद्वन्द्यस्य दोर्विक्रमम् ।
नेदं नेदमिदञ्चनेति चकितैर्दुर्गं प्रविश्य द्रुतं निर्गच्छद्भिर-
28. रातिभूपनिवहैर्भ्रान्त्यद्भिरेवास्यते ॥ [१७] आकर्णाञ्चलमेलकार
विशिख-
- क्षेपैः समाने द्विषां दानाम्भःकणगर्भदर्भ कलनैर्गी-
29. क्षीषु निष्ठावताम् । नीवीबन्धविसारणैः परिषदि त्रस्यत् कुरङ्गीदृशा-
मव्यापारमुखासिकां क्षणमपि प्राप्नोति नैतत्करः ॥ [१८]
30. तापिच्छैः परिष्पीलितेव सरितां कच्छस्यलीनीरदैर्नीरन्ध्रेवनभस्तटी
मरकतैः क्षमाभुवः क्षारुहः । नीलया-

31. वक्रदम्बकैरविरला भोगेव मुक्तावली लेखासीददसीययञ्जत-
मुग्धमावली खिलति ॥ [१६] कल्पद्वारुहकाननानि कनकद्वामृद्वि-

Second Vide.

32. ग्मागान्निधे रत्नानां पुलिनान्तराणिच परिभ्रम्य प्रयासालसा ।
एत[त्]पादपयोधरप्रणयिनीच्छायावितानाञ्चले विश्राम्यन्ति सता-
मनि-
33. द्रविदशोद्भ्रान्तामनोवृत्तयः ॥ [२०] किमेतदिति विस्मयाकुलित
लोकपाला
वली विलोकितविष्टङ्गलः प्रधानजैत्रयात्राभवः । शशास ए-
34. थिवीमिमां प्रथितवीरवर्गाग्रणीः सगन्धयवनान्वयप्रलयकाल
रुद्रोन्मत्तः ॥ [२१] पद्मालयेति याख्यातिर्लक्ष्मणा एव जगत्त्रये
सरस्वत्य-
35. पि तां लेभे यदाननकृतालया ॥ [२२] आरुह्याभ्रंलिहगृह-
शिखामस्य
सौन्दर्यलेखां पश्यन्तीभिः पुरि विहरतः पौरसीमन्तिनीभिः ।
36. वार्त्ताकृतैर्नयनचलितैर्विभ्रमं दर्शयन्त्या दृष्टाः सख्यः क्षण-
विघटितप्रेमरुद्धैः कटाक्षैः ॥ [२३] एतेनोन्नतवेश्मसङ्कटभुवः खो-
37. तस्वतीसैकतक्रीडालोलमराल कोमलकलत्क्वाणप्रणीतोत्सवाः ।
विप्रेभ्यो ददिरे महीमघवतानेकप्रतिष्ठाभृतः पाकप्रक्रमशा-
38. लिशालिशवलक्षेत्रोत्कटाः कर्वटाः ॥ [२४] इह खलु फल्गुग्राम-
परिसर
श्रीमज्जयस्कन्धावारात् समस्तसुप्रशस्युपेत अरिराजवृष-
39. भ शङ्करगौडेश्वर श्रीमद्विजयसेनदेव पादानुध्यात समस्त सुप्रश-
स्युपेत अरिराज निःशङ्करगौडेश्वर श्रीमदल्लालसेन-
40. देवपादानुध्यात समस्तसुप्रशस्युपेत अरिराजसूदन
शङ्करगौडेश्वर श्रीमल्लक्ष्मणसेन देवपादानुध्यात समस्त
41. सुप्रशस्युपेत अश्वपति गजपति नरपति राजत्रयाधिपति
सेनकुलकमलविकासभास्कर सोमवंशप्रदीप प्रतिपन्न-

ERRATA.

In Journal, Vol. X, p. 102.—Edilpur Grant of Keśavasena,
eighth line from the top :—

Read

34. थिवीमिमां प्रथितवीरवर्गाग्रणीः सगर्गं यवनान्वय प्रलयकाल

instead of

34. थिवीमिमां प्रथितवीरवर्गाग्रणीः सगन्धं यवनान्वय प्रलयकाल ।

42. कर्ण सत्यव्रतगाङ्गेय शरणागतवज्रपञ्जर परमेश्वर परमभट्टा-
रक परमसौर महाराजाधिराज अरिराज अ-
43. सहाय शङ्कर गौडेश्वरश्रीमत् केशवसेनदेवपादा विजयिनः ॥
समुपगताशेषराजराजन्यक राज्ञीराणक राजपुत्र रा-
44. जामात्य महापुरोहित महाधर्माध्यक्ष महासान्धिविग्रहिक
महासेनापति महादौःसाधिक चौरोज्जरणिक नौबल ह-
45. स्यश्च गोमहिषाजाविकादिव्यापृत गौल्मिक दण्डपाणिक दण्ड-
नायकविषयपत्यादीनन्यांश्च सकलराजपादोपजीविनो
46. ऽध्यक्षानध्यक्षप्रवरांश्च चट्टभट्टजातीयान् ब्राह्मण ब्राह्मणो-
त्तरांश्च यथाहं मानयन्ति बोधयन्ति समादिशन्ति च वि-
47. दितमस्तु भवतां यथा पौण्ड्रवर्द्धनभुक्तयन्तःपाति वङ्गे
विक्रमपुरभाग तालपडापाटक
48. पूर्वे सत्रकाद्वीग्रामः सीमा दक्षिणे शङ्करपाशा गोविन्दकेलिनो
भूः सीमा पश्चिमे पञ्चको ... शङ्करग्रामः सी-
49. मा उत्तरे वागुलीवित्तगदो ... मानभूःसीमा इत्यं यथा प्रसिद्धं
स्वसीमावच्छिन्ना बृहत् नृपतिचरणौ शुभव.
50. षंष्टद्वौ दीर्घायुष्ट कामनया समुत्सर्गित साश्वतं दायोत्पत्तिकस्य
सभूमिः ससाटविटपाः सगर्तोषराः सजलस्थ-
51. ला पलाश ताला सगुवाकनालिकेरा अचट्टभट्टप्रवेशा तृणा
युति पर्यन्ता आचन्द्रार्क क्षिति समकालं यावत् दिनं नाना
52. पुष्करिण्यादिकं कारयित्वा गुवाकनारिकेलादिकं लगावयित्वा
पुत्रपौत्रादिसन्ततिक्रमेण स्वच्छन्दोपभोगे
53. नोपभोक्तुं वात्स्यसगोत्रस्य भार्गवचवन आप्रवान् चैर्व
जामदग्न्य पञ्चप्रवरस्य परासर देवशर्मणः प्रपौत्रा-
54. य वत्ससगोत्रस्य तथा पञ्चप्रवरस्य गवर्भेश्वरदेवशर्मणः प्रौत्राय
वत्ससगोत्रस्य तथा पञ्चप्रवरस्य वनमालिशर्मणः
55. पुत्राय वत्ससगोत्राय भार्गवचवन आप्रवान् चैर्व जामदग्न्य
पञ्चप्रवराय अतिपाठक (1) य श्री ईश्वर देवशर्मणो ब्रा-

56. क्षणाय सदाशिवमुद्रया मुद्रयित्वा दृतीयाकीय ज्यैष्ठदिना
भूच्छिद्रन्यायेन ताम्रशासनौक्य प्रदत्तास्माभिः
57. यत्र चतुःस्रीमावच्छिन्नस्री (मा) शासनभूर्हि ३०० तद्भुवद्भिः सर्वै
रेवानुमन्तव्यं भाविभिरपिन्द्रपतिभिरपहरणे नरक
58. पातभयात् पालनेधर्मगौरवात् पालनीयम् ॥ भवन्ति चात्र
धर्मानुशंसिनः प्लोकाः । आस्फोटयन्तिपितरो वलगयन्ति
59. पितामहाः भूमिदोऽस्मत्कुले जातः सनस्त्राता भविष्यति ॥ भूमिं
यः प्रतिगृह्णाति यश्चभूमिं प्रयच्छति । उभौ तौ पुण्यक-
60. र्माणी नियतं स्वर्गगामिनौ ॥ वज्रभिर्वसुधा दत्ता राजभिः
सगरादिभिः । यस्य यस्य यदा भूमिस्तस्य तस्य तदा फलम् ॥ स्वद-
61. त्तां परदत्तां वा यो हरेत वसुधराम् । सविष्ठायां कृमिर्भूत्वा
पिष्टभिः
सहपच्यते ॥ षष्टिं वर्षं सहस्राणि स्वर्गे तिष्ठति भूमिदः ।
62. आक्षेप्ता चानुमन्ताच तान्येवनरकेवसेत् ॥ सर्वेषामेवदानाना
मेकजन्मानुगं फलम् । इतिकमलदलाम्बुविन्दलोलां श्रिय-
63. मनुचिन्त्य मनुष्यजीवितञ्च । सकलमिदमुदाहृतञ्चबुद्ध्या नहि
पुरुषैः परकीर्तयोविलोप्याः ॥ सचीव शतमौलिलालित प
64. दाम्बुजस्यानुशासनभूतः श्रीयुतदत्तोद्भव गौडमहामहत्तकः ख्यातः
श्रीमन्महासाकरणि श्री महामह नुक ...
65. करणनि ॥ श्रीमत करणनी ॥ सं ३ ज्यैष्ठदिने

11. Kāthkari.

By B. A. GUPTA.

Communicated by MAHAMAHOPADHYAYA HARAPRASAD SHASTRI.

Sir James Campbell, the editor of the *Bombay Gazetteer*, to which work he devoted the best energies of his life, derives the word 'Kātkarī' (Catechu-maker) from Kāth (Catechu). But K. C. M., writing in the July number of the "Indian Antiquary," page 206, states that the derivation is "thoroughly untenable." Mr. K. C. M. following Rājwāde's Marāthi essay derives the word from the word 'Kāraskara' used in Baudhāyana, Karnaparva of Mahābhārata and Pānini. He never gives any interpretation of the word 'Kāraskara,' that is what 'Kāra' means. But deriving 'Kāthkara' from 'Kāraskara' in the following way (Kāraskar-Kārachkara-Kāchkara-Katkara). But the elimination of "R" in this way is against all rules of Prākṛit Grammar. It is only in modern Marāthi that "S" changes into "C," but not in the Marāthi Prākṛit. His appeal to Pānini is of no avail to him, for that eminent Grammarian says that "Kāraskara" means only a tree. Even if it is not a Sutra but a Gana, there too it means a "Vriksa" or tree. *If it meant a tribe or a country it would have been "Kārakara."* So Pānini's reference does not help either Mr. K. C. M. or Mr. Rājwāde. It seems that Pānini knew no country or tribe as "Kāraskara." He knew only a tree of that name. Do these scholars agree to derive the word "Kāthkar" from "Kāraskara"? If they agree, I would demand from them the rule of Prākṛit Grammar which they want to apply.

The reference to Karnaparva of Mahābhārāt and also to Baudhayana as against Pānini is but very weak. The use of the word "Kāraskara" in these two instances might be as an adjective, meaning tree-like, hard, and so on.

Sir James Campbell's derivation however stands good, for "Kāth" in Marāthi means "Catechu" and "Kara" means "one who does" and so "Kāthkar" means "Catechu-maker." It was no business of his to indulge into antiquarian vagaries about the derivation.

12. Grooved Stone Hammers from Assam and the Distribution of Similar Forms in Eastern Asia.

By J. COGGIN BROWN, M.Sc., F.G.S.

[With Plate I.]

Grooved hammers and axes are perhaps the rarest of the numerous Neolithic stone implements recorded from Eastern Asia. Only one specimen of this type appears to have been described from India. It was found by J. Cockburn together with a number of other stones under a sacred tree at Alwara, two miles north of the Jumna, and thirty-seven miles southwest of Allahabad, and described by J. H. Rivett Carnac as a tough greyish quartzite implement, flat at both ends and slightly curved on the upper surface, 3.50" in length by 2.10" in breadth and 1.80" in thickness. A groove has been cut around the centre and the base hollowed out in a gouge-like form. The whole arrangement suggests that the hammer was attached by a ligature to a wooden or withy handle, the ligature being kept in place by the upper groove while the lower groove held the hammer in position on the rounded haft. Certain minute marks which the specimen bears, especially on the lower groove, are believed to be the result of chipping with a metallic instrument, and if this supposition is correct, the implement must belong to a period in a transition culture from stone to metal, when metal, though available, was scarce. Cockburn adds that he possessed several other hammerstones of a less perfect form, bearing no trace of metallic tooling, which appear to be waterworn pebbles grooved to admit of being attached to a withy handle. (J. Cockburn, *On Stone Implements from the North-West Provinces of India*. *J.A.S.B.* 1883, pp. 221-230).

The original specimen referred to above is now in the British Museum, though a cast of it is preserved in the Indian Museum. During an examination of the large collections of prehistoric remains preserved in the latter institution, I have met with two or three specimens of grooved hammerstones of the same general type from neighbouring localities. One was obtained by Major-General A. Cunningham from Tikari in the Harimpur district and was presented to the Museum in 1883. Others have been collected in the Banda district by Sir H. Seton-Karr.

There are at least two belted stone hammers in the magnificent prehistoric collection of the Madras Museum which I

had the privilege of examining last year. They were both discovered by the late Mr R. Bruce Foote—the first near Hoshalli, Kudligi Taluq, Bellary district; it is a broad, round-faced hammer made of pink granite. The round face is much broader than the butt end, and there is a very distinct constriction round the middle of the hammer to enable it to be attached to a haft or withy. The specimen is unfinished, and was evidently rejected by its maker owing to a false blow which smashed a large piece out of the edge of the striking face. The second specimen was found on an old copper smelting site at Rupavati, fifteen miles south-east by south of Damnaga, Baroda. In its general shape it is very near the former one, but it has been completely finished and polished, though afterwards greatly injured by much usage. The deep and highly polished belt groove remains nearly entire, and shows that great care must have been taken in its manufacture. It is fashioned from a grey gabbro.

In spite of the extended list of this type of belted hammerstones now brought forward, the fact remains that such implements are of the greatest rarity, and are only very occasionally found amongst the thousands of other Neolithic artifacts in which certain parts of the Indian Empire abound. A commoner type of hammerstone from the United and Central Provinces and from Central India, is not grooved at all, though often covered with circular indentations, which may perhaps have served for holding the weapon in the hand.

The specimens from Assam belong to an entirely different type and are well worthy of a description here. There are 6 specimens in all, 5 of which are made from a fine, close-grained, greyish, bluish or reddish-grey quartzite; one from a dark, fine-grained, schistose diorite. Each specimen has been formed by splitting an elongated, ovoid, water-worn pebble into two pieces, across its transverse diameter, and then grinding down the fractured end until it assumed a smooth, slightly convex surface. The groove or belt is cut into the implement roughly two-thirds of the distance between the face and the pebble butt. In each case it is broad and well marked though not deep. In two of the quartzite hammers the groove forms a complete ring around the stone; in the other three, it is not continued round the edge which evidently faced the hand when the implement was held in its withy. In the case of the diorite hammer the belt is continued around one face and two edges but not around the other side. The largest specimen measures approximately 10 cms. long by 7 broad by 5 thick; The smallest, 6.5 cms. long by 6 broad by 3 thick. The others are intermediate in size though usually somewhat thinner than the largest one. The specimens were found along with others by Mr. W. Penny, a tea-planter of Bishnath, Tezpur district, Assam, in digging a ditch on his estate. They reached

the Indian Museum in 1908, through the Viceroy, Lord Curzon, to whom they had been presented.

It is interesting for the sake of comparison to enumerate briefly the occurrences of similar forms from other countries in Eastern Asia. So far as I am aware, belted hammerstones have not been found in Burma, Malaya, Borneo, Indo-China or Yünnan. Only a single specimen is recorded from the whole of the Chinese Empire, where it was discovered by Mr. S. Couling, a medical missionary of the English Baptist Mission in Ts'ing-chou Fu, Shangtung Province, in the vicinity of his station. It is described and figured by Berthold Laufer (*Jade, A Study in Archæology and Religion*, Field Museum of Natural History, Publication 154, Vol. X, 1912, p. 50), along with a grooved hammerstone found in a shell mound north-west of Koraskoosk on the southern shores of Saghalin Island by Dr. Iijuna, (derived from the *Journal of the Anthropol. Soc. of Tokyo*, Vol. XXI, No. 247, 1906), and the oblong grooved maul, which is still a common household utensil among the Chukchi to the far north-east on the Bering Strait. The shell mounds of Ainu origin in Japan have yielded objects which are regarded by some writers as grooved stone hammers and by others as net sinkers.

Grooved stone axes are common in North America and seem to be very generally distributed through the United States. An excellent example is preserved in the Indian Museum collection, and figures are given by Charles Rau (*Smithsonian Contributions to Knowledge. The Archæological Collection of the United States National Museum in charge of the Smithsonian Institution, Washington, D.C., 1876*).

There is no evidence to prove that the grooved-stone axe which only occurs sporadically in Eastern Asia, did not evolve as an independent unit in the North American culture area, but on the other hand, the lack of evidence in this particular case, does not lessen the probability that in certain other archæological types America borrowed from Asia.



Bemrose, Colln., Derby.

GROOVED STONE HAMMERS FROM ASSAM.

13. On the Reproductive System of *Atopos*, Simroth.

By EKENDRANATH GHOSH.

[Read at the First Indian Science Congress, January 16, 1914.]

The genus *Atopos* was constituted by Simroth (5) in 1891 for the reception of three species of slugs included in the genus *Vaginula*, Latrille, which forms the type-genus of the family Vaginulidae. Later on, Heude established a new family, Rathouisiidæ, for the reception of the present genus and a few others.

In 1900 Babor established a new subgenus *Podangia* for *Atopos schildii*, which differs from the other species of the genus in some minor details.

Since the establishment of the genus, a good number of species have been described from time to time, but the anatomy has been studied in a very few instances only. Simroth described and figured the main anatomical features of the three species he established, viz. *A. semperi*, *A. leuckarti* and *A. strubelli*. Later on Collinge (1, 2) while describing some new species of *Atopos* from Malaysia briefly described the gross anatomy of *A. maximus* and *A. sarasini* and illustrated his descriptions with figures of the digestive and reproductive systems. Two years ago I described the anatomy of *A. (Podangia) sanguinolenta* (Stolickza, MS.), and last year the anatomy of *A. kempii* (4) a new species from the Abor country and of another new species from Tenasserim which has not yet been published. Recently, I have studied the anatomy of a big specimen (probably *A. maximus* or another species closely allied to it) from Tavoy. I should specially mention that I received all the specimens from the Indian Museum.

The reproductive system of *Atopos* consists of the following parts:—

1. The hermaphrodite gland is a small lobulated body lying on the ventro-lateral aspect of the anterior end of the digestive gland. Two types of hermaphrodite gland may be recognized as follows:—

(a) A distinct hermaphrodite gland separate from the albumen gland. This type occurs in *A. maximus*, *A. sarasini*, *A. sanguinolenta* and in another species (not named) mentioned in the paper. In *A. sanguinolenta*, the hermaphrodite gland is a big lobulated body lying in contact with the albumen gland. In *A. sarasini*, the gland lies embedded in the albumen gland, although quite distinct from the latter.

(b) A compact gland inseparably connected with the albumen gland so that the whole gland is divisible into two

portions,—an acinar portion (or glandular portion) and an albuminiparous portion. This type occurs in all the other species.

The hermaphrodite gland consists of a large number of acini held together by connective tissue. Each acinus consists of a wall of thin fibrous layer lined by a single layer of flattened fusiform epithelial cells. These cells give rise to both ova and spermatozoa so that both the elements are developed side by side in the same acini.

Collinge described the gland as ovary in his species, *A. maximus* and *A. sarasini*. But in all the species I studied I have found both the ova and spermatozoa after careful histological work.

2. The albumen gland, in accordance with the types of the hermaphrodite gland, is also represented in two forms:—

In the first type, it forms an elongated irregular mass surrounding the hermaphrodite duct, which may be coiled in various ways. The gland surrounds the duct, and is intimately connected with it.

In the second type, the albuminiparous portion consists of irregular masses of simple racemose glands which open separately, sometimes at fairly long intervals, into the hermaphrodite duct.

3. The hermaphrodite duct is a fairly stout tube which passes forwards for a shorter or longer length to end in the external aperture on the right side in the groove between the foot and the margin of the mantle at a little distance from the opening of the combined tube of the penis and the right Simrothian gland.

4. The receptaculum seminis is a pyriform sac opening into the hermaphrodite duct by means of a narrow stalk.

The hermaphrodite gland has no connection with the penis. Simroth described a vas deferens from the hermaphrodite gland to the penis, but in all other species, described both by Collinge and myself, no such structure was found.

5. The penis is a stout tubular body lying in a sheath with which it is connected at the free end. The penial sheath is fusiform and dilated at the proximal end, but is narrowed down to a tubular structure opening into the exterior behind the right lower tentacle in conjunction with the right Simrothian gland.

6. A fine tubular structure is always found opening into the distal end of the penis. It passes forwards along the penial sheath, and then curves backwards for some distance along the base of the right Simrothian gland. This has been termed vas deferens by Collinge (2), but it corresponds to the flagellum described in *Helix*.

7. The retractor penis muscle is a fine strand which arises from the posterior end of the penial sheath and passes back-

wards over the hermaphrodite gland to be attached to the body-wall behind the latter.

8. The Simrothian glands, one on each side, are two tubular glands opening into the exterior at the base of the lower tentacles, the right one being united with the penial sheath just behind the external opening.

Each Simrothian gland is divisible into three portions in all the species. They are as follows, starting from the free proximal end:—

(a) The free portion of the tube, which is much coiled in some species but loosely so in others. It generally lies beneath the buccal mass and salivary glands.

(b) A very narrow portion forming a fractional part of the whole length. It is loosely coiled in all the species described.

(c) The stoutest portion forming the base which opens to the exterior. This part of the tube invariably presents a small process at its proximal end, and gives attachment to a muscular strand which is inserted to the body-wall close to it. In *A. (P.) sanguinolenta*, this portion is not well developed, although the process is present; the muscular strand, however, has disappeared. Moreover, there is an additional stouter portion intervening between the second and the third (last) portion of the gland.

The arrangement of the generative organs and the ducts in the present genus is closely similar to those in the Cephalaspidae (Opisthobranchia Tectibranchia) and corresponds to the first type of duct described by Lang.

It is an important point to note that, considering the structure of the reproductive system, the present genus seems to be far removed from the genus *Vaginula*, with which it was formerly associated in the family Vaginulidae. It has rightly been removed from that family and placed in a separate one.

LITERATURE.

1. Collinge, W. E. "Report on the Non-operculate Land Mollusca," Fasciculi Malayensis, Zool. part II.
2. Collinge, W. E. "On the Non-operculate Land and Freshwater Molluscs," Journal of Malacology 1902, Vol. IX, pt. 3.
3. Ghosh, E. "The Anatomy of *Atopos* (Podangia) *sanguinolenta*, Stol., MS.," Records of the Indian Museum, Vol. II, part II, No. 17.
4. Ghosh, E. "Mollusca, I; Rathouisiidae," Records of the Indian Museum, Vol. III. Zoological Results of the Abor Expedition, 1911 12, Part III.
5. Simroth, H. "Über das Vaginuliden genus *Atopos*, n.g.," Zeit. f. Wiss Zool. 1891, Bd. III, pp. 593-616 T. XXVII. C. P. R.

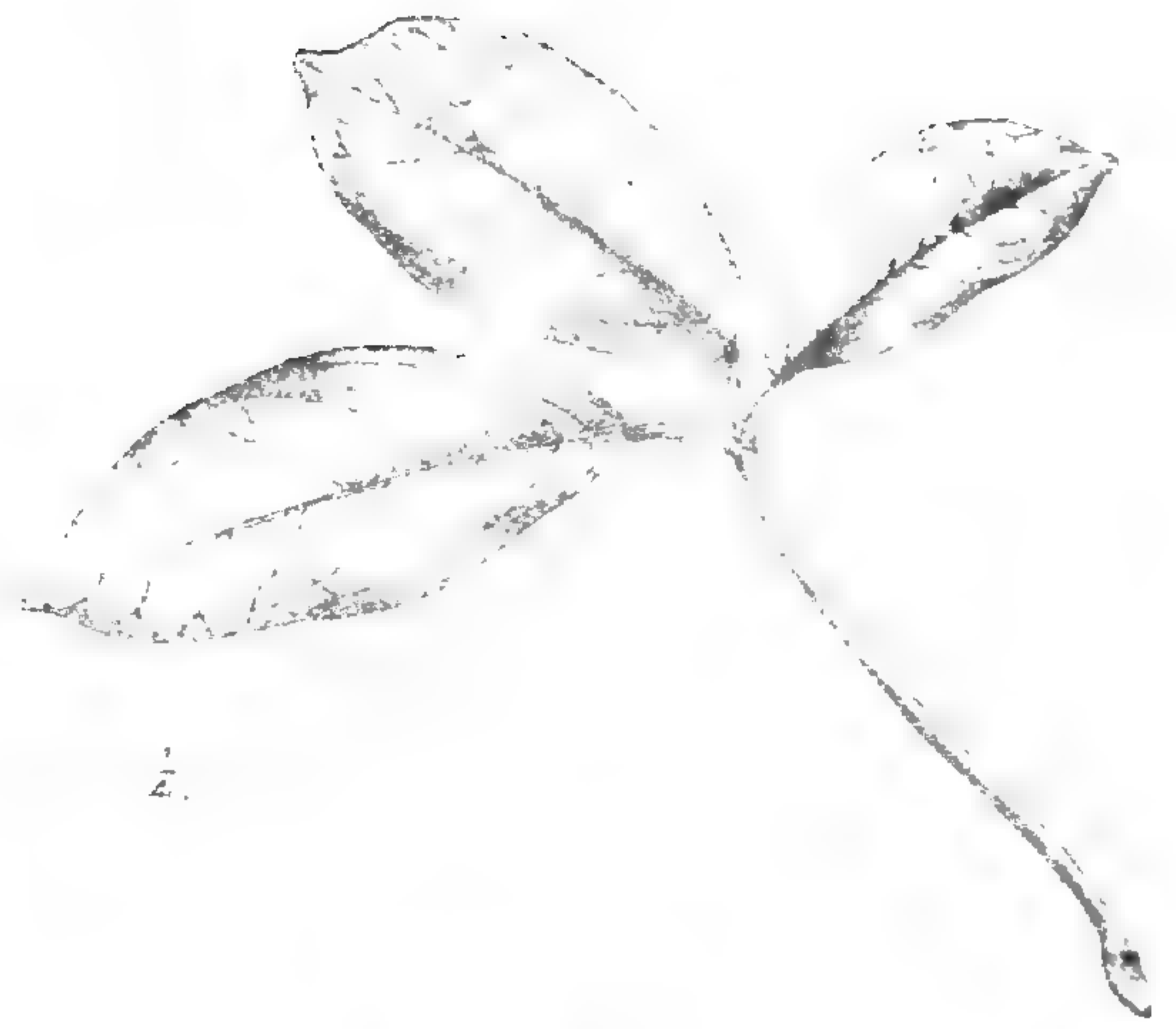

HEPTAPLEURUM VENULOSUM, Seem. A.C. Chowdhary, lith

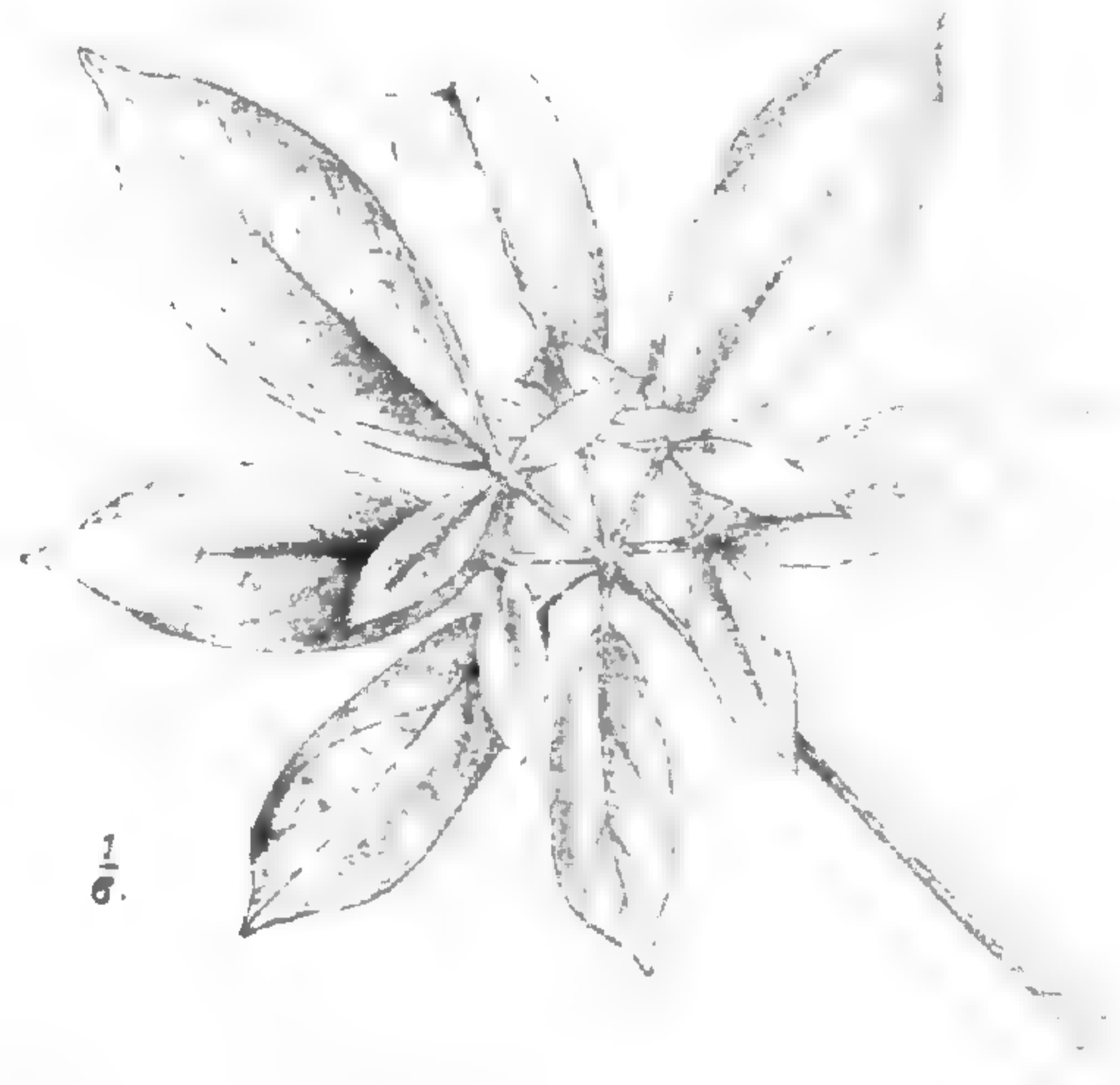
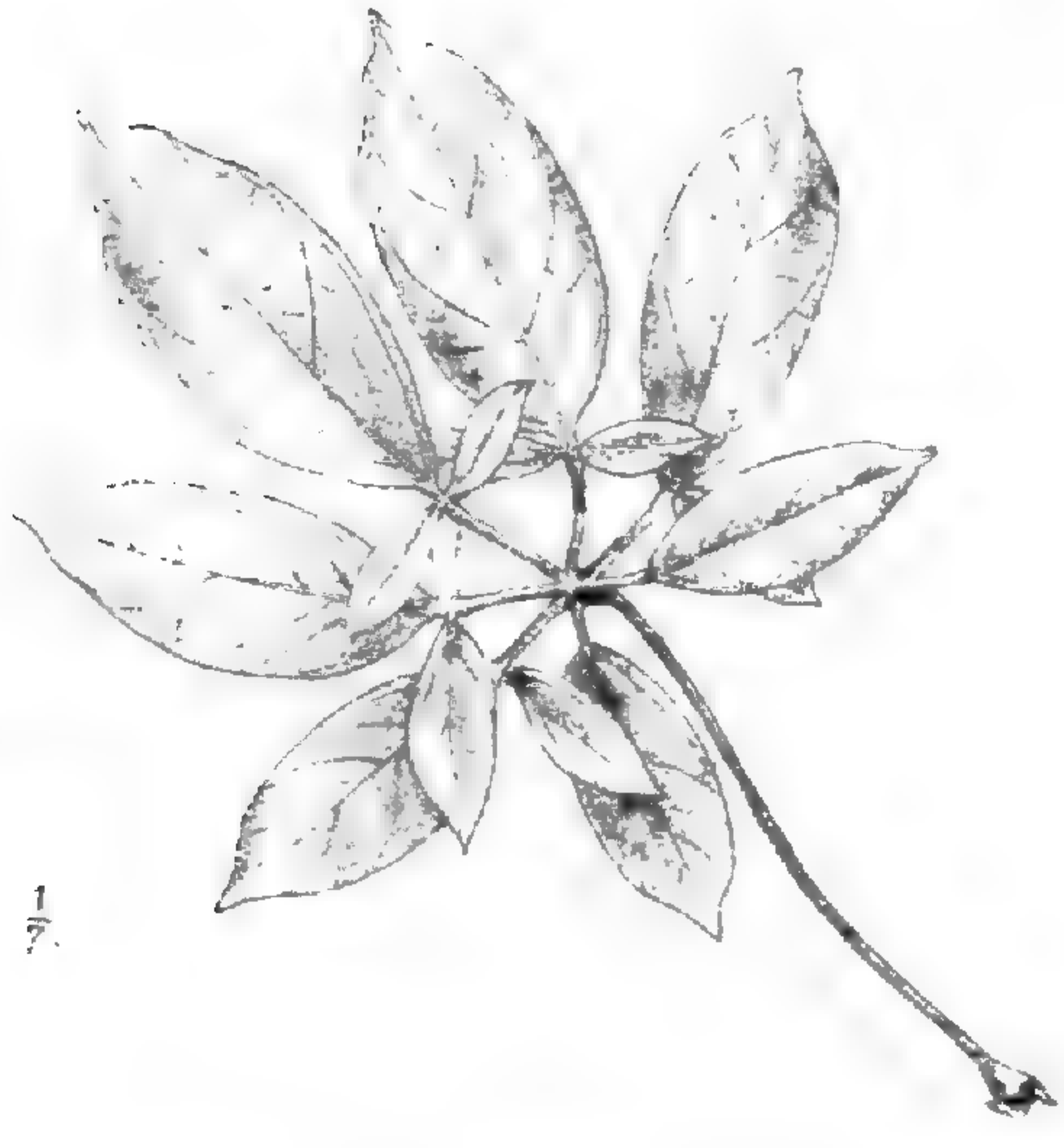
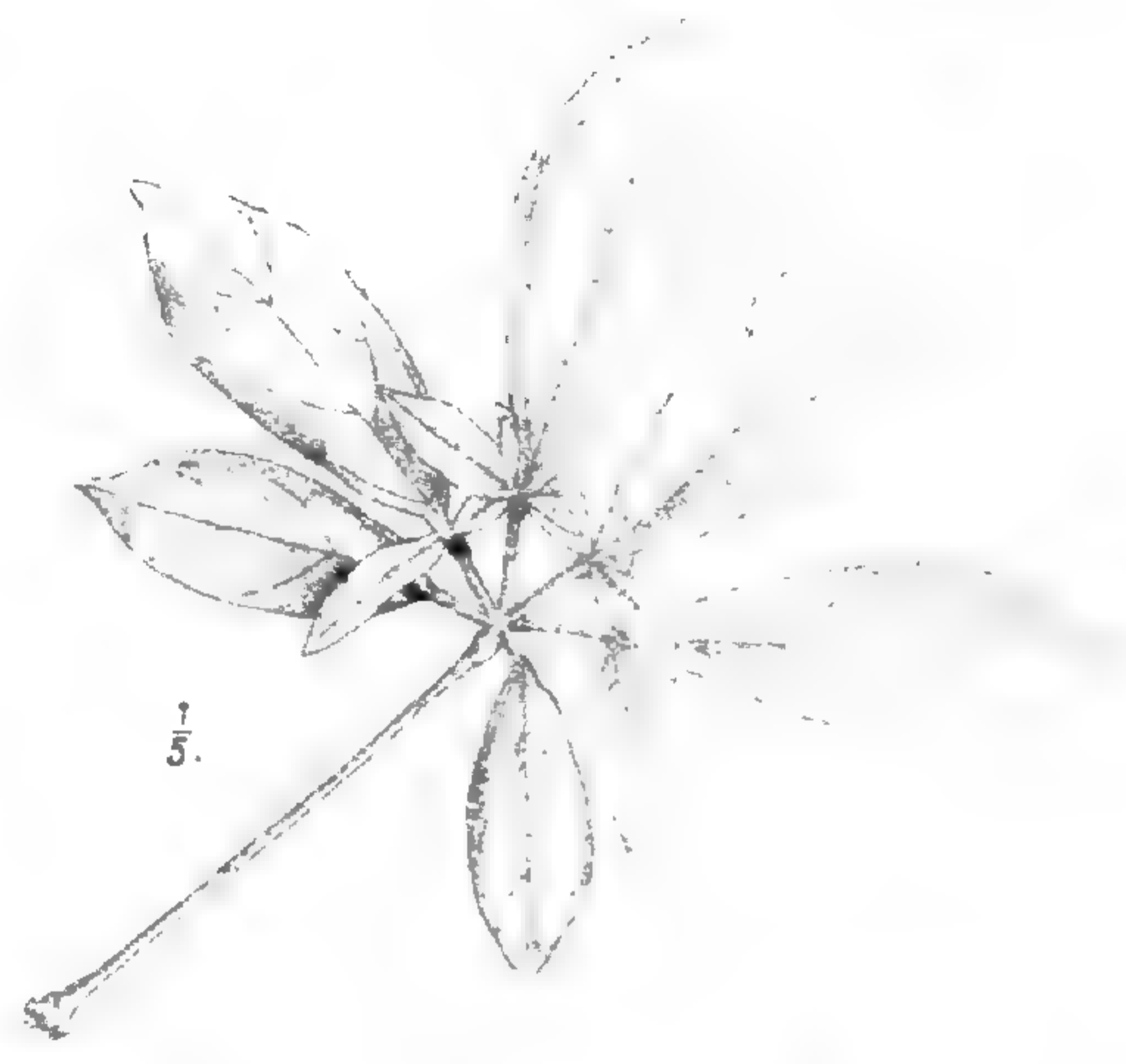
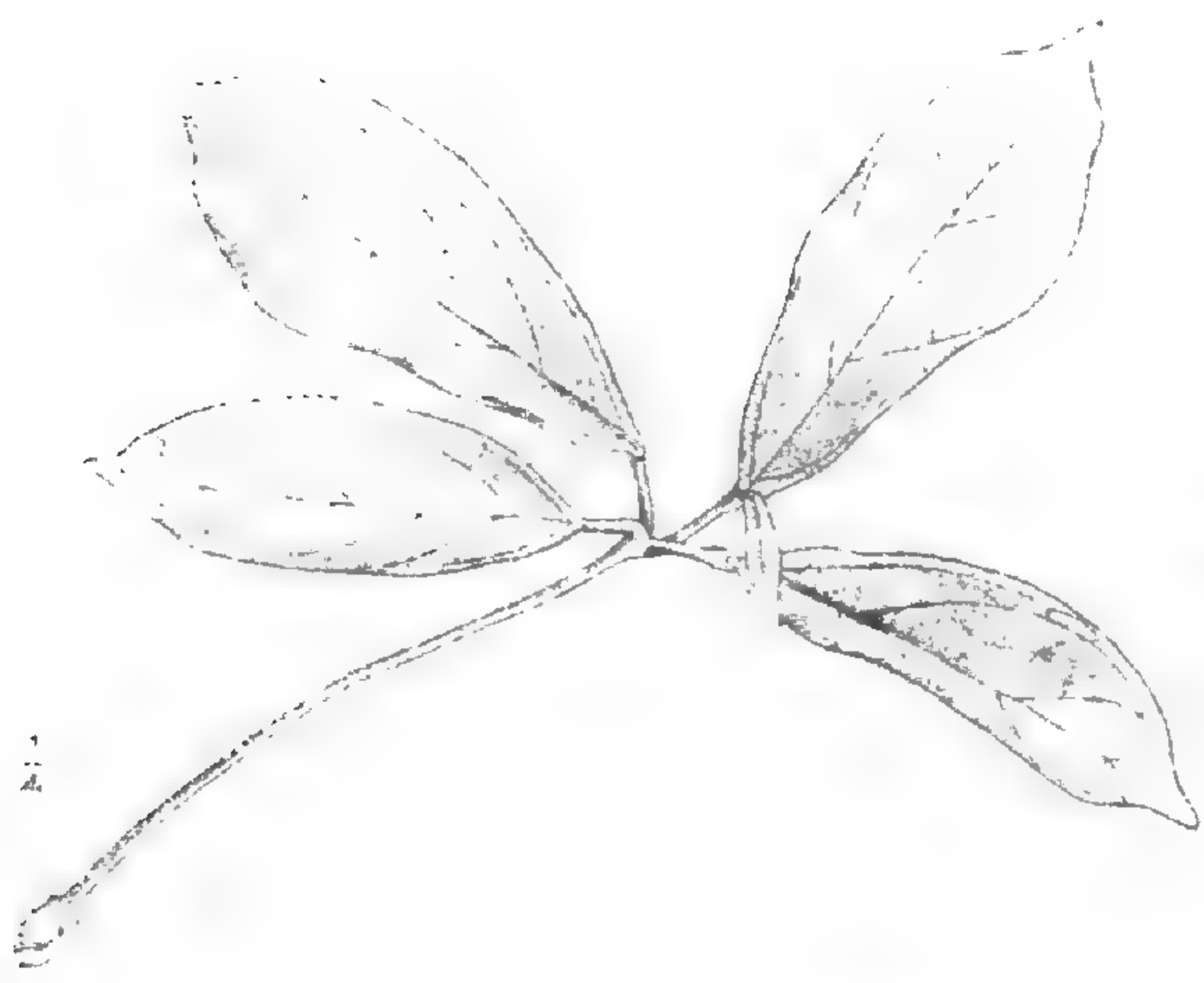
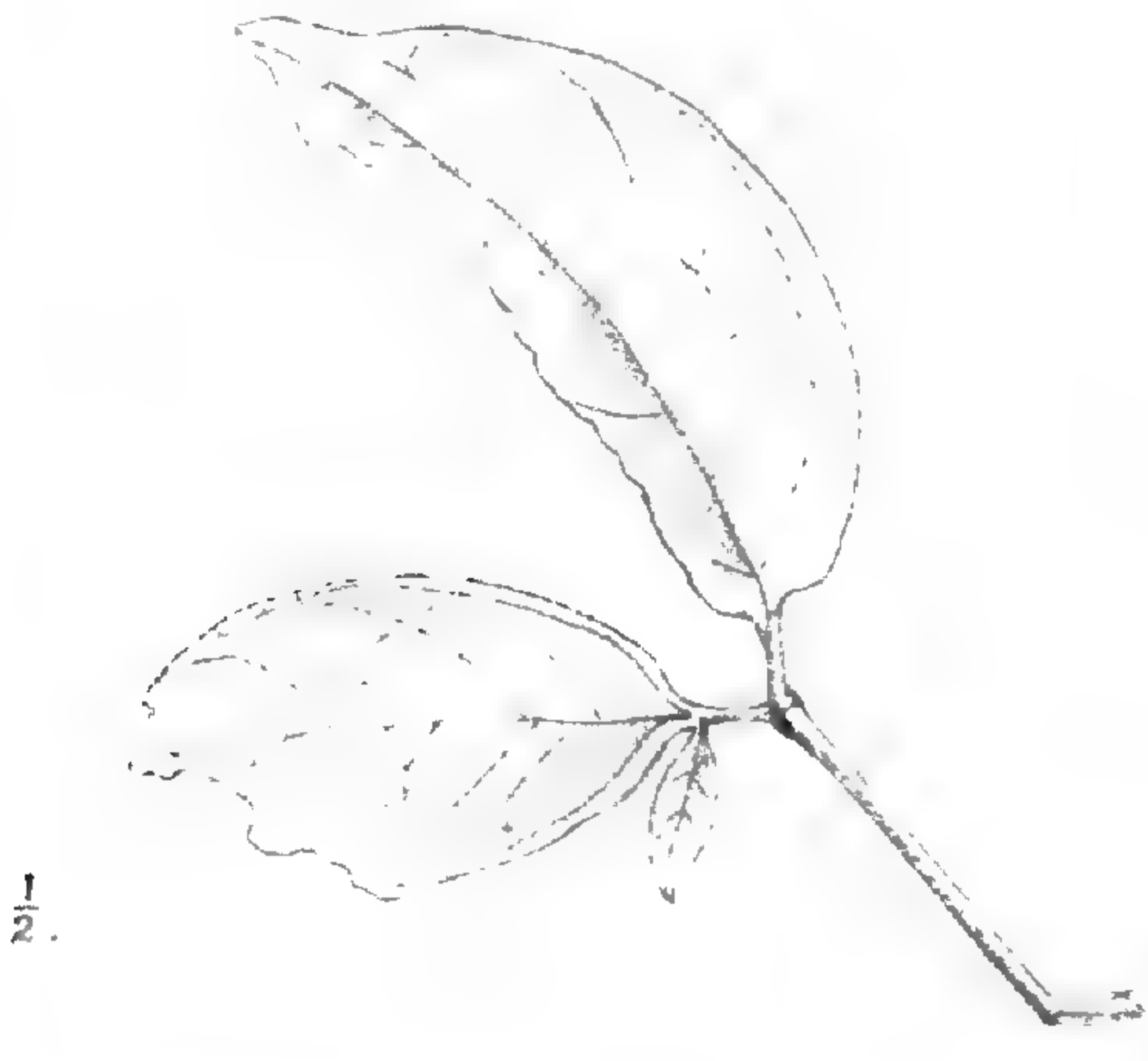

A. C. Chowdhary, lith
HEPTAPLEURUM VENULOSUM, Seem.

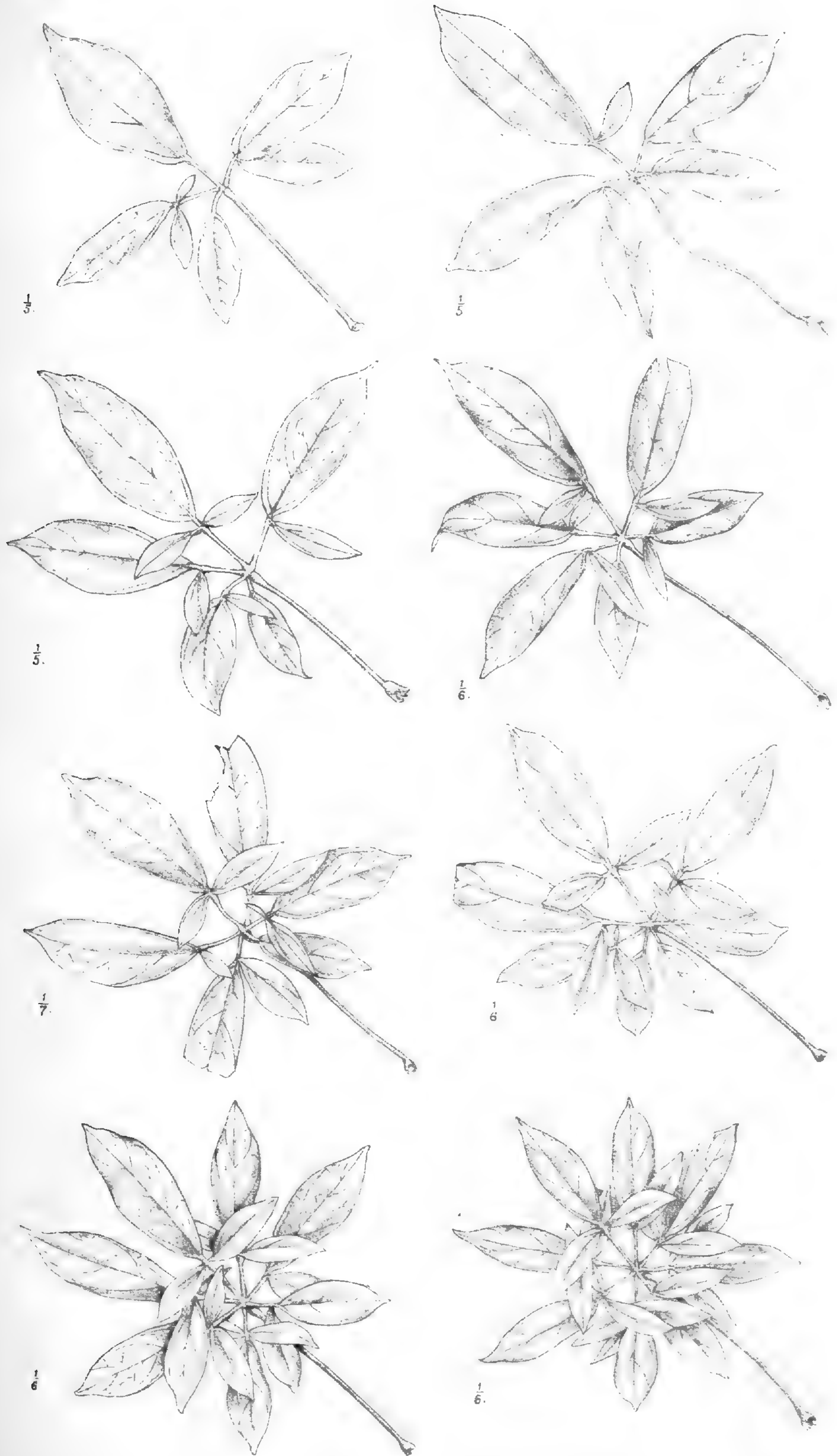

A. C. Chowdhary, lith.

HEPTAPLEURUM VENULOSUM, Seem.

14. Note on Leaf Variation in *Heptapleurum venulosum*,
Seem.

By M. S. RAMASWAMI, M.A. (CAL.), B.A. (MAD.),
*Officiating Curator of the Herbarium, Royal Botanic Garden,
Calcutta.*

[With Plates XII—XIV.]

The late Mr. C. B. Clarke in his account of the Natural Order *Araliaceae* in the Flora of British India when dealing with the genus *Heptapleurum* has put *H. venulosum* Seem. under a section of the subgenus *Euheptapleurum* which includes plants whose leaves are simply digitate and leaflets are 5 to 7 in number as distinct from another section of the same subgenus which consists of those having twice digitate or digitately decomposed leaves.

Observations made on shrubs of this species growing in the Royal Botanic Garden, Sibpur, tend to prove that this distinction, at any rate as far as this species is concerned, cannot always be relied upon. The leaves of *Heptapleurum venulosum* Seem. vary very widely along several lines to such an extent that on the same shrub we find all sorts of intermediate forms between a compound leaf having two leaflets and a twice digitate leaf containing 24 leaflets (i.e. 8 ternate leaflets). The chief lines of variation, however, are:—

- (1) Frequent changes in the shape and size of individual leaflets.
- (2) Increase in the number of leaflets (from 2 to 24).
- (3) A gradual transformation from a simply digitate to a twice digitate arrangement.

The accompanying three plates were drawn from specimens collected on two shrubs and show the more interesting variations. As nothing has been published regarding this wide range of leaf-variability in this species and as it is desirable that this should be on record for the use of Systematic Botanists generally, I venture to present this small note for the consideration of the members of the Society.

EXPLANATION OF PLATES.

Plate XII.—The figures show the variation in shape, size and number of leaflets.

Plates XIII and XIV.—The various intermediate forms found between a compound leaf (consisting of two large leaflets and a small one) and a twice digitate leaf (consisting of 24 leaflets, i.e. 8 ternate leaflets).

15. The "Shous" or Big-horned Deer of Tibet.

By LIEUT.-COL. J. MANNERS-SMITH, V.C., C.V.O., C.I.E.

[Presented at the First Indian Science Congress, January 16, 1914.]

[With Plates XV—XVII.]

In writing about the above animals I must disclaim at once any pretension of being a Scientific Naturalist. In regard to such points as relate to technical questions of species structure and so forth, I must refer to the accepted authorities, who have written and described the various species before, and shall rely particularly on the accounts given by Brian Houghton Hodgson 60 to 70 years ago, and as recently as 1912 by R. I. Pocock, F.R.S., of the Zoological Society's Gardens in London.

The name "Shou" is I believe used by the Tibetans indiscriminately for the 3 species of deer about to be described. It has been my good fortune, owing to the interest taken by my friend His Highness Maharaja Sir Chandra Shumshere Jang, the ruling Prime Minister of Nepal, in these splendid creatures, to have had the opportunity of seeing and examining live specimens of each species besides a considerable number of horns and skins belonging to the first named.

Taking the Shou in order the three kinds are—

- (1) The stag known to Natural History as "*Cervus wallichii*."
- (2) The stag named by Hodgson "*Cervus affinis*."
- (3) Thorod's deer or "*Cervus albirostris*."

For a scientific description of these species it is only necessary to refer to Mr. Pocock's full and careful paper No 30 of the Proceedings of the Zoological Society of London, 1912. The stag (*Cervus wallichii*) which is the principal subject of his paper was imported into Nepal in 1909, and was kept at large at an elevation of about 6000' from that time until presented to His Majesty the King-Emperor in December, 1911, with a collection of other Nepalese and Himalayan animals. In this connection I would also refer to the notes by Brian Hodgson No. 5 of the Journal of the Bengal Asiatic Society, dated 1551, and No. 117, dated 1841. The earlier note was written while Hodgson was still the British Resident in Nepal, but the later one about 7 years after he had retired from that post, and taken up his abode in Darjiling in order to carry on his natural history and other scientific work.

It will be seen that in the first instance Hodgson jumped to the conclusion that in his specimen of stag's skull and horns which he obtained in the Nepal Tarai, he had discovered a stag which corresponded with the true *Cervus elaphus* of Europe, and he promptly gave it the name of "*Cervus affinis*." Later on he discovered his error, but he was still keen to establish the affinity of the Asian and European stags, and when he received the 'abundant' spoils, through his friend Dr. Campbell and the Sikkim Vakil in 1851 at Darjiling, he came to the conclusion that the horns and skull of the stag which he had seen when in Nepal was a similar "Shou" to that the spoils of which had just come to his hand through Sikkim from Tibet. Hodgson did not see, or describe, the skin of the Shou which he obtained in the Nepal Tarai; and the only Shou skins he ever seems to have described are those with a small white caudal disk, and a dark mesial line running down.

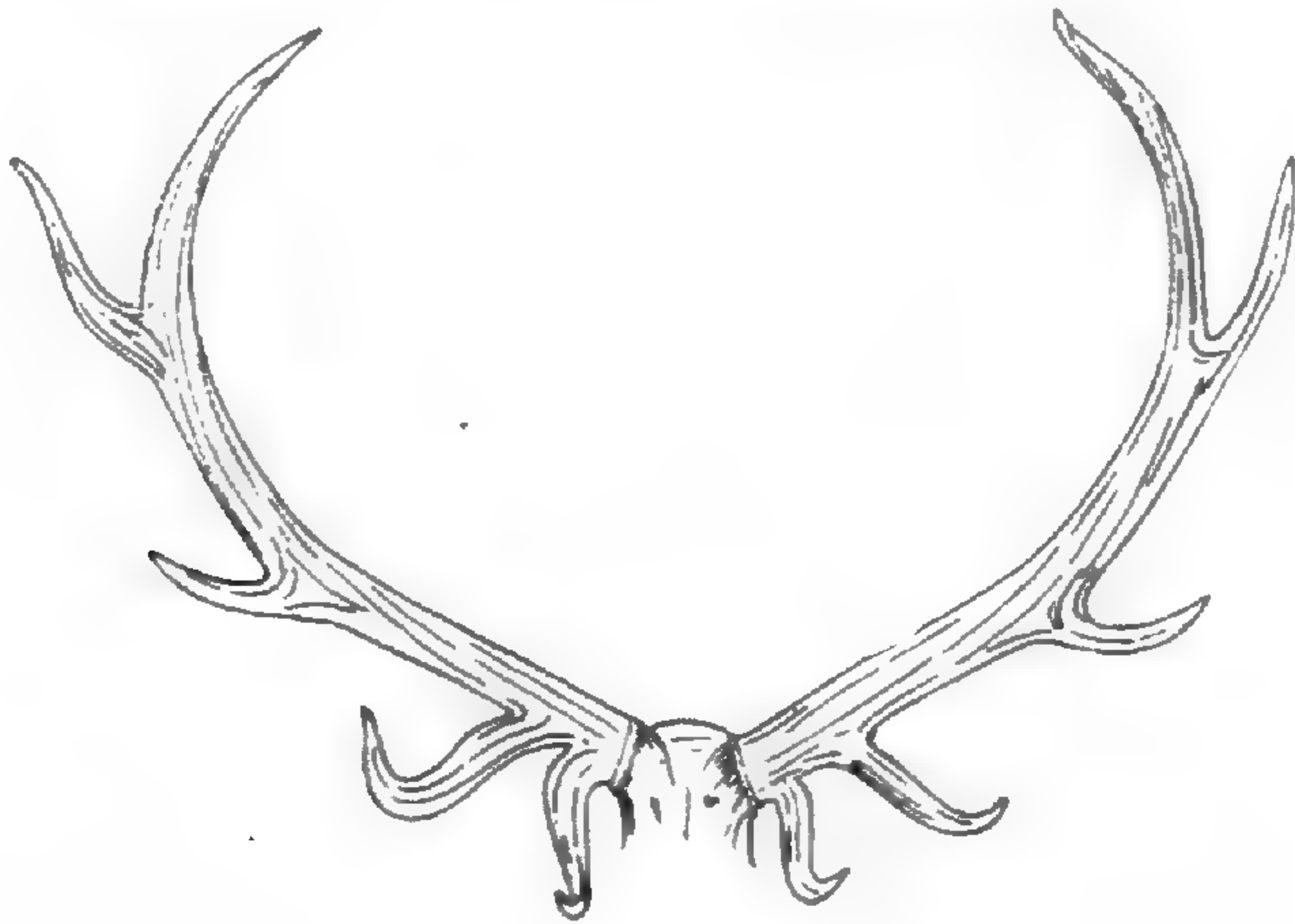

Antlers of *Cervus wallichii*.

from the back along the top of the tail. Hodgson indeed in his earlier days of natural history work, to quote his own words, appears to have relied on "the number and position of the antlers especially the inferior ones" in distinguishing the several species of *Cervus*—more than other distinguishing characteristics.

The picture which he gives of his Shou the stag of the Saul forest, in connection with his note No. 117 of the B.A.S. Journal, 1841, and the description of the horns of the Shou or Tibetan stag (*Cervus affinis*) in his note No. 5 of 1851, will I think be found on comparison to apply with equal exactitude to a specimen in my possession of the Shou now known to naturalists as *Cervus wallichii* (text-figure 1), and to that of the veritable *Cervus wallichii* sent home to the London Zoological Gardens from Nepal and described by Mr. Pocock in 1912. The left antler in that case is the normal one. I think, therefore, that it is quite possible that the skull and horns which

[N.S.]

Hodgson first saw and described while in Nepal came from Western Tibet and belonged to a "Shou" from that part of the country, and that the specimen would have rejoiced also in a large white caudal disk had the skin been present with the other spoils.

The Shou known now as *Cervus affinis* is I think the stag of Eastern Tibet extending westwards as far as Lhasa, and perhaps beyond, as I believe I am right in saying that the specimens of Shou obtained by Major Iggulden near Lhasa during the Younghusband Mission were all of *Cervus affinis*, and not of *wallichii*.

The last and third kind of Shou in Tibet is the brown stag known as Thorold's Deer, or *Cervus albirostris*. The live specimen now in Nepal, of which the photographs (pl. XV, fig. *b*; and plate XVII) give a good idea, corresponds fully with the description of it in Rowland Ward's book "Records of Big Game," 6th edition, pages 38-39. The caudal disk in this species is larger than in *Cervus affinis*, but not so large as in *wallichii* and is yellow instead of white. The animal is about 4 years old, and was also brought to Nepal *via* Lhasa and is said to have been caught near Hokku Djong about 80 miles to the S. E. of Lhasa.

Turning now to the second species of Shou or *Cervus affinis* of Hodgson. The three photographs (on plate XV, fig. *a*; and plate XVI) give an idea of the appearance of a young stag in his third year. He was imported to Katmandu for Maharaja Sir Chandra Shumshere *via* Lhasa in 1912, with the Thorold's deer, and is also said to have come from the vicinity of Hokku Djong.

Except upon the living specimen in Nepal I have never before seen in Nepal a skin of *Cervus affinis*, *i.e.* that of a Shou with the small white caudal disk and dark mesial line dividing it and the tail. All the skins that have previously been shown to me by the Maharaja have had the big white caudal disk and white tail of the Shou known to naturalists as *Cervus wallichii*. My inference from this fact is that the Shous found in Tibet to the North of Central and Western Nepal are probably all *wallichii* and not *affinis*.

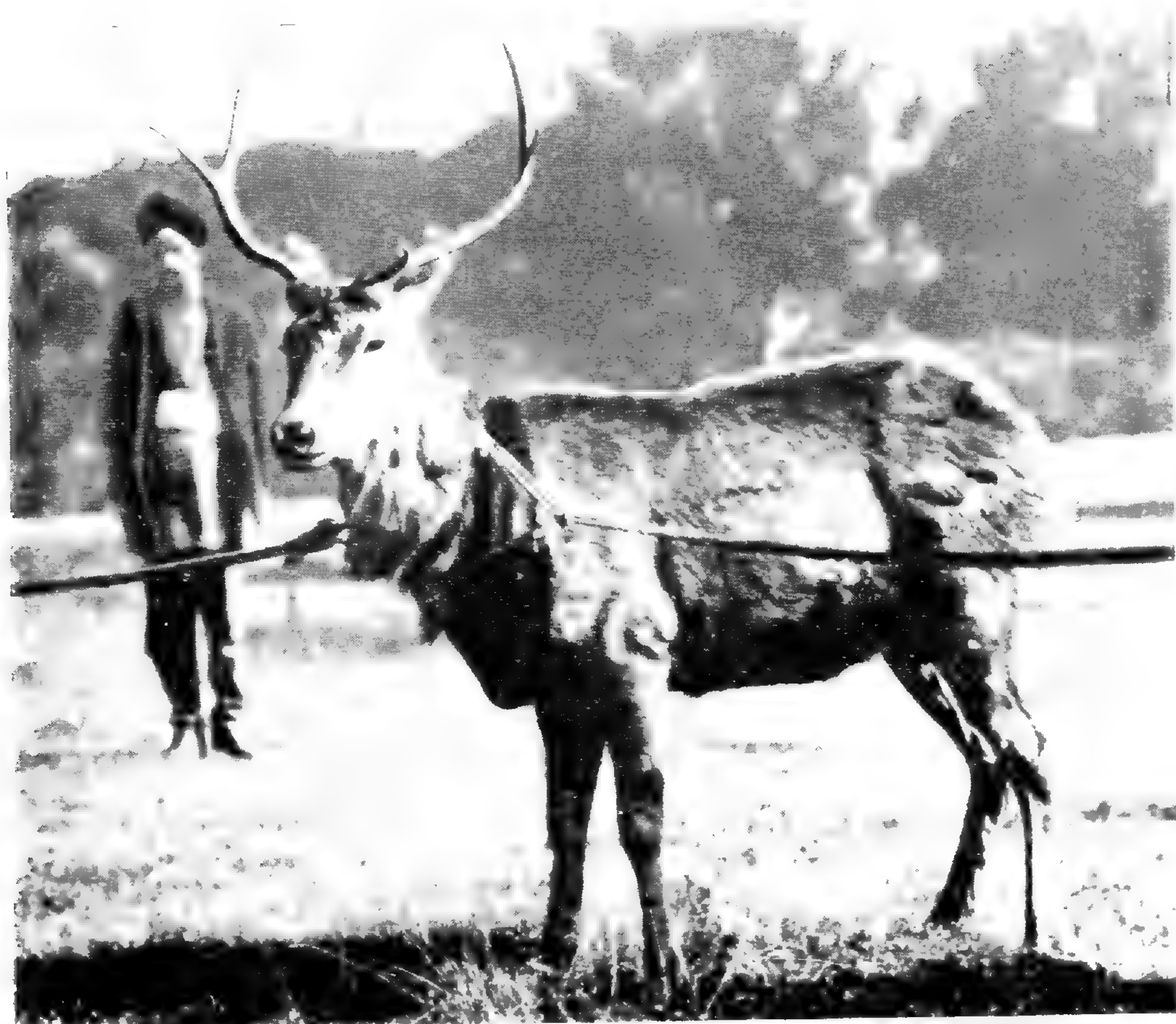

(a) *Cervus affinis*.



(b) *Cervus albirostris*.



Cervus affinis.

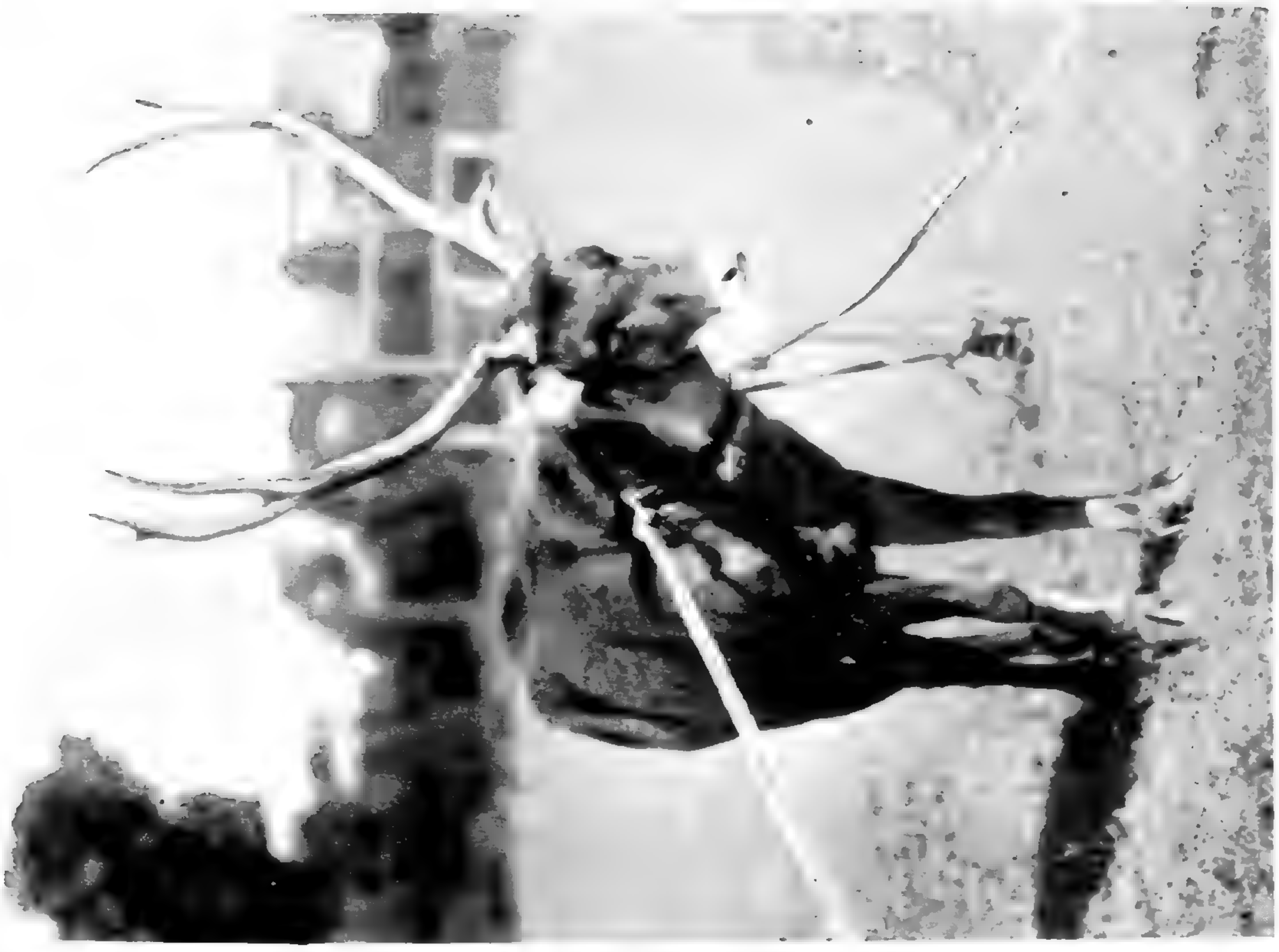

Cervus albirostris.

16. The Belabo Grant of Bhojavarman.

By R. D. BANERJI, M.A., *Indian Museum, Calcutta.*

[With Plates XVIII – XX.]

The copper plate on which the above-mentioned record is incised was discovered by a Muhammadan cultivator in the village of Belabo or Belaba in the district of Dacca. It was purchased from him by Babu Pramatha Nath Dutta, B.A., Assistant Settlement Officer, Dacca, and brought to the town of Dacca. A version of the text prepared by Pandit Bidhubhushan Goswami, M.A., appeared in the *Dacca Review* for August 1912, with a translation by Messrs. S. N. Bhadra, M.A., K. K. Sen, M.A., and N. K. Bhattasali, M.A., a historical introduction by Mr. Bhattasali, and a preface by Mr. F. D. Ascoli, M.A., I.C.S. A small photograph of the inscription appeared in the next issue of the *Journal*. An improved version of the text and translation by Mr. Radha Govinda Basak, M.A., Lecturer in Sanskrit in the Rajshahi College, appeared in the Bengali monthly journal *Sāhitya* for *Śrāvaṇa* and *Bhādra* of the Bengali year 1319. Mr. Basak's edition of the text is not free from mistakes, and he was obliged to leave gaps in two or three places in the metrical portion of the text. I obtained a loan of the original plate through Mr. F. D. Ascoli, I.C.S., who kindly brought it over with him to Calcutta and handed it over to me for examination. The inked impressions accompanying this paper were prepared under my personal supervision, and the photograph of the seal was taken by Messrs. Johnston and Hoffmann of Calcutta.

The inscription is incised on a single plate of copper and consists of fifty-one lines of writing, of which 26 are to be found on the first side and the remaining 25 on the second. The royal seal is attached to the top of the plate. The plate itself measures $10\frac{3}{4}$ " in length and $9\frac{1}{2}$ " in breadth. The seal is round in shape with a row of round beads running along its circumferences. There is a small rosette above the topmost bead. The impression on the seal consists of two concentric circles, the outer one of which is higher and thicker than the inner one, and a circular sunken area inside. This area again is divided into two equal parts; the upper part containing a wheel, with a thick axle, and spokes which are thick in the centre but tapering towards extremities, and a nude dancing human figure on each side of it. The lower part evidently bore an inscription as faint traces of letters are still legible. This part of the area bears signs of being recently damaged. It seems that somebody has been trying to dig the

surface with some pointed instrument. I have been told that the Muhammadan cultivator of Belabo, who discovered the plate, thought at first, that the plate was of gold and tried to verify his opinion by removing the verdigris from the surface and cutting away a portion from the bottom of the plate. The height of the seal is 4" and the diameter of the impression is 3½". The diameter of the small wheel in the area of the seal is ¾". The seal is referred to in the text of the inscription as "the seal of the wheel of Viṣṇu" (L. 48).

The text of the inscription is divisible into the usual parts:—

- (i) The metrical portion giving the genealogy of the King;
- (ii) the prose portion containing the names of the donee and the object of the grant;
- (iii) the imprecatory verses; and
- (iv) the date.

The metrical portion consists of fourteen and a half verses and supplies us with the following account:—

"The sage Atri was the son of the Self-existent-one. The moon was born from the rays which issued from his eyes (v. 1). From him Budha son of Rohiṇī and from Budha, Pururavas, son of Ilā, who was the chosen husband of Ūrvaśī, was born. He procreated Āyus, and from him was born Nahuṣa, who was equal to Manu and from him was born Yayāti. He received Yadu as his son. In the royal family which spread out from Yadu, Vīraśrī and Hari were born many times (v. 3). In this family was born Hari who was a part incarnation of the lover of the milkmaids, the stage manager of the Mahābhārata, the Great Kṛṣṇa (v. 4). These Yadus occupied a town named Simhapura (v. 5). Once upon a time a man named Vajravarmān was born whose presence was counted as auspicious when the Yādava army started on a campaign (v. 6). From him was born Jātavarman, who had married Vīraśrī, the daughter of Karṇa (the Cedi King), and spread his sway in the Aṅga country, defeated the King of Kāmarūpa, defeated Divya (the Kaivartta leader Divvoka), and Govardhana, and obtained paramount power (v. 8). Vīraśrī gave birth to Sāmalavarmān (v. 9). There was one named Udayī and his son Jagad-vijayamalla, had a daughter named Mālavadevi (v. 11), became the principal queen (*agra-mahiṣī*) of Sāmalavarmān (v. 12). From them was born Bhojadeva (v. 13).

The inscription is written in protobengali characters of the late eleventh or early twelfth century A.D. It refers itself to the reign of PARAMA-VAIṢṆAVA-PARAMEŚVARA-PARAMA-BHAṬṬĀRAKA-MAHĀRĀJĀDHIRĀJA ŚRĪ-BHOJA (DEVA), who meditated on the feet of MAHĀRĀJĀDHIRĀJA SĀMALAVARMADEVA, and was issued from the victorious camp of Vikramapura. It records the grant of the village of Upyalikā pertaining to the *Khaṇḍala* of the eight *gacchas* of Kauśāmbī, in the *maṇḍala* of

Adhahpattana of the *Paundrabhukti* to a Brāhmaṇa named Rāmadevaśarmman, *Sāntyāgārādhikṛta*, of the Sāvarṇa gottra, a student of Kānva śākhā of the white Yajurveda, whose pravaras were *Bhṛgu*, *Cyavana*, *Apnavān*, *Aurva* and *Jāmadagni*; and who was a great-grandson of Pītāmvaradevaśarmman, an inhabitant of the village of Siddhala in Northern Rādhā (*Uttara-Rādhā*) who had emigrated from the middle country (*Madhya-Deśa*), grandson of Jagannāthadevaśarmman and son of Viśvarūpadevaśarmman. The grant was issued on the 14th¹ day of the month of Śrāvaṇa in the fifth year of the King's reign.

The principal importance of the grant lies in the bringing to light of a new dynasty of Kings, and in exposing their relations to the already known ones. Previous to the discovery of this record it was not known that the Yādavas in their migrations had succeeded in crossing the dominions of the Pālas and in carving out an independent principality for themselves in the extreme East. They succeeded in maintaining themselves for three generations at least. The following genealogical table shows the relations of the new dynasty with the Pālas of Bengal and the Kālachuri-Haihayas of Tripuri:—

PĀLAS.	KĀLĀCURIS.	YĀDAVAS.
Mahīpāla I, Nayapāla, Vigrahapāla III—m. Yauvanśrī,	Gāṅgeyadeva, Karnnadeva, Yasaḥkarṇa,	: : Vajravarmman, Viraśrī m.—Jātavarmman,
 Mahīpāla II, Śūrapāla II, Rāmapāla.	 Gayakarṇa.	 Sāmalavarmman.

Besides this, the inscription proves that for three generations at least in the 11th or 12th centuries A.D., Eastern Bengal was independent. It is also an important one for the history of the Yādava tribe. The record mentions that the Yādavas got hold of a strong place named Simhapura. This place appears to have remained a Yādava stronghold for a long time. It is mentioned in another record incised at the instance of a Yādava princess; the Lakkhamandal prasasti.² This inscription records the dedication of a temple of Śiva by a princess named Isvarā, who belonged to the royal race of Simhapura. It gives in detail a description of a dynasty of Yādava king of Simhapura consisting of twelve princes in eleven generations.

¹ It should be noted that Prof. Radhagovinda Basak reads the date as 19th Śrāvaṇa.

² Ep. Ind., Vol. I, p. 10.

Yadu-vaṅśa-bhuvāim rājñām
Saiṅhapuram rājyam-āyugād dadhatām
Sri-Senavammanāmārajaṣiḥ
prakramen-āsīt, II—V, 2.

This shows that in the 6th and 7th centuries A.D. Singhapura or Simhapura was regarded by the Yādavas as their ancestral territory. The place has been indentified by Dr. Bühler with the *Sang-ho-pu-lo* described by Hiuen-Thsang.¹ Simhapura is common as the name of towns in ancient India and we have another "Singhpoor or Seehore" in Malwa.²

The inscription does not state definitely who founded the kingdom of the Yādavas in the extreme East. The genealogy of the family begins with Vajravarmman, but there is nothing to show that he was a king himself. We have more definite information about his son Jātavarmman who is said to have had aspirations for Imperial power. The words *vitatarān sārva-bhaumaśrīyam* should be taken with great caution. The phrase most probably indicates that he (Jātavarmman) acquired independence. From the same verse (v. 8) we learn that Jātavarmman married Viraśrī, the daughter of Karṇṇa, so he was the brother-in-law of the Pāla Emperor Vigrahapāla III who had, according to the Rāmacarita of Sandhyākaranandin, married another daughter of the Cedi King, named Yauva-naśrī.³ He (Jātavarmman) is also said to have made his power felt in the Aṅga⁴ country. So he must have taken part in the long wars between the Kaḷacuri-Cedis Gāngeya and Karṇṇadeva on one side and the Pālas Mahīpāla I, Naya-pāla and Vigrahapāla. A description of the war will be found in detail elsewhere.⁵ He is also said to have defeated a chief named Divya. This Divya has been correctly identified with Divvoka, the leader of the Kaivartta rebellion in the time of Vigrahapāla III. This Divya or Divvoka was a servant of the king Vigrahapāla III who had risen to power. His nephew (brother's son) was the opponent of Rāmapāla and was overthrown by him. Jātavarmman defeated another person named Govardhana. Two men of this name are to be found in contemporary records:—

(1) A King of Kauśāmbī whose name has been read *Dvorapavardhana* by Mahāmahopādhyāya Haraprāsad Śāstrī and which seems to be the copyist's mistake for Govardhana.⁶

(2) A Brāhmaṇa general of the King of Southern Bengal

¹ Beal's Si-yu-ki, Vol. I, pp. 143-147.

² Forbes, "Rasmala," p. 348.

³ Mem. A.S.B., Vol. III, p. 22 (I. 9).

⁴ Mr. Radha Govinda Basak felt uncertain about this word and Mr. Nagendra Nath Vasu reads *Paṅdresu* (*Paṅdresu*) instead of *yo-zṅg?ju*.

⁵ Palas of Bengal in the Memoirs A.S.B., Vol. V.

⁶ Ibid., p. 37 (II. 6).

[N.S.]

or *Vālavabhī*, whose son, Bhavadevabhaṭṭa, was the minister of Harivarmman.¹

It should be noted that the King of Kauśāmbī mentioned in the *Rāmacarita* of Sandhyakaranandin was not a king of Kauśāmbī in the *Madhyadeśa* (Kosam near Allahabad) but a minor prince of Bengal, because the Belabo grant proves that there was a Kauśāmbī in the *Paundra bhūkti*. It is most probably the modern Pargana of Kūsumba or Kusambi in the Rajshahi District.²

Jātavarmman had a son by Viraśrī, named Sāmalavarmman. At this point at least one new name is introduced. This is Udayin. By a slip of the pen *tasya* instead of *tathā* has been written at the beginning of the tenth verse. There are some more mistakes or omissions in the verse which makes it very difficult to understand it. Mr. Basak takes the word Udayin in its literal sense and makes the other name Jagad-vijayamalla an adjective of Manobhū (Kāma) but he fails to interpret the real connection between verses 9 and 10. Mahāmahopādhyāya Haraprāsad Śāstri and Babu Nagendra Natha Vasu, who has merely quoted the former's opinion, take Udayin and Jagadvijayamalla as proper names, and relying on the name "Mālavadevī" assert that Udayin is the same as the Paramāra Udayāditya who defeated the Kalacuri-Cedi King Karṇṇa and identify Jagadvijayamalla with Jagaddeva or Jagdeo, the youngest son of Udayaditya who served under Jayasimha-Siddharaja of the Chaulukya dynasty of Anahilapāṭaka. There is a good deal of truth in their statement and the tenth verse is not intelligible if "Udayi" is not taken as a proper name. The word "Jagadvijayamalla" is more difficult. It can easily be taken to be an adjective of Manobhū and at the same time it can be said that it is a proper name. The last view is most probably the correct one as Udayi's son is mentioned in verse 10 and so it is quite natural to expect the name after it. The name Mālavadevi has led Mahāmahopādhyāya Haraprāsad Śāstri to place the people named in these verses in the Mālava country or modern Mālwā. But the difficulty caused by the difference between the names Jagaddeva and Jagad-vijayamalla cannot be so easily surmounted. A name might be given arbitrarily or for insufficient reasons. There are other names which approach Jagadvijayamalla much more than Jagaddeva phonetically. The name Jagadekamalla is a better approach to Jagad-Vijayamalla than Jagaddeva, and we find two kings of this name in the Chalukya dynasty of Kalyani. But here we do not find Udayi. The identity of Jagadvijayamalla, the father-

¹ Epi. Ind., Vol. VI, p. 203.

² W. W. Hunter. *Statistical Account of Bengal*, Vol. VIII, Rajshahi and Bogra, p. 304.

in-law of Sāmalavarmman, must remain an open question so long as fresh material is not available.

The name of the *bhukti* in which the village granted was situated is Puṇḍra, which is most probably the same as Paṇḍravardhana of the Pāla and Sena copperplate grants. The name of the Maṇḍala Adhaḥpattana is new to Indian Epigraphy. The Kauśāmbī-aṣṭa-gaccha seems to have been situated somewhere in the Pargana of Kusumba or Kusumbi in the Rajshahi District. This seems to indicate that at this period Sonargaon or Suvarnnagrāma was included in Varendri and the Ganges met the Brahmaputra much lower down the Delta than it does at present. The land granted measured 1 *Pātaka* and $9\frac{1}{4}$ *Dronas*. Among the names of officers we find a new name *Pīthikā-vitta*. The name of the composer of the verses of the grant is Puruṣottama. Two persons of this name are known to have belonged to this period according to Mahāmahopādhyāya Haraprāsad Śāstrī. One is known from the *Sadukti-Karṇāmṛta*¹ and the other for his Supplement of the Amarakoṣa,² Hārāvali, etc.

The only other point of interest in this grant is the 4th verse. Here the use of the term *aṁśāvatāra* raises some doubts. Perhaps it contains a veiled reference to Harivarmman. Devout Vaiṣṇavas regard Kṛṣṇa as a full incarnation and would not style him *aṁśāvatāra*. But it should be noted that the Viṣṇu Purana refers to Kṛṣṇa as the *aṁśāvatāra*.

The characters are Bengali characters of the 11th century A.D. The principal peculiarity is the use of the Nāgarī and Bengali forms of *ta* side by side. The inscription has been very carelessly incised. Some verses have surely been omitted after the 9th in line 17. The 14th verse has been very carelessly written. Single letters have been omitted in many cases. Cf. *Kaṣṭam* in l. 22 and *bhavatām* in l. 37.

I edit the inscription from the original plate:—

TEXT.

Obverse.

1. Om Siddhi [h] ॥ Svāyambhuvam-ih-āpatyam munir-atri [r] divaukasām | Tasya yan-nāyanam tejas = ten = ājā-
2. -yata Candramāḥ ॥ (1). Rauhineyo Vu(Bu)dhas = tas-mād = asmād = aila-Pururavāḥ [i] Jajñe svayam-vṛtaḥ kirttyā
3. c-Orvvaśya ca bhuvā ca yaḥ ॥ (2). Sopy-āyum samajījan-manusamo rājñas-tato jajñivān [i] Kṣmā
4. -pālo Nahasas³-tatojani mahārājo Yayātiḥ sutam [i] S-opi prāpa yandum⁴ tataḥ kṣiti-bhu-

¹ Notices of Skt. MSS., Vol. III, p. 138.

² Aufrecht Cat., Vol. I, p. 342. ³ Read *Nahasas*. ⁴ Read *yadum*

[N.S.]

5. -jām vaśś-oyam-ujjambhate¹ [1] Vīra-Śrīś = ca Hariś =
ca yatra vad-bhaśah² pratyakṣam-ev-aikṣatu³ ॥ (3). S-op-ihā
6. Gopī-śata-kelikārah Kṛṣṇo mahābhārata-sutrādhārah
arghyaḥ pumān-amśa-kṛt-āvatā-
7. -rah prādur-vabhūv-oddhr̥ta-bhūmi-bhārah ॥ (4). Pūm-
sām-āvarāṇam trayī na ca tayā hīnā na nagnā iti
8. trayyā [ñ]-c-ādbhuta-saṅgareṣu ca rasād-rom-odgamair-
varmmanah [1] varmmān-oti-gabhīra-nāma-dadhataḥ
9. ślaghyau bhujau bibhrato bhejuḥ Siṃhapuram guhām-
iva iva ṛgendrāṇām harer-vāndhavāḥ [ñ] (5)
10. Abhavad-atha kadācid-yādavinām camūnām samara-
vijaya-yātrā maṅgalam VAJRAVARMMA [] Śama-
11. -na iva ripūṇām soma-vad = vāndhavānām kavir-api
ca kavīnām paṇḍitaḥ paṇḍitānām ॥ (6). JĀ-
12. TAVARMMA tato jāto Gāṅgeya iva Śāntanoḥ dayāvra-
tam raṇaḥ kṛdā tyāgo yasya maho-
13. -tsavaḥ ॥ (7). Gr̥hṇan-vaiṅya-pṛthu-śriyam pariṇayan-
KARṆASYA VĪRAŚRIYAM y-Oṅgeṣu prathayañchriyam paribha-
vam
14. -stām Kāmarūpa-śriyam [1] Nindan-DIVYA-bhujā-
śriyam vikalayan-Govarddhanasya-śriyam kurvan śrotriya-
15. -sāchriyam vitatavān = yām sārvaabhauma-śriyam ॥ (8).
Vīraśriyam-ajani Sāmalavarmmadevaḥ
16. Śrīmāñ-jagat-prathama-maṅgala-nāmadheyah [1] kim-
varṇayāmy-akhila-bhūpa-guṇ-opapanno doṣai
17. -r-mmanāg-api padam na kṛtaḥ prabhur-mme ॥ [9].
Tasy-odayī sūnur-abhūt prabhūta-durvāra-vīreṣvapi saṅga-
18. -reṣu [1] yaś candrahāsa-prativimvitam svam-ekam
mukham sammukham-ikṣate sma ॥ (10). Tasya Mālavadevy
= ā
19. sīt = kanyā trailokyasundarī jagadvijayamallasya
vaijayantī manobhuvah ॥ (11) 'ūrṇṇe-py-aśe
20. -ṣa-bhūpāla-putrīṇām-avarodhane [1] tasy = āsīd =
agra-mahiṣī s-aiva Sāmalavarmmanah ॥ (12). Āsī-
21. -t = tayoh sunur⁴-ih-anurūpaḥ ŚRĪ-BHOJAVARMMA-
obhaya-vaśśadīpaḥ [1] Pātreṣu sarvāsu daśāsu ye-
22. -na sneho na luptaś = ca hatam tamaś = ca ॥ (13). Hā
dhik [ka]ṣṭam-avīram-adya-bhuvanam bhūyopi kam⁵ rakṣasā-
23. -m-utpāt-oyam-u[pa]sthitostu kuśalī śaṅkāsu lavdhā
(?) dhiyah ॥ (14) Iti yam guṇa-gāthābhis-tuṣṭā-
24. -va puruṣottamaḥ [1] majjayannivā vāg-vrahma-may-
ānanda-mahodadhau ॥ (15) Sa khalu Śrī VIKRAMAPU-
25. -RA samāvāsita Śrīmarjjaya⁶-skandhāvārāt Māhārājā-
dhirāja⁷-ŚRĪ SĀMALAVARMMA-DEVAPĀ-

1 Read °ujjambhate.

3 Read aikṣata.

6 Read kim.

2 Read vahusah.

4 Read sūnur°.

6 Read Śrīmarjjaya°.

7 Read Mahā°.

26. -DĀNUDHYĀTA-PARAMA-VAIṢṆAVA-PARAMEŚVARA-PARAMA-BHATṬĀRAKA MAHĀRĀJĀDHIRĀJA ŚRĪMAD-BHOJA[H]

Second Side.

27. Śrī-Paundra-bhukty-antahpāti Adhahpattana-manḍale Kauśāmvī-aṣṭagaccha-kha-

28. -ṇḍala-saṁ[vaddha] Upyalikā-grāme guvāk-ādisameta-sapāda-navadron-ādhi-

29. -ka-pāṭaka-bhūmau samupagat-āśeṣa-rāja-rājanyakarājñī-rāṇaka-rā-

30. -japutra rājāmātya purohita pīṭhikāvitta-mahādharm-mādhyakṣa mahāsāndhivi-

31. -grahika mahāsenāpati mahāmudrādhikṛta antaraṅga vrhaduparika mahākṣapa-

32. -ṭalika mahāpratihāra mahābhogika mahā-vyūhapati mahapīlupati mahāga-

33. -ṇastha daus-sādhika caur-oddharaṇika nauvala-hasty-aśva-go-mahiṣ-ājāvika-ādi-

34. -vyāpṛtaka gaulmika daṇḍapāśika daṇḍanāyaka viṣayapaty-ādīn anyāms-ca saka-

35. -la-rāja-pād-opajīvinō [ṛ] dhyakṣapracār-oktān-ihākīrttitān caṭṭa-bhaṭṭa-jāti-

36. -yān janapadān kṣettrakarāms-ca vrāhmaṇān vrahmaṇ-ottarān yath-ārham-mānāyati

37. vodhayati samādiśati ca matam-astu bha [va] tām | yath-oparolikhitā bhūmir-iyam sva-

38. sīmāvacchinnā tṛṇa-yuti-gocara-paryantā satalā soddeśā sāmra-panasā sa-

39. -guvāka-nālikerā sa-lavaṇā sa-jalas ha [lā] sa-garttoṣarā sahya-daśāparādhā pari-

40. -hrta-sarvapīḍā acāda-bhada-praveśā akiñcit-pragrāhyā samasta-rāja-bhoga-ka-

41. -ra hiraṇya-pratyāya-sahitā Sāvaruṇa-sagoṭrāya Bhṛgu-Cyavana-Āpnuvān-Au-

42. -rvva-Jamadagni-pravarāya Vājasaneyā caranāya Yajur-veda-Kaṇva-śākhādhyāyi-

43. -ne Madhyadeśa vinirggata Uttara-Rādhāyām Siddhala-grāmīya Pītāmvā (ba) ra-deva

44. Śarmmaṇaḥ prapautrāya Jagannātha devaśarmmaṇaḥ pautrāya Viśvarūpadevaśarmma

45. -ṇaḥ putrāya śāntyāgārādhikṛta Śrī-Rāmadevaśarmmane | Śrīmatā Bhoja-

46. -varmmadevena puṇye ahani vidhivad-udaka-pūrvam kṛtvā bhagavantam Vāsudeva-bha-

47. -ttārakam-uddiśya mātā-pitror-ātmanaś-ca puṇyayaśobhivṛddhaye ācandrārka-kṣi-

48. -ti-samakālam yāvāt bhū (bhū)-micchidra-nyāyena Śrī-mad-viṣṇu-cakra-mudrayā tāmra-śā-

49. -sanī-kṛtya pradattāsmābhiḥ ॥ Bhavanti c-āttra
dharmmānusamsinaḥ ślokāḥ ॥

50. Sva-dattām-paradattām-vā yo hareta vasundharām sa-
viṣṭhāyām kṛi (kr) mir-bhūtvā pitṛbhiḥ sahapa

51. -cyate ॥ Śrīmad-Bhojavarmma-devapādiya samvat 5
Srāvāṇadine 14 [॥] Ni Anu Mahākṣa ni [॥]





SEAL OF THE BELABO GRANT OF BHOJAVARMAN.

17. Relics of the Worship of Mud-Turtles (*Trionychidae*) in India and Burma.

By N. ANNANDALE, D.Sc., F.A.B.S., and MAHAMAHOPADHYAYA HARAPRASĀD SHĀSTRĪ, C.I.E., M.A., F.A.S.B.

(Read at the First Indian Science Congress, January 17th, 1914).

[As my friend Haraprasād Shāstri and I naturally regard mud-turtles from entirely different points of view—he as a sanscritist, I as a zoologist—I have arranged these notes as a kind of dialogue in which the two authors express their opinions quite independently.—N. A.]

I. *Mud-turtles kept living in shrines at the present day.*

The practice of keeping tortoises living in shrines as sacred animals is probably one of wide distribution in the East and is not now confined to any race or cult. Both land-tortoises and aquatic species are thus honoured in China: at Penang there is a well-known Chinese temple in which chelonians of different kinds, some of them brought from foreign countries, are kept. In India and Burma the animals are usually, if not always, mud-turtles of the family *Trionychidae*. I have myself visited three shrines, one of them Hindu, one Mahomedan and the third Buddhist, at which mud-turtles of the genus *Trionyx* live in a semi-domesticated state. The first of these shrines is at Puri in Orissa, the second near Chittagong in Eastern Bengal and the third at Mandalay in Upper Burma; they are thus distributed in districts in which Uriya, a dialect of Bengali, and Burmese, are the respective languages of the people and afford at any rate some indication of their race.

The mud-turtles of Puri belong to a subspecies of the common Indo-Gangetic Mud-Turtle (*Trionyx gangeticus*, Cuvier) to which the racial name *mahanaddicus* has lately been given,¹ because the form is only known to occur in the Central Provinces and Orissa in the river-system of the Māhanaddī. The large bathing-tank in which these animals are kept is attached to a small Vishnuite shrine that is apparently not connected with any of the larger temples for which the town is famous. The tank covers an area of perhaps half an acre and is surrounded by stone steps. For the greater part of its periphery, however, its banks are free from buildings, and it is probably possible for the mud-turtles to leave it at night.

¹ *Rec. Ind. Mus.*, vol. VII, p. 252. Before this subspecies was distinguished I thought that the Puri turtles might represent *T. hurum* (*op. cit.*, p. 155), but I had not then had a clear view of them.

The Brahmins attached to the shrines are in the habit of inviting pilgrims and other visitors to feed the turtles with sweetmeats made of parched rice and palm-sugar. To attract them these men, having first sprinkled some of the sweetmeats or even a little rice on the surface of the water, call out repeatedly, standing on the steps round the tank, "Gópal, ao! Gópal, ao!" Sometimes the animals thrust their heads out of the water, swim towards the edge and devour the food provided; but they often decline to make an appearance. They are less shy in doing so at dusk than by daylight.

The Brahmins at the shrine tell a confused story of a man called Gópal, who annoyed Juggernāth by his laziness. The god therefore turned him into a tortoise and made him carry bricks (or stones) on his back. The actual mud-turtles living in the tank are believed to be in some way identified with Gópal, but the Brahmins confess that they breed regularly, laying their eggs on the far side of the tank in the rainy season.

Dr. B. L. Chaudhuri informs me that there is another tank in Orissa in which tame *Trionyces* are kept. It is situated near Sambalpur in the interior of the country. The Brahmins refused him permission to take away any of the turtles on any consideration, but they probably belong to the same race as Puri ones, for this race is found in the river Mahanaddi at Sambalpur.

The pool at Mandalay in which mud-turtles are kept is in the famous Arrakan Pagoda. It is much smaller than the tank at Puri and entirely surrounded by buildings. Many of the turtles (all of which apparently belong to a single species, *Trionyx formosus*, Gray) are deformed and some of them are considerably larger than any specimens of their species preserved in museums. They come when called, and eat curry and rice thrown into the water. They are tamer than those at Puri.

From a zoological point of view the Mahomedan mud-turtles of Chittagong are much the most interesting of those we know to live in shrines, for they are the only living individuals of *Trionyx nigricans*, Anderson that have been seen of recent years, and it is quite possible that the species is extinct except in a condition of optional captivity. The Chittagong Mud Turtle, as Anderson's species may be called, was described by him in 1875 and was then said to be found in "the Chittagong tanks." It was almost completely lost sight of until I discovered in the Indian Museum the skeletons of the specimens on which the original description of the species had been based. These I redescribed in 1912.¹ As Anderson's account of the

¹ *Op. cit.*, p. 164, pl. V, fig. 5.

[N.S.]

external characters of this species appears to have been based on specimens either dried or preserved in spirit, and as nothing whatever has hitherto been known of its habits, I give here some notes on those I saw alive in 1912.

They live in a large pond attached to the shrine of Sultan Bagu Bastan (a saint who is said to have lived in the eighteenth century) about five miles from the town of Chittagong. The Mahomedans will neither kill them nor permit them to be killed; they believe that they are in some way connected with the saint. Their tank is surrounded by several flights of steps leading down to a platform a few inches under water, and the turtles are so tame that they come to feed when called, placing their fore feet on the edge of the platform or even climbing bodily upon it and stretching their necks out of the water. The largest are tamer than the smaller ones. Some even allowed us to touch them, and eat pieces of chicken from wooden screwers held in our hands. They greatly preferred the chicken to bananas, which as a rule (but not always) they rejected. The only sound they emitted was a low hiss. When undisturbed they remained at the bottom of the pond half buried in mud. A man connected with the shrine told us that they left the water every evening and climbed a small hill, on which they slept. He said that they laid their eggs on the same hill during the "rains". People sometimes found dead turtles and buried them. The oldest individual were said to be about 150 years old.

The largest turtles had a carapace at least 3 feet long and of extraordinarily massive appearance. This was greatly increased by the fact that there was always a deep longitudinal groove in the middle line of the dorsal surface, at any rate on the posterior part. The skin above the base of the neck and the fore-limbs was much wrinkled and swollen, especially in old individuals, and as some of the wrinkles ran at right angles to others, the skin had a markedly tubercular appearance. The carapace itself was almost smooth, bearing only a few indistinct prominences posteriorly. The heads of very large turtles was much broader, and the snouts blunter, than those of well-grown but not very large individuals.

The normal colouration of well-grown turtles was as follows:—Dorsal surface of carapace copper-brown indistinctly marbled with a darker shade and a little iridescent in some lights when wet; tail, limbs and neck apparently dark clay-colour but always covered with mud; top and sides of head bright glaucous green, taking a yellowish tinge above the eyes and nostrils and boldly reticulated with black or very dark green, the reticulation being as a rule closer on the vertex and snout than between the eyes. The coppery colour of the carapace was brightest in half-grown individuals. In some such individuals the black markings of the head already predominate.

ated over the green areas, and in all very old turtles this was the case, so that the colouration of the head might be described as black with small greenish spots, which tended to disappear altogether with age. The smallest turtle seen had a carapace rather over a foot long. It was diversified above with black and yellow vermiculations which formed an incomplete reticulation; it bore traces of four large blackish ocelli with pale margins. The markings of the head were more distinct than in large individuals. It is evident, therefore, that *T. nigricans* differs considerably in colouration from any other Indian species, but resembles its ally *T. phayrei* in a general way in this respect, as it does also in skull-characters. Many of the turtles at the shrine had large white blotches on the skin of the head, neck and limbs; but these were evidently due to disease or injuries.

[N. ANNANDALE.]

II. Some instances of the use of mud-turtles in worship and iconography in Northern India.

(a) Altars (*Vedi*) raised for Vedic sacrifices are generally built on bricks of various shapes, sizes and forms; but when the ground is prepared for building an altar, they make a rather deep depression at the centre of the area covered by the altar. In that depression they put a mud-turtle and give it food to last till the end of the sacrifice and the destruction of the altar. If the turtle is alive, the sacrifice is regarded as auspicious; if it dies, inauspicious. There was such a *Vedi* (of course without the tortoise) in existence at the house of the Nepalese Pandit Śiromaṇi Bhaṭṭācāryya at Benares five years ago, when I visited that place. They told me that after the sacrifice the turtle was found living. The *Vedi* may yet be in existence, for Śiromaṇi's son told me that they would keep it as a memento of the sacrifice. It was a *Śyena Yāga* and the altar was in the form of a hawk.

(b) At Viṣṇupur in the district of Bankura sets of round lacquered cards, a hundred and twenty in number, are used both in play and in gambling. The hundred and twenty cards are divided into groups of twelve, each group representing one of the incarnations of Visnu. The first of the group is the King, and when the incarnation is human it has two hands, but when it is not human four hands, the lower half of the body being represented by the lower part of the animal. The second of the group is the *Mantri* or minister. He is of the same shape as the Raja, but smaller in size and has two companions. The other ten cards of the group contain one to ten of the emblems of the appropriate incarnation. In the case of the tortoise incarnation the emblem is a tortoise. So in the set of cards there are fifty-five figures of tortoises and two more, but they

[N.S.]

are only lower halves. The tortoise represented is certainly a mud-turtle and not a land-tortoise.

(c) In chapter LXIV of *Vrhat Samhitā* of Varāha Mihir (a Sanskrit encyclopaedia of the 6th century A.D.) kings are enjoined to rear up tortoises and turtles with the following auspicious signs :—The colour should be either like that of a crystal or silver variegated with lines of blue. The shape should be like that of a water jar, with a beautiful bridge at its back ; or it may be of the rosy colour like that of the morning sun with spots (most likely black) like mustard.

If such a tortoise is kept in the house it increases the greatness of the king. The tortoise which has a body black like eye-paint or like the bee, variegated with spots, which has no defective limbs, and whose head is like that of a serpent and the throat thick, increases the prosperity of the empire.

The tortoise which shines like lapis-lazuli, whose neck is thick, which has covered holes at three points and which has a good bridge at its back, is worthy of praise. [The variegated colours mentioned, though the precise meaning is obscure, certainly point to Trionychidae being the tortoises intended. The species which has “covered holes at three points” is probably an *Emyda*, the three points being the apertures through which emerge the two hind limbs (separately) and the head and fore limbs together.—N. A.]

(d) In the survival of Buddhism in Bengal which I identified in 1893 with the Dharmapūjā in Western Bengal, the tortoise plays an important part. In some of the Dharma temples the figure of the deity is exactly like that of a tortoise and he is often represented in Bengali Mantras, with which he is worshipped, as Kūrmārūpī or Kacchapākara. I may suggest the following explanation for this iconography of Dharma. Dharma is the second member of the Buddhist Triad, but Dharma is always represented as a stupa or mound. The earliest stupas were of a semi-circular shape, but in the course of time the mound became higher and higher, with a top forming any segment of a circle. In the beginning they had no niches. In the Kushan period they had one niche to the East ; but with the expansion of the Mahāyāna School the number increased till it became four at the four cardinal points of the stupa, giving resting places to the four Dhyani Buddhas—Akṣobhya, Raṭhasambhava, Amitābha and Amoghasiddhi. The fifth, but the first in order of merit, being supposed to reside at the very centre of the stupa in the flagstaff which at the top held the umbrellas ; but in one of the great stupas in India, the first Dhyāni Buddha has his niche located at the South-East. This is at Svayambhū Stupa in Nepal. A stupa with five niches would look like a tortoise with four legs and the head. There is a small stupa of the kind in the Indian Museum. The worshippers of Dharma I believe associated the five-niched stupa

with some totemistic form of tortoise-worship, and now as they have forgotten that they are Buddhists, they worship the tortoise-shaped deity as Kūrmārūpi Bhagavān.

[HARAPRASĀD SHĀSTRĪ.]

III. *Some general considerations.*

Chelonia play an important part in Hindu iconography mainly in two connections (if they are actually distinct), viz. the Tortoise Incarnation of Vishnu and the myth of the Churning of the Ocean. Both are frequently illustrated in the stone-carvings of temples, in the wood-carvings of processional cars and in paintings of various kinds, more particularly in South India. Haraprasād Shāstri's note on the occurrence of a tortoise-figure on playing cards in Bengal shows that representations of the kind are also found in the northern part of India. Since visiting the three shrines to which allusion is made in the first part of this paper, I have examined a large number of carvings, paintings and clay models both of the Tortoise Incarnation and of the gods and demons churning the Ocean by means of the great snake wound round Mount Mandār, which rests on a tortoise. In many examples of both subjects the tortoise is highly conventionalized and cannot be recognized as a representation of any particular type of chelonian. In every case, however, in which it is recognizable, it clearly represents a Trionychid, with its round, flat carapace devoid of any external plates, its very long neck, comparatively small head and tubular nostrils. In some cases in which the figure is unusually elaborate I believe that the actual species that has served as a model is *Chitra indica*. This species is distinguished from all other Indian forms by the peculiar shape of the head and by the proximity of the eyes to the tip of the snout. It appears to be represented even in some sculptures from Madras.

Now, the larger Trionychidae are very scarce in Peninsular India south of the Mahānaddī and, indeed, are probably absent altogether from the greater number of the rivers of the Madras Presidency. *Chitra indica* is only known from the Ganges, the Indus¹ and the Irrawadi river-systems. The genus *Emyda* on the other hand, to which the little soft-shelled pond-turtles of the plains belong, is common both in the valleys of the Ganges and the Indus and also all over the Peninsular Area properly so called. It is to this genus that the mud-turtles placed in altars in Northern India probably belong (p. 134). The people of the Ganges valley distinguish clearly between the different species of mud-turtles found in rivers and ponds in Bengal

¹ Mr. Bains Prasad of the Government College, Lahore, has recently obtained a specimen from a small stream on the Indus system near Ferozepur.—*June 25th, 1914.*

[N.S.]

and Bihar, because most of them are used as food and some are more highly esteemed than others.¹ The largest and most powerful species is *Chitra indica*. It is apparently the species that is regarded as the "vehicle" of the goddess of the Jumna,² just as the crocodile is the "vehicle" of Mother Ganges.

Such evidence as is at present available would, therefore, seem to suggest that the "tortoise" of Indian iconography is not one of the land-tortoises (Testudinidae) but a mud-turtle belonging to the family Trionychidae, and that the reverence for the animal originated in Northern India. All representatives of the family probably share or shared in the respect due to the form assumed in an incarnation, but it is possible that the actual species at one time revered was *Chitra indica*, which may very well have been the totem or the ancestral god of some particular clan or tribe. The strength of these mud-turtles is very great and *Chitra indica*, although it has not the powerful jaws of the species of *Trionyx*, is said even to attack boats with blows.³ Its carapace alone may attain a length of at least six feet. It is, therefore, an animal that would naturally attract both the attention and the respect of a primitive people.

[N. ANNANDALE.]

ADDENDUM.

Note by Mr. H. E. Stapleton on the Chittagong Turtles.

The correct name of the saint (not 'place' I think) known to you as "Sultan Bagu Bastan" is "Sultan Bayazid of Bastam." 'Bastam' (or 'Bistam') is a town in Persia, and the saint is said to have visited Chittagong for devotional exercises. The mausoleum, which is some 5 miles out of Chitta-

¹ See Chaudhuri, *Rec. Ind. Mus.*, vol. VII, p. 212. Various species of tortoises are allowable as clean food for Hindus. There are Hindus who are absolutely vegetarian, but the majority of them do not object to fish or meat. As regards tortoise-meat, that of some species is considered clean and that of some unclean. The meat of that species of tortoise which is called *Dundi* is allowable even for Brahmans. It has a hard shell above and a hard cartilage below. It has a ridge on its back. It is the species called *Dhoor* in Mr. B. L. Chaudhuri's note, *i.e.* *Kachuga dhongoka* (Gray). The eggs are considered a delicacy. These are found inside the tortoise in the form of a garland several yards long. There is another species called *Sundi*, a small land-tortoise, which is also eaten by the higher classes. *Keto* (that is, "wooden") is another species the meat of which is allowable. But the big tortoises, all called *Barkole*, are never used as food except by the lower classes. These are very big, sometimes containing maunds of meat. In one of Asoka's inscriptions he prohibited the use of *Dudi's* meat, that is, the meat of *Dudr* or *Dhoor*.—*Haraprasād Shastri*.

² Large individuals of this species may often be observed in the water from the train as it passes over the railway bridge at Allahabad, a short distance below the junction of the Jumna and the Ganges.

³ Chaudhuri, *loc. cit.*

gong, has a tank close by which is full of turtles locally known as *Mádáris* and fishes called *Gajáris* [large *Ophiocephali*—N. A.]. I have not yet found out what these words mean, but Shah Madár is the name of another Muhammadan saint and, perhaps, Bayazid Bistami named the tortoises after his rival in derision. It is locally believed that these tortoises were once sinful men whom the saint metamorphosed into turtles as a punishment for their wickedness. I have, however, recently got hold of a Persian History of Chittagong which, I hope, will give further information on the subject. The saint, I believe, did not die in Chittagong, but is buried somewhere up-country. Probably, the shrine was formerly a Hindu or aboriginal one which was taken over by the Muhammadans.

[H. E. S. 1-7-1914.]

18. A short account of our present knowledge of the
Cestode Fauna of British India and Ceylon.

By T. SOUTHWELL, A.R.C.Sc. (LOND.), F.L.S., F.Z.S.,
Dy. Director of Fisheries, Bengal, Behar and Orissa ;
Honorary Assistant, Indian Museum.

[Presented at the First Indian Science Congress, January 16th, 1914.]

The Cestoda are a group of worms commonly known as Tapeworms. There are about 3,000 species known. They are all parasitic, and the adult forms invariably live in the intestine of the animals infected. They are introduced into carnivorous animals by their prey, and into herbivorous animals by means of water and plants.

Besides being of considerable scientific importance, they are a group of animals not entirely devoid of human interest. The orient pearl of Ceylon is, in reality a sarcophagus laid round the dead remains of a cestode larva.

It is reported that in Abyssinia, owing to the practice of eating raw beef, every human individual, whether male or female, is infected with worms from the fourth or fifth year of age. The same remark is, to a great extent, true of the Esquimaux, the Buratis, and of the late American slaves. Taeniasis, or *Taenia helminthosis*, is very common in Germany. In India human infection is much rarer, owing to the fact that the flesh of animals is not extensively eaten. Indian animals generally, are, however, usually heavily infected, particularly sheep, goat and poultry.

The range in size within the group Cestoda is remarkable. *Echinococcus granulosus* (Batsch, 1786), Rudolphi 1805, a worm inhabiting the intestines of the dog and other similar animals, rarely measures more than 1 to 2 mm. in length, whilst *Taenia saginata*, Goeze, 1782, a human parasite common in Europe, occasionally attains a length of 10 metres (over 33 feet).

As all adult members of the group live in the intestinal cavity, they are in every case provided with hooks or suckers, or both, to enable them to attach themselves to their host. From this head, a chain of segments or proglottides is produced. These, as they mature, may drop off singly or in clusters. In most cases each segment is hermaphrodite and contains a single set of male and female reproductive organs.

In the genus *Dioicocestus*, Fuhrmann, 1900, recorded from a stork (*Plegadis guarauna*), and a diver (*Colymbus dominicus*), the entire strobila is either male or female.

Beddard has recently recorded (P.Z.S., London, December,

1912) a peculiar asexual tapeworm (*Urocystidium gemmiporum*), from the rodent, *Fiber zibethicus*.

Segmentation of the strobila is absent or indistinct in certain of the lower forms of Cestoda, and also in the following genera :—

Triplotaenia, Boas, 1902.

Parvirostrum, Führmann, 1907.

Nematotaenia, Lühe, 1899.

The family Fimbriariidae, Frölick, 1802.

Tetracisdicotyla, Führmann, 1907.

Typically, each segment possesses a single genital aperture situated laterally. These pores may be unilateral, or regularly, or irregularly, alternate.

Genital pores appear to be absent in the genus *Aporina*, Führmann, 1902.

In the genus *Mesocestoides*, Vaillant, 1863, the genital pores are located in the ventral surface of the segment.

Within the order *Pseudophyllidae*, Carus, 1863, external segmentation may be present or absent, and three genital pores are present. The uterine pore is always on one of the surfaces, whilst the vaginal and cirrus pores may be on the same surface as the uterine, or on the opposite surface or marginal.

In the genus *Copesoma*, Führmann, 1907, the genital pores are ventral in young strobila, and marginal in *gravid* segments.

Genital pores are duplicated in the following genera :—

Cittotaenia, Riehm, 1881.

Moniezia, Blanchard, 1891.

Thysanosoma, Diesing, 1835.

Cotugnia, Diamare, 1893.

Dipylidium, Leuckart, 1863.

Pancerina, Führmann, 1899.

Stilesia, Railliet, 1893.

Diploposthe, Jacobi, 1896.

Amabilia, Diamare, 1893.

Triplotaenia, Boas, 1902.

The latter genus possesses 4 or 5 cirrus pouches in each lateral half of the segment.

In the genus *Diplohallus*, Führmann, 1900, and *Amabilia*, Diamare, 1893, each segment contains a double set of male, and a single set of female, genital organs.

In the genus *Dioicocestus*, Führmann, 1900, where the strobila is entirely male or female, the female reproductive organs are single in each segment, whilst the male genital organs are double.

In the family *Fimbriariidae*, Wolffhügel, 1898, neither the strobila nor the reproductive organs are segmentally arranged.

Instances of other variations to be met with could be

multiplied, but the preceding examples suffice to show the wide range exhibited.

Of the genera mentioned in the preceding paragraphs, the following are represented in the collection of the Indian Museum :—

Mesocestoides, Vaillant, 1863.

Cittotaenia, Riehm, 1881.

Moniezia, Blanchard, 1891.

Thysanosoma, Diesing, 1835.

Cotugnia, Diamare, 1893.

Dipylidium Leuckart, 1863.

Stilesia, Railliet, 1893.

The topographical relation of the parts of the reproductive organs to each other, and to the longitudinal vessel and nerves, together with the nature and arrangement of the armature on the head of the worm, are the details upon which, during very recent years, an extensive and satisfactory system of classification has been elaborated, principally in Germany and America.

The table on the following page gives the host containing the adult worm, and the host harbouring the larva, for a number of species of Cestoda, and will serve to emphasize the food relationships existing between the hosts in question for each parasite named.

Name of Cestode.	Final host.	Larval name.	Intermediate host.
<i>Tetrarhynchus unionifactor</i> , Shipley & Hornell.	<i>Ginglymostoma concolor</i> and possibly other Elasmobranchs.	<i>Tetrarhynchus unionifactor</i> ..	Pearl oyster.
<i>Taenia serrata</i> , Goeze ..	Dog ..	<i>Cysticercus pisiformis</i> , Zeder ..	Rabbit, hare, mice (in liver and peritoneum).
<i>Taenia saginata</i> =(<i>T. medio-canellata</i> , Kùch.) ..	Man ..	<i>Cysticercus bovis</i> , Cobb ..	Ox, Giraffe (in muscles).
<i>Taenia solium</i> , Rud. ..	Man ..	<i>Cysticercus cellulosae</i> , Rud., (? <i>Cyst. acanthotrias</i> , Weiml.) ..	Man, monkey, bear, dog, cat, black-rat (in various organs).
<i>Taenia crassicollis</i> , Rud. ..	Cat and other <i>Felidae</i> , Stoat ..	<i>Cysticercus fasciolaris</i> , Rud. ..	Rat, mouse, bat (in liver).
<i>Taenia coenurus</i> , Kùch. ..	Dog, Arctic fox ..	<i>Coenurus cerebralis</i> , Rud. ..	Brain of sheep, ox, goat, Dromedary, camel, antelope, horse.
<i>Hymenolepis diminuta</i> , Rud., =(Taenia <i>flacropunctata</i> , Weiml.) ..	Man, mouse, rat ..	<i>Cercocystis</i> ..	Meal-moth. <i>Asopia (Pyralis) farinalis</i> ; also certain Orthoptera and Coleoptera.
<i>Drepanidotaenia gracilis</i> , Zeder. ..	Duck, goose, wild duck ..	?	The Ostracods <i>Candona rostrata</i> and <i>Cypris compressa</i> , and also <i>Cyclops viridis</i> .
<i>Drepanidotaenia setigera</i> , Frol. ..	Goose ..	?	<i>Cyclops brevicaudatus</i> .
<i>Drepanidotaenia inquadibuliformis</i> , Goeze. ..	Common fowl ..	?	House-fly.
<i>Drepanidotaenia friedbergerei</i> , von Linstow. ..	Pheasant ..	Unkown ..	Ants.
<i>Bothriocephalus latus</i> , Bremm. ..	Man, dog, ? cat ..	Plerocercoid, i.e. solid elongate larva, with no bladder ..	Probably first enters an intermediate host, which is eaten by Pike, Perch, Trout, etc.

Most Cestode parasites have particular hosts and they will not mature in any other. Amongst Elasmobranchs however the same species of Cestode may occur in many species of this group of fishes. The same is true of some parasites from birds and mammals, both circumstances being partly explained by the manner of specific feeding.

The hosts concerned in harbouring the cystic stages of by far the vast majority of Cestodes have yet to be determined, and in this connection nothing has been done as yet in India.

Up to a short time ago the number of species of Cestoda in the Indian Museum did not exceed twenty. The attempt is now being made to extend the collection so as to include at least all the principal Indian forms. General field collecting is being carried on extensively. Nearly all animals which die in the Zoological Gardens, Calcutta, are examined, and the Veterinary Colleges in the Punjab and in Madras have also promised to supply specimens.

The following is a general summary of the Cestoda recorded from India and Ceylon to date.

I. From Invertebrates. Nothing. Although larval stages have been seen in *Mytilus bullata* by the writer

II. From Fish.

(a) From Ceylon.	By Shipley and Hornell,			
		Genera	22,	Species 56.
	By Hornell,	„	1,	„ 2.
	By Southwell,	„	2,	„ 19.
(b) „, India.	By Southwell,	„	6,	„ 6.
			<hr/>	
	Total	„	31,	„ 83.

Of the above, the following were new, genera 16 and species 74. In addition to the above, about 20 cystic forms from Teleosts have also been recorded.

The collection made in Ceylon by the writer, comprises the major part of the genera and species tabulated above. Until the material has been worked out anatomically it is impossible to say precisely how many genera and species are represented in the collection of the Indian Museum.

The principal forms obtained from fish which are worthy of special attention are the following:—

A. An *Amphilina magna*, Southwell, from the coelom of *Diagramma crassispinum*, Ceylon Pearl Banks. It measured over 250 mm. long, the largest hitherto recorded being *A. liguloidea*, 80 mm.

B. *Ligula simplicissima*, from Bengal carp. It lives in the body cavity and the adult form occurs in fish-eating birds. It is reported that within recent years, carp brought to the Calcutta market were occasionally so heavily infected that people refused to buy them. The parasites often measure

2 feet long. In certain parts of Italy and France, this larva is sold in the public markets for human consumption.

C. Two adult parasites, *Ophryocotyle bengalensis*, Southwell and *Bothriocephalus* (*Anchistrocephalus*) *polypteri* (Leyd) from Teleosts. The occurrence of adult forms of Cestoda is rare in Teleosts. Larval stages are, however, common, the adult forms usually occurring in Elasmobranchs. Adult forms are more common in freshwater Teleosts than in marine forms, probably owing to the fact that such Teleosts are more rarely devoured by their larger and more powerful brethren, in freshwater, than is the case in the sea.

It is fortunate that, up to the present, the larva of *Dibothriocephalus latus* (Linnaeus, 1758), Lühe, 1899, has not been recorded from Indian fish. The adult worm measures up to 10 metres and inhabits the intestine of man. In Europe, the larva occurs in the pike, the ling, the perch, and several members of the salmon family.

III. From Amphibians. Up to the present no Cestodes (either adult forms or cystic stages) have been obtained from Amphibians.

IV. From Reptiles. Only three species, comprising three genera (*Solenophorus*, *Duthiersia*, and *Ichthyotaenia*) have been recorded up to the present from India. They were obtained respectively from a python and from *Varanus* spp. These are in the collection of the Indian Museum. Two other species have been recorded from Ceylon by Von Linstow, but are not represented in our collection.

V. From Birds.

(a) From Ceylon, by von Linstow, genera 10, species 13. Of these genera 2, and species 9, were new. Three species of the above (included in three genera), are in the collection of the Indian Museum.

(b) From India. The preparation of a paper on Cestoda from Indian birds is in progress. Up to the present 16 species have been named, of which four are new. Ten genera are represented. There are still 32 species to name in the collection, which is steadily growing.

VI. Mammals. The collection comprises 18 species only, distributed in 9 genera, and excluding cystic forms of the genus *Taenia*. Of the latter we have 5 species only. From Ceylon, *Cittotaenia bursaria* has been recorded from a hare, by von Linstow, and most of the usual human tapeworms have also been obtained. Doubtless other parasites have been collected by the Veterinary authorities in Ceylon, but of such I have been unable to obtain any account.

The rate of growth of some of the larger parasites is very great. On November 29th, 1913, a four-horned antelope died in the Zoological Gardens, Calcutta, and the carcass was sent to the Indian Museum for examination. The animal was born on

July 25th, 1913. It was thus four months and four days old, or 127 days. It contained a specimen of *Moniezia expansa*, which measured roughly four feet long, $\frac{1}{2}$ inch broad, and $\frac{3}{16}$ inch thick, when preserved. When alive the parasite probably measured over 5 feet. In the Zoological Gardens the antelope had been fed entirely on grain, bran, crushed oats and green grass. The intermediate host for this parasite is not known.

The rapid growth of the larger forms of Cestoda has however been frequently noted. Van Beneden referring to the development of cysts in the final hosts remarked in 1876 (*Animal Parasites and Messmates*, London, 1876), that "in less than six weeks we often find a tapeworm many metres in length."

In conclusion, I beg to say that the Museum will welcome any additions to its present collection of Cestoda. The study of Helminthology may be interesting enough, but I am well aware that the collection of material cannot at the best be said to be a congenial occupation. But with a full inheritance of the true scientific spirit, the work is possible.

In collecting, the intestine should be slit open longitudinally, if very long, cut into suitable lengths, and then immersed in water, preferably in a black dish. The water causes the parasites to leave their attachments. They may then be preserved in 50% formalin, but if possible, it is better to preserve them in corrosive-acetic for half an hour, wash well in water, and then pass them through 30%, 50% and 70% alcohol up to 90%.

19. Hot Springs in Raj Darbhanga, Khargpore Hills, District Monghyr.

By C. SCHULTEN.

[Presented at the first Indian Science Congress, January 15th, 1914.]

In India there are numerous hot springs, some of which have been reported on, though the following list is not complete.

Dr. T. Oldham, Superintendent of the Geological Survey of India, describes some hot springs in the Memoirs of the Geological Survey of India, Vol XIX, 301, but writes that this list is not even approximately complete. He gives the situation, the source from which information has been obtained, description, and, in many cases, the temperature of the springs which vary considerably, the highest being 192°F.

Col. L. A. Waddell, Indian Medical Service (Vol. LIX. Part II, Journal of the Asiatic Society) gives an essay on "Some new and little known Hot Springs in South Behar", in which he describes 15 hot springs, 9 of which are not included in Dr. Oldham's list. Of four springs he gives analytical data.

Sir W. W. Hunter gives a description of some hot springs in Monghyr in Vol. V of the Statistical Account of Bengal.

As early as in 1838 Mr. Montgomery Martin published some notes on hot springs in Monghyr in the History, Antiquities, Topography and Statistics of Eastern India, also Mr. L. S. S. O'Malley refers to them in the Bengal District Gazetteer, Monghyr, 1909.

As His Highness the Maharajah of Darbhanga was desirous of having the hot springs of the Khargpore hills examined, I was instructed by his manager, Mr. Donald Sunder, F.L.S., F.R.G.S., to visit the place, take samples and examine the springs.

I proceeded to Haveli Khargpore at the beginning of August 1913, and visited Rameswar Koond, a hot spring situated in the hills 5 miles west of Haveli Khargpore, and about 4 miles from the village Santali. Hot water spouts out on the slope of a hill at a temperature of 112°F, no smell of sulphuretted gas was perceptible, and by the application of chemical tests no traces of the gas could be detected. The hot water issues from white quartz debris and air bubbles accompany it. Not having the necessary apparatus I could not make a chemical examination of them, but I collected some of the bubbles, which did not appear to be inflammable. Most probably they consist of air drawn out by the force of water. Hardly any deposit was formed on the stones. Some yards away from the spring a masonry cistern was built in 1904 bearing

the inscription "Rameswar Koond 1904". Into this the water can be made to run and pilgrims use it for bathing.

The water of the spring flows into the Mun river, which is dammed up at Haveli Khargpore and forms a large picturesque lake. A sample of the water was taken and later on examined by me in Calcutta, the result obtained being given below.

The second well I visited was Karmanburi or Lachmi Koond. It is situated 8 miles S. W. from Khargpore and 22 miles from Karmanburi village on the slope of a hill consisting of white quartz and siliceous hornstone and a laterite soil. The temperature was 144.5°F , no smell of sulphuretted gas and no chemical reaction for the gas could be obtained. Air-bubbles appear frequently. The water flows into the Mun river and a slight deposit was noticed. Samples were taken for chemical examination, the results of which are given below.

The third spring, the finest of all, made of several small ones, was then visited. It is situated 314 feet above sea-level, 16 miles S. W. from Haveli Khargpore and a mile from the village of Bhimbandh. Its water also runs into the Mun river and is practically its source. At this place there are several springs along the slope of the hill, which latter consists of quartzite and siliceous hornstone. The highest temperature noted was 148°F and in some places slightly lower. Many air-bubbles accompanied the hot water and the stones are covered with a thin layer of a deposit which most probably is siliceous matter. The air-bubbles had no smell and no sulphuretted gas could be detected by chemical reactions. These springs have been visited by several travellers who have recorded the temperature.

In the year 1809 Dr. Buchanan Hamilton found the temperature to be 150°F , Sterwell in September 1847 found 147° , and Colonel Waddell in January 1890, 146.2° .

The natives of the place use the water of the spring after it has cooled down for irrigating their rice-fields, which are said to grow luxuriant crops. The analysis which is given below does not show any special manurial value, but the still warm water may account for it to some extent. Colonel Cunningham has identified this place with one mentioned by Hien Tsiang in the seventh century A.D. as the site where Buddha overcame the Yaksha Vacula, but Colonel Waddell has shown, however, that there are good grounds for doubting this identification and that the natural features of the country do not agree with the description of the Chinese pilgrims. There are no remains of a Buddhist temple.

As time was pressing I sent out men to sample the Richikund springs which are situated 14 miles N. of Haveli Khargpore, and 4 miles from village Jalimpore. It is 7 miles distance S.W. from Bariarpore Railway Station. A fair is held at Richikund every leap year and from 5000 to 6000 pilgrims bathe in the spring during the fair.

The results of the chemical analysis of the four hot springs are so similar that I can discuss them together.

The waters are exceedingly pure, total solids ranging from 5.4 to 7.5 in 100,000 parts of water. The siliceous matter is the highest and represents more than half of the solids, ranging from 2.8 to 5.1. The waters are very poor in lime and magnesia and consequently the hardness is very low, ranging from 0.88° to 1.16° .

Judging from the composition of the waters they would be excellent for steam raising and other technical purposes. For drinking purposes they are not as good as they contain less lime and magnesia than is recommendable for daily use, a little harder water being preferable. However the water of the hot springs would be very safe to drink in case of epidemic diseases prevailing in the country. They also would be very suitable for the manufacture of aerated waters, provided the necessary precaution is taken to avoid contamination, as they themselves are free from bacteria. The waters have no medicinal properties.

The hot springs are perennial. According to local information there is never a diminution in the outflow of water and occasionally, as in Bhimbandh, new channels open out increasing the outflow. The quantity of water in the dry season is the same as in the rainy season.

The temperature of the Bhimband spring has been noticed, as above mentioned, during the last 100 years several times, and has been all this period and at different times of the year about 148°F .

Considering all these circumstances, the source of the water must be looked for underground, otherwise a difference in quantity would have been observed in the dry and rainy seasons and also a difference in the temperature.

Buchanan Hamilton expressed an opinion that probably "the heat is first communicated to some gaseous fluid, and this rising until it meets the water of a spring, heats it and issues in part along with it". I do not agree with this opinion. Most probably the water is a juvenile water which comes out of the depths of the earth. When the gases come to the colder strata the water is condensed and is driven to the surface by pressure from below. The air-bubbles may have the same origin or may have been carried from holes in the rocks, which afterwards are filled with water. The pureness of the springs leads to the conclusion that they are formed within the quartzite area as their principal constituent is silicic acid.

I examined the water from an artificial well opposite Mr. Sunder's bungalow and the figures obtained by analysis are quite different to those of the hot springs. The well contained 44.00 total solids in 100,000 parts and the hardness was 15.83° .

The hot springs of the Bhavnagar hills are situated in a beautiful country, good roads are leading to the Bhimband springs and to the lake formed by the damming of the Mun river. The lake is surrounded by steep hills densely covered with forest.

RAMESWARA KOOND.

Temperature—112°F.

Parts per 100,000.

Total Solids	4.680
Silica	3.160
Iron	0.015
Alumina	Traces.
Lime	0.475
Magnesia	0.326
Soda	0.262
Potash	0.009
Chlorine	0.177
Sulphates	0.048
Phosphoric acid	None.
Nitrate	None.
Nitrite	None.
Alkalinity as Calcium Carbonate	0.750
Free Ammonia..	None.
Albuminoid Ammonia	None.
Organic matter..	0.632
Oxygen absorbed	0.032
Total Hardness..	1.16°
Temperature	112°F

KARMANBURI OR LACHNI KOOND.

Temperature—144.5°F.

Parts per 100,000.

Total Solids	7.520
Silica	5.120
Iron	0.010
Alumina	Traces.
Lime	0.411
Magnesia	0.209
Chlorine	0.142
Sulphates	0.041
Phosphoric acid	None.
Nitrate	None.
Nitrite	None.

[N.S.]

Soda	0.274
Potash	0.021
Alkalinity as Calcium Carbonate	0.875
Free Ammonia..	None.
Albuminoid Ammonia	None.
Organic matter..	0.632
Oxygen absorbed	0.032
<hr/>			
Total Hardness..	0.88°
Temperature	144.5°F

BHIMBANDH.

Temperature—148°F.

Parts per 100,000.

Total Solids	6.800
Silica	4.920
Iron	0.015
Alumina	Traces.
Lime	0.281
Magnesia	0.324
Soda	0.249
Potash	0.038
Chlorine	0.106
Sulphates	0.017
Phosphoric acid	None.
Nitrate	None.
Nitrite	None.
Alkalinity as Calcium Carbonate	0.687
Free Ammonia..	None.
Albuminoid Ammonia	None.
Organic matter..	0.632
Oxygen absorbed	0.032
<hr/>			
Total Hardness..	0.92°
Temperature	148°F

RICHIKOOND.

Parts per 100,000.

Total Solids	5.400
Silica	2.880
Iron	0.015
Alumina	Traces
Lime	0.389
Magnesia	0.310
Soda	0.174

Potash	0·033
Chlorine	0·106
Sulphates	0·017
Phosphoric acid		None.
Nitrate	None.
Nitrite	None.
Alkalinity as Calcium Carbonate			..	0·875
Free Ammonia..		None.
Albuminoid Ammonia		None.
Organic matter..		0·632
Oxygen absorbed		0·032
				<hr/>
Total Hardness..		1·03°
Temperature	Warm.

WELL OPPOSITE BUNGALOW, HAVELI KHARGPORE,

In 100,000 parts.

Total Solids	44·00
Silica	4·00
Lime	9·72
Magnesia	2·10
Sulphates	0·25
Chlorine	3·99
				<hr/>
Total Hardness..		15·83°
				<hr/>

20. NUMISMATIC SUPPLEMENT No. XXII.

Note.—The numeration of the article below is continued from p. 485 of the “Journal and Proceedings” for 1913.

125. THE POST-MUGHAL COINS OF AHMADĀBĀD, OR A STUDY
IN MINT-MARKS.

(With Plates IX—XI).

Dr. Taylor in his admirable account of the coins of Ahmadābād to be found in J.B.B.R.A.S. No. 56, Vol. XX, has confined his detailed treatment almost wholly to the coins minted, when the Mughals were a power in the land. In this note I propose to discuss the coins struck after the first date on which the administration of Ahmadābād city and its parganas ceased to be in the hands of the Mughal Emperor's nominee and before the date of the introduction of the British Imperial coinage. The period between these two dates I have called the Post-Mughal period. It was an epoch of transition during which Ahmadābād and its environs were the theatre of constant struggles, negotiations and agreements between the Peshwa, the Gāyāvād (*Anglice* Gaikwar) and the British. The Mughal Emperor at Dehli was still regarded as the suzerain of Gujarāt, but only a suzerain in the vaguest meaning of the word. He was respected, even deeply respected, but only as a tradition. The newly emancipated states felt towards the Emperor much as a boy who has just left school feels towards his old head master—an attitude of respect mingled with complete independence. And as an “old boy” is wont to wear his old school colours, so did the Marāthās retain the name of the Emperor on their coins and even titles which had been bestowed upon them from Dehli.

The retention of the Emperor's name upon coins issued by independent states has caused a serious difficulty in classification. Various methods have been adopted and the Numismatic Society of India has adopted a provisional system of including under the name of Mughal all coins bearing the name of a Mughal Emperor up to the close of the reign of Shāh ‘Ālam.

This paper does not follow this system and will, I hope, make it clear that the end of the reign of Ahmad Shāh sees the last of the issues of coins by the Mughal Emperors in Ahmadābād and that the accession of ‘Ālamgīr II in A.H. 1167 inaugurates a series of non-Mughal coins, broken only by the issues of A.H. 1170 and possibly also of A.H. 1171, when Ahmadābād

was for a last brief space in the hands of an Imperial Governor. The proof of this statement must be left to the history of the period and to the coins themselves.

History—(1) (General).

Authorities : Watson, *Bombay Gazetteer*, Vol. I, Part I (Mir'āt-i-Aḥmadi).

From 1707 till 1817 A.D., the City of Aḥmadābād was in a continual turmoil, except for short periods of comparative peace during the Gaikwar's and the earlier part of the Peshwa's administration. But up to 1738 A.D. the city, though repeatedly plundered by the Marāṭhās, remained still with parts of the adjacent districts in the hands of a Mughal Governor.

In 1738 A.D. the Marāṭhās were powerful enough to bring about a division of the city between the Mughal Governor and the agent of the Gaikwar, who represented their Peshwas in Gujarāt. The arrangements lasted with interruptions until A.D. 1753, A.H. 1166. Then it was that the Peshwa and the Gaikwar uniting their forces captured the city, a large part of the Mughal province of Gujarāt having been in the preceding year shared between them. The Baroda volume of the *Bombay Gazetteer* of 1883 A.D. says, "From this time the Mughal Empire in Gujarat practically came to an end and the country was divided between the Peshwa and Gaekwar according to the terms first settled in 1751-52 and elaborated in 1753."

The city was recovered in 1755 A.D., 1169 A.H., by Momin Khān, Nawāb of Cambay, who took possession of it in the name of 'Ālamgīr II early in 1170 A.H. For this exploit the Emperor bestowed a dress of honour and the title of Bahādur upon him. Watson (*B.G.*, Vol. I, Part I, page 341) records an interesting incident in this connection from the *Mir'āt-i-Aḥmadi*, which shows what respect was paid to the Imperial suzerainty. When the envoys bearing the Imperial farmān granting the dress of honour and the title were reported to be nearing Aḥmadābād, the city was being closely besieged by the Marāṭhās who had lost no time in trying to recover their conquest of 1753 A.D. Momin Khān asked and actually obtained permission from the besiegers to proceed from the city to meet the envoys in accordance with the etiquette of the Mughal court.

The siege terminated in A.D. 1757, A.H. 1171, with the surrender of the city by Momin Khān to the combined armies of the Peshwa and Gaikwar. The last efforts on behalf of the Empire had resulted only in an occupation of less than two years, and henceforward Gujarāt was governed without reference to Dehli.

After their second conquest of Aḥmadābād, the Peshwa and Gaikwar divided the revenues of the city. The adminis-

tration remained as formerly in the hands of the Peshwa, while the Gaikwar to safeguard his interests held one gate and kept a representative in the city. The surrounding districts were held as before, partly by the Peshwa and partly by the Gaikwar.

For the next 20 or 25 years the Gaikwar was constantly at loggerheads with the Peshwa and the quarrel culminated in Fatehsin̄ha Gaikwar calling in the aid of the British. General Goddard captured the city in February 1780 A.D., 1194 A.H. It was then handed over to Fatehsin̄ha.

Fatehsin̄ha remained in possession for nearly three years and at the end of this period the treaty of Sālbai 1783 A.D., 1197 A.H., restored the *status quo*. The Peshwa administered the city until 1800 A.D., 1214 A.H., in which year the Gaikwar's general Babaji attacked and defeated Abu Shelukar, the governor of the Peshwa. The Peshwa had long been anxious to get rid of Abu Shelukar, who had been troublesome, and made no attempt to restore him, but leased Aḥmadābād for four years to the Gaikwar. This transaction took place late in 1800 A.D. in the earlier half of 1215 A.H. The lease was renewed in 1804 A.D. for ten more years, but on the expiration of the latter period the Peshwa fearing, no doubt, the rivalry of the Gaikwar refused to renew, and leased the city to a private individual.

The result was disastrous to the prosperity of the city and in 1817 A.D., 1232 A.H., the Peshwa yielding to strong pressure from the British Government let the farm of Aḥmadābād in perpetuity to the Gaikwar. The Treaty of Poona, which contained among other provisions the above agreement, was signed in May 1817 A.D. in the first half of 1232 A.H.

Later in the year the Gaikwar agreed to hand over Aḥmadābād with his rights in it to the British Government, and in December 1817 A.D., in the first month of 1233 A.H., the city was formally transferred. Mr. Dunlop was appointed as the first Collector.

History—(2) (Numismatic).

Watson, *Bombay Gazetteer*, Vol. I, Part 1.

Campbell, *Bombay Gazetteer*, Vol. IV, Ahmedabad.

Bombay Government records, Ahmedabad, 1818-1835.

Major Watson in his *History of Gujarāt* makes various references to coinage, for which his chief authority is the *Mir'āt-i-Aḥmadī*. Speaking of the first occupation of the city by the Marāthās in 1753 A.D., 1166 A.H., he says, "In the Ahmedabad mint coin was no longer struck in the name of the Emperor." The appendix to this note contains a list of known Aḥmadābād coins of 1165 A.H. and after. From it we see that the last coin minted by Aḥmad Shāh is dated in the earlier part of the year 1165 A.H. There is then a gap of some years and Major Watson's statement is so far borne out, though it is incorrect in so far as it implies that the name of the Emperor was not used on any subsequent coins. It is quite possible,

however, and even probable, that the statement refers merely to the stoppage of the mint for all coins.

During Momin Khān's occupation of Aḥmadābād, 1756-1757 A.D., 1170-1171 A.H., Major Watson records, "The copper vessels of such of the townspeople as had fled were now melted and coined into money and given to the soldiery." Nothing is said about silver coinage, but it is *á priori* unlikely that the mint should be opened for coinage of copper only. And in fact Dr. Taylor has in his cabinet (see appendix Nos. 5 and 6) two coins of this period, i.e. 1170 and 1171 A.H.

To confirm the statement that copper was coined about the time of Momin Khān's occupation, I have in my cabinet (v. app. 2a) an Aḥmadābād paisa of 'Ālamgīr II dated either 2, 3 or 4 A.R. The right-hand extremity of the "Julūs" year is not on the coin, and on consideration of the evidence I feel inclined to put the figure at 3 or 4. It occupies an earlier place in the list of the appendix than I now consider it should hold, because it was my first impression that the accession of 'Ālamgīr would involve fresh coinage both of silver and copper and there was a temptation to believe that the copper coin was of the same date as the earliest silver coin of 'Ālamgīr.

A third and most interesting remark made by Major Watson is as follows: "On receiving the government of the city (from Momin Khan) the Maratha general ordered new coin bearing the mark of an elephant goad to be struck in the Ahmedabad mint." This was the second occupation of Aḥmadābād in 1171 A.H. by the Marāthās and the first coin (app. No. 7) known to be issued after 1171 A.H. bears the ankush or elephant goad, just as Major Watson states. But this is not the first time the ankush appears on an Aḥmadābād coin. The rupees issued during the first Marāthā occupation also bear the ankush, and the quotation from Watson contains a want of correspondence of dates easily accounted for, when we remember that Major Watson is the earliest English authority for the fact of the two occupations of Aḥmadābād by the Marāthās. By previous historians the Marāthās were considered to have occupied the city continuously after its first surrender to them until the time when the British Government took it over. Probably the Momin Khān who recaptured the city in A.H. 1169 was erroneously identified with the earlier Momin Khān, Governor of Aḥmadābād, who died circ. A.H. 1156.

The Bombay Gazetteer, Vol. IV, Aḥmadābād, supplies certain information of value for our purpose. We hear (page 72) that "in 1817 on taking over charge from the Gaekwar authorities of the city of Ahmedabad, Mr. Dunlop found the mint closed and the supply of circulating medium so low as seriously to impede traffic. He soon administered relief by issuing a large quantity of new sicca rupees."

[N.S.]

It is probable that the mint had not been closed for long, as we have both Peshwa's and Gaikwar's coinage for the year 1232 A.H., but the fact that the supply of currency was short, need not be doubted.

Mr. Dunlop was then responsible for the issue of the silver coins dated 1233 A.H. (1818 A.D.) and onwards. The abandonment by him of the ankush and the adoption of the conventional rose in its stead need not be dwelt upon in this place, as mintmarks are being dealt with under a separate and subsequent section.

Government of Bombay records show how the standard of sikkais were fixed. Mr. Dunlop mentions the standard fixed by Shelukar (Abu Shelukar, the Peshwa's governor) expelled by the Gaikwar in Samvat 1849 (1793 A.D., 1207-08 A.H.) "according to which we now coin." The Bombay Assay Master in 1819 specially complimented the Collector of Ahmadābād (Mr. Dunlop) on the close adherence to a uniform standard both of weight and purity. The mean standard which the Assay Master accepts is of weight 181 grains and of touch (percentage of pure silver) 85.25. It is interesting to notice the amount of variation considered as reasonable. Mr. Dunlop's heaviest average coin for one month weighed 182 grains, touch 85.25, and his lightest 180.25, touch 85.5—a variation either way of about 1 grain as regards weight and negligible as regards touch.

Mr. Dunlop also states that "the siccas of those days" (in 1788 A.D.) "were worth intrinsically $\frac{3}{4}\%$ more" than those following Shelukar's standard.

In addition to the silver coinage, Mr. Dunlop obtained permission in 1818 to coin 100 maunds of copper. The shroffs had been making a corner in copper coin and earning large profits. A new issue was greatly in demand.

Mr. Dunlop ascertained that the normal rate of exchange for copper coin was 60 pice to the rupee. He fixed the exchange for the sake of convenience (for divisions into annas apparently) at 64 pice to the rupee. The coins he issued are obviously those dated from 12—1234 to 14—1236, which have puzzled so many authorities.

The weight of the new coin was determined apparently by weighing 60 or a rupee's worth of old pice, which were found to amount to a seer of 40 rupees weight. The new pice were therefore coined at 64 to the seer.

This gives the weight of the old pice at $120\frac{2}{3}$ gr. and the weight of the new pice at $113\frac{1}{8}$ gr. But in point of fact, what I take Mr. Dunlop to mean by the old pice, i.e. the recently issued Maratha pice (type B, p. 159) weigh from 127—118 grs.: 121 grs. is, however, not an uncommon weight and great exactitude in copper coins is not to be expected. The weights of the "new pice," i.e. those of type C (p. 160) range from 121—

116 grs. It is clear that they were meant to weigh less than the old pice and the fact that none are known to weigh the prescribed 113 grs. need not be made much of. It is possible that a fall in the price of copper may have made rigorous exactitude of weighment unnecessary.

Dr. Taylor suggests in his article upon Aḥmadābād coins in the B.B.R.A.S. Journal the descent of these "new pice" from the Akbari Do Tānkī. Their connection with the "old pice" is one step towards the working out of this idea.

There is no other historical evidence ready to hand. It appears that the year 1835 A.D. which signalized the appearance of the imperial coins of William IV marked also the disappearance of the Aḥmadābād sikkai mint. At any rate records show that in 1835, there was some difficulty in finding the ex-Daroga of the mint a suitable post and the presumption is that the mint had been closed about that year.

The latest date on a rupee in my cabinet is 1249 A.H. or 1833-34 A.D.

The Coins. (1) Description of types.

I shall now give a description of the types of coin of the period, which fortunately are not numerous.

Gold.—As far as I know, no gold coins were minted.

Silver.—The silver coins known are rupees and half rupees. The weight of the rupee is 180 grs. more or less and that of the half rupee averages 90 grs. I have in the preceding section referred to the method of determination of the standard weight for practical purposes. It does not differ from the ordinary Mughal standard. The length of the diameter of the coins is unimportant; they exhibit the same variations as similar Mughal coins. There is similarly no difference of type of inscription. Dr. Taylor has described the stock inscription of coins subsequent to Muḥammad Shāh's reign and for the sake of convenience this is repeated below:—

<i>Obverse.</i>	<i>Reverse.</i>
King's name date.	
←————— پادشاه غاز ————— سکه صبار	مانوس میمنت number. سده جلوس ضرب احمد آباد

There is however a variation in the coins minted in and after A.H. 1242. On them we find the date *below* the yā of

Ghāzī instead of above and in the last years of the mint in the middle instead of on the *right*-hand side of the obverse.

The half rupees were struck from the same die as the rupee and bear almost always very fragmentary inscriptions.

The metal of which these coins are composed are of varying touch. Without having made any analyses, I may record my impression from observation that the older coins contain a larger proportion of pure silver than the latter, particularly those minted during the British regime. But analyses were made in the past by the Assay Office at Bombay and the Assay reports seem to prove that the British minted rupees of Aḥmadābād were of higher touch than the Marāthā rupees.

The rupees vary much as regards mint marks and this is important enough to be treated later separately and in detail.

Copper.—Copper coins are not numerous, but there are at least three types minted at three different periods.

Type A.—Period 1170—1171 A.H. App. 2a.

wt. 111 grs.

<i>Obverse.</i>	<i>Reverse.</i>
عالم کبیر	ک
←	مبار
فلوس	جلوس
	number.
	ضرب
	احمد آباد

Mubārak on the reverse is a tentative reading, the stroke forming base of the kāf being alone visible.

Type B.—Period 1231—1232 A.H. App. 47a. and 49a.b.

wts. 127—118 grs.

<i>Obverse.</i>	<i>Reverse.</i>
اکبرشاهه	ک
date ا	مبار
فلوس باد	number.
	سنه جلوس
	ضرب
	احمد آباد

Type C.—Period 1234—1236 A.H. App. 53a-c.

wts. 121—116 grs.

Obverse.

اکبر شاه

date

فاوس

Reverse.

جاوس

number.

سده

احمد آباد

v JBBRAS, Vol. XX,
No. LVI, p. 439 and
plate.

I know of only one specimen of type A and that is in my cabinet. Specimens of type B are rare, but type C is not infrequently met with. It may be said that type A may be ascribed to Aurangzib. But a comparison of the type with similar types of Aurangzib and 'Ālamgīr II will, I believe, unhesitatingly pronounce in favour of the second 'Ālamgīr. The sizes of the coins are unimportant. They are very irregular and vary from an imperfect circle to an uneven square. The points are rather smaller though thicker than the current imperial paisa (pice). The mint marks to be found on the copper pieces will be discussed later.

The coins (2) (mint marks and comments).

I now come to what perhaps is the most important part of this paper. In the majority of expositions of coins, so much information has been obtainable from other features, such as literal and pictorial inscriptions, that no attempt has been made to deal at all systematically with the variations of conventional marks. I do not claim that my selection of subjects was due to any originality or thoroughness of treatment, and in fact it was only the numismatic dullness of the period which was in such striking contrast to the bustle and action of its history, which directed my attention to the remarkable variation of mint marks, as a mine which might profitably be dug in. I was, in fact, forced to make my differentiations by mint marks or not at all. The immediate cause of my attention being turned to the matter was the sentence that I have quoted from the Bombay Gazetteer that Mr. Dunlop, the first Collector of Ahmadābād, finding the commerce of the city much impeded by the want of coin, obtained permission to reopen the mint at Ahmadābād. Coins of the period subsequent to the British occupation were known to exist both in Dr. Taylor's cabinet and in other collections, although no definite ascription of them had been made to Mr. Dunlop's

Mint. It struck the eye on looking through Dr. Taylor's cabinet that some coins of the later Mughals bore the ankush and others not, and it was a natural step forward to enquire whether the presence and absence of the ankush corresponded with any definite period of occupation by different powers. A short examination showed that the British coins did not bear the ankush, and this fact together with the knowledge that one or two coins existed bearing the letters $\pi\pi$ (presumably for Gaikwar) lay a wide field open to further inquiry. But the scarcity of material presented difficulties and Dr. Taylor's cabinet of Mughal coins, extremely helpful as it was, could not be expected to contain coins which were obviously not Mughal. I therefore made a special search among the so-called sikkais of Ahmadābād, which are to be found in large numbers in the silver dealers' shops. These sikkais I found to be struck with extraordinary uniformity, so as to exclude the date both of the Hijrī years and of the Mughal Emperor's "julūs." The result was that only about one coin in a hundred yielded the requisite data, and it will be understood that a perfectly complete series was hard to obtain.

A list of the known coins of the Ahmadābād Mint of and after 1165 A.H. is to be found in the Appendix, which to a large extent explains itself. Its indebtedness for the years between 1165 and 1200 A.H. to Dr. Taylor's cabinet will be seen. The subsequent coins are mainly from my own cabinet.

The principal mint marks in this series appears to be in the loop of the *sin* of *julūs* on the reverse, and unless it is stated to the contrary, all mint marks will be understood to occupy this position. The last Mughal marks are those of Ahmad Shāh (v. app. No. 1) and of 'Ālamgir II (v. app. Nos. 5 and 6). The former resembles a sprig of a tree and is chiefly noticeable, because it appears to be reproduced on the copper coins Nos. 47 *a* and 49 *a* and *b* of the Appendix. This mark may, however, represent a glorified trisul, and in any case it stands upright and not slantwise like the "sprig." A comparison may be made with Wright I.M.C. Vol. III, Mint mark No. 94.

The mark on coins Nos. 5 and 6 in the Appendix is not especially distinctive. It bears a close resemblance to that on British-minted coins, Appendix No. 51, though the two marks differ in detail.

The next distinctive mark is the ankush of which our earliest specimen is Appendix No. 2. It definitely replaces the sprig in the *sin* of *julūs*. Mention has been made of the evidence, which leads us to believe that the ankush is purely a Marāthā sign. It seems conclusive enough. Upon the origin of the sign light is thrown by the Hon'ble Mr. Justice Ranade in his article on currencies and mints under Marāthā rule in J.B.B.R.A.S., Vol. XX, No. LV. He remarks on page

199, "the Ankushi rupee, so called on account of the ankush or elephant goad which it bore on the inscription, was issued by the Rastes from their mint at Vai." I do not know of any but the Ahmadābād rupees bearing the ankush. The quotation, if it refers to them, is doubly interesting. In any case, it provides another authority for the connection of the ankush mark on coins with the Marāthās. Mr. Ranade gives other relevant information on page 198 *id.* "In the Peshwa's own mints Malharshahi rupees appear to have been the standard. They were called Malharshahi after Malharrao Bhicaji Raste as stated above. This Raste family was at first a great banking firm, and Malharrao was the brother of Gopi Kalbhai, wife of Balaji Bajirao (Peshwa). When the Karnatic was conquered from the Nawab of Savanur, the Rastes were appointed Subedars and Malharrao opened a mint at Bagalkot about 1753 A.D." 1753 A.D., 1169 A.H., is the date of the first Marāthā occupation of Ahmadābād. It is quite probable that the Peshwa's general adopted the sign of the chief Marāthā mint master for the new coinage, both because he was chief mint master and because he was their ruler's brother-in-law. It is even just possible that the Ahmadābād coins were minted by Malharrao at Vai or Bagalkot, but I do not consider this very likely. That the Rastes had a stake in Gujarāt is shown by Grant Duff, *History of Marathas*, Vol. III, page 386. One of the conditions of the Treaty of Poona of 1817 was that the Jāgīr of "Madhu Rao Rastia" forfeited years before should be restored.

Whether it was the Rastes or others who were responsible for the introduction of the ankush mark into Gujarāt, the sign was continued right up to the date of the British occupation. In 1200 A.H. variations of the ankush are introduced. I can only account for these by supposing that they are private marks of mint masters. If so, changes of head of staff must have been frequent. In 1215 A.H. the Peshwa leased Ahmadābād to the Gaikwar, and the latter was for the first time in independent occupation recognized by the Peshwa. About this time we see a corresponding change in the mint mark. We have the regular Marāthā ankush with the addition of न in Nāgrī, which obviously stands for नयकवाड. This mark is with differentiations maintained in conjunction with the ankush almost continuously until the termination of the Gaikwar's lease in 1229 A.H. We should expect the symbol न to have been added first in the year 1215 A.H., when the lease was made. But Nos. 32 and 33 App. show that the change occurred in the year 39 A.R. No. 32 has the plain ankush and No. 33 the ankush with न. The corresponding Hijri period is 1211—1212. The discrepancy need not, however, detain us. For the ten or twelve years previous to 1215 the julūs year was allowed to fall one or two years behind the proper figure. For instance No. 26 should read 34 or 35—1207 instead of 33,

and No. 34 should read 42 or 43—1215 for 40—1215. The Hijrī dates wanting on Nos. 32 and 33 are more probably 1214 and 1215 than anything else.

I have said above that the mark ग was maintained *almost* continuously until 1229 A.H. The exceptions are Nos. 38 and 39 App. which bear the word राम in the place of ग. The dates are 121 and 122, which seem to indicate 1219 and 1220. If this is so, the connection of this change of mark with the termination and the renewal of the original four years' lease in 1219 A.H. is probable. I have not been able, however, to hit upon a plausible signification of राम. Can it be a disinclination to continue the use of ग from the fear of the Peshwa thinking it presumption after the termination of the old lease? This coupled with a desire to give a hint to the inhabitants of Aḥmadābād, that the Peshwa had not actually resumed possession, as the replacement of the simple ankush might be held to show, may account for this curious variation. Is it to boot a pious invocation of Rāma to the end that Aḥmadābād may remain under the Gaikwar's sway?

Whatever the inscription means, the year 1220 Hijri marks a return to the old symbol, which is continued in the year 50 of the reign of Shāh 'Ālam II. A remarkable figure this, as the Emperor died in the 49th year of his reign, but it shows how careless was the Marāṭhā at this period of the change of the name of his shadowy suzerain. On the coin that bears the figure (No. 41) the ankush has a small mark of differentiation due no doubt to the appointment of a new mint Daroga. But later a return was made to academical exactitude. The next coin (No. 42) the first of Akbar's reign has the julūs year to correspond with the Hijrī date, and further the correcter symbol ग (i.e. ग + the abbreviation sign) is used instead of ग for the first syllable of the word गायकवाड.

In No. 44 we note an additional sign, which seems to read क. Its meaning is obscure. It is only possible to suggest it may stand for Khān, which in Gujarāṭi frequently is so spelt.

The resumption of the lease of Aḥmadābād from the Gaikwar is marked by the issue of No. 46 without the sign ग. In its place is a sign like the spectacles on a cobra's hood. Justice Ranade in the article referred to a few pages back makes no mention of this mark, but it appears on a silver coin in my cabinet bearing the date 1244 in Marāṭhā figures. The coin bears a very close resemblance to the Marāṭhā Chhatrapati (v. Dr. Abbott's article in J.B.B.R.A.S., Vol. XX, No. LV) and its main "lieu de provenance" is Poona, although my specimen was discovered in Aḥmadābād. These facts, it is true, do not throw much light upon the mark in question, but are so far useful as to suggest that it denotes an issue of the Peshwa rather than of the Gaikwar.

The ankush persists on this coin. It appears also on subsequent silver coins with the differentiation of two streamers attached until 1232—10. The ‘cobra’s spectacles’ are now absent.

Omitting for a moment mention of the copper coin of this epoch, we find No. 50 marking the restoration of Aḥmadābād to the Gaikwar by the return to the simple ankush and the replacement of the symbol 𑂔 . There is nothing in the date to contradict this view. In the first month of the next year 1233 A.H. Aḥmadābād was formally transferred to the British Government and the coins henceforth issued bear nothing but a simple conventional rose in the sīn of the julūs. This bears a very close resemblance to the mark on Nos. 5 and 6 and in fact is identical with it save that it is somewhat more coarsely delineated. The mark was evidently conceived by the British mint master as the most suitable one for the purpose. It suggests that the British are inheritors of the Mughal Empire and indicates the flower that is England’s badge.

The mark on the copper coins, which, it is to be noticed, comprise both the paisa (pice) and the pai (pie) is not a conspicuous one and appears to be a mere ornament.

Henceforth the series proceeds more or less regularly to the year 1249 A.H. The julūs date is almost invariably incorrect. In 1242 A.H. a slight change of type appears. This has been already noticed.

From the fact that rupees and half rupees of certain dates are found missing, it is probable that no coins were minted of these dates. This does not mean that the mint stopped issuing coins, but that no trouble was taken to change the dies. The dates found are 1233, 1236, 1239, 1241, 1242, 1243, 1244, 1248 and 1249. Half rupees are listed in the Appendix of all these dates except 1239. It is possible that Nos. 55 and 58 are not of 1236 and 1241, but probably these years were on the die, as after the first two or three years of British occupation, not more than one regular year was ever ascribed to a Hijri date, so far as can be determined. And the existence of both rupees and half rupees of certain dates and the absence of both denominations of others certainly supports the view that the change of dates was made not regularly, but from time to time.

I have thought it wise not to break the thread of the argument by the notice of a striking coin which interrupts the series issued in the name of Shāh ‘Ālam II. This is a coin minted by Bīdār Bakht in 1203 Aḥad, and bearing a mint name which looks remarkably like Aḥmadābād. The best specimen of which a plate has been made appears to be No. 2499 I.M.C. (Wright). There is a remote possibility that the mint name is not Aḥmadābād but something else, e.g. Muḥammadābād, for

why Bīdār Bakht should have shown Aḥmadābād as a mint town and the only one besides the obvious Shāhjahānābād is far from clear. But whether the coin bears the name of Aḥmadābād or not, I feel perfectly sure from the style of it that it was not minted very far from Shāhjahānābād. The type resembles too closely that of its immediate predecessor No. 2498 of Bīdār Bakht and its immediate successor No. 2500 of Akbar II, for it to be possible that it is anything but a true Mughal coin. It cannot therefore have been actually coined in Aḥmadābād, for as we have seen the Peshwa then in possession of the city was minting a series of coins of a particular stamp. The recognition of Shāh Jahān III (v. app. No. 8 and 9) is not on the same footing. In his case, the death of 'Ālamgir the second was accompanied by the actual proclamation of Shāh Jahān as Emperor. Shah 'Ālam II, now reckoned as 'Ālamgir's successor by historians, was then in Bihār and remained there some little time before physically asserting his claim to the Imperial throne. It was therefore doubtful for a while which claimant would prevail, and it causes no surprise to find that the Emperor actually proclaimed at Dehli was the one recognized by the Marāthās. The latter appear to have ceased coining for some years subsequent to 1175 A.H.¹ and the next coin known is dated A.R. 10 of Shāh 'Ālam, by which date he had had ample time to become universally acknowledged as Emperor.

For the coin of Bīdār Bakht I have referred to, we have, I think, an exact parallel in Nādir Shāh's issue of 1152 A.H. It is well known that Nādir Shāh had no connection with Gujarāt. He conquered Dehli and imprisoned the Emperor. Watson (B.G., page 322) says, "except that coin was struck in Nadir's name the collapse of Mughal power caused little change in Gujarat." It is probably just as true to say that the collapse of Mughal power caused *no* change in Gujarāt. Aḥmadābād was in joint possession of the powerful Momin Khān and the Marāthā Rangojī.² Neither of them was likely to recognize a foreign invader to the extent of striking coin in his name. Nādir Shāh is said to have converted a portion of the plunder of Dehli into coin at Shāhjahānābād, and from the similarity of style of the Aḥmadābād to the other pieces of the invader,

¹ Two coins have just (June 1913) come to hand, one Shāh 'Ālam II, A.R. aḥad, and the other A.R. 4, both with the plain ankush mark. The Marāthās did not therefore cease coining as I have supposed, but either issued coins under the names of the two rival Emperors at once or antedated the Shāh 'Ālam issue, when the claim of that Emperor was established. *Vide* last remark in Appendix.

² I venture here to differ from Dr. Taylor (Coins of Aḥmadābad J.B.B.R.A.S. 1901) who is of opinion that Nādir's coin was struck at Aḥmadābād. I do so with less diffidence as Dr. Taylor has not advanced the possibility of the coins being struck elsewhere than at Aḥmadābād.

probability seems to be on the side of the Aḥmadābād as well as the coins with other "mint" names being all struck at one time in Dehli.

It is a curious coincidence that Ghulām Qādir minted the coin for Bīdār Bakht from his plunder of Shāh 'Ālam's palace. The desire to assert a claim over a wealthy and important city like Aḥmadābād, which was nominally under Mughal rule, would appear to have been sufficient inducement for the striking of the coins referred to by Nādir Shāh and Bīdār Bakht.

I attach considerable importance to the differences of style of execution in the coins from the normal Aḥmadābād type, as apart from these two exceptions, the Aḥmadābād mint keeps to a uniform style for the century 1138 A.H. to 1237 A.H. and a few years after.

I cannot conclude this note without a word of thanks to Dr. Taylor for his kind and generous help and warm encouragement in my efforts to throw a little light upon a hitherto uninvestigated period of Aḥmadābād Numismatics.

It will be seen from the appendix that I am almost entirely dependent upon his cabinet for the description of the coins of the earlier part of my period. By affording me opportunities of access at all times to his cabinet and library as well as by actual research and communication of his numismatic experience he has rendered me most valuable assistance.

Surat, 1913.

A. MASTER.

APPENDIX.

COINS OF AHMADĀBĀD, 1165 AND AFTER.

All coins silver unless otherwise stated.

	Emperor.	A.H.	A.R.	Period within which struck. Months in Roman figures.	Mint Mark.	REMARKS.	
1	T	Ahmad Shāh	1165	4	I-V	☞
	1166	6	VI	..	<i>The Marāthās occupy Ahmadābād.</i>
2	T	Ālamgīr II	1169	2	I-VII	☞
2a	M	2	Copper fulūs A. R. 2 or 3.
	1169	2	III	..	<i>Momin Khān captures Ahmadābād (nominally on behalf of Emperor).</i>
3	M	..	116-	3	VIII-XII	☞	Date can be nothing but 1169 as 1169 is A.R. 2 and 3.
	1170	3	I	..	<i>Momin Khān enters Ahmadābād.</i>
5	T	..	1170	3	I-VII	☞	Coin No. 4 is that in the I.M.C. (Wright) and has A.H. 1170 which must be 1170.
6	T	..	117-	1	1170 VIII-1171 VII.	id.	<i>id.</i> means that the mark is same as in previous No.
	1171	4	VI	..	<i>Momin Khān surrenders Ahmadābād to Marāthās</i>
7	T	..	117-	6	1172 VIII-1173 IV
	IMC						

	Emperor.	A.H.	A.R.	Period within which struck Months in Roman figures.	Mint Mark.	REMARKS.
8	Shāh Jahān III..	1173	1	<i>id.</i>
9	"	1175	1	<i>id.</i>
10	Shāh 'Ālam II	10	1182 V-1183 IV ..	<i>id.</i>	$\frac{1}{2}$ rupee.
11	"	..	11	1183 V-1184 IV ..	<i>id.</i>
12	"	118-	12	1184 V-1185 IV ..	<i>id.</i>
13	"	1188	15	I-IV	<i>id.</i>
14	"	..	15	1187 V-1188 IV ..	<i>id.</i>
15	"	1188	16	V-XII	<i>id.</i>
16	"	1192	20	V-XII	<i>id.</i>
17	"	119-	21	1193 V-1194 IV ..	<i>id.</i>
18	"	1194	22	V-XII	<i>id.</i>	1194 II capture of Ahmadābād by General Goddard.
19	"	119-	23	1195 V-1196 IV ..	<i>id.</i>
20	"	1196	24	V-XII	<i>id.</i>
21	"	12-	27	I-IV	ꣳ	Ā.H. 12—which must be 1200.
22	"	..	28	1200 V-1201 IV ..	<i>id.</i>

23	M	"	"	"	I-IV	"	<i>id.</i>	"	
24	T	"	"	"	1201 V-1202 IV	"	as 21	"	Mark crowded out by smallness of flan.	
25	M	"	"	"	I-XII	3-	1205	३	
26	M	"	"	"	33	1207	३३		The whole of the left-hand portion of the ankush is not visible, but has been filled in. The A.R. dates from this point become very erratic; in this case 34 or 35 would be correct.
27	M	"	"	"	3-	1208	<i>id.</i>	
28	M	"	"	"	35	..	३५		(The variations of the ankush seem to be annual).
29	M	"	"	"	36	..	३६	
30	M	"	"	"	1209	३७	
31	M	"	"	"	37	..	३७		Note the return to the simple ankush.
32	M	"	"	"	39	..	<i>id.</i>	
	..	"	"	"	V	43	1215	४३		<i>Peshwa leases Ahmadābād to Gaikwar.</i>
33	M	"	"	"	39	..	३९		The A.R. date is wrong as usual 39 may well refer to the latter part of 1214 or earlier part of 1215 when Gaikwar turned Abu Selukar, the Peshwa's governor, out of Ahmadābād. Note that 39 A.R. is the year in which the change of mark occurs.

	Emperor.	A.H.	A.R.	Period within which struck. Months in Roman figures.	Mint Mark.	REMARKS.
34	M Shāh 'Ālam II	1215	40	<i>id.</i>
35	M "	1216	<i>id.</i>	½ rupee.
36	M "	1217	4-	<i>id.</i>
37	M "	..	4-	Not room for all of mark on coin.	½ rupee.
				VI		
		1219		<i>Peshwa renews lease of Ahmadābād to Gaikwar.</i>
38	M "	121-	𑂔 𑂔𑂔) These two coins are probably 1219-1220 of the same A.R. and are marked with an expression of joy at the renewal of the lease.
39	M "	122-	<i>id.</i>	
40	M "	1220	4-	as 23
41	M "	..	50	𑂔 𑂔	The die engravers rather overshoot the mark as Shāh 'Ālam II died in the 49th year of his reign.
42	M Akbar II	1227	6	𑂔 𑂔𑂔	The A.R. year is now correct. Note also the correcter 𑂔𑂔 for 𑂔.
43	M "	12--	7	<i>id.</i>
44	M "	1--	8	𑂔 𑂔𑂔 𑂔	All the 𑂔 is not visible on No. 44, but the mark is clear on No. 45 which is not given as it has no other mark of interest.

45	M
		..	1229	9	..	X	<i>Lease terminated with Gaikwar. Peshwa takes over Ahmadābād.</i>
46	T	..	1230	8	A.R. should be 9 or 10, probably 9.
47	M	9	..	1229 IX-1230 VII	
47a	M	9	Fulūs or paisā.
48	TM	..	1231	10	as 47
49	M	..	1232	1-	id.
49a	M	..	1232	10	½ rupee. A.R. should be 11 or 12, but probably 10.
t	M	..	1232	10	Fulūs or paisā. These marks are on the edge of the coin and not complete. The complete mark is clearly Ψ. Average weight 124 grs. (Subsequently verified from other coins in my cabinet).
		..	1232	VI	<i>Treaty of Poona signed. Peshwa restores Ahmadābād to Gaikwar.</i>
50	M	..	12--	11	..	1231 IX-1232 VIII	A H. is in all probability 1232.
		..	1232	XII	<i>Agreement made by Gaikwar with British Government to hand over Ahmadābād to latter.</i>
		..	1233	I	<i>Formal transfer of Ahmadābād to British Government.</i>
51	M	..	1233	11	A.R. should be 12 or 13, probably a copy of Gaikwar's coin.

	Emperor.	A.H.	A.R.	Period within which struck. Months in Roman figures.	Mint Mark.	REMARKS.
52	M Akbar II	11	<i>id.</i>	.. ½ rupee.
53	"	.. 1233	12	<i>id.</i>
53a	M	.. —3	12		Fulūs or pai (pie) A.H. probably 1233.
b	IMC	.. 1234	12	<i>id.</i>	Fulūs or paisā wt. 118-119 grs. A.R. should be 12 or 13.
c	M	.. 1234	13
d	M	.. 1235	14
e	TM	.. -236	14 A.R. should be 15 or 16, weight about 120 grs.
54	M	.. 1236	13	as 51	.. A.R. should be 15 or 16.
55	M	.. 12—	13	<i>id.</i>	.. ½ rupee.
56	M	.. 1239	15	<i>id.</i>	.. A.R. should be 18 or 19.
57	M	.. 1241	16	<i>id.</i>	.. A.R. should be 20 or 21.
58	M	.. 12—	16	<i>id.</i>	.. ½ rupee.
59	M	.. 1242	<i>id.</i>	.. A.R. should be 21 or 22—date for first time below the yā of Ghāzī.
60	M	.. 1242	<i>id.</i>	.. ½ rupee.
61	M	.. 1243	2—	<i>id.</i>



POST-MUGHAL COINS OF AHMĀDĀBAD

(the numbers correspond with those in the Appendix).

("Note" refers to the last paragraph of the Note at end of Appendix).

28



29



32



33



38



41



42



44



46



48



POST-MUGHAL COINS OF AHMĀDĀBAD
(the numbers correspond with those in the Appendix).

50



51



59



2a



Æ

2a (var)



Æ

47a



Æ

49b



Æ

53b



Æ

POST-MUGHAL COINS OF AHMĀDĀBAD
(the numbers correspond with those in the Appendix).

62	M	"	"	1243	<i>id.</i>	..	$\frac{1}{2}$ rupee.
63	M	"	"	1244	<i>id.</i>
64	M	"	"	1244	<i>id.</i>	..	$\frac{1}{2}$ rupee.
65	M	"	"	1248	28	<i>id.</i>
66	M	"	"	1248	<i>id.</i>	..	$\frac{1}{2}$ rupee.
67	M	"	"	1249	<i>id.</i>
68	M	"	"	1249	<i>id.</i>	..	$\frac{1}{2}$ rupee.
69	M	"	"	1250	<i>id.</i>	..	Mint still carried on.
70	M	"	"	1251	<i>id.</i>	..	Mint Daroga discharged. Mint apparently closed—this A.H. being coincident with 1835, 1836—when the Imperial coinage was introduced.

NOTE.—The coins are as far as possible representative of the period. Where two or more coins in different cabinets are similar only one number has been given to the type, but the names of the three cabinets from which the types have been drawn are given. IMC stands for Indian Museum (from Wright's catalogue), T for Dr. Taylor Ahmadābād, and M for myself. All coins quoted are rupees of the sicea standard weight (i.e. apparently just under 179 grs.) unless a mark is made to the contrary.

Copper coins are not given a separate serial number, but are distinguished by serial letters against the number of the silver coin bearing the date on which the series commenced.

In cases where the A.R. is erratic the months determining the period within which the coin was minted are not given. The dates of accession of the Emperor are taken from Dr. Taylor's article in Numismatic Supplement J.A.S.B. No. VI.

After drawing out the above list, the following coins have come to hand:—
Shāh 'Ālam:—āhad, 4, 15 (-1187), 16, 25, 26, 34 A.R. and one 1219 A.H. Their marks are the same as those of the years most nearly corresponding on the text. The coin of 1219 A.H. is as No. 33.

126. GUPTA GOLD COINS FOUND IN THE BALLIA DISTRICT.

[With Plate II.]

During the past few years a number of gold coins have been found by cultivators near a mound in the village of Kasarwa in tahsil and district Ballia. The fact having recently come to the notice of the district authorities, seventeen of the coins have been recovered and sent to the Government of the United Provinces by whom they have been acquired for the Lucknow Museum.

All the coins are of the time of Samudra Gupta and are of the following types :—

Aśwamedha	3
Javelin, variety α	10
Javelin, variety γ	2
Battleaxe	1
Kācha	1

The classification adopted is that of Mr. V. A. Smith in "The Coinage of the early or Imperial Gupta Dynasty," J.R.A.S., 1889.

AŚWAMEDHA.

Obverse.

1. Horse standing left facing a pole. The horse has a band or collar with a boss on the near shoulder. The pole is adorned with long streamers above and small streamers on each side. *Si* below the horse. There is no pedestal and no sign of pavement.

Right margin .. *Rājādhirājā prīti* . . .

Left margin . . t.v.j.māh.

A .85 in., 117 grs.

This coin differs in general appearance from the ordinary type of Aśwamedha. The horse is shaped differently and the collar is more on the shoulder than the neck. The female figure on reverse is more attenuated than usual. I am unable to suggest an interpretation of the obverse legend which is distinctly $\overline{\text{H}}$ Δ E V —

Mr. John Allan of the British Museum informs me that Dr. Hoey, I.C.S., retired, has a similar coin, the legend of which has not been read.

2. Horse as in the usual type. Low pedestal under "*si*." Legend missing.

Female figure. The post has streamers on one side only as usual.

A .8 in., 119 grs. (has been ringed).

This coin has apparently been struck from the same die as that figured as No. 3, Plate XIV of the Indian Museum Catalogue.

3. Similar to No. 2, but with a higher pedestal under the "si" and legend . . *ja pṛithivīm* in right margin.

Similar to 2.

A .8 in., 120 grs. (has been ringed).

JAVELIN, var. a.

These ten javelin coins are of the common variety; but they present a number of small differences in the arrangement of the legend, the absence or presence of streamers to the standard and javelin and in the dress of the king.

4. King left with javelin, altar and garuda standard as usual. Samudra under left arm. The javelin is adorned with streamers. The standard has streamers and no staff.

Throned goddess and inscription *parākramah* as usual. Mon. No. 8 of Plate XVIII of the Indian Museum Catalogue. Above cornucopiae Δ . The throne shows two legs only.

Right margin . . *Samara śa*.

Left margin . . *vijayo j*.

A .85 in., 118 grs.

5. Similar but with staff and no streamers to garuda standard.

Similar but Mon. No. 9.

Right margin . . *Samara śata v*.

Left margin . . *ta vijayo jīt*.

A 8 in., 117 grs.

6. As No. 5.

Right margin . . *Samara śata vitata*.

Left margin

As No. 4, but Mon. No. 2 and mark No. 47 of the same plate above cornucopiae.

A 8 in., 116 grs.

7. As No. 5, but with streamers neither to javelin nor standard. The javelin head at base of coin is very clearly shown.

As No. 4, but the throne shows four legs and a back. Mon. No. 9 and no mark over cornucopiae.

Right margin . . *Samara śata vit*.

Left margin . . *jayo j*.

A .8 in., 120 grs. (has been ringed).

8. As No. 4, but with long staff and no streamers to garuda standard and a crescent above. The ring does not show the usual long ear-rings, but has a headdress covering the ears.

As No. 4, but the throne shows three legs and has a back. Mon. No. 29.

Right margin . . *Samara śata vit.* .

Left margin . . *tar.* .

A .8 in., 115 grs. (has been ringed).

9. As No. 4, but with long staff and no streamers to standard.

Right margin . . *Samara śata ritata v.*

Left margin . . *yo jitari puro. ru (?)*.

There is apparently a **†** above the garuda, which does not fit in any known legend

A .8 in., 117 grs.

10. As No. 4, but with long staff to standard and the king wears a long coat coming down almost to his knees in front.

Right margin . . *Samara śata vitata.*

Left margin . . *jitari.*

A .85 in., 117 grs.

11. As No. 4, but no streamers to standard and with the marginal legend beginning on the opposite margin.

Left margin . . *mara śata vita.*

Right margin . . *ta vijayo j.* .

A 85 in., 117 grs.

12. As No. 5, but with legend arranged as No. 11. Javelin head shown distinctly.

Left margin . . *mara śata vitata vijayo.*

Right margin

A .8 in., 118 grs.

13. As No. 12, but with long staff to standard.

Left margin . . *Samara śata.*

Right margin . . *vitata vijay.* .

There is space for several letters and apparently the remains of one immediately before *vitata*.

A .85 in., 116 grs.

As No. 4, but the throne shows four legs. Mon. No. 2 and no mark over cornucopiae.

As No. 4, but with mark **Λ** over cornucopiae and a back to the throne.

As No. 4, but Mon. No. 29.

As No. 4, but throne shows four legs and Mon. is No. 29.

As No. 12.



OBV .

1.



REV .



8. OBV .



9. OBV .



10. OBV .



OBV .

16.



REV .



17. REV .



1. OBV .



2. OBV .



3. OBV .



4. REV .

I. GUPTA GOLD COINS. ART. 126.

II. NEPALESE WAR MEDALS, ART. 128.

JAVELIN, var. γ .

14. Usual type of standing king with javelin at altar. Short staff to standard. No streamers to staff of standard or javelin. Crescent or tail of a letter over the garuda.

Samudra to left of javelin.

Guptā to right of javelin.

Left margin . . *ara śata*.

Right margin . . *tata vijay*.

A .8 in., 117 grs.

Usual throned goddess.

Throne shows two legs and a back. Mark Δ over cornucopiae.

Mon. No. 2.

15. As No. 14.

Left margin *Samara śata vitata*.

Right margin . .

A .75 in., 115 grs.

As No. 14, but no mark over cornucopiae.

On 14 and 15 both in name and inscription the m takes the form 𑀘 instead of 𑀙 as in variety *a*.

BATTLEAXE.

16. King left grasping battle-axe in left hand. Right hand on hip. Wearing a dagger on left side. Small male figure and crescent-headed standard on left . . . between the two figures. *Samudra* under left arm. Marginal legend fragmentary.

A .75 in., 117 grs.

Goddess on four-legged throne with cornucopiae. The footstool is not the lotus as figured in J.R.A.S. 1889, Plate I, No. 11, but is more like that of the javelin type, Mon. No. 2. No mark over cornucopiae. Legend which follows the margin is as usual *kṛitānta paraśu*.

The King also wears a dagger in the specimen figured in the Indian Museum Catalogue and apparently also in the one figured by Mr. Burn in "A Find of Gupta Gold Coins", Numismatic Chronicle, Fourth Series, Vol. X. The coins figured by Mr. V. A. Smith in his "Coinage of the early or Imperial Gupta Coinage" show no dagger.

KACHA.

17. Usual type of king at altar with solar standard. *Kācha* under left arm.

Left margin *Karmabhir attamair*.

Right margin . .

A .8 in., 119 grs. (has been ringed.)

Standing goddess with inscription *Sarvarājochchettā* as usual.

Mon.



W. E. M. CAMPBELL.

127. LIST COMPLEMENTARY TO MR. WHITEHEAD'S "MINT TOWNS OF THE MUGHAL EMPERORS OF INDIA."

Since the publication in 1908 of Mr. Nelson Wright's Volume III of the "Catalogue of the Coins in the Indian Museum", with its invaluable introduction, no more important contribution has been made to Indian Numismatics, and none could be more welcome than the list, recently issued by the Asiatic Society of Bengal, of "the Mint Towns of the Mughal Emperors of India." By the preparation of this list Mr. Whitehead has laid all coin-collectors in this country under a deep debt of obligation, for evidently he has spared no pains to ensure that it should be as complete and accurate a list as possible. The material to be explored in order to the production of so extensive a Coin-Register, running as it does into a hundred pages, was sufficiently formidable, but Mr. Whitehead has fulfilled his self-appointed task with admirable courage and patience.

The entries, as now arranged, reveal, and at a single glance, for each mint the metals, gold or silver or copper, in which coins were struck by each of the Emperors, and also indicate some one cabinet in which a specimen of each coin registered is to be found to-day.

The list of twenty-seven Emperors (claimants included) is noteworthy as containing for the first time the name of 'Azīmu-sh-shān, son of Shāh 'Ālam Bahādur and father of Farrukh-siyar; and all who have read Mr. Whitehead's convincing article (No. 103) in Numismatic Supplement No. XX will, I am confident, approve of the inclusion of this name. On the other hand, the name of Nikū-siyar no longer has a place in the list, and, inasmuch as no coin of his is known, the omission is, for the present at least, free from objection. A fortunate "find" however, may some day warrant the reinsertion of Nikū-siyar's name, for Khāfī Khān in his *Muntakh-abu-l-Lubāb* definitely states, "His accession was announced by peals of cannon, and coins of gold and silver were struck in his name."¹

The order adopted in the list of the Emperors is unusual, and will, I fear, fail to win absolute approval. No. 9 Murād Bakhsh and No. 10 Shāh Shujā' should surely come before No. 8 Aurangzeb 'Ālamgīr rather than before No. 11 Shāh 'Ālam Bahādur. Similarly both No. 12 A'zam Shāh and No. 13 Kām Bakhsh should precede, not follow, No. 11 Shāh 'Ālam Bahādur. Also, even though the 'Azīmu-sh-shān rupee was in all probability struck by Farrukh-siyar's orders, it should, chronologically considered, stand before rather than after Jahāndār's coins, and hence in the list Nos. 14 and 15

¹ Dowson's *Elliot*, Vol. VII, page 482.

might with advantage change places. Then the Mints, too, Sitpūr and Sīkākul, should come after Sahrind instead of after Shergarh.

In the coin-entries I have noticed only one serious omission. The well-known coins struck both in silver and in copper by Murād Bakhsh at the Sūrāt mint have been overlooked. I would, accordingly, suggest that B.M. be inserted in the *Æ* column, and I (Roman numeral) in the *Æ* column.

On the coins Muṣṭafa-ābād is written *سب* *عبد* with *ب*, not with *ت*. Bahādurpattan, Chīnāpattan, and Machhlipattan should, all of them, when transliterated, have a "double t," also Ujjain a "double j," unless the immediately preceding vowel be lengthened.

Mr. Whitehead's list shows *for each mint* the reigns during which it was active. It hence became a very simple matter to prepare a Complementary List that should exhibit *for each reign* its active mints and their metals. I have pleasure in now supplying such a list, in the hope that it too may at times prove of use to my fellow coin-collectors.

G. P. TAYLOR.

List exhibiting for each Reign its active Mints and their Metals.

Emperor.	MINT.		
	<i>Æ</i>	<i>Æ</i>	<i>Æ</i>
1. BĀBUR Total number of Mints: 7; of these the Mints issuing coins— in gold were <i>nil</i> , in silver were 7, and in copper were 1.		Urdū Āgra Tatta Jaunpūr Kābul Lāhor Lakhnau	Āgra
2. HUMĀYŪN Total: 9. Gold: <i>nil</i> . Silver: 7. Copper: 7.		Ujjain Āgra Champānīr Dehlī Qandahār Kābul Lāhor	Āgra Jaunpūr Champānīr Dehlī Qandahār Lāhor Mandū
3. ĀKBAR Total: 78.			Atak Banāras Ajmer

Emperor.	MINT.		
	<i>N</i>	<i>R</i>	<i>E</i>
Gold : 18. Silver : 39. Copper : 60.	Ahmadābād Udaipur Urdū Urdū zafar qarīn. Asīr Akbar-nagar Agra	Ujjain Ahmadābād Ahmadnagar Urdū Urdū Z. Q. Akbarpūr Tānda Akbar-nagar Agra Alwar Ilahābād Elichpūr Bālāpūr Bāndhū Burhānpūr Bangāla Bhakkar Bairāta Pattan Patna Tatta Jaunpūr Chunār Hiṣār Hiṣār Fīroza Dehlī Dewal Bandar Srinagar Sūrat (?)	Ajmer Salīmābād Ujjain Ahmadābād Urdū Z. Q. Akbarpūr Akbarpūr Tānda Akbar-nagar Agra Alwar Ilahābas Amīrkoṭ Khīṭa Awadh Budāon Burhānpūr Bandar Shāhī Bahrāich Bhakkar Bairāta Pattan Patna Jaiālpūr Jalālnagar Jaunpūr Chunār Chītor Hiṣār Hiṣār Fīroza Khairābād Khairpūr Dogāon Dehlī Sironj Srinagar Salīmābād Sambhal Sahāranpūr Sahrind Shāhgarh Qanauj Sherpūr
	Sahrind		

Emperor.	MINT.		
	<i>N</i>	<i>R</i>	<i>E</i>
	Fathpūr	Shergarh Sītpūr Fathpūr Kābul Kālpī	Fathpūr Kābul Kālpī
	Kashmīr		Kalānūr Korā Kiratpūr
		Gadraula	Gwāliār Gobindpūr Gorakpūr Gohad
	Lāhor	Lāhor	Lāhor Lakhnau
	Mālpūr	Lahrī Bandar Mālpūr	Mālpūr Mānikpūr Mānghar Madan Kot
		Multān	Multān Mīrtha Nārnol
4. JAHĀNGĪR	Ajmer	Nārnol Ajmer Ujjain	Ajmer
Total : 30.	Aḥmadābād	Aḥmadābād	Aḥmadābād
Gold : 14.	Aḥmadnagar	Aḥmadnagar	Aḥmadnagar
Silver : 27.	Urdū		Udaipūr
Copper : 9.		Urdū dar rāh-i- dakhan.	
	Āgra	Akbarnagar Āgra	Āgra
	Burhānpūr	Ilahābād Elichpūr Burhānpūr	
	Patna	Bairāta Patna Panjnagar	Bairāta
	Jahāngīrnagar	Tatta Jālnapūr Jaler	
	Dehlī	Jahāngīrnagar Dehlī Ruhtās	Dehlī
		Sūrat	Sūrat
	Fathpūr	Zafarnagar Fathpūr	
	Qandahār	Qandahār Kābul Katak	Kābul

Emperor.	MINT.		
	₹	₠	₡
	Kashmīr Lāhor Mandū	Kashmīr Lāhor	
5. JAHĀNGĪR AND NŪR JAHĀN Total : 6. Gold : 3. Silver : 6. Copper : nil.	Aḥmadābād Sūrat Lāhor	Aḥmadābād Akbarnagar Āgra Patna Sūrat Lāhor	
6. DĀWAR BAKHSĤ Total : 1. Gold : nil. Silver : 1. Copper : nil.		Lāhor	
7. SHĀH JAHĀN I Total : 41. Gold : 23. Silver : 35. Copper : 15.	Ujjain Aḥmadābād Akbarābād Akbarnagar Āgra Ilahābād Burhānpūr Balkh Bhīlsa Pattan Deo Patna Tatta Jahāngīrnagar Daulatābad Sūrat Shāhjahānābād	Ajmer Ujjain Aḥmadābād Aḥmadnagar Urdū Z. Q. Akbarābād Akbarnagar Āgra Ilahābād Aurangnagar Burhānpūr Bhakkār Bhīlsa Pattan Deo Patna Peshāwar Tatta Jūnagarh Jahāngīrnagar Daulatābād Dehlī Sūrat Shāhjahānābād Zafarābād Zafarnagar Fathpūr Qandahār	Ujjain Aḥmadābād Udaipūr Akbarābād Ilahābād Elichpūr Bairāta Patna Dogāon Dehlī Sūrat Shāhjahānābād

Emperor.	MINT.		
	N	R	Æ
	Kābul	Kābul	
	Kashmīr	Katak	Kashmīr
	Kambāyat	Kashmīr	
	Gulkanda	Kambāyat	
	Lāhor	Gulkanda	
	Lakhnau	Lāhor	Lakhnau
	Multan	Lakhnau	
		Multān	Nārnol
8. AURANGZEB	Itāwa	Itāwa	
‘ĀLAMGĪR	Ajmer	Ajmer	
Total : 72.	Ujjain	Ujjain	Ujjain
Gold : 40.	Aḥsanābād	Aḥsanābād	
Silver : 70.	Aḥmadābād	Aḥmadābād	Aḥmadābād
Copper : 24.	Aḥmadnagar	Aḥmadnagar	
	Islāmābād	Adonī	
		Islāmābād	
		Islām Bandar	
	Akbarābād	Aḥmadnagar	Aḥmadnagar
	Akbarnagar	Akbarābād	Akbarābād
	Ilahābād	Akbarnagar	Akbarnagar
		Ilahābād	
	Aurangābād	Imtiyāzgarh	
		Aurangābād	Aurangābād
	Burhānpūr	Elichpūr	Elichpūr
		Burhānpūr	Burhānpūr
		Barelī	
		Bankāpūr	
		Bhakkar	
		Bhīlsa	
	Bījāpūr	Bījāpūr	Bījāpūr
			Bairāta
	Patna	Patna	
		Purbandar	
		Pūnch	
		Peshāwar	
	Tatta	Tatta	
	Toragal	Toragal	
		Jinjī	
	Jaunpūr	Jaunpūr	
		Jūnagarh	
	Jahāngīrnagar	Jahāngīrnagar	
	Chīnāpattan	Chīnāpattan	
	Haidarābād	Haidarābād	Haidarābād
	Khujista Bunyād	Khujista Bunyād	
		Khairnagar	
		Ranthor	
		Sāmbhar	
	Sūrat	Sūrat	Sūrat
		Sahāranpūr	
		Sahrind	

Emperor.	MINT.		
	A	Æ	Æ
	Shāhjahānābād Sholāpūr Zafarābād Zafarpūr 'Ālamgīrpūr 'Azīmābād Kābul Katak	Shāhjahānābād Sholāpūr Zafarābād Zafarpūr 'Ālamgīrpūr 'Azīmābād Kābul Katak Karpā Karīmābād Kashmīr Kambāyat Gulbarga Gulkanda Gwāñār Gūtī	Shāhjahānābād Sholāpūr 'Azīmābād Kābul Katak Gulbarga Lāhor Lakhnau Machhlīpattan
	Lāhor Muḥammadābād Murshidābād Multān Malikanagar Nuṣratābād	Lāhor Lakhnau Machhlīpattan Muḥammadābād Maḥmūd Bandar Makḥṣūṣābād Murādābād Murshidābād Mu'azzamābād Multān Mailāpūr Nārnol Nuṣratābād	Lāhor Lakhnau Machhlīpattan Sūrat
9. MURĀD BAKḤSH Total: 3. Gold: 2. Silver: 3. Copper: 1.	Aḥmadābād Kambāyat	Aḥmadābād Kambāyat Sūrat	Sūrat
10. SHĀH SHUJĀ'. Total: 1. Gold: nil. Silver: 1. Copper: nil.		Akbarnagar	
11. SHĀH 'ĀLAM BAHĀDUR. Total: 51. Gold: 19. Silver: 49. Copper: 12.	Itāwā Ujjain	Itāwā Ajmer Ujjain Aḥsanābād Aḥmadābād Aḥmadnagar Arkāt	Aḥmadābād Aḥmadnagar

Emperor.	MINT.		
	A	Æ	Æ
	Akbarābād	Akbarābād Akbarnagar Ilahābād Imtiyāzgarh Ausā	Akbarnagar
	Burhānpūr	Elichpūr Burhānpūr Barelī Bankāpūr Bahādurgarh Bijāpūr Purbandar	Elichpūr Bijāpūr
	Peshāwar Tatta Toragal	Peshāwar Tatta Toragal Jūnagarh Jahāngīrnagar Chīnāpattan	Jahāngīrnagar
	Haidarābād Khujista Bunyād Sūrat	Haidarābād Khujista Bunyād Sūrat Sahrind	Haidarābād Sūrat
	Shāhjahānābād	Shāhjahānābād Sholāpūr	Shāhjahānābād Sholāpūr
	Sikākul		
	‘Azīmābād Fīrozgarh	‘Ālamgīrpūr ‘Azīmābād Fīrozgarh Fīroznagar Kābul Karīmābād Kashmīr	
	Kambāyat	Kambāyat Gūtī	Kambāyat
	Lāhor	Lāhor Lakhnau	
	Muhammadābād	Muhammadābād Murādābād Murshidābād	Machhlipattan
	Multān Mailāpūr	Multān Mailāpūr Nārnol Nuṣratābād	
12. A‘ZAM SHĀH.		Ujjain	
Total: 6		Aḥmadābād	
Gold: 3.	Aḥmadnagar	Aḥmadnagar	
Silver: 6.	Burhānpūr	Burhānpūr	
Copper: nil.	Khujista Bunyād	Khujista Bunyād Sūrat	

Emperor.	MINT.		
	A	R	Æ
13. KĀM BUKHSĪH. Total: 7. Gold: 1. Silver: 7. Copper: <i>nil.</i>	Haidarābād	Aḥsanābād Bijāpūr Toragal Haidarābād Gulbarga Gokulgarh (S. India) Nuṣratābād	
14. JAHĀNDĀR SHĀH. Total: 33. Gold: 9. Silver: 30. Copper: 4.	Itī wa Akbarābād Burhānpūr Khujista Bunyād Sūrat Shāhjahānābād Gulbarga Gwāliār Mu'azzamābād	Itāwā Ajmer Ujjain Aḥmadābād Aḥmadnagar Arkāt Akbarābād Akbarpūr Akbarnagar Elichpūr Burhānpūr Barelī Bahādurgarh Bhakkār Bijāpūr Peshāwar Tatta Haidarābād Khujista Bunyād Sūrat Sahrind Shāhjahānābād Fathābād Dhārūr Karārābād Kambāyat Gwāliār Lāhor Lakhnau Murshidābād Multān	Aḥmadābād Bijāpūr Sūrat Kābul
15. 'AZĪMU-SH- SHĀN. Total: 1. Gold: <i>nil.</i> Silver: 1. Copper: <i>nil.</i>		Jahāngīrnagar	

Emperor.	MINT.		
	Æ	℞	Æ
16. FARRUKH-SIYAR. Total: 57. Gold: 28. Silver: 50. Copper: 8.	Itāwā	Itāwā	
	Ajmer	Ajmer	
	Ujjain	Ujjain	
		Aḥmadābād	Aḥmadābād
		Aḥmadnagar	Aḥmadnagar
	Arkāt	Arkāt	
	Islāmābād	Islāmābād	
		A'zamnagar	
		A'zamnagar Go-	
		kulgarh	
	Akbarābād	Akbarābād	Akbarābād
		Akbarnagar	
	Ilahābād	Ilahābād	
	Imtiyāzgarh	Imtiyāzgarh	
		Aurangnagar	
		Elichpūr	
	Burhānpūr	Burhānpūr	
	Barelī	Far-lī	
		Bankāpūr	
		Bahādurgarh	
	Bhakkar		
Bijāpur		Bijāpur	
Patna			
Purbandar	Purbandar		
Peshāwar	Peshāwar		
	Tatta		
	Toragal		
	Jūnagarh		
	Jahāngīrnagar		
	Chīnāpattan		
Haidarābād	Haidarābād		
Khujista Bunyād	Khujista Bunyād		
	Sīronj		
	Sa'dnagar		
Sūrat	Sūrat	Sūrat	
Sahrind	Sahrind		
Shāhjahānābād	Shāhjahānābād		
Sikākul		Sholāpūr	
	'Ālamgīrpūr		
'Azīmābād	'Azīmābād		
	Fathābād 'Iharūr		
	Farrukhābād		
	Kābul	Kābul	
	Katak		
	Kaārābād		
Kashmīr	Kambāyat		
	Gulshanābād		
	Gwāliār		
Gūtī	Lāhor		
Lāhor	Lakhnau		

Emperor.	MINT.		
	A	R	Æ
	Machhlipattan Murshidābād Mu'azzamābād Multān	Machhlipattan Murshidābād Multān Mumbai	Machhlipattan
17. RAFI'U-D- DARJĀT. Total : 22. Gold : 10. Silver : 20. Copper : 1.	Ahmadābād Akbarābād	Itāwā Ajmer Ujjain Ahmadābād Akbarābād Burhānpūr Barelī Patna	
	Peshāwar Khujista Bunyād Sūrat	Khujista Bunyād Sūrat Sahrind	Sūrat
	Shāhjahānābād Kābul	Shāhjahānābād Kābul Korā Kambāyat Gwāliār	
	Lāhor	Lāhor Lakhnau Murshidābād	
	Mu'azzamābād Multān	Multān	
18. RAFI'U-D- DAULA (SHĀH JAHĀN II). Total : 25. Gold : 9. Silver : 22. Copper : 2.	Ujjain	Itāwa Ajmer	
	Arkāt	Ahmadābād	
	Akbarābād Burhānpūr	Islāmābād Akbarābād Burhānpūr Barelī Tatta Jūnagarh	Akbarābād
	Haidarābād Khujista Bunyād Sūrat	Khujista Bunyād Sūrat Sahrind	Sūrat
	Shāhjahānābād	Shāhjahānābād 'Azīmābād Korā Kambāyat Gwāliār	

Emperor.	MINT.		
	A	R	Æ
	Lāhor	Lāhor Lakhnau Murshidābād Multān Mumbai	
19. MUḤAMMAD IBRĀHIM. Total : 1. Gold : 1. Silver : 1. Copper : nil.	Shāhjahānābād	Shāhjahānābād	
20 MUḤAMMAD SHĀH. Total : 61. Gold : 35. Silver : 56. Copper : 10.	Itāwā	Itāwā	
	Ujjain Aḥmadābād Arkāt Islāmābād	Atak Ajmer Ujjain Aḥmadābād Arkāt Islāmābād A'zamnagar Go- kulgarh Akbarābād Akbarnagar Ilahābād	Aḥmadābād
	Akbarābād	Akbarābād Akbarnagar Ilahābād	
	Ilahābād Imtiyāzgarh Akhtarnagar Awadh Aurangābād	Akhtarnagar Awadh	
	Bālāpūr Burhānpūr	Ausā Elichpūr	Elichpūr
	Banāras (Muḥ)	Burhānpūr Barelī Balwantnagar Banāras (Muḥ) Bhakkar Purbandar	Bhakkar
	Peshāwar Tatta	Peshāwar Tatta Jūnagarh Jahāngīrnagar	
	Jaipūr	aipūr Chīnāpattan	Hāfizābād
	Haidarābād Khujista Bunyād	Haidarābād Khujista Bunyād Derajāt Zainu-l-bilād Satārā Sironj	

Emperor.	MINT.		
	A	Æ	Æ
21. AHMAD SHAH BAHADUR Total : 45. Gold : 15. Silver : 42. Copper : 2.	Sind		
	Sūrat	Sūrat	Sūrat
	Sahrind	Sahrind	
	Shāhābād	Shāhābād Qanauj	
	Qanauj		
	Shāhjahānābād	Shāhjahānābād	Shāhjahānābād
		Sholāpūr	
		'Alamgīrpūr	
	'Azīmābād	'Azīmābād	
	Farrukhābād	Farrukhābād	
		Fīroznagar	
		Qamarnagar	
		Qandahār (S. India)	
	Kābul	Kābul	Kābul
	Katak	Katak	
	Kashmīr	Kashmīr	Kashmīr
	Korā	Korā	
		Kambāyat	
	Gwāliār	Gwāliār	
	Lāhor	Lāhor	
		Lakhnau	
Machhlīpattan	Machhlīpattan	Machhlīpattan	
Murshidābād	Murshidābād		
Mu'azzamābād	Mu'azzamābād		
Multān	Multān	Multān	
	Mumbai		
Itāwā	Itāwā		
	Ajmer		
	Ahmadābād		
	Arkāt		
Islāmābād	Islāmābād		
Akbarābād	Akbarābād		
	Akbarnagar		
	Ilahābād		
	Imtiyāzgarh		
		Elichpūr	
Burhānpūr	Burhānpūr		
	Bareīlī		
	Balwantnagar		
Banāras (Muh)	Banāras (Muh)		
	Bhakkar		
		Peshāwar	
	Toragal		
	Jodhpūr		
	Jahāngīrnagar		
Jaipūr	Jaipūr		
	Khujista Bunyād		
Dera	Dera		
Derajāt	Derajāt		
	Sūrat		

Emperor.	MINT.		
	A	R	Æ
	Sahrind	Sahrind	
	Shāhjahanābād	Shāhābād Qanauj Shāhjahanābād	
	‘Azīmābād	Sikākul	
	Farrukhābād	‘Azīmābād Farrukhābād	
		Kālpī	
		Katak	
		Kashmīr	
		Korā	
		Kambāyat	
		Gwāliār	
	Lāhor	Lāhor	
	Mujāhidābād		
		Machhlīpattan	
		Murādābād	
		Murshidābād	
	Multān	Multān	
		Mumbai	
		Mahindrapūr	
		Narwar	
22. ‘ĀLAMGĪR II.	Itāwā	Itāwā	
Total : 52.		Ajmer	
Gold : 16		Ujjain	
Silver : 50.		Aḥmadābād	
Copper : 6.	Arkāt	Arkāt	
	Islāmābād	Islāmābād	
	Akbarābād	Akbarābād	
		Akbarnagar	
		Ilahābād	
	Imtiyāzgarh	Imtiyāzgarh	
		Aurangnagar	
		Ausā	
		Elichpūr	
		Burhānpūr	
	Barelī	Bare.ī	
		Bikānīr	
		Balwantnagar	
	Banāras (Muh)	Banāras (Muh)	
		Bharoch	
		Jodhpūr	
		Jahāngīrnagar	
	Jaipūr	Jaipūr	
		Khujista Bunyād	
		Dilshādābād	
		Dera	
		Sironj	
		Sūrat	
			Hāfizābād

Emperor.	MINT.		
	A	Æ	Æ
	Sahrind	Sahrind	
	Shāhjahānābād	Shāhābād Qanauj Shāhjahānābād Zafarābād ‘Azīmābād	Shāhjahānābād
	Farrukhābād (Aḥmadnagar)	Farrukhābād Farrukhābād (Aḥmadnagar)	
		Kābul Kālpī Kashmīr Kalkatta	
	Korā		
		Kambāyat Gwāljār	
	Lāhor	Lāhor Machhlipattan Murādābād	Lāhor Machhlipattan
	Multān	Murshidābād Multān	
	Mahindrapūr	Mumbai Mahindrapūr	Mahindrapūr
	Najibābād	Nāgor Najibābād Narwar	Najibābād
		Aḥmadābād	
23. SHĀH JAHĀN			
III.			
Total: 9.	Islāmābād		
Gold: 5.		Akbarābād	
Silver: 8.		Sūrat	
Copper: nil.		Shāhābād Qanauj	
	Shāhjahānābād	Shāhjahānābād	
	‘Azīmābād	‘Azīmābād	
	Farrukhābād (Aḥmadnagar)	Farrukhābād (Aḥmadnagar)	
	Mahindrapūr	Mahindrapūr	
24. SHĀH ‘ĀLAM			
II.		Itāwā	
Total: 87.	Ajmer	Ajmer	
Gold: 19.		Ujjain	
Silver: 75.		Aḥmadābād	Aḥmadābād
Copper: 35.		Arkāt	Arkāt
	Islāmābād	Izlāmābād	Islāmābād
		Isma‘ilgarh	Isma‘ilgarh
	Akbarābād	Akbarābād	Akbarābād
			Akbarpūr
		Ilahābād	
		Anūpnagar Shā- hābād	
	Awadh Sūba		

Emperor.	MINT.		
	A	Æ	Æ
		Orchha Aurangnagar Ānwala	Orchha
		Bālānagargadhā Braj Indrapūr Baroda Burhānpūr Bareli Bareli Āṣafābād Bisaulī	Elichpūr Baroda Burhānpūr Bareli
Burhānpūr		Balwantnagar Banāras (Muh)	Banāras (Muh) Bindraban
Banāras (Muh)		Bindraban Mū- minābād	
Bahādurpattan		Bharatpūr Bhopāl Pānīpāt Jammūn Jodhpūr	Bharatpūr
		Jahāngīrnagar Jaipūr Chhatarpūr	Jhānsī Jaipūr
Jaipūr		Ḥasanābād Dilshādābād Daulatābād Deogarh Ravishnagar Sāgar	Chhachraulī Ḥasanābād Dādar Dāmla Dilshādābād Daulatābād
		Sironj Srīnagar (in Garh- wāl)	
Sūrat		Sūrat Sahāranpūr Shāhābād Qanauj Shāhjahānābād	Sahāranpūr Shahjahānābād
Shājahānābād Zafarābād 'Azīmābād		'Azīmābād Farrukhābad Farrukhābād (Aḥmadnagar)	
Farrukhābād (Aḥmadnagar)		Firoznagar Kālpī	Farrukhnagar
		Katak	Kānān

Emperor.	MINT.		
	A	Æ	Æ
		Kalkatta Korā Kūnch Gwāliār Gokulgarh Gohad	Kalkatta Gwāliār Gohad
	Mathurā Islāmābād	Mathurā Islāmābād Machhlipattan Muhammadnagar Murādābād	Mathurā Islāmābād Machhlipattan
	Murshidābād	Murshidābād Muṣṭafa-ābād Muzaffarnagar Mulhārnagar	
	Mumbai	Mumbai Mandisor Mūngīr	
	Mahindrapūr	Mahindrapūr Mahisor Nāgor	Mahindrapūr
	Najafgarh Najībābād	Najafgarh Najībābād Narwar Nasrullanagar Hāthras Hānsī Şāhibābād Hardwār	Najafgarh Najībābād Narwar
25. BEDAR BAKHT.	Aḥmadābād	Aḥmadābād	Aḥmadābād
Total : 2. Gold : 2. Silver : 2. Copper : 1.	Shāhjahānābād	Shāhjahānābād	
26. AKBAR II	Shāhjahānābād	Shāhjahānābād	Shāhjahānābād
Total : 1 Gold : 1 Silver : 1. Copper : 1.			
27. BAHĀDUR II		Shāhjahānābād	
Total : 1. Gold : nil. Silver : 1. Copper : nil.			

Appendix showing for each reign the total number of Mints known to have been working, also showing how many of these Mints issued coins in Gold, how many in Silver, and how many in Copper.

Emperor.	Total.	A	Æ	Æ
1. Bābur	7	..	7	1
2. Humāyūn	9	..	7	7
3. Akbar	78	18	39	60
4. Jahāngīr	30	14	27	95
5. Jahāngīr and Nūr Jahān	5	3	6	..
6. Dāwar Bakhsh	1	..	1	..
7. Shāh Jahān I	41	23	35	15
8. Aurangzeb 'Ālamgīr	72	40	70	24
9. Murād Bakhsh	3	2	3	1
10. Shāh Shujā'	1	..	1	..
11. Shāh 'Ālam Bahādūr	51	19	49	12
12. A'zam Shāh	6	3	6	..
13. Kām Bakhsh	7	1	7	..
14. Jahāndār Shāh	33	9	30	4
15. 'Azīmu-sh-shān	1	..	1	..
16. Farrukhsiyar	57	28	50	8
17. Rafī'u-d-darjāt	22	10	20	1
18. Rafī'u-d-daula Shāh Jahān II	25	9	22	2
19. Muḥammad Ibrāhīm	1	1	1	..
20. Muḥammad Shāh	61	35	56	10
21. Ahmad Shāh Bahādūr	45	15	42	2
22. 'Ālamgīr II	52	16	50	6
23. Shāh Jahān III	9	5	8	..
24. Shāh 'Ālam II	87	19	75	3
25. Bedār Bakht	2	2	2	1
26. Akbar II	1	1	1	..
27. Bahādūr II	1	..	1	1

128. NEPALESE WAR MEDALS.

[With Plate II.]

I recently received in a parcel of coins from Katmandu the following medals which possibly have not been published:—

1. *Obverse.* A small shield with four bosses, surrounded by the inscription: "Sri 3 Maharaja Jang Bahadur, Rajdal Paltan."

Reverse. A trisul formed of the sword (khadg) and skull necklace (mundmal) of Kali surrounded by the inscription "1912 sal ma Gurkha Sarkar bata Bhot fateh."

2. *Obverse.* As No. 1 but "Chhass Kamini Paltan."

Reverse as before.

3. *Obverse.* As No. 1 but "Kali Bahadur paltan."

Reverse as before.

The campaign against Tibet was undertaken by Maharaja Sir Jang Bahadur in the spring of 1855 ostensibly only to obtain redress for continuous outrages on Nepalese traders: but really also to recover territory to the south of the trade centres of Kerang and Kuti, which it was alleged the Chinese had taken from Nepal in former times.

After some hard fighting the Tibetans were forced to sue for peace. A treaty was concluded on the 24th March, 1856. Prisoners were exchanged, the trade and other grievances of Nepal were redressed, and Tibet agreed to pay an annual tribute of Rs. 10,000: but ceded no territory. Nepal had found that to insist on the cession of territory would embroil her with China, whose suzerainty both countries recognized in the treaty.

According to the life of the Maharaja written by his son General Padma Jang Bahadur, Jang Bahadur held a review of the victorious troops on the 20th April, 1856, and granted two months' leave to each soldier and officer. On their return to duty medals and rewards were bestowed.

The pieces described show that different medals were struck for each regiment. The regiments named still exist in the Nepalese army. The "Rajdal" is "The King's Own"; the other two are named after their patron goddesses.

W. E. M. CAMPBELL.

129. ON TWO FINDS OF BAHMANI COINS.

I recently examined for the Central Provinces Government two finds of Bahmani copper coins from the Bhandāra District, one consisting of 196, and the other of 600 coins. In the former only ten coins were indecipherable; of the remaining 186, 184 were of the reign of Ahmad Shāh II and of no particular interest. One new date, 839 A.H. for I.M.C. No. 29 was among them. The remaining two coins were, curiously enough, of Nizām Shah—one dated 867 was Codrington Num. Chron., 1898, No. 2, and the other was Codrington No. 4.

The find of 600 coins was more interesting but in far worse preservation, the coins being largely corroded together. Two hundred and six were quite worthless. Among the remainder were examples of all the Bahmani Kings from Ahmad Shāh I to Kalīm-ullah, with the exception of three, whose coins are probably unknown. The coins must therefore have been concealed in the troublous times when the last Bahmani was a puppet in the hands of Amīr Barīd, who shortly afterwards assumed the sovereignty of Bīdar. The different kings are represented as follows: Ahmad Shāh I (2), Ahmad Shāh II (102), Humāyūn Shāh (25), Nizām Shāh (1), Muḥammad II (99), Muḥmūd II (127), Wali-ullah (5), Kalīm-ullah (31), doubtful (2). No new types

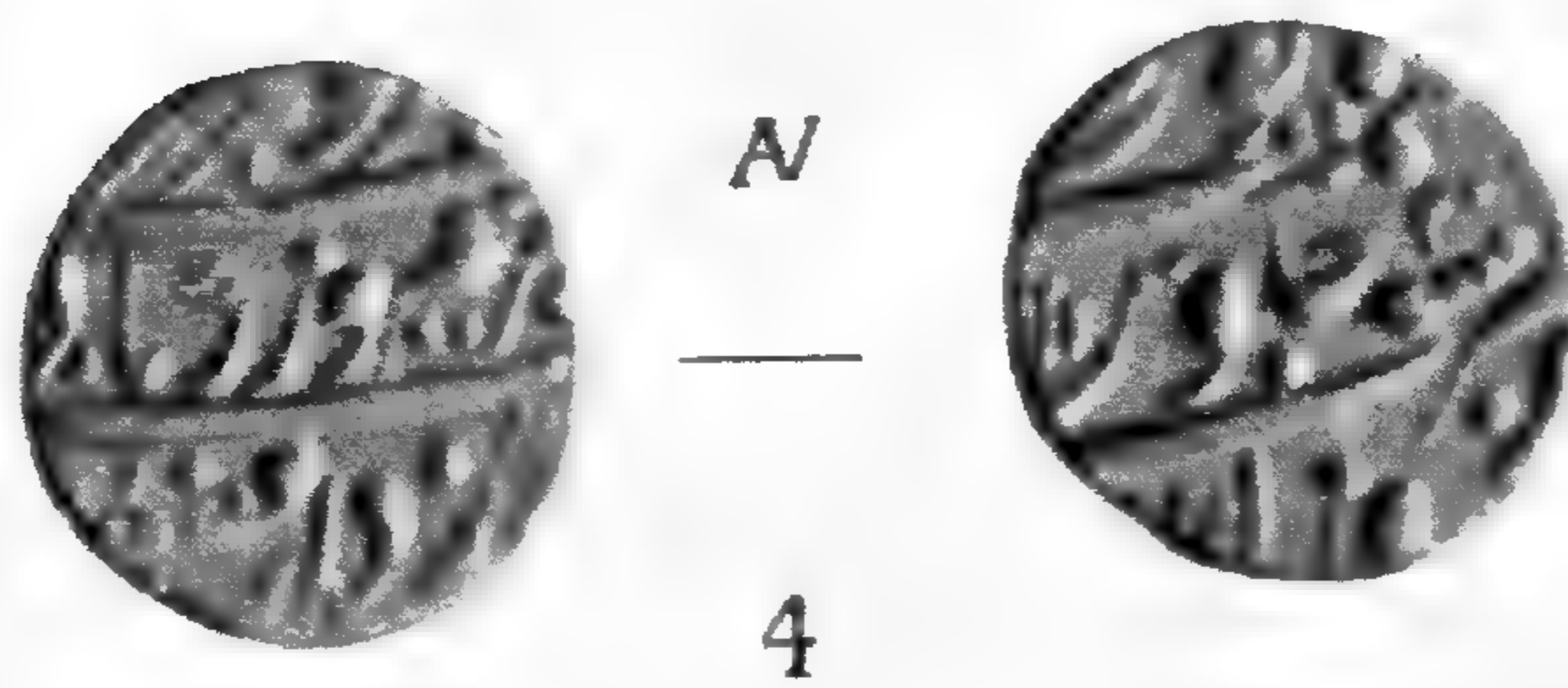
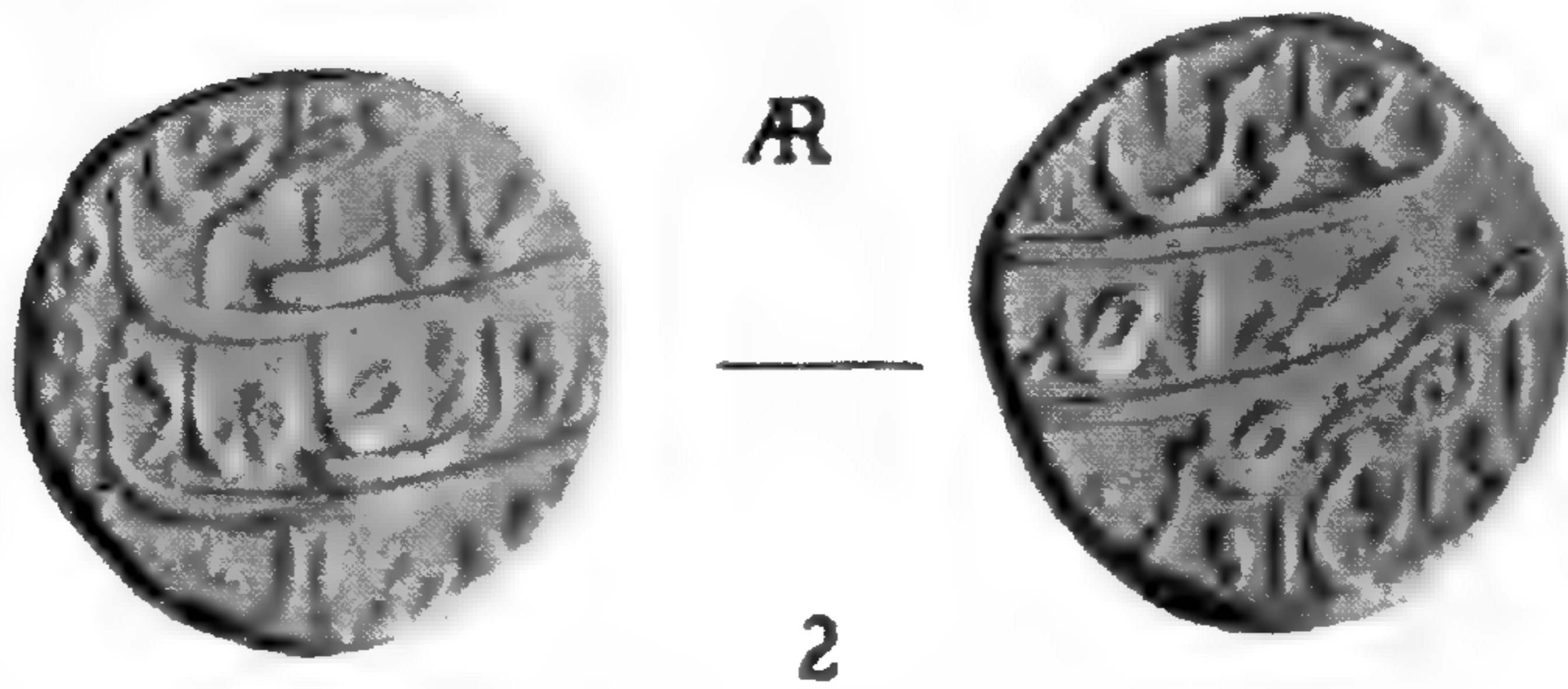
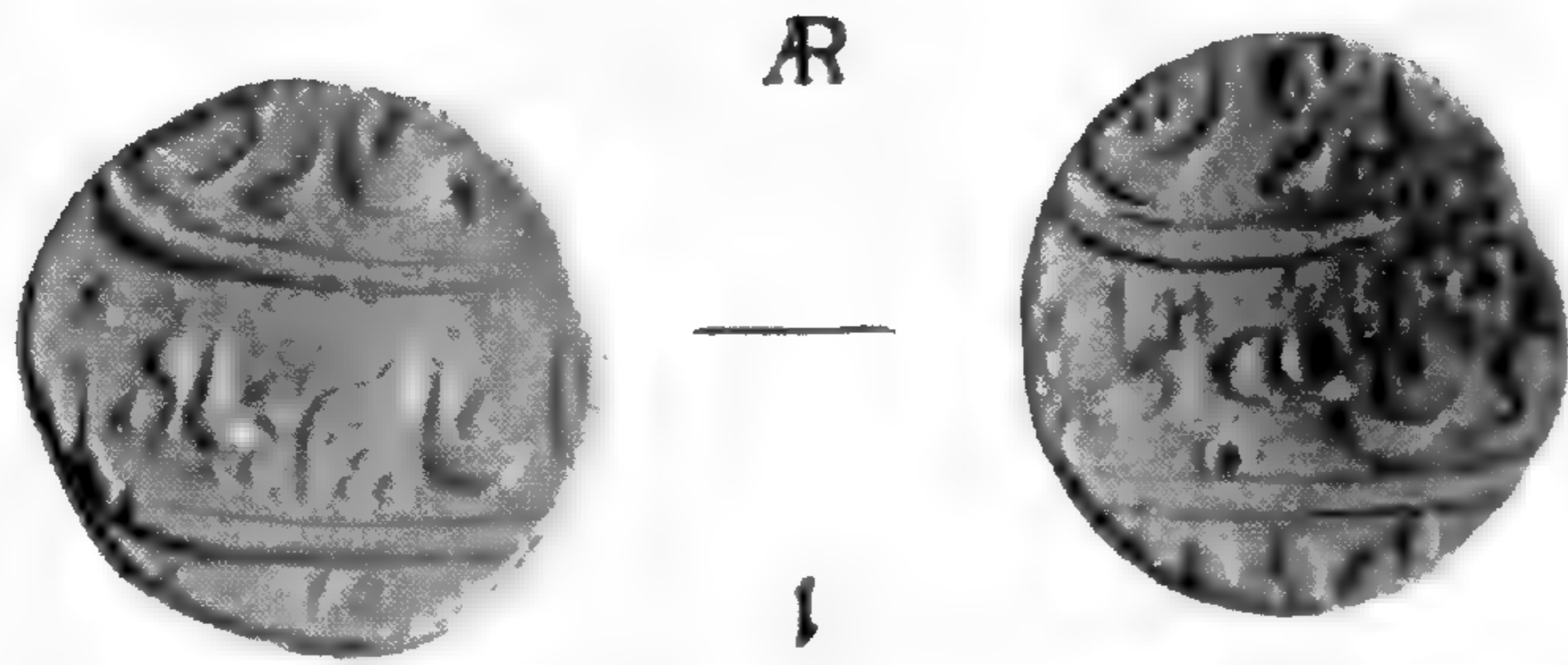

FOUR RARE MUGHAL COINS - art 130.

were among these, but the following appear to be unrecorded dates:—Muhammad Shāh bin Humāyūn (B.M.C. No. 474)—869 and 870 (1st size), for the second size of the same 877, and Kalīm-ullah (F. J. Thanawala. Num. Supp. No. XI, No. 12)—933. The coins of Kalīm-ullah and Walī-ullah were in particularly good preservation. The coins have been distributed among the various Indian Museums.

C. J. BROWN.

130. ON FOUR RARE MUGHAL COINS.

[With Plate VII].

1. Shāh 'Ālam Bahādur.

A		<i>Obverse.</i>
Mint	A'zamnagar	غازی
Date	———— 4 R.	دش————ا
Wt.	173	با عالم بہادر
S.	.95	س————کھ

Reverse.

مانوس

میدانت

سندھ

جالوس اعظم نگر

ضر LUCKNOW MUSEUM.

This is the first A'zamnagar coin published of Bahādur. It conforms to the type of rupees of Aurangzeb and Farrukhsiyar of this mint with the exception of the last line on the reverse which is quite unlike that on the Aurangzeb coin published by Mr. Whitehead (Num. Suppl. xv, 89, No. 10) or the Farrukhsiyar rupee published by Dr. Taylor (N. S. xiv, 84, No. 11). For the latter coin Dr. Taylor suggests Gokulgarh, and this reading is supported by No. 3 in this article. But in the present coin I see no resemblance to this name. The figure μ , though indistinct in the cast, can be read without difficulty on the coin. The provenance of the coin was Larkhana District, Sind, and was acquired in 1912.

2. A'zam Shāh.

Æ

Obverse.

Mint Dāru-l fath Ūjain ممالک اعظم شاہ

Date ——— ahd شہ —————

Wt. 174 بدولت و جاہ باد

S. 95 کہ —————

زد در جهان

Reverse.

جلوس اشو

ف

سنہ احد

ضرو

دار الفتح اوجین LUCKNOW MUSEUM.

This unique coin has I believe never been published before.

3. Farrukh-siyar.

Æ

Obverse.

Mint A'zamnagar بہتر و بر فروخ سیر

Date ——— 6 R. شہ —————

Wt. 176 حق بر سیم و زر باد

S. 95 ف —————

سکہ زد از

Reverse.

مانوس

میمنہت

سنہ

جلوس ۶ اعظم نگر

ضرو

گوکل ۲

LUCKNOW MUSEUM.

I publish this coin because in the first place it seems to confirm Dr. Taylor's conjecture Gokulgarh for the last line of

the reverse; and also because of the two dots under *اعظم* in which alone it differs from Dr. Taylor's specimen and that in the B.M., No. 936. This I think must be a die-cutter's error. A'zīm is an impossible form, and the only other possible suggestion is that the long stroke is not the *ب* of *ضرب* but a *ت* and part of the mint name, but this again is unlikely. This coin came from the Bījāpūr District and was acquired by the Museum in 1907.

4. *Farrukh-siyar.*

A

Obverse.

Mint	Fīrozgarh	بہار و بہر [فرخ سیر]
Date	———— 3 R.	شہ
Wt.	169	برسیدم وزر باد
S.	·8	سہ

زد از فضل [حق]

Reverse.

مانوس
 میدت
 سہ س جلوس
 ضرب
 فیروزگرہ

Gold and silver coins of this mint of Bahādur are in the Lahore Museum and were published by Mr. Whitehead in Num. Suppl. XV, 89, Nos. 20-21. No coins of any other Emperor are recorded.

The casts of coins for this article were kindly made for me by Babu Prayag Dayal of the Lucknow Museum.

C. J. BROWN.

131. SILVER COINS OF THE CHANDELLA, MADANAVARMAN.

In September last a find consisting of 48 silver coins was found in a village named Panwar of the Teonthal Tahsil of the Rewah State. It consisted of 8 large and 40 small silver coins of Madanavarman of the Chandella dynasty. Gold coins of Madanavarman are fairly well known. One copper and two gold coins were described by General Cunningham.¹ The

¹ *Coins of Mediæval India*, p. 79, pl. VIII, 19.

Cabinet of the Indian Museum contains three gold coins, two large and one small.¹ Several private collections are also known to contain Chandella gold coinage, especially those of Madanavarman and Paramarddin. But silver coins of this dynasty are very little known. Cunningham has referred to a single silver coin of Jayavarman,² son of Sallakṣaṇavarman and cousin of Madanavarman.³

Like the gold coinage, the silver coins also are divided into two classes:—(1) the larger and (2) the smaller. The larger coins vary in weight from 60 to 62·75 grains Troy. The smaller also vary in weight from 14·17 to 16·07 grains. They are exact copies of the larger and smaller issues in gold, the obverse having the legend

- (1) *Srīman-Ma-*
(2) *-dana-varmma*

in two lines instead of three and the reverse the seated goddess as on the coins of Gāṅgeyadeva.

R. D. BANERJI.

¹ V. A. Smith, *Cat. of the Coins in the Indian Museum, Calcutta*, Vol. I, p. 253.

² *Coins of Mediæval India*, pp. 77-78.

³ *Epigraphia Indica*, Vol. VIII, App. I, p. 16.

21. **The Evolution and Distribution of certain Indo-Australian Passalid Coleoptera.**¹

By F. H. GRAVELY, M.Sc., *Assistant Superintendent in the Indian Museum.*

(Read at the First Indian Science Congress, January 16th, 1914.)

[With Plate XXIV.]

In a previous paper in the Journal of this Society² I gave a preliminary account of the taxonomic results of some investigations which I have recently been making on the Indo-Australian Passalidae. In the present paper I propose to describe, as briefly as possible, certain facts connected with the evolution and distribution of these beetles, facts which have come to light as a result of the same investigations and of the modifications in classification advocated in that paper.

Of the six subfamilies of Indo-Australian Passalidae there recognized, two—the *Aceraiinae* and *Gnaphalocneminae*—are remarkable in that many of the species belonging to them are more or less highly asymmetrical; and a study of the diagram on pl. XXIV, and of its explanation, will be sufficient to show that the asymmetrical condition has been evolved separately, not only in the two subfamilies as a whole, but also in different groups of the *Gnaphalocneminae*. For it will be noticed that five different types of asymmetry occur, which show separate lines of evolution diverging from some symmetrical or almost symmetrical ancestor.

These five types of asymmetry may be termed the *Aceraius*, *Protomocoelus*, *Gnaphalocnemis*, *Plesthenus* and *Gonatas* types respectively, after the genera in which they severally attain their fullest development; and each is characteristic of a different group of genera,³ capable, with one exception,⁴ of complete separation one from another on the characters afforded by the mentum and antennae, as well as by those of the struc-

¹ Published with the permission of the Trustees of the Indian Museum.

² "A preliminary account of a revised Classification of the Indo-Australian Passalidae," J.A.S.B. (N.S.), viii (1912), pp. 403-7.

The *Plesthenus* group contains only one genus *Plesthenus*. The precise relation of the genus *Tatius* to the other genera of the *Gonatas* group has yet to be determined.

³ The distinction between the *Gnaphalocnemis* and *Plesthenus* groups rests solely on the structure of the anterior margin of the head.

tures (the mandibles and the anterior margin of the head) which are apt to be asymmetrical.

It is evident, therefore, that the degree of asymmetry which any species exhibits cannot be regarded as an indication of affinity to asymmetrical species of another type; but that it is to be regarded rather as an indication of the degree of specialization which has been attained.

The *Aceraiinae* are found in the Oriental Region only; and this Region may be divided, with reference to them, into three principal parts—Ceylon, the Indian Peninsula, and the countries east of the mouths of the Ganges, including the Eastern Himalayas and everything south and east of them as far as the Straits of Macassar. Not a single species belonging to this subfamily is found in more than one of these tracts; and in the tracts between them¹ no *Passalids* of any kind are known to exist.

In the countries between the mouths of the Ganges and Straits of Macassar, three genera are found. One of these (*Tiberioides*) is symmetrical and includes only three species, none of them very common, and all practically confined to the Eastern Himalayas and the Naga Hills. Both the others are highly asymmetrical, and so complete a series of transitional forms exists between them as to leave no room for doubt that one has been derived directly from the other. Both these genera are larger as regards number of species, more plentiful, and more widely distributed than the first mentioned; and one of them (*Aceraius*), in which alone the mandibles are asymmetrical as well as the anterior margin of the head, is much larger, more plentiful, and perhaps more widely distributed, than the other (*Ophrygonius*). Further, one species of the former of these two genera stands out from all others of both genera by reason of its extraordinary asymmetry, its abundance, its occurrence over the whole of the area they inhabit, its gregarious habits,² and its variable dimensions—which are often as great as if not greater than those of any other species of the genus. It is quite evident that at present this species, *Aceraius grandis*, is the dominant species of the subfamily all over the countries east of the mouths of the Ganges.

Similar characteristics distinguish the dominant species of the Indian Peninsula and Ceylon respectively from the other species of *Aceraiinae* living there. Only two species of *Aceraiinae* are found in each of these areas. In the Indian Peninsula the two are almost equally asymmetrical and almost

¹ *i.e.* (1) the Gangetic Plain, and (2) probably the dry low country between the hills of S. India and Ceylon, as well as the Straits between them.

² Of very few other species of the genus are the habits yet definitely known and I suspect that a few of them will prove to be gregarious in some degree.

[N.S.]

equally abundant and widely distributed. But one of them (*Episphenus*¹ *indicus*) is much more variable in size than the other (*E. neelgherriensis*), and usually much larger; it also appears to be slightly gregarious and the other not²; and besides having, if anything, slightly more highly asymmetrical mandibles than the other, it differs from it in having the anterior angles of the head produced forwards, a character found in a few species of the genus *Aceraius*, and in an especially pronounced form in the dominant species of that genus.

In Ceylon the parallel is even closer. The dominant and only asymmetrical species (*Episphenus comptoni*), which is again of much more variable, and usually of larger, dimensions than the other (*E. moorei*), is far more abundant. It is also markedly gregarious. Nothing definite is known about the habits of the other species; but it is sufficiently evident, from the absence from collections of any considerable series from a single locality, that specimens do not live together in large numbers. With regard to distribution, the data are probably insufficient for any generalization as regards either species.

I have not been able to study the Gnaphalocneminae in such detail as the Aceraiinae: but it is already evident that they present phenomena of at least a similar nature. Thus in the *Gnaphalocnemis* group—the only group of the subfamily that has established itself in the Oriental Region—species belonging to the genus *Gnaphalocnemis* are more numerous, are much better represented in collections, and attain a much larger size than those of the less markedly asymmetrical genera *Trapezochilus* and *Parapelopides*; and the symmetrical or almost symmetrical genus *Parapelopides* is the rarest of the three. Similarly in the *Gonatas* group also, species of the genus *Gonatas* are more numerous, larger, and better represented in collections than those of the genus *Omegaricus*.

Another point which is brought out in pl. XXIV is the way in which the degrees of asymmetry, severally attained by the three dominant species of Aceraiinae, are related to the distribution of these species. Thus *Episphenus comptoni* in Ceylon is less highly asymmetrical than *E. indicus* in the Indian Peninsula; and *E. indicus* is itself less highly asymmetrical than *Aceraius grandis* on the other side of the Gangetic Plain. The dentition of even the dominant Indian Peninsula form is, indeed, less highly asymmetrical than that of the great majority of the species found beyond the Ganges; and both the Peninsular forms are more highly asymmetrical than

¹ Incl. *Chilomazus* (part) + *Basilianus* (part), see Mem. Ind. Mus. III, 1913-1914, pp. 316-8.

² In both species, of course, the two parents live together with their larval offspring, as is usual in the Passalidae. Gregariousness, as here understood, implies the association together of several such families.

even the dominant form in Ceylon. Moreover, although one symmetrical genus of Aceraiinae—*Tiberioides*—is found in the northern parts of the area dominated by the genus *Aceraius*, a comparison of the structure of the upper surface of its head with that found in the other genera of the subfamily, seems to show that this genus is a lateral offshoot from the main trend of evolution, and is related to the other genera only through the one symmetrical species found in Ceylon—*Episphenus moorei*—which must therefore be regarded as the most primitive existing species of the subfamily.

From this it appears that the species of Aceraiinae inhabiting Ceylon are less highly specialized than those inhabiting the Indian Peninsula; and that those inhabiting the Indian Peninsula are less highly specialized than are those found on the other side of the Ganges, taking these as a whole.

In the Gnaphalocneminae the three most primitive genera are confined to Australia, except for one species (*Episphenoides pectinigera*, Heller) from New Guinea, the remaining genera being distributed over the East Indian Archipelago and Malay Peninsula, one species penetrating into Burma as far as Tavoy.

The line of demarcation between the Oriental and Australian Regions separates, almost completely, the Aceraiinae and the *Gnaphalocnemis* group of the Gnaphalocneminae from the other groups of the latter subfamily, the only transgressors of the line yet recorded being two species of the genus *Gonatas*, and one of the genus *Gnaphalocnemis*.

In order to explain the geographical separation of the primitive symmetrical and closely related forms found in the two regions, by the more highly specialized and less closely related allies of each, it must be supposed that conditions on either side of "Wallace's Line" are for some reason peculiarly favourable to the evolution of highly specialized forms; and that these have migrated outwards, driving before them the less highly specialized, which have rarely survived to the present day except where they have been able to establish themselves behind zoogeographical barriers that the more recently evolved forms have not yet been able to cross.

This is further supported by the fact that of the less highly asymmetrical forms which are not uncommon in the Australian half of the East Indian Archipelago, one whole group at least (comprising the genera *Hyperplsthenus*, *Labienus*, *Kaupiolus* and *Aurelius*) shows a high degree of specialization, in structures which are perfectly normal in most of the more highly asymmetrical forms among which they live.

There is a curious similarity between the relation of specialization to geographical distribution found in the asymmetrically inclined Passalidae, in the Thelyphonidae (see Gravely, J.A.S.B., VII [8], 1911, Proceedings, pp. cxxiii-cxxv) and in the Crinoidea (see Clark, Echinoderma of the Indian

Museum, Pt. vii, Crinoidea; Calcutta 1912; pp. 18-19). That so close a similarity should exist between groups so widely separated in the animal kingdom is sufficiently remarkable to suggest that the phenomenon may be one of more widespread occurrence. Louis Agassiz, in his "Essay on Classification" (Boston 1857, London 1859), devotes section xxviii to the "Relations between the Structure, the Embryonic Growth, the Geological Succession, and the Geographical Distribution of Animals"; and Cope has considered the question from an evolutionary standpoint in his essay on "The Origin of Genera," and in his notes on this essay in the introduction to his volume of collected essays entitled "The Origin of the Fittest" (New York, 1887, pp. vi-vii and 112-123). But neither of these authors appear to have been aware that the relation of distribution and structure is ever so detailed as it can be shown to be in the groups noted above. These are the only additional references to the subject that I have yet been able to find. It is, however, less easy to trace the scattered literature of a question of this kind, than it is to trace that of systematic zoology, and I shall be greatly indebted to anyone who will give me references to any other published work on these lines.

With regard to the Thelyphonidae only a preliminary note has yet been published (*loc. cit.*), and the details have not yet been fully worked out. The work of Austin H. Clark on Crinoids is, however, most interesting in this connection. In discussing the relative ages of the recent crinoid faunas of different seas (*loc. cit.*), he bases his conclusions on the degree to which the centrodorsal plate differs from its primitive form, in adults of species of Comasteridae found in different regions. He finds the greatest difference in the majority of Australian and East Indian forms (especially the former), somewhat less difference in African forms, and least difference of all, in the same geographical direction, in West Indian. In other geographical directions relatively "young" (*i. e.* primitive) faunas are found in Japan, in the Antarctic and thence northward along the American coast, and in the Arctic. He says, moreover (p. 18): "This [the connection between distribution and structure] holds good regardless of the subfamily or genus to which the species may belong, and exactly the same thing may be worked out in regard to other characters in this family, and with other characters in other families."

Another point brought out alike by the study of Crinoids and of Passalids is the existence, in different groups of species, of one particular species which greatly exceeds all others both in its geographical range and in its variability. But both here, and in the relation of distribution to specialization, the conformity of the two groups seems to be less deep than the striking character of this conformity would lead one to

expect Clark says (*loc. cit.*, p. 15): "There is one zoological principle well brought out by the crinoids of the East Indian region which I cannot remember to have seen stated anywhere, though it is equally well shown in many groups, both terrestrial and aquatic, and that is, that in all natural genera which are adequately known and sufficiently well represented in the present fauna, there exists typically a single species which covers the entire range inhabited by all the other species of the genus collectively. This species is always the most variable, individually, of all contained within the genus and, if the species of the genus be arranged according to the development of the specific characters in them, this species typically falls midway between the two extremes. In each family also there is typically to be found a genus which in every way corresponds to this species." The italics are mine, and indicate the feature in which the Passalidae differ from the Crinoidea and from the other groups to which Clark refers. In the Aceraiinae, the only asymmetrically inclined group of Passalidae which has been sufficiently worked out for comparison, the most variable species is *Aceraius grandis*, which occurs throughout the region inhabited by the genus *Aceraius*; but this is, with the single exception of the very rare and closely allied *A. occulidens*, the most highly specialized of its genus. And I can hardly regard it as a mere coincidence that in Ceylon, if not in the Indian Peninsula also (in each of which areas only two species of this subfamily occur), it is the more specialized that is the more variable. On Clark's hypothesis of the "Ontogeny of a Genus" (see *Amer. Nat.* xlv, 1911, pp. 372-4) the reverse would rather be expected.

Similarly, the rich and highly specialized Aceraiine fauna towards the centre of the Indo-Australian area, most of which belongs to the genus *Aceraius*, cannot be regarded as senescent, like the highly specialized Crinoid fauna of Australian waters. For senescent genera are "characterised by having but few species in widely separated localities, each widely different from the others" (*Amer. Nat.* xlv, p. 374)—which is emphatically not the case in this instance.

This fauna must rather be looked upon as a "mature" genus with *A. grandis* as its species "whose range is coterminal with that of the genus as a whole" and "the most variable of any in the genus" (*Amer. Nat.* xlv, p. 373), although this species does not come in the middle of the series formed by the species of the genus arranged "according to the proportionate value of their specific characters," and is (with the one rare exception noted above) the furthest from instead of "probably very close to the original stock."

The essential difference between Clark's hypothesis, and that put forward above to account for the distribution of the asymmetrically inclined groups of Indo-Australian Passalidae,

[N.S.]

lies in the nature of the conditions postulated towards the centre of distribution in each case. Clark says, speaking of a potential genus as yet scarcely distinguishable from a species (Amer. Nat. xlv, p. 373): "There is somewhere within the range of this young genus, normally at or near the centre, an area of optimum conditions, where life is easy and there is no severe struggle for existence." And again (Indian Ocean Crinoids, p. 18): "The crinoids of Australia came from the northward, from the great East Indian Archipelago; but here continual changes in the distribution of land and sea have constantly rejuvenated the fauna so that none of its component species has been permitted to drift into the peaceful old age so obvious in almost all of the species along the Australian shores."

In the case of Indo-Australian Passalidae, on the other hand, I have been forced to regard the centre of distribution as the site of keen competition among forms well adapted for survival; resulting in a radial pressure of more, on less highly specialized species—the latter surviving chiefly when cut off from the former by some barrier which gives a check, probably of a more or less temporary nature, to the distribution of the newer forms.

Clark does not find it necessary to point out the radial character of the relation between the structure and distribution of Crinoids, although it exists, as deduced above from his data; but that he recognizes its frequent occurrence, and also the occurrence of a certain amount of radial pressure, is shown by the following passages from "The Ontogeny of a Genus" (*loc. cit.*, p. 373):—"Here [in the central "area of optimum conditions"] various more or less aberrant types arise and are able to perpetuate themselves, spreading out in every direction as did the original stock, but never so far, as they are not so well prepared to encounter adverse conditions." And "The forms occupying the limits of the range of a genus as a whole (geographical or bathymetrical) are continually trying to colonize new territory, both from their own initiative and as the result of pressure from behind."

Clearly the two hypotheses are not mutually exclusive; for the initiative of the relatively primitive forms living on the limits of the range of the "genus" as a whole, may in some groups be as nothing compared to the pressure from behind, while in others the reverse may be the case¹. Each may be true of certain groups; or possibly, when a "mature" group reaches a certain maximum of vigour, a temporary increase in competi-

¹ The exceptional richness of the fauna of the East Indian Archipelago indicates the presence there, of conditions which may well be responsible for a very great increase, in the Indo-Australian area, of this pressure from behind.

tion at the centre of distribution results in conditions such as are now found in the Indo-Australian Passalidae, a condition which might well accelerate the advent of senescence in the same area, with its accompaniment of "curious and eccentric species" and the "great development of certain characters at the expense of others, which usually leads to prompt extinction"—characters "which, so far as we can see, serve no useful purpose" (*Amer. Nat.* xlv, p. 374). Some of the most highly asymmetrical Passalidae might well be termed curious and eccentric; nor is their asymmetry known to serve any useful purpose.

The occurrence both among Passalids and among Crinoids, to which the two hypotheses seem respectively to apply, of single species having a geographical range coterminous with those of all the species closely allied to it; and the occurrence in the same groups of a well marked correlation, radial in character, between distribution and specialization, suggests that some connection between the two hypotheses is likely to exist, in spite of apparent differences.

Some of these differences are probably differences of interpretation only; for the two hypotheses have been worked out quite independently. I had already noticed the radial distribution of the Thelyphonidae before the publication of Clark's "Ontogeny of a Genus." And although this paper attracted my attention at that time, my recollection of it lay dormant throughout the whole period of my work on the Passalidae: and it was only when searching for references in connection with the preparation of the present paper that I recollected it, and discovered, not only its important bearing on my work, but also that of its author's zoogeographical notes in "Crinoids of the Indian Ocean." In view of the separate origins of our respective hypotheses, and the many differences there must have been in the facts noticed in connection with each, differences of opinion are almost certain to have arisen, and to have resulted in our interpreting other facts, not essentially different in themselves, from different points of view.

Especially, it seems to me, have our points of view been influenced by the difference in position in its group of the single variable and widely distributed species of each of the groups with which we have respectively dealt. This difference is even greater than appears at first sight from what has already been said about it above. For although this species "typically falls midway between the two extremes" in the instances from which Clark's conclusions were drawn, it does so not because it stands in the middle of the now existing section of a single line of evolution in its group; but because it stands at the base of two or more divergent lines and "is probably very close to the original stock." Its genealogical position, consequently is as widely removed as it could possibly be from the

position in which this species stands—at the top of the most progressive line of evolution in its group—in the Passalidae.

Evidently, then, the existence of this species in many groups, both terrestrial and aquatic, to which Clark calls attention, is a fact which calls for further investigation, with a view to determining in which cases it stands at the bottom, and in which at the top of the evolutionary series of the group or “genus” to which it belongs; and whether it is ever situated between the two. For this is bound to have a considerable bearing on the interpretation of the geographical distribution of that group.

EXPLANATION OF PLATE XXIV.

(From a block lent by the Trustees of the Indian Museum.)

Examples of all known genera of Aceraiinae and Gnaphalocneminae, and all known species of the genus *Episphenus*,¹ are here figured diagrammatically, in a manner designed to show the evolution of the five different types of asymmetry found in the two subfamilies, and their geographical relations. All forms connected by arrows with *Episphenus moorei* from Ceylon, belong to the Aceraiinae, of which that species appears to be the most primitive survivor; and all connected with the Australian genera *Pharochilus*, *Mastochilus* and *Episphenoides*, belong to the Gnaphalocneminae. In the former subfamily only one type of asymmetry is found; in the latter there are four types, one of which is here indicated as derived directly from the genus *Kaupioloides* and the other three from the genus *Hyperplesthenus*. It should, however, be pointed out that the genera *Kaupioloides* and *Hyperplesthenus*, with their allies *Aurelius*, *Kaupiolus*, and *Labiensus*, although transitional between the forms shown above and below them as regards the characters at present under consideration, cannot be regarded as representing actual ancestral types, on account of their specialised metatsterna and certain other characters. But the *actual* ancestors of all forms now living are clearly to be sought for only as fossils; and no fossil Passalids yet appear to be known.

The only known exceptions to the distribution shown are: (1) a species of *Episphenoides* from New Guinea; (2) one or two species of *Gonatas* from the Sunda Islands; (3) a species of *Gnaphalocnemis* said to be found in Amboina; and (4) the genus *Plesthenus* whose anomalous distribution (in Australia and Celebes) calls for further study.

¹ The species of this genus from the Indian Peninsula and Ceylon appear to have much the same zoogeographical value as the genera found in other parts of the Indo-Australian area.

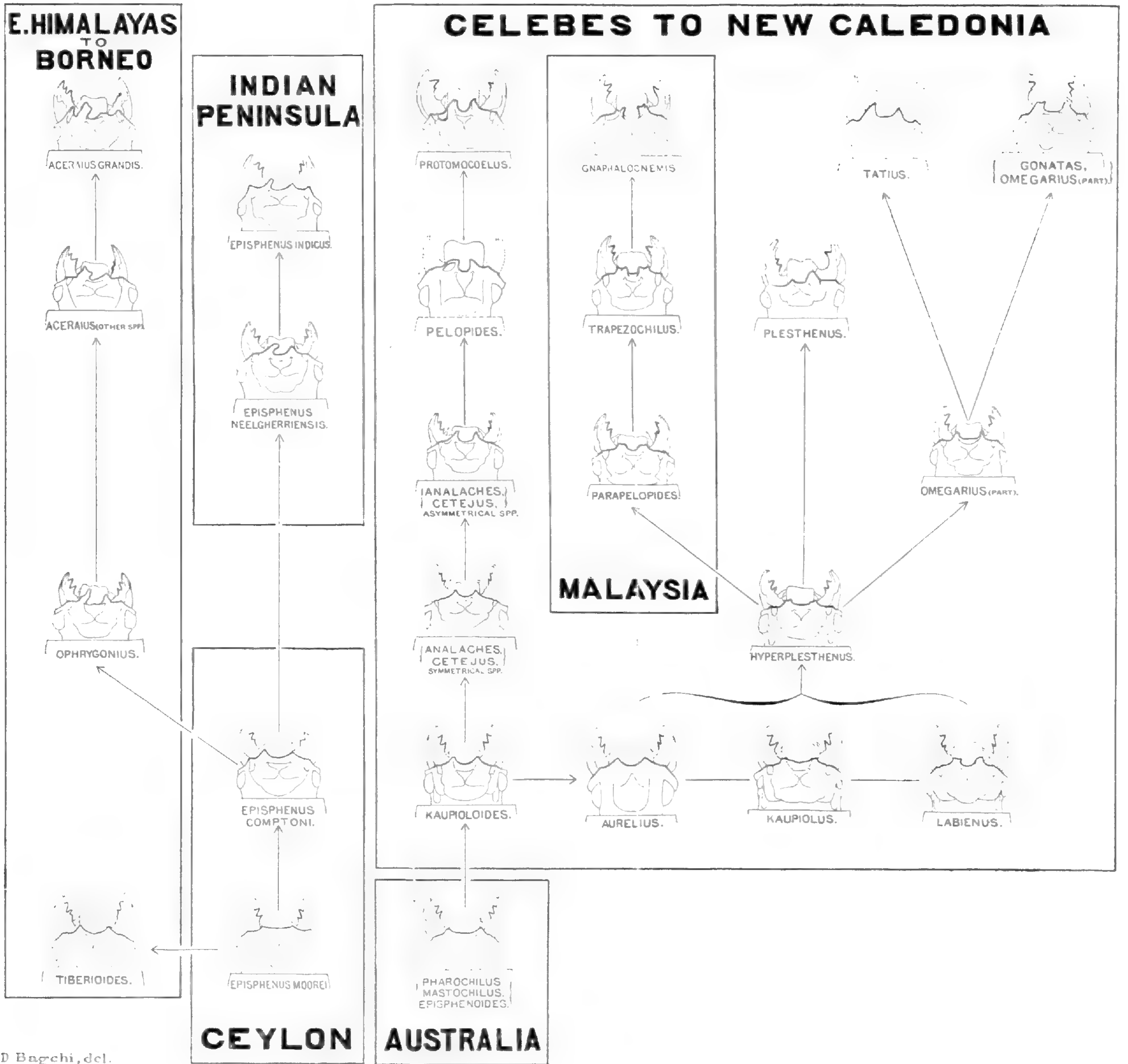

Relation of Specialization to Distribution in Indo-Australian Passalidæ.

22. Presence and Absence of the Gall-bladder in certain Rodents.

By R. E. LLOYD, Major, I.M.S., Professor of Biology in the Medical College, Calcutta.

[Read at the First Indian Science Congress, Jan. 16th, 1914.]

A short time ago my attention was drawn to the fact that there was no gall-bladder in the rat.

Reference to Owen's Anatomy of Vertebrates and other works showed that the fact had long been known, though it is omitted from certain standard works on comparative anatomy, in most of which the absence of the gall-bladder from the horse is noted.

Owen writes that "the gall-bladder is absent from *Mus*, *Cricetus*, *Lemmus*, *Echimys*, *Erethizon*, *Synetheres*, also that Cuvier did not find it in *Sciurus maximus* and in a species of *Pteromys*, but in that dissected by Hunter (*Pt. volucella*) it was present, as also in *Sciurus cinereus* and the common squirrel. The porcupine (*Hystrix*) has a small gall-bladder and the common Jerboa (*Dipus sagitta*) has one of the usual size. The Cape Jerboa (*Helamys*) had it not. In all other Rodents the gall-bladder is present."

In Flower and Lydekker's well-known work on the Mammalia we find in the chapter devoted to the Rodents the following statement—"The gall-bladder though present in most is absent in a few."

In Max Weber's large work on the Mammalia, 1904, we read, under the heading Rodentia, "The gall-bladder may be absent (Muridae)."

The subject seemed interesting as bearing on the question of the utility of the gall-bladder, and as a number of Rodents, preserved in alcohol, were available in the Indian Museum, I examined them in order to ascertain whether the gall-bladder was present or absent. The cases observed were as follows:—

Muridae.

Species.	Number examined.	Locality.	Gall bladder.
<i>Mus rattus</i>	2	Calcutta	Absent.
<i>Mus decumanus</i>	2	Calcutta	Absent.
<i>Mus mettada</i>	3	Etawah	Absent.
		1	Madras

Species.	Number examined.	Locality.	Gall bladder.
<i>Gunomys bengalensis</i> ..	{ 2	Calcutta	Absent.
	{ 1	Purneah	Absent.
<i>Bandicota nemorivaga</i> ..	1	Calcutta	Absent.
<i>Gerbillus indicus</i> ..	{ 2	Poona	Present.
	{ 1	Berhampore	Present.
	{ 1	Travancore	Present.
<i>Gerbillus meridionalis</i> ..	2	Turkestan	Present.

Spalacidae.

<i>Rhizomys pruinosus</i> ..	1	Ponsee	Present.
		Khakhyen Hills	Present.

Dipodidae.

<i>Dipus blanfordi</i> ..	1	Persia	Present.
---------------------------	---	--------	----------

Sciuridae.

<i>Sciurus palmarum</i> ..	3	Calcutta	Present.
<i>Sciurus macclellandii</i> ..	{ 1	East of Irrawaddy	Present.
	{ 1	Mouimein	Present.
<i>Sciurus atridorsalis</i> ..	2	East of Irrawaddy	Absent.
<i>Sciurus caniceps</i> ..	2	East of Irrawaddy	Absent.
<i>Sciurus locroides</i> ..	{ 1	Preparis Isle	Absent.
	{ 1	?	Absent.
<i>Sciurus carolinensis</i> ..	1	?	Present.
<i>Sciuropterus pearsoni</i> ..	1	Yunnan	Absent.

Lagomyidae.

<i>Lagomys rufesens</i> ..	2	Persia	Present.
<i>Lagomys roylei</i> ..	2	?	Present.

Hystriidae.

<i>Hystrix leucurus</i> ..	1	?	Present.
----------------------------	---	---	----------

In the above classification I have followed Blanford, but it is necessary to note that the genus *Sciurus* has quite recently been sub-divided. *S. palmarum* now appears in the genus *Funambulus*, while *S. macclellandii* is in the genus *Tamiops*. I have not had the opportunity of consulting this new classification of the squirrels. It would be interesting to know how far it is in agreement with the condition of the gall-bladder.

On looking through these observations it will be noticed that though the gall-bladder is absent from the genus *Mus*

and its close allies, it is not absent from all the Muridae, since it is present in the genus *Gerbillus*.

But perhaps the most interesting fact is the curious distribution of the organ among the squirrels. It is present in some species but not in others.

It is surprising to find that the gall-bladder may be present or absent within the narrow limits of a single genus¹, since this organ has been established in the vertebrate series for a longer time even than the limbs, if we are to believe the evidence afforded by the Cyclostomata which have a gall-bladder but no limbs.

Most explanations of organic phenomena that have hitherto been given have started from the idea of utility. Both Teleology and the Selection theory have this common origin. It is therefore worth while to consider any observations that bear on this subject.

It seems obvious that within the same genus the presence and absence of the gall-bladder cannot both be advantageous at the moment. It is however possible to imagine that there was a time in the past history of the squirrels when absence of the gall bladder might have been of advantage to one branch of the genus. It has been shown lately that the gall bladder has a pathological importance. Major E. D. W. Greig found that both the typhoid and the cholera bacilli persisted in the gall-bladder long after they had otherwise been eliminated from the body. The ascertained fact that two distinct kinds of bacilli have a special predilection for the gall-bladder suggest that in certain circumstances it might be advantageous to a race of animals to lose this organ.

Having demonstrated that the absence of the gall-bladder might be of advantage, the Selectionist regards its absence as thereby explained. In regard to that explanation we may say definitely, that it is satisfying to some but not to others.

But let us leave this problem and return again to the facts. It must be admitted, I think, that the gall-bladder has dropped out of the Rodent series on more than one occasion and perhaps on several occasions. If we were to believe that the loss had occurred on one occasion only we should have to believe that the genus *Mus* was derived from one branch of the squirrels, that which had lost the gall-bladder, and there is no reason for making such an assumption on general anatomical grounds. It seems evident then that *Sciurus* and *Mus* lost their gall-bladder on different occasions and more facts would probably show that the organ must have been lost on several occasions among the Rodents alone. The loss of the organ in other parts of the vertebrate series, in the horse and the saw fish

¹ *Sciurus carolinensis* is still left in *Sciurus* by Miller. See *U. S. Nat. Mus. Bull.* 79, p. 332 (1912).

for example, must of course have been quite independent in time and place of occurrence though due no doubt to a like cause. What that cause may be is, I believe, quite unknown.

In conclusion I must express my thanks to Dr. Annandale for permission to examine the collection of Rodents in the Indian Museum, and also to B. Pranaba P. Sen Gupta, one of my students who first drew my attention to the subject and dissected a number of our local Rodents, at my suggestion, in order to ascertain the state of the biliary apparatus.

23. An Improved Method of using Oil Gas.¹

By KENNETH SOMERVILLE CALDWELL, B.Sc., Ph.D., F.I.C.

[Read at the First Indian Science Congress, January 15th, 1914.]

One of the great difficulties met with in carrying on scientific work in India is connected with the question of gas supply. In most mofussil laboratories *oil gas* is used and is prepared in the well-known apparatus manufactured by Messrs. Mansfield & Sons. This apparatus is simple in construction, requires little attention and no skilled labour. The gas is prepared by dropping ordinary kerosine oil into a red hot iron retort, and after washing with water is collected in a gas-holder. The one drawback to such a gas from a practical point of view is the fact that it is very much richer in unsaturated hydrocarbons than coal gas and requires in consequence a far larger quantity of air for its complete combustion (Table I). If used with the ordinary Bunsen and allied types of burners a large percentage of gas escapes complete combustion, resulting in considerable waste and rendering the gas unsuitable for laboratory work. This difficulty is in part overcome by adopting a specially made burner and by supplying the gas at a higher pressure. The arrangement however cannot be regarded as satisfactory for two reasons; firstly, because burners with such small nozzles more easily get out of order than the ordinary burner, and secondly, because it is impossible to use with the gas the various other types of burners so necessary in chemical work. To one accustomed to work in Physical and Chemical laboratories these points are obviously of great importance.

It was with the object of overcoming these difficulties that the following investigations were undertaken:—

The gas under consideration was prepared in the manner indicated above and the following may be taken as a typical analysis of the same. For purposes of comparison figures for an analysis of purified coal gas are also given.

TABLE I.

	Volume per cent.	
	Oil Gas.	Coal Gas.
Hydrocarbon vapours ..	8.2	..
Unsaturated hydrocarbons ..	31.0	4

¹ Indian Patent No. 878 of 1913.

	Volume per cent.	
	Oil Gas.	Coal Gas.
Carbon Dioxide	0·0	1
Oxygen	0·0	0
Carbon Monoxide	0·2	8
Methane	48·9	34
Hydrogen	0·8	49
Nitrogen (by difference)	10·9	4
	100·0	100·0

On exploding the gas with excess of air it was found that one volume of gas required for its complete combustion 1·3 volumes of air, whereas the coal gas found to be most useful for domestic, industrial, and scientific purposes and for internal combustion engines is one of such composition that one volume of gas requires 5 to 5·5 volumes of air for its complete combustion. (Butterfield, "Chemistry in Gas Works". A lecture delivered in December, 1912, before the Institute of Chemistry, London). "Close conformity in character with such a gas presents the advantage that burners and apparatus applicable for use without re-adjustment or modification are readily obtainable." It occurred to the author that such a gas might be obtained by mixing air with oil gas in bulk in the gas-holder, and in order to determine the extent to which this might be done without danger of explosion the rate of propagation of progressive combustion in mixtures of the gas and air in varying proportions was measured. This was done by allowing the gas mixtures to flow through tubes of known area of cross-section with a velocity just sufficient to prevent the flame from travelling against the current. (Bunsen, Gasometrische methoden 1877, p. 317; Michelsen, Zeit. phys. Ch. 3, 493).

The results are shown in the following table:—

TABLE II.

Volume per cent of oil gas in mixture.	Rate of propagation of combustion.
5·8	21·5 cm per sec.
7·1	26·0 ,, ,,
A. 7·5	28·5 ,, ,,
B. 8·2	33·5 ,, ,,
8·7	31·5 ,, ,,
9·2	30·0 ,, ,,
10·1	20·2 ,, ,,
12·1	10·8 ,, ,,
16·0	0·3 ,, ,,

The mixture A contains exactly the amount of air necessary for complete combustion, and it is interesting to note that this is not the mixture in which the rate of combustion has reached its maximum value. (Cf. Michelsen, *Zeit. phys. Ch.* 3, 493) As the quantity of oil gas in the mixture increases beyond about 9%, the rate of combustion rapidly falls off until in the mixture containing 16% it is only measured with difficulty, and beyond this limit progressive combustion does not take place and the mixture is non-explosive.

A comparison of the values found for mixtures of oil gas and air with those given by Michelsen (*loc. cit.*) for mixtures of coal gas and air and hydrogen and air is instructive.

In the following table n = the volume per cent of combustible gas in the mixture and u = rate of propagation of combustion in centimetres per second.

TABLE III.

Oil gas and air.		Coal gas and air.		Hydrogen and air.	
n	u	n	u	n	u
5.8	21.5	11	28	15	40
7.1	26.0	12	38	20	65
7.5	28.5	13	48	25	140
8.2	33.5	14	57	30	235
8.7	31.5	15	64	35	270
9.2	30.0	16	68	40	277
10.1	20.2	17	70	45	270
12.1	10.8	18	71	50	250
16.0	0.3	19	68	55	222
		20	62	60	172
		21	53	65	105
		22	43	70	74
		23	33		
		24	24		
		25	16		
		26	11		

It will be observed that the maximum rate in the coal gas air mixture is more than twice that of the oil gas-air mixture and that the upper explosive limit in the former is much higher than in the latter. The high percentage of hydrogen in coal gas, Table I, is obviously the cause of the difference in behaviour between these two gas mixtures.

It is possible therefore to mix up to 80% of air with oil gas without danger of forming an explosive mixture. Now as one volume of oil gas requires about 12.3 volumes of air for its complete combustion, it will be necessary to mix with it about 1.2 volumes of air in order to get a gas mixture which

shall require for its complete combustion five times its volume of air. Actual experiments show that when oil gas is mixed with an equal volume of air a mixture is obtained which can be used with all types of Bunsen and allied burners and blow pipes such as are used with ordinary coal gas with entirely satisfactory results.

By regulating the air supply at the burner in the usual way a perfectly colourless flame is obtained which leaves no deposit on crucibles and which can be used for quantitative and blow pipe work in exactly the same manner as coal gas.

As such a mixture contains only 50% of air and as an explosive mixture must contain over 80%, the margin of safety is ample.

The calorific value of coal gas is about 600 B. T. units, whereas undiluted oil gas has a calorific value of some 1350 B.T. units. A mixture of oil and air in equal volumes will therefore have a calorific value of approximately $\frac{1350}{2} = 675$ B T. units, i.e. a value about the same as, or rather greater than, that of ordinary coal gas.

It is clear from the above that not only do we obtain a gas far more useful for laboratory and industrial purposes, but that a very considerable saving in expense is involved. It is only necessary to half fill the gas holder with oil gas and to complete the filling by the addition of air. Only half the usual amount of kerosine oil is required and the gas holder is filled in about half the usual time with consequent saving in furnace fuel. Oil gas diluted in this way with an equal volume of air has been in use in the Patna College Laboratory for nearly a year, and not only has it proved to be entirely satisfactory with all types of burner but the expenses in connection with the gas supply have been reduced to about one half.

EXPERIMENTAL DETAILS.

Analysis of oil gas.—This was carried out in the usual manner and requires no comment beyond calling attention to the fact that it is impossible to estimate the oxygen in a mixture of this gas and air by absorption with phosphorus. The hydrocarbon vapours present (considerable quantities of Benzene were isolated from the tarry distillate) entirely prevent the absorption of oxygen by phosphorus.

In one experiment phosphorus was actually heated above its melting point in a mixture of oil gas and air containing 28% of the latter and the resulting diminution in volume measured only some 0.2%.

For the estimation of oxygen it is necessary to use some other absorbent such as an alkaline solution of pyrogallol.

Measurement of the rates of propagation of progressive combustion in mixture of oil gas and air:—The gas mixtures

were delivered from a graduated gas-holder of two litres capacity, to which was attached a barometer and regulating valve capable of fine adjustment for the admission of water.

The areas of cross section of the combustion tubes were measured by means of a Vernier Microscope. A capillary tube of fairly wide bore introduced between the combustion tube and the gas holder was found to be an efficient safeguard for the prevention of explosion in the experimental gas-holder.

The stream of gas was so adjusted that the flame was just prevented from travelling against the current and remained steady at the particular point in the tube at which the area of cross section was afterwards measured.

In the following tables V = reading of the water level in the gas-holder in cubic centimetres. (After correcting the graduations of the gas-holder for the volume occupied by the tube delivering the water each "100 cc." = 98.7 cc.).

T = time in $\frac{1}{5}$ seconds.

R = Rate of the stream of gas in the combustion tube when equilibrium is established.

a = area of cross section of the combustion tube.

Experiment I.

Volume per cent of oil gas in mixture = 5.78

$a = 0.0945$ sq. cm.

V	1100	1200	1300	1400	1500
T	790	1030	1266	1504	1745
T per "100 cc."		240	236	238	241

Average time for 98.7 cc. = 47.8 secs.

Hence $R = 21.5$ cm. per sec.

Experiment II.

Volume per cent of oil gas in mixture = 7.14.

$a = 0.0935$ sq. cm.

V	1400	1500	1600	1700
T	0	207	411	610
T per "100 cc."		207	204	199

Average time per 98.7 cc. = 40.6 secs.

Hence $R = 26.0$

Experiment III.

Volume per cent of oil gas in mixture = 7.53.

$a = 0.0935$ sq. cm.

V	700	800	900	1000	1100	1200
T	0	186	371	559	—	926
T per "100 cc."		186	185	188	184	

Average time per 98.7 cc. = 37 secs.

Hence $R = 28.5$ cm. per sec.

Experiment IV.

Volume per cent of oil gas in mixture = 8.14

 $a = 0.0945$ sq. cm.

V	1700	1800	1900	2000	2100
T	0	155	310	465	618
T per "100 cc."		155	155	153	

Average time per 98.7 cc. = 31 secs.

Hence $R = 33.5$ cm. per sec.*Experiment V.*

Volume per cent of oil gas in mixture = 8.73

 $a = 0.0935$ sq. cm.

V	800	900	1000	1100	1200	1300
T	0	171	339	—	671	838
T per "100 cc."		171	168	166	167	

Average time per 98.7 cc. = 33.5 secs.

Hence $R = 31.5$ cm. per sec.*Experiment VI.*

Volume per cent of oil gas in mixture = 9.15

 $a = 0.0935$ sq. cm.

V	800	900	1000	1100	1200
T	0	179	364	548	728
T per "100 cc."		179	185	184	180

Average time per 98.7 cc. = 36.4 secs.

Hence $R = 29$ cm. per sec.*Experiment VII.*

Volume per cent of oil gas in mixture = 10.14

 $a = 0.0945$ sq. cm.

V	1300	1400	1500	1600	1700	1800	1900
T	0	255	517	776	1035	1288	1543
T per "100 cc."		255	262	259	259	253	255

Average time per 98.7 cc. = 51.8 secs.

Hence $R = 20.2$ cm. per sec.*Experiment VIII.*

Volume per cent of oil gas in mixture = 12.06

 $a = 0.683$ sq. cm.

In this experiment a much larger combustion tube had to be used. With the smaller combustion tube the gas could not be driven off slowly enough to balance the rate of combustion.

V	2000	2200
T	0	133
T per "100 cc."		66.5

Average time per 98.7 cc. = 133 secs.

Hence $R = 10.9$ cm. per sec.

Experiment IX.

Volume per cent of oil gas in mixture = 16.02
a = 1.814 sq. cm.

In this experiment it was found necessary to use a still wider tube with a diameter of over 1.5 centimetres.

V 820 920

T 0 845

T per "100 cc." = 845

Average time per 98.7 cc. = 169 secs.

Hence R = 0.3 cm. per sec.

SUMMARY.

1. "Oil Gas" requires 12.3 times its own volume of air for its combustion, whereas coal gas requires only 5 to 5.5 times its volume of air.

2. It is owing to these facts that oil gas cannot be used satisfactorily with ordinary Bunsen and allied types of burner, a large percentage of the gas always escaping complete combustion.

3. A mixture of oil gas and air in equal volumes requires for its combustion about the same volume of air as ordinary coal gas and can be used for all purposes in the same way as the latter with the various types of coal-gas burners.

4. The calorific value of such a gas mixture is slightly greater than that of ordinary coal gas.

5. It is perfectly safe to mix this and even much larger quantities of air with oil gas as the explosive limit is not reached until over 80% of air has been added.

6. By using the gas diluted in this way its complete combustion is assured and not only do we get a gas far more convenient for laboratory and other purposes but a very considerable saving in expense is effected.

7. A simple method of mixing air with gas has been devised and Messrs. Mansfield & Sons are prepared to fix the necessary attachment to their older form of apparatus.



24. The Date of Chashtana.

By RAMESH CHANDRA MAJUMDAR.

The scholars almost unanimously hold that the Western Kshatrapas (excluding Nahapana and Bhumaka) belong to the Saka tribe, and Chashtana is the founder of the royal dynasty. We also know from a passing remark of Ptolemy ("Oozene, the royal residence of Tiastenes") that Chashtana was a famous king and had his capital at Ujjayini. His grandson Rudradaman is known from the famous Girnar Inscription to have certainly ruled in A.D. 150. All these agree so very well with the Jaina tradition that the Sakas conquered Ujjayini in A.D. 78, and established their era, that we may be naturally led to assume that Chashtana was the first regal Viceroy (for he calls himself as such in his coins) of the Saka king on whose behalf he conquered and ruled Ujjayini about A.D. 78. But the scholars have not accepted so early a date for Chashtana. The remarks of Ptolemy have been interpreted to signify that Chashtana was a contemporary of Ptolemy, i.e. was living at a time when Ptolemy received his latest information about India, say about A.D. 130. It is obvious that though such a presumption is not unnatural it is not certainly inevitable, i.e. it does not necessarily follow from Ptolemy's remark that Chashtana was his contemporary. But almost all theories have been built up on such a supposition. Pandit Bhaganlal Indraji at first held that Chashtana lived considerably earlier than A.D. 130, being to some extent contemporary of Nahapana (latest known date A.D. 124) (J.R.A.S. 1890). But when writing the *Bombay Gazetteer* he mentions Chashtana as a successor of Nahapana (B.G. Vol. I, p. 20ff.). Prof. R. G. Bhandarkar also brings him down to about A.D. 132 (E.H.D., p. 21). Oldenberg (I.A. Vol. X, 1881), Burgess (A.S.W.I., Vol. IV, p. 37), and V. Smith ("Early History," p. 200) not only hold Chashtana as posterior to Nahapana but they regard him as viceroy of the Andhra kings Gautamiputra and Pulumayi who defeated Nahapana and totally destroyed his family. Lastly Rapson in his recent book "Catalogue of Indian Coins (Andhras and Western Kshatrapas)" has, after weighing all evidence, come to the following conclusion. "All that is known as to the duration of Chashtana's reign, both as Kshatrapa and Mahākshatrapa, is that it must be included, together with the reign of his son Jayadāman as Kshatrapa in the period limited by the years 46 and 72, i.e. A.D. 124 and 150."

It is with great diffidence that I maintain against this

brilliant array of formidable opponents that Chashtana certainly did flourish before Nahapana and as such was not the viceroy of the Andhra Kings, who conquered the latter, and that there is every reason for the belief, and none against it, that he flourished as early as A.D. 78. I give my reasons below. In page 35 of the "Progress Report of the Archaeological Survey of W. India for 1905-6, Mr. D. R. Bhandarkar describes six very old inscription stones at present situated at Bhuj in the stores of the Engineering Department. "Five of these stones," says he, "are on the whole, well preserved and belong to the time of the W. Kshatrapas Of these four refer to the reign of Rudradāman and all bear the same date, viz. the year 52 on the second day of dark half of Fālguna." This inscription conclusively proves that Rudradāman ascended the throne some years (call it x) before A.D. 130. We also know that the latest inscriptional date of Nahapana is 46 (A.D. 124); he must therefore have ceased to reign some years (call it y) after that. We further know that Chashtana and Jayadaman both preceded Rudradaman. If therefore we assume that Chashtana succeeded Nahapana it follows that:—

Chashtana's reign (both as Kshatrapa and Mahākshatrapa) + Jayadāman's reign + x + y = 6 years (i.e. 52 - 46). Assuming x and y to be each even equal to 2 years, the two reigns of Chashtana and Jayadāman are comprised within only two years. This is obviously impossible as Chashtana cannot certainly be held to be an ephemeral king in view of the honorific mention of his name by Ptolemy in connection with Ujjayini. Such a mention unmistakably shows that Chashtana ruled for sufficiently long time to have his name closely associated with the city which had once been his capital. It may of course be argued that Ptolemy mentioned his name because he was the reigning king at the time Ptolemy wrote his accounts and hence such a mention does not indicate anything regarding the length or importance of the reign. But I shall hereafter show that Chashtana was not the reigning king at the time of Ptolemy.

Rapson assigns Chashtana to the "period between Saka 46 and 72 = A.D. 124 and 150." It is not a little strange that a scholar of his type should have failed to notice the important inscriptions which push back the date of Rudradāman by 20 years. These inscriptions were made known at least two years before the book was published, and yet we do not find any allusion to them in the book.

Mr. V. Smith has of course noticed the inscriptions but then he seems to have clung to his old opinion still. A simple statement of his chronological scheme, will, I believe, throw the whole of it into discredit

"In the year A.D. 126 the Andhra King Vilivāyakura II utterly destroyed the power of Nahapana."

“After the destruction of Nahapana the local government of the west was entrusted to one Chashtana who seems to have been a Saka and to have acted as viceroy under the Andhra conqueror.”

“Previous to A.D. 130, the satrap Rudradaman, grandson of Chashtana, had assumed the government of the western provinces.”

V. Smith makes no mention of Jaydaman, but we know from coins that he certainly ruled between Chashtana and Rudradāman (Rapson, *ibid.*, p. 76). Chashtana ruled both as Kshatrapa and Mahākshatrapa, his son ruled as Kshatrapa, and all these are comprised within two to three years. I believe every impartial mind would at once reject this scheme as wholly improbable.

If then Chashtana is not the successor of Nahapana what would be his probable date? It is generally assumed that four generations of kings cover one century. We may apply this with more confidence in this case as we know that the three generations of kings, viz Rudradaman, his son Dāmajadasri and his grandson Jivadāman, ruled between the years 52 and 120 of Saka years, i.e. for about 70 years. If we hold the first three kings also to have ruled for 70 years Chashtana's accession falls about the year 2 of the Saka era. The last date of Dāmajadasri, fourth in descent from Chashtana, is 100 Saka era. This also places Chashtana at the beginning of the era. Again the two lineal successors of Rudradaman ruled from A.D. 72 to 120 or 48 years. If we assign the same period to his two predecessors the accession of Chashtana falls about the year 4 of the Saka era. Lastly as the beginning of Rudradaman's reign almost coincides with the end of Nahapana's, Rudradaman's two predecessors' may be held to be contemporary with Nahapana and his predecessor Bhumaka. Now these two are known to have reigned for about 46 years. This also agrees with the other conclusions we have arrived at regarding the date of Chashtana.

Thus we arrive at a probable date of Chashtana within 2 to 4 years of the era uniformly used by the W. Kshtrapas. Bearing in mind that Chashtana is described in all the genealogies of the W. Kshatrapas as the founder of that dynasty the conclusion is almost irresistible that he should be held to be contemporary with the foundation of the era. That era has unanimously been taken to be the Saka era and the most probable date for Chashtana is therefore A.D. 78.

I have already answered to some extent the objection that will possibly be raised that Chashtana is thus made considerably earlier than Ptolemy. I have said that the statement in Ptolemy “Oozene, the royal residence of Tiastenes” does not necessarily signify that Tiastenes was a contemporary of Ptolemy. I shall now prove this beyond all doubt. Now

Ptolemy mentions Siro Polemaios (King Pulumayi) in the same way as he does Chashtana. Ptolemy's account must therefore have been written after the accession of that prince. This took place some years after A.D. 131 (V. Smith gives the date 138, Rapson gives the date $131 + x$, where x may be taken to be any number less than 10), whereas Chashtana must have ceased to reign some time before the year 130, as we find his grandson ruling in that year. Chashtana therefore cannot have been living at the time when Ptolemy wrote his book. It follows further from this deduction that it is not legitimate to take Ptolemy to mean that the kings whom he associated with some distinguished cities were necessarily his contemporaries. The only certain and legitimate conclusions from Ptolemy's statement regarding Chashtana are:—

(1) That Chashtana must have flourished before and not after the death of Ptolemy, which event probably took some years after A.D. 161.

(2) That he was a famous king of Ujjayini, with the name of which city his name was very familiarly associated.

Both these conditions are satisfied by our assumption that he conquered Ujjayini and founded a royal line there about A.D. 78

Thus we see that the historical evidence corroborates the Jaina tradition that 135 years after Vikrama the Sakas again conquered Ujjayini; we need only add "under the leadership of Chashtana."



25. Improvements in Measurements with Quadrant Electrometers.

By V. H. JACKSON, M.A., and A. T. MUKERJEE, M.A.

[Read at the first Indian Science Congress, January 15th, 1914.]

[With Plate XXIII.]

The difficulties connected with the use of quadrant electrometers in India are well known. It would be hard to suggest a more unfavourable climate for accurate electrostatic work than that e.g. of Patna, where a period of two or three very hot months during which everything becomes covered with dust is succeeded by another of three or four months in which the air is practically saturated with moisture and the laboratory temperature usually remains between 28° and 34° C. Even if it were worth while for special reasons, the older type of Kelvin quadrant electrometer could scarcely be converted under any circumstances into an instrument which would work satisfactorily under such conditions, owing to the troubles connected with its glass insulation. Though electrometers of the Dolezal k type are much more simple in use as well as more sensitive, they do not give satisfactory results in India without special precautions, and we believe that for this reason their use in physical laboratories in this country is more limited than is desirable in view of the increasing importance of electrostatic measurements.

We have been working on this subject in the laboratory of the Patna College at intervals extending over more than four years, and the object of this short paper is to show that a few comparatively simple additions to the electrometer are all that are necessary to render it capable of very accurate work even during the dampest weather of the monsoon. These additions are required (1) to secure greater accuracy in the observations, and (2) to maintain high insulation under all circumstances. These may be discussed separately.

(1) *Improvements in accuracy of measurement.*

It is unnecessary to elaborate the point that no measurements can be trusted unless all keys and connections which are used are efficiently screened from electrostatic disturbances.

In electrometer work as in many other electrical measurements it is advisable, especially in India, to depend as far as possible on air for insulation and solder for contacts.

The most serious practical difficulty is the slight shift of the zero of the electrometer which is usually noticed when one

pair of quadrants is insulated after being earthed. As this varies from time to time, and may amount to two or three scale divisions or even more, it is impossible to obtain anything like accuracy in measurements, such as those on capacity, in which a knowledge of the true deflection is required. Of course the zero-shift hardly matters when ionisation currents are being observed.

This defect can usually be traced to the fact that the wire which makes connection with the quadrants is supported on some insulator, and that this has become electrified by some accidental disturbance. When this insulator consists of paraffin with the usual mercury cups let into it, the shift of zero is sometimes very marked, and on several occasions we have found that after a key of this type has been merely moved from one place to another it has had to be kept with all its cups earthed for more than twenty-four hours before the effect disappears.

For measurements such as the ionisation of gases due to radioactivity, the only essential key is a simple one to connect the quadrants to earth. For general work, however, it is convenient to use a key which will give all the connections required. If this key is made up as a separate apparatus it requires its own and a more complicated type of insulation, thus increasing the liability to accidental electrification.

In all measurements it is desirable to have some means for ascertaining the capacity of the electrometer and other apparatus used in connection with it, at any time, since the capacity of the quadrants depends to a large extent on the potential of the needle. The number of connections which should therefore be arranged on the key is five, namely :—

- (1) To one pair of quadrants (the other pair always earthed).
- (2) To one pole of a standard cell, the other being earthed.
- (3) To earth.
- (4) To a condenser of known, preferably variable, capacity.
- (5) To the ionisation or other apparatus used in the measurements.

The only special device necessary is one to prevent a short-circuit of the standard cell by accidental connection between (2) and (3).

The following arrangement which we have adopted secures these requirements, and at the same time reduces the amount of insulation required to a minimum :—

A stout brass wire is screwed underneath the electrometer to the terminal of one pair of quadrants. This carries at its other end four small brass rings, through each of which a brass cylinder, kept in metallic connection with the wire by a soldered spiral, can be pulled in the usual way by means of silk loops, the insulation of the latter being further improved by sulphur on the hooks. The pointed and amalgamated ends of the

cylinders are adjusted so as to dip when necessary into metal cups containing mercury, which are carried by stout wires, entirely in air, or through small sulphur plugs, from the other parts of the apparatus. The key thus amounts to an ordinary four-way key in permanent connection to one pair of quadrants, with lateral and diagonal connections which can be operated from a distance by threads. Practically the whole of the insulation of this key is thrown on the ambroid insulators of these quadrants, and as it can be enclosed in the same case as the electrometer no separate drying agent is necessary

Simple adjustments are added to centre the points of the cylinders in the mercury cups, and to prevent breaking the suspensions by sudden jerks.

The connections are shown in the diagram.

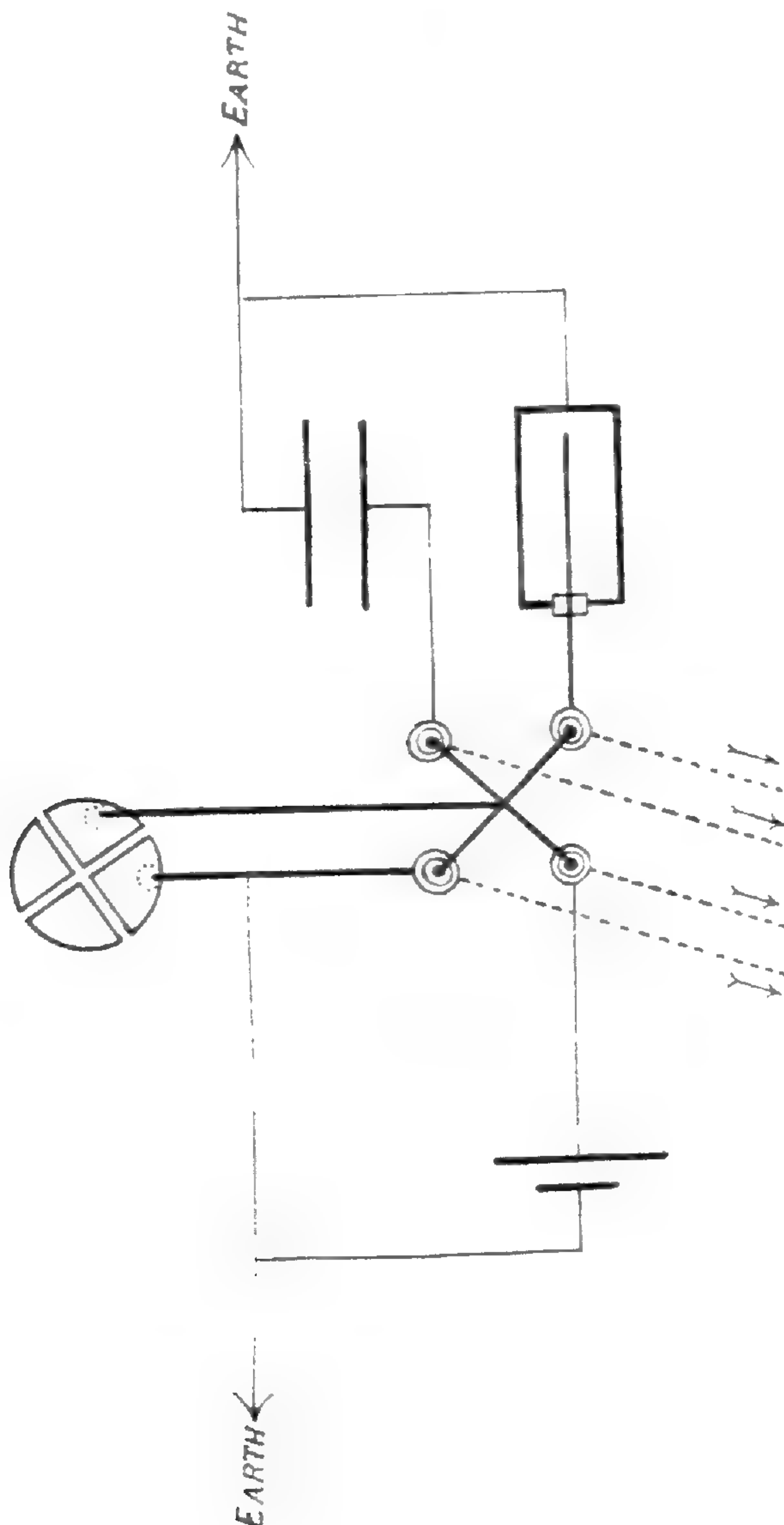

If an ordinary cylindrical air-condenser is used as the standard capacity, it is convenient to enclose it in the electrometer case. The standard cell may also be shut up in this case, but if the silk were to break it would be short-circuited, so that it is preferable to take the wire which supports the mercury cup connected to it through the wall of the case by means of a sulphur plug. A similar plug is necessary in any case in order to establish connection between the quadrants and the testing vessel outside.

On the table which carries the lamp and scale, arrangements are made so that the observer can easily operate the threads to charge, insulate, or discharge the quadrants and any other apparatus connected to them on the key. It is thus possible either to check the capacities at any time or to keep the condenser connected in parallel with the quadrants when it is desirable to increase the capacity of the latter.

Provided that the points of the cylinders which make contact with the mercury are well amalgamated, the trouble caused by zero-shift on insulating the quadrants disappears.

The capacity of a key of this kind is small, between five and ten electrostatic units.

(2) *Improvements in insulation.*

Using a key of the type just described, a series of observations on the insulation of the various parts of the apparatus was made from July to October, 1913, i.e. at the most unfavourable season.

In electrometer work, it is usually considered that the insulation is satisfactory when the rate of leak from the quadrants which after being charged to about one volt are then insulated does not exceed $\cdot 01$ volt per minute¹. This is a reasonable standard to accept, and it will be seen that with the arrangements adopted by us there is no difficulty, even during the monsoon, in keeping the leakage at less than half this amount for many days.

The capacity of the air-condenser used in our measurements was about 80 E.S.U., or at least three times as large as that of the quadrants and attached key. Hence when the quadrants and condenser are connected in parallel, the rate of leak ought not to exceed $0\cdot 0025$ volt per minute, if the insulation of the latter is good.

The surface of the ambroid insulators of the quadrants must of course be carefully cleaned. A point often overlooked is that these insulators are hollow, and the walls of the cavity are usually more in need of cleaning than the exterior.

When no drying agent is used, the leak from the quad-

¹ e.g. Makower and Geiger, *Pract. Radioactivity*, p. 13.

rants, except perhaps in very dry weather, is usually two or three times as large as the maximum defined above, and in wet weather becomes still greater. The tubes of the air-condenser were insulated from one another by ebonite. This substance is extremely sensitive to moisture, and the leak without the use of drying agents was from ten to more than a hundred times its proper value.

TABLE I.

Electrometer and condenser enclosed in teak case. Quadrants charged to 1.018 volt before insulating Front of case opened only for the measurements. No drier used.

Date 1913.	LEAK AFTER INSULATING (VOLTS PER MINUTE).	
	Quadrants only.	Quadrants + Condenser.
April 3rd	0.032	..
„ 4th	0.023	0.090
July 31st	0.039	..
August 7th	0.025
„ 8th	0.025	..
„ 13th.. ..	0.032	..

Calcium chloride was introduced into the case on August 9th. Table II shows that this had no effect four days later. It also shows that when the case was kept open for some hours on a very damp day the increase of the leak, especially on the ebonite of the condenser, was very rapid.

TABLE II.

August 13th, 1913. Raining. Front of case kept open from 11 a.m.

Time.	LEAK AFTER INSULATING (VOLTS PER MINUTE).	
	Quadrants only.	Quadrants + Condenser.
11-0 a.m.	0.032	..
11-20 a.m.	0.076
11-45 a.m.	0.058	..
11-50 a.m.	0.150
2-30 p.m.	0.067	..
2-40 p.m.	0.300

DIAGRAM I

Volts/min

Leak of Quadrants

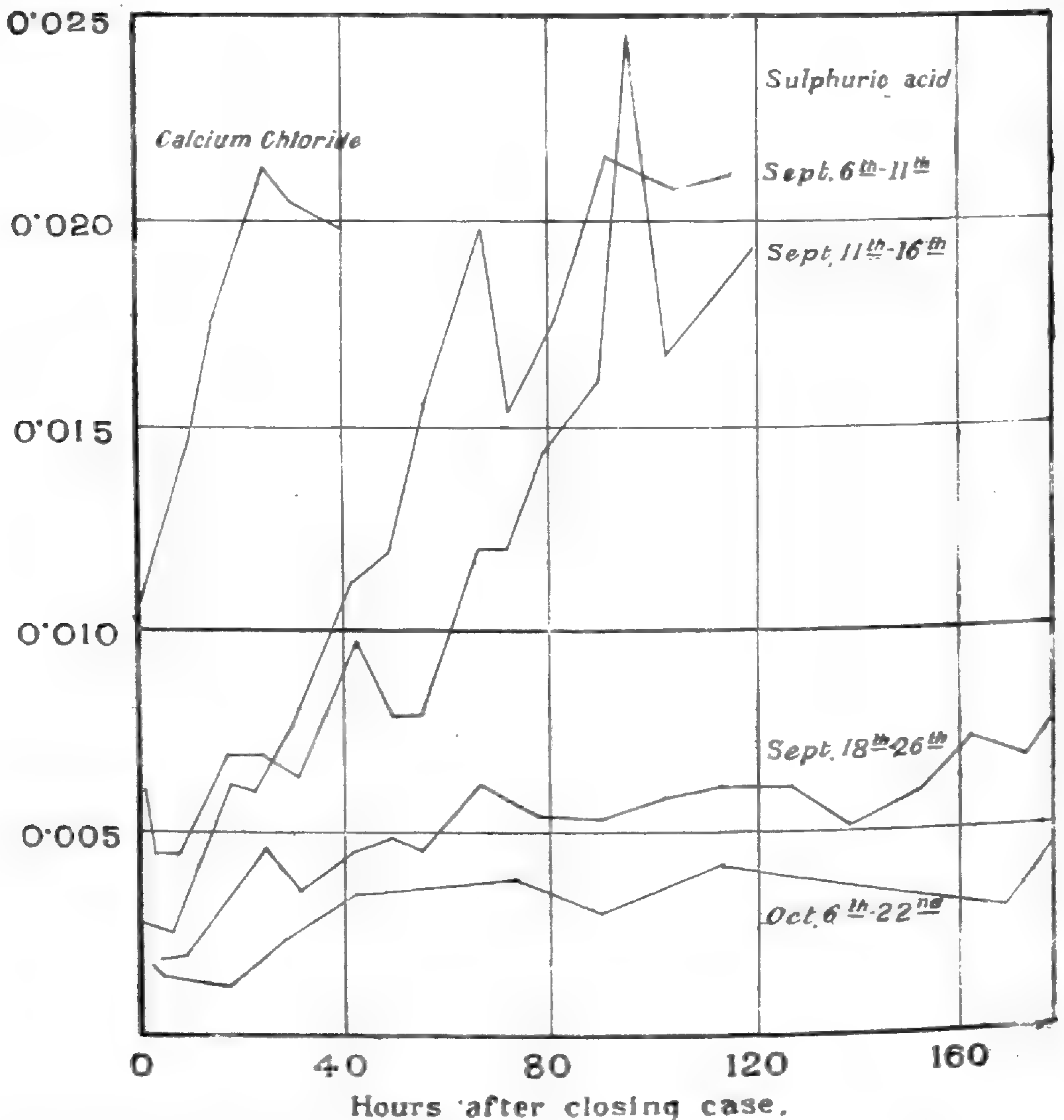

As it was obvious that no improvement could be expected so long as the electrometer case had to be kept open during a series of measurements, modifications were introduced so that it became unnecessary to open the case at all. The glass front was replaced by teak, with a mica window for the ray of light to the mirror, and with four very small holes through which the threads passed to connect with the key. As the needle was suspended by a quartz fibre, an arrangement was added so that when necessary it could be charged from the outside of the case, by connecting the phosphor bronze strip to one terminal of a battery and then screwing it up, against a spring, into connection with the suspension.

DIAGRAM II

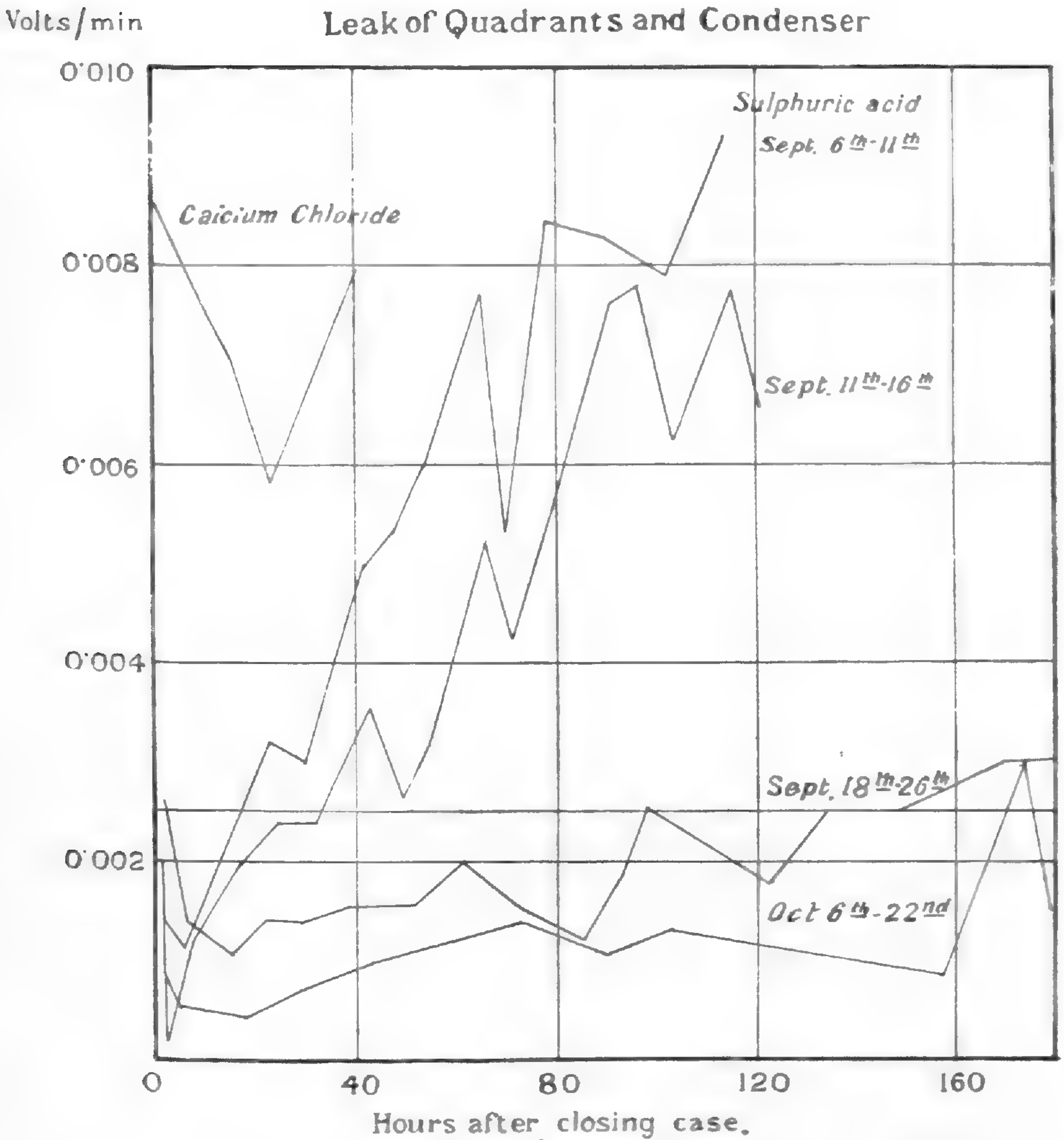

After this alteration, calcium chloride was again introduced into the case, which was then closed. It will be seen from Diagram I, which shows the quadrant leaks under various conditions, that calcium chloride is unsuitable. Though the leak immediately after the case was closed fell to near the standard value of 0.01 volt per minute, it rapidly increased to double this value after 16 hours, after which it remained more or less steady. On the ebonite of the condenser the improvement lasted rather longer, as is shown in Diagram II. The results for the first sixty hours after the case was closed are summarized in Table III:—

DIAGRAM III

Volts/min

Leak of Quadrants & Sulphur Plug.

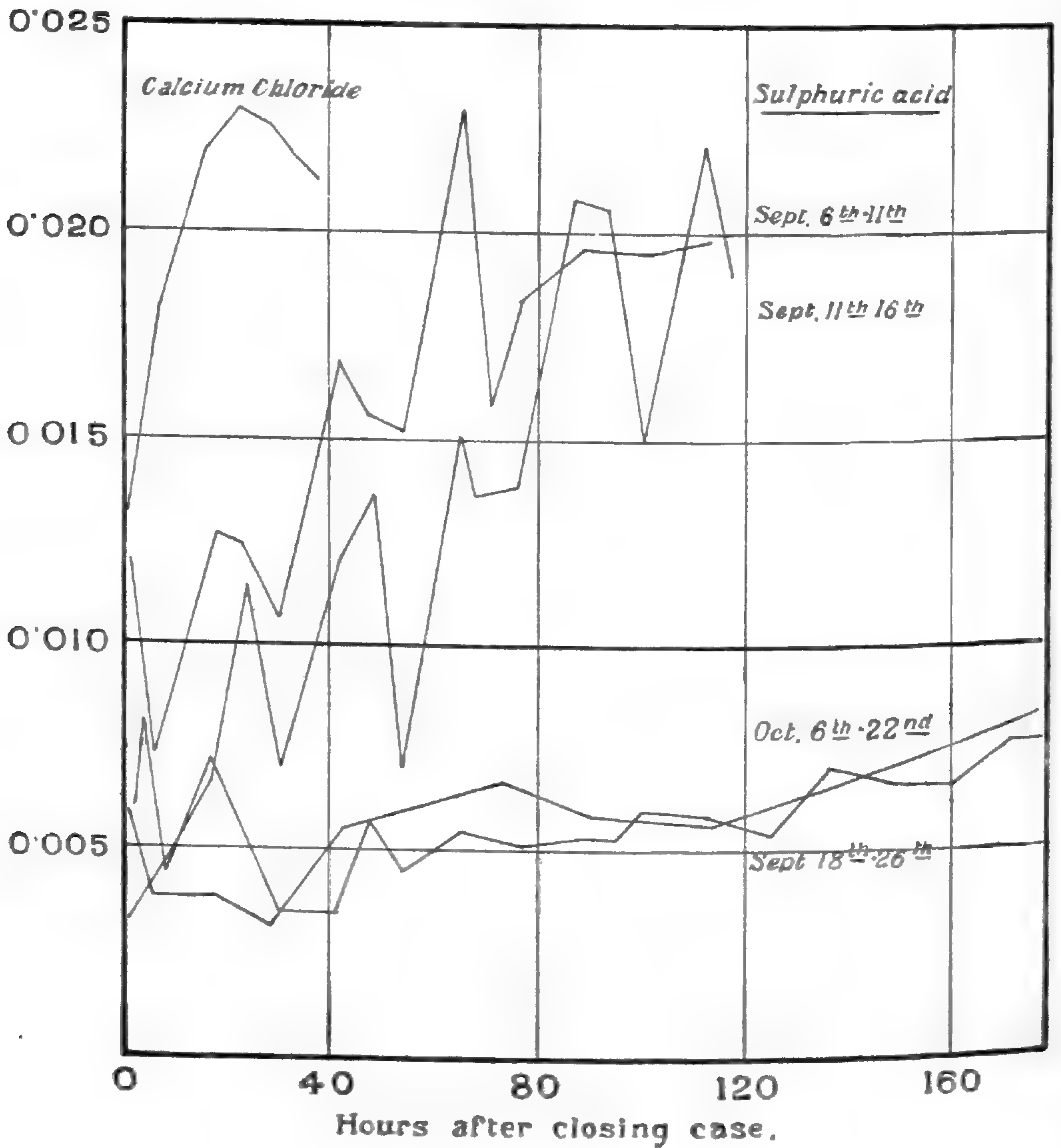

TABLE III.

Drying agent, calcium chloride. Teak case. August 26th to September 4th.

Hours after closing.	LEAK AFTER INSULATING (VOLTS PER MINUTE).	
	Quadrants only.	Quadrants + Condenser.
4	0·012	0·0082
12	0·016	0·0073
24	0·021	0·0059
36	0·020	0·0074
48	0·019	..
60	0·019	..

When strong sulphuric acid was substituted for the calcium chloride, the improvement of the insulation was very marked at first. After about six hours the leak from the quadrants fell to a minimum value of about 0·0025 volt per minute, or only one quarter of the maximum allowed. The insulation of the condenser also greatly improved. The effect, however, was merely temporary. After forty hours the quadrant leak exceeded 0·01 volt per minute, and continued to increase until after three days it reached more than double that value.

In Table IV, which shows these results for the first sixty hours, a third series of values has been added, which gives the leak when the quadrants were connected to the sulphur plug through which the connection with apparatus outside the case was made. The outer surface of the sulphur was necessarily exposed to damp air. Before the measurements were made, it was lightly brushed to remove spider webs, which are frequently formed on all insulators not protected.

TABLE IV.

Drying agent, sulphuric acid. Teak case. September 6th to 11th.

Hours after closing.	LEAK AFTER INSULATING (VOLTS PER MINUTE).		
	Quadrants only.	Quadrants and sulphur plug.	Quadrants and condenser.
4	0·0026	0·0092	0·0014
12	0·0044	0·0100	0·0018
24	0·0065	0·0127	0·0032
36	0·0095	0·0140	0·0041
48	0·0124	0·0156	0·0054
60	0·0178	0·0195	0·0066

These observations made it clear that moisture gradually entered the case, so that the sulphuric acid became more and more dilute until it ceased to produce any effect. It was thought that this moisture probably entered by diffusion through the teak, so that this was soaked in paraffin to protect it from direct contact with moist air. This merely retarded the deterioration of the insulation. A leak of 0·01 volt per minute from the quadrants was not reached until sixty hours after the case was closed. These measurements, made from September 11th to 16th, are shown in the diagrams.

In order to test whether diffusion of water vapour through the wood was the cause of the failure of the insulation, the whole of the case was protected with a zinc cover, soldered at all edges so that moisture could only reach the interior through the small holes left for the passage of the threads to the key. Observations made after this alteration showed that a satisfactory solution had been obtained, as although the wood was damp when first enclosed the leak of the quadrants remained below 0·01 volt per minute for nine days after the case was soldered up. For the first sixty hours the measurements are shown in Table V:—

TABLE V.

Drying agent, sulphuric acid. Sealed zinc case. September 18th to 26th.

Hours after closing.	LEAK AFTER INSULATING (VOLTS PER MINUTE).		
	Quadrants only.	Quadrants and sulphur plug.	Quadrants and condenser.
4	0·0018	0·0081	0·0020
12	0·0027	0·0058	0·0012
24	0·0044	0·0052	0·0014
36	0·0038	0·0034	0·0014
48	0·0048	0·0055	0·0015
60	0·0055	0·0047	0·0018

When the wood inside the zinc cover had become thoroughly dry, the improvement of the insulation became still greater. In the final series of observations, the first part of which is shown in Table VI, the quadrant leak remained below the standard value for more than fifteen days, although the weather was very unfavourable owing to heavy rain from October 13th to 16th.

TABLE VI.

Drying agent, sulphuric acid. Sealed zinc case. October 6th to 22nd.

Hours after closing.	LEAK AFTER INSULATING (VOLTS PER MINUTE).		
	Quadrants only.	Quadrants and sulphur plug.	Quadrants and condenser.
4	0·0015	0·0043	0·0006
12	0·0013	0·0039	0·0004
24	0·0015	0·0035	0·0006
36	0·0028	0·0045	0·0008
48	0·0035	0·0057	0·0010
60	0·0038	0·0062	0·0012

In all the above measurements the rate of leakage observed was slightly greater than the figures given in the Tables, on account of the diminution of deflection due to the gradual loss of charge on the needle. This was found to be practically independent of the drying agent used. The apparent leak did not exceed the true leak by more than 0·001 volt per minute in any case, and was usually about 0·0008 volt per minute in excess.

(3) *Increase of accuracy obtained.*

A few examples are added to show that with a constant zero and the high degree of insulation already secured, the accuracy of measurements of capacity by the ordinary method of mixture is much increased.

(a) *Effective capacity of the electrometer.*

Consecutive tests with a condenser of known capacity gave the following results for capacity of the quadrants and attached key, when the needle was charged to 16 volts :—

	February 17th, 1910.	January 8th, 1914.
	52·6	26·25
	56·5	26·20
	60·9	26·24
	57·6	26·19
	53·8	26·22
	55·6	26·42
	54·7	26·32
	54·5	26·29
	—	—
Mean ..	55·8	26·27
	—	—
Probable error of a single observation..	1·75	0·04

In the earlier series the electrometer needle was of the original paper type, and the key was separate, its capacity together with connections being about 21 E.S.U. In the later measurements an aluminium needle and the later type of key were used, the capacity of the latter being about 8 E.S.U.

Measurements of capacity by the method of mixture probably do not reach as a rule a higher standard of accuracy than that of the earlier series quoted above. For instance, the figures given by F. C. Brown,¹ in a recent paper on "A practical electrical method of measuring the distance between parallel conducting planes" show that the values of consecutive measurements varied by several electrostatic units:—

	45·1	31·2	96·6
	36·1	35·7	100·9
	32·9	30·0	99·1
Mean ..	38·0	32·3	98·9

(b) Variation of the effective capacity of the quadrants with the potential of the needle.

In February 1898 Prof. Clifton at the Clarendon Laboratory, Oxford, first noticed that the effective capacity of the quadrants of an electrometer depended very largely on the charge given to its needle. By increasing the charge on the needle of his modification of the Kelvin type of instrument, from a value which gave moderate sensitiveness to one at which the limit of stability was almost reached, Clifton found that the effective capacity of the quadrant system was increased practically five-fold. The capacity of the parallel-plate air-condenser, which was kept constant during the measurements, and the potential given to the needle, were not measured, but a summary of his results shows the effect very clearly:—

Date, 1898.	Sensitiveness.	Capacity of quadrants (Air condenser = 1).
February 2nd ..	100	0·51
.. 2nd ..	264	2·54
.. 4th ..	190	1·62
.. 5th ..	163·5	1·30

Owing no doubt to the very high values of the charge on the needle, the sensibility was not proportional to its potential, and the true connection of the latter with the variation of the capacity was not apparent.

The measurements summarized in the following Table

¹ *Phys. Review*, 2nd Series ; II, 4 ; Oct. 1913 ; page 317.

show that in accordance with the theory first given by Sir J. J. Thomson,¹ and since developed by Stewart,² Beattie,³ and others, the effective capacity of the quadrants, as determined by the method of mixture with a known capacity, varies as the square of the potential given to the needle. The figures in the third column of this Table have been calculated from the equation $C = 24.5 + 0.0114 V^2$. In order to make the initial deflection of the electrometer approximately constant, the potential applied to the quadrants was varied, but in no case exceeded 1.018 volt.

TABLE VII.

Needle charged to	Capacity observed.	Capacity calculated.
2.0 volts	24.6 E.S.U.	24.5 E.S.U.
5.8	25.1	24.9
15.6	27.0	27.3
19.7	28.4	28.9
23.8	30.3	30.0
26.0	32.2	32.2
29.6	33.9	34.5
34.8	37.3	38.3
37.4	41.1	40.5
41.4	43.5	44.0
46.5	49.2	49.2
49.4	53.4	52.5

Allowing for the capacity of the key, that of the quadrant system with an uncharged needle was therefore about 16 E.S.U.

(c) Observations of the insulation resistances of the arrangements described in this paper, made from November 11th to 18th, 1913, gave the following results:—

Quadrants + key	..	0.4 to 0.6 × 10 ⁶	megohms.
Ebonite of condenser	..	2.0 to 6.0 × 10 ⁹	„
Sulphur plug	..	0.2 to 0.6 × 10 ⁹	„

Though ebonite is much affected by moisture, its insulation resistance is extremely high in a thoroughly dry atmosphere.

The arrangements described in section 2 of this paper cannot be regarded as entirely satisfactory, as moist air is still allowed free access to the inside of the electrometer case, through the four small holes left for the passage of the threads to the key. Temperature differences amounting to four or five degrees are set up when the laboratory doors are kept open. As the capacity of the case is about forty litres, a difference of five degrees at a mean temperature of 30° C would set up a flow

¹ Phil. Mag. 46, p. 537, Dec. 1898.

² Phys. Review, 1st Series; XXI, 4; Oct. 1905; p. 229

³ Electrician, LXV, No. 18; Aug. 12, 1910; p. 729.

of about 600 c.c. of air in or out of the case, and this, if saturated, would carry about 0·02 gm. of water with it. In course of time the sulphuric acid would become too dilute to exert any influence on the insulation. It is evident from the diagrams that this actually takes place. About twenty-four hours after fresh acid has been introduced and the case sealed, the insulation commences to deteriorate, and in damp weather it would be necessary to reopen the case after about a month in order to renew the acid.

It would of course be easy to make arrangements to renew the acid without opening the case. As we wish to test the effect of more powerful desiccators than sulphuric acid, such as phosphorus pentoxide (or metallic sodium), we think that it would be better either to make the case absolutely airtight, or to allow the free circulation of air to continue, whilst ensuring that any air which enters the case is thoroughly dried. By passing the threads through small U tubes containing mercury, direct communication with moist air can be prevented. This point is now under investigation.

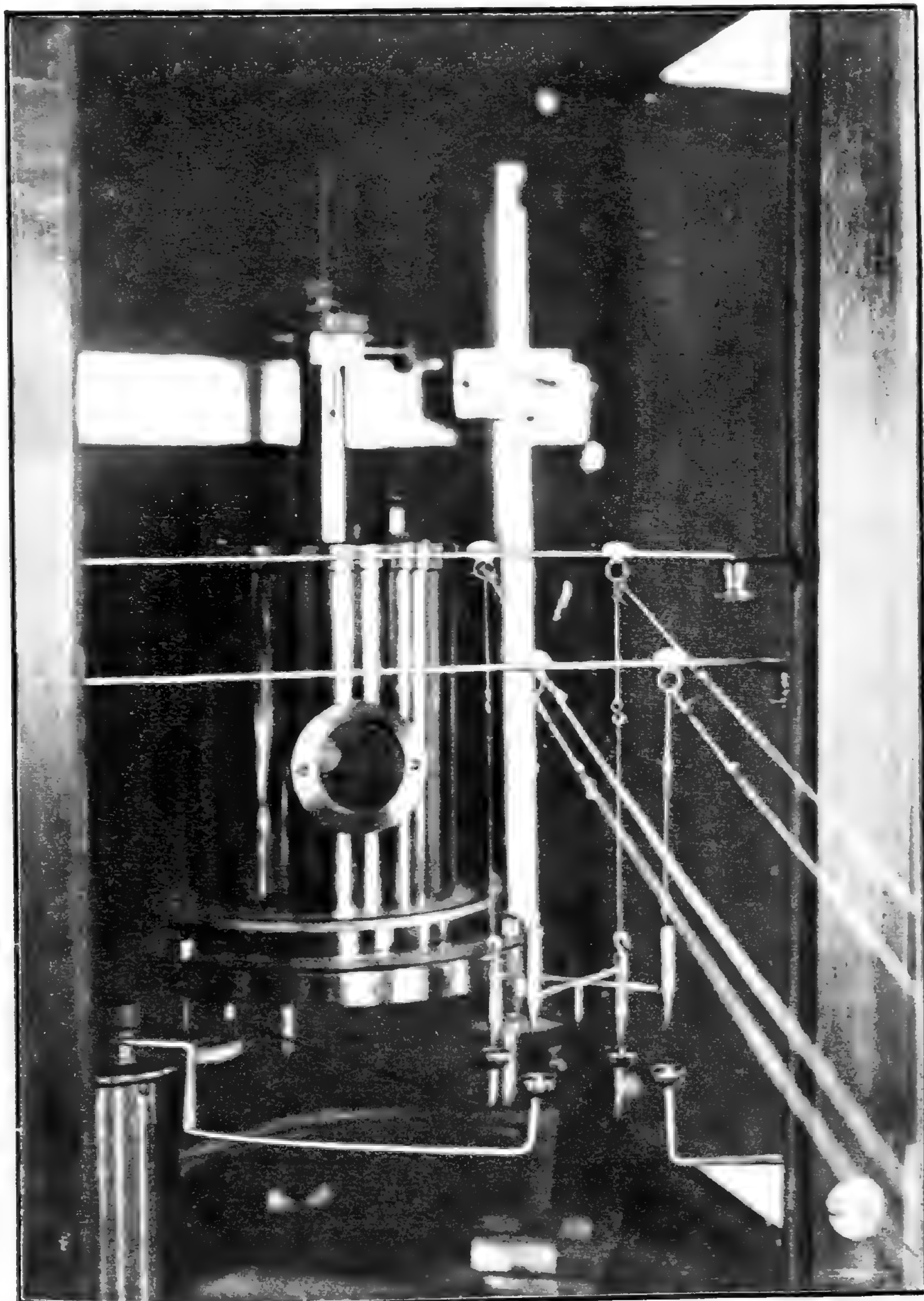

ARRANGEMENTS INSIDE CASE OF ELECTROMETER.

26. Jhalrapatan Stone Inscription of Udayaditya
[Vikrama] Samvat 1143 (1086 A.D.).

By SĀHITYĀCHĀRYA PROF. PT. BISHWESHWAR NATH,
SHASTRI, Jodhpur.

[With Plate XXII.]

This stone inscription lies in Sarvasukhiyākoṭhi at Jhāl-rāpātān. It contains ten lines of writing which cover a space of 8" (in breadth) by 6½" (in height.) It is well preserved. The characters are Nāgarī. The letters in the first seven lines are bigger than those in the last three.¹ The language is Sanskrit and the whole of the inscription is in prose.

The inscription is dated the 10th of the bright half of Vaiśhākha in the [Vikrama] year 1143. It is mentioned in this inscription that Janna a teli Patel built a temple of Śiva and dug a vāpi (tank) in the reign of Udayāditya. Two praśastis (eulogies) of Udayāditya, dated Vikrama Samvat 1116 and 1137, have already been published. From this inscription it appears that Udayāditya Paramāra reigned till 1143. How this prince was related to Paramāra Bhoja has not yet been known. But his inscriptions show that he was related to Bhoja. A copper-plate of Paramāra Jayasinha I, dated Vikrama Samvat 1112 (A.D. 1055), published in Epigraphica Indica, vol. III, page 48, shows that Bhoja was succeeded by Jayasinha and afterwards by Udayāditya. A detailed account of these has been published by me in the issue of January 1914 of the Saraswati Magazine.

TEXT.²

- 1 ओं³ नमः शिवाय ॥ संवत् ११४३ वैशाख⁴शुदि १० अ-
- 2 येह श्रीमदुदयादित्यदेवकल्याणविजयराज्ये । तै-
- 3 लिक्कान्वय(ये) पट्टकिल⁵चाहिलसुतपट्टकिल⁶जन्न [के]-
- 4 न शंभोः प्रासादमिदं कारितं⁷ । तथा चिरिहिहल्लतले चा-

¹ It is probable that the last lines may have been engraved afterwards.

² From an impression kindly supplied by Mr. G. H. Ojha.

³ Denoted by a symbol.

⁴ Read वैशाख ।

⁵ Read पट्टकिल ।

⁶ Read पट्टकिल ।

⁷ Read प्रासादोऽयं कारितः ।

- 5 डाघौषकूपिकाव्रुवासकयोः अंतराले वापी च ॥
 6 उत्कीर्ण्यं पडित¹ हर्षुकेने² ति ॥ * ॥ जानासत्कमा-
 7 ता धादृणिः प्रणमति ॥ श्रीलोलिगस्वामिदेवस्³ केरिं⁴-
 8 तैलका⁵ न्वयपट्टकिल⁶ चाहिलसुतपट्टकिल⁷ जंनकेन ॥ श्रीसेंधव-
 देवपर-
 9 वनिमित्यं⁸ दीपतैल्य⁹ चतुःपलं मेकं मुदकं क्रीत्वा¹⁰ तथा वरिषं¹¹
 प्रति स(°)विष्ठा-
 10 ॐ तं ॥ ॐ ॥ मंगलं महाश्री ॥ ६

TEXT.¹²

1. Om¹³ namaḥ Śivāya ॥ samvat 1143 Vaisa(śā)kha Śudi
 10 a-
 2. dyēha Śrīmad-udayādityadēvakalyāṇavijayarājye | Tai-
 3. likānvayē PaṭṭakilaCāhilasutaPaṭṭakilaJanna-[kê]-
 4. na Śāmbhoḥ prāsādamīdam¹⁴ kāritam¹⁵ | Tathā Cīrihil-
 latalêchā--
 5. dâ-ghaushâ-kūpikāvruvāsakayoh antarālêvāpicha ॥
 6. utkirṇṇ-ēyam Paḍita¹⁶ Harṣukēnēti¹⁷ ॥ * ॥ Jānāsātkamā-
 7. tā Dhāiniḥ praṇamati ॥ Śrī Lōligasvāmidēvassa¹⁸
 kērim¹⁹
 8. Tailakānvāē²⁰ PaṭṭakilaCāhilasutaPaṭṭakilaJannake-
 na ॥ Śrī Sēndhavādēvapara
 9. -va²¹ nimityam²² dīpateilya²³ catuḥpalam-ēkam muda-
 kam²⁴ kṛitvā tathā varīṣam²⁵ prati savi-[jnā]-
 10. ॐ tam²⁶ ॥ ॐ ॥ Maṅgalam Mahāśrī ॥ ६

1 Read पडित ।

2 Read हर्षुकेणे ।

3 Read °देवस्य ।

4 The meaning is not clear : perhaps कृते is meant.

5 Read तैलिका ।

6 Read पट्टकिल ।

7 Read पट्टकिल ।

8 Read पवनिमित्तं ।

9 Read तैल ।

10 The meaning is not clear : perhaps मोदकं क्रीत्वा is meant.

11 Read वर्ष ।

12 From an ink impression kindly supplied by Mr. G. H. Ojha.

13 Denoted by a symbol.

14 Read prāsādoyam.

15 Read karitaḥ.

16 Read Paṇḍita.

17 Read Harṣukēnēti.

18 Read Dēvasya.

19 Read kṛitê.

20 Read Tailikānvayê.

21 Read parva.

22 Read nimittam.

23 Read taila.

24 Read Mōdakaṁ.

25 Read varṣam.

26 Read Samvijñātam.

TRANSLATION.

1. Om! Reverence to Śiva.
In Saṅvat 1143 on the 10th of the bright half of the
month Vaiśākha.
 2. To-day in the prosperous reign of Udayādityadêva.
 3. Taili Patêla Châhila's son Patela-Janna.
 4. Erected this temple of the god Śiva and also in
Chirihilla.
 5. Between Châdâghansha Kûpikâ and Vruvasaka (dug) a
Vâpî (tank).
 6. This inscription is engraved by Paṇḍita Harṣuka, the
mother of Janna.
 7. Dhâini bows. For Śrī Loligasvâmidêva.
 8. Taili Patela Châhila's son Patela-Janna at the cere-
mony of Sêndhavadêva.
 9. Promises four pala (a measure) oil and a ball of sweet
to be offered every year.
 10. Prosperity! Great fortune!
-

नमो शिवाय ॥ सर्वस्य १४३ ॥ वर्षा ॥ ५१ ॥ ॥ ॥
 ॥ इन्द्रा ॥ मद्रमा ॥ दिगा ॥ दिववा ॥ पवित्र ॥ मा ॥ द्या ॥ न
 ॥ विष्णु ॥ वा ॥ पृथु ॥ कि ॥ न ॥ वा ॥ नि ॥ त्र ॥ न ॥ पृ ॥ थु ॥ कि ॥ त्र ॥ न
 ॥ न ॥ शं ॥ नि ॥ ः ॥ पा ॥ अ ॥ ध ॥ मि ॥ र ॥ का ॥ नि ॥ त ॥ त्र ॥ वा ॥ वि ॥ नि ॥ दि ॥ नू ॥ त ॥ रि ॥ त्त ॥
 ॥ डा ॥ पि ॥ त्र ॥ क ॥ पि ॥ का ॥ बु ॥ वा ॥ स ॥ क ॥ मा ॥ इ ॥ त ॥ रा ॥ ल ॥ वा ॥ पी ॥ ति
 ॥ उ ॥ क ॥ म ॥ भ ॥ पा ॥ ट ॥ र ॥ इ ॥ त्त ॥ त्र ॥ इ ॥ ति ॥ ॥ इ ॥ ति ॥ वा ॥ स ॥ क ॥ मा ॥ इ ॥ त ॥ रा ॥ ल ॥ वा ॥ पी ॥ ति
 ॥ वा ॥ पृ ॥ थु ॥ कि ॥ त्र ॥ न ॥ पृ ॥ थु ॥ कि ॥ त्र ॥ न ॥ पृ ॥ थु ॥ कि ॥ त्र ॥ न ॥ पृ ॥ थु ॥ कि ॥ त्र ॥ न
 ॥ इ ॥ ति ॥ वा ॥ स ॥ क ॥ मा ॥ इ ॥ त ॥ रा ॥ ल ॥ वा ॥ पी ॥ ति ॥ इ ॥ ति ॥ वा ॥ स ॥ क ॥ मा ॥ इ ॥ त ॥ रा ॥ ल ॥ वा ॥ पी ॥ ति
 ॥ इ ॥ ति ॥ वा ॥ स ॥ क ॥ मा ॥ इ ॥ त ॥ रा ॥ ल ॥ वा ॥ पी ॥ ति ॥ इ ॥ ति ॥ वा ॥ स ॥ क ॥ मा ॥ इ ॥ त ॥ रा ॥ ल ॥ वा ॥ पी ॥ ति

Jhalrapatan stone inscription of Udayaditya (Vikram) Samvat 1143 (1086 A. D.)

27. NUMISMATIC SUPPLEMENT No. XXIII.

Note.—The numeration of the article below is continued from p. 200 of the “Journal and Proceedings” for 1914.

132. AN UNISSUED RUPEE OF EDWARD-VII.

It gives me pleasure to submit the following description of a noteworthy rupee which I have had an opportunity of seeing. It is of standard weight and diameter, and with straight milling.

Obverse : Broad rim with inner fringe of small semicircles. Crowned bust of King to right; the crown surmounted by an orb and cross: embroidered collar and tippet: star at throat: sash-bow on right shoulder: two chains pendent on breast. Legend: to left of bust, “Edward VII”; to right of bust, “King and Emperor.”

Reverse : Rim as on obverse.
Interior to fringe of rim two linear circles.
Area : Circle with legend.

ONE
RUPEE
INDIA
1910

یک روپیہ

Margin containing wavy line, and enclosing
at top : side view of lotus ;
at bottom : lotus viewed from above ;
to right : rose and shamrock and thistle, each
with leafy stalk ;
to left : same as to right.

It is matter of common knowledge that the design adopted for the rupees that were struck as currency during the reign of Edward VII did not in this country meet with popular approval. The bust on the obverse was not merely uncrowned, it was emphatically bald-headed, and to the Indian mind baldness does not comport with the majesty that should attach to a personage so exalted as a “King and Emperor.” The design, while marked by a severe simplicity that might indeed suggest a certain innate strength, was lacking in those elements of richness and luxuriance which the Oriental deems of the essence of royalty. It is thus not surprising that the mint authorities at Calcutta decided to impress a new design.

In due course fresh dies were prepared, and all the material necessary for a new issue was collected. On the eve of the fateful 6th of May, 1910, everything was in complete readiness, when alas! further action was stayed, for the mournful intelligence flashed across the wires that our beloved King was dead. It would seem, however, that a dozen or so rupees were struck, but none were issued as currency. The new coin, had it been issued, would, I am confident, have won immediate acceptance, inasmuch as the blemishes which in popular estimation had marred the earlier rupee had all been happily avoided. On the obverse King Edward appears as a King indeed, royally robed and crowned.

The new design is for the numismatist of special interest, since clearly it was adopted, *mutatis mutandis*, for the later struck rupees of George V. Of both the reverse is identical, save that on the Edward rupee the date is 1910. We have the same circular area with the same legend, and the same wavy margin, exhibiting at the top and at the bottom the Indian lotus, while on either side come a rose, a shamrock, and a thistle.

On the obverse the bust of King Edward is to right, facing thus the bust on the rupees of the immediately preceding and succeeding reigns. The rim is broad and slightly raised, and the legend reads to the left of the bust "Edward VII," and to the right "King and Emperor" (not the "King Emperor" of our present coin). With these exceptions the unissued Edward rupee is but an "advance copy" of King George's. Both exhibit the same imperial crown surmounted by a Maltese cross, both the same ermine tippet, both the same two chains distinctive of the Orders of the Star of India and of the Indian Empire, and on both we find that same diminutive representation of an elephant which, curiously misapprehended, was to become the storm-centre of so much hostile criticism.

GEO. P. TAYLOR.

133. A NEW COIN OF SHAH ALAM II.

[Plate XXI.]

Mint: Murādābād.

Metal: Copper.

Size: .8 inches = 21 mm.

Weight: 290 grs. = 18.8 grms.

Obverse:

شاه عالم
 بادشاه غار
 سکه مبارک

Reverse :

جلوس
 میمذت
 مانوس سده
 ضر مرادا باد

ن (m. 91. I.M. Cat., vol. 3, p. 359) to the left of ر.

ن in the س of مانوس

Provenance : Amroha, District Murādābād.

No. 2441 in the Indian Museum Catalogue, vol. 3, is a Murādābād rupee of the same king. Rupees of this mint are also known of Aurangzeb, Shāh 'Alam Bahādur, Aḥmad Shāh Bahādur, and 'Ālamgir II, but a copper coin seems to be a novelty.

PANNA LALL, I.C.S.

134. A NEW TYPE OF AUDAMBARA COINAGE.

[Plate XXI.]

Thirty copper coins were made over to me for examination by Dr. A. Venis, C.I.E., of the Queen's College, Benares, which he had received from Mr. Nelson Wright, I.C.S. Subsequently Mr. Nelson Wright sent a batch of 333 coins to me from the same find. They were found in the village of Irippal in the Dehra Tahsil, Kangra District, Punjab. They belong to a very little known variety of the tribal coin of the Audumbaras, which has never been described before.

The earliest notice of a type of Audambara coinage approaching this type was made by Cunningham.¹ He establishes definitely that the Odumbaras or Audambaras were a North-Western tribe because they have been twice coupled by Varāhamihira with the *Kapisthalas*, who were the *Kambisthioli* of Arrian's *Indica*, and with the *Traigarttas* and *Kulindas* in *Mārkaṇḍeya Purāna*. He then proceeds to describe this particular type of coinage :—

“The coins are thin pieces of copper, either square or oblong, with a temple on one face and an elephant on the other. Beside the temple are the Buddhist symbols of the Swastika and Dharmachakra, and beneath it, a snake. Before the elephant there is a tree surrounded by a Buddhist railing, with an Arian legend on two sides, of which one-half reads distinctly *Odumbara*. I conclude therefore that the tree represented is an *Udumbara*.”²

¹ *Arch. Survey. Rep.*, Vol. XIV, p. 116.

² *Ibid.*, p. 117.

In his "Coins of Ancient India" Sir Alexander Cunningham has dwelt on the tribal coins of the Audumbaras at length.¹ In his account he has described only one coin which bears some resemblance to the variety which is being described in this paper. But even in this case the specimen was in such poor condition that the author was obliged to publish a drawing instead of a photograph² from a cast. The following are the points of resemblance between the type published by Cunningham and that under discussion:—

(1) On the obverse, we have in each case (a) a sacred tree inside a railing, (b) an elephant walking towards it, and (c) below these two a snake. The only points of difference are the position of the Kharoṣṭhī legend *Odumbarisa* which is placed under the snake in Cunningham's coins, but which is to be found to the right of the elephant in the new variety, and the figure of the elephant. In Cunningham's drawing the entire body of the elephant is to be found, but in the new variety, the head, trunk and the fore-legs only are to be found. The entire body must have been absent even in the die as the word *Odumbarisa* in Kharoṣṭhī is to be found to the right of the elephant's forepart.

(2) On the reverse we have in each case a temple. The one in the new variety appears to be a three-storeyed one, and slightly different in shape from that in Cunningham's coin. To the right of this we find a trident (*triṣūla*). It differs from Cunningham's drawing in two respects; (a) we find a shaft surmounted by a wheel instead of the *triṣūla*, and (b) we find a *svāstika* on a pillar to the left of the temple.

One hundred and three coins out of this find of three hundred and sixty-three bear names of three of the rulers of the tribe, viz. *Dharaghoṣa*, *Sivadāsa* and *Rudradāsa*. Out of these three the coins of *Dharaghoṣa* have been described before,³ but the other two names are new to Numismatists. Cunningham has included coins of Rudravarma, Ajamitra, Mahimitra, Bhanumitra, Virayaśas and Vṛṣṇi among the coins of the Audumbaras, but none of these seem to have had any connection with that tribe. The coins of *Dharaghoṣa* described by Cunningham expressly mention the name *Odumbara* along with that of the King. So on the coins of *Dharaghoṣa*, *Sivadāsa* and *Rudradāsa*, belonging to this find, we invariably find that the name of the tribe is associated in the legend with that of the King. Consequently the attribution of coins which do not bear the name of the tribe to the Audumbaras, must be very doubtful. All of these coins bear legend both in Brāhmi and Kharoṣṭhī and the complete legends run as follows:—

¹ *Coins of Ancient India*, p. 66.

² *Coins of Ancient India*, pl. IV, 2.

³ *Ibid.*, p. 67.

[N.S.]

Obv. : *Mahadevasa Raña Dharaghoṣasa Odumbarisa* (Kharoṣṭhī).

Rev. : *Mahadevasa Raña Dharaghoṣasa Odumbarisa* (Brāhmī).

In the coins of Rudradāsa and Śivadāsa, the names of the kings, spelt Rudradasa and Śivadasa, are introduced into the Kharoṣṭhī and Brāhmī legends without any further change. The Brāhmī letters belong to the 1st century B.C. when angular forms had taken the place of the more cursive alphabet of the inscriptions of Aśoka. The letters of the Kharoṣṭhī legend would also point to the same date. In the legends the use of long vowels such as *ā*, *ū* *āi* and *au* seems to have been avoided both in Kharoṣṭhī and in Brāhmī, so we have *Śivadasa* for *Śivadāsa*, *Rudradasa* for *Rudradāsa*, *Odumbarī* for *Audumbarī* and even *Mahadevasa* for *Mahadevasa* in Brāhmī. As the names of these princes are very often incomplete I have illustrated eight coins.

I. *Dharaghoṣa.*

1. *Obv.* : Sacred tree within railing, and front part of elephant; traces of Kharoṣṭhī legend to left.

Rev. : Trident with banners and traces of temple to left. Brāhmī legends: on top, *Mahadevasa ra (ña)*, to right, *Dharagho (ṣasa)*.

2. *Obv.* : Sacred tree. Kharoṣṭhī legend: on top (*Maha*) *devasa raña*; to left *Dharagho (ṣasa)*.

Rev. : Brāhmī legend to left (*Dha*) *raghoṣasa*.

3. *Obv.* : Sacred tree within enclosure; front part of elephant to right. Kh. legend: on top *raña*, to left *Dharaghoṣas(a)*.

Rev. : Illegible.

II. *Śivadāsa.*

4. *Obv.* : Kh. legend *Odumbari (sa)*.

Rev. : Temple and trident, snake below. Brāhmī legend to right. *Śivadasa*

5. *Obv.* : Sacred tree within enclosure; front part of elephant to right. Kh. legend to left. *Śivadasasa*.

Rev. : Three-storeyed temple and trident. Fragmentary Brāhmī legend on top (*Maha*) *devasa*.

III. *Rudradāsa.*

6. *Obv.* : Sacred tree and front part of elephant. Kh. legend to right *Odumba (risa)*; on top *Mahadevasa raña*; to left *Rudrada (sasa)*.

Rev. : Three-storeyed temple and trident Brāhmī legend: to top, *Mahadevasa raña*; to right, *Rudra (dasasa)*.

7. *Obv.*: Sacred tree within enclosure and front part of elephant. Kh. legend, on top, (*Ma*) *hadēvasa*.

Rev.: Three-storeyed temple, trident, with banners, below snake. Br. legend: on top (*Ma*) *hadēvasa ra (ña)*; to right *Rudradasasa*.

8. *Obv.*: Sacred tree inside enclosure and front part of elephant. Kh. legend: on top *Mahadēvasa raña*; to left *Rudradasa (sa)*.

Rev.: Three-storeyed temple, below snake. Traces of Br. legend on top; to right *Odu (m) barisa*.

R. D. BANERJI.

135. BAIRĀTA OR BARĀR ?

[Plate XXI.]

Some time ago M. Muhammad Abdus-Saboor, who is engaged in cataloguing the coins of the Nāgpūr Museum, sent me a cast of a rupee of Akbar of the type hitherto supposed to have issued from the Bairāt Mint. He expressed some difficulty in reading the mint name as Bairāt and suggested that the word looked more like "Barār."

Appreciating his difficulty, I corresponded with some of the members of the Numismatic Society of India on the subject and eventually by the kindness of Mr. Framjee Jamasjee Thanawala was able to procure two other rupees of the same mint on which the terminal letters of the mint name were more clearly visible than is usual on coins of this type. An examination of these coins satisfied me that there was good reason to prefer the reading Barār to Bairāt or Bairāta. This view was strengthened by the comparison of the coins with rupees of Akbar of Elichpūr, the capital of Barār (Varhād).

The fact that Barār was the name of a *ṣūbah* and not of a town need, I think, be considered no obstacle to the acceptance of the proposed reading. We know that there are rupees of Akbar assigned to the *ṣūbah* of Bangāla, whereas in later times there are instances of coins *ضرب صوبه وده* (struck in the *ṣūbah* of Awadh).

Barār was ceded to the Mughals by treaty in 1004 A.H.,¹ the 41st year of Akbar's reign, and as far as I know there are no so-called "Bairāta" rupees which bear an earlier date than 42 Ilahi.

On the other hand fulūs from the Bairāta mint are known with dates as early as 971.² I have myself two of 979 and 980 A.H. In these coins the *ā* at the end of the mint name are quite distinct and bear no resemblance to the terminal letters of the mint name on the rupees in question. Further the

¹ Burgess, *Chronology of Modern India*, p. 58.

² I.M.C., Vol. III, No. 169.

ART. 133.

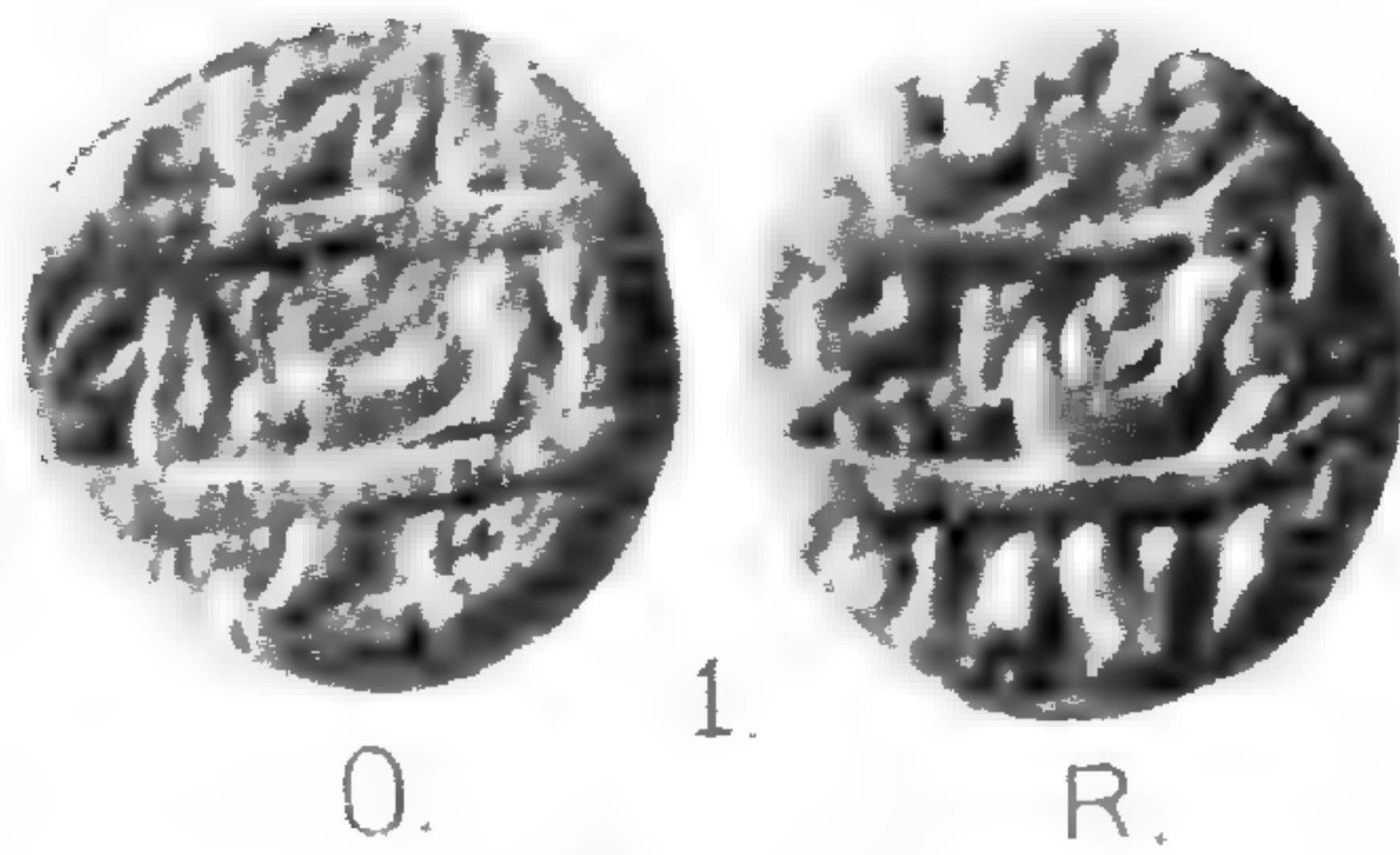

ART. 134.

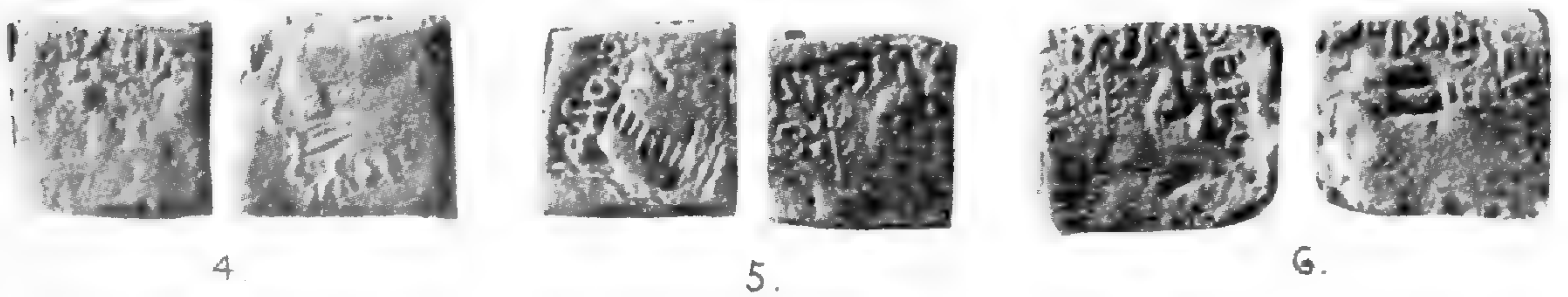
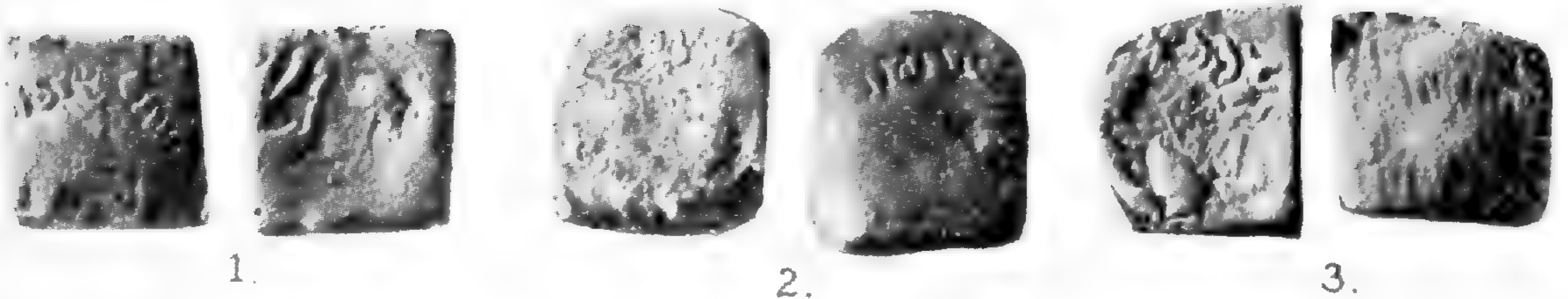

ART. 135.

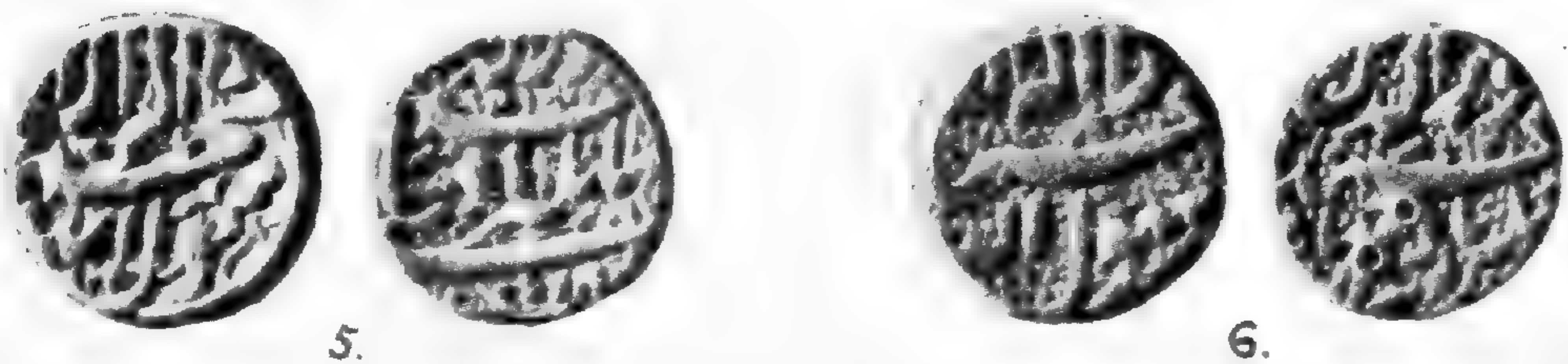

A New Coin of Shah Alam II. (Article 133).

A New Type of Audambara Coinage. (Article 134).

'Bairāta' or Barār ? (Article 135).

“ye” of چ is also clearly present, whereas on the rupees there is no separate stroke for that letter. The similarity of the “Bairāta” rupees in type and lettering with those struck at Elichpūr is most striking.

There is also a coin of Jahāngīr’s first year 1014 A.H. which Lieut.-Col. Vost has ascribed to “Bairāta.”¹ The coin is in the Lucknow Museum, and I have recently seen it with the result that I am satisfied that on it too the mint name can unhesitatingly be read “Barār.” In this case also the type and lettering—even the rather unusual position of the date—are identical with the earlier coins of Jahāngīr of the Elichpūr mint.

Taking all these facts into consideration the arguments appear to tell strongly in favour of the reading “Barār.” The matter was brought up for discussion at the recent annual meeting of the Numismatic Society of India and the result was that an unanimous resolution was passed adopting the reading “Barār” in preference to “Bairāta” on the rupees of Akbar hitherto ascribed to the latter mint. It is suggested, therefore, that Bairāta be excluded from and Barār be included in the list of silver mints of Akbar and Jahāngīr.

H. NELSON WRIGHT.

136. NOTE ON THE DATES OF THE MAULŪDĪ ERA OF TIPŪ SULTĀN OF MYSORE.

The coinage of Tipū Sultān is in many respects so interesting that it has received a large share of attention from numismatists, yet in spite of this there has been a good deal of confusion with regard to the question of dates. As is well known the coins issued during the first four years of the reign bear the Hijrī date, while those from the fifth year to the year of Tipū’s death, are dated in accordance with his special Maulūdī era, which, as the name indicates, takes its origin from the birth and not from the flight of the Prophet. In the coins of the second period the dates read from right to left. While the coins of the fourth year are dated 1200 A.H., those of the fifth year bear the date 1215 A.M., and it appears probable that the commencement of a new century influenced Tipū in making the change at this time. The Hijrī years are lunar ones of twelve lunar months each, but those of the Maulūdī system are luni-solar of twelve lunar months, with an intercalated or *adhika* month added to the year at certain intervals. Tipū’s new calendar, as was pointed out by Kirkpatrick in 1811, was simply the Hindu one in common use in Mysore, with a cycle of sixty years, Arabic names taking the place of Hindu ones for the cyclic years and months.

¹ Num. Supp. to J.A.S.B., No. XI, art. 65.

Several writers puzzled by the difference of fourteen years between the two systems at the time the new one was introduced, have supposed that the term Maulūdī was used in a figurative sense, and that the era originated in the commencement of Muḥammad's mission, or had reference to the time when he first announced himself as the Messenger of God. The true explanation was, however, furnished by Marsden (*Numismata Orientalia*, Part II, p. 701, 1825) who pointed out, that if the year of the Prophet's birth in the Christian reckoning be subtracted from the Christian year in which the innovation was introduced, the result is 1215. For this purpose Marsden takes the date of Muḥammad's birth as 571 A.D., and the first year of the new era as 1786 A.D. ($1786 - 571 = 1215$); but as we shall see, Tipū Sultān, for some unexplained reason, appears to have assumed that Muḥammad was born in 572 A.D., as the first year of the new era certainly commenced in 1787 A.D. The correct formula is, therefore, $1787 - 572 = 1215$.

All writers on the subject since the time of Marsden have, so far as I know, without a single exception, assumed, not unnaturally, that because the fourth regnal year terminated in 1786 A.D., the year 1215 A.M. also commenced in the same year, but this, as I shall proceed to show, is an error, and the year 1215 really commenced in 1787. In certain of Tipū's letters referred to in Kirkpatrick's *Select Letters of Tippoo Sultan* (1811), Beatson's *View of the Origin and Conduct of the War with Tippoo Sultan* (1800), and Wood's *Review of the War in Mysore* (1800), the complete Maulūdī date, and the corresponding Hijrī one, were both noted at the time the letter was written. At my instance these dates have been examined by the Hon'ble Diwan Bahadur L. D. Swamikannu Pillai, M.A., LL.B., author of *Indian Chronology* (Madras, 1911) and a well-known authority on the subject. He reports that they completely establish the facts that the months of Tipū's new system were Indian lunar months, that the days of the month were simply *tithis* continuously numbered from one to thirty, the fortnights being omitted and further that Tipū's extra months were without a single exception the Indian *adhika* months. Mr. Swamikannu Pillai finds that the Maulūdī year began regularly at the same time as the Indian luni-solar year, i.e. on *Chaitra śukla pratipadā*, or the first *tithi* of the bright fortnight of Chaitra, and that the serial numbers of Tipū's cyclic years, recorded on many of his gold and silver coins, are exactly the same as those of the South Indian cyclic years.

To take an illustration which is of more than ordinary interest, the date on which Tipū Sultān signed the preliminary articles of the treaty framed after the capture of Seringapatam by Lord Cornwallis, is recorded by Kirkpatrick (appendix p. ii) as follows:—

28th of Jamādūssāny, 1206 A.H.

1st of Rubbāny, year Zuburjud, 1219 A.M.

22nd February, 1792 A.D.

Mr. Swamikannu Pillai finds that of the three dates thus given as equivalent, the first and third correspond, but the second, which was the one recorded by Tipū himself, was really 23rd February, 1792. The 22nd February was *amāvāsyā* or new-moon day, the *tithi* ending about 3 A.M., *i.e.* before sunrise on 23rd February, while 1st Rabānī commenced at sunrise on 23rd February and ran until sunrise on 24th February. Mr. Swamikannu Pillai added that Tipū from his well-known superstitious views and belief in Hindu astrology, would be unlikely to sign the articles on *amāvāsyā* day, which was inauspicious for such a transaction, and that he probably signed after 3 A.M. on 23rd February. He wrote subsequently to say that his supposition was confirmed, for in Major Dirom's *Narrative of the Campaign in India which terminated the War with Tippoo Sultan in 1792* (1793), p. 226, the following statement occurs:—"These were the terms, which after different conferences with the vakeels, were dictated by Earl Cornwallis to Tippoo Sultan, and to which he found it necessary to submit. They were sent to him on the 22nd, and returned by him, signed and sealed, the night of the 23rd February." An examination of these dates shows conclusively that the Maulūdi year 1219 corresponds to 1791-92 A.D., and not to 1790-91, as has so often been assumed.

While Marsden erroneously antedates by a year in the Christian reckoning all the earlier coins with Maulūdi dates, yet in referring to the Nagar *paisa* dated 1227, the only coin known to have been struck by Tipū in the last year of his reign, he records the year correctly. With reference to this coin he states (*Numismata Orientalia*, part II, p. 724):—"This is probably the latest specimen of his coinage that has been preserved, and must have been struck within about a month of his death; the year 1227 of his era having begun on the 6th of April 1799, and the storming of Seringapatam, on which occasion he fell, having happened on the 4th of May of that year, being the anniversary of his accession." So firmly, however, had the other dates been established, that the late Major Tufnell, in his *Catalogue of Mysore Coins in the Collection of the Government Museum, Bangalore* (1839), actually corrects Marsden in regard to the Nagar coin, and points out that the year should be 1798 and not 1799. It will be seen that the acceptance of the latter date affords the only satisfactory explanation of the fact that, whereas in the year 1226 A.M., coining was in full operation at Seringapatam and two other mints, in 1227 A.M., which commenced less than a month before Tipū's death, only a single type of coin was

struck, and that at a remote mint, lying outside the sphere of the military operations which terminated in the capture of Seringapatam.

If, as appears certain, the Maulūdi year 1215 commenced on 20th March, 1787, the first day of the Indian luni-solar year which was numbered 41 both in the Indian and in Tipū's calendar, the question arises were coins struck by Tipū Sulṭān in the period amounting to nearly five months, which elapsed between the last day of the Hijrī year 1200 (23rd October, 1786), and the first day of the Maulūdi year 1215 (20th March, 1787). It is hardly likely that coinage was suspended during this period, and the coins were probably dated 1215 in anticipation of the new era. It is, however, possible that the coins dated 1201, of which at least four varieties are known from the Seringapatam and Nagar mints, were issued during this intermediate period. These coins, which are now somewhat rarely met with, have been hitherto supposed to have been dated in error, owing possibly to the die-engraver being unaware of the introduction of the new era.

The following table, which shows the date according to the Christian reckoning of the commencement of each year of Tipū Sulṭān's reign, will make clear some of the foregoing references:—

Regnal year.	Cyclic year.	Letter year.	Maulūdi year.	First day of Maulūdi year (Hindu New Year's day).	Hijrī year.	First day of Hijrī year.
1	37	1197	7th Dec., 1782
2	38	1198	26th Nov., 1783
3	39	1199	14th ,, 1784
4	40	1200	4th ,, 1785
5	41	..	1215	20th March, 1787	1201	24th Oct., 1786
6	42	..	1216	7th April, 1788	1202	13th ,, 1787
7	43	..	1217	27th March, 1789	1203	2nd ,, 1788
8	44	..	1218	16th ,, 1790	1204	21st Sept., 1789
9	45	..	1219	4th April, 1791	1205	10th ,, 1790
10	46	..	1220	23rd March, 1792	1206	31st Aug., 1791
11	47	..	1221	13th ,, 1793	1207	19th ,, 1792
12	48	..	1222	1st April, 1794	1208	9th ,, 1793
13	49	..	1223	21st March, 1795	1209	29th July, 1794
14	50	..	1224	8th April, 1796	1210	18th ,, 1795
15	51	..	1225	29th March, 1797	1211	7th ,, 1796
16	52	..	1226	18th ,, 1798	1212	26th June, 1797
17	53	..	1227	6th April, 1799	1213	15th ,, 1798
		..			1214	5th ,, 1799

Notes.—The letter years are those on which the first four letters of the Arabic alphabet are found on the coins. The

column showing the commencement of each Maulūdi year is taken from p. xcv of the *Indian Calendar*, by Sewell and Bālakrishna Dīkshit (1896).

Haidar 'Alī died on 7th December, 1782 (1st Muharram, 1197 A.H.). Tipū Sulṭān died on 4th May, 1799 (28th Dhū l-qa'da, 1213 A.H., or 29th Ahmadī, 1227 A.M.).

In conclusion, I desire to thank the Hon'ble Diwan Bahadur Swamikannu Pillai for the assistance which he so generously rendered in clearing up the question of dates and thus enabling me to state that the year 1215 A.M. of Tipū Sulṭān commenced in 1787 A.D.

J. R. HENDERSON,
Supdt., Madras Government Museum.

137. THE LEGEND OF SAMUDRAGUPTA'S AŚVAMEDHA COIN TYPE.

The legend of Samudragupta's Aśvamedha coin type has survived only in fragments. In the *Catalogue of Gupta Coins in the British Museum* I was unable to illustrate coins giving the complete legend. The portion there given from the coins illustrated

Rājādhirāja (ḥ) pṛthivīm vijitya (or vīnavitvā) Divamjayaty

is sufficient to show that the legend is an *Upajāti* couplet. On Pl. V. 10, two *akṣaras* follow the *tya* of which the second is certainly *t*; thinking of expressions like *aprariratha* and *aprativāryavīrva*, etc., I read the first of these two characters as *pra* and suggested the latter epithet to complete the couplet. Dr. Venis has recently examined the coin and pointed out to me that the first *akṣara* is really *hr* (with Eastern *h* as on Pl. V, 1-7). Having established this reading he suggested vocalising the following consonants *v-j-m* on the Ballia coin, a cast of which I owe to Mr. W. E. M. Campbell, I.C.S., as *vājime*. We still require a syllable to complete an *Upendravara* line. Dr. Venis calls my attention to Thomas's statement in *Records*, p. 22, that the restored legend of the Aśvamedha type is *navamajamadhaḥ rājādhirājah pṛthivīm jayatyā*. The misreading *na* for *ta* is readily explained and there is no reason to doubt that Thomas saw a coin, unfortunately not illustrated anywhere, which ended *t-v-m dh*. This supplies the missing *dh*, and we need have no hesitation in agreeing with Dr. Venis that the epithet is *āhrtavājimedhaḥ*, to be translated as a *Bahuvrhi*, "he who has restored the horse-sacrifice." Although not as common as *aśvamedha* its synonym *vājimedha* is well established; it is hardly necessary to recall the *cirot-sannāsvamedhāhartr*, "the restorer of the Aśvamedha long in abeyance," of Samudragupta's Allahabad inscription, and it is significant that the same root *a-hr* is used in both cases. It

was quite a common occurrence for the Gupta engravers to have exhausted the space at their disposal before they had completed the legend. It is to be hoped however that a specimen may be found with *dh* like the coin seen by Thomas. The Ballia coin is not unique in containing the latter part of the legend, for there is a duplicate of it in the collection of Dr. William Hoey, I.C.S. (retired), of Oxford. The ending of the first line presents some difficulty. The last word on the coin in the Bodleian library and on one in Dr. Hoey's collection is *vijitya*: one form of the legend therefore is

*Rājādhirājah pṛthivīm vijitya
Divam jayatyāhṛtāvājimedhah.*

The king of kings having conquered the earth
Wins heaven, being the restorer of the Aśvamedha.

On the majority of coins however the last *akṣara* is clearly *tvā*; *vijitvā* is of course an impossible form, and as on some specimens like B.M. Pl. V. 14 the *akṣara* before *tvā* is certainly not *j* but seems to be *v*, I have suggested *pṛthivīmavitvā* as one form of the legend. It is possible that other coins have *jivā* preceded by some synonym of *pṛthivīm*. There can be no doubt however that Dr. Venis has established one form of the legend with certainty.

J. ALLAN.

PS.—Dr. Venis asks me to add that his pupil Pandit Harirāmachandra Divekar, M.A., drew his attention to the use of the root *ā hṛ* in connection with Aśvamedha in the Allahabad *praśasti*, and that he owes the reference to Thomas to Mr. W. E. M. Campbell.

J. A.

28. Spirit Belief in the Jātaka Stories.

By NILMANI CHAKRAVARTI.

In this paper an attempt has been made to give a brief account of spirit belief as can be gathered from the Pāli Jātaka stories which form the oldest and largest collection of fables in the world.

The origin of the belief in spirits can be traced back to the Pan-Indian Soul theory of the Upanishads, according to which every being, whether rational or irrational, possesses a soul,

The origin of the belief.

which never dies but passes from one body into another. Even the tree is not without a soul; when the soul leaves the tree it dies.

Of the various Vedic gods only the following names are to be found in the Jātakas, viz., Sakka—a counterpart of the Vedic Indra *Pajjunna*¹ or the rain god, and *Aggi*² or the fire god.

Vedic gods mentioned in the Jātaka stories.

Of these, Sakka comes in every now and then. He is the protector of the righteous and scourge to the wicked. It is at his order that Viśvakarman, the celestial architect, comes down to the earth for constructing a hermitage for righteous men renouncing household life. Sakka is not however an eternal god like the Vedic *Indra*. He was originally a righteous man, raised to that eminence in his next birth, through his merit. According to the *Dadhivāhana Jātaka*³ there were once four brothers who were ascetics in the Himalayas. The eldest of them became Sakka and used to come to attend on his brothers. In the *Biḷāra Kosiya Jātaka* we find that righteous men after their death became Sakka, Canda (the moon-god), Suriya (the sun god) and Pañcasikha Devaputta.⁴ It is curious to see here

Character of Sakka.

Pañcasika Devaputta. Pañcasikha mentioned as a god. He is widely known as a teacher of the Sāṃkhya philosophy. He is the fourth in succession from Kapila, the founder of the system. He has been mentioned also in the *Culladhanuggaha Jātaka*⁵ and as a gandhabbaputta in the *Mahāgovindasutta* of the *Dīghanikāya*. If Pañcasikha of the Sāṃkhya philosophy is the same as Pañcasikha gandhabbaputta of the *Nikāya* or Pañcasikha Devaputta of the Jātakas, we have some data for ascertaining his time. Unfortunately

¹ Jātaka, Vol. I, p. 331.

² Jātaka, Vol. I, p. 235.

³ Jātaka, Vol. II, p. 101.

⁴ Jātaka, Vol. III, p. 222.

⁵ Jātaka, Vol. III, p. 222.

there is no other means of establishing the identity. The rain-god and the fire-god have been mentioned once only.

Coming to the world of spirits we have a host of them, both good and evil. The evil spirits are called Yakkhas, while the others go by the name of Deva or Devatā. The lord of the evil spirits is Vessavana Kuvera. They have to attend on him by turns and they have to live on whatever is enjoined on them by (the order of) Kuvera. They are supposed to live principally on human flesh, but occasionally we find that when they are instructed by the Bodhisattva, they abstain from the practice and some of them continue to be worshipped by the villagers like good spirits. In one place¹ we find that a Yakkha obtained, in return for the service rendered to Vessavana, the privilege of eating any men entering a certain house, provided they failed to utter the word "jīva" (live) immediately after one had sneezed, and likewise those who would not say "Patijīva," i.e. "live on your turn," being told "Jīva" after sneezing. The practice of saying "Jīva" after sneezing is still prevalent, but the significance of it cannot be clearly given. In another place² a Yakkhinī used to devour the babes of a king while they were still in the lying-in room, and to prevent her from doing so the mother was placed in an iron room and palm leaves were placed there. Fortunately that time the Yakkhinī died while serving her turn of service to Kuvera and so the child was safe. There was a belief that the Yakkhas are afraid of palm leaves and iron. Even in these times on the sixth day of childbirth a palm leaf is placed in the confinement room, and it is seldom left alone without a piece of iron on the bed. Nowadays however people believe that on the sixth day the Ordainer of destiny comes to write the fortune of the child. In another place we find a Yakkhinī detected in the act of stealing a child for the purpose of eating, but at last desisted, being influenced by the teachings of a wise man. In many places Yakkhinīs have been described, disguised as beautiful women, beguiling shipwrecked merchants as well as men passing through forests.

Turning now to the good spirits, who used to be called *Devas* or *Devatā*, we find that their number is very large. When the Buddha preached the Mahāsamaya Suttanta the gods were present in myriads, also at the time of his parinirvāṇa. They are not spirits of heaven. They are inhabitants of this earth. They generally form three classes, viz., (1) spirits dwelling in towns, houses, etc.; (2) spirits dwelling in trees; (3) spirits of rivers, the sea, etc.

The good spirits.

Three classes of spirits.

¹ *Jātaka*, Vol. II, p. 15.

² *Jātaka*, Vol. IV, p. 491.

First about the spirits living in houses and cities, etc. We find in the introduction of the Khadirāṅgāra Jātaka¹ that a spirit lived in the portal of the 4th gate of the house of Anāthapiṇḍika. The house of the merchant was constantly visited by the Buddha and his followers. Whenever they passed that particular gate the god had to alight from his place and to stand on earth. It was extremely troublesome, and he tried a remedy. Anāthapiṇḍika nearly exhausted his wealth in his liberality towards the Buddhist monkhood. The god thought of advising Anāthapiṇḍika not to spend any more on the monkhood to save himself from penury and thus to put an end to the constant visits of the monks. So one night while Anāthapiṇḍika was sleeping in the chamber he appeared before him assuming a bright radiant form. The banker awoke and asked him who he was, and what was his object. He said that he was the god dwelling in the 4th gate of the house and he came there to advise him not to spend any more on the monkhood, for by doing so he would bring ruin on himself and his family. At this the banker was highly incensed and ordered him to quit his house at once. One peculiar characteristic of the gods is this, that they are always afraid of the Buddha and his followers. In this respect they are similar to the epic gods who are in constant fear of men practising austerities. Now the banker was a follower of the Buddha and reached the first stage of perfection. The god became highly afraid of him and had no other course but to leave the house. Holding his children by their hands he went out of the house and not finding refuge anywhere thought of appeasing the anger of the banker. With this object he went to the guardian deity of the town and requested him to intercede on his behalf. But he was not bold enough, so he went to the four *Mahārājas*, the guardian deities of the quarters. They too dared not, and he went to *Sakka*, who pointed out to him the way in which he could appease the wrath of the banker. In the *Mugapakkha Jātaka*² and in the *Vidhurapaṇḍita Jātaka*, there is mention of deities dwelling in the royal umbrella. These deities were in their previous births the mothers of the kings. They are represented as looking after the welfare of their sons. In the *Vidhurapaṇḍita Jātaka*,³ the king plays dice with a *Yakkha*. He is being guided by his guardian deity. The *Yakkha* perceiving this casts threatening looks at the deity, whereupon she fled to the top of the *Cakkavāla* mountain and stood trembling there. Besides these domestic spirits we meet with another

Spirits dwelling in houses, etc.

Their similarity to the epic gods.

Spirits dwelling in the Royal Umbrella.

¹ *Jātaka*, Vol. I, p. 227.

² *Jātaka*, Vol. VI, p. 4.

³ *Jātaka*, Vol. VI, p. 255.

body of them, viz., the guardian deities of a town. They watch over the towns and look after the doings of the inhabitants. They dwell in the city gates and offerings are made to them. In the *Takkāriya Jātaka*¹ we find that a new gate of a town was to be constructed, the former gate being abandoned as inauspicious, and that the new one was to be consecrated by offering a human sacrifice to the great deity presiding over that gate. In the *Mātanga Jātaka*² we find the guardian spirit of a town tormenting the inhabitants for insulting an ascetic. In addition to these there was a belief that there were

Guardian deities of
kings.

guardian deities of kings. When the kings engaged themselves in fighting with one another their guardian deities too used to fight. In the *Cullakalinga Jātaka*³ mention is made of a battle between the Kings of Kalinga and Assaka. The Assakas had a settlement on the Godavari and their capital was Potana. In this battle the guardian deities of the kings appeared as two great bulls, one all white and the other all black. There was a fight between the two deities and the victory fell to him whose guardian deity was victorious.

The spirits in the
trees.

We now come to the second class of spirits, the spirits in the trees. These spirits are more important than the others and their number is very large. Not merely the big trees are the abodes of spirits, but even the castor tree has its spirit. In the *Kundaka pūva Jātaka*⁴ and in the *Anta Jātaka*⁵ we come across spirits in the castor trees. In the former there is a very interesting story of a tree-god. In one of his previous births the Bodhisattva was born as spirit in a castor tree. During a festival men were making offerings of flowers and scents and eatables to the tree gods. It must be noted here that every individual had his own god to look after. A poor man wanted to take charge of a tree-god and for that purpose he went with cakes made of scum of rice and water to the castor tree in which the Bodhisattva was born. But nearing the tree he began to think: "The gods live on celestial food; my god will not accept this cake of scum. What is the use of wasting these? Rather I would eat them myself." Thinking thus he was turning his back, when the Bodhisattva seeing that his devotee was going away, appeared in a visible form, and calling the man said that as he was not rich there was no harm in his offering the coarse cake. He too had no other alternative but

Details of a tree
worship.

to receive the offering. The details of a tree-worship have been given in the *Palāsa Jātaka*.⁶ The foot of the tree used to be

¹ *Jātaka*, Vol. IV, p. 246.

³ *Jātaka*, Vol. III, p. 3.

⁵ *Jātaka*, Vol. II, p. 446.

² *Jātaka*, Vol. IV, p. 383.

⁴ *Jātaka*, Vol. I, p. 423.

⁶ *Jātaka*, Vol. III, p. 23.

[N S.]

cleared, the grasses removed and the ground levelled. The tree used to be surrounded by a fence and sand scattered round the tree. Offerings of flowers, garlands, and sandal pastes were made and flags hoisted. Lamps were placed near the tree and food used to be offered. According to the Dum-medha Jātaka¹ men used to kill goats, lambs, pigs and cocks and offer their flesh and blood to the gods. In the same story there

Human sacrifice
before tree-gods.

is reference to human sacrifice before a tree-god. The King in the story promises to sacrifice a man if a certain desire of

his is fulfilled. In the Dhonasākha Jātaka² and in the Mahāsutasoma Jātaka³ we find the details of human sacrifice before tree gods. After killing the victim they used to wash the trunk of the tree with the blood flowing from the neck and marks of five fingers used to be made with the blood. The tree used to be surrounded by the entrails of the victim and the five sweet parts from the victim's body used to be offered to the tree-gods. The five sweet parts or "fleshes," as I have been told by a modern Tantrik, are those from the head, the two sides, the breast and the neck respectively. In modern times there is the practice of performing a *homa* with the five sweet "fleshes," according to the *tantrik* rites, whenever the victim offered to a god is not killed by a single stroke. Kings used to have in their gardens *Maṅgalarukkhas* or auspicious trees and worshipped them with offerings.

Whenever a tree grows up a spirit comes and takes its abode there. These spirits are in con-

Their fear of the des-
truction of abodes.

stant fear of the destruction of their abodes. In the Bhaddasāla Jātaka⁴ as

well as in the Kusanālī Jātaka,⁵ we have accounts of the god's discomfiture at the proposal of cutting down trees. In the Hatthipāla Jātaka⁶ a king's priest threatens a tree-god with cutting down the tree for not giving a son to the king in spite of his getting annual offerings worth a thousand coins of the realm. The god in great difficulty goes from place to place and at last succeeds in persuading Sakka to grant sons to the king. In the Rukkhadhamma Jātaka⁷ we find that the Bodhisattva was born as a tree god. He warned his kinsmen not to take their abodes in the trees growing near human habitations. Some of his kinsmen took his advice, but others thought that they would be gainers by taking their abodes near human habitations. They would be worshipped and respected and would receive offerings, and accordingly they took their abodes near houses. One day there was a heavy storm and

¹ Jātaka, Vol. I, p. 259.

² Jātaka, Vol. III, p. 159.

³ Jātaka, Vol. V, p. 472.

⁴ Jātaka, Vol. IV, p. 154.

⁵ Jātaka, Vol. I, p. 441.

⁶ Jātaka, Vol. II, p. 474.

⁷ Jātaka, Vol. I, p. 327.

all those trees that stood singly near human habitations were destroyed and the spirits dwelling in them were without shelter. They went from one kinsman to another, holding the hands of their children, begging piteously for refuge. In the Bhaddasāla Jātaka a tree-god says, "Our existence terminates with the existence of the tree." This is rather peculiar. Most probably the spirit residing in the tree has to transmigrate as soon as a tree is destroyed. In the Vyaggha Jātaka,¹ it has been said, that in a certain forest there were a large number of tree-spirits, and Boddhisattva was one of them. In that forest there were lions and tigers. Men clearing jungles for cultivation could not approach that particular forest for fear of the animals and so the spirits were safe in their abodes. One day, however, one of the gods not being able to endure any longer the stench of putrid flesh assumed a terrific appearance and scared them away. After some time men not finding any trace of those animals began to clear the forest. The gods were in a sorrowful plight. They went to their former protectors, the lions and tigers, to request them to come back to the forest and to save them from destruction. But they did not come back, and to the great grief of the gods the whole forest was destroyed.

The gods had a great dislike for unclean places. This appears from the Vyaggha Jātaka referred to above. In the Samuddavāṇija Jātaka,² we find that a number of men being troubled by their creditors left their country in a boat and arrived at an island in the sea. There they lived happily on the fruits and roots, and the sugarcane and paddy which grew there of themselves. But they were warned by a man who had arrived there before them, not to make the place filthy but to cover up the filth. They continued to dwell there happily for some time. But subsequently some of them disregarded the advice and committed nuisance in the place. The gods were angry seeing the filthy condition of the island, which was their favourite haunt. They made up their mind to take revenge by flooding the island with sea-water, one of the gods, however, out of compassion, warned the men to leave the place. Some of them took his warning and left the island while those who remained perished in the flood.

The spirits are occasionally revengeful as will appear from above. In the Mahāvāṇija Jātaka³ we find that a number of merchants, in course of their journey, came to a desert. There they found a banyan tree. In utter distress for want of water, they cut off a branch of the tree and there came out a stream

¹ Jātaka, Vol. II, p. 356.

² Jātaka, Vol. IV, p. 161.

³ Jātaka, Vol. IV, p. 351.

of water from the trunk. Then the merchants cut off another branch and got savoury food. They cut off a third and fourth branch and got beautiful women and valuable jewels, etc. Then they wanted to cut down the tree itself in hope of getting more. But the spirit (here called a Nāgarāja) was wrath, and as soon as the trunk was cut down there came out a large number of armed warriors who killed all of them except a righteous merchant who had tried to dissuade them from cutting down the tree.

We now come to the third class of spirits. These are the spirits of seas and rivers, etc. The spirits of this class are of less importance and less numerous than the former ones. In

The spirits of seas
and rivers.

the Samuddavāṇija Jātaka, it has been said that the four great rulers of the four quarters appointed a goddess named Manimekhalā to watch over the ocean and to rescue those shipwrecked persons who were righteous and who were believers in the three jewels of Buddhism. In the Silānisamisa Jātaka¹ the sea-god appears before a righteous man and a believer who being shipwrecked took shelter in an island, and the sea-god and the Nāgarāja in that island assuming respectively the shape of a vessel and a pilot carried him safely across the ocean. In the Sammudda Jātaka² the sea-god is represented as angrily scaring away a crow who wanted to drink the ocean dry. In the Kimcchanda Jātaka,³ a river-god appears before a man who was sitting for seven days without taking any food or drink, looking at its water, to have his desire fulfilled. In the Macchudāna Jātaka⁴ there is the story of a virtuous man offering rice to the river Ganges and to the fishes living in her. The river goddess was pleased with him. One day the virtuous man's brother wanting to cheat him of a purse containing a thousand coins threw it into the river. The purse was swallowed by a big fish. But the grateful Gangā-devatā took the fish out of water and in the guise of a fisherman went to his house with the fish and sold the same for seven *Kahāpanas*. In many places in the stories we find that lakes are inhabited by spirits, but they are seldom good spirits. They are generally Yakkhas or rākkhasas. They used to drag into the lakes the animals that would touch the water, and eat them up.

¹ Jātaka, Vol. II, p. 111.

² Jātaka, Vol. II, p. 441.

³ Jātaka, Vol. V, p. 3.

⁴ Jātaka, Vol. II, p. 423.

29. Further Descriptions of Stone Implements from
Yünnan.

By J. COGGIN BROWN, M.Sc., F.G.S.

[With Plates XXV-XXX.]

Presented at the First Indian Science Congress, January 17th, 1914.

Published with the permission of the Director, Geological
Survey of India.

In the year 1868, John Anderson was the first to discover stone implements in Yünnan, or, indeed, in China itself. Noticing a stone implement exposed for sale on a stall in the Têng-yüeh bazaar, he purchased it for the equivalent of a few pence. No sooner was his liking for such objects known, than he was besieged by needy persons who willingly parted with them for small sums. In this way about one hundred and fifty specimens were procured by different members of the expedition which he was accompanying in the capacity of medical officer and naturalist. Most were obtained in Têng-yüeh, and a few in the Santa Valley.¹

Following in Anderson's tracks in 1909, I was able to procure numerous specimens of the same kinds of implements in Têng-yüeh, and I have described and figured a representative series of twelve of these artifacts. Nine of the specimens were fashioned from various varieties of jadeite, the other three being cut from a slate-like rock, a fine-grained white quartzite and a basaltic rock.²

During extensive travels through Yünnan in 1909 and 1910, I succeeded in making a large collection of stone implements from other localities. These I propose to describe here, after which I shall discuss the bearing which they have on the vexed question of the stone age in China as a whole.

Figure 1 represents one of the largest specimens in the collection, a heavy, broad axe of polished basalt from Hsia-

¹ An account of the travels of this expedition is to be found in the following works: (a), *A Report on the Expedition to Western Yünnan, via Bhamo*, by John Anderson, M.D., Calcutta, 1871; and (b) *Mandalay to Momein*,—a narrative of two expeditions to Western China of 1868 and 1875, by the same author, London, 1876. Appendix C, pp. 410-415 of Anderson's 1871 report is entitled, *The Stone Implements of Yünnan*, with the description of a bronze, axe-like weapon from the Santa Valley.

² J. Coggin Brown, *Stone Implements from the Têng-yüeh District, Yünnan Province, Western China, with a short account of the beliefs of the Yünnanese regarding these objects*. *Journ. Asiatic Soc. Bengal*. Vol. V, New Series, No. 8, 1909, pp. 299-305.

kuan near Ta-li Fu. It measures 19 cms. in length by 9 in breadth, at the maximum point just above the cutting edge. Its thickness is about 5.5 cms. The sides which are smoothly rounded to meet the two faces, are parallel in the lower half of the specimen and then taper gently to a broad and somewhat broken butt. The edge is crescentic and meets the two faces symmetrically at rather wide angles. It is worn and bears the marks of use. Long continued exposure has resulted in the formation of a tinting or patina over the surface, but this does not entirely hide the beautiful polish which it bears.

Figure 2 represents a large elongated celt from Mi-chih, Yünnan Hsien district, which resembles very nearly certain Indian Neolithic types from the United Provinces and the Shevaroy Hills. It is abnormally long for its width and thickness and measures $23 \times 7 \times 6$ cms. The front face of the specimen is distinctly convex and the back one much flatter. The sides are very broad and well rounded in to the faces. They taper gently to both edge and butt, the broadest point being just below the middle of the specimen. The edge takes the form of an unequally disposed crescent, and is continued to the same extent on both faces. The surface was undoubtedly polished originally but has now a pecked appearance due to weathering. The material appears to be a trap rock of some kind.

Figure 3 shows a smaller implement of the same general type, from Ongkong, in the Mekong Valley. The plano-convex character of the two faces is still very evident, but the sides are thinner and bevelled off to meet the faces at much acuter angles. The polished surface bears a light reddish aeonic tinting under which the light grey decomposed rock is visible. I am unable to state its nature without seriously injuring the specimen. Dimensions, $16 \times 5.5 \times 4$ cms.

Figure 4 represents a large, roughly cylindrical hammer-stone or pounder with sides flattened for convenience in holding. Both ends of this remarkable specimen bear marks of much usage, otherwise it is in good condition. Its dimensions are—length 17 cms., greatest breadth 7 cms., thickness across the middle of the flattened sides, 5 cms. The flattened sides commence close to one end, where they have their maximum development, and extend fully three quarters of the total length of the stone, tapering gradually outwards. A slight flattening of one of the faces is also visible. The implement still retains traces of a fine polish, and is made of some tough volcanic rock, probably of an andesitic nature. It was purchased in Lao-niu-kai, a village between Mung-hua Ting and A-lu-shih.

Figure 5. Small cylindrical pounder or pestle. The specimen bears an excellent polish, though somewhat pecked in places by weathering. The ends are well flattened. Dimen-

sions, $8 \times 4 \times 3$ cms. The stone is not perfectly cylindrical and the flattening may have been intentional for convenience in holding.

Figure 6. Large stone hammer, with rounded butt, and broad, flattened cutting-edge. This specimen appears to agree very closely with the one found by S. Couling near Tsing-chou Fu in Shantung and figured by B. Laufer¹ Three parts of the hammer are perfectly cylindrical, after this the sloping off which produces the flattened edge commences, rather lower down on one face than the other. All corners and edges are bevelled off. Dimensions, total length—16 cms., breadth 5.5 cms., greatest width across flattened cutting edge—1.5 cms. The hammer is fashioned from a coarse diorite and has been excellently polished. Purchased in Lao-niu-kai.

Figure 7. Stone hammer, of the same general type as figure 6 with the following minor differences. An oval instead of a cylindrical section, and more symmetry in the angles between the faces and the flattened edge. The latter is worn and broken. The sloping of the faces to the edge commences from one quarter to one half of the total length of the stone from the butt, so that the general appearance of the hammer is more wedge-shaped. It is made from a coarse diorite and is well polished. Dimensions, length—11.5 cms., width across edge—6 cms., shorter axis of oval section—4.5 cms. Purchased in Lao-niu-kai.

Figure 8. Stone hammer, very similar to figure 7. The section is still more ovoid, and the sides have more tendency to taper to the rounded butt. The specimen is damaged near the butt and the edge, though sufficient of the latter remains to show that it was intentionally flattened as in the previous two examples. Fashioned from a basaltic rock and polished. Dimensions, length—12.5 cms., longer axis of oval—6 cms., shorter axis—4.5 cms. Purchased in Mi-chih.

Figure 9. This broken hammer from Mi-chih exhibits a more strongly arched edge, sharper than that in any of the preceding examples. It is ovoid in section. The butt is entirely missing. Dimensions, breadth across top of edge—6 cms., length of short axis of sectional oval—5 cms. Material, a coarse dolerite?

Figure 10. In this form we have a transition from the cylindrical or slightly ovoid stone hammers with broad rounded butts, flattened edges and more or less parallel sides, to the commoner, polished stone, axe-like celts, with smaller, more pointed butts, sharper edges and more tapering sides, the type in fact which is so prevalent in Indian Neolithic finds.

¹ Jade, a study in Chinese Archaeology and Religion by Berthold Laufer. Field Col. Mus., Pub. 154, Anthropol. Ser., Vol. X, Chicago, 1912. p. 40, plate xi.

Although the specimen still retains the large flattened butt of the hammer, its ovoid section is more pronounced, and the sloping off of the faces to produce the cutting edge commences low down at a greater distance than three-quarters of the total length. The edge although worn and broken was evidently fairly sharp originally. Dimensions, greatest length—10·5 cms., greatest breadth just above the edge—5 cms., thickness—3·5. Originally polished the surface of the stone is now weathered and decayed. It is cut from a fine-grained, basaltic rock and was obtained in Shun-ning Fu.

Figure 11. A celt in which the peculiar characters of the one shown in Figure 10 are still more pronounced. The edge is sharp and forms the same kind of angles with the faces. The sides are more tapering and the general outline more triangular. The butt is small and rounded. General section, a well developed oval. Dimensions, length—11·5 cms., greatest breadth—6 cms., least breadth 3·3 cms., shortest axis of oval section at centre of specimen, i.e. thickness—3·5 cms. A polished surface pecked by weathering. Material basaltic. Purchased in Mi-chih.

Figure 12. In this specimen the same characters are carried to a still further degree, resulting in deliberate flattening of the lower halves of both back and front faces, so that the section of the stone just above the edge is rectangular with bevelled corners. The upper half is of the usual tapering character. The cutting-edge was sharp, and the faces which form it start at a still lower point. Originally polished the surface is now indented and pecked by weathering. The material appears to be doleritic. Dimensions, greatest length—12 cms., greatest breadth—6 cms., greatest thickness—3·5 cms. Obtained in Mi-chih.

Figure 13. This specimen appears to be unfinished with the exception of the sharp cutting edge. The sides are thick and meet the faces in slightly rounded angles. Partly pecked and partly polished, it bears a bright tinted surface and is probably manufactured from a fine-grained basalt. Dimensions, length—13 cms., breadth across the edge—5·5 cms. Purchased in Mien-ning Ting.

Figure 14. This and the following specimen are the most remarkable forms which I have obtained in Yünnan. In general outline they greatly resemble certain specimens collected by Yersin and Guerlach from the Bahnars, Sedang and Reungoas territories in Indo-China.¹ They recall vividly the bronze hoes found both in that country and in Yünnan,² and they

¹ Mission Pavie, *Indo-China*, Vol. III (Anthropologie), 1904, pp. 27-38, pl. vi.

² I hope to describe a series of bronze implements from Yünnan in this Journal, shortly.

exhibit a distinct family resemblance with the spade or shouldered celt of the Mon-Hkmer country in Burma, Indo-China and Chota Nagpur. Their general shape is best appreciated from the photographs, and it will suffice to say that they commence with a well marked stock or handle and then suddenly splay out into a broad, semi-circular cutting-edge. I obtained both specimens from a Chinese family in Chen-pien (Ma-kai), Mekong Valley, and as they had formed part of the domestic pharmacopœia for several years, they are both badly damaged, though in both cases the beautifully polished surface still partially remains. The rock used in the manufacture of this the larger specimen is a greyish quartz porphyry. Its dimensions are, greatest length—15.5 cms., greatest breadth across the edge—10.5 cms., average diameter of stock—5.3 cms.

Figure 15. Fashioned from a brownish volcanic rock. Dimensions greatest length—10 cms., greatest breadth, across edge—7 cms., average diameter of stock—3.3 cms. The latter measurement is taken before the stock commences to swell out to form the shoulders. The questions which present themselves to my mind are, have we here a prototype of the common form of the Yünnanese bronze axe, or a copy of the latter in stone, belonging to some later period?

Figure 16. Rectangular stone hammer remarkably like a specimen in the Couling collection from Shan-tung. According to B. Laufer this type is particularly interesting as revealing the stone prototype of the carpenter's iron hammer common all over China. On the front face the blade starts from a little more than half way down, gradually sloping to meet a shorter and more abrupt sloping away of the back face. The rounded butt shows signs of much use. The stone is a fine grained quartzite and bears a high polish. Dimensions, length—11 cms., breadth—5 cms., thickness—3 cms. Purchased in Shih-tien.

Figure 17. Thin, elongated, rectangular chisel, identical with forms collected by Massie¹ in the Luang Prabang and Black River regions. The edge is completely broken away. Dimensions of remaining portions, length—10.5 cms., breadth—2.5-3 cms., thickness—.75 cms. Made from an indurated slate and finely polished. Locality, Shih-tien.

Figure 18. Rectangular chisel, with short well-polished blade, formed almost entirely from the front face. The sides are flat and the angles which they make with the faces are only slightly bevelled. Considerable fracturing has taken place near the edges and butt, which appears to have resulted from the fissile nature of the material, a hard, dark greyish-blue, siliceous slate. Dimensions, length—9 cms., breadth—4

¹ Mission Pavie, Vol. III, Anthropologie. *Loc. cit.*, pp. 10-27, pl. i.

cms., thickness—1 cm. The blade is slightly convex. Purchased in Shih-tien.

Figure 19. Chisel, formed by obliquely grinding away one end of an elongated pebble of siliceous slate. On the convex back surface there is a scratched outline which bears a remarkable resemblance to the form of a double-shouldered or spade-shaped celt, similar to one figured in the illustrations of the Massie collection. Dimensions, length—8·5 cms., breadth across edge—3 cms., thickness—1·5 cms. Purchased in Shunning Fu.

Figure 20. Broad chisel with sloping sides, the edge is formed by bevelling off the front face and is only slightly curved. The flat sides, slightly bevelled off where they meet the faces, slope towards an irregular butt. Both faces are very slightly convex. Material, a brownish, siliceous slate with a fine polish. Dimensions, length—8 cms., breadth across edge—5 cms., across butt—4 cms., thickness—2 cms. Purchased in Shih-tien.

Figure 21. This example so closely approximates figure 20 that a separate description is unnecessary. The only noteworthy difference is found in the sharp edge made by the side with the back and front faces, near one corner of the edge. Material, a drab, siliceous slate; somewhat broken. Dimensions, length—8 cms., breadth across the edge—5 cms., across the broken butt—4 cms., thickness—1·5 cms. Purchased in Shih-tien.

Figure 22. Chisel celt with rounded sloping sides meeting in a straight butt. The portion of the sharp edge which remains is straight. Material, a fine-grained basalt. Dimensions, length—9·5 cms., breadth across edge—5 cms., across butt—3·5 cms. The slight conchoidal fractures which this specimen bears are attributed not to accidents after its manufacture but to the pecking which preceded the polishing of the stone. Locality, Wa-tou-tien.

Figure 23. This polished stone chisel represents a type in which both back and front faces are ground down to produce the blade. The sloping of the front face commences at three-quarters of the length from the butt, but that of the back face is done at a high angle and only proceeds a very short distance above the edge. The result is a straight, remarkably sharp blade. The remaining portions of both faces are flat, though slightly bevelled off to meet the flat sides which taper a little towards the butt. Material, a light, bluish grey, siliceous limestone with a high polish. Purchased in Shih-tien. Dimensions, length—6·5 cms., breadth across blade—4 cms., across butt—3, thickness 1·5.

Figure 24. Another example of the same type with a still broader blade. One of the sides of this specimen appears to be a natural joint plane. The back face is slightly convex.

Material, dark, indurated, siliceous slate. Purchased in Shih-tien. Dimensions, length—5.5 cms., breadth across blade—3.5 cms., across butt—2.5 cms., thickness—1.5 cms.

Figure 25. A polished stone chisel with the same type of edge particularly well marked. The sharp edge has been ground down and replaced by a flat surface. The flat sides are bevelled off to meet the back and front faces which in this case slope towards the butt, so that the thickest part of the stone is just above the blade. The butt is partly polished and convex. Material, hard, dark slate. Dimensions—5 cms., breadth across blade—3 cms., across butt—2.5 cms., thickness near blade—1.3 cms., near butt—0.9 cms. Purchased in Yung-chang Fu.

Figures 26, 27 and 28. Chisels of the same general type. The photographs show their natural sizes. They are made of the usual kinds of rocks and come from Yung-chang Fu, Shih-tien and Shun-ning Fu respectively.

Figure 29. A broken rectangular chisel in which both faces partake equally in the formation of the blade. Locality Wa-tou-tien. Photographed in natural size.

Figure 30. Thick rectangular chisel, with convex back, sloping to both edge and butt. Sharp straight edge. Material, siliceous slate. Locality Mi-ti. Natural size.

Figure 31. Thick chisel with flat sides tapering to a flat butt. Material, banded siliceous slate. Locality Yung-chang Fu. Natural size.

Figure 32. Large, thick chisel with slightly convex sides bevelled to meet the faces, except along the steeply sloping edge. Flat butt. Material, brownish-grey, fine-grained quartzite?. Locality, Shun-ning Fu. Dimensions length—7 cms., breadth across edge—4 cms., across butt—3.2 cms., thickness at top of edge 2.2, at butt somewhat less.

Figure 33. Polished chisel celt with rounded hatchet edge and butt. The convex faces almost meet in a slightly flattened side. Material, brown, aeonitic tinted basalt. Locality, Shun-ning Fu. Dimensions, length—10 cms., breadth across top of edge—5.5 cms., thickness across centre of specimen—2.5 cms. The specimen is much chipped and injured.

Figure 34. Broken celt, similar to figure 33, though somewhat thinner. Locality Wa-tou-tien. Dimensions, length—+ 6.5 cms., breadth—5 cms., thickness—1.5. The sides do not taper as rapidly as those of the previous specimen.

Figure 35. Very weathered celt of the same general type. Locality, Western Yünnan (exact locality lost). Material, shale. Dimensions, length—+ 8, breadth across edge 4.5 cms., thickness—2 cms.

Figure 36. Broken celt with crescentic edge, flattened sides slightly tapering to a broken butt and very slightly convex faces. Dimensions, length—+ 7.5 cms., breadth across

edge—6 cms., across top—4·3 cms., thickness—2·5 cms. Material, weathered porphyrite, originally polished. Locality, Wa-tou-tien.

Figure 37. Large polished celt with flat sides bevelled to meet slightly convex surfaces, tapering towards a flat, truncated butt. The edge is much broken. Material hard, laminated, siliceous limestone?. Locality, Wa-tou-tien. Dimensions, length—10·5 cms., breadth across edge—6·5 cms., across butt—4·5 cms., thickness through middle of the specimen—2·5 cms.

Figure 38. Broken celt with crescentic edge and thin, tapering sides. Material, indurated slate with well-marked cleavage which has resulted in considerable injury to the specimen. Locality, Wa-tou-tien. Dimensions, length—10 cms., breadth across top of edge—5 cms., near butt—3·5 cms., thickness—1·3 cms.

Figure 39. Small polished celt, with straight edge meeting flat sides in sharp corners. The latter are bevelled to meet the slightly convex faces which terminate in a crescentic butt. Material, indurated slate. Locality Shih-tien. Dimensions, length—5 cms., breadth across edge—4 cms., across butt—3 cms., thickness—1·5 cms.

Figure 40. Hatchet edged celt in polished grey and brown jadeite. This specimen is of beautiful design and finish. The sides are flat and barely rounded off to meet the faces, which are convex. The butt and sides form one continuous uninterrupted band of equal width, which terminates in sharp angles with each end of the crescentic blade. The latter bears no sign of use though it is slightly injured in one place. Locality, Mien-ning Ting. Dimensions, length—8·5 cms., breadth across top of blade—5·5 cms., thickness across centre of specimen—2 cms.

Figure 41. Polished hatchet celt in streaked black and dark grey jadeite. In general outline this remarkable example is slightly broader than the preceding one. The sides too are well rounded into the faces while the butt is thinner. Each face bears a convexity, ridge or collar crossing it from side to side at half its length between butt and angles of the edge. This is unmistakably meant for some handle or fastening. The edge is perfect in symmetry and quite sharp. Locality Mien-ning Ting. Dimensions, length 8·5 cms., breadth across top of blade—6·5 cms., across base of butt—4·5 cms., thickness across centre of collars—2·5 cms.

Figure 42. Broken celt used as a polishing and sharpening stone. The celt itself is of the elongated chisel variety with thick, flat and very slightly tapering sides. Both edge and butt have been completely broken away. Both faces bear hollows and grooves due to polishing or sharpening operations. Locality Wa-tou-tien. Material, slate. Dimensions,

length—+ 11, breadth at bottom—2·5 cms., at top—3·5 cms., thickness—2·5.

THE RELATION OF THESE TO OTHER CHINESE FINDS.

The list of stone implements hitherto discovered in China is a small one, which may be briefly summarised—

1. Anderson's specimens.
2. E. Colborne Baber in 1886 reported the discovery of polished axe-heads and chisels from stone coffins in Chung-king, Ssu-ch'uan.
3. In 1884 J. Edkins described a stone hatchet found by Williams in a grave mound near Yu-Chou, 110 miles west of Peking.
4. Descriptions of two flint arrow heads found by Armand David in Mongolia were published in 1886.
5. Giglioli has published an account of a stone implement found in 1896 by Coltelli near Yen-an Fu, in Shensi.
6. In the Bishop collection there are a few jade implements which Bushell has described.
7. My own first collection.
8. Laufer has collected and described 15 jade implements from Sin-ngan Fu in Shensi, where they were obtained from ancient graves of the Chou dynasty (1122 B.C.—249 B.C.), and has also described Couling's collection of 12 surface finds from Tsing-chou Fu in Shantung.

Our new specimens show the intermingling of two groups, one containing forms similar to those from Shan-tung in North China, and the other very like certain Indo-Chinese implements. It is practically certain that they were produced rather by an aboriginal non-Chinese race than by a Chinese one.

From a study of the available evidence Laufer¹ has summarised our present knowledge of the Chinese stone culture, and as our collections help to prove his conclusions still further they may be brought forward here.

1. All stone implements so far found in China are polished, and they therefore belong to that class which so far as prehistoric India, Egypt or Europe are concerned, is termed Neolithic.

2. The finds can be divided into two groups. Those from the surface and those from graves. The former are rougher and more primitive than the latter, which are often of perfect design and exquisite finish. Whether there is any chronological difference between them is still an open question.

3. The prevailing types so far discovered are chisels, hammerstones and hammer-shaped axes and mattocks.

4. No stone workshops, implement factories, or traces of

¹ Loc. cit., pp. 54-55.

an extensive industry in stone, carried on by, and for the benefit of a large local population, have been found. It is therefore not justifiable in the present stage of knowledge to speak of a stone age for China or still less of a stone age of the Chinese.

5. The burial of jade implements was much practised during the historical period of the Chou dynasty (1122 B.C.-249 B.C.) and continued down to the epoch of the two Han dynasties (206 B.C.-A.D. 221), but this only shows that in these early days a pronounced symbolical cult had gathered around these objects, which were probably then regarded as relics of a forgotten past.

The conventional forms of the Chou dynasty mortuary finds undeniably proves that they are directly traceable to immensely older forms of a more realistic character, but with the evidence at our disposal in China to day, this primeval period can only be artificially reconstructed. From the archaeological standpoint, the Chou implements are very recent products and are contemporaneous with a period when the Chinese bronze age, after an existence of several milleniums was nearing its end, and being gradually replaced by iron.



1



2

STONE IMPLEMENTS FROM YÜNNAN.

Photos by J. C. B.

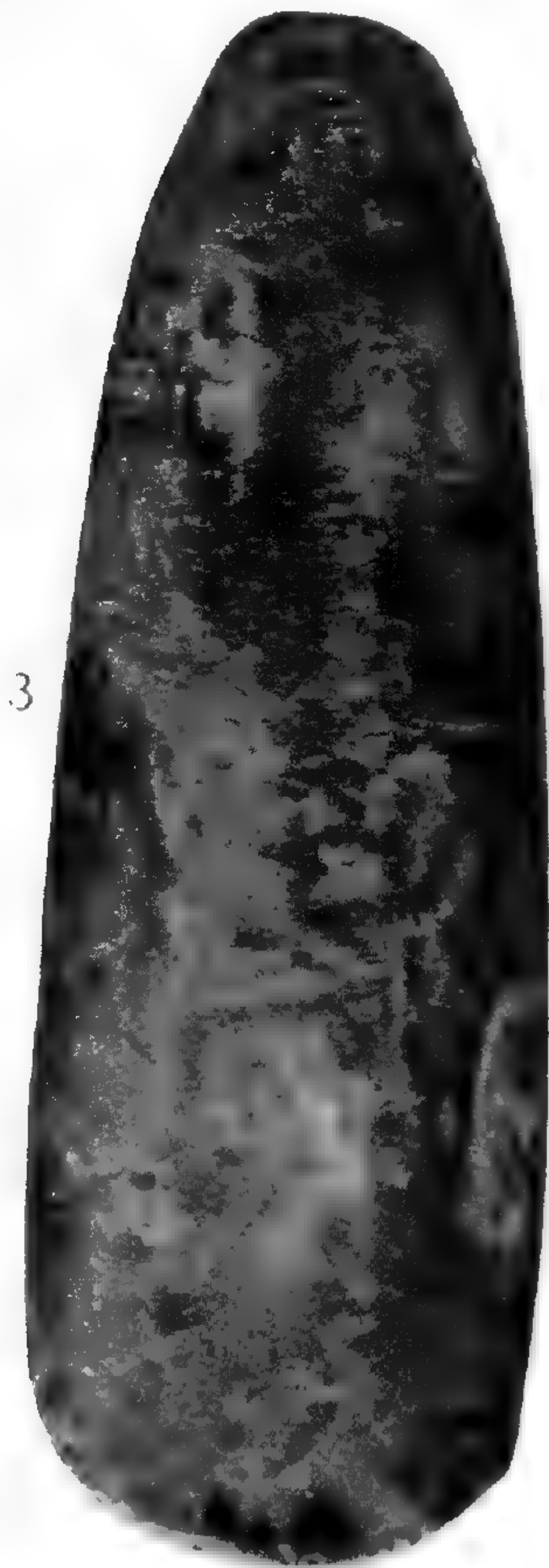

3



5



4



6



7



8

STONE IMPLEMENTS FROM YÜ NNAN.

Photos by J. C. B.

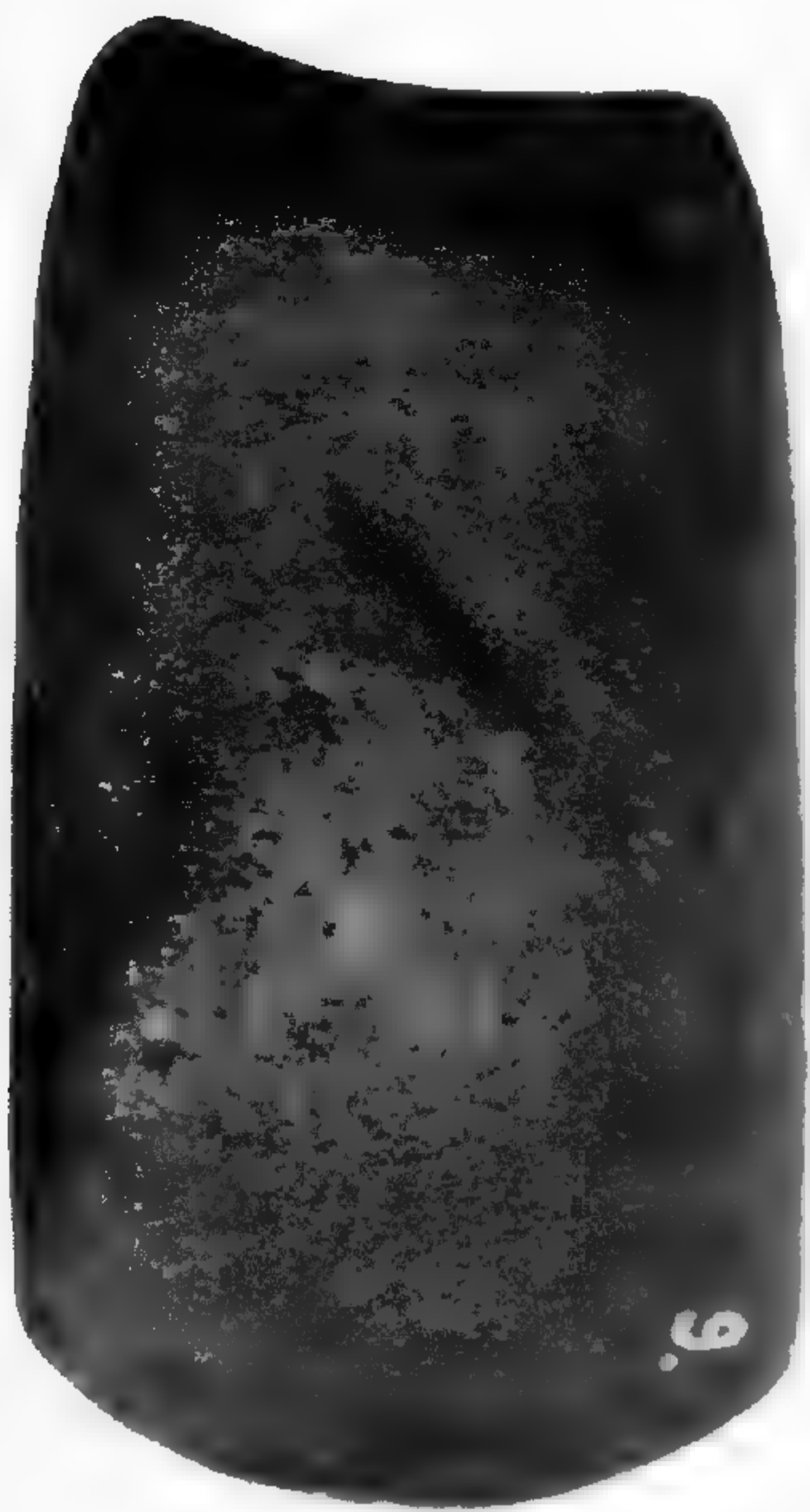

9

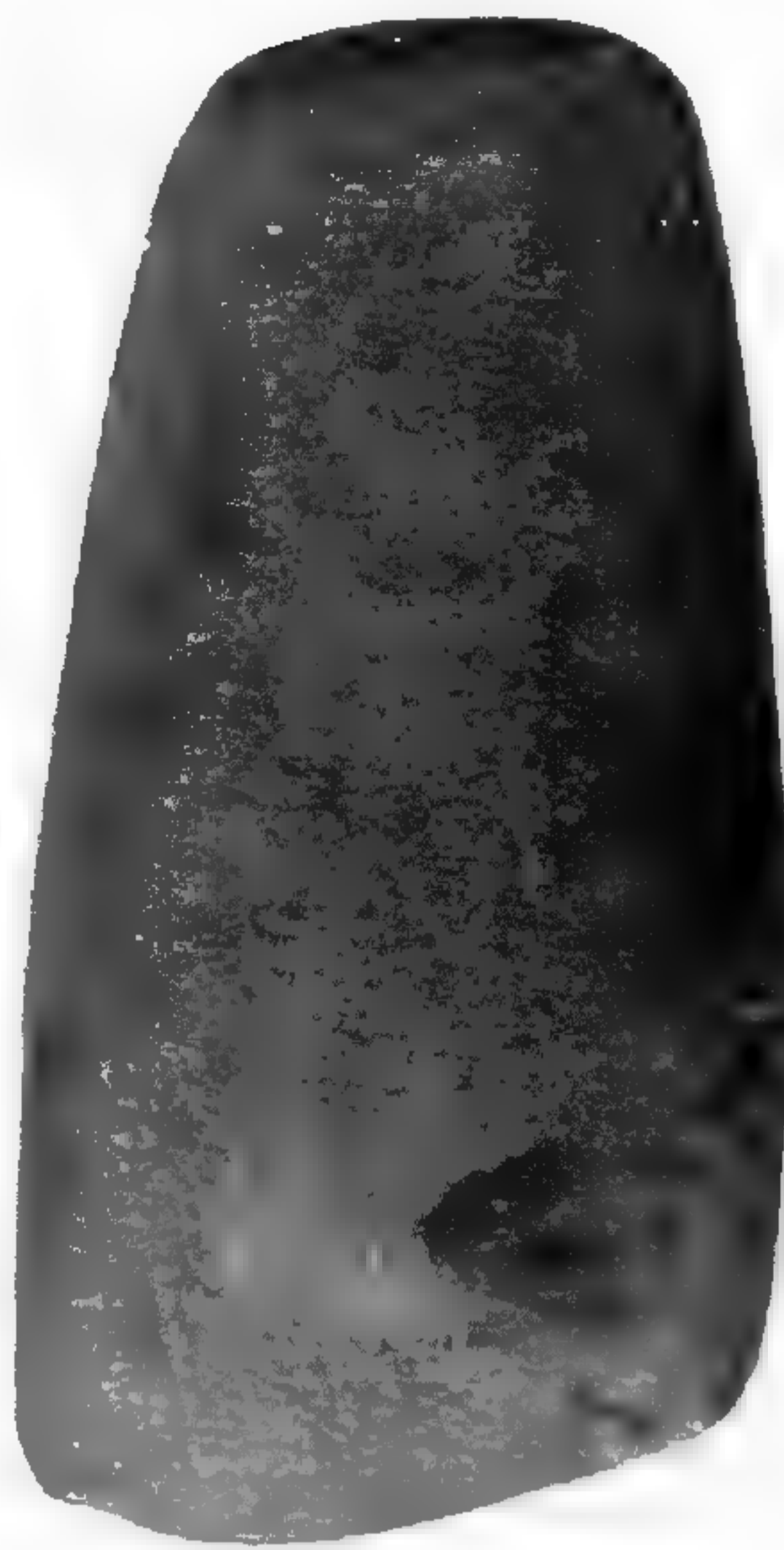

10



11



12



13



14

STONE IMPLEMENTS FROM YÜNNAN.

Photos by J. C. B.

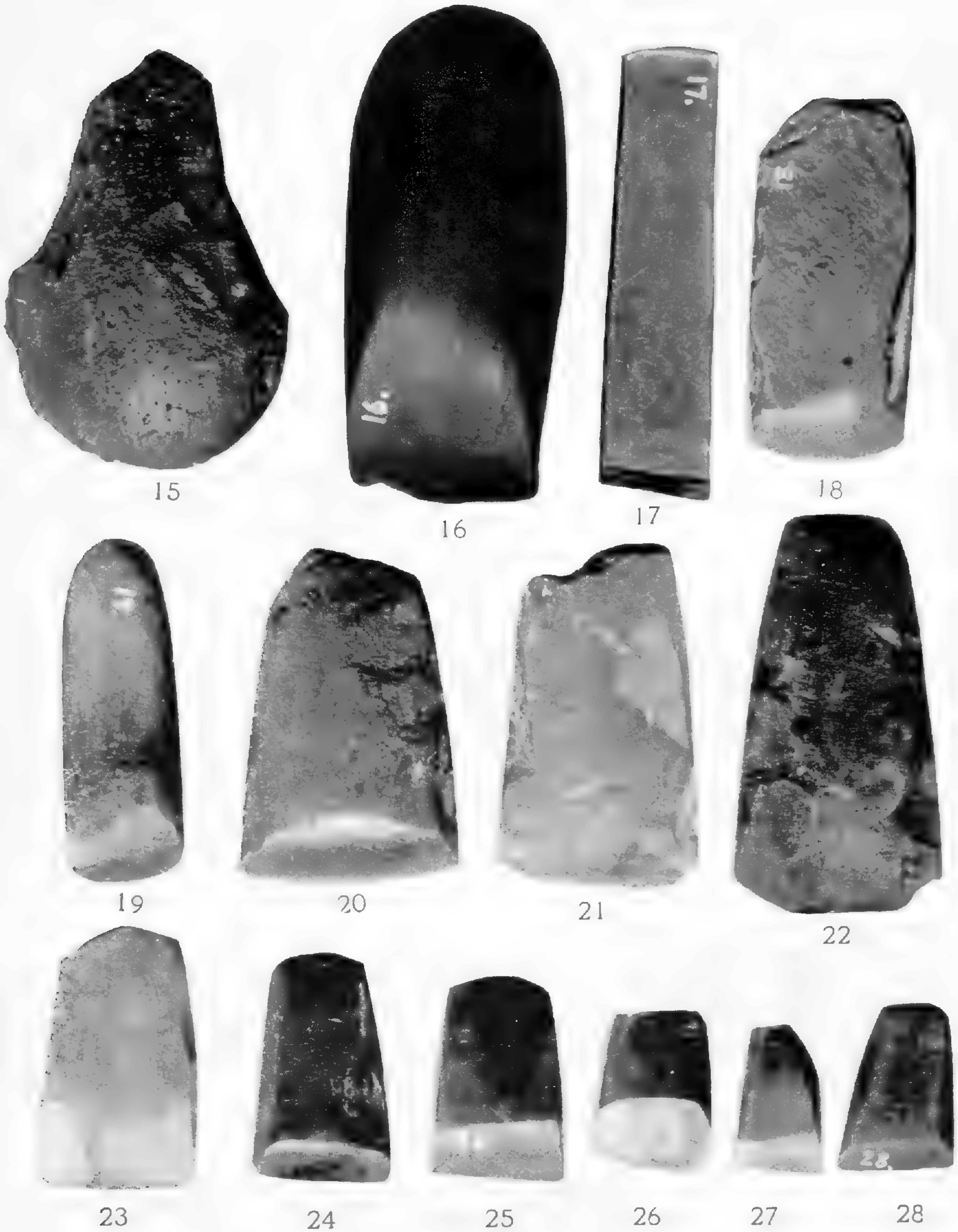

STONE IMPLEMENTS FROM YÜNNAN.

Photos by J. C. B.

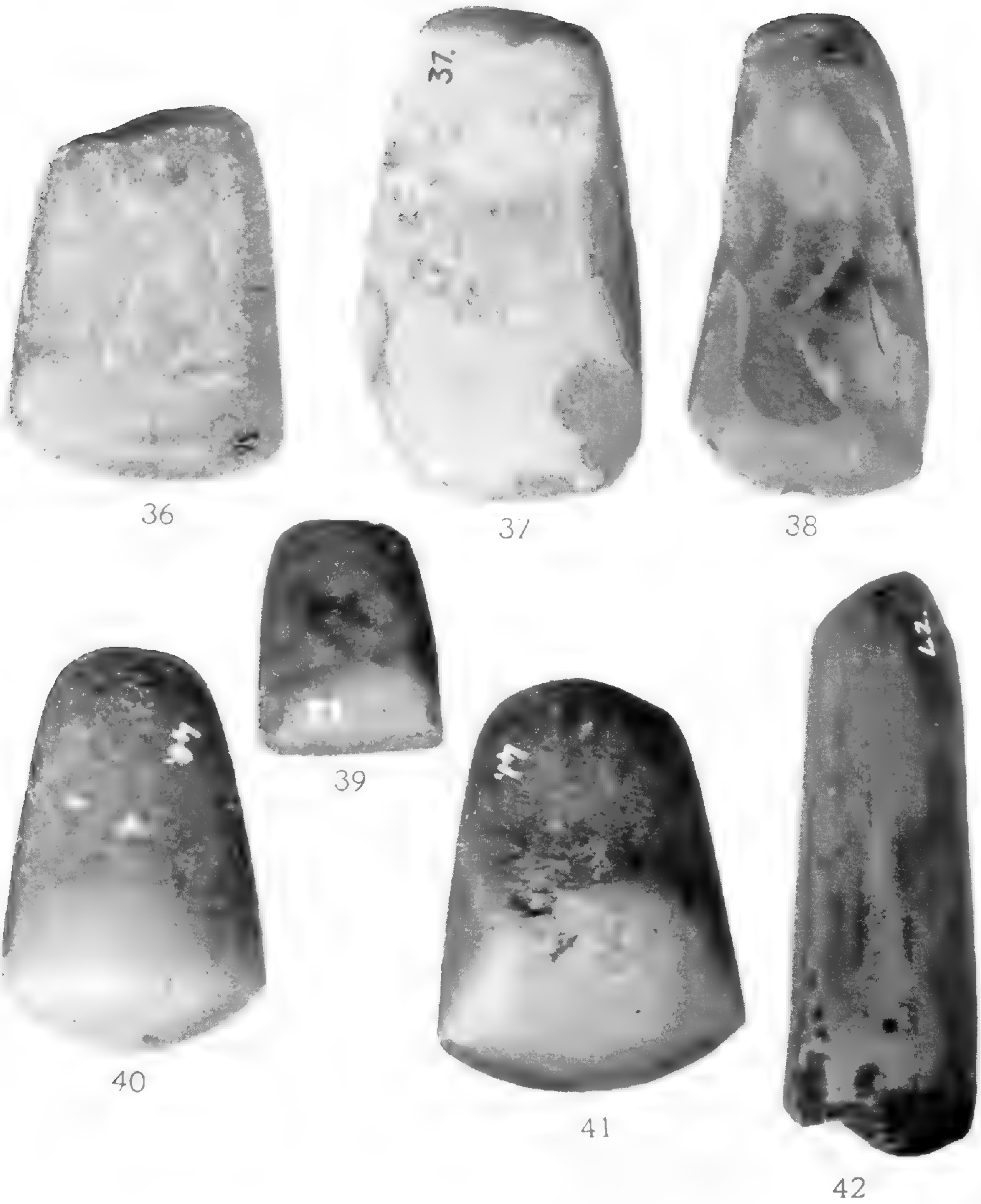

STONE IMPLEMENTS FROM YÜNNAN.

Photos by J. C. B.

30. **Note on the Application of the Principle of Isostatic Compensation to the Conditions prevailing beneath the Indo-Gangetic Alluvium.**

By H. H. HAYDEN, C.I.E., D.Sc.

The appearance last year of a paper by Colonel S. G. Burrard on the "Origin of the Himalaya" has drawn a considerable amount of attention to a theory put forward by him to the effect that the depression in which the Indo-Gangetic alluvium lies is of the nature of a deep rift or crack in the surface of the earth, and that similar cracks occur beneath the Himalaya. The most recent contribution to the question is a note by Colonel G. P. Lenox-Conyngham¹ in which he comments adversely on certain suggestions made by me in a paper dealing with the subject of the postulated rift and designed to show that there is at present no valid reason for discarding the generally accepted hypothesis that the Indo-Gangetic trough is a perfectly normal phenomenon, being merely a wedge-shaped depression, having a sloping floor and a depth varying from zero at the edge which corresponds with the northern border of the Peninsular rock-mass to perhaps 20,000 feet at the mountain foot.

Colonel Lenox-Conyngham's note reached me a few days ago, and, as I am now and shall probably be for several months completely cut off from all literature, I should have preferred to allow the matter to stand over until I was once more within reach of libraries. This, however, I cannot do, in consequence of the imputation conveyed in the third paragraph of the note, to the effect that in acknowledging my indebtedness to the Trigonometrical Survey, I had given cause for the inference that my results were accepted by that office. I need hardly remark that nothing was further from my intention; in conformity with the etiquette observed by most writers on scientific matters, I acknowledged to the best of my ability any indebtedness for such help as I had received, and I had no reason to imagine that my readers, who would naturally be expected to be familiar with the ordinary practice, would attribute to my remarks any such designs as that implied, or would mistake them for more than the usual acknowledgment demanded by scientific etiquette.

The hypothesis usually accepted with regard to the nature of the Indo-Gangetic depression was not discussed by Colonel

¹ Records of the Survey of India, Vol. V.

Burrard in his paper, but was tacitly dismissed in favour of his new theory of a deep rift, a theory based on the fact that certain anomalies had been observed in the deflection of the plumb-line and in the attraction of gravity, which could not be accounted for on the assumption that isostatic compensation occurred at a depth of 113·7 kilometres everywhere beneath India and the Himalaya, while the postulated rift was regarded as capable of producing these anomalies.

The summary rejection of the generally accepted hypothesis without any attempt to discuss or combat the results derived from the extensive work of some of the foremost geologists of the nineteenth century, led me to examine the results on which such rejection was based, although it must be admitted that they had no apparent connection with the hypothesis itself. The results in question were those obtained by Major H. L. Crosthwait from the application of a certain aspect of the principle of isostatic compensation to India. Major Crosthwait confined himself to the assumption that such compensation occurred at a depth of 113·7 km., an assumption which had been found to eliminate most of the geodetic anomalies in the United States, when applied to observation made in that country. It seemed to me that the condemnation of the hypothesis of isostatic compensation on the mere ground that the assumption of its occurrence at a depth of 113·7 km. beneath India failed to explain observed geodetic anomalies was not justifiable and savoured of that commonest of all fallacies, the deduction of the universal from the particular. I made an attempt therefore to investigate the effects for depths other than 113·7 km., as had been done by Messrs Hayford and Bowie in America. In publishing the results I pointed out that they were on the whole more favourable for other depths than for 113·7 km. and that, therefore, if the occurrence or otherwise of isostatic compensation is under investigation, it is not fair to dismiss the hypothesis merely because it happens to be found inadequate if compensation be assumed to occur at one particular depth. To this suggestion Colonel Lenox-Conyngham appears to take exception on the ground that the depth of compensation must be one and the same everywhere; he regards my conclusions as based on a misconception of the theory of isostasy generally and as resting on no "consistent theory of the distribution of matter in the earth's crust." With regard to the first criticism, I can only say that my conception of the theory of isostasy is based on the original idea as enunciated by its author, Dutton, and that any difference in our respective points of view may be due to the fact that Colonel Lenox-Conyngham has restricted his consideration of the question to one particular aspect, circumscribed by his own convictions as to a suitable arrangement of the materials composing the earth. So far as my own views as

[N.S.]

to the distribution of those materials are concerned, they certainly appear to differ from Colonel Lenox-Conyngham's, but I did not attempt to express them in my paper, nor do I propose to do so here, since the matter is not germane to the real issue, which is the probability or otherwise of the presence of an immense rift along the foot of the Himalaya. I may say, however, that my views are based partly on my own observations and partly on those recorded by geologists and physicists generally. When we realize the highly complex nature of such portions of the crust—extending probably to no greater depth than twenty miles—as the operations of natural forces have laid bare to our observation, few among geologists at any rate would have the temerity to dogmatize with regard to the exact distribution of matter below the surface and stigmatize as impossible the suggestion of the possible occurrence of conditions other than those that they themselves believe to exist. For myself, I must confess that I have not the faculty of being able, undeterred by the extreme paucity of the information available, to marshal the component parts of the earth with the meticulous precision of a drill-sergeant. In making the suggestion that the results of my calculations indicated the possibility of isostatic compensation occurring at one depth under India and at another under the United States, I was not unaware of the probable form of an ideal equipotential surface, but I was not satisfied that in the case of the earth it must of necessity coincide with an ellipsoid of revolution. I hold no brief for the principle of isostasy and am by no means convinced that it will prove, in its more restricted aspect at any rate, to be the panacea for all geodetic ills, but I endeavoured to plead, and do plead still, that it is premature to reject on a partial discussion of the evidence for and against it, while it is still more premature to reject the accepted hypothesis as to the nature of the Indo-Gangetic depression with no discussion of the evidence at all. If isostasy is to be judged by the rigid standard that Colonel Lenox-Conyngham appears to demand, it must fail even for the United States, since I think I am right in saying that Hayford has suggested that there may be local variations in the depth of the surface of compensation under the area that he has dealt with.

The sum total of what is known as to the distribution of matter at considerable depths beneath the surface is so small that it would require no little hardihood to say what conditions are or are not possible. What one generation of scientific enquirers has declared to be impossible has become to the next a household truth. To condemn an hypothesis supported by a long series of careful investigations merely because it does not fall in with certain views of our own, based on analogy and supported by no direct evidence, is to disregard the experience of past generations; and the comparatively recent instance of

the discovery of the properties of the radio-active minerals and consequent vindication of the claims of historical geology to an age for the earth which was asserted by a certain section of the scientific world to be impossible, emphasizes the danger of claiming to possess the one and only true view as to the physical constitution of the earth. I am still disposed to agree with Major Crosthwait, who is not only a geodesist but a geologist also, that the difference in geological age between most of the tectonic features of the United States and the Himalaya should lead us to expect some difference in their respective conditions of equilibrium.

Colonel Lenox-Conyngham rightly points out that a table by means of which I attempted to compare the effects of isostatic compensation in adjacent areas at different depths is of no real significance. He omits to mention, however, that we had some considerable correspondence on this as well as on most of the other points with which he deals, and that I agreed with him that the table in question, as it stood, involved a fallacy, a fact which had already been pointed out to me by Mr. R. D. Oldham, immediately after the publication of my paper. The elimination of this table, however, has no effect on the general conclusion at which I arrived, namely that the application of the principle of isostasy to India had not been so exhaustive as to justify its wholesale condemnation. Nor would the omission of the table in any way affect the validity or otherwise of the prevailing hypothesis as to the nature of the Indo-Gangetic depression. Whether we assume isostatic compensation to take place at a depth of 113·7 km. or not to be operative at all, the anomalies in the observed force of gravity at a number of stations on the alluvium—at all those with which I had the opportunity of dealing—entirely support that hypothesis, based on geological observations, as to the form of the depression. I gave in my paper certain figures, deduced in two separate ways, for the depth of the alluvium: these figures were based on calculations for which some of the data were derived from the published work of Colonel Lenox-Conyngham himself, but lest I should be suspected of a design to imply that he agrees with the results observed, I hasten to add that I have no reason to suppose that he does agree. In his note he has not made any reference to this aspect of the question, presumably therefore he is not prepared to show that my results are incorrect. I should mention, however, that from the correspondence to which I have already referred, I gather that he is not satisfied with the figure that I employed for the average density of the alluvium. I feel that I owe him an apology for mentioning this fact without his permission; I must plead as my excuse the improbability of my being able to receive answers to correspondence during the next five months.

[N.S.]

The probability of the approximate correctness of the results arrived at by me with regard to the form and depth of the Indo-Gangetic depression has recently been most strikingly confirmed by Mr. R. D. Oldham, who had taken up independently an investigation into the effect on the plumb-line of a depression of the above type filled with alluvium; in a paper published in a recent number of the *Geological Magazine*, he has pointed out that such a phenomenon is capable of producing the observed anomalies. The rift postulated by Colonel Burrard thus becomes superfluous.

With reference to Colonel Lenox-Conyngham's last criticism on my paper, namely that in dealing with the deflections on the basis of isostatic compensation occurring at a variety of depths, I ought not to have employed the algebraic sums of the residuals in the respective groups, but the sums of their squares, it ought not to be necessary for me to repeat the reason for the course that I adopted, since it was stated clearly not only in my paper, but at greater length in the correspondence with Colonel Lenox-Conyngham, to which I have already referred and which he seems to have overlooked. Not only did I realize, but I stated in my paper, that the sums of the squares would probably give a more accurate result: I purposely refrained, however, from employing that method in order that my results might be derived in an identical manner, and be therefore directly comparable with those of Major Crosthwait. The sole object that I had in view, so far as my calculations were concerned, was to ascertain how the effects of isostatic compensation occurring at depths other than 113·7 km. would compare with those given by Major Crosthwait for that particular depth. Such comparison would not have been legitimate if I had deduced my results by a method different from that employed by him. Even apart from this, the fact that the algebraic sum had been employed in the most recent publication on the subject issued by a body of geodetic experts would seem to show that it had been deliberately employed as being the most suitable method and therefore worthy of adoption by others dealing with the same subject. Colonel Lenox-Conyngham's endeavour to justify its use in that particular instance does not appear to me to be very convincing, since he bases such justification on the predominance of sign in the individual groups. If my figures are examined, I think it will be found that the percentage of variation compares not unfavourably with those quoted by Colonel Lenox-Conyngham from Major Crosthwait's paper. Thus in one region, out of four figures, two have a positive sign and two a negative,—thus producing the maximum variation possible, fifty per cent each way. In another region out of 17 figures two have no sign at all, while of the remaining fifteen 20 per cent have one sign and 80 per cent the other. In yet another region the

corresponding figures are respectively 66·6 and 33·3 per cent. In certain cases no doubt all the figures have the same sign, but I think—I cannot confirm this, as I have not the paper with me—that similar groups will be found among my figures. But in neither case—that of Major Crosthwait's results or that of mine—would my temperament be sufficiently sanguine to allow to me to say, as Colonel Lenox-Conyngham does of the former, that “there was a very strong tendency to persistence of sign.”

In my discussion of the ‘rift hypothesis,’ I purposely avoided confusing the issue by any detailed consideration of Colonel Burrard's further ingenious suggestion as to the occurrence of other “subcrustal” cracks. So far as its original purpose is concerned, the suggestion has now probably become unnecessary, since the more usual hypothesis as to the nature of the Indo-Gangetic depression appears capable of accounting for the various geodetic anomalies. The new hypothesis is undoubtedly a convenient one, since it is capable of infinite adaptability, any individual anomaly being removable by the postulation of a suitable crack: unfortunately, it is unsupported by other evidence and until the accepted hypothesis, which is based on solid foundations in other respects as well, has been shown to be inadequate on geodetic grounds, it would be difficult to justify the introduction of a new one. At the same time Colonel Burrard's interesting application of his idea to tectonic processes cannot fail to attract attention and will no doubt receive careful consideration. His suggestion that the opening of a crack may result in the folding of the overlying material and so produce mountain ranges is difficult of investigation to the extent required to remove it from the realm of conjecture. Subterranean cracks are of course familiar phenomena; those that would seem of sufficient importance to produce the required effect are always found to contain intrusive igneous material, which is believed with good show of reason to have been injected contemporaneously with the formation of the crack. The problem thus becomes an extremely complicated one and will require very extensive investigation before it can hope to supplant the elaborate structure built up by Professor Joly with such ingenuity and detail and based on such extensive observations of mountain structure.

31. Sirhind or Sehrind.

By H. BEVERIDGE.

The Indian Gazetteer says, xxiii, 20, that the spelling Sirhind is modern and due to a fanciful derivation. But Khāfi Khān I, 402, Bib. Ind. ed., says that Sirhind is the old name and that Shah Jahān, early in his reign, changed it to Sehrind. He adds that the style Sirhind was applicable in the time of Ghaznavi princes because their kingdom extended as far as Sirhind, or the Head of India, but ceased to be appropriate when the Indian Empire included Afghanistan.

Khāfi Khān can hardly have been mistaken, and he is supported by the fact that in the earlier Persian histories, such as the Ṭabaqāt Nāsirī, the Akbarnāma, and the Persian translation of Bābur's Memoirs, the name is commonly written Sirhind. The Bādshāhnāma of 'Abdul Hāmid is a remarkable instance. In the first volume, Bib. Ind. ed. 65, in recounting the events of Humāyun's reign, the word is twice written Sirhind, but in the second volume, which contains Shāh Jehān's reign, it is Sahrind. See the Indices; see also the quotation from General Cunningham in Jarrett's translation of the Ayīn Akbarī II, 281. Blochmann also seems to regard Sarhind or Sirhind as the proper spelling. It is quite likely that Sahrind was the old Hindi name, and that this was why Shah Jehān adopted it, but it does not seem correct to say that Sirhind is modern and of a fanciful derivation. I might add that the alteration might be found useful as a means of tracing the ages of undated MSS. Thus if we find Sahrind written in a Persian MS. it cannot be older than Shah Jahān's reign. Thus it seems to show that the Ilminsky MS. of Bābur Turkī Memoirs is older than the Haidarabādi one, for the former, p. 332, writes Sirhind whereas the corresponding passage in the Haidarābād MS., viz. 257, has Sahrind. I have, however to acknowledge that at p. 289 of Ilminsky, near the top, it is written Sahrind, just as in the Haidarabādi, p. 225^b. The latter invariably has Sahrind (see Index II), whereas Ilminsky oscillates between Sirhind and Sahrind.

NOTE.

On reflection, it seems to me doubtful that Shāh Jahān would revive a Hindu name for the city of Sirhind. It is also doubtful if there ever was a Hindu city called Sahrind or

Sirhind. Is it not more probable that the change was like that which converted Pūrūshpūra into Peshawar? Sihra means a chaplet or garland and is used by Khāfi Khan, I, 126, to designate a row of pearls, and Shāh Jehān may have thought that as the name Sirhind, or Head of India, was no longer appropriate, it might, by a slight change, be converted into Sirhind, "the chaplet of India," in allusion to the gardens for which the city was famous. Whatever was the reason of the change, it was not long effectual, for the city soon became known again as Sirhind, and it is still so called.

H. B.

32. The Date of the Death of Shah Beg Arghūn, the ruler of Sind.

By H. BEVERIDGE.

It is curious that there should be any doubt about the exact date of Shah Beg's death for he was a distinguished man, a conqueror and a man of letters, and his death occurred in a well-known part of Sind and so late as the first quarter of the sixteenth century. But there is a conflict, and one that extends to years, and not to days and months, for Ferishta and Erskine say he died in 1524 (930 A.H.), whereas the local historians, and Elliot (vol. I, Appendix 502), and Aitken in the new *Gazetteer of Sind*, hold that he died in 1522 (928 A.H.)

On looking into the sources we find that the earliest authority for the date 1524 is Nizāmu-d-dīn Ahmad in his *Ṭabaqāt Akbarī*. Near the end of his history he has a chapter on Sind, and at p. 637 of the Newal Kishore edition he gives the date of the death as 930. He does not mention where it took place. His history was completed in 1594 (1003 A.H.), Elliot V, 183, and is thus a few years earlier than the work of Mir M'asūm Bhakharī, the local historian of Sind, which was completed in 1600. But Mir M'asūm had long meditated his history, and had collected materials for it for several years, though he only finished it in his old age. He was Nizāmu-d-dīn's contemporary and assisted him in writing his history. See the *Maasīru-l-Umarā* which speaks, vol. III, 327, of the association of the two men. Nizāmu-d-dīn Ahmad also mentions in his preface the *Tārīkh Sind* as one of his sources, and this can hardly be any other book than M'asūm's. It follows that as regards date of information M'asūm is as good an authority as Nizāmu-d-dīn, and he had a far better opportunity of knowing the truth, for his forefathers had been for some generations in Qandahar, and he himself was born and bred in Bhakkar. He is also far more circumstantial than Nizāmu-d-dīn for he gives Shah Beg's last words, and he tells us where he died, and gives the day and the month as well as the year, and adds a chronogram.

Ferishta, it is true, gives 930 A.H. as the date, but his statement adds nothing to the authority of Nizāmu-d-dīn for he merely copies him, and is equally vague about the place and date of the death. He is also a later writer than M'asūm. Elliot is clear for 928 (1522), saying "under these conflicting evidences, we may rest assured that the chronogram is correct, and that Shāh Beg Arghūn, the conqueror of Sind, died at

Agham on the 23rd of the month of Sha'bān, 928 A.H. (18 July, 1522).” Curiously enough, Elliot has, by a clerical error, overstated the extent of the conflicting evidence for he quotes the Tarkhānnāma as giving the date of 926 whereas MSS. show, and Elliot himself tells us at p. 312 of the same volume, that the Tarkhānnāma gives the date as 928.

As a fact, all the local histories (they are, apparently, four in number), except the Tārīkh Tāhirī, give the date as 928, and the authority of this last is destroyed not only by its being a comparatively modern work, but by its giving the impossible date of 924.¹ It is remarked by Elliot that the author of the Tuḥfta-l-kirām gives satisfactory reasons why the statements of the Tārīkh Tāhirī should not be accepted. On referring to the Tuḥfat I find that the author says that the Tārīkh Tāhirī in one place says that Shāh Beg died in Qandahar, and in another that he died in Multan. “Both statements,” he continues, “are far from the truth, for Bābur had taken Qandahar from Shah Beg, and the latter had taken Shal and Sibūī; how in so short a time could Shāh Beg go back to Qandahar?” To Elliot’s authority may be added that of Major Raverty, who though always ready to find fault with Elliot and Dowson, says in his Notes on Afghanistan, p. 587, note, that there is not the shadow of a doubt that Shāh Beg died in the seventh month of 928. Erskine, rather inconsistently, accepts M’aṣūm’s date for the day and the month, but rejects it for the year, and makes no mention of M’aṣūm’s chronogram, *Shahr Sha'bān*, which yields 925.

The only real ground for doubting the date 928 is one which is not taken by Erskine, and is the circumstance that the date appears to conflict with the Ḥabību-s-siyar and the Qandahar inscription. Khwāndāmīr certainly seems to imply that Shāh Beg was in Qandahar in 928, and he quotes a passage of a letter, or an oral statement of Bābur’s, to the effect that he hoped to take Qandahar and to send Shāh Beg in chains to Herat. But Khwāndāmīr does not say in so many words that Shāh Beg was in Qandahar in 928, and there is no mention of the fact in Bābur’s Memoirs for there is a gap in these from 926–932.

Khwāndāmīr is, no doubt, a valuable writer, and he is Shāh Beg’s contemporary, but his subject was not Afghanistan, but Persia, and Shāh Ism‘ail. He does not give details of the sieges of Qandahar, and does not even mention the fact that Shāh Beg sent the keys of Qandahar to Bābur in 923 by his (Khwāndāmīr’s) grandson Ghīāṣu-d-dīn. If he indeed thought that Shāh Beg was in Qandahar in 928, he may have

¹ It also gives the chronogram *Kharābī Sind* for the conquest of Sind. This yields 927, and all the other authorities say that the conqueror was Shāh Beg.

been mistaken. That he was there, is exceedingly unlikely, for he had given up the keys and said farewell to the place in 923, and in 926 and 927 he was at Tatta in Southern Sind and a long way from Qandahār. He may very well have encouraged the Qandahāris to resist Babur, without being there himself. As regards the Qandahār inscription which says that the place was taken on 13 Shawwāl 928, it has to be stated that this differs from Khwāndāmīr's account which makes Bābur report the capture earlier in the year.

Erskine considers M'aṣūm's chronology as confused, and Malet's translation makes Shāh Hasan (Shāh Beg's son) be present in Qandahār in 921, whereas he seems to have been with Bābur at that time. But the Persian original places Shāh Hasan's presence at Qandahār in 922, and one MS. of the *Tarkhānnāma* says, Shāh Hasan was two or three years with Bābur. I do not find M'aṣūm's dates confusing. He gives them year by year from 913 when Bābur first conquered Qandahār, and I do not think that they conflict with Bābur's *Memoirs*. He mentions how the Arghūns recovered possession of Qandahār, and how Babur tried for successive years to recover it. In 922 the Arghūns were hard pressed, though Mehtar Sambhal contrived to get supplies of food into the citadel. In 923 Shāh Beg went to Shāh and Sibūi, and endured great privations there for two years. Then he went further south and fought two battles with the Jām and his son. In 928 Payanda Moghul was put in charge of Bhakkar by Shāh Beg, and the latter went on to take Gujarat, but died on the way at Agham in the Hyderabad district. There is not a word in any local historian about his going back to Qandahār in 927 or 928. It may be remarked here that though Abul Faḍl puts the conquest of Sind (by Shāh Beg) into 929, Ferishta agreeing with the local authorities, and the chronogram Khārābī Sind, puts it into 927.

33 The Action of Nitric Oxide on Metallic Peroxides suspended in Water. Part I.

By BARUN CHANDRA DUTT and SURYA NARAYAN SEN,
Scottish Churches College Laboratory.

[Read at the First Indian Science Congress on January 15, 1914.]

In a previous paper (Proc. Chem. Soc., 1913, 29, 235) one of the present authors in collaboration with two others, discussed the reaction which takes place when nitric oxide is passed through a neutral solution of potassium permanganate in an atmosphere of hydrogen. It was pointed out that a nitrate is formed and that there is no intermediate formation of nitrous acid. We accordingly thought that milder oxidizing agents might bring about the formation of nitrites, and with a view to ascertain whether this is really the case, we decided to study the action of nitric oxide on metallic peroxides suspended in water. Sabatier and Senderens (Compt. Rend., 114, 1476-1479) have shown that when the gas is passed into water containing lead dioxide, manganese dioxide and silver oxide, appreciable quantities of nitrite are formed, even when air is entirely absent. The reaction is most distinct in the case of the lead compound so that a solution containing four grams. of lead nitrite per litre can be obtained; if the passage of the gas is prolonged, or if the liquid is concentrated, basic lead nitrite is formed. It was thought desirable to repeat the experiment with lead dioxide before studying the action of the gas on other peroxides.

2. The nitric oxide was prepared by dropping a solution of sodium nitrite into a saturated solution of ferrous sulphate in strong hydrochloric acid. It was stored up in gas-holders, and before being allowed to come in contact with the mixture of lead peroxide and water it was washed thoroughly by bubbling through caustic soda solution contained in two wash bottles. A small quantity of lead dioxide with about 50 cc. of water was introduced into a flask which was placed in connection with a three way stop-cock. Of the two free-ends of the stop-cock one was connected with a hydrogen generator and the other with the gas-holder containing nitric oxide. The air in the flask was first displaced by a slow stream of hydrogen and the contents were then heated to boiling to expel dissolved air. After cooling to the ordinary temperature (29°-30°) of the laboratory in a current of hydrogen nitric oxide was bubbled through the mixture of lead peroxide and water for several minutes with constant shaking. The whole of the

lead compound was not allowed to react with the gas, and after displacing the nitric oxide by means of a current hydrogen the contents of the flask were vigorously shaken to facilitate the oxidation of the dissolved nitric oxide by the lead peroxide left over. The cork closing the mouth of the flask was then removed and the liquid filtered, when a pale yellow solution was obtained. This answered to the metaphenylene diamine test for nitrites and gave a white precipitate of lead sulphate with dilute sulphuric acid. The nitrous acid was removed completely by heating with an excess of ammonium sulphate as long as the liquid gave a colour reaction with Griess's reagent, the precipitated lead sulphate was filtered off and on now applying the brucine test for nitric acid a distinct red colouration was obtained. It, therefore, appeared that both lead nitrite and lead nitrate had been formed. Ray Dhar and De (*T. Chem. Soc.*, 1912, 101. 1185), however, are of opinion that when ammonium nitrite is heated for the preparation of nitrogen, a small portion breaks up according to the equation :—



They were led to this conclusion by the result arrived at by Lord Rayleigh and Prof. Ramsay while endeavouring to prepare "chemical nitrogen" from a mixture of ammonium chloride and potassium nitrite. It was pointed out that the crude gas from this source always has an ammoniacal smell. If, however, potassium nitrite be dissolved in water containing ammonium chloride the solution should, according to the laws of chemical equilibrium, contain the four substances—potassium chloride, ammonium nitrite, ammonium chloride and potassium nitrite—so that we are not justified in assuming without experimental proof, that the ammonia in the above instance is a product of the decomposition of ammonium nitrite. If, on the other hand, ammonium nitrite, actually decomposes on heating into ammonium nitrate, nitric oxide and ammonia, the colour reaction obtained with brucine, as indicated above, is inconclusive. We, accordingly, proceeded to study the action of heat on a solution of ammonium nitrite.

3. A strong solution of the salt was prepared by dissolving freshly prepared silver nitrite in boiling water and adding barium chloride as long as a precipitate separated out. The silver chloride was filtered off and to the solution of barium nitrite thus obtained ammonium sulphate was added slightly in excess. The precipitated barium sulphate was removed by filtration and the clear solution of ammonium nitrite boiled as long as it gave a yellow colouration with a solution of metaphenylene diamine hydro-chloride in dilute hydrochloric acid. On now applying the brucine test for nitric acid no red colouration was obtained. It, therefore, follows that by the action

of nitric oxide on a mixture of lead peroxide and water both lead nitrite and lead nitrate are formed.

4. This fact was further confirmed quantitatively. Twenty-five cubic centimetres of the yellow solution obtained by passing nitric oxide through water containing lead peroxide were precipitated with sodium sulphate, and after filtering off the lead sulphate the clear liquid was diluted to 100 cc. in a measuring flask. Five cubic centimetres of this solution shaken with concentrated sulphuric acid over mercury in a Crum nitrometer gave 3.30 cc. of nitric oxide measured over water at 30.5 C and 756.2 mm. pressure (tension of aqueous vapour at 30.50 C = 32.463 mm.). Ten cubic centimetres of the solution similarly treated gave 6.8 cc. of nitric oxide. The total weight of nitrogen present, therefore, in 10 cc. of the diluted liquid = .0036 gram.

5. For the estimation of the weight of nitritic nitrogen present, the Rupp method was employed. Twenty-five cubic centimetres of N/10 potassium permanganate solution were added to 10 cc. of the diluted liquid and a few crystals of sodium carbonate dissolved in the mixture. The solution was warmed on the water bath for fifteen minutes, cooled, acidified with dilute sulphuric acid, and excess of potassium iodide then added; the liberated iodine was titrated with N/10 sodium thio-sulphate (reduction factor 1.01) of which 20.6 cc. were required. As the deci-normal solution of potassium permanganate employed had been lying unused for some time it was decided to redetermine its strength by titration. Twenty-five cubic centimetres of the liquid were found to be exactly equivalent to 24.6 cc. of N/10 sodium thio-sulphate (reduction factor 1.01). The volume of potassium permanganate solution, therefore, used up in oxidizing the nitrite = $1.01 \times (24.6 - 20.6)$ cc. or 4.04 cc. 1 cc. of N/10 $\text{KMnO}_4 = .00345 \text{ NaNO}_2$. Consequently the weight of nitritic nitrogen present = .0028 gram. It will be seen that this is less than .0036 gram., the total weight of nitrogen contained in 10 cc. of the diluted liquid by .0008 gram.

6. We must now proceed to explain how lead nitrite and lead nitrate are formed by the action of nitric oxide on a mixture of lead peroxide and water. The former is evidently obtained according to the equation :—



The formation of lead nitrate is not so easily understood. If the passage of the gas through the mixture is prolonged and the whole of the lead compound allowed to take part in the reaction a yellow powder insoluble in water is left behind. This dissolves in dilute acids without evolution of nitrous fumes and the clear solution gives a white precipitate with

dilute sulphuric acid, but no colour reaction with Griess's reagent. It, therefore, appears that during the formation of lead nitrite and lead nitrate a part of the peroxide is reduced to lead monoxide.

7. If a little of the yellow solution obtained by the action of nitric oxide on lead dioxide in presence of water is shaken up with the peroxide, its colour becomes fainter and after filtration the residue on the filter-paper is found to contain lead monoxide which may be readily separated from the unchanged dioxide by treatment with dilute nitric acid. It, therefore, follows that lead nitrate is formed, partly at least, by the oxidizing action of lead peroxide on lead nitrite.¹

BARIUM PEROXIDE.

The apparatus used was the same as that employed in the case of lead dioxide. On filtering the liquid in the flask after passing nitric oxide through it a colourless solution was obtained. This answered to the metaphenylene diamine test for nitrites and gave a white precipitate of barium sulphate with dilute sulphuric acid. On exposure to air it became turbid on account of the presence of barium hydroxide which was formed when the mixture of barium dioxide and water was boiled previously to passing the gas through it, and which uniting with the carbon dioxide of the air formed barium carbonate. After removing the nitrous acid with ammonium sulphate in the usual way no red colouration was obtained on adding a solution of brucine in strong sulphuric acid. It, therefore, follows that when nitric oxide is passed into water containing barium peroxide only a nitrite is formed.

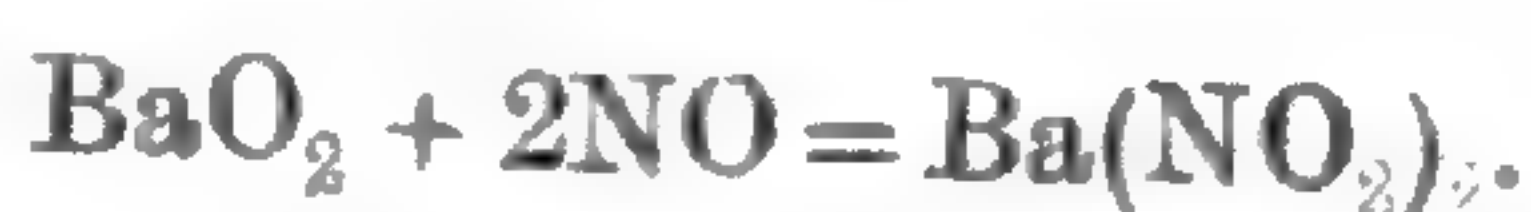

Quantitative experiments were made to confirm this result. Five cubic centimetres of the liquid obtained by passing nitric oxide through water containing barium peroxide gave, on shaking with concentrated sulphuric acid over mercury in a Crum Nitrometer, 5.5 cc. of nitric oxide, measured over water at

¹ This conclusion was confirmed in the following manner:—

Ten cubic centimetres of the yellow solution were diluted to 50 cc. after precipitation with sodium sulphate and filtration. The nitrite present in 10 cc. of the diluted liquid was oxidized with N/10 potassium permanganate (25 cc.) containing free alkali, and after adding excess of potassium iodide the liberated iodine was titrated with N/10 sodium thio-sulphate (reduction factor 1.01).

Volume of $\text{Na}_2\text{S}_2\text{O}_3$ solution required = 21.5 cc.

After shaking up 10 cc. of the yellow liquid with lead peroxide for a few minutes, and treating it in the same manner the volume of thio-sulphate solution required was 22.1 cc. This was evidently due to the oxidation of a part of the lead nitrite into lead nitrate by the peroxide.

30.5°c and 765 mm. pressure (tension of aqueous vapour at 30.5c = 32.46 mm.). It will be seen, therefore, that the total weight of nitrogen present = .003 gram. nearly.

For the estimation of the weight of nitric nitrogen present the same method was employed as in the case of lead peroxide. Ten cubic centimetres of the solution of barium nitrite, obtained as described above, were precipitated with sodium sulphate and diluted to 50 cc. After oxidation with 25 cc. of N/10 KMnO₄ (reduction factor 1.01) containing free alkali, 10 cc. of the diluted liquid were titrated with N/10 Na₂S₂O₃. Two experiments were made, the volumes of Na₂S₂O₃ solution required being 22.55 cc. and 22.6 cc. (mean 22.57 cc. respectively). From these data it follows that the weight of nitric nitrogen present in 5 cc. of the original liquid = .0047 gram.

It should be noticed that this is slightly greater than the total weight of nitrogen obtained by the nitrometric method, but considering the greater accuracy of the Rupp method, the agreement between the two results is, in our opinion, pretty close.

34. Notes on the Fat of *Garcinia indica*, the so-called *kokam* butter.

By HAROLD H. MANN and N. V. KANITKAR.

Some very interesting data, contributed by Mr. D. Hooper, with regard to the fats of various species of *Garcinia* appeared in the Journal of the Asiatic Society of Bengal in 1907¹, and the present note is intended to supplement the information contained in that article as far as it concerns the *kokam* butter of Western India, obtained, as is well known, from the seeds of *Garcinia indica*.

Full details with regard to this tree and the method of extraction of the oil will be found in Watt's Dictionary of the Economic Products of India², but we may supplement that account with a few additional facts. The *kokam* trees are found chiefly in the two southern talukas (Malvan and Vengurla) of the Ratnagiri district. Thirty-two villages in the former taluka and at least half the villages in the latter are known to grow the tree. They are not cultivated or specially planted but grow naturally on the so-called *varkas* or high, dry land in these talukas. They are found particularly on the slopes of, and in the valleys among, laterite hills. The extraction of *kokam* butter is a purely cottage industry, and no factories exist. The extracted butter, however, is chiefly taken to Bombay.

We examined two samples of the butter, one of them extracted in the laboratory and the other purchased in the bazaar. These gave the following constants, which we place side by side with those given by Hooper for the sample (from the Indian Museum) which he examined:—

MANN & KANITKAR.			
	Sample prepared in laboratory.	Sample bought in bazaar.	HOOPER.
Specific Gravity at 50°C.	·896	·826	·910
Melting point	41°C	43°C	43°C
Acid value	4·9	24·8	41·3
Saponification value	189	194	191·5
Iodine Value	33·2	35·3	25·0
Reichert Meissl value	·6	·7	·98
Percentage of fatty acids	95·1	94·2	93·5

¹ The Fats of *Garcinia* species by David Hooper. Journal, Asiatic Society of Bengal, Vol. III, page 257 (1907).

² Vol. III.

There is little difference in the figures except with regard to the acidity, and this is obviously due to the fat turning rancid on keeping. Our freshly extracted sample was hardly acid at all, and the fresh product we bought in the bazaar was much less acid than Hooper's museum sample.

We separated the non-volatile fatty acids, and these gave the following constants:—

Iodine value	..	27.1
Mean Molecular weight	..	278

Our results confirm those reached by Heise¹ (1897) and Hooper (*loc. cit.*) that the fat consists almost wholly of oleodistearin.

The presence of volatile fatty acids in *kokam* butter has been denied (*vide* Watt's Dictionary), but from the high saponification value, there was reason to suppose that volatile or soluble fatty acids were really present. On saponifying and distilling with forty per cent sulphuric acid in a current of steam, a quantity of acid was obtained in the distillate equivalent to .084 per cent of acetic acid. On standing, this distillate separated giving an oily layer in very small quantity, probably Lauric Acid (*vide* Heise, *loc. cit.*), and a watery layer containing a much larger quantity of the soluble fatty acids. These proved to be free from butyric acid,—and on examination by Duclaux's fractional distillation method, the proportion distilling with each fraction is shown in the following table:—

Lower Volatile Fatty Acids.

				Figures actually obtained.	Figures required for a mixture of equal quantities of Acetic and Propionic Acids.
	1st fraction	%	%
1st &	2nd	9.8	9.7
1st to	3rd	18.4	19.6
1st to	4th	27.8	29.3
1st to	5th	39.5	39.1
1st to	6th	48.1	48.8
1st to	7th	56.5	58.6
1st to	8th	65.1	68.4
1st to	9th	74.9	78.4
1st to	10th	86.9	88.7
				100.0	100.0

The volatile and soluble fatty acids in *kokam* butter are therefore a mixture of acetic and propionic acid in approximately equal proportions.

¹ Arbeiten aus dem Kais. Gesundheitsamte, Vol. 13, part 2 (1897).

35. A Comparative Study of the Marriage Customs of
the Cochin Castes.

By L. K. ANANTHA KRISHNA IYER.

[Read at the First Indian Science Congress, January 17th, 1914.]

In encyclopedical and philosophical works, several different definitions of the word 'marriage' are met with, and most of them are of merely juridical or ethnical nature, comprehending either what is required to make the union legal or what in the eye of an idealist the union ought to be. Broadly defined, marriage is nothing else than a more or less durable connection between male and female lasting beyond the mere act of propagation till after the birth of the offspring. This excludes all loose connections, which, by usage, are never honoured with the name of marriage.¹

Marriage and Celibacy.—So indispensable does marriage seem to man, that a person who does not marry is looked upon with contempt or is at any rate disdained. Among the Hindus, celibacy is regarded as an impiety and misfortune: "an impiety, because one who does not marry puts the happiness of the manes of the family to peril; a misfortune because he would receive no worship after his death." A man's happiness in the next world depends upon his having a continuous line of male descendants whose duty it is to make the periodical offerings for the peace of his soul. Hence it is that marriage has become a religious duty, the twelfth *samskara* incumbent upon all.² Until he finds a wife, a man is only half of a whole; and among the Hindus of the present day, a celibate is considered to be a useless member of the society; 'and is looked upon as beyond the pale of nature,' and all women without exception are bound to marry. Mahomedans also consider marriage a duty both for man and woman. It was declared to be an institution ordained for the protection of society, and in order that human beings may guard themselves from foulness and unchastity.³ Among the Hebrews also celibacy is unheard of, and marriage is, as among the Brahmans, looked upon as a religious duty. According to the Talmud, the authorities can compel a man to enter into wedlock with a woman of the race, and he who lives single at the age of 20, is accursed by God, as if he were a murderer. There is a Jewish proverb which says, that he who does not marry is no

¹ Source Book for Social Origins; part iv, Sex and Marriage, page 455.

² Laws of Manu, ch. ix, verse 137.

³ Ibid., ch. ii, verse 66.

⁴ Islam by Ameer Ali Syed, page 29.

man. The desire for offspring, particularly sons, had its root in the religious belief, and is the outcome of the idea that the spirit of the dead would be made happy by homage received at the hands of the male descendants.¹

It must be noted that the number of celibates in all Hindu castes is very small; and this is a marked contrast to the increasing number of them, in European and other countries, where the growing difficulties of supporting a family is keenly felt. The same difficulties, though existing in the former case, is not here properly understood. It has been observed that the frequency of marriages is a very sensible barometer of the hope which the mass of people have for the future. This statement is true among the very low castes, in which more weddings take place after a good harvest, and very few in the absence of it. In the higher castes marriages are compulsory before girls come of age.

The Liberty of Choice.—In all the castes of the State from the Nambuthiri Brahmans down to the Pulayans, the liberty of choice in matrimonial alliance is seldom allowed to the contracting parties. As early marriage is the rule, the parents of the bride and bridegroom along with the maternal uncle and their nearest relatives make all the necessary arrangements preliminary to the wedding. This custom prevails in all Hindu castes without exception. Even when the parties are of age, the same functions are exercised by the parents. This is probably on account of the exclusive right and control which the father has over his children.² Among the Hebrews, according to the Talmudic law, a marriage to be valid must be contracted with the voluntary consent of both the parties concerned.³ According to all the Mahomedan schools, a son is free to enter into conjugal union without the consent of his father, after his fifteenth year. The Hanafis and Shiahhs grant the same privilege to a daughter, whereas according to other schools, a woman is made free from paternal control only through marriage. A Mahomedan father has a right to get his sons and daughters married alike during their minority, but the law takes care that this right shall never be exercised to the prejudice of the infant. Any act of the father prejudicial to the rights of the minor is considered illegal, and entitles the judge to prevent the completion of such an act or, if completed, to annul it.⁴

Prohibition of Marriage between Kindred.—As a rule, the selection of persons for marriage is guided mainly by two rules: first, that they must be outside the family; secondly, that

¹ Cochin Tribes and Castes, vol. ii, pages 407-408.

² The History of Human Marriage, ch. x, pages 225-231.

³ & ⁴ Ibid., page 235. Maine, 'Early Law and Custom', page 224.

Note.

they must be inside the caste. According to the Hindu Sāstras, persons who are related as *Sāpindas*¹ cannot marry. This relationship extends to six degrees, where the common ancestor is a male; but there is a difference of opinion as to the rule when the common ancestor is a female. To this restriction is also added another rule, that the parties to the marriage should not be of the same *gōtra* or *pravara*, i.e., they must not be of the same family, nor invoke the same ancestor. Conjugal relationship between the first cousins is seldom allowed. Among the Nambuthiri Brahmans, the members of a vedic family avoid matrimonial alliances with those of a non-vedic; but among their various sections, intermarriage is generally in vogue, and marriage among the various sub-divisions of the non-vedic community is endogamous. Among the Tamul and Konkani Brahmans also, the same *gōtra and pravara* restrictions prevail. Among the latter, a young man may marry the daughter of his maternal uncle or paternal aunt.

Among the high caste Sudras (Nayars), marriage is hypergamous, while among the low caste Sudras it is endogamous. This is the general rule, though exceptions may sometimes be found. A Nayar is allowed to form matrimonial alliance with a woman either in his own sub-division or one lower in the social scale than himself, but his womenkind in the latter case are prohibited from exercising the same liberty. This is called *Anulomam* and *Pharthilomam*. Dr. Gundert derives *Anulomam*, from *Anu* with *lomam* or *romam*, hair, going with the hair or grain. According to this usage, a Nayar woman consorting with a man of the higher caste, follows the hair, purifies the blood, and raises the progeny in social estimation. By cohabiting with a man of lower sub-division, *clan* or *caste*, she would be guilty of *Prathilomam*; and if the difference of caste were admittedly great, she would be turned out of her family to prevent the whole family being boycotted. In many cases, the Nambuthiris, Embrāns, Pōthis, and Tamul Brahmans, Kshatriyas and Ambalavāsis form alliances with Nayar women; but the latter and their children cannot touch their husbands and fathers without polluting them. Children of this union belong to the mother's family. In the clan system, descent was at first reckoned in the female line; uterine ties alone constituted kinship. The father was not regarded as related even to his children, nor was he considered as a member of the family. In this system, all the children bear the clan name, and the clan name becomes the test of blood relationship. Among the Nayars, Ambalavāsis, and Malayāli

¹ Beginning from the bride or bridegroom, and counting exclusive of both six or four degrees upward according as the relationship with the common ancestor is reached, with the aforesaid degrees—on both sides, the person so related are known as *sapindas*.

Kshatriyas, the same customs are in force, and kinship is reckoned through the female line. "The womb dies the child."

Marriage is endogamous among the low caste Sudras; it is strictly prohibited even in the case of two persons belonging to the same family or whose relationship cannot be traced to its origin, but it is only traditional. A man cannot marry the sister of his deceased wife, nor from the family of his deceased wife. These customs are slowly changing.

The marriage custom above referred to is applicable to the Izhuvans also. The best form of marriage among them as among the Nayars is, where a man marries the daughter of his maternal uncle over whom he has preferential claim. Marriage of cousins which alludes to a matrimonial custom prevailing among the Dravidians of Southern India, is more widespread, and on the whole more deleterious than the custom of premature marriage. This is the Dravidian custom by which a man marries his mother's brother's daughter, his sister's daughter, or father's sister's daughter. The custom is not confined to any particular caste, and is creeping into Brahmanism.¹ Speaking broadly, marriage among the fishing castes (Vālan, Arayan, Mukkuvan and Marakkān), the Kammālans (Asāri—carpenter, Musāri—bell-metal worker, Kollan—blacksmith, Tattān—goldsmith, and Thōl-kollan—leather-worker), Pānan, Vēlan, and Kaniyān—astrologer—is exogamous as regards *illam* or *kiriyam* (house) which corresponds to *gotram*. In certain parts of the State, the Pulluvans marry in the same family, and this custom is also dying out.

The agrestic serfs follow the customs of their landlords, those serving the Nayars and Izhuvans observe the marriage prohibitions of the Nayars, while those under the Brahmans observe the exogamic rule of *illam* and *kiriyam* already referred to. Among the jungle folk, the Kādars do not marry a girl related to him on the male side. As a rule marriage between persons descended in a direct line from the same parents is forbidden if the relationship can be traced to any extent. The same custom prevails also among the Konga Malayans. Among the Jews and Jōnakan Mapillas, cousins of all degrees intermarry.

Prohibitions of intermarriage between kindred are based on the fear of complicate relationship, concentration of affection within too narrow a circle, inducement to keep the property within the family, violation of God's law as they outrage natural modesty, incest and the injurious results to the offspring.² In this connection it is interesting to note that the result of many frequent consanguineous marriages of the Jews of Europe and elsewhere has been an exceedingly large num-

¹ Census of India, 1911, vol. xii, part 1, page 107.

² Cochin Tribes and Castes, vol. ii, page 407.

ber of physical and mental defectives among them. Many writers on the pathology of the Jews say, that the excessive proportion of the deaf, mute, blind, insane, idiotic, imbecile and diabetic persons among them is the result of breeding in-and-in, which has been going on for centuries among the Jews of Europe.¹ The same facts are observed in some of the members of the South Indian castes. Dr. Nayar states, that in a large number of deaf mutes that come under his observation, an appreciable percentage are children of consanguineous marriages.²

Age of the Contracting Parties.—Religious compulsion to marry, the obligation to marry girls before the attainment of puberty, and the prohibition of the marriage of widows, which are so characteristic of the majority of the Indian population, are in force in the Cochin State, only among the Tamil, Konkani and other foreign Brahmans and also among some Tamul Sudras. The Nambuthiris are the only indigenous Brahmans among whom child marriage is absolutely unknown. The early age at which the girls are married, and the great preponderance of widows over widowers are features sufficiently prominent in Cochin as elsewhere in India. Nearly 20 per cent of the population of the State follow the *Marumakkathayam* law of inheritance, and among them marriage is not compulsory from a religious point of view as it is among the several other classes of the Hindus. Child marriage in the form of irrevocable betrothal is unknown among them, nor is the remarriage of widows prohibited. In these latter respects, the Kammālans, the fishing castes (Vālans, Kadal Arayans, Mukku-vans and Marakkāans), the Izhuvans, Kaniyans and other indigenous castes, though to a certain extent governed by the *Marumakkathayam* law, follow the lead of the Nayars, while the Christians and the Jonakan māpillas, who form a third of the population, marry their girls only after they come of age (though exceptions are often met with), and freely allow remarriage of widows. Tamul Brahman girls and those of the Konkans are married before they come of age. Even among them the marriagable age is gradually rising. Among the rest of the people, girls are seldom married before they attain the twelfth year, the average age, when all sections of the population, including Christians and Muhammadans, are taken together, being about 14. In the case of males the average is about 20; though these ages are quite early when compared with most parts of India. The different religious communities of the State present somewhat different features in regard to early marriage. Christian males marry earlier, and Christian females later than their Hindu brothers and sisters, while in the case

¹ The Jews, Contemporary Science Series, pages 250-251.

² Census of India, vol. xii, part 1, page 146.

of Muhammadans both males and females marry later than the followers of other religions. No Jew male under 15, and only 31 females between 10 and 15 in a thousand of each in that age period are married.¹ In this respect the various castes present marked differences. Of a thousand girls of the ages between five and twelve, 120 are married among Kudumichetties, 85 among Tamul Brahmans, 52 among Konkani Brahmans and 32 among foreign Kshatriyas—all non-indigenous castes. The proportion is much smaller among the Izhuvans, Vālans and Kadupattans who have only three girls in a thousand of that age period, while the Nayars, Pulayans, and Vālans have only four each. Considerably over a hundred males in a thousand between twelve and twenty are married among Devāngas, Tamul Brahmans, Kudumichetties and Kusavans; while considerably less than thirty of the same age period are married among the Nayars, Malayāli Kshatriyas, Izhuvans and Ambalavasis. Early marriage of males obtains comparatively to a large extent in some of the lower castes, the proportion of married men between twelve and twenty in a thousand being as high as 508 among Ārayans, 186 among Vālans and 151 among Parayans.

Origin of the Infant Marriage.—The vedic mantras recited at the various stages of the wedding ceremony, other portions of the vedic texts²—early *Grihya* and *Dharma Sutras* of *Sankhāyana*, *Āswalayana*, *Jaimini*, *Bauddhayana*, and others,³ as also the *Smrithis* of *Manu*, *Nārada* and *Puranās*,⁴ bear unmistakable evidence to the fact that Brahman girls were married after puberty during the vedic age. Instances are found of young women who enjoyed the right to exercise the choice of husbands for themselves. Marriage then was as optional with the female as with the male sex, and there are instances of young women who remained with their parents unmarried, either rendering filial service or doing penance and speculating on the absolute.⁵ But towards the end of what Mr. Dutt calls the Epic age, the practice of marrying girls before puberty began to make its appearance. Gōbilla, Vasishtha, Gautma and others advocated the marriage of girls either before puberty or within the first three years thereafter, which was subsequently modified into three *ritus*⁶; if left unmarried beyond that time

¹ Census of India, 1911, vol. xviii, part 1, pages 40-42.

² Marriage after Puberty, by V. S. Srinivasa Sastri, pages 24-27.

³ Ibid., pages 28-37.

⁴ Ibid., pages 36-37, 72, 70-74.

⁵ Marriage after Puberty, by V. S. Srinivasa Sastri, pages 24-25.

⁶ Ritus. (a) Vedavyasa, ch. ii, verse 7. If owing to neglect of her guardian, a maiden attains puberty, he incurs the sin of embryo murder at each *ritu* and becomes a *patita* (fallen from puberty). (b) Yama, ch. iii, verses 18-82. If a girl remaining unmarried in her father's house attains puberty, he incurs the sin of embryo murder, she is a *surda*. (c) Vide *Samhitas* of Sankara, chap. 15. Angir as verses 126-128.

they might themselves arrange a marriage with a suitable young man. The whole question, however, is one of conjecture.

It is said that during later times, an influential sect had grown up who approved of early marriage. The view that the girls should be married before puberty developed partly from the fear of their defilement, and partly because of the belief that the neglect of parents to provide husbands for their daughters who were fit to conceive, and who, being eligible for marriage, was tantamount to an embryo murder at each *ritu*. Considerations such as these began to assert themselves, and were laid hold of by the later Smrithi writers, who began to lay down elaborate rules regarding matrimonial alliances before puberty, and the idea of the embryo murder, already referred to, was much exaggerated. The custom of post-nubile marriage was not yet condemned wholesale, but gradually owing to the altered conditions in the later periods the view that marriage should take place before puberty became generally held. Yama, Parāśara, Samvartha and other writers prohibit the custom of post-nubile marriage, showering curses upon the delinquent parents for their negligence and proclaiming all of them to be out-castes. They also mentioned the rewards that went to parents who gave their daughters in marriage before they reached puberty and emphasized the gifts of them before puberty as producing great merits, the principal motive being not their conjugal happiness, but the father's spiritual gain. The religious idea of the time, such as the importance of the purity of birth, and the chastity of the mother, grandmother, great-grandmother, whose names a Brahman has to pronounce on the *Sradha* day, favoured this change. Thus, the gradual lowering of the position of women from the standard of the vedic times, and the distrust of their virtue induced by the example of prematrimonial license set by the Dravidian races, must have had its effects. These facts are not obscurely hinted at in the literature of the subject, and girls were, as at present, married before puberty in order to avoid the possibility of causing scandal later on.¹ When once the custom of infant marriage had been started under pressure of social necessity by the families of the highest groups, a fashion was set which was blindly followed by other groups.

The practice of infant marriage has spread much further, and had more deeply taken root among the lower castes than the prohibition of widow marriage. Both customs appear to have been borrowed from the higher castes, and are now regarded as steps leading to social distinction. To marry a girl sufficiently early causes her parents no particular inconvenience, and confers on them some consideration which may attach to religious orthodoxy and social propriety. Among the

¹ *Marriage after Puberty*, pages 75-89.

primitive "Animists" and low caste peoples, the practice of early marriage is probably a lingering survival of the ancient promiscuity.

Child or premature marriages have their own advantages and disadvantages. The validity or propriety of a marriage is solely determined by the standards of society to which the contracting parties belong. The extremely Brahman ideal of marriage safeguards the female chastity; and must necessarily involve certain individual and social evils. In respect of the individual woman, the physical effects of the early sexual intercourse and premature maternity, which in most cases are the natural sequence of immature marriage, are obvious to all; although theoretically immature marriage on the male side is not a necessary compliment to that on the female, practically it must be so to a large extent. The physical and mental quality of a community, made up to an extent of the offspring of immature parents, must necessarily deteriorate. The above remark requires strong verification. Considering the unions of the contracting parties to turn out happy, as they do in a large number of instances, a too early consummation of the nuptial troth, the breaking down of constitution and the ushering in of disease are the necessary results. The giving up of studies on the part of the boy-husband, the birth of children, the necessity of feeding too many mouths, poverty and dependence, in fact a disorganized household leading to sin, in short a wreck of two lives which might otherwise have attained to a happy old age are also its other evils. The customs relating to the evils above referred to were denounced by Mr. Malabari in 1884 with his usual vigour and earnestness, which created a lively and permanent interest in the subject, and this led to the Act on the Age of Consent, by the Government of India, under which sexual intercourse by a man with his own wife under twelve years of age is an offence. About twenty years ago Mr. Manomohan Ghose, a renowned lawyer of this province (Bengal), put forward a proposal regarding the passing of a general law for British India to the effect that no marriage should be valid, if the contracting parties at the celebration of marriage were below twelve years. This proposal was based on the main argument that there was nothing in the Hindu scripture to make it obligatory upon a Hindu to marry his daughter before she is twelve.¹

Social Reform by Legislation.—The views above set forth were taken advantage of by the enlightened State of Mysore for the introduction of a regulation to prevent infant marriages in its territory. The main provision of the Mysore Act is that any person who causes the marriage of an infant girl or aids

¹ Papers relating to Infant Marriage and Enforced Widowhood in India, pages 3-8.

or abets such a marriage is liable to be punished with imprisonment up to six months. No restriction is placed upon infant marriages between the age of eight and fourteen. The law is mainly intended to stop the practice of aged widowers from marrying child wives. Any man who has completed 55 years of age marries a girl who has not completed fourteen years of age, is liable to be punished with fine or imprisonment, which may extend to two years, or with both.¹

Ten years after the passing of the above regulation in Mysore, a similar legislation was enacted in the progressive State of Baroda, according to which the age limit of girls was fixed at twelve as against eight in Mysore. But there is a clause in the Baroda Act authorizing the marriage of girls between nine and twelve after obtaining exemption from the Government of His Highness the Maharaja. The Act shows that the present legislation in Baroda is much more advanced than in Mysore, and is far ahead of the current notions and practices among the people at large.² There is at present a general feeling among the Hindus of all castes in the State, as in other parts of India, to defer the marriage of their daughters to as late as possible, and avoid the danger of a life-long misery.

Fortunately in the Cochin State, the marriage of Tamul and Konkani Brahmans is mostly between twelve and fourteen and gives no room for comment. Among the Nambuthiri Brahmans there is a large percentage of unmarried girls at the ages of 12 and 20, and this illustrates two peculiarities of their social system. The first is that the women marry after puberty; the eldest alone of a Nambuthiri family marries in his own caste, while the junior members form *Sambandham* alliance with the women of other castes. Consequently, the difficulty of procuring a husband for the daughter of a Nambuthiri is very great. He has to pay a heavy price for securing a bridegroom. In other cases he either allows an exchange of daughters in matrimonial alliances between two females, or takes two or three wives in exchange to get rid of his superfluous daughters. Further he possesses a singularly efficient safeguard of morality in their custom of outcasting all men, implicated by a fallen woman, whose statements as to her lovers are conclusive.³

The necessity of early marriage and difficulty of its early accomplishment being more urgent on the side of the bride than that of the bridegroom, the question may be viewed from the standard of a parent anxious to marry his daughter. (1) The girl must not have attained puberty; (2) the horoscopes of the bride and bridegroom must have already agreed;

¹ & ² Census of India, 1911, vol. xvi, part I, page 153.

³ Cochin Tribes and Castes, vol ii, pages 308-309.

(3) the bridegroom should be older than the prospective bride; (4) they must be of the same caste and sub-caste, but of different *gotrās*, and *pravarās*; (5) he must be prepared to pay a lump sum and presents of cloth, which the bargaining ability of the bridegroom can command in the matrimonial market. On the last the enlightened opinion is unanimous, and yet the practice does not follow theory.¹

Marriage Ceremonies and Rites.—Among primitive men, marriage was celebrated without any ceremony whatever, and this is still the case with many uncivilized people in various parts of the world. Marriage ceremonies arose by degrees and in various ways. The ceremony often indicates the new relation into which the man and woman enter. Sometimes it symbolises sexual intercourse, but far more frequently the living together or the wife's subjection to the husband: but the Brahman ideal of marriage according to Hindu *shāstras* falls under two main sub-divisions viz., *Dharma Vivāham* or canonical marriage, and *Kāma Vivāham* or marriage for the sake of enjoyment. Under the former are included *Brahmam*, *Daivam*, *Ārsham*, and *Prājāpatyam*;² and under the latter, *Āsuram*, *Gāndarvam*, *Rākshasam*, and *Paisācham*.³ The first class of alliance or canonical marriage is a form of social marriage, the primary object of which is to enable a man to perform certain appointed duties (*dharmas*) to society, and to provide for the discharge of those duties in the family even after his death. Hence the married life or the *Grahasta* stage of life is considered a very important one, on which alone vitally depend the other stages, *Bramachāri*, *Vānaprasta* and *Sanyāsi*. For the purpose of this alliance, the selection of suitable partners is an essential pre-requisite. The husband and wife have also to exercise different functions; the former in addition to his social duties is the guardian of the wife's interests, both temporal and secular, and the latter holds herself responsible for all the domestic functions. The bond of interdependence connects the two in permanent union, and protects it against danger from the possible effects of time on the body and mind of either partner. These advantages are absent in the other type of marriage known as *Kāma Vivāham*, in which the object of the marriage is only individual, and each seeks to get the best partner suited in his or her personal taste and happiness. Here the children are the by-products of a "conveniency alliance." The question of the ownership of the offspring has to be judged from the history of the human marriages, which have often arisen as a separate question.³

The marriage customs of the Cochin Hindu castes may,

¹ Cochin Tribes and Castes, vol. ii, pages 210-214.

² Laws of Manu, chap. iii, pages 27-30. ³ Ibid., pages 31-34.

at first sight, appear to be different, but on a closer examination, it may be seen that most of the customs of the Nambuthiri and Tamul Brahmans which do not vary in the shastric details, are grafted on the Malayali and Tamul non-Brahman communities; but the recitation of the vedic marriage hymns are studiously avoided in the case of sudras and other lower castes. The formal advent of the bridegroom with his party after due invitation to the house of the bride, the waving of lamps and vessels of water round the heads of the bride and bridegroom to avoid the potency of evil eye, the gift of the bride to the bridegroom (*Udakapurva Kanyakadānam*) with the recitation of the appropriate Vedic hymns, clasping of the bride's hand (*Pānigrahanam*), worship of the sacred fire (*hōmam*) with oblations of ghee (clarified butter), invocation of the blessings of gods, tying of the *tāli* (marriage badge) round the neck of the bride by the bridegroom, going round the sacred fire (*pradakshinam*), the bridegroom taking in hand the right foot of the bride and placing it on a mill stone (*Saptapadi*) which is the essential and binding portion of the wedding ceremony, looking at the *Ursa major* are common both to the Nambuthiris, the Tamul and other classes of Brahmans. Among the former the *tali*-tying is done by the father, while among the latter, by the bridegroom alone. Consummation (*sēkam*) takes place among the Nambuthiris on the night of the fourth day; while that among Tamul Brahmans, on an auspicious night after the bride comes of age. A Nambuthiri returns to his *illam* (house), if it happens to be near to that of his bride, on the same day for adoration of the sacred fire, while a Tamul Brahman youth, on an auspicious day after four days' feastings in the bride's house.

The above rites are more or less being adopted by the Tamul Sudras, Ambattans, Chakkāns (oil-mongers), Devāngas, Kaikōlans, Kudumichetties and Pandārams, for whom the sacred fire is prepared by an inferior class of Brahman priests. They are not directed to recite the vedic text, but are given specific directions regarding the performance of each act in the programme. The joining of the hands of the bride and bridegroom, taking the bride by the hand, is an important function in the programme. Sometimes the little finger of the right hand of the bridegroom is joined to the left hand of the bride. Sometimes the bride and the bridegroom eat from the same dishes. The bridegroom is accompanied by the best man, who seems originally to have been the chief abettor of the bridegroom in the act of capture.

The religious ceremonies connected with marriage are not limited to prayers, sacrifices and other means of pleasing the gods. Efforts are made to ascertain their will beforehand. Among the Hindu castes, astrologers are often consulted beforehand as to their agreement of the horoscopes; auspicious

days, even hours, are selected. Among the Hebrews, marriage was no religious contract, and there was no trace of a priestly consecration of it, either in the scriptures or in the Talmud. Yet, according to Ewald, it may be taken for granted, that a consecration took place on the day of betrothal or wedding, though the particulars have not been preserved in any ancient description. Among the Muhammadans also, marriage, though a civil contract, is concluded with a prayer to Allah. "Christianity gave back to marriage its religious character. The founder of the Christian Church had not prescribed any ceremonies in connection with it, but in the earliest times, the Christians on their own accord asked for their pastor's benediction. This was not indeed a necessity, and for widows, sacerdotal nuptials were not even allowed. Though the dogma was recognized in the twelfth century, marriage was considered valid without ecclesiastical benediction till the year 1563, when the Council of Trent made it an essentially religious ceremony. Protestants do not regard marriage as a divine institution." Hence the sacerdotal nuptial remains as indispensable as ever.¹

The Nayars who follow the inheritance in the female line observe matrimonial customs different from those above described. There are two forms of marriage in vogue among them, viz. the *Thālikettu Kalyānam* (*tali*-tying ceremony) and the *Sambandham* (the customary nuptial union of man and woman); the first of which is performed for every Nayar girl before puberty, and the second, the real adult marriage, is celebrated after she comes of age. The *tali*-tying for every girl is compulsory before she attains maturity; and the omission or neglect of it will place her and her family under a ban; for it is considered a religious impurity for a girl to attain puberty before the performance of this ceremony. There is however a tendency for these restrictions to be overlooked nowadays.

The main features of this ceremony are the following:—(1) the performance of this ceremony (*tāli*-tying) in the family for all the girls down to the cradle for the sake of economy; (2) the fixing of an auspicious day and hour for the ceremony by the village astrologer (*Kaniyān*) after consulting with the horoscopes of the girls; (3) information to the friends and relations in the village, and also to the local chieftain or to their landlord regarding the performance of the ceremony; (4) *Ashtaman-galyam vekkal* (procession to the marriage pandal to place the eight auspicious things, viz., rice, paddy, tender leaves of cocoanut trees, an arrow, a looking-glass, a well-washed cloth, lighted fire and a small wooden box called *cheppu*, which is

¹ History of Human Marriage, by Westermarck, chap. xix, pages 427-428.

the formal beginning of the ceremony; (5) a feast during the previous night (*athāzham*); (6) the worship of the Sun on the next morning; (7) *tāli*-tying for each girl by a separate member of the caste, or by a Thirumalpad for a number of girls, or by the mother before the deity in the nearest temple or on the *ōnam* day in front of the clay image *Mahadēvar*; (8) certain formalities indicative of the wife's duties, viz., giving the bridegroom betel to chew, giving him water to wash his feet; (9) the feast during the next three days; (10) their bath on the fourth day, worship of the deity in the temple close by; (11) their eating together from the same dish, and (12) their formal separation.

Some are of opinion that this is a sacrament similar to that which prevails among the Brahmans, but looking on this form of marriage now in vogue, it is not regarded as constituting a religious ceremony, or a *samskāra* or sacrament in the Hindu or European sense of the word. "There is no officiating priest in attendance, there is no formula to be repeated, there is no *vedic*, *puranic* or religious chant or exhortation, and there is no formal benediction. The essential elements of a Brahmanical marriage, viz., taking the bride by the hand, or *Pānigrahanam*, the walking of seven steps or *Saptapati*, and the *hōmam* or sacrifice to the fire, are not to be found among its details. Therefore the marriage customs among *Marumakkalhayam* Hindus have no connection with their religious observances, such as exists under the ordinary Hindu law, though several of the details bear a resemblance to a portion of the marriage ritual of the Nambuthiris."¹

The second or the real marriage of the Nayar girls is the *Sambandham* (the customary union of man and woman) which is the principal word denoting the conjugal relations among the Nayars. The customs connected with it vary in different places, but the main features are the same all over. The best form of *Sambandham* is that between the daughter of a maternal uncle and his nephew; but, as a rule, the girls are grown up, and they enjoy very much freedom in the choice of their husbands than other classes of people. As in the *tāli*-tying ceremony the consent of the Kārnavar, parents and maternal uncle of the contracting parties, the selection of an auspicious day in consultation with the village astrologer, the departure of the bridegroom with a few of the castemen of the village and friends to the house of the bride-elect, the perusal of the Ramaynam or other sacred book referring to marriage and the happy conjugal life attending it, a sumptuous dinner in the house of the bride, the presentation of cloth to the bride at the auspicious hour, and the

¹ Malabar Marriage Commission Report, page 87.

gifts to the Brahmans who pronounce their benediction upon the conjugal pair, and their cohabitation during night, and the departure of the bridegroom to his house next morning are the chief characteristics.¹

The orthodox view of this union is that it is not a marriage in the legal or sacramental sense of the term. It is said that the Nambuthiris consort with Nayar women by *sambandham*, and precisely the same ceremony is gone through, and yet they do not look upon it as a marriage, because the husband cannot eat with his sudra wife, and is therefore unable to join with her in the wedding feast. It is the same case with other classes of Brahmans also. The aristocracy of the District of Malabar, the Rajas who are admittedly the heads of the Nayar caste, and the Nambuthiris who are the expounders of religion, opine, that chastity is not one of the duties prescribed for the Nayar community, and *slokas* (verses) are quoted to prove this. This view is not held in the Cochin State.

It is also said that either party to the union may terminate it at any time from wantonness, caprice or any other reason, and that if the couple joined together by the presentation of cloths (*Pudamuri*), were satisfied with one night of hymeneal bliss, there is no legal impediment to prevent their separating without any formality on the following morning. Some are of opinion that some formality is necessary, and that parties should not separate without the approval of the *Kārnavans* or of their relatives or of their caste people. Under the *Marumakkathāyam* law, he is no way responsible for the maintenance of the children whom he has begotten upon her. Further, the person that begot a child in a *Marumakkathāyam* female was originally regarded as a casual visitor and the sexual relation depended for his continuance on mutual consent.²

The views expressed above are those of the landed aristocracy, and the rulers who were admittedly of the Nayar caste—Nambuthiris of Malabar, who, to gratify their selfish ends, quote chapter and verse of their own creation in support of the custom and teachings, which the Nayars of these days will never submit to. All or nearly all of them cling to one wife for life, and with them *sambandham* is the real marriage, *de facto* and *de jure*. This is the real state of affairs in Cochin and Travancore, as well as in British Malabar. The present and growing tendency in nearly all cases, in which a man, whether a Nambuthiri or a Nayar, consorts with a Nayar woman, is to look upon her as the true wife, and the children of such unions are looked upon as theirs and duly provided for, so far as their means permit. Nevertheless, the existing state of

¹ The Cochin Tribes and Castes, vol. ii, pages 30-38.

² Malabar Marriage Commission Report, pages 38-44.

things in the community did not quite satisfy the sentiments of the educated public. There was a loud cry for reform and legislation in British Malabar. The Madras Government appointed a commission which, after its protracted labours, enacted a permissive law, Act IV of 1896. The main provisions of the Bill are, that, when a *sambandham* has been registered, it shall have the incidence of a legal marriage: that is to say, the wife and children shall be entitled to maintenance by the husband or father respectively and to succeed to half his self-acquired property if he dies intestate, while the parties to such a *sambandham* cannot register a second one during its continuance. The law does not extend to the State. The fewness of the number of marriage registration shows how little the Nayars, as a community, have availed themselves of it. The principal objections urged against it are:—(1) that it ignores caste and customary restrictions on marriage and thereby interferes with caste; (2) that it sanctions what according to social usage is deemed to be incestuous marriage; (3) that marriage before the Registrar is obnoxious to the people, and that no one has any scruples about going through the customary form; (4) that the provisions relating to divorce are ill-adapted to the present state of Society in Malabar, and that revelations of conjugal infidelity in public courts are the most repulsive to the people; (5) that the provisions relating to the giving of the whole of the self-acquired property to wives and children amount to violent interference with the customary law.

The mass of the people continued to regard the marriage law with aversion and suspicion, and even the educated members of the community who are in favour of the measure, shrink from taking advantage of it from fear of offending the elderly members of their *tarwads* (families), and all the powerful Nambuthiris and other great landlords. The Registrar of Calicut also points out, that the power conferred by the marriage law, to make provision for one's own wife and children, has hitherto acted as some inducement to persons to register their *sambandhams*, but as Act V of 1898 enables the followers of the *Marumakkathayam* law to attain this object without registering their *sambadham*s, and "unnecessarily curtailing their liberty of action, and risking the chance of divorce proceeding," he thinks it unlikely that registration under the marriage law would increase in future.

Polygamy.—Among Hindus, though the Shāstras allow polygamy, Brahmans, as a rule, are monogamous; but the custom is still in force among the Nambuthiris of Malabar, Cochin and Travancore; and a Nambuthiri can have as many as four wives. He resorts to this either when the first wife is barren or sickly or to dispose of the superfluous daughters and sisters. Among the Tamul Brahmans and other higher

castes, a second wife is allowed not as a luxury at the mere caprice of the husband, but only when the existing wife either proves barren, or is afflicted with some loathsome or incurable disease or is guilty of immoral conduct. How much polygamy is discouraged may be judged from the fact that the first wife alone, except when cast off for immoral conduct, is entitled to join the husband in religious ceremonies, and that the second or subsequent wife has no status here except with acquiescence and consent of the first wife. Thus the first wife is the real mistress and the rest are little better than handmaids or superior class of concubines, like those of the Jewish patriarchs.

Hindu law books do not restrict the number of wives whom a man is permitted to marry. Undoubted cases of polygamy are found in the hymns of the Rig Veda, and several passages in the law of Manu provide for a plurality of wives without any restriction.¹ Tradition shows that polygamy and concubinage were customary among the Jews during the patriarchal age. Esau married Judith and Basemeth, Jacob married Leah and Rachael.² In later times, we read of Solomon who had "700 wives, princesses, and 300 concubines, and of Rehoboam who took 18 wives and three score concubines." According to the Talmudic right also, it was permitted no longer, though the number of legitimate wives was restricted to four. The Cochin Jews are now mostly monogamous.

The Koran allows a man to have four legitimate wives, and he may take as many concubines as he likes. Between a wife and a concubine, the difference is indeed not very great. The former has her father as her protector, while the latter is defenceless against the husband.³

Polygamy is very much in vogue among the Jonakan Mapillas of the State, as well as amongst those in the Ernad and Valluvanad taluks of South Malabar. It may be stated without fear of contradiction that a very large number of these people are polygamists, having more than two wives, and some amongst them have even four. The wives all stay with him in the same house, and disunion amongst them is a perennial source of uneasiness to the husband, and frequently leads to divorce. Disparity in age is never considered objectionable.

It is evident that Islamism arose amidst the full polygamic regime. Its founder could not dream of establishing any other. Polygamy was therefore established by divine right among the faithful, and as at the bottom it is in accord with primitive instincts of man, it has maintained itself in Mussalman

¹ Code of Manu, chap. ix, verses 149-151.

² Genesis, chap. xxvi, verse 34; chap. xxiv, verses 23-28.

³ Westermarck's *History of Human Marriage*, chap. xx, page 442.

countries from the time of Muhammad to our own days.¹ It is absolutely unknown among the Syrian Christians.

Polygamy was at one time the privilege of the princes and the great, and now the custom tolerates a second wife only in the case of sterility of the first.

Polyandry.—Among the Nayers of ancient times in Malabar, Cochin and Travancore there was polyandry of the matriarchal type, with the primitive family form—matriarchate—which corresponds to a system that takes no account of paternal filiation and leaves the children to the family of the mother. Another form of polyandry prevailing in the Northern parts of the State among the Thandāns, Kanyāns, and Pānans is the fraternal polyandry, in which the eldest brother takes a woman of the caste as wife, and allows his younger brother a share in the wife, who must otherwise have had to live unmarried. As the first married wife in polygamous families is the chief wife, so the first husband in the polyandrous families of the fraternal type is the chief husband; while the younger brothers have the position of, if the term may be used, “the male concubines.” Fraternal polyandry is said to be superior to the polyandry of the Nayar type; because the paternal filiation assures them a sort of collective paternal parenthood, since the fathers are of the same blood.² The custom is prevailing to a certain extent in a few low castes.

The very striking coincidence of polyandry with the poverty of the people among whom it prevails has to be carefully noted. It was a most polite measure for a set of poor people who could not get sufficient food for their maintenance. Another cause of polyandry is the desire to keep the common patrimony from being distributed among the number of brothers.

Leverite is the name given to the obligation imposed by custom or law on the brother of the deceased husband to marry his sister-in-law when she became a widow. The custom of the leverite, which for a long time has been thought peculiar to the Jews, is very widely spread, and is found among races most widely differing from one another. The custom is in vogue among most of the primitive tribes all over the world. The code of Manu imposes the leverite even on the brother of a betrothed man who dies: when the husband of a younger girl happens to die after the betrothal, let the brother of the husband take her for wife. The object of this legal precept in India is to give the posterity to the deceased brother, but a verse seems to limit the duration of the cohabitation with

¹ Islam by Ameer Ali Syed, pages 29-30.

² The History of Human Marriage, chap. xxi, pages 483-485.

the widowed fiancée, and it seems that all commerce is to cease after the first pregnancy.¹

The leverite among the Hebrews is twice alluded to in the Bible.²

It was a sort of obligatory and fictitious adoption of a nephew by the deceased uncle. It was rather a moral than a legal obligation with them, and a brother-in-law could even refuse it, but in doing so, he had to submit to a degrading ceremony. And if the man did not take his brother's wife, the latter would go up to the elders, and say that the husband refused to raise up unto his brother a name in Israel, and that he would not perform the duty of her husband's brethren unto her. Then the elders would call him and speak to him about the matter, and then in the presence of the elders, would remove his shoe from his foot and spit in his face. The elders would then approve of her act, and the matter would be made known among the people. The principal object of the Hindu leverite was to furnish the dead man with a fictitious son, who could perform for him the offerings of the manes, while the Hebrew leverite had only an earthly object of keeping up the name or family of the deceased and all that belong to it.³

Among the Izhuvans, Thandāns, Vālans, Kaniyans, Pānans, Pulayans and Parayans the custom of leverite is still in vogue. The woman after the death of her husband mates with the brother-in-law next to him. Leverite is undoubtedly a widespread custom, and some sociologists too much given to theorize, say that the leverite was a remnant of polyandry; and that they tried to prove that it was practised under a polyandric regime, but polyandry has never been more than an exceptional mode of marriage among the Hindus, Hebrews, and other nations. Where women were regarded as property, they were of course inherited like other possessions. In many cases the brother, or in default of him the nearest male relation, was expressly stated to be entitled to have the widow, and if he did not marry her, he had the guardianship over her, and he might give her away or even sell her to anybody.

Widow Marriage is strictly prohibited among the Brahmans and a few other foreign castes of the State, but in all the Malayali castes there is no such restriction. It prevails in a few Tamul castes. The ceremony relating to the performance of a widow marriage is never so elaborate as that of a first marriage. It is generally celebrated at night. The widow neatly dressed in her best, remains in her house, and the husband, usually a widower, visits her with a few of his friends at

¹ Code of Manu, chap. ix, page 69.

² Genesis, chap. xxviii, verse 8.

³ Evolution of Marriage, pages 264-265.

the appointed hour, and gives her necessary clothes. Rice is sprinked over the newly married couple, who in company with a few friends partake of sweatmeats. A Tuesday or Sunday is generally selected for solemnizing a widow marriage. No ceremonies are performed among the low caste men for the marriage of a widow. Her dress and other expenses are defrayed by the husband, it is only a loose marital connection—a kind of concubinage. Among the Kadars widow marriage is unknown, but widows may live in a state of concubinage. Among the Eravalans a widow can mate with a widower only with the consent of her castemen. There is no formal ceremony whatever for the marriage of widows among the Nayadis. A Parayan widow is never allowed to marry her husband's brother; but a Pulayan widow may form conjugal relations with any member of the caste except her brother-in-law. A Vettuvan widow may marry her own brother-in-law or anybody she likes.

It is said that the prohibition of widow marriage was unknown in Vedic times. The Mahabhāratha furnishes several instances of widow marriage. Ulupi, the widowed daughter of the King of the Naga Tribe, was given in marriage by her father to Arjun. The Padma Purān refers to the marriage of the widowed daughter of the King of Benares who was married twenty times, the reason being her peculiar misfortune to lose her husband immediately after her marriage.

It is difficult to trace the motives which induced the Brahmans of a later age to prohibit widow marriage, but the causes which favoured the growth of the custom which prevents the widows of the highest castes from marrying again have been thus summarized by Sir Herbert Risley in the last Census Report, page 428 :

“ In the first place the anxiety of the early Hindu lawgivers to circumscribe a woman's rights to property would unquestionably tend to forbid her to join her lot to a man whose interest would be to assert and extend those rights as against the members of her husband's family. At the same time the growth of the doctrine of spiritual benefit would require her to devote her life to the annual performance of her husband's *srādha*. Technical obstacles to her remarriage also arise from the Brahmanical theory of marriage itself. The ceremony being regarded as a sacrament ordained for the purification of women, and its essential portion being the gift of the woman by her father to her husband, the effect of the gift is to transfer her own *gōtra* or exogamous group into that of her husband's.”

* * * * *

“ Some influence must also have been exerted in the same direction by the competition for husbands resulting from the action of hypergamy. Widows certainly would be the first to be excluded from the marriage market, for in their case the

interest of the individual families would be identical with those of the group. The family would already have paid a bridegroom's price to get their daughter or sister married, and would naturally be indisposed to pay a second, and probably higher price to get her married again. The group, in its turn, would be equally adverse to an arrangement which tended to increase the number of marriageable women.''

Adultery and Divorce.—It is in regard to adultery that the cruelty and injustice of men are most strongly shown. As for the adultery of the husband men have been very slow in admitting that it was a wrong of which the wife might complain, the reason of this revolting partiality being very simple. Diderot says that the tyranny of man has converted the possession of a woman into a property. In all legislations she is more or less openly considered as the property of the husband, and is very often confounded with things possessed. To use her, therefore, without the permission of the authority of the owner is a theft, and human societies have never been tender to thieves. In adultery, the object of the larseny, the wife, is a sentient and thinking being, i.e., an accomplice in the attempt on her husband's property in her own person. The husband has her in his own keeping; he can chastise her freely and satisfy his rage on her without any harm being raised for her defence. When the latter does not take on herself the punishment of the guilty one, the husband will always have the public opinion and law on his side. The code of Manu gives us a very complete information in regard to the penalty for adultery in ancient India.¹ It is understood that the adultery of the husband ought not to trouble the wife at all; although the conduct of her husband may be blameworthy in such matters, the wife ought constantly to revere him as a god. The adultery of the woman is naturally quite another thing. To pay little attentions to a woman, to send her flowers and perfumes, to frolic with her, to touch her ornaments or vestments, to sit with her on the same couch, are considered by wise men as proof of an adulteress love.¹

In human marriage, every degree of duration is met with from unions which, though legally recognized as marriages, do not endure long enough to deserve to be so called by others which are only dissolved by death. Among high castes, death alone separates husband and wife. In some castes, a man repudiates his wife on the slightest provocation and marries again. Generally speaking, among members of various castes, custom or law has limited the husband's power to dispose of his wife permitting divorce under certain conditions. Generally, the chief offence for which a wife can be divorced is adultery. There are also other reasons for divorce—barrenness, lasciviousness, loquacity, thievishness, and inveterate

¹ Code of Manu, chap. v, page 154.

infirmity. According to the laws of Manu, a wife who drinks a spirituous liquor, is of bad conduct, rebellious, mischievous, or wasteful, may at any time be superseded in the eighth year, one whose children all die in the tenth, who bears only daughters in the eleventh; who is quarrelsome without delay. Divorces are common among the lower castes, but they are rarely practised among higher classes of Sudras.¹

Among the Brahmans cases of adultery are condemned. The woman and her paramours are generally outcasted.² Among the Sudras and other castes, when a woman is charged with criminal intimacy with a member of the lower caste, she is placed under a ban and is eventually outcasted; but, when it is with a member of her own caste the woman is severely punished, and prevented from resorting to the same act. The adulterer is either heavily fined or excommunicated. In the absence of serious reasons, the Mussalman law justifies divorce in the eye of religion or the law. If he abandon his wife or put her away from simple caprice, he draws down upon himself the divine anger, for the curse of God rests on him who repudiates his wife capriciously. Practically, however, a Muhammadan may, without assigning any reason, say, "Thou art divorced," and she must return to her parents or friends.

Among the Christians, the indissoluble nature of marriage was early vindicated by many fathers in accordance with the injunction, 'What God hath joined together, let not man put asunder,' came into full force by degrees.

Conclusion.—From the foregoing account of the matrimonial customs prevailing among the various Cochin and other foreign indigenous castes, it may be seen that a few which necessitate social reform are: (1) the intermarriage between the various sections or subdivisions of the same caste or community; (2) the abnormally enhanced price which the bride's parents among the Brahmans and other higher castes have to pay to secure suitable husbands for their daughters; (3) the heavy expenses for feast and other items in the ceremony which they are put to. Reforms on the lines of the *Walterkrit Rajaputra Hithakarini Sabha* of Rajaputana is more desirable. Unless the rich and other gentlemen of light and leading set the example by following the old shastraic ideals and put an end to the recently developed customs above referred to, and societies be also organized in all important centres, to condemn the practice, and thereby to elevate the moral tone of the people in these matters, worse evils may be anticipated, i.e., only girls whom their parents can afford to marry can survive.

¹ Code of Manu, chap. ix, pages 80-81.

² Cochin Tribes and Castes, vol. ii, pages 210-214.

36. Notes on Ancient Aṅga or the District of Bhagalpur.

By NUNDOLAL DEY.

CHAPTER I.

THE COUNTRY OF AṅGA.

Aṅga is one of the most ancient countries of Northern India. The people who lived in it are mentioned in the Atharva Veda¹ by the name of Aṅgas, and it is well known

Derivation of the name of Aṅga.

that a country was then generally called after the name of the tribe which dwelt in it. The Aṅgas are mentioned there along with the Magadhas, and they appear to have been the most eastern nation known when the Atharva Saṁhītā was composed. Both the Aṅgas and the Magadhas have been spoken of there in terms of contempt.

It is, however, related in the Rāmāyaṇa that Madana, the god of Love, incurred the displeasure of Mahādeva. He fled from the hermitage of the latter to escape his consuming anger, and the region where “he cast off his body (Aṅga)”, or rather it was reduced to ashes, has since been known by the name of Aṅga, and the god of Love has since been called by the name of “Anaṅga” (without body).² Since that event the hermitage of Mahādeva also has been known by the name of Kāmāśrama³ or the hermitage of Kāma: the Raghuvamśa likewise calls this place by the name of Madana-tapovana.⁴ The Rāmāyaṇa further relates that the hermitage of Mahādeva was situated at the junction of the river Saraju and the Ganges, and Biśvāmītra Ṛṣi’s hermitage was situated on the southern side of the river Ganges just in front of the confluence.⁵ Local tradition points out to Kāron (Kāmāśrama) as the place where Mahādeva performed asceticism and destroyed Madana with the fire of his third eye. Kāron is eight miles to the

¹ *Atharva-saṁhita*, v, 22, 14.

गन्धारिभ्यो मुजवद्भ्यो ऽगंभ्यो मगधेभ्यः ।

प्रेष्यं जनमिव श्रेयधिं तक्लाणं परिददामि ॥ १४ ।

“ We to Gandhāris, Mujavans, to Aṅgas and to Magadhas
Hand over fever as it were a servant and a thing of price.”

Translated by Ralph T. H. Griffith in his *Hymns of the Atharva Veda*.

² *Rāmāyaṇa*, Bāla-Kāṇḍa, ch. 23.

³ *Ibid.*, ch. 23, v, 22.

⁴ *Raghuvamśa*, xi, 13.

⁵ *Rām.*, i, 28, 29.

north of Koranḍedī in the district of Balia on the opposite side of Buxar across the Ganges, and Buxar is the reputed hermitage Rṣi Viśvāmitra. Kāron contains a temple of Mahādeva called Kāmeśvaranāth and also Kauleśvaranāth. Two facts may be deduced from this story: 1st, that at the time of the Rāmāyaṇa the river Saraju joined the Ganges in front of Buxar in the district of Shahabad, whereas the former has now receded to the east and joins the Ganges near Singhi, eight miles to the east of Chāprā in the district of Sāran; 2nd, that the northern portion of the country of Magadha along the southern bank of the Ganges was then included in the country of Aṅga.

The Mahābhārata and the Purāṇas, however, do not admit the derivation of the name of Aṅga as given in the Rāmāyaṇa. They mention that Bali, one of the descendants of Yayāti through his son Anu, had five *kṣetraja* sons Aṅga, Baṅga, Kaliṅga, Sumha and Puṇdra, who founded five kingdoms in the east after their respective names.¹ Thus Aṅga founded the kingdom of Aṅga and his descendants reigned over it. Hiuen Tsiang also, while he visited the country of Campā (चम्पा or Aṅga), confirms this Pauranic tradition and speaks of a Devī having given birth to four sons who divided among themselves the government of Jambudvīpa, and each founded a capitāl, built towns and marked out the limits of the frontiers. He further says, “this (town of Champā) was the capital of the country of one of them and the first of all the cities of Jambudvīpa”.²

Aṅga is identified with the district of Bhagalpur including Monghir, and a portion of the district of Santal Parganas. Its limits, however, varied at different periods. According to Sir George Birdwood, Aṅga included also the districts of Birbhum, Murshidabad, and Manbhum. Its northern boundary has always been the Ganges, though its extent was not always the same.

According to the Saktisaṅgama Tantra, Aṅga extended from Baidyanātha to Bhuvaneśa,³ which latter has been identified with Bhuvaneswara in Orissa.⁴ The limits thus assigned to the country are imperfect and misleading. If Baidyanātha be the northern limit, then it has the effect of excluding Campā which, according to all accounts, Hindu, Jaina and

¹ *Mahābhārata*, Ādi Parva, ch. 104; *Viṣṇu Purāṇ*, pt. iv, ch. 18; *Matsya Purāṇ*, ch. 48; *Bhāgavata*, Bk. ix, ch. 23.

² Beal: *Records of Western Countries*, Bk. x,—Chenpo.

³ *Saktisaṅgama Tantra*, ch. vii:—

वैद्यनाथं समारभ्य भूवनेशान्तमं शिवे ।

तावदङ्गाभिधो देशो याचायां न हि दृष्यते ॥

⁴ *Bīṣvakosa*, s. v. *Aṅga*.

[N.S.]

Buddhist, was the capital of Aṅga and which is situated far to the north of Baidyanātha. Then, again, in the same Tantra “Bhuvaneśa” also appears to be the southern boundary of Gauḍa.¹ “Bhuvaneśa” or Bhubaneswara evidently could not have been the southern boundary of both the countries of Aṅga and Gauḍa at the time when the Tantra was composed, and there is no authentic record to show that Aṅga ever extended to Orissa. If we may hazard a conjecture, “Bhuvaneśa” as the southern boundary of Aṅga is evidently a mislection for “Bhuvaneśī” which is another name for Kīrīteśvarī,² whose temple is situated at Kīrītaknoṇā, three miles from Murshidabad city, and which is one of the fifty-two Pithas where Śatī’s Kīrīta (crown) is said to have fallen, and it will be remarked that the Śaktisaṅgama Tantra described the extent of Aṅga from one celebrated temple to another. The substitution of “Bhuvaneśī” for “Bhuvaneśa” does not at all violate the metre.

In the Rāmāyaṇa we find Aṅga mentioned as a kingdom under the sway of its monarch Romapāda called also Daśaratha, who was an ally of Daśratha, king of Kośala

Brief history of the country.

(Oudh). Romapāda averted the calamity of a dreadful drought and consequent famine by performing a sacrifice presided over by Ṛṣi Ṛṣyaśringa.³ The people of Aṅga are mentioned in the work along with those of Videha, Kāśī, Kośala and Puṇdra.⁴ Romapāda it appears from the Purāṇas was the fifth or sixth in descent from Aṅga, the founder of the kingdom.⁵

At the time of the Mahābhārata Aṅga appears to have been a feudatory kingdom under the Kurus of Hastināpur, for when Arjuna refused to fight with Karṇa as not being a person of equal rank with him, Duryodhana at once installed him as king of Aṅga in the very arena of the tournament.⁶ This exercise of sovereign power was only possible on the part of Duryodhana if it be considered that Aṅga had been conquered before by Pāṇḍu along with the neighbouring kingdoms, though it has not been expressly mentioned among his conquests.⁷ Karṇa was the foster son of Adhiratha, and all the

¹ *Saktis. Tant.*, vii :—

वङ्गदेशं समारभ्य भूवनेशान्तगं शिवे ।
मौड़देशः समाख्यातः सर्वविद्याविशारदः ॥

² *Tantrachūḍāmaṇi*, ch. 51 :—

भूवनेशी सिद्धरूपा किरौटस्या किरौटतः ।
देवता विमलानाम्नी संवर्तभैरवस्तथा ॥

³ *Rām.*, i, 9.

⁴ *Ibid.*, iv, 40.

⁵ *Vish. Purān.*, iv, 18.

⁶ *Mbh.*, i, 138 ; *Śānti P.*, ch. 5.

⁷ *Ibid.*, i, 113.

Purāṇas agree that the latter was a descendant of Romapāda of the Rāmāyaṇa, though they differ as to the degree of his descent. Adhiratha was a charioteer of the Kauravas.¹ In his expedition to secure tributes for the Rājasūya sacrifice of Yudhiṣṭhira, Bhīma after the conquest of Magadha fought with Karna (king of Aṅga), defeated him and brought him under subjection.²

The 6th century before the Christian era forms one of the greatest epochs in the history of the religious ideas of the Hindus. Mahāvīra, the last Tirthaṅkara of the Jainas, and Buddha, the founder of a new sect, flourished during this period. The theories of salvation and doctrines of morality as propounded by them prevailed over those of other reformers who arose at that period. The kings and nobles at that time rolled in riches and revelled in luxury; parricide,³ murder and deception were not deemed as offences; morality was at its lowest ebb; Brahminism was reduced to a mere form,⁴ liberation of the soul was associated with the performance of sacrifices and merit was considered to depend upon the number of animals sacrificed;⁵ priestcraft was in the ascendant, the people were steeped in superstition and self-enjoyment was the order of the day. There was a reaction: self-culture, self-restraint, kindness to all living creatures and elevation of thoughts were promulgated as the only means of liberation from re-birth. The Tirthaṅkara and the Tathāgata were contemporaries: Mahāvīra was older than Buddha by eighteen years. The former died in 569 B.C. at 72 years of age, and the latter died in 543 B.C. when he was 80 years old.⁶

Aṅga was then one of the sixteen great kingdoms of India.⁷ At the latter end of the 7th century and beginning of 6th century B.C., the country was governed by Dadhivāhana,

¹ *Mbh.*, i, 137.

² *Ibid.*, ii, 30.

³ Kautilya's *Arthaśāstra*, ch. xvii (Protection of Princes): Bharadwāja quoted.

⁴ *Kassapa-sihanāda Sutta* (Dr. Rhys Davids: *Dialogues of the Buddha*).

⁵ See *Kuṭadanta Sutta*. Though this Sutta is a sarcastic travesty, yet it describes the ordinary practices and rituals at real Vedic sacrifices: "And further, O Brāhman, at that sacrifice [of King Mahā-Vijita] neither were any oxen slain, neither goats, nor fowls, nor fatted pigs, nor were any kinds of living creatures put to death. * * * And the slaves and messengers and workmen there employed were driven neither by rods nor fear, nor carried on their work weeping with tears upon their faces." In another place it is said: "And a hundred bulls and a hundred steers, and a hundred heifers, and a hundred goats, and a hundred rams had been brought to the post for the sacrifice."

⁶ According to the Ceylonese Chronology and Prof. Lassen: see Goldstücker's *Pāṇini*, pp. 231-233; *Anguttara*, i, 213, iv, 252f; *Vinaya Texts*, ii, 146; *S.B.E.*, xvii, 146 note.

⁷ The sixteen great kingdoms (*Mahā-Janapadas*) were: Aṅga, Magadha, Kāśī, Kośala, Vajji, Malla, Chetiya, Vamśa, Kuru, Paūchāla, Maccha, Śūrasena, Assaka, Avantī, Gāndhāra, Kāmboja.

whose daughter Candanā or Candravālā was the first female who embraced Jainism shortly after Mahāvīra attained the Kevaliship and afterwards became the head of thirty-six thousand nuns. Śātānīka, king of Kausāmbī, attacked Campā, his capital, and in the confusion which ensued she fell into the hands of a robber, but all along she maintained the vows of of the order.¹ Magadha was then a small kingdom. A great struggle for supremacy was going on between Aṅga and Magadha.² The Vidhura-Paṇḍita Jātaka³ describes Rājagrha as a city of Aṅga, which evidently points to the prevailing relations between the two countries. Śrī Harṣa speaks of a king of Aṅga named Dr̥ḍha-Varmma (Dr̥iḥa Varmman) being restored to his kingdom by Udayana, king of Kauśāmbī and contemporary of Buddha.⁴ Brahmadata, king of Aṅga, defeated Bhaṭṭiya,—Kṣatraujas of the Purānas,—king of Magadha. But when his son Bimbisāra called also Śrenika, or Śrenīya, then a prince, grew up, he invaded Aṅga, killed Brahmadata and took his capital Campā. He resided there as viceroy till his father's death when he returned to Rājagrha, the capital of Magadha.⁵ This is corroborated by the Sonadaṇḍa-Sutta, from which it appears that Bimbisāra granted some lands in Campā as a royal fief to a Brahmin named Sonadaṇḍa.⁶ Dr. Rhys Davids perhaps refers to Bimbisāra when he says that at the time of Buddha, Aṅga was governed by a "wealthy nobleman" who granted a pension to a particular Brahmin.⁷ Brahmadata was the last independent sovereign of Aṅga, and according to Spence Hardy it never recovered its independence but remained subject to Magadha. The conquest of Aṅga took place when Buddha was yet a boy. Thus from a very remote period down to the time of Kṣatraujas, Aṅga retained its independence, but the Matsya and other Purānas give only the names of kings who reigned there, from Aṅga, the founder of the kingdom, to Prithusena, the grandson of Karṇa of the Mahābhārat.

The country of Aṅga, however, did not merge into the kingdom of Magadha, as it was always governed as a separate province under a governor with Campā as its capital. Bimbisāra was its first viceroy while his father Kṣatraujas was alive, and when he himself ascended the throne of Magadha,

¹ Dr. Jacobi's *Jaina Sūtras*, p. 267; Dr. Stevenson: *Kalpasūtra*, p. 93; Barodia's *Hist. and Lit. of Jainism*.

² *Jātaka* (Cam. Ed.), vol. iv, p. 281,—*Champeyya-Jātaka*.

³ *Ibid.*, vi, 133.

⁴ *Priyadarśikā*, Act iv.

⁵ Duff's *Chronology of India*, p. 5; Csoma Korösi: *Dulva*; Spence Hardy's *Manual of Buddhism*, p. 166 note.

⁶ See also *Mahāvagga*, i. 19; v. 1 (note by Dr. Rhys Davids in *S.B.E.*, xvii, 1).

⁷ *Buddhist India*, p. 24.

his son Ajātaśatru, called Kunika or Kuniya by the Jainas, became governor of Aṅga, where he plundered the people to such an extent that they were obliged to complain to the king.¹ According to the Jaina authorities Kunika made Campā his capital after the death of his father, and after his death his son Udāyin transferred the seat of government from Campā to Pātaliputra.² The Buddhist works, however, do not mention that Ajātaśatru removed the capital from Rājagṛha to Campā: on the other hand, it appears that he reigned all along in Rājagṛha.³ It is possible that he might have resided at Campā at different times, for we find that he persecuted his brothers Hala and Bihala, who fled from Campā and took refuge in the court of their maternal grandfather Cetaka at Vaiśālī, the capital of Videha (Tirhut). On Cetaka's refusal to surrender them, Ajātaśatru led an army against him from Campā and killed him in battle. Thus he annexed Videha to his dominion. His two brothers escaped and took refuge into the holy order of Mahāvīra.⁴ Udāyin, who according to the Buddhist and Jaina works was the son of Ajātaśatru and according to the Purāṇas his grandson, like his predecessors became governor of Aṅga,⁵ and after Ajātaśatru's death removed to Pātaliputra (Patna) which henceforth became the capital of Magadha.

The influence of Mahāvīra after he attained the Kevaliship extended over Videha, Magadha and Aṅga, as the rulers of these kingdoms were his relations. Cetaka, king of Vaiśālī, was his maternal uncle; Bimbisāra, king of Magadha, was Cetaka's son-in-law, having married his daughter Cellanā called also Videha-devī, and Ajātaśatru, ruler of Aṅga, was the son of the latter.⁶ Bimbisāra became a convert to the teachings of Mahāvīra, and Ajātaśatru also befriended the Nigranthis as the followers of Mahāvīra were called, Mahāvīra being known to the Buddhists as Nigantha Nātaputta, because he belonged to the family of Jñāta or Nāta of Kuṇḍapura. Mahāvīra spent three *pajjusanas* (or rainy season retirement) in Campā, the capital of Aṅga, and its suburbs (Prsthā-Campā) and two *pajjusanas* in Bhadrīkā (Bhaddiya) in Aṅga.⁷ Buddha also visited these two principal towns⁸ and converted the people to Buddhism. Buddha went to Aṅga from Srāvastī at the instance of Subhaddā, a daughter of the celebrated

¹ Dr. Bühler: Hemachandra's *Sthavirāvali*, vi: Rockhill's *Life of Buddha*, p. 24.

² *Jñātādharmasūtrapāṭha* (MS., Sans. College, Calcutta).

³ *Sāmanna-phala Sutta*; *Mahāparinibbāna Sutta*, vi, 62.

⁴ Jacobi: *Jaina Sūtras*, Intro., pp. xii-xiv; Barodia: *Jainism*.

⁵ Bühler: *Sthavirāvali*, vi.

⁶ Bühler: *Indian Sect of the Jainas*, p. 27.

⁷ Jacobi: *Jaina Sūtras*, p. 264.

⁸ For Campā see *Sonadanda Sutta*; *Mvg.*, ix, 1, 2; for Bhaddiya see *Mvg.*, v, 8; vi, 34; Kern: *Manual of Indian Buddhism*, p. 29.

[N.S.]

Anāthapiṇḍika, who was married there in a family who were the lay devotees of the Jaina religion. The whole family was converted and Buddha came away after leaving Anuruddha to complete the work of conversion in that country.¹ The religion of Mahāvira had spread over Vaiśālī, Rājagṛha and Campā, the three chief cities of three of the most powerful kingdoms of the time, but the genius of Buddhism prevailed over the doctrines of Jainism. Siha, the Lichavi general of Vaiśālī,—an influential personage and a follower of the Nigranthi sect,—embraced the Buddhist faith, notwithstanding that he was prohibited by Nigranthi Nātaputta himself to visit Buddha.² Bimbisāra became a convert to Buddhism out of conviction, and Ajātaśatru became a follower of Buddha, as Dr. Jacobi says, out of policy³; but the qualms of conscience that he felt on account of murdering his father, which found solace in the teachings of Buddha,⁴ and the disconsolate condition to which he was reduced when he heard the tidings of Buddha's death,⁵ clearly indicate that his conversion was not dictated by policy simply to spite a rival sect for giving shelter to his recalcitrant brothers.

The subsequent history of Aṅga since its conquest by Bimbisāra is bound up with that of Magadha. In the 4th century before the Christian era, Candragupta (321-297 B.C.) subjugated the whole of Northern India and became a Cakravartī or emperor of India,⁶ and his extensive dominion comprised “the kingdoms of Kośala and Benares, as well as Aṅga and Magadha proper.”⁷ But it is difficult to ascertain how the administration of the province of Aṅga was carried on. It is, however, certain that in the 3rd century B.C., during the reign of Aśoka (273-231 B.C.), the administration of his vast empire was, as may be gleaned from his rock-edicts, carried on by viceroys or governors who were either princes of the royal house or near relations of the monarch, and the whole empire for this purpose, so far as it appears, was divided into four provinces, the headquarters of which were at Taxila, Ujjayinī, Tośalī and Suvarṇagiri.⁸ The eastern territories were under the governor of Tośalī, which has been identified by James Prinsep with Tośala-Kośalaka or simply Kośala of the Brahmāṇḍa Purāṇ, in which the Dhauli or Durvala (Dublā)

¹ Kern : *M.I.B.*, 37, 38.

² *Mvg.*, vi, 3.

³ *Intro.*, *Jaina Sūtras*, p. xiv.

⁴ *Sāmannaphala Sutta*.

⁵ Spence Hardy : *M.B.*, vii, 52.

⁶ Kauṭilya's *Arthasāstra*, Bk. ix. where Candragupta's dominion is mentioned as “चक्रवर्तीक्षेत्रं” ; *Viṣṇu Purāṇ*, xxiv, iv, 7.

⁷ Mr. V. Smith : *Early Hist. of India*, 36.

⁸ Smith's *Asoka*, 44: the Dhauli and Brahmagiri Edicts, 136, 138.

monastery was situated not far from Bhuvaneśvara in the district of Katak.¹ Dr. Fleet has identified Suvarṇagiri with Sonagiri, one of the hills at old Rajgir. If this identification is correct, then Aṅga was possibly administered by the governor of Suvarṇagiri.

From the Hāthigumphā inscription of Khāravēla, king of Kalinga, it may fairly be concluded that in the 2nd century B.C., after the death of Aśoka, his vast empire lost all the outlying provinces, and it consisted “only of the ancient kingdoms of Magadha and Campā, together with the eastern portion of Kośala.”²

During the next three centuries after the death of Aśoka. Buddhism spread rapidly and steadily, notwithstanding the encouragement which Sampriti, the grandson and immediate successor of Aśoka according to the Jaina authorities,³ and who perhaps was identical with Daśaratha of the Purāṇas, gave to the Jaina religion and the Brahminical faith. In the 1st century of the Christian era Nāgārjuna, the promoter and expounder of the Mahāyāna system of Buddhism, flourished at the time when the third Buddhist synod was convened by Kaṇiṣka. The Mahāyāna system, according to Dr. Waddell, “substituted for the agnostic idealism and simple morality of Buddha a speculative theistic system with a mysticism of sophistic nihilism in the background.” As it laid much stress on the practice of fervent devotion and active compassion, it found an echo in the heart of millions of people and enlisted their sympathy.⁴ Aṅga, Baṅga and Magadha at once welcomed and adopted the new doctrine, and many images of gods and goddesses belonging to the Tāntric system, which was the later development of the Mahāyāna creed, may be found abounding in various parts of the district of Bhagalpur.

In the 3rd century of the Christian era, the Śakas, taking advantage of the weakness of the later kings of the Andhrabhr̥tya dynasty, must have attacked Aṅga and ruled over it, as is testified by a silver coin of “Mahākṣatrapa Svāmi Rudra Sena” found with a coin of Candragupta Vikramāditya,⁵ that is Candragupta II of the Gupta dynasty, at the bottom of a stupa at Sultanganj in the district of Bhagalpur. The successes and victories of the Śakas under Rudradāman, the founder of the Western Satrapy, at Surāstra or Kathiawad in the 2nd century, must have encouraged them to extend their conquests to the east during the disorder that prevailed at the latter part of the rule of the Śātakarnī princes. Though Samudragupta

¹ *J.A.S.B.*, 1838, pp. 136, 138.

² Rhys Davids: *B.I.*, 310.

³ *Sthavirāvalīcharita* (Jacobi's Ed.), canto xi.

⁴ Waddell: *Buddhism of Tibet*, 10; Kern: *M.I.B.*, 124.

⁵ *Arch. Surv. Rep.*, xv, 29; see also *J.A.S.B.*, xxxiii, 361.

conquered the whole of Northern India,¹ yet it does not appear that he was able to oust the Śakas from their possession in Aṅga. His son Candragupta II (Vikramāditya) at the latter end of the 4th century A.D. conquered Rudrasimha II, son of Satyasena, annexed Surāṣṭra and Mālwā to the Magadha empire and wrested Aṅga from the hands of the Śakas, which remained under the sway of the Guptas² till the 8th century A.D. The coin of the “Mahākṣatrapa Svāmi Rudrasena,” which was found in the Sultanganj stupa, must have been the coin of his immediate predecessor Rudrasena IV, son of Simhasena.³ Satyasena could not have been the father of Rudrasena, as it has been supposed by General Cunningham⁴: he was the father of Rudrasimha, who was perhaps the last of the Western Kṣatrapa dynasty.⁵ The passage in the *Harṣacharita*⁶ which alludes to the slaying of the profligate king of the Śakas by Candragupta in the guise of a woman at the “enemy’s town”, evidently means the assassination of Rudrasena by Candragupta II in his capital at Ujjayinī (Ujin),⁷ and does not refer to the conquest of Pāṭalīputra by Candragupta I as has been supposed by some.

At the beginning of the 5th century A.D., Fa Hian who travelled in the Magadha empire during the reign of Candragupta II from A.D. 405 to 415, visited Aṅga. His account of it is very meagre. He says that the country was situated on the southern bank of the Ganges. He saw some memorial towers and some Buddhist priests. He, however, speaks of Aṅga as “the great kingdom of Chen-po [Campā].”⁸ It should be here observed that the country was promiscuously called “Aṅga” and “Campā” from its capital. Barāhamihira and Daṇḍin, who flourished in the 6th century A.D., call the country both by the names of Aṅga and Campā.⁹ Hiuen Tsiang who visited it in the 7th century, calls it by the name of “the country of Chenpo.” Bāṇa Bhaṭṭa, who also flourished in the 7th century, does not name Aṅga, but calls its king as “King of Campā.”¹⁰ The *Yoginī Tantra*, which is a work of modern date, mentions the name of Aṅga.¹¹

¹ The Allahabad Pillar inscription of Samudragupta: *Corpus Ins Ind.*, III, 57; *J.A.S.B.* (1837), vi, 978.

² *Vāyu Purāṇ*, pt. ii, ch. 37, v. 379.

³ See the *List of Mahākṣatrapas of Kāthiawad-Mālwā* in Dr. Bhandarkar’s *Peep into the Early History of India*.

⁴ *Arch. S. Rep.*, xv, 29.

⁵ Duff: *Chron.*, 29.

⁶ Ch. vi.

⁷ Dr Bhandarkar’s *Peep*.

⁸ Beal: *Buddhist Records of the Western World*, Intro., p. lxxi.

⁹ *Brih. Sam.*, chs. 14, 16; *Daśakum.*, Madhya kh., i, p. 63 (Bom. ed.).

¹⁰ *Harṣa-ch.*, vi: “नम्याधिपचमुचरभटाः चामुष्ठीपतेः चाचेसुः प्राणान् पुष्करस्य”.

¹¹ *Yoginī Tan.*, p. 148: “राहोरजे तु वङ्के”.

The kingdom of Karṇasuvārṇa could not have been founded earlier than the latter end of the 5th century A.D. Local traditions as recorded by Captain Layard and others¹ as well as the architectural remains that still exist associated with the name of Karṇa lead to the conclusion that the kingdom was founded by Karṇa Sena. Though as yet we have not got the advantage of any epigraphical evidence, yet the discovery of Gupta coins at its capital of the same name now called Bāṅgāmāṭi, six miles below Berhampur, and the fact that its last king bore the name of Narendra Gupta (Śaśāṅka), go to establish that Karṇa Sena must have been a prince belonging to the royal house of the Guptas charged with the administration of the eastern provinces as viceroy under the reigning sovereign. The decline of the Gupta empire after the death of Skanda Gupta, already weakened by the frequent inroads of the Hūṇas, afforded a suitable opportunity to Karṇa Sena like others to throw off his allegiance and carve out an independent kingdom for himself, consisting of the district of Murshidabad which was gradually extended over to Aṅga and it is very probable that the kingdom was called Karṇasuvārṇa after the name of the founder. Major Wilford places Karṇa of Sultan-ganj-Karṇagar in the 3rd century A.D.² but according to tradition as recorded by Buchanan this Karṇa was identical with Karṇa of Campānagar-Karṇagar, and traditionally he was a contemporary of Vikrama as the Gupta kings were generally called.³ Hence considering all circumstances he could not be placed earlier than the 5th century A.D. No mention of the name of Karṇasuvārṇa appears before the 7th century A.D. Hiuen Tsiang was the first to mention the name, and he states that Śaśāṅka, the murderer of Rājyavarddhana, the elder brother of Śrī Harṣa of Kanouj, was king of Karṇasuvārṇa. It is generally believed that Bāṇa Bhaṭṭa does not mention the name of the murderer of Rājyavarddhana, but as a matter of fact he does mention his name. He says that the murderer of Rājyavarddhana was king of Gauḍa, who is described as the “wicked Narendra”⁴ in one place and

¹ *J.A.S.B.*, xxii, p. 281; Martin: *East. Ind.*, vol. ii; Rev. J. Long: *Banks of the Bhagirathi* (C. R., vi). Capt. Layard says: “The city of Kansonapuri [Karṇasuvārṇa or Rāṅgāmāṭi] is said to have been built hundreds of years ago by a famous Mahārājā of Bengal named Karn Sen, who resided chiefly at Gour. He erected also a country palace about four miles distant, which was called after him Gowkurn from the circumstance of his ears being of gold and shaped like those of a cow.”

² *Asia. Res.*, ix, 108.

³ Martin: *East. Ind.*, i, 32, 39.

⁴ *Harṣa-ch.* (Calcutta ed.), pp. 436, 438: the compound word “दुर्नरेन्द्राभिभवरोषित” means “enraged at the discomfiture sustained from the wicked Narendra”. It should be remarked that Bāṇa uses the prefix “Duh” (wicked) before the word “Narendra,” punning upon every

“Gupta”¹ in another. Bāṇa would not have certainly applied the complimentary epithet of “Narendra” to the murderer of Rājyavarddhana, the elder brother of his patron, had it not been his real name. The discrepancy about the country he governed may be reconciled by the supposition, which is not an unreasonable one, that Narendra Gupta—the Śaśāṅka of Hiuen Tsiang—had extended his dominion over Gauḍa, though he was still known as king of Kārṇasuvārṇa.

Karnagarh or the fort of Rājā Karṇa in Campānagar near Bhagalpur, Karnachaurā in Monghir, and a high mound also known as Karnagarh on the west side of Sultanganj in the district of Bhagalpur said to be the remains of a fort, are all associated with the name of Karṇa who was either the founder of Kārṇasuvārṇa or a prince of his house sent to govern the province of Aṅga. That Aṅga was under the sway of the kings of Kārṇasuvārṇa is further confirmed by the fact that the construction of the ruined fort on the Kherhi hill in the same district is ascribed to Śaśāṅka, the last king of Kārṇasuvārṇa. The governors were called by the dynastic name of Karṇa and their administrative headquarters was at Karnagarh near Campā where the remains of a fort still exist. These Karṇa kings, as they were called, were traditionally not less than seven in number.² It is curious that the names of all Karṇas of Aṅga, whether a king or a nobleman, were associated with riches and benefactions, and all of them had a valuable ornament for the ear (*kārṇa*)³. This tradition and that of the raining down of gold by Bibhīṣana indicate that the kings of the Karṇa dynasty did not lack in riches, resources and influence, and they would have perhaps extended their dominion to the west had not their career been checked by the superior military genius of Kīrttivarman or Harṣavarddhana of Kanouj.

In the latter part of the 6th century A.D., there being no paramount power, it was easy for Kīrttivarman I, son of Pula-keśī I, to conquer Aṅga, Baṅga, Kaliṅga and other countries of Northern India, Aṅga being then under the sway of the kings

word of the passage of which this word forms a part. Compare “दुन्दुभाभिभवरोषित” with “दुष्टगौड़भुजङ्ग” in the same chapter at p. 457: “दुष्टगौड़भुजङ्ग जग्धजौविते च राज्यवर्द्धने”

¹ *Ibid.*, ch. vii, p. 603: “देवभूयं गते देवे राज्यवर्द्धने मप्रनात्वा च म्दौवे कुशस्यसे (Kanouj).”

² Martin: *East. Ind.*, ii; *Asia. Res.*, ix.

³ *Mbh.*, iii, 305; *Arch. Surv. Rep.*, xv, 16, 17; *J.A.S.B.*, xxii, 282: Śruta-vimśati-koti or Śroṇa-koti-vimśa, a nobleman of Hiranya-parvata (Monghir) had an ear ornament worth 20 kotis: Śruta or Śroṇa means Karṇa or ear (see Beal: *Records*, 186); another nobleman was Sroṇa-koti-kārṇa, whose *kārṇa* (ear) ornament was worth a koti or crore (*Avadāna-kalpalatū*, ch. 29, v. 5).

of Karṇasuvarṇa. But it was not so easy for the Cālukya king to govern these countries from so long a distance as Bādāmī, his capital, and hence it is not probable that he retained possession of Aṅga for a long period after his conquest.

Dandin in the 6th century speaks of a king of Aṅga named Śimhavarmmā, whose capital Campā was besieged by Caṇḍavarmmā, the regent of Darpasāra, king of Malwa.¹ Śimhavarmma is said to have been a contemporary of Naravāhana-datta, king of Vatsya. But it does not seem that Śimhavarmmā had any real existence, though Naravāhana-datta was a real personage, being the son of Udayana or Udena of the Buddhists, a contemporary of Buddha² and Caṇḍa-pradyota, king of Malwa,—the Caṇḍavarmmā of the Daśakumāra-charita. Aṅga had then already been conquered by Bimbisāra and had become a part of the Magadha kingdom.

In the 7th century the splitting up of the vast Gupta empire into several petty principalities, enabled Harṣavarddhana or Śilāditya II of Kanouj to wrest the kingdom of Magadha along with that of Aṅga from the hands of the weak princes who governed them. He extended his conquests and ultimately became the paramount sovereign of Northern India.

Hiuen Tsiang who visited Aṅga in the second quarter of the 7th century A.D., describes the country as being 4000 li or 800 miles in circuit with its capital on the south bank of the Ganges. There were many Saṅghārāmas or monasteries mostly in ruins, with 200 priests who followed the Hina-yāna system of Buddhism. There were also twenty Deva temples. He does not mention the name of its king, nor does he mention it as a separate kingdom. He visited India during the reign of Harṣavarddhana, the country being then governed by that monarch.

The dismemberment of the empire of Harṣavarddhana after his death made Ādityasena, a scion of the royal house of Guptas, independent sovereign of Magadha in the middle of the 7th century, and the excavation of the Papahāriṇi tank at the foot of the Mandāra hill in the district of Bhagalpur about thirty miles to the south of Campānagar, by his wife Koṇadevī or Kondadevī as mentioned in an inscription,³ shows that Aṅga still formed a part of the Magadha kingdom. There is no record to show when Aṅga passed out of the dominion of the Karṇa kings: most probably when Śāsāṅka was defeated and Gauḍa was conquered by Harṣavarddhana. It appears that from the latter end of the 5th century to the middle of the 8th century two dynasties were reigning side by side in Magadha, East Magadha being under the "later Guptas," as they were called, and West Magadha under the

¹ *Daśakum.*, Madhya-bhāga, ch. i.

² *Kathā-sarit-sāgara.*

³ *Corp. Ins. Ind.*, iii, p. 211.

[N S.]

Maukharis called the Varmma dynasty including Pūrṇavarmma mentioned by Hiuen Tsiang, who restored the Bodhi-tree after its destruction by Śāsāṅka.¹ Aṅga was governed by Ādityasena and his three successors Deva Gupta, Viṣṇu Gupta and Jivita Gupta II, who asserted claims to paramount sovereignty till the first quarter of the 8th century.

Since then we do not hear anything about the Gupta princes of Magadha: they gradually disappeared into obscurity. But it should be noted that before its conquest by Gopāla, the founder of the Pāla dynasty, towards the end of the 8th century, Aṅga was conquered by Jayadeva II of Nepal, the successor of Śivadeva II of the Lichchhavi dynasty, and Bengal was also invaded by him.² On account of the frequent inroads of foreign princes and internal dissensions, Bengal in the 8th century became a scene of confusion and anarchy, and before the close of that century Gopāla, a native of Varendra, was elected king. He gradually extended his conquest over Magadha and established his capital at Uddandapura, the modern town of Bihar, Pātaliputra being then in ruins. But it appears that the capital of the Pāla kingdom was shifted, from time to time, to different places according to the whims and caprices of the monarchs. It is very probable, as may be inferred from a copperplate inscription found at Monghir, that this town was the capital of Deva Pāla Deva, the grandson of Gopāla, "whither so many mighty chiefs of Jambudvīpa resort to pay their respects that the earth sinks beneath the weight of the feet of their attendants."³ There can not, however, be the least doubt that Aṅga formed a part of the dominion of the kings of the Pāla dynasty,⁴ and there is abundant evidence to show that it was governed by a prince belonging to the royal house or some relation of the reigning monarch. Rāma Pāla appointed Mahana, the maternal grandfather of Kumāradevī, wife of king Govindachandra of Kanouj, as governor of Aṅga at the latter end of the 11th century or beginning of the 12th century.⁵ In a Jaina work called *Campakasreṣṭhī-kathā* we find the name of Sāmanta Pāla as king of Cāmpā, whose minister was Brddhadatta.⁶ We do not find the name of Sāmanta Pāla in the list of the Pāla kings: he must have been a prince

¹ Beal: *Records*, Bk. viii, p. 118; *Arch. S. Rep.*, xv, p. 166.

² *Ind. Ant.*, ix: "अङ्गप्रिया परिमती जितकामरूप" (stone inscription of Jayadeva II).

Monghir copperplate inscription of Deva Pāla Deva: *Ind. Ant.*, vol. xxi, p. 254.

⁴ Nārāyana Pāla's copperplate inscription of Bhagalpur: *Ind. Ant.*, vol. xv, p. 305.

⁵ *J.A.S.B.*, 1908.

⁶ *Cata. of Sansk. Manuscripts*, 1892, by M. M. Haraprasad Sastri, M.A., C.I.E.

connected with the reigning monarch sent to govern the province, but we are not aware who that monarch was or when he flourished. It is therefore evident that from the time of Bimbisāra to the time of the Pāla kings, Aṅga was always considered to be an important province to be administered by a governor who was connected with the royal house of Magadha, and therefore it seems that he was called a “King” by courtesy.

In the latter part of the 8th century and at the beginning of the 9th century, Aṅga, Baṅga, Kāliṅga and Magadha were invaded by the most powerful of the Rāṣṭrakuṭa monarchs, Govinda III called Prabhutavaṛṣa and Jagattuṅga¹ (794-814); and his son Amoghavaṛṣa I, called also Nṛpatuṅga (814-877), invaded the same countries while Dharma Pāla and Deva Pāla were reigning in Magadha; but it appears that these invasions were either simply predatory raids undertaken with a view to exact tributes or they were repulsed by the powerful kings of Magadha; hence we find that the Sirur inscription skips over the expedition of Amoghavaṛṣa by stating that he was worshipped by the lords of Aṅga, Baṅga and Magadha. It is, however, certain that Dharma Pāla married Rannā Devī, who was the daughter of the Rāṣṭrakuṭa king Vallava, who was evidently the powerful king Govinda III called also Prthvī-Vallava.²

In the latter part of the 9th century or in the first quarter of the 10th century, Amoghavaṛṣa's son Kṛṣṇa II, called also Akālavaraṣa (877-915), invaded Aṅga, Baṅga, Kāliṅga and Magadha during the weak reigns perhaps of some of Nārāyaṇa Pāla's successors, and the kings of these countries are represented as honouring his commands by waiting at his gates, and Dr. Bhandarkar believes that the account given of this invasion may be relied upon as true.³ But it appears that the king of Magadha must have shortly recovered the countries from the Rāṣṭrakuṭa king. From the Khajuraho inscription which records the exploits of the Candelia king Dhāṅga Deva, who reigned in Jejubhukti (Bundelkhand) from A.D. 950 to 999, it appears that he invaded Aṅga and other countries, and he was “so successful in his wars that the wives of the kings of Kāñcī, Andhra, Rādḥa, and Aṅga lingered in his prisons.”⁴ The inscription magnifies the war-

¹ *Ind. Ant.*, vol. xii, p. 221.

² Bhandarkar: *Early Hist. of the Dekkan*, p. 51. But Dr. Kielhorn thinks that Dharmma Pāla married the daughter of Parabala not Vallabha.

³ See the Karhād Plate Inscription of Krishna III in *Ep. Ind.*, iv, pp. 278-290: दारव्याङ्गकलिङ्गमाङ्गमधैःश्वरिनाञ्जयिरं सुनुसुहृत्तवाग्भवः परिदृष्टः त्रौहण्यराजोः धवत्। १०। See also *Ep. Ind.*, vol. v, v. 13; vol. ii, p. 190.

⁴ Khajuraho Inscription no. iv: *Ep. Ind.*, i. 138, 105; v. 46.

like exploits of the king. As a matter of fact Aṅga had no independent king, but it was then under the sway of Gopāla II or Vīrāha Pāla II of the Pāla dynasty of Magadha.

In the first half of the 11th century Rājendra Chola Deva I (1011-1059) invaded Baṅga and Magadha and overran the neighbouring countries.¹ A dark period followed this expedition. Disorder and misrule prevailed during the nominal rules of the later Pāla kings and before the rise of the Sena-dynasty of Bengal. The Varmman kings wrested and ruled over a portion of Bengal, and it appears from tradition recorded by Dr. Buchanan that a colony of the Colas lived in the district of Bhagalpur and built the temples in Baidyanāth and the neighbouring places, though the expedition is wrongly ascribed to one Āditya Sena, king of Cola.²

It appears from the Balagamve inscription,³ which is confirmed by the Vikramāṅkadeva-charita,⁴ that Tribhuvana Malla, afterwards Vikramāditya II of the Calukya dynasty, subdued Aṅga, Baṅga, Kāliṅga, Magadha and other countries during the reign of his father Āhavamalla or Someśvara (1040-1069), who founded the city of Kālyāna and made it his capital; and it seems that he was satisfied with the tributes he obtained from the conquered princes. Karṇadeva (1042-1093) of the Kalachuri dynasty of Cedi also attacked Gauḍa, Baṅga, Kāliṅga and other countries.⁵

These frequent invasions considerably weakened the powers of the kings of Magadha. But the conquest of the eastern provinces of the kingdom including Gauḍa in the second half of the 11th century by Vijaya Sena, the founder of the Sena dynasty, gave a new turn to the history of Aṅga. It seems that Aṅga was conquered either by him or his son Ballāla Sena and annexed to the kingdom of Gauḍa. Though we do not find definite statement to that effect, yet the frequent invasions of Udantapura (the modern town of Bihar) by Ballāla Sena and his repeated repulses,⁶ indicates that Aṅga had already become a part of the kingdom of Gauḍa, otherwise he would not have dared to invade Kikāṭa

¹ *Ep. Ind.*, ix, p. 232.

² Martin: *East. Ind.*, ii, 23.

³ Balagamve Stone Inscription dated A.D. 107 (Lewis Rice: *Mysore Inscriptions*, p. 45).

⁴ Ch. iii.

⁵ Karanbel and Bheraghat inscriptions.

⁶ Ānanda Bhatta: *Ballāla-charitam*, pt. ii, ch. 2, vs. 1, 2:—

पुरोदन्नपुराधीशं जिग्रौषुर्वनौपतिः ।

विनाद्याद्वह्मभानन्दद्विष्णुकोटिं मृद्वीतवान् ॥

बारंबारं जितो राजा यतो कनिपुराडवे ।

ततोऽभिजानं घोरं स कर्त्तमासीत् समुद्यतः ॥

(Magadha)¹, leaving the rear exposed to the attacks of his enemies. Hence it is that Murāri Paṇḍit, the author of the *Anargha Rāghava*, who flourished about this period, goes so far as to say that Campā was the capital of Gauda.² We are not aware from any other source that Campā was ever the capital of Gauda, but there can not be any doubt that all along it maintained its importance and supremacy as a town.

It appears therefore from the inscriptions of the 11th century and the Harihara inscription of Jagadekamalla II of the 12th century, that the eastern kingdoms of Northern India including Aṅga were peculiarly exposed to invasions from the Deccan, the object of the invaders being plunder and exaction of tributes; but they likewise prove the declining powers and weakness of these kingdoms. The frequent inroads took away their vitality and left them prostrate, thus paving the way for the easy conquest of the Mahomedans and the establishment of their dominion at the latter end of the 12th century. The ethical bond of Buddhism was gone, giving rise to sacerdotal influence without that sense of duty which individuals owed to each other and to society, and the result was disunion, rupture, sects and social disorder. The Pālas were Buddhists and the Senas were of the Brahminical faith. So it was easy for the Mahomedans to walk over and conquer the country. The last king of Bengal was Lakṣmana Sena, and the last of the Pāla Kings who was conquered by Bakhtiyar Khiliji, as may be inferred from epigraphical evidence, was Govinda Pāla who, according to his Gaya inscription, ascended the throne in A. D. 1161.³ But Dr. Buchanan says that Indradyumna was the last monarch of the Pāla dynasty, who being unable to contend with the Mahomedans retired with his army and family to Jagannath.⁴ General Cunningham, however, is of opinion that he retired to Jayanagar near Kiyul after he was defeated by Makhdum Maulana Nur, a general under Bakhtiyar Khiliji.⁵

¹ *Ibid.*, v. 5.

² Act VII, 124, p. 312: “रामः — देवि, इधं पुनस्ततोऽपि पुरस्ताच्चम्यानाम
मौड़ानां विनयमधुरशृङ्गारविभ्रमरमणौया मरकेतनकुमारव्रतचयातपोवनमिव
राजधानी ।”

³ *Arch. S. Rep.*, xv, p. 155.

⁴ Martin: *East. Ind.*, ii, p. 23.

⁵ *Arch. S. Rep.*, iii, 159.

CHAPTER II.

PRINCIPAL TOWNS.

All authorities, whether Hindu, Jaina or Buddhist, agree that Campā was the capital of ancient Champānagara. The *Kathā-sarit-sāgara*, however, says that the capital of Aṅga was Viṭankapura,¹ but it cannot be identified with Campā, as it was “situated on the shore of the sea”: it is evidently a fictitious name. But the name of Campā does not appear in the *Rāmāyaṇa*, at least in the Bengal recension. According to this work Romapāda was king of the country of Aṅga. The name of Campā appears for the first time in the *Mahābhārata*, and it was the capital Karna. From the *Purāṇas* it appears that the town of Campā was founded by Campa, the great-grandson of Romapāda of the *Rāmāyaṇa*.² Its ancient name was Mālinī,³ and hence to distinguish it from the towns of the same name it was called Campā-Mālinī. In the *Jātaka* stories it is also called Kāla-Campā,⁴ but it is difficult to trace the origin of this name. Its present name is Champānagara and it is situated at a distance of about four miles to the west of Bhagalpur. It gradually rose into importance, became celebrated as an emporium of commerce on account of its situation on the Ganges, and at the time of Buddha’s death it was considered as one of the six great cities of India, the other five being Rājagṛha, Śrāvastī, Sāketa, Kośāmbī and Benares, so that Ānanda asked him to have his *parinirbbāna* in one of those cities instead of at an insignificant town like Kuśināra.⁵ Pataliputra had only recently come into existence as a fortified frontier town of Magadha to repel the attack of the Vajjians. Campā increased in wealth, and traders sailed from it to Suvarṇabhūmi (Burma) for trading purposes.⁶ Emigrants from Campā to Cochin China named their settlement after this famous town of India.⁷ The celebrity of the capital

¹ Tawney: *Kathā-sarit-sāgara*, ii, ch. 82, p. 272; i, ch. 25, pp. 206, 207; ch. 26, p. 225.

² *Matsya P.*, ch. 48; *Viṣṇu P.*, Pt. iv, ch. 18.

³ *Matsya P.*, ch. 48, v. 97: “चम्पस्य तु पूरौ चम्पा पूर्व वाः मालिनीभवत् ।”

⁴ *Jātaka* (Cam. Ed.), vi: Mahā-Janaka Jātaka (No. 539), p. 20; Vidhura Paṇḍita Jātaka (No. 545), p. 127. Perhaps it was called *kāla* or *black* Campā in contradistinction to Campā of the *snow-clad* Himalaya, the ancient capital of Kumaun, now called Champauti (Campāvati of the *Mahābhārata*).

⁵ *Mahāparinibbāna Sutta*, ch. v: *Mahāśudassan Sutta*, ch. i.

⁶ *Jātaka* (Cam. Ed.), vi, No. 539, p. 20; Rhys Davids: *Bud. Ind.*, 96.

⁷ *Ind. Ant.*, vi, 229; I-tsing, 58.

became so great that its name superseded that of the country. and in the 5th and 7th centuries the Chinese travellers called the country of Aṅga by the name of Campā (Chen-po), and Campā was rightly designated as the capital of Eastern India. Campā continued to be the capital of the new province of Aṅga under the Magadha king after its conquest by Bimbisāra. The governors resided at Campā, Bimbisāra being its first governor.

Mahāvīra, after he became a Kevalin, passed three rainy seasons at Campā and its suburbs, and made many converts to his faith. It became a stronghold of the Jaina religion. Campāpurī is held very sacred by the Jainas as Bāsupujya, their twelfth Tirthaṅkara, lived and died at this place. A beautiful temple at Nāthnagar, which is a Mahallā or quarter of Campānagar, marks the site of his birth and consecration. The temple is said to have been built by a chief of Jaipur¹ named Sungri Śrī Dhāta and his wife Sungviñ Śrī Surjai in the Yudhiṣṭhira era 2559.² Bāsupujya was the son of Basupujya and Jayā, and his symbol is the buffalo. His name is mentioned in an inscription of the 12th century discovered at Ajmir.³ In Campā existed a temple called Caitya Punnabhadda where Mahāvīra resided and where Sudharman, one of the eleven disciples of Mahāvīra, who succeeded him as head of the Jaina hierarchy after his death, recited the *Uvāsagadasāo*, the seventh Aṅga of the Jainas, when he visited the town while it was governed by Kunika or Ajātaśatru.⁴ This temple is mentioned in the Ubbāi Sutta⁵ as Puṇyalabdha Caitya ("Punya-latva Ceyiya"). Bāsupujya's temple belongs to the Digamvara sect. There is another temple at Campā which belongs to the Svetāmvara sect. The Caitya which existed outside of Campā was called Aṅgamandira Ceyiya.⁶

Buddha made frequent excursions to Campā,⁷ and resided on the bank of the Gaggarā lake, which was excavated by Queen Gaggarā. On its bank were groves of Campaka trees (*Michelia Champaka*) under which wandering mendicants

¹ Jaipur is situated in the sub-division of Bānkā in the district of Bhagalpur (Martin's *East. Ind.*, ii, 60). Prabhava, who succeeded Jambu as the head of the Jaina Sect, was the fourth patriarch from Mahāvīra and was the younger son of Vindhya, king of Jaipur (*Jambuvāmi-Charita*).

² Major Francklin: *Site of Ancient Palibothra*, 16, 17, where the inscription is given.

³ *J.A.S.B.*, 1838, p. 5.

⁴ Dr. Hoernle: *Uvāsagadasāo*, chs. 1, 2, where the temple is mentioned as "उष्महे चेर"; *Sthavirāvali*.

⁵ MS. in A.S.B.; see also *Jñātūdharmasūtrapāṭha* (MS. in Cal. Sans. Col. Lib.).

⁶ Rockhill; *Buddha*, 154.

⁷ *Ibid.* 70.

[N.S.]

resided.¹ It is curious that the *Mahābhārat*² also says that Campā was surrounded with Campaka trees. This lake may be identified with the large silted-up lake now called Sarovara situated on the skirt of Campānagar, from the depth of which Buddhist and Jaina statues were recovered when partially re-excavated from time to time.

Campā was also a sacred place to the Hindus. It is described in the *Mahābbārata*³ and the *Padma Purāṇ*⁴ as a *tīrtha* or place of pilgrimage.

Aśoka's mother Subhadrāṅgī was born in Campā. Her father was a poor Brahmin who took her to Pātaliputra and presented her to Bindusāra, called also Amitraghāta, king of Magadha (297-272 B.C.), in consequence of a prognostication that she would be a great queen. The jealous queens, however, employed her in menial works, but she attracted the attention of the king who made her his queen. She became the mother of Aśoka and Vitāśoka.⁵

Dandin in the 6th century A.D. describes it as a wealthy town.⁶ Hiuen Tsiang, who visited Campā in the 7th century, says that it was situated on the southern bank of the Ganges and that it was 40 li or 8 miles in circumference. There were many Buddhist monasteries in a ruinous state belonging to the Hinayāna system with about 200 priests and some 20 Deva temples. The town was surrounded by a brick wall many feet in height, and the "foundations of the wall were raised on a lofty embankment, so that by their high escarpment, they can defy the attack of enemies." The remains of the "embankment" on which the surrounding wall of the town was raised, may still be seen in the scooped-out and worn-off wall-like heaps of earth close to the Nāthnagar Railway station, though the brick superstructure has long since disappeared. The *Mahā-Janaka Jātaka* also says that Campā was surrounded by walls with gates and watch-towers.⁷

Campānagar is traditionally the abode of Cānd Sadāgar, the story of whose son Nakhindhara and his wife Behulā is so graphically described in the poem called *Manasāra-bhāsān*. The place where Nakhindhara was bitten by a snake and the Ghāt where the raft containing his dead body was launched are still pointed out. The Ghāt is still called the Behulā-Ghāt and is situated at the junction of the Ganges and the Cāndan, whence Behulā is said to have carried the raft to different places till her deceased husband was miraculously restored to life. A fair is held here every year in the month of Bhādra in

1 *Sonadaṇḍa Sutta* with Rhys Davids' note; *Mvg.*, ix. 1.

2 xiii, ch. 42, v, 16: "तदा जगाम तूर्बह चम्यां चम्यकमालिनौम् ।"

3 iii, chs. 84, 85.

4 *Svarga kh.*, ch. 19.

5 *Aśoka Avadāna*.

6 *Daśakum.*, ch. 2.

7 *Jātaka* (Cam. Ed.), vi, 20—No. 539.

honour of Behulā. The Ganges flowed by the side of the town, but within the course of the last fifty years it has receded about a mile to the north. Of all the places that claim the honour of being the residence of Cānd Sadāgar, as Campānagarī on the Dāmudā in the district of Burdwan and Cāndnia or Cāndmaya in the district of Bogra, about four miles to the north of Mahāsthānagarh, Campānagarī in the district of Burdwan has the most preferential claim, inasmuch as it is situated near the Dāmudā on which the story and the tradition place the Campānagar of Cānd Sadāgar.

The Ubbāi Sutta, a Jaina work, professes to give a description of the town of Campā at the time of Kūṇie or Ajātaśātru, who is mentioned there as its "king."¹ It was then thickly populated and was in a flourishing condition: it should be borne in mind that it had recently been conquered by Bimbisāra. It was then quite a picturesque town with its *sringātaka* (junction of four roads), *caukka* (squares), *cacchara* (courtyards), *caumuka* (platforms for seats), *ceyiya* (temples), tanks and avenues of trees on the road-sides. Its prosperity did not diminish by the lapse of time: even at the time of the Pāla kings it was in a flourishing condition. From the Campaka-śreṣṭhī-kathā,² another Jaina work, which enumerates the castes and trades of the town, we can glean the nature of the principal professions and industries which were carried on and make some inference as to the condition of the people. There were perfumers, spice-sellers, betel-sellers, sugarcandy-sellers, jewellers, leather-tanners, garland-makers, carpenters, goldsmiths, weavers, etc.

Campā was the birthplace of many celebrated authors who flourished during the Buddhist period and before it. Pālakapya Muni, the author of the *Hastyāyurveda*, a treatise on the disease of elephants, flourished at the time of Romapāda, king of Campā,³ and he has been referred to as "Sūtrakāra" by Kālidāsa⁴; Sonakilviśa, the author of one of the *Theragāthās*, who was a contemporary of Buddha, was a resident of Campā⁵; "Biraja" Jina, the author of the *Lankāvatāra Sūtra*, was also born at this place⁶; Sāyambhava, the

¹ "चम्पाए णयरोए कूणिए णामराया परिवसइ", p. 6 ka.

² See *Catal. of Sans. Manuscripts* by M. M. Haraprasad Sastri, C.I.E., 1892: *Notices of Sans. Manuscripts*, vol. iii. p. 176. by Dr. R. L. Mitra.

³ Nakula's *Aśvacikitsā*, ch. 2.

⁴ *Raghuramśa*, vi, v. 26—Commentary by Mallinātha: *Refutation of Max Müller's Theory* by M. M. Haraprasad Sastri in *J.A.S.B.*, 1910, p. 308.

⁵ *Mvg.*, v, 1—see Dr. Rhys David's Note, p. 1.

⁶ See *Lankāvatāra Sūtra*, ch. 10. It is difficult to say whether the word "Biraja" was a part of his name or simply an adjective meaning "sinless."

[N.S.]

fifth Patriarch of the Jaina Church, who succeeded Prabhava, lived at Campā where he composed for his son Manaka the *Daśavaikālika Sūtra* containing in ten lectures all the essence of the sacred doctrines of Jainism¹ in the 4th century B.C.

The town next in importance to Campā in the country of Āṅga was Mudga-giri or Monghir. It was the Modāgiri of the Mahābhārat,² which was conquered by Bhīma. Mudgalaputra or Maudgalya, a disciple of Buddha, converted Śrutaviṃsatikoṭi, a rich merchant of this place, into Buddhism.³ Hence it was called Maudgalya-giri. Buchanan says that it was the hermitage of "Mudgala Muni who lived long ago."⁴ The tradition still exists that Mudgala Ṛṣi lived on an eminence which is now submerged in the Ganges in front of Kaṣṭaharaṇa Ghāt. In the Monghir copperplate inscription of Deva Pāla it is called Mudgagiri.⁵ The town was visited by Hiuen Tsiang in the 7th century A.D.: he calls it by the name of I-lan-na Po-fa-to, which has been rendered as Hiraṇya Parvata, but according to General Cunningham it is a transcription of Harāṇa Parvata or Kaṣṭa-Harāṇa Parvata as the town, which is situated on a rocky eminence, overlooked the sacred bathing place called Kaṣṭa-Harāṇa Ghāt.⁶ This ghāt is said to have derived its sanctity from Rāmachandra having bathed in it to expiate his sin for having killed Rāvana, who, though a Rākṣasa, was nevertheless a Brahmin, being the son of Ṛṣi Pulastya. This story does not find a place in the Rāmāyaṇa, or the story of Sitā having undergone the ordeal of fire at the place called Sitā Kuṇḍa, a spring of hot water, four miles to the east of Monghir. The priests, however, say that the sanctity of the ghāt is mentioned in the Kurma Purāṇa, though we could not trace it out in any of the published work.

Monghir was no doubt under the sway of the Karṇa kings whose governors had their head-quarters in Campā, at the place called Karnagarh, as the tradition about Karracaurā, the highest peak of the Monghir hill, is associated with Rājā Karṇa.

Bhagalpur is a modern town, but eight miles south of it there is a large village called Bhadariyā which in the 6th century B.C. was called Bhadarikā, where Mahāvira, the last of the Jaina Tirthaṅkaras, spent two *pajjusanas* or rainy season retirement after he attained the Kevaliship.⁷ It must have been a very wealthy and populous town at that period, as it was also visited by Buddha, and in the Buddhist works it is called by

¹ Dr. Buhler: *Sthavīrāvalī or Parisiṣṭaparvan.*

² ii, ch. 29.

³ Martin: *East. Ind.*, ii, 45.

⁶ *Arch. S. Rep.*, xv, 15, 16.

³ Beal: *Records*, ii, 186.

⁶ *Ind. Ant.*, vol. xxi.

⁷ Dr. Jacobi: *Kalpasūtra.*

the names of Bhaddiya and Bhaddiynagara. Buddha resided there for three months in the Jātiyavana when he visited it, and converted Bhaddaji, son of a very rich merchant.¹ The town, though situated in Aṅga,² appertained at that period to the kingdom of Magadha, as Aṅga had already been conquered and annexed to the Magadha dominion. It was also visited by Bimbisāra, king of Magadha. Bhaddiya was the birth-place of the celebrated Bīśākhā, who became the chief of the Upāsikās or lay disciples of Buddha. She was the daughter of Dhanañjaya and granddaughter of Menḍaka, both of whom were treasurers to the king of Aṅga. The people of Bhaddiya were Jainas before, being believers in the Kriyāvāda doctrine, but Bīśākhā and Menḍaka appear to be the first converts to Buddhism in that town.³ Her father removed to Sāketa, where she was married to Pūrṇavarddhana or Puṇyavarddhana, son of Migāra, the treasurer of Prasenajit, king of Śrāvastī. She, like Sumāgadhā, the daughter of Anāthapiṇḍada,⁴ was the means of converting her father-in-law Migāra, who had been a follower of Nigrartha-nātha-putra (Mahāvīra), to Buddhism, and hence she was called Migāramātā or mother of Migāra.⁵ She constructed the Purvārāma-vihāra at Śrāvastī and gave it to Buddha; it is now called the Orā Jhār mound, about a mile to the east of Jetavana.

Rohinnālā, now called Rahuānālā, must have been an important place in ancient time. It

Rehuānālā.

is the Lo-in-ni-lo of Hiuen Tsiang. Buddha is said to have resided here for three months, and a stupa of Aśoka existed at the time when Hiuen Tsiang visited the place in the seventh century. Vivien St. Martin restores Lo-in-ni-lo to Rohinnālā, but General Cunningham was not sure of his own identifications, and considered Rohinnālā of Vivien St. Martin to be quite imaginary.⁶ Nevertheless Rehuānālā, which is evidently a corruption of Rohit nālā or Rohinnālā, exists and is five miles to the north-east of Kiyul and five miles to the north-west of Urain. There are many Buddhist and other ancient remains at Rehuānālā and also at Urain which was formerly called Ujjayinī. That Rehuānālā was an important place may be gathered from the saying still extant among the people that "One Rehuānālā is equal to twelve Bhātis of Bāngālā (Bengal)." It was perhaps situated on the Ganges when it was visited by the Chinese traveller.

¹ *Mvg.*, v, 8; vi, 34; *Mahā-Panāda Jātaka*, in *Jūt.* (Cam. ed.), ii, 229.

² Kern: *M.I.B.*, 29.

³ *Mvg.*, vi, 34, 50, 12, 13; for Kriyāvāda doctrine see *ibid.*, vi, 31, ss. 1, 2, 5.

⁴ *Avadāna-Kalpalatā*, ch. 19.

⁵ *Mvg.*, iii, 13; viii, 15; Spence Hardy: *M.B.*, 226.

⁶ *Arch. S. Rep.*, iii, 152, 156; xv, 14.

Rehuānālā was in the dominion of Indradyumna who is supposed to have been the last king of the Pāla dynasty, defeated by the Mahomedans.¹

At a remote period, Aṅga was considered to be a holy place, and three celebrated Ṛṣis [Rishis] lived in it. The hermitage of Ṛṣi Ṛṣyaśṛṅga was situated at Rishikuṇḍa, twenty-eight miles to the west of Bhagalpur and four miles to the south-west of Bariarpur, one of the stations of the East Indian Railway. It is mentioned in the Rāmāyaṇa that Romapāda, king of Aṅga, in order to avert the calamity of a severe drought which lasted for several years, wheedled away this young ascetic of miraculous birth from the hermitage of his father Ṛṣi Bibhāṇḍaka and caused him to perform a sacrifice which brought down rain to the country. The success which attended the sacrifice induced Romapāda to send Ṛṣyaśṛṅga to Ayodhyā at the request of his ally Daśaratha to perform an Aśvamedha sacrifice in order to enable him to get a son. This also was crowned with success. The hermitage of the Ṛṣi was situated in a circular valley formed by the Maira hill which is a spur of the Kharakpur range: it is evidently the Maruk hill of Captain Thuillier.² The valley is open only on the northern side. It contains a series of seven springs issuing from the foot of the western hill, five being of hot water and two of cold, at the extremities. The combined water of these springs is collected in a tank or pool called Rishikuṇḍa, the superfluous water flowing out through the northern side in a small stream called Abhinadī falls into the Ganges at a distance of five miles; but it is evident from the existence of a dry bed that the Ganges formerly flowed very close to the north of the valley. A small space enclosed with broken stones on the south bank of the reservoir is pointed out as the place where the Ṛṣi and his father Bibhāṇḍaka used to sit in meditation. To the south of these are some temples containing the phallic images of Śiva. A fair is held here every third year in honour of the Ṛṣis. There are, however, other places in the district of Bhagalpur, as the Singirik hill, about 8 miles to the south of Kajra, Singhesvar in the subdivision of Madhipurā and Singhol hill, about 7 miles to the south of Rehuānālā, which also claim to be the hermitage of the Ṛṣi. But the position of the Rishikuṇḍa to the Ganges, which afforded facility to the women sent by Romapāda to entice away in their boat the young hermit from his seclusion, and the statement in the Mahābhārat that the hermitāge was situated not far from the river Kusi (ancient Kauśikī)³ which has now receded some miles to the

¹ Martm: *East. Ind.*, ii, 26.

² *J.A.S.B.*, 1852, p. 204.

³ iii, ch. 110, vs. 21, 22.

east,¹ and that its distance was three *yojanas* or twenty-four miles² from Campā where the houses of the women were situated, make it highly probable that R̥ṣyaśṛṅga's hermitage was at this spot rather than in any other.

Just in front of Sultanganj, which is about 15 miles to the west of Bhagalpur, the rocky hill of Jahṇu-āśrama. Jāhngira stands out boldly from the middle of the Ganges which here takes a northerly course. It is said to have been the hermitage of Jahṇu Muni. According to General Cunningham Jāhngira is Jahṇu's *gr̥ha* or house,³ and according to Dr. Rajendralala Mitra it is Jahṇu's *giri* or hill.⁴ Whether Jahṇu's *gr̥ha* or Jahṇu's *giri*, the name has now been corrupted to Jāhngira which, however, has no connection with the Emperor Jahangir as is supposed by some. It consists of heaps of irregular masses of granite forming ledges and terraces, and surrounded at the base with blocks rounded by the action of the water and weather. The whole face of the cliff is covered with the the images of Nṛsinha, Surya, Gaṅgā and other deities of the Hindu pantheon cut in high relief. On the top, it is surmounted by a temple of Mahādeva called Gaibināth. Jahṇu's place of meditation is pointed out in a cave cut in the rock which is reached by a flight of stairs leading to the temple of Gaibināth. The river Gaṅgā (Ganges) on her way to the ocean to relieve the sons of Sagara, was drained off in a draught by Jahṇu Muni who was disturbed in his worship and meditation by the rush of the water, but owing to the intercession of Bhagīratha who was leading the way, he relented and let her out from his ear,⁵ or according to some account, from his thigh: hence the Ganges is called Jāhṇavī or the daughter of Jahṇu. Evidently in times past, this hill was connected with a rocky bluff in front of it on the bank of the river called Baiskaran, also carved with sculptures and crowned with a mosque of the Pathan style. The inscriptions on the Jāhngira rock are in Gupta character, and therefore it appears that the whole place belonged to the Hindus and not to the Buddhists, and there can be no doubt that the sculptures were executed in the 3rd century A.D. under the early Gupta Emperors, as supposed by General Cunningham,⁶ though Sultanganj itself contains many sculptures and remains of a monastery which belonged to the Buddhists.⁷ But I should here observe that the hermitage of Jahṇu Muni is also pointed out at Bhairavaghāṭi below Gangotri in Garhwal at the junction of the Bhāgirathī and the Jāhṇavī, and also at Gour, Sib-

¹ For the movement of the river Kusi see *J.A.S.B.*, 1908, p. 465; also vol. xlv, p. 1.

² *Mbh.*, iii, ch. 111, v, 11.

⁴ *J.A.S.B.*, xxxiii (1864) 360.

⁶ *Arch. S. Rep.*, xv, 24.

³ *Arch. S. Rep.*, xv, 24.

⁵ *Rām.*, i, 43.

⁷ *J.A.S.B.*, xxxiii (1864), 361.

ganj and Jahanagar near Nadia, where the Ganges is likewise said to have been drunk up by the R̥ṣi.¹ Jahnu is an allegorical representation of a change in the course of the Ganges.

The hermitage of R̥ṣi Durvāsā is pointed out on the highest peak of a hill called Khalli-pāhār or Khadi-pāhār, a limestone rock which Durvāsā-āśrama. is now worked for chalk. A temple of Mahādeva occupies the site of the hermitage. The hill is situated on the bank of the Ganges, 23 miles to the east of Bhagalpur and two miles to the north of Kahalgāon (Colgong) or Kalahagrāma, a sobriquet which the place has received on account of the irascible temper of the R̥ṣi. The hermitage of Durvāsā, however, is also shown at Dubāur in the sub-division of Nowadah in the district of Gaya.²

There are two famous shrines in the country of Aṅga : one is the temple of Baidyanātha at Deogarh, and the other the temple of Baidyanāth. Madhusūdana on the Mandāra hill. The former contains a *Jyotirlinga* of Mahādeva, and the other an image of Viṣṇu. The phallic image of Baidyanātha is said to have been established by Rāvana, king of Laṅkā, at a place which was variously called by the names of Citābhumi, Briṣa-Khaṇḍa,³ Jhāda-Khaṇḍa,⁴ Pāraligrāma corrupted into Palu-gāon, and Pampāpurī.⁵ It is described as a place of pilgrimage in the Padma Purāṇ.⁶ The sanctity of Baidyanātha as containing one of the twelve great Liṅgas of Mahādeva is very great, but its sanctity is further enhanced by the fact that it is also one of the fifty-two Piṭhas. Satī's heart is said to have fallen at this place and therefore it is called Hārda Piṭha. The temple of Pārvatī faces that of Baidyanātha, and the pinnacles of the two temples are connected by a piece of cloth stretched from one to the other to indicate their union.⁷ According to a local tradition recorded by Dr. Buchanan, the temples are said to have been built by a Rājā of Chola.⁸

The Mandāra hill is situated in the Bānkā sub-division, two or three miles to the west of Ban- Mandāra Hill. śi and thirty miles to the south of Bhagalpur. It is an isolated hill about seven hundred feet high with a groove all round the middle, the chisel marks of which are still visible, to indicate the impression of the coil of the serpent Bāsuki which served as a rope for churning the

¹ Fraser: *Himala Mountains*, 476.

² Grierson's *Notes on the District of Gaya*.

³ *Siva P.*, Pt. i, chs. 38, 55. + *Mahā-Liṅgeśvara Tantra*.

⁴ *Uttara P.*, quoted by Francklin in his *Ancient Palibothra*, p. 21.

⁵ *Uttara-Khaṇḍa*, ch. 59.

⁷ For description of the temples of Baidyanāth see Dr. R. Mitra's

“ *On the Temples of Deoghar* ” in *J.A.S.B.*, 1883, p. 164.

⁸ Martin: *East. Ind.*, ii, 23.

ocean with the hill as the churn-staff, the gods holding at the tail and the Asuras at the mouth of the serpent, the hill itself resting on the back of the tortoise, a form which Viṣṇu had assumed. The hill is sacred to Madhusūdana. There are two Jaina temples on the highest peak of the hill. On a lower bluff on the western side of the peak was the original temple of Viṣṇu called Madhusūdana now in ruins; but the idol is now kept at Baṅśi, the Bāliśa of the *Mandāra-māhātmya*, whence it is brought every year to a temple at the foot of the hill on the last day of Pous. On the western side of this is a dark low rave containing an image of Nṛsiṃha carved in the rock, and near it are situated a colossal image Vāmana Deva, a huge but rude sculpture of Madhu Daitya,¹ and a cave containing some limpid spring-water called Ākāśa-Gaṅgā. At the foot of the hill and on its eastern side are extensive ruins of temples and other buildings, and among them is an old building called Nāth-thān which was constructed in A.D. 1589. Flights of stairs carved out of the rocks lead almost to the top of the hill, which at various parts contains ruins of buildings. These ruins are said to belong to the time of the Chola Rajas, especially of Rājā Chhatar Singh.² At the foot of the hill, there is a tank called Pāpahāriṇī which is considered to be very sacred. As stated before, it was excavated by Koṇadevī, the queen of Āditya Sena who became independent sovereign of Magadha in the 7th century A.D. The Hindus consider it to be an act of great merit to see Madhusūdana on the Mandāra hill³ like Vāmana on the car, and therefore its sanctity has been extolled in many Purāṇas.⁴ The Mahābhārata,⁵ however, does not recognize any other Mandāra Parvata except the Mandāra of the Himalaya range. The Varāha Purāṇ⁶ and the Mandāra-māhātmya, which is a portion of the Skanda Purāṇ, mention that Mandāra is situated on the south of the Ganges and in the Vindhya range.

The Pāla Kings were Buddhists. Their powerful and judicious administration put an end to all dissensions and the state of anarchy which prevailed before their time, and their strong arms repelled the invasions to which Eastern India was frequently subjected. They restored peace and encouraged learning. Literature and the arts flourished, and the Buddhist religion took a definite shape and developed into Tāntric mysticism. Their kingdom comprised the ancient countries of Magadha, Aṅga and Gauḍa. There existed three universities in these

¹ For a description of the figure see *J.A.S.B.*, xx, 272.

² Martin: *East. Ind.*, ii.

³ "मन्दारे मधुसूदन" (*Garuḍa Purāṇ*, ch. 81).

⁴ *Varāha P.*, 143; *Nṛsiṃha P.*, 65; *Skanda P.*, *Yoginī T.*, pt. ii, 4.

⁵ xiii, ch. 19; iii, 162.

⁶ Bk. iii.

countries when they were governed by the Pāla kings: namely, the universities of Nālandā, Bikramaśilā, and Jagaddala respectively. They encouraged the Nālandā university situated near Rājgir, the ancient capital of Magadha, which had been founded long before Gopāla ascended the throne. Dharmapāla, according to the Tibetan historian Tārānāth, founded the celebrated university at Bikramaśilā in Aṅga, and a third university existed at Jagaddala in Varendra, one of the provinces of Gauda. Bikramaśilā has been identified with Pātharghātā,¹ which is 24 miles to the east of Bhagalpur and 6 miles to the north of Kahalgāon. The vast remains of the monastery, which contained the university, still exist. Instructions were given there in religious literature, arts and sciences, including medicine, grammar and logic, and also in the Mādhyamika and Yogāchārya doctrines² of the Mahāyāna system, and other doctrines of philosophy. The Tripitaka was taught and the doctrines of the Sarvāstivāda school were principally followed. As the Bikramaśilā university was a later institution, it must have followed in its instructions the course adopted by the Nālandā university, an account of which we get from I-tsing's work.³ The Bikramaśilā university became a renowned centre of the Tāntric doctrines, whence they spread over all parts of India, especially to Tibet. Its superintendents were all Mantra-Vajrāchāryas.⁴ The sculptures which adorned the place were perhaps the works of the celebrated Dhīmāna and Bitapala who flourished during the reigns of Dharmapāla and his successor Devapāla. Dr. Tytler rightly suspected from the similarity of construction of the "Chambers," that is, the rock-cut caves at Pātharghātā with those at Brambanan in Java dedicated to Buddha, that similarity of worship obtained in the two places.⁵

¹ See my article on *The Vikramśilā Monastery* in *J.A.S.B.*, 1909, p. 1.

² The Mādhyamika and the Yogāchārya schools were idealistic; the Mādhyamika is a Buddhistic form of the Vedānta philosophy and the Yogāchārya agrees with the Yoga system. The Yogāchārya school was founded by Āryasaṅga or Asaṅga who lived in the latter part of the 4th century A.D. (Monier-Williams: *Buddhism*, 157; Bhandarkar's *Peep*: xx, *J.B.B.R.A.S.*, 406).

³ Takakusu: *Rec. Bud. Rel.*, chs. 33, 34; Intro. xxiii, xxiv.

⁴ Prof. Kern: *M.I.B.*, 133.

⁵ Francklin: *Tenets and Doctrines of the Jainas and Buddhists*.

CHAPTER III.

MISCELLANEOUS.

We have stated that at the time of the Atharva Veda the people who lived in the country of Aṅga were known by the name of Aṅgas. Early inhabitants. The contemptuous manner in which they have been spoken indicates that they were an aboriginal tribe and did not belong to the Aryan race. Though we are not aware by what name their descendants were called, yet from the tradition of the Santals¹ we know that they were the aborigines of Campā or rather of the country of Aṅga, as the Cherus were the aboriginal inhabitants of the neighbouring country of Magadha. It appears that Rṣi Dīrghatamā was the first to colonize Aṅga and the neighbouring countries with Aryans and introduce Aryan civilization into them.² The name of Campā is associated with Campā trees (*Michelia Champaka*) which evidently grew wild in this country. Even in the 4th century B.C., the country in many parts abounded with forests, and the elephants of Aṅga were the most famous. Cāṇakya, who set up Candragupta on the throne of Magadha, says that the elephants of Aṅga, Kāliṅga, Karuśa and the eastern countries were the best in India.³ There can be no doubt that with the increase of population forests were cleared and converted into culturable lands. The Ganges, the Cāndan and the Campā, the three principal rivers of the country, favoured cultivation with copious supply of water and rendered the lands highly productive. The Cāndan, which is also called the Andhelā⁴ from one of its two principal branches, is the Andomatis of Arrian, which he describes as a tributary of the Ganges. It falls into the Ganges near Campā. The Campā river is mentioned in the Champeyya-Jātaḥa as forming the boundary between Aṅga and Magadha.⁵

Aṅga was always famous as a rice-producing country.⁶ A sort of rice was grown in this country which for its fragrance was secured for the table of Bimbisāra, king of Magadha, and for Buddha himself. According to the Buddhist legend, the rice was

¹ Mr. C. H. Bompas : *Folklore of the Santāl Parganas*, 406, 447, but Mr. Bradley-Birt places this Campā to the north-west corner of Hazari-bagh (*Story of an Indian Upland*).

² *Viṣṇu P.*, pt. iv, ch. 18; Max Müller's *Hist. of Ancient Sanskrit Literature*, p. 57.

³ Kautilya's *Arthasāstra*, ii, ch. 2 :—

कलिङ्गाङ्ग मजाः त्रेष्ठाः प्राचास्येति करमजाः ।

दशार्णश्चापरन्नास्य द्विपानां मध्यममताः ॥

⁴ Martin : *East. Ind.*, ii, 12; McCrindle : *Ptolemy*, 98 and *Arrian*.

⁵ *Jātaka*, iv, no. 506 (Cam. Ed.).

⁶ *Rām.*, ii, 10.

grown in Campā by Sona,¹ a rich nobleman of that place, who from the description appears to be no other than Sona Kolivisa, the reputed author of one of the Theragāthās,² whereas Hiuen Tsiang says that the rice was grown by Śrutavimsatikoti, a rich householder of Hiraṇya-parvata or Monghir.³ The story related by Hiuen Tsiang is almost the same as related in the Avadāna-Kalpalatā, the only difference being in the name which is mentioned as Śronakotivimśa in the latter work instead of Śrutavimśakoti, and also in the locality in which he lived, which is mentioned there as Campā instead of Monghir, and it should be observed that Sona is the Pāli form of Śrona as the nobleman was called.⁴ Bimbisāra is said to have visited Sona at Campā, and Mudgaliputra or Maudgalyāyana, the celebrated disciple of Buddha, himself came to Aṅga to procure the rice for the sage when the latter was ill.

From the Buddhist works we get a glimpse of the religious practices followed by the people of Aṅga at and before the time of Buddha's attaining Buddhahood. The stories of the Jaṭila Uravela Kassapa and the Brahmin Kuṭadanta clearly prove that the people performed the Vedic rites and sacrifices and followed the four Āśrama systems as laid down in the Gṛihya-sūtras. We find that those who adopted the Bānaprastha system, that is, the Jaṭilas or Ṛsis with matted hair on the head, kept up the sacred fire in the fire-room, performed the Aṣṭaka festivals as laid down in the Gṛhya sūtras, celebrated the Agnihotra sacrifice and recited the mantras at sacrifices.⁵ Rich householders also performed the Vedic sacrifices.⁶ The people of Aṅga also followed the religious practices that prevailed at the time, and it is related that they went with the people of Magadha with customary offerings to help the Jaṭila Uravela Kassapa in performing a Vedic sacrifice; and it is mentioned in the Ubbāi Sutta that Bānaprastha ascetics lived on the banks of the Ganges at Campā.⁷ In most part of Aṅga, Brahminism gave way to Jainism by the powerful influence of Mahāvīra himself who was related to the royal house of Magadha, Bimbisāra and Ajātaśatru being his early disciples; and the hold that he obtained upon the people was kept alive by the revival of the memory and worship of Bāsupujya, the twelfth Tirthankara, at Campā, the capital, where he lived and died. But the superior genius of Buddha, who personally visited Aṅga and made frequent excursions to Campā,⁸ served to a great extent to establish his system and

¹ Hardy: *M.B.*, 254.

³ Beal: *Records*, ii, x.

⁵ *Mvg.*, i, 15, 20, 22.

² *Mvg.*, v, 1.

⁴ Ch. 27, vs. 3, 6; Rockhill, 72.

⁶ *Kuṭadanta Sutta*.

⁷ “ इमे महाकुलका वानपत्वा तावसा भवन्ति : ”

⁸ *Mvg.*, vi, 34: Rockhill, 70.

contributed much to the decline of Jainism in that country. Buddhism gave a turn to the thoughts and ideas that prevailed at the time, shaped the character of the nation, and sent Hindu civilization running through a new channel. A new era dawned, which lasted for five hundred years or so, as predicted by Buddha himself; and then it was replaced by new thoughts, new rites and new philosophy,—an admixture of the past and the present. The improvement which Nāgārjuna introduced into original Buddhism in the 1st century A.D., and which was known by the name of Mahāyāna system, assumed a new phase on the revival of Brahminical doctrines during the early Gupta period, and gradually developed into Tāntrism from the 8th century when the Pāla kings began to rule over Magadha and Gauḍa. The worship of the images of Buddhas and Bodhisvattas with their female energies (*śaktīs*) and other Buddhist gods came into vogue, which during the continuance of the rule of those monarchs still further developed into mysticism and sorcery. The Mantra-yogācāryas maintained the popular propensity for magic rites and mystic practices by the performance of marvellous feats. Hinduism also imbibed the spirit of the time, and the Buddhist Tāntric rites were absorbed in its system. The tide of Buddhism, however, was checked when Śāṅkarācārya visited the country of Aṅga.¹ But it appears that Kṛṣṇa cultus was introduced in Aṅga by Satyajit, son of Amṛtajit, who was an unbeliever before, but whose faith and devotion to Kṛṣṇa grew up by listening to the Janmāṣṭamī story.² In the Mahābhārata,³ the people of Aṅga have been described as *Sujāti* or of good birth, but in later times we find one of the Samhitās interdicting journey to Aṅga, Baṅga, Kaliṅga, Saurāṣṭra and Magadha without doing penance except for the purpose of pilgrimage.⁴ Baudhāyana also is to the same effect: he describes the people of Aṅga, Baṅga, Kaliṅga, Saurāṣṭra and Magadha as of mixed origin, and prescribes the penance of Punastoma or Sarvapṛsthā for those who visit these countries.⁵ There cannot be the slightest doubt that the prohibition to visit the countries named above was due to the people having abandoned the Vedic rites and adopted the Jaina and Buddhist doctrines, and we are confirmed by the fact that according to Manu the Brāhmins and Kṣatriyas

¹ *Śāṅkaravijaya*, ch. xv, v. 161.

² *Ind. Ant.*, vi, 176—*On the Krishnajanmāṣṭamī* by Prof. A. Weber.

³ ii, 52.

⁴ अङ्गवङ्गकलिङ्गेषु सौराष्ट्रमगधेषु च ।

तौर्ययात्रां विनागच्छन् पुनः संस्कारमर्हति ॥

⁵ *Pras.* i, ch. i, Khanda 1, 2, vs. 13, 14 (*S.B.E.*, xiv).

of Pundra, Odra, etc., who gave up the Brahminical rites and doctrines became Sūdras and were called Dasyus.¹

The Aṅgas had the peculiar custom of abandoning their dead and selling their wives and children, as mentioned in the Mahābhārata.² This was evidently a survival of the old primitive practices, which confirms the idea that they were originally the aborigines of the country, as it appears from the Atharvasaṁhitā which speaks of them in contemptuous terms, but were subsequently absorbed into the Aryan stock. Hence the Aṅgas are said to be of mixed origin by Baudhāyana. Notwithstanding the frequent predatory inroads to which Aṅga was subjected, it appears that it was a very flourishing country up to the 11th century, and its capital Champā all along maintained its importance and dignity as one of the principal towns of Eastern India. Prosperity brought luxury in its train with the concomitant vices, and accordingly we find Campā described in the 6th century A.D. as a resort of gamblers, swindlers, rogues, roughs and footpads.³

¹ *Manusamhitā*, x. 43-45.

² viii, ch. 46.

³ *Daśakumar.*, ch. 2.

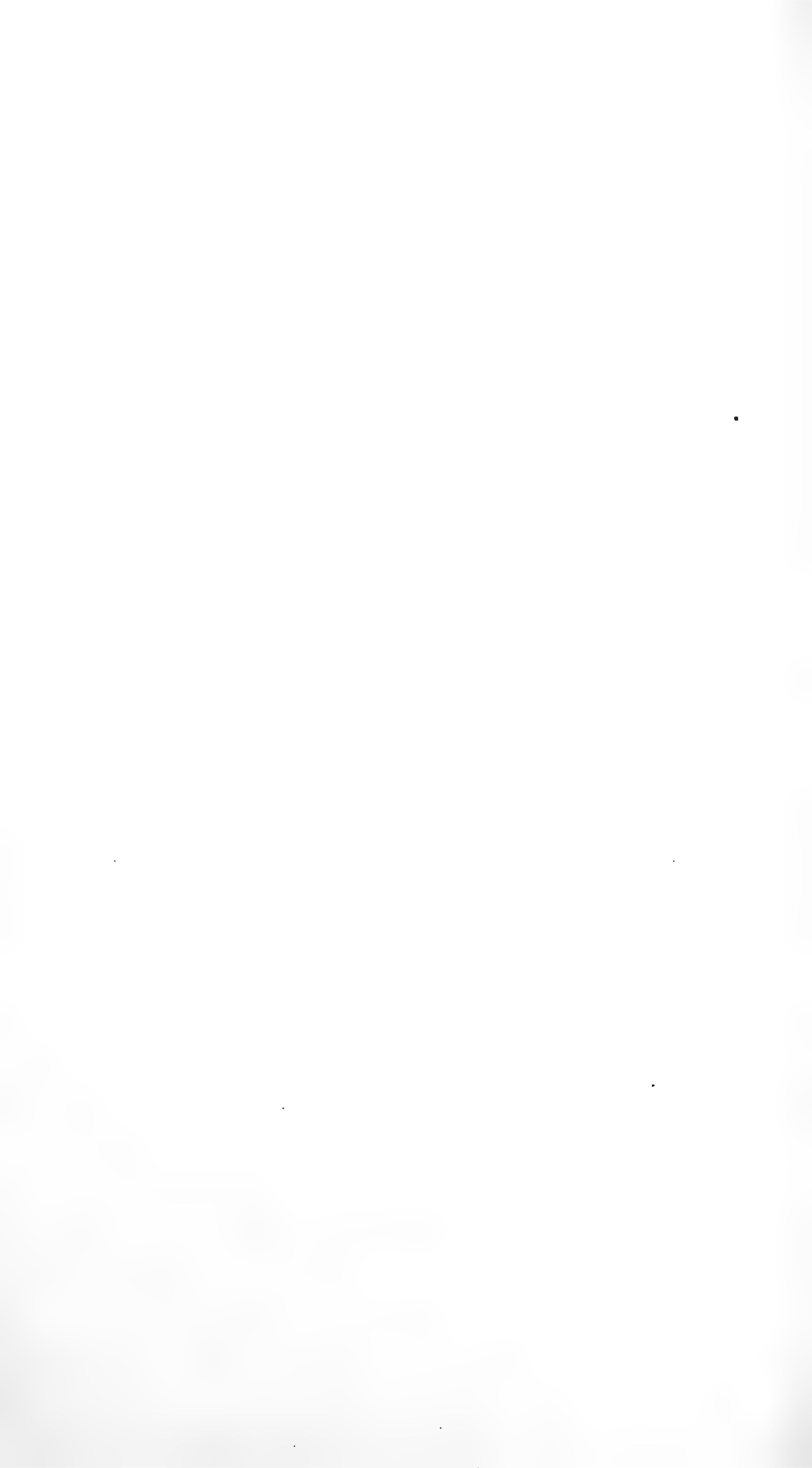

37. Magic and Witchcraft on the Chota Nagpur Plateau.

By SARAT CHANDRA ROY, M.A., B.L.

[Presented at the First Indian Science Congress, January 17, 1914.]

Although among the Chōtā Nāgpur aborigines, I have not yet come across any term equivalent to the *mana* of the Melanesians or the *orenda* of the Iroquoian tribes, the idea of a mysterious impersonal force connoted by such terms is fully recognized by the Mūndās and the Orāons. It is this mysterious energy or *mana* that, for the Orāon and the Mūndā, gives the leaves of the mango-tree or the twig of the *pial* (*buchania latifolia*) its fertilizing influence, which gives the *bhelōā* (*semicarpus anacardium*) twig its power of averting the 'evil eye,' which gives the small perforated *rāti-jārā* stone its power of curing fever by its contact, which gives the vegetable love-charm or hate-charm, sometimes used by the Orāon youth, its magic potency, which gives the *Dhōrā* snake its supposed magnetic power of harming people who may happen merely to look at it, and which gives the *Chāndi* stone, sometimes carried as a fetish by an Orāon hunting-party, its power of bringing luck in the chase.

The means adopted by the Chōtā Nāgpur aboriginal, as by other peoples of the lower culture, for securing alliance with the *helpful impersonal powers*, has been Sympathetic Magic—through contact, direct or indirect, and through imitative suggestion. The means adopted by him to avoid the *harmful impersonal powers* has been either to keep at a distance from them, or to divert their attention to other objects, or to control or repel them through the help of some beneficent power or through the superior force of man's own *mana*. These are the *modus operandi* of Magic. And thus Religion and Magic are the two methods adopted by the man of the lower culture in his dealings with the supernormal and the mysterious. As to whether the one preceded the other or was evolved out of the other, or whether both were independently evolved, authorities are divided in opinion. Among the aborigines of Chotā Nāgpūr, however, we find the two methods often combined in practice.

I shall now proceed to give a few illustrations of the different kinds of magic *proper* as practised by the Mūndās and the Orāons of Chōtā Nāgpūr.

I. BENEFICENT MAGIC AND THE PRINCIPLE OF SYMPATHETIC ALLIANCE.

(a) *Beneficent Contagious Magic.*

As typical instances of contagious magic in Chōtā Nāgpur, I may mention the practice, though not very general now, of an Orāon hunter eating the eye of a hare to get the hare's keen vision, and that of an Orāon singer eating the liver of a fox to acquire musical voice. The use of amulets of various kinds further exemplifies the same principle. Thus, the charred remains of fuel with which a corpse has been burnt are worn on the neck by the Orāons as a remedy for fever; and a shred torn out of the cloth which a man had on while being eaten by a tiger, is tied to the tail of an ox, cow, or buffalo, as a cure for cattle-disease. The strong hand of death and the powerful jaws of the tiger have in these cases imparted their mysterious energy to the charcoal and to the rag respectively. On a similar principle, rings and bracelets made of iron which had been laid out in the open during an eclipse of the sun, are worn by the Mūndās and the Orāons to avert lightning-strokes. Among other instances of beneficent contagious magic I may refer to the various customs relating to purificatory baths, expiatory drinking of sacrificial blood, and fire-lustration, or rather purification by fumigation, in vogue amongst the Orāons and the Mūndās.

Water, fire, and sacrificial blood are beneficent powers, and contact with them is believed to counteract the evil influences of harmful powers.

(b) *Beneficent Imitative Magic.*

Of beneficent imitative magic, the rain-making ceremony of Orāon women is an interesting illustration. In a season of drought, on a day appointed beforehand, the women of an Orāon village, after ablutions, proceed in a body to a certain sacred *pipar* tree (*Ficus religiosa*) in their village, each woman carrying a pitcherful of water from the *sarnā dāri* or sacred spring of the village. Arrived at the tree, they all simultaneously pour the water of their pitchers over the foot of the tree. It is believed that after this ceremony has been duly performed, the needed showers of rain are not long in coming.

As another instance of mimetic magic I may mention the custom which requires the women of every Orāon family to put a live crab into their burning hearth, on the occasion of the spring festival known as the *sarhūl*. As the crab crackles in the fire, the women exclaim, "May our *urid* (*Phaseolus Roxburghii*) lentils burst their pods like this."

II. EVIL MAGIC AND THE PRINCIPLE OF AVOIDANCE.

From a fear of the mischievous effects of contact with vague and indefinite evil powers arose the various *tabus* imposed by primitive communities on their members. The idea of pollution through eating food or drinking water touched by a man of another tribe or caste is not a monopoly of any one race or tribe, but is widely prevalent among peoples of the lower culture. Although the idea has been greatly improved upon by the Hindu with his higher culture, it is among such peoples of the lower culture as the Mūndās and the Orāons that the original motive behind the practice may be seen in its naked simplicity. In fact, these tribes have carried the idea to its utmost logical limits. Thus, the Orāon or the Mūndā not only deems it a pollution to take cooked food at the hands of a non-Orāon or a non-Mūnda, but he even believes that should he chance to walk across a plate or a cup from which an alien has taken food, he is sure to get pain in his gullet. The evil power residing in an alien is, in such a case, believed to have imparted part of its energy into the plate or the cup through contact, and this imparted energy is further transferred, on the principle of sympathetic magic, to the gullet of the unfortunate person who may have chanced to walk across it.

The idea of tabu, however, is not always the avoidance of evil powers; in some cases, it is the fear of harm through unskilful or untimely handling of the mysterious and the sacred. This is illustrated by an interesting custom in vogue amongst the aborigines of Chōtā Nāgpūr. An Orāon of a village in which the annual *sarhūl* ceremony has not yet been celebrated always avoids entering the houses—and, if possible, the limits—of a village where the *sarhūl* has been already celebrated. Even if unavoidable necessity takes him to such a village, he will on no account eat, or drink, or even smoke, or chew tobacco with a person of that village, nor sit on the same mat with him, nor touch the springs or wells of that village. But an Orāon in whose village the *sarhūl* has been celebrated may take food or water at the hands of people in whose villages the festival has not yet been celebrated. The celebration of this festival is believed to arouse all the deities into activity, and this is why Orāons who have not yet renewed their alliance with the gods by celebrating the *sarhūl* in their villages, are afraid of approaching a village where the ‘gods are up’—‘*deo ūthlak*’—as they put it.

Maleficent contagious magic is further illustrated by various practices of the witch and the sorcerer of Chōtā Nāgpūr. Superior spiritual energy or *mānā*, partly natural and partly acquired through occult practices, the help of a familiar spirit, and the mysterious force of the *mantram* or magic spell,—these account for the occult powers of the witch and the sorcerer.

It is believed to be a common practice with the witch or the sorcerer to injure a person in health by secretly mixing with his food a bit of a bone or a nail-paring over which some magic spell has been pronounced. This bit of bone or nail is believed to grow in bulk inside the stomach of the man who swallows it unawares, and finally to kill him unless he secures the timely aid of some other magician.

Again, the soul of the Chotā Nāgpūr witch is believed to be able to quit the body and walk about at night in the shape either of a black cat or of a pigmy, no bigger than the size of a man's thumb. Such a cat enters the houses of people and licks up the saliva trickling down the corners of the mouths of sleeping persons, or bites off their hair, with the result that they fall dangerously ill. While walking about in the guise of a pigmy, the Chōtā Nāgpūr witch is believed to carry a diminutive *bāng̃hi* pole made of the twig of a castor-plant. To each end of this *bāng̃hi*-pole is attached a proportionately small carrying-net or *sīkā* made of human hair. With this magical *sīkā-bāhīngā*, the pigmy enters people's granaries and carries off their grain. Although the grain thus taken away be no more than a mere handful, the magic touch of the witch soon exhausts the granary in question; and, through sympathetic magic, even the fields of the owner of the granary cease to yield their wonted produce.

Although the Chōtā Nāgpūr magician or *māti* has always his *sādhak-bhūt* or familiar with whom he has entered into a secret compact to enable him to effect his mischievous designs, yet, when in a case of spirit-possession he has to exorcise an evil spirit, he must invoke the help of all the good and beneficent gods—indigenous and foreign—that he can think of: Even *Kalikātā Kālimāi* (the famous goddess of Kālighāt)—and Meccā-Medinā (the holy places of the Muhammadans)—are not overlooked. When the evil spirit has been exorcised by magic spells and magnetic 'passes', two mechanical contrivances, known respectively as the *tikli* and the *singhi*, are employed to confine the exorcised spirit and transfer it to some other person. The *tikli* is a very small thin circular bit of metal about one-third the size and thickness of a two-anna bit, and the *singhi* is a small tapering iron tube. Just when an evil spirit is expelled, the spirit is compelled by the *māti* to enter either the *tikli* or the *singhi*, or both. Subsequently the *māti* goes to some market or fair with the *tikli* concealed in his clothes, and secretly manages to throw it on the garments of some unmarried girl who thereupon becomes obsessed with the evil spirit. Sometimes the *tikli* is affixed to a copper-coin which is then left on a public thoroughfare in the belief that whoever takes up the pice will be 'possessed' by the spirit. Sometimes, again, the *tikli* is attached to the wings of a pigeon or other bird in the belief that the evil spirit will

go to the house where the bird first goes or is taken to. As for the *singhi*, after an evil spirit has been confined in it, the *singhi* is secretly carried at night and buried in the compound, or stuck into the mud-wall of the house of an enemy, so that the evil spirit may thenceforth trouble such enemy by bringing disease to himself or his people. This sort of 'trafficking with the devil' is, however, held in as much abhorrence and detestation by savage and barbarian societies as by the civilized man. And the Mūdās and the Orāons of Chōtā Nāgpūr believe that a witch and a black magician, though they may prosper in the world for a while, are sure to end their lives in misery as a divine punishment for their nefarious practices.

The principle of Avoidance by diverting the attention of an evil power is illustrated by the use of certain amulets such as cowrie-shells worn on the neck or waist of a child. The Chōtā Nāgpūr aboriginal believes that such striking objects divert the 'evil eye' of the sorcerer or the malice of an evil spirit from the child to the amulet. Avoidance of evil powers through mimetic repulsion may be illustrated by various practices in vogue on the Chōtā Nāgpūr plateau. A typical instance is the ceremony of driving cattle-diseases. By previous appointment, the young bachelors of the village and the village-cowherd assemble at the village dancing-ground or *ākhrā* at dead of night. A *tharki* or wooden cow-bell is tied to the neck of the cowherd. Thus arrayed, the cowherd has to run towards the boundary of an adjoining village, and the young bachelors, with all their clothes stripped off and with wooden clubs in their hands make a show of chasing the cowherd. The latter on reaching the boundary of the adjoining village drops down the cowbell, which is apparently meant to represent the disease-spirit, and beats a hasty retreat. His pursuers, too, go up to the spot where the cowbell has been dropped, leave their own clubs on the same spot, apparently as a threat to the disease-spirit, and return home in the conviction that their village is now rid of the spirit.

In such a case, it is not the fear of physical force but the pressure of the cumulative spiritual force or *mānā* of the batch of naked bachelors that compels the disease-spirit to take flight.

Such are a few illustrations of the principles and practice of Magic and Witchcraft on the Chōtā Nāgpūr Plateau. It is evident that it is the intellect and not so much the heart of the man of the lower culture that is at fault. He too is in quest of the good,—the good as he vaguely and sometimes erroneously understands it. And thus amongst these younger brethren of humanity, as amongst their elder brethren of the higher culture, we meet with the same ceaseless striving after what they consider to be the good,—the arduous striving which commenced when Time began and will continue till Time shall be no more.

A REPORT ON THE BIOLOGY OF THE LAKE OF TIBERIAS.

FOURTH SERIES.

List of subjects dealt with in Fourth Series.

	<i>Page</i>
Hydrophilidae	357
Amphipoda and Isopoda	361
Chironomidae	369

The first series of papers in this Report was published in Vol. IX, No. 1 of this Journal, pp. 17-88; the second series in the same volume, No. 6, pp. 211-258; the third series in the same volume, No. 11, pp. 459-480. All these Nos. were issued in 1913.

38. Hydrophilidae from the Lake of Tiberias.

By A. D'ORCHYMONT.

(Communicated by DR. N. ANNANDALE.)

The insects captured by Dr. Annandale at the Lake of Tiberias in October 1912, comprise a few Hydrophilidae, represented only by two genera and six species, sixteen specimens belonging to the tribe *Hydrobiini* in all. Little is known of the geographical distribution of the Palpicornia in Syria, and most of the papers published on the subject are fragmentary. It seems therefore advantageous, although the material now under examination is very scanty, to publish the following notes as a further contribution in addition to the lists of Syrian Hydrophilidae given by Régimbart and Sahlberg (*Revue biol. Nord France* V, 1893, p. 364 and *Ofvers Finsk Vet. Soc. Forh.* XLV, 1902-1903, n°18, p. 8).

Enochrus (subg. *Methydrus*)? *nitidulus*, Kuw.

Syn. *Philhydrus* (subg. *Agraphilydrus*) *nitidulus* Kuw.

D. E. Zeitschr. 1888, 280, 290; *Verh. Naturf. Ver Brunn.* xxviii, 1890, 59.

Two ♂♂ seem to belong to this very little species. They were captured at the edge of Lake Tiberias and on that of a small spring on the shore three miles north of the town of Tiberias. The example from the latter locality is less punctured on the pronotum, so as to make its surface more polished. In this species the antero-external and medio-external systematic rows of the pronotum are very conspicuous under a binocular microscope, on account of the smoothness of the surrounding punctuation. These rows occur also more or less in the more strongly punctured European species of *Methydrus*, but they are of course not so easily observed. As the absence of these rows is the only characteristic given by authors for the subgenus *Methydrus*, this group may perhaps not be a valid one. Several exotic species belonging to the subg. *Lumetus* (*Philhydrus*, Sol.) are besides of the same small size as most of the *Methydrus*. The two specimens under examination are provided with the little ciliate emargination, independent of sex¹, at the extremity of the fifth

¹ cf. H. C. Fall, *California Acad. Sc. Occasional Papers* viii, 1702, 219.

ventral plate. Nothing of this is said by Kuwert. I have not been able to see typical examples.

Enochrus (subg. *Lumetus* = *Philhydrus*, Sol.) sp.

A single ♀ from W. es Semakh looks, judging from the description, very like *Philhydrus tetraspilus*, Rég from Mahé (India) and Calicut. It is of the same small size as that species (3.38 mm.) and seems to be of the same coloration, punctuation and structure. Yet, as Régimbart did not state the presence of the little ciliate emargination on the posterior margin of the fifth abdominal ventral plate, which does not occur in all the species of the genus, and taking in consideration the occurrence of the unique specimen under examination in a very different faunistic region, I consider it necessary, no typical specimen of Régimbart being at hand, to leave it undetermined for the present and only to point out its peculiarities for future studies. The prefront of the Syrian example is deeply emarginated on the fore side and the yellow clypeus very conspicuous in the emargination, the lateral prefrontal yellow spots limited backwards by the deep black coloured antenno-frontal suture and the antennal sternite or narrow space between this suture and the eyes¹, is yellowish (individual variation?). The black labrum has a transverse row of systematic punctures. The maxillary palpi are wholly yellow, the four little dark spots on the disc of pronotum are very conspicuous, the middle of the latter is very faintly infuscated, the yellow scutellum is narrowly margined with black and the shoulders of the elytra are marked with an infuscated spot. The systematic rows of the elytra are present. From the European *quadripunctatus* Herbst ♀, the Syrian specimen is readily distinguished by its small size, not so strongly impressed punctuation, not deeply darkened middle of pronotum and the ciliate notch of the fifth ventral plate. Nothing of this emargination is to be detected in *quadripunctatus*.

Laccobius (s. str.) *revelieri*, Perris, var. *leucaspis*, Kiesw.

Berl. Ent. Zeitsch. xiv, 1870, Beih. 68; Rottbg., *ibid.* xviii, 1874, 323; Rey, *Ann. Soc. Linn. Lyon* xxx, 1885, 297 nota; Kraatz, *Deutsch. Ent. Zeitschr.* 1888, 176; Kuw. *Verh. Naturf. Brünn.* xxviii, 1890, 75.

Syn. elongatus Tourn. *Mitt. Schweiz. Ent. Ges.* v, 1879, 437.

Seven specimens from W. es Semakh were captured. This beetle has not, I believe, been recorded from Syria hitherto.

¹ cf. A. d'Orchymont. "Einige Bemerkungen über die äussere Morphologie der Hydrophiliden" in *Entom. Mitteil.* II, 1913, p. 104.

It is well known by the yellow colour of the scutellum and of the underside of the prothorax and ventral plates, by the purple spot on the disc of the pronotum and by the distinctly punctured surface of the latter¹. The discal spot is narrower than that on North African examples (Nefich) belonging to the same variety in my cabinet. The antennal sternite is quite entirely yellow, not or very slowly infuscated near the median spot of the head, so that the yellow colour of the sides of the prefront reaches the eyes and that the antenno-frontal suture is drawn through it. Nothing of the specula or goggles discovered by D. Sharp on the underside of the labrum in the ♂ of several European species of *Laccobius* is to be detected on *leucaspis*.

Laccobius (*s. str.*) *gracilis*, Mots.

Etud. Entom. IV, 1855, 84; *Rey Ann. Soc. Linn. Lyon* xxxi, 1885, 306; *Kuw. Verh. Naturf. Ver. Brunn.* xxviii, 1890, 72; *Ganglb. Käf. Mitteleur.* IV, 1, 1904, 254.

Syn.: *viridiceps* Rottbg; *Berl. Ent. Zeitschr.* xiv, 1870, 23, xviii, 1874, 312.

intermittens Kiesw, *op. cit.* xiv, 1870, Beih. 69.

subtilis Kiesw *ibid.*

Three specimens captured in a small pool at the edge of Lake and one at that of a small spring on the shore three miles north of Tiberias belong to this chiefly mediterranean beetle. The antennal sternite of this species is dark on the whole and the little yellow lateral spot on the prefront is placed immediately before the antenno-frontal suture. No specula seem to be present under the labrum of the ♂ of *gracilis*.

Laccobius (*s. str.*) sp.

A single *Laccobius* from W. es Semakh, closely allied to *gracilis*, Mots., is not sufficient in itself to identify the species accurately. It seems therefore better to leave it undetermined for the present, the more as it is represented only by a ♀ specimen. From *gracilis* it may at once be distinguished by the finer and sparser punctuation of the head, faintly indicated metopico-sagittal suture and distinctly alutaceous interspaces. The pronotum is also much more feebly punctuated and very obscurely alutaceous under a good microscope; the discal spot instead of being transverse is rounded, being only a little broader than long and triangularly emarginated

¹ The specimens at hand are blackish here and there, but this is due to the manner wherein the beetles were mounted on card.

on its front side. The mentum is dark with sparser and finer punctures, less ribbed on its fore and side edges. *L. roseiceps* Rég., from Annam, seems, judging from the description, to be the nearest ally, but I am not acquainted with this species.

Laccobius (s. str.) syriacus, Guillebeau.

Bull. Soc. Ent. Fr. 1896, 228.

Dr. Annandale met with a single ♂, taken on the Plain of Gennesaret, that agrees almost perfectly with Guillebeau's description. The punctuation of the postfront seems only to be a little more dispersed than on the prefront, the punctuation of the mentum mixed with any larger punctures, and the base of intermediate and posterior thighs of a light colour, that of the anterior femora being infuscated only. The species belongs to the *nigriceps*-series having the not alutaceous head and pronotum and the not very regular disposed rows of punctures of the elytra known in that group. From *nigriceps*, Thoms. especially it may be separated at a glance by the ♂ specula of the labrum being about twice as wide as long, and by the absence of a patch of yellow pubescence on the underside of the middle femora in that sex. From *sinuatus*, Mots., Ganglb., Edwards¹, certainly its nearest ally, it is differentiated by the broadly, well marked lateral yellow spots of the prefront before the antenno-frontal suture, by the softness of the punctuation of mentum (approaching *scutellaris*, Mots. Ganglb., in this respect) and finally by the dark transverse discal spot, which does not quite reach the base of the pronotum.

¹ A specimen of *sinuatus*, Mots., of my cabinet has been captured in Syria (Haifa) by Reitter. It was forwarded to me by Bodemeyer as *scutellaris*, Mots. The *L. scutellaris* var. *albescens* of Sahlberg's List may perhaps belong to *sinuatus*, Mots.

39. Amphipoda and Isopoda from the Lake of Tiberias.

By WALTER M. TATTERSALL, D.Sc., *Manchester Museum.*

(Communicated by DR. N. ANNANDALE.)

I am indebted to Dr. Annandale for the opportunity of examining a small collection of Amphipoda and Isopoda made by him in October, 1912, in and near the Lake of Tiberias.

Dr. Annandale's immediate purpose was an investigation of the fauna of the lake itself and consequently no special attention was paid to the terrestrial fauna. As a result, but one specimen of a true terrestrial woodlouse is contained in the present collection. The latter comprises otherwise three species of Amphipoda and three of Isopoda, all of which are either completely or partially aquatic in habit. Our knowledge of the Amphipoda and Isopoda of Palestine is derived mainly from the collections made there by Dr. T. Barrois and described by Dollfuss, 1892 (Isopoda) and Chevreux, 1895 (Amphipoda). A small collection of Isopoda collected in the same country by Dr. Festa and described by Dollfuss (1894) practically confirmed that made by Barrois, only one species not being found in the latter collection. Dr. Festa does not appear to have collected any Amphipoda, at least I am not aware of any published account of them. Lortet (1883) recorded the first Amphipoda found in the lake and described them as a new species of *Orchestia*, *O. tiberiadis*, but later research has shown that his name must be regarded as a synonym of the earlier species, *O. platensis*, Kröyer.

Dr. Annandale's collection contains nothing new but adds one species, *Philoscia couchii*, to the fauna of Syria. Otherwise it serves to confirm the earlier collections of Barrois and Festa and, as far as the aquatic and semi-aquatic Amphipoda and Isopoda are concerned, it does not seem likely that any new forms remain to be discovered.

The collection comprises the following species :—

AMPHIPODA.

- Gammarus pungens*, M.-Ed.
- Gammarus syriacus*, Chevreux.
- Orchestia platensis*, Kröyer.

ISOPODA.

- Asellus coxalis*, Dollfuss.
- Philoscia couchii*, Kinahan.
- Leptotrichus*, sp.
- Metoponorthus swammerdami*, Aud. & Sav.

Of the Amphipoda, the two species of *Gammarus* are truly aquatic while the *Orchestia* is more properly a semi-aquatic form, since it was found under stones above but near the margin of the lake. *Asellus coxalis* is the only truly aquatic Isopoda in the collection, *Philoscia couchii* and *Leptotrichus*, sp., being semi-aquatic, and *Metoponorthus swammerdami*, terrestrial.

Of the species in the collection, one Amphipod, *G. syriacus*, and one Isopod, *A. coxalis*, are endemic and have not so far been found outside Syria. The remaining species are distinctly "Mediterranean" in character though one, *Orchestia platensis*, is known also from the Atlantic coasts of America. *Philoscia couchii*, though not recorded from Syria hitherto, has an extensive distribution on the shores of the Mediterranean basin and on the Atlantic shores of Europe as far north as the south of England and the west of Ireland. It has, up till now, been found only near the sea, so that its association with comparatively fresh water in Syria is a new factor in its ecology.

AMPHIPODA GAMMARIDEA.

Family GAMMARIDAE.

Gammarus pungens, M.-Ed.

Localities: Wadi Semakh, L. Tiberias, under stones at edge of lake, 13th October, 1912—eighteen. Mejdal, L. Tiberias, lower surface of stones in small brackish spring—ten. Lake Tiberias, under stones at the edge of the lake, on the south and west side—common. Et Tabghah, L. Tiberias, among grasses and water plants—thirty.

These records show that this species is abundantly and regularly distributed round the entire margin of the lake. Chevreux (1895) who is the only previous recorder of this form from the Lake of Tiberias, likewise found it to be abundant on practically all the shores of the lake. The species is known otherwise from Italy, Sicily and Cyprus and represents, therefore, in L. Tiberias a mediterranean element.

Gammarus syriacus, Chevreux.

Localities: R. Barada, Damascus—twenty-three, up to 10 mm. in length. Spring at Ain-et-Tineh, L. Tiberias, under stones, October 1912—two.

This species is readily distinguished from *G. pungens* by the form of the third pair of uropods. In the latter species, the inner ramus of these appendages is quite short, shorter than the peduncle, whereas in *G. syriacus* the inner ramus of the uropods is at least two-thirds of the length of the outer.

G. syriacus is at present only known from the fresh

waters of Syria. It was first obtained by Dr. T. Barrois and described by Chevreux (1895), who records it from several places in Syria, but not from the L. of Tiberias itself. Curiously enough, Dr. Annandale's specimens confirm this distribution. Though found in the fountain at Ain-et-Tineh I have not detected a single specimen among the Amphipoda collected on the shores of the lake itself.

Family TALITRIDAE.

Orchestia platensis, Kröyer.

O. tiberiadis, Lortet, 1883.

Localities: Lake Tiberias, under stones at the edge of the lake on the west side, and just above the water-level of the lake, on the south side, under damp stones—common.

The females were carrying young at the time of their capture, October. This species was first recorded from L. Tiberias by Lortet under the name of *O. tiberiadis*. Chevreux (1895) in recording the species again from Syria showed that Lortet's species was synonymous with the earlier species of Kröyer. It is a very widely distributed form, known from the Atlantic shores of North and South America, Bermudas, and the shores of the Mediterranean.

ISOPODA.

Tribe ASELLOTA.

Family ASELLIDAE.

Asellus coxalis, Dollfuss.

A. coxalis, Dollfuss, 1892 and 1894.

Localities: Ain-et-Tineh, L. Tiberias, under stones in small pool—fifteen. Mejdal, L. Tiberias, under stones—twelve. Under stones at the edge of the lake, near Tiberias—three.

Dr. Annandale obtained no specimens from the south and west shores of the lake, but on the north-eastern shores it is apparently quite abundant. *A. coxalis* is a small species, the males reaching only 5 mm. in length and are, on the average, larger than the females. It was first described by Dollfuss (1892) from specimens collected in Palestine by Dr. T. Barrois and again recorded by the same author (1894) from the material brought home from the same part of the world by Dr. Festa. It is not known outside Syria.

It appears to me to be very nearly related to the common species, *A. aquaticus*, differing mainly in its smaller size and the less pronounced sexual difference in the form of the first

gnathopod of the male and female. I figure the distal joints of the first gnathopod of an adult female bearing eggs, and an adult male, to show the amount of difference between the sexes. The males are, on the average, larger than the females, resembling, in this respect, *A. aquaticus*. A large male

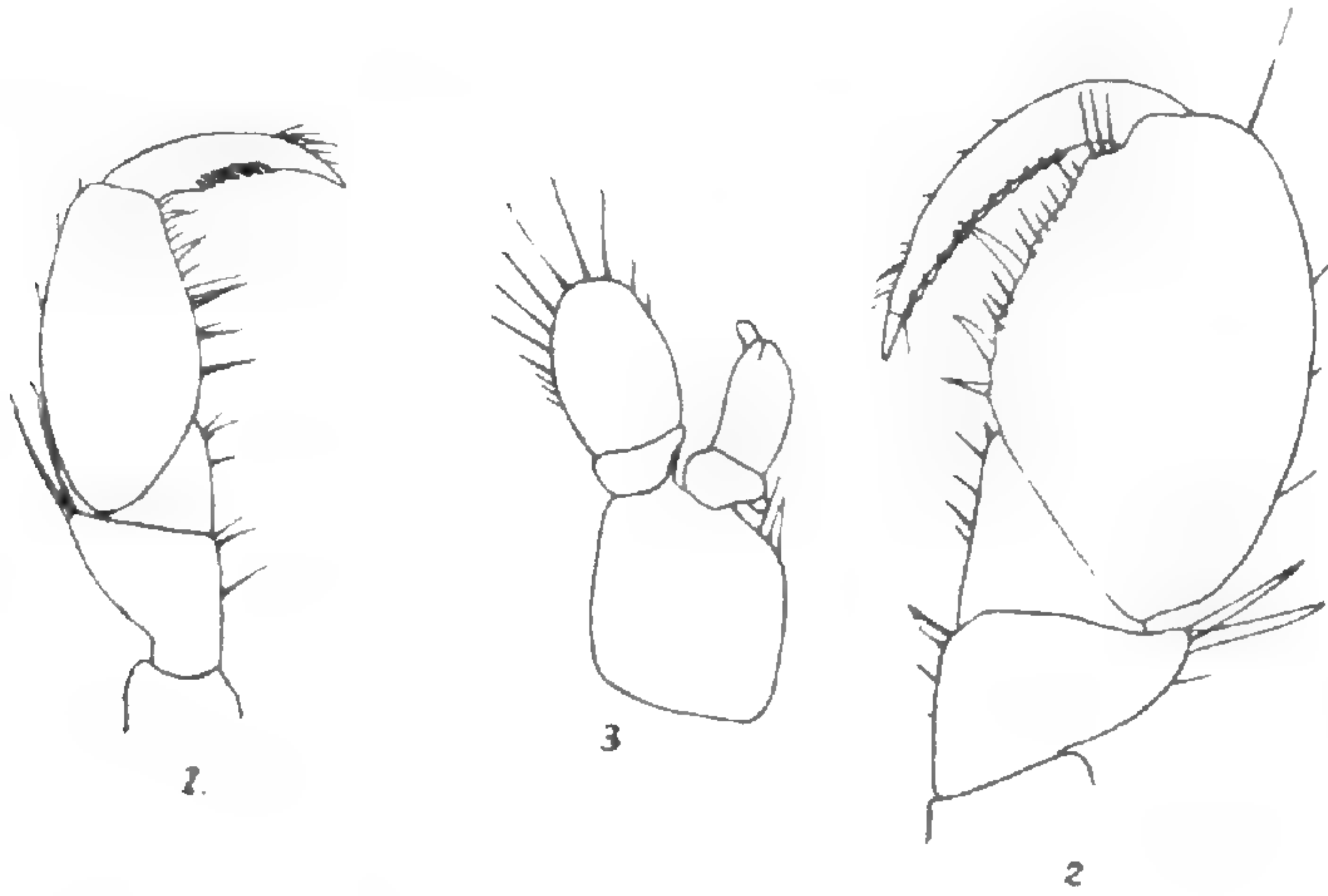

FIG. 1. *Asellus coxalis*, Dollfuss, distal joints of first gnathopod of female.
 „ 2. „ „ „ „ „ distal joints of first gnathopod of male.
 „ 3. „ „ „ „ „ second pleopod of the male.

measures 5 mm., an egg-bearing female, 4 mm. I also figure the sexual appendage of the second pleopod of the male, for comparison with that of other species. There is only one coupling seta on the inner margin of the basal joint of the first pleopod of the male.

Tribe ONISCOIDA.

Family ONISCIDÆ.

Metoponorthus swammerdami, Aud. et Sav.

Locality: In a house at Tiberias—one specimen.

This species has been recorded previously from Syria by Dollfuss and is a fairly common species in the Eastern Mediterranean region. The single specimen here recorded is the only true land species obtained by Dr. Annandale in Palestine. All the other woodlice collected are semi-aquatic forms.

Philoscia couchii, Kinahan.

Locality: Common under stones at the edge and just above the margin of the L. Tiberias.

The identification of these specimens has given considerable

trouble, but after a comparison with specimens in the Büdde-
 Lund and Norman collections in the British Museum and with
 Irish examples kindly lent me by Mr. Nevin H. Foster, I am

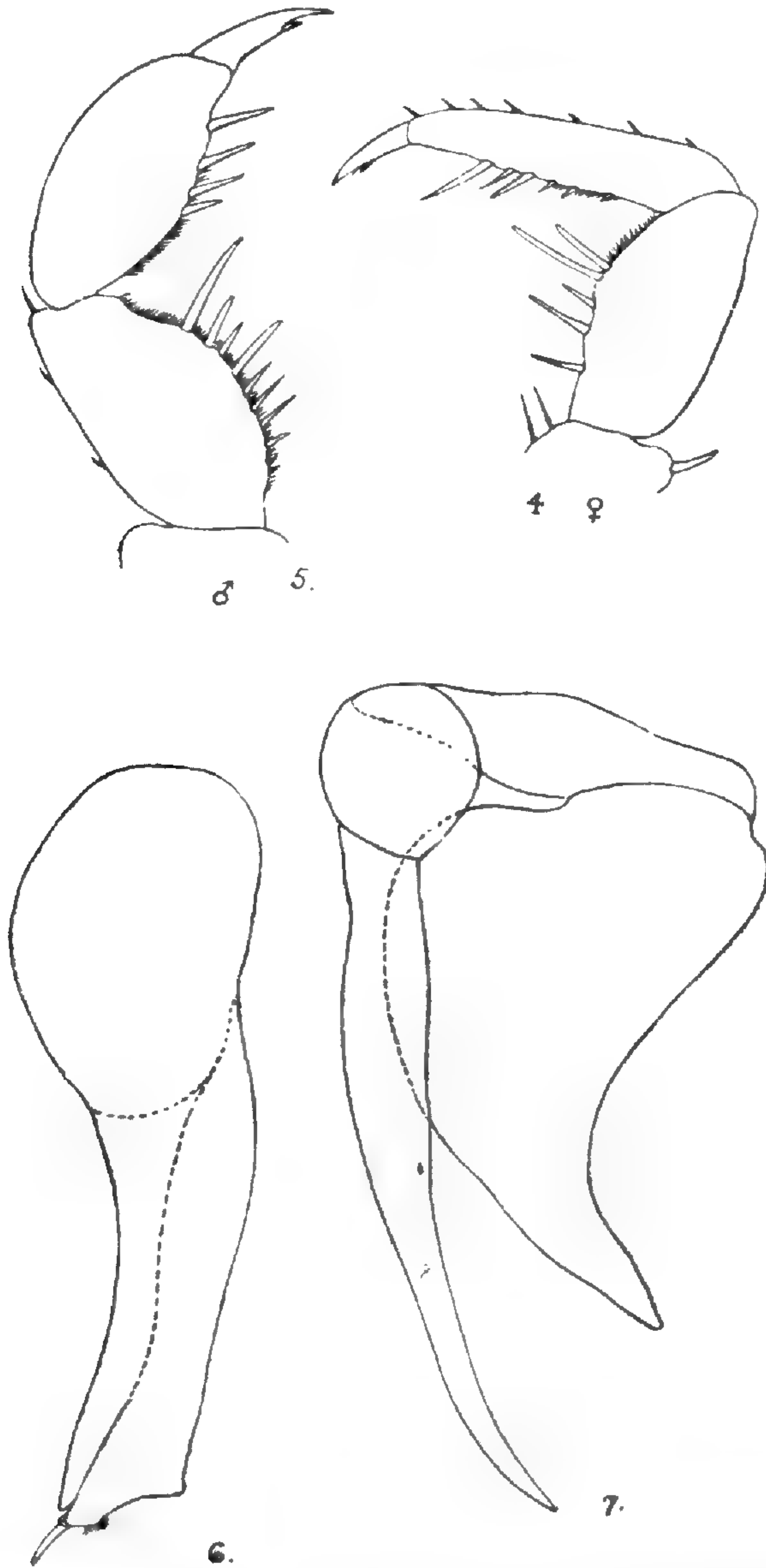

FIG. 4. *Philoscia couchii*, Kin., distal joints of first gnathopod of female.
 " 5. " " " distal joints of first gnathopod of male.
 " 6. " " " inner ramus of first pleopod of male.
 " 7. " " " second pleopod of male.

convinced that they belong to this species. I rely mainly on
 the form of the first gnathopods in both sexes and the struc-
 ture of the pleopods of the male. The first gnathopod of the
 male differs from that of the female in having the carpus and
 especially the propodus much more swollen and expanded. I
 figure here the distal joints of the first gnathopods in both

sexes to show this difference. The figure of the male gnathopod here given agrees closely with that given by Dollfuss (1897) for this species. I am not aware that so marked a sexual difference in the gnathopods exists in any other European species of *Philoscia*, though, as Dollfuss points out, analogous differences between the sexes are found in some of the American species, e.g. *Philoscia bermudensis*, Dahl. The inner ramus of the first pleopods in the male is also characteristic. Compared with that of *P. muscorum*, the distal end is more expanded and truncate, with a prominent spine at the outer distal corner. British specimens of *P. couchii* agree exactly with those here dealt with. I give, herewith, figures of the inner branch of the first pleopod and the second pleopod of the male, taken from the present specimens.

Dollfuss (1897) identifies *Philoscia longicornis*, Büdde-Lund, with this species, but Büdde-Lund (1909) does not agree with this opinion. He suggests that *P. couchii* is identical with *P. cellaria*, Dollfuss, and that *P. longicornis* is a distinct species. Moreover, he would appear to suggest that *P. couchii* is an Atlantic species not found in the Mediterranean region. I would point out that the habitats of *P. couchii* and *P. cellaria* are quite distinct. The former is always found under stones quite near to water, whereas *P. cellaria* is a much more terrestrial species, characteristic of caves and grottoes and gardens. On Büdde-Lund's own showing, *P. longicornis* is found in close proximity to the sea and therefore in similar situations to *P. couchii*. I, therefore, accept Dollfuss' opinion that *P. couchii* and *P. longicornis* are synonymous.

P. couchii has not before been found in Palestine, nor, indeed, in the neighbourhood of fresh water. Hitherto it has only been found near the sea, but if Dollfuss' opinion on the identity of this species with *P. longicornis* be accepted, it has been found at Alexandria, in Egypt, and there seems to me to be no inherent reason against the eastward extension of its geographical distribution implied by the present record from the shores of L. Tiberias. The habitat in which it was found, under stones at the edge of the lake, is exactly the kind of situation in which one would expect it to occur.

Leptotrichus, sp.

Localities: Under stones near the margin of the lake—eight specimens.

Three species of *Leptotrichus* are known from Syria,—*L. panzeri*, Aud. & Sav., *L. tauricus*, B.-L., and *L. pulchellus*, Dollfuss. The present specimens do not belong to the first of these species, specimens of which I examined in the British Museum. I have, however, not been able to see specimens of the other two species. I, consequently, do not feel certain

of the identity of the present specimens and prefer to leave the matter until I am able to compare them with authentic specimens of *L. tauricus* or *L. pulchellus*.

LITERATURE CITED.

- Büdde-Lund (G.), 1885:—Crustacea Isopoda terrestria per familias et genera et species descripta. Hauniae.
- „ 1909:—“Terrestrial Isopoda from Egypt” in Results of the Swedish Zoological Expedition to Egypt and the White Nile, 1901, under the direction of L. A. Jägerskiöld. Part III.
- Chevreaux, E., 1895:—Rev. Biol du Nord de la France, Vol. 7.
- Dollfuss, A., 1892:—“Note sur les Isopodes terrestres et fluviatiles de Syrie recueillis principalement par M. le Dr. T. Barrois.” Rev. Biol. du Nord de la France, Vol. 4.
- „ 1894:—Viaggio del Dr. E. Festa in Palestina nel Libano e regioni vicine. X. Crustacees Isopodes Terrestres et d'eau douce.” Boll. Mus. Zool. Anat. Comp. Torino, Vol. IX, No. 177.
- „ 1897:—“Tableau iconographique des Philoscia d'Europe. La Feuille des Jeunes Naturalistes, III^e Ser., 27^e année, nos. 316-317.
- Lortet, L., 1883:—Arch Mus. d'Hist. Nat. Lyon, t. III., p. 190.
-

40. Chironomides du Lac de Tibériade.

Par J. J. KIEFFER, *Dr. Phil. nat. (Bitsch)*.

(*Communicated by DR. N. ANNANDALE.*)

Les espèces mentionnées ou décrites dans ce petit travail, ont été recueillies en Palestine, au Lac de Tibériade, en Octobre 1912, par Mons. N. Annandale, Conservateur à l'Indian Museum de Calcutta.

Pelopia cygnus, n. sp.

♂. Blanc; flagellum brun, 4 bandes raccourcies sur le mesonotum, et le metanotum roussâtres, un faible anneau avant l'extrémité des fémurs brunâtre, bord postérieur des segments abdominaux brunâtre au moins sur les côtés. Antennes de 14 ou 15 articles. Ailes poilues et tachetées de brun, une tache bien distincte sur la transversale et une autre sur l'extrémité du radius, une 3^e sur le bord postérieur vis-à-vis des transversales, une trace de tache à l'extrémité alaire, cubitus non dépassé par la costale. Pattes antérieures seulement pubescentes, leur tibia d'un tiers plus long que le métatarse. Abdomen brillant, à poils blanchâtres; articles basaux de la pince à poils dressés, très longs et denses; articles terminaux ayant la forme du cou et de la tête du cygne. L. 3,5 mm.—Lac de Tibériade.

Pelopia monilis, L.

Cette espèce existe dans toute l'Europe et au Sud de l'Afrique. Une ♀ a été capturée au lac de Tibériade.

Trichotanytus tiberiadis, n. sp.

♂ ♀. D'un brun sombre; pattes blanchâtres comme les balanciers, sans tache, bord postérieur des segments abdominaux, blanchâtre. Antennes du ♂ de 15 articles, dont le 2^e et le 3^e sont transversaux, 14^e un peu plus long que 2-13 réunis. Antennes de la ♀ blanchâtres, sauf l'article terminal. Ailes blanchâtres, poilues avec une tache d'un brun noir sur les transversales, partie distale depuis la bifurcation de la posticale jusqu'à l'extrémité de l'aile légèrement enfumée; cubitus longuement dépassé par la costale, tige de la posticale aussi longue que le rameau inférieur, radius bifurqué; les ailes de la femelle sont conformées comme chez le mâle, sauf que, le long du bord postérieur, sous les transversales, se trouve un grand espace enfumé. Tarse antérieur brun. Articles basaux de la

pince gros, articles terminaux grêles, plus courts, graduellement amincis de la base au sommet, finement pubescents. L. ♂ 2 mm. ♀ 1,5 mm.—Lac de Tibériade.

[This is the species I referred to in a note on a former paper (*J.A.S B. (n.s.) IX*, p. 45 : 1913) as being a troublesome blood-sucker at Tiberias.—*N. Annandale.*]

Polypedilum genesareth, n. sp.

♂ ♀. Brun noir; antennes blanchâtres sauf, chez la femelle, le 6^e article qui est assombri; mesonotum ayant de chaque côté, dans la moitié postérieure, une bande longitudinale grisâtre; balanciers et pattes blancs, fémurs assombris sauf le quart distal. Antennes du mâle composées de 14 articles, dont le dernier est deux fois aussi long que les 12 précédents réunis, articles 3-13 environ deux fois aussi gros que longs, poils du panache gris, formant 2 rangées sur les articles 3-13, disposés sans ordre sur le 14^e article. Antennes de la femelle de 6 articles, dont le dernier est subcylindrique, presque deux fois aussi long que le 5^e, muni d'une longue soie à son extrémité; article 4^e conformé comme le 3^e, avec un col ayant les deux tiers de la longueur du renflement, verticille très long, atteignant l'extrémité du 6^e article; 5^e article fusiforme, à col plus court que chez les articles 3^e et 4^e, verticille dépassant de beaucoup l'article terminal. Ailes blanches, ciliées, avec des taches petites, brunes et irisées, dont trois entre le cubitus et la discoïdale, à savoir: la plus petite située à la base de la discoïdale, une 2^e, en ellipse, située vers le milieu de la discoïdale, la 3^e allongée, la plus longue, bifurquée au tiers proximal, située près de l'extrémité distale de la discoïdale; trois autres taches se trouvent entre la discoïdale et le rameau supérieur de la posticale, l'une sur la base de la discoïdale, l'autre sur le rameau supérieur de la posticale, au tiers distal, la 3^e entre l'extrémité de ce rameau et celle de la discoïdale; entre les deux rameaux de la posticale se voient trois taches, dont la plus grande est proche de la bifurcation, la 2^e contre le milieu du rameau supérieur, la 3^e au bord postérieur de l'aile; une dernière tache est située entre le milieu de la tige de la posticale et le bord postérieur de l'aile; bifurcation de la posticale située sous la transversale. Métatarse antérieur du maximum de moitié plus long que le tibia, tarse antérieur non barbu, les 4 pulvilles aussi minces et aussi longs que l'empodium. Lamelle de la pince arrondie en arrière sans pointe; article terminal de la pince presque d'égale largeur partout, non argué, pubescent jusqu'à l'extrémité, le tiers distal porte au côté médian quelques longs poils alignés mais pas de soies rigides; appendice supérieur mince, arqué, pointu, n'atteignant pas l'extrémité de l'article basal; appendice inférieur

dépassant faiblement l'article basal, n'ayant que la demie largeur de l'article terminale. L. ♂ 3,5 mm., ♀ 2 mm.—Lac de Tibériade.

Polypedilum tiberiadis, n. sp.

♀. Blanchâtre; article terminal des antennes brun; quatre bandes raccourcies du mesonotum, metanotum, et mesosternum ainsi que l'abdomen bruns, extrémité des fémurs et des tibias sombre; un exemplaire a le thorax brun en entier. Antennes de 5 articles, dont le 2^e est rétréci au milieu, son col transversal, le 3^e et le 4^e ovoïdaux, avec un col ayant un col qui atteint les deux tiers de leur longueur, verticilles trois fois aussi longs que l'article avec son col; 5^e article composé d'un renflement basal, ovoïdal, portant un verticille très long et deux appendices sensoiels comme les articles précédents, et d'une pièce distale, cylindrique, fendre latéralement, plus de deux fois aussi longue que le renflement basal mais plus mince et couronné de quatre soies aussi longues qu'elle. Ailes blanches, longuement ciliées, avec des taches brunes et peu grandes, dont une allongée reliant le cubitus à la discoïdale, et distante de l'origine de la discoïdale d'environ toute sa longueur, la 2^e située sous la 1^e, plus étroite mais presque trois fois aussi longue, longe le bord inférieur de la discoïdale et dépasse de chaque côté la 1^e; une 3^e, située sous la 2^e, se trouve dans l'angle formé par les deux rameaux de la posticale et ne dépasse pas le milieu de ces rameaux; une 4^e, située sous la 3^e, est adjacente au bord inférieur de l'aile, contre l'extrémité du rameau inférieur de la posticale; une 5^e, transversale, relie le milieu de la tige de la posticale au bord inférieur de l'aile; la 3^e et la 4^e taches sont parfois réunies en une seule, en forme de bande transversale; nervures jaunes, bifurcation de la posticale notablement distale de la transversale. Métatarse antérieur deux fois aussi long que le tibia, celui-ci bien plus court que le fémur, les 4 pulvilles aussi minces et aussi longs que l'empodium. L. 1,5 mm.—Lac de Tibériade.

Tendipes bethsaida, n. sp.

♀. D'un jaune pâle; antennes blanches, article terminal brun; mesonotum parfois avec une trace de trois bandes un peu plus sombres; tarses assombris. Yeux réniformes, très amincis au vertex où ils sont rapprochés, distants seulement de deux fois leur largeur terminale. Articles 3-5 des antennes ellipsoïdaux, à col pas plus long que gros, le 6^e article de moitié plus long que le 5^e. Ailes hyalines, nervures pâles, bifurcation de la posticale un peu distale de la transversale. Métatarse antérieur presque de moitié plus long que le tibia, articles 2 et 3 subégaux, 5^e égalant la moitié du 4^e, pulvilles larges. L. 4,5 mm.—Lac de Tibériade.

Tendipes galilaeus, n. sp.

♀. D'un jaune pâle; antennes blanchâtres, 6^e article assombri; trois bandes raccourcies de mesonotum, metanotum et mesosternum bruns; pattes blanchâtres, tibia antérieur assombri. Yeux ovalaires, non amincis supérieurement, où ils sont distants de toute leur longueur. Antennes de 6 articles, dont le dernier est de moitié plus long que l'avant-dernier, articles 3-5 en ellipse courte, dépourvus de col. Ailes très finement pointillées, cubitus à peine deux fois aussi long que le radius, transversale presque nulle, bifurcation de la posticale un peu distale de la transversale, radius avec des soies alignées et espacées. Prothorax couvrant la tête. Métatarse antérieur de moitié plus long que le tibia, les quatre tibias postérieurs avec le peigne caractéristique des *Tendipes*, pulvilles larges. L. 1,5 mm.—Lac de Tibériade.

41. A Scheme for the Bardic and Historical Survey
of Rajputana.

By DR. L. P. TESSITORI.

INTRODUCTION.

When, in consequence of my appointment as an editor of the Bardic and Historical Literature of Rajputana by the Government of India, I arrived in Calcutta on the 11th April, 1914, and presented myself before the Asiatic Society of Bengal, which for the last nine years had been in charge of a preliminary survey of the work now entrusted to me, I naturally began by inquiring how far things had proceeded; and I was then shown Mahāmahopādhyāya Hara Prasāda Śāstrī's *Preliminary Report on the Operation in Search of MSS. of Bardic Chronicles* (Calcutta, 1913), and a heap of foolscap-copies of Bardic and Historical works made by the Bardic Office in Jodhpur and presented by the same State to the Asiatic Society of Bengal. This was all that had been done, and the funds (Rs. 2,400 only) placed by the Government of India at the disposal of the Asiatic Society of Bengal had been thereby exhausted, and the necessity was felt of immediately asking for a grant from the Government, so that the work might proceed. A *Scheme*, in which an annual grant of Rs. 9,000 was demanded from the Government, had been submitted by Mahāmahopādhyāya Hara Prasāda Śāstrī in his aforementioned *Preliminary Report*, but it had not been passed by the Council of the Society, nor did it seem to be satisfactory. In Mahāmahopādhyāya Hara Prasāda Śāstrī's idea I was to work in Calcutta, on the foolscap-copies presented by the Jodhpur State, and therefore no arrangements had been made by the Society for my stay in Rajputana. Under such circumstances, what with my applying to the Society to be allowed to go to Rajputana and what with the Society asking the consent of the Government of India and the delay necessarily involved in these proceedings, it was only on the 22nd July I was able to leave Calcutta for Rajputana on a preliminary tour of about three months to make myself acquainted with local conditions in regard to bards and manuscripts and to enable myself properly to criticize Mahāmahopādhyāya Hara Prasāda Śāstrī's Scheme and to prepare a new one. The three months I was detained in Calcutta were almost entirely wasted for my work, as I had neither helps nor materials to work upon there. The foolscap-copies sent from Jodhpur were found to be

absolutely worthless for any philological purpose, having evidently been prepared by half illiterate and careless copyists.

After three months' stay in Rajputana, partly spent in touring and partly in studying Dīngāḷa and Mārwarī manuscripts in Jodhpur, where I established my headquarters, I am now able to submit a *Scheme for the Bardic and Historical Survey of Rajputana*, which I am confident will answer the purpose of the Government of India. Besides the Scheme, I have also been able to prepare for the press the first fasciculus of a *Descriptive Catalogue of Bardic and Historical MSS.* and to collect materials for the edition of the *Vacānikā Rāthōṛa Rāva Ratana Singhaḷī rī Mahēsadāsōta rī*, a bardic poem of the seventeenth century referring to the battle of Ujain between Jasvant Singh of Jodhpur and Aurangzeb (A.D. 1658). Specimens of both the *Catalogue* and the *Vacānikā*, as well as of the *Bulletin*, a quarterly publication, the object and nature of which is described in the following pages, have been prepared in illustration of the Scheme and are given in Appendix to the same. Many years have been wasted in sterile talks and fruitless attempts, and it is time to set to work in earnest and destroy the feeling, which has begun to prevail in Rajputana, that the Government of India's Scheme for the publication of the Bardic literature is nothing more than a mere show and will never lead to any practical results.

The sum involved by the following Scheme is Rs. 12,000 a year. Deducting from this sum Rs. 2000, it may possibly be 3000 or more, which will be contributed by the Jodhpur State, the annual sum to be contributed by the Government of India is Rs. 10,000. If the plan of work described in the following Scheme is agreed upon, the Government should sanction the first yearly grant of Rs. 10,000 for the official year beginning with 1st April 1915. The work and publications of the Survey, however, should begin from the 1st January, 1915, and therefore an additional further non-recurring grant of Rs. 1000 necessary for starting the Survey and continuing it for three months, exclusive of the editor's stipend, which has been already paid as far as April, 1915, will have to be sanctioned for the period 1st January to 31st March.

PRELIMINARY OBSERVATIONS.

It is obvious that without a clear knowledge of local conditions in Rajputana, and especially of the languages, manuscripts and bards in general, no serious attempt can be made to prepare a Scheme that will work and bring results. The first problem I had to meet before drawing the outlines of the proposed work, was connected with the three subjects just mentioned, and it was only after coming to definite conclusions in regard to them, that I was able to realize the course

and means to be adopted. These conclusions have not only a certain interest for themselves, but actually form the basis of the present Scheme and contain the reasons for all technical points and items in it. I therefore think it necessary briefly to explain them, before entering into the discussion of the plan of the work.

It is well known that there are two languages used by the bards of Rajputana in their poetical compositions, and they are called *Ḍiṅgaḷa* and *Piṅgaḷa*. These are no mere "style of poetry" as held by Mahamahopādhyāya Hara Prasāda Śāstri, but two distinct languages, the former being the local *bhāṣā* of Rajputana, and the latter the Braja *bhāṣā*, more or less vitiated under the influence of the former. Sir George Grierson in his *Linguistic Survey of India*, Vol. IX, Part II (1908), p. 19, has given the following clear definition: "Mārwarī has an old literature about which hardly anything is known. The writers sometimes composed in Mārwarī and sometimes in Braj Bhākhā. In the former case the language was called *Ḍiṅgaḷ* and in the latter *Piṅgaḷ*", a definition which would have given the Śāstri a good clue if he had not overlooked it. Leaving aside *Piṅgaḷa*, on which it would be superfluous here to make any remarks in addition to the statement made above, I will confine myself to a few considerations in regard to *Ḍiṅgaḷa*, which I think necessary in order to eliminate the prejudice current in Rajputana that *Ḍiṅgaḷa* is an artificial language invented by the bards, and to show its real nature and relationship to the other languages of India.

In my "Notes on the Grammar of the Old Western Rājasthānī with special reference to Apabhramṣa and to modern Gujārātī and Mārwarī", which are being published in the *Indian Antiquary*, I have tried to prove the common derivation of the vernaculars of Rajputana and Gujarat from a unique stock, which I have termed "Old Western Rājasthānī", and have explained as the immediate offspring of the Saurasena Apabhramṣa. This language had been explained as simply Old Gujārātī, but from the fact that it contains many peculiarities which nowadays are not found in modern Gujārātī, whilst they are common in modern Mārwarī, and also that it seems to have been in use over an area including a great part, if not most, of Rajputana, it is clear that it is to be considered as the parent of Mārwarī not less than Gujārātī. I have fixed A.D. 1200 and A.D. 1600 as the approximate limits of the Old Western Rājasthānī, and shown that the differentiation of this single language into Gujārātī and Mārwarī began long before the sixteenth century. I have also shown that in the later stage of the Old Western Rājasthānī the differentiation is so marked that it is always possible to say whether a work is written under the influence of the

Gujarātī or the Mārwarī tendency. It has seemed to me that as far as Old Western Rājasthānī goes, the difference between these two currents of speech is not so important as to justify the classing of them as separate; otherwise I would have distinguished in the later Old Western Rājasthānī stage two different dialects to be named Old Gujarātī and Old Mārwarī. With the latter, whether we call it Old Mārwarī or simply Old Western Rājasthānī, *Ḍiṅgaḷa* is to be identified.

Ḍiṅgaḷa is therefore in origin Old Western Rājasthānī, i.e. the old local speech of Western Rajputana, and consequently identical with the language so well preserved to us in the works of Jain commentators and poets of the fifteenth and sixteenth century and described in my "Notes" mentioned above. It is, however, the Mārwarī side of the Old Western Rājasthānī, and it is partly for this reason and partly also because of its having been somewhat modernised in orthography during the four or five centuries in which it came down to us, that the bards nowadays ignore and deny its identity with the language preserved in Jain works, which they call "Jatīyā rī bōlī", and attribute its invention to themselves. The term *Ḍiṅgaḷa*, which has nothing to do with *Ḍagara* nor with any other of the fantastic etymologies proposed by the bards and pandits of Rajputana, but is a mere adjective meaning probably "irregular", i.e. "not in accordance with the standard poetry" or possibly "vulgar", was applied to it when the use of the Braja Bhāṣā (*Piṅgaḷa*) as a polite language of the poets was in general vogue. *Ḍiṅgaḷa* is therefore the old vernacular of Rajputana which, though long a dead language, has survived in the songs of the bards, a fact which, however strange and inexplicable it may appear at a first sight, yet is quite natural in the case of professional poets, whose oral patrimony—art, style, language and manuscripts—is transmitted from father to son. But this should not be taken to mean that *Ḍiṅgaḷa* has been transmitted *qualis talis* and that there are no differences in it. It is obvious that the *Ḍiṅgaḷa* poetry composed during the Old Western Rājasthānī period, i.e. before the seventeenth century, must necessarily partake of all the Old Western Rājasthānī peculiarities of which the most characteristic is the hiatus in the vocalic nexus *aī* and *aū*; whereas the *Ḍiṅgaḷa* poetry composed within and after the seventeenth century, i.e. after the development of modern Mārwarī, must to a certain extent have undergone some modifications under the influence of the latter language. Thus in the later *Ḍiṅgaḷa* *aī* and *aū* cannot be expected to remain in hiatus, but they are contracted into *ai* (*ē*) and *au* (*ō*) after the example of modern Mārwarī. We shall have therefore to distinguish, in the *Ḍiṅgaḷa* literature, two stages, namely *Old Ḍiṅgaḷa*, included in the Old Western Rājasthānī period, and *Later Ḍiṅgaḷa*, included in the modern Mārwarī period. The

difference between the two stages is more in points of phonetics and morphology than lexicography, and the unintelligibility of Dīngala largely depends on the use of obsolete words, which are no longer understood by the people. The same modernising influence which has been exercised on Later Dīngala, has not been without an effect on the poetry composed during the Old Dīngala stage, which has therefore come down to us in an incorrect and uncritical form, and this accounts for the modern bards ignoring its very existence. To reconstitute Old Dīngala into its original form must now be one of the tasks of the editor, and it can be accomplished through the analogy of the Old Western Rājasthānī of Jain writers, of which numbers of good and reliable manuscripts are available, and also through searching for very old bardic manuscripts, which, though I have never seen any to this day, yet are sure to be found.

Besides Dīngala and Piṅgala, which are the languages used for the poetry, the editor of the Bardic and Historical Literature will have to consider the various modern vernaculars of Rajputana, which are used for the prose, and chiefly in the composition of *khyātas*, *vātas*, genealogies etc. It is certain that some of these works were composed during the Old Western Rājasthānī period, and in course of time underwent the same modernising process as Old Dīngala. Should any of these works in prose be found of such an interest as to deserve to be edited, it is clear that the text should be restituted to its original form. Prose-chronicles written in modern Mārwarī or in any other of the modern vernaculars of Rajputana present no particular difficulty. The practical conclusion to be drawn from the above considerations in regard to our Scheme is that Dīngala is no artificial jargon, but an old dead language, the key to the understanding of which cannot be attained through guessing at random, but only through a critical study of all the factors in its derivation and development, made according to the principles of modern philology and on all the available materials. These materials are the manuscripts.

Bardic manuscripts are, as a rule, very incorrect. Hence the necessity of obtaining many manuscripts for each text that is to be edited. Happily they exist in large numbers, so that in the case of famous works different copies can easily be procured. Of the *Vacanikā Rāva Ratana Singhajī rī*, I was able to collect a dozen manuscripts from Marwar only, in less than a month. The search for a sufficient number of manuscripts is therefore the first step preliminary to the editing. Bardic and historical manuscripts are found with Cāraṇas, Bhāṭas and inferior classes of bards, Sevagas, Pancōlis, and, though not necessarily, with Rajput *Jagirdars* and Jain *Jais*. Most of these people, and especially those who keep

genealogies and live on them, will never part with their books, and some go even so far in their jealousy as to conceal their books from any inquirer, out of fear they might be taken from them. But, fortunately for us, concealment is not very frequent, and generally those who are not willing to sell their books have no objection to showing them and even lending them for a time. In Jodhpur I have examined some bardic and historical collections of Cāraṇas, that have been found to be very rich and to contain most valuable materials. I have also been borrowing books from them and have started a *Descriptive Catalogue*, the commencement of which I hope may be published shortly, and specimens of which will be found in the Appendix to the present Scheme. Bardic and historical manuscripts are also necessarily found in the Darbar Library of each Rajput State. It is only after the most important of such collections have been explored and the manuscripts in them described and classified, that a fairly adequate idea of the vastness of the Bardic and Historical Literature and also of the importance of these materials for the history of Rajputana as well as of India, as a whole, can possibly be attained. Manuscripts in large collections are, as a rule, carefully kept by their possessors, and freely shown to anybody who takes interest in them, and so in their case there is no need of trying to secure them lest they might get lost or destroyed, nor of making copies of them. They are kept ready for us any time we need to refer to them, and all we want is a Descriptive Catalogue that will tell us where they are. The case is different with small collections and scattered manuscripts, which are not much cared for, and might possibly fall into fresh hands. In the case of these, efforts should be made to secure them, in order to save them from neglect or destruction, and when purchasing is not possible, pains should be taken to obtain them on loan so that they may be examined and studied and, in the case of very important manuscripts, copied in a critical way. As a rule scattered manuscripts, when they are sold at all, are sold very cheaply, and it will always pay to buy as many as possible. I have bought for one rupee manuscripts of which—apart from their intrinsic value—the mere copying would now cost ten or twelve.

Turning now to the bards, I must point out that Mahāmahopādhyāya Hara Prasāda Śāstrī in his afore-mentioned *Preliminary Report* has given an Appendix on the bards, in which of the two chief classes of them, Cāraṇas and Bhāṭas, the former are rather diminished and discredited, whilst the latter are dignified beyond what they actually are. The reason for this is simply that the Śāstrī derived most of his information from a Bhāṭa, who naturally enough availed himself of the opportunity of discrediting his rivals, the Cāraṇas, before him. The fact is that by far the most influential class of bards in Rajputana,

with the exception of some places in the South-East, are the Cāraṇas, and the proof is in the number of villages they still enjoy as *sāsanas*. In the Marwar State, where their influence is most felt, they continue to enjoy not less than about 350 villages, whilst the villages of the Bhāṭas are only seven or eight. And their superiority is not less in literary achievements. Whilst the Bhāṭas are nowadays generally confined to keeping genealogies and possess no literary education, Cāraṇas are still found who are good composers, and besides having a command of both *Diṅgaḷa* and *Piṅgaḷa*, have also some knowledge of the Sanskrit language and literature. An example is the late Kavirāja Murāra Dāna of Jodhpur, the author of the *Jasavanta Jasō Bhūsana*. The Cāraṇas generally are no doggerel verse-makers, nor mere repeaters of oral songs, they are lettered poets and their works have not only an historical and ethnological value, but also a literary one. Titles like *kavirāja* and *kaviśvara* are common amongst the Cāraṇas, and that these titles are not lavishly conferred upon them is shown by Tod, in the xth chapter of his *Annals of Marwar*, where the Cāraṇa Karaṇī Dāna is introduced to the reader, and an allusion is made to the studies requisite to form a *kaviśvara* and the difficulties that make his path to Parnassus a most thorny one. By this I do not mean to say that the poetry, genealogies etc. of Bhāṭas and other inferior bards are of little account; I only mean to impress the idea that it is from the Cāraṇas we can expect most. A pity that their activity is decreasing nowadays, and this for the reason that chiefs and nobles hardly take any interest in them and do not encourage them with rewards and honours as their forefathers did. The profession of a Cāraṇa has ceased to be a remunerative one, and many of these Homers of the Rajput bravery now lead a miserable life in the villages, which formerly were a rich *sāsana*, but nowadays are hardly sufficient to support their numerous progeny.

PLAN OF THE WORK.

In formulating a plan for such a vast work as the Bardic and Historical Survey of Rajputana we cannot ignore one principle, and it is that we cannot do all at one time. If the Survey is to be in any way uniform and exhaustive, it must be undertaken methodically and carried on systematically. It must be started at one end and brought forward step by step till the other end is reached. It is an analytical, not a synthetic work, and the synthesis will, if at all, be possible only when the analysis has been brought to bear on all the extant materials and these have been made known in their entirety. I have already spoken about the necessity for the editor to settle down himself in the centres of bardic and historical activity and to have access to the original sources. It goes without

saying that he cannot be in different places at the same time, nor make a contemporary study of works belonging to distant and different States. Rajputana, even without including Malwa and other parts of Central India and Gujarat, which also possess some bardic and historical literature, is a very vast country and each State in it has a separate history of its own. Even if manuscripts could be contemporaneously supplied from all the States, it would be a foolish attempt for the editor to try to master all their different histories at one and the same time, and the results, if any, would be most imperfect and defective. He must do one State at a time.

By this I do not mean to say that the other States should be completely left to themselves till their turn comes. Some of them are deeply interested in the Survey and eager to help the Government of India in their undertaking, and in this case advantage should be taken of their spontaneous offers of services. The State that best of all has been alive to the importance of the work and shown its thankfulness to the Government of India for an undertaking that will bring to light unknown pages of the Rajputs' glorious history, is Jodhpur, which since 1910 has been budgetting a yearly sum of Rs. 2,000 to supply the Government of India with materials for the Survey. and if results have not been equal to the efforts made, it is simply for want of proper instructions and a directive mind with the requisite philological knowledge. Second comes Bikaner, which has also been keeping a Bardic Office and would have done much if rightly advised what to do. Other States have been showing their interest in the Survey and have offered to assist the Government in their task, and these are Bundi, Jesalmer, Sirohi, Kisangarh, Partargarh, Dungarpur and Banskara. These States would be greatly disappointed if their offers of services were not readily accepted and appreciated, and on the other hand it would be an incomparable loss for the Survey if the enthusiasm of these States were allowed to cool down, and possibly it would be difficult to rouse it again. It will be therefore necessary to profit by the offers of all the States that are willing to help, and to organize in each of them a Bardic and Historical Office, with the scope of exploring them for information about the manuscripts scattered in the villages and towns in its territory. The results of such a preparatory search, if conducted systematically, will be of great help to the editor when he is ready to settle down in these States and take to publish their bardic and historical literature.

On what State should attention first be concentrated? Practical as well as political and moral reasons combine to show that the first to be made the object of the Survey must be Jodhpur, the State that has been already spending some thousands of rupees for the work and is willing to give all assistance possible, not in empty words, but in facts, for the

success of the Survey. Indeed the help that will be derived from the Jodhpur Darbar is the utmost we can ever expect, and it will be a magnificent example for the other States, which, when their turn comes, will do all in their power to emulate it. Besides this, the Jodhpur State is the richest, as far as I can guess at the present moment, in bardic and historical productions, and its history is perhaps the most important, not only for its grand warlike deeds, but also for its bearing on the history of a number of other States, Bikaner and certain minor ones, which are connected with it in blood and origin. Up to the sixteenth century there is only one history of all the Rāṭhōra States of Rajputana, and this is the history of the Rāṭhōras that founded Jodhpur. It is logical that after finishing with the Jodhpur State, the Survey should take up Bikaner, the oldest and biggest of all the offshoots of Jodhpur, and then by turn Kisangarh etc., all of which, fortunately, are ready to give help. This Survey of the Rāṭhōra States will take eight to ten years at least to complete, and we cannot foresee now what circumstances will make it advisable to do at that time. But this much we can say, that, for practical reasons, the preference shall be given to that State which, besides being rich in materials, will also be most willing to give assistance in the work. It may be Bundi and Kota, or it may be Jesalmer, or it may even be one of the few States, whose leaders, handicapped by exaggerate orthodoxy and obscurantism, have as yet failed to realize the benefit the Government of India is ready to confer upon them by means of the Bardic and Historical Survey, provided they awake from their slumber and take up their position by the side of the glorious Rāṭhōras.

What will be the object of the Bardic and Historical Survey and what the means to attain it? In entrusting the preliminary survey to the Asiatic Society of Bengal in 1905, the Government of India stated that their object ultimately was to have manuscripts of Bardic Chronicles searched for and properly edited, translated and annotated. Here the term "Bardic Chronicles" is rather an obscure and improper one, but it is clear that by it the Government of India mean bardic poems and songs and prose chronicles. Now these are two very different things, and though they can be treated together in the search, they must be kept separate in the editing and publishing. The fact is that whilst bardic poems, when they have any interest at all, always deserve to be critically edited and translated, on account of the literary form in which they are couched; prose chronicles, with very few exceptions, would never pay the pains and cost of editing and translating. They are no finished historical works and have no literary claims: they are simply a source of historical information, a rich mine of rough gems, which will only shine after they are polished and arranged in a necklace. They are no histories, but simply

materials for the history. In the case of them, therefore, if they are to be taken into account at all, as they certainly ought to be, an altogether different method should be adopted from that in the case of bardic poems. They should be searched for and classified by means of a Descriptive Catalogue, so that they may all be ready for reference, and their contents critically examined and compared with a view to ascertaining their historical value and discarding doubtful and fictitious matter from authentic information. It is only authentic information that deserves to be published, and it should be given in the form of a connected History. In the particular case of Jodhpur, prose-chronicles are exceptionally faithful and reliable and their dates correct from the time of Rāva Jōdhō (first half of the sixteenth Samvat century) to the present day, but as regards the antecedent period traditions are doubtful and dates wrong. Two important dates, the one referring to Rāva Sīhō (Samvat 1330) and the other to his son Dhūhara (Samvat 1366) have been fixed from inscriptions recently discovered, and it is evident that it is only from inscriptions we can now derive the means for checking and correcting the chronicles of the earlier period in the Rāthōra history. That inscriptions referring to all the descendants of Sīhō as far as Riṇamala are in existence, can hardly be doubted, and if a proper search is made in the historical localities where they are most likely to be found, many new materials are sure to come to light. I shall return to this point later on, when treating of the search for bardic and historical manuscripts, and will show that both the search for manuscripts and that for inscriptional records can and should be carried on together.

Bardic poetry includes poems of some extension (*vēla*, *jhūlanā*, *rāsō* etc.) and small historical songs (*gīta*, *kavitta* etc.), of which rich collections have been preserved in manuscripts and go under the general name of *phutakara gīta*. A good number of these are anonymous and some, no doubt, very old, though they have been much modernized in form, as might be expected. As regards the publication of bardic poems, it is obvious that, when important and interesting, they should be published separately as literary texts, and their historical value examined and discussed in introductions to each of them. They should also be accompanied by English translations and notes, without which they would be of very little help even to the average Hindi scholar. As regards the publication of the small songs, there are some distinctions to be made. Songs referable to a single poet, of whom the name has been preserved, should be collected and, if sufficient can be obtained, they should be published together as one body, under the name of the author, and this in view of the fact that literary compositions by one author are his property, and whatever their contents may be, reflect his personality, and the unification of

an author's personality is more important than any classification according to contents, form, etc. If these songs are not in a sufficient number to make a separate publication, they can find place in the *Bulletin*, of which I shall speak presently. Anonymous songs, which cannot possibly be unified nor referred to any author or definite period, should be grouped together according to their contents under the name of the historical personage to whom they refer, and in whose lifetime they have possibly been composed. Many of these songs are real historical documents and the oldest of them form a most valuable supplement to the accounts in the prose-chronicles and should necessarily be taken into consideration in the compilation of the History.

In addition to the special publications above advocated,—viz., a Descriptive Catalogue of Bardic and Historical Manuscripts, and a Series of Bardic and Historical Texts, a publication for matter of a more miscellaneous nature will obviously be required. This is the *Bulletin*, which has just been mentioned. It should be a quarterly journal containing—besides the necessary information concerning the work and administration of the Survey, like progress reports, annual balance, etc., notices of the most important discoveries, both literary and inscrip-tional, brought to light by the search, articles on bardic and historical arguments, editions of small scattered songs that could not be published separately, in short all that minute and multiform information which cannot be given except in a periodical and is important enough to be given out as soon as at hand.

Let us now turn to consider the means by which the objects before described can be gained. The chief object of the Survey being that of editing, it goes without saying that most, if not all, of the responsibility of the work will fall on the editor, and it is therefore reasonable that the editor should have the power of controlling all other officers in the Survey, who should work under his supervision, for it would be absurd to make him responsible for the work of people beyond his control. That the search and, in part, also the publishing are subordinate to the editing is plain enough when we think that the ultimate scope of the search is to supply the editor the proper and sufficient materials on which to work, and nobody except him can judge of the value of these materials; whereas the scope of the publishing is to give his work a permanent form, and nobody better than him can see that the execution is correct.

The editor should, of course, be a European scholar or a native scholar trained in Europe, for he will have to deal with almost virgin languages, whereof grammar and lexicon, as well as origin and connection with the other old and modern Indo-Aryan vernaculars, are only to be ascertained and fixed accord-

ing to the strict principles of modern philology. And he should reside in the very country, whereof the bardic and historical literature is to be searched into and published, so that he may be able to make himself acquainted with local conditions and utilize all the helps that can be derived from local scholars and manuscript collections. He should have two assistants: a Mārwarī Paṇḍit and a Cāraṇa, the former to help him in the reading of prose chronicles, in the study of modern Mārwarī and general matters, and the latter to help in the reading of bardic poems and the interpretation of Diṅgaḷa. Since the assistance of the Cāraṇa will not be required continuously, the editor should manage things so as to have him on assistance-duty on certain days, say about fifteen days in a month, and free during the remaining days when he could be sent on tour to make a search for the manuscripts with the Cāraṇas in the villages. He would thus work both in the editing and in the searching department, but in the latter his sphere of work would include only the Cāraṇas, his fellow-brothers, who could never be successfully approached except by a Cāraṇa himself. For similar reasons the task of approaching the Bhāṭas and all other kinds of bards and possessors of manuscripts, should be imposed on a Bhāṭa or other inferior bard, and since he will have to carry on the exploration village by village and be permanently on touring duty, this man must be considered as the chief travelling agent in the search. He should also be entrusted with the search for inscriptions, copper-plates and any kind of antiquarian remains that may be of help to history,—a task which he can easily carry out contemporaneously with the search for manuscripts. The results of the search as carried on by these two travelling agents, the Bhāṭa and the Cāraṇa, cannot be expected, of course, to be anything definitive, but only preliminary to a more careful investigation to be made by the editor into the materials thus brought to his knowledge. In the case of rich and important collections, he would go to see them himself, in the case of small ones he would try to obtain a loan. The first object of the search will be the publication of a *Descriptive Catalogue*, in which all manuscript materials are collected and classified, and the purchase of as many manuscripts—in no case very many—as can be secured. The discoveries of antiquarian records should be made public in the *Bulletin*, as suggested above. One more employee will be necessary for the searching department, namely a copyist. Manuscripts of great philological value or unique manuscripts, which cannot be secured and might get lost in the course of time, should be copied to preserve them from possible destruction. The copyist need not be a scholar, on the contrary must not be a scholar, as a scholar generally makes the worst copyist, but should be well acquainted with old manuscripts and be directly trained by the editor to work on

the proper lines. As a rule, he will have to work in the editor's office, though exceptionally he may be sent into the *mofussil* to copy manuscripts which are not allowed on loan.

This much as regards the work and staff under the editor, who so far is the highest and only responsible person here. His proper designation would be "Editor and Local Superintendent of the Bardic and Historical Survey of Rajputana." Now, whoever he may be, it is obvious that some sort of control must be exercised on this man, who, as will be seen further on, is to be the sole arbiter and manager of a survey costing about twelve thousand rupees, and on whom all the success of the work depends. Though it is not for me to point out the person who is to exercise this control, yet it may not be out of place here to make some considerations in regard to a point which is of no small importance for the success of the survey.

The work has so far been entrusted to the Asiatic Society of Bengal since 1905, when the Government of India placed Rs. 2,400 at its disposal for a preliminary survey. The first four years passed without anything being done, as the Society could not find a man for the work. In 1909 Mahāmahopādhyāya Hara Prasāda Śāstrī was appointed and spent the Rs. 2,400 in making three tours in Rajputana and publishing a *Preliminary Report* containing the scheme alluded to above. This preliminary report took four years to prepare and yet has little real value; and the foolscap-copies prepared by the Jodhpur Bardic Office under the Śāstrī's directions are worthless for philological purposes. In fact, eight years have been wasted without any practical results, and one, possibly the chief, reason of the failure was the impossibility for the Asiatic Society of Bengal to realize the actual needs and conditions of a work that was to be carried on in so distant a country as Rajputana. In 1914 the Government of India appointed me to edit the materials so far collected by the Society. They were possibly misled by Mahāmahopādhyāya Hara Prasāda Śāstrī's report, in which it was stated that materials for the editor had been collected; for no one could have suspected that these materials were absolutely useless. My appointment was therefore made under the Asiatic Society of Bengal, and I was enjoined to proceed to Calcutta. Seeing that there was nothing to be done there, I applied at once to be allowed to transfer myself to Rajputana, but since my application had first to go before the Council of the Society and had then to be communicated to Government through the Society, about three months elapsed before I was able to start. If the present Scheme is put into execution, the situation will be an altogether new one. The central office will be permanently transferred from Calcutta to Rajputana, and both the searching and the editing

will be coordinate and localized. Under these new circumstances will it still be convenient to keep the Survey under the control of the Asiatic Society of Bengal?

There are three sides to this question; a practical, a moral and a political one, and they should all be taken into consideration by the Government of India and also by the Asiatic Society of Bengal. The first is the distance of Calcutta from the field of the work, which means an impossibility on the part of the Society to judge of the adaptability of the plan followed by the editor to the local conditions and needs of Rajputana, a retardation in the progress of the work, if the editor and local superintendent is to communicate with the Government through the Society, and lastly a certain waste of time and money which will necessarily be involved in the editor's periodical visits to Calcutta and in all his dealings with the Society. The second or moral side of the question is the diminution in prestige that will be suffered in a country like Rajputana if the Survey is represented as the undertaking of a private society of which most of the inhabitants have never heard, instead of that of the Government of India, and the consequent diminution in efficiency. The Asiatic Society of Bengal is a name without meaning to most, if not all, of the native people with whom the Survey will have to deal, not to say an hostile one, in so far as it indicates an alien province with which Rajputs and bards keep no connection and which they would not like to interfere in their affairs. The third point is a political one. The Bardic and Historical Survey of Rajputana is a work such as cannot be done except with the consent and co-operation of the States concerned. In the States that are hostile and diffident it would be both vain and dangerous to undertake even a mere search. In the States that are willing to give help, the work should be organized and carried on in agreement with the political circumstances, and the editor and local superintendent should keep in continuous touch with the various Darbars, submit to them periodical reports, plans and suggestions, consult them on the means to be adopted in particular cases, make inquiries as to how they approve of his work, and keep their interest constantly awake. Now, all this cannot be done through nor in the name of the Asiatic Society of Bengal, but only through the political agents to the Government of India, who should be consulted as to the advisability of adopting any particular course, or putting before the Darbar any particular question. Indeed the very plan of the Survey is to be drawn in accordance with political conditions, and the proof is in the present Scheme which is especially made for one particular State, in which political conditions are most favourable.

The three points discussed above combine to show, in my opinion at least, that if the control on the Bardic and His-

torical Survey be transferred from the Asiatic Society of Bengal to the dependence of the Agent to the Governor General in Rajputana—who might take the title of Honorary Superintendent—the Survey would gain both in local prestige and in efficiency. The control to be exercised by the afore-mentioned Political Agent would be, of course, chiefly administrative and political; the scientific criticism of the publications being left to the scholars in the world that are specialists in the subject. The services of the Asiatic Society of Bengal will be chiefly useful in the matters of printing and publishing, and of preserving the manuscripts that are collected.

There are two points in the Survey which are not taken into consideration in the present Scheme. One is the Bardic and Historical Literature of Gujarat, and the other the oral bardic songs. As regards the former, I need hardly say that the reason for not taking it into consideration is simply the impossibility of carrying on the exploration of Gujarat at the same time as that of Rajputana. I have shown that the work must be done gradually and systematically, State by State, village by village. After finishing with Rajputana, the turn of Gujarat may come, and we shall possibly have a separate Survey of this country too. As regards the oral bardic songs, I think their importance has been much exaggerated. There is no doubt that there are oral songs recited by illiterate bards and transmitted from father to son, but how many of these are actually extant only in oral tradition and never were committed to writing, nobody can say. The search only will tell. It goes without saying that, should any valuable oral song come to the knowledge of the editor, he will try to put it into writing with a view to editing it, a task which he will be able to carry out himself with his ordinary means and the help of his assistants. Under no circumstances should the taking down of a song be entrusted to a common scribe, nor to a literate bard; for in both cases the results would be most fallacious. In the case of oral songs the reciter plays the rôle of a manuscript—the most recent manuscript possible—and should be referred to directly.

Let us now turn to the consideration of the details and figures in each of the three departments of the Survey: the editing and local superintending, the searching, and the publishing.

THE EDITING AND LOCAL SUPERINTENDING DEPARTMENT.

This department includes three officers: the editor and local superintendent, and his two assistants in the editorial work—a Pandit and a Cāraṇa. The former is appointed by the Government of India, whereas the two latter, as well as all other officers in the Survey, are selected by the former

from amongst the persons he thinks best qualified for the work. The editor has a full control over all his subordinates and can dismiss them and put others in their place whenever circumstances may seem to require it. A changing of the subordinates will be particularly necessary whenever the central office shall be transferred from one seat to another, as people of one State cannot be expected to be intimately acquainted with the bardic and historical literature of another State, though in the particular case of States connected in blood, language and history, as for instance Jodhpur and Bikaner, the same men may perhaps be successfully utilized. The services of all subordinate officers being accordingly required only for a certain time, their employment will be considered as a temporary one.

As regards the nature and conditions of the appointment of the editor and local superintendent, I hardly like to make any suggestions, lest I might be accused of writing in support of my own interests. But it may not seem too much to ask that, since the Bardic and Historical Survey of Rajputana is such a vast work that it can never be hoped to be completed in one's lifetime, the appointment be made a permanent one and considered as an appointment under Government. I am only twenty-six now and am ready to spend all my life in the service of the Government of India, for a work that is a labour of love with me. I have been called to India on a trial appointment for one year on a stipend of Rs. 500 per mensem. If the present Scheme and specimens of publications are a sufficient testimony to my being qualified for the work, my appointment might be made a permanent one from the first of April 1915, and the stipend of Rs. 500 a month be considered as an initial one to be increased according to the Indian Educational Service Regulations.

The stipend of the Mārwarī Paṇḍit and of the Cāraṇa would be Rs. 600 and Rs. 420, respectively. For the former I would appoint Paṇḍit Rāma Karṇa of Jodhpur, a Dahimā brahman, aged 55, who has made a particular study of the history and antiquities of Marwar as well as of inscriptions, and is versed in Sanscrit as well as in Hindī and Mārwarī. His designation would be "First Assistant to the Editor etc." For the Cāraṇa or "Second Assistant", I would appoint Kiṣōra Dāna of Lōlāvas in the *parganā* of Jodhpur, a Bārāṭha Cāraṇa, aged about 40, who is by far the best learned bard I ever came across in Marwar. As noted above, the latter assistant would work half time in the editing and the other half in the searching department, but his appointment should be considered as properly belonging to the editing, where his services are more urgently required.

The seat of the Editing and Local Superintending Office will be Jodhpur, as long as the Survey has to deal with the

history and literature of this State, which means a period of time certainly outreaching the five years for which the present Scheme is made and a grant is asked from the Government of India. At the end of each year a detailed report, giving an account of the progress of the Survey as well as annual balance etc., will be submitted to the Government and copies sent of all publications made during the year. The building for the office will be freely given by the Jodhpur Darbar. The editor and local superintendent should be given the use of service stamps and letter paper for his office-correspondence, the sending of books etc., and the privilege should be extended also to the two travelling agents in the searching department. Putting down Rs. 36 (Rs. 3 a month), as the annual cost of office stationery, including registers, foolscap-paper, ink, etc., and Rs. 48 (Rs. 4 a month) as the cost of stamps and letter-paper, the figures in the editing and local superintending department would be the following:—

	Rs.
Stipend of the editor and local superintendent	6,000
" " first assistant	600
" " second assistant	420
Office stationery	36
Service stamps and letter-paper	48
Total Rs. ..	7,104

THE SEARCHING DEPARTMENT.

As remarked above, the search is to be carried on first by sending round two travelling agents, a *Bhāṭa* and a *Cāraṇa*, and then by the editor and local superintendent visiting himself the places, which are so rich in materials or so important as to require it. The search will be carried on in this way. First a circular letter from the *Mehkma Khas* will be sent to the chief authority in the villages that are to be visited, whether he be a *Hakim* or a *Jagirdar*, informing him that an officer of the Bardic and Historical Survey will pay him a visit on such and such a day and enjoining him to have previous enquiries made as to who are the *Cāraṇas*, *Bhāṭas*, *Pancōlis*, *Sēvagas* etc., living under his jurisdiction and see that all these people are found in the village on that day. Much cannot be expected from this circular letter, but it will serve at least to prepare the ground for the visit of the travelling man, and if any enquiry at all is made, it will be so much gaining of time. About eight or ten days after the circular letter, the *Bhāṭa* shall visit the place, and, if nothing has been done, shall have enquiries made immediately, see all private collections of manuscripts, with the exception of those with the *Cāraṇas*, make a rough list of the manuscripts in each

collection, and enquire about antiquarian remains, inscriptions and copper-plates in the village and neighbourhood. The reason for which he should not be allowed to interfere with the Cāraṇas is not only the well-known rival feeling extant between Bhāṭas and Cāraṇas, but also the impossibility for a single man to carry on all the searching work and the consequent necessity of having the work divided with another. On receiving the Bhāṭa's report, the editor will be able to judge if the places in question deserve to be visited by him or not. In case they do, the editor shall visit them taking with him his first assistant and, if Cāraṇas are reported to be there, his second assistant too. It is obvious that only in case of very rich collections or very important antiquarian remains, a visit of the editor will be required; in the case of small collections, it will be sufficient to send over the Cāraṇa, or second assistant, who shall visit the Cāraṇas left out in the first visit, and try to procure, whether by loan or purchase, such manuscripts in the list submitted by the Bhāṭa as may seem important. Important manuscripts that cannot be purchased, but can be obtained on loan, shall be copied by the scribe in the office; and only manuscripts that cannot be had on loan, which will be very rarely the case, shall be copied on the spot.

It is a fact that possessors of Bardic and Historical manuscripts in Rajputana generally disdainfully refuse to part with them, and therefore a very rich collection of manuscripts can never be expected from the search. But I have shown that in our case there is not so much need of collecting manuscripts, as of compiling a *Descriptive Catalogue*. Some original manuscripts, however, can be collected, and most, if not all, can be borrowed and copied, if necessary. To avoid distrust, for any manuscript that is asked on loan, besides a regular receipt, a sum corresponding to the value of the manuscript should also be given as a pledge, on the understanding that it be refunded when the manuscript is restored to its proprietor. In this way borrowing may become a means for securing manuscripts, inasmuch as in many cases lenders, who could never be induced to sell directly, when asked to refund the sum and take back the manuscript, will prefer to keep the former and renounce the latter. In fact the sum that is given as a pledge is soon spent and when the time of the refunding comes, the lender is very likely to view the thing in the light of a purchase and possibly think that his manuscript is not worth the money. Another device for securing manuscripts, which may be successfully used in some cases, is to offer the proprietor a new and accurate copy in exchange of the old and worn-out manuscript in his possession. All these means, of course, should be used only in the case of important manuscripts, that deserve to be preserved.

Now, as to the charges in this department. The first

travelling agent—for whom I propose to appoint Bhāṭa Nānū Rāma of Jodhpur, his age about forty, a very keen explorer, to whom we owe the discovery of both Sīhō's and Dhūhara's inscriptions—shall be given a pay of Rs. 300 (Rs. 25 a month). He will be on permanent travelling duty, and will therefore get travelling allowances for 365 days, which, at the rate of Re. 0-4-0 a day, make the annual sum of Rs. 91-4-0. The travelling expenses of this officer may be calculated at the average of Re. 0-8-0 a day—the cost of hiring a camel—which comes to Rs. 180 a year. This sum will also cover occasional use of railway. The second travelling agent, i.e., the Cāraṇa, gets his pay from the editing and local superintending department. He will have to tour 15 days in a month, i.e., 183 days in the year, for which he will get Rs. 68-4-0 as annual travelling allowances, calculated at the rate of Re. 0-6-0 a day. His travelling expenses would theoretically come to half those of the Bhāṭa, i.e., Rs. 90 a year, but since, owing to his being an assistant in the editor department, he will have to make a larger use of railway to go from Jodhpur to the field of research and from this back to Jodhpur, an additional provision of Rs. 3 a month, i.e., Rs. 36 a year, should be made for him, which added to the Rs. 90, representing the cost of entertaining a camel for half the period in the year, make Rs. 126.

The editor and local superintendent will have to spend about 6 days in a month in touring, i.e., 72 days in a year. To save time and money, he will arrange his tours so as to make them as few and at the same time as comprehensive as possible. He will go by railway—when railway is available—close to the field of research, and thence by camel to each village in the neighbourhood that deserves to be visited. Supposing that out of the 72 days in the year, he has to travel by camel 36 days and when travelling by camel makes about 12 miles a day, and out of the other 36 days has to halt 12 and travel by train 24, his mileage allowances for the 36 days will be Rs. 216, and his halting allowances for the 12 days Rs. 60. He will always be accompanied by his first assistant who will get Rs. 27 as mileage allowances for the 36 camel-days, and Rs. 6 as halting allowances for the 12 halting days. When travelling by camel, the editor and his assistant will require four camels, which mean an expense of Rs. 2-0-0 a day, i.e., Rs. 76 for the 36 days. When travelling by railway the editor will incur the average expense of Rs. 6-9-6 a day (first class), which doubled comes to Rs. 13-3-0, i.e., Rs. 316-8-0 for the 24 days. The railway expenses of the first assistant will be Re. 1-2-6 a day (intermediate), i.e. Rs. 27-12-0 for the 24 days, which doubled is Rs. 55-8-0. The above railway charges are calculated on an average distance, equal to half the number of miles from Jodhpur to the farthest station in Marwar (Jasvantgadh, 149 miles).

The editor and local superintendent will also have from time to time to visit the capitals of the States that are willing to start a Bardic and Historical Office and help the Survey by making a preliminary search of the materials in their territory. Visits to other States will also be necessary in particular cases and chiefly in the case of places that possess some materials connected with the history of Jodhpur, or places in which some very important discovery is reported to have been made. For such visits to places out of Marwar an annual sum of Rs 500 should be given as a travelling fund. Two other funds will be necessary to the Survey and these are a fund for purchasing and borrowing manuscripts, say Rs. 300 yearly, and a reward fund, say Rs. 200, for giving rewards to the travelling agents for any important discovery made by them in order to stimulate them to action. It is only by tempting them by the lure of a reward that they can be made to work so as not to leave anything unexplored, and this is the reason for their stipends being kept rather low in the present Scheme.

Under the searching department fall the pay of the copyist, Rs. 180, and the cost of writing paper for him and the two travelling agents, which may be calculated at Rs. 3 a month, i.e., Rs. 36 a year.

The following is a prospectus of the figures covering the charges in this department :—

	Rs.	As.	P.
Stipend of the first travelling agent ..	300	0	0
His travelling allowances for 365 days ..	91	4	0
His travelling expenses in 365 days ..	180	0	0
Travelling allowances of the second travelling agent for 182 days.	68	4	0
His travelling expenses in 182 days ..	126	0	0
Mileage allowances of the editor and local superintendent for 36 days.	216	0	0
His halting allowances for 12 days ..	60	0	0
Mileage allowances of the first assistant for 36 days.	27	0	0
His halting allowances for 12 days ..	6	0	0
Travelling expenses of the editor and local superintendent in 72 days (including camel-expenses of the first assistant).	392	8	0
Railway expenses of the first assistant in 24 days.	55	8	0
Travelling fund for visiting bardic and historical centres out of Marwar.	500	0	0
Fund for purchasing and borrowing MSS.	300	0	0
Reward fund	200	0	0
Stipend of the copyist	180	0	0
Stationery	36	0	0
Total Rs. ..	2,738	8	0

THE PUBLISHING DEPARTMENT.

Whatever the Government of India's views and decision concerning the proposed dependency of the two former departments on the Agent to the Governor General in Rajputana may be, it is certain that in the publishing department the expert advice and help of the Asiatic Society of Bengal will be very useful to the Survey. The Government of India ought, I think, to take advantage of the Society's willingness to help in the work and have all publications of the Survey printed at the Baptist Mission Press, Calcutta, under the auspices of the Asiatic Society of Bengal. Again, the Society might be made the depository of the publications of the Survey and be entrusted the sale of them. Bardic and historical manuscripts collected by the Survey might also be committed to the custody of the Society and so, when the Survey will cease to exist after having fulfilled its task, the Society would remain as the custodian of all the work done and all the materials collected, except epigraphic records (stone-inscriptions and copper-plates) which may be sent to the Rajputana Museum in Ajmer.

Three kinds of publications of the results of the Bardic and Historical Survey have been advocated above, and it is advisable that all the three should be printed on the same paper and size so as to form a uniform and unique collection, though divided into three sections. The size that seems to be the best suited for all the three purposes, is that adopted for the *Indian Antiquary* and *Epigraphia Indica*, and also the new series of the *Bibliotheca Indica* published by the Asiatic Society of Bengal. The three publications are the following :—

(1) The *Bulletin of the Bardic and Historical Survey*, a quarterly publication, containing, besides progressive reports of the Survey etc., notices of important discoveries in regard to manuscripts as well as historical remains, editions of small bardic songs, articles on bardic and historical subjects, and similar multiform and minute information which cannot be given except in a periodical. Each number will consist of two forms for 16 pages, which will make 64 pages in the year. The *tirage* will include 500 copies and the annual cost according to the estimate of the Baptist Mission Press, Rs. 3 a page, will be Rs. 200.

(2) The *Descriptive Catalogue of Bardic and Historical Manuscripts*.—This publication will be divided into three sections: one containing descriptions of manuscripts of prose chronicles including *Khyātas* and general historical information, another containing descriptions of manuscripts of bardic and historical poems, and the third containing descriptions of collections of miscellaneous bardic songs (*phutakara kavita*). They will be printed separately, though, as far as possible, contempo-

raneously, and each section will include a series of *fasciculi* issued in succession and forming a whole. Supposing 200 pages can be printed yearly, which is quite reasonable, the cost for 500 copies would be Rs. 600.

(3) *The Series of Bardic and Historical Texts.*—This series will include works large enough to be printed by themselves and having both an historical and a literary interest. Each work will make two parts or volumes: one containing the text with philological introduction and critical notes, and the other, the English translation, with historical introduction and explanatory notes. The first part will be presented in the light of a literary work, the second in the light of a historical document. The number of copies will be 750 as a rule, but in particular cases, and chiefly in the case of very popular poems which can be sold very largely in Rajputana, it will pay to have some four or five hundred more copies made of the part containing the text. Putting down 350 as the average number of pages, inclusive of both text and translation as well as introductions, that can be printed in the year, the cost at the rate of Rs. 3-6-0 a page would be Rs. 1,181.

To sum up, the figures in this department would be the following:—

	Rs.
Cost of the <i>Bulletin</i> , 64 pages yearly ..	200
Cost of the <i>Descriptive Catalogue</i> , 200 pages yearly.	600
Cost of the <i>Series of Bardic and Historical Texts</i> , 350 pages yearly.	1,181
Total Rs. ..	1,981

The *khyātas* or prose-chronicles, as remarked above, will neither be edited nor translated, but first collected and classified into a *Descriptive Catalogue* and then utilized for a *History of the Jodhpur State*. For the printing of this *History*, when ready, there will be no need of asking for any special grant from the Government, because the Jodhpur Darbar, who are taking a very deep interest in the matter and have been keeping—though without any practical results—an Historical Office for about 30 years, are very likely to take the charge on themselves. *Vātas*, when found to be interesting, can be published in the Series.

Putting together the charges in the three different departments, and adding Rs. 200 as a fund to meet contingencies, the total amount necessary for the bringing into execution of the present Scheme is the following:—

		Rs.	As.	P.
Editing and Local Superintending De- partment.		7,104	0	0
Searching Department	2,738	8	0
Publishing Department	1,981	0	0
Contingencies Fund	200	0	0
		<hr/>		
Total Rs.	..	12,023	8	0
		<hr/>		
Rs.	..	12,000	0	0

APPENDIX I.

SPECIMEN-PAGES OF THE SERIES OF BARDIC AND HISTORICAL TEXTS.

(a) *Dingala Text.*

॥ दूहा ॥

जीवत म्रित हुइ साहिजाँ दिल्लीवै सुरताँण ।
 राति दीह अंदर रहै नह मंडै दीवाँण ॥ ९ ॥
 धुंध हुवै सारी धरा सहर दिली पड़ि सोर ।
 मुहिमु ऊँता त्याँ मंडियौ ज्याँ सोहिजादाँ जोर ॥ १० ॥
 गुज्जर धरा मुराद ग्रहि दुजड़ौ तोलि दुबाह ।
 माथै कुत्र मंडाडियौ ऊइ बैठौ पतिसाह ॥ ११ ॥
 धर पूरब सूजौ धणी दिखणी खरौ दुगाँम ।
 साहिजहाँ दारासुकर त्याँ सिर कोपै ताँम ॥ १२ ॥
 हिंदू ताँम हकारिया सिंघजसौ जैसिंघ ।
 क्रिया विदा कूरम कमंध औ वेवै अरडिंग ॥ १३ ॥
 दिया वधारा देस दे हैवर द्रव्व हसत्ति ।
 पतिसाही थाँ ऊपरा यँ कहियौ असपत्ति ॥ १४ ॥
 सुजा दिस जैसिंघ सजि दूजौ माँन दुबाह ।
 पोतौ साथै परठियौ पूरब धर पतिसाह ॥ १५ ॥
 साँहिजादाँ विऊँ साँसुहौ एक जसौ अणभंग ।

माँडण असपति माँडियौ जोधकुलोधर जंग ॥ १६ ॥
 दलवादल ताबीन दे हिंदू मुस्लिमाँण ।
 चकतै जसौ चलावियौ जुध मंडण जमराँण ॥ १७ ॥

॥ छंद भुजंगी ॥

जसौ हालियौ आगरा हँति ज्याराँ ।
 लियाँ साह रा उमराँ सब लाराँ ।
 कमंधाँ वडाँ कूरिमाँ साथि कौधाँ ।
 लजाधंभ सीसोदियाँ लारि लीधाँ ॥ १८ ॥
 हाँडा गौड़ जादम्म भाला हठाला ।
 वले वंस क्वीस साथै वडाला ।
 गाँडी गालि गोला चलै फौज गज्जं ।
 धरा व्योम आधोपरै ऊडि धज्जं ॥ १९ ॥

(b) *Variae lectiones.*

9. SNIGDD घत; R घत; SD होय; I उय; T उये; R उवे;
 G व्हे (?); D हवी; S साहिजहाँ; DR साहजिहाँ; D साहिच्याँ; TSIR
 दिलीवै; N दिहौचै; D दीलीरो; T सुरिताण; IGDDR रात; SIDR
 दिवस (for दौह); R ईंदर; T यंदर; S नांह; G नहीं.

10. SG धंध; TID दुंद; T उद; DR उवै; I होय; ND उवो;
 S सैहर; D सहिर; IGR पड; T मुहौम; NIDDR मुहसु; S मुहसु; D
 सहातदपि (sic! for सहर दिली); TG जाँ (for त्याँ); N सीई (for
 त्याँ); D तिहाँ; T माँडियौ; N मंडीय; TG जाँ; N जिहाँ; D साहीजादाँ
 मिर जीर.

11. TIDR गुजर; SG गूजर; D गुजरा; IR घह; ND गहि;
 TSIGDR तोल; DD विजडो; (for दु०); N मंडावीयो; I मंडायैन;
 D मंडायनै; SR होय; IG उय; NIGDR पतसाह.

12. TDR: दपणी; N दिष्ण; T साहिजादौ (for साहिजहाँ)
 दुधार G द्वार; R दुवार; D धारा; TG तां; पीजे (for कोपै).

13. TGDR हींदु; NIDD जाम; TG साहिजिसौ; I सीहजसौ

N क्रुरम; NR कमधः N वेई; I वे; R वेऊंवे; ND अरिडंम; TGR अरडीम; D अरिडंम.

14: T दे; TGR हैमर; NID हैवर; TIG द्रव; SD द्रय; N द्रय; R दरव; TIGDR हसत; SND हसति; NIDR पत०; TNGD ऊपरै; D ईयू; TG थां; D कहदियो; TIGR असपत; SNDD ०पति.

15: TG सुभो; N सुभै; D सुजै; TG जैसीघ सभि; I दे (for सजि); N दुजड़ो, दुबाह S साथि; N ०थ NIGR पत०.

16: TSGD दुऊं (for बिऊं): D दुऊं साहिजादां सां०; S सांमुहै; TNIGDR सांमहो; D जोसो; S असि०; ND मंडियो; TIGDDR कलो०.

17: TG ताबौष; T दे; TGD हीदू; DR हीदु; TGD सुसलि०; S सुसल०; NIDR सुसलमान; ND चकथै; I चषथै; DR चगथै; N युध; TG घष जाण.

18: TG आगरै; IGDDR हंत; TGDDR जारां; DD ऊवरां; TNG सर्व; DD सर्व; R सब; TIG कूर०; N क्रुरि०; NID साथ लौधां (for लारि लौधां); SDR संग लौधां.

19: TNGDR जादम; SID जादव; I हयाला: T वलै; I बत्तीस; R बत्तीस; SNIGDDR नाल; TSIGDR ०जं; TGDR वीम; I ०फिरै; R ०फरां; TSIGR ०जं.

(c) *Critical and Philological Notes.*

9: दिखीवे is evidently < दिखिपति (cf. चखव < चक्रपति in verse 2), a compound whereof the meaning seems to have been obscure to some later copyists who substituted दिखी चै (N) and दिखी रौ (D) for it.

राति. A Cāraṇa will say that this form is wrong and should be corrected into रात. But राति, from Ap. रति < Skt. रात्रि, is the regular form in Old Western Rājasthānī and Old Dīngala, and only in the Modern Mārwarī period the terminal र has been dropped, according to a general law that seems to have been in force in the beginning of the modern period in the Neo-Indian vernaculars. In the Old Baiswarī of Tulasī Dāsa the र is still retained.

10: पड़ि is for पड़े, the form for the 3rd singular present indicative. Examples of अड़ (> ऐ) being simplified into अ are very common in the Old Western Rājasthānī (see *Notes*, §10 (1)). In this case too, the Cāraṇas would nowadays write पड़.

11 : ग्रहि, the feminine form of the past participle passive, with ई shortened to इ for the sake of prosody.

तोलि, a conjunctive participle, in which the weak termination इ is still retained. Modern Dīngāḷa has now तोल. One of the characteristics of Mārwarī, in comparison with Gujarātī, is the preference for the weak form of the conjunctive participle, in substitution for the strong form in ई, that was general in Old Western Rājasthānī.

12 : दारासुकर is a poetical modification of दारासिकौ, evidently introduced to create a contrast in meaning with the दुर्गम in the preceding half-verse.

13 : अरडिंग is one of those words, whereof the etymological meaning is no longer clear to the Cāraṇas. I feel inclined to take it as अरि डिंगणवालो. i.e., "pusher back of foes," an etymology which is in perfect agreement with the sense in which the word is employed.

14 : देवर. Here the *anunāsika* is inorganic, the word being from Skt. हयवर, but it is supported by the evidence of the equivalent form देसर, in which the स cannot be explained unless by admitting an antecedent व. It therefore appears that the word हयवर had come to be considered as a single word, instead of a compound. Cf. the analogous case of तयवर.

15 : The form स्रज, which is found in the MSS. *N D*, points to an influence of the Thālī. Cf. सांसुदे (S) in the next verse, and आगरै (TG) in verse 18.

16 : The reading दुडुँ for बिडुँ is an evident modernization, बिडुँ is the regular Old Western Rājasthānī form. See *Notes*, § 81.

कुलोधर, an irregular Sanskrit compound, probably staying for कुलोदर and meaning कुल रौ उदार करणवालो.

17 : मुसल्लिमाँष. The substitution of इ for अ in open syllables is one of the characteristics of Mārwarī. Cf. खिमा < Skt. क्षमा. किंवाड़ < Skt. कषाट. किन्या < Skt. कन्या, etc. It is reasonable that in the old poetical language, where अ in open syllables is never quiescent as it is in the modern spoken vernacular, the substitution of इ for अ must have a much larger application than in the latter. The bards and *paṇḍits* of Rajputana ignore this fact and consider all forms, in which a quiescent अ is turned into इ, as wrong and attribute them to an influence of the जतिर्याँ रौ बोली, the so-called peculiar jargon of the Jains.

(d) *English Translation.*

9. Being half alive and half dead, Śāh Jahān, the Sultan lord of Dillī, remains night and day in his inner apartments, and never holds council.

10. Disturbances arise over the whole earth and a clamour breaks up in the city of Dillī, [as] the [three] princes by their [simultaneous] march [from their respective provinces] prepared to use force there.

11. Murād, the brave one, weighing his sword, took the country of the Gūjaras, started having the royal parasol [held] on [his] head, [and] set up himself as a sovereign.

12. [In the same way] Sūjō [made himself] lord of the Eastern country, [and so did in] the Southern [country] the actually athwart [Aurangzeb]. Then Šāh Jahān and Dārā Sikō got angry with them.

13. Then [Šāh Jahān] called the Hindūs Jasavanta Siṅha and Jai Siṅha, and dismissed [them both]—the Kūrma as well as the Kāmandha—these two repellers of foes.

14. [And he] gave [them] promotions, by granting land, horses, wealth, and elephants, and [he], the emperor, thus said [to them]: “ [My] empire depends on you.”

15. Against Sūjō having made ready Jai Siṅha, a second Māna [Siṅha] in bravery, the emperor sent with him his nephew, to the Eastern country.

16. [But] to face both the [other] princes, Jasavanta alone, the invincible one [was sent, and thus], to establish the emperor [on his throne], the descendant of Jōdhō made war.

17. Having entrusted [to him] an army of [both] Hindūs and Mussulmans, the emperor sent Jasavanta, the god Yama as it were, to make war.

18. Then Jasavanta moved from Agra, having behind all the emirs of the emperor, taking with [him] the great Kāmandhas and Kūrmas, and having behind the Sīsōdiyās, pillars of dignity.

19. Hādās, Gauras, Yādavas and stubborn Jhālās [are] with [him], and also [other] great [representatives, of the thirty-six [Rajput] families. Carts, guns, balls, troops and elephants march on, and between earth and sky banners wave.

APPENDIX II.

SPECIMEN-PAGES OF THE DESCRIPTIVE CATALOGUE OF BARDIC AND HISTORICAL MANUSCRIPTS.

(a) *Prose Chronicles.*

No. 6. राठौड़ाँ रौ फुटकर कविता तथा ख्यात चौर पौढियाँ .

A MS. in the form of a *vahī*, or account book, consisting of 133 leaves, of the size of 32 $\frac{1}{4}$ " to 11"; accurate and beautiful handwriting. Each page generally contains 26 lines, and each line from 30 to 35 *akṣaras*. The MS. contains :

(a) ख्यात रौ फुटकर कविता, from p. 7b to p. 9b. A collection of miscellaneous songs recording some historical persons or facts. The first is a somewhat disconnected series of verses referring to Prithirāja Cahūāna and Jai Canda. It begins :

ग्यारै सै एकावने । चैत तीज रबिवार ।

कनवज देषण कारणै । चलयौ तु संभरवार ॥ १ ॥

Next follow miscellaneous songs on the Rāthōras of Marwar from Cūḍō to Rāghō Dāsa Dvārakadāsōta. The first one is by Cāraṇa Bārahata Dūdō, and it begins :

असुरां स्रं कौध कमंध असंकित ।

The songs are not given in due order. After a series of 27 *dūhās* on Gaja Singha by Cāraṇa Khiriyō Narabada (p. 9a), the songs come of Karaṇa Rāmōta, Jālaṇa Si, Dvārakā Dāsa Khaṅgārōta, and Rāghō Dāsa Dvārakadāsōta.

(b) राठौड़ाँ रौ वंसावली तथा ख्यात ब्रह्मा स्रं महाराज श्रीजसवंतसिंघजी ताँई, from p. 13a to p. 45b. In the beginning it is a mere list of bare names, but from Sihō the *vamsāvalī* is enlarged into a real *khyāta*, illustrated by frequent quotations of *phutakara kavita*. It begins :

ब्रह्मा १ मरीच २ कश्यप ३ सूर्य ४ मनु ५ इक्ष्वाकु ६ विकुक्क
७ पुरंजय ८ प्रद्युम्न ९ समुद्र १०...etc.

The *khyāta* ends abruptly p. 45b with Jasavanta Singha's marriage at Sirōhī, Samvat 1715:

पकै महाराज जोधपुर स्रं सं० १७१५ चैत सुद ५ असवार ऊआ
दसराहौ सयलाणै कियो पकै वैर मै सीरोही परगिया ॥

Probably the *khyāta* was composed about that time or shortly afterwards.

Between this part of the MS. and the next (c), some disconnected information is inserted, namely :

(1) An account of the Bhātī Māgō having married the daughter of the Cāraṇa Varasarō Māvāla, her name Jhīmā, and having had a son, by name Canda, from her. And :

(2) An account of the feud between the Bhātī Gōyanda Dāsa, a subject of Sūra Singha, and Kisana Singha, and of Sūra Singha's taking revenge on Kisana Singha (Samvat 1671).

(c) राठौड़ाँ रौ खाँपाँ रौ पौढियाँ, from p. 46a to p. 123b. A genealogy of the Rāthōras, according to their different *khāpas*, from Rinamala down to about the end of the Samvat-century 1600. It begins :

राव रिणमल वडौ रजपूत अवसांगसिध राहवेधौ असंघ प्रवाडै
जैतवादी मंडोवर राज क्रियौ सता कन्हा सूं मंडोवर लियौ । राव
चूंडा रै पाट एक वार केहिक वरस कान्हौ बैठौ पक्कै कान्ह कना राव
रिणमल नूं मंडोवर लैण रौ सूंस थौ...etc.

(d) फुटकर ख्यात री वार्ताँ, p. 128b. A few notes on different historical subjects, i.e. the sons of Tīdō and Salakhō, the date of Sīhō's killing Lākhō Phūlānī (S. 1209), of Cūḍō's taking Maṇḍōra (S. 1438) and Nāgōra (S. 1456), the Paṁvāra and Paṛihāra rule on *Navakōṭī Māravāra*, the founding of Maṇḍōra by Paṛihāra Nāhara, the descendants of Nāhara, etc.

The MS. belongs to the collection of the late Kavirāja Cāraṇa Murāra Dāna of Jodhpur.

No. 4. जोधपुर रा राठौड़ाँ री ख्यात. The same work as that contained in the preceding MS. (No. 3), complete in three volumes, leather-bound, in the shape of a *vahī* or Marwari account book, each leaf measuring inches $32\frac{1}{4}$ to $7\frac{3}{4}$, and including from 40 to 60 lines of 16-23 *akṣaras*. The MS. contains the same and identical text as the preceding and, being somewhat older, appears to be the original from which the latter was copied. It is itself a copy of an older original, of which no mention is made.

The first volume consists of 118 leaves, of which the first two were originally left blank, and therefore are not included in the original numeration, though afterwards these were also filled with some subsidiary information, and all the leaves were numbered afresh. The volume contains :

(a) मंडोर का वर्णन, p. 1b. A very short description of Maṇḍōra, in Hindī, not going beyond 29 lines of writing. It begins

अवल में यहाँ मांडय रिसी का आसम था इस सबब से इस
जगे का नाम माडयासम ऊवा इस लफज विगड़ कर मंडोवर
ऊवा हे....

It states that the first inhabitants of Maṇḍōra were Nāgas and supports the statement by quoting the word *Nāgadari*, the name of the torrent which flows at Maṇḍōra in the rainy season, and the *Nāgapañcamī* festival, which is still held there.

(b) कितरौक वार्ताँ नीचला पाँनाँ मैँ बाका रहा तिकै अठै
लिखौ, p. 2a and 3ab, i.e. some subsidiary information to be added to the following text of the *Khyāta*. It comprises three notes: one on Jai Canda and Prithirāja to be inserted p. 5, one on Salakhō to be inserted p. 10, and one on the ancient

history of Marwar. This is written in Hindi. The note on Jai Canda begins :

राजा जेचंद राजसु जिग कियौ जि[ग] मै सारा राजा आया चवांग
प्रथीराज नही आयौ.....

(c) राठौड़ाँ री वंसावली, from p. 4a. to p. 5a. A genealogy of the Rāthōras from the creation to Bharatha—the 123rd in descent from Nārāyaṇa—who is represented as having installed himself on the throne of Kanauja, after killing its Paṃvāra ruler Ajaipāla, in the year Saṃvat 516 or shortly afterwards. The first lines are in a kind of Hindī, corrupted by Mārwarī peculiarities :

ईसवर अरूप है जिस कै जिहान बनानै की म[न]सा हई जब
जमीन पांनी आग हवा आसमान वगैरै पेदा हवै...

(d) राठौड़ाँ री वंसावली तथा ख्यात, आदिनारायण सँ महाराज श्रीजसवंतसिंघजी ताँई, from p. 6a. to p. 117b. In the beginning it is a mere genealogical list of names, borrowed from the Purāṇas, with occasional biographical notes, which become more and more diffuse as we go on, till with *rāva* Sīhō—the 131st in the genealogy—the *vamśāvalī* takes the form of a real *khyāta*. The origin of the Rāthōras is traced to Kalyāṇī, in the Karaṇāṭaka, and thence to Kanauja :

उतन कुंकणदेस गठ कल्याणी करणाटक पछे कनवज थी
कनोजीया कहाणा (p. 6a).

Leaf 9 is blank. For Jai Canda two dates are given, *viz.* Saṃvat 1132 and Saṃvat 1181, the former being the date of his accession to the throne, and the latter the date of his death. He is represented as having had a son by name Varadāi Sēna, who, at his turn, had two sons, Sētarāma and Thirapāla. The former of these was the father of Sīhō. The account of the exploits of Malinātha, son of Salakhō and step-brother of Vīramadē, which is one of the most important omissions in Tod's *Annals of Marwar*, is given p. 10a. ff. Here Malinātha is represented as having made himself king of Khēra, in Mahēvō, Saṃvat 1431. Of his eldest son Jagamāla, it is said that he helped Ghara Sī of Jēsalamēra against the Mussulman invaders. The date of the death of Vīramadē is given as Saṃvat 1440.

With p. 17a begins the *khyāta* of Cūḍō, the first episode related being the well-known legend of the hospitality granted him by Cāraṇa Ālhō at Kālāū.

वीरमजी जोयावटि मै माराणा तरै चूंडाजी री मा मांगलियांगी
चूंडाजी नै लै नै मारवाड़ मै आई सो थलि मै गांव कालाऊ चारण

आल्हा बारठ रै घरै आय मांगलियाणी आय रो आपो क्किपाय रही...
etc.

The particulars of the death of Cūḍō are not related, and it is simply stated, as also remarked by Tod, that he died in battle together with one thousand Rajputs:

पक्कै कवरं रो साथ नागौर सु नीसरीयौ नै राव चूंडो अक
हजार रजपुतां सु काम आयौ (p. 18b).

The history of Cūḍō's successors proceeds in chronological order, and particulars become more and more ample as we come down with the times. The last reign described in this volume is that of Jasavanta Singha (1), whose account begins from p. 77b. After the figures of the income of the then *jāgīr* of Marwar, drawn up by the Pañcōlī Manōhara Dāsa, the narrative begins as follows:

महाराज जसवंतसिंघजी संवत १६८३ रा महाबद ४ मंगलवार
रौ बुरहानपुर हवैली मै जनम संवत १६६१ रा सावण सुद ६ कासमीर
मै राजा गजसिंघजी पातसाह साहजिहां सू अरज कर वडौ बेटौ
अमरसिंघजी टीका थी दूर कर जसवंतसिंघजी टीका नू थापिया
संवत १६६४ रा असाठ बद ७ महाराज जसवंतसिंघजी नू टीको
पातसाह साहजिहां आपरा हाथ सू आगरै दियो जसवंतसिंघजी
जोधपुर सू बूंदी परणीजण गया उठै महाराज गजसिंघजी री
घबर आई.... etc.

After the *khyāta* of Jasavanta Singha, which comes to an end on p. 105a, we have:

(e) राव अमरसिंघजी री ख्यात, from p. 106a to p. 110a, namely a biographical account of Amara Singha, Gaja Singha's eldest son, who was excluded from the succession to the throne. It begins:

महाराज गजसिंघजी रे पाटवी कवर अमरसिंघजी था सौ
महाराज इयां सु नाराज था तिण सु अमरसिंघजी नै टीका सु दूर
कीया संवत १६६२.... etc.

(b) *Bardic Poetry.*

No. 1. साँद मालाजी री कविता रो संग्रह. A MS. consist-
ing of 178 leaves, about 10 to 6 inches in size. Thirteen leaves
in the beginning and 20 at the end are left blank, and some
other blank leaves are also left in the middle of the book

between one poem and another. The MS. is apparently about two hundred years old, and in many parts the paper has become crumbly so that some leaves are broken into pieces and margins have broken away. Each page comprises from 9 to 15 lines of writing, and each line from 20 to 28 *akṣaras*. The writing is generally accurate and clear.

The MS. contains a collection of the poems of Sādū Mālō, a Cāraṇa who lived at the time of Akbar. These are the following:

(a) भूलखा महाराज श्रीरायसिंघजी रा, from p. 15a to p. 22b, in 15 stanzas. It begins:

वौका टीका जोधहर धर जंगलहनां ।

and ends :

परियां रासै पांचमै वाली बापौती ॥ १५ ॥

The eponymous hero is the well-known king of Bikaner.

(b) भूलखा राणा प्र[तापसिंघजी रा], from p. 27a to p. 35b, also in 15 stanzas. Five lines at the top of the first and second page are broken into pieces and partly lost. It ends :

दौह अवाड़ो कौ करै श्रीनाथ सवाड़ो

थयो नागद्रह न्यसचरे कुरघेत कराड़ो ॥ १५ ॥

The subject of the poem is evidently the famous *rāṇā* of Mēvāra, also contemporary with Akbar.

(c) भूलखा अकबर पातसाहजी रा, from p. 37a to p. 40b, in 8 stanzas. It begins :

बंगयलायत तिवरलिग घर उतै वंदै ।

and ends :

अकबर दुजो रामचंद रामायण जीता ॥ ८ ॥

(d) गीत, from p. 47a to p. 74b. A collection of 48 *gītas*, beginning :

आगल नव कोट नवै गढ ओपम ।

and ending :

आदीत किरणां जेम ऊनी क्रीत गंगा कंत ॥

(e) वेल राजा रायसिंघजी रा, from p. 75a to p. 77b, in 42(?) stanzas. It begins :

पित भगत रायसिंग भगत परम गुर ।

and ends :

सगली जीभ दीयै जो सेष ॥

(f) गीत जूना फुटकर, from p. 97a to p. 156a. The first *gīta* begins :

सुरधर षंड दिसी हाल मन मोरा ।

and the last :

यला चाड सुण प्रकारं बीयां वित वासतै ।

As it may be argued from the title, the above collection does not contain *gītas* by Sādū Mālō only, but besides these, which are a good many, contains also old anonymous *gītas* as well as *gītas* by other poets.

In addition to the above compositions, which, with the aforesaid restriction, are positively by Sādū Mālō, the MS. contains :

(g) गीत राजवंस री पीढियां रा, from p. 90a to p. 96b. It is a series of 24 *gītas*, celebrating the Rāthōra rulers of Jodhpur from Sīhō to Vijai Singha. They are all anonymous, except the *gīta* of Mahārāja Udai Singha, which is stated to be by the same Sādū Mālō. The *gīta* of Sīhō begins :

सूधै मनजात चालियौ सीहै ।

(h) भूलणा भाटी गोयंदासजी रा, from p. 40b to p. 41a. Anonymous and apparently incomplete, as it does not go beyond the second stanza. It begins :

बुध समापण बुध ग्रह किहि(?)यौ पायै ।

The Bhātī Gōyandāsa lived under Sūra Singha of Jodhpur.

The MS. is in the possession of the Cāraṇa Mahā Dāna of Jodhpur.

APPENDIX III.

SPECIMEN PAGES OF THE BULLETIN OF THE BARDIC AND HISTORICAL SURVEY.

Epigraphical Records of the Twelfth Century A.D., in Pāla (Jodhpur).

There are two localities in the neighbourhood of Pāla, a village about 6 miles to the west of Jodhpur, which contain interesting epigraphical records of the twelfth century A.D. The one is the spot where there formerly stood a Jain temple,

now almost entirely rased to the ground and its remnants in great part removed; the other is the locality called *Dūgēlāva*, where there formerly existed a tank, which has since dried up and the depression been levelled by the sand of the desert. In the former place there are seven inscriptional records, and in the latter twelve, of which two, however, are illegible.

The Jain temple above mentioned was dedicated to Mahāvira and built in the first half of the Samvat-century 1200. Probably the shrine was completed some years before the antechamber, which, it seems, was being executed in the Samvat-years 1244-48. The temple was destroyed in some Muhamadan invasion, and its scattered remnants were in course of time utilized for some construction in the neighbourhood. To-day it is only a part of the antechamber that is still standing, and it consists of six columns in red sand-stone, surmounted by lintels most of the figures in which have been mutilated. Of the two remaining columns one is lying on the ground and the other is not found. The few other remains that are scattered on the spot seem to have no particular interest, except a lintel on which ten *tīrthakaras* are carved, one seated in the middle and the others at both sides of him.

All the inscriptions are incised on the columns of the antechamber; the three longer ones on the two central columns in the front, and the others on the four columns in the back. They are the following:

(1) An inscription incised on the right central column in the front, comprising 9 lines of writing, covering a space of 10" broad by 7 $\frac{5}{8}$ " high. It opens with the date [VIKRAMA]—SAMVAT 1241, VAIŚĀKHA SUDI 7, and refers to the reign of *Kēlhanādēva*, when his son *Sōdhalādēva* was enjoying the *jāgīr* of *Ghañghānakapadra*, apparently included in the territory of *Māṇḍavyapura*. The object of the inscription is to record a permanent monthly provision of $\frac{1}{2}$ *dramma*, made in the *Māṇḍavyapuramandapikā* by the *Bhaṇḍārī Yaśovīra*—who is qualified as a lord of *Palla* and a *gaṇadhara*—to the temple of *Ghañghānaka* for the annual expenses for the god Mahāvira.

Kēlhanādēva is obviously the *Cāhamāna* king of *Naddūla*, of whom six inscriptions have been found by Mr. D. R. Bhandarkar (*Ep. Ind.*, XI, pp. 26-79) with dates ranging from Vikrama-Samvat 1221 to 1236, and one has come to light at Pālādī (Sīrōhī) bearing the date Vikrama-Samvat 1249. *Ghañghānaka* is the modern *Ghañghānā*, *Māṇḍavyapura* *Maṇḍōra*, and *Palla* *Pāla*, the village near which the temple is situated. The meaning of *gaṇadhara* is not very clear. The same word occurs in the *Jālōra* inscription of *Sāmantasimha* (V.S. 1353, *Ep. Ind.*, XI, pp. 60-62), and was taken by Mr. D. R. Bhandarkar as a proper name, but in the present inscription it seems to be used as a title. I would explain it as *gaṇadhara*, and all the more so as there are other instances of initial *gaṇa*^o

changed to *guṇa*° in Diṅgaḷa and Mārwarī (e.g. *Guṇapati*), and in the afore-mentioned inscription of Sāmantasimha the word is used in connection with *saṃghapati*, another title of a similar meaning.

The chief interest of the inscription, in regard to the history of Marwar, lies in the fact that it proves that at the time in question Maṇḍōra was under the rule of the Cāhamāna Kēlhanadēva of Naddūla, and had been assigned as a *jāgīr* to his son Sōḍhaladēva, a name which has remained unknown to this day. Sōḍhala probably was a younger brother of *Jayantasiṃha*, who succeeded his father Kēlhana on the throne of Naddūla. The third inscription below shows that Sōḍhala continued to enjoy the *jāgīr* of Maṇḍōra at least as far as [Vikrama-] Saṃvat 1250, when his father Kēlhana was probably dead. In the time of *Udayasiṃha*, for whom we have dates covering the period [Vikrama-] Saṃvat 1262-1306, Maṇḍōra still continued in the possession of the Cāhamānas, though it had been possibly lost to them for a time after the invasion of Quṭub-ud-Dīn.

1. ओं¹ ॥ सं १२४१ वैशाखसुदि ७ अद्येह श्रीकेल्लहादेवरा-
2. ज्ये तस्यात्मजश्रीसोडलदेवस्व(?)भुज्यमाने घंघाणक-
3. पद्रचैत्ये श्रीमहावीरदेववर्षगतिनिमित्तं पल्ला-
4. धिपभं० य[श]²वीरगुणधरेन³ मांडव्यपुरीयमंड-
5. पिकायां दानमध्यात् द्रं० ॥ मासं प्रति दातव्या⁴
6. चंद्रार्क⁵ यावत् ॥⁶ पञ्जभिर्वसुधा भुक्ता । राजभिः
7. स[ग]रादिभिः । यस्य यस्य यदा भूमि । तस्य⁷ तस्य
8. तदा फलं ॥ स्वदत्त⁸ परदत्तं वा देवानां जो⁹ हरेद्-¹⁰
9. नं । षष्टिवर्षसहस्राणि¹¹ नरके स कृमिभवेत्¹² .

(2) An inscription comprising 16 lines of writing, covering a space of 9¼" broad by 16¾" high. It is incised on the left central column in the front, and is so weather-worn that a good part of the letters are quite illegible. The date itself is not

1 Expressed by a symbol.

3 Read ०रेण

5 Read ०वाचं०

7 Read भूमिसस्य

9 Read यो

11 Read ०साणि

2 Read यशो०

4 Read ०वः

6 Read वड०

8 Read ०त्तं

10 Read ०द०

12 Read ०भवेत् .

clear, but it seems to be [VIKRAMA-] SAMVAT 12[50] VAIŠĀKHA SUDI 7, the 9th anniversary of the date of the first inscription. It records a permanent provision, the nature whereof it is not possible to make out, granted, for the annual expenses of the temple, apparently by the assembly of the *Mēharas*, *Vaniks* and *Kṣatriyas* of *Ghaṅghāṅakapadra*. The provision was to be defrayed from some income (*utpatti*), which cannot be determined.

The importance of this inscription lies chiefly in the mention of the *Mēharas*, the modern *Mēras*, who are here represented as one of the elements in the local assembly. The same in the inscription following. It is evident that *Ghaṅghāṅaka* must have been a place in which *Mēharas* settled in great number, and at the time in question they were exercising not a small influence. Another settlement of *Mēharas* in *Mārwār* was at *Sācōra*, as proved by the inscription of the *Cāhamāna Sāmantasimha*, dated [Vikrama-] Samvat 1345 (*Ep. Ind.*, XI, pp. 57-9). The most important settlements of *Mēharas*, as it is well known, were in *Kāthiāwār* and *Mērwāra*. See J. F. Fleet's note to the *Hāthasni* inscription of the *Mēhara* chief *Thēpaka*, in *Ind. Ant.*, XV, pp. 360-2, where reference is made to three other inscriptions, also containing some mention of the *Mēharas*. It is significant that in the present inscription no mention of any king or *jāgirdār* is made.

1. ओं¹ ॥ संवत् १२[५० (?)] वै[श]खसुदि ७ प्र-
2. तिवर्षं वर्ष[ग]तिनि[मित्तं] श्रीघंघाण-
3. कपद्रेस्थानीयस[मस्तमे]हरवणि-
4. क्त्तत्रिय[- - - - -]पिठो(?)त्य-
5. त्तिमध्यात् [- - - - -] लोपि(?)भागु(?)
6. दसतउ (?) प्रदत्तः ॥ आचंद्रार्कं यावत्
7. प्रभुश्रीमहावी[र - - स्व]त्ति ॥ [- -]
8. अस्मिन् कुले [च ये भू]ता । भवि[व्यं]ति
9. भवंति च । तेषाम[हं] करे ल[भो] । [अस्म]द-²
10. त्तं न लोपयेत् ॥ [बज्ज]भिर्वसुधा सु[क्ता ।] रा-
11. जभिः सगरादिभिः । यस्य यस्य यदा [भू-]
12. मिन्मस्य तस्य तदा फलं ॥ स्वदत्तं पददत्तं³ [वा ।]

¹ Represented by the same symbol as in the precedent inscription.

² Read [अस्म]द-

³ Read परदत्तं

13. देवानां यो [हरे]द्धनं । षष्ठिवर्षसहस्राणि¹
14. नरके स कृमिर्भवेत् ॥ मंगलं भ[वतु ॥]
15. अन्यत्स(?)भावे एष(?) अदाने तमुखोह(?)[-]द-
16. नं कर्त्तव्यं² ॥ पं³ ठवइयहस्तेन ॥

(3) An inscription incised on the back of the left central column in the front, comprising 12 lines of writing, covering a space of 9 $\frac{1}{4}$ " broad by 11" high. The writing is very much injured by the weather, and a good many of the letters are hopelessly erased. The inscription opens with the date [VIKRAMA-] SAMVAT 1250, KĀRTTIKA VADI 1, and refers to the *bhukti* or *jāgīr* of *Māṇḍavyapura* and the reign of the *Mahārājaputra Sodhaladeva*. It then records a grant of a certain number of *vimśopakas*. made by the same *Yaśovīra* of the 1st inscription, who is here stated to be the son of *Jēhāḍa*. The grant was made in the presence of all the *Mēharas*, *Vaniks* and *Kṣatriyas* of *Ghaṅghāṇakapadra*.

1. ओं⁴ ॥ संवत् १२५० वर्षे कार्तिकव[दि] १ श्रीमांडव्यपु-
2. रभुक्त्यां महाराजपुत्रश्रीसोठलदेवराज्ये
3. घंघाणा⁵पद्रवास्तव्यसम[स्तमेह]रवणिक⁶क्ष-
4. त्रियप्रत्यक्षं ग्राम[- - - - -]जेहड-
5. सुतजसवीर⁷[- - - - -]निमित्तं
6. ⁸विसोप[क - -] प्र[दत्त - - अस्मिन्]कु-
7. ले च [ये भू]ता [भविष्यंति भवंति च । तेषा]महं
8. करे लमो । धर्मदत्तं [न लोपयेत् ॥] वज्रभि-⁹
9. र्वसुधा भुक्ता राज[भिः सगरादि]भि¹⁰ । यस्य
10. यस्य यदा भूमि । ¹¹त[स्य तस्य तदा फ]लं । स्वद-
11. त्तं परदत्तं [वा देवानां यो हरे]द्धनं । षष्ठि]वर्ष[स]-
12. हस्राणि¹² नरके स [कृमिर्भवेत् ॥ शुभं] भव[तु ॥]

1 Read °साण 2 The phrase, as it stands, has no meaning.

3 Apparently the inscription has । पिं .

4 Represented by a symbol.

5 For घंघाणक, the contraction being a feature of the vernacular.

6 Read वणिक 7 Read यशोवीर 8 Read विंशो 9 Read व०

10 Read °भिः । 11 Read सास्य . 12 Read °साण

The four inscriptions incised on the four columns in the back have no particular interest. They simply record the names of the benefactors that caused the columns in question to be made. Two columns were caused to be made by a certain *Sthiradeva*, son of *Yasodhavala*, and presented to the temple in the year [VIKRAMA—] SAMVAT 1244 MĀGHA SUDI 10 (SOMAVĀRE); and the other two by his son *Yaśaścandra* and his daughter *Dūdī*, in the year [VIKRAMA—] SAMVAT 1248, VAIŚĀKHA SUDI 4 (SUKRADINE). The two inscriptions on the back of the two former columns are identical, and so are the other two, so that we have practically only two inscriptions. Under each of the inscriptions the figure of a *śaṅkha* is incised.

From the evidence of these inscriptions it is clear that the antechamber of the temple was not completed till at least the year [Vikrama—] Samvat 1248. It follows that the first inscription of Sodhaladeva, which records a grant made in the year [Vikrama—] Samvat 1241, must have been engraved on the temple some time after this date.

1. ओं । संवत् १२४४

2. माघसुदि १० सोम-

3. वारे य[शधव]ल^१सु-

4. तेन ^२थिर[देवे]न स्तं-

5. भञ्जु[गलं]^३ करापितं^४ [॥]

1. ओं । संवत् १२४८ वैशाख^५सुदि ४ शु-

2. कदिने ॥ ^६थिरदेवपुत्र यशचंद्र^७प-

3. त्रिका दूदी धर्मार्थं स्तंभयुगलं प्रदत्तं ॥ ॐ [॥]

1 Read यशोधवल° 2 Read थिर° 3 Read युगलं . + Read का°

5 Read वैशाख 6 Read थिर° 7 Read यशचंद्र .

42. The Evolution and Distribution of Indian Spiders belonging to the Subfamily Aviculariinae.¹

By F. H. GRAVELY, M.Sc., *Assistant Superintendent in the Indian Museum.*

[With Plate XXXI].

On pp. 201-210 of the last volume of this Journal, attention was called to the correlation of distribution with progressive specialization in Passalid beetles of the subfamily Aceraiinae, in whip-scorpions and in crinoids. I have now obtained evidence showing that a similar correlation exists in the case of certain spiders. The evidence is, unfortunately, less complete, as the material available for reference in Calcutta is almost entirely Indian, Assamese and Burmese. But it is so strong as far as it goes that a record of it seems desirable. Specialists dealing with material from other parts of the Indo-Australian area will no doubt be able to complete it later.

The Aviculariinae are a subfamily of Mygalomorph spiders, and include the largest of these spiders found in India, where they are popularly called Tarantulas.

The special interest of Mygalomorph spiders from a zoogeographical point of view has already been emphasized by Pocock (1903, pp. 341-2). He points out that "owing to the relatively large size and great weight of the newly hatched young of the Mygalomorphae, coupled with the reduction in the number of spinning appendages and the greater simplicity of the silk-glands, it seems probable that aerial sailing is not practised to any great extent by the members of this sub-order." In a footnote he adds, "The young of the only British representative of this group, namely *Atypus*, have been seen to scatter over small areas by this method of travelling (F. Enoch, Tr. Ent. Soc. 1885)" and notes that the distribution of this genus is exceptionally wide.

Of the eleven groups into which Simon divides the Aviculariinae (1897, pp. 918-9) five are characterized by the presence of stridulating organs between the chelicerae and palps. All but one of these five are exclusively Indo-Australian, the exception being the Harpactireae from Africa. In the six remaining groups stridulating organs of this nature are found only in the genus *Psalmopeous* (group Avicularieae). With the

¹ Published with the permission of the Trustees of the Indian Museum.

exception of the Ischnocoleae, which occur all round the world, these six groups are confined to Africa and America.

Five of the eleven groups of Aviculariinae are found in the Oriental Region. Three of these—the Ischnocoleae, Thrigmopoeae, and Poecilotherieae—are confined to the Indian Peninsula and Ceylon, with the exception of one or two species of Ischnocoleae. The Ornithoctoneae extend, according to Pocock (1903, p. 354), from Burma to the Moluccas; and the Selenocosmieae from Ceylon to Australia.

With the exception of the Poecilotherieae, which live in trees and in the thatch of houses, all these spiders appear to live on the ground. The Indian Ischnocoleae live under stones and logs of wood, and are so closely related to the Thrigmopoeae (see three following paragraphs) that, in the absence of any contrary information, the same may be assumed for them. At least one species—*Cyriopagus minax*¹—of Ornithoctoneae lives in silk-lined burrows in the ground. *Chilobrachys* is known to live on the ground in burrows or in natural crevices, and probably this is equally true of other Selenocosmieae. The relation of the *Poecilotherieae* to the other groups, though somewhat uncertain, is not without interest and will be discussed later. It is clear from its habits, however, that this group does not enter directly into competition with any of the others, and must therefore be left out of account where the results of competition among the others are being dealt with.

Of all the Oriental Aviculariinae, the Ischnocoleae, which lack the stridulating organ developed in the other groups, are clearly the least specialized, as has already been recognized by Pocock² (1903, p. 354). The Indian species of this group form a series leading from the smaller forms of the genus *Plesio-phrictus*—in which the posterior sigilla of the sternum are small and marginal, the tibiae and metatarsi are extensively armed and the first legs of the male have a tibial apophysis—to the larger and stouter forms of the genus *Phlogiodes*—in which the posterior sigilla are large and submedian, the legs are less extensively armed, and there are no tibial apophyses on the first legs of the male.

Three points in this series have been regarded as generic limits, but the series is so complete that I have found it by no means easy to determine into which genus some of the new species in the Indian Museum collection should go.³ Species of the genus *Phlogiodes*, moreover, resemble the Thrigmopoeae

¹ Concerning the generic name of this spider see Gravely, 1915.

² Pocock's nomenclature differs from that adopted by Simon, which is followed here, and he speaks of the Ischnocoleae of the present paper as Aviculariinae. Simon's subfamily Aviculariinae corresponds to Pocock's family Aviculariidae.

³ For descriptions of these new species see Gravely, 1915.

very closely—much more closely than they do those of the genus *Plesiophrictus*. The Thrigmopoeae are, indeed, distinguished from them only by the possession of a stridulating organ, sometimes of a very rudimentary nature, between the chelicerae and the coxae of the palp (see pl. xxxi, figs. 1, 2); and they appear to represent a further stage in the progressive series of genera which comprises the Indian Ischnocoleae.

There can therefore, I think, be no doubt that in the Thrigmopoeae and the Indian Ischnocoleae we have a single line of evolution, related to the Ischnocoleae found outside the Oriental Region only through its most primitive genus *Plesiophrictus*. In Simon's arrangement the Indian genera are, it is true, dispersed among genera from other parts of the world, but there is no reason to think that Simon's classification is a natural one. It is based on characters of the same kind as those by means of which he separated the groups of Aviculariinae defined in the first volume of his "Histoire Naturelle des Araignées," characters which he gladly abandons as diagnostic of groups, in his "Supplément Général" at the end of the second volume of that work, saying "J'avais classé ces Araignées à l'exemple de Ausserer, presque exclusivement sur des caractères artificiels et souvent quantitatifs . . .". It is unfortunate that characters of greater value seem to be far from numerous in spiders; but it is to be hoped, now the unity of the Indian Ischnocoleae has been pointed out, that some character of real phylogenetic significance may be found by which they may be separated from Ischnocoleae from outside the Oriental Region.

The Selenocosmieae have evidently been derived, through forms with a stridulating organ of the rudimentary type found in the genus *Neochilobrachys* (pl. xxxi, fig. 3), from forms without any stridulating organ at all—perhaps, therefore, from the Burmese Ischnocoleae—and they must first have appeared somewhere beyond the Ganges¹, in the countries where all the forms of Selenocosmieae with primitive or transitional (and most of those with the most highly specialized) stridulating organs are found to-day. That the specialized forms found in the Indian Peninsula and Ceylon have entered from across the Ganges, driving their more primitive ancestors out eastwards, and have not originated in those countries, is proved by the fact that, although the transitional forms between the primitive Ischnocoleae and the higher Selenocosmieae are all trans-gangetic, the Ischnocoleae themselves, which should be the first to suffer from competition with higher forms, are almost entirely confined, in the Oriental Region, to Western and Southern India and to Ceylon.

¹ i.e. from the point of view of an inhabitant of Calcutta which, though situated in the Delta, is on the Peninsular side of the main stream.

It is unfortunate that so little is known about the Burmese Ischnocoleae. Two species have been described, and both have been doubtfully referred to the genus *Ischnocolus*—a genus that should probably be confined to species from the Mediterranean and Ethiopian Regions as pointed out by Simon (Nat. Hist. Ar. II, p. 925). These two species are the only Ischnocoleae, apart from those found in the Indian Peninsula, that have yet been recorded from the Oriental Region. But there is in the Indian Museum collection an immature specimen from the Darjeeling District which must also, I think, be referred to this group.

The occurrence of these three species of Ischnocoleae in the Oriental Region north and east of the Gangetic plain seems to indicate that such primitive forms once inhabited the whole of the transgangetic area, but have now, with these exceptions, been swept out by their more highly specialized descendants which compose the Selenocosmieae and perhaps also the Ornithoctoneae. The possibility, therefore, suggests itself that they may be more closely related to the less specialized forms of Selenocosmieae than to the Indian Ischnocoleae, in spite of the presence of rudimentary stridulating organs in the former.

In addition to its characteristic stridulating organs, the Selenocosmieae are distinguished from all other groups of Aviculariinae found in the Oriental Region by a character which has not hitherto received as much notice as it seems to deserve. I refer to the somewhat fine and extremely close granulation of the anterior part of the labium, which is strikingly different in appearance from the coarser and sparser denticulation of this surface found in the other groups.

Of the three transgangetic Aviculariinae in which no stridulating organ occurs, one, "*Ischnocolus*" *brevipes*, appears from Thorell's description (1896, pp. 170-173) to possess this character; and it is further separated from all Indian Ischnocoleae except some of the higher forms, by the reduced armature of its legs and by the absence of the tibial apophysis of the front legs of the male. When a species shows affinities with a group centred in its own district and also with groups centred in others, it is obviously best to keep it with the former if suitable definitions can be framed. This can be done in the present instance by basing the definition of the Selenocosmieae on the structure of the labium instead of on that of the stridulating organ. "*Ischnocolus*" *brevipes* may then be referred to the genus *Neochilobrochys* by a slight widening of the limits of this genus; or a new genus may be established for it. Since unnecessary multiplication of small genera is always undesirable, I prefer the former course.

The two remaining transgangetic forms without stridulating organs ("*Ischnocolus*" *ornatus*, Thorell, and the specimen

[N.S.]

from the Darjeeling District in the Indian Museum collection) are unfortunately known from immature specimens only. Their genus cannot, I am afraid, be determined with certainty; but the structure of the labium and the armature of the legs seem to ally them more closely with the Indian Ischnocoleae than with even the most primitive Selenocosmieae, and they will probably have to remain in the former group.

In the transgangetic part of the Oriental Region we have, then, one or two species of Ischnocoleae, known from immature specimens only, and evidently very rare; one species of *Neochilobrachys*, also apparently very rare, resembling them in the absence of any stridulating organ; and one species of the same genus, apparently confined to the Nicobars, in which rudimentary stridulating organs are present between the chelicerae and the coxae of the palps.

From the rudimentary type of stridulating organ present in this species (see pl. xxxi, fig. 3) the more striking type found in the genera *Lyrognathus*, *Selenostholus*, *Selenocosmia* (including *Phlogiellus*, see Hirst, 1909, p. 384), *Coremiocnemis*, and *Selenotypus* has presumably been developed. Of these genera the first contains only three known species and appears to be confined to Assam and perhaps the Himalayas; the second is only known from one species from Australia; the third is a much larger genus and extends from Assam to Australia; the fourth is only known from one species from Penang and one from the "East Indies" and the fifth is only known from one species from Australia. These genera are separated by characters which are so slight as to be of very doubtful phylogenetic significance and may be considered here as one.

The type of stridulating organ found in all of them is figured on pl. xxxi, fig. 4. It consists of a number of more or less slender spines, more or less mixed with hairs, on the chelicerae, and of an oval group of very numerous bacilli on the coxae of the palps. Many of these bacilli are more or less distinctly claviform, especially those towards the middle of the ventral margin of the group, but the whole depth of both ends of the group consists of small hair-like bristles only.

Although much commoner and more widely distributed than the transgangetic Ischnocoleae or the genus *Neochilobrachys*, the genus *Selenocosmia* appears to be much less common in Continental Asia at least—I am unable to judge with certainty of other parts of the Oriental Region—than is the genus *Chilobrachys*, in which the remaining stages in the increase of specialization of the stridulating organs are found. *Chilobrachys*, to which the monospecific genus *Orphnoecus* seems to bear the same relation as the small genera associated above with *Selenocosmia* bear to that genus, is certainly the dominant representative of the group in the north-western part of the transgangetic Oriental Region, as well as being the most highly

specialized, and it appears to be the only one which has spread into the Indian Peninsula and Ceylon.

Whether it is also dominant in the south-eastern parts of the Oriental Region I cannot say with certainty; but further east still, in the Australian Region, it has never been recorded, although *Selenocosmia* and some other genera of that type occur there. This may be due to inferior migratory ability in *Chilobrachys*, which is not, I think, very likely; or to its having originated after the appearance of a more complete separation of the Oriental and Australian Regions than was in existence when *Selenocosmia* passed from one to the other. In either of these cases *Chilobrachys* should be at least, and *Selenocosmia* at most, as common in the eastern parts of the Oriental Region as it is in the western.

There is also, however, the possibility that *Chilobrachys* may have originated in continental Asia, and not in the Archipelago, in which case it may still be spreading slowly eastwards as opportunity offers. Although the Archipelago is clearly the main centre of evolution in the Indo-Australian Thelyphonidae and Passalidae, in the former group the numerous species of the almost exclusively Burmese genus *Hypoctonus* seem to indicate a secondary centre in Burma, whose secluded valleys are, in addition, well known to have favoured the evolution of innumerable small tribes from the various ancient stocks of the human race which have from time to time migrated and settled there. If Burma has been and still is the centre of evolution of *Chilobrachys*, this genus will be less abundant in the Archipelago. This is, I think, most probably the case, for Simon does not record it from the Sunda Islands at all.

Several stages in the increasing specialization of the stridulating organs are to be found in *Chilobrachys*. The form which most closely approaches that found in *Selenocosmia* is found in *C. assamensis* and *C. fumosus*¹ figured on pl. xxxi, fig 5. In these species the structures borne on the chelicerae are still markedly spiniform, though not mixed with hair as in *Selenocosmia*²; and, although the bacilli on the coxae of the palps still cover a broadly oval area, those of the whole length of the outer half of the ventral row are more or less sharply distinguished from the others by their greater size and strongly claviform shape, this being especially marked in three or four

¹ The type of this species is a dried female of uncertain locality. The species to which I apply this name is that identified with it by Hirst (1909, pp. 386-7).

² Except in *S. himalayana*, which is exactly like the *C. assamensis* and *C. fumosus* in this respect. It also resembles them more nearly than does any other *Selenocosmia* known to me in the structure of the group of bacilli on the coxa of the palp. It is, in fact, transitional between the more typical species of *Selenocosmia* and *Chilobrachys*.

of them situated a little on the outer side of the middle of the whole row.

The highest type of stridulating organ known to me is that found in *C. stridulans* (pl. xxxi, fig. 6). In this the palpal portion of the organ consists almost entirely of the ventral row of large claviform bacilli, the largest of which in this species are on the inner, not the outer side of the middle; and the portion situated on the chelicerae consists not of spines but of stout denticles.

In all other species known to me the organ is of the *stridulans* type, or intermediate between this and the *assamensis* type. The portion of the organ situated on the chelicerae always consists of denticles, not spines, but the extent of the relatively small dorsal bacilli on the coxae of the palps differs in different species. The position of the stoutest bacilli also varies in different species, and may possibly indicate a polyphyletic origin for the genus; but in the present state of our knowledge it is not possible to discuss this further.

There still remain the Ornithoctoneae and the Poecilotherieae to be considered. In neither case is any clear evidence of their origin available. The type of stridulating organ found in the Ornithoctoneae resembles that found in the Thrigmopoeae; but there is no evidence to show that the latter ever existed north or east of the Indian Peninsula, or that the former ever existed north or west of Burma. So it is probable that the two originated independently.

The stridulating organ of the Poecilotherieae, a group consisting of the single genus *Poecilotheria*, somewhat resembles that of *Chilobrachys*, but could only be derived from it by a considerable degeneration of the claviform bacilli. It could be more directly derived from *Selenocosmia*; but there is no evidence that *Selenocosmia* ever occurred in the Indian Peninsula, or that *Poecilotheria* ever occurred out of it. Indeed, if the former genus had ever entered this Peninsula it might be expected to occur there more abundantly than further east, just as the Ischnocoleae do; and if the latter had originated further east it is difficult to see, in view of its peculiar habits, by the competition of what other group it could have been exterminated there. The labium of *Poecilotheria*, moreover, is sparsely denticulate, not closely granular. Most probably, then, *Poecilotheria* originated from the Ischnocoleae or Thrigmopoeae (or both) in the Indian Peninsula itself, the modified habits of its earliest arboreal ancestors having been in some way correlated with an increase in the potentiality of these ancestors to give rise to forms more highly specialized than themselves. This increase has carried the group far beyond the stage reached by the highest of the *Plesiophrictus-Thrigmopoeus* series, in a direction largely paralleled, so far as the stridulating organ is concerned, by the evo-

lution of the ground-dwelling genera of Aviculariinae centred in the transgangetic area.

In comparing the distribution of the Aviculariinae described above, with that of the Aceraiinae described in my last communication to this Society, the first point to be noted is that the evidence in the present case does not relate to forms found south or east of the Indian Empire and Ceylon, and that whether the Aviculariine fauna of continental Asia beyond the Ganges has originated there or in the Archipelago must be left an open question.

Secondly, it must be pointed out that in the Aviculariinae equally primitive forms—as far as I am at present able to judge—are found in both sides of the Ganges and on both sides of the Palk Strait. Forms sufficiently primitive to connect the faunas found on either side of the Ganges are not, as in the Aceraiinae, confined to Ceylon, nor do they appear to be more common in Ceylon than in India. But they are far more common in India and Ceylon, especially Western and Southern India, than in the countries beyond the Ganges.

In dealing with the Aviculariinae it is evident that no distinction can be drawn between the faunas of India and Ceylon. When this has been allowed for the similarity between the distribution of the Aviculariinae and Aceraiinae is very close. The gradual increase in specialization seen in the relatively primitive Indian and Ceylonese Ischnocoleae and Thrigmopoeae finds its parallel in the gradual increase in specialization seen in the relatively primitive Indian and Ceylonese genus *Episphenus*. And the much higher degree of specialization reached in the essentially transgangetic group Selenocosmieae than in the Ischnocoleae and Thrigmopoeae, finds its parallel in the much higher degree of specialization reached by the genus *Aceraius* than by the genus *Episphenus*.

With regard to the latter parallel, however, certain differences must not be allowed to escape notice. Firstly, although the derivation of the genus *Chilobrachys* from *Selenocosmia* can be paralleled by the derivation of the genus *Aceraius* from the genus *Ophrygonius*, the transgangetic Aviculariine series can be traced back to a primitive group, the Ischnocoleae, which, though very much rarer in the countries beyond the Ganges than in India and Ceylon, are not extinct there; whereas the most primitive existing representatives of the Aceraiine series are confined to Ceylon. Secondly, the most highly specialized genus of the former series has already spread into the Indian Peninsula and Ceylon; whereas that of the latter series has not. Thirdly, the Poecilotherieae, which appear to be derived from Indian or Ceylonese ancestors as a result of a change in their mode for life, find no parallel, so far as I can see, among the Aceraiinae. The position of the Ornithoctoneae

is doubtful, and perhaps also without a good parallel among the Aceraiinae.

The evolution of the Aviculariinae is thus correlated with the distribution of that subfamily in a more complex manner than is that of the Aceraiinae. But, excluding groups whose habits take them out of competition with the other groups of their subfamily, we find in each subfamily that the evolutionary process has progressed further in the groups centred beyond the Ganges than in those centred on this side of it. The correlation of evolution with distribution is quite as marked among the Aviculariinae as it is among the Aceraiinae, but it is somewhat obscured by the extension of the range of the most highly specialized transgangetic genus *Chilobrachys* into India and Ceylon, and by the appearance in these countries of the highly specialized genus *Poecilotheria* with arboreal habits.

With regard to the distribution of other Oriental Mygalomorph spiders I have nothing to say at present. Their smaller average size must make aerial distribution easier among them than among the Aviculariinae; and this will presumably be a factor tending to obscure very considerably any correlation that might otherwise be seen between their evolution and distribution. They are, moreover, very imperfectly represented in the Indian Museum collection, and consequently I have little personal knowledge of them.

LIST OF LITERATURE REFERRED TO.

1896. Thorell, T. "Secondo saggio sui ragni Birmani." Ann. Mus. Civ. Genova XXXVII (2 A, XVII) 1896-7, pp. 161-267.
1897. Simon, E. "Histoire Naturelle des Araignées II, Paris, 1897.
1903. Pocock, R. I. "On the Geographical Distribution of Spiders of the order Mygalomorphae." Proc. Zool. Soc. London, 1903 (I), pp. 340-368, text-figs. 58-61.
1907. Hirst, S. "On two Spiders of the genus *Selenocosmia*." Ann. Mag. Nat. Hist. (7) XIX, 1907, pp. 522-4, 2 text-figs.
1909. Hirst, S. "On some new or little-known Mygalomorph Spiders from the Oriental Region and Australia." Rec. Ind. Mus. III. 1909, pp. 383-390, pl. xxiv.
1914. Gravely, F. H. "The Evolution and Distribution of certain Indo-Australian Passalid Coleoptera." J.A.S.B. (N. S.) X, 1914, pp. 201-210, pl. xxiv.
1915. Gravely, F. H. "Notes on Indian Spiders. I, Mygalomorphae." Rec. Ind. Mus. (in the press).

EXPLANATION OF PLATE XXXI.

The stridulating organs of some Indian Spiders.

- FIG. 1.—*Haploclastus kayi*, Gravely (type).
,, 2.—*Thrigmopoeus*, sp. juv.
,, 3.—*Neochilobrachys subarmatus*, Thorell (♂).
,, 4.—*Selenocosmia*, sp.¹
,, 5.—*Chilobrachys assamensis*, Hirst (♂ cotype).
,, 6.—*Chilobrachys stridulans*, Wood-Mason. (♂ type).¹

¹ Some of the bacilli have been broken in these specimens: they have been restored in the figures.



D. Bagchi, Phot.

Stridulating organs of Indian Spiders.

43. A Note on the Floral Mechanism of *Typhonium trilobatum*.

By MAUDE L. CLEGHORN, F.L.S., F.E.S.

Communicated by the HON. MR. W. A. LEE, F.R.M.S.

(With Plate XXXII.)

Typhonium trilobatum, Schott, the Ghet-Kachu, is a tuberous rooted plant found growing among grass in thickets in most parts of tropical India. It is easily recognized, when in flower during the hot weather and early rains, by its broad dark reddish purple spathe about nine inches in height, and the carrion-like odour given off at dusk. It has three or four rather large 3-lobed leaves, with long petioles, which raise the leaf blades well above the grass among which it usually grows.

The erect spathe, which partly encloses the spadix, stands close to the ground with its base half buried in the soil. It varies much in size. In small plants it is sometimes only three inches high, while in a large specimen it may attain a height of about twelve inches. The upper part of the spathe unfurls completely into the broad reddish purple limb of the spathe, which tapers off into a fairly long slender tip. The margins of the spathe in the lower portion, below the constriction, do not unroll, but remain overlapping, to form a short barrel-shaped cavity (the tube of the spathe) opening above at the constriction (Fig. 1).

The erect spadix, which is shorter than the spathe, has the lower part enclosed in the tube. The upper exposed part, which stands out of the spathe above the constriction, consists of (a) the long smooth reddish purple appendage which forms the greater part of the exposed portion of the spadix, and which tapers to a blunt point, and (b) a pale reddish purple cylindrical portion, about a quarter of the appendage in length, bearing numerous closely packed minute staminate flowers. At the constriction, and a little below it, enclosed within the tube, the spadix is very slender and quite bare: this slender portion is about equal in length to that of the staminate portion and so allows of a clear passage into the lower part of the cavity of the tube, where the pistillate flowers are situated. Low down in the tube, near the base, the spadix bears, (c) a tangled mass of long thread-like bodies (rudimentary neuter flowers), which partly hang over (d) the green pistillate flowers situated at the bottom of the tube. The pistillate flowers are a little larger than the staminate ones. They are considerably

fewer in number, and the portion of the spadix occupied by them is about half that taken up by the staminate flowers (Fig. 4).

On examining a spathe at sundown, when the strong unpleasant odour is being given off, it will be found that the narrow constricted part is open, forming a passage down into the lower chamber, where the pistillate and thread-like neuter flowers are concealed (Fig. 1).

The margins of the spathe at the constriction are wide apart, and the slender portion of the spadix stands close against the spathe, leaving a clear passage down into the tube. At this, the first stage, the stigmas are very sticky and the strong carrion-like odour is given off from the pistillate flowers: but the staminate flowers will be found to be still immature, with no pollen shed. If examined on the following morning, when in the second stage, the spathe will be found to present a very different appearance. There is no disagreeable odour and the beautiful upper portion of the spathe is hardly recognizable, having faded into a dull pale purplish colour and fallen back, away from the spadix, with the tip dangling on the ground (Fig. 2). The opening leading down into the tube is also closed by the margins of the spathe having overlapped tightly round the base of the staminate portion of the spadix (Fig. 2 and plant to left in Fig. 3). In the afternoon the opening will still be found closed; but on closer examination the staminate flowers will be found to have started shedding their pale pink pollen. On the following morning, when in the third stage, the spathe will be found in a still more faded condition, and the whole of the exposed part of the spadix, consisting of the appendage and staminate portion, also fallen back, and the passage into the tube again wide open, but not quite as fully open as on the evening of the first day. At this stage the staminate flowers have matured and have shed all their pollen. The pollen collects at the mouth of the tube and on the spathe. The upper part of the spadix, having fallen back over the spathe, prevents the pollen from falling into the tube (Fig. 4).

On cutting open the tube of a spathe in the second stage, when the passage is tightly closed, a number of small brown Lamellicorn beetles (belonging to the dung-frequenting sub-family Coprini) will be found imprisoned inside. They had evidently been attracted into the spathe by the strong disagreeable odour during the first stage, when the passage was wide open, and they were being kept prisoners till their release in the third stage.

It is clear that the floral mechanism of the spathe is of the nature of a trap, and by this ingenious method the plant ensures cross-pollination, for the beetles carry the pollen from one spathe to another.

Observations made by me on the opening and closing of

the passage into the tube of the spathe in a potted Ghet-Kachu are as follows :—

- May 12, 3 p.m. Spathe begins to open.
1913. 5 p.m. Spathe completely open.
6 p.m. Has started giving off a strong unpleasant scent, and the constriction is open forming a passage into the lower part.
9 p.m. The constricted part appears to have widened still more, and the slender bare portion of the spadix, below the staminate flowers, is resting against the spathe and so the opening is as little blocked by it as possible.
11-45 p.m. Lobes of the spathe begin to wrap round the spadix at the constricted part.
11-55 p.m. Scent not strong, lobes more closely wrapped round and the opening is *almost* completely closed.
May 13, 2 p.m. Completely closed; no space for even a very small insect to pass up or down at the constricted part.
8 a.m. Spathe still closed.
5 p.m. Remained closed all day.
8 p.m. The margins of the spathe at the narrow part have begun to unfold and the passage is reopening.
Midnight. Opening is almost as wide as it was in the first stage, and there is a collection of pollen at the mouth of the opening.

On examining other Ghet-Kachus, in various stages of flowering, I found that the time of opening and closing of the spathe is, on the whole, very regular, and that the spathe, in its first stage, captures quite a number of beetles by about 9 p.m.

Unfortunately beetles seldom came to potted Ghet-Kachus kept in an upper verandah, but when the plants were taken down into the garden, the beetles were soon captured.

The beetles remain among the pistillate flowers during their term of imprisonment in the second stage, but by the evening, when the spathe has reopened in its third and last stage, the beetles are most anxious to make good their escape, and soon crawl out of the mouth of the tube and up the lower staminate portion of the spadix, and so become covered with pollen before flying away, only to be deceived and recaptured, by another spathe in the first stage. While among the pistillate flowers of the fresh spathe the pollen with which they are covered adheres to the sticky stigmas, and thus cross-pollina-

tion is readily effected. The thread-like neuter flowers appear to keep the beetles among the pistillate flowers after the disagreeable odour ceases, for they seem to like going in and out under them during the day, in the second stage of the spathe.

The trap-mechanism of the Ghet-Kachu resembles that of the Cuckoo-pint (*Arum maculatum*) in the entrance and exit, being *above* through the *same* opening at the constriction of the spathe, but it differs from it in the deliberate opening and closing of the passage leading down into the tube of the spathe, and in the staminate flowers being situated on the exposed upper part of the spadix and not within the tube.

The floral-mechanism of the Ghet-Kachu differs much from that of the common Kachu (*Colocasia antiquorum*), in which the entrance for the flies is formed by the margins of the spathe opening slightly only in front below the constriction, and the exit by the spathe opening only partly above. However it resembles that of *C. antiquorum* by having no neuters at the constriction and by the closing of the constricted part of the spathe after the first stage, but again differs from it by the constriction reopening in the second stage.

The floral-mechanism of the Ghet-Kachu does not seem to be so perfect as that of *C. antiquorum*, the common Kachu, but it appears to be an advance on that of the Cuckoo-pint.



Fig. 1. First stage taken by flashlight at 10-45 p. m.



Fig. 2. Second stage showing passage closed



Fig. 3. Plant to right showing spathe opening at about 5 p.m.
Plant to left in second stage with passage closed.



Fig. 4. Third stage showing passage reopened and pollen shed.

Inflorescence of *Typhonium trilobatum*.

Sections of spathe cut lengthwise on growing plants to show trap-mechanism

From photographs by author.

44. Four Forged Grants from Faridpur.

By R. D. BANERJI, M.A.

In the July number of the Journal of the Royal Asiatic Society for 1913 Mr. F. E. Pargiter has said that "both Dr. Bloch and Babu R. D. Banerji have pronounced this fourth grant to be spurious, but they had not the advantage of seeing the three other grants, whereas I had the advantage of reading all four before pronouncing any opinion on any of them." When I wrote my first article on the subject of these plates, entitled "The Kotwalipara Grant of Samacaradeva,"¹ I had not the advantage of examining all the plates, and so a considerable number of mistakes and defects crept into it. But my second article on the subject of these plates, entitled "The Evidence of the Faridpur Grants," was written after a long examination of the plates, which had then been returned to the Asiatic Society of Bengal by Dr. Hoernle. I find to my regret that I have not been able to express myself clearly on the subject of the genuineness of these copper-plate grants from Eastern Bengal. In my opinion, all of these four grants are ancient forgeries. Mr. Pargiter has already observed that "these grants are of a somewhat new kind. They are not Royal Deeds, but are grants of lands by private persons to Brahmans." In fact, this set of four plates differ in the nature of their contents from any other copper-plate or sets of plates discovered up to date in India. I am rather astonished to find that the learned editor of these plates has not dilated on this point sufficiently. In my second article I gave a summary of the contents of these plates. For the convenience of the readers I am repeating them briefly :—

I. First Plate—INSCRIPTION OF THE TIME OF DHARMMĀDITYA OF THE YEAR 3.

In the third year of the reign of the Emperor Dharmmāditya, while one of his vassals named Sthānudatta, who had been raised to that dignity by the Emperor, was still reigning, an officer (*Viṣayapati*) was holding charge of the *Maṇḍala* or Province of Vāraka. At that time a *Sāghanika* named Vātabhoga approached certain officials and common people with the request that he should be allowed to buy a parcel of land from them and to bestow it to a Brāhmaṇa.

¹ Journal of the Asiatic Society of Bengal, Vol. VI, p. 429.

The land was consequently measured out and the price of it paid.

The second part of the same grant records that this Vāta-bhoga bestowed the land purchased by him to a Brāhmaṇa named Candrasvāmin. The boundaries of the village or land are then given at length, and the inscription ends with the usual imprecatory verses and the date.

II. Second Plate—UNDATED GRANT OF THE TIME OF DHARMMĀDITYA.

During the reign of Dharmmāditya when a certain officer (*Mahāpratīhāra-uparika*) Nāgadeva was governing Navyāvā-kāśikā, and when *his* deputy Gopālasvāmin was in charge of the affairs of the Vārakamaṇḍala, a certain person named Vasudevasvāmin approached certain officers and the leading men of the district and stated that he wanted to purchase a certain piece of land from them in order to bestow it on a Brāhmaṇa. The land was sold and the price of it paid. The second part of this plate contains details of the boundaries of this land, and says that the land was sold to, and was bought by Vāsudevasvāmin, but it does not contain anything about the land being granted to the Brāhmaṇa Somasvāmin, who is mentioned in the first part of the inscription as the future donee.

III. Third Plate—INSCRIPTION OF THE TIME OF GOPACANDRA—OF THE YEAR 19.

In the reign of Gopacandra when the *Mahāpratīhāra Vyāpārāṇḍya-dhṛtamūla-Kumārāmātya-uparika* Nāgadeva was ruling, his deputy Vatsapālasvāmin was in charge of the province of Vāraka, somebody, whose name appears to have been lost, approached the officers, etc. with the request that he may be allowed to buy a certain piece of land in or to bestow it on a certain Brāhmaṇa. The second part of the inscription records that the land was sold and the price of it paid. We also come to know that the purchaser of the land was the very same Vatsapālasvāmin, who had been placed in charge of the affairs of the Vārakamaṇḍala, and the donor of the land. The land purchased by him was bestowed on Bhaṭṭagomidattasvāmin “with the right of succession to son and grandson.” The details of the boundary of the land granted are given, which is followed by the imprecatory verses and the date.

IV. Fourth Plate—INSCRIPTION OF THE TIME OF SAMĀCĀRADEVA—OF THE YEAR 14.

According to Mr. Pargiter’s version when the Emperor Samācāradeva was reigning and the Uparika Jivadatta was the

[N.S.]

Governor of Navyāvakāśikā and his deputy Pavitrūka was in charge of the Vāraka Province, a certain Brāhmaṇa named Supratikasvāmin approached the officials and begged for a piece of waste land. The officers conferred together and gave away the land wanted. The remaining part of the inscription contains the boundaries, the imprecatory verses and the date.

It is now evident that these four copper-plate inscriptions differ in their nature from all other copper plate grants discovered up to date. They are neither Royal Grants, nor was the grant approved by Royalty. In grants 1 and 2, a private person approaches the officers of a district with the request of being granted permission to purchase a piece of land in order to grant it to a Brāhmaṇa. In the third grant, the officer in charge of the affairs of the district approaches a number of officials his own subordinates, for permission to purchase a piece of land and to grant it to a Brāhmaṇa. The fourth grant is peculiar. According to the inscription on it, a certain Brāhmaṇa approaches the district officers with the request of being given a piece of waste land. In my humble opinion these four inscriptions, whether they be genuine or not, are not grants, but merely deeds of transfer of land. I am much obliged to Mr. Pargiter for the improvement made by him on my reading of the fourth plate, but I am unable to agree with him about the correctness of some of them.

The word Anumoditaka in line 4 means sanction, and need not be translated "which is cause to rejoice." Antaraṅga and Uparika are names of different officials which were held by one and the same person Jivadatta in this particular case. Several instances have been found of the separate use of these official titles. Antaraṅga in one case at least has been used as the title of a Royal Physician.¹ The word Jyeṣṭhādhikaraṇika cannot be translated "the District Government," because if the word Adhikaraṇa be taken to be the name of an office and Adhikaraṇika that of a Government, then the word Karaṇika in line 15 should also be taken to mean "a Government" or "a Department," and not a single office, which is simply impossible, because the officers are mentioned by name.

The identification of the Maṇḍala of Vāraka with modern or ancient Vārendrī does not carry conviction, the forms of the names are widely different, and though there may be a common root in both, there is nothing to show that they were one and the same; moreover, in the copper-plate grants of Sena Kings of Bengal the name is usually found to be Varendrī and not Varendra. The form of Varendra is found in later records, principally in genealogical works, none of

¹ Cakradatta, edited by Jasodanandan Sarkar, Calcutta, B.S. 1302.

which can be called ancient. Mahāpratīhāra in the second and third plates should not be taken to mean “the Chief Warden of the Gate.” The office was a much higher one and should be translated as “Chief or Prefect of the Guards.” The word Mahattara cannot be taken to mean “the leading man of the village,” which is also the name of an official. Mr. Pargiter’s conjecture about its extant form (Matabbar ماتبّر) is unnecessary. The word Mahattara is always used to denote the name of a separate office, and Mr. Pargiter will, I have no doubt, find many instances of this among Northern Indian inscriptions. There is nothing in this inscription to support the following statement “that under him local administration continued to be, as in the grants B and C, conducted by a Board of Officials, in which the Chief was the oldest official named Dāmuka.” Supratikasvāmin seems to have approached the entire body of officials at this particular locality, of which Dāmuka was not the oldest, but the *chief* official. Jyeṣṭhādhikaraṇika means the chief Adhikaraṇika. Similarly the word Jyeṣṭha Kāyastha should not be taken to mean the “Oldest Kayastha,” but “the Head Clerk or the chief of the scribe.” Sūrada, not Svarada, is the qualifying adjective of the man Vihitaghoṣa, while the word Mahattara is the separate title of the majority of the officials mentioned in this grant. There is no necessity for the conjecture about two classes of leading men, for they were no leading men at all. Mr. Pargiter’s rendering of the name Coraka does not carry conviction. It is true that in Bengal the word *chur* is used to denote any alluvial formation thrown up in at the side of a river bed. But there is no proof whatsoever to show that this chur land has anything to do with the Coraka. For purposes of marking boundaries a plant or a plot of land called after a thief is quite sufficient by itself.

THE VALIDITY OF THE GRANTS.

In a previous paper I have already analysed the characters of these four grants in length, but to my great regret I find that I have failed to explain myself clearly to Mr. Pargiter. I have said that “the characters used in this copper-plate inscription (the Ghagrahati or the Kotwalipada Inscription) were collected from alphabets used in three different centuries.” On this statement Mr. Pargiter remarks as follows:—“Now it is well known that old habits persist in out-of-the-way places long after they have disappeared from more important and progressive places.” This, in fact, is quite true, but it does not help us in proving the genuineness of these inscriptions. “Hence we ought to expect that a document executed in this outlined region should show older styles of writing than should be found in contemporaneous inscriptions

at Bodh-Gaya and Ganjam with which he compares this grant.” The fact is that in these four grants characters of two or three different centuries are found to be used side by side. In out-of-the-way places it is often found that archaic characters are still being used when a much later form of the alphabet is found to be current in busier and more populous localities. But nowhere will be found that characters used in two or three different centuries are used in one and the same inscription. I shall now take each of these inscriptions one by one.

1. THE GRANT OF DHARMMĀDITYA—THE YEAR 3.

In a previous paper I have already shown that two forms of *Ha* and *La* have been used in this inscription.¹ The first form is the Eastern variety of the early Gupta alphabet and the other the Western variety. In the Dhanaidaha Grant of Kumāragupta I of the Gupta year 113 we find that the Western form of the Gupta alphabet was already being used in North-Eastern India with forms of the Eastern variety. So it must be taken for granted that at that time the older Eastern form of the alphabet was gradually dying out in North-Eastern Provinces and the Western form taking its place. So it is not likely than the same admixture of Eastern and Western forms would be found in an inscription which is at least 150 years later than the Dhanaidaha Grant. Mr. Pargiter’s analysis of my treatment of the characters of the fourth inscription is very faulty. He asserts that my proposition about the changes in the alphabet of North-Eastern India in the first decades of the 5th century A.D. “must be revised in the light of the three grants edited by him.” His arguments are curious in the extreme. He goes on saying “in the grant A of 531 A.D. both forms of H are used, the Eastern 9 times and the Western 6 times.” The first point is the date of the grant A. Mr. Pargiter arrives at 531 A.D. after assuming that Dr. Hoernle’s assertion about Dharmmāditya’s identity with Yaśodharmman is correct and that the latter began to reign in 528 A.D. In his previous article on the subject he says “He (Dr. Hoernle) thinks that the Emperor Dharmmāditya is the Emperor Yaśodharmman.” I would like to enquire whether Dr. Hoernle can cite any reliable proof in support of this assertion. I am sure that among the published records of Indian antiquities there is nothing whatsoever which can be cited in support of this proposed identification. The three inscriptions of Yaśodharmman published by Dr. Fleet are the only sources of information about him and they contain nothing about the identity of Dharmmāditya and Yaśodharmman, or anything that will

¹ Journal of the Asiatic Society of Bengal, Vol. VII, p. 290.

help us in fixing the year of Yaśodharmman's accession. Mr. Pargiter should not have accepted Dr. Hoernle's conclusions beforehand, but should have waited for the appearance of the proofs, which Dr. Hoernle may be holding in abeyance in support of his proposed identification. Yaśodharmman may have had the *Biruda* of Dharmmāditya, but this again requires proof. Consequently, it must be taken for granted that Dr. Hoernle's proposed identification of Dharmmāditya with Yaśodharmman is not correct, and his proposal for accepting the year 528 A.D. as the initial year of Yaśodharmman is not based on facts. In fact, there is no sufficient ground to hold that the date of the grant A is 531 A.D. and his treatment of my analysis of the characters of these four grants cannot be accepted. The genuineness of all these inscriptions is to be doubted because he used obsolete forms in conjunction with forms of much later date. The same thing must be said of his next statement: "and it appears they (the Eastern and Western form of H) were used indifferently because both are used in the same words." On the other hand, this will have to be taken as a conclusive proof of the fact that the writer or writers of the inscriptions were not aware that he or they were using characters which were impossible when used in the same inscription. This fact is further proved by the characters used in the seals. Mr. Pargiter has himself admitted that in one case at least the form of a character used in the inscription is earlier than that used in the seal. Usually a seal, the impression of which is placed on a grant, is older than the grant itself, for one and the same seal is used to seal a number of documents. I believe Mr. Pargiter would not admit that in the ancient days people made a separate seal for each document and sealed the document some decades after it had been drawn up. It may be asserted that the seals were made in the Western Provinces of Northern India, while the documents were drawn up in the East; but this explanation cannot be accepted because the practice itself is unusual. We find another unsupportable assumption in Mr. Pargiter's date of second inscriptions, which he avers is "567 at the latest." I fail to understand what reason there can be to place Yaśodharmman's death in 568 A.D. and what connection Yaśodharmman may have with Dharmmāditya. Mr. Pargiter based his final conclusion upon premises which have not yet been proved to be true, and states "Those grants show clearly that the two forms (of H) were in use side by side in this region during the 6th century." Fresh comment is unnecessary, because these grants prove nothing beyond the fact that the characters used in them belong to two or three different centuries. He continues to state that the Eastern variety of the early Gupta alphabet was used in Eastern India at least a century and a half than my estimate. Having come

[N.S.]

to these conclusions, Mr. Pargiter proceeds to state "the fact then that in this grant the Western form is used generally and the Eastern once un-compounded and twice in HM is in full agreement with other grants and has no indication of falsity, but rather a local characteristic of genuineness." (Page 493). The evidence based on the use of two varieties of H when compared with the same evidence derived from the Dhanaidaha grant tends to prove distinctly that either these four inscriptions cannot be placed in the 6th century and must be assigned to the 4th or 5th century A.D., or that they are forged. The evidences supplied by the characters used in the seals of three of these inscriptions prove that records were incised several centuries after the preparation of the seals when the public had forgotten between the forms of characters used in previous centuries.

Mr. Pargiter proceeds to examine my analysis of the characters of the fourth inscription. While treating of the medial form of the long I, Mr. Pargiter admits in the first place that its form "tended to vary considerably,"—a statement which serves very well to prove my own conclusions. Among the instances quoted by Mr. Pargiter, it may be pointed out that the medial *ī* in the word *Grhītvā*, in the eighth line of inscription No. 1 (Grant A of Mr. Pargiter) is really *Grhotvā*. If it be taken to be a medial I it will have to be admitted that the form is an abnormal one of the Eastern variety of the early Gupta alphabet. The use of this form in these inscriptions and the Eastern variety forms of *Ṣa*, *La* and *Ha* along with the scroll like form of medial *ī* found in all other instances cited by Mr. Pargiter would alone be sufficient to prove that there is something fishy about these records. In the fourth inscription the form of the medial *ī* is that of the Eastern variety of the early Gupta alphabet with a very slight modification. Mr. Pargiter states "there is a tendency to reduce the size of the inner curl of this vowel sign, and in these last two words and in *Vikriya* (Grant B, line 14) it has practically degenerated into a dot connected with the outer curve. To separate the dot and the curve would be a natural modification, as we find in this grant; and here the I sign always consists of a dot or a small stroke, and a curve on its right, except in *Supratika* (line 17) where their position is reversed." This statement is sufficient to prove that the form of the medial *ī* in this inscription was something different from the curl which is usual in other inscriptions of the 6th century A.D. The form used seems to be a development of the two curved strokes of which the Eastern variety of the early Gupta form consisted and which again was a very slight modification of the Asoka-Brahmi form. The form used in the word *Supratika* (line 17) serves to prove that the left half did not consist of the dot but was really a curve, which in many

cases had become a dot or a small stroke owing to the ignorance of the scribe. In fact, he or they did not perceive that unwittingly a slight modification was being made. Consequently, Mr. Pargiter's conclusion that "the form of I then in this grant is no indication that it is spurious" is erroneous. If Mr. Pargiter wants to prove that the form of medial I in North-Eastern epigraphs of the 6th century A.D. was almost the same as that of the Eastern variety of the early Gupta alphabet, he must base his conclusions on records other than these four inscriptions, otherwise there will be a case of begging the question.

The initial I, as I have already stated, presents a further difference in form. On the first side, in line 9, it consists of two dots, one above the other, and a straight vertical line to the right. This is the form peculiar to the Eastern variety of the early Gupta alphabet, and it is to be found only in the Allahabad Inscription of Samudragupta and Kahaum Inscription of Skandagupta. When we compare the other form of the initial I, which is to be found in the first letter of the word *Ichato* in line 14 on the second side, we find that it is really the 6th century form. The word as it stands cannot be anything but *Ichato*. Mr. Pargiter may take it to be anything in order to render it. But here the form is that of 6th century and of later inscriptions, consisting of two dots or circles placed side by side above a short horizontal straight line. Mr. Pargiter says: "There is nothing suspicious in this form, because it is used in the same word in Grant A." As I have said above, the evidence of the characters of any of these plates cannot be taken to prove either the age or validity of any of them.

Mr. Pargiter has next tried to prove that the form of *Ma* in the 4th Grant is not abnormal, because the same form is to be found in inscriptions Nos. 2 and 3 and so are not open to distrust. I can only answer that the evidence of the characters of all four inscriptions being questionable, the forms of characters in any one of them cannot be cited to prove the regularity of those in any one of them. His treatment of the form of *Ya* is more important. He says that the form of *Ya* used in the 4th inscription "the instances here present three stages in its formation. In the earliest of these the left perpendicular reaches the bottom horizontal stroke, as shown in the second *Y* of *Yayāti* (line 1), *Viṣaya* (line 4) and *Yogāya* (line 11); and this shape constitutes a connecting link with the second form figured in my article." His ingenious treatment of the forms of this letter need not be examined in detail. I regret to find that he has missed the force of my argument. *Ṣa*, *La* and *Ha* of the Eastern variety of the Gupta alphabet has never been found to be used along with the bipartite form of *Ya* except in these four inscriptions—a fact which alone would

serve to raise grave doubts about the genuineness of these records. He has again committed the fallacy of citing the forms found in some of these inscriptions in support of the genuineness of the fourth record.

In his examination of the next letter *La*, Mr. Pargiter has tried to prove that the occurrence of the Eastern and Western forms of the letter *La* should not be wondered at, because they occur side by side in the other inscriptions. He says it thus appears that both the Eastern and Western forms of *La* were in use in this region in 531,—the date of Grant A. His whole argument depends for its validity upon the identification of Yaśodharmman with Dharmmāditya and upon the assignment of the date of his coronation to 528 A.D. It might be stated in reply that as the identity of Yaśodharmman and Dharmmāditya still remains to be proved, and as there is nothing to prove that Yaśodharmman began to rule in 528 A.D., so nothing can be definitely affirmed of the date of any of the inscriptions bearing the name of the Emperor Dharmmāditya: consequently Mr. Pargiter fails to prove that the Eastern and Western variety forms of *La* were used side by side in a 6th century epigraph in Northern India. In conclusion we find that the whole structure of his arguments at once fall to the ground. The forms of the letters used in the word *Parkkatti* in line 17 of the second side of the 4th inscription come next in order. Here also I find to my regret that I have utterly failed to make myself understood. Mr. Pargiter has tried to prove that there is nothing abnormal in the forms of these letters. Take for instance, the first letter *Pa*. Mr. Pargiter goes on to argue that it has the same shape as that in *Pravartaniya* (line 10), *Nrpasya* (line 14) and *Pisāca* (line 18); if Mr. Pargiter had examined the forms of *Pa* in the words quoted above carefully, he would have come to the conclusion that in the majority of cases the form of *Pa* is that of the Northern Indian epigraphic alphabets of the 4th or 5th century A.D., having a clearly pronounced acute angle at one end of the base. In some cases the other angle, that is, the obtuse angle, makes way for a slight curve. This curve is very well pronounced in the word *Pisāca* (line 18). There is a further difference between the form of *Pa* in the word *Pisāca* and *Parkkatti*. The common element between these two forms is the existence of the curve and the acute angle at its lower extremities, while the differentia is the elongated form of the letter in the latter word. This elongation of the form is to be found in no other case and is a clear indication of the fact that the letter belongs to the Nāgarī alphabet and cannot in any way be taken to be connected with the earlier forms of the Northern Indian epigraphic alphabet.

The Bodh-Gaya Inscription of Mahānāman of the Gupta year 269 should never be taken to be the prototype of the

Eastern variety of the Northern Indian epigraphs of the 6th century A.D. It is doubtless that though this record was incised in North-Eastern India in or about the year 588-89 A.D., it cannot be said that the characters represent the ordinary epigraphic alphabet of North-Eastern India of the 6th century. The characters have much more advanced forms than those of the Mundesvari Inscription of Udayasena of the Harṣa year 30,¹ or the Patiakella Grant of Śivarāja of the Gupta year 283,² but it should be noted that the form of *Pa* used in the inscription of Mahānāman is in no case like that of the word *Parkkatti* in the fourth inscription from Faridpur; the pronounced curve of the lefthand side vertical and the elongation of the letter are altogether wanting there.

It is quite true that in the next syllable of the word both the *Kas* are not looped and that the same form of the compound is to be found in the first line of Bodh-Gaya Inscription of Mahānāman. It might be stated in reply that the letters of the Bodh-Gaya Inscription cannot be taken to be the representatives of the 6th century alphabet of the North-Eastern India. If Mr. Pargiter will take the trouble to examine the form of the same compound in the seventh line of the Mundesvari Inscription of Udayasena, he will have to admit that its form is really abnormal. Moreover, he will find no inscription in Northern India where such late forms occur side by side with letters which decidedly belong to the Eastern variety of the Gupta alphabet, and consequently his remarks cannot be taken to be decisive. My former statement about the form of *Ka* in the fourth inscription from Faridpur still remains to be refuted and needs no modification as yet.

At the end of this palaeographical examination, Mr. Pargiter proceeds to sum up: "I have now considered all his criticisms on the script in this grant, and have shown that the features which he distrusts are to be found in other almost contemporaneous inscriptions which are genuine; so that as regards the script, there is nothing suspicious in this Grant." I have stated at length that the peculiarities of the characters used in these inscriptions are so varied and unprecedented that no one would venture to pronounce these four grants from Faridpur to be genuine records of the 6th century A.D. All of these inscriptions show forms of characters which belong partly to the Eastern variety of the Gupta alphabet and partly to the Western,—a conjunction which cannot be expected in a genuine record of the 6th century. The Dhanaidaha Grant of Kumāragupta I of the Gupta year 113 = 432-33 A.D.³ is an undoubted proof of the fact that in the earlier decades of the

¹ *Epigraphia Indica*, Vol. IX, p. 289.

² *Ibid.*, p. 287.

³ *Journal of the Asiatic Society of Bengal*, Vol. V, pp. 458-59.

5th century A.D. the Eastern variety of Gupta alphabet was already dying out in North-Eastern India and its place had to a very large extent been already occupied by the Western variety. Consequently, either the first three inscriptions from Faridpur will have to be assigned to the 4th or 5th century A.D., or declared to be forgeries. The evidence of the fourth inscription is conclusive on this point. In this inscription we find that the Eastern variety of the Gupta alphabet is being used along with the Western variety and certain other forms, which cannot be taken to have been used in North-Eastern India earlier than the 7th or 8th century A.D. The result I believe is apparent and does not need a fresh statement. In the first three inscriptions from Faridpur we find certain forms of the Eastern variety of the Gupta alphabet which are altogether new to Indian palaeography. The form of *Ha* in the word *Himasena* in line 23 of inscription No. 1, is an example of the above statement. The letter does not resemble any form of *Ha* of the Gupta alphabet, but is more akin to the *Ra* of the 8th or 9th century alphabet of Northern India. This peculiar shape of the letter *Ha* is a result of a man's attempt to copy a form of a letter which is altogether unfamiliar to him.

Mr. Pargiter is of opinion that the fourth grant at least is "not a royal grant, but a grant by the business men of *Santha* of a part of the common land of their village,"¹ and consequently he proceeds to reject my second ground for discrediting the fourth grant, viz. that it differs from the formula found in the majority of copper-plate grants. If this statement be correct, then we shall have to admit that Mr. Pargiter has discovered a new class of grants,—private grants,—which are to be distinguished from the majority of known copper-plate grants which are royal grants. Mr. Pargiter does not seem to be aware that even a private grant needs royal confirmation. "According to the Law Books (Jolly, *Recht um Sitte*) all *Sāsanas* must bear the royal seal."² This statement is fully borne out by the discovery of the *Kamauli Grant* of the *Siṅgāra Prince Vatsarāja* of the reign of *Govindacandra*,³ the plates of the reign of the *Caulukya Prince Ajayapāla*, recording the grant of his officer (*Mahāmandaleśvara*) *Vaijalladeva*,⁴ the *British Museum Plate* of the *Mahārānaka Śalakhanaṇavarmadeva* in the reign of the *Kalacuri Mahārājādhirāja Vijayadeva*,⁵ etc. Numerous inscriptions have been found in Northern India which illustrate this principle, and consequently Mr. Pargiter's assumption may be rejected

¹ Above, Vol. VII, p. 496.

² Buhler's *Indian Palaeography*, English Edition, p. 92.

³ *Epi. Ind.*, Vol. IV, p. 131.

⁴ *Ind. Ant.*, Vol. XVIII, p. 82.

⁵ *Ibid.*, Vol. XVII, p. 228.

Mr. Pargiter thinks that "a poor brahman of no position, who wanted only a parcel of waste land for his personal occupation, foisted himself into this village by forging a copper-plate grant for a piece of char-land as having been given to him by the business men of the village" is incredible. Mr. Pargiter's position seems to be very strong and unassailable, but he has left one little thing out of his consideration, which is that the inscriptions were manufactured hundreds of years after its reputed date, most probably by powerful landholders whose interests were at stake and who claimed to be either the descendants or owners by transfer from the descendants of the poor Brahmin mentioned in them. Lastly, Mr. Pargiter is obliged to state that "there are certainly some words which are not proper Sanskrit, but their use, so far from being suspicious, is only what might be expected when local conditions peculiar to this outlying region had to be put into Sanskrit dress. In answer it might be said that Mr. Pargiter's translations of these words have not as yet been proved to be correct; it will take some time before they can be proved so and the discovery of fresh records must be awaited. Mr. Pargiter's ingenuity is apparent, but it still remains to be proved whether his explanations are correct or not. It may also be that the forger of the document has put some unintelligible words into his composition in order to mystify his audience, for unintelligible quotations even, carry great weight with them in the East, and, more specially so, when the audience is wholly or partly illiterate.

The statements of Messrs. Hoernle and Pargiter about the date of these records are of no value at all, as they are based on assumed identities. If, at some future date, Dr. Hoernle can produce some direct evidences to prove the identity of Yaśodharmman with Dharmmāditya, the case will have to be argued over again on the merit of such evidence.

I must conclude with some remarks on Mr. Pargiter's peculiar method of determining castes. For example, we find that he says "the termination Deva in names often designates Brahmans." One who is acquainted with Northern Indian Inscriptions would emphatically deny such a thing. If on the basis of such evidence we have to admit that Samācāradeva was a Brahmin, then we shall have also to admit that Lakshmana Sena, Rāmapāla and Govindacandra were all Brahmans. I do not know what evidence he has to prove that "the names of Mahataras in this inscription do not appear to be genuine compound words in which the component parts had been on one another, such as Dharmmāditya, Sthānudatta and Kulacandra in Grant A (11=2-4), but seem to consist merely of two separate words in juxtaposition. Hence we may with full propriety write them as Vatsa Kuṇḍa, Suci Pālita, Vihita Ghosa, Priya Datta and Janārdana Kuṇḍa; and perhaps Jivadatta may be so treated.

Hence it appears that in these names we have four of the caste-surnames which are common in Bengal now, namely Kuṇḍa (modern Kundu), Pālit, Ghosh and Datt. When a person's caste is mentioned, the surname is sometimes omitted, as in the case of the Karaṇikas, for while one is named Naya Nāga (Nag is another modern surname), the other is called simply Keśava." The futility of such arguments are self-evident and they stand self-rebutted. It may be argued on the other side that if such names as Naya Nāga and Suci Pālita are taken to consist of one word instead of two then there is no mistake. Moreover, Mr. Pargiter seems to have forgotten that in modern Bengal nomenclature names usually consist of three parts, such as Priya Nath Dutta, Jiva Chandra Datta, Kesava Chandra Mittra, and these names are quite different from such names as Priyadatta, Jivadatta, Kesavamitra, etc. The word Karaṇika qualifies both names, and had it been a caste surname then another such in the case of Naya would have been deemed superfluous. Unfortunately the words Kāyastha and Karaṇika are not caste-surnames up to the 11th century A.D., they are the names of scribes. Dr. Bühler's classical work on Indian Palaeography may be consulted with great advantage for both of these points: "Two works just mentioned (Rājataranginī and Kṣemendra's Lokapraśāsa) as well as other contemporaneous ones, designate the writers also by the term Kāyastha, which first occurs in the Yājñyavalkya-Smṛti, I. 335, and even at present is common in Northern and Eastern India." ¹ A chance remark made by the father of the Indian Palaeography throws a flood of light on the date of these four grants. In genuine Northern Indian inscriptions the word Kāyastha does not occur before the 8th century A.D. "In the inscriptions, the Kāyasthas occur since the 8th century, first in the Kanasva Inscription of A.D. 738-39 from Rajputana." Karaṇika also means a scribe, and according to Kielhorn, the greatest of Indian Epigraphists, "a writer of legal documents." To Bühler the words Kāyastha and Karaṇika appeared "to be merely official titles without any reference to caste." Mention might be made here of one inaccuracy in the translation of the first grant. He, Mr. Pargiter, has taken the word Vṛhac-ṇṇa (11=4-5) to be a proper name, but it is well known to be the name of a class of officers, who were most probably the head of the Caṇṇas.

¹ Bühler's Indian Palaeography, English Edition, p. 101.

45. On the Language of the Gypsies of Qainat¹ (in Eastern Persia).

By W. IVANOW.

The Gypsies of Eastern Persia are a wandering folk, scattered through many villages, living exclusively in tents. During the winter, however, many families will hire small houses or occupy ruins. And often they resort to a certain definite place, as for example Serbishe near Birjand. At other times they are all only to be met with in large numbers on some extraordinary occasion, such as a wedding, when they come into the neighbourhood of the towns. Although they differ from the Persians in their features and not seldom in the colour of their skin, I am unable to agree with Mr. Sykes ('Ten thousands miles in Persia'), who saw them in Kerman province, that they seem not to be of Aryan origin. There are unmistakable signs of admixture of non-Aryan blood; it would be impossible to ignore the influence of other peoples upon them during the time of their wanderings. We should expect traces of Semitic, Turkish and even Dravidian influences.

They exhibit a great variety in their features, but the commonest type seems to be a round face with a large, broad, seldom hooked, nose, thin lips and a thick growth of coarse hairs. Many of them recall vividly the Semitic appearance of those Arab tribes, who still inhabit the Central Desert of Persia, and there is sometimes a strong likeness between the faces of Gypsies and of Arab *ḥammāls* (coolies) of Birjand. I may remark that the Gypsies, as far as I could learn, intermarry with Arabs far more than with Persians, who despise them. As a rule they are of excellent physique, sober, hard-working people of the meanest intellectual capacity.

Of their history in these lands hardly anything is known. Still there are some interesting points besides well-known allusions in the *Shāhnāmāh* and in DeGoeje's work, based on *Hamza Isfahānī*, worth mentioning here.

Southern Persia, still almost unexplored, contains many races, or rather fragments of races, which might in varying degrees have influenced the Gypsies. Such are the *Brāhūīs* of Dravidian origin, the dark inhabitants of S. Persia (perhaps the *Qus̄* or *Qus̄j*, *Qus̄j* of Arab historians), and the Balūchi

¹ I am much indebted to Mr. A. F. Scholfield, for help with my English.

themselves. The Arab geographers of X-XII cent. mention a race, living in Mokrān—az-Zuṭ or al-Jat (الزط) or (الجت).

It is known, that the Massagetoï of Herodotus, corresponding to “Da-Yueti” or “Yueji” of Chinese, and “Getae” of later Greek historians, and “Ephtalites” (هپطل) of European and Muhammadan writers, followed the Scythians at the time of their invasion of S. Persia and India (“Scythians” = “Se”, “Sey” of Chinese, “Sakas” of Indian, “Segzi, Seji” [Sejestān-Seyistān-Sakastan-Seistān] of Persian historians). Chinese and Greek historians often notice the Da-Yueti, and it appears that they sprang originally from the same stock as the Scythians, with whom they lived in close connection. In India their name can be recognized in “Jat” (King Kanishka was of this tribe). According to many accounts they were of Aryan race, although Dr. Tomaschek in his *Centralasiatischen Studien* (1877) calls them “a tribe of Tangut origin.”

Now those Jatts are still a numerous tribe (78,400 acc. the last census) in British Balūchistan, not to mention many other tribes with the same name throughout India. And the likeness between the name of the above-mentioned Az-zuṭ or Al-jat of Arab Geographers, and the contemporary Jatts and Syrian zatts, zotts (Nawars) is very striking. Besides the name “jat” is still applied in some places of Eastern Persia to the Gypsies.

Against the opinion of Mr. Sykes (a note in the *Journal of Gypsy Lore Soc.* v. III (new series), p. 320) I believe this likeness is not fortuitous. It must mean that the Gypsies lived a long time among the Jatts, as they did among other peoples. This may throw some light on the enigma: what road did they take on their way from India?

It is tempting to suppose that the Gypsies were originally but a tribe of the same Jatts, the most western of them, inhabiting the south-eastern part of the Iranian plateau. We know, that Seistan and the neighbouring countries to the south were in ancient times not so desolate as now. There were numerous towns and villages with a thick population. Is there no relation between the migration of the Gypsies and the gradual decay of these countries? And were they simply pushed out by the growing dryness of the lands? This would be a very simple explanation of a fact not so common in history, viz. the migration of an isolated tribe from the centre of India to the coasts of the Atlantic.

A comparative study of the affinities linguistic and anthropological between the Kanjar tribe of India and the Jatts and Gypsies of Baluchistan might yield much of interest.

There were many other peoples in ancient times who might have influenced the Gypsies. The modern name of *Mokrān*, as is proved, is not of Aryan origin, but seems to be derived from the name of a tribe, perhaps of Dravidian stock, whom the

Greeks knew as “*Makai*” (Μάκαι) or “*Mukai*” (Μύκαι), and who appear in cuneiform inscriptions as “*Maka*” or “*Masia*.” Stephanos of Byzantium gives the name of the country as “*Makarēnē*” (Μακαρήνη), and in Muhammadan geographers we find the parallel form “*Makūrān*”).¹

The ancient Greek name for Southern Persia, “*Hedrosia*”, seems to have originated in the name of a tribe whom Herodotus styles “*Dērousiaioi* (Δηρουσιαῖοι).² We know but little about the real distribution and peculiarities of the Gypsies in Persia. Still less about those of Afghanistan. From what I have seen of them on the Persian frontier they are of the same type (sometimes even fairer), speaking a kind of Turko-Gypsy patois.

About the Gypsies of Baluchistan we know a little more, and I cannot abstain from quoting here an interesting passage by Mr. Denys Bray, I.C.S., in his *Census of Baluchistan, 1911*, p. 173, (v. IV). “*Zōrī*—10,936. They are dispersed throughout the whole country, and reach far away into Persia and beyond. Asked about their origin they usually spin some yarn connecting them with the particular race among whom they live: they hail from Aleppo; they are descended from *Sarmast*, youngest of the sons of *Mīr Hamza*, the Prophet’s uncle; it was under *Chākar* the King, that they came first to *Makrān*, and on into Baluchistan, and much more in the same strain. Asked about the meaning of their name, they usually explain that old father *Sarmast* was luckless enough to get overlooked when *Mīr Hamza*’s patrimony was being divided up, and there was nothing left him but a *lōr* or share in the lot of his more fortunate brothers. As a matter of fact, they are not overfond of the name of *Zōrī*, and many of them much prefer to be called *Sarmastārī* after their legendary ancestor, or *Zōpī*, for which they have no explanation to offer at all, or else to be dubbed *usta*, short for (P.) *ustād*, master-craftsman. By craft they are tinkers, first and last; after their own fashion they work well enough in gold and silver; they are not bad hands at carpentry; they are expert beggars; several of them are *dōmb* or professional minstrels; the wives of the *dōmb* are the midwives of the country. After this long list of their attainments it is not surprising that the tribes to which they are attached—and nearly every section among the Balōch and Brāhūis has its own little *Zōrī* group—are fully alive to the value of their services and keep a pretty tight hold over them, taking them along on their wanderings and fiercely resenting any overtures on the part of other tribes to lure them away.

¹ It is noteworthy that the patois of *Zōrī*, or Gypsies of Baluchistan is still called *Mōkki*.

² I must refer the reader generally to W. Bartold’s *Historico-Geographical Description of Iran* (in Russian), S. Petersb., 1903.

The tribal headmen the *Zōrī* have jealous guardians of their petty rights and privileges, and under their protection they lead a charmed if lowly life, for the excellent reason that their blood-money is set at some fancy price, generally twice the blood-money of an ordinary tribesman."

As to their literary name "Zūlī" or "Zūrī," analogous to Balūchī "Zōrī", this is absolutely unknown in Qāināt, while in Western Persia it is applied only to an inhabitant of Zūristān. "Kāūlī," which is derived presumably from the Gypsy "Kālā" "Kāūlā"—black, dark (not from *Kābūl*), I have never heard used. In the east it signifies an Afghān, in the west, an Indian Muhammadan. The most common name is "Qirishmōl" (or *Qirishmāl*), and in Qāināt "Ustōkōr", from the Persian *ustād-i-kār*, i.e. master-craftsman, in allusion to their craftsmanship, by which they earn a livelihood. Their word *Kōzengi(r)* is a translation of this. The word "Qurbati" with its parallel forms "Qulwati", "Khulwati", is often applied to them and especially to their language. The origin of this term, as I have been told by many Persians and by Gypsies themselves, is to be sought in the familiar Muhammadan tradition of the prophet Ibrahīm. He persisted in rebuking his countrymen for the depravity of their lives: they used to "approach" (Ar. *qārība*) their own mothers, daughters and sisters. They seized him and were about to burn him alive, when he was delivered by a miracle. Thereupon Ibrahīm cursed them and devoted them to perpetual wanderings.

But this word can be explained much more simply as coming from "ghurbat, gharībī" meaning "to be a stranger," or "to live in foreign country," because *q* and *gh* are almost always absolutely undistinguishable in the local pronunciation. Another name for Gypsy very seldom used here, is "Bahlūlī." It belongs properly to a Balūchī tribe, living in some parts of Birjand province.

II.

Perhaps a few notes on the peculiarities of their customs and manner of life would not be out of place.

In the matter of clothes they differ but little from the ordinary Persian peasant. The women however often dress in red, and unlike the Persian peasant woman, who usually covers her face outside her own village, they never do. Often too they wear nose-ornaments, a custom common enough to Arab women, but extremely rare among Persians. Their tents and their belongings are just those of Balūchīs and Eastern Kurdish and Arab tribes.

Their religion is Islam of the Shi'a sect. But the genuineness of their faith is suspected by the orthodox as they are lax in the performance of the ritual, and in the saying of the most essential prayers. Religion does not enter deeply into

their lives and I have never heard of there being any derwishes or saints among them. "Kerbelai", i.e. persons who have undertaken the pilgrimage to Kerbela, the shrine of Imām Huseyn, are almost as rare. Their standard of morality is low, and many women are reputed to be occasional prostitutes.

They are mostly copper- and iron-smiths or carpenters. They also make a special kind of felt cap. Their productions are of a simple kind, requiring no particular skill, reaping-hooks, chains, shovels, etc., *qalyān*-pipes of *onnab*-wood, the apparatus for weaving and other domestic utensils. Women prepare a kind of guimp lace, called "*bendi shālwār*", which is chiefly used for cloth belts by them.

The Gypsies are known everywhere for their clever singing and dancing. But in this province they show no particular skill.

All Persians despise them; to eat with them is considered derogatory even by the lowest persons.

Their customs, in short, are much the same as those of the ordinary Persian peasants, though tending to a greater simplicity owing to their poverty. As an example I may cite their wedding ceremonies, which are celebrated with great merry-making, much music and dancing. Even their women and girls take part in the last, and they are joined by hundreds of spectators. For the traditional bridegroom's walk to the bath is substituted a ceremony, in which the bridegroom, accompanied by all the people, with girls dancing at intervals of a few paces is taken to the nearest spring or pool. Then the crowd stops, and he quickly performs the ritual of "ghusl", or bathing the whole body. I was assured that this custom is observed even in winter. The traditional washing of the bride's right hand and left foot by the bridegroom is often omitted.

They are of course, strictly speaking, endogamous. The rates of "*mahr*", i.e. bride's price, or "*shīr-behā*", i.e. the price of milk, are very low. An old man boasted to me that he had given all his daughters in marriage and "had made a good thing out of it", receiving no less than 10 tumāns (Rs. 25) "per head"! The girls are married at from 13 to 16 years of age, the boys later.

It is very difficult to discover the real numerical strength of the Gypsies, they live so scattered in the remotest corners all over the province. I am inclined to believe that they cannot be very numerous.

III.

Gypsy jargon has lost its own grammar and uses only that of the Persian as spoken in Qāināt. Abounding in many kindred original forms, Gypsy language easily melted into Persian. (Even the language of English Gypsies retains a

number of Persian words). The few genuine Gypsy words preserved were preserved with the special object of concealing their "secrets"; and thus the speech of scattered families possessing no poetry (even the possibility of this seems to them now ridiculous), nor anything deserving the name of "folklore", lay at the mercy of every chance influence. (The same is the case with the Arab tribes of the Central Persian Desert.) Judging from the state of their language, one may legitimately suppose that they were the first emigrants, who came to Persia in ancient times in small numbers before the main body of Gypsies migrated.

Yet, notwithstanding many phonetic changes in their corrupted language the origin of nearly all their words can be traced to an Indian source.

I am not able to share the view of Mr. Dames in his notes on the short vocabularies Mr. Sykes (*Journal of Anthropolog. Inst. of Grt. Brit. etc.*, v. XXXII, 1902, p. 339, and v. XXXVI, 1906, p. 302), that this jargon is entirely of artificial origin, for I may point out that neither of the vocabularies is a safe ground for forming an opinion, being full of mistakes. It is very hard indeed to obtain from the average Gypsy any adequate linguistic material; their stupidity is sometimes beyond all descriptions. Ask a Gypsy: "How do you say 'horse' in your language?" He will answer in 99 cases out of 100—"A horse is good, is tall, is cheap" etc., but never directly to the question. It is, I suppose, a common feature of many Gypsy tribes—incapacity for abstraction. And Prof. S. Macalister says just the same about Syrian Zotts: that such linguistic inquiries among them require particular cautiousness, and even the most "learned Persian", who compiled the vocabularies for Mr. Sykes, can fall into many mistakes. Such is the case, I believe, e.g. with a very strange form in the vocabulary of Gypsies from Sirjān and Zirutt—"marzi" meaning "I." I dare wager that the Gypsy, who was asked: "How do you say 'I'?"—answered "I am a man", "*man marzi (mardi)-um*" (*d* is pronounced often very softly). The same with the word *shay-tumi*, which occurs many times in the vocabulary in very different significations. The Gypsies use this word very often for anything whose name they do not know. It means simply "thing, something", and = Arabic word 'shey' (شيء). Of course the only sure method is to analyse their stories or to converse with them in their language.

The case is just the same with the so-called *Mōkkī* or *Zōrī-chīnī* of Baluchistan. Mr. Denys Bray says (op. cit., p. 140): "It is an artificial jargon, invented on the basis of the language of the people among whom they (Gypsies) live, and which they more especially employ when they want to keep their meaning to themselves. And yet so successfully and universally is the jargon used, that it seems doubtful whether its artificiality

suffices to debar it from being classed as a language. It is at any rate acquired naturally by Zōrī children, as a language for the home circle.”

There are many words in Gypsy language which are used in the secret code of derwishes, beggars and, I believe, thieves. These words are often artificial, “symbolical”, even drawn from several other tongues.

The Qāinī idiom being the basis of local Gypsy jargon is a link in the great chain of Iranian dialects, at one end of which are the languages of the Pashtoo family, at the other those of Kurdish. The idiom in question is closely related to that of Turshīz (or Turshīsh) and Sebzewār, and shares many words with the dialect of Tabas. This last is in a transition stage towards the dialects of Biābūnak, Nāin etc., which probably belong to the same group as the dialect of Kāshān. Many of their phonetic rules govern also Kurdish dialects and can be met, as far as I know, in the idioms of Aorami and Kendule, which belong to the Tajik family, the direct heir of Zend.

PHONETICS.

The chief peculiarities of this Gypsy idiom, i.e. as spoken in Qāināt, are as follows:—

The guttural \tilde{n} as in *degñō*. The use of cerebrals t and d as in *til*. The r sometimes recalls the r of Hindustani, e.g. in the word *barā*; k and g are more velar than in Persian, although not so strong as Persian g or gh . Their strong pronunciation is retained even when they are palatalized (I mark the palatalization with the sign). Dentals are usually softer than in Qāinī. The n on the end of words is often pronounced as a guttural \tilde{n} or deep Hindustani \dot{n} , and very seldom as Qāinī $m = n$.

Palatals are much softer, similiar to those in Hindustani; ch and j are sometimes undistinguishable.

The sibilants are also pronounced softer.

The labials can become a little aspirated, as *bhutok*, but they vary very much according to individual pronunciation. B and w , p are often interchangeable. Ex.: *bībe = bīwe*, *taqwīm = tagbīn*, *sefid = ispid*, etc.

The liquids l and r seldom differ at all in pronunciation. They very often cause the transposition (metathesis) of syllables. Besides there is always some thing like a softly sounding r or $r\check{r}$ after every final vowel: *gorōr*, *chetīr*, etc.

The sound “ a ” is more guttural and deeper, than in Qāinī, e.g. —*lakar*, etc. But long \bar{a} is pronounced always as in Q.—i.e. as \bar{o} , a sound which can never be confounded either with $o = \check{u}$ in North Persia (mostly Tehrān and Azerbeyjān), or with the Indian pronunciation of P. \bar{u} , as in *kōh = P. kūh*. As in Q. a long \bar{a} (= \bar{o}) at the end of a word becomes often $e\bar{o}$

or *ew*: *bachō* = *bacheŷ* (P. *bechehā*), *koldō* = *koldew*, etc. As a rule the final syllable *āb* is also *eŷ* or *ew*: *khew* = P. *Khwāb*, *ishtew* = P. *shitābeh*, just as in Qāinī. In the last *ā* is pronounced, though very seldom, as *ī*: e.g.—*dīshte* = *dāshte*. *E* and *i* are often deeper than in Qāinī. *U* is often sounded in the place of *e* or *i* and vice versa: *dīz* = P. *dūr*, *zīd* = P. *zūd*; *sūr* = P. *sīr*, etc. This rule is one of the most common to all the dialects of Iranian languages, observable as well in Pashtoo as in Balūchī and Kurdish.

There is a short *ō*, which can be called a peculiar Gypsy sound having no corresponding one in local Persian idiom. I believe in many cases this *o* = the suffix of substantives, corresponding to that of English Gypsy *o*, as in *senuto*, etc. But very often on the end of a word it is pronounced longer, and then is hardly different from *ō* = *ā*. Only in the middle of words it can be observed properly, as in *jodō*, *gorō*, *gelor*, etc.

Changes of the consonants in real Gypsy words are almost untraceable, owing to the deplorably scanty remnants of their vocabulary. Some changes which appear there can only be exceptions. Thus: *z* = *k*—P. *bāzī* = G. *bōkī*; *s* = *k*—P. *būsīden* = G. *bākīden*. *t* = *sh*, P. *keshīden*, G. *katōīden*, etc. In Smart and Crofton's "Dialect of the English Gypsies" (Lond. 1875) there are many phonetic changes given, but many of them, as far as I know, are not observed in Qāinī Gypsy. Such changes as *k*—*f*, *kh*—*f*, *b*—*d*, etc. I never met. The change of the labials into gutturals is very common to the Iranian languages and in some of Persian dialects, e.g. that of Biābūnak, it is a rule: *gis* = Pers. *bist*; *gechō* = P. *bechehā* etc.

Some changes in Qāinī Gypsy are very strange: *dehewīden* = P. *dewīden*; *meñōñ* = P. *nān*; *kutāgōn* = P. *kujā*, etc.

Synharmonic tendencies of Qāinī are not common to the Gypsy, although there are sometimes the traces of assonance.

Euphonicallly are used *n* and *w*, sometimes *y*: *sūni* = P. *sūyi*; *kīne* or *kéwe* = P. *kiest*? *palūnum* = P. *pahlūyem*, etc. But hiatus is also used very freely.

Accentuation is not so strong as is Qāinī.

The transposition of syllables and of their elements is almost a rule in this Gypsy dialect.

IV.

MORPHOLOGY.

Here as well as in the vocabulary I will only note the differences between Gypsy and Persian.

Nouns.—The gender is not distinguished as in Persian. But there are many traces of it in the most common terminations of two chief forms: *o* (*ō* or *ō*) and *i*, corresp. to Masculine and Feminine suffixes in Engl. Gypsy.

But *ō* often really means here *ā* and so it is used just as *ā* in Indian languages, as a Masculine suffix. Ex.: *gōrō*, *gomō* etc., *cheti*, *chemuri*, *jewi*, etc.

The plural is formed by *ō* slightly aspirated = P. *nā*; the other suff.—*ū*, *ūn*, *ūn̄*, = P. *ān*. Both are added to the last consonant of the root, or to the last vowel, notwithstanding hiatus:—*bechō* or *bechaō* = P. *bechehā*, etc.

There are also words not requiring special suffixes for plural, as *gorō*, *gerā*, *jodō*, etc.

The declension consists only in the addition (for the Dat. and Acc.) of *rō*, or more often—*ri*, T. *rā*. It is used also pleonastically, and even euphonicly after every final vowel (see above).

Acc. as in many P. dialects and also in Qāinī can be often expressed by the addition of *a*, *u*, *e*, *i* (like the *Izāfat* in sound); and it is used in this Gypsy dialect as well.

The *i* of status constructus (*Izāfat*) of Persian becomes, as in Qāinī, here—*u*, *e*, *i*, in assonance with the last syllable or under the influence of final labial, etc. Often it can be omitted.

The Pronouns are the same as in Qāinī or Persian, with exception that *ish* = Pers. *ān*; *ū* is seldom used. But there is almost always added to them the P. particle *rā* = *rō* or *ri*, even in Nom. *meri* = P. *men* = I; *teri* = P. *tu* = thou; *ūri* = P. *ū* = he, she, it; *mōri* = P. *mā* = us; *sumōri* = P. *shumā* = you; *ūri* and *īri* (in Qāinī *ū* and *ī*) = Pers. *ān* and *īn*, that, he, and this, he.

The Numerals are lost and those of Persian only used. Instead of P. *tā* is used *hōt* in the dialects of Jiruft and Sirjān, and it = *hālād* which means piece, head, many, etc.

The Verbs.—The peculiarities of the Qāinī verb, preserved in local Gypsy, are: the suffix of the 2 p. plur. *ey* or *ay*, instead of P. *īd*, e.g. *mīgūyay* = P. *mīgūyīd*. The Imper. almost always has the form of 2 p. sing. with *i*. There is also a peculiar particle, added to every personal form of the verb—*di*.

Personal suffixes *m*, *d* and *nd* are very often omitted. Persian particles of continuity and completeness of action—*mī* and *bē*, *bī*—usually undergo many phonetic changes: they become *mā*, *me*, *mi*, *mu* and *ba*, *be*, *bi*, *bu*. So—*māīdi* = P. *mīgūyed*; *mārāe* = P. *mīrewed*; *mūkhūre* = P. *mīkhūred*, etc. These particles, especially *bē*, *bī*, are very often used with all forms of certain verbs, and sometimes it is very difficult to distinguish them from the part of the root of a verb.

A peculiar Gypsy feature is to use causal (or causative) forms of the verbs, even of active ones, in the sense of simple active: *dōrū-nīm* = P. *dārīm*; *kerdūni* = P. *kerd*, etc.

The auxiliary verb is here *hana*, *ana*, *ane*, etc., also *aniste*, Negat. form—*na'ane*, *na'ne* *na'ni*. Past tense—*bi*, *bū*, as in Qāinī, P. *hūd*.

The Composition of Words. There are peculiar suffixes, by

which every word can be made a Gypsy one and admitted for use into the "secret code." This is common also to the jargon of the derwishes. But it seems that Gypsy suffixes are of natural origin and were already in use for the formation of adjectives, participles, etc., etc., as appears from their likeness to those used in other Gypsy dialects. Seemingly there is now no difference in the use of these suffixes: *ok, nok, tok* (in Zōrī *osk*)—perhaps fr. P. dim. suff.—*ek, ik* or *chi, che, hūz*—perhaps Engl. G.—*ūs, os, amus*, etc. of the subst. *tum, tom, kom, kum*, (in Zōrī *kaī*) Engl. G.—*um, pen, tan*, which can be used with every substantive.

Dew—is very rare, as also—*ugo*, e.g.—*shōlūgo* = P. *shāl*.

Ex. *shīrdew, shīrkom, shīrtum* = P. *shīr*; *mūchok* = P. *mū*; *shīrīnok* = P. *shīrīn*, etc., etc.

Gurghūz = P. *gurg.*, etc.

Ghis or *gis* are used for the names of the relations: *bōgis* = father; *mōgis* = mother; *khōrghis* = sister, etc.

The prefixes, which Mr. Denys Bray says occur in Zōrī, I have not met with. Perhaps this feature in Zōrī originates from Brāhūī, and other influences.

V.

VOCABULARY.

Ar. means here Arabic word. B—the dialect of Biābūnak, a province of Central Persia. H—Hindi and Hindūstāni. I P—literary Persian. Q—the dialect of Qāināt (East Persia). EG—the Gypsy of England, as in B. Smart and Crofton, *The Dialect of the English Gypsies*, 2nd ed., Lond. 1875.

J, S and Kh—the dialects of the Gypsies of Jiruft, Sirjān and Khorāsān, as in Mr. Sykes' notice in the J. of Anthropol. Society of G. B. and I. v. XXXVI, 1906, p. 302.

K—the dialect of the G. of Kermān, as pr. in the notice by Mr. Sykes, op. cit. v. XXXII, 1902, p. 339.

T—the d. of Turkish G., as in A. Paspati's *Memoir on the Language of the Gypsies*, tr. by Hamlin, 1861. Also see v. II (1891—old ser.) of the J. of the Gypsy Lore Soc., the extract from Sir Ouseley's "Travels."

Naw.—the d. of Nawārs or Zotts, from the papers of Prof. Stewart Macalister in the J. of the Gypsy Lore Soc., vv. III and V (new ser.).

A.

Abīl (?), P *kheyli* (A), J *ubīl*, S *uīl*—much, plenty.

ajūden, ajō(den) H *jānā* (?)—cause, come, make.

akūl, J *haluk*, S *aluk*—a walnut.

al, alūkō, alūgō (Turkish *altın* ?)—a coin of shāhi.

amrāt, amrōt, P *in, im*, H G *rāt*—to-night.

archi, alchi, P *burj*—a tower.
areki, aleki, Ar. *qal'a*—a castle.

B.

Bagal, J *bakil*, H *bakrā*, EG *bokoro*—a goat, sheep.
bagnoy (?), EG *per*—belly, stomach.
bahandar, H *byah*—marriage (Punjabi *bôhtrī*, the bride).
bahöt, bahüt, H *bahüt*, EG *booti*, J *buhük*, Kh *burüt* (!)—an honourable man, chief, great, much, plenty.
barnögi, H *nāk*, B *nāk*—the nose.
bartö(y), bertöy (?)—a coat, a fur coat.
benew(den), H *bandhnā*, P *benden, besten*—to bind, to tie, to close.
beröghis, beröqis, P *berāder*, Q *berör*—brother.
betik(īden), H *baiḥnā*—to sit.
beylüt, H *bhukhā*, EG *bokalo*, J *bukār*, S *būnī*—hungry.
beynī(den)(Imp. *bedey*), K *būnīden*, H *denā*, P *dāden*—to give.
beytīden (probably *bemeytīden*), H *bujhāna*—to extinguish (light).
bagūndenī, P *bādām*—almond tree and fruits.
bökī, P *bāzī*—play, dance, etc.
böqīs, bābā (J *bāng* (?), S *bāhāng* (!)), father.
būhker, bhuker, P *nūker*—a servant (male).
būkī(den), P *būsīden*¹—to kiss.
būre (fr. P *būr* brown)—woollen coat.
bartew, (fr. Q *partew*)—spread, a counterpane, quilt.
bütök, bhütök, būktök, P *bāgh*—a garden.

CH.

Chekel, chikil, EG *chik*, H *chik, chikār*, B *chinō* (EG *chiklo*—adj. dirty)—mud, dirt, filthy.
chemuri, Kh *chamri*, H *chiriā*, P *murgh*, EG *cheriklo*—a bird, hen.
chetī(r), EG *chiti*—chain, any metallic vessel, copper, of copper.
chekati, chekati. EG *chingar*. P *channe*—bargaining, begging.
chölügō, chölükō (*shölügō*), P *shāl, shāle*, EG *chooko*—cloth, carpet.

D.

Dakh, dah, S *dakhu* (?), Punj. *dhann*—Well! good, well.
dashbur, H *dokhā*—a juggler.

¹ *Mōch kerdēn* is used, as Mr. Sykes states, in Kerman. Mr. Dames does not know this word, although it is the only expression for “to kiss” in West Persia, e.g. in Kermanshah, Kamadan and Kurdistan.

- dehew*(iden), P *dewiden*, H *daurnā*—to run, fly.
dendik, H *dant*, P *dendān*—a tooth.
denew, *danew*, J *dinki*, S *nidu*, Kh *nideo*, Zōri *nodō*, P *zan*,
zen (dial. *dan*?). Perhaps from *dōmni*, *rōmni*, Indian *Dom*?—
a woman.
denūf -de (perh. corr. P *dar*, *der* (in), and *nūf*), H *nind*?
JS *nuffden*, Q *da khew*, P *dar*, *khāb* (*khwab*)—sleep, asleep.
degñō, *degñō*, P *dehān*—the mouth, lips, etc.
dōhōs, P *āwāz*, H *dohā*—a couplet, a song, cry, sound, etc.
dōhōkī(den), H *dekhnā*—to see, look.
dolī(den), H *ḍarṇā*—to be afraid.
dowri, fr. Ar. *dawr*—a frying pan.
duhuri(den), H *dhonā*—to wash.
dukhlāj, *dukhlōch*, H *larḳi*, EG *rakli* (P dim. suff. ?), P *dukhtar*,
Punjābi *hdhia*—a girl, daughter.

G.

- Gawja*, EG *gav*—village, a furnace, fireplace.
gelar—the weight of one Persian man
gerā, H *gadhā*, P *khar*, J, S and Kh *gure*—an ass.
gering, Q *gōwarz*—a kind of millet.
gergew, P *gerden*, EG *gooshum*—the neck.
gerze, EG *gorjo*—not a Gypsy. (Fr. Pashtoo v. *garzedal*?)
Used in the code of the derwishes, a derwish, beggar.
ghaft(iden), H *ghatānā*—to diminish, to steal.
ghaybī(den), Ar. *ghayb*, H *ghatnā*—to fall, to lay.
gōmo, *qōmo*, Ar. *qawn*—the family, relations.
gōrō, H *ghorā*, EG *grei*—a horse.
gunj, EG *gono*, P *guni*—a bag, sack, saddle-bag.
guri, EG *guri*, H *gorū*—a cow, bull.

H.

- Hastrāt*—P *haft* (7) and H or G *rāt*—a week.
hamkur, *hamkul*, P *ham* (together) and *kur*, *kul* (house)—a
friend.
hantumi, see *shaytumi*.
hantī(den), P *gerdiden*—to turn.
hastar(den), P *gusterāniden*—to spread.
hōt (fr *bohōt*? q. v.)—a piece, much, many, corr. to P part. *tā*.
husar (Ar. *huqqa* and P *sar*?)—a portable qalyān, as used
in India, *huqqa*.
huterō (?), P *pāre* EG *kotor*—piece, part, fragment, a bit.

J.

- Jahl*—Punjābi *jahl*—*salvadora oeroides*, mulberry.
jewi, *jewīd*, *jewīt*—EG *joovel*, Skt. *jivitnatha*—the husband.
P *zan*, *zen*. Kurdish *zhen* (as in *Biābūnaki*)—a woman, wife.

jindi (?), a water-mill.

jādō J, S *jādeh*, *jādu*, EG *chowo*, *choro*, H *jat*—a child, boy.

jō(īden), H *jānā*, EG *jal*, *jol*, *jil*, etc.—to go, run, etc.

jōlihe (?)—pea.

juw.—P *chi*, *che*, H *ji*—what ?

K.

Kam, H *kām*, P *kār*—business, work, task.

kāmkār (*kām* and P suff *kār*, *gār*)—a worker.

kalīr, *kelīr*. Ar *kalīl*, EG *koosi*—little, small, few.

kalpīk. Ar. *kalb*—a dog.

kamosi (?)—dry.

katō(īden), P *keshīden*—to draw, to take.

kelōri, P *kurud* (used in East. Persia, in West. *keshk* and in the Cent., *pirū*), EG *kal*—cheese, a kind of dried milk of goats.

kelur, P *kelle*—the head.

kelūch—a Balūchi.

ker(īden), P *kharīden*—to buy, to accept.

keshtok (?)—a pillar of the tent.

kimīt, *kimīden*, S *kimūndan* (H *jhapatnā* or *gayā* ?)—he went.

kitīr, *ketīr*, P *kāghiz*, H *kāgut*—paper.

khas, EG *wast*, *vas*, P *dast*, H *hāthh*—the hand, finger.

khasbhur (P *khushe*—spike, and *būrīden*—to cut)—a peasant.

khatak (?)—a cucumber, melon.

khōl, *qōl*, P *kulāh*—a felt cap.

khōdūr—beggar, mendicant.

khōrghīs, P *khāher* (*khwāhee*)—sister.

khushkew, P *khushk*—dry.

khushpak, P *khushk*—a stick, tent-peg, “qalam.”

kogñe, *kogñō*, P *kuhne*—old, a respected man, priest, chief.

koldō, *köldew* (H *putr* ?)—a boy, pupil.

kōkī(den), P *khānden* (? Punjābi *kuk*—to cry, howl)—to laugh.

kōzengīr (H *kām* and Gypsy suff. as of EG *engro* ?)—a workman, the word by which Q. G. translate “*ustōkōr*.”

kulgi, *kurgi*, EG *koori*—an earthen vessel for water.

kulwat, *khulwat*, JS *kulut*, Kh *kālār* ? Q *kelūt*—barren hill, fr. H *kharā* ? EG *kumbo*—a hill, stone, nail, peg, stick.

kullmull, P *kulāh-māl*—maker of felt caps.

kunō, B *kur*, EG *koro*—blind.

kur, *kulp*, *kurb*, *kurm*, *kulm*, EG *kair*, H *ghar*—a house, tent.

kutagōn—P *kujā*—there.

L.

(*Laka*)—a brick.

lakar, *lekar*, H *ruk*, EG *rook*—a tree, wood.

- lāl̄j* (?)—a loop, knot.
lāt̄ir, Kerm *lamir*, P *pānir*—a kind of cheese.
lākhi, Ar *khālī*—empty.
lebe, *lebi*, P *belī*—yes.
lehar, P *rik*, *rig*—the sand.
lewe, *lawi*—Ar *laban*—a kind of sour milk (P *māst*).
limar, S *limrū*, Punjābi *lelā* (lamb)—a sheep, goat.
lochūr (?), P *shutur*—a camel.
lodéngi (?)—pomegranate tree and fruit.
lōhō, *lokh*, H *lohā*. JSKh *lū*—iron and every metal.
lokō (EG *loko*, heavy)—money, silver.
lōpūn, P *pōlān*—a bag saddle.
lūgūndeni (?)—an egg.
luhut, H *lahu*—blood.
lumō, *mullō*, Ar. *mawla*—a priest.
luṅgur (H *laṭnā* and P suff. *gar* ?)—a priest, judge, thief, robber. EG *looromengro*—thief.

M.

- Mandal*, *mandar*, *mandel*, JS *mindāl*, H *mandal* (or Ar *manzil* ?)—a village, town.
mahanjī(den), *muji*(den), *mōji*(den) (= H *jamānā* ?)—to stop, put on, lay down.
melugi, P *meges*, T *mohia*—a fly.
meṅgi(den), H *maṅgnā*, EG *mong*—to love, ask, desire.
meñōñ, JS *mena*, Kh *munā*, EG *monro*, P *nān*—bread.
merek, T *dark* (T *Mol*—wine) H *madhu*, Greek *meli*—grapes.
meytī(den) EG *mer*, *mel*, H *marnā*—to die.
mezūl (?)—fortune-telling.
miskī(den), H *samajhnā* ?—to know, understand.
mōqīs, *mōghis*, Kh *mārghis*, P *māder*—mother.
monis, EG *manoosh*, H *manuj*, *manushya* (Skt.)—a man, husband.
moñsi, EG *mas*, H *mañs*—the meat.
myonew (*pōnew*) (P *miān-i-āb*, Q *miōnew* ?)—water.

N.

- Nalugo*, Ar *na'l*—a horse-shoe.
nōchūkū, P *nākhūsh*—ill, unwell.
muhu(r), H *ānkh*—eye.

O.

- Ogi*, EG *yog*, Skt. *agni*, Pers. dialects *āher*, *āyār*, *āger*—fire.
onde, *unde* (?)—a respectable man, priest.
ondōlū, P *zerdālū*—an apricot.
orra, *urra* (?) as in J and S—bad, wicked.

okyōl(īden), EG *haw, hol, kol*, H *khānā, khilānā*, P *khūrden*—
to eat, to feed.

P.

Paley, palew, P *pul*, EG *luva*, roop, H *rupiya*, Naw. *ple*—
money, silver.

parū(īden), P *furūshīden*—to sell.

pek(īden), EG *pek*, H *paknā*—to roast, cook.

pel(īden), EG *peer* (to walk)—H *phernā*, to drive.

petu (Q ?)—an Afghān.

peyrufti, peyresti, P *pirāhan*—a shirt.

piaulti (?), P *parche*—stuff, cloth.

pīrewot, J *piruſta*, S *pirvat*, P *pīr*, H *purānā*—old, old man.

pīrī(den), EG *pal, per*, H *mārna*—to throw, to pour out.

pōgumi, pōyumi, P *pā*—foot, boots, shoes.

pōnew, EG *paani*, H *pānī*—water.

poweri (?)—God, Prophet, Imam, prayer, etc., etc.

powosi, puwosi, EG *motsi*, P *pūst*—leather, skin.

puke, P *pembe*—cotton.

pūr, P *bār*—a load.

pūsh, fr. P *pūshīden*—cloth, dress, blanket.

Q.

Qōl. See *khōl*.

R.

Rakhshō, rahsō, Ar *ṣahra*—desert, field, etc.

risak, riski, P *rismān*, J and S *riskāi*, Biāb, *ris*—thread,
cord.

rizb, rizm, Pashtoo *wrizhe*—rice.

rōt, rāt as in EG, J, S, H—night, evening.

S.

Samāl, semer, Ar *thamār* ?—a fruit, grass.

sawshub (?), P *sabz*—green, grey, blue.

sefīnūk, sefīnōk, P *sefīd*, white.

segī(den), *sekī*(den), H *samajhnā* ?—to know, understand.

sekōl, sehōl, EG *saala*, Ar *ṣahar*—dawn, day, light.

seng—a sum of 25 tumans.

sennuta, Kerm. *senufta*, P *seg* (fr. *shīnuften* ?)—a dog.

setū, sitew, P *shālwar*—cloth, trousers.

sewlet, sewīl, sembīl, P *sebīl*—the moustachios.

seylāk, silākī, P *serd*—cold, cool.

sīrdew sīr—satisfied (with food).

sīs (?) (perhaps symbolically fr. P *sīs*—hops)—bread.

shaytumi, sheytumi, hantumi, Ar. *shay*—something, a
piece, thing.

shelew (?)—fuel, wood.

shift (?), P *shir*—milk.

shōlugō. See *chōlugō*.

shirujtōk, *shirinōk*, P *shirīn*—sweet, pleasant, sugar.

shūī(den), EG *shoon*, H *sunnā*, P *shinīden*—to listen, hear.

shūreki, *shūregi*, P *shūr*—brackish, salt.

sina (?)—young

sukh(īden), P *sukhten*, H *sulgānā*—to burn.

sūmī(den), *sūn(īden)*. See *shūīden*.

sute, *sutew*, also in J and S—black.

T.

Tamger (?)—a barber.

temñōñ (?)—straw.

tengōwar, P *tufang*—a musket.

terighō, Ar *tariq*—a road, way.

tīl, *tel*, H *tel*—oil, butter.

tōrij, P *tārīk*—dark, black.

tūbur(den), *tur(den)*, EG *tarder*, J and S *butūr*, *tū*—to beat, strike.

tuhur(īden). See *duhuriden*.

tupūr, *tupō*, *tūpōl*, *tupōlō*, *tupōr*, P *khurmā*—dates.

U.

urra. See *orra*.

unde. See *onde*.

W.

Wāl, Eg *bāl*, H *bāl*—hairs, wool.

warpōr(īden), H *paṛnā*—to cause to fall, and P *bar* (*wer*, *war*)—to rise up, to put up.

wursū(den), *wursī(den)*, *Yursī(den)* J *varsūden*. EG *aver*, P *resīden*—to come, to reach.

wōtū(den), Kerm. *wōtōbīden*, P *wā istāden*? (Cp. also Q *waddapīde*—a person who sits with his knees under his chin) —to stay, to stop.

Z.

Zabīl, J *zupīl*—barley.

zertūl, P *zerd* and G suff *l*, *lo*—yellow.

zugūme, P *zūd*—quick, soon.

Y.

Yamōsh(ten), *yumūsh(ten)*, H *samajhnā*?—to understand, know.

APPENDIX.

A GYPSY STORY.

Yek manisei jōi be yek mandeli, yursī be yek dukhlōchi, handiger memingīdan. Bōz yeki gide kelūre dukhlōcha (Acc.) warhantū. Ī wō mejōi dumbōle unde wursīde, yumushtō, ki, “pīshkōm unde, ī bōr arz ajūden, ki ijewīde mōri aniste. Hōlō amre ez undei abīl, har chi shumōri biamōrin (fr. Ar amr ?), mō ez ūri amal ajōnīm. “Ez ū tōl bu ū tōl arz ajōnī. Ūri unde aval ū tōl bupurse, “ki ūri sheydōr?”—“Mōri shey nedōrūnī.” Pīshkōm unde-i-lumō har hōti, ki mejōye, pahlewi beyna,—mō shey nedōrūnī, mō sheydōr na’ni. Be mōri ne mōlūnā (fr. Ar. meyl ?), ḥarfi mō kerīd ne dōrūna. Lumō si rdew ajōn, yō paleyi mō wa khūri, yō jewīde mōri. Lumō Yumūsh, ki harfe ze mīri ane, wer ī khas tuburdīm, wer-ī-āt tuburdī—de (Q) sengi wō kharīdum, jewīde jowūndum. Har hōte, ki palei beynī, harfe merī kerīden.

Literal translation.—A man came to a village and met a girl; they fell in love. Then another (man) turned the mind (head) of the girl. At this time he went to the priest (judge),—you must know—(and said): “Mister priest, I will tell you now, the woman is mine (now). Then (let it be) the order of the respected priest. Everything you will order, I will perform accordingly.” In this way and in that way he spoke. (But) then that priest asked first: “Has he anything?” “I have nothing, Mister priest; (but) when I will get money, I will give you, (now) I have nothing, I am not possessor of anything.” He paid no attention to my words, he did not agree to my right. Make the priest satisfied, or he will “eat” either my money or my wife! The priest understood, that the right is mine, and I threw myself (=ran) in one direction and in the other direction and got 2 sengs (=50 tumāns) and brought back my wife. When I gave money, my right was agreed to.

46. NUMISMATIC SUPPLEMENT No. XXIV.

Note.—The numeration of the articles below is continued from p. 256 of the “Journal and Proceedings” for 1914.

138. THE AHOM COINS OF A.D. 1648.

The Ahom coins dated 1570 *Sāka*, or A.D. 1648, have hitherto been attributed to Susengpha or Pratāpa Singha. (Vide Mr. Gait’s *Report on the Progress of Historical Research in Assam*; Mr. Allan’s paper on *The Coinage of Assam*, in the Numismatic Chronicle 1909, pages 300–331, and Mr. Stapleton’s *Contributions to the History and Ethnology of North-Eastern India, II*, in the Journal of the Asiatic Society of Bengal, Vol. VI, No. II).

The inscriptions on these coins, which are in Sanskrit, are as follows :—

- (i) *Obv. Sri Sri Svarga Nārāyana devasya Sāke 1570.*
Rev. Sri Sri Hari Hara carana parāyānasya
- (ii) *Obv. As on (i)*
Rev. Sri Sri Hari Harendra carana parāyanasya.

As Mr. Gait explains at page 103 of his *History of Assam*, Pratāpa Singha was also known as Buddha Swarga Nārāyana on account of his great wisdom, and it has usually been assumed that the coins in question were minted by Pratāpa Singha under a variation of this title.

This attribution however is not free from difficulty. According to the Buranjis or Assamese chronicles, which can usually be trusted in the matter of chronology, Pratāpa Singha died in A.D. 1641. It is true that Kāsināth places his death in A.D. 1649, but Kāsināth’s history was published as late as A.D. 1844, and there is nothing to show on what his date was based. It is not impossible that he was influenced by the existence of the coins dated 1648, and attributed to Pratāpa Singha. Mr. Gait in his *History* discredited Kāsināth and preferred to rely on the Buranjis. Both Mr. Allan and Mr. Stapleton regard the 1648 coin as proving that Mr. Gait was mistaken, but the fact remains that the earlier authorities are unanimous in stating that Pratāpa Singha died seven years before the date of these coins. There is another difficulty in the attribution of the coins to Pratāpa Singha. Even assuming that he lived to A.D. 1649, it seems scarcely likely that, in a reign of 38 years, he should coin only in the year before his death. The usual practice of the Ahom

Kings, before the time of Rudra Singha, was to issue coins bearing only the date of accession. This is exemplified by all the known coins of Chakradhvaja Singha, Udayāditya, Suhung, and Gadādhara Singha. It is true that the coins of Suklengmung are dated A.D. 1543, four years after his accession, but he was the first of the dynasty to issue coins, and his coins were doubtless dated from the year in which the innovation was introduced. A third difficulty occurs in the description of the King on the reverse of these coins as a worshipper of Hari Hara or Hari Harendra (Vishnu and Siva) which, as Mr. Stapleton points out, is "in marked contrast to the legends on most of the subsequent Kings of Assam in which veneration for Hara Gauri (Siva and Durga) is usually expressed." It is at least probable that the king who struck these coins belonged to the Vaishnava sect. whereas Pratāpa Singha appears to have been a Saivite.

The traditional attribution of these coins is therefore full of difficulty, and should, I think, be abandoned. In that case the coins would naturally be assigned to Jayadhvaja Singha, who came to the throne, according to the Buranjis, in A.D. 1648, the date borne by the coins. The title *Svarga Nārāyana Deva* is found in inscriptions on cannon, applied to Chakradhvaja, Udayāditya, and Gadādhara (Mr. Gait's *Report* page 29), and the shorter expression *Svarga Deva* was a common appellation of all the Ahom Kings. The coins are therefore anonymous, like the full coins of the Jaintia Kings, and the issuing king is described only by his title. This attribution removes all the difficulties connected with these coins. They bear, like the coins of the other earlier Ahom kings, the date of the issuing king's accession; and the veneration which is expressed on them for Vishnu is in accord with the intimate connection of Jayadhvaja with the great Vaisnavite *Sattras* of Auniati and Jakhlabandha. (Vide Mr. Gait's *History* page 138). Why the coins should have been issued anonymously, is a matter for conjecture. In the case of the Jaintia coins, the omission of the king's name is explained by the tradition that, on the subjection of Jaintia by Silarai, brother of the Koch King Nar Nārāyan, the stipulation was made that the Jaintia Kings should refrain from issuing coins in their own names. It is possible, though hardly likely, that a similar stipulation was made by the Muhammadans at the conclusion of peace with Pratāpa Singha in 1638, and was observed until after the departure of Mir Jumla's expedition from Assam in 1663. These coins were, however, so far as is known, the first coins issued by an Ahom King in the Sanskrit language, and it is not unlikely that the form of the inscription was borrowed from the Jaintia coins, the Ahom title *Svarga Nārāyana Deva* appearing in the place of the Jaintia title *Jayantapura Purandara*.

A. W. BOTHAM.

139. CHRONOLOGY OF THE JAINTIA KINGS.

Mr. Gait described a small collection of the coins of the Jaintia Kings in an article ¹ published in the Journal in 1895. The collection consisted of whole coins of *Sāka* 1591, 1592, 1630, 1653, 1696, 1704, 1707 and 1712, a quarter coin of 1653 bearing the name of Raja Bara Gosain, and a quarter coin of 1712 bearing the name of Rām Simha. The whole coins, as is the case with all known whole coins of the Jaintia Kings, are anonymous. Some of the coins described are not uncommon in Assam, but no fresh coins appear to have been discovered.

The following is a list of the Jaintia Kings for the period covered by these coins, with the tentative chronology assigned to them in Mr. Gait's *History of Assam*.

	Date of Accession.	Death.
Pratāpa Singha	.. 1669	1678
Lakshmi Nārāyan	. 1678	1694
Rām Singh I	.. 1694	1703
Jay Nārāyan	.. 1708	1731
Bar Gosain	.. 1731	1770
Chattra Singha	.. 1770	1780
Bijay Nārāyan	.. 1780	1790
Rām Singh II	.. 1790	1832

The dates in bold type are given by Mr. Gait as conjectural.

I venture to think that in framing this tentative chronology Mr. Gait has not attached sufficient weight to the probability that all the dates borne by the coins described by him represent dates of accession. The only Jaintia King the date of whose accession is known for certain from other sources is Jay Nārāyan, who is known from the Ahom Buranjis to have come to the throne in A.D. 1708 (1630 *Sāka*), which is one of the dates represented on the coins. The coins of the Ahom Kings, to which the Jaintia coins are closely related, bore only the date of accession of the issuing ruler until the institution of an annual coinage by Rudra Singha. The Jaintia Kings do not appear ever to have issued an annual coinage. The coins of 1707 and 1712 *Sāka* are sufficiently common to make it probable that intermediate coins would have been discovered had they existed. The probability therefore is, in my opinion, that, like the earlier Ahom Kings, the Jaintia Kings issued coins bearing only the dates of accession.

A.D. 1670 (1592 *Sāka*) was the date of the death of the Ahom King Chakradhvaja, and the accession of his successor

¹ J.A.S.B. 1895, p. 242.

Udayāditya. According to the *Jaintia Buranji* described by Mr. Gait at page 18 of his *Report on the Progress of Historical Research in Assam*, friendly letters passed between Lakshmi Singha of Jaintia and the Ahom Kings Chakradhvaja and Udayāditya. Lakshmi Singha or Lakshmi Nārāyan therefore must have been on the throne in A.D. 1670, and the coin bearing that date was probably issued in the year of his accession. It is not unlikely that Chakradhvaja congratulated him on his accession, and that he returned the compliment by congratulating Udayāditya on the latter's accession to the Ahom throne later in the same year. If this is the case, the coin dated 1591 *Sāka* (A.D. 1669) must mark the accession of Lakshmi Nārāyan's predecessor Pratāpa Singha. Nothing is known of this ruler except his name, and there is therefore nothing improbable in the assumption that his reign lasted only for one year. The ruined palace at Jaintiapur bears an inscription stating that it was erected by Lakshmi Nārāyan in some date which is indistinct, and which is suggested by Mr. Gait to be 1602 *Sāka* or A.D. 1680. According to the *Jaintia Buranji* Lakshmi Nārāyan was still on the Jaintia throne on the accession of the Ahom King Rudra Singha in A.D. 1696. The tone of Lakshmi Nārāyan's letter to Rudra Singha on the occasion of his accession was considered to be not what it should have been, and some coldness appears to have resulted between the two monarchs. The Ahom Buranjis contain a detailed account of a war which broke out between Rudra Singha and Lakshmi Nārāyan's successor Rām Singha I in A.D. 1707. Lakshmi Nārāyan therefore must have died between 1696 and 1707, but no specimen of Rām Singha's coinage has as yet been discovered. Rām Singha was captured by the Ahoms and died whilst still a prisoner in 1708. The Jaintia coin dated 1630 *Sāka* (A.D. 1708) was therefore struck on the accession of his successor Jay Nārāyan. Jay Nārāyan was succeeded by Bara Gosain, the date of whose accession is fixed by a named quarter coin and an anonymous whole coin as 1653 *Sāka* (A.D. 1731). In A.D. 1774 Jaintia appears to have been conquered by a British force under a Major Henniker, but it was restored on payment of a fine. The coin dated the same year (1696 *Sāka*) may have been issued by Bara Gosain on the occasion of his restoration to the throne. The next two anonymous coins must mark the accession of Chattra Singha and Bijaya Nārāyan in A.D. 1782 and 1785 respectively. Bijaya Nārāyan is known from a copper plate to have been reigning in A.D. 1788. Bijaya Nārāyan was succeeded by Rām Singh II, the date on whose coins (1712 *Sāka*, or A.D. 1790) no doubt marks the date of his accession, and who lived till A.D. 1832.

A copper plate dated A.D. 1770 states that the King Bara Gosain, having become a Sanyasi, made a grant of land

to a certain Brahmin with the consent of his nephews and nieces including his successor Chattra Singha. Mr Gait accordingly places the abdication of Bara Gosain, and the accession of Chattra Singha in this year. If this is correct, the coin of A.D. 1774 might mark the re-accession of Chattra Singha after the temporary occupation of Jaintia by the British, but the 1782 coin remains unaccounted for. It is, I think, more probable either that Bara Gosain never actually abdicated, or that the transfer of sovereignty to Chattra Singha was not complete until the death of Bara Gosain.

I would therefore suggest the following chronology for the Jaintia Kings from Pratāpa Singha to Rām Singha II :—

	Date of Accession.	Death.
Pratāpa Singha	.. 1669	1670
Lakshmi Nārāyan	.. 1670	c. 1697
Rām Singha I	c. 1697	1708
Jay Nārāyan	.. 1708	1731
Bara Gosain	.. 1731	1782
Chattra Singha	.. 1782	1785
Bijaya Nārāyan	.. 1785	1790
Rām Singha II	.. 1790	1832

A. W. BOTHAM.

140. A NOTE ON A BABYLONIAN SEAL IN THE CENTRAL MUSEUM, NAGPUR.

While examining the coins and seals of the Muhammadan kings of India placed in the Central Museum, Nagpur, with a view to preparing a list of them, my attention was drawn to a small engraved roller, apparently of stone, set in a gold handle and bearing two lines of inscriptions in some strange character. This roller was placed along with the ornaments in the Industrial Section, but its peculiar shape excited my curiosity, and on examining it more minutely I found that it contained five human figures, of which two were large and three smaller in size, a lightning fork, a crescent and a disc. Its general appearance led me to doubt whether it was correctly classed as an ornament, and the more I examined it the stronger grew my impression that it was something else than an ornament. My next thought was to get the inscription deciphered, which I was sure would throw more light on this point. An impression of the engravings was sent to Dr. J. H. Marshall, Director General of Archaeology in India, who forwarded it to Mr. L. W. King of the British Museum, London. Mr. King, who was able to decipher the inscription, sends the following description :—

“The scene engraved on the seal represents a goddess standing with hands raised in adoration before the weather-god Adad or his West-semitic equivalent Amurru. In the field are his emblem, the lightning fork, the disc and crescent. The small figures are probably divine attendants. The inscription gives the owner’s name and reads ‘Libur-beli, servant of (.....)’. The end of the second line is apparently rubbed or worn and has not come out in the impression; it probably stated that Libur-beli was ‘the servant of the god Amurru’ or Adad. The meaning of the Babylonian name Libur-beli is ‘May my lord be strong.’ The seal dates from about 2000 B.C., the period of the First Dynasty of Babylon.”

As the seal had so long been mistaken for an ornament no record has been kept to show where, when, and how it was found.

A photograph of the seal and its cast, together with an impression of the same, is appended.



1. Seal.



2. Impression.



3. Cast.

M. A. SUBOOR.

141. THE GUJARĀT MAĤMŪDĪ.

I.

In article No. 45 of No. VI of the Numismatic Supplement, Dr. Taylor has by a process of elimination of possible rivals identified the MaĤmūdĪ mentioned by certain European travellers of the early seventeenth century with the coin of Gujarāt Fabric described by him in article No. 14 of Numismatic Supplement No II. The European evidence has been collected with great care and affords ample material for testing the author's conclusions.

I have never been able to bring myself to agree with those conclusions in their entirety, but in the absence of a better theory felt bound to accept them provisionally.

Just recently documentary evidence has come to hand, which makes it impossible to accept the exclusive identification of the MaĤmūdĪ with the coin of Gujarāt Fabric. This consists of a passage from the *Mir'āt-i-AĤmadĪ* written about A.H. 1170 (A.D. 1756) in the reign of 'ĀlamgĪr II, which will be given later 'in extenso.'

But first I propose to examine the article above cited and to give my reasons for considering it not altogether conclusive.

Of the three authorities quoted it is de Mandelslo to whose information the greatest weight has been attached.

The author has based his arguments largely upon the statements (1) that the MaĤmūdĪ was a coin of inferior silver and (2) that it was current only in Southern Gujarāt.

Now Terry makes no mention of the quality of the silver in the MaĤmūdĪ, but Herbert says expressly that the MaĤmūdĪ is of good silver. Ovington¹, fifty years later than

¹ Ovington, *Voyage to Suratt*, 1689, p. 221.

de Mandelslo (A.D. 1689)¹, writes: "And the silver (of Suratt), which is the same all over India, outdoes even the Mexico and Sevil dollars and has less Alloy than any other in the world..... 'Tis rare if either the Gold or Silver be falsified."

Next de Mandelslo confines the distribution of the Maḥmūdī to the country between Surat and Cambay. Terry states that it was current in Gujarāt and Herbert in "Indostan", which means, it may be supposed, that part of "Indostan" in which he travelled. Looking to the extraordinary mixture of currencies to be found at that time in every country of the world² and to the political unity of Gujarāt, both as a kingdom and a province, we may take de Mandelslo's statement merely to mean that the Maḥmūdī was the standard currency in South Gujarāt and not that it was to be found nowhere else in Gujarāt. By supposing de Mandelslo to be guilty of a slight overstatement, we are able to reconcile the apparent inconsistency of the various accounts.

II.

The identification of the coin of Gujarāt Fabric with the Maḥmūdī depends upon the exclusion of

- (1) The Persian Maḥmūdī,
- (2) the Korī,
- (3) the coins of the Gujarāt Saḷṭanat.

(1) The Persian Maḥmūdī is, as Dr. Taylor has clearly shown, quite out of the question.

(2) *The Korī*.—I would first venture to question the assertion in section III, para. 2 of the article that the trade between Gujarāt and Cutch (Kachchh³) or Gujarāt and Kathiawar (Kāthiāvād³) was more land than sea borne. But as it is not material to my argument, which has tried to show that the Maḥmūdī must have been to some extent current in north Gujarāt, I shall reserve discussion of the matter for a separate paper, if occasion should arise.

In favour of the korī, we have the fact that it was "originally called Maḥmūdī". The passage, which I think the author of the article had in mind as the authority for this statement, comes from the *Tarīkh-i-Sorāth* of Divān Ranchhodjī of Jūnāgaḍh.

¹ Fryer 1672-1681, as quoted in section II of the article discussed, shows that the Maḥmūdī was current in Surat a few years previously.

² French, Spanish and Venetian moneys were accepted by the money-changers of Surat; *vide* section I(c) of the article, which quotes from de Mandelslo.

³ Following the usual transliteration of the Gujarātī कच्छ and कानोचावाद ।

It runs as follows:—

“Jam Satrasal (of Navanagar).... ascended the masnad of his father in Samvat 1625 (A.D. 1557).... and was allowed to coin money by Sultan Muzaffar, whose name it bore; but he ordered it to be called Maḥmudi, after his father.... The Sultan ordered it to be called Kūnvarī in the Hindu language and by the mispronunciation of the vulgar it is now called ‘Korī’.

The coin had therefore a Muhammadan or official name and a Hindu or popular name. There would be nothing surprising in the two names existing side by side. Examples of this universal tendency will occur readily to every mind. “Pound sterling” and “sovereign”, “two-shilling piece” and “florin”, “franc” and “vingt-sous”, besides innumerable slang or colloquial synonyms, may be instanced.

The statement in section III, para. 3, that “this designation (Maḥmūdī) soon gave place to the term ‘korī’” is therefore difficult to accept in the absence of any definite evidence.

The last argument against the korī (para. 4) is that it was considerably inferior in value to the “Sūrat Maḥmūdī.” The value of the latter is stated to be 12*d.* as compared with the 27*d.* of the rupee. “The Cutch korī is now and was probably then too appraised at 7*d.* (and that) of Navānagar at 7*d.*” (In making this quotation I omit Jūnāgadh, as its coinage of korīs appears to be of no great antiquity¹, and Porbandar, as it is known when the coining of korīs was commenced.)²

But it seems unsafe to assume that the value of the old korī was the same as the value of the korī of to-day. In the absence of the data on which Dr. Taylor has made his calculations, I cannot venture to say more. If, as is possible, they are derived from the Bombay Gazetteer, written about A.D. 1875, when the rupee was worth 24*d.*, they seem to be, if anything, over-liberal to the korī, that is to say, its value is even smaller than has been stated by the author. To-day it is reckoned to be worth 4*d.* only (*vide* Imperial Gazetteer s.v. Cutch).

I admit the depreciation of the korī, but not a consistently low value from the time of its being minted.

Looking to the relative values of the silver in the korī and the rupee of Akbar and Jahāngīr and taking average weights as grs. 70³ and grs. 175⁴, we find that 2½ korīs equal

¹ *Vide* Codrington, *Coinages of Cutch and Kathiāvār* (Reprint from *Numism. Chron.*, vol. XV, third series, pp. 59-88), p. 28.

² *Vide* *id.*, p. 25.

³ *Vide* Codrington *op cit.*, *passim*.

⁴ *Vide* Wright *I.M.C. Akbar and Jahāngīr*, pp. 16-37, etc. The market quotations would naturally be based on worn rather than new coins, which form but a small part of the total currency.

1 rupee. The intrinsic value of the kori falls therefore well within the limits defined by Dr. Taylor for the Sūrāt Maḥmūdī.

I may put this argument in another way. The kori is to-day worth 4*d.* in a Gujarāt bazār. A Mughal rupee is worth from 11*d.* to 12*d.* The relative ratios of the two coins are therefore $2\frac{3}{4}:1$ or $3:1$.

I have assumed that the quality of the silver in the kori is as good as that of the Akbarī rupee, but I do not think that this will be disputed. The koris in my possession all seem excellent silver.

The question may be asked “Why, if the kori was worth nearly half a rupee in A.D. 1638, should it have in A.D. 1744 an average value of four to a rupee (*vide* Capt. Hamilton’s remarks quoted in Codrington *op. cit.* (p. 9))”?

The relative values of currencies is largely a matter of sentiment, which has from early times been exploited by money-lenders. In A.D. 1850 the Broach rupee was the favoured currency in Broach. Its intrinsic value was 5% below par, but local prejudice had so far depreciated the company’s rupee that often for months together both currencies exchanged at par. (Bombay Gazetteer, vol. II, Broach, p. 446).

The fluctuations of the Maḥmūdī were still more violent. The author of the article has shown that it fluctuated from 10·8*d.* to 13*d.* in relation to foreign coins, when appreciated by the Surat demand, and there is, at least, quite a possibility of a depreciation even to 7*d.* (a quarter approximately of 27*d.*) by the universal demand for the Mughal rupee, which must have been established by A.D. 1744 in S. Gujarāt.

It is possible that Capt. Hamilton’s estimate is put only in integers for convenience sake and the value of the kori was rather more than $\frac{1}{4}$ rupee. If we take the intrinsic value of the kori to be 10·8*d.* (or $\frac{2}{5}$ of the rupee of 27*d.*), it gives a figure midway between the two extremes of 13*d.* and 7*d.*

There seems, in short, no reason why the Sūrāt Maḥmūdī should not be the Maḥmūdī kori of Cutch and Navānagar.

(3) But cannot the term have also been applied to the coins of the Gujarāt Saḥtanat? I do not wish to make out a case for any coins of the Saḥtanat, except for that of which the kori was a copy, the silverling of Muzaffar III. The arguments which affect the kori hold good also for the coin of Muzaffar and need not be repeated.

But a few words may be said on the improbability of “the coinage of the conquered province of Gujarāt—never very plentiful”—maintaining “its standing as the recognised currency of the Southern districts” (section IV, para. 3 of the article). Old currency is apt to linger longer in the backwaters of a

district or province than in the headquarters. The Bābāshāi or Baroda rupee, which was at one time one of the accepted currencies of Aḥmadābād district, was in universal use in the remote mahal of Mōdasā in A.D. 1875 (Bombay Gazetteer, Ahmadabad). Similarly the Broach rupee, which was not coined at any rate after A.D. 1835, was at the same date the usual currency in the forest taluka of Māndvī in the Surat district (Bombay Gazetteer, vol. II, Surat, p. 204).

Supplemented by the outturn of the kori mints, the currency of Muzaffar would not fail for some years, and afterwards the kori was issued with sufficient regularity to prevent either coin falling into disuse.

It may be added that though the coins of the Saḷṭanat are not plentiful, yet the kori-like coin of Muzaffar is now far more frequently to be met with than all the remaining silver coins of the Saḷṭanat.

Section IV, para 4 of the article deals with the weight of the Maḥmūdī. It is unnecessary to add anything to what has been said, except that 70-74 grains is a fairly close approximate to four-ninths (four-fifths appears to be a misprint) of a Mughal rupee.

In Section V the arguments for the identification of the coin of Gujarāt Fabric with the Maḥmūdī are summed up. I go so far in agreement with them as to say that it may have been popularly known as Maḥmūdī, but I maintain that the true and original Maḥmūdī is the kori.

I would further say in reference to Section V, para. (d), that if the metal of the coins of Gujarāt Fabric be examined once more, it will be found that they cannot be said to be 'of a very base alloy'. All the specimens I have seen, including 80 from the Bānsdā State treasury, which I examined last year, seemed to be of good though hard silver.

III.

I have exhausted my *a priori* arguments. I now quote a translation of the passage from the Mir'āt-i-Aḥmadī (Bombay Lithographed edition of A.H. 1307, p. 225¹), which I referred to at the beginning of this article.

¹ The Bombay Gazetteer, vol. 1, Part I, p. 279, lines 1-8 and note, gives an abstract from this passage, made apparently from the edition I cite. It is as follows: "The Jam, who of late years had been accustomed to do much as he pleased... in 1640 A.D. withheld his tribute and set up a mint to coin koris." It goes on to say that 'Azām Khān (viceroy of Gujarāt, A.D. 1642) then marched against Navānagar. The statement that the mint was set up in 1640 A.D. is not found in my edition: and in fact the inference to be drawn from the passage is that the mint was an old established one. There are one or two other small inaccuracies in the Gazetteer account, which was written for the general reader.

“As the Jām had not performed the homage which it was incumbent upon zamīndārs to make, ‘Azam Khān made an advance with the intention of teaching him his manners ‘Azam Khān sent a message to him that until a tribute (pīshkash) was fixed and the mint of Navānagar, in which Maḥmūdīs were coined, abandoned, his safety could not be guaranteed. The Zamindār, who had no choice but obedience, agreed to give a hundred Kachh¹ horses and three lakhs of Maḥmūdīs by way of tribute and to abandon the mint. . . . It is quite certain that for a time the mint there was suspended, but up to the present day (A.D. 1756) Maḥmūdīs are being struck in the name of Sulṭan Muḥaffar. As the modern coin bears the name of the Jām on one side in Hindī, they also call it a Jāmī. In the Zilla of Baroda, it used to be called Changīzī because it had been coined in the time of the domination of Changīz Khān, the Ḥabshī. In that zilla the currency, trade transactions, valuations of tribute and fixed revenue and (the assessments) of the parganas are in that coin. And in Aḥmadābād, even to this day transactions in ghī are calculated in Maḥmūdīs. The Maḥmūdī weighs four and a half māshās.² Sometimes two and a half Maḥmūdīs and sometimes three are reckoned to the rupee. A sacred and sublime (i.e. imperial) decree was issued on the subject of the foundation of a mint in Jūnagadh for the melting of Maḥmūdīs, but it was not satisfactorily carried into effect and the merchants with an eye to their convenience and to economy had the silver and gold that came from the ports of Dīū and elsewhere into the Aḥmadābād territory minted on the spot. So in consequence of a request from Mīr Ṣabir, the dīvān of the Sūbah, an order for the suspension (of the mint) there had the honour of issuing.’”

We have in this translation evidence of

(1) The use of the name Maḥmūdī for the Navānagar korī in A.H. 1050, A.D. 1640 (two years after de Mandelso’s visit to Surat).

(2) The extent to which the coin was current as shown in the payment of three lacs of Mahmudis as pīshkash to the Mughal Governor.

(3) The use of the Maḥmūdī under the name of Changīzī in the Baroda Zilla.

(4) Its use as a coin of account in Aḥmadābād about A.H. 1170 (A.D. 1756).

(5) Its weight.

(6) Its exchange value, which corresponds closely with

¹ Following the spelling of my text.

² Taking the ratī with Thomas Numismata Orientalia p. 68 at 1.9375 grains and calculating 8 ratīs to the māshā, the result comes to about 70 grains.

that given by the earlier European travellers, though it disagrees with that indicated for the korī by Capt. Hamilton in A.D. 1744.

The author of the *Mir'āt-i-Aḥmadī* also gives some interesting details in his list of the sarkārs of the Gujarāt Saltanat drawn from the records of the hereditary record-keeper Mūlchand (Bayley's Gujarāt, p. 19).

In A.H. 979 (A.D. 1571), the year before Akbar's conquest of Gujarāt (Bayley, op. cit., p. 5), the revenue of the ports of Sūrāt, Bharūj, and Khambhaiāt were reckoned in rupees. We should now call these port-revenues imperial, as distinct from the district or provincial revenues. Maḥmūdābād, Nadiād (now both in Kaira (Khedā) district) and Rānder (Surat district), as well as the parganas of Aḥmadābād, were also assessed in rupees. Baroda, on the other hand, and the sarkār or district of the port of Surat, excluding the port itself, were assessed in Changīzī Maḥmūdīs. Bharūj pargana, i.e. the town and environs, but not the port, was assessed in Changīzīs, and so also were the numerous parganas attached to the Sarkār of Bharūj, including Orpād, Māndvī (Chār-māndavī) and Tadkeshvar (Tarkesar) now situated in the Surat district (Bayley, p. 13).

The Chāmpānīr Sarkār corresponds very closely to the Pānch Mahāls district when combined with the Godhra Sarkār (Bayley, p. 14).

These sarkārs, which are accurately covered by the areas under "Surat, Brodra, Broitchia, Cambaya and those parts" of de Mandelslo, are likely to have been assessed in the coin most generally current in their areas. The author of the *Mir'āt-i-Aḥmadī*, while supporting de Mandelslo's statement that the Maḥmūdī was the standard currency in South Gujarāt and that Mughal rupees were also used, does not consider it any inconsistency to say elsewhere that the Maḥmūdī was also in use in Aḥmadābād, although the district and its environs were assessed in rupees.

In any case the Changīzī Maḥmūdī of A.H. 979 could not be identical with the coin of Gujarāt Fabric, which was minted, as far as we know, after the conquest and which bore Akbar's name.

The fluctuation of the value of the Changīzī Maḥmūdī in the time of Muzaḥfar III corresponds very nearly with that found in the European writers of the early seventeenth century.

The values given for different districts of Gujarāt by the *Mir'āt-i-Aḥmadī* range from $\frac{1}{2}$ to $\frac{2}{5}$ of a rupee. The Surat details give a very high appreciation at $\frac{1}{18}$ of a rupee, but for other reasons (Bayley, p. 12), the figures are suspicious and it is safer not to make use of them.

To sum up my conclusions, I have attempted first to

show that the coin of Gujarāt Fabric could not be considered to have an exclusive claim to the term Maḥmūdī—then that it is the Navānagar korī and its congeners that have the real right to the name. But I have not entirely rejected the possibility that the coin of Gujarāt Fabric may have been classed with the Maḥmūdī.

The Mughal emperors minted alien coins into rupees, as is shown in our extract from the *Mir'āt-i-Aḥmadī* and by Ovington, who says (*Voyage to Suratt*, p. 220) that Aurangzib's officers melted down and converted into rupees 'strange coyn'. And it is just possible that Akbar deliberately struck the coin of Gujarāt Fabric in an attempt to oust the Maḥmūdī and it was perhaps shown to de Mandelslo by the Surat officials as the Maḥmūdī, which they hoped it would replace. It resembles the Maḥmūdī closely, but is rather heavier and would lead the way to the introduction of a half rupee, to which it so nearly approximates in weight. It would be the most likely coin to supplant the Maḥmūdī korī.

I owe this conjecture to the concluding remarks of Dr. Taylor's article, but that the coin of Gujarāt Fabric may have been known as a Maḥmūdī and may have been minted in Surat, is only a conjecture and needs further evidence to justify.

July 1914.

A. MASTER.

Note upon the Eponym of Changīzī.

The *Mir'āt-i-Aḥmadī* tells us that the Changīzī is an alternative term for Maḥmūdī and was used principally in Baroda. Baroda was the Jāgīr of Changīz Khān, son of Imādul-Mulk (*Bayley Gujarāt*, p. 12). He was for the ten concluding years of Muẓaffar's reign the most important person in Gujarāt and it was his assassination in A.D. 1571, which led indirectly to the fall of the Gujarāt Saḷṭanat. His assassin Jujhār Khān was thrown beneath the feet of an elephant at Akbar's orders on the prayer of his widow.

He was not a Habshī, as the *Mir'āt-i-Aḥmadī* states, but most probably of Turkish extraction, as the name Rūmī, used by his father, indicates. It was a Habshī, who assassinated him; hence probably the mistake.

The korī Maḥmūdī was minted just when Changīz Khān was at the zenith of his power and his name was naturally associated with the new coin.

A. M.

142. REVIEW.

R. B. WHITEHEAD : *Catalogue of the Coins in the Panjab Museum, Lahore. Vol. II, Coins of the Mughal Emperors.*

It is with no ordinary pleasure we record the publication of a work that for many years to come will prove invaluable to all who contemplate a serious study of Indian Numismatics. This work owes its origin to the wise and public spirited action of the Panjāb Government in sanctioning the preparation of a detailed and adequately illustrated catalogue of the rich collection of coins in the Museum at Lāhor, action abundantly justified by the recent issue from the Clarendon Press of the two large and handsome volumes compiled by Mr. Richard B. Whitehead, I.C.S. The Government were fortunate in being able to secure for this undertaking a scholar who, as Honorary Secretary of the Numismatic Society of India, had already given proof of special competence. Those who were familiar with his earlier papers on Indian Numismatics awaited this larger work of his with high expectations, and now with the catalogue in our hands we feel that our best hopes have been fulfilled.

So far as relates to the Mughal coins of India, two, or at the most but three, books have hitherto been recognized as authoritative. There is Stanley Lane-Poole's volume in the British Museum Catalogue, a volume published so far back as 1892, and there is also Nelson Wright's admirable contribution to the Indian Museum Catalogue. To both of these and to Rodgers's List—one can scarcely call it a Catalogue—of the Mughal coins that twenty-one years ago were in the Cabinets of the Panjāb Museum, every collector who has specialized in this series will cordially acknowledge his deep debt of obligation. But henceforward along with these Mr. Whitehead's recent volumes must be assigned an honoured place, perhaps I should say the place of honour. Certainly Mr. Rodgers's List, eminently serviceable as it was in its day, is now definitely superseded, for in future any one desirous of informing himself regarding the coins in the Panjāb Museum will be sure to turn to the presentment of them supplied by Mr. Whitehead's finely illustrated catalogue.

The British Museum volume also will now inevitably be relegated to a comparatively subordinate position, and not merely because the coins therein registered fall in number far below those to be found not only in the Museums at Calcutta and Lāhor, but even in the cabinets of some three or four private collectors. The simple truth is the published catalogue, however representative, it may have been of the Mughal coins possessed by the British Museum some two decades ago, is not by any means a satisfactory record of the

coins it possesses to-day. Year by year for the past twenty years it has continued steadily adding to its store, and recently through the munificence of Mr. Henry Van den Bergh it has acquired the Bleazby Cabinet with its numerous rare and even unique specimens, so that not improbably the National Collection is to-day, as it should be, the finest in the world. But alas! a full half of its treasures, and that the choicer half, remains unreported, and hence unknown, to the British public. It is much to be desired that the Museum authorities, recognizing the lamentable situation, will take early steps to issue a superb catalogue worthy of their superb collection. But, so long as this incumbent duty remains undischarged, they must be prepared to see their present obsolescent catalogue, as it falls more and more out of date, yielding more and more its once high place to such scholarly volumes as Mr. Nelson Wright's or Mr. Whitehead's, containing as they do ample records of the more recent numismatic discoveries.

These two books distinctly take rank in the highest class, and they stand, moreover, in intimate relation each to the other. Mr. Whitehead indeed repeatedly makes express acknowledgment of his indebtedness to Mr. Nelson Wright's earlier labours in the same numismatic field, an indebtedness which is, we fancy, shared by all collectors of the Mughal coins of India. Mr. Wright's catalogue of these coins, as represented in the Indian Museum and in the Cabinet of the Asiatic Society of Bengal, constituted, when six years ago it issued from the Clarendon Press, a marked advance on the best works till then available, and the lines that he at that time laid down Mr. Whitehead has followed almost in their entirety. Indeed so closely do the two books resemble each other that they might almost be regarded as consecutive volumes of some numismatic series projected by a common editor. The interval, however, of six years that separates their publication was a period that witnessed considerable additions to our knowledge of the Mughal coins, and Mr. Whitehead has been careful to turn this fresh material to good account. For this reason his catalogue will, we anticipate, be in more frequent request than Mr. Nelson Wright's, yet one may truly say that the later work is but the natural fruition of the earlier. Not that the two are absolutely identical in their methods, for Mr. Whitehead has by no means shrunk from introducing such changes as he has deemed desirable. The most notable of these is the new order in which he has presented the mint-towns of the several reigns. The names of the mints, written in Persian characters, and also transliterated into English, are now arranged not in the English but in the Persian alphabetical order. To English collectors this change may just at first prove somewhat inconvenient,

but surely from the scholar's point of view this new arrangement is the only one free from objection, and it will, we believe, meet ere long with general acceptance.

The first volume of Mr. Whitehead's Catalogue deals with the Indo-Greek coins struck during the two centuries or so immediately before, and the two immediately after the Christian era. Of the Greek Kings of Bactria and India, also of the Indo-Scythians, Indo-Parthians, and Kushāns our knowledge is derived almost entirely from the study of their coins. These contemporary documents in metal are, as Mr. Whitehead says, to a very large extent the only testimonies to a period which would otherwise have disappeared from history. To extract from them all they can tell us regarding a field so obscure was no easy task, but in entering on it Mr. Whitehead possessed exceptionally high qualifications for its fulfilment. Any critical estimate, however, of this portion of his work must be undertaken by a writer more competent than myself. I shall only say that, if the first volume be characterized by the same qualities as mark the second, it is a workmanlike and scholarly production that will prove an invaluable aid to the study of the early history of India.

Collectors of the coins of the Mughal Emperors will appreciate very highly certain features of Mr. Whitehead's Catalogue that serve in no small degree to render it more practically useful. He has, for example, given in ordinary course a full list of such coins possessed by the Panjab Museum as issued from the various mints during the reign of each Emperor: but he has in each case also appended a further brief list showing those mints of each Emperor that are unrepresented in the Museum. Thus by simply combining the two lists we obtain a register of all the mints that were active in any one reign. Another welcome entry consists of the coin-couplets, each one of which, the first time it occurs on a coin, has been incorporated in metrical form into the text, while along with it has been given its English translation. A mere index of the coins thus treated would of course enable one to make a complete record of the many quaint couplets of the Indian Mughal series.

Then too it is a distinct gain that mention is made of the years in which were issued in gold and silver and copper the earliest and the latest known coins of each emperor, also the exact dates of his accession to the throne and of his death. Twenty beautifully executed plates serve to illustrate the coins in the Panjāb Museum, but numismatists will be also grateful for the supplementary Plate XXI, reserved for reproductions of twenty rare and interesting coins in other cabinets.

The list given on page xv of the Mughal Emperors and Claimants is of interest for its exclusion of Muḥammad Nekosiyar, and still more, for its inclusion of 'Azīmu-sh-shān.

Both these changes will be approved by all who have read Mr. W. Irvine's article in the *Journal of the Asiatic Society of Bengal* for 1899, and Mr. Whitehead's in the *Numismatic Supplement XVII*. Mr. Whitehead, however, does well to mention (page xxiii) that historians tell of coins having been struck in Nekosiyar's name; though up to the present none have been discovered.

Another noteworthy and admirable feature of this catalogue is the frequent silent correction of errors that blemish some of the previously published works. For instance, the *muh*r and rupee of Shāh 'Ālam I, attributed in the British Museum to the Sholāpūr mint, are here correctly assigned to Mailāpūr; the Farrukhsiyar *muh*r, B.M.C. No. 893, wrongly ascribed to Bareilī, is here duly registered as from Purbandar; and the rupee attributed to the extraordinary mint Mumbai-Sūrāt is now accredited to Mahisor. So also the Ilāhī *muh*r assigned in the catalogue of the Bodleian Library Collection to Tatta is in a brief footnote on page 20 traced, and rightly, to Akbarnagar. Rodgers's tentative readings of the mint-names Bandar Shāhī and Dāru-l-birt Kāndī are happily abandoned in favour of Srīnagar and Dāru-l-barakāt Nāgor respectively.

The map, supplied in this catalogue, of the mint-towns of the Mughal Emperors indicates many of the ascertained results of research during the past six years. Bandar Shāhī has been omitted altogether, the location of Mālpūr, and Pattan Deo has been corrected, and several newly discovered mints have been inserted. These include Islām Bandar, Toragal, Jinjī, Karpā, Sīkākul, Bikāner, Sa'dnagar, and Mailāpūr. Srīnagar, which may represent the capital of Kashmīr, but may with at least equal probability be the Srīnagar of Garhwāl, has wisely been located on the map at both these places.

It is by no means on the map alone that we find ample evidence of a scholarship perfectly informed regarding the latest additions to our knowledge of the Mughal coins. Amongst the new couplets recorded are those on the Akbarābād rupee of Shāh 'Ālam Bahādur (No. 2015), the Shāhjahānābād rupee of 'Ālamgīr II (No. 2797), and the Tatta rupee of Shāh Jahān II (page lxxv). Farrukhsiyar's remarkable title ثالث صاحب قران "Third lord of the conjunction" is entered in a luminous note, in Appendix C, on the symbol *Ṣāhib i qirān*. More than one reference is made to the interesting formula جلوس ظفر مانوس present on the reverse of two rupees that issued in the first regnal year of Shāh 'Ālam Bahādur, one from the Kambāyat and the other from the Aḥmadābād mint. We also find mention of the Akbarnagar rupee of Nūr Jahān in the Lucknow Museum, of Mr. C. J. Brown's unique rupee of Aurangzeb's first regnal year from the Shāhjahānābād mint, of the newly

discovered Lāhor rupee of Muḥammad Shāh, on which that monarch calls himself Muḥammad Shāh Bahādur, of Mr. Framjī J. Thanawala's rupee, possibly from the Sītpūr mint, bearing the denominational epithet *درب*, of Mr. Nelson Wright's Multān rupee of Shah 'Ālam I with its *حامي دين* legend, and of the unique four *tānkī* piece, found by Mr. A. Master in Aḥmadābād, on which the word *چو* is spelt *چار*. The statement on page lxxx regarding the mint-town bearing the epithet Zainu-l-bilād indicates precisely the view that at present holds the field. From the existing evidence we can only say that the coins from this mint may have been, we are not just sure that they were, struck at Aḥmadābād. It is interesting to note that whereas Mr. Nelson Wright, when compiling his Indian Museum Catalogue six years ago, referred, in a mere parenthesis, to the Urdū Zafar Qarīn muhr of 984 as "possibly still unique", Mr. Whitehead is now able to state, also parenthetically, that this round gold muhr is "one of two known specimens." Again on page lx we read, "The name on these latter coins looks more like Bairāt (than Bairāta), or, as suggested by Mr. H. Nelson Wright, Berār." Were Mr. Whitehead writing this sentence to-day he would not fail to add that at the annual meeting of the Numismatic Society of India held last January (1914), it was unanimously agreed that so far as relates to Akbar's rupees from this mint the reading *برار* Barār, be adopted.

In Appendix B is given a table that should prove useful of the Ilāhī synchronisms of the Hijrī New Year's Day from 964 to 1070. Page 441 exhibits 103 "Marks on Mughal Coins." This interesting plate would gain immensely in value if a list were drawn up indicating for each mark the several coins on which that special work is found.

The Āsafābād Bareli rupees merit a more detailed statement than the short reference made to them on page lv. In a letter, received now five years ago, from Colonel W. Vost, I.M.S., he mentions having seen Bareli Qit'a rupees of A.H. 1203, 1205, and 1207, bearing 29 as the regnal year,

of A.H. 1208, and 1209,	„	31	„	„	„
of A.H. 1209, and 1211,	„	35	„	„	„
of A.H. 1211,	„	36	„	„	„

and of A.H. 1211, 1212, 1213, 1214, 1215, 1216, bearing 37 as the regnal year. To this list Mr. Whitehead's Catalogue now adds Bareli Qit'a rupee of A.H. 1218 and R.Y. 37. The Āsafābād Bareli rupees, on the other hand, seem to be confined to the three Hijrī years 1209, 1210, and 1211, with which is invariably associated the one regnal year 35, written either as *٣٥* or as *٣٥*. It is thus probable that the Āsafābād issue appeared only in the interval between A.H. 1209 and

1211, though both in 1209 and in 1211 Bareli Qit'a rupees were also struck. It would be interesting to learn whether in A.H. 1210 the Āṣafābād entirely superseded the Qit'a rupee, or whether in that year too both types were issued at Bareli.

The three Baroda rupees Nos. 3198—3200 are, we observe, assigned in the catalogue to the reign of Shāh 'Ālam II. Now Shah 'Ālam's Baroda coins are extremely rare, and in the absence of that Emperor's name—it is absent from all the three coins—it would be far safer to assume that the top line of the obverse bore the name not of Shāh 'Ālam (II) but of Akbar (II). The quasi-regnal years ۱۲۱۶ and ۱۲۱۷ entered on the reverse should then date from A.H. 1221, the year of Akbar II's accession, and in that case the three rupees would fall outside the range of coins deemed to be Mughal issues.

For a book abounding, as this catalogue does, in diacritical marks the errata that we have been able to note are marvelously few. Mr. J. Allan, who was so kind as to correct the proof-sheets, and the staff of the Clarendon Press have between them produced a work remarkably free from typographical blemishes. On page xli, line 35, the "1166" should read "1136." The regnal year on the reverse of coin No. 3004, should be not ۲۶ but ۲۸: see the representation of this coin on plate xviii. The "Kathiāwār" on page lxviii, line 11, should have its first 'a' long and also its 'i,' thus Kāthiāwār.

We should like to see "Ujain" changed throughout to "Ujjain." This name occurs on the coins in two forms, either as اچين, Ujjain, or as وچين, Ujain, but Ujain with short 'u' and a single 'j' is neither the one nor the other. Similarly چينا پتن is Chīnāpattan with a double 't,' and مچھاي پتن Machhlipattan: compare پتن ديو = Pattan Deo.

The Akbarpūr Tānda rupees, Nos. 249, 250, should have been entered before, not after, those from Āgra, Nos 227—248. In the group of the four Khalīfas given on page xx, line 23, Abū Bakr should stand first and 'Alī fourth. Should not the words جل جلاله be translated, "May His glory be glorified," rather than, as on page xxi, line 1, "Eminent is His glory"? On page xx it is stated that the epithets of the Four Khalīfas are "usually," ابرقضى and ابونورين, الفاروق, الصديق. But these epithets are, if we mistake not, found on Pathān rather than on Mughal coins, and surely the "virtues" attributed far and away the most frequently to the orthodox Khalīfas are those contained in the legends that so often stand in the margins of the coins of "the Great Mughals", to wit,

بصدق ابي بكر و عدل عمر بارزم عثمان و علم علي

“By the Truth of Abū Bakr and the Justice of ‘Umar, by the Modesty of ‘Uṣmān and the Wisdom of ‘Ali.

This excellent catalogue by Mr. Whitehead is the product of a rare combination of numismatic scholarship of a very high order with thorough-going research and immense application; and we are delighted to be able to add that already within a few weeks of its publication it has been crowned by the Académie Française des Inscriptions et Belles Lettres. That distinguished body of savants, adjudging it to be the best contribution to Numismatic Science within the past four years, has awarded Mr. Whitehead the Prix Drouin. The late M. Ed. Drouin was himself a scholar deeply interested in the coins of India, and that the prize bearing his honoured name should fall to one who has with conspicuous ability specialized in the field of Indian Numismatics is singularly felicitous. To collectors in India the decision of the Academy will entirely commend itself, while to members of the Numismatic Society of India, it is especially gratifying to know that their much esteemed Honorary Secretary has been chosen to be the recipient of a distinction so honourable and so well deserved.

GEO. P. TAYLOR.

London, 8th July, 1914.

143. REVIEW.

W. H. VALENTINE: *The Copper Coins of India. Part I, Bengal and the United Provinces.*

Coin-collectors in India will be grateful to Mr. W. H. Valentine for the second volume, recently published, of his work on “The Copper Coins of Muhammadan States.” There is a tendency on the part of some numismatists to underestimate the copper currency, and it is true that the majority of early copper coins, now obtainable, are in poor condition, and also true that their legends are generally brief even to baldness. Still should only the king’s name and mint-town be legible, the coin thereby becomes a record, may be a valuable record, which neither the historian nor the coin-collector should affect to disregard. Mr. Valentine with a most praiseworthy diligence and enthusiasm has for some years now devoted himself to research in this comparatively neglected portion of Oriental numismatics. He has managed to obtain, or at least to handle, a very large number of specimens in copper, and has been careful to describe the many various types represented. By thus specializing he has rendered a very real service to all who are students of Eastern coins.

The present volume, dealing with the copper coins of

Bengal and the United Provinces, is but the first instalment of a work designed to record the chief types of copper coins that have at any time been issued in any part of India. So large an undertaking calls for much courage as well as much skill and diligence, and we trust that Mr. Valentine will see the completion of a work he has so bravely faced.

This Part I naturally contains a considerable amount of what may be regarded as matter introductory to the entire series. Unfortunately a Table of Contents is wanting, an omission the more to be regretted inasmuch as so many varied subjects have been included in the preliminary 58 pages. The "Introduction," in the first four of those pages, deals with the more personal elements in the preparation of the book, and thus might more appropriately have been styled a Preface. Then from pages 5 to 29, we have a "History of India." This is necessarily the merest outline, and contains little more than the names of the different dynasties that at one time or another held sway over the various portions of the country. It is well, however, to have the sequence of these dynasties indicated so clearly as they are in the marginal insets. Next follow (1) chronological lists of the Sultāns of Dehlī, also of the English sovereigns from the founding of the English East India Company; (2) the characters of the Hindūstānī alphabet, both in Persi-Arabic and in Devanāgarī; (3) the numerals in Arabic, Persian, and Hindūstānī; (4) a glossary of words and phrases present on the coins, also of poetical legends or couplets; (5) a note on eras, followed by a comparative table of the Christian and the Hijrī years; (6) notes on the weights and denominations of the coins; and (7) a list of abbreviations. It will thus be seen that a large portion of this section is purely elementary. The glossary will be helpful for reference, but both here and in the couplets the transliteration is faulty and the vowel-marks are sadly defective. Surely one does not now-a-days represent ق by *k*, or سي by *see* or صاحب قرانی by *sahib kiranī* (p. 45); nor does one write Urdibihisht, or soubah, or falus, or raij, or butayid. How is it possible to transliterate خلافة as *khalīfat* (p. 41) or as *khalifat* (p. 42)? Unless vowel-marks be indicated with absolute accuracy, it were better, I fancy, not to employ them at all.

After this somewhat extensive preliminary portion the book proper begins, pages 59 to 80 being assigned to the coins of Bengal and Burma, and pages 81 to 123 to those of the United Provinces of Agra and Oudh. Here we have, along with further "history" of the districts specified, excellent lithographed Plates, twenty-two in all, and facing each Plate a page describing in detail each coin represented. This is the really valuable portion of the book, and it is of quite exceptional value. The drawings of the coins, though lacking in shade, are beautifully clear, and much care and skill have been

employed in deciphering the legends. Especial interest attaches to the grouping together of the coins that issued from a given mint during entirely different dynasties. For example, we have the Jaunpūr coins of the Sultāns of Dehlī side by side with Akbar's Mughal pieces, or, again, the Mughal coins of Awadh side by side with the Native State issues.

The well-known bilingual and trilingual paisa of the East India Company are exhibited on pages 71 and 99, and Mr. Valentine, after correctly giving the Persian and Bengali readings, adds that the same legend appears also "in debased Nāgrī." We have often thought that this last character is just a crude form of Gujarātī, to which certainly the letters on the coins bear a remarkable resemblance. Thus the different characters would suggest that these coins were legal currency over the whole of India from Bengal in the East to Gujarāt in the West.

We tender hearty congratulations to Mr. Valentine on the admirable work he has accomplished in this Part I, and shall await his later volumes with high expectations.

GEO. P. TAYLOR.

LONDONDERRY,

2nd September, 1914.

144. A COPPER COIN FROM THE NAHRWĀLA SHAHR PATTAN MINT.

Last February (1914) I had the good fortune to find in the Aḥmadābād bazar a copper fulūs of Akbar from the mint Nahrwāla Shahr Pattan. Coins of the Pattan mint are known in all three metals, but they are extremely rare and those hitherto published have all been of the year 984 H. On the rupee the mint name appears as Nahrwāla (*Note* or "Anhirwāla"; *vide* the coin in the Lucknow Museum Cabinet.--*Edr.*) Pattan, and in the fulūs as Shahr Pattan. Mr. Whitehead, emending the reading that had been suggested of the legend on the gold *muh*r, Plate III, No 61, in the British Museum Catalogue of Mughal Coins, has shown that this *muh*r also exhibits the mint name as Shahr Pattan. The copper coin which I have now the pleasure to submit bears the date 985 H., and gives the Pattan associated with *both* the epithets Shahr and Nahrwāla. It thus records in full the triple name Nahrwāla Shahr Pattan.

The *Obverse* reads as follows:—

شهر پتن
 نهرواله
 ضر فلوس

and the *Reverse* as :—

پنج
ہشتاد
فی نصد و
۹۸۵
س—ذہ

Pattan, to-day commonly called Kadī Pāṭan, or Pāṭan of the Kadī *prānt* of the Baroda State, is said to have been founded in A.D. 766. During the next six hundred years it witnessed many vicissitudes, capitulating to Maḥmūd of Ghazni in 1025, and again in 1297 to 'Alāu-d-dīn's general Ulugh Khān, while in the first quarter of the 15th century it surrendered its proud position as the Capital of Gujarāt to the fast-rising city of Aḥmadābād. It is interesting to note that the copper coins which in the reign of Akbar issued simultaneously from the mints in these two cities were of one and the same type. See Indian Museum Catalogue, Vol. III. Nos. 349, 352, and plate IV.

Tradition tells that Anhil was the founder of the city Pattan, which hence received the name Anhil-pūr or Anhil-vādā. The latter form would supply successively the variants Anhal-wāra, Nahalwāla, Naharwāla, and finally Nahrwāla.

Of Pattan in the zenith of its prosperity a graphic but exaggerated description is given in the Kumār Pāḷ Charitra. It states that the city measured twelve kos in circumference, while its wards numbered eighty-four, also that it contained a mint whence issued both gold and silver coins and that of the eighty-four bazārs one was reserved for the money-changers. Of this coinage, if it ever existed, it would seem no specimen has survived to the present day, unless indeed it be represented by the debased Gadhaiyā, then current in silver and copper but not in gold.

GEO. P. TAYLOR.



145. NOTE ON SOME COPPER COINS DISCOVERED
IN BALAGHAT, C.P.

[With Plate XXXIII.]

In September last a hoard of 740 small square copper coins were discovered in Mouza Bodanda, Bālāghāt Tehsils and were forwarded to me to decipher. Their interest seems to me two-fold; they may serve to throw some light on the political history of Gondwāna, of which practically nothing is known until the coming of the Mahrātas; they also illustrate very clearly the debasing of a type; in this case the debasement is complicated by the confusion of four separate types of coinage—of Gujarāt, Mālwā, Sūrī and the Mughal Emperor Akbar. Unfortunately not a single date is discernible.

Coins.

1. Aḥmad Shāh II of Gujarāt.

Obverse. In square area. قطب الدنيا

والدين

Reverse—

خليفة

[۱] حمد شاه

المومنين

The attribution of this coin is not quite satisfying, but it seems fairly close to the legend of I.M.C No. 12a (Plate ix). There are perhaps traces of a date at the bottom of the reverse. It is obviously a local coin, but both this and the following coin seem to have been struck by some authority from the Saltanat of Gujarāt, and this is previous to the occupation of Mālwā by Bahādur of Gujarāt in 937 A.H. (=1530 A.D.). Dr. Taylor in his paper on the Coins of Gujarāt in Bomb. A. S. Journal, 1902, says that he has never seen square coins of Gujarāt. These two coins therefore have a special interest.

2. Maḥmūd Shāh III of Gujarāt.

Obverse—

ناصر الدنيا والدين

[ابو] الفتح

المغان

الوائق بالله

*Reverse.—*In a circle السلطان

بن لطيف شاه

محمود شاه

For the inscription compare I.M.C., Vol. II, No. 80. I call this Gujarāt type A, with reference to this hoard.

3. As No. 2, but corrupt. *Type B.*

4. *Obverse.* The Kalima—as arranged in Akbar's early issues محمد at the foot of the coin.

Reverse—

.
 محمد
 لـطـفـيـن

 خلد الله ملكه

Type C. This is a confusion with No. 6. خلد الله ملكه is taken from the coins of Muzaffar Shāh III of Gujarāt. On some coins there appears to be a mixture of this with the formula الواثق بالله

5. *Obverse.—*Corruption of

السلطان
 بـن
 ۛۛ
 السلطان

*Reverse.—*As No. 4.

Type D. Here we have a mixture of the legends of a Gujarāt and a Mālwā coin. The curious and distinctive mark ۛۛ is probably derived from the Mālwā coins of Nāṣir Shāh Khaljī (Cf. I.M.C. No. 77).

6. Akbar.

*Obverse.—*The Kalima (early arrangement) surrounded by a border of dots.

Reverse—

بادشاه اکبر
 غازی
 جلال الدین

Surrounded by a border of dots.

Type A. By the fineness of execution this would appear to be the first coin of this type, but curiously the word محمد does not appear to be present on the reverse. The design is evidently copied from the Aḥmadābād coins. This and the following coin would seem to have been struck by Imperial authority, and one cannot help comparing them with the Maḥmūdīs of Gujarāt which start in 989 A.H. I do not think this type has been published before. The only reference I can

find to them is in Jackson's "Coin collecting in the Deccan" he says, p. 21: "The Māl wā (copper) issues of the Emperor Akbar of the same square shape as those of the Sultans are frequently met with."

7. Akbar.

Obverse.—As No. 6, but no border.

Reverse—
 اکبر بادشاہ
 غازی
 محمد
 جلال الدین

Type B. The majority of the coins in the hoard were of this type; a few coins had the mint marks—× on the reverse or ⌘ on the obverse.

8. *Obverse*.—As No. 5, very debased.

Reverse.—As No. 7.

Type C. A mixture of Māl wā and Mughal types.

9. *Obverse*.—As No. 7.

Reverse.—As obverse of No. 5.

Type D. The reverse variety of No. 8.

10. Jalālu-d-din formula on both obverse and reverse.

11. The Kalima formula on both obverse and reverse.

12. *Obverse*.—Corrupt form of Kalima.

Reverse.—Corrupt. السلطان

 السلطان

The reverse shows an interesting form of corruption, the line of dots being taken from the border of No. 6, and confused with the single line of — in the Māl wā coins.

13. *Obverse*. Very corrupt form of No. 5.

Reverse.—As No. 12.

14. Sūrī Muḥammad 'Ādil Shāh.

Obverse—
 المعتمد محمد
 ابو الله
 السلطان ?

Reverse.—Corrupt.

Both obverse and reverse are copied from a type of Muḥammad 'Ādil's coins which I illustrate, but which I do not seem to have seen previously published.

Note.—I only recognized the identity of this coin after the article had been written and the plate prepared—hence its position in the list.



The whole style of this coin is like those of Mālwā. But the obverse inscription is of Gujarāt (Maḥmūd Shāh III) except that *د. س. م.* seems to be written: especially on the corrupt form of this coin No. 15. The obverse however is a corruption of Maḥmūd Shāh Khaljī's legend of I.M.C. No. 114.

15. Corrupt form of the above.

16. *Obverse.*—As No. 14.

Reverse—

.....
 ۱۸۶

This coin again presents elements from the Aḥmadābād dotted border coins.

17. 18. Specimens of corrupt forms containing parts of various legends.

From the weight of these coins not much can be learnt. One class of coins seem to conform to the 80 rati Mālwā standard (= 140 grains), four specimens weighing 68, 68, 61, 61 respectively. Three other coins weighed 83, 80, 81 which might suggest the 100 rati Gujarāt standard (= 185 grains). One coin however weighed 119 grains and another 96. The 80 rati Mālwā standard however was the prevalent one as 10 other coins gave an average of 54.5 grains. With the exception of No. 1¹ these coins would appear to date from the annexation of Mālwā by Bahādur Shāh of Gujarāt in 937 A.H. (= 1530). Gondwāna, in which Bālāghāt was included, was of course an outlying district and probably only nominally under Mālwā influence. It was a place of refuge for exiles. In 923 A.H. Jalāl Khān who after the death of Sikandar Lodī had

¹ As *قطب الدین* is also the title of Bahādur Shāh, this coin may belong to him, but I think I can make out *محمد* on the reverse and the design seems to be nearer to the coins of Aḥmad Shāh II.

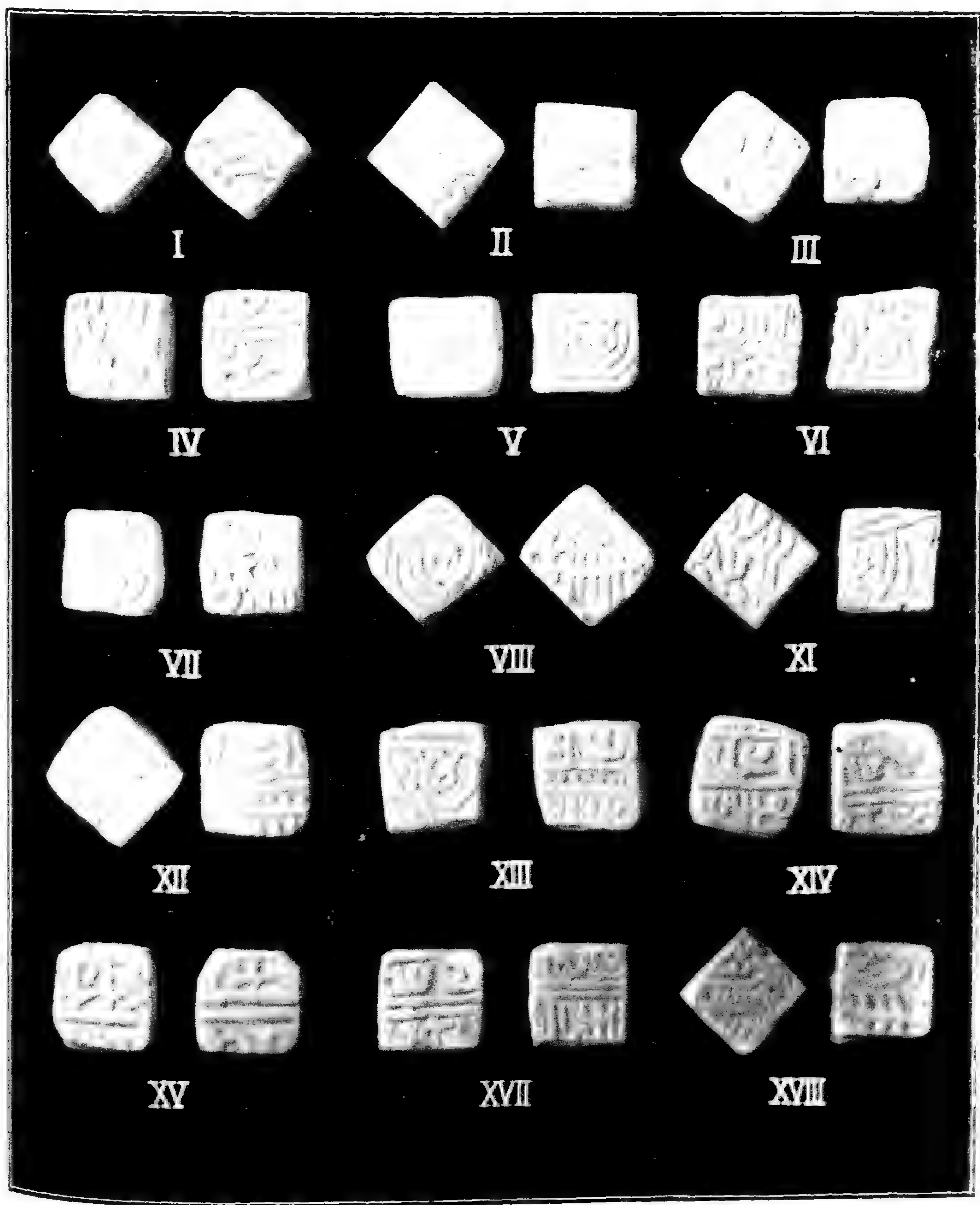

SOME COPPER COINS DISCOVERED IN BALAGHAT. C. P. ART. 45

usurped the Kingdom of Jaunpūr, fled to Gondwāna after being expelled and being refused an asylum first in Gwāliār and then in Mālwā.

During the years 970-978 A.H. (1561-1570) Bāz Bahādur, son of Shujā' Khān Sher Shāh's Governor, was in hiding in Gondwāna. He had assumed independence and been defeated by Akbar. Perhaps coins like Nos. 3, 4, 14, 15 may be connected with this period.

In 1564 Chaurāgarh in Western Gondwāna was sacked by one of Akbar's Generals and five years later Mālwā was annexed and made a sūbah of the Empire. The modern Bālāghāt was part of the Gārha Sarkār.¹ At this time perhaps were issued Nos. 6 and 7.

I have been able to find nothing more recorded of Gondwāna until Jahāngīr's time, when the 'Ain-i-Akbarī records "From the time of Akbar's death the Kings of the Dakhin had been restless and Malik 'Ambar had seized upon several places in the Bālāghāt district."²

Bālāghāt appears to have been a centre of operations until this trouble was finally settled in the 11th year of Jahāngīr 1025 A.H. when Malik 'Ambar³ "handed over the keys of Ahmadnagar and other forts, together with the parganas of Bālāghāt which he had conquered."

Conjectures based on find spots are notoriously hazardous, but perhaps we may infer that a large hoard of small copper coins like this was not likely to be carried far from the districts in which the coins were current. These were probably then the current coins of Gondwāna from soon after the occupation of Mālwā by Bahādur of Gujarāt in 1530 A.D. Maḥmūd Shāh III of Gujarāt, to whom No. 2 belongs, began his reign in 1537. Gujarāt influence in Gondwāna during this period may be surmised until about 1570 (= 978 A.H.). Soon after this the Akbarī coins must have come and continued to be struck perhaps until the coming of the Mahrātas.

It may be noticed that whereas the Gujarāt and Mālwā elements in these coins have become very confused, in very few if any cases were the Akbarī inscriptions beyond recognition though they frequently appeared with a Gujarāt type obverse or reverse. The date of the deposit might perhaps be conjectured to be about the end of Jahāngīr's reign.

C. J. BROWN.

Lucknow, September 1914.

¹ It is called Sarkār Kanauj in 'Ain-i Akbari, vol. II, p. 199, but I think this must be a mistake. There is no place Kanauj in the Sarkār, and on p. 196 he mentions Gārha as a separate state.

² 'Ain-i Akbari, Vol. 1, p. 412.

³ " " " " Vol. 1, p. 336.

146. A GOLD COIN OF CROESUS.

It is not on record whether a Lydian coin has ever been found in Indian soil before this, but I am sure that a coin of Croesus has not as yet been found anywhere in this country. Only a few specimens of the coinage of this monarch have been discovered and have found their way to the various big Museums of Europe. The coin described below was purchased by me in October last in Mari on the Indus from a money-changer. It is an oblong gold coin with rounded ends bearing on its obverse the front part of a lion and a bull and on the reverse two square impressions, one of which is slightly smaller than the other.

I stumbled on a reproduction of a similar coin in Prof. J. B. Bury's *History of Greece* (Macmillan & Co., 1902¹), where it is described as a "Gold Coin of Sardis (middle of 6th century). Obverse:—fore parts of a lion and bull, reverse:—two incuse squares." I submitted the coin to Babu Rakhal-das Banerji of the Indian Museum, who pronounced it to be a genuine specimen.

A similar coin is described in G. F. Hill's *Historical Greek Coins*, where it is stated that although the attribution on this coin to Croesus is not absolutely settled, still it is highly probable that these are *κροίσεια στατήρες* (Kroiseioi Stateres), i.e. Staters of Croesus.² They are of fine gold and were struck in two standards: (1) The gold Shekel standard of 8.18 grammes = 126 grains, and (2) the Babylonian standard of 10.91 grammes = 168 grains. Similar Staters were also struck in the latter standard. Prof. Bury states that the earlier Lydian coinage was of White metal, i.e. a mixture of silver and gold, and that Croesus was the first King of Lydia, who struck coins in pure gold and silver. The coin purchased by me weighs 10.680 grammes = 164.75 grains. It, therefore, belongs to the Babylonian standard. Coins struck on the Babylonian standard were used for commerce with the East, while those struck on the gold Shekel standard were used for commerce with the Greek cities of the Asia Minor.³

These gold Staters of Croesus are of special interest:

(1) They are the first gold coins ever issued as far as we know, and superseded the earlier white metal or electrum coins. The proportion of gold in these Staters varies from 5 to 72%.⁴ Most probably touchstones were used for testing these electrum coins, as they must also have been in India where

¹ Top of p. 217.

² p. 18, No. 7: see also Percy Gardner "The Gold Coins of Asia before Alexander the Great," p. 9.

³ G. F. Hill, "Historical Greek Coins," p. 19.

⁴ Percy Gardner, "The Gold Coinage of Asia before Alexander the Great," p. 8.

the billon coins (a mixture of silver and copper) of the Pathān Sultāns of Dehli were current.

(2) They form the first State coinage, if they are really what they are taken to be, viz., Staters of Croesus. The wealth of Croesus was well known and the power of Lydia before its overthrow in 546 B.C., would be such as to win general respect for its coinage. In addition to this, they were a great improvement on the former electrum coins.

On the fall of the Lydian kingdom the Persian Darics (or Staters) and Sigloi (or Drachms) took the place of the Lydian coins in Asiatic commerce. The Persian Daric was a few grains heavier than the Babylonian Stater of Croesus. The device on my coin, the lion in opposition to the bull, is supposed by G. F. Hill to be connected with the cult of the Anatolian Mother Goddess. This motive is common in the art of the Near East.

It is perhaps rash to conjecture how such a coin reached India, but the find-place, Mari on the Indus, is suggestive. Mari is situated on the left bank of the river, a few miles south of Kalabagh (which is on the right bank), where the road from Jhīlam and Rāwal Pindi crosses the river. About forty miles south of this place is Isakhel, where the Kurram and Tochi Rivers join the Indus, each descending from passes, which are very little known.¹ These rivers connect India with Afghānistān, the former leading to Kābul and the latter to Ghazni. They are very difficult and little known, but may have served as trade routes in earlier times. More significant is the fact the Kalabagh is conjectured to be the northern boundary of the old Persian satrapy in India, which stretched thence southwards the sea.²

As the coin appears to be in good condition, there is no reason why it should not have been brought into India previous to Alexander's conquest and have lain hidden in sand until recent times. It may be that one of the first gold coins ever issued had passed into the hands of an Indian and was hoarded, to be re-discovered within the boundaries of the old Indian satrapy after 2500 years, as the craze for hoarding gold in India is one of remote antiquity.

Croesus was the son and successor of Allyattes, during whose reign Lydia was at the apogee of her power. Croesus attacked the Greek cities of Ionia and Aetolia and subdued all of them except Miletus. The Dorian cities of Caria were also forced to submit and the empire of Croesus extended from the Halys to the Aegean. The fall of the Lydian dynasty was due to the rise of the Achaemenidae of Persia. Cyrus, the Persian, overthrew Astyages, King of Media, who had

¹ Sir Thomas Holditch, "Gates of India," p. 512.

² V. A. Smith, "Early History of India," 2nd edition, p. 34.

married Croesus' sister. The fall of Astyages was a fit opportunity for the ambitious Lydian to turn his arm towards the East, the restoration of his brother-in-law being a sufficient plea. Croesus consulted the celebrated oracle of Delphi, and the answer returned was that if he crossed the Halys he would destroy a mighty empire. Croesus invaded Cappadocia. Cyrus drove him back to Lydia and won a decisive victory under the walls of Sardis, which fell into his hands after a short siege. The fate of Croesus is lost in mystery and fable. The story of Croesus, ascending the funeral pyre and suddenly remembering the name of Solon the Athenian, is well known. Nothing now remains of Croesus but some pillars dedicated by him in a temple of Artemis in Ephesus. The bases bear inscriptions "Dedicated by King Croesus."

I am indebted to Prof. Brown for helping me with some valuable materials in writing this paper.

MRITYUNJOY ROYCHOWDHURY.



Note.—The photographs of the coins from which the plates accompanying article No. 125 of N S. No. XXII, published in the Society's Journal for May 1914, were taken by my friend Mr. D. R. Bhandarkar, Superintendent, Archæological Survey, Western Circle, from casts, which he also prepared.

I may be permitted now to make the acknowledgment, which I inadvertently omitted from the end of my paper, of his kindness and of the careful and skilful manner in which he has prepared the photographs.

Surat.

A. MASTER.

PROCEEDINGS

For the year

1914

JANUARY, 1914.

The Monthly General Meeting of the Society was held on Wednesday, the 7th January, 1914, at 9-15 P.M.

D. HOOPER, Esq., F.C.S., F.L.S., F.A.S.B., Vice-President, in the chair.

The following members were present :—

Maulavi Abdul Wali, Dr. N. Annandale, Dr. P. J. Brühl, Mr. G. R. Clarke, Mr. F. H. Gravely, Mr. H. G. Graves, Mr. K. A. K. Hollowes, Mr. L. K. Anantha Krishna Iyer, Rev. W. R. LeQuesne, Mr. R. D. Mehta, C.I.E., Roy Bahadur Lalit Mohan Singha Roy, Lieut.-Col. L. Rogers, I.M.S., Mr. G. Stadler, Mr. T. Southwell, Dr. Satisa Chandra Vidyabhusana, Rev. J. Watt, and Rev. A. W. Young.

Visitors :—Babu Susil Kumar Acharya, Mr. H. G. Carter, Babu Gauripati Chatterjee, Babu Hem Chandra Das Gupta, Babu Dwijendra Kumar Mazumdar, Babu Manindranath Maitra and another.

The minutes of the last meeting were read and confirmed.

Thirty-four presentations were announced.

The General Secretary reported that Mr. K. N. Knox, I.C.S., had expressed a wish to withdraw from the Society.

The following gentleman was balloted for as an Ordinary Member :—

Dr. O. Strauss, Professor, Calcutta University, proposed by the Hon. Justice Sir Asutosh Mukhopadhyaya, Kt., seconded by Dr. G. Thibaut, C.I.E.

Dr. N. Annandale exhibited a bull roarer from Chittagong.

Dr. E. P. Harrison exhibited an apparatus for measuring the expansion coefficient of metal wires at different temperatures

The following papers were read :—

1. *On a Demonstration Apparatus for determining Young's Modulus.* By GOUBIPATI CHATTERJI. Communicated by DR. E. P. HARRISON.

2. *A new Species of Diospyros from the Tinnevelly Hills.* By M. S. RAMASWAMI, M.A.

3 *Studies on the Leaf Structure of Zoysia pungens, Willd.*
By M. S RAMASWAMI, M.A.

4. *Grooved Stone Hammers from Assam and the Distribution of Similar Forms in Eastern Asia.* By J. COGGIN BROWN.

These four papers will be published in a subsequent number of the *Journal*.

5. *Intermittent Springs at Rajapur in the Bombay Presidency.*
By HAROLD H. MANN and S. R. PARANJPYE.

This paper has been returned to author.



The Adjourned Meeting of the Medical Section of the Society was held at the Society's Rooms on Wednesday, the 16th January, 1914, at 9-30 P.M.

DR. W. C. HOSSACK, M.D., in the chair.

The following members were present :—

Lieut.-Col. A. R. S. Anderson, I.M.S., Dr. Adrian Caddy, Dr. K. K. Chatterjee, Dr. H. Finck, Lieut.-Col. C. R. M. Green, I.M.S., Capt. R. E. Lloyd, I.M.S., Lieut.-Col. E. A. R. Newman, I.M.S., Lieut.-Col. L. Rogers, I.M.S., Capt. E. O. Thurston, I.M.S.

Visitors :—Capt. Green Armytage, I.M.S., Lieut.-Col. H. E. Banatvala, I.M.S., Lieut.-Col. G. G. Gifford, I.M.S., Dr. J. B. Moloney, Lieut.-Col. W. D. Southerland, I.M.S.

The minutes of the last meeting were read and confirmed.

The discussion on the Emetine and other treatments of Amoebic Dysentery and Hepatitis was concluded and Major Thurston, I.M.S., read his paper on 101 cases of liver abscess.



FEBRUARY, 1914.

The Annual Meeting of the Society was held on Wednesday, the 4th February, 1914, at 9-15 P.M.

HIS EXCELLENCY THE RIGHT HON'BLE THOMAS DAVID BARON CARMICHAEL of SKIRLING, G.C.I.E., K.C.M.G.. President, in the chair.

The following members were present :—

Maulavi Abdul Wali, Dr. N. Annandale, Dr. C. A. Bentley, Babu Ramakanta Bhattacharjee, Dr. P. J. Brühl, Mr. J. Coggin Brown, Mr. Percy Brown, Lieut.-Col. W. J. Buchanan, I.M.S., Babu Nilmani Chakravarti, Mr. J. A. Chapman, Dr. B. L. Chaudhuri, Dr. W. A. K. Christie, Mr. D. A. David, Major B. H. Deare, I.M.S., Rev. W. K. Firminger, Rev. E. Francotte, S.J., Dr. Harinath Ghosh, Mr. T. P. Ghosh, Mr. F. H. Gravely, Major E. D. W. Greig, I.M.S., Mr. B. A. Gupte, Mr. A. H. Harley, Mr. D. Hooper, Rev. H. Hosten, S.J., Mr. S. W. Kemp, Mr. W. Kirkpatrick, Mr. W. A. Lee, Mr. J. McLean, Mr. R. D. Mehta, C.I.E., Mr. W. H. Miles, Hon. Justice Sir Asutosh Mukhopadhyaya, Kt., Babu Panchanan Mukerjee, Syed Abdulla-ul-Musawy, Babu Puranchand Nahar, Major C. L. Peart, I.A., Dr. G. E. Pilgrim, Mr. M. S. Ramaswami, Dr. C. Schulten, Mr. M. J. Seth, Mahamahopadhyaya Haraprasad Shastri, C.I.E., Rai Bahadur Lalit Mohan Singha Roy, Babu Bahadur Singh Singhi, Maulavi Mahomed Kazim Shirazi, Capt. J. A. Shorten, I.M.S., Mr. T. Southwell, Mr. G. Stadler, Dr. Satish Chandra Vidyabhusana, Rev. J. Watt, Rev. A. W. Young.

Visitors :—Mrs. Percy Brown, Mrs. Bruhl, Mrs. Chapman, Mr. C. S. Mukerjee, Mrs. M. S. Ramaswami, Mr. Allain Raffin.

The President ordered the distribution of the voting papers for the election of Officers and Members of Council for 1914, and appointed Captain J. A. Shorten, I.M.S., and Maulavi Abdul Wali to be scrutineers.

The President announced that as no candidate has received a majority of votes of the Fellows voting, no one is recommended for election as a Fellow this year.

The Annual Report was then presented.

ANNUAL REPORT FOR 1913.

The Council of the Asiatic Society has the honour to submit the following report on the state of the Society's affairs during the year ending 31st December, 1913.

Member List.

The number of Ordinary Members at the close of the year was 499. Twenty-eight Ordinary Members were elected during 1913. Out of these 4 have not yet paid their entrance fees. The number of Ordinary Members, therefore, added to the list is 24. On the other hand 34 withdrew, 3 died and 5 were struck off under Rule 40.

The numbers of Ordinary Members in the past six years are as follows :—

YEAR.	PAYING.				NON-PAYING.			GRAND TOTAL.
	Resident.	Non-Resident.	Foreign.	Total.	Life.	Absent.	Total.	
1908 ..	181	193	17	391	19	38	57	448
1909 ..	183	217	13	413	20	40	60	473
1910 ..	209	217	16	442	23	43	66	508
1911 ..	200	225	19	444	22	53	75	519
1912 ..	203	229	19	451	23	43	66	517
1913 ..	200	211	19	430	23	46	69	499

The following members died during the course of the year :—

Rai Ram Saran Das, Bahadur, Mr. James Luke and Mr. V. Venkayya.

The number of Special Honorary Centenary Members and Honorary Fellows remain unchanged.

The name of Mr. Ekendra Nath Ghosh has been added to the list of Associate Members. The number now stands at 14.

Indian Museum.

On the representation of the Secretary to the Trustees of the Indian Museum, pointing out that the Hon. Justice Sir

Asutosh Mukhopādhyāya. Kt., C.S.I., had ceased to represent the Society upon the Board of Trustees under clause II (3) of the Indian Museum Act of 1910, the Council reappointed Sir Asutosh Mukhopādhyāya to fill the vacancy on behalf of the Society.

At the instance of Dr. N. Annandale, regarding the Centenary celebration of the foundation of the Asiatic Society's Museum which afterwards developed into the Indian Museum, a Special Committee, to represent the Society, was formed to work out a scheme. The first meeting was held in April 1913 and the Proceedings were approved by the Council. The second meeting of the Trustees was held in December 1913, when final arrangements were made for the celebration of the Centenary of the Museum in conjunction with the Science Congress to be inaugurated by the Society during January 1914. H.E. Lord Carmichael was nominated as the chairman of the Centenary Committee appointed jointly by the Trustees and the Council of the Society.

The Council also gave permission to the Trustees of the Indian Museum to make use of the Society's publications, especially the Centenary volume in the preparation of a history of the Indian Museum, and to reproduce the portrait of Mr. Edward Blyth in the possession of the Society.

Deputations.

On an invitation from the 12th International Geological Congress held at Toronto in August 1913, Sir Thomas Holland, K.C.I.E., attended the Congress as a delegate on behalf of the Society.

The IXth International Congress of Zoology was held at Monaco from the 25th to 30th March, 1913, and Capt. R. B. Seymour Sewell, I.M.S., represented the Society. Capt. Sewell submitted his report as the delegate of the Society and copies of the report were forwarded to the Government of India, Dept. of Education, and to the Indian Museum for information.

Indian Science Congress.

Referring to the meeting held in the Society's Rooms on the 2nd November, 1912, for a preliminary Science Congress, a Special Committee was appointed to work out the scheme, and the Council accepted the proposal for holding a Science Congress in January 1914. At a meeting of the Special Committee held on the 20th November, 1913, the Special Committee was reconstructed. H.E. Lord Carmichael was appointed to be Patron and Sir Asutosh Mukhopādhyāya to be President with Mr. D. Hooper as Honorary Secretary and Treasurer. It was finally arranged that the meetings of the Science Congress be held

on January 15th, 16th, and 17th, 1914, in the rooms of the Society, and a Provisional Programme has been drawn up and circulated.

Meetings.

An informal meeting of the Society was held on the 30th January, 1913, at 9-30 P.M., at the Society's rooms to meet Dr. H. Oldenburg, Professor of the University of Göttingen and an Honorary Fellow of the Society.

Finance.

The appendix contains the usual classified statements showing the accounts of the Society.

Under statement No. 1 will be found the account of Receipts and Disbursements of the Society during the year 1913.

Statement Nos. 2, 3, 4, 5, 6 and 7 show how the money administered through the Society in the Oriental Publications, Sanskrit MSS., Arabic and Persian, and Bardic Chronicles Funds, has been spent during the past year.

Statement No. 8 gives an account of money due by and to the members of this Society.

In a statement No. 9 an account is given of the sum invested in Government securities and held in deposit by the Bank of Bengal.

Statement No. 10 shows the sum invested in Government securities known as the Trust Fund, the interest of which is applied to the payment of pension to the menial servants of the Society.

The cash receipts and expenditure of the Society as well as those of the different Funds are summed up in a statement No. 11.

Statement No. 12 exhibits the Balance Sheet of the different statements.

The Budget Estimate for 1913 was taken at the following figures: Receipts Rs. 32,010, Expenditure Rs. 31,469.

Taking into account the items of Receipts and Expenditure for year 1913, the actual results have been: Receipts Rs. 31,642, Expenditure Rs. 22,893.

The receipt thus shows a decrease of Rs. 368, while the expenditure shows a saving of Rs. 8,576 on the budget estimate, leaving a balance in favour of the Society on its ordinary working of Rs. 8,749.

There is an increase under the heads of Subscriptions for the Society's "Journal and Proceedings" and "Memoirs," and "Miscellaneous." Subscriptions for the "Journal and Proceedings" and "Memoirs" were estimated at Rs. 1,608, while the actuals were Rs. 1,680, the excess being due to some of the arrear subscriptions from subscribers having been realized.

There is an increase of Rs. 75 under head "Miscellaneous." This is due to the advances recovered from the members.

The falling-off in receipts under the heads of "Members' Subscriptions" is due to non-receipt of subscription from members. "Sale of Publication" on account of certain sale proceeds not having been realized during the year. "Interest on Investment" owing to non-realization from the Bank of Bengal. The sum of Rs. 736 has been received as entrance fees under the head "Admission Fees," and the sum of Rs. 130 has been received under the head "Subscription to Indian Science Congress."

The expenses have been nearly within the sanctioned budget estimate. There is a very slight increase under the head "Salaries," and "Commission." "Postage" shows a heavy increase for despatching publications of 1912 issued in 1913 and notices sent to members for the several lectures held in the Society's rooms during 1913. "Petty repairs" are higher on account of painting the lower parts of the pillars of the meeting room, the edges of the stair-case, repairing the out-offices, and an iron safe. Under the heads, "Books" were estimated at Rs. 2,600 and "Binding" were estimated at Rs. 1,000, whilst the expenditure has been Rs. 1,120 and Rs. 705 respectively. "Journal and Proceedings and Memoirs" shows heavy decrease owing to certain bills from the Baptist Mission Press not yet paid.

There were four items of expenditure during 1913 under the heads of "Grain Allowance," "Gratuity," "Interest on Investment," and "Indian Science Congress" not provided in the budget which has been sanctioned by the Council.

The Permanent Reserve Fund at the close of the year amounted to Rs. 1,64,100 and the Temporary Reserve Fund at the close of the year was Rs. 83,200 against Rs. 1,63,350 and Rs. 73,900 respectively.

The Permanent Reserve Fund has increased by Rs. 750 from the Admission fees received during the year, and the Temporary Reserve Fund has increased by Rs. 9,250 from the Government paper purchased during the year. The Trust Fund at the close of the year was Rs. 1,400.

The budget estimate of probable Receipts and Expenditure for the year 1914 including the "Subscriptions to the Indian Science Congress" has been fixed as follows:—Receipts Rs. 31,370, Expenditure Rs. 30,234.

On the expenditure side, the changes in the last year's estimate are small. Freight has been slightly increased to meet the bills of 1913. Books have been allotted Rs. 1,480 more than the actuals of 1913 as it is proposed by the Library Committee to purchase a considerable number of new books for the Library. Binding has been increased by Rs. 298, on account of Periodicals, Magazines, etc., not yet bound.

“Journal and Proceedings” and “Memoirs” shows an increase of Rs. 5,838, to meet the payments of bills for printing not yet paid.

There will, however, be an item of expenditure to be dealt with during the year 1914 under the head “Indian Science Congress.”

The expenditure on the Royal Society’s Catalogue has been Rs. 476-3-9, while the receipt under this head from the Government of India is Rs. 1,000, for the maintenance of the Regional Bureau.

The Hon. Justice Sir Asutosh Mukhopādhyāya continued Honorary Treasurer throughout the year.

BUDGET FOR 1914.

Receipts.

	1913. Estimate. Rs.	1913. Actuals. Rs.	1914. Estimate. Rs.
Members’ Subscriptions ..	11,500	11,113	11,500
Subscriptions for the Society’s “Journal and Proceedings” and “Memoirs” ..	1,608	1,680	1,608
Sale of Publications ..	2,000	1,115	2,000
Interest on Investments ..	8,392	8,293	8,392
Rent of Room ..	600	600	600
Government Allowance ..	3,000	3,000	3,000
Do. (for Researches in History, Religion, Ethnology and Folklore of Bengal) ..	3,600	3,600	3,600
Miscellaneous ..	100	165	100
Loan refunded ..	1,210	1,210	..
Admission Fees	733	..
Indian Science Congress Subscriptions	130	570
Total ..	32,010	31,642	31,370

Expenditure.

	1913. Estimate. Rs.	1913. Actuals. Rs.	1914. Estimate. Rs.
Salaries ..	6,750	5,768	5,750
Commission ..	600	612	600
Carried over ..	7,350	6,380	6,350

	1913. Estimate.	1913. Actuals.	1914. Estimate.
	Rs.	Rs.	Rs.
Brought forward ..	7,350	6,380	6,350
Pension	420	420	420
Stationery	150	189	150
Light and Fans ..	260	200	200
Municipal Taxes ..	1,495	1,495	1,495
Postages	700	816	700
Freight	250	214	225
Contingencies ..	700	659	650
Books	2,600	1,120	2,600
Binding	1,000	702	1,000
Journal and Proceedings and Memoirs	12,000	6,162	12,000
Printing (Circulars, etc.) ..	350	270	250
Auditor's fee	150	150	150
Petty Repairs	100	201	100
Insurance	344	344	344
Salary (for Researches in History, Religion, Eth- nology and Folklore of Bengal)	3,600	3,300	3,600
Grain allowance	72	..
Gratuity	100	..
Interest on G.P. Notes	62	..
Indian Science Congress	37	..
Total	31,469	22,893	30,234

Agencies.

Mr. Bernard Quaritch and Mr. Otto Harrassowitz have continued as the Society's Agents in Europe.

The number of the copies of the *Journal and Proceedings* and of the *Memoirs* sent to Mr. Quaritch during the year 1913 was 352, valued at £54-18-4, and of the *Bibliotheca Indica* 1122, valued at Rs. 1,011-2-0.

The number of the copies of the *Journal and Proceedings* and of the *Memoirs* sent to Mr. Harrassowitz during 1913 was 108, valued at £16-13-2, and of the *Bibliotheca Indica* 639, valued at Rs. 609-14-0.

Library.

The total number of volumes and parts of magazines added to the Library during the year was 3202, of which 332 were purchased and 2870 were either presented or received in exchange.

It was ordered to continue subscription to the "Jahresbericht über die Fortschritte der Chemie," "Philosophical Magazine," "Genera Insectorum" and "The Journal of the Washington Academy of Sciences."

In connection with the proposed preparation of a Catalogue of Scientific Periodicals available in Calcutta, some of the various libraries and institutions possessing scientific periodicals have returned the slips with particulars of the periodicals entered, and as soon as the remainder of the slips have been received back, the work of compilation will be taken in hand. At the suggestion of the Board of Scientific Advice, Sir Edward Maclagan, Secretary to the Dept. of Commerce and Agriculture has asked the Department of Education to ascertain whether the Society was prepared to undertake the compilation of a list of Scientific Periodicals available in the various institutes and offices in India, and the matter is before the Council for consideration.

Mr. J. H. Elliott has continued as Assistant Secretary throughout the year.

Babu Surendra Nath Kumar, First Library Assistant, took leave for 6 months to join his new appointment in the Imperial Library from the 5th April, 1913, and Babu Monmotha Nath Sur was appointed from the 1st June, 1913. Babu Monmotha Nath Sur resigned his post from 2nd July and Babu Balai Lal Dutt has been appointed to succeed him from the 1st August, 1913. In September 1913, Babu Surendra Nath Kumar resigned his appointment in the Society.

During the year, the appointment of the Pandit fell vacant owing to the promotion of Babu Balai Lal Dutt and Babu Sures Chandra Banerji has been appointed to fill the vacancy.

Maulavi Asaduz-Zaman Khan has been appointed as the Maulavi of the Society in the place of Munshi Ahmad Husain.

The question of appointing a Lama indefinitely to encourage Tibetan learning is before the Council for consideration. Meanwhile, Lama Lob-Sang has been appointed for 2 months on Rs. 40 per month.

International Catalogue of Scientific Literature.

The Natural History Secretary and Mr. F. H. Gravely acted as joint secretaries of the Regional Bureau.

2415 index slips were forwarded during the year to the Central Bureau and 466 volumes of the catalogue were distributed.

The expenses of the Regional Bureau amounted to Rs. 476-3-9.

Fellows of the Society.

At the Annual Meeting held on the 5th February, 1913, Major A. T. Gage, I.M.S., Mr. E. Vredenburg, B.L., B.Sc.,

A.R.S.M., A.R.C.S., F.G.S., Mr. J. P. Vogel, Ph.D., Litt.D., and Mr. S. W. Kemp, B.A., were elected Fellows of the Society.

There were 28 Fellows on the list at the end of 1913.

Elliott Prize for Scientific Research.

Sixteen essays were received in competition during 1912, and from the reports furnished by the different experts to whom they were sent for examination, the Trustees decided that none of the essays submitted was of sufficient merit to deserve a prize.

The Trustees have again sanctioned the award of four prizes for the year 1913 for original work or investigations by the essayist in Physical, Chemical Mathematical and Natural Sciences. This Notification was printed in the "Calcutta Gazette" of the 16th June, 1913. Twelve essays have been received in competition and have been referred to the Trustees for report.

Barclay Memorial Medal.

On the recommendation of the "Barclay Memorial Medal" Special Committee, the Council awarded the Medal for 1913 to Major William Glen Liston, M.D., C.I.E., I.M.S., Senior Member of the Plague Research Commission, Bombay, in recognition of his biological researches.

Society's Premises and Property.

At the suggestion of Mr. D. Hooper, the Council agreed to the erection in the Society's rooms of a brass memorial tablet with a suitable inscription in commemoration of the late Dr. David Waldie, provided by Messrs. D. Waldie & Co. The tablet was unveiled at the General Meeting on the 5th November, 1913, and it is set up at the top of the main stair case of the rooms of the Society.

The roof of the servants' quarters were in a very bad state of repairs, and Rs. 78 has been spent to stop the leakage.

The building of the new premises for the Society has not yet been taken in hand. There was a meeting of the Building Committee on the 20th June, 1913, when it was decided to apply to Government for permission to sell or lease part of our ground, and to write to the Mining and Geological Institute of India regarding their former offer to contribute a lump sum for accommodation in the Society's building. It is hoped that final steps will be taken shortly.

The Council has also considered the question of endangering the Society's premises from fire by smoking cigars and cigarettes at the Society's Meetings, and notices to the effect

“No Smoking Allowed” have been put up in the rooms of the Society.

The plaster bust of Dwarka Nath Tagore fell down accidentally and has been completely destroyed. The Council has informed the family of the loss and asked them if it would be possible to replace it.

Exchange of Publications.

During 1913, the Council accepted four applications for exchange of publications, viz.: (1) from the Government Oriental Manuscript Library, Madras; the Society's *Journal and Proceedings* and the *Memoirs* to be exchanged for all the publications of their Library; (2) from the Società Italiana di Scienze, Milano; the Society's *Journal and Proceedings* and the *Memoirs* for their “Atti” and “Memorie”; (3) from the Proprietor, “The Chemical News,” London; the Society's *Journal and Proceedings* in exchange for his periodical; and (4) from the Editor of the T'oung pao; the Society's *Journal and Proceedings* in exchange for his periodical.

On an application from Capt. R. B. Seymour Sewell, I.M.S., he was supplied with 20 numbers of the Society's Journals dealing with the R.I.M.S. “Investigator” work for the Surgeon Naturalist's Library as a presentation from the Society.

The Anthropological Institute of Great Britain and Ireland have agreed to send a copy of their “Man” in addition to their Journal, in exchange for the Society's *Journal and Proceedings* and the *Memoirs*.

Publications.

There were published during the year twelve numbers of the *Journal and Proceedings* (Vol. VIII, Nos. 9-11, and Vol. IX, Nos. 1-9) containing 745 pages and 26 plates. The Society has also received Dr. Sten Konow's Bashgali Dictionary printed by the Secretary of State for India for distribution as an Extra No. of the Society's Journal for 1913, and members will be asked whether they desire to receive a copy of it.

Of the *Memoirs*, three numbers were published (Vol. III, Nos. 6-7, and Vol. V, No. 1) containing 106 pages and 5 plates.

Numismatic Supplement Nos. 19 and 20 have been published in the *Journal and Proceedings*, Vol. VIII, Nos. 10 and 11.

Office-bearers.

Mr. S. W. Kemp officiated for Mr. G. H. Tipper as General Secretary and editor of the *Proceedings* until April when Mr. Tipper returned and took charge of his office. Mr. Tipper resigned in June and Capt. C. L. Peart was appointed to suc-

ceed him. There have been no other changes among the officers of the Society. Capt. Peart was Philological Secretary and editor of the Philological Section of the Journal; Dr. W. A. K. Christie was Natural History Secretary and editor of the Natural History Section of the Journal; Mr. J. Coggin Brown was Anthropological Secretary and editor of the Anthropological Section of the Journal; Dr. Satis Chandra Vidya-bhusana carried on the duties of the Joint Philological Secretary and was in charge of the Sanskrit portion of the Bibliotheca Indica, while Mahamahopadhyaya Haraprasad Shastri continued as Officer-in-Charge of the Search for Bardic Chronicles, and of the work of collecting Sanskrit Manuscripts. Capt. Peart was also Officer-in-Charge of the Arabic and Persian Search and Capt. J. D. Sandes continued as Medical Secretary throughout the year. The Coin Cabinet was in charge of Mr. H. Nelson Wright, who has reported on all Treasure Trove coins sent to the Society.

Lectures.

During the year the following four lectures were delivered in the Society's rooms: -1. On Recent Biological Work on R.I.M.S. "Investigator," with lantern illustrations, by Capt. R. B. Seymour Sewell, M.R.C.S., L.R.C.P., I.M.S., on the 22nd January, 1913. 2. On the Distribution of the Tribes of Upper Burma, with lantern illustrations, by Mr. J. Coggin Brown, M.Sc., F.G.S., on the 19th February, 1913. 3. On the Psychology of Indian Music, by Mr. Alfred Westharp, Mus. Doc. (Münich), accompanied with selections of Indian music by Mrs. Satyabala Devi, on the 14th March, 1913. 4. On the Evolution of Flying Animals, with lantern illustrations, by Dr. E. H. Hankin, M.A., on the 19th November, 1913.

Philology, etc.

Prof. H. Oldenberg, an Honorary Fellow of this Society, read on the 30th January, 1913, "a note on Buddhism" which gives in a short compass an interesting review of the Buddhistic researches made in Europe and eventually in Asia during the last thirty years. After paying a tribute to our Society, the erudite Professor discusses the relative priority of the Northern and Southern Schools of Buddhism and arrives at the conclusion that the Southern type as embodied in the Pali literature is the older one, and that the philosophical thought common to both has been evolved out of the Upanisad portion of the Vedic literature. Mr. K. P. Jayaswal, in his article on "the date of Asoka's coronation," places, on the evidence of the 13th Rock Edict, the aforesaid coronation in the year 272 B.C. and Chandra Gupta's accession to the throne of Magadha in 324-25 B.C. In an article entitled "The plays of Bhāsa and king Darśaka of

Magadha," the same writer maintains, on the authority of poet Bhāsa, that king Darśaka, mentioned in the Purānas as successor of Ajatasatru, was an historical personage appearing in the Pali chronicle under the name of Nāga-Dāsaka.

Mr. G. R. Kaye, in an article on "the Bakhshali Manuscript," examining the manuscript in question from the standpoints of a mathematician and a philologist, concludes that it is not older than 11th century A.D., although Dr. Hoernle, who edited the manuscript for the first time in 1888, assigned the date of its composition to the 3rd or 4th century A.D. Babu Rakhal Das Banerji in his article called "Lakṣmaṇa Sena," agrees on epigraphical grounds with Dr. Kielhorn in maintaining that Lakṣmaṇa Sena ascended the throne of Bengal in 1119-20 A.D., and ceased to reign in 1170-71 A.D. Babu Manomohan Chakravarti, in an article on "Bhaṭṭa Bhavadeva," maintains that Bhavadeva, author of several well known works on Hindu social laws, was a Rādhiya Brāhmaṇa, who flourished in West Bengal in the 11th century A.D.

Mahamahopadhyaya Haraprasad Sastri, C.I.E., in his article on "the Visen family of Majhawali," discusses several theories on the origin of the Visen Kṣatriyas, and identifies the founder of their family with Viśvasena, a Kṣatriya Rājā of Benares. Pandit Ananda Koul, in an article on "the history of Kāsmīra," gives, on the authority of Hasan, a Persian historian, an account of eight kings who are said to have reigned in Kāsmīra from 191 A.D. to 521 A.D., but whose names do not occur in the Rājatarāṅgiṇī.

"Srid-pa-ho—a Tibeto-Chinese tortoise chart of divination" is the title of a memoir in which Mahamahopadhyaya Dr. Satis Chandra Vidyabhusana, after pointing out the veneration in which the chart is held by Tibetans, who hang it on their walls and door-frames to keep off evil spirits, traces its history from its introduction into Tibet from China in 639 A.D. to its development into the present form by Dalai Lama the fifth in the 18th century A.D. In a paper headed "Tibetan MS. vocabularies by Capuchins" Rev. Father Felix gives an account of a Tibeto-Italian Dictionary supposed to have been written by Father Francesco Orazio Della Penna about 1738 A.D., and presented to the Bishop's College, Calcutta, in 1824 A.D. The same Father, in his paper "on the Persian Farmans granted to Jesuits by the Moghul Emperors, and Tibetan and Newari Farmans granted to the Capuchin Missionaries in Tibet and Nepal," describes briefly some Tibetan and Newari documents unearthed from the missionary archives at Agra, two of which bearing the seals of the Dalai Lama and his regent, and dated respectively 1741 and 1751 A.D., are supposed to have been used as passports by Capuchin Missionaries for the purpose of preaching Christianity in Tibet. Similar documents, engraved on copper-plates and conferring further privileges on the afore-

said missionaries, were received from Jayaranajit Malladeva and Jayaprakāśa Malladeva of Nepal in 1737 and 1740 A.D. respectively. All such documents, unless they are "impudent forgeries" are bound to prove of great value to antiquarian scholars.

In an article entitled "the Pitt-diamond and the eyes of Jagannath," Father H. Hosten recounts the story which charges a Dutchman with the theft of the Pitt-diamond from the statue of Jagannātha at Puri.

"The Rev. L. Bernard among the Abors and the cross as a tattoo-mark" is the title of a paper in which Father Hosten discusses the origin of the Abor tattoo-marks which were considered by Father Krick as possible relics of ancient Christian missions, but in which Father Bernard refuses to see any Christian origin or signification.

Maulavi Hedayat Husain gives us some account of the life and works of Muhibb Allah of Bihar, the author of *Musallam al-Subut*. The same Maulavi has also edited and translated the unique MS., the *Mirza Namah* (the book of the Perfect Gentleman), the supposed work of Mirza Kamran, the learned son of Babar Shah. The writer of the paper discusses at some length the doubtful question of its authorship and fixes A.H. 11th century as its date. The etymology and history of the word "Mirza" is also dealt with.

Mr. W. Kirkpatrick contributes a paper in which he attempts to prove that the European Gypsies originally migrated from India by showing the similarity of Romnichal or the language of European Gypsies and colloquial Hindustani. The writer points out that the fact of the migration of Gypsy-like people from India into Persia (where they are called Luris) has been confirmed by Fardausi and the Arabian historian Hamrya.

Mr. R. B. Whitehead, in his paper on the Mint Towns of the Mughal Emperors of India, has followed the same lines as Mr. Burns in the preparation of a new edition of his tables, but with certain differences which he enumerates in detail.

Natural History, etc.

Twenty-nine scientific papers were issued in the *Journal* and two in the *Proceedings* in the year under review—sixteen zoological, ten chemical, two botanical, two geological, and one geographical.

ZOOLOGY.

The Crustacea Decapoda of the Lake of Tiberias. By N. Annandale, D.Sc., F.A.S.B., and Stanley Kemp, B.A., F.A.S.B.

Entomostraca from the Lake of Tiberias. By Robert Gurney.

- Notes on the Fishes, Batrachia and Reptiles of the Lake of Tiberias. By N. Annandale, D.Sc., F.A.S.B.
- Indian Dermaptera collected by Dr. A. D. Imms. By Malcolm Burr, D.Sc., F.E.S.
- Aquatic Oligochaeta from the Lake of Tiberias. By Major J. Stephenson, D.Sc., I.M.S.
- Tipulidae and Culicidae from the Lake of Tiberias and Damascus. By F. W. Edwards, B.A., F.E.S.
- Some Noxious Diptera from Galilee. By E. Brunetti.
- Preliminary Account of a revised Classification of Indo-Australian Passalidae. By F. H. Gravely, M.Sc.
- Note on Rotifers from Galilee. By C. F. Rousselet, F.R.M.S.
- The Polyzoa of the Lake of Tiberias. By N. Annandale, D.Sc., F.A.S.B.
- Note on a Sponge-Larva from the Lake of Tiberias. By N. Annandale, D.Sc., F.A.S.B.
- Note on the Dragonflies of Syria and the Jordan Valley. By F. F. Laidlaw, F.Z.S., F.E.S., F.L.S.
- A New Springtail from Galilee. By George H. Carpenter, B.Sc., M.R.I.A.
- The Leeches of the Lake of Tiberias. By N. Annandale, D.Sc., F.A.S.B.
- An Account of the Sponges of the Lake of Tiberias, with Observations on certain Genera of Spongillidae. By N. Annandale, D.Sc., F.A.S.B.
- On the internal Anatomy of the Blind Prawn of Galilee. (*Typhlocaris galilea*, Calman). By Ekendra Nath Ghosh.

CHEMISTRY.

- A Compound of Sodium Cuprous Thiosulphate and Acetylene Cuprous Acetylide. (Preliminary note). By Kshitibhushan Bhaduri, M.Sc.
- Note on the Interaction of Hydrazines with Ferri-cyanides. By Priyadarajan Ray and Hemendra Kumar Sen.
- On isomeric Allylamines (Second Communication). By Prafulla Chandra Ray and Rasik Lal Datta.
- On a new Series of the double Sulphates of Barium with the Sulphates of the substituted Ammonium Bases. Part I. By Rasik Lal Datta and Haridas Sen.
- The Composition of the Water of the Lake of Tiberias. By W. A. K. Christie, B.Sc., Ph.D.
- Action of Stannic Chloride on Phenylhydrazine. By Jitendra Nath Rakshit.
- The double Mercuri-periodides of substituted Ammonium Bases. Tetrapropylammonium Mercuri-periodide. By Rasik Lal Datta and Haridas Mukherjea.

The Action of Nitrosyl Chloride on secondary Amines.
Methylbenzyl nitrosamine and Ethylbenzyl nitrosamine
By Rasik Lal Datta.

BOTANY.

On Variations in the Flowers of *Limnanthemum indicum*,
Thwaites. By H. M. Chibber.

The Ash of the Plantain (*Musa sapientum*, Linn.). David
Hooper.

GEOLOGY.

On a crystallized Slag from Kulti. By Hem Chandra Das-
Gupta.

Preliminary Note on the Origin of Meteorites. By L. L.
Fermor, D.Sc., A.R.S.M., F.G.S.

GEOGRAPHY.

Two Letters of Major James Rennell. By the Rev. W. K.
Firminger, B.D., F.R.G.S.

Notes were also read on "A double Compound of Mercuric
Oxide with Acetone" by Jitendra Nath Rakshit, and "A new
Compound of Ethylacetoacetate with Mercuric Oxide" by
Saratchandra Jana. These have been published in the Pro-
ceedings.

Exhibits were made by Mr. S. W. Kemp, of a small collec-
tion of birds recently made in the Mishmi Hills by Captain
R. S. Kennedy, and by Mr. D. Hooper, of a specimen of the
gum of *Livistona chinensis* from Singapore.

The most important work of the year has been the issue of
two special series of papers dealing with the zoological collec-
tions made by Dr. N. Annandale in the Lake of Tiberias and
its neighbourhood. The series, to which many distinguished
naturalists have contributed, will be concluded in 1914, and
Dr. Annandale proposes, in one of the later issues, to discuss
the wider biological problems which the results have helped to
solve.

Anthropology and Allied Sciences.

There was a slight increase in the number of papers deal-
ing directly with anthropological subjects, communicated to
and published by the Society during the year, and it is hoped
that this is the beginning of a revival in attention paid to such
studies. The neglect from which anthropological investigations
have suffered in India for some time is commented on in
the preceding Annual Reports.

Mr. W. Kirkpatrick has continued his valuable researches
into the folklore and customs of the Gehara Kanjars and has
published a paper dealing with the marriage ceremony and
marriage customs of this Gypsy tribe. The same author has

also contributed a paper on the resemblances which exist between colloquial Hindustani and the language of the European Gypsies. Mr. J. Coggin Brown has given an account of the A-ch'ang or Maingtha tribe of the Hohsa-Lahsa States in Yünnan, and has attempted to prove that the grouping of these people with the Tai is incorrect, and that they are really an almost submerged Tibeto-Burman clan.

The important branch of prehistoric archaeology has received some attention. Babu H. C. Das Gupta has described two spade celts from Assam, and has added evidence which helps towards the association of these and similar forms with the ancestors of the Mon-Hkmer peoples. Mr. J. Coggin Brown exhibited a number of polished stone implements from Yünnan before a meeting of the Society.

An exhaustive memoir by Mr. James Hornell on the antiquity and present condition of the Chank Bangle Industry in India, published during the year, forms a timely contribution to our knowledge of an important though comparatively little known art.

Mr. F. H. Malyon's memoir on some current Pushtu folk stories, also published during the year, though primarily intended to illustrate the forms of certain dialects, is not without anthropological interest, and is an instance of the manner in which members of the Society, thoroughly acquainted with the languages of the races amongst whom they live, may advance our knowledge of Indian folklore.

Owing to the absence of its author on the eastern frontier for the greater part of the year, the memoir on the Abor and Galong tribes by Sir George D. S. Dunbar, Bart., and the anthropometrical supplement by Messrs. S. W. Kemp and J. Coggin Brown, which it was intended to publish during the year, has been delayed. It is now in page proof and will be issued shortly. The delay has not been without its advantages, as it has enabled the author to add valuable appendices giving the results of his recent work. This exhaustive memoir will certainly rank as the most important anthropological work which has been published in Northern India for some years. The Society has also published a translation by the Rev. Gille, S.J., of Fr. Krick's account of his work among the Abors in 1853,—a few months before the murder of the intrepid traveller by Mishmis. Rev. H. Hosten, S.J., has given an account of the visit made by another Jesuit missionary to the outlying Abor clans, and has discussed Krick's contention that their tatoo marks, in the form of crosses, are relics of ancient Christian influence. Before the April meeting of the Society Messrs. S. W. Kemp and J. Coggin Brown exhibited a large collection of objects illustrating the ethnology of the Abors and their neighbours.

A paper communicated by Dr. Annandale, J. Coggin

Brown and F. H. Gravely deals partly with the archaeology and folklore of the limestone caves of Burma and the Malay Peninsula.

Many of the philological and historical papers communicated to or published by the Society during the year have a direct bearing on anthropological matters. Amongst others the following are especially noteworthy: Mahamahopadhyaya Haraprasad Sastri's account of the ancient civilization of Bengal; Dr. Satis Chandra Vidyabhusana's memoir on Srid-pa-ho, a Chinese tortoise chart of divination; and Dr. Jivanji Jamshedji Modi's paper on India in the Avesta of the Parsees.

A set of anthropometrical instruments belonging to the Society has been lent to Capt. Kennedy, I.M.S., Medical Officer to the expedition at present working through the Daffa country, and it is anticipated that valuable results will be obtained by their use.

The co-operation of members of the Society interested in the study of man is earnestly invited, otherwise it is impossible for this branch of the Society's work to advance in line with the development of the science in other countries. In many parts of the Indian Empire there are races and remnants of races suffering rapid absorption by more virile communities, and the opportunity for their study cannot last much longer. Unless anthropological researches on these tribes are undertaken at once, the valuable information they can afford, and the light which they may be able to throw on many unsettled problems, will be irretrievably lost.

Medical Section.

Meetings of the Medical Section of the Society have been held regularly throughout the year and have been fairly well attended. Six new members were elected during the year. Many interesting papers were read and much original work brought before the Society. Lieut.-Col. Sutherland read two valuable papers on Anaphylaxis and on the Serodiagnosis of Syphilis. Lieut.-Col. Rogers, C.I.E., opened a most important and interesting discussion on the Emetine and other treatments of Amoebic Dysentery and Hepatitis (including Liver abscess). The discussion was prolonged for several meetings and much valuable experience and information put on record. Other papers were read at various meetings by Dr. Hari Nath Ghosh, Rai Bahadur, Dr. U. N. Brahmachari and Babu S. N. Mitter.

Bibliotheca Indica.

Of the 17 fasciculi of texts of different dimensions published in the *Bibliotheca Indica* series during the year under review, 8 belong to Brahmanic Sanskrit, 1 to Buddhist Sans-

krit, 1 to Sanskrit and Tibetan, 1 to Jaina Prakrita and the remaining 6 to Arabic and Persian literature. These fasciculi include Lieut.-Col. T. Wolseley Haig's translation of Muntakhab-ut-Tawarikh, Vol. III, Fasc. II; Mr. H. Beveridge's translation of Akbarnāma, Vol. III, Fasc. IV, V, and Maasir-ul-Umara, Vol. I, Fasc. III, IV; Mahāmahopādhyāya Dr. Gaṅganātha Jhā's translation of Tantravārtika, Fasc. XII; and the second edition of Maitrī-Upāniṣad, Fasc. I, revised by Mahāmahopādhyāya Dr. Satis Chandra Vidyābhūṣaṇa.

Of the new works sanctioned last year three fasciculi have been published this year, viz. :—

1. *Kavīndra-Vacana-Samuccayaḥ*—a Sanskrit anthology edited by Dr. F. W. Thomas. It is a valuable collection of *ślokas*, from Buddhistic as well as Brahmanic sources, culled by an unknown author who seems to have lived not earlier than 1000 A.D.

2. *Kavi-kalpa-latā*—a work on Sanskrit Rhetoric edited by Pandit Sarat Chandra Sastri. It contains the text and commentary of Deveśvara, son of Vāgbhaṭa, a minister of the King of Maiwa about the 12th century A.D.

3. *Viśva-hitam*—a work on Sanskrit astronomy composed by Rāghavānanda Śarmā of West Bengal in the year 1591 A.D. It has been edited by Pandit Biśvambhara Jyotiṣ-ārṇava and Srīsa Chandra Jyotiratna.

Search for Sanskrit Manuscripts.

The acquisition of Sanskrit manuscripts has been by a tacit consent of the Council limited to works of extraordinary interest pending the completion of the catalogue of the large collection of Sanskrit manuscripts in the Society's Library. The most important manuscripts acquired are :—

Paśupati-paddhati.—Composed in the 12th century. Not known to Aufrecht.

Buddhāvadāna.—A unique copy of a work absolutely unknown to the world.

Aśokāvadāna.—A good copy, though others are known to exist. Vasundhara unknown, though other works of the same name are known. A trial was made by employing a book hawker to collect Sanskrit manuscripts in the district of Bankura, but the trial hasn't proved successful. He would be an excellent man for those who are making a new collection. The only important manuscript that has been obtained from him is a copy of Bhaṭṭi on palm leaf made in the 17th century.

Coins.

Three gold, fourteen silver and one copper coins were presented to the Society during the year. Of these, two (gold)

were S. Indian, one (copper) Pathān, seven (silver) Mughal ; The remainder consisted of five *larins*, one rupee of Tipu Sultān, one rupee of the French East India Company and one Venetian ducat.

None of the coins was of any exceptional interest.

The Numismatic Secretary examined and reported on 431 coins, the result of proceedings under the Treasure Trove Act.

Search for Arabic and Persian Manuscripts.

During the year, the policy adopted last year of applying this Fund to ascertaining the existence and whereabouts of rare and interesting MSS. in lieu of purchasing has been maintained. With this object in view the First Travelling Maulavi visited four libraries at Lucknow and one at Benares, and also examined the stocks of several MSS. dealers at Cawnpur and Lucknow.

Notes on these MSS. consisting of short bibliographical accounts have been prepared and will be sent to the press shortly. In this connection and in that of advising regarding the search for MSS. generally, Maulavi M. Hedayat Husain, who was for several years himself First Travelling Maulavi, has offered to assist the Society, and he has been appointed as Honorary Assistant to the Officer-in-Charge of the Arabic and Persian MS. Search.

Khan Bahadur Shams-ul-ulama Maulavi Ahmed Abdul Aziz of Hyderabad presented sixty-nine volumes of Persian and Arabic books to the Government collection.

Bardic Chronicles.

No tour was undertaken during the course of the year as the funds placed at the disposal of the Society by the Government of India were exhausted. The officer-in-charge was engaged in drawing up the report of the operation for the past four years, passing it through the press, and having it adopted by the Society. The scheme for future work as foreshadowed in the report is under consideration of the Council of the Society along with other philological expenditure. It will be submitted to the Government of India very soon. In the meantime Government proposes to appoint Signor L. P. Tessitori, a young Italian scholar, who has made Guzerati and the dialects of Western Rajputana his special study, on a salary of Rs. 500 a month experimentally for a year to edit the works on chronicles collected by the search.

The report which has been submitted gives a history of the operations since 1904 when the Government of India asked for a preliminary report on the subject and formulates a scheme for future operations. It contains the following appendices

throwing light on some of the most intricate and difficult problems connected with Bardic Literature :—

Appendix I.—Who are the Bards ?

Appendix II.—What is the language of Bardic poetry ?

Appendix III.—In how many different ways were the Bards remunerated ?

Appendix IV.—A catalogue of 36 Kṣatriya royal races as opposed to 36 Rajput royal races as given in Todd.

Appendix V.—Whether and to what extent is Chand's *Prithwirajrasa* genuine with Chand's genealogy ?

Appendix VI.—A history of Sekhowati.

Appendix VII.—The discovery of a lamp worship as a survival of the fire worship of the Persians at Belada in Marwar.

Appendix VIII.—Rev. Dr. Macalister's perpetual loans of Hindi and Bardic manuscripts to the Society.

Appendix IX.—Manuscripts donated, acquired and copied in Rajputana.

Appendix X.—Gifts of Bardic Manuscripts by the Jodhpur Durbar to the Society.

Appendix XI.—Bardic Manuscripts in different Durbar Libraries in Rajputana.

Appendix XII.—Collection of Bardic songs of the Gaekwar family found in the Education Department at Baroda.

Catalogue of Sanskrit Manuscripts.

Connected with the search of Sanskrit Manuscripts is the work of cataloguing the manuscripts in the Society's Library. In the last report the number of manuscripts described was 4700. At the present moment the number stands at 5900. This means 1200 for the year. One manuscript, the *Desavali-bibriti*, a Gazetteer in Sanskrit of Eastern India written during the early years of the 17th century at Patna under the patronage of a local Zemindar, took nearly a month. There are other manuscripts also which took a long time to describe. These belong to that very obscure period of Buddhist literary history which intervened between the fall of the Mahāyāna School of Buddhism and the Muhammadan conquest. The manuscripts are generally very old, copied in the 11th and 12th centuries, written in ungrammatical and often unintelligible Sanskrit, giving descriptions of rituals, obsolete, obscure, mystical and therefore hard to understand.

Bureau of Information.

The Bureau of Information was not very active this year, still an important reference was made by the Chairman of the Calcutta Improvement Trust on the subject of the removal of

temples, images and emblems. Two notes were submitted to the Chairman, one explaining the principles of such a removal and the other giving the details. A large number of manuscripts of Hindu Law and Rituals had to be consulted with a view to explain the law and customs on the subject.

The Private Secretary to His Excellency the Governor sent what was represented to him to be a work 5000 years old. It proved to be a very modern print of the Buddhist Golden Book of Burma which is already well known. Another reference came from the same quarter for an expression of opinion on an English poem on "Mārkaṇḍeya."

Dr. Annandale asked for a note on the "Tortoise incarnation of Visnu," and the notes submitted by the Bureau so pleased him that he made his paper on the "Land tortoises and mud turtles" a joint paper in the Science Congress in which the officer in charge of the Bureau has been associated with him as a collaborator.

The catalogue of manuscripts in the Bishop's College was delayed for the want of a Lama and a Burmese scholar to help the officer in charge of the Bureau of Information. The Lama of the Society came to Calcutta in August and a competent Burmese student was found in the same month. A catalogue has been completed and is in the Press.

An enquiry was made by the Government of Bengal as to the usefulness of the Bureau, and a request has been made to re-affirm the Notification of November 1908 which seems to have slipped out of the memory of the Civil Officers. The re-affirmation of the Notification is likely to enhance the usefulness of the Bureau.



His Excellency Lord Carmichael, President, delivered an address to the Society.

Annual Address, 1914.

LADIES AND GENTLEMEN,

I find that the addresses of the Presidents of the Asiatic Society have been of three kinds. In former years when men perhaps had more time to give to such things, the President's address used to be a history of the progress of science and literature throughout the world, or of such branches of these as particularly interested the members of the Society. Such were the addresses of Sir Alfred Croft, Director of Public Instruction in Bengal, and of that wonderfully versatile scholar, Sir Charles Elliott, who was Lieutenant-Governor of this province. An address of this kind has not been delivered

since 1897. The second type of address dealt with some branch of knowledge, in which the President himself was an expert. Our late President, the Hon'ble Colonel Harris, addressed us last year on the progress of medical science, and men like Dr. Hoernle and Sir Herbert Risley contributed addresses which will always remain in the Society's archives as monuments of learning. The third type of address is a review of the work of the Society during the year. I wish it were possible for me to address you on that branch of science in which I am myself most interested, but my public duties have rendered it impossible for me to give the time necessary to the preparation of anything of the kind. I must, therefore, in this my first presidential address, fall back upon the third type, and merely review shortly the work of the Society during the past year.

Before I begin, however, I should like to thank the members for the honour they have done me in electing me to the proud position of the President of the premier Scientific Society in India—a Society, the work of whose members has been known and appreciated since the days of Sir William Jones, not only in India, but throughout the world. The number of members during 1913 is not so large as it was previously: we have now 499 members, compared with 517 last year. I trust that during the next year there will be a considerable accession to the membership, especially amongst the younger generation in the mofussil. In my tours throughout the province during the past two years, I have been interested to find how many of the younger generation, both officials and non-officials, are genuinely interested, especially in archæological matters. The membership of the Society, I believe, would do much to encourage and to guide these younger members in their researches. I was specially interested to find a genuine keenness for research work in the centres at Dacca, at Rajshahi and at Rangpur. In Dacca and in Rajshahi archæological museums have already been started, and when I visited Rangpur I was invited to view an excellent exhibition by the local Sahitya Parisad. These facts, I think, show an increasing interest in such matters—an interest, which if cultivated and properly directed, would help much in increasing our knowledge, especially of the ancient history of Northern and Eastern Bengal.

During the year our finances were managed by Sir Asutosh Mukharji, and I am told that the financial position of the Society is sound; but the useful work of the Society could be much extended if more funds were available. The annual allotment for the library, for example, is necessarily small, though a Society of this kind ought to be able to keep its magnificent library up to date. The Society also could assist scholars to a very much larger extent by publishing important oriental manuscripts, were larger funds for this purpose at its disposal.

Lately, I regret to say, we have had to postpone the publication of further works for a period of at least one year, through want of the necessary money. This is a point which I greatly regret. It is very disappointing, especially to those who have spent their days in laborious research entirely without remuneration and out of a pure love for learning—to find that the results of their labours cannot, for want of funds, be placed at the disposal of scholars in other parts of the world.

The building of the new premises for the Society has not yet been taken in hand. We will all be sorry to leave these historic rooms which are associated with the work of so many great scholars, but I am told this building is beyond the possibility of adequate repair and at the same time I realize that we must provide a house befitting the dignity of the Society, with an up-to-date library in which to keep the valuable collection of books and manuscripts which we now possess. I hope that it may be possible to make a beginning before next year. It was decided by the Building Committee in June last year to apply to the Government for permission to sell or lease a part of our garden, and it was decided also to write to the Mining and Geological Institute in India regarding their former offer to contribute a lump sum for accommodation in the Society's buildings. As soon as these points have been settled, the Building Committee will get to work.

I now turn to the literary and scientific work done by the Society and its members during the year. Professor Oldenburg whom we had the honour to welcome in our city last year, an Honorary Fellow of this Society, read "A note on Buddhism" in January 1913, which gave in a short compass an interesting review of the Buddhistic researches made in Europe and eventually in Asia during the last thirty years. After paying a tribute to our Society the erudite Professor discussed the relative priority of the Northern and Southern schools of Buddhism and arrived at the conclusion that the Southern type, as embodied in the *Pali* literature, is the older one, and that the Philosophical thought common to both has been evolved out of the *Upanishad* portion of the *Vedic* literature. Mr. K. P. Jayaswal, in his article on "The date of Asoka's Coronation" places on the evidence of the thirteenth rock edict, the coronation in the year 272 B.C. and *Chandra Gupta's* accession to the throne of *Magadha* in 324-25 B.C. In an article entitled "The plays of *Bhasa* and King *Darsaka* of *Magadha*" the same writer maintains on the authority of the poet *Bhasa* that King *Darsaka*, mentioned in the *Puranas* as successor to *Ajatasatru*, was an historical personage appearing in the *Pali* chronicle under the name of *Naga-Dasaka*.

Mr. C. R. Kaye, in an article on the "*Bakshali Manuscripts*" examining the manuscript in question from the standpoint of a mathematician and philologist, concludes that it is

not older than the eleventh century A.D., although Dr. *Hoernle*, who edited the manuscript for the first time in 1888, assigned the date of its composition to the 3rd or 4th century A.D. Babu *Rakhal Das Banarji*, in his article called "*Lakshmana Sena*," agrees on epigraphical grounds with Dr. *Kielhorn* in maintaining that *Lakshmana Sena* ascended the throne of Bengal in 1119-20 A.D. and ceased to reign in 1170-71 A.D. Babu *Manmohan Chakravarti* in an article on "*Bhatta Bhavadeva*" maintains that *Bhavadeva*, author of several well-known works on Hindu social laws, was a *Radhaya Brahmana* who flourished in West Bengal in the 11th century A.D.

Mahamahopadhyaya Hara Prasad Shastri, C.I.E., in his article on "The *Visen* Family of *Majhawali*" discusses several theories on the origin of the *Visen* Kshatriyas and identifies the founder of their family *Visvasena*, a *Kshatriya Raja* of Benares. Pandit *Anando Koul* in an article on "The History of *Kasmira*" gives, on the authority of *Hasan*, a Persian Historian, an account of eight kings who are said to have reigned in *Kasmira* from 191 A.D. to 521 A.D., but whose names do not appear in the *Rajtarangini*.

"*Sri-pa-ho*—a Tibeto-Chinese tortoise chart of divination" is the title of a memoir in which *Mahamahopadhyaya Dr. Satish Chandra Vidyabhusan*, after pointing out the veneration in which the chart is held by the Tibetans, who hang it on their walls and doorframes to keep off evil spirits, traces its history from its introduction into Tibet from China in 639 A.D. to its development in its present form by the Fifth Dalai Lama in the 18th century A.D. In a paper headed "Tibetan M.S. vocabularies by Capuchins," Rev. Father Felix gives an account of a Tibeto-Italian Dictionary supposed to have been written by Father Francesco Orazio Della Penna about 1738 A.D. and presented to the Bishop's College, Calcutta, in 1824 A.D. The same Father in his paper "On the Persian Farmans granted to Jesuits by the Moghul Emperors, and Tibetan and *Newari* Farmans granted to the Capuchin Missionaries in Tibet and Nepal," describes briefly some Tibetan and *Newari* documents unearthed from the missionary archives at Agra, two of which bearing the seals of the Dalai Lama and his Regent, and dated respectively 1741 and 1751 A.D., are supposed to have been used as passports by Capuchin Missionaries for the purpose of preaching Christianity in Tibet. Similar documents engraved on copper-plates and conferring further privileges on the aforesaid missionaries were received from *Jayaranjit Malladeva* and *Jayaprokisa Malladeva*, of Nepal, in 1737 and 1740 A.D. respectively. All such documents are bound to prove of great value to antiquarian scholars.

In an article entitled "The Pitt-Diamond and the eyes of Jagannath," Father *Hosten* recounts the story which charges

a Dutchman with the theft of the Pitt-Diamond from the statue of Jagannath at Puri.

The "Rev. L. Bernard among the Abors and the cross as a tattoo-mark" is the title of a paper in which Father Hosten discusses the origin of the Abor Tattoo-marks which were considered by Father Krick as possible relics of ancient Christian Missions, but in which Father Bernard refuses to see any Christian origin or signification.

Maulvi Hedyat Husain gave us some account of the life and works of Muhib Allah of Bihar, the author of *Musallam-al-Subut*. The same Maulvi has also edited and translated the unique manuscript "the Mirza Namah" (the book of the perfect gentleman), the supposed work of Mirza Kamran, the learned son of Babar Shah. The writer of the paper discusses at some length the doubtful question of its authorship and fixes the Hijri Era 11th century as its date. The etymology and history of the work "Mirza" is also dealt with.

Mr. W. Kirkpatrick contributed a paper in which he attempts to prove that the European Gypsies originally migrated from India by showing the similarity of *Romnichal* or (the language of European Gypsies) and colloquial Hindustani. The writer points out that the fact of the migration of Gypsy-like people from India into Persia (where they are called *Luris*) has been confirmed by *Firdausi* and the Arabian Historian *Hamrya*.

Mr. R. B. Whitehead, in his paper on the Mint Towns of the Mughal Emperors of India, has followed the same lines as Mr. Burns in the preparation of a new edition of his tables but with certain differences which he enumerates in detail.

I now turn to the Natural and Physical Sciences. Twenty-nine scientific papers were issued in the Journal and two in the Proceedings in the year under review—16 Zoological, 10 Chemical, 2 Botanical, 2 Geological and 1 Geographical. Mr. Kemp exhibited a most interesting collection of birds made in the Mishmi Hills by Captain Kennedy, but the most important work of the year has been the issue of two special series of papers dealing with the zoological collections made by Dr. Annandale in the Lake of Tiberias and its neighbourhood.

There was a slight increase in the number of papers dealing directly with anthropological subjects, communicated to and published by the Society during the year, and it is hoped that this is the beginning of a revival in attention paid to such studies. The neglect from which anthropological investigations have suffered in India for some time is commented on in the preceding Annual Reports.

I have been making enquiries particularly with regard to the grant for Ethnographic research which is made by Government to the Society. The grant of Rs. 3,600 a year was

made in view of the importance to the officers of Government of a knowledge of the customs of the people of the country and their traditions and conditions of life. The original idea appears to have been that the Society would become a centre of reference and a Bureau of information for all Government officers in Bengal who desired to pursue researches in these matters. I regret to find that the Civil officers of Government are not taking advantage of the Bureau to the extent that was anticipated, but I believe that the reason is that the existence of the Bureau and the assistance it is capable of giving are not sufficiently well known. I find that many of the officers with whom I come in contact never heard of it. One officer to whom the Bureau was invaluable, was Mr. O'Malley, whose excellent Census Report appeared during the past year. The subjects with which the Bureau deals are such as should be of profound interest to officers of Government in all departments; and the direct management of the Bureau is in the hands of Mahamahopadhyaya Hara Prasad Shastri who is exceptionally well qualified to answer enquiries upon these subjects and to offer suggestions as to sources of information, courses of study, or method of treatment. I trust that henceforward far greater use may be made of the services of the learned Shastri by officers of Government in this Presidency than has been made in the past. I am taking steps to make the existence of the Bureau and its objects well known, and I hope in the near future to see a considerable development in this branch of the Society's work.

Mr. W. Kirkpatrick has continued his valuable researches into the folklore and customs of the *Gehara Kanjars* and has published a paper dealing with the marriage ceremony and marriage customs of this Gypsy tribe. The same author has also contributed a paper to which I have already referred on the resemblances which exist between colloquial Hindustani and the language of the European Gypsies. Mr. J. Coggin Brown has given an account of the *A-Ch'ang* or *Maingha* tribe of the *Hohsa-Lahsa* States in Yunnan, and has attempted to prove that the grouping of these people with the Tai is incorrect, and that they are really an almost submerged Tibeto-Burman Clan.

The important branch of prehistoric Archæology has received some attention. Babu H. C. Das Gupta has described two spade celts from Assam, and has added evidence which helps towards the association of these and similar forms with the ancestors of the Mon-Hkmer peoples. Mr. J. Coggin Brown exhibited a number of polished stone implements from Yunnan before a meeting of the Society.

An exhaustive memoir by Mr. James Hornell on the antiquity and the present condition of the *Chank Bangle* industry in India, published during the year, forms a timely contribu-

tion to our knowledge of an important though comparatively little known art.

Mr. F. H. Malyon's memoir on some current Pushtu folk stories, also published during the year, though primarily intended to illustrate the forms of certain dialects, is not without anthropological interest, and is an instance of the manner in which members of the Society, thoroughly acquainted with the languages of the races amongst whom they live, may advance our knowledge of Indian Folklore.

Owing to the absence of its author on the Eastern Frontier for the greater part of the year, the memoir on the *Abor* and *Galong* tribes by Sir George Dunbar and the anthropometrical supplement by Messrs. Kemp and Coggin Brown which it was intended to publish during the year, has been delayed. It is now in page proof and will be issued shortly. The delay has not been without its advantages, as it has enabled the author to add valuable appendices giving the results of his recent work. This exhaustive memoir will certainly rank as the most important anthropological work which has been published in Northern India for some years. The Society has also published a translation by the Rev. Gille of Father Krick's account of his work among the Abors in 1853—a few months before the murder of the intrepid traveller by Mishmis. Before the April meeting of the Society, Messrs. S. W. Kemp and J. Coggin Brown exhibited a large collection of objects illustrating the ethnology of the Abors and their neighbours.

A paper communicated by Dr. Annandale, J. Coggin Brown and F. H. Gravely deals partly with the Archæology and Folklore of the limestone caves of Burma and the Malay Peninsula.

Many of the philological and historical papers communicated to or published by the Society during the year have a direct bearing on anthropological matters. Amongst others the following are especially noteworthy: *Mahamahopadhyaya Hara Prasad Shastri's* account of the ancient civilization of Bengal, *Dr. Satis Chandra Vidyabhusan's* memoir on *Sri-pa-ho*—a Chinese tortoise chart of divination—and *Dr. Jivanji Jamsedji Modi's* paper on India in the Avesta of the Parsees.

A set of anthropometrical instruments belonging to the Society has been lent to Captain Kennedy, I.M.S., Medical Officer to the Abor Expedition, at present working through the Dafia country, and it is anticipated that valuable results will be obtained by their use.

The co-operation of members of the Society interested in the study of man is earnestly invited, otherwise it is impossible for this branch of the Society's work to advance in line with the development of the science in other countries. In many parts of the Indian Empire there are races and remnants of races suffering rapid absorption by more virile communities, and the

opportunity for their study cannot last much longer. Unless Anthropological researches on these tribes are undertaken at once, the valuable information they can afford, and the light which they may be able to throw on many unsettled problems, will be irretrievably lost.

During many years past the Society has keenly felt the urgent need for the close association of European Sanskritists in the important work of editing the texts published in the *Bibliotheca Indica*. It is no disparagement to Indian scholars, especially of the older type, to say that their very familiarity with the texts makes it extremely difficult for them to assume that critical spirit in their examination which is imperatively demanded by genuine scholarship. We have had men like *Dr. Rajendra Lal Mitra* and *Pundit Satyabrata Samasrami*,—to mention only names of departed scholars,—who have been distinguished by critical acumen and who have produced works which will stand the test of scrutiny from the point of view of Western scholars. But men of this type are rather the exception than the rule, and if the reputation of the Society is to be maintained, we must endeavour to attract the cooperation of Western scholars in a much larger measure than we have been able to do in recent years. From this point of view it is fortunate that a number of Orientalists have recently been in our midst, mainly through the endeavours of the University of Calcutta, such men as *Dr. Oldenberg*, one of the foremost among the Vedic and Buddhistic scholars of the present generation, and *Dr. Jacobi* who is the leading authority on the subjects of Indian Poetics and Indian Logic. We have also amongst us *Dr. Strauss*, who is a distinguished scholar in Vedic learning, and last but not the least *Dr. Thibaut*, who is famous for his contributions to our knowledge of Indian Philosophy and Indian Astronomy. There is no reason why men of the type I have mentioned should not be persuaded to take a leading part in the work of the *Bibliotheca Indica* and thereby to set up a standard from which our successors will not willingly depart.

The acquisition of Sanskrit manuscripts has been limited to works of extraordinary interest pending the completion of the catalogue of the large collection of Sanskrit manuscripts in the Society's library. During the year only three manuscripts were acquired. The policy adopted last year in the search for Arabic and Persian manuscripts has been maintained. The fund set apart for the object has been applied to information concerning the existence and the present *locale* of rare and interesting manuscripts rather than in the purchase of new manuscripts. With this object in view, the first travelling Maulvi visited four places at Lucknow and one in Benares. He also examined the stocks of several manuscript dealers at Cawnpore and Lucknow. Short accounts of these manuscripts have

been prepared and will soon be published. The thanks of the Society are due to Khan Bahadur *Shams ul-Ulama Maulvi Abdul Aziz, of Hyderabad*, who presented 69 volumes of Persian and Arabic books to the Government collection. A report has been submitted to the Government of India giving a history of the efforts made in the search after *Bardic* chronicles. The scheme for future work, as foreshadowed in the report, is under the consideration of the Council. But in the meantime the Government proposes to appoint Signor Tessiteri, a young Italian (who has made Gujrati and the dialects of Western Rajputana his special study), to edit the chronicles collected by the Society.

For much in the foregoing notes I am indebted to the Secretaries of the different sections. The study of their notes has brought myself into touch with much work of the Society of which I did not know, and I hope that their repetition by me will lead the members as a whole to realize what is being done by the different sections. I hope also that those members of the Society and friends who are here to-night will be enabled to appreciate what the Society is doing to advance the bounds of knowledge.

There are one or two incidents of general interest closely connected with the Society's life to which I would like to refer. The first of these is the revival of the Calcutta Historical Society. In May 1911, the work of the Society, as well as the continuance of the Society's journal '*Bengal Past and Present*' came to a standstill owing to the departure from India of the members who were responsible for their conduct. Attempts were made in vain to find substitutes, and it was resolved that the Council of the Calcutta Historical Society should approach the Asiatic Society with a view, if possible, to amalgamation on such terms and conditions as the representatives of the two Societies could agree upon. The representatives met in June, but could not find amalgamation feasible. Hence in the beginning of 1912 the Council of the Calcutta Historical Society, deeming it impracticable to carry on the business of the Society, but believing it to be inexpedient—in view of a possible re-organization—that the Society should be dissolved—resigned their several offices.

The Society is now being organized by some energetic members, and a good many of the old members have already rejoined.

One of the main difficulties is to find members for the Editorial Board—for it has been clearly shown in the past that it is only by having a group of co-workers that any permanence can be assured for the publication of a journal. This difficulty, I am informed, is gradually being overcome, and you will all I know join with me in wishing the Calcutta Historical Society all success in its labours.

The other two events of which I wish to make special mention are the Centenary of the Indian Museum and the holding of the first Science Congress.

Not the least among the many scientific institutions and departments now under Government control that owe their origin to the Asiatic Society is the Indian Museum. A hundred years ago, thirty years after the foundation of the Society, Dr. Nathaniel Wallich, the eminent Botanist, suggested to our Council that a Museum should be formed, offering his own services as Honorary Curator and also duplicate specimens from his own valuable collections. His offer was enthusiastically received. It is interesting to note that Wallich was not an Englishman, but a Danish Jew, and who was taken as a prisoner of war at the Siege of Serampore, but released on account of his scientific attainments. He subsequently became the head of the Royal Botanic Gardens at Sibpur. Sir Asutosh Mukharji, the present Chairman of the Trustees of the Indian Museum, described in a recent erudite address, which many of us had the privilege of hearing, the growth and development of the great Institution that sprang from Wallich's suggestion. The Centenary has been celebrated in Calcutta with the dignity due to so well-established an Institution, and perhaps no more fitting temporary memorial could have been devised than the special Centenary Exhibition, arranged to serve as an epitome of the various sections of the Museum. The question of raising a more permanent record or aid to progress is still to be considered by the Centenary Committee of which I am the Chairman.

The first of what we hope may be a long series of Indian Science Congresses recently met in our historic meeting-room under the auspices of our Society. Representatives from all parts of India assembled to read and discuss scientific papers, and, what is perhaps more important, to become acquainted with one another personally and with one another's work. The Government of India liberally assisted its Scientific Officers to take part in the Congress by permitting them to visit Calcutta on duty. The date of the first meeting was a day of the 130th anniversary of the foundation of the Society; that the assistance of our Council should have been involved in convening the Congress is in itself a proof that the Society's old age is not its dotage, and our thanks are due to Mr. Hooper, and to the members of the Local Committee, for the manner in which our traditions were maintained on this important occasion. It is hoped that arrangements may be made for the publication, in a fitting and convenient form, of the Proceedings of the Congress which has requested us to make the necessary arrangements.

I feel I cannot close without reference to the early departure of two of our most distinguished members—Dr. Denison Ross and Mr. Hooper. Mr. Hooper's connection with the

Society extends over many years. He has done much valuable work for us and has filled the posts of Treasurer and Vice-President. Dr. Denison Ross has been the Philological Secretary of the Society for over ten years. He signalled his tenure of that post by bringing about a revival of interest in Tibetan studies. It was through his efforts that an important work in manuscript by the celebrated Hungarian traveller and scholar *Csoma de Koros* was printed and published, and it was at his instance that the Society engaged a Lama to work on the Tibetan manuscripts owned by the Society.

The Society, as you are aware, has been engaged for many years in the search after valuable Sanskrit manuscripts on behalf of Government. Dr. Denison Ross obtained the sanction and pecuniary assistance of the Government of India to a similar search being made for rare Arabic and Persian manuscripts known to be scattered throughout India, with the result that there is now stored, side by side with the Society's own collection, some 3,000 manuscripts in these languages which in proper hands should throw much further light on points connected with Indian history.

Dr. Ross' services to literature and research have been invaluable to us in India, and we know how greatly they will be appreciated in the sphere of his new labours.

Our best wishes go with Dr. Ross and Mr. Hooper in their new spheres of work; we feel sure that we shall always be proud to think that we have counted them among our active members, and we know that this Society will always have a warm place in their hearts.



The President announced the election of Officers and Members of Council to be as follows:—

President.

His Excellency the Right Hon'ble Thomas David Baron Carmichael of Skirling, G.C.I.E., K.C.M.G.

Vice-Presidents.

The Hon'ble Justice Sir Asutosh Mukhopadhyaya, Kt.,
C.S.I., D.L., D.Sc, F.R.S.E., F.R.A.S., F.A.S.B.

Mahamahopadhyaya Haraprasad Shastri, C.I.E., M.A.,
F.A.S.B.

Lieut.-Col. L. Rogers, C.I.E., M.D., B.S., F.R.C.P.,
F.R.C.S., F.A.S.B., I.M.S.

Colonel S. G. Burrad, C.S.I., R.E., F.R.S.

Secretary and Treasurer.

General Secretary :—Major C. L. Peart, I.A.

Treasurer :—R. D. Mehta, Esq., C.I.E.

Additional Secretaries.

Philological Secretary—Major C. L. Peart, I.A.

Natural Science Secretaries — { Biology—N. Annandale,
Esq., D.Sc., C.M.Z.S.,
F.L.S., F.A.S.B.
Physical Sciences—W. A.
K. Christie, Esq., B.Sc.,
Ph.D.

Anthropological Secretary—J. Coggin Brown, Esq.,
M.Sc., F.G.S.

Joint Philological Secretary—Mahamahopadhyaya Satis
Chandra Vidyabhusana, M.A., Ph.D., F.A.S.B.

Medical Secretary :—Capt. C. A. Godson, I.M.S.

Honorary Librarian :—S. W. Kemp, Esq., B.A., F.A.S.B.

Other Members of Council.

H. H. Hayden, Esq., D.Sc., C.I.E., B.A., B.A.I., F.G.S.,
F.A.S.B.

W. K. Dods, Esq.

W. C. Hossack, Esq., M.D., D.P.H.

D. B. Spooner, Esq., B.A., Ph.D.

P. J. Brühl, Esq., D.Sc., F.A.S.B.

G. R. Clarke, Esq., I.C.S.

W. Kirkpatrick, Esq.

The meeting was then resolved into the Ordinary General meeting for the election of ordinary members.

The following gentlemen were balloted for as Ordinary Members :—

The Hon'ble Mr. W. W. Hornell, Indian Educational Service, 1, Outram Street, Calcutta, proposed by Mr. D. Hooper, seconded by Dr. P. J. Brühl; *Babu Panchanan Neogi*, M.A., F.C.S., Senior Professor of Chemistry, Government College, Rajshahi, proposed by Mr. D. Hooper, seconded by Dr. P. J. Brühl; *Babu Benoyendra Ghosal*, Merchant, c/o K. Norris & Co., 33, Canning Street, Calcutta, proposed by Mr. D. Hooper, seconded by Dr. G. D. Hope; *Babu Surendra Chandra Banerjee*, M.A., Asst. for systematic Botany in the Botanical Survey of India, 30, Shastitala Road, Narikeldanga, Calcutta, proposed by Hon. Justice Sir Asutosh Mukhapadhyaya, Kt., seconded by Dr. P. J. Brühl; *The Hon'ble Nawab Syed Nawab Ali Choudhury*, Zemindar, 27, Weston Street, Calcutta, proposed

by Shams-ul-Ulama Maulavi Kamaluddin Ahmad, seconded by Dr. Satis Chandra Vidyabhusana.

The meeting was then closed.



The Adjourned Meeting of the Medical Section of the Society was held at the Society's Rooms on Wednesday, the 11th February, 1914, at 9-30 P.M.

LIEUT.-COL. L. ROGERS, C.I.E., I.M.S., in the chair.

The following members were present:—

Dr. C. A. Bentley, Dr. H. Finck, Mr. T. P. Ghosh, Major E. D. W. Greig, I.M.S., Dr. W. C. Hossack, Dr. A. M. Leake, Surgeon Capt. F. F. MacCabe, Capt. C. A. Godson, Honorary Secretary.

Minutes of the last meeting were read and confirmed.

Dr. Bentley read a paper on "Malaria in Lower Bengal, its origin and remedy."

Owing to want of time he was only able to deal with the first portion of the paper, and the question of the remedy was postponed to a later date.



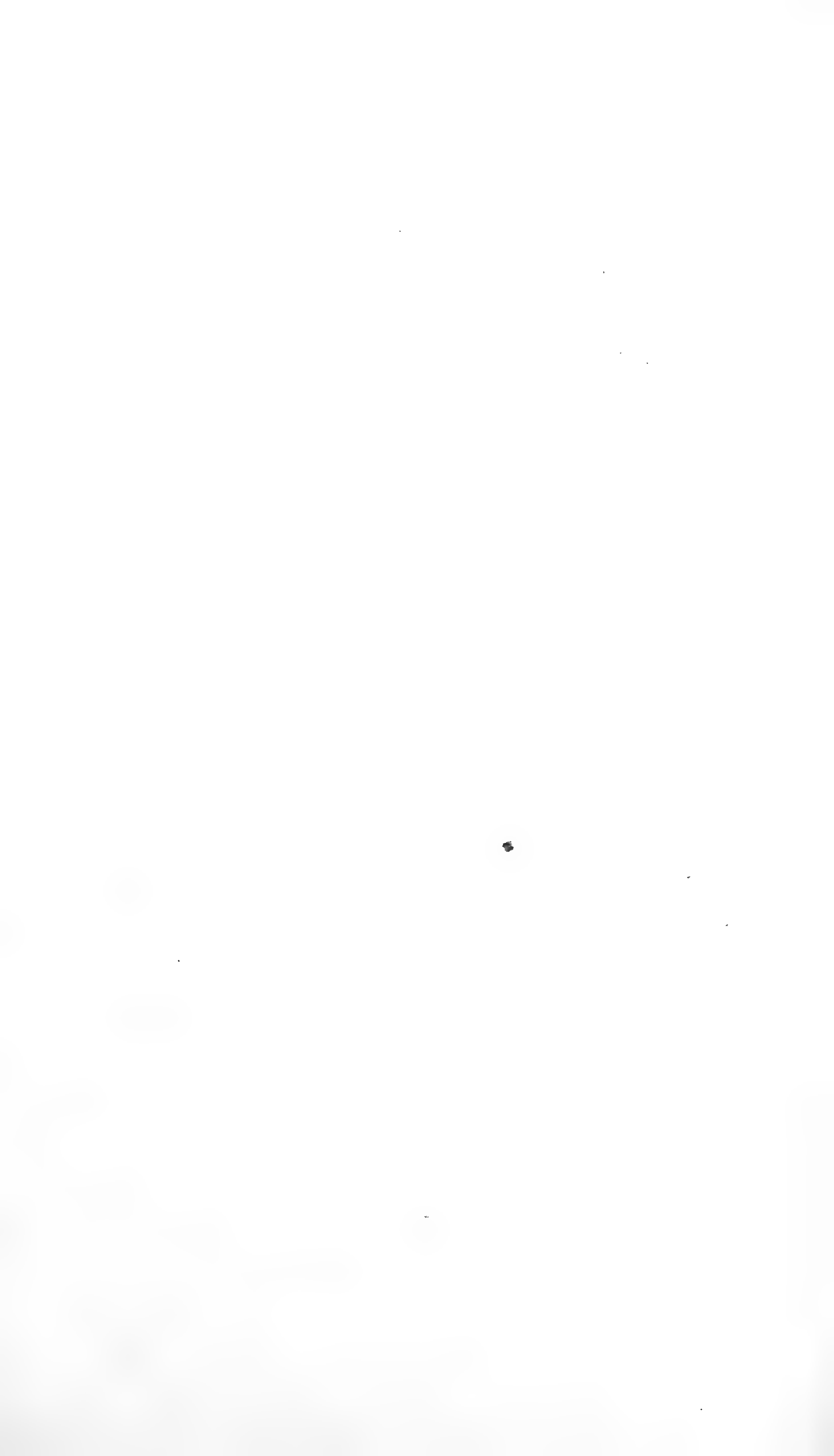

LIST OF MEMBERS
OF THE
ASIATIC SOCIETY OF BENGAL.
ON THE 31ST DECEMBER, 1913.

LIST OF OFFICERS AND MEMBERS OF COUNCIL
OF THE ASIATIC SOCIETY OF BENGAL
FOR THE YEAR 1913.

President :

His Excellency the Right Hon'ble Thomas David Baron
Carmichael of Skirling, G.C.I.E., K.C.M.G.

Vice-Presidents :

Colonel G. F. A. Harris, C.S.I., M.D., F.R.C.P., I.M.S.
G. Thibaut, Esq., Ph.D., C.I.E., D.Sc., F.A.S.B.
Mahāmahopādhyāya Haraprasād Śāstrī, C.I.E., M.A.,
F.A.S.B.
D. Hooper, Esq., F.C.S., F.A.S.B.

Secretary and Treasurer.

General Secretary :—G. H. Tipper, Esq., M.A., F.G.S., suc-
ceeded by Major C. L. Peart, I.A.
Treasurer :—The Hon. Justice Sir Asutosh Mukhopadhyaya,
Kt, C.S.I., D.L., D.Sc., F.R.S.E., F.R.A.S., F.A.S.B.

Additional Secretaries.

Philological Secretary :—Major C. L. Peart, I.A.
Natural History Secretary :—W. A. K. Christie, Esq., B.Sc.,
Ph.D.
Anthropological Secretary :—J. Coggin Brown, Esq., M.Sc.,
F.G.S.
Joint Philological Secretary :—Mahāmahopādhyāya Satīś
Chandra Vidyābhūṣana, M.A., Ph.D., F.A.S.B.
Medical Secretary :—Capt. J. D. Sandes, M.B., I.M.S.

Other Members of Council.

E. P. Harrison, Esq., Ph.D., F.R.S.E.
H. H. Hayden, Esq., D.Sc., C.I.E., B.A., B.A.I., F.G.S.,
F.A.S.B.
N. Annandale, Esq., D.Sc., C.M.Z.S., F.L.S., F.A.S.B.
W. K. Dods, Esq.
S. W. Kemp, Esq., B.A., F.A.S.B.
W. C. Hossack, Esq., M.D., D.P.H.
G. H. Tipper, Esq., M.A., F.G.S.

LIST OF ORDINARY MEMBERS.

R. = Resident. N.R. = Non-Resident. A. = Absent. L.M. = Life Member.
F.M. = Foreign Member.

An Asterisk is prefixed to the names of the Fellows of the Society.

N.B.—Members who have changed their residence since the list was drawn up are requested to give intimation of such a change to the Honorary General Secretary, in order that the necessary alteration may be made in the subsequent edition. Errors or omissions in the following list should also be communicated to the Honorary General Secretary.

Members who are about to leave India and do not intend to return are particularly requested to notify to the Honorary General Secretary whether it is their desire to continue Members of the Society; otherwise, in accordance with Rule 40 of the rules, their names will be removed from the list at the expiration of three years from the time of their leaving India.

Date of Election.		
1907 April 3.	N.R.	Abdul Ali, Abul Faiz Muhammad, M.A., Deputy Magistrate. <i>Netrokona, Mymensingh.</i>
1909 Mar. 3.	N.R.	Abdul Latif, Syed, Deputy Magistrate. <i>Barisal.</i>
1894 Sept. 27.	L.M.	Abdul Wali, Maulavi. 23, <i>European Asylum Lane, Calcutta.</i>
1912 Aug. 7.	N.R.	Abdulla-ul-Musawy, Syed, B.A., Zemindar. <i>Bohar, Burdwan.</i>
1909 July 7.	R.	Abdur Rahim, Maulavi. 51, <i>Taltolla Lane, Calcutta.</i>
1895 May 1.	R.	Abdus Salam, Maulavi, M.A., Presidency Magistrate. <i>Calcutta.</i>
1903 April 1.	N.R.	Abul Aâs, Maulavi Sayid, Raees and Zemindar. <i>Langar Toli, Bankipore.</i>
1904 Sept. 28.	N.R.	Ahmad Hasain Khan, Munshi. <i>Jhelum.</i>
1911 April 5.	N.R.	Ahmad Husain, Nawab, Khan Bahadur. <i>Rais of Pargawan, Partabgarh, Dist. Oudh.</i>
1888 April 4.	R.	Ahmud, Shams-ul-Ulama Maulavi. 3, <i>Maulavi's Lane, Calcutta.</i>
1903 Oct. 28.	R.	Allan, Alexander Smith, M.B. 17 & 18. <i>Esplanade Mansions, Calcutta.</i>
1913 Nov. 5.	N.R.	Aminullah, Maulvi, Pleader. <i>Ghazipore.</i>
1893 Aug. 31.	N.R.	Anderson, Lieut.-Col. Adam Rivers Steele. B.A., M.B., D.P.H., C.M.Z.S., I.M.S. <i>Dacca.</i>
1912 July 3.	N.R.	Andrews, Egbert Arthur, B.A. <i>Tooklai Experimental Station, Cinnenara P.O., Jorhat, Assam.</i>

Date of Election.			
1904	Sept. 28.	R.	*Annandale, Nelson, D.Sc., C.M.Z.S., F.A.S.B., Superintendent, Indian Museum. <i>Calcutta.</i>
1910	Apl. 6.	N.R.	Ascoli, Frank David, I.C.S. <i>Dacca.</i>
1909	May 5.	R.	Ashgar, A. A., Barrister-at-Law. 8, <i>European Asylum Lane, Calcutta.</i>
1911	May 3.	R.	Atkinson, Albert Charles. 11, <i>Loudon Street, Calcutta.</i>
1904	July 6.	N.R.	Aulad Hasan, Sayid, Khan Bahadur, Inspector of Registration. <i>Dacca.</i>
1909	May 5.	R.	Azad, Maulavi Abul-Kalam Mohyuddin Ahmad. 13, <i>McLeod Street, Calcutta.</i>
1870	Feb. 2.	L.M.	Baden-Powell, Baden Henry, M.A., C.I.E. <i>Ferlys Lodge, 29, Banbury Road, Oxford, England.</i>
1891	Mar. 4.	N.R.	Baillie, Hon. Sir Duncan Colvin, K.C.S.I., I.C.S., Member, Board of Revenue, North-West Provinces of Agra and Oudh. <i>Allahabad.</i>
1909	Feb. 3.	N.R.	Banerjee, Charu Deb, B.A., LL.B. <i>Allahabad</i>
1910	Dec. 7.	N.R.	Banerji, Devendra Kumar. <i>Dacca College, Dacca.</i>
1905	Mar. 1.	R.	Banerjee, Muralidhar. <i>Sanskrit College, Calcutta.</i>
1907	Jan. 2.	R.	Banerji, Rakhal Das, M.A. 45.4, <i>Simla Street, Calcutta.</i>
1896	Mar. 4.	N.R.	Banerji, Satish Chandra, M.A., LL.D., Advocate, High Court. <i>Allahabad.</i>
1911	June 7.	N.R.	Barik, Ganesh Lall, Zemindar, <i>Chandchaura, Gaya.</i>
1869	Dec. 1.	L.M.	Barker, Robert Arnold, M.D., F.G.S. <i>Thorncroft, Horndean Road, Emsworth, Hants, England.</i>
1885	Nov. 4.	R.	Barman, Damodar Das. 55, <i>Olive Street, Calcutta.</i>
1898	Mar. 2.	N.R.	Barnes, Herbert Charles, M.A., I.C.S., Deputy Commissioner, Naga Hills. <i>Kokima, Assam.</i>
1908	Nov. 4.	N.R.	Barnes, James Hector, B.Sc., F.I.C., F.C.S., Principal, Punjab Agricultural College. <i>Lyallpur.</i>
1902	May 7.	R.	Bartlett, Edward William John. 4, <i>Esplanade, East, Calcutta.</i>
1894	Sep. 27.	R.	Basu, Nagendra Nath. 20, <i>Kantapukur Lane, Bagbazaar, Calcutta.</i>
1903	Feb. 4.	N.R.	Batra, Bhawani Das, Rai Bahadur, M.A., Revenue Asst. <i>Amritsar.</i>
1909	July 7.	N.R.	Bazuz, Rangnath Khunraj. <i>Girgaon, Bombay.</i>
1895	July 3.	L.M.	Beatson-Bell, Hon. Mr. Nicholas Dodd, B.A., C.I.E., I.C.S. <i>Dacca.</i>
1907	Feb. 6.	N.R.	Bell, Charles Alfred, I.C.S. <i>Gangtok, Sikkim.</i>
1909	April 7.	R.	Bentley, Charles A., M.B., D.P.H. <i>Dum Dum, 24-Parganas.</i>

Date of Election.			
1876	Nov. 15.	F.M.	*Beveridge, Henry, F.A.S.B., I.C.S. (retired). <i>Pitfold, Shottermill, Haslemere, Surrey, Eng- land.</i>
1913	April 2.	N.R.	Bhatnagar, R.S., Civil Judge, Shahpura, <i>Raj- putana.</i>
1908	Nov. 4.	N.R.	Bhattacharji, Bisvesvar, Sub-Divisional Offi- cer, <i>Katwa, Burdwan.</i>
1909	Aug. 4.	N.R.	Bhattacharjee, Jyotis Chandra, M.A., B.L. <i>Purneah.</i>
1910	April 6.	R.	Bhattacharyya, Ramakanta. 77, <i>Lansdowne Road, Calcutta.</i>
1909	July 7.	R.	Bhattacharjee, Shib Nath, M.B. 17, <i>Mohan- bagan Road, Calcutta.</i>
1911	April 5.	R.	Bion, H. S., B.Sc., F.G.S., Assistant Superinten- dent, Geological Survey of India. <i>Calcutta.</i>
1910	May 4.	N.R.	Bishop, T. H., M.R.C.S., L.R.C.S., D.PH. <i>Paksey, Pabna Dist.</i>
1893	Feb. 1.	N.R.	Bodding, Revd. P. O. <i>Dumka, Sonthal Par- ganas.</i>
1912	Oct. 30.	N.R.	Bolton, H. O. <i>Graham's Building, Rangoon.</i>
1912	July 3.	N.R.	Bomford, Lieut. Trevor Lawrence, I.M.S., M.B., B.S., M.R.C.S., L.R.C.P. <i>3rd Skinner's Horse, Meerut.</i>
1895	July 3.	N.R.	Bonham-Carter, Norman, I.C.S. <i>Dacca.</i>
1898	Feb. 2.	R.	Bose, Amrita Lal, Dramatist. 9-2, <i>Ram Chandra Maitra's Lane, Calcutta.</i>
1908	June 3.	R.	Bose, Hira Lall, <i>Dewan Bahadur</i> , L.M.S. 25, 2, <i>Indian Mirror Street, Calcutta.</i>
1895	Mar. 6.	R.	*Bose, Jagadis Chandra, C.S.I., M.A., D.Sc., C.I.E., F.A.S.B. <i>Presidency College, Calcutta.</i>
1910	July 6.	N.R.	Botham, Arthur William, I.C.S. <i>Shillong.</i>
1911	Nov. 1.	N.R.	Boyle, Lieut. Cecil Alexander, 11th King Edward's Lancers, Cavalry Lines, The Kurram Valley Militia. <i>Parachinar, Kurram Valley, N.W.F.P.</i>
1908	Jan. 1.	R.	Brahmachari, Upendra Nath, M.A., M.D. 10, <i>Nimtola Ghat Street, Calcutta.</i>
1913	Aug. 6.	N.R.	Brown, Prof. C. J. <i>Canning College, Lucknow.</i>
1906	July 4.	R.	Brown, Lieut.-Col. Edwin Harold, M.D., I.M.S. (retired). 4, <i>Harrington Street, Calcutta.</i>
1907	July 3.	R.	Brown, John Coggin, M.Sc., F.G.S., F.C.S., Assistant Superintendent, Geological Survey of India. <i>Calcutta.</i>
1909	Oct. 6.	R.	Brown, Percy, A.R.C.A. <i>Government School of Art, Calcutta.</i>
1905	Mar. 1.	A.	Brown, William Barclay, I.C.S. <i>Europe.</i>
1909	Oct. 6.	R.	*Brühl, Paul Johannes, F.A.S.B. 3, <i>Middleton Row, Calcutta.</i>
1901	Sept. 25.	R.	Buchanan, Lieut.-Col. Walter James, I.M.S. <i>United Service Club, Calcutta.</i>

Date of Election.			
1913 Jan. 1.	R.	Burgess, Capt. J. H., I.M.S.	<i>Government House, Calcutta.</i>
1901 June 5.	F.M.	*Burkill, Isaac Henry, M.A., F.A.S.B.	<i>Botanical Garden, Singapore.</i>
1896 Jan. 8.	N.R.	Burn, Hon. Mr. Richard, I.C.S.	<i>Allahabad.</i>
1912 Apl. 3.	R.	Burns, William Alexander, B.A.	<i>4, Metapooker Road, Kidderpur, Calcutta.</i>
1913 Nov. 5.	R.	Burton, R. C., Assistant Superintendent, Geological Survey of India.	<i>Calcutta.</i>
1913 Jan. 1.	R.	Burrard, Col. S. G., C.S.I. F.R.S., Surveyor General of India.	<i>13, Wood Street, Calcutta.</i>
1900 May 2.	N.R.	Butcher, Flora, M.D.	<i>Lohaghat, Almora Dist.</i>
1898 Sept. 30.	A.	Cable, Sir Ernest, Kt.	<i>Europe.</i>
1906 Dec. 5.	R.	Caddy, Adrian, M.D. (Lond.), F.R.C.S. (Eng.), D.P.H., M.R.C.P.S. (Lond.).	<i>2-2, Harrington Street, Calcutta.</i>
1913 Apl. 2.	R.	Calder, Charles Cumming.	<i>Royal Botanic Garden, Sibpur, Howrah.</i>
1907 Apl. 3.	R.	Calvert, Lieut.-Col. John Telfer, M.B., M.R.C.P., I.M.S.	<i>14, Russell Street, Calcutta.</i>
1907 Mar. 6.	L.M.	Cama, Camaji Byramji Navroji, B.A., LL.B., I.C.S.	<i>Raipur.</i>
1901 Mar. 6.	N.R.	Campbell, William Edgar Marmaduke, I.C.S.	<i>Mirzapur, U. P.</i>
1895 July 3.	N.R.	Carlyle, Hon. Sir Robert Warrand, K.C.S.I., C.I.E., I.C.S., Revenue and Agriculture and P.W.D. Member, Government of India.	<i>Simla.</i>
1912 Mar. 6.	R.	Carmichael, His Excellency the Right Hon'ble Thomas David Baron, of Skirling, G.C.I.E., K.C.M.G., Governor of Bengal.	<i>Calcutta.</i>
1911 Feb. 1.	R.	Carnduff, Hon. Justice Sir Herbert William Cameron, Kt., C.I.E., I.C.S.	<i>5, Hungerford St., Calcutta.</i>
1910 May 4.	N.R.	Carter, Capt. Robert Markham, I.M.S.	<i>Bombay.</i>
1905 May 3.	R.	Chakravarti, Dwarkanath, M.A., B.L., Vakil, High Court.	<i>Calcutta.</i>
1890 June 4.	N.R.	*Chakravarti, Monmohan, M.A., B.L., F.A.S.B., Deputy Magistrate.	<i>Khulna.</i>
1909 Mar. 3.	R.	Chakravarti, Nilmani, M.A.	<i>Presidency College, Calcutta.</i>
1905 July 5.	N.R.	Chakravarti, Vanamali.	<i>Cotton College, Gauhati.</i>
1906 Jan. 3.	R.	Chapman, John Alexander, Librarian, Imperial Library.	<i>Calcutta.</i>
1908 Feb. 5.	R.	Chatterjee, Gopal Chandra, M.B.	<i>Medical College, Calcutta.</i>
1911 June 7.	R.	Chatterjee, Karuna Kumar, F.R.C.S.	<i>154, Dharamtola Street, Calcutta.</i>

Date of Election.		
1909 Mar. 3.	R.	Chatterjee, Manmatha Nath, M.B. 295/1, <i>Upper Circular Road, Calcutta.</i>
1907 Sept. 25.	R.	Chatterjee, Promode Prakas. 8, <i>Dixon Lane, Calcutta.</i>
1902 Aug. 27.	R.	Chaudhuri, Hon. Mr. Justice Ashutosh. 47, <i>Old Ballygunge, Calcutta.</i>
1893 Sept. 28.	R.	Chaudhuri, Banawari Lal, B.A., D.Sc. (Edin.), F.R.S.E., F.L.S. (Lond.). 120, <i>Lower Circular Road, Calcutta.</i>
1911 Mar. 1.	N.R.	Chaudhuri, Charu Chandra, Rai Bahadur, Zemindar, Sherpur Town. <i>Mymensingh Dist.</i>
1913 June 4.	R.	Chaudhuri, P., Bar.-at-Law. 2, <i>Bright Street, Ballygunge, Calcutta.</i>
1912 Aug. 7.	N.R.	Chetty, P. S. Ramulu. 5, <i>Strotton Muthia, Mudelly Street, Georgetown, Madras.</i>
1907 July 3.	R.	Christie, William Alexander Kynock, B.Sc., Ph.D., Chemist, Geological Survey of India. <i>Calcutta.</i>
1909 Nov. 3	N.R.	*Christophers, Major Samuel Richmond, M.B., F.A.S.B., I.M.S. <i>Research Laboratory, Kasauli.</i>
1902 April 2.	R.	Chunder, Rajchunder, Attorney-at-Law. 2, <i>Old Post Office Street, Calcutta.</i>
1906 Nov. 7.	R.	Clarke, Geoffrey Roth, I.C.S., Deputy Director General of Post Offices in India. <i>Calcutta.</i>
1907 Dec. 4.	A.	Cohen, Rachel Nathaniel, M.B., F.R.C.S. <i>Europe.</i>
1906 July 4.	A.	Connor, Captain Frank Powell, F.R.C.S. (Eng.), L.R.C.P. (Lond.), I.M.S. <i>Europe.</i>
1908 Nov. 4.	N.R.	Cook, Capt. Lewis, I.M.S. <i>Midnapur.</i>
1912 June 5.	N.R.	Coppinger, Major Walter Valentine, M.B., B.Sc., F.R.C.S.I., I.M.S. <i>Dibrugarh, Assam.</i>
1898 June 1.	F.M.	Cordier, Dr. Palmyr. 37, <i>Rue des Granges, 37, Besançon (Doubs), France.</i>
1907 July 3.	R.	Cotter, Gerald de Purcell, Assistant Superintendent, Geological Survey of India. <i>Calcutta.</i>
1908 Jan. 1.	R.	Crake, Dr. Herbert Milverton, Health Officer. 15, <i>Loudon Street, Calcutta.</i>
1901 June 5.	A.	Crawford, Lieut.-Col. Dirom Grey, I.M.S. <i>Europe.</i>
1876 Mar. 1.	F.M.	Crawford, James, B.A., I.C.S. (retired). <i>Thornwood, Uddington, Lanarkshire, Scotland.</i>
1887 Aug. 25	R.	Criper, William Risdon. F.C.S., F.I.C., A.R.S.M. <i>Konnagar, E.I.R.</i>
1895 July 3.	R.	Cumming, Hon. Mr. John Ghest, C.I.E., I.C.S. <i>Chief Secy., Govt. of Bengal, Calcutta.</i>
1873 Dec. 3.	F.M.	Dames, Mansel Longworth, I.C.S. (retired). <i>Ventnor, Wodeland Road, Guildford, Surrey, England.</i>
1901 Aug. 28.	N.R.	Das, Govinda. <i>Durgakund, Benares City.</i>

Date of Election.			
1896	Mar. 4.	R.	Das-Gupta, Jogendra Nath, B.A. (Oxon), Barrister-at-Law. <i>Hughli College, Chinsura.</i>
1912	April 3.	N.R.	Das, Kasi Nath, Prof. Ravenshawe College. <i>Cuttack.</i>
1910	Jan. 5.	R.	David, David A. 55, <i>Free School Street, Calcutta.</i>
1895	Sept. 19.	N.R.	De, Kiran Chandra, B.A., I.C.S. <i>Rungpur.</i>
1906	Dec. 5.	R.	Deare, Lieut.-Col. Benjamin Hobbs, M.R.C.S. (Eng.), L.R.C.P. (Lond.), D.P.H. (Cantab), I.M.S. 14, <i>Russel Street, Calcutta.</i>
1899	Aug. 30.	N.R.	Deb, Raja Saccidananda Tribhuban, Feudatory Chief of Bamra. <i>Deogarh, Bamra.</i>
1904	Sept. 28.	N.R.	DeCourcy, William Blennerhasset. <i>Leddelsdale Estate, Naduwatum P.O., Nilgiris.</i>
1912	May 1.	R.	Demetriadi, Stephen. 2/1 <i>Russell Street, Calcutta.</i>
1906	Dec. 5.	N.R.	Dentith, Arthur William, I.C.S. <i>Cooch Behar.</i>
1904	Jan. 6.	N.R.	Dev-Sharman, Gulab Shanker, F.T.S., M.R.A.S., Private Secretary to H.H. the Maharani Sahiba of Bettiah. <i>Allahabad.</i>
1901	June 5.	R.	Dey, Nundolal. <i>Chinsura.</i>
1910	Dec. 7.	A.	Dharmapala, The Anagarika Hevavitarana. <i>Europe.</i>
1910	May 4.	L M.	Dhavle, Sankara Balaji, I.C.S. <i>Nawadah.</i>
1912	July 3.	R.	Digby, Everard, B.Sc. (Lond.). 1, <i>Garstin's Place, Calcutta.</i>
1907	Oct. 30.	N.R.	Dixit, Pandit Sri Ram, B.A., <i>Dewan of Banswara, Rajputana.</i>
1898	Jan. 5.	R.	Dods, William Kane. Agent, Hongkong and Shanghai Banking Corporation. <i>Calcutta.</i>
1906	Dec. 5.	N.R.	Donnan, Major William, Indian Army, Examiner of Ordnance Factory Accounts in India. <i>Lucknow.</i>
1909	Nov. 3.	N.R.	Donovan, Lieut.-Col. Charles, M.D., I.M.S. <i>Medical College, Madras.</i>
1902	July 2.	R.	Doxey, Frederick. 9, <i>Queen's Park, Ballygunge, Calcutta.</i>
1909	Aug. 4.	N.R.	Drake-Brockman, Hon. Sir Digby Livingstone, Kt., I.C.S. <i>Allahabad.</i>
1892	Sept. 22.	N.R.	Drury, Lieut.-Col. Francis James, I.M.S. <i>Ranchi.</i>
1912	Nov. 6.	N.R.	Dube, Manana. <i>Tahsildar, Dist. of Ballia, Ballia, U.P.</i>
1912	April 3.	N.R.	Duff-Sutherland-Dunbar, Capt. Sir George, Bart., Commandant, Military Police. <i>Lukhimpur, Dibrugarh.</i>
1905	April 5.	A.	Dunnett, James Macdonald, I.C.S. <i>Europe.</i>
1877	Aug. 30.	R.	Dutt, Kedar Nath. 1, <i>Sikdarpara Lane, Calcutta.</i>

Date of Election.			
1906 Nov. 7.	F.M.	Eadie, Capt. John Inglis.	97th Deccan Infantry, C/o Messrs. Grindlay & Co., 45, Parliament Street, London.
1910 April 6.	N.R.	Ebden, Capt. F. T. P.	73rd Cavalry, Trichinopoly.
1903 May 6.	A.	Edwards, Walter Noel.	Europe.
1910 May 6.	N.R.	Edwards, Lieut. W. M., Indian Army.	Barian, Murree Hills.
1910 April 6.	R.	Elmes, Dr. Cecil H.	1, Middleton Row, Calcutta.
1911 Nov. 1.	A.	Esch, V. J., Architect.	Europe.
1901 Mar. 6.	N.R.	Fergusson, John Carlyle, I.C.S.	Agra.
1904 Aug. 3.	A.	Fermor, Lewis Leigh, A.R.S.M., D.Sc., F.G.S., Superintendent, Geological Survey of India.	Europe.
1908 Sept. 2.	N.R.	Fida Ali, Syed.	Arrah.
1906 Dec. 5.	R.	Finck, Herman H. G., M.D., Surgeon to the Consulate-General for Germany.	7, Camac Street, Calcutta.
1906 Oct. 31.	N.R.	Finlow, Robert Steel, Fibre Expert to the Govt. of Assam.	Dacca.
1907 Mar. 6.	R.	Firminger, Revd. Walter Kelly, M.A., B.D., F.R.G.S.	St. John's House, Council House Street, Calcutta.
1910 Sept. 7.	N.R.	Fortescue, Capt. Archer Irvine, R.A.M.C.	Benares.
1906 Dec. 5.	R.	Foster, Capt. Henry Bertram, I.M.S.	45, Park Street, Calcutta.
1913 Nov. 5.	R.	Fox, Cyril S., Assistant Superintendent, Geological Survey of India.	Calcutta.
1910 April 6.	N.R.	Francis, Lieut. Reginald Frankland, Indian Army.	Jullunder, Punjab.
1910 Nov. 2.	N.R.	Friend-Pereira, Joseph Ernest, B.A.,	Madhipura, Bhagalpur.
1903 Mar. 4.	A.	*Gage, Major Andrew Thomas, M.A., M.B., B.Sc. F.L.S., I.M.S.	Europe.
1893 Jan. 11.	N.R.	*Gait, Hon. Mr. Edward Albert, C.S.I., C.I.E., I.C.S.	Ranchi.
1912 Mar. 6.	R.	Ganguli, Manmohan, B.E., District Engineer.	50, Raja Rajballava's Street, Calcutta.
1909 Mar. 3.	R.	Ganguli, Matilal, Rai Bahadur.	Currency Office, Calcutta.
1909 Oct. 7.	R.	Ganguli, Ordhendhu Kumar.	12, Ganguli's Lane, Calcutta.
1908 Feb. 5.	N.R.	Gardner-Brown, John Gerald Gardner, M.A., Director, State Education,	Holkar College, Indore.
1903 Jan. 1.	N.R.	Ghatak, Suresh Chandra, Depy. Magistrate and Depy. Collector.	Dacca.

Date of Election.		
1905 May 3.	N.R.	Ghose, Hemendra Prasad, Zemindar and Litterateur. <i>Prasad Lodge, Changalbha P.O., Jessore.</i>
1889 Jan. 2.	R.	Ghose, Jogendra Chandra, M.A., B.L., Pleader. 25, <i>Hurrish Chunder Mookerjee Road, Bhowanipore, Calcutta.</i>
1909 Dec. 1.	A.	Ghose, Panchanan, M.A. <i>Europe.</i>
1905 July 5.	R.	Ghosh, Amulya Charan, <i>Vidyabhusana. 66, Manicktolla Street, Calcutta.</i>
1912 Aug. 7.	R.	Ghosh, Atal Behari, M.A., B.L. 59, <i>Sookeu's Street, Calcutta.</i>
1907 Oct. 30.	R.	Ghosh, Birendra Nath, L.M.S., Medical Practitioner. 109, <i>College Street, Calcutta.</i>
1912 Mar. 6.	R.	Ghosh, Harinath, M.D., Assistant Surgeon. 91 <i>Manicktala Street, Calcutta.</i>
1907 Mar. 6.	R.	Ghosh, Prafulla Chundra, M.A. 27/3, <i>Boitakhana Bazar Road, Calcutta.</i>
1869 Feb. 3.	N.R.	Ghosh, Pratapa Chandra, B.A. <i>Vindiyachal.</i>
1912 Sept. 4.	R.	Ghosh, Tarapada. 14, <i>Paddupuker Street, Kidderpur, Calcutta.</i>
1902 June 4.	N.R.	Ghuznavi, Abu Ahmed. <i>Mymensingh.</i>
1913 Dec. 3	R.	Godson, Capt. Charles Aubery, I.M.S. <i>Medical College, Calcutta.</i>
1909 April 7.	R.	Goenka, Briz Mohan. 24, <i>Banstolla Street, Calcutta.</i> [cutta.
1907 Mar. 6.	R.	Goenka, Roormall 57, <i>Burtolla Street, Calcutta.</i>
1905 July 5.	N.R.	Gossain, Hemchandra, Extra Assistant Commissioner. <i>Tezpur.</i>
1909 Jan. 6.	R.	Gourlay, William Robert, C.I.E., I.C.S. <i>Government House, Calcutta.</i>
1910 Sept. 7.	R.	Gravely, Frederic Henry, M.Sc., Assistant Superintendent, Indian Museum. <i>Calcutta.</i>
1905 May 3.	R.	Graves, Henry George, A.R.S.M. 1, <i>Council House Street, Calcutta.</i>
1910 Nov. 2.	N.R.	Graves-Law, H. D., I.C.S. <i>The Regency, Hyderabad, Deccan.</i>
1907 June 5.	R.	Green, Lieut.-Col. Charles Robert Mortimer. M.D., F.R.C.S., I.M.S. 6, <i>Harrington Street, Calcutta.</i>
1910 Mar. 2	R.	Greig, Major Edward David Wilson, M.B., I.M.S. <i>United Service Club, Calcutta.</i>
1910 Sept. 7.	N.R.	Grey, Lt.-Col. William George, Indian Army. Asst. Political Agent. <i>Koweit, Persian Gulf.</i>
1900 Dec. 5.	L.M.	Grieve, James Wyndham Alleyne, Deputy Conservator of Forests. <i>Darjeeling.</i>
1910 April 6	A.	Grubl, D E. <i>Europe.</i>
1901 April 3.	N.R.	Guha, Abhaya Sankar, Extra Assistant Commissioner. <i>Nowgong.</i>
1898 June 1.	R.	Gupta, Bepin Behari. <i>Hooghly College, Chinsura.</i>

Date of Election.			
1911 Aug. 2	N R.	Habiber Rahman, Depy. Supdt., Telegraph Department. <i>Allahabad.</i>	
1901 Mar. 6.	N.R.	Habibur Rahman Khan, Maulavi, Raees. <i>Bhikanpur, District Aligarh.</i>	
1892 Jan. 6.	F.M.	Haig, Lieut.-Col. Wolseley, Indian Army, H. B. M.'s Consulate Genl., <i>Meshhed, Persia.</i>	
1907 Aug. 7.	N.R.	Haines, Henry Haselfoot, F.C.S., F.L.S. <i>Nagpur.</i>	
1908 June 3.	R.	Hallowes, Kenneth Alexander Knight, B.A., A.R.S.M., F.G.S., Assistant Superintendent, Geological Survey of India. <i>Calcutta.</i>	
1904 Sept. 28.	A.	Hallward, Norman Leslie. <i>Europe.</i>	
1913 May 7.	R.	Hankin, E. H., M.A., D.Sc. <i>Grand Hotel, Calcutta.</i>	
1912 May 1.	R.	Harley, A. H. <i>Madrassa, Calcutta.</i>	
1906 Dec. 5.	N.R.	Harris, Lieut. G. 56th Infantry, F.F., <i>Hangu.</i>	
1906 July 4.	R.	Harris, Hon Col. George Francis Angelo. C.S.I., M.D., F.R.C.P., I.M.S., Inspector-General of Civil Hospitals, Bengal. <i>Calcutta.</i>	
1908 April 1.	R.	Harrison, Edward Philip, Ph.D., F.R.S.E. Observatory. <i>Alipur, Calcutta.</i>	
1910 May 4.	N.R.	Harvey, Captain William Frederick, I.M.S. <i>Pasteur Institute, Kasauli.</i>	
1897 Feb. 3.	R.	*Hayden, Henry Herbert, D.Sc., C.I.E., B.A., B.E., B.A.I., F.G.S., F.A.S.B., Director, Geological Survey of India. <i>Calcutta.</i>	
1911 June 7.	R.	Hedayat Husain, M., Lecturer, Presidency College. 7-1, <i>Ramsankar Roy's Lane, Calcutta.</i>	
1907 Nov. 6.	A.	Hepper. Captain Lionel Lees, Royal Artillery. <i>Europe.</i>	
1908 June 3.	N.R.	Herron, Alexander Macmillan, B.Sc. <i>Poona.</i>	
1911 April 5.	N.R.	Hiralal, Rai Bahadur, B.A., M.R.A.S., on special duty. <i>Nagpur.</i>	
1908 April 1.	N.R.	Hirst, Captain Frederick Christian. <i>Indian Army, Shillong.</i>	
1906 Dec. 5.	F.M.	Hirst, Reginald John. C/o Messrs. H. S. King and Co. 9, <i>Pall Mall, London.</i>	
1891 July 1.	F.M.	*Holland, Sir Thomas Henry, K.C.I.E., D.Sc., A.R.C.S., F.G.S., F.R.S., F.A.S.B. <i>Westwood, Alderley Edge, Cheshire, England.</i>	
1908 July 1.	R.	Holmwood, Hon. Mr. Justice Herbert, I.C.S. 22, <i>Theatre Road, Calcutta.</i>	
1910 Jan. 5.	A.	Hope, Geoffroy D., B.Sc., Ph.D. <i>Europe.</i>	
1898 Feb. 2.	R.	*Hooper, David, F.C.S., F.L.S., F.A.S.B. 1, <i>Sudder Street, Calcutta.</i>	
1909 May 5.	N.R.	Horovitz, Josef, Ph.D. <i>M.A.O. College, Aligarh.</i>	
1901 Dec. 4.	R.	Hossack, William Cardiff, M.D., D.P.H. <i>Bengal Club, Calcutta.</i>	
1873 Jan. 2.	L.M.	Houstoun, George L., F.G.S. <i>Johnstone Castle, Renfrewshire, Scotland.</i>	

Date of Election.		
1905 July 5.	N.R.	Humphries, Edgar de Montfort, B.A., I.C.S., Settlement Officer. <i>Pertabgarh, Oudh.</i>
1908 June 3.	N.R.	Hutchinson, C. M. <i>Pusa.</i>
1911 Feb. 1.	R.	Insch, Jas. 89, <i>Park Street, Calcutta.</i>
1904 Jan. 6.	N.R.	Jackson, Victor Herbert, M.A. <i>Patna Colleye, Bankipur.</i>
1908 Nov. 4.	N.R.	Jacob, Sydney Montague, I.C.S. <i>C/o Messrs. King King & Co., Bombay.</i>
1907 Dec. 4.	R.	James, Henry Rosher, M.A., Bengal Education Service. <i>Principal, Presidency College, Calcutta.</i>
1905 May 3.	R.	Jayaswal, Kashi Prasad, Bar.-at-Law, High Court. <i>Calcutta.</i>
1907 Sept. 25.	N.R.	Jenkins, Owen Francis, I.C.S., Offg. Joint Magistrate. <i>Muttra.</i>
1912 Mar. 6.	R.	Jessop, W. 25, <i>Chowringhee Road, Calcutta.</i>
1908 June 3.	R.	Jones, Herbert Cecil. A.R.S.M., A.R.C.S., F.G.S., Asst. Supdt.. Geological Survey of India. <i>Calcutta.</i>
1911 Sept. 1.	N.R.	Juggarao, Sir Raja Ankitam Venkata. <i>Zemin-dar of Shermahamadpuram, Dabagardens, Vizagapatam.</i>
1911 Nov. 1.	N.R.	Kamaluddin Ahmed, Shams-ul-Ulama. <i>Supdt., Govt. Madrassa, Chittagong.</i>
1891 Feb. 4.	N.R.	Kapur, Raja Ban Behari, C.S.I. <i>Burdwan.</i>
1911 Jan. 1.	N.R.	Kaye, George Rusby. Registrar, Govt. of India, Dept. of Education. <i>Simla.</i>
1910 May 4.	R.	*Kemp, Stanley W., B.A., F.A.S.B., Senior Assistant Superintendent, Indian Museum. <i>Calcutta.</i>
1882 Mar. 1.	N.R.	Kennedy, Pringle, M.A., B.L., Vakil. <i>Mozaffer-pur.</i>
1906 Aug. 1.	R.	Kennedy, William Willoughby, M.A., M.D., D.P.H., M.R.S.C., L.R.C.P. 36, <i>Chowringhee, Calcutta.</i>
1906 Sept. 19.	R.	Kesteven, Charles Henry, Solicitor to Government. 26, <i>Dalhousie Square, Calcutta.</i>
1909 Oct. 6.	R.	Khaliluddin Ahmed, Dr. 36, <i>Taltolla Lane, Calcutta.</i>
1909 April 7.	F.M.	Kilner, John Newport, M.B., L.R.C.S., L.R.C.P. <i>C/o Army & Navy Stores, Victoria St., London.</i>
1910 Mar. 2.	R.	Kirkpatrick, W. <i>Chartered Bank Buildings, Calcutta.</i>
1904 May 4.	N.R.	Knox, Kenneth Neville, I.C.S. <i>Almora.</i>
1911 Jan. 4.	N.R.	Koul, Anand, Supdt. Customs and Excise Department. <i>Srinagar, Kashmir.</i>

Date of Election.			
1896 July 1.	A.	Küchler, George William, C.I.E., M.A.	<i>Europe.</i>
1910 Sept. 7.	N.R.	Kumar, Sahu Ram.	<i>Thakurdware, Moradabad.</i>
1887 May 4.	L.M.	Lanman, Charles Rockwell.	9, <i>Farrar Street, Cambridge, Massachusetts, U.S. America.</i>
1889 Mar. 6.	L.M.	*La Touche. Thomas Henry Digges, B.A., F.G.S., F.A.S.B.	<i>Alfriston Hills Road, Cambridge, England.</i> [Calcutta.
1911 Feb. 1.	R.	Law, Narendra Nath.	96, <i>Amherst St.,</i>
1909 Jan. 6.	R.	Leake, A. Martin, F.R.C.S., V.C.	14, <i>Garden Reach Road, Calcutta.</i>
1902 July 2.	F.M.	Leake, Henry Martin, M.A., F.L.S.	13, <i>Court Road, West Norwood, London, S.E.</i>
1889 Nov. 6.	R.	Lee, William A., F.R.M.S.	2, <i>New China Bazar Street, Calcutta.</i>
1909 Mar. 3.	A.	LeQuesne, Rev. W. R.	<i>Europe.</i>
1889 Feb. 6.	N.R.	Little, Charles, M.A.	<i>Patna College, Bankipur.</i>
1907 Dec. 4.	N.R.	Little, James Henry, Assistant Master,	<i>Nawab Bahadur's Institution, Murshidabad.</i>
1907 Mar. 6.	R.	Lloyd, Captain Richard Ernest, M.B., B.Sc., I.M.S.	<i>Medical College, Calcutta.</i>
1909 Nov. 3.	A.	Löffler, Emanuel Mano.	<i>Europe.</i>
1911 May 3.	R.	Lomax, C. E., M.A.	11, <i>Loudon Street, Calcutta.</i>
1906 Oct. 31.	N.R.	Luard, Captain Charles Eckford, Indian Army, M.A. (Oxon).	Resident, <i>Indore.</i>
1910 April 6.	N.R.	Ludwig, Eugen.	<i>Gudur.</i>
1905 Aug. 2.	N.R.	Lukis, Hon. Surgeon-General Sir Charles Pardey, K.C.S.I. C.S.I., M.B., F.R.C.S., I.M.S., Director-General, Indian Medical Service.	<i>Simla.</i>
1913 Jan. 8.	R.	Luxburg, Count Graf. Karl L., Imperial Consul-General for Germany.	16, <i>Store Road, Ballygunge, Calcutta.</i>
1870 April 7.	L.M.	Lyman, B. Smith.	708, <i>Locust Street, Philadelphia, U.S. America.</i>
1905 Aug. 2.	R.	McCay, Captain David, M.B., I.M.S.	<i>Medical College, Calcutta.</i>
1912 April 3.	R.	MacCabe, Surgeon Capt. Frederick, F.,	5, <i>Harrington Mansions, Harrington Street, Calcutta.</i>
1893 Jan. 11.	L.M.	Maclagan, Hon. Sir Edward Douglas, M.A., K.C.S.I., C.S.I., I.C.S.	Secretary, Government of India, Revenue and Agriculture Department. <i>Simla.</i>
1912 May 1.	R.	McLean, David.	6, <i>Russell Street, Calcutta.</i>
1913 Mar. 5.	N.R.	MacMahon, Prof. P. S.,	<i>Canning College, Lucknow.</i>
1899 Mar. 1.	N.R.	McMinn, Charles W., B.A., I.C.S. (retired).	<i>Jath Tal, Bhim P.O., Kumaon.</i>

Date of Election.		
1891 Feb. 4.	R.	Macpherson, Hon. Mr. Duncan James, M.A., C.I.E., I.C.S. <i>Chinsurah.</i>
1893 Jan. 11.	L.M.	Madho Rao Scindia, Colonel His Highness Maharajah Sir, <i>Alijah Bahadur</i> , G.C.S.I. G.C.V.O., A.D.C., LL.D., Maharajah of Gwalior. <i>Jai Bilas, Gwalior.</i>
1906 Dec. 5.	R.	Mahalanobis, Subodh Chandra, B.Sc., F.R.S.E., F.R.M.S. 210, <i>Cornwallis Street, Calcutta.</i>
1911 Mar. 1.	R.	Mahatap, Hon. Sir Bijoy Chand, K.C.S.I., Maharajadhiraj of Burdwan. 6, <i>Alipur Road, Calcutta.</i>
1898 Nov. 2.	N.R.	Maitra, Akshaya Kumar, B.A., B.L. <i>Rajshahi.</i>
1901 July 6.	N.R.	Malyon, Lieut. Frank Hailstone. 21st <i>Punjabis, Peshawar.</i>
1901 June 5.	N.R.	Mann, Harold Hart, D.Sc., M.Sc., F.L.S., Principal, Agricultural College. <i>Poona.</i>
1907 Dec. 4.	N.R.	Manners-Smith, Lieut.-Col. John, Indian Army, C.V.O., C.I.E., Resident, Nepal. <i>Khatmandu.</i>
1899 Aug. 30.	N.R.	Mannu Lal, Rai Bahadur, Civil Surgeon. <i>Barabanki.</i>
1905 Dec. 6.	F.M.	Marsden, Edmund, B.A., F.R.G.S. 12, <i>Elerdale Road, Hampstead, London.</i>
1911 June 7.	N.R.	Maturin, Lieut. Hugh Geoffrey, 61st <i>King George's Own Pioneers. United Service Club, Simla.</i>
1911 Aug. 2.	A.	Maulik, Samarendra. <i>Europe.</i>
1892 April 6.	R.	Maynard, Lieut.-Col. Frederic Pinsent, M.B., D.P.H., F.R.C.S., I.M.S., Professor of Ophthalmic Surgery, Medical College. <i>Calcutta.</i>
1912 Jan. 10.	N R	Mazumder, Rai Jadunath, Bahadur, Government Pleader. <i>Jessore.</i>
1913 June 4.	R.	Mazumdar, Ramesh Chandra. 16, <i>Chandrunath Chatterji Street, Bhowanipur, Calcutta.</i>
1905 Feb. 1.	N.R.	Megaw, Captain John Wallace Dick, M.B., I.M.S. <i>Civil Surgeon, Monghyr.</i>
1886 Mar. 3.	L.M.	Mehta, Roostumjee Dhunjibhoy, C.I.E. 9, <i>Rainey Park, Ballygunge, Calcutta.</i>
1895 July 3.	F.M.	Melitus, Hon. Mr. Paul Gregory, C.I.E., I.C.S. C/o Messrs. Grindlay & Co., 54, <i>Parliament Street, London.</i>
1911 April 5.	N.R.	Meston, Hon. Sir J. S., K.C.S.I., C.S.I., C.S. <i>Government House, Lucknow.</i>
1884 Nov. 5.	R.	*Middlemiss, Charles Stewart, B.A., F.G.S., F.A.S.B., Superintendent, Geological Survey of India. <i>Calcutta.</i>
1905 Dec. 6.	R.	Midhut Mohamed Hossain Khan. 8, <i>Golam Sobhan's Lane, Calcutta.</i>
1884 Sept 3.	R.	Miles, William Harry. 7, <i>Church Lane, Calcutta.</i>

Date of Election.		
1904 April 6.	A	Miller, Sir John Ontario, C.S.I., I.C.S. <i>Europe.</i>
1906 Mar. 7.	N.R.	Milsted, Walter Percy Spencer. <i>Boys' High School, Allahabad.</i>
1912 June 5.	N.R.	Misra, Champaram, Tahsildar. <i>Kaisergunj, Bahraich.</i>
1911 July 5.	N.R.	Misra, Shyam Behari, B.A., I.C.S., Revenue Member, Council of Regency. <i>Jodhpur.</i>
1897 Jan. 6.	N.R.	Misra, Tulsi Ram, M.A., Prof., D. J. High School. <i>Kanauj.</i>
1906 June 6.	R.	Mitra, Kumar Manmatha Nath. 34. <i>Shampukur Street, Calcutta.</i>
1910 July 6.	R.	Mohapatra, Srikrishna. 10/1, <i>St. James's Square, Calcutta.</i> [pore.
1908 Mar. 4.	R.	Moitry, Manmatho Nath, Landholder. <i>Seram-</i>
1908 Mar. 4.	A.	Mollison, James. <i>Europe.</i>
1901 Aug. 7.	N.R.	Molony, Edmund Alexander, I.C.S. <i>Gorakhpur.</i>
1895 July 3.	N.R.	Monohan, Francis John, I.C.S., <i>Jalpaiguri.</i>
1910 Feb. 2.	R.	Monohar Lal, M.A. <i>Barrackpore.</i>
1906 Dec. 5.	N.R.	More, Capt. James Carmichael. 51st <i>Sikhs U.S. Club, Simla.</i>
1906 Dec. 5.	N.R.	Morton, Captain Sidney. 24th <i>Punjabis Nowshera.</i>
1908 Dec. 2.	A.	Moses, Capt. Owen St. John, M.D., F.R.C.S., I.M.S. <i>Europe.</i>
1909 Mar. 3	R.	Mukherjee, Brajalal, M.A. 9, <i>Old Post Office Street, Calcutta.</i>
1909 Jan. 6.	R.	Mukherjee, Govinda Lall. 9, <i>Old Post Office Street, Calcutta.</i>
1899 Sept. 29.	R.	Mukherjee, Jotindra Nath, B.A., Solicitor. 3, <i>Old Post Office Street, Calcutta.</i>
1911 Feb. 1.	R.	Mukherjee, Manmathanath, Sub-Divisional Officer. <i>Uluberia, Howrah.</i>
1900 May 2.	R.	Mukherjee, Phani Bhusan, B.Sc. 57, <i>Jhowtola Road, Ballygunge, Calcutta.</i>
1898 May 4.	R.	Mukherjee, Sir Rajendra Nath, K.C.I.E. 7, <i>Harrington Street, Calcutta.</i>
1894 Aug. 30.	R.	Mukherjee, Sibnarayan. <i>Uttarpara, Bally.</i>
1886 May 5	L.M.	*Mukhopadhyaya, Hon. Justice Sir Asutosh, Kt., C.S.I., M.A., D.L., D.Sc., F.R.S.E., F.R.A.S., F.A.S.B., Judge, High Court. <i>Calcutta.</i>
1908 Feb. 5.	R.	Mukhopadhyaya, Girindra Nath, B.A., M.B. 80, <i>Russa Road North, Bhowanipur, Calcutta.</i>
1892 Dec. 7.	R.	Mukhopadhyaya, Panchanan. 45, <i>Bechoo Chatterji's Street, Calcutta.</i>
1909 Mar. 3.	R.	Mullick, Indu Madhab, M.A., M.D. 70, <i>Harrison Road, Calcutta.</i>
1901 April 3.	R.	Mullick, Pramatha Nath, Zemindar. 7, <i>Prasanno Kumar Tagore's Street, Calcutta.</i>
1913 Mar. 5.	R.	Munro, Capt. David. <i>Presidency General Hospital, Calcutta.</i>

Date of Election.		
1910 Nov. 2.	A.	Murray, William Alfred, B.A. (Cantab), M.B. <i>Europe.</i>
1911 Sept. 1.	N.R.	Murtaza Hosein Khan, Nawab, Vakil and Zemindar. Katra abu Torabkhan. <i>Lucknow.</i>
1908 Sept. 23.	N.R.	Muzaffur Ali Khan Bahadur, Syed, Zemindar and Rais. <i>Jausath, Dist. Muzaffarnagar.</i>
1906 Mar. 7.	R.	Nahar, Puran Chand. 48, <i>Indian Mirror Calcutta.</i>
1908 Sept. 23.	N.R.	Nande, Lala Jyotiprakas, Zemindar. <i>Burdwan.</i>
1904 Dec. 7.	R.	Nathan, Robert, C.S.I., I.C.S. <i>Calcutta.</i>
1890 Feb. 5.	N.R.	Nesfield, Capt. Vincent Blumhardt, F.R.C.S., L.R.C.P., I.M.S., Sanitary Commissioner. <i>Agra.</i>
1901 Mar. 6.	N.R.	Nevill, Henry Rivers, I.C.S., Editor, District Gazetteers. United Provinces. <i>Nainital.</i>
1910 May 4.	R.	Newman, Major Ernest Alan Robert, I.M.S. 16, <i>Alipore Road, Calcutta.</i>
1889 Aug. 29.	L.M.	Nimmo, John Duncan. <i>C/o Messrs. Walter Duncan & Co., 137, West George Street, Glasgow.</i>
1894 June 6.	N.R.	Nomani. Shams-ul-Ulama Maulavi Shibli. <i>Lucknow.</i>
1906 Dec. 5.	N.R.	Norman, Henry Campbell, M.A. <i>Queen's College, Benares.</i>
1913 July 2.	N.R.	Norton, E. L., I.C.S., District Magistrate. <i>Allahabad.</i>
1908 Feb. 5.	R.	Nott, Lieut.-Col. Arthur Holbrook, M.D., I.M.S. <i>Howrah.</i>
1906 Dec. 5.	R.	O'Kinealy, Lieut.-Col. Frederick, M.R.C.S. (Eng.), L.R.C.P. (Lond.), I.M.S. <i>Presidency General Hospital, Calcutta.</i>
1905 May 3.	N.R.	Ollenbach, Alfred James, B.A., I.C.S. <i>Cordite Factory, Aruvankadu P.O., Nilgiris, S. India.</i>
1905 Nov. 1.	A.	O'Malley, Lewis Sydney Steward, B.A., I.C.S. <i>Europe.</i>
1909 April 7.	N.R.	Ozzard, Lieut.-Col. Fairlie Russell, I.M.S. <i>Jask, Persian Gulf.</i>
1907 July 3.	R.	Page, William Walter Keightley. 10, <i>Old Post Office Street, Calcutta.</i>
1901 Jan. 2.	N.R.	Pande, Ramavatar, B.A., I.C.S., District Judge. <i>Mirzapur, U.P.</i>
1907 Feb. 6.	R.	Panioty, John Emanuel, L.R.C.P. (Lond.), L.R.C.P. & S. (Edin.). 19, <i>Boyd Street, Calcutta.</i>
1901 Aug. 28.	N.R.	Panton, Edward Brooks Henderson, B.A., I.C.S. <i>Berhampore, Murshidabad.</i>
1904 Aug. 3.	N.R.	Parasnis. Dattalraya Balwant. <i>Satara.</i>

Date of Election.			
1910 April 6	N.R.	Patuck, Pestonji Sorabji, I.C.S.	<i>Wardha.</i>
1899 Aug. 2	A.	Peake, Charles William, M.A.,	<i>Europe.</i>
1906 Dec. 5	R.	Peart, Major Charles Lubé.	<i>106th Hazara Pioneers, Secretary and Member, Board of Examiners, Calcutta.</i>
1888 June 6	L.M.	Pennell, Aubray Percival, B.A., Bar.-at-Law.	<i>Rangoon.</i>
1877 Aug. 1	N.R.	Peters, Lieut.-Col. Charles Thomas, M.B., I.M.S. (retired).	<i>Dinajpur.</i>
1906 April 4	R.	Petrocochino, Leonidar.	<i>4, Clive Ghat Street, Calcutta.</i>
1889 Nov. 6	L.M.	*Phillott, Lieut.-Colonel Douglas Craven, PH.D., F.A.S.B.	<i>Indian Army (retired). C/o Messrs. Grindlay & Co., 54, Parliament Street, London.</i>
1904 June 1	R.	Pilgrim, Guy Elcock, D.Sc., F.G.S., Assistant Superintendent, Geological Survey of India.	<i>Calcutta.</i>
1908 Jan. 1	A.	Pilgrim, Lieut.-Col. Herbert Wilson, M.B., F.R.C.S., I.M.S.	<i>Europe.</i>
1910 Aug. 3	R.	Podamraj, Jain, 9.	<i>Joggomohan Mullick's Lane, Calcutta.</i>
1910 Feb. 2	N.R.	Poplai, Sri Ram.	<i>Kabul Gate, Delhi.</i>
1906 Aug. 1	N.R.	Price, Charles Stanley.	<i>Victoria Boys' School, Kurseong.</i>
1907 Jan. 2	A.	Pulley, Lieut. Henry Cuthbert,	<i>12th Pioneers. Europe.</i>
1910 Dec. 7	N.R.	Radha Krishna.	<i>Banker, Chauk, Patna City.</i>
1880 April 7	N.R.	Rai. Bepin Chandra.	<i>Giridih, Chota Nagpur.</i>
1895 Aug. 29	N.R.	Rai Chaudhuri, Jatindranath, M.A., B.L., Zemin- dar.	<i>Taki, Jessore.</i>
1913 April 2	R.	Ramaswami, M. S., Curator of the Herbarium.	<i>Royal Botanic Garden, Sibpur, Howrah.</i>
1908 Feb. 5	N.R.	Randle, Herbert Neil, B.A.	<i>Queen's College, Benares.</i>
1908 July 1	N.R.	Ranganathasvami, S. P. V.,	<i>Aryavaraguru, Arshya Library, Vizagapatam.</i>
1905 Jan. 4	N.R.	Rankin, James Thomas, I.C.S.	<i>Comilla.</i>
1907 Aug. 7	N.R.	Ranking, Lieut. James.	<i>Nowshera.</i>
1904 Mar. 4	F.M.	Rapson, E. J.	<i>8, Mortimer Road, Cambridge.</i>
1890 Mar. 5	R.	*Ray, Prafulla Chandra, D.Sc., F.A.S.B., Pro- fessor, Presidency College.	<i>Calcutta.</i>
1887 May 4	R.	Ray, Prasanna Kumar D.Sc. (Lond. and Edin.).	<i>7, Ballygunge Circular Road, Calcutta.</i>
1905 May 3	R.	Richardson, Hon. Mr. Justice Thomas William, I.C.S., Judge, High Court.	<i>Calcutta.</i>
1908 Feb. 5	N.R.	Rigo-de-Righie, Alceste Carlo.	<i>Royal Hotel, Naini Tal.</i>
1910 April 6	A.	Robertson, A. White, L.R.C.P.	<i>Europe.</i>

Date of Election.			
1913	Sept. 3.	R.	Rogalsky, P. A., Attaché to the Imperial Russian Consulate General. 3, <i>Upper Wood Street, Calcutta.</i>
1903	Mar. 4.	N.R.	Rogers, Charles Gilbert, F.L.S., F.C.H., Forest Department. <i>Port Blair, Andamans.</i>
1900	April 4.	R.	*Rogers, Lt.-Col. Leonard, C.I.E., M.D., B.S., F.R.C.P., F.R.C.S., F.A.S.B., I.M.S. <i>Medical College, Calcutta.</i>
1901	Dec. 4.	R.	*Ross, Edward Denison, C.I.E., Ph.D., F.A.S.B. <i>Bengal Club, Calcutta.</i>
1889	June 5.	N.R.	Roy, Maharaja Girjanath. <i>Dinagepore.</i>
1903	July 1.	L.M.	Roy, Maharaja Jagadindranath, Bahadur. 6, <i>Lansdowne Road, Calcutta.</i>
1910	Sept. 7.	N.R.	Roy, Kumar Sarat Kumar. <i>Dayarampur. Rajshahi.</i> [<i>Rungpur.</i>]
1909	Nov. 3.	N.R.	Roychaudhury, Mrityunjoy. <i>Shyampur P.O.</i>
1908	June 3.	N.R.	Roychaudhury, Surendra Chandra, Zemindar. <i>Koondi, Rungpur.</i>
1906	Feb. 7.	N.R.	Russell, Charles, M.A. <i>Patna College, Bankipur.</i>
1908	Feb. 5.	N.R.	Russell, Robert van, I.C.S., Supdt. of Gazetteer and Ethnography. <i>Mandla, C.P.</i>
1913	Apl. 2	N.R.	Sahay, Rai Sahib Bhagvati, M.A., B.L., Offg. Inspector of Schools, Patna Division. <i>Bankipur.</i>
1911	Nov. 1	N.R.	Sahni, Dayaram, M.A., Supdt. of Archaeology. <i>Srinagar, Kashmir.</i>
1896	Aug. 27.	R.	Samman, Hon. Mr. Herbert Frederick, I.C.S., Secretary, Govt. of Bengal, Genl. Dept. <i>Calcutta.</i> [<i>Calcutta.</i>]
1910	May 4	R.	Sandes, Capt. J. D., M.B., I.M.S. <i>Medical College,</i>
1906	June 6.	N.R.	Sanial, Surendra Prasad, M.A., F.C.S., Private Secretary to Raja Bahadur. <i>Majhauri.</i>
1899	June 7.	N.R.	Sarkar, Chandra Kumar. <i>Kankani, Moulmein.</i>
1898	Mar. 2.	N.R.	Sarkar, Jadunath. <i>Patna College, Bankipur.</i>
1909	Mar. 3	R.	Sarvadhikari, Hon. Mr. Deva Prasad, M.A., B.L. 2, <i>Old Post Office Street, Calcutta.</i>
1911	Jan. 4.	R.	Sarvadhikari, Dr. Suresh Prasad. 79-1, <i>Amherst St., Calcutta.</i>
1902	Feb. 5.	R.	Schulten, Joseph Henry Charles, Ph.D. 4, <i>Pollock Street, Calcutta.</i>
1900	Dec. 5.	N.R.	Schwaiger, Imre George, Expert in Indian Art. <i>Kashmir Gate, Delhi.</i>
1908	July 1.	N.R.	Seal, Brojendra Nath, M.A. <i>Victoria College, Cooch Behar.</i>
1911	June 7.	A.	Seconde, Lieut. Emile Charles. <i>Europe.</i>
1906	Feb. 7.	R.	Sen, Girindra Kumar. 303, <i>Bowbazaar Street, Calcutta.</i>
1902	May 7.	R.	Sen, Jogendra Nath, <i>Vidyaratna, M.A.</i> 31, <i>Prasanna Kumar Tagore's Street, Calcutta.</i>

Date of Election.			
1905	Jan. 4.	R.	Sen, Sukumar. 220, <i>Lower Circular Road, Calcutta.</i>
1897	Dec. 1.	R.	Seth, Mesrovb J. 11, <i>Wellesley Square, Calcutta.</i>
1911	July 5.	R.	Sewell, Capt. Robert Beresford Seymour, M.R.C.S., L.R.C.P., I.M.S. <i>Indian Museum, Calcutta.</i>
1906	Dec. 5.	N.R.	Sharp, Henry, C.I.E., M.A., Depy. Secy., Govt. of India, Dept. of Education. <i>Simla.</i>
1885	Feb. 4.	L.M.	*Shastri, Mahamahopadhyaya, Haraprasad, C.I.E., M.A., F.A.S.B. 26, <i>Pataldunga Street, Calcutta.</i>
1902	Dec. 3.	N.R.	Shastri, Harnarain Goswami. <i>Hindu College, Delhi.</i>
1912	Jan. 10.	R.	Shirazi, Aga Muhamad Kazim. 23, <i>Lower Chitpur Road, Calcutta.</i>
1909	Jan. 6.	N.R.	Shirreff, Alexander Grierson, B.A., I.C.S. <i>Gonda, U.P.</i>
1913	Dec. 3.	R.	Shorten, Capt. James Alfred, B.A., M.B., B.Ch., I.M.S. <i>Medical College, Calcutta.</i>
1908	Mar. 4.	R.	Shujaat Ali, Nasurul Mamalik Mirza, <i>Khan Bahadur, Acting Consul-General for Persia. 10, Hungerford Street, Calcutta.</i>
1902	Feb. 5.	N.R.	Shyam Lal, Lala, M.A., LL.B., Deputy Collector. <i>Naimadri, Agra.</i>
1899	May 3.	N.R.	Silberrad, Charles Arthur, B.A., B.Sc., I.C.S.. <i>The Secretariat. Bombay.</i>
1913	Mar. 5.	N.R.	Simonsen, Prof. J. I. <i>Presidency College, Madras.</i>
1909	April 7.	F.M.	Simpson, George Clarke, D.Sc. <i>C/o Delhi and London Bank, Simla.</i>
1903	Aug. 26.	F.M.	Simpson, John Hope, I.C.S. <i>C/o Messrs. Barclay & Co., 1, Dickinson Street, Manchester, England.</i>
1912	Sept 5.	N.R.	Singhi, Bahadur Sing. <i>Azimjung, Murshidabad.</i>
1901	Aug. 7.	R.	Singh, Chandra Narayan, <i>Rai Bahadur. 82, Lansdowne Road, Calcutta.</i>
1904	Mar. 4.	N.R.	Singh, Kumar Kamlanand. <i>Srinagar Raj, Srinagar P.O., Purneah District.</i>
1894	July 4.	N.R.	Singh, Raja Kushal Pal, M.A. <i>Narki.</i>
1895	Aug. 29.	R.	Singh, Lachmi Narayan, M.A., B.L., Pleader, <i>High Court, Calcutta.</i>
1912	May 1.	R.	Singh Ray, Lalit Mohan, <i>Rai Bahadur. 4, Creek Row, Calcutta.</i>
1893	Mar. 1.	N.R.	Singh, Maharaja Kumara Sirdar Bharat, I.C.S. (retired). <i>Shankergar, Allahabad.</i>
1892	Mar. 2.	L.M.	Singh, Raja Ooday Pratab, C.S.I., <i>Raja of Bhinga. Bhinga.</i>

Date of Election.		
1899 Aug. 29.	N.R.	Singh, H.H. The Maharaja Sir Prabhu Narain, <i>Bahadur</i> , G.C.I.E., Maharaja of Benares. <i>Ramnagar Fort, Benares.</i>
1909 April 7.	N.R.	Singh, Raja Prithwipal, Talukdar of Surajpur. <i>District Barabanki, Oudh.</i>
1889 Nov. 6.	N.R.	Singh, H.H. The Hon. Maharaja Sir Ramesh-wara, <i>Bahadur</i> , K.C.I.E. <i>Durbhanga.</i>
1912 Mar. 6.	R.	Singh, Maharaja Ranjit, of Nasirpur. 58, <i>Chowringhee Road, Calcutta</i>
1913 July 2	N.R.	Singh, Rudradat, M.A., LL.B., Vakil. <i>Lucknow.</i>
1894 Feb 7.	N.R.	Singh, H.H. The Maharaja Vishwa Nath <i>Bahadur</i> . <i>Chhatturpur, Bundelkhund.</i>
1897 Jan. 6.	R.	Sircar, Amrita Lal, F.C.S., L.M.S. 51, <i>Sankari-tolla Lane, Calcutta.</i>
1898 Aug. 3.	N.R.	Sita Ram, B.A., Depy. Magistrate. <i>Allahabad.</i>
1913 July 2	N.R.	Sivaprasad, B.A., Offg. Junior Secretary to the Board of Revenue, C.P. <i>Allahabad.</i>
1909 July 7.	A.	Smith, Capt. H. Emslie, I.M.S. <i>Europe.</i>
1911 Mar. 1.	A.	Smith, Major O. A. 27th <i>Punjabis</i> . <i>Europe.</i>
1907 Mar. 6.	N.R.	Sofiulla Saifuddin Ahmed, Maulavi, In-spector of Excise. <i>Silchar.</i>
1912 Jan. 10.	R.	Southwell, T., A.R.C.S., F.Z.S., F.L.S., Deputy Director of Fisheries. <i>Writers' Buildings, Calcutta.</i>
1901 Dec. 4.	R.	Spooner, David Brainerd, Ph.D., 27, <i>Chowringhee, Calcutta.</i>
1913 July 2.	N.R.	Srinivas Iyenger, P. T., Principal, M.A.V.N. College. <i>Vizagapatam.</i>
1912 May 1.	R.	Stadler, George L., Consul for Belgium. 37, <i>Chowringhee Road, Calcutta.</i>
1912 Oct 30.	N.R.	Stallard, Dr. Philip Lechmen, District Surgeon. <i>G.I.P. Railway, Jhansi.</i>
1909 April 7.	A.	Stanley, Sir John, Kt., K.C.I.E., K.C. <i>Europe.</i>
1904 Sept. 28.	N.R.	Stapleton, Henry Ernest, B.A., B.Sc. <i>Dacca.</i>
1908 Dec. 2.	A.	Steen, Capt. Hugh Barkley, M.B., I.M.S. <i>Europe.</i>
1904 June 1.	R.	Stephen, Hon. Mr. Justice Harry Lushington, Judge, High Court. <i>Calcutta.</i>
1899 Aug. 30.	R.	Stephen, St. John, B.A., LL.B., Barrister-at-Law. 7, <i>Russell Street, Calcutta</i>
1900 Aug. 29.	N.R.	Stephenson, Major John, I.M.S. <i>Lahore.</i>
1907 Dec. 4.	R.	Stevens, Major C. R., I.M.S. <i>Medical College, Calcutta.</i>
1907 June 5.	N.R.	Stewart, Capt. Francis Hugh, I.M.S. <i>Bombay.</i>
1906 Dec. 5.	F.M.	Stokes, Captain Claude Bayfield, Military At-taché. <i>Teheran, Persia.</i>
1911 Feb. 1.	R.	Stonebridge, Arthur W., Chief Engineer, Messrs. Burn & Co. 7, <i>Hastings St., Cal-cutta.</i>
1907 Aug. 7	N.R.	Subramania Iyer, Valavannur, Extra Asst. Conversator of Forests. <i>Coimbatore.</i>

Date of Election.			
1907	June 5.	R.	Suhrawardy, Abdulla al-Mamun, M.A., D.Litt., LL.D., Bar.-at-Law. 34, <i>Elliott Road, Calcutta.</i>
1907	June 5.	N.R.	Swinhoe Rodway Charles John, Solicitor. <i>Mandalay, Upper Burma.</i>
1909	Jan. 6.	R.	Tagore, Kshitindranath, B.A. <i>Howrah.</i>
1898	April 6.	R.	Tagore, Hon. Maharaja Sir Prodyat Coomar. <i>Bahadur, Kt. Pathuriaghatta, Calcutta.</i>
1906	Mar. 7.	R.	Tagore, Kumar Shyama Kumar, Zemindar. 65, <i>Pathuriaghutta Street, Calcutta.</i>
1904	July 6.	N.R.	Talbot, Walter Stanley, I.C.S., Revenue Commissioner. <i>Jammu.</i>
1910	Aug. 3.	N.R.	Tancock, Capt. Alexander Charles. 31st <i>Punjabis, Nowshera, N.W.F.P.</i>
1893	Aug. 31.	N.R.	Tate, George Passman, Assistant Superintendent, Survey of India. <i>Mussoorie.</i>
1909	Jan. 6.	N.R.	Taylor, Charles Somers, B.Sc. <i>Bhagalpur.</i>
1906	Dec. 5.	N.R.	Tek Chand. Dewan, B.A., M.R.A.S., I.C.S., Deputy Commissioner. <i>Gujranwala, Punjab.</i>
1878	June 5.	N.R.	Temple, Colonel Sir Richard Carnac, Bart., Indian Army, C.I.E. <i>C/o Messrs. King, King & Co., Bombay.</i>
1904	May 4.	N.R.	Thanawala, Framjee Jamasjee. 90, <i>Cawasjee Patel Street, Fort, Bombay.</i>
1875	June 2.	R.	*Thibaut, G., Ph.D., C.I.E., F.A.S.B. 10/2, <i>Elgin Road, Calcutta.</i>
1911	Mar. 1.	F.M.	Thomas, F. W., M.A., Ph.D., Librarian, India Office. <i>London.</i>
1909	Aug. 4.	N.R.	Thompson, John Perronet, M.A., I.C.S. <i>Lahore.</i>
1908	Nov. 4.	N.R.	Thornely, Major, Michael Harris, I.M.S. <i>Arrah.</i>
1898	Nov. 2.	R.	Thornton, Edward, F.R.I.B.A. 6, <i>Clive Street, Calcutta.</i>
1911	Mar. 1.	A.	Thorpe, Godfrey Francis. Bengal Pilot Service. <i>Europe.</i>
1911	July 5.	N.R.	Thurston, Capt. Edward Owen, I.M.S., B.S., F.R.C.S. <i>Burdwan.</i>
1904	June 1.	N.R.	Tipper, George Howlett, M.A., F.G.S., Assistant Superintendent, Geological Survey of India. <i>Minbu, Burma.</i>
1912	Nov. 6.	R.	Tomkins, H. G., C.I.E., F.R.A.S. 9, <i>Riverside, Barrackpur.</i>
1909	Dec. 1.	R.	Toth, Eugene. 13, <i>Sudder Street, Calcutta.</i>
1907	Feb. 6.	N.R.	*Travers, Morris William, D.Sc., F.R.S., F.A.S.B., Director of Indian Institute of Science. <i>Bangalore.</i>
1861	June 5.	L.M.	Tremlett, James Dyer, M.A., I.C.S. (retired). <i>Dedham, Essex, England.</i>
1900	Aug. 29.	N.R.	Vaughan, Lieut.-Col. Joseph Charles Stoelke. I.M.S. <i>Bhagalpur.</i>

Date of Election.			
1890 Feb. 5.	N.R.	*Venis, Arthur, M.A., D.Litt., C.I.E., F.A.S.B. <i>Benares.</i>	
1902 June 4.	R.	*Vidyabhusana, Mahamahopadhyaya Satis Chandra, M.A., Ph.D. F.A.S.B. 26/1, <i>Kanay Lal Dhur's Lane, Calcutta.</i>	
1901 Mar. 6.	A.	*Vogel, Jean Philippe, Litt.D., F.A.S.B. <i>Europe.</i>	
1894 Sept. 27.	L.M.	Vost, Lieut.-Col. William, I.M.S., Civil Sur- geon. <i>Saharanpore.</i>	
1902 Oct. 29.	R.	*Vredenburg, Ernest, B.L., B.Sc., A.R.S.M., A.R.C.S., F.G.S., F.A.S.B. 27, <i>Chowringhee Road.</i>	
1909 Jan. 6.	N.R.	*Walker, Gilbert Thomas, D.Sc., F.R.S., F.A.S.B., Director-General of Observatories. <i>Simla.</i>	
1907 July 3.	R.	Walker, Harold, A.R.C.S., F.G.S., A.M.Inst.M., Assistant Superintendent, Geological Survey of India. <i>Calcutta.</i>	
1900 Jan. 19.	A.	Wallace, David Robb. <i>Europe.</i>	
1901 June 5.	N.R.	Walsh, Hon. Mr. Ernest Herbert Cooper, C.S.I., I.C.S., Member of the Board of Reve- nue, Behar and Orissa. <i>Ranchi.</i>	
1909 July 7.	R.	Waters, Major Ernest Edwin, I.M.S. <i>Chinsurah.</i>	
1911 Feb. 1.	A.	Waters, Dr. Harry George, F.R.I.P.H. <i>Europe.</i>	
1905 Dec. 6.	N.R.	Watson, Edwin Roy, M.A., B.Sc. <i>Dacca.</i>	
1912 Mar. 6.	R.	Watt, Rev. J., Principal, Scottish Churches College. 4, <i>Cornwallis Street, Calcutta.</i>	
1910 Sept. 7.	R.	Watts, H. P., B.A. (Cantab). 11, <i>Loudon Street, Calcutta.</i>	
1909 Dec. 1.	N.R.	Webster, J. E., I.C.S. <i>Kohima, Naga Hills, Assam.</i>	
1907 April 3.	R.	White, Lieut. Arthur Denham, M.B., B.S., (Lond.), I.M.S. <i>General Hospital, Calcutta.</i>	
1913 April 2.	R.	White, Bernard Alfred, 139, <i>Alexandra Court, Calcutta.</i>	
1907 Feb. 6.	A.	White, Captain J. R., D.S.O. <i>Europe.</i>	
1906 Sept. 19.	A.	Whitehead, Richard Bertram, I.C.S. <i>Europe.</i>	
1909 April 7.	A.	Wilkinson, Major Edmund, I.M.S., L.R.C.S., D. Litt. <i>Europe.</i>	
1910 April 6.	N.R.	Williams, Garfield Hodder, M.B., B.S. (Lond.), M.R.C.S., L.R.C.P. <i>St. John's College, Agra.</i>	
1909 Mar. 3.	F.M.	Wilson, J. R. R., M.I.C.E., F.G.S., H. M. Inspec- tor of Mines. <i>Woodlands, Westwood Lane, Leeds, England.</i>	
1913 Dec. 3.	R.	Wilson, Major Roger Parker, F.R.C.S., D.P.H., I.M.S. <i>Campbell Hospital, Sealdah, Calcutta.</i>	
1910 Dec. 7.	A.	Windsor, Major Frank Needham, I.M.S. <i>Europe.</i>	
1904 Mar. 4.	A.	Wood, William Henry Arden, M.A., F.C.S., F.R.G.S. <i>Europe.</i>	
1909 April 7.	A.	Woodhouse, E. J., B.A. <i>Europe.</i>	
1906 July 4.	A.	Woodley, Rev. Edward Carruthers, M.A. <i>Europe.</i>	

Date of Election.		
1912 Mar. 6.	R.	Woodroffe, Hon. Mr. Justice John George. 13, <i>Alexandra Court, Calcutta.</i>
1906 Mar. 7.	N.R.	Woolner, Alfred Cooper, M.A., Principal, Oriental College. <i>Lahore.</i>
1908 April 1.	R.	Wordsworth, William Christopher. Asst. Director of Public Instruction, Bengal. <i>Writers' Buildings, Calcutta.</i>
1894 Aug. 30.	N.R.	Wright, Henry Nelson, B.A., I.C.S. <i>District Judge, Bareilly.</i>
1905 Mar. 1.	R.	Young, Rev. Arthur Willifer. 23, <i>Chowringhee, Calcutta.</i>
1911 Aug. 2.	A.	Young, Gerald Mackworth, B.A., I.C.S. <i>Europe.</i>
1906 June 6.	N.R.	Young, Mansel Charles Gambier. <i>Dhanbaid.</i>
1910 April 6.	N.R.	Young, Capt. Thomas Charles McCombie, M.B., I.M.S. <i>Shillong, Assam.</i>
1913 May 7.	N.R.	Zutshi, Paudit Monohor Lal, Head Master, Govt. High School. <i>Shahjehanpur.</i>

SPECIAL HONORARY CENTENARY MEMBERS.

Date of Election.		
1884 Jan. 15.		Dr. Ernst Haeckel, Professor in the University of Jena. <i>Prussia.</i>
1884 Jan. 15.		Revd. Professor A. H. Sayce, Professor of Assyriology, Queen's College. <i>Oxford, England.</i>
1884 Jan. 15.		Monsieur Émile Senart. 18, <i>Rue François Ier, Paris, France.</i>

HONORARY FELLOWS.

Date of Election.		
1879 June 4.		Dr. Albert Günther, M.A., M.D., Ph.D., F.Z.S., F.R.S. 23, <i>Lichfield Road, Kew, Surrey, England.</i>
1879 June 4.		Dr. Jules Janssen. <i>Observatoire d'Astronomie Physique de Paris, France.</i>
1883 Feb. 7.		Dr. Alfred Russell Wallace, LL.D., D.C.L., F.L.S., F.Z.S., F.R.S. <i>Curfe View, Parkstone, Dorset, England.</i>
1894 Mar. 7.		Professor Theodor Noeldeke. <i>C/o Mr. Karl T. Trübner, Strassburg, Germany.</i>
1895 June 5.		Lord Rayleigh, M.A., D.C.L., D.Sc., LL.D., Ph.D., F.R.A.S., F.R.S. <i>Ferling Place, Witham, Essex, England.</i>
1895 June 5.		Charles H. Tawney, Esq., M.A., C.I.E. <i>C/o India Office, London.</i>

Date of Election.	
1896 Feb. 5.	Professor Charles Rockwell Lanman. 9, <i>Farrar Street, Cambridge, Massachusetts, U.S. America.</i>
1899 Feb. 1.	Dr. Augustus Frederick Rudolf Hœrnle, Ph.D., C.I.E. 8, <i>Northmoor Road, Oxford, England.</i>
1899 Dec. 6.	Professor Edwin Ray Lankester, M.A., LL.D., F.R.S., <i>British Museum (Nat. Hist.), Cromwell Road, London, S.W.</i>
1899 Dec. 6.	Professor Edward Burnett Tylor, D.C.L., LL.D., F.R.S., <i>Keeper, University Museum. Oxford, England.</i>
1899 Dec. 6.	Professor Edward Suess, Ph.D., Professor of Geology in the University of Vienna.
1901 Mar. 6.	Professor John Wesley Judd, C.B., LL.D., F.R.S., F.G.S., <i>Late Prof. of the Royal College of Science. 30, Cumberland Road, Kew, England.</i>
1902 Nov. 5.	Monsieur René Zeiller. <i>Ingénieur en chef des Mines. École supérieur des Mines, Paris.</i>
1904 Mar. 2.	Professor Hendrick Kern. <i>Utrecht, Holland.</i>
1904 Mar. 2.	Professor Sir Ramkrishna Gopal Bhandarkar, K.C.I.E. <i>Poona.</i>
1904 Mar. 2.	Professor Ignaz Goldziher, Ph.D., D.Litt., LL.D. <i>Budapest, Hungary.</i>
1904 Mar. 2.	Sir Charles Lyall, M.A., K.C.S.I., C.I.E., LL.D. 82, <i>Cornwall Gardens, London, S.W.</i>
1904 Mar. 2.	Sir William Ramsay, Ph.D. (Tüb.), LL.D., Sc.D. (Dubl.), F.C.S., F.I.C. <i>University College, Gower Street, London, W.C.</i>
1904 July 2.	Sir George Abraham Grierson, K.C.I.E., Ph.D., D.Litt., C.I.E., I.C.S. (retired). <i>Rothfarnham, Camberley, Surrey, England.</i>
1906 Mar. 7.	The Right Hon'ble Baron Curzon of Kedleston, M.A., D.C.L., F.R.S. 1, <i>Carlton House Terrace, London, S.W.</i>
1908 July 1.	Lt.-Col. Henry Haversham Godwin-Austen, F.R.S., F.Z.S., F.R.G.S. <i>Nora Godalming, Surrey, England.</i>
1908 July 1.	Dr. H. Oldenberg. <i>The University, Gottingen, Germany.</i>
1911 Sept. 6.	Lieut.-Col. Alfred William Alcock, I.M.S., C.I.E., M.B., LL.D., C.M.Z.S., F.R.S. <i>Heathlands, Erith Road, Belvedere, Kent, England.</i>
1911 Sept. 6.	Prof. Edward George Browne, M.A., M.B., M.R.C.S., L.R.C.P., M.R.A.S. <i>Pembroke College, Cambridge.</i>
1911 Sept. 6.	Dr. A. Engler, Prof. of Systematic Botany, University of Berlin, <i>Prussia.</i>
1911 Sept. 6.	Sir Clements Markham, K.C.B., F.R.S., D.Sc. 21, <i>Eccleston Square, London, S.W.</i>
1911 Sept. 6.	Mahamahopadhyaya Kamakhyanath Tarkavagisa. 111-4, <i>Shambazar Street, Calcutta.</i>

FELLOWS.

Date of Election.		
1910 Feb.	2.	Dr. N. Annandale, D.Sc., C.M.Z.S., F.L.S.
1910 Feb.	2.	The Hon'ble Justice Sir Asutosh Mukhopadhyaya, Kt., C.S.I., M.A., D.L., D.Sc., F.R.A.S., F.R.S.E.
1910 Feb.	2.	I. H. Burkill, Esq., M.A., F.L.S.
1910 Feb.	2.	Mahamahopadhyaya Haraprasad Sashtri, C.I.E., M.A.
1910 Feb.	2.	Sir Thomas Holland, K.C.I.E., D.Sc., A.R.C.S., F.G.S., F.R.S.
1910 Feb.	2.	D. Hooper, Esq., F.C.S., F.L.S.
1910 Feb.	2.	T. H. D. LaTouche, Esq., B.A., F.G.S.
1910 Feb.	2.	Babu Monmohan Chakravarti, M.A., B.L.
1910 Feb.	2.	Lieut.-Colonel D. C. Phillott, Ph.D., Indian Army.
1910 Feb.	2.	Dr. Prafulla Chandra Ray, D.Sc.
1910 Feb.	2.	Lieut.-Col L. Rogers, C.I.E., M.D., B.S., F.R.C.P., F.R.C.S., I.M.S.
1910 Feb.	2.	Dr. E. D. Ross, C.I.E., Ph.D.
1910 Feb.	2.	Mahamahopadhyaya Satis Chandra Vidyabhusana, M.A., Ph.D., M.R.A.S.
1910 Feb.	2.	Dr. G. Thibaut, Ph.D., C.I.E.
1910 Feb.	2.	Dr. M. W. Travers, D.Sc., F.R.S.
1910 Feb.	2.	A. Venis, Esq., M.A.
1910 Feb.	2.	Dr. G. T. Walker, C.S.I., M.A., F.R.S.
1911 Feb.	1.	Hon. Mr. E. A. Gait, C.S.I., C.I.E., I.C.S.
1911 Feb.	1.	H. H. Hayden, Esq., D.Sc., C.I.E., B.A., B.E., B.A.I., F.G.S.
1912 Feb.	7.	H. Beveridge, Esq., I.C.S. (retired).
1912 Feb.	7.	J. C. Bose, Esq., C.S.I., C.I.E., M.A., D.Sc.
1912 Feb.	7.	Prof. P. J. Bruhl, F.C.S.
1912 Feb.	7.	Capt. S. R. Christophers, I.M.S.
1912 Feb.	7.	Charles Stewart Middlemiss, Esq., B.A., F.G.S.
1913 Feb.	5.	Major A. T. Gage, I.M.S.
1913 Feb.	5.	E. Vredenburg, Esq., B.I., B.Sc., A.R.S.M., A.R.C.S., F.G.S.
1913 Feb.	5.	J. Ph. Vogel, Esq., Ph.D., Litt.D.
1913 Feb.	5.	S. W. Kemp, Esq., B.A.

ASSOCIATE MEMBERS.

Date of Election.		
1875 Dec.	1.	Revd. J. D. Bate. 15, <i>St. John's Church Road, Folkstone, Kent, England.</i>
1882 June	7.	Herbert Giles, Esq. <i>Europe.</i>
1885 Dec.	2.	Dr. A. Führer. <i>Europe.</i>
1886 Dec.	1.	Sarat Chandra Das, Rai Bahadur, C.I.E. 32, <i>Creek Row, Calcutta.</i>
1899 April	5.	Pandit Visnu Prasad Raj Bhandari. Chief Librarian, <i>Bir Library, Katmandu, Nepal.</i>
1899 Nov.	1.	Revd. E. Francotte, s.J. 30, <i>Park Street, Calcutta.</i>
1902 June	4.	Revd. A. H. Francke. <i>Niesky Ober-Lausitz, Germany.</i>

Date of Election

1908	July	1.	Babu Dinesh Chandra Sen.	19, <i>Kantapuker Lane, Calcutta.</i>
1908	July	1.	Revd. Father J. Hoffmann, s.J.	<i>Mauresa House, Ranchi.</i>
1909	Mar.	3.	Rai Balkrishna Atmaram Gupte, Bahadur.	<i>Belvedere, Calcutta.</i>
1910	Sept	7.	Shamsul Ulama Maulvi Ahmad Abdul Aziz.	<i>Azeez Bag, City-Hyderabad, Deccan.</i>
1910	Sept.	7.	L. K. Anantha Krishna Iyer, Esq.	<i>Thichur.</i>
1910	Dec.	7.	Rev. H. Hosten, s.J.	<i>30, Park Street, Calcutta.</i>
1913	Feb.	5.	Ekendranath Ghosh, Esq., L.M.S.	

LIST OF MEMBERS WHO HAVE BEEN ABSENT FROM INDIA THREE YEARS AND UPWARDS.*

* *Rule 40.*—After the lapse of three years from the date of a member leaving India, if no intimation of his wishes shall in the interval have been received by the Society, his name shall be removed from the List of Members.

The following members will be removed from the next Member List of the Society under the operation of the above Rule:—

William Barclay Brown, Esq., I.C.S.
 Sir Ernest Cable, Kt.
 Miss Rachel Nathaniel Cohen, M.B., F.R.C.S.
 Lieut.-Col. Dirom Grey Crawford, I.M.S.
 Golap Shanker Dev-Sharman, Esq., F.T.S., M.R.A.S.
 Emanuel Mano Löffler, Esq.
 Sir John Ontario Miller, C.S.I., I.C.S.
 Sir John Stanley, Kt., K.C.I.E., K.C.

LOSS OF MEMBERS DURING 1913.

BY RETIREMENT.

Nawab Ali Hussain Khan.
 Babu Satis Kumar Banerji.
 Cyril Bergtheil, Esq.
 Ratnakrishna Curran Bonerji, Esq.
 Francis Bradley Bradley-Birt, Esq.
 Major G. P. Lenox Conyngham, R.E.
 Henry Thoreau Cullis, Esq., I.C.S.
 Hon. Sir Archdale Earle, K.C.I.E., I.C.S.
 Alexander Hale, Esq., M.I.C.I.E.
 Evelyn Berkeley Howell, Esq., B.A., I.C.S.
 James Charles Jack, Esq., I.C.S.
 Captain George King, M.B., I.M.S.
 Major Clayton Lane, M.D., I.M.S.

J. Walter Leather, Esq., Ph.D.
 Capt. Frederick Percival Mackie.
 Hon. Sir Arthur Henry Macmahon, K.C.I.E.
 Capt. William Macrae, R.E.
 Arthur Cecil McWatters, Esq., I.C.S.
 Rev. Niel Meldrum.
 Babu Pramatha Nath Mukherjee, M.A.
 Major John Mulvany, I.M.S.
 Capt. Charles Cecil Rowe Murphy.
 Major William Frederick Travers O'Connor, C.I.E.
 Capt. Terence Francis Owens, I.M.S.
 David Petrie, Esq.
 Major John W. Forbes Rait, M.B., R.S., I.M.S.
 T. A. Gopinath Rao, Esq., M.A.
 Rai Bahadur Rajendra Chandra Sastri, M.A.
 Shah Munir Alam, Esq., B.A., LL.B.
 Hon. Mr. Justice Syed Sharfuddin.
 Capt. Frank Robinson Teesdale.
 J. H. Towle, Esq.
 Major Henry John Williams.
 Harold Wright, Esq., A.M.I.C.E.

BY DEATH.

Ordinary Members.

Rai Ramsaran Das, Bahadur.
 James Luke, Esq.
 V. Vankaya, Esq.

UNDER RULE 40.

J. A. Anderson, Esq.
 Rev. Evan Mackenzie.
 Capt. Arthur C. Osburn, R.A.M.C.
 Major George Alam Robertson, 15th Lancers.
 Prof. E. Sommerfeldt.

ELLIOTT GOLD MEDAL

RECIPIENTS.

1893 Chandra Kanta Basu.
 1895 Yati Bhusana Bhaduri, M.A.
 1896 Jnan Saran Chakravarti, M.A.
 1897 Sarasi Lal Sarkar, M.A.
 1901 Sarasi Lal Sarkar, M.A.
 1904 { Sarasi Lal Sarkar, M.A.
 { Surendra Nath Maitra, M.A.
 1907 Akshoyakumar Mazumder.
 1911 { Jitendra Nath Rakshit.
 { Jatindra Mohan Datta.

BARCLAY MEMORIAL MEDAL.

RECIPIENTS.

- 1901 E. Ernest Green, Esq.
1903 Major Ronald Ross, F.R.C.S., C.B., C.I.E., F.R.S., I.M.S.
(retired).
1905 Lieut.-Colonel D. D. Cunningham, F.R.S., C.I.E.,
I.M.S. (retired).
1907 Lieut.-Colonel Alfred William Alcock, M.B., LL.D.,
C.I.E., F.R.S.
1909 Lieut.-Colonel David Prain, M.A., M.B., LL.D.,
F.R.S., I.M.S. (retired).
1911 Dr. Karl Diener.
1913 Major William Glen Liston, M.D., C.I.E., I.M.S.
-

[APPENDIX.]

ABSTRACT STATEMENTS
OF
RECEIPTS AND DISBURSEMENTS
OF THE
ASIATIC SOCIETY OF BENGAL
FOR
THE YEAR 1913.

1913.

STATEMENT

Asiatic Society

Dr.

To ESTABLISHMENT.

	Rs.	As.	P.	Rs.	As.	P.
Salaries	5,768	5	6			
Do. (Officer in charge for Researches in History, Religion, Ethnology and Folklore in Bengal)	3,300	0	0			
Commission	611	10	8			
Pension	420	0	0			
Grain Allowance	71	13	6			
Gratuity	100	0	0			
				10,271	13	8

To CONTINGENCIES.

Stationery... ..	188	10	0			
Taxes	1,495	0	0			
Postages	816	5	9			
Freight	213	15	11			
Auditing	150	0	0			
Lights and Fans	200	0	6			
Insurance fee	343	12	0			
Petty Repairs	201	3	0			
Miscellaneous	659	7	2			
				4,268	6	4

To LIBRARY AND COLLECTIONS.

Books	1,120	6	7			
Binding	701	11	0			
				1,822	1	7

To PUBLICATIONS.

“Journal and Proceedings” and “Memoirs”	6,161	9	0			
To printing charges of Circulars, etc. ...	270	7	0			
				6,432	0	0
Interest on Government Paper purchased ...				61	8	9
Indian Science Congress				37	2	0
To Personal Account (write-off and miscellaneous)				213	12	0

To EXTRAORDINARY EXPENDITURE.

Royal Society's Scientific Catalogue				476	3	9
Balance				2,41,382	7	5
TOTAL Rs.				2,64,915	7	6

No. 1.
of Bengal.

1913.

Cr.

	Rs.	As.	P.	Rs.	As.	P.
By Balance from last Report	2,32,334	7	8

BY CASH RECEIPTS.

Interest on Investments	8,292	6	3			
Rent of Room	600	0	0			
Publications sold for cash	120	8	0			
Allowance from Government of Bengal for the publication of papers on Anthropological and Cognate subjects	2,000	0	0			
Do. do. Chief Commissioner of Assam do. do. do.	1,000	0	0			
Do. do. Government of Bengal for Researches in History, Religion, Ethnology, and Folklore in Bengal	3,600	0	0			
Loan	1,210	0	0			
Subscription to Indian Science Congress	130	0	0			
Miscellaneous	165	4	4			
				17,118	2	7

BY EXTRAORDINARY RECEIPTS.

Grant from Government of India to Royal Society's Scientific Catalogue	1,000	0	0
---	-----	-----	-----	-------	---	---

BY PERSONAL ACCOUNT.

Admission fees	736	0	0			
Members' subscription	11,371	0	0			
Subscriptions for the "Journal and Proceedings" and "Memoirs"	1,680	0	0			
Sales on credit	543	11	9			
Miscellaneous	132	1	6			
				14,462	13	3

TOTAL Rs. ... 2,64,915 7 6

ASUTOSH MOOKERJEE,

*Honorary Treasurer,
Asiatic Society of Bengal.*

STATEMENT
1913. Oriental Publication Fund, No. 1, in

Dr.

TO CASH EXPENDITURE.

				Rs.	As.	P.		Rs.	As.	P.
Salaries	1,766	0	0				
Commission	32	10	1				
Postage	219	12	9				
Editing charges	1,513	8	0				
Contingencies	41	12	6				
Printing charges	3,448	13	0				
Stationery	12	7	10				
Freight	102	13	7				
Lights and Fans	33	13	10				
Grain allowance	26	11	3				
								7,198	6	10
To Personal Account (write-off and miscellaneous)		110	11	0
Balance		7,126	14	1
								14,435	15	11
			TOTAL Rs.		14,435	15	11

STATEMENT
1913. Oriental Publication Fund, No. 2, in

Dr.

TO CASH EXPENDITURE.

					Rs.	As.	P.
Printing charges		2,643	5	0
Balance		2,981	14	0
			TOTAL Rs.	...	5,625	3	0

No. 2.

Acct. with the Asiatic Soc. of Bengal. 1913.

Cr.

			Rs.	As.	P.	Rs.	As.	P.
By Balance from last Report			3,193	5	5
BY CASH RECEIPTS.								
Government Allowance	9,000	0	0			
Publications sold for cash	541	3	3			
Advances recovered	67	12	9			
						9,609	0	0
BY PERSONAL ACCOUNT.								
Sales on credit	1,629	8	6			
Miscellaneous	4	2	0			
						1,633	10	6
TOTAL Rs.						14,435 15 11		

ASUTOSH MOOKERJEE,

*Honorary Treasurer,
Asiatic Society of Bengal.*

No. 3.

Acct. with the Asiatic Soc. of Bengal. 1913.

Cr.

				Rs.	As.	P.
By Balance from last Report	625	3	0
BY CASH RECEIPTS.						
Government Allowance	5,000	0	0
TOTAL Rs.				5,625 3 0		

ASUTOSH MOOKERJEE,

*Honorary Treasurer,
Asiatic Society of Bengal.*

STATEMENT

1913. Oriental Publication Fund, No. 3, in

Dr.

TO CASH EXPENDITURE.

				Rs.	As.	P.
Printing charges	691	6	0
Balance	507	3	6
TOTAL Rs.				1,198	9	6

STATEMENT

1913. Sanskrit Manuscript Fund in Acct.

Dr.

TO CASH EXPENDITURE.

				Rs.	As.	P.	Rs.	As.	P.
Salaries	1,518	6	9			
Postage	21	4	6			
Contingencies	66	6	9			
Stationery	18	12	1			
Purchase of Manuscripts	189	2	0			
Insurance	125	0	0			
Grain allowance	5	0	0			
Lights and Fan	33	13	10			
Balance							1,968	13	11
TOTAL Rs.							3,665	6	9
TOTAL Rs.							5,634	4	8

No. 4.

Acct. with the Asiatic Soc. of Bengal. 1913.

				Cr.		
				Rs.	As.	P.
By Balance from last Report	1,198	9	6
TOTAL Rs.				<u>1,198 9 6</u>

ASUTOSH MOOKERJEE,
Honorary Treasurer,
Asiatic Society of Bengal.

No. 5.

with the Asiatic Society of Bengal. 1913.

				Cr.		
				Rs.	As.	P.
By Balance from last Report	2,394	4	8
BY CASH RECEIPTS.						
Government Allowance	3,200	0	0
Publications sold for cash	5	0	0
				<u>3,205</u>	0	0
BY PERSONAL ACCOUNT.						
Sales on credit		35	0 0
TOTAL Rs.				<u>5,634 4 8</u>

ASUTOSH MOOKERJEE,
Honorary Treasurer,
Asiatic Society of Bengal.

STATEMENT

1913. Arabic and Persian MSS. Fund in

Dr.

To CASH EXPENDITURE.

	Rs.	As.	P.		Rs.	As.	P.
Salaries	1,983	10	3				
Contingencies	4	10	0				
Stationery	8	4	1				
Lights and Fan	11	2	10				
Travelling charges	344	10	0				
Loan	1,210	0	0				
Insurance	31	4	0				
Printing	623	4	0				
					4,216	13	2
Balance					1,346	10	10
				TOTAL Rs.			5,563 8 0

STATEMENT

1913. Bardic Chronicle MSS. Fund in

Dr.

To CASH EXPENDITURE.

					Rs.	As.	P.
Travelling charges					148	6	6
Balance					138	4	0
				TOTAL Rs.			286 10 6

No. 6.

Acct. with the Asiatic Soc. of Bengal. 1913.

Cr.

				Rs.	As.	P.
By Balance from last Report	1,230	2	8

BY CASH RECEIPTS.

Government Allowance	4,333	5	4
----------------------	-----	-----	-----	-------	---	---

TOTAL Rs.	...			<u>5,563</u>	<u>8</u>	<u>0</u>
-----------	-----	--	--	--------------	----------	----------

ASUTOSH MOOKERJEE,
Honorary Treasurer,
Asiatic Society of Bengal.

No. 7.

Acct. with the Asiatic Soc. of Bengal. 1913.

Cr.

				Rs.	As.	P.
By Balance from last Report	286	10	6

TOTAL Rs.	...			<u>286</u>	<u>10</u>	<u>6</u>
-----------	-----	--	--	------------	-----------	----------

ASUTOSH MOOKERJEE,
Honorary Treasurer,
Asiatic Society of Bengal.

STATEMENT

1913.

Personal

Dr.

			Rs.	As.	P.	Rs.	As.	P.
To Balance from last Report	5,213	10	7

TO CASH EXPENDITURE.

Advances for purchase of Manuscripts, etc.	461	5	9
To Asiatic Society	14,462	13	3			
„ Oriental Publication Fund, No. 1	1,633	10	6			
„ Sanskrit MSS. Fund	35	0	0			
			<hr/>			16,131	7	9

TOTAL Rs. .. 21,806 8 1

STATEMENT

1913.

Invest-

Dr.

			Value.			Cost.		
			Rs.	As.	P.	Rs.	As.	P.
To Balance from last Report	2,38,700	0	0	2,35,951	0	10
„ Purchase	10,000	0	0	9,612	8	0
			<hr/>			<hr/>		
TOTAL Rs.	2,48,700	0	0	2,45,563	8	10

FUNDS.	PERMANENT RESERVE.				TEMPORARY RESERVE				Total Cost.	
	Value.		Cost.		Value.		Cost.			
	Rs.	A. P.	Rs.	A. P.	Rs.	A. P.	Rs.	A. P.	Rs.	A. P.
Asiatic Society	1,64,100	0 0	1,62,785	9 8	83,200	0 0	81,438	9 2	2,44,224	2 10
Trust Fund	1,400	0 0	1,339	6 0	1,339	6 0
TOTAL Rs.	1,65,500	0 0	1,64,124	15 8	83,200	0 0	81,438	9 2	2,45,563	8 10

No. 8.
Account.

1913.

Cr.

	Rs.	As.	P.	Rs.	As.	P.
By Cash Receipts						
„ Asiatic Society	213	12	0			
„ Oriental Publication Fund, No. 1 ...	110	11	0			
						16,793 9 2
						324 7 0

By Balance.	Due to the Society.			Due by the Society.		
	Rs.	As.	P.	Rs.	As.	P.
Members ...	4,177	5	2	110	13	9
Subscribers	24	0	0
Employés ...	30	0	0	100	0	0
Oriental Publication Fund, No. 1 ...	432	0	0
Bardic Chronicle Fund ...	360	0	0
Arabic and Persian Fund ...	150	0	0
Miscellaneous ...	249	12	6	415	12	0
	5,339	1	8	650	9	9

4,688 7 11

TOTAL Rs.

21,806 8 1

ASUTOSH MOOKERJEE,

*Honorary Treasurer,
Asiatic Society of Bengal.*

No. 9.
ment.

1913.

Cr.

	Value.			Cost		
	Rs.	As.	P.	Rs.	As.	P.
By Balance	2,48,700	0	0	2,45,563	8	10
TOTAL Rs. ...	2,48,700	0	0	2,45,563	8	10

ASUTOSH MOOKERJEE,

*Honorary Treasurer,
Asiatic Society of Bengal.*

STATEMENT

1913.

Trust

Dr.

	Rs.	As.	P.	Rs.	As.	P.
To Pension	48	0	0			
„ Commission for realizing interest ...	0	4	0			
	<hr/>					
Balance ...				1,468	7	10
				<hr/>		
TOTAL Rs. ...				1,516	11	10
				<hr/>		

STATEMENT

Cash

Dr.

	Rs.	As.	P.	
To Balance from last Report	1,565	11	10	
RECEIPTS.				
	Rs.	As.	P.	
To Asiatic Society	18,118	2	7	
„ Oriental Publication Fund, No. 1 ...	9,609	0	0	
„ Do. do. No. 2 ...	5,000	0	0	
„ Sanskrit MSS. Fund ...	3,205	0	0	
„ Arabic and Persian MSS. Fund ...	4,333	5	4	
„ Personal Account ...	16,793	9	2	
„ Trust Fund ..	49	0	0	
	<hr/>			
			57,108 1 1	
			<hr/>	
TOTAL Rs. ...			58,673	12 11
			<hr/>	

No. 10.

Fund.

Cr.

				Rs.	As.	P.
By Balance from last Report	1,467	11	10
„ Interest on Investment	49	0	0
TOTAL Rs.				...	1,516	11 10

ASUTOSH MOOKERJEE,
Honorary Treasurer,
Asiatic Society of Bengal.

No. 11.

Account.

Cr.

EXPENDITURE.

				Rs.	As.	P.	Rs.	As.	P.
By Asiatic Society	23,369	4	1			
„ Oriental Publication Fund, No. 1	7,198	6	10			
„ Do. do. No. 2	2,643	5	0			
„ Do. do. No. 3	691	6	0			
„ Sanskrit MSS. Fund	1,968	13	11			
„ Arabic and Persian MSS. Fund	4,216	13	2			
„ Bardic Chronicles MSS. Fund	148	6	6			
„ Personal Account	461	5	9			
„ Investment	9,612	8	0			
„ Trust Fund	48	4	0			
							50,358	9	3
							8,315	3	8
							58,673	12	11
TOTAL Rs.				...					

ASUTOSH MOOKERJEE,
Honorary Treasurer,
Asiatic Society of Bengal.

No. 12.

Sheet.

1913.

ASSETS.

	Rs.	As. P.	Rs	As. P.
Personal Account	4,688	7 11		
Investment (3½% Government Pro. Notes cost)	2,45,563	8 10		
Cash Account	8,315	3 8		
			<u>2,58,567</u>	<u>4 5</u>
3% Government Pro. Note at the Bank of Bengal's Safe Custody Account, Cashier's Security Deposit, Rs. 500
			<u>2,58,567</u>	<u>4 5</u>
TOTAL Rs. ...				

ASUTOSH MOOKERJEE,

*Honorary Treasurer,
Asiatic Society of Bengal.*

Liabilities up to 31st December, 1913.

FUNDS.

				Rs.	As.	P.
Asiatic Society	4,655	10	0*
Oriental Publication Fund, No. 1 (For printing and editing)				4,833	2	0
Do. do. No. 2 (For printing)				704	13	0
Do. do. No. 3 (For printing)				327	0	0
Bardic Chronicles MSS. Fund (For printing)	...			332	4	0
			TOTAL Rs.	10,852	13	0

* As against a cash balance on the year's working in favour of the Society of Rs. 8,997-15-9.

MARCH, 1914.

The Monthly General Meeting of the Society was held on Wednesday, the 4th March, 1914, at 9-15 P.M.

MAHĀMAHOPĀDHYĀYA HARAPRASĀD SHĀSTRĪ, C.I.E., Vice-President, in the chair.

The following members were present:—

Maulavi Abdul Wali, Dr. N. Annandale, Dr. P. J. Brühl, Mr. G. R. Clarke, Mr. O. C. Ganguly, Mr. F. H. Gravely, Rev. H. Hosten, S.J., Dr. O. Strauss, Rev. J. Watt.

Visitor:—Miss M. Tonnet.

The Minutes of the January Meeting and the Annual Meeting were read and confirmed.

Forty-nine presentations were announced.

The General Secretary reported that Mr. J. R. R. Wilson, Major D. Munro, I.M.S., and Mr. D. J. Macpherson, I.C.S., have expressed a wish to withdraw from the Society.

The General Secretary also reported the death of Dr. Albert Gunther and Dr. Alfred Russell Wallace, Honorary Fellows, and Paṇḍit Viṣṇuprasād Rājbhāṇḍārī, an Associate Member of the Society.

Subbā Viṣṇuprasād Rājbhāṇḍārī was descended from a long line of hereditary Prime Ministers of the Newar Rājās of Nepal. His grandfather did his best to support the cause of the Newar Rājās against the Gurkha invaders. Unsuccessful in his attempt he went to voluntary exile with the Rājā at Benares and died on the bank of the Gaṇḍak where it is said that he was turned into a hillock. Viṣṇuprasād's father was a class friend of Jung Bahadur and was the Governor of Western Nepal. When Jung made himself master of Nepal by the events of 1846, Viṣṇuprasād's father retired from State Service and trained his son for literary profession. Jung Bahadur made him Librarian of the Durbar Library—a post which eminently fitted him. Viṣṇuprasād was an ardent student of Tantra and thorough believer in its doctrines. He has made a large collection of Tantric works and Tantric charts and pictures which has made that Library a unique source of information on Tantric subjects. His death is mourned by a large circle of friends and admirers both among the Newars and Gurkhas of Nepal.

The Council reported that there is a vacancy in the list of Associate Members and therefore recommended Bada Kāji Marīcimān Siṃha of Nepal and an Examiner of the Calcutta University in Pahāria, for election as an Associate Member at the next meeting.

Bada Kāji Marīcimān Siṃha is a Newar gentleman of good family, who has risen high in the Gurkha State Service. He knows Newari because that is his mother-tongue; he knows Pahāria, the State language of Nepal; he knows Sanskrit and he knows English. He has long been an Examiner in Pahāria language in the Calcutta University. His thorough knowledge of the language and literature in Newari, Pahāri and Sanskrit in Nepal and his intimate acquaintance with the literary movements outside Nepal make him a valuable acquisition to the Asiatic Society of Bengal.

The General Secretary laid on the table the minutes of a meeting of the Fellows of the Society recommending the following addition to Regulation 2 governing the nomination and election of Fellows among the Ordinary Members for the information of the Monthly General Meeting under Rule 48 (a):

“ Each Fellow shall be at liberty to nominate one candidate only.”

The General Secretary read the names of the following gentlemen who were appointed to serve on the various committees during 1914:—

Finance Committee.

Dr. N. Annandale.
 Hon. Justice Sir Asutosh Mukhopādhyāya, Kt.
 Mahāmahopādhyāya Haraprasād Shāstrī, C.I.E.
 Mahāmahopādhyāya Satīś Candra Vidyābhūṣaṇa, M.A.
 Mr. W. K. Dods.
 Mr. W. Kirkpatrick.

Library Committee.

Dr. N. Annandale.
 Hon. Justice Sir Asutosh Mukhopādhyāya, Kt.
 Dr. W. A. K. Christie.
 Mahāmahopādhyāya Haraprasād Shāstrī, C.I.E.
 Mr. J. A. Chapman.
 Dr. E. P. Harrison.
 Dr. H. H. Hayden.
 Major C. L. Peart, I.A.
 Dr. G. Thibaut.
 Dr. D. B. Spooner.
 Mr. J. Coggin Brown.
 Mr. S. W. Kemp.

Captain C. A. Godson, I.M.S.
 Dr. O. Strauss.
 Mahāmahopādhyāya Satis Candra Vidyābhūṣaṇa.
 Dr. P. J. Brühl.

Philological Committee.

Dr. Abdulla-al-Mamun Suhrawardy.
 Hon. Justice Sir Asutosh Mukhopādhyāya, Kt.
 Dr. Girindra Nath Mukhopadhyaya.
 Mahāmahopādhyāya Haraprasād Shāstri, C.I.E.
 Babu Monmohan Chakravartī.
 Babu Muralidhar Banerji
 Babu Nogendra Nāth Vasu.
 Babu Rākhāl Dās Banerji.
 Dr. Satīś Candra Vidyābhūṣaṇa.
 Dr. G. Thibaut.
 Major C. L. Peart, I.A.
 Maulavi Abdul Wali.
 Dr. E. Venis.
 Babu Nilmaṇi Chakravartī.
 Dr. O. Strauss.
 Maulavi M. Hedayet Hossein.

The following gentlemen were balloted for as Ordinary Members :—

Mr. A. de Bois Shrosbree, Chief Valuer, Calcutta Improvement Trust, proposed by Dr. W. A. Christie, seconded by Mr. S. W. Kemp; *Monsieur J. Bacot*, Member of the Société Asiatique de Paris, 31 quai d'Orsay, Paris, proposed by Dr. E. Denison Ross, seconded by Major C. L. Peart, I.A.; *Mr. Alain Raffin*, Inspector of Accounts, E. I. Ry., Burdwan, proposed by Major C. L. Peart, I.A., seconded by Aga Muhamad Kazim Shirazi; *Lieut.-Col. William Dunbar Sutherland*, I.M.S., proposed by Lieut.-Col. L. Rogers, I.M.S., seconded by Major W. E. D. Greig, I.M.S.

Mahamahopadhyaya Haraprasad Shastri, on behalf of Dr. Satis Chandra Vidyabhusana, exhibited a stone image of Amitabha of Uttarakuru.

The following paper was read :—

Note on a Buddhist sculpture from Kandy.—By DR. J. P. VOGEL.

This paper will be published in a subsequent number of the *Journal*.

The reading of the following papers were postponed :—

1. *Edilpur Grant of Kesavasena.*—By R. D. BANERJI.
2. *Kathkari.*—By B. A. GUPTE.

The Adjourned Meeting of the Medical Section of the Society was held at the Society's Rooms on Wednesday, the 11th March, 1914, at 9-30 P.M.

LIEUT.-COL. L. ROGERS, C.I.E., F.A.S.B., I.M.S., in the chair.

The following members were present :—

Dr. C. A. Bentley, Mr. J. Coggin Brown, Lieut.-Col. J. T. Calvert, I.M.S., Major E. D. W. Grieg, I.M.S., Dr. W. C. Hossack, Dr. A. M. Leake, Surgeon Capt. F. F. MacCabe, Lieut.-Col. E. A. R. Newman, I.M.S., Mr. Alain Raffin, Captain C. A. Godson, I.M.S., Honorary Secretary.

Visitors :—Dr. A. H. W. Baily, Dr. R. H. Marsall and others.

The minutes of the last meeting were read and confirmed.

Two clinical cases—(1) a case of cervical ribs, (2) a case of transposition of viscera, were shown to the meeting.

Col. Newman read a paper entitled "The Operation of election for the radical cure of inguinal hernia" which was followed by the second portion of Dr. Bentley's paper "Malaria in Lower Bengal, its Origin and Remedy."

It was proposed by Dr. Hossack and passed that the Medical Section address the Council of the Asiatic Society with a view to arranging a special meeting of the Medical Section to which Engineers and others interested in the subject may be invited to discuss Dr. Bentley's paper, owing to the general importance of the subject and suggested remedy.

APRIL, 1914.

The Monthly General Meeting of the Society was held on Wednesday, the 1st April, 1914, at 9-15 P.M.

MAHAMAHOPADHYAYA HARAPRASAD SHASTRI, M.A., C.I.E., F.A.S.B., Vice-President, in the chair.

The following members were present :—

Maulvi Abdul Wali, Dr. N. Annandale, Mr. J. Coggin Brown, Mr. S. W. Kemp, Mr. C. S. Middlemiss, Dr. G. E. Pilgrim, Mr. G. Stadler, Dr. Satis Chandra Vidyabhusana.

Visitor :—Mr. L. A. Matley.

The minutes of the last meeting were read and confirmed.

Seventy-one presentations were announced.

The following gentlemen were balloted for as Ordinary Members :—

Mr. T. K. Laddu, Prof. of Sanskrit, Queen's College, Benares, proposed by Dr. O. Strauss, seconded by Dr. Satis Chandra Vidyabhusana; *Mr. Alexander L. Davenport*, Asst., Messrs. Bird & Co., Calcutta, proposed by Mr. W. Kirkpatrick, seconded by Major C. L. Peart; *Babu Profulla Nath Tagore*, Zemindar, 1, Durponarain Tagore's Street, Calcutta, proposed by Babu Rakhal Das Banerji, seconded by Dr. Satis Chandra Vidyabhusana; *Mr. M. A. Latif*, Merchant, 83, Elliott Road, Calcutta, proposed by Maulvi Hidayet Hosain, seconded by Dr. Satis Chandra Vidyabhusana; *Babu Nikhil Nath Maitra*, M.A., Prof., Presidency College, 72, Lansdowne Road, Calcutta, proposed by Maulvi Hidayet Hosain, seconded by Babu Prafulla Chandra Ghosh; *Mr. Amir Ahmed Ansari*, B.A., Begam Cothee, Meerut, proposed by Aga Mahammad Kasim Shirazi, seconded by Major C. L. Peart; *Babu Gopaldas Chaudhuri*, M.A., Zemindar, 32, Beadon Row, Calcutta, proposed by Dr. B. L. Chaudhuri, seconded by Dr. Satis Chandra Vidyabhusana; *Dr. Nares Chandra Sen-Gupta*, M.A., D.L., Vakil, High Court, 3, Duff Lane, Calcutta, proposed by Babu Rakhal Das Banerji, seconded by Dr. Satis Chandra Vidyabhusana.

The following gentleman was balloted for as an Associate Member :—

Bada Kāñi Marichiman Singha.

Mr. C. S. Middlemiss exhibited specimens and articles of jade and allied minerals obtained in Kashmir.

Mr. J. Coggin Brown exhibited some recently discovered stone implements from Burma.

The following papers were read:—

1. *Hydrophilidae from the Lake of Tiberias.*—By A. D'ORCHYMONT. Communicated by DR. N. ANNANDALE.

This paper will be published in a subsequent number of the *Journal*.

2. *Note on Leaf Variation on Heptapleurum venulosum, Seem.*—By M. S. RAMASWAMI, M.A.

3. *Amphipoda and Isopoda from the Lake of Tiberias.*—By WALTER N. TATTERSALL, D.Sc. Communicated by DR. N. ANNANDALE.

This paper will be published in a subsequent number of the *Journal*.



The Adjourned Meeting of the Medical Section of the Society was held at the Society's Rooms on Wednesday, the 8th April, 1914, at 9-30 P.M.

His Excellency THE RIGHT HON'BLE THOMAS DAVID BARON CARMICHAEL OF SKIRLING, G.C.I.E., K.C.M.G., in the chair.

The following members were present:—

Dr. C. A. Bentley, Mr. W. K. Dods, Dr. W. C. Hossack, Lieut.-Col. F. O'Kinealy, I.M.S., Lieut.-Col. L. Rogers, I.M.S., Capt. J. D. Sandes, I.M.S., Mr. G. Stadler, Capt. C. A. Godson, I.M.S., Honorary Secretary.

Visitors:—Sir R. P. Ashton, Mr. J. Bowie, Mr. S. Eustace, Dr. W. M. Haffkine, Mr. C. A. Tegart, Mr. G. Findlay Shirras.

The minutes of the last meeting were read and confirmed.

The following subject was discussed:—

“The Method of Bonificazione as a Remedy for the Prevalence of Malaria in Lower Bengal.”



MAY, 1914.

The Monthly General Meeting of the Society was held on Wednesday, the 6th May, 1914, at 9-15 P.M.

N ANNANDALE, Esq., D.Sc., C.M.Z.S., F.L.S., F.A.S.B., in the chair.

The following members were present :—

Maulvi Abdul Wali, Mr. J. A. Chapman, Mr. F. H. Gravely, Babu Ramesh Chandra Mazumdar, Major C. L. Peart, I.A., Mahamahopadhyaya Haraprasad Shastri, C I.E., Mr. G. Stadler, Dr. Satis Chandra Vidyabhusana

The minutes of the last meeting were read and confirmed.

Thirty-four presentations were announced.

The General Secretary reported that Mr. E. W. J. Bartlett, Hon'ble Col. G. F. A. Harris, C.S.I., Dr. K. Ahmed, Capt. J. H. Burgess, I.M.S., Mr. W. A. Burns, and Lieut. H. G. Maturin have expressed a wish to withdraw from the Society.

The Chairman announced :—

1. That Dr. E. P. Harrison has been appointed to act as Physical Science Secretary and Honorary Secretary to the Regional Bureau of the International Catalogue of Scientific Literature, in the place of Dr. W. A. K. Christie, gone home.

2. That Dr. N. Annandale has been appointed as Joint Honorary Secretary to the Regional Bureau of the International Catalogue of Scientific Literature, in the place of Mr. F. H. Gravely, resigned.

3. That Mr. C. S. Middlemiss has been appointed a member of Council in the place of Dr. H. H. Hayden, resigned.

The following gentlemen were balloted for as Ordinary Members :—

Major Horace Hayman Wilson, The King's Own Royal Lancaster Regiment, Lebong, Darjeeling, proposed by Major C. L. Peart, I.A., seconded by Lieut.-Col. W. J. Buchanan, I.M.S.; *Mr. K. Rumuni Menon*, Prof. of Zoology, Presidency College, Madras, proposed by Dr. N. Annandale, seconded by Mr. F. H. Gravely.

The following papers were read :—

1. *Edilpur Grant of Kesavasena.*—By R. D. BANERJI.
(Postponed from last Meeting.)

2. *Kathkari.*—By B. A. GUPTÉ. (*Postponed from last Meeting.*)

These two papers have been published in the *Journal* for March, 1914.

3. *Talcher plate of Gayadatungadeva.*—By R. D. BANERJÍ, M.A.

This paper will be published in a subsequent number of the *Journal*.

An account of the Proceedings of the Indian Science Congress held in the rooms of the Asiatic Society of Bengal, January 15th, 16th and 17th, 1914.

The first Indian Science Congress was held in the rooms of the Asiatic Society of Bengal on January 15th, 16th and 17th, 1914, with His Excellency Lord Carmichael, G.C.I.E., K.C.M.G., Governor of Bengal, as Patron, and the Hon. Justice Sir Asutosh Mukhopadhyaya, Kt., C.S.I., as President. One hundred and five members attended from various parts of the Indian Empire, though this number was undoubtedly increased by delegates to the Centenary of the Indian Museum, which was celebrated at the same time.

At the opening meeting the President in his address dealt fully with the history, objects and scope of the movement. The address is printed *in extenso* below.

The reading of papers commenced at the conclusion of the address, the Congress dividing into sections, the Chairmen of which were:—

Chemistry	.. Prof. P. S. MacMahon	Lucknow.
Physics	.. Prof. V. H. Jackson	.. Patna.
Zoology	.. Dr. J. R. Henderson	.. Madras.
Geology	.. Dr. H. H. Hayden	.. Calcutta.
Botany	.. Mr. C. C. Calder	.. Calcutta.
Ethnography	.. Mr. L. K. Anantha Krishna Iyer	.. Cochin.

Mr. D. Hooper of the Botanical Survey was Honorary Secretary and Treasurer until his departure from India in February, 1914.

ADDRESS.

GENTLEMEN,

I do not use the language of mere conventional courtesy when I say that although I am deeply grateful to you for your invitation to take the Chair at this the inaugural meeting of the Indian Science Congress, I cannot but feel that on this occasion the Chair might have been more fittingly occupied

by one of the many distinguished investigators who are present in this assembly and who have devoted the best of their lives exclusively to the work of the advancement of Science. Let me assure you, however, that although I am deficient in many respects, I yield to none in an anxious desire to promote those objects for the attainment of which this Congress has been convened.

We meet in this historic building on the anniversary of a date ever memorable in the annals of research, scientific and philological, in the British Empire in the East, for it was just one hundred and thirty years ago, on the 15th of January, 1784, that the Asiatic Society was founded by Sir William Jones, one of the most gifted of the many noble sons of Britain who have devoted their lives to the cause of the advancement of knowledge amongst the people of this land. The Asiatic Society thus founded has been throughout its long career the principal source of inspiration in the organization and advancement of scientific research of every description in this country, and it is eminently befitting that the first meeting of the Indian Science Congress should be held in the rooms of the Society and directly under its auspices. It is further fortunate that we should be able to hold the Congress simultaneously with the celebration of the centenary of the foundation of the Indian Museum, which had its origin in the activities of the members of the Asiatic Society, and which by the invaluable work of its scientific officers in various departments has justly attained world-wide reputation. The times are manifestly favourable to the establishment of an Indian Science Congress, and I trust I may rely upon your indulgence, while I briefly narrate how the idea to hold such a Congress originated, took shape and was developed.

It is now more than two years ago that Professor MacMahon of the Canning College at Lucknow, and Professor Simonson of the Presidency College at Madras, brought forward a proposal for the foundation of an Indian Association for the Advancement of Science. The object and scope of the proposed Institution were stated to be similar to those of the British Association for the Advancement of Science, namely, to give a stronger impulse and a more systematic direction to scientific enquiry, to promote the intercourse of Societies and individuals interested in Science in different parts of the country, to obtain a more general attention to the objects of Pure and Applied Science and the removal of any disadvantages of a public kind which may impede its progress. This proposal was widely circulated amongst persons of culture interested in the spread and development of Science in this country, and the fundamental idea, as might easily have been anticipated, met with favourable reception. The scholars approached were not slow to recognize the desirability of co-

ordination of scientific work and co-operation amongst scientific workers. It is not necessary on the present occasion to attempt an exhaustive enumeration of the different branches of scientific activity in which teachers and investigators are engaged throughout this great continent. To enable us to appreciate the vast extent and varied nature of the scientific work to which they are devoted one need recall to mind only the numerous colleges affiliated to the various Indian Universities, where the study of Mathematics, Pure and Applied, Astronomy, Physics, Chemistry and Biology is enthusiastically pursued; the excellent Institutions where branches of professional knowledge like Medicine and Engineering, whose foundations lie on a deep-rooted scientific basis, are studied; the Institutes which are maintained in a high state of efficiency by private munificence or by State grants, solely for the cultivation and advancement of Pure and Applied Science; the Observatories where Astronomical and Meteorological investigations are regularly carried on; the various departments of the State entrusted with the special care of important branches of knowledge like Geology, Botany, Agriculture, Forestry, Sanitation, Bacteriology, Meteorology, Trigonometrical Survey, Marine Survey, and Archaeology; finally, our splendid Museums which have been in the past the chief centres of Zoological and Anthropological study and research. In a domain so vast in extent and diverse in character, it is obviously essential, if the fullest measure of efficiency and success is to be achieved, that the men of Science, engaged in study and instruction, whether individually or in small groups, should be brought into close association with each other; they really constitute an army of workers whose services to the State are materially impaired in strength if they are allowed always to remain scattered and isolated. The advantages of personal intercourse between scientific workers, engaged in the same field of activity or in the pursuit of allied lines of research, are too obvious to require much elaboration. The most beneficent results may be achieved by an instructive interchange of ideas between scientific men; they may, however, not only mutually communicate their ideas, they may also state the advance made in their own respective spheres of action, and indicate to each other the special departments which may be most profitably cultivated or the outstanding problems which may be attacked with the greatest utility. But personal association amongst scientific men may be pregnant with important consequences, not merely by a fruitful exchange of ideas; cultivators of Science, by periodical meetings and discussions, may bring their aims and views prominently into public notice, and may also, whenever necessary, press them upon the attention of the Government, —a contingency by no means remote, for, as experience has

shown, even the most enlightened Governments occasionally require to be reminded of the full extent of the paramount claims of Science upon the Public Funds. The votaries of Science may, in this manner, give to their researches a profitable direction, enable teachers and investigators to obtain an intimate acquaintance with the practical needs of the country, foster the growth of active co-operation between Europeans and Indians in the spread of scientific education, and, what is of the greatest importance in our present condition, on the one hand, bring home to the commercial community the inestimable value of science as an essential factor of industrial regeneration, and, on the other hand, make the landed aristocracy realize that science enables us to solve difficult agricultural problems and thereby to revolutionize agricultural methods. In view of the various standpoints I have just briefly indicated, it was only natural that the idea, which lay at the basis of the proposal to establish an Indian Association for the Advancement of Science, should meet with ready recognition. But it was felt by many men of experience that the pressure of heavy official duties under which many investigators here carry on their scientific work, the climatic conditions which prevail in this country, and the long distances which have to be traversed, constitute practical difficulties of no mean order in the way of the immediate formation of a peripatetic association, designed to meet periodically in turn in all the different centres of scientific activity. As the result of full discussion of the situation, the view ultimately prevailed that the desired object could be attained if a Science Congress was held in the first instance in Calcutta, under the leadership of the Asiatic Society, and simultaneously with the Indian Museum Centenary Celebrations, which, under the special facilities generously afforded by the Government of India to scientific officers, was likely to be attended by a large number of distinguished scientific men. It is, I think, distinctly fortunate for the success of the movement that we have been able to secure as our Patron, His Excellency Lord Carmichael, whose devotion to the cause of scientific research is equalled only by his fame as a just and sympathetic statesman. I trust it may fairly be maintained that we have started our work under as favourable an auspice as the promoters and supporters of the movement could reasonably expect under the present conditions. Their call to scientific workers has met with generous response, as is amply indicated by the presence here of many notable investigators from all parts of the Indian Empire. We have also been favoured with a number of important papers on Chemistry, Physics, Zoology, Geology, Botany, and, last but not least, the fascinating subject of Ethnography which is too often regarded, very erroneously, as a popular and non-scientific branch of study. I now beg to

accord a most cordial welcome to each and every one of our members and guests and declare this Congress open.

LIST OF PAPERS.

Chemistry.

- The Hot Springs of India. By C. Schulten.
 Contribution to our Knowledge of the Element Boron. By W. M. Travers
 Contribution to our Knowledge of the Chemistry of Santalin. By J. C. Cain and J. L. Simonsen.
 The action of Nitric Oxide on Metallic Peroxides. By B. C. Dutt.
 An Improved Method of using Oil Gas. By K. S. Caldwell.
 The Action of light on Silver Chloride. By Prof. MacMahon.
 An Attempt to apply Newton's Law of Universal Attraction to explain some important facts newly observed (by Author) in Physical Chemistry. A Contribution to our present Knowledge of Chemical Affinity. By M. N. Banerjee.
 A note on Magnesium Boride and Amorphous Carbon. By R. C. Roy.

Physics.

- The Thermal Value of Sunlight in Northern India. By J. Hector Barnes.
 Modification of the Sensitive Quadrant Electrometers, and Measurement of Atmospheric Electricity at Patna. By Prof. V. H. Jackson.
 Experiments on the Interference and Diffraction of Light at Oblique Incidences. By C. V. Raman.
 Investigations of the Maintenance of Vibration. By C. V. Raman.
 The Dynamical Theory of Diffraction. By D. N. Mallik.
 Optical Theories: a brief survey. By D. N. Mallik.
 The Basis of Seasonal Forecasting. By G. T. Walker.

Zoology.

- A short account of the Cestoda of British India. By T. Southwell.
 Hilsa Cultivation in Bengal. By T. Southwell.
 Convergence in Aquatic Animals. By N. Annandale.
 Medical Entomology: its Scope and Economic Aspects. By Capt. W. S. Patton, I.M.S.
 Habits and Distribution of the Tibetan Stag (*Cervus Wallichii*). By Lt.-Col. J. Manners Smith.
 Indo-Australian Passalid Beetles and their Distribution. By F. H. Gravely.

The Peritoneum and the Absorption of Fluids from the Peritoneal Cavity. By T. H. Bishop.

The Presence and Absence of the Gall Bladder in the Rodentia. By Major R. E. Lloyd, I.M.S.

On the Reproductive System of *Atopos*. By E. Ghosh.

Geology.

The Classification of the Gondwana System. By E. Vredenburg.

On the Correlation of the Kamthi Beds. By H. C. Dass Gupta.

A Note on Radio-activity of the Kolar Rocks. By H. E. Watson.

Botany.

Indian Botanical Problems. By P. Brühl.

Wild Plants in the neighbourhood of Calcutta. By P. Mukerjee.

Ethnography.

A comparative study of the Marriage Customs of the Cochin Castes. By L. K. Anantha Krishna Iyer.

Relics of the Constitution of Mud Turtles in India and Burma. By N. Annandale and M. Haraprasad Shastri.

Stone Implements from Yünnan. By J. Coggin Brown.

Distribution of the Shan Tribes of Yünnan. By J. Coggin Brown.

Magic and Witchcraft of Chota Nagpur. By S. C. Roy.

The Nambuthin Brahmins of Malabar. By L. K. Anantha Krishna Iyer.

The Council of the Asiatic Society of Bengal has agreed to publish such of these papers as are accepted by its Publication Committee.

RESOLUTIONS PASSED AT A MEETING OF THE INDIAN SCIENCE CONGRESS, JANUARY 29TH, 1914.

1. That the Asiatic Society be requested to publish for the present an account of the proceedings of the Congress, and of such of the papers read as might be agreed upon by the Congress Committee and the Secretaries of the Society.

2. That the invitation to have the next meeting of Congress at Madras be accepted, the date and all other details to be settled by the Madras Committee in consultation with the Calcutta Committee and the Committees to be formed in other centres.

INDIAN SCIENCE CONGRESS ACCOUNT, 1914.

	Rs.	A.	P.	Rs.	A.	P.
Subscriptions raised			883	0	0
Expenditure	504	7	0			
Balance in hand. (This sum has been remitted to the Local Secretary at Madras)	378	9	0			
TOTAL ..	883	0	0			

JUNE, 1914.

The Monthly General Meeting of the Society was held on Wednesday, the 3rd June, 1914, at 9-15 P.M.

Lieut. Colonel L. ROGERS, C.I.E., M.D., B.S., F.R.C.P., F.R.C.S., F.A.S.B., I.M.S., Vice-President, in the chair.

The following members were present:—

Maulvi Abdul Wali, Dr. N. Annandale, Mr. A. C. Atkinson, Mr. H. S. Bion, Dr. P. J. Bruhl, Mr. J. A. Chapman, Dr. B. L. Chaudhuri, Mr. C. S. Fox, Mr. F. H. Gravely, Mr. A. H. Harley, Dr. E. P. Harrison, Mr. H. C. Jones, Mr. S. W. Kemp, Major C. L. Peart, Dr. G. E. Pilgrim, Mr. G. Stadler, Rev. J. Watt.

Visitors:—Mr. R. W. Palmer, Mr. M. Sale, Mr. A. T. Wilson.

The minutes of the last meeting were read and confirmed.

Thirty-five presentations were announced.

The General Secretary reported that the Hon. Justice Sir Herbert William Cameron Carnduff, Kt, C.I.E., I.C.S., and Babu Manmathanath Mukherjee have expressed a wish to withdraw from the Society.

The following gentlemen were balloted for as Ordinary Members:—

Dr. Satyendra Nath Roy, M.B. (Cal.), F.R.C.S.E., Lecturer on Medicine, Albert Victor Hospital, 46, Beadon Street, Calcutta, proposed by Rai Bahadur Hiralal Bose, seconded by Major C. L. Peart I.A.; *Mr. B. K. Basu*, B.A. (Cal. and Cantab), I.C.S., Assistant Magistrate, Burdwan, proposed by Mahamahopadhyaya Haraprasad Shastri, seconded by Babu Rakhal Das Banerji; *Mr. P. R. Awati*, B.A. (Cantab), D.I.C. (Lond.), F.E.S., 29, Samavaya Mansions, Corporation Street, Calcutta, proposed by Lieut.-Col. L. Rogers, C.I.E., seconded by Major E. D. W. Greig, I.M.S.

Dr. N. Annandale and Mr. S. W. Kemp exhibited specimens illustrating the fauna of the Chilka Lake in Orissa and Ganjam.

The Chilka Lake is a shallow lagoon on the east coast of India, some thirty miles long and ten miles broad. It is connected with the sea by a narrow mouth which opens into a channel separated from the main body of the lake by a series of peninsulas and islands and running parallel to the coast. The salinity of the water differs greatly at different seasons, but that of the outer channel is always much higher

than that of the rest of the lake. The fauna, which we are now investigating in detail, consists of a mixture of marine and freshwater types with a certain element that appears to be peculiar to brackish water. Among mammals *Orcella brevirostris* and *Lutra macrodus* are common. Crocodiles, marine turtles and the mud-turtle *Emyda granosa intermedia*, with a species of *Hydrophis*, *Cerberus rhynceps* and *Chershydrus granulatus*, represent the reptiles. Fish, including several species of shark and ray, are numerous, the great majority belonging to small species. Prawns of the family Penaeidae occur in great abundance, together with forms so characteristic of fresh water as *Caridina*; except in the outer channel, the crabs are poorly represented. Of the other crustacea, four species of Mysidae have been found, three of Stomatopoda and large numbers of Amphipoda, Isopoda, etc. Most of the molluscs are small and, except in the outer channel, a large proportion are noteworthy on account of their extremely delicate shells. Several of the Polyzoa and coelenterates have already been found in brackish water in the Gangetic delta; others are new to science. The sponges include representatives of three genera—*Spongilla*, a characteristic freshwater genus, and *Suberites* and *Cliona*, as characteristically marine. The first two actually grow together and similarities in their biology have been observed. The boring sponge *Cliona* is found in the shells of the larger Lamellibranchs and Gastropods.

An account of the fauna will be published later in the *Memoirs of the Indian Museum*.

Dr. E. P. Harrison exhibited the "Gore Effect" in iron.

The reading of the following papers was postponed:—

1. *Note on the application of the principle of Isostatic compensation to the conditions prevailing beneath the Indo-Gangetic alluvium.*—By H. H. HAYDEN, C.I.E., D.Sc.

2. *Action of Nitric Oxide on Metallic Peroxides suspended in water, Part I.*—By BARUN CHANDRA DUTT and SURYA NARAYAN SEN. Communicated by the Physical Science Secretary.

3. *Contributions from the Chemical Laboratory, Presidency College:*—

(a) *Nitrites of the Sulphurium Bases, Part I.—Trimethylsulphurium Nitrite.*—By RASIK LAL DATTA. Communicated by DR. P. C. RAY.

(b) *A new method for the preparation of Colloids.*—By JNANENDRANATH MUKHOPADHYAYA. Communicated by DR. P. C. RAY.

(c) *On Mercuric Nitrite as a helpful reagent in determining tautomerism in organic Thio-compounds.*—By PRAFULLA CHANDRA RAY. Communicated by DR. P. C. RAY.

JULY, 1914.

The Monthly General Meeting of the Society was held on Wednesday, the 1st July, 1914, at 9-15 P.M.

MAHAMAHOPADHYAYA SATIS CHANDRA VIDYABHUSANA, M.A., PH.D., F.A.S.B., in the chair.

The following members were present:—

Maulavi Abdul Wali, Dr. N. Annandale, Babu Rakhal Das Banerji, Mr. Percy Brown, Dr. P. J. Bruhl, Babu Nilmani Chakravarti, Dr. B. L. Chaudhuri, Mr. F. H. Gravely, Mr. A. H. Harley, Maulavi M. Hidayat Husain, Hon. Mr. W. W. Hornell, Rev. H. Hosten, S.J., Hon. Mr. C. H. Kesteven, Babu Ramesh Chandra Majumdar, Mr. R. D. Mehta, C.I.E., Major C. L. Peart, Dr. C. Schulten, Dr. O. Strauss.

Visitors:—Mr. W. Ivanow, Dr. L. P. Tessitori, and Miss M. Tonnet.

The minutes of the last meeting were read and confirmed.

Thirty-four presentations were announced.

The General Secretary reported that the Rev. A. Willifer Young has expressed a wish to withdraw from the Society.

The following gentleman was balloted for as an Ordinary Member:—

Babu Satya Charan Laha, M.A., B.L., Merchant and Zemindar, 24, Sukea Street, Calcutta, proposed by Mahamahopadhyaya Haraprasad Shastri, seconded by Babu Panchanan Mukhopadhyaya.

Dr. N. Annandale exhibited, on the lantern, a series of photographs of Indian statues of Buddhas, illustrating the conventional method of representing the robes in the later periods.

The following papers were read:—

1. *The date of Chashtana.*—By RAMESH CHANDRA MAJUMDAR.

This paper has been published in the *Journal* for June 1914.

2. *Spirit belief in the Jataka stories.*—By NILMANI CHAKRAVARTI.

3. *The date of the death of Shah Beg Arghun, the ruler of Sind.*—By H. BEVERIDGE.

4. *Sirhind or Sehrind.*—By H. BEVERIDGE.

5. *Note on a history of Firuz Shah called Sirat-i-Firuz Shahi.*—By MAULAVI M. HIDAYET HOSAIN.

Among the many valuable and rare MSS. in the Oriental Public Library at Bankipore, I came across one interesting MS. called *Sirat-i-Firuz Shāhī*. In Europe there is no other copy of this MS. in any of the libraries. I have also visited many Libraries in India, such as that of Rampur, Lucknow, Hyderabad, Madras, Bombay, etc., but I did not find this rare MS. in any of them. It may, therefore, be presumed that this is the only copy of the MS. in existence.

I should like to draw the attention of the Archæological Department to this valuable MS. as it contains a description of architecture, etc. If this MS. is translated or at least its text is published it will be of great interest to the students of Indian history.

No particular name has been given to this book, but as it deals with an account of Fīrūz Shāh it is called *Sirat-i-Firuz Shāhī*. There is also no mention of the author of the work, but the following lines in the book

باعتلاء شاه جهان شد کتابت طریق سلاطین و آداب شاهی

prove that it must have been dictated by Fīrūz Shāh himself, as the word *imlā'* املاء means lecture or dictation. The preface however appears to have been added by some one else though the original work, or at least its contents, are the dictates of Fīrūz Shāh himself.

The work in question begins with :—

کتاب سیدرت فیروز شد—شاهی مؤلف شد بت—ائید آہی

It is divided into four chapters :

1st chapter contains a short account of the reign of Fīrūz Shāh from his accession to the conquest of Gujrāt

2nd chapter deals with his justice, charitable deeds, benevolence, suppression of evil and murder, etc. It also gives a description of birds, animals, their habits, peculiarities, and also a description of his hunting excursions.

3rd chapter contains a description of buildings erected by him, also what crops were cultivated, and what kind of trees were grown at the time. It also deals with how he brought a huge minaret from *Sirmur* mountain to Fīrūzābād (Delhi). Folios 94b, 102b contain illustrations showing the different positions of the minaret when it was being carried to Fīrūzābād.

4th chapter deals with astronomy and all the various books written on this subject during his time. It also gives a description of observatories erected by him. This chapter ends with a description of the instruments of war.

It was composed in A.H. 772, A.D. 1370.

Folios 58, 59, 71, 73, 89 and 90 are either missing or have been misplaced.

This MS. also bears many seals of Shāh Jahān and Aurangzīb. It is written in *nasta'liq* with gold ruled and coloured borders. It was copied in Rabi' II A.H. 1002.

This work is being referred to in the Bankipore Library Catalogue which is now in course of preparation by the staff of the Library.

It has 182 folios, lines 17, size $9\frac{1}{4} \times 5\frac{1}{4}$, $6\frac{3}{4} \times 3\frac{1}{2}$.

6. *Jhalrapatan Stone inscription of Udayaditya, Vikram Samvat 1143 (1086 A.D.).—By SAHETYACHARYA PT. BISHWESHWAR NATH SHASTRI. Communicated by the Joint Philological Secretary.*

This paper has been published in the *Journal* for June 1914.



The Adjourned Meeting of the Medical Section of the Society was held at the Society's Rooms on Wednesday, the 8th July, 1914, at 9-30 P.M.

LIEUT.-COLONEL SIR L. ROGERS, KT., C.I.E., M.D., B.S., F.R.C.P., F.R.C.S., F.A.S.B., I.M.S., in the chair.

The following members were present :—

Major W. V. Coppinger, I.M.S., Major E. D. W. Greig, I.M.S., Dr. W. C. Hossack, Captain J. A. Shorten, I.M.S., Major R. P. Wilson, I.M.S., Captain C. A. Godson, I.M.S., Honorary Secretary.

Visitors :—Capt. Green Armitage, I.M.S., Major A. C. MacGilchrist, I.M.S., Major H. H. Proctor, I.M.S.

Minutes of the April meeting were read and confirmed.

Major A. C. MacGilchrist, I.M.S., read a paper entitled "The relationship between Chemical Composition and Pharmacological Action, with special reference to Modern Therapeutics."



AUGUST, 1914.

The Monthly General Meeting of the Society was held on Wednesday, the 5th August, 1914, at 9-15 P.M.

LIEUT.-COLONEL SIR L. ROGERS, Kt., C.I.E., M.D., B.S., F.R.C.P., F.R.C.S., F.A.S.B., I.M.S., Vice-President, in the Chair.

The following members were present :—

Maulavi Abdul Wali, Dr. N. Annandale, Mr. J. Coggin Brown, Dr. P. J. Brühl, Mr. C. C. Calder, Dr. B. L. Chaudhuri, Mr. F. H. Gravely, Mr. H. C. Jones, Mr. R. D. Mehta, C.I.E., Mr. C. S. Middlemiss, Mr. E. B. H. Panton, Dr. Satis Chandra Vidyabhusana, Rev. J. Watt.

Visitors :—Mr. B. C. Dutt and Mr. S. N. Sen.

The minutes of the last meeting were read and confirmed.

Thirteen presentations were announced.

The General Secretary reported that the Hon. Mr. Henry Sharp, C.I.E., Babu Ganesh Lal Barik, and Major John Wallace Dick Megaw, I.M.S., have expressed a desire to withdraw from the Society.

The Chairman announced that the Council has added the name of Mr. G. H. Tipper to the Library Committee.

The following gentlemen were balloted for as Ordinary Members :—

Signor L. P. Tessitori, D.Litt., Officer in charge of the *Bardic Chronicles*, 8, Esplanade, Calcutta, proposed by Dr. N. Annandale, seconded by Mr. F. H. Gravely; *Babu Bimala Churn Law*, B.A., Zemindar, 24, Sukea Street, Calcutta, proposed by Dr. B. L. Chaudhuri, seconded by Babu Gopal Das Chaudhuri.

Mr. J. Coggin Brown exhibited three new Indian meteorites.

The following papers were read :—

1. *Note on the Application of the Principle of Isostatic Compensation to the Conditions prevailing beneath the Indo-Gangetic Alluvium.*—By H. H. HAYDEN, C.I.E., D.Sc. (*Postponed from June meeting*).

This paper has been published in the *Journal* for July, 1914.

2. *The Action of Nitric Oxide on Metallic Peroxides suspended in Water. Part I*, by BARUN CHANDRA DUTT and SURYA NARAYAN SEN. *Communicated by the Physical Science Secretary. (Postponed from June meeting).*

3. *Materials for a Flora of the Malayan Peninsula, No. 25.*—By J. SYKES GAMBLE, C.I.E., M.A., F.R.S., *late of the Indian Forest Department. Communicated by the Biological Secretary.*

This paper will be published in a subsequent number of the *Journal*.

4. *Notes on the Fat of Garcinia indica, the so-called kokam butter.*—By HAROLD H. MANN and N. V. KANITKAR.

.....

SEPTEMBER, 1914.

The Monthly General Meeting of the Society was held on Wednesday, the 2nd September, 1914, at 9-15 P.M.

MAHAMAHOPADHYAYA HARAPRASAD SHASTRI, C.I.E., M.A., F.A.S.B., Vice-President, in the Chair.

The following members were present :—

Maulavi Abdul Wali, Dr. N. Annandale, Babu Nilmani Chakravarti, Mr. F. H. Gravely, Hon. Mr. W. W. Hornell, Rev. H. Hosten, S.J., Hon. Mr. C. H. Kesteven, Mr. R. D. Mehta, C.I.E., Hon. Mr. F. J. Monahan, Major C. L. Peart, Mr. P. A. Rogalsky, Dr. Satis Chandra Vidyabhusana, Rev. J. Watt.

Visitor :—Mr. A. N. Taylor.

The minutes of the last meeting were read and confirmed. Seventeen presentations were announced.

The General Secretary reported that Babu Jyotis Chandra Bhattacharjee has expressed a desire to withdraw from the Society.

The General Secretary also reported the death of Rai Bahadur Chandra Narayan Singh, an Ordinary Member, and Prof. Edward Suess, an Honorary Fellow of the Society.

The following gentleman was balloted for as an Ordinary Member :—

Professor B. C. Dutt, Professor of Chemistry, Scottish Churches College, proposed by Dr. J. Watt, seconded by Dr. P. C. Ray.

The following papers were read :

1. *On the Language of the Gypsies of Qāināt (in Eastern Persia).*—By W. IVANOW. Communicated by the Philological Secretary

This paper will be published in a subsequent number of the *Journal*.

2. *The tomb of Princess Zebu-n-nissā.*—By G. VAZDANI. Communicated by the Philological Secretary.

This paper has been returned to the author.

3. *Western Art at the Moghul Court.*—By the REV. H. HOSTEN, S.J.

This paper has not yet been submitted for publication.

4. *Notes on Fr. Monserrate's Mongolicae Legationis Commentarius*, by H. BEVERIDGE, and *the Surat Incident*, translated from the Portuguese, by R. G. WHITEWAY.

This paper will be published in a subsequent number of the *Journal*.

5. *Notes on ancient Anṅa or the District of Bhagalpur.*—
By NUNDOLAL DEY. Communicated by BABU RAKHAL DAS
BANNERJI.



NOVEMBER, 1914.

The Monthly General Meeting of the Society was held on Wednesday, the 4th November, 1914, at 9-15 P.M.

LIEUT.-COL. SIR LEONARD ROGERS, KT., C.I.E., M.D., B.S., F.R.C.P., F.R.C.S., F.A.S.B., I.M.S., Vice-President, in the Chair.

The following members were present :—

Maulavi Abdul Wali, Dr. N. Annandale, Mr. H. S. Bion, Dr. L. L. Fermor, Mr. F. H. Gravely, Col. C. R. M. Green, I.M.S., Mr. H. C. Jones, Mr. S. W. Kemp, Mr. W. Kirkpatrick, Mr. C. S. Middlemiss, Dr. G. E. Pilgrim, Aga Mahamad M. Kazim Shirazi, Dr. O. Strauss, Dr. Satis Chandra Vidyabhusana and Mr. H. P. Watts.

Visitors :—Mr. W. E. Andrews, Mr. A. S. Subha Iyer, Lady Rogers, Mr. O. G. Hoorbleicher and another.

The minutes of the September meeting were read and confirmed.

One hundred and seven presentations were announced.

The Chairman announced that the second Indian Science Congress would be held at Madras on 14th, 15th and 16th January, 1915, as previously fixed.

The Chairman also announced :—

1. That Dr. N. Annandale had been appointed Anthropological Secretary in the place of Mr. J. Coggin Brown, resigned.
2. That Dr. P. J. Brühl had been appointed Biological Secretary in the place of Dr. N. Annandale.

The General Secretary reported the death of Lieut.-Col. Herbert Wilson Pilgrim, I.M.S., and Dr. G. Thibaut, C.I.E., Ordinary Members of the Society.

The General Secretary also reported that the Rev. W. R. Le Quesne, Lieut. W. M. Edward, and Pandit Anand Koul had expressed a desire to withdraw from the Society.

The following gentlemen were balloted for as Ordinary Members :—

Mr. Alfred Donald Pickford, Merchant, 12, Mission Row, Calcutta, proposed by the Hon. Mr. W. W. Hornell, seconded by Mr. C. H. Kesteven; *Mr. Vireshwar Bhattacharjee*, M.A.,

Rawalpindi, proposed by Rai Monmohan Chakravarti, Bahadur, seconded by Dr. Satis Chandra Vidyabhusana; *Babu Birendra Nath Basu Thakur*, Landholder, 59 1, Patuatola Lane, Calcutta, proposed by Dr. B. L. Chaudhuri, seconded by Babu R. D. Banerji.

Dr. N. Annandale exhibited a remarkable freshwater Polyzoa from the Punjab.

Dr. N. Annandale also exhibited a prawn-trap from the Chilka Lake.

Mr. H. Cecil Jones exhibited some specimens of marble and other building stones proposed for the building of Imperial Delhi.

Mr. H. S. Bion showed Lantern slides illustrating some features due to "glacial protection" in Kashmir and the Alps.

The following papers were read :—

1. *Chironomides du Lac de Tibériade par J. J. KIEFFER.*
Communicated by DR. N. ANNANDALE.

This paper has been published in the *Journal* for September 1914.

2. *Recent additions to our knowledge of the Copper Age Antiquities of the Indian Empire.—By PANDIT HIRANANDA SASTRI.*
Communicated by the Anthropological Secretary.

This paper will be published in a subsequent number of the *Journal*.

DECEMBER, 1914.

The Monthly General Meeting of the Society was held on Wednesday, the 2nd December, 1914, at 9.15 P.M.

MAHAMAHOPADHYAYA HARAPRASAD SHASTRI, M.A., C.I.E., F.A.S.B., Vice President, in the Chair.

The following members were present :—

Maulavi Abdul Wali, Dr. P. J. Brühl, Babu Nilmani Chakravarti, Mr. T. P. Ghose, Babu Amulya Charan Ghosh, Mr. F. H. Gravely, Mr. H. G. Graves, Mr. A. H. Harley, Rev. H. Hosten, S.J., The Hon. Mr. W. A. Lee, Aga Mahamad, Kazim Shirazi, Dr. A. Suhrawardy, Dr. L. P. Tessitori, Dr. O. Strauss, Dr. Satis Chandra Vidyabhusana.

The minutes of the last meeting were read and confirmed.

Thirty-one presentations were announced.

The Chairman announced that Mr. F. H. Gravely had been appointed General Secretary in the place of Major C. L. Peart, I.A., resigned.

The General Secretary reported that Major Walter Valentine Coppinger, I.M.S., Mr. James Macdonald Dunnet and Mr. Alfred James Ollenbach, I.C.S., had expressed a desire to withdraw from the Society.

The following gentleman was balloted for as an Ordinary Member :—

Mr. C. J. Hamilton, Calcutta University, proposed by Mr. Percy Brown, seconded by Mr. S. W. Kemp.

Mahamahopadhyaya Haraprasad Shastri exhibited five photographs of stone inscriptions forwarded by the Dewan of Patna State, Bolingir.

Mahamahopadhyaya Dr. Satis Chandra Vidyabhusana exhibited a Tibetan scroll depicting the processes of subduing an enemy by charm.

The following papers were read :—

1. *Note on the Tarikh-i-Salatin-i-Afaghinah.*—By H. BEVERIDGE.

2. *A note on the Bodkamta Narttesvara Image Inscription.*—By NALINI KANTA BHATTASALI. Communicated by Joint Philological Secretary.

These two papers will be published in a subsequent number of the *Journal*.

3. *On the Vikramaditya of the Indian Tradition* —By
MAHAMAHOPADHYAYA HARAPRASAD SHASTRI, C.I.E.

This paper has not yet been submitted for publication.

4. “*So-sor-thar-pa*”, a complete code of monastic laws of
the Tibetan Buddhists.—By MAHAMAHOPADHYAYA DR. SATIS
CHANDRA VIDYĀBHŪSANA.

This paper will be published in a subsequent number of
the *Journal*.

INDEX

TO THE

SOCIETY'S JOURNAL AND PROCEEDINGS,

Vol. X, 1914.

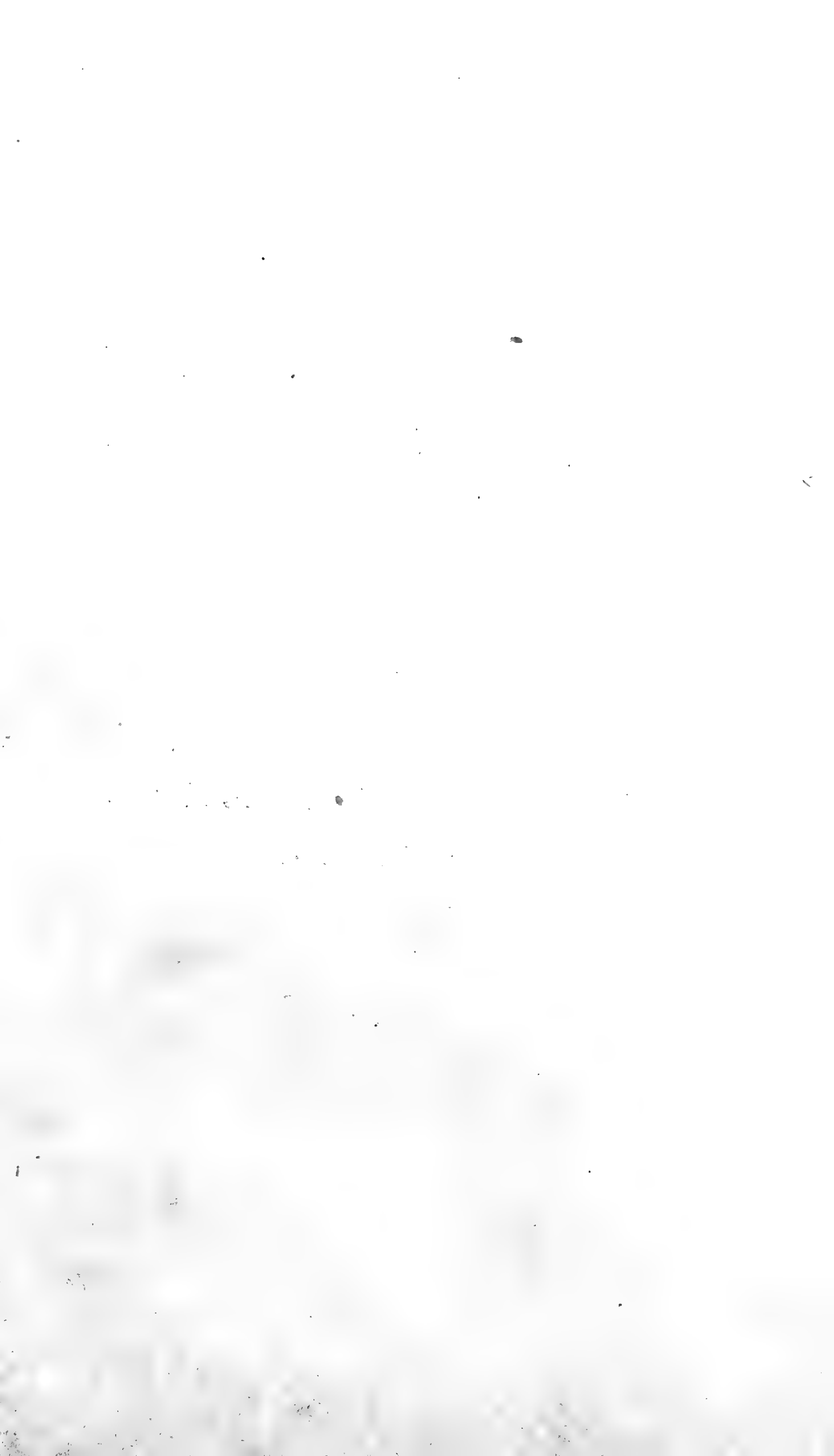

INDEX.

- A
- acanthotrias*, Weinl (*Cysticercus*), 142.
- Aceraius*, 201, 202, 203, 204, 206, 418.
- aculeata*, Linn. (*Dioscorea*), 7, 19.
- Āditya Sena of the Guptas, a note on, 328.
- affinis* (*Cervus*), 117, 118, 119.
- Agencies of the Society, ix.
- Aggi (Fire-God), character of, 257.
- Aḥmad Shāh, coins of, struck in Aḥmadābād, 167.
- Aḥmad Shāh II of Gujarāt, a note on the copper coins of, 481.
- Aḥmad Shāh Bahādur, active mints and metals of, 190.
- Aḥmadābād, appendix of the coins of, 167.
- „ descriptions of types of the coins of, 158.
- „ mint marks and comments of the coins of, 160.
- „ the Post-Mughal coins of, 153.
- Ahom coins of A.D. 1648, note on, 457.
- Ajātaśatrū, son of Bimbisāra, an account of, 322.
- Akbar, a note on the copper coins of, 482, 483.
- Akbar, active mints and metals of, 179.
- Akbar II, active mints and metals of, 194.
- „ coins of, struck in Aḥmadābād, 170.
- ‘Alamgīr II, active mints and metals of, 191.
- „ coins of, struck in Aḥmadābād, 167.
- aiata*, Linn. (*Dioscorea*), 11, 39.
- albirostris* (*Cervus*), 117, 119.
- Allan, J., on the legend of Samudragupta’s Aśvamedha coin type, 255.
- Alwara stone implement, its description, 107.
- Amabilia*, Diamare, 140.
- Amphilina*, 143.
- Amphipoda, 362.
- „ and Isopoda from the Lake of Tiberias, 361-367.
- Āṅga, ancient, or the district of Bhagalpur, notes on, 317.
- Anchistrocephalus*, 144.
- anguina*, Roxb. (*Dioscorea*), 9, 32.
- Anulomam*, meaning and derivation of the term, 297.
- Annual Address, xxiii-xxxiii.
- Annual Report for 1913, iv-xxiii.
- Anta Jātaka*, on the spirits in the trees, 260.
- Antaraṅga. explanation of the word, 427.
- Anthropology, notes on the papers on, xvii.
- antiquorum* (*Colocasia*), 424.
- Aporina*, Führmann, 140.
- Apostles, Fr. Jerome Xavier’s Persian lives of the, 65.
- „ Hindustānī translation of the lives of the, 72.
- „ the Persian text of the preface of the lives of the, 79.
- Arabic and Persian manuscripts, search for, xxi.
- Arachidna* (*Dioscorea*), 7, 21.
- Araliaceae*, 115.
- arenarius*, Retz. (*Cyperus*), 57.
- Arracan, the Chandra dynasty of, 89.
- Arum*, 424.
- Asellidae, 363.
- Asellota, 363.
- Asellus*, 361, 363.
- Asiatic Society of Bengal, a note on its control over the Bardic and Historical Survey of Rajputana, 386.
- Aśoka, an account of his administration, 323.
- Aśokāvadana*, a note on the Sanskrit manuscript of, xx.
- Asopia*, 142.
- aspersa*, Prain et Burkill (*Dioscorea*), 9, 29.

Asrafpur plates, dates of, 86.
 Assam, grooved stone hammers from, 107-109.
assamensis (*Chilobrachys*), 416.
 Asutosh Mukhopadhyaya, Sir, Address in the Indian Science Congress, lxxxviii-xcii.
 Aśvamedha Coin Type of Samudragupta, the legend of, 255.
 Aśwamedha Type of Gupta coins, 174.
Atopos, 111-113.
atridorsalis (*Sciurus*), 212.
 Audambara coinage, a new type of, 247.
 Aurangzeb 'Ālamgīr, active mints and metals of, 183.
Aurelius, 204, 210.
 A'zam Shāh, active mints and metals of, 185.
 Ā'zamnagar, mint town, a short note on, 197, 198.
 Azīmu-sh-Shan, active mints and metals of, 186.

B

Babylonian Seal in the Central Museum, Nagpur, a note on, 461.
 Baḍa Kājī Maricimān Simha, a brief career of, lxxxii.
 Badami, the image of, 88.
 Bahādur II, active mints and metals of, 194.
 Baidyanāth, a town of Aṅga, note on, 341.
 Bahmani coins, two finds of, description of, 196.
 Bābur, active mints and metals of, 179.
 Bairāta or Barār? mint, a note on, 250.
 Bālāghāt, C.P., note on some copper coins discovered in, 481.
 Baluchistān, gypsies of, 441.
Bandicota, 212.
 Bar Gosain, Jaintia King, date of, 459.
 Barār or Bairāta? mint, a note on, 250.
barberi, Ramaswami (*Diospyros*), 47.
 Barclay Memorial Medal, xi.
 Bardic and Historical Manuscripts, specimen pages of the descriptive catalogue of, 399.
 Bardic and Historical Survey of Rajputana, a scheme for the, 373.
 Object of, 381.
 Bardic and Historical Survey of Rajputana, specimen pages of the bulletin of the, 405.
 Bardic and Historical Texts, specimen pages of, 395.
 Bardic chronicles, work on, xxi.
 ,, manuscripts, characteristic of, 377.
 Barium peroxide, the action of nitric oxide on, 290.
Batatas, Decne. (*Dioscorea*), 8, 27.
 Battle-axe type of Gupta coins, 177.
 Bedār Bakht, active mints and metals of, 194.
 Belabo grant of Bhojavarman, 121.
 Bengal, East, a forgotten kingdom of, 85.
bengalensis (*Gunomys*), 212.
 ,, Southwell (*Ophryocotyle*), 144.
benthamii, Prain et Burkill (*Dioscorea*), 11, 38.
bethsaidae (*Tendipes*), n. sp., 371.
 Beveridge, H., preface of the lives of the Apostles, translated from the Persian, by, 74.
 Bhadariyā, a town of Aṅga, note on, 337.
 Bhaddasāla Jataka, on the spirit belief, 261.
 Bhagabanlal Indrajī, Pandit, on the date of Chashtana, 223.
 Bhagalpur, the district of, see Aṅga.
 Bhandarkar, D. R., his description of stone inscriptions regarding the time of Western Kshatrapas, 224.
 ,, Prof. R. G., on the date of Chashtana, 223.
 Bhāsarvajna, Nyāya Sara of, 94.
 Bhātas, a note on, 378.
 Bhojavarman, the Belabo grant of, 121.
 Bibliotheca Indica ed., an extract from, 94. [9, 29.
bicolor, Prain et Burkill (*Dioscorea*),
 Bidār Bakht, coins of, struck in Ahmadābād, 164, 194
 Bijay Nārāyan, Jaintia King, date of, 459.
 Bikramaśilā, a monastery of Aṅga, note on, 342.
 Bilāra Kosiya Jātaka, notes on, 257.
biloba, Forsk (*Ipomoea*), 57.
 Bimbisāra, king of Aṅga, a note on, 321.

- birmanica*, Prain et Burkill (*Dioscorea*), 6, 13.
 Birdwood, Sir George, his identification of Aṅga, 318.
 Bishweshwar Nath, Sāhityāchārya, Prof. Pt., on the Jhalrapatan stone inscription of Udayaditya, 241.
blanfordi (*Dipus*), 212.
Blumei (*Dioscorea*), 8, 25.
 Borderea, 5, 11.
 Botany, list of papers on, xvii.
 Botham, A. W., on the Ahom coins of A.D. 1648, 457.
 " " on the chronology of the Jaintia kings, 459.
Bothriocephalus, 142, 144.
bovis, Cobb. (*Cysticercus*), 142.
Brandisii (*Dioscorea*), 8, 27.
brevicaudatus (*Cyclops*), 142.
brevipes (*Ischnocolus*), 414.
brevipetiolata (*Dioscorea*), 11, 38.
brevirostris (*Orcella*), xcvi.
 Broach, coins of, 466.
 Buddha, the Mahāsamaya Suttanta of, 258.
Buddhāvadāna, a note on the Sanskrit manuscript of, xx.
 Buddhism, its prevalence over Jainism, 323.
 " Mahāyāna system of, a note on, 324.
 Brahmadata, king of Aṅga, a note on, 321.
 Buddhist Stupa of Asoka Raja, its identification, 87.
 Budget for 1914, viii.
bulbifera, Linn. (*Dioscorea*), 8, 26.
bullata (*Mytilus*), 143.
 Bureau of Information, working of, xxii.
 Burma, history of, 90.
 Burgess, on the date of Chashtana, 223.
 Bury, J. B., on the gold coin of Croesus, 486.
- C
- cambodiana* (*Dioscorea*), 6, 12.
 Candanā, the first female Jaina, 321.
Candona, 142
 Cāraṇas, a note on, 378.
Caridina, xcvi.
 Carnac, J. H. Rivett, his description of a stone implement found by J. Cockburn at Alwara, 107.
carolinensis (*Sciurus*), 212, 213.
 Cattle diseases in Chota Nagpur ceremony of driving them, 353.
caucasica, Lipsky (*Dioscorea*), 6, 16.
celophylla, Voigt. (*Dioscorea*), 10, 36.
celophylloides, Prain et Burkill (*Dioscorea*), 10, 36.
 Cephalaspidae (Opisthobranchia Tectibranchia), 113.
cellulosae, Rud. (*Cysticercus*), 142.
Cerberus, xcvi.
cerebralis, Rud. (*Coenurus*), 142.
Cervus, 117-119.
 Cestode fauna of British India and Ceylon, an account of our present knowledge of the, 139-140.
 Champānagara, a town of Aṅga, note on, 333.
 Chandella dynasty, silver coins of Madanavarman of, 199.
 Chandragupta, king of Magadha, an account of, 323.
 Changīzī, note upon the Eponym of, 470.
 Chashtana, the date of, 223.
 Chattra Singha, Jaintia King, date of, 459.
 Chemistry, list of papers on, xvi.
Chershydrus, xcvi.
 Chilka Lake, exhibition of specimens illustrating fauna of, xcv.
Chilobrachys, 412, 415-419.
 Chironomides du Lac de Tibériade, 369-372.
 Christ, life of, published by Louis de Dieu, 68.
Chitra, 136, 137.
 Chittagong, sacred turtles, 132, 137-138.
 Chota Nagpur, ceremony of driving cattle diseases in, 353.
 " " contagious magic in, 350.
 " " imitative magic in, 350.
 " " magic and witchcraft in, 349-353.
 Chota Nagpur magic and witchcraft. Beneficent magic and the principle of sympathetic alliance, 350.
 Evil magic and the principle of avoidance, 351-353.
 Chota Nagpur magician, 352.
 " " sarhul ceremony in, 351.

Chota Nagpur witch, 352.
cinereus (*Sciurus*), 211.
cirrhusa, Loureiro (*Dioscorea*), 9, 31.
Cittotaenia, Riehm, 140-144.
Clarkei (*Dioscorea*), 6, 15.
Cliona, xevi.
 Cochin castes, adultery and divorce, 314-315.
 „ „ age of the parties to be married, 299-300.
 „ „ comparative study of their marriage customs, 295-315.
 „ „ liberty of choice in marriage, 296.
 „ „ marriage and celibacy, 295-296.
 „ „ marriage ceremonies and rites, 304-309.
 „ „ origin of the infant marriage, 300-302.
 „ „ polygamy and polyandry, 309-314.
 „ „ prevention of infant marriage by legislation, 302-304.
 „ „ prevailing matrimonial customs requiring social reform, 315.
 „ „ prohibition of marriage between kindred, 296-299.
 Cochin state, *Marumakkathāyum* law in the, 29.
 Cockburn, J., his discovery of a stone implement at Alwara, 107.
Cerebralis, 142.
Coenurus (*taenia*), Kūch., 142.
 Coins, annual report on, xx.
 „ Ahom, of A.D. 1648, 457.
 „ Bahmani, description of two finds of, 196.
 „ from Bālāghāt, a note on, 481.
 „ from Ballia district, 174.
 „ gold, of Croesus, 486.
 „ of Ahmad Shāh, 167.
 „ of Akbar, 482, 483.
 „ of Akbar II, 170.
 „ of Ālamgīr II, 167.
 „ of Croesus, 486.
 „ of Gupta dynasty, 174.
 „ of Audambara tribe, 247.
 „ of Madanavarman (Chandella dynasty), 199.
 „ of Shāh Ālam II, 168.
 „ of Shāh Jahān III, 168.
Colletti, Hook. (*Dioscorea*), 6, 17.

Colocasia, 424.
Colymbus, 139.
 Combilium, 7, 19.
compressa (*Cypris*), 142.
comptoni (*Episphenus*), 203.
conchii (*Philoscia*), 361, 364.
concolor (*Ginglymostoma*), 142.
Copesoma, Führmann, 140.
 Copper coins discovered in Bālāghāt, C.P., note on, 481.
 Copper plate inscriptions of Deva Khadga, 85.
Coremiocnemis, 415.
Cotugnia, Diamare, 140, 141.
coxalis, Dollfuss (*Asellus*), 361, 363.
crassicollis, Rud. (*Taenia*), 142.
Cricetus, 211.
 Croesus, a gold coin of, 486.
 Culla Kalinga Jātaka, on the spirit belief, 260.
 Culladhanuggaha Jātaka, notes on, 257.
Cumingii, Prain et Burkill (*Dioscorea*), 8, 25.
 Cunningham, his notice of Audambara coinage, 247.
 Cutch, coins of, 466.
Cyclops, 142.
 Cyclostomata, 213.
cygnus (*Pelopia*), n. sp., 369.
Cyperius, 57.
Cypris, 142.
Cyriopagus, 412.
Cysticercus, Weinl., 142.

D

Dadhivāhana, king of Aṅga, an account of, 320.
 „ Jātaka, notes on, 257.
 Daṇḍin, his account of Champagnagara, 333.
 „ on Aṅga, 328.
 Dārul-Fath Ujain, mint town, a short note on, 198.
 Daśaratha, same as Romapāda, 319.
daunaea. Prain et Burkill (*Dioscorea*), 6, 12.
 Davids, Dr. Rhys, on Bimbisāra, king of Aṅga, 321.
 Dāwar Bakhsh, active mints and metals of, 182.
decipiens, Hook (*Dioscorea*), 9, 31.
decumanus (*Mus*), 211.
 Deer, big-horned, of Tibet, 117.
deflexa, Hook. (*Dioscorea*), 11, 40.
deleteria, Noronha (*Dioscorea*), 5, 41.
deltoidea, Wall. (*Dioscorea*), 6, 16.
 Deputations from the Society, v.

- Deva Khadga, two copperplate inscriptions of, 85.
- Devaka, kingdom of, its identification, 86.
- Dēvapāla, Mungir, grant of, 97.
- Devapāla Deva, king of Varendra, a note on, 329.
- Devatā, the good spirits, notes on, 258.
- Dhanaidaha grant of Kumaragupta I, 429.
- Dharaghosa, description of the Audambara type of coins of, 249.
- Dharma Vivāham*, significance of this form of marriage, 304.
- Dharmmādityā, a note on the inscription of, 425.
- „ a note on an undated grant of the time of, 426.
- Dhonasākhu Jātaka, on human sacrifice before tree-gods, 261.
- Dibothriocephalus*, 144.
- Dieu, Louis de, life of Christ, published by, 68.
- „ „ life of St. Peter, published in Persian, with a Latin translation and notes, by, 65.
- Ḍiṅgala Bhāṣā* of Rajputana, a note on, 375.
- Dioicocestus*, Führmann, 139, 140.
- Dioscorea* of the Old World, Africa excluded, synopsis of, 5-41.
- „ *aculeata*, Linn., 19.
- „ *alata*, Linn., 39.
- „ *anguina*, Roxb., 32.
- „ *arachidna*, 21.
- „ *aspersa*, Prain et Burkill, 29.
- „ *batatas*, Decne., 27.
- „ *belophylla*, Voigt., 36.
- „ *belophylloides*, Prain et Burkill, 36.
- „ *benthamii*, Prain et Burkill, 38.
- „ *bicolor*, Prain et Burkill, 29.
- „ *birmanica*, Prain et Burkill, 13.
- „ *blumei*, 25.
- „ *brandisii*, 27.
- „ *brevipetiolata*, 38.
- „ *bulbifera*, Linn., 26.
- „ *cambodiana*, 12.
- „ *caucasica*, Lipsky, 16.
- „ *cirrhusa*, Loureiro, 31.
- Dioscorea clarkei*, 15.
- „ *collettii*, Hook., 17.
- „ *cumingii*, Prain et Burkill, 25.
- „ *daunaea*, Prain et Burkill, 12.
- „ *decipiens*, Hook., 31.
- „ *deflexa*, Hook., 40.
- „ *deleteria*, Noronha, 5, 14.
- „ *deltoidea*, Wall., 16.
- „ *doryophora*, Hance, 28.
- „ *elmeri*, Prain et Burkill, 24.
- „ *enneaneura*, Prain et Burkill, 15.
- „ *flabellifolia*, Prain et Burkill, 12.
- „ *fordii*, Prain et Burkill, 36.
- „ *foxworthyi*, 34.
- „ *georingiana*, Kunth, 41.
- „ *gibbiflora*, Hook., 36.
- „ *glabra*, Roxb., 37.
- „ *goeringiana*, Kunth, 5.
- „ *gracillima*, Miq., 17.
- „ *grata*, 35.
- „ *hamiltonii*, Hook., 39.
- „ *hastifolia*, 30.
- „ *havilandii*, 39.
- „ *hemsleyi*, Prain et Burkill, 17.
- „ *hypoglauca*, Palibin, 17.
- „ *inæquifolia*, Elmer, 24.
- „ *intermedia*, Thwaites, 29.
- „ *japonica*, Thunb., 28.
- „ *kalkapershadii*, 8.
- „ *kamoonensis*, Kunth, 21.
- „ *kerrii*, 20.
- „ *laurifolia*, Wall., 39.
- „ *lepcharum*, 36.
- „ *listeri*, Prain et Burkill, 32.
- „ *loheri*, 33.
- „ *luzonensis*, Schauer, 28.
- „ *martini*, 18.
- „ *melanophyma*, Prain et Burkill, 21.
- „ *membranacea*, Pierre Ms., 13.
- „ *merrillii*, Prain et Burkill, 35.
- „ *morsei*, Prain et Burkill, 17.
- „ *myriantha*, Kunth, 38.
- „ *nipponica*, Makino, 13.
- „ *nitens*, 18.
- „ *nummularia*, Lam., 35.
- „ *obcuneata*, Hook., 30.
- „ *œnea*, 16.
- „ *oppositifolia*, Linn., 30.
- „ *orbiculata*, Hook., 31.

Dioscorea panthaica, Prain et Burkill, 16.
 „ *pentaphylla*, Linn., 23.
 „ *peperoides*, Prain et Burkill, 28.
 „ *persimilis*, Prain et Burkill, 39.
 „ *pierrei*, 22.
 „ *polyclades*, Hook., 32.
 „ *polystachya*, Turcz., 5, 41.
 „ *prazeri*, Prain et Burkill, 15.
 „ *pulverea*, 31.
 „ *punctata*, R. Brown, 27.
 „ *pyrenaica*, Bubani et Bordère, 11.
 „ *pyrifolia*, Kunth, 33.
 „ *quinqueloba*, Thunb., 14.
 „ *ridleyi*, 12
 „ *rogersii*, 27.
 „ *scortechinii*, Prain et Burkill, 25.
 „ *seemannii*, 34.
 „ *septemloba*, Thunb., 14.
 „ *sikkimensis*, Prain et Burkill, 16.
 „ *soror*, Prain et Burkill, 34.
 „ *sp.*, Prain et Burkill, 13, 24.
 „ *spicata*, Roth., 29.
 „ *stenomeriflora*, 40.
 „ *subcalva*, 18.
 „ *tamarisciflora*, 22.
 „ *tentaculigera*, 15.
 „ *tenuipes*, Franchet et Savatier, 14.
 „ *tokoro*, Makino, 14.
 „ *tomentosa*, Koenig, 21.
 „ *transversa*, R. Brown, 30.
 „ *trimenii*, 29.
 „ *trinervia*, Roxb., 32.
 „ *triphylla*, Linn., 25.
 „ *velutipes*, 19.
 „ *vexans*, Prain et Burkill, 38.
 „ *vilis*, Kunth, 5, 41.
 „ *villosa*, Linn., 15.
 „ *wallichii*, Hook., 31.
 „ *wattii*, Prain et Burkill, 35.
 „ *wightii*, Hook., 29.
 „ *warburgiana*, Uline, 40.
 „ *yunnanensis*, Prain et Burkill, 17.
 „ *zingiberensis*, C. H. Wright, 17.
 „ *zollingeriana*, Kunth, 32.
Diospyros, 47-49.
Diploposthe, Jacobi, 140.
Diplathallus, Fürhmann, 140.

Dipodidae, 212.
Dipus, 211, 212.
Dipylidium, Leuckart, 140, 141.
Divvoka, same as *Divya*, 124.
doryophora, Hance (*Dioscorea*), 8, 28.
Drepanidotaenia, 142.
Dummedha Jātaka, on human sacrifice before tree-gods, 261.
Divya, the Kaivartta leader, an account of, 124.
dominicus (*Colymbus*), 139.
Duthiersia, 144.
Durvāsā-sārama, a town of Aṅga, note on, 341.

E

Echinococcus (Batsch), Rudolphi, 139.
Echimys, 211.
Edilpur grant of Kesava Sena, 97.
Edward VII, an unissued rupee of, 245.
 „ currency during the reign of, 245.
elaphus (*Cervus*), 118.
Elephanta, the image of, 88.
Elliott Prize for Scientific Research, xi.
Ellora, the image of, 88.
Elmeri, Prain et Burkill (*Dioscorea*), 8, 24.
Emyda, xevi, 136.
Enantiophyllum, 8.
Enneaneura, Prain et Burkill (*Dioscorea*), 6, 15.
Enochrus, 358.
Epigraphical Records of the 12th cent. A.D. in Pāla (Jodhpur), 405.
Episphenoides, 204.
Episphenus, 203-4, 210, 418.
Erethizon, 211.
Euheptapleurum, 115.
expansa (*Moniezia*), 145.

F

Fa Hian, on Aṅga, 325.
Faridpur, four forged grants of, 425.
farinalis (*Asopia Pyralis*), 142.
Farrukh Siyar, active mints and metals of, 187.
fasciolaris, Rud. (*Cysticercus*), 142.
Fellows of the Society, x.
Fiber, 140.
Fimbriariidae, 140.
Finance of the Society, vi.

Firūzgarh, mint town, a short note on, 199.
 Firuz Shah, a note on a history of, xcvi.
flabellifolia, Prain at Burkill (*Dioscorea*), 6, 12.
flavopunctata, Weinl. (*Hymenolepis Taenia*), 142.
 Floral mechanism of *typhonium trilobatum*, 421-424.
Fordii, Prain et Burkill (*Dioscorea*), 10, 36.
Formosus, Gray (*Trionyx*), 132.
Foxworthyi (*Dioscorea*), 10, 34.
friedbergeri von Linstow (*Drepanidotaenia*), 142.
fumosus (*Chilobrachys*), 416.
Funambulus, 212.

G

Gait, Mr., a note on his attribution of the Ahom coins of A.D. 457 to Pratāpa Sinha, 457.
 „ on the coins of Jaintia Kings, 459.
galilaeus (*Tendipes*), n. sp., 372.
Gammarus, 361, 362.
gangeticus, Cuvier (*Trionyx*), 131.
Garcinia indica, notes on the fat of, 293.
gemmiporum (*Urocystidium*), 140.
genesareth (*Polypedilum*), n. sp. 370.
 Geography, list of papers on, xvii.
 Geology, list of papers on, xvii.
Gerbillus, 212-3.
Gibbiflora, Hook (*Dioscorea*), 10, 36.
Ginglymostoma, 142.
glabra, Roxb. (*Dioscorea*), 11, 37.
Gnaphalocnemis, 201, 203, 204, 210.
goeringiana, Kunth (*Dioscorea*), 5, 41.
Gonatas, 201, 203, 204, 210.
 Gopacandra, a note on the inscription of the time of, 426.
 Gopāla, king of Varendra, a note on, 329.
 Gotama-kunḍa, origin of, 44.
 Govardhana, an account of, 124.
Gracillima, Miq. (*Dioscorea*), 7, 17.
gracilis, Zeder (*drepanidotaenia*), 142.
 „ *laccobius* (s. str.), Mots., 359.
 Grammaridae, 362.
 Grammaridae (amphipoda), 362.
Granulosus (Batsch), *echinococcus*, Rudolphi, 139.
grata (*Dioscorea*), 10, 35.

Grierson, Sir G. A., on *Dingala* and *Pingala*, 375.
 Grooved stone hammers from Assam, 107-109.
 Grooved stone hammers from Assam, their description, 108.
 „ occurrences of similar forms in Eastern Asia, 109.
guarauna (*Plegadis*), 139.
 Gujarat Mahmudī, 463.
 Gujarāt Mughal coins, the identification of—with the Mahmudī, 464.
 Guleri, Chandradhara, on the authorship of *Jayamangalā*, 1.
 Guṇaratna, Tarka-Rahasya Dipikā of, 94.
Gunomys, 212.
 Gupta gold coins found in the Ballia district, 174.
 Gypsies of Baluchistan, 441.
 „ of Qainat (E. Persia) language of the, 439, 443, 445.
 „ vocabulary of, 448.
 Gypsy, customs and manner of life, notes on the peculiarities of, 442.
 Gypsy story, appendix of a, 455.

H

Hamiltonii, Hook. (*Dioscorea*), 11, 39.
Haploclastus, 420.
 Haraprasād Śāstri, his report on Bardic chronicles, a note on, 373.
 Harṣavarddhana, his conquest of Aṅga, 328.
hastifolia (*Dioscorea*), 9, 30.
Havilandii (*Dioscorea*), 11, 39.
 Hazrat Jesus, see Jesus, Hazrat, 74.
Helamys, 211.
Hemsleyi, Prain et Burkill, (*Dioscorea*), 7, 17.
Heptapleurum, note on leaf variation in, 115.
 Hill, G. F., on the gold coin of Croesus, 486.
 Historical and Bardic Survey of Rajputana, a scheme for, 373.
 Hiuen Tsiang, on Aṅga, 328.
 „ „ the description of Samatata, 86.
 Hoernle, Dr. A., a note on his identification of Dharmāditya with Yaśodharman, 429, 430.

Hot springs in Raj Dharbhanga, Khargpore Hills, District Monghyr, 147.

Human sacrifice before tree-gods, mention of, in Dummedha Jātaka, 261.

Humāyun, active mints and metals of, 179.

hurum (*Trionyx*), 131.

Hydrophilidae from the Lake of Tiberias, 357-360.

Hydrophis, xcvi.

Hymenolepis, 142. [43.

Hymns in Rigveda, localisation of, *Hyperplesthenus*, 204, 210.

Hypoctonus, 416.

hypoglauca, Palibin (*Dioscorea*), 7, 17.

Hystriidae, 212.

Hystrix, 211-2.

I

Ichthyotaenia, 144.

inaequifolia, Elmer (*Dioscorea*), 8, 24.

Indian Museum, representation of the Society to, iv.

„ Science Congress, an account of the proceedings of, lxxxviii.

„ Science Congress, committee regarding, v.

Indian spiders belonging to the subfamily Aviculariinae, evolution and distribution of, 411-420.

indica (*Chitra*), 136, 137.

indicus (*Epispheus*), 203.

„ (*Gerbillus*), 212.

Indo-Australian Passalid Coleoptera, evolution and distribution of certain, 201-210.

Indo-Gangetic Alluvium, note on application of principle of isostatic compensation to the conditions prevailing beneath the, 275.

infundibuliformis, Goeze (*Drepanidotaenia*), 142.

Inscriptions on the Jain temple of Jodhpur, a note on, 406.

intermedia, Thwaites (*Dioscorea*), 9, 29.

„ (*Emyda granosa*), xcvi.

International Catalogue of Scientific Literature, x.

Ipomœa, 57.

Ischnocolus, 414.

Isopoda, 363.

„ and Amphipoda from the Lake of Tiberias, 361-367.

Isostatic Compensation, note on application of principle of, to the conditions prevailing beneath the Indo-Gangetic Alluvium, 275.

It-Sing, description of Samatata, 86.

J

Jagad-Vijayamalla, a note on, 125.

Jahāndār Shāh, active mints and metals of, 186.

Jahāngīr, active mints and metals of, 181.

„ and Nūr Jahān, active mints and metals of, 182.

Jahnu-āsrama, a town of Aṅga, note on, 340.

Jain temple of Jodhpur, a description of, 406.

„ tradition on the Sakas, 223.

Jaintia kings, chronology of, 459.

Jamvugrama, camp at, 99.

Jang Bahadur, note on his campaign against Tibet, 196.

japonica, Thunb. (*Dioscorea*), 8, 28.

Jātaka stories, spirit belief in, 259.

Jātavarman, Yādava King, an account of, 124.

Javelin type, var. α . of Gupta coins, 175.

Javelin type, var. γ . of Gupta coins, 177.

Jesus, Hazrat, story and description of the virtues of the Apostles of, 74.

Jhalrapatan Stone Inscription of Udayaditya, 241.

Jiva (live), note on, 258.

Jodhpur Durbar, its help regarding Bardic Survey, 381.

„ epigraphical records of, 405.

Jayamangalā, the real author of, 1.

Jay Nārāyan, Jaintia King, date of, 459.

K

Kācha type of Gupta coins, 177.

Kalacuris, genealogical table of the dynasty of, 123.

Kalkapershadii (*Dioscorea*), 8.

Kām Bukhsh, active mints and metals of, 186.

Kāmāsrama, localisation of, 317.

Kāma vivāham, significance of this form of marriage, 304.

kamoonensis, Kunth (*Dioscorea*), 8, 21.
 Kamrupa, kingdom of, its identification, 86.
 Karmmanta, the city of, 85.
 „ the Khadgu dynasty of, 85.
 Karnagarh, the fort of Rāja Karṇa, localisation of, 327.
 Karnasena, the founder of Karṇasuvarna, 326.
 Karṇasuvarna, the kingdom of, a note on, 326.
 Kāron, its identity with Kāmāśrama, 317.
Kaupioloides, 210.
Kaupiolus, 204, 210.
 Kavīśvara, a note on the title of, 379.
Kavirāja, a note on the title of, 379.
Kēlhaṇadēva, king on Naddula, date of, 406.
kempii (*Atopos*), 111.
Kerii (*Dioscorea*), 7, 20.
 Kesavasena, Edilpur grant of, 97.
 Khadirangāra Jātaka, on the spirits dwelling in houses, etc., 259.
 Kielhorn, Dr., statement of, 97.
 King, Mr., L. W., his description of a Babylonian seal in the Central Museum, Nagpur, 462.
 Kīrttivarman I, his conquest of Aṅga, 327.
 Kokam butter, notes on the fat of *Garcinia indica*, the so-called, 293.
 Kori of Gujarat, 464.
 Kshatrapas, Western, description of five stone inscriptions of the time of, 224.
 Kumāragupta I, the Dhanaidaha grant of, 429.
 Kuṇḍakapūva Jātaka, on the spirits in the trees, 260.
 Kunika or Kuniya, same as Ajātaśatru, 322.
 Kusanāli Jātaka, on the spirit belief, 261.
 Kyansittha, king of Pegu, notes on, 91.

L

Labienuus, 204, 210.
Laccobius, 358-360.
Lagomyidae, 212.
Lagomys, 212.

Lahore, review on R. B. Whitehead's catalogue of the coins in the Punjab Museum, 471.
 Lakkhamandal prasasti, a note on, 123.
 Lakshmi Nārāyan, Jaintia King, date of, 459.
 Lasiophyton 7, 20.
 Laskar, G. M., on the Asrafpur plate, 85.
latus, Bröms. (*Bothriocephalus*), 142.
 „ Lühe (*Dibothriocephalus*), 144.
Launea, Cass, 57.
laurifolia, Wall. (*Dioscorea*), 11, 39.
 Layahachandradeva, his identification, 89.
 Lead peroxide, action of nitric oxide on, 287.
 Lectures delivered in Society's rooms, list of, xiii.
Lemmus, 211.
Lepcharum (*Dioscorea*), 10, 36.
Leptotrichus, sp., 361, 366.
leucaspis, Kiesw. (*Laccobius reverlieri*, var.), 358.
leuckarti (*Atopos*), 111.
leucurus (*Hystrix*), 212.
 Library, report on the, ix.
Ligula, 143.
Listeri, Prain et Burkill (*Dioscorea*), 9, 32.
locroides (*Sciurus*), 212.
Loheri (*Dioscorea*), 10, 33.
Lumetus, 358.
Lutra, xcvi.
luzonensis, Schauer (*Dioscorea*), 9, 28.
Lyrognathus, 415.

M

maccllellandii (*Sciurus*), 212.
macrodus (*Lutra*), xcvi.
maculatum (*Arum*), 424.
 Madanpāda, grant of Viśvarūpa-sēna, 97.
 Madanavarman of the Chandella dynasty, silver coins of, 199.
 Mādhavāchārya, Saṃkṣepa Saṅkar Jaya of, 93.
 Madras Museum, two belted stone hammers in the, 107.
 Magadha, kingdom of, a note on, 321.
 Magic, contagious, in Chota Nagpur, 350
 „ evil, in Chota Nagpur, and the principle of avoidance, 351-353.

- Magic, imitative, in Chota Nagpur, 350.
 Magic and witchcraft in Chota Nagpur, 349-353.
magna, Southwell (*Amphilina*), 143.
 Mahābhārata, on the derivation of the name of Aṅga, 318.
 Mahāgovindasutta, notes on, 257.
 Maha-taing-tsandra, the first king of the Chandra dynasty, notes on, 90.
 Mahāparinirvānatantra, notes on, 99.
 Mahāvānija Jātaka, on the spirit belief, 262.
 Mahāvira and influence of his religion, 323.
 Mahāyāna system of Buddhism, a note on, 324.
 Maḥmūd Shāh III, of Gujarāt, a note on the copper coins of, 481.
 Maḥmūdī, the identification of the coin of Gujarāt Fabric with the, 464.
Mana, meaning implied by the term, 349.
 Manasāra-bhāṣān, on Champanagar, 335.
 Mandāra Hill, a town of Aṅga, note on, 341.
 Mari on the Indus, its position, 487.
 Marriage customs of the Cochin castes, 295-315.
Martini (*Dioscorea*), 7, 18.
Marumakkathāyum law of inheritance in the Cochin State, 299.
Mastochilus, 210.
 Matanga Jātaka, on the spirit belief, 260.
 Maulūdī era of Tipu Sultān of Mysore, note on the dates of the, 25.
maximus (*Atopos*), 111, 112.
 „ (*Sciurus*), 211.
 Medical Section of the Society, working of, xix.
 Meetings of the Society, vi.
melanophyma, Prain et Burkill (*Dioscorea*), 8, 21.
 Members, list of, in 1913, xxxix.
 „ ordinary, numbers of, iv.
membranacea, Pierre Ms. (*Dioscorea*), 6, 13.
meridionalis (*Gerbillus*), 212.
Merrillii, Prain et Burkill (*Dioscorea*), 10, 35.
Mesocestoides, Vaillant, 140, 141.
Methydrus, 357.
Metoponorthus, 361, 364.
mettada (*Mus*), 211.
minax (*Cyriopagus*), 412.
 Mints and their metals, list of active, exhibiting for each Mughal reign, 179.
 Mints, total number of, appendix showing for each Mughal reign, 195.
 Mir'āt-i-Ahmadi, translation of the passage of identification of the Maḥmūdī with the coin of Gujarāt Fabric from the, 467.
 Mir'at-ul-Quds, or life of Christ, 66.
Mokṣa, the nature of, 93.
 Monghir, a town of Aṅga, note on, 337.
Moniezia, 145.
 „ Blanchard 140, 141.
monilus (*Pelopia*), L., 369.
moorei (*Episphenus*), 203, 204, 210.
morsei, Prain et Burkill (*Dioscorea*), 7, 17.
mucronota, Pers. (*Frachys*), 57.
 Mud-turtles, practice of keeping them living in shrines at the present day, 131-134.
 „ relics of worship of, in India and Burma, 131-138.
 „ some general considerations on, 136-137.
 „ their use in worship and iconography in Northern India, 134-136.
 Mugapakkha Jātaka, on the spirits dwelling in the umbrella, 259.
 Mugapakkha Jātaka, story of, 259.
 Mughal coins, four rare types of, 197.
 Mughal Emperors, review on R. B. Whitehead's catalogue of the coins of, 471.
 Mughal Emperors of India, list complementary to Mr. Whitehead's mint towns of the, 178.
 Mughal reign, list of active mints and their metals exhibiting for each, 179.
 Muḥammad 'Adil Shāh, Sūrī, a note on the copper coins of, 483.
 Muḥammad Ibrāhīm, active mints and metals of, 189.
 Muḥammad Shāh, active mints and metals of, 189.

Mungir grant of Dēvapāla, 97.
 Murād Bakhsh, active mints and metals of, 184.
 Murādābād, mint town, a short note on, 246.
Muridae, 211, 213.
Mus, 211, 212, 213.
myriantha, Kunth (*Dioscorea*), 11, 38.
Mytilus, 143.

N

Nahapana, inscriptional date of, 224.
 Nahrwāla Shahr Pattan mint, a copper coin from the, 479.
 Nahrwāla Shahr Pattan mint town, a short note on, 479.
 Naravāhanadatta, king of Vatsya, an account of, 328.
 Narendra Gupta (Śaśānka), king of Gauḍa, a note on, 326, 327.
 Nartteswara, the image of, 88.
 Nataraja Siva, an inscribed image of, 85.
 Natural History, notes on the papers on, xv.
 Navānagar, coins of, 466.
neelgherriensis (*Episphenus*), 203.
 Nebuchadnezzar, the ruler of Babylon, 75.
Nematotaenia, Lühe, 140.
nemorivaga (*Bandicota*), 212.
Neochilobrachys, 413, 414, 415, 420.
 Nepala, kingdom of, its identification, 86.
 „ war medals, description of, 195.
nigricans (*Trionyx*), 132, 134.
Nipponica, Makino (*Dioscorea*), 6, 13.
nitens (*Dioscorea*), 7, 18.
 Nitric oxide, the action of, on metallic peroxides, 287.
 Numismata Orientalia, 90.
nummularia, Lam. (*Dioscorea*), 10, 35.
Nyāya, ancient, optimism in, 93.
Nyāya and *Vaiśeṣika* systems, the nature of *mokṣa* in, 93.
Nyāya Sāra, a passage from, 94.

O

obcuneata, Hook (*Dioscorea*), 10, 30.
oenea (*Dioscorea*), 6, 16.
 Office-bearers of the Society, xii.
 Oil gas, an improved method of using, 215.

Oldenburg, on the date of Chash-tana, 223.
Omegarius, 203.
 Oniscidae, 364.
 Oniscoida, 364.
Ophrygonius, 202, 418.
Ophryocotyle, 144.
oppositifolia, Linn. (*Dioscorea*), 9, 10, 30.
 Opsophyton, 8, 26.
orbiculata, Hook. (*Dioscorea*), 9, 31.
Orcella, xcvi.
Orchestia, 361, 363.
ornatus (*Ischnocolus*), Thorell, 414.
Orphnoecus, 415.

P

Pajjunna (Rain-God), character of, 257.
 Palaeographical examination of the four forged plates of Faridpur, 433, 434.
 Pālas, genealogical table of the dynasty of the, 123.
 Palāsa Jātaka, on tree worship, 260.
palmarum (*Sciurus*), 212.
Pancerina, Führmann, 140.
 Pañchashikhā Dēvaputta, teacher of Sāṅkhya Philosophy, 257.
panthaica, Prain et Burkill (*Dioscorea*), 6, 16.
 Paramāra Jaya Sinha I, a note on a copper plate of, 241.
Parapelopides, 203.
 Pargiter, on the four forged grants of Faridpur, 425.
 „ on the inscription of the time of Samācāradeva, 426.
Parvirostrum, Führmann, 140.
Pasūpatipaddhati, a note on the Sanskrit manuscript of, xx.
 Patikara, Purganah of, 91.
pearsoni (*Sciuropterus*), 212.
 Pegu, king of, 91.
Pelopia, 369.
pentaphylla, Linn. (*Dioscorea*), 8, 23.
Peperoides, Prain et Burkill (*Dioscorea*), 9, 28.
 Persian grammar, notes on the differences of grammar between Gypsy and, 446.
persimilis, Prain et Burkill (*Dioscorea*), 11, 39.
Pharochilus, 210.
 Phayre, on "History of Burma," 90.
 „ on "Numismata Orientalia," 90.

- phayrei* (*Trionyx*), 134.
Philhydrus, 358.
 Philology, note on the papers on, xiii.
Philoscia, 361, 364.
Phlogiellus, 415.
Phlogiodes 412.
Phutakara gīta, the general name for Bardic poetry, a note on, 382.
pierrei (*Dioscorea*), 8, 22.
Piṅgala bhāṣā of Rajputana, a note on, 375.
pinnatifida, Cass (*Launea*), 57.
pisiformis, Zeder (*Cysticercus*), 142.
platensis, Kröyer (*Orchestia*), 361, 363.
Plegadis, 139.
Plesiophrictus, 412, 413.
Plesiophrictus, 417.
Plesthenus, 210
Podangia, 111.
Poecilotherieae, 412, 417, 419.
polyclades, Hook. (*Dioscorea*), 9, 32.
Polypedilum, 370-1.
polypteri (Loyd) (*Bothriocephalus*, *Anchistrocephalus*), 144.
Polystachya, Turcz. (*Dioscorea*), 41.
 Post-Mughal coins of Aḥmadābād, or a study in Mint Marks, 153.
 Pratāpa Singha, Jaintia King, date of, 459.
Prathilomam, meaning of the term, 297.
prazeri, Prain et Burkill (*Dioscorea*), 6, 15.
 Premises and property of the Society, xi.
 Prinsep, on Edilpur Grant, 97.
Protomocoelus, 201.
pruinus (*Rhizomys*), 212.
Psalmopeous (group *Avicularieae*), 411.
Pseudophyllidae, Carus, 140.
Pteromys, 211.
 Ptolemy, on Chashtana, 223.
 „ on the date of Chashtana, 223.
 Publications of the Society, exchange of, xii.
pulverea (*Dioscorea*), 9, 31.
punctata, R. Brown (*Dioscorea*), 8, 27. [362.
pungens, M.-Ed. (*Gammarus*), 361,
pungens, Willd. (*Zoysia*), 57-63.
 Punjab Museum, Lahore, revision on R. B. Whitehead's Catalogue of the coins in the, 471.
 Purāṇas, on the derivation of the name of Aṅga, 318.
Pyralis, 142.
pyrenaica, Bubani et Bordère (*Dioscorea*), 5, 11.
pyrifolia, Kunth (*Dioscorea*), 10, 33.
- Q
- Qaināt (in Eastern Persia), on the language of the Gypsies of, 439.
 Qandahār, Shāh Hasan's (Shāh Beg's son) presence at, 285.
 Quadrant Electrometers, improvements in measurements with, 227.
quinqueloba, Thunb. (*Dioscorea*), 6, 14.
- R
- Rafi'ud-Daula (Shāh Jahān II), active mints and metals of, 188.
 Rajasthani, Old Western, notes on the grammar of, by Dr. Tessitori, 375.
 Rajbhatta, the king, the identification of, 90.
 Rajputana, a scheme for the Bardic and Historical Survey of, 373.
 Rām Singh II, Jaintia King, date of, 459.
 Rāmāyāna, on the derivation of the name of Aṅga, 317.
 Ranabankamalla, copperplate inscription of, 91.
 Ranking, George, copy of J. Xavier's Persian lives of the apostle, 71.
 Rapson, on the date of Chashtana, 223, 224.
rattus (*Mus.*), 211.
 Rehuānālā, a town of Aṅga, note on, 338.
 Report, Annual, for 1913, iv.
revelieri, Perris (*Laccobius*), 358.
Rhizomys, 212.
rhyncops (*Cerberus*), xcvi.
ridleyi (*Dioscorea*), 6, 12.
 Risley, Sir Herbert, on causes preventing re-marriage of Hindu widows, 313-314.
 Rigveda, the localization of certain hymns in, 43.
 Rodents, presence and absence of gall-bladder in certain, 211-214.
rogersii (*Dioscorea*), 8, 27.
 Romapāda, king of Aṅga, an account of, 319.
rostrata (*Candona*), 142.

roylei (*Lagomys*), 212.
 Ṛsyaśṛṅga-āsrama, a town of Aṅga,
 note on, 338.
 Rudradaman, the grandson of
 Chashtana, 223.
 „ date of, 224.
 Rudradāsa, description of the
 Audambara type of coins of,
 249.
rufesens (*Lagomys*), 212.
 Rukkhadhamma Jātaka, on the
 spirit belief, 261.

S

Sadāśiva, description of, 99.
Sadāśiva-mudrayā mudrayitvā —
 meaning of the term, 99.
saginata, Goeze (*Taenia*), 139.
sagitta (*Dipus*), 211.
 St. Peter, life of, published in Per-
 sian with a Latin translation
 and notes by Louis de Dieu,
 65.
 Śakas, their invasion of Aṅga, 324.
Sakka (Vedic Indra), character of,
 257.
 Śaktisaṅgama Tantra, on the iden-
 tification of Aṅga, 318.
 Samācāradeva, inscription of the
 time of, 426.
 Samatata, kingdom of, its identi-
 fication, 86.
Sambandham, customs connected
 with this form of marriage,
 307-309.
Samksepa Śaṅkara Jaya, 93.
 Samuddavāṇija Jātaka, on the spirit
 belief, 262.
 Samudra Gupta, the Allahabad
 inscription of,
 86.
 „ his Aśvamedha
 coin type, the
 legend of, 255.
sanguinolenta, (*Atopos*, *Podangia*),
 111, 113.
 Śaṅkarāchārya, Sarvadarsana—
 siddhantasangraha of, 93.
 Sanskrit Manuscripts, catalogue of,
 xxii.
 „ „ search for,
 xx.
 Saradaršana samuchchaya, Luigi
 Sualì's edition of, 94.
sarasini (*Atopos*), 111, 112. [351.
Sarhul ceremony in Chota Nagpur,
Sarvadarsanasiddhantasangraha, 93.
schildii (*Atopos*), 111.
 Science Congress, Indian, commit-
 tee regarding, v.

Sciuridae, 212.
Sciuropterus, 212.
Sciurus, 212, 213.
 „ *atridorsalis*, 212.
 „ *caniceps*, 212.
 „ *carolinensis*, 212, 213.
 „ *cinereus*, 211.
 „ *locroides*, 212.
 „ *maccllellandii*, 212.
 „ *maximus*, 211.
 „ *palmarum*, 212.
Scortechinii, Prain et Burkill (*Dios-
 corea*), 8, 25.
Seemannii (*Dioscorea*), 10, 34.
 Sehrind, or Sirhind, note on, 281.
Selenocosmia, 415, 416, 417, 418.
 „ sp., 420.
Selenostholus, 415.
Selenotypus, 415.
semperi (*Atopos*), 111.
septemloba, Thunb. (*Dioscorea*), 6,
 14.
 Serampur MS., description of the,
 69.
 Sēna kings of Bengal, a copperplate
 inscription of, 99.
 „ the genealogy of, 98.
serrata, Goeze (*Taenia*), 142.
setigera, Frol. (*Drepanidotaenia*),
 142.
 Shilabhadra, his identification, 86.
 Shāh-Ālam II, coins of, struck in
 Aḥmadābād, 168.
 „ active mints and
 metals of, 192.
 „ a new coin of, 246.
 Shāh 'Ālam Bahādur, active mints
 and metals of, 184.
 Shāh Beg Arghūn, the ruler of
 Sind, the date of the death
 of, 283.
 Shāh Hasan's (Shāh Beg's son)
 presence at Qandahār, 285.
 Shāh-Jahān I, active mints and
 metals of, 182.
 Shāh-Jahān III, coins of, struck
 in Aḥmadābād,
 168.
 „ active mints and
 metals of, 192.
 Shāh Shujā, active mints and
 metals of, 184.
 Shahr Pattan mint, a copper coin
 from the Nahrwāla, 479.
Shannicorea (*Dioscorea*), 7, 17.
 Shous, or Big-horned deer of Tibet,
 117.
sikkimensis, Prain et Burkill (*Dios-
 corea*), 6, 34.
 Sīlānisamisa Jātaka, on the spirits
 of seas and rivers, 263.

- Simhavarmmā, king of Aṅga, an account of, 328
simplicissima (*Ligula*), 143.
 Sind, the date of the death of Shāh Beg Arghun, the ruler of, 283.
 Singhapura, its identification, 124.
 Sinhapura, same as Singhapura, 124.
 Sirat-i-Firuz, a note on, xcvi.
 Sirhind or Sehrind, note on, 281.
 Sivadāsa, description of the Audambara type of coins of, 249.
 Smith, V., on the date of Chashtana, 223, 224.
Solenophorus, 144.
solium, Rud. (*Taenia*), 142.
 Sonadanda Sutta, on Bimbisāra, king of Aṅga, 321.
Soror, Prain et Burkill (*Dioscorea*), 10, 34.
 Soul theory, Pan-Indian, notes on, 257.
 Spalacidae, 212.
spicata, Roth. (*Dioscorea*), 9, 29.
Spinifex, 57.
 Spirit belief in the Jātaka stories, 257.
Spongilla, xcvi.
Sporobolus, 57.
squarrosus, Linn. (*Spinifex*), 57.
 Stapleton, H. E., on Chittagong turtles, 137-138.
Stenocorea, 11, 40.
stenomeriflora (*Dioscorea*), 11, 40.
Stenophora, 6, 12.
 Sthānudatta, a vassal of Dharmāditya, 425.
Stilesia, Railliet, 140, 141.
 Stone hammers, grooved, from Assam, 107-109.
 „ two belted, in the Madras Museum, 108.
 Stone implements from Yünnan, descriptions of, 265-274.
 „ from Yünnan, their relation to Chinese finds, 273-274.
stridulans (*Chilobrachys*), 417, 420.
strubelli (*Atopos*), 111.
 suali, Luigi, Saradaršana Sammuchchaya of, 94.
subarmatus, Thorell. (*Neochilobrachys*), 420.
subcalva (*Dioscorea*), 7, 18.
Suberites, xcvi.
 Suboor, M. A., note on a Babylonian seal, 461.
 Survey of Rajputana, Bardic and Historical, a scheme for, 373.
swammerdami, And. and Sav. (*Metoponorthus*), 361, 364.
Synetheres, 211.
syriacus, Chevreux (*Gammarus*), 361, 362.
syriacus Guillebean (*Laccobius*), 360.
- T
- Taenia*, 142, 144.
 Takkāriya Jātaka, on the spirit belief, 260.
 Talitridae, 363.
tamarisciflora (*Dioscorea*), 8, 22.
Tamiops, 212.
Tarka-Rahasya-Dīpikī, 94.
Tatius, 201.
Tendipes, 371-2.
tentaculigera (*Dioscorea*), 6, 15.
Tenuipes, Franchet et Savatier (*Dioscorea*), 6, 14.
Tetracisdicotyla, Führmann, 140.
Tetrarhynchus, 142.
Thālikettu Kalyānam, main features of this form of marriage, 306-307.
 Thomas, on the Aśvamedha coin type, 255.
Thrigmopoeus, 417, 420.
Thysanosoma, Diesing, 140, 141.
 Tibériade Lac, Chironomides du, 369-372.
tiberiadis (*Orchestia*), 361.
 „ (*Polypedilum*), n. sp., 371. [369.
 „ (*Trichotanypus*), n. sp.,
 Tiberias Lake, Amphipoda and Isopoda from the, 361-367.
 „ Hydrophilidae from the, 357-360.
Tiberioides, 202, 204.
 Tibet, Jang Bahadur's Campaign against, note on, 196.
 Tinnevelly Hills, *diospyros* from, 47-49.
 Tipū Sultān, chronographical table showing regnal years of, 254.
 Tipū Sultān of Mysore, note on the date of the Maulūdī era of, 251.
Tokoro, Makino (*Dioscorea*), 6, 14.
tomentosa, Koenig (*Dioscorea*), 7, 21.
 Tortoises, used as food by the Hindus, 137.
Trachys, 57.
transversa, R. Brown (*Dioscorea*), 9, 30.

- Trapezochilus*, 203.
 Tree worship in Palāsa Jataka, 260.
Trichotanypus, 369. [421.
trilobatum Schott (*Typhonium*),
Trimenii (*Dioscorea*), 9, 29.
trinervia, Roxb. (*Dioscorea*), 10, 32
Trionyx formosus, Gray, 132.
 „ *gangeticus*, Cuvier, 131.
 „ *hurum*, 131.
 „ *nigricans*, 134.
 „ „ Anderson, 132.
 „ *phayrei*, 134.
 Trionychidae, 136, 137.
triphylla, Linn. (*Dioscorea*), 8, 25.
Triplotaenia, Boas, 140.
Typhonium trilobatum, a note on
 the floral
 mechanism
 of, 421-424.
 „ „ Schott, 421.

U

- Ubbāi Sutta*, a Jaina work on
 Champanagora, 336.
 Udayaditya, Jhalrapatan stone
 inscription of, 241.
Udayin, discussion of the term, 125.
unionifactor (*Tetrarhynchus*), 142.
Urocystidium, 140.

V

- Vaginula*, Latrille, 111.
 Vaginulidae, 111.
 Valentine, W. H., copper coins of
 India, Part I, Bengal and
 the United Provinces, review
 on, 477.
 Vāraka, Maṇḍala of, its identifica-
 tion with ancient Vārendrī,
 427.
 Vasu, N. N., on Madanpāda grant
 of Visvarūpasēna, 97.
velutipes (*Dioscorea*), 7, 19.
 Venis, Dr., on the Aśvamedha coin
 type, 255. [115.
venulosum, Seem. (*Heptapleurum*),
 Vessavana Kuvera, the lord of the
 evil spirits, notes on, 258.
vexans, Prain et Burkill (*Dioscorea*),
 11, 38.
 Vidhurapandita Jātāka, on the spi-
 rits dwelling in the umbrella,
 259. [of, 89.
 Vikrampur, the Chandra dynasty
vilis, Kunth (*Dioscorea*), 5, 41.
Villosa, Linn (*Dioscorea*), 6, 15.
 Virasena, dynasty of, 98.
virginicus, Kunth (*Sporobolus*), 57.
viridis (*Cyclops*), 142.

- Visṇuprasād Rājbhāndārī, a brief
 career of, lxxxii.
 Viśvakarman, the celestial archi-
 tect, notes on, 257.
Viśvarūpa, the word, notes on, 97.
 Viśvarūpasēna, Madanpāda grant
 of, 97.
volucella (*Pteromys*), 211.
 Vyaggha Jātaka, on the spirit belief,
 262.

W

- wallichii* (*Cervus*), 117, 118.
 „ Hook. (*Dioscorea*), 9, 31.
warburgiana, Uline (*Dioscorea*), 11,
 40.
wattii, Prain et Burkill (*Dioscorea*),
 10, 35.
 Whitehead's mint towns of the Mu-
 ghal Emperor of India,
 complementary list to, 178.
 Whitehead, R. B., catalogue of the
 coins in the Punjab Museum,
 Lahore, Vol. II, coins of the
 Mughal Emperors, review,
 471.
Wightii, Hook. (*Dioscorea*), 9, 29.
 Witchcraft and magic in Chota
 Nagpur, 349-353.

X

- Xavier, Fr. Jerome, Persian lives
 of the Apostle, 65.

Y

- Yādava dynasty, an account of,
 122.
 Yadavas, genealogical table of the
 dynasty of, 123.
 Yakkhas, the evil spirits, notes on,
 258.
 Yasodhara, the supposed author of
 Jayamangalā, 1.
 Young's modulus, on a demonstra-
 tion apparatus for determin-
 ing, 51.
 Yünnan, description of stone imple-
 ments from, 265-274.
yunnanensis, Prain et Burkill (*Dios-
 corea*), 7, 17.

Z

- zibethicus* (*Fiber*), 140.
zingiberensis, C. H. Wright (*Dios-
 corea*), 6, 17.
Zollingeriana, Kunth (*Dioscorea*),
 9, 32.
 Zoology, list of papers on, xv.
Zoysia pungens, studies on the leaf
 structure of, 57-63.