

743/16 x 6 1/2  
outside  
9 1/2 x 6 1/4

PKB  
B468  
61

# THE BOTANICAL GAZETTE

133.15

**THE UNIVERSITY OF CHICAGO PRESS**  
**CHICAGO, ILLINOIS**

---

**Agents**

**THE CAMBRIDGE UNIVERSITY PRESS**  
**LONDON AND EDINBURGH**

**THE MARUZEN-KABUSHIKI-KAISHA**  
**TOKYO, OSAKA, KYOTO**

**THE MISSION BOOK COMPANY**  
**SHANGHAI**

**KARL W. HIERSEMANN**  
**LEIPZIG**



THE  
BOTANICAL GAZETTE

---

EDITOR  
JOHN MERLE COULTER

---

VOLUME LXI  
JANUARY-JUNE 1916

---

WITH THIRTY-ONE PLATES AND SIXTY-SIX FIGURES



THE UNIVERSITY OF CHICAGO PRESS  
CHICAGO, ILLINOIS

**Published**  
**January, February, March, April, May, June, 1916**

**Composed and Printed By**  
**The University of Chicago Press**  
**Chicago, Illinois, U.S.A.**



## TABLE OF CONTENTS

	PAGE
The action of Schumann rays on living organisms (with four figures) - - - - -	<i>W. T. Bovie</i> I
Western plant studies. III - - <i>Aven Nelson</i> and <i>J. Francis Macbride</i>	30
A Mexican <i>Aytonia</i> . Contributions from the Hull Botanical Laboratory 211 (with plates I-IV and four figures) - - - - -	<i>Anna M. Starr</i> 48
Notes on succession from pine to oak - - -	<i>Barrington Moore</i> 59
The pathology of ornamental plants - - -	<i>Mel. T. Cook</i> 67
Origin and development of the lamellae in <i>Coprinus</i> (with plates V-XII and six diagrams) - -	<i>Geo. F. Atkinson</i> 89
On the germination of the pollen grains of apple and other fruit trees - - - - -	<i>J. Adams</i> 131
The decrease of permeability produced by anes- thetics (with six figures) - - - - -	<i>W. J. V. Osterhout</i> 148
On pairs of species (with twelve figures) - -	<i>Reginald Ruggles Gates</i> 177
Abscission in <i>Mirabilis jalapa</i> (with plate XIII and two figures)- - - - -	<i>Francis E. Lloyd</i> 213
The development of the conceptacle in <i>Fucus</i> . Contributions from the Hull Botanical Lab- oratory 212 (with plates XIV-XVII)- - -	<i>Mabel Lewis Roe</i> 231
A new method of separating fungi from protozoa and bacteria <i>Nicholas Kopeloff</i> , <i>H. Clay Lint</i> , and <i>David A. Coleman</i>	247
Biochemical and physiological study of the rest period in the tubers of <i>Solanum tuberosum</i> (with two figures) - - - - -	<i>Charles O. Appleman</i> 265
Decay and soil toxins. Contributions from the Hull Botanical Laboratory 213 - - - - -	<i>George B. Rigg</i> 295
Nuclear division of <i>Spirogyra</i> . II. Nuclear divi- sion in <i>S. bellis</i> (with plates XVIII-XX) - -	<i>Mabel L. Merriman</i> 311
The embryo sac of <i>Richardia africana</i> Kth. (with plates XXI-XXIII) - - - - -	<i>Margaret R. Michell</i> 325
<i>Stangeria paradoxa</i> . Contributions from the Hull Botanical Laboratory 214 (with plates XXIV- XXVI and one figure) - - - - -	<i>Charles J. Chamberlain</i> 353



	PAGE
Undescribed plants from Guatemala and other Central American Republics. XXXIX - - <i>John Donnell Smith</i>	373
Notes on the anatomy of the young tuber of <i>Ipo-</i> <i>moea Batatas</i> Lam. (with eight figures) - <i>Florence A. McCormick</i>	388
Xerofotic movements in leaves (with eight figures) <i>Frank C. Gates</i>	399
Physical properties of some toxic solutions <i>George B. Rigg, H. L. Trumbull, and Mattie Lincoln</i>	408
Five undescribed species of <i>Ravenelia</i> - - - <i>W. H. Long</i>	417
A study of the life history of <i>Trillium cernuum</i> L. (with plate XXVII) - - - - - <i>Margaret Heatley</i>	425
The significance of color changes in oxidase re- agents - - - - - <i>G. B. Reed</i>	430
Reduction divisions in the pollen mother cells of <i>Allium tricoccum</i> . Contributions from the Hull Botanical Laboratory 215 (with plates XXVIII-XXX and one figure) - - - - <i>Mildred Nothnagel</i>	453
The vegetation of the Selkirks (with map) - - <i>Charles Hugh Shaw</i>	477
Studies in the genus <i>Bidens</i> . III. Contributions from the Hull Botanical Laboratory 216 (with plate XXXI) - - - - - <i>Earl E. Sherff</i>	495
The occurrence of bacteria in frozen soil (with two graphs) - - - - - <i>E. C. Harder</i>	507
The prothallia of <i>Ophioglossum vulgatum</i> (with four figures) - - - - - <i>Norma E. Pfeiffer</i>	518
The measurement of oxidation potential and its significance in the study of oxidases (with two figures) - - - - - <i>G. B. Reed</i>	523
BRIEFER ARTICLES—	
Edward Lee Greene (with portrait) - - - - <i>J. N. Rose</i>	70
The pollination of <i>Asclepias cryptoceras</i> (with one figure) - - - - - <i>Edwin Payson</i>	72
Physical conditions in sphagnum bogs - - - <i>George B. Rigg</i>	159
Chloroform as a paraffin solvent in the imbedding process - - - - - <i>D. M. Mottier and W. J. G. Land</i>	252
<i>Besseyosphaera</i> , a new genus of the Volvocaceae - <i>Walter R. Shaw</i>	253
A method for the dehydration of histological mate- rial - - - - - <i>J. Ben Hill</i>	255
Bisporangiate cones of <i>Larix</i> (with one figure) - <i>J. E. Kirkwood</i>	256
Preparation of copy - - - - -	337



	PAGE
The structure of the spikelet of <i>Aphanelytrum</i> (with one figure) - - - - -	<i>Agnes Chase</i> 340
Count Solms-Laubach (with portrait) - - - -	<i>D. H. Scott</i> 433
Charles René Zeiller (with portrait) - - - -	<i>E. C. Jeffrey</i> 528
CURRENT LITERATURE - - - - -	75, 164, 258, 344, 435, 530
For titles of book reviews see index under author's name and reviews	
Papers noticed in "Notes for Students" are indexed under author's name and subjects	

---

DATES OF PUBLICATION

No. 1, January 15; No. 2, February 19; No. 3, March 15;; No. 4, April 18 ;  
No. 5, May 15; No. 6, June 15



## ERRATA

### VOL. LX

P. 297, line 3 from top, for *Cunninghamia Davidiana* read *Cunninghamia sinensis*

P. 462, line 7 from bottom, for angle read angles

P. 499, line 15 from top, for embryo read cotyledon

### VOL. LXI

P. 52, line 21 from top, for under read upper

P. 77, line 11 from bottom, for Beec. read Becc.

P. 77, line 10 from bottom, for 291-410. *pl.* 20 read 391-410. *pls.* 15-20

P. 78, line 14 from top, for 1914 read 1913

P. 78, line 20 from top, for 11:326-403 read 17:326-403

P. 78, line 20 from bottom, for *Chamodora* read *Chamaedorea*

P. 78, line 12 from bottom, for *Piricande* read *Piricauda*

P. 78, line 9 from bottom, for 1914 read 1913

P. 78, line 7 from bottom, for *Hendersonia* read *Hendersonina*

P. 79, line 8 from top, for DIRLS read DIELS

P. 79, line 32 from top, for *Crepyaceae* read *Cyperaceae*

P. 149, table I, line 3 from top, for 870 read 820

P. 149, line 16 from bottom, for 870 read 820

P. 149, line 3 from bottom, for new read net

P. 158, line 12 from top, for absorption read adsorption

P. 228, line 10 from top, for *Parthenium* read *Parthenocissus*

P. 376, line 20 from top, for longae read longi

P. 376, line 25 from top, for crenulatatus read crenulatus

P. 385, line 16 from top, for eodum read eodem

P. 385, line 31 from top, for laevilus read laevibus



THE  
BOTANICAL GAZETTE

*JANUARY 1916*

THE ACTION OF SCHUMANN RAYS ON LIVING  
ORGANISMS

W. T. BOVIE

(WITH FOUR FIGURES)

The effect of light upon organisms is a subject of steadily growing interest and importance. The work of recent years indicates that we may hope to discover the fundamental principles involved in the action of light on protoplasm more readily by turning attention to the shorter light waves than by continuing to investigate the action of the longer waves which occur in sunlight. The chief reason for this is that light of shorter wave lengths acts more rapidly and produces chemical and structural changes in such a way that its action can be much more readily followed. While these changes may not be identical with those produced by light of longer wave lengths, it may be taken for granted that the knowledge gained by studying the effects of the shorter light waves will prove to be of the greatest assistance in explaining the action of the longer waves.

The present paper is a report of some observations by the writer on the effects upon protoplasm of light in the Schumann region of the spectrum, the region containing wave lengths between 2000 and 1250 Ångström units. This region of the spectrum is of particular interest because the light which it contains has a much more injurious action upon protoplasm than has the light of longer wave length.



No previous investigations have been made of the effects upon protoplasm of light in this region of the spectrum.<sup>1</sup> One reason for this is that the employment of Schumann rays presents many difficulties. A special technique is required, and sources of these rays suitable for biological investigations have been lacking. The investigations on Schumann rays described in this paper were made possible by the kindness of Professor THEODORE LYMAN, who placed at the disposal of the writer the necessary apparatus and pointed out the methods by which the difficulties of technique might be surmounted.

The effects of ultra-violet light upon a variety of organisms have been studied and an attempt has been made to follow as carefully as possible the changes produced in the protoplasm. The changes in structure have been followed by observing the organisms under the microscope during the action of the ultra-violet light. The comparative efficiency of waves of various lengths in producing these changes has been studied by a variety of methods.

As previously stated, it has been found that Schumann light is much more injurious to protoplasm than any light heretofore reported. An exposure of only a few seconds to the light from a comparatively feeble source is sufficient, not only to bring about death, but also to cause a complete disorganization of the protoplasm. It has further been found that the destructive action is not lessened when the organism is exposed while it is thoroughly desiccated and in a high vacuum. As will be pointed out later, this fact is significant, for it indicates the direction in which we must look for an explanation of the changes produced by these and other electromagnetic waves.

While no record of previous investigations of the biological effects of Schumann rays has been found, it seems advisable to give a brief review of certain investigations relating to the biological effects of light of longer wave lengths.

Taking sun baths for hygienic purposes is a very ancient and widespread practice. The *heliosis* and the *insolatio* were

<sup>1</sup> BILLON-DAGUERRE (Compt. Rend. 149 and 150: 1909) claims to have sterilized liquids by the Schumann rays. He made no study of the biological effects of the rays, and, moreover, it is by no means certain that his results were due to the action of Schumann rays. On this point see LYMAN (28).



important features of the public baths of the Greeks and the Romans.

In the beginning of the nineteenth century VALLET (33) reported a complete cure of a case of dropsy by exposing the patient to sunlight one hour each day for 14 days, and LÖBEL (24) cured a case of amaurosis by focusing sunlight upon the diseased eye. LÖBEL thought that the beneficial effects of the exposure were due, not only to the physical action of the heat and the light, but also to the chemical action of the sunlight.

In 1858 CHARCOT (9) reported the experiences of two chemists who were using an electric arc for vitrifying certain materials. The electric current was obtained from a Bunsen pile of 20 elements. The experiment lasted one and one-half hours. The experimenters were 50 cm. from the arc, and experienced no change in temperature, but their eyes pained them so severely the following evening and night that they were unable to sleep. The next day they had a painful erythema of the skin. CHARCOT cites other cases of electric light burn caused by an arc from a battery of 600 Bunsen elements. He concluded that the erythema was due to the chemical action of the light, and not due to the heat.

The first impetus to a critical study of the destructive action of light came when the germ theory of disease had been thoroughly established and scientists had recognized the importance of discovering efficient methods of disinfection. In 1877 DOWNES and BLUNT (10) reported the results of their experiments on the effect of light upon bacteria and other organisms. They undertook an investigation to determine whether or not light has a deleterious effect upon bacteria. They exposed culture media contained in glass tubes to sunlight. They showed that light is inimical to and, under certain conditions, may wholly prevent the development of organisms which are prone to appear in culture media. The action is more energetic upon bacteria than upon mycelial fungi. The fitness of the substratum for growing bacteria is not impaired by insolation. By using colored screens they showed that the blue end of the spectrum is more active than the red end. In a second paper (11) they showed that light will kill organisms which are in distilled water, and organisms which are air-dried. They tried to



approach the problem of the mechanism of the light action by studying the action of light upon organic substances. The study of the action of light upon oxalic acid showed that by insolation oxalic acid is decomposed into carbon dioxide, carbon monoxide, and water. They found that oxygen is necessary for this decomposition. Experiments were then conducted on the action of light upon ferments. They showed that light, in the presence of oxygen, destroys the power of yeast to ferment sugar. They had intended to make an exhaustive study of the action of light upon organic compounds, but CHASTAING preceded them, showing that many organic substances were oxidized by the light when in the presence of free oxygen.

DUCLAUX (15) in 1885 studied the action of light upon the anthrax bacillus. He was the first to study the action of light upon pure cultures of bacteria. He found that the ability of the organisms to resist the action of the light varies with the species, with individuals within the species, and with the nature of the culture medium.

In 1887 ROUX (30) found that his culture media, when exposed to sunlight, became toxic to the spores of the anthrax bacillus. DUCLAUX had previously shown that carbohydrates are easily oxidized in sunlight. ROUX concluded, therefore, that his culture media were rendered antiseptic by the oxidation of the carbohydrates which they contained.

WARD (34) in 1892 separated the action of the light upon the medium from the action of the light upon the organism by exposing the spores in a thin film on glass and then adding agar. The exposed spores were killed. In other experiments he first exposed the agar to the light, and then added it to thin films of unexposed spores on glass. The unexposed spores grew in the exposed agar. He attributed the action of the light to the destruction, in the presence of oxygen, of fatty foods stored in the spores. WARD in later papers (35, 36, 37) described experiments on the relative toxicity of the various parts of the spectrum. Instead of exposing culture tubes to various parts of the spectrum, as several observers had done before, he exposed a culture evenly charged with organisms (*Bacillus anthrax* and *B. subtilis*) to the spectrum, formed by a



quartz prism, of the light from a carbon arc. He was unable to tell exactly where the effect began, but in general it began at the blue end of the green, reached a maximum in the violet end of the blue, and diminished again in the violet and ultra-violet. The action extended into the ultra-violet. The culture was cooled on ice during the exposure. WARD suggested that light from a naked arc might prove efficient in disinfecting hospital wards, railway carriages, or other places where rays can proceed directly to the organism. He pointed out that a study of the action of light upon cells might teach us much concerning sunburn, sun baths, etc.

Thus far the use of light as an agent for disinfection had not proved practicable, and interest in the destructive effects of light was becoming purely academic, but the subject received a new impetus by the discovery of phototherapy. In 1871 two papers appeared in the *Lancet*, one by BARLOW (2), the other by WATERS (38), on the deleterious effects of light in the treatment of smallpox. In 1893 FINSEN (16) published a paper in which he reviewed the work of CHARCOT, WIDMARK, and HAMMER. A little later he published a second paper on the treatment of smallpox cases in the absence of the chemical rays (17). This paper was followed shortly by three others on the same theme, and later in the same year by a paper concerning the destructive action of chemical rays upon animal organisms (18). FINSEN'S work, published in 1893, was entitled *Negative phototherapy*.

In 1896 there was held in Copenhagen a meeting of university professors and influential laymen for the purpose of studying the value of light in the treatment of disease. At this meeting FINSEN read a paper entitled "Om Anvendelse of koncentrerede, kemiske Lysstråler i Medicinen" (Kopenhagen, 1896), which set forth what he called "positive phototherapy," as opposed to his "negative phototherapy" of 1893. As a result of this meeting the "Finsen Medicinske Lysinstitut" was founded. The personnel of the institute consisted of 7 doctors, a physicist, an electrician, and 33 nurses. The results of the research of the institute from 1900 to 1907 were published in the *Mitteilungen* of the institute.

The basis of "positive phototherapy" is given by BIE, a member of the institute, in a paper published simultaneously in medical



journals in England, America, Germany, and France (3, 4, 5, 6, 7). The experimental basis of FINSEN'S phototherapy is (1) the bactericidal property of the chemical light waves; (2) the power of the chemical rays to produce erythema; (3) the power of the chemical rays to penetrate the skin. The bactericidal property of the chemical rays had been demonstrated by previous workers. WIDMARK had proved by experiment the fact, pointed out by CHARCOT 30 years before, that photoerythema is produced by the chemical rays of light and not by the heat rays. GOODNEFF and FINSEN demonstrated the powers of chemical rays to penetrate the skin, by placing sealed glass tubes containing silver chloride under the skin of cats and of dogs and exposing to light. The silver chloride was blackened. FINSEN also showed that light will penetrate bloodless tissue, but will not penetrate tissue containing blood. He placed strips of sensitive paper on one side of a man's ear and allowed blue and violet rays of concentrated sunlight to fall upon the other side of the ear. After 5 minutes the sensitive paper was not affected, but if the blood was forced out by pressing the ear between glass plates, the paper was blackened in 20 seconds. In agreement with this is the fact that the spectrum obtained by passing light through an ear filled with blood consists of only a red stripe, while the spectrum obtained by passing light through an ear made anemic consists of all colors.

It is worth while to consider in some detail the method used in the practice of FINSEN'S phototherapy. A carbon arc, carrying 50-60 amperes, is used as a source of light. Previous to 1901 sunlight which had passed through a concentration apparatus was used for treating the patients. Its use was abandoned because, aside from the uncertainty of weather conditions, it was found that sunlight is not only weak in the extreme ultra-violet region (the therapeutically effective part of the spectrum), but it contains an abundance of light in the blue-violet region. The blue-violet waves so tan the skin that after one or two treatments the deposit of pigment makes further treatment impossible. The carbon arc, on the other hand, emits light of shorter wave lengths than those found in sunlight. These short light waves have a marked action upon the surface layers of the skin. They destroy many of the epidermal



cells, including those which contain the pigment. The skin, therefore, becomes more transparent with each successive exposure, and hence there is a continual increase in the penetration of the light.

Experiments were made with light sources which emit a relatively greater amount of light in the extreme ultra-violet than is emitted by the carbon arc; but it was found that there was no increase in the therapeutic effects, while there was an undesirable increase in the amount of destruction of the epidermal cells (29).

The therapeutically effective rays are those which have wave lengths between 4000 and 3220 Ångström units. These rays, after passing through a layer of skin 4 mm. thick, have a strong destructive action upon bacteria. Light of wave lengths shorter than 3220 Ångström units has no action upon bacteria which lie beneath the surface of the skin (23).

The light from the carbon arc is passed through a concentration apparatus provided with condensing lenses of quartz, and also with water filters for absorbing the heat rays. The area to be treated is made as nearly bloodless as possible and is exposed to the light for 1 hr. and 15 min. at intervals of 1-3 days. The local anemia is produced by pressing the area during the exposure with a quartz lens. In certain skin diseases, notably *Lupus vulgaris*, the light treatment is so successful that out of 350 cases treated previous to 1899 there were none which did not show improvement, and only 5 which were not cured. The result is so certain and so constant that there is every reason to doubt the accuracy of the diagnosis of *Lupus vulgaris* when the method fails.

Besides developing "positive phototherapy" to a high degree of perfection, the studies carried on at the Finsen Institute contributed a large amount of information to our general knowledge of the destructive action of light. The experiments of previous investigators were carefully repeated and their significance was critically discussed, while extended researches were made into new fields.

As pointed out by LÖBEL long ago, the biological effects of exposure to light are the result of photochemical action. Hence if we are to obtain a clear understanding of the biological action of ultra-violet light, it will be necessary to consider some of the characteristics of photochemical reactions.



Photochemical action necessitates light absorption, although all light absorption is not accompanied by photochemical action. Since, for substances in general, light absorption increases as the wave length decreases, chemical action also increases as the wave length decreases; and, as pointed out in the pioneer work of DOWNES and BLUNT, the destructive action of light upon protoplasm increases as the wave length decreases.

There is evidence for the supposition that the chemical characters of some of the elements are changed when they are acted on by ultra-violet light. For example, when oxygen is acted on by light of short wave length ozone is formed; that is, ozone is more stable in such oxygen than it is in ordinary oxygen. In passing, it may be pointed out that this fact is of particular interest to the biologist, for ozone is more opaque to short light waves than is molecular oxygen, and it seems that life on earth is possible only because the ozone formed in the upper layers of the atmosphere by the ultra-violet of sunlight serves as a light-filter and protects the organisms on the surface of the earth from these shorter and more destructive rays. Chlorine may be mentioned as another example. In this case, not only are the chemical characters of the atom changed, but according to TRAUTZ (32) the specific heat as well.

In consequence of the fundamental nature of the changes produced by the light, it is often found that many compounds containing the same element are photosensitive. For example, light affects many of the compounds containing silver. Protoplasm contains many photosensitive elements, and it is found that protoplasm and a large number of the substances elaborated by protoplasm (sugar, starch, cellulose, chitin, hair, rubber, etc.) are decomposed when exposed to ultra-violet light.

The temperature coefficient of light reactions is very low. For photochemical reactions, therefore, temperature has but little influence upon the speed of the reaction. Photochemical changes may take place in dry materials or in a vacuum. The writer has found that the time required to kill spores of fungi was the same, whether the spores were exposed while in a very high vacuum or while in the air and turgid with imbibed water. This result is most



surprising in view of what we know of biochemical reactions, all of which take place in aqueous media.

DREYER and HANSEN (14) showed that albumins and globulins were coagulated when exposed to ultra-violet light, and the writer (8), by an investigation of the temperature coefficient of the reaction, showed that light coagulation, like heat coagulation, involves two reactions: (1) a chemical change in the albumin and (2) the precipitation of the albumin. He showed that the first reaction has a very low and the second a high temperature coefficient.

HENRI (19) determined the coefficient of absorption of egg white and found that there is a close parallelism between the absorption by the albumin of the various wave lengths and their destructive action.

A very important phase of the biological effects of light is to be found in connection with the action of the so-called photodynamic substances. The reader is referred to a summary of this subject by TAPPEINER (31), as space does not permit a discussion of it here.

The writer has found no published record of previous investigations on the visible effects of the Schumann rays upon protoplasm. Several investigators, however, have made microscopic studies of the visible changes produced in protoplasm by light of longer wave lengths. For the most part such studies have dealt with the effects produced in the tissues of higher organisms, and secondary physiological changes have not been sharply distinguished from the immediate effects of the light. DREYER (12, 13) and HERTEL (21, 22) have studied the visible effects of ultra-violet light upon unicellular organisms, but neither of these investigators used light which contained the Schumann rays.

In the writer's investigations, described later, the visible effects of light containing the Schumann rays have been studied. The source of light was a hydrogen discharge tube similar to the one described by LYMAN (25). The tube had two compartments connected by the internal capillary *D*, fig. 1. This capillary had an internal diameter of about 3 mm. In each compartment there was a ring electrode (*A*) of aluminum. The discharge passing between the electrodes was compressed in the capillary *D*, thus becoming a source of light. The bottom of the tube was closed by the plate *F*;



the top was closed by a transparent fluorite plate *E*. The Schu-

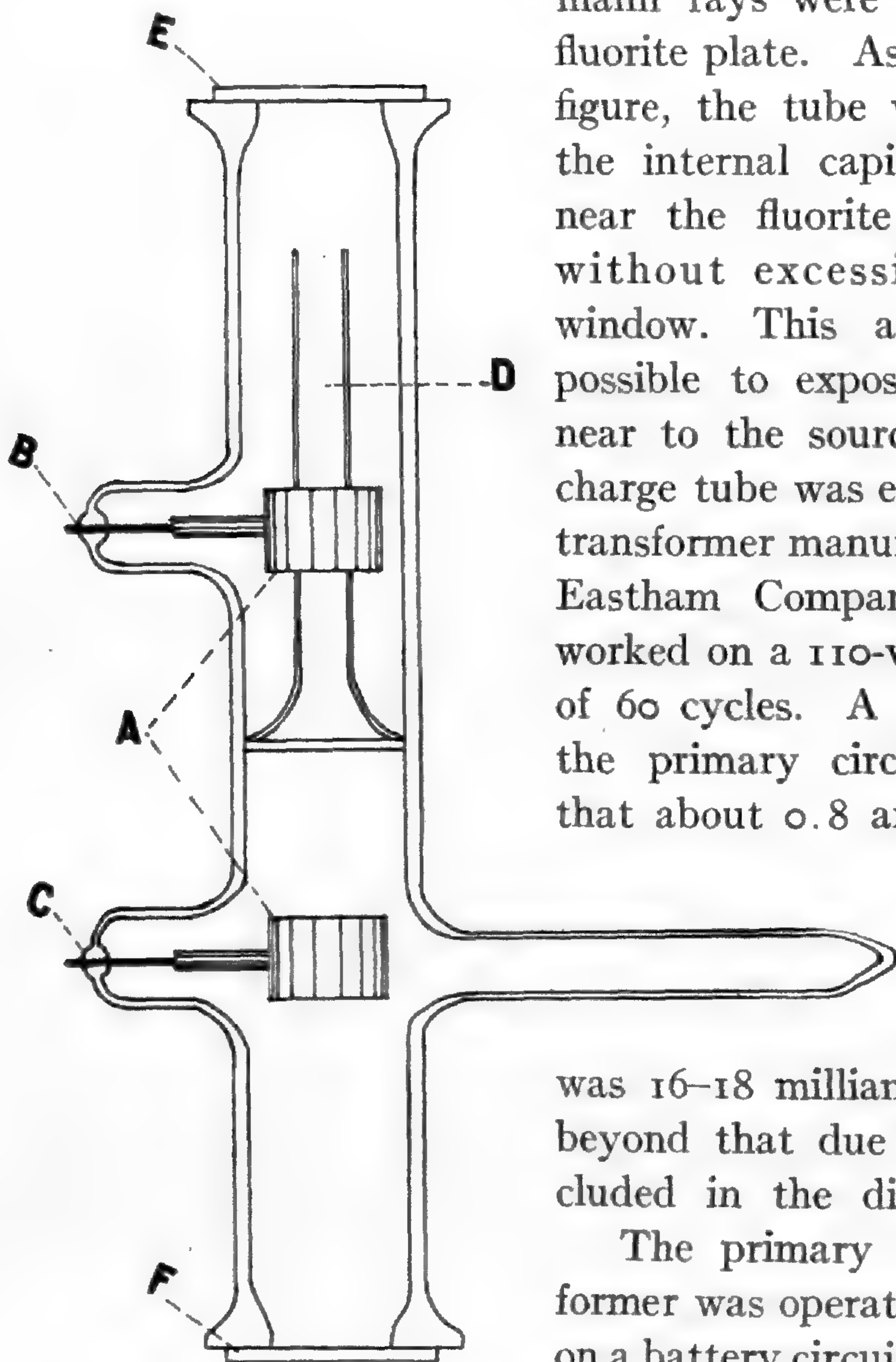

FIG. 1.—Discharge tube used for generating Schumann rays: *A*, ring electrodes of aluminum; *B*, *C*, terminals connecting with a source of high potential (*E*, *M*, *F*); *D*, capillary for increasing the current density; *E*, fluorite window; *F*, glass window.

mann rays were emitted through this fluorite plate. As will be seen from the figure, the tube was so designed that the internal capillary was brought as near the fluorite window as possible without excessive heating of the window. This arrangement made it possible to expose the organism very near to the source of light. The discharge tube was excited by a  $\frac{1}{2}$ -kilowatt transformer manufactured by the Clapp Eastham Company. The transformer worked on a 110-volt alternating circuit of 60 cycles. A variable resistance in the primary circuit was adjusted so that about 0.8 ampere flowed through

the primary of the transformer. The current through the discharge tube

was 16–18 milliamperes. No capacity, beyond that due to the leads, was included in the discharge tube circuit.

The primary circuit of the transformer was operated by a relay working on a battery circuit which was controlled by an ordinary telegraph key. The relay circuit had connected with it another circuit which moved the pens on a chronograph. From the chronograph record the exact length of any exposure could be determined. The use of the relay circuit and telegraph key made it possible to operate the dis-

charge tube without the risk of coming in contact with lines carrying currents of higher voltages. This was important when the



tube was used in connection with a compound microscope, for it was often desirable not to look away from the microscope while operating the discharge tube.

The discharge tube was placed upright under the stage of a compound microscope, in the place usually occupied by the condenser and other substage attachments, with the fluorite window flush with the upper surface of the microscope stage. When the discharge tube was in this position the microscope mirror could not be used. Hence it was necessary to illuminate the objects under observation by some other means. Various methods were employed: an arc lamp was placed beneath the work table, and by means of mirrors and lenses a beam of parallel light was directed up through the discharge tube; or the objects were lighted from above, either by concentrating the light on the microscope stage with a condensing lens or by using a special vertical illuminating objective.

The discharge tube was held by a mechanical support so arranged that by moving a lever the discharge tube moved down and away from the microscope stage. The regular substage attachments could then be swung back into operating position. The change from the discharge tube to the substage attachments or from the substage attachments to the discharge tube could be made very quickly, and without interrupting observations through the microscope.

The Schumann region of the spectrum is a region of general absorption for most substances. But few solids are known which transmit even the longest Schumann waves (26). Air absorbs all except the longer waves, the absorption being due to the oxygen (27). Fluorite is the only substance known which transmits the entire Schumann spectrum. In fact, the Schumann spectrum extends in the direction of short wave lengths only as far as fluorite transmits. It is evident, therefore, that if we wish to expose organisms to the entire Schumann spectrum we can have no substance other than fluorite between the organism and the source of light. Even air must be displaced by the more transparent fluorite. Occasionally the organisms were placed directly on the fluorite window of the discharge tube; more often a special slide was used. The special



slide was a regular microscope slide with a hole 1.5 cm. in diameter bored through it. A disk of fluorite was cemented into the hole with its upper surface flush with the upper surface of the slide. This slide was held in the regular mechanical stage of the microscope and the fluorite window of the discharge tube was thus brought into contact with the fluorite disk in the slide.

When the tube was excited for any great length of time it became hot, and sufficient heat was conducted to the microscope slide to vitiate the results. It was found, however, that the light was so destructive that during a single exposure of sufficient length to kill the organisms, the temperature did not increase more than 1° C. The discharge tube was moved away from the microscope slide immediately after each exposure. The temperature of the drop of water which contained the organisms was measured by means of a thermal junction made of copper and constantin. The sensitiveness of the galvanometer used was such that, with these junctions, one division on its scale corresponded to 0°05 C. The constant junction was kept packed in ice in a thermos bottle. The variable junction was flattened out very thin and was attached to a flexible support in such a manner that it could be placed beside the organisms under the cover glass. The junction was held in place on the slide by the capillary pressure of the cover slip, and was in the field of view of the microscope during the entire experiment. If the temperature of the drop of water was raised more than 1° C. by the exposure to the light, the experiment was discarded. The arrangement of the tube, slide, and thermal junction is shown in fig. 2.

The length of time required for killing varied both with the species and with the individual organisms. In general, a small organism was killed more quickly than a large one. With a given light intensity, an exposure of several minutes was not sufficient to kill such organisms as rotifers and lumbricoid worms, while *Sphaerella*-like swarm spores, which contain both chlorophyll and an "eye spot," were killed almost instantly. The swarm spores were killed so quickly that there was not sufficient change in temperature to be indicated by the thermal junction. In some of the experiments the intensity of the light was reduced until an exposure



of 10 seconds was required to kill the swarm spores. Exposures of one second duration were then made at intervals of several seconds. It was found that the action of the Schumann rays is additive. The swarm spores were killed only when the total exposure equaled 10 seconds. Other organisms gave similar results. The fact that the action of the light is additive made it possible to interrupt the exposure from time to time, and to make a detailed study of the progress of the changes produced by the light. The protoplasm of the swarm spores which had been killed by the light had a granular appearance. Often some of the protoplasm was extruded from the cells and was rounded up into drops.

The cells of a large *Spirogyra* of the *crassa* type were killed by an exposure of 45 seconds when the discharge tube was carrying 18 milliamperes. The first visible change was the disappearance of the wavy margin of the chlorophyll bands. This began on the side of the cell nearest the light. Later the bands broke into isolated rounded drops, each drop containing a pyrenoid. At the same time that the bands were breaking up, they became shorter and contracted around the nucleus. As they contracted, they moved away from the cell wall, pulling the protoplasm lying next to the wall out into threads of viscous appearance. The nucleus became swollen and distended.

When an active amoeba was exposed to the light of the hydrogen discharge tube there was a momentary cessation of motion, followed by a withdrawal of the advancing pseudopodia. Locomotion in another direction began again at once, before the pseudopodia were entirely withdrawn. The extended pseudopodia often turned directly upward away from the light of the discharge tube, and

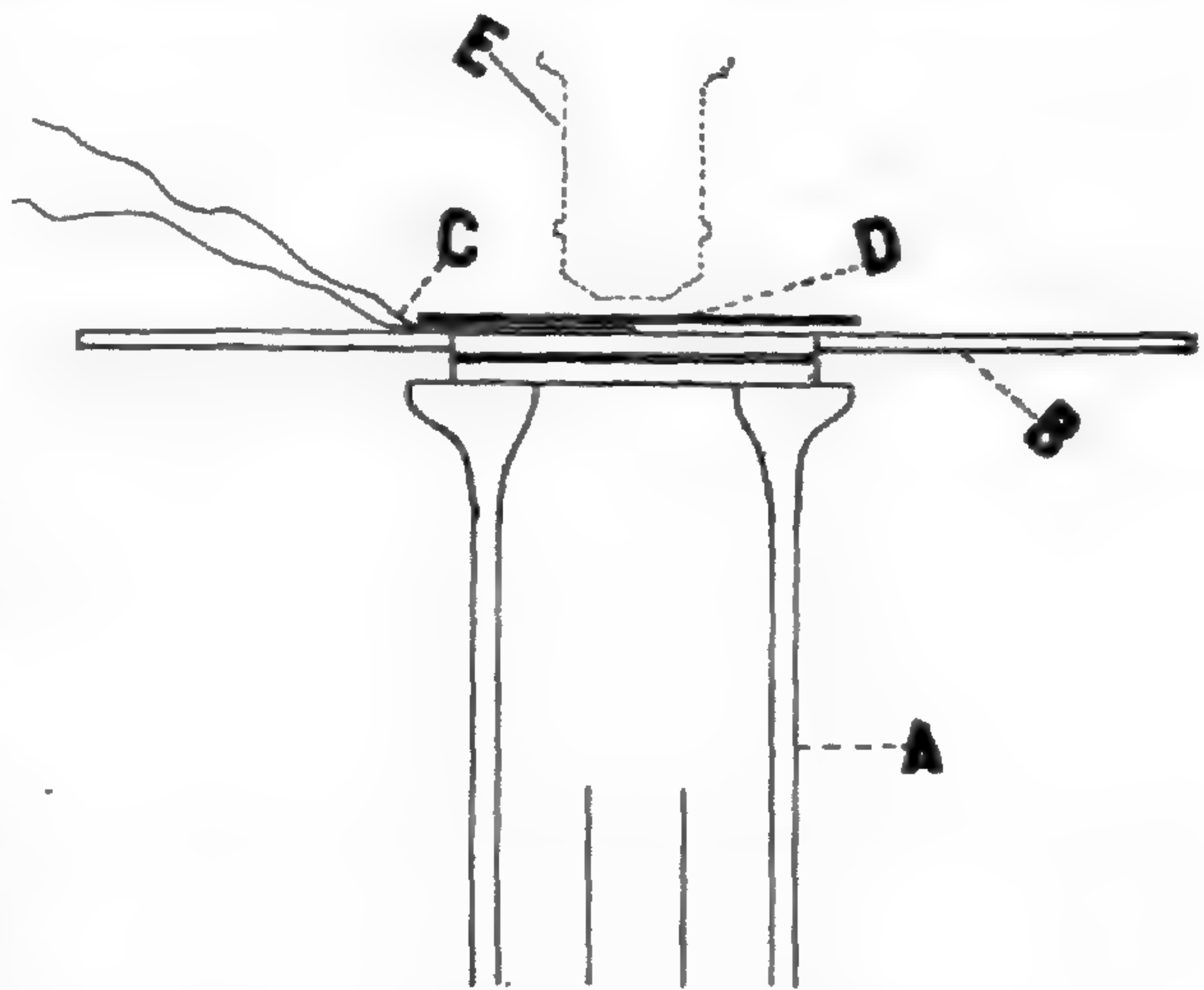

FIG. 2.—Arrangement of apparatus for microscopic observation of the effects of Schumann rays: A, discharge tube; B, microscope slide containing a fluorite window; C thermal junction; D, cover glass; E, microscope objective.



usually a pseudopodium was sent upward from the upper surface of the body. This pseudopodium was often seen to flatten out against the cover slip. The nucleus moved up into the upper part of this pseudopodium. In some cases so much of the protoplasm flowed up into the pseudopodium that the amoeba became top-heavy and toppled over. One amoeba was seen to send up a pseudopodium, to fall over, and then to repeat the process three times before it was killed. These reactions are really negative phototropic responses, the amoeba moving upward away from the light.

As the protoplasm flowed up into the vertical pseudopodium a thick hyaline ectoplasm was left below. The ectoplasm usually constituted the greater part of the lower half of the amoeba. Often the amount of ectoplasm increased until it nearly equaled the amount of endoplasm. In one case the cover glass was pressed down on an amoeba while in this condition, and the endoplasm and the ectoplasm separated and rounded up into separate drops. Under a magnification of 2200 diameters the ectoplasm showed a few small granules in Brownian motion, but showed no vacuoles. After a prolonged exposure there was often a peculiar flowing of the granular endoplasm out into the ectoplasm. It did not appear to be the same kind of motion that one observes in the regular streaming of the protoplasm, but it was not easy to say wherein the difference lay. After this all motion ceased and the protoplasm appeared coagulated. Under a high magnification (2200 diameters) the protoplasm was seen to be filled with fine vacuoles which were so numerous that it was converted into a fine froth. These vacuoles were not visible before the organism was exposed to the light.

It often happened that only a part of an amoeba was killed; for example, in one case an amoeba which happened to be near a bit of opaque substance when the exposure was made sent a pseudopodium up on top of the opaque substance. The nucleus was next sent up, and then as much of the granular protoplasm as possible. The bit was not large enough to protect the whole organism, and a fringe of protoplasm (ectoplasm) extended beyond it all the way around. The exposure was continued until this fringe was killed. After the exposure, the unexposed part of the organism moved away, leaving the dead fringe behind. In another case the light



was allowed to act for a few seconds on an amoeba which was moving very rapidly across the field of the microscope. The amoeba became quiet during the exposure. As soon as the light was turned off, motion was resumed, but only part of the amoeba moved away; a part of the protoplasm was coagulated and was left behind. The exposure was continued in this way, a few seconds at a time, killing a part of the amoeba at each exposure, until only the nucleus and a small mass of surrounding protoplasm remained alive. A final exposure killed this. The length of exposure necessary to bring about these changes varied from 30 to 100 seconds with the hydrogen discharge tube carrying 29 milliamperes. As previously stated, the entire exposure was not made at one time, but at intervals, so that the experiment often extended over an hour. The changes produced by the light could thus be more carefully observed.

Infusoria are very quickly cytolized by the rapid vibrations of these ultra-violet rays. The nature of the cytolysis varies greatly with the species, and in some of the minor details it varies with the different individuals. The writer has observed three kinds of photocytolysis in ciliated infusoria: (1) a cytolysis which is accompanied by the formation of vesicles on the surface; (2) a cytolysis in which some of the internal portions of the protoplasm coagulate; and (3) a cytolysis in which some protoplasm disintegrates directly. The first two types of cytolysis were observed in *Colpoda*-like forms, and the third type was observed in *Stylonychia*.

1. *Cytolysis by the formation of vesicles.*—The cytolysis is, in general, like that of *Paramecium* in distilled water, in weak alkali, and in 5 per cent alcohol, as described by WULZEN (39). When a *Colpoda*-like infusorian is exposed to the light from the discharge tube carrying 18 milliamperes there is first an increase, then a decrease, in the rate of motion of the organism. Soon vesicles filled with a clear liquid begin to form on the surface of the animal. The infusorian loses its original shape and swims in circles. A vesicle may continue to grow until it is larger than the original organism, or it may increase in size for a short time and then slowly shrink and disappear. As one vesicle is shrinking, others may be forming at some other part of the surface of the organism. If the exposure is



not continued too long the vesicles may entirely disappear and the organism apparently recover. A longer exposure causes the inner wall which separates the organism from the vesicle to rupture and the protoplasm to flow out into the vesicle; while a still longer exposure may cause the outer wall of the vesicle to rupture, permitting the protoplasm to flow out into the surrounding water, with which it is miscible. Sometimes the protoplasm disorganizes and rounds up into drops before it flows into the vesicle. This type of photolysis requires a total exposure of about 30 seconds.

2. *Cytolysis in which parts of the protoplasm coagulate.*—In this type of cytolysis an exposure of 10 seconds causes small areas of the protoplasm to coagulate. The coagulated masses move to the side of the organism and are extruded at once. A longer exposure causes more masses of coagulum to form. As the exposure continues, the masses of coagulum form faster than they are extruded. A swelling appears on one side of the body, which increases in size and then bursts, allowing the protoplasm to flow out into the surrounding water.

3. *Cytolysis in which the protoplasm disintegrates directly.*—When *Stylonychia* is exposed to the light from a hydrogen discharge tube excited by a current of 18 milliamperes, the organism is stimulated and its rate of motion is increased. It then loses its power of coordination, moves about in circles for a time, and finally comes to rest with its cilia still vibrating. Suddenly the outer membrane breaks at some point and a little protoplasm squirts out. Then, starting from this point, a wave of disintegration passes over the organism, leaving the protoplasm in isolated rounded drops. The drops show surface tension against each other, and also against the fluid in which they lie; but a further exposure may cause some of them to unite. If the discharge tube is excited by a stronger current, 50–70 milliamperes, the cytolysis begins at once before the loss of coordination occurs. Cytolysis begins at the posterior end of the organism. The infusorian darts across the field, leaving behind it a trail of its cytolysed protoplasm. It continues its motion until only a very small amount of the original protoplasm remains intact, and this cytolyses at the instant motion ceases.



When the dry spores of *Monilia* sp. are exposed to the light no visible change is observed. If, however, after exposure the spores are allowed to absorb water they become turgid, but their protoplasm assumes a coarsely granular, coagulated appearance, which is quite different from the finely punctate appearance of turgid unexposed spores. When turgid spores of *Monilia* are exposed to the light two kinds of changes are observed: either the protoplasm takes on a coagulated appearance, after which no further change is seen, or the spore wall suddenly bursts and some of the protoplasm squirts out with such force that the spore is driven backward by the reaction. The protoplasm, both outside and inside the spore wall, appears granular. Approximately 50 per cent of the turgid spores burst in this manner when exposed to the light. An exposure of 20 seconds, when the discharge tube is carrying 18 milliamperes, is required to cause the spores to burst. A similar squirting out of the protoplasm was observed in a *Navicula*-like diatom, and in the spores of certain water molds when they were exposed to the light.

The fact that the light acts directly upon the organism itself, and not indirectly through the formation of some toxic substance in the medium, was made evident in the experiments in which the drop containing the swarm spores was larger than the window of the discharge tube, so that a few of the spores which were on the outer edge of the drop were not exposed. Those swarm spores which were not exposed to the light were not killed, even though they were at the very edge of the illuminated area. When the exposure was over they often swam into the region where spores had been killed the instant before. As they entered this region they did not make any change either in the rate or in the direction of their motion. From this it may be concluded that the light did not produce any toxic substance in the solution. This conclusion is further strengthened by the fact that occasionally a swarm spore which was within the range of the light from the discharge tube was protected from the direct influence of the light by the shadow of some opaque material contained within the drop. No change which could be attributed to the action of the light was observed in such an individual. Again, the fact that the position of the dead swarm spores



always marked out exactly the outline of the window of the discharge tube may be taken as evidence that no toxic substances were formed in the solution. The observations made on other species of organisms lead to the same conclusion, that the action of the light is on the organism itself.

Notwithstanding the fact that the light was from an exceedingly feeble source, the changes in the organisms were immediate. In the small swarm spores with thin transparent cell walls the changes appeared the instant the discharge tube was excited. It is evident that the Schumann rays are very destructive to protoplasm. The examples just given of the visible effects of these rays upon organisms are sufficient to make it apparent that we are dealing here with a powerful cytolytic agent, and one which warrants further study.

The relation between the wave length and the destructive action of light in the Schumann region of the spectrum has not been previously studied. For the longer light waves this relation has been investigated to some extent, as will appear from the brief summary which follows.

DOWNES and BLUNT, using colored screens, showed that blue light is more destructive to bacteria than red light. WARD, using a quartz prism, confirmed the results of DOWNES and BLUNT, and showed that the killing power extends into the ultra-violet.

Two papers appeared in 1905 on the bactericidal action of light, describing experiments in which not only the wave length but also the intensity of the light was measured. BANG spread the light of a carbon arc into a spectrum by means of quartz lenses and a quartz prism, and measured the relative destructive action of the various parts of the spectrum by determining the length of time it took in a given region of the spectrum to kill an organism (*Bacillus prodigiosus*) growing on the surface of an agar plate. His results showed that, in general, as the wave length of the light decreases the destructive action increases, but that the curve is not uniform, showing a break in the region of wave length 3000 Ångström units. In this region the light is several hundred times less destructive than in the regions on either side, so that the curve shows two maxima. The secondary maximum is in the region of wave length 3500



Ångström units. A measurement of the energy of the spectrum (which was made with a bolometer) showed that the amount of energy decreased with the decreasing wave length; but that in a region nearly coinciding with the region in which the destructive action of the light fell off the amount of energy increased, so that, when the two curves, the energy curve and the destructive curve, are compared, the one is seen to be the inverse of the other. The depression in the destructive curve and the elevation in the energy curve do not quite coincide, but BANG attributed this to a slight shift in some part of his spectrograph.

HERTEL (21) used quartz lenses and a quartz prism to form a spectrum of the light from various spark gaps. He measured, by means of a thermopile, the energy of the light of various wave lengths which he allowed to fall upon living tissues. He found that the destructive action of the light varies directly as the energy, and inversely as the wave length. He did not find the two maxima described by BANG.

HENRI (19, 20) in 1912 measured the relative destructive action of light of various wave lengths. He used as sources of light a mercury vapor arc in quartz, and spark gaps with cadmium and magnesium terminals. The relative intensity of the light of various wave lengths was measured by the effect upon a photographic plate. He made use of screens for filtering out the various wave lengths. The efficiency of the screens was determined by spectrographic methods. He found that the destructive action of the light increases continuously as the wave length decreases. HENRI did not find a secondary maximum at 3500 Ångström units, as reported by BANG. With the exception of BANG, these investigators have agreed that, in the regions of the spectrum studied, the destructive action of light increases as the wave length decreases. None of their investigations have included the region of the spectrum lying below wave length 2000 Ångström units.

In the experiments described in this paper the relation between the wave length and the destructive action in the Schumann region has been studied. Because of the small amount of energy in the Schumann rays, no attempt has been made to measure the intensity of the light of the various wave lengths. A knowledge of the



relative intensity has been approximated from their effect on a photographic plate. It is known that the spectrum from a hydrogen discharge tube contains a number of bright lines in the neighborhood of wave length 1600 Ångström units, while if the hydrogen is extremely pure there are no lines between wave lengths 2000 and 1675 Ångström units. In this study the destructive action of light including the wave lengths in the region of 1600 Ångström units has been compared with the destructive action of light from which these waves have been filtered out by means of screens. The hydrogen

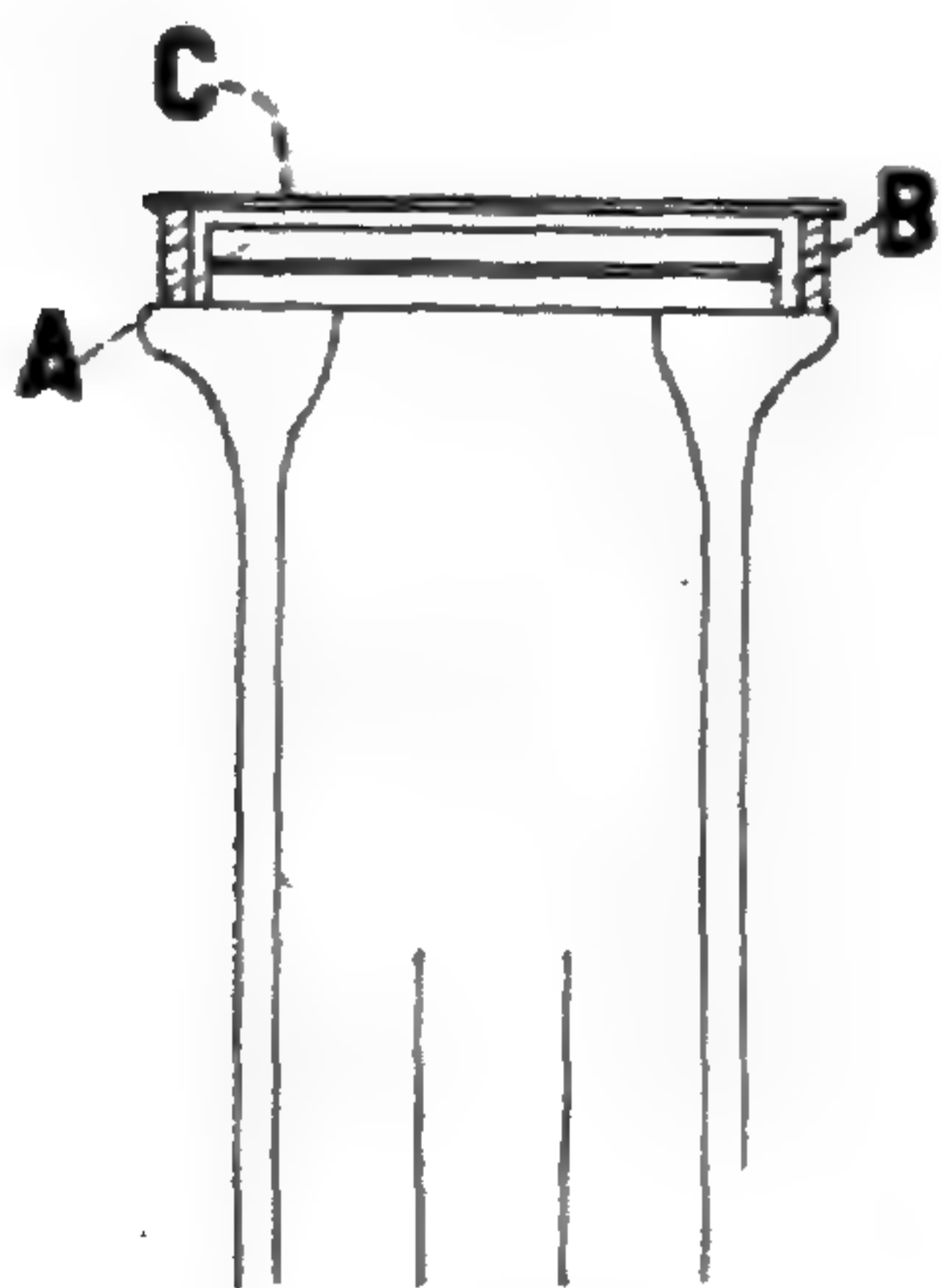

FIG. 3.—Arrangement of discharge tube for studying the relation between wave length and the destructive action of Schumann rays: *A*, rock salt screen; *B*, brass ring; *C*, cover slip.

discharge tube previously described was used as a source of light. Three different methods were used.

In the first method the hydrogen discharge tube was placed upright with the fluorite window above. The rock salt screen *A* (fig. 3) was laid upon the fluorite window. Glass plates were coated with nutrient agar and set aside in a sterile closet until the agar became air dry. Spores of *Penicillium* were placed upon the agar surface, and the plate *C* placed, spores downward, on the ring support *B*. The lower surface of the plate was about 0.05 mm. from the salt screen. After the exposure, the

plates were placed in Petri dishes lined with damp filter paper and the Petri dishes set in the incubator. The agar absorbed water and the uninjured spores germinated.

Exposures of various lengths were made, and the shortest exposure which would kill determined. The amount of current flowing through the discharge tube was measured and kept constant during all the experiments. The rock salt screen cut out the light of wave lengths shorter than 1800 Ångström units (26). Control experiments were made by removing the rock salt screen and laying in its place a screen of fluorite having the same thickness. The fluorite was transparent to waves longer than 1250 Ångström units. By using the fluorite screen the distance between the spores and the



source of light was kept constant. The short waves would have been absorbed by the air had it not been replaced by the more transparent fluorite.

Spores of *Cephalothecium roseum* were not killed by an exposure of 60 seconds, and spores of a species of *Monilia* were not killed by an exposure of 420 seconds when the screen of rock salt was used, while the spores of both forms were killed by an exposure of 15 seconds when the screen of rock salt was replaced by the screen of fluorite.

In the two other methods the apparatus shown in fig. 4 was used. A glass tube *A*, 31 cm. in diameter, was closed at one end with a glass stopper *B* which was ground in. The other end was closed by a brass ring *C* which had a fluorite disk *D* sealed into its center. The seal was made with De Khotenski cement. A side tube *E* connected the tube *A* with a mercury vacuum pump and a McLeod gauge. The tube was used in a vertical position. An upright brass tube *F* was cemented to the glass stopper. At its upper end it carried a platform *H*. The platform was a copper disk soldered to the head of a screw *I* which passed through a nut soldered to the top of the brass tube *F*. By turning the screw the distance between the platform *H* and the fluorite window *D* could be regulated. A hemisphere *K*, 5 mm. in diameter, was pressed out of a polished platinum plate. Its open side was brazed to a small piece of brass plate *L*.

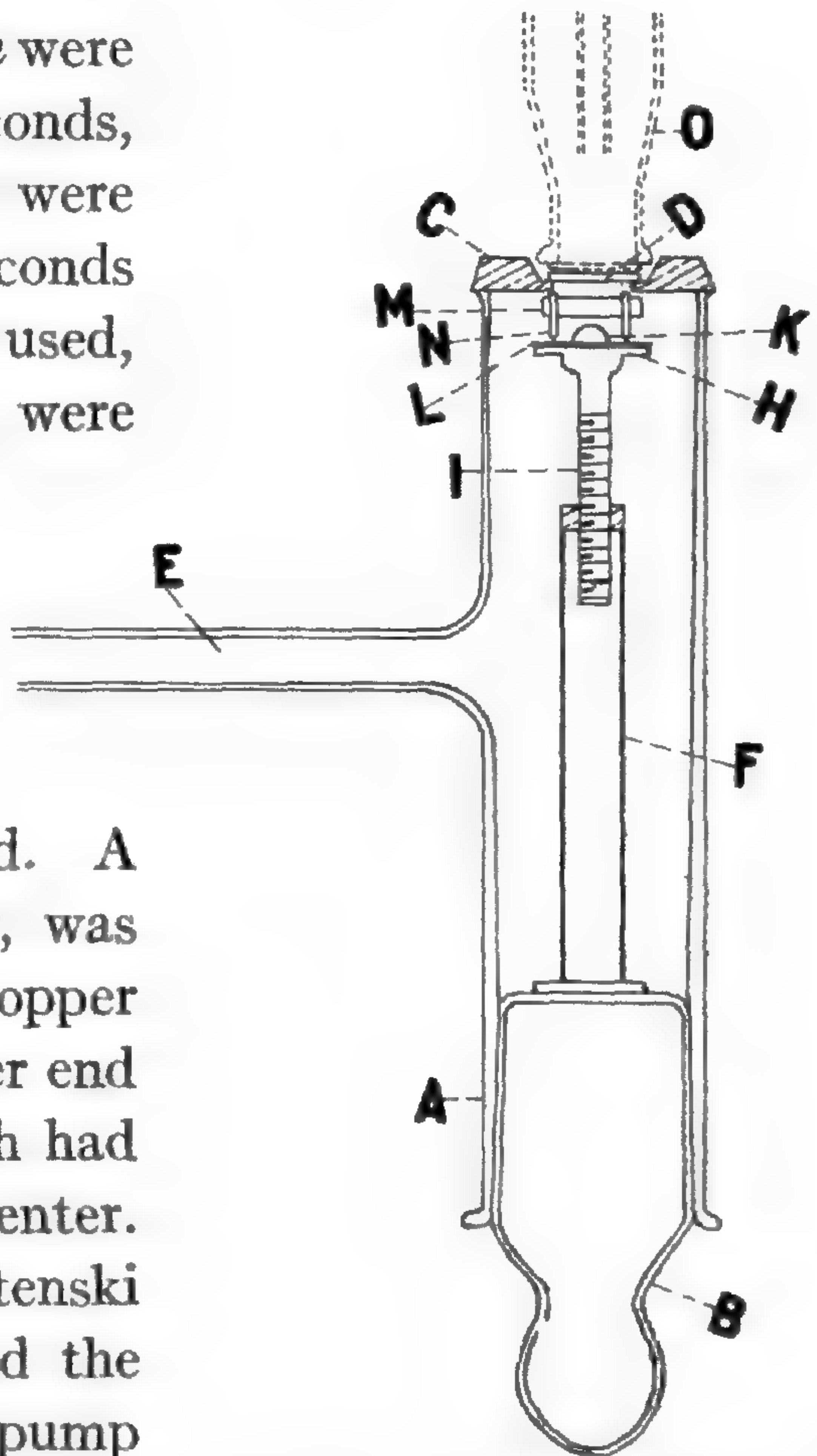

FIG. 4.—Chamber for studying the relation between wave length and the destructive action of the Schumann rays: *A*, glass tube; *B*, stopper; *C*, brass ring supporting fluorite window *D*; *E*, exhaust tube; *F*, adjustable support for the platform *H*; *K*, platinum hemisphere which is brazed to the brass plate *L*; *M*, rock salt screen supported by the brass pins *N*; *O*, discharge tube.



A disk of rock salt *M* with plane parallel faces had holes bored through it into which were inserted brass pins *N*, which served as legs. In operation, these parts were placed in the tube, as shown in the figure. The source of light was a hydrogen discharge tube, as shown at *O*. Its fluorite window was in contact with the fluorite window *D*.

In one method the apparatus was used as follows: The glass stopper with its attached parts was removed from the tube, the platinum hemisphere sterilized in a flame, and then placed convex side upward upon the stage of a binocular dissecting microscope. Fungus spores were transferred to the top of the hemisphere with a platinum needle. By means of the binocular microscope the arrangement of the spores on the platinum hemisphere could be easily observed. After the spores were transferred to the dome a current of air blown through sterile cotton was allowed to play upon the hemisphere. All of the spores which were not in actual contact with the platinum were thus removed. This treatment gave a thin layer of spores quite evenly distributed over a small area at the very top of the hemisphere. The platinum hemisphere was now placed upon the platform *H*, and the screen *M* placed in position, the glass stopper *B* inserted and carefully turned until an airtight joint was formed. The tube was then exhausted to about 0.001 mm. mercury pressure, and the exposure made. After the exposure, air was admitted into the tube and the stopper *B* removed. The platinum hemisphere with the exposed spores was again placed on the stage of the binocular microscope. A small drop of agar had been allowed to solidify on the under side of the cover slip of a van Tieghem cell. This cover slip was removed from the cell and brought over the spores on the platinum hemisphere. Then, while observation with the binocular microscope was being made, the cover slip was carefully lowered until the "hanging drop" of agar just touched the spores on the top of the hemisphere. The cover slip was immediately lifted, taking the spores with it, and placed back on the ring of the van Tieghem cell. The cell was then set in an incubator. Because of the curved surface of the platinum hemisphere the spores were transferred to the agar without changing their relative positions, and as the agar drop came in contact



only with the spores on the top of the hemisphere, only those which had been directly exposed to the rays of light were transferred. The length of exposure required to kill the spores with and without the salt screen was determined. The results obtained with the spores of *Trichothecium roseum* are given in table I.

TABLE I

WITHOUT ROCK SALT SCREEN		WITH ROCK SALT SCREEN	
Time of exposure in seconds	Percentage of germination	Time of exposure in seconds	Percentage of germination
0.....	20.5	0.....	20.0
3.....	2.9	120.....	2.0
7.....	3.2	300.....	1.0
15.....	1.3	600.....	0.0
30.....	0.0	1200.....	0.0
60.....	0.0		
120.....	0.0		

An unknown amount of light was reflected from the surface of the salt screen. In order to avoid this source of error, the experiments were repeated, and the length of exposure required for killing was determined first with the tube containing air at atmospheric pressure, and then with the tube evacuated. The distance from the top of the platinum hemisphere to the fluorite window *D* was 1 cm. This gave a filtration of 1 cm. of air. LYMAN (27) has shown that an air filter 1 cm. thick cuts out all of the shortest Schumann rays. The results obtained with *Trichothecium roseum* are given in table II.

TABLE II

Time of exposure in seconds	Conditions	Results
7.....	Vacuum	Growth
15.....	"	"
30.....	"	Dead
30.....	Air	Growth
60.....	"	"
120.....	"	"
240.....	"	"
480.....	"	Dead

I was not able to kill the tan-colored spores of *Penicillium brevicaulis* or the black spores of *Stemphylium* sp. (probably *S.*



*macrosporoidium*). The Schumann rays have not sufficient penetrating power to pass through the colored cell walls.

By this method we were comparing the time required to kill spores in air with the time required to kill them in a vacuum, but preliminary experiments in which the hemisphere *K* was brought very close to the fluorite window *D* showed that the presence or absence of air makes no difference in the length of exposure required for killing. It should be pointed out that for these experiments organisms were selected which had very thin and transparent cell walls. It was impossible to obtain similar results with organisms with thick, dark-colored spore walls. The length of exposure required to kill dark-colored spores was so great that it is doubtful if the Schumann rays took any part in the killing.

The light emitted from the fluorite window of the hydrogen discharge tube is much less destructive when the light waves of a length shorter than 1700 Ångström units are filtered out. The results obtained by the three methods are comparable. The light is 15-20 times more destructive when it contains the short waves than when it does not. The significance of these figures lies in the fact that in the Schumann region, as in the regions of longer wave length, the destructive action of the light increases as the wave length decreases. Necessarily, this statement does not hold true for organisms protected by membranes which are opaque to the Schumann rays.

### Summary

By a number of methods it has been shown that the action of the light is on the organism directly, and not indirectly through the formation of some toxic substance in the medium.

It is a well-established fact that the Schumann region of the spectrum is a region in which nearly all substances have strong absorption bands. While no studies have been made upon the absorption of protoplasm in this region of the spectrum, undoubtedly strong absorption does occur. Gelatin, which is a much simpler substance than protoplasm, is so opaque to the rays that the ordinary photographic plate cannot be used in photographing the Schumann spectrum. Special plates, in which the silver salts



are for the most part deposited on the surface of the gelatin, must be used.

HENRI (19, 20) has shown that a very thin layer of egg white is opaque to ultra-violet waves between 3000 and 2000 Ångström units in length, and that in this region the opacity increases as the wave length decreases. If the absorption coefficient of egg white can be applied to living protoplasm, and if the opacity of egg white continues to increase with decreasing wave length as we pass from the region studied by HENRI into the Schumann region, then it is reasonable to suppose that the Schumann rays penetrated only a short distance into the substance of the organism. The extreme destructive action of these rays is a result of the strong absorption.

That the rays penetrate only a short distance into the substance of the organism is indicated by the observations made on amoebae, in which only a part of the protoplasm was killed by the exposure to the light. It may have been that the nucleus and the protoplasm which moved up into the vertical pseudopodium were well protected from the shortest waves of the Schumann rays by the thick layer of ectoplasm which remained below. Those parts of the protoplasm which were on the side away from the source of light were killed by the longer, less active light waves only after a prolonged exposure. Again, in the experiments on *Spirogyra*, the visible changes always began on the side of the cell nearest the light. Fungus spores, with brown or tan coloring matter in their cell walls, even though the walls were thin, were not killed by a prolonged exposure to the light. The Schumann rays could not pass through the cell wall.

Because of this strong absorption, the Schumann rays have a marked localized action which gives them a peculiar value for investigations in the experimental morphology and physiology of the cell.

In the experiments on the motile organisms, amoebae and infusoria, it was seen that the Schumann rays have a stimulating effect, to which the amoebae respond by drawing in the pseudopodia and assuming a spherical form, and to which the infusoria respond, first, by an increase in the rate of motion followed by a decrease, then by a loss of the power of coordination, and finally by the disintegration of the living substance.



The examination of highly differentiated cells like those of *Spirogyra* has shown that the visible changes produced by the light are not the same in all protoplasmic structures. The change produced is often one which results in an alteration of the equilibrium of the water content of the protoplasm, as shown by the shrinking and swelling of various parts, by the bursting of spores, and by the miscibility with the surrounding water of the protoplasm of cytolized infusoria.

As pointed out in a former paper (8), ultra-violet light causes certain chemical changes in egg albumen, changes which lead to a change in the time-temperature-coagulation curve. A study of the nature of these chemical changes has shown that they result in a decomposition of the albumen molecule. Preliminary experiments upon the effects of ultra-violet light on other protein bodies show a similar destructive action of the light. It would seem, therefore, that the stimulus of light is to be classed with those exciting stimuli which accelerate catabolic changes; and that using, as we have in these experiments, light with high vibration frequencies, we have been able within a short space of time and with no very great light intensity to carry the chemical changes through fatigue and death, and finally to a complete destruction and dissolution of the protoplasm.

The writer has found that spores dried *in vacuo* may be killed by ultra-violet light. This becomes understandable from experiments which the writer made, and which will be published later, which show that albumen and other proteins, dried *in vacuo*, are readily decomposed by ultra-violet light. The effect of these high-frequency electromagnetic vibrations on proteins is comparable to that of dry distillation at high temperature.

These experiments suggest to us a mechanism of the killing action of ultra-violet light, and furnish a clue which, it is hoped, will explain the mechanism of all the effects of light on protoplasm, including those which are not injurious; for it is evident that if the decomposition of the protein molecule is not carried too far it may stimulate the cell without producing injury. A good example of this sort of stimulation is seen in artificial parthenogenesis, which is produced by substances the action of which kills the egg if allowed



to go too far, but merely stimulates it if stopped at the right time.

It is interesting to note that the photolyses previously described follow the photo-chemical-energy law first formulated by TALBOT, that the amount of chemical change is proportional to the product of the intensity times the length of exposure, or, if the intensity is constant, that the amount of chemical change is proportional to the length of exposure. It required the same total length of exposure to bring about cytolysis when the illumination was interrupted as when it was continuous.

In the Schumann region of the spectrum, as in the regions of longer wave length, the destructive action of the light increases as the wave length decreases, and when we consider the very short exposure which was required for killing, notwithstanding the feeble source of light used, it is evident that the light of the Schumann region is much more destructive than the light of the regions of longer wave length. In other words, the curve representing the relation between wave length and destructive action, which slopes upward in the regions of shorter wave lengths, continues into the Schumann region of the spectrum without changing its character.

LABORATORY OF PLANT PHYSIOLOGY  
HARVARD UNIVERSITY

#### LITERATURE CITED

1. BANG, Über die Verteilung bakterientötender Strahlen im Spektrum des Kohlenbogenlichtes. *Mit. Fin. Med. Lichtinst.* 9:164. 1905.
2. BARLOW, On the exclusion of light in the treatment of smallpox. *Lancet.* 1871.
3. BIE, Finsen's Phototherapy. *Phila. Med. Jour.* 1899.
4. ———, Finsen's Phototherapie. *Die Medicinische Woche.* 1900.
5. ———, Finsen's Phototherapie. *Therapeutische Monatshefte.* 1900.
6. ———, Professor N. R. Finsen's Lichttherapie. *Zeitsch. Elektrotherapie und Ärztliche Elektrotechnik.* 1899.
7. ———, Remarks on Finsen's Phototherapy. *British Med. Jour.* Sept. 30. 1899.
8. BOVIE, The temperature coefficient of the coagulation caused by ultra-violet light. *Science N.S.* 37:373. 1913.
9. CHARCOT, Erythème produit par l'action de la lumière électrique. *Compt. Rend.* 10:63. 1858.
10. DOWNES and BLUNT, Researches on the effect of light upon bacteria and other organisms. *Proc. Roy. Soc. London* 26:488. 1877.



11. DOWNES and BLUNT, On the influence of light on protoplasm. Proc. Roy. Soc. London 28:199. 1878.
12. DREYER, Die Einwirkung des Lichtes auf Amöben. Mit. Fin. Med. Lichtinst. 4:81. 1903.
13. ———, Untersuchungen über die Einwirkungen des Lichtes auf Infusorien. Mit. Fin. Med. Lichtinst. 7:98. 1904.
14. DREYER and HANSSEN, Sur la coagulation des albumines par l'action de la lumière ultra-violette et du radium. Compt. Rend. 145:234. 1907.
15. DUCLAUX, Influence de la lumière de soleil sur la vitalité des germes de microbes. Compt. Rend. 100:119. 1885.
16. FINSEN, Om Lysets Indvirkninger paa Huden. Hospitalstidende. July 5. 1893.
17. ———, Über die Pockenbehandlung mit Ausschliessung der chemischen Strahlen des Tageslichtes. Hospitalstidende. September 6. 1893.
18. ———, Om de kemiske Straalers skadelige Virkning paa den dyriske Organisme. Hospitalstidende. 1:1069. 1893.
19. HENRI, Variation de pouvoir abiotique des rayons ultraviolets avec leur longueur d'onde. Compt. Rend. 155:315. 1912.
20. HENRI *et al.*, Étude quantitative de l'absorption des rayons ultraviolets par l'albumine d'œuf et le sérum. Compt. Rend. 73:319. 1912.
21. HERTEL, Über physiologische Wirkung von Strahlen verschiedener Wellenlänge. Zeitschr. Allgem. Phys. 5:95. 1905.
22. ———, Über die Einwirkung von Lichtstrahlen auf Zellteilungsprozessen. Zeitschr. Allgem. Phys. 5:534. 1905.
23. JANSEN, Untersuchungen über die Fähigkeit der baktericiden Lichtstrahlen durch die Haut zu dringen. Mit. Fin. Med. Lichtinst. 4:37. 1903.
24. LÖBEL, Wichtige Ansichten über die Berücksichtigung der Insolation in mehreren Übelseynformen vorzüglich in der Amourse, und über die Realisierung der Idee eines Sonnenbades. Jour. Prakt. Heilkunde 2:56. 1815.
25. LYMAN, The spectrum of hydrogen in the region of extremely short wave lengths. Mem. Amer. Acad. 13:125. 1906.
26. ———, The absorption of some solids for light of extremely short wave lengths. Astrophys. Jour. 25:45. 1907.
27. ———, The absorption of some gases for light of very short wave lengths. Astrophys. Jour. 27:87. 1908.
28. ———, The sterilization of liquids by light of very short wave lengths. Nature 84:71. 1910.
29. REYN, Apparate und Methoden zur Lichtbehandlung. Mit. Fin. Med. Lichtinst. 10:128. 1906.
30. ROUX, De l'action de la lumière et de l'air. Ann. Inst. Pasteur. 1887.
31. TAPPEINER, Die Photodynamische Erscheinung (Sensibilisierung durch fluoreszierende Stoffe). Egeb. Phys. 8:698. 1909.
32. TRAUTZ. (See review in Die Naturwissenschaften 1:38. 1913.) Zeitschr. f. Elektrochem. 18:513.



33. VALLET, Jour. Gen. Med. Chirurgie. 1814.
34. WARD, Experiments on the action of light on *Bacillus anthracis*. Proc. Roy. Soc. London 52:393. 1892.
35. ———, Further experiments on the action of light on *Bacillus anthracis*. Proc. Roy. Soc. London 53:23. 1893.
36. ———, The action of light on bacteria. Proc. Roy. Soc. London 54:472. 1893.
37. ———, Further experiments on the action of light on *Bacillus anthracis* and the waters of the Thames. Proc. Roy. Soc. London 56:315. 1894.
38. WATERS, On the action of light in smallpox. Lancet. 1871.
39. WULZEN, On the mechanism of cytolysis in *Paramoecium*. Quart. Jour. Exp. Physiol. 2:293. 1909.



## WESTERN PLANT STUDIES. III

AVEN NELSON AND J. FRANCIS MACBRIDE

**POLYPODIUM VULGARE** L. var. **hesperium** (Maxon), n. comb.—*P. hesperium* Maxon, Proc. Biol. Soc. Wash. 13:200. 1900.—The intermountain form with shorter, broader, and usually very obtuse pinnae.

**ISOETES OCCIDENTALIS** Hend. var. **Piperi** (A. A. Eat.), n. comb.—*I. Piperi* A. A. Eat. Fern Bull. 13:51. 1905; *I. Howellii* Engelm. var. *Piperi* Clute, Fern Allies 258. 1905.—The velum broader and the spores larger with obtuse tubercles.

**Muhlenbergia setiglumis** (Wats.), n. comb.—*M. sylvatica* Torr. var. *setiglumis* Wats. Bot. King Exped. 378. 1871.—Very closely allied to the eastern *M. sylvatica* Torr., but each confined to its own range.

**Streptopus streptopoides** (Ledeb.), n. comb.—*Smilacina streptopoides* Ledeb. Fl. Ross. 4:128. 1852; *Kruhsea Tilingiana* Regel Nom. Mem. Soc. Nat. Mosc. 11:122. 1859; *S. brevipes* Baker, Jour. Linn. Soc. 14:592. 1875.—This form of species name is always to be regarded as unfortunate, but at the present time, at least, it must be used in cases like this.

**Majanthemum dilatatum** (Wood), n. comb.—*Unifolium bifolium* DC. var. *dilatatum* Wood, Proc. Phil. Acad. 154. 1868.—The genus *Majanthemum* is one of the *nomina conservanda* of the international rules. The plant is well worthy of specific rank.

**Arenaria macra**, n. n.—*A. tenella* Nutt. T. and G. Fl. 11:79. 1838, not Kit. in Schuet. Oestr. Fl. ed. II. 1:662. 1814, a valid species of Austria.

**Spergularia bracteata** (Robinson), n. comb.—*S. salsuginea* Fenzl. var. *bracteata* Robinson, Syn. Fl. 1:251. 1897.—The bractlike upper leaves are very different in aspect from the apparently entirely Siberian *S. salsuginea*.

**DELPHINIUM MENZIESII** DC. var. **fulvum**, n. var.—Pubescence, especially above, yellowish-villous and slightly viscid.—Eastern Oregon and adjacent Idaho.



**Delphinium stachydeum** (Gray), n. comb.—*D. scopulorum* Gray var. *stachydeum* Gray, BOT. GAZ. 12:52. 1887.—One of the most readily distinguished species of the group to which it belongs.

**Meconella linearis** (Benth.), n. comb.—*Platystigma linearis* Benth. Trans. Hort. Soc. II. 1:407. 1834; *Hesperomecon lineare* (Benth.) Greene, Pitt. 5:146. 1903.—GREENE (*op. cit.*) has called attention to the earlier and valid *Platystigma* of ROBERT BROWN. In our judgment, however, *Hesperomecon* Greene is not distinct from *Meconella* Nutt.

**Horkelia Tweedyi** (Rydb.), n. comb.—*Ivesia Tweedyi* Rydb. N.A. Fl. 22:288. 1908.—This plant was long included in the nearly related but much more southern *H. utahensis* (Wats.) Rydb. It is consistently distinct from that species, however, and seems to be confined to Washington on the eastern slope of the Cascades. In making this transfer we would call attention to our remarks in BOT. GAZ. 55:375. 1913 on the fallacy of maintaining certain segregate genera in this group.

**Trifolium Kennedeanum** (McD.), n. comb.—*T. involucratum* Ortega var. *Kennedeanum* McD. N.A. Trif. 56. 1910—The broad, equal, entire involucral teeth readily distinguish this plant. In the species to which it was referred, the involucral teeth are sometimes entire, but narrower and very unequal in length.

CARDAMINE CORDIFOLIA Gray var. **Lyallii** (Wats.), n. comb.—*C. Lyallii* Wats. Proc. Am. Acad. 22:466. 1887; *C. cordifolia* Gray subsp. *Lyallii* (Wats.) O. E. Schulz, Engl. Bot. Jahrb. 32:438. 1903.—SCHULZ is undoubtedly justified in no longer maintaining this plant as a species. We give it varietal rank that it may accord with those variations deemed unworthy of specific status, and then treated as varieties by most American botanists.

CLARKIA and its near allies.—In BOT. GAZ. 52:267. 1911, there were separated from *Clarkia* some species that are evidently aberrant in that genus. It is very doubtful whether the restoration of the genus *Phaeostoma* relieved a difficult situation. Granting that *Phaeostoma* has 8 fertile anthers while *Clarkia* has only 4, separating on this basis creates an equal difficulty between *Godetia* and *Phaeostoma* in that both have 8 stamens and the latter may have petals either clawed or not clawed. But the same is true



of *Godetia* if *G. biloba* Wats. be left in the genus. This latter might be transferred to *Phaeostoma* but for its bilobed petals, or to *Clarkia* if judged by its aspect alone. The larger the series of specimens and the more species included in the study, the more probable it seems that unbroken series can be established running through the three genera on the following characteristics:

1. Stamens 4-8 and all alike or in two sets, the one gradually reduced in size and finally to sterility and extinction.

2. Petals from entire to deeply 2 or 3-lobed, and from sessile to long and narrowly clawed.

It would not seem unwise to reduce all three to one genus but for the fact that to do so would again necessitate a number of new combinations.

***Pachylophus psammophilus*, n. sp.**—Wholly glabrous throughout, caulescent, branching near the base, usually 1 dm. or more high: leaves lanceolate, entire or slightly repand, acutish, each attenuate into a petiole with margins narrower than the midrib: calyx tube only twice as long as the narrow acute segments: petals white (drying pink), 2-3.5 cm. long: capsules sessile, narrowly conical, somewhat curved and tapering gradually, 3-3.5 cm. long, not at all tuberculate, slightly angled.

Plants growing in sand dunes in the vicinity of St. Anthony, Idaho. Very distinct in aspect and technical characters from its nearest relative, *P. caespitosus* (Nutt.) Raimann, of South Dakota.

PERIDERIDIA Reichb. Handb. 219. 1837; Meisn. Genera 1:150. 1837; Endl. Gen. Pl. 792. 1838; Steudel, Nom. Bot. ed. II. 2:304. 1841.—*Eulophus* Nutt. in DC. Coll. Mem. 5:69. 1829, not *Eulophus* R. Br. in Bot. Reg. 573. 1821, in the English text.

ROBERT BROWN in 1821 published his new orchidaceous genus *Eulophus*, and though he changed this to *Eulophia* in 1823, the earlier form of the word must, of course, be used. This necessitates, unfortunately, another name for the plants we have known so well as *Eulophus* Nutt. It may be questioned if REICHENBACH really published his genus in his *Handbuch*; certainly he makes no reference to a species, as stated in the *Kew Index*. The genus is given good descriptions by the authorities cited above, however; and STEUDEL publishes it with the species. The following new combinations, together with the type, are noted.



PERIDERIDIA AMERICANA Reichb. ex Steudel, Nom. Bot. ed. II. 2:304. 1841; *Eulophus americanus* Nutt. in DC. Coll. Mem. 5:69. 1829.

**Perideridia Parishii** (C. and R.), n. comb.—*Eulophus Parishii* C. and R. Rev. N.A. Umbell. 112. 1888.

**Perideridia Pringlei** (C. and R.), n. comb.—*Eulophus Pringlei* C. and R. *op. cit.* 113.

**Perideridia simplex** (C. and R.), n. comb.—*Eulophus simplex* C. and R. Contrib. Nat. Herb. 7:112. 1900.

**Perideridia Bolanderi** (Gray), n. comb.—*Podosciadium Bolanderi* Gray, Proc. Am. Acad. 7:346. 1868; *Eulophus Bolanderi* C. and R. Rev. N.A. Umbell. 112. 1888.

**Perideridia californica** (Torr.), n. comb.—*Chaerophyllum* (?) *californicum* Torr. Pacif. R.R. Rep. 4:93. 1856; *Eulophus californicus* C. and R. *op. cit.* 114.

DODECATHEON JEFFREYI Van Houtte, Fl. des Serres 16:99. 1865.—It seems doubtful if there are any indigenous plants in this country answering to the original description. Even the specimens from the Californian Sierras that we have seen do not have "hispidulous styles and a capsule valvate from the very apex." The description was drawn from European garden plants, supposedly grown from Californian seed, but this might easily have been an error. The plant that has long passed as *D. Jeffreyi* seems to be quite variable, and that has led to different forms of it receiving specific names, so that now its name and synonymy seems to be as follows:

DODECATHEON VIVIPARUM Greene, Erythea 3:38. 1895; *D. tetrandum* Suks. ex Greene, *op. cit.* 40; *D. crenatum* Greene, Pitt. 2:74. 1890, not *D. crenatum* Raf.; *D. dispar* A. Nels. BOT. GAZ. 52:369. 1911.

FRASERA NITIDA Benth. var. **Cusickii** (Gray), n. comb.—*F. Cusickii* Gray, Proc. Am. Acad. 22:310. 1887.—This is now represented in herbaria by a number of CUSICK'S collections and differs from the species only in the orbicular and concave scales between the filaments. These are nearly entire and surpass the ovary, as is not rare in the species. Both forms occur in Oregon, the variety seemingly confined to the northwestern part of the state.



**Phacelia argentea**, n. sp.—Differs from *P. magellanica* (Lam.) Coville, in the broad suborbicular or broadly oval densely sericeous leaves (2–4 cm. long, 2–3.5 cm. broad). Although evidently nearest related to *P. magellanica* as understood by BRAND in his discriminating monograph, *P. argentea* is of unique aspect, entirely different from any of the plants referable to this group. The stems and petioles are hispid or hirsute, but the leaf blades are clothed with an appressed (less so beneath) satiny pubescence.

The specimen is imperfect, but the plant is probably robust and tall. Even though only vegetative characters are available for discrimination, there is no evidence that these intergrade, so the plant is proposed as a new species.

Sandy seashore, Chetco, Oregon, June 1884, *Howell* no. 209 (type in Gray Herb.).

**GILIA** and **COLLOMIA**.—Although BRAND in his recent monograph of the Polemoniaceae maintains *Collomia* as a genus distinct from *Gilia*, it is surely no better marked than some other sections raised to generic rank by many American botanists. “Calyx not ruptured by the maturing capsule” is a good enough (and the only constant) sectional character, but scarcely to be considered generically in a family in which the more natural genera run hopelessly together technically. And when all the *Collomia* species are taken into account, they present no common aspect that might tempt one to treat them as a genus, a characteristic which some of the other sections possess. In accord with this view we are making two necessary transfers.

**Gilia mazama** (Coville), n. comb.—*Collomia mazama* Coville, Proc. Biol. Soc. Wash. 11:35. 1897.

**Gilia tenella** (Gray), n. comb.—*Collomia tenella* Gray, Proc. Am. Acad. 8:259. 1870.—The range given in the COULTER and NELSON *Manual* would be more nearly correct, if it read “Mountains of southern Idaho to Oregon and Utah.”

**GILIA ACHILLEIFOLIA** Benth. var. **Chamissonis** (Greene), n. comb.—*G. Chamissonis* Greene, Erythea 3:105. 1895; subsp. *Chamissonis* (Greene) Brand, Pflanzenreich 4, fam. 250. III. 1907.—Mostly, if not entirely, replaces in the Northwest the typical form with permanently arachnoid-villous calyx. Both grow in California.



**GILIA FLOCCOSA** Gray var. **filifolia** (Nutt.), n. comb.—*G. filifolia* Nutt. Jour. Acad. Phil. 1:156. 1848; *Navarettia filifolia* Brand, *op. cit.* 167; *G. virgata* Steud. var. *filifolia* Milliken, Rev. Col. Polem. 39. 1904.—Although *G. virgata* and *G. floccosa* admittedly merge, they are distinct enough in their typical development to warrant their separation, which is conducive to clearness and simplicity when one considers their respective variations. *G. Wilcoxii* A. Nels. BOT. GAZ. 34:27. 1902 is *G. floccosa*. The foregoing variety is distinguished by its shorter, more salverform corolla, the narrow lobes much shorter than the tube.

**POLEMONIELLA**.—BRAND in his recent monograph of the Polemoniaceae reduces *Polemoniella* Heller, Muhl. 1:57. 1904. This genus is undoubtedly as strong as the *Gilia* segregates he accepts. It not only has the technical characters indicated and the corolla shorter than the calyx, but these combine to give the plants an aspect that suggests *Nemophila* or *Ellisia*. In fact, BRAND marked a specimen (in this herbarium) of *Polemoniella*, *N. breviflora*. Besides *P. micrantha* (Benth.) Heller, the genus contains the following species, both South American.

**Polemoniella Gayanum** (Wedd.), n. comb.—*Gilia Gayanum* Wedd. Chlor. And. 2:82. 1859; *P. Gayanum* (Wedd.) Brand, Pflanzenreich 4:46. 1907.

**Polemoniella antarcticum** (Griseb.), n. comb.—*P. antarcticum* Griseb. in Goett. Abh. 6:131. 1854.

**HELIOTROPIUM CURASSAVICUM** L. var. **xerophilum** (Ckll), n. comb.—*H. xerophilum* Ckll. BOT. GAZ. 33:379. 1902; *H. spatulatum* Rydb. Bull. Torr. Bot. Club 30:262. 1903.—COCKERELL has called attention (Proc. Biol. Soc. Wash. 26:204. 1913) to the fact that his name for this large-flowered inland form antedates RYDBERG'S. He is wrong, however, in believing that it is the only form found in New Mexico and Chihuahua, there being collections from these localities that represent the species perfectly. Especially in California and the Southwest intermediates occur which prove the fallacy of trying to maintain the inland plant as a species. *H. oculatum* Heller, Muhl. 1:58. 1904, judging from the author's specimens, is one of these intermediate states. In its best development, however, the variety is



strongly marked by its almost showy flowers and usually broader leaves.

**Amsinckia Menziesii** (Lehm.), n. comb.—*Echium Menziesii* Lehm. Pug. 2:29. 1830; *A. intermedia* F. and M. Ind. Sem. Hort. Petrop. 2:26. 1835.—PIPER in Contrib. Nat. Herb. 11:480. 1906 cites under *A. intermedia*, "*Eutoca Menziesii*," etc., "not R. Br. 1823." However, LEHMANN did not publish the species as a *Eutoca* but as an *Echium*. Hence his name is five years earlier than that of FISCHER and MEYER'S, and there is no earlier *Menziesii* in the genus *Amsinckia*. This variable species should therefore bear the name *A. Menziesii* according to both the American and the international rules of botanical nomenclature. It is possible that some of the segregate species proposed rather recently are valid or at least worthy of varietal rank.

**ALLOCARYA SCOULERI** (H. and A.) Greene var. **hirta** (Greene), n. comb.—*A. hirta* Greene, Pitt. 1:161. 1887.—Differs from the species in being more or less setosely hispid, the leaves ciliate with widely spreading hairs. It is represented in the Gray Herbarium by SUKSDORF'S no. 45, Klickitat County, Washington, May 26, 1881.

**ALLOCARYA CUSICKII** Greene var. **jucunda** (Piper), n. comb.—*A. jucunda* Piper, Bull. Torr. Bot. Club 29:643. 1902.—In the original description the leaves are said to be glabrous above, but they vary in this respect as in the species. The shorter and relatively broader leaves, together with the more bristly hirsute pubescence, serve to distinguish the variety. The nutlets are essentially the same.

**LAPPULA**.—The following key and the accompanying notes are given in the hope of helping to clear up the confusion that has existed in regard to our annual species of *Lappula*. No one apparently has ever made a serious effort to determine to what plants the names in literature actually apply, and consequently this section of the genus has reached a nearly chaotic condition.

Nutlets not cupulate, the prickles distinct nearly or quite to the base

Prickles in two rows

Nutlets 2.5–3 mm. long, the granulations on the face minute and even

1. *L. echinata*



Nutlets 4-7 mm. long, the median tuberculations more prominent than the outer

Plant not bushy branched, ashy pubescent; nutlets 4-4.75 mm. long  
2. *L. Fremontii*

Plant bushy branched; herbage green; nutlets 6-7 mm. long  
3. *L. cenchrusoides*

Prickles in one row . . . . . 4. *L. Redowskii*, 4a, and 4b.

Nutlets, at least in part, cupulate

Cup shallow, the prickles united toward the base and forming a spreading flange, scarcely or not at all inflated; nutlets all alike

Pubescence rather soft, little papillose; stems branched above  
5. *L. cupulata*

Pubescence harsher, more papillose; stems branched from the base  
5a. var. *foliosa*

Cup deep, the inflated margin more or less involute; nutlets frequently dissimilar

Stems branched above; pubescence soft; nutlets dissimilar, strongly tuberculate on sides and face . . . . . 6. *L. texana*

Stems branched and floriferous from the base  
Nutlets dissimilar . . . . . 6a. var. *heterosperma*

Nutlets similar  
Faces and sides tuberculate . . . . . 6b. var. *homosperma*

Faces and sides smooth . . . . . 6c. var. *coronata*

1. LAPPULA ECHINATA Gilib. Fl. Lith. 1:25. 1781: *L. Lappula* (L.) Karst. Deutsch. Fl. 979. 1880-1883.—This widely naturalized species has the prickles of the nutlets quite distinct to the base and in two very evident marginal rows.

2. LAPPULA FREMONTII (Torr.) Greene, Pitt. 4:96. 1899.—*L. erecta* A. Nels. Bull. Torr. Bot. Club 27:268. 1900 as to specimens cited and description in large part.—This was described as having the prickles of the nutlets in a single row. Since they are in two irregular rows in authentic specimens this must have been an oversight. Part, at least, of the original collection of *L. Fremontii* is deposited at the Gray Herbarium, and *L. erecta* is clearly a synonym. The species is a good one. It is distinguished from *L. Redowskii* by the double row of prickles and from *L. echinata* (its nearest relative) by the distinctly larger nutlets, the more irregular distribution of the prickles, and the tendency of the median tuberculations to become more prominent, differences well noted by TORREY in his original diagnosis (Pacif. R.R. Rep. 12:46. 1860).



Specimens examined: ASSINIBOIA: Crane Lake, June 15, 1894, *John Macoun* (5807); WYOMING: Fort Steele, Carbon County, June 16, 1900, *Aven Nelson* (7257); Chug Creek, June 29, 1900, *Aven Nelson* (7302); Laramie, Albany County, June 10, 1900, *Aven Nelson* (7269); UTAH: Carter Dugway, Uintah Mountains, July 19, 1902, *Leslie N. Goodding* (1410).

3. LAPPULA CENCHRUSOIDES A. Nels. Bull. Torr. Bot. Club 26:243. 1899.—GREENE (*loc. cit*) states that this is a synonym of *L. Fremontii*. It is much nearer a *Lappula* of Asia. *L. cenchrusoides* is low, bushy branched, with the pubescence so scanty that the herbage has a clear green hue, giving an aspect that is entirely different from that of the strict gray-pubescent *L. Fremontii*. The fruits, too, are much larger and are not mature until late August or September, long after *L. Fremontii* has dried away. The only specimens we have seen are from sandy canyons in the Laramie Hills. These are identical with specimens of the Asian *L. semiglabra* (Ledeb.) Gurke, except that the prickles are in two rows.

4a. LAPPULA REDOWSKII (Hornem.) Greene var. OCCIDENTALIS (Wats.) Rydb.—This variety has always been supposed to be confined to North America. It is, however, impossible to distinguish the Siberian specimens referred to the species by LEDEBOUR, DECANDOLLE, and others. HOOKER (Fl. Brit. India 4:163) gives what seems to be the correct range for the species. HORNEMANN (Hort. Hafn. 1:174) stated that the original was sent from Moscow and purported to have been collected in "Imperio Ruthenico," probably somewhere in Southwestern Russia. The supposed differences in branching break down completely, but the repeatedly described fruiting differences are well marked.

There is another interesting variation of the species that has been collected in this country on ballast. This is *L. patula* (Lehm.) Aschers. WATSON (Bot. King Exped. 246. 1871) gives a somewhat exaggerated figure but a good presentation of its diagnostic characters. He writes "differs from *E. Redowskii* only in the tuberculations upon the fruit, which are few in number and arranged regularly in longitudinal rows upon the back and upon the outer edge of the sides." Some of the specimens are separated from *L. Redowskii* only with difficulty. HOOKER as long ago as 1885 (Fl. Brit. India 4:163), in a note after *E. Redowskii*, wrote "perhaps



*E. patulum* Lehm. is not specifically distinct." Altogether, it seems well to treat it as a variety. Like the species, it is a native of Southern Asia and Southeastern Europe.

4b. LAPPULA REDOWSKII (Hornem.) Greene var. *patula* (Lehm.), n. comb.—*Echinosperrum patulum* Lehm. Asperif. 1:124. 1818.

Specimens examined: PENNSYLVANIA: Philadelphia, May 1877, *Isaac C. Martindale*; Greenwich Point, June 23, 1877, *Parker*; OREGON: Linnton, near Portland, July 12, 1912, *W. N. Suksdorf* (1930); AUSTRO-HUNGARY: between Paks and Komlod, *Haynald* (3707); ALGERIA: Hedna, 1865 (possibly introduced); ELISABETHPOL (in Caucasia), June 1834, *Hohenacker*.

5. LAPPULA CUPULATA (Gray) Rydb. Bull. Torr. Bot. Club 28:31. 1901.—*Echinosperrum Redowskii* (Hornem.) Lehm. var. *cupulatum* Gray, Bot. Calif. 1:530. 1876; *L. columbiana* A. Nels. Bot. Gaz. 34:28. 1902.—GREENE (Pitt. 4:94. 1899), referring to var. *cupulata*, wrote "that was made to include a number of easily definable species, and there is no determining to what one of the segregate species the name should be applied rather than to another." The first part of this statement is undoubtedly correct; but fortunately, as PIPER (Contrib. Nat. Herb. 11:475. 1906) indicated, the proper application of the name *cupulata* is perfectly clear. The original specimen cited by WATSON (*op. cit.* 247), no. 862, Trinity Mountains, Nevada, May 1865, and later indicated by GRAY (*loc. cit.*), is deposited in the Gray Herbarium. This plant is well described by AVEN NELSON (*loc. cit.*), who followed RYDBERG'S conception of *L. cupulata* (*loc. cit.*). The latter's remarks no doubt apply to the Rocky Mountain variety of *L. texana* (Scheele) Britton, a very different plant. *L. cupulata* (Gray) Rydb., in addition to its strong fruiting characters, has a very distinct range, as is shown by the following typical specimens.

IDAHO: Snake River Plains, 1893, *Edward Palmer* (19, 115, and 78); sandy soil, valley of Clearwater River, Nez Perces County, April 24, 1892, *Sandberg*, *Macdougall*, and *Heller* (17); OREGON: Pine Creek, Crook County, June 12, 1894, *J. B. Leiber* (213); eastern Oregon, 1898, *William C. Cusick* (1945); WASHINGTON: Almota, May 27, 1893, *C. V. Piper* (1703).

On the dry plains of southern Idaho and Wyoming a variation of the above occurs that is bushy branched, the branches floriferous nearly to the base, a variation common in this genus and always



intergrading more or less with the typical form. Extremes in habit so striking, however, are often well worthy varietal rank. Such is the case with

5a. *LAPPULA CUPULATA* (Gray) Rydb. var. **foliosa** (A. Nels.), n. comb.—*L. foliosa* A. Nels. in COULTER and NELSON Rocky Mountain Botany 413. 1909.

Specimens examined: IDAHO: dry stony plains, Castleford, Twin Falls County, June 26, 1912, *Nelson* and *Macbride* (1709); Snake River Plains, 1893, *Edward Palmer* (280); dry river bank, St. Anthony, July 5, 1901, *Merrill* and *Wilcox* (839); WYOMING: waste ground, Bench, Uinta County, June 25, 1902, *Leslie N. Goodding* (1188); gravelly slopes, Kemmerer, Uinta County, June 1, 1907, *Aven Nelson* (9015).

6. *LAPPULA TEXANA* (Scheele) Britton Mem. Torr. Bot. Club 5:27. 1894.—*L. collina* Greene, Pitt. 4:96. 1899.—It seems strange that this strong species has been misunderstood for so long. Ever since GRAY reduced it to his totally different var. *cupulata*, there is scarcely an annual *Lappula* that at some time or other has not masqueraded under the name. SMALL'S Fl. S.E.U.S. 997. 1913 contains the most nearly correct description that has come to notice. As indicated in the key, the species and its variations are separable at a glance from *L. cupulata* by the different fruit. The dissimilarity of nutlets is a striking character that is absolutely valid for the typical form. The following specimens (many from San Antonio, the type locality) indicate a range far removed from *L. cupulata*. Where the species meet in one form or another in the central Rocky Mountains, the fruit characters remain just as pronounced.

Specimens examined: TEXAS: San Antonio, April 17, 1894, *A. A. Heller* (1585); gravelly plain, San Antonio, April 1853, *George Thurber*; San Antonio, *G. Jermy* (225); San Antonio, 1841, *F. Lindheimer* (477); light sandy soils, Brown County, April, *J. Reverchon* (2117a); Comanche, May 10, 1900, *H. Eggert*; Abilene, May 20, 1902, *S. M. Tracy* (7833); El Paso, March 1851, *George Thurber* (153); NEW MEXICO: 1851, *C. Wright* (1573).

Northward the plant gradually assumes a habit entirely analogous to *L. cupulata* (Gray) Rydb. var. *foliosa* (A. Nels.) Nels. and Macbr., which, becoming extreme in Colorado and Wyoming, may be known as



6a. LAPPULA TEXANA (Scheele) Britton var. **heterosperma** (Greene), n. comb.—*L. heterosperma* Greene, Pitt. 4:94. 1899; *L. desertorum* Greene, *op. cit.* 95; *L. cucullata* A. Nels. BOT. GAZ. 34:29. 1902, at least as to specimens cited.—*L. cucullata* was described as having similar nutlets, but authentic specimens have exactly the nutlets of *L. heterosperma*.

Specimens examined: WYOMING: Sandy plains, Fort Steele, Carbon County, June 16, 1900, *Aven Nelson* (7250); sandy canyon, Birds Eye, Fremont County, June 22, 1910, *Aven Nelson* (9407); COLORADO: dry hills, Paradox, Montrose County, June 13, 1912, *E. P. Walker* (80); 1864, *Parry* (3).

6b. LAPPULA TEXANA (Scheele) Britton var. **homosperma** (A. Nels.), n. comb.—*L. heterosperma* Greene var. *homosperma* A. Nels. BOT. GAZ. 34:29. 1902.

Specimens examined: ASSINIBOIA: Medicine Hat, July 5, 1894, *John Macoun* (5806); MONTANA: Gallatin City, June 20, 1883, *F. Lamson Scribner* (172); COLORADO: New Windsor, Weld County, June 4, 1901, *George E. Osterhout* (2388); Mesa County, May and June, 1893, *H. C. Long*.

6c. LAPPULA TEXANA (Scheele) Britton var. **coronata** (Greene), n. comb.—*L. coronata* Greene, Pitt. 4:94. 1899.—This variety seems to be an extreme desert form of the south, almost too close to the preceding. It is a smaller plant, however, the nutlet margins being inordinately developed and the faces and sides smooth or merely somewhat papillose. A variation of *L. Redowskii* occurs in Europe which is not unlike this, the nutlets exhibiting the same tendency to smoothness.

Specimens examined: ARIZONA: dry plains near Camp Lovell, April 16, 1881, *C. G. Pringle* (362); dry hills, Santa Cruz, April, 1884, *W. F. Parish*, (164).

LAPPULA ARIDA Piper var. **Cusickii** (Piper), n. comb.—*L. Cusickii* Piper, Bull. Torr. Bot. Club 29:542. 1902.—Like the species except in the smaller and blue flowers. The forms are entirely similar in aspect and the nutlets are the same. Although the author suggested the possibility that future collections might prove *L. Cusickii* a synonym of *L. arida*, the size and color of the flowers of the former seem to remain constant, and therefore it may well be left as a variety.



LAPPULA SUBDECUMBENS (Parry) A. Nels. in COULTER and NELSON Rocky Mountain Botany 412. 1909.—PIPER, in his excellent revision of the western perennial species of *Lappula* (Bull. Torr. Bot. Club 29:539. 1902), wrote "*Echinospermum subdecumbens* Parry is probably a synonym of *L. diffusa*." Others have shared this view, so a few remarks calling attention to this evident error may not seem inappropriate.

LAPPULA DIFFUSA (as described) has glabrous or merely papillate corolla appendages. The material from the Wasatch Mountains, Utah, which represents the plant PARRY was writing about in Proc. Davenport Acad. 1:148. 1876, has softly pilose appendages. Moreover, where the species meet in Idaho they are consistently distinct as to color, *L. subdecumbens* being white or merely marked with blue, thus agreeing with material from the type region. These are two of the characters of which PIPER rightly makes so much. They are strengthened in this case by an evident difference in habitat. *L. subdecumbens*, PARRY tells us (*loc. cit.*), is "quite common in gravelly débris at the outlet of ravines," and GARRETT in his *Spring flora of the Wasatch region* notes that it grows on "dry plains and hillsides." *L. diffusa*, on the other hand, is a species of streamlands and woods or thickets. In southern Idaho and adjacent Nevada it is not infrequent to find the species growing within a few yards of each other, the one on the dryer, higher, and usually rocky places, the other on the moister and richer flats or slopes. The ranges of the two are at present not well enough known to be significant, but in all probability will later prove interesting. *L. caerulescens* Rydb., with long-hirsute appendages, is no doubt rightly treated by GARRETT as a variety of the Utah plant. It extends much farther north than the typical form.

**Cryptantha muricata** (Hook. and Arn.), n. comb.—*Myosotis muricata* Hook. and Arn. Bot. Beechy 369. 1840; *C. muriculata* (A.DC.) Greene, Pitt. 1:113. 1887.—DECANDOLLE, treating this plant as an *Eritrichium* (Prodr. 10:132. 1846), discarded HOOKER and ARNOTT'S name because of the earlier and valid *E. muricatum* (R. and P.) DC. The latter is now known to belong to the genus *Allocarya*. Accordingly, the earliest name, not



being preoccupied in the genus *Cryptantha*, must replace *muri-culata* DC.

LEHMAN'S genus has been commonly spelled *Cryptanthe* ever since GREENE resurrected it. The first valid publication, however, seems to have been by FISCHER and MEYER in Sem. Hort. Petrop. 35. 1836, and there at least the name is *Cryptantha*.

CRYPTANTHA TORREYANA (Gray) Greene var. **grandiflora** (Rydb.), n. comb.—*C. grandiflora* Rydb. Bull. Torr. Bot. Club 36:679. 1909.—Because of the conspicuous corolla (5–6 mm. wide) this may well deserve varietal rank. The leaves are often, though not always, broader than those of the species.

**Oreocarya salmonensis**, n. sp.—Pallid throughout; duration unknown: stems solitary or few, apparently not tufted, simple, 1.5–2 dm. high, distinctly angled, very leafy, white-hispid, and finely strigose with reflexed hairs: leaves (basal unknown) large for the genus, 3–8 cm. long, scarcely reduced below the inflorescence, oblanceolate or broadly spatulate, obtuse, the lower strongly 1-nerved, hispid-ciliate, petiolar portion about as long as the sparsely pustulate-hispid and finely and intricately pubescent blade: inflorescence thyrsoid-glomerate, dense, even in fruit: calyx lobes pubescent like the leaves, but not pustulate, linear-lanceolate, 5–7 mm. long in fruit: corolla white, the tube shorter than the calyx: anthers oblong: nutlets fully 3 mm. long, long-ovate, obtuse, acutely margined, smooth and shining, gray with a lighter indistinct keel on the back; scar linear, nearly as long as the nutlet, forked at the very base.

Unique among the short corolla species of the Northwest, being the only one with smooth nutlets. Equally distinct in leaf and inflorescence from the *O. multicaulis* group of the South and from *O. leucophea*. The type is by Charles L. Kirkley, "prairies, in loose soil," Salmon, Idaho, June 1896.

OREOCARYA CILIO-HIRSUTA Nels. and Macbr. BOT. GAZ. 55: 378. 1913 is *O. spiculifera* Piper, Contrib. Nat. Herb. 11:481. 1906. The species is very well marked by its usually numerous stems and striking pubescence.

**Nicotiana Torreyana**, n. n.—*N. attenuata* Torr. in Wats. Bot. King Exped. 276. 1871; not *N. attenuata* Steudel, Nom. ed. 1. 554. 1821.



**PEDICULARIS CONTORTA** Benth. var. **ctenophora** (Rydb.), n. comb.—*P. ctenophora* Rydb. Bull. Torr. Bot. Club 24:293. 1897.—Distinguished from the species by the more or less villous-ciliate calyx base. The variety has a purplish corolla, that of the species usually being yellow. Both forms occur in Montana and Yellowstone Park, but the variety seems to be confined to the eastern part of the plants' range.

Besides the type, the following collections may be noted: MONTANA: near snow, July 17, 1880, *Watson* (326); YELLOWSTONE PARK: 1884, *R. S. Williams* (809); WYOMING: Bighorn Mountains, July 19, 1900, *J. G. Jack*.

**MIMULUS LANGSDORFII** Don var. **microphyllus** (Benth.), n. comb.—*M. microphyllus* Benth. DC. Prodr. 10:371. 1846; *M. luteus* L. var. *depauperatus* Gray.—As pointed out by GRAY in Syn. Fl. 448. 1886, this often grows with the typical form. Such is not always the case, however; and when it is found by itself its slender and few-flowered stems, and small leaves and flowers make it hard to consider it as identical with the well developed state.

**CASTILLEJA PILOSA** (Wats.) Rydb. var. **inverta** (Nels. and Macbr.), n. comb.—*C. fasciculata* A. Nels. var. *inverta* Nels. and Macbr. BOT. GAZ. 55:381. 1913.—Although bearing a striking resemblance to the species to which we first referred it, the plant is rather a variation of *C. pilosa*, since it has the unequally cleft calyx of that species. The short corolla and the short, fine pubescence seem to make it the connecting link between two groups in this genus.

**CASTILLEJA CONFUSA** Greene, Pitt. 4:1. 1899.—An examination of a large amount of material in this group (the *miniata* group), both in herbaria and in the field, has convinced us that some of the characters relied upon to maintain proposed species are both inconstant and inconsequential. For instance, *C. confusa*, when rightly interpreted, should not be confined to plants that have the two primary calyx lobes so deeply cleft that the calyx appears 4-lobed, for this character exists in all degrees, but should include all those plants of its alliance with galea only one-half to one-third as long as the tube. The latter is a fairly constant character and must be the chief if not the only means, often, of separating *C. confusa* from *C. miniata*, in which it was at one time included.



The galea of the latter plant is nearly or quite as long as the tube. Measured by this yardstick the group divides into two species which are more or less distinct in habit and aspect. Both present interesting and analogous variations in pubescence; one, *C. rexifolia* var. *pubens* Nels. and Macbr., with this interpretation of *C. confusa* must become

CASTILLEJA CONFUSA Greene var. **pubens** (Nels. and Macbr.), n. comb.—*C. rexifolia* Rydb. var. *pubens* Nels. and Macbr. BOT. GAZ. 55:380. 1913.

CASTILLEJA MINIATA Dougl. var. **crispula** (Piper), n. comb.—*C. crispula* Piper, Contrib. Nat. Herb. 11:516. 1906.—The bracts, at least the uppermost, are few-toothed near the apex. The species varies somewhat in the dissection of the bracts.

CASTILLEJA ANGUSTIFOLIA (Nutt.) G. Don var. **subcinerea** (Rydb.), n. comb.—*C. subcinerea* Rydb. Bull. Torr. Bot. Club 40:484. 1913.—Since FERNALD published his discriminating analysis of this group (Eryth. 6:41-51), several additional species have been described, among them *C. subcinerea* Rydberg. This form is of particular interest as it in some degree connects *C. angustifolia* and its varieties with *C. Bennittii* Nels. and Macbr. of southwestern Idaho. The latter is very distinct, however, by reason of its subequal corolla and calyx and the color of its bracts (old rose). The eastern Idaho plant (*C. subcinerea*), although simulating *C. Bennittii* in pubescence, has the well-exserted corolla and relatively long calyx (2-3 cm.) of the old species. It would seem conducive to clearness and more natural, therefore, to treat it as another variety of *C. angustifolia*, regarding its pubescence as its most marked characteristic.

CORDYLANTHUS BICOLOR A. Nels. BOT. GAZ. 54:416. 1912.—RYDBERG (*loc. cit*) states that this species "is evidently the same as *Adenostegia ciliosa* Rydb." The latter, however, is the same as *C. ramosus* Nutt., which has 4 stamens and 2-celled anthers. *C. bicolor* is distinguished from *C. capitata*, its nearest relative, which has 2 stamens and 1-celled anthers, by its viscid-glandulosity and the presence of a rudimentary anther cell.

**Ricinophyllum horridum** (Sm.), n. comb.—*Panax horridum* Sm. Rees Cycl. 26: no. 10. 1812; *R. americanum* Pall. ex Ledeb.



Fl. Ross. 2:375. 1844; *Fatsia* and *Echinopanax* Dcne. and Planch. Rev. Hort. 4:105. 1854.—This widely distributed and conspicuous plant ought to bear its acknowledged earlier designation.

**Gnaphalium Ivesii**, n. n.—*G. decurrens* Ives Am. Jour. Sci. 1:380. 1819, not L. Syst. ed. 10. 1211. 1758.

**Gnaphalium Grayi**, n. n.—*G. strictum* Gray, Pacif. R.R. Rep. 4:110. 1858, not Moench, Meth. Pl. Hort. Bot. et Agric. 576. 1794; nor Roxb. Hort. Bengal. 61. 1814.

**Gaillardia crassifolia**, n. sp.—Apparently perennial from a thickened semi-fleshy root, pale green, sparsely pubescent with fine, short, jointed hairs, the pubescence extending to all parts of the head: stems few to several from the crown, branching from near the base and upward, striate, 3–5 dm. high, the upper third pedunculate: root leaves (wanting) probably early deciduous; the lower stem leaves narrowly oblanceolate, 3–8 cm. long, on slender-margined petioles often as long as the blade; the upper narrower, becoming linear and nearly sessile; heads medium; the disk 15–20 mm. broad, corollas purplish above; rays yellow, rather short (15 mm. or less), cleft into narrowly oblong lobes: achenes short, densely pubescent all over: pappus longer than the achene, the weak awn longer than the scarious portion.

*M. E. Jones* no. 5177, La Verken, Utah, May 7, 1894, is the type. Another specimen by *Jones* from Green River, Utah, June 21, 1889, is doubtfully referred to the proposed species.

→ **SENECIO CANUS** Hook. var. **celsus** S. S. Sharp, n. var.—More densely tomentose, usually with a tuft of white wool at the base: stems stouter, single, or somewhat tufted (not tufted as in the species), 3.5–5 dm. high: basal leaves oval, repand, dentate, or sinuately dentate, obtuse, 2–3 cm. broad, larger than in the species; upper leaves oblong-lanceolate, sinuately dentate, mostly sessile: heads 12–20, in a subumbellate cyme, 15 mm. broad, on peduncles 3–10 cm. long; bracts sometimes dark-tipped, silky-hairy or often tomentose at base; rays about 10.

The type was found on grassy banks in Little Goose Canyon, 15 miles south of Sheridan, Wyoming, at an elevation of about 5000 feet, no. 362, *Seymour S. Sharp*, June 22, 1913. No. 2332, *Aven Nelson*, from exactly the



same locality July 15, 1896, is also typical. In size and general aspect, this variety seems to differ considerably from typical forms of *S. canus*.

**Hieracium cineritium**, n. n.—*H. cinereum* Howell, Fl. N.W. Am. 396. 1901, not Doell, Rhein Fl. 524. 1843; *et al.*

MICROSERIS NUTANS (Geyer) Gray var. **major** (Gray), n. var.—*M. major* (Gray) Sch. Bip. 1866; see *Kew Index* and GRAY *Syn. Fl.*—Except for the large heads this plant has no constant character different from the typical form.

MICROSERIS NUTANS (Geyer) Gray var. **macrolepis** (Rydb.), n. comb.—*Ptilocalais macrolepis* Rydb. Bull. Torr. Bot. Club 38:11. 1911.—This is exactly like the variety *major* (Gray) Nels. and Macbr. except for the lanceolate-attenuate and elongate pappus scales. Thus intermediate between the species and the latter variety, which belongs to Oregon and Idaho, it seems best to consider it a geographical variant.

The following specimens may be noted in addition to those cited by RYDBERG: UTAH, Salt Lake City, May 1869, *Sereno Watson* 696 (referred by GRAY *Syn. Fl.*, to *M. major*); Fort Douglas, May 25, 1908, *Mrs. Joseph C'emens*; Emmigration Canyon, Salt Lake County, June 14, 1913, *A. O. Garrett* (2726b).

ROCKY MOUNTAIN HERBARIUM  
UNIVERSITY OF WYOMING, LARAMIE



## A MEXICAN AYTONIA

CONTRIBUTIONS FROM THE HULL BOTANICAL LABORATORY 211

ANNA M. STARR

(WITH PLATES I-IV AND FOUR FIGURES)

To this genus ENGLER and PRANTL refer six names, among which *Aytonia* Forst and *Plagiochasma* L. are most familiar in botanical literature. LEITGEB (14) made a study of *Plagiochasma cordatum*, *P. intermedium*, *P. crenulatum* (Gottsche), *P. appendiculatum*, and *P. Aytonia*. He gives an account of the appearance, the position, and the formation of the antheridial and archegonial receptacles, describing the order of the appearance of the archegonia and the origin of the archegonial cavity and of the involucre. He describes also the protective scales about the receptacles and their origin from a single row of cells, and accounts for the stalk of the receptacle as simply a dorsal outgrowth of the thallus. He concludes with an account of the structure of the sporogonium and its dehiscence.

The material for this investigation was collected in Mexico in 1908 by Dr. W. J. G. LAND and the late Dr. CHARLES R. BARNES. Most of it came from the rocky sides of the deep canyon of the Rio Santiago in the state of Jalisco near Guadalajara, the rest from Carrizal in the state of Vera Cruz. The species cannot be determined definitely. Of the four Mexican forms described by GOTTSCHKE, it resembles most closely his *Plagiochasma crenulatum*, but differs in that the ventral scales reach the margin of the thallus. This Mexican form presents some variations in external appearance, and an examination of structure offers some details not covered by LEITGEB, so that it has seemed worth while to give a description of the external appearance, an account of the internal structure of the thallus and of the formation of rhizoids, a complete description of the development of the air cavities of the archegonial receptacle, and an addition to the history of development following fertilization.



### Vegetative body

The thallus (fig. 1) is dorsiventral, dichotomously lobed and branched, with no groove on the dorsal side, but on the ventral side (fig. 2) a thickened median region, covered thickly with scales and rhizoids. The upper surface is green, showing purple at the edges; the ventral is light along the central region, with broad purple wings; the scales are in two rows, extending laterally from the median line, arranged alternately; they are attached along the posterior edge, lapping over those in front, and are shaped like the half of a crescent and have one or two appendages, the scales being purple and the appendages hyaline (fig. 3). Two appendages seem not to have been reported before.

The first rhizoids appear behind the first three or four pairs of scales and then occur in great abundance between the scales. They are of two kinds, pegged and smooth, the pegged appearing in bunches. They are deformed at the ends (fig. 4), but are not branched. The smooth rhizoids vary greatly in size, and frequently within the larger, smaller ones are produced (fig. 5); whether this occurs only when the larger are injured could not be determined, as most of the rhizoids were broken in collecting. The exterior rhizoids, having heavy walls, appear much older than those inside. This phenomenon is not uncommon in liverworts, often appearing in *Marchantia*, in which pegged rhizoids sometimes occur within plain ones. DIXON (9) also reports rhizoids within rhizoids in *Lunularia cruciata*, *Dumortiera hirsuta*, *Conocephalus conicus*, *Anthoceros punctatus*, and *Marchantia polymorpha*. WEINERT (17), in a study of *Marchantia* and *Conocephalus*, says "lost rhizoids are not regenerated, but other epidermal cells grow out into new rhizoids," which is plainly the case here. A new cell or several new cells just above the layer of old rhizoids push down into the cavity of the old rhizoid.

### Structure

The thallus shows the usual differentiation into thin wings of spongy tissue and a thick median region composed of close colorless tissue below and spongy chlorophyllose tissue above, the latter



often occupying almost all of the thallus. The cavities have no regular chlorophyllose filaments, although single cells frequently project into them (figs. 11 and 16). In these respects *Aytonia* differs markedly from *Marchantia*, *Fegatella*, and *Targionia*.

The close tissue of the thallus is generally infested with intracellular fungi (fig. 6), filamentous, non-septate, not contracted in passing through the walls, branching irregularly, and forming sporelike bodies occasionally as vesicles within a swollen part of the main filament or in short branches. One naturally questions the origin of the fungi and the relation existing between them and the liverworts. CAVERS (6) reports fungi in many liverworts, and says they are nearly always related to the soil, always occurring with humus; then he finds them traversing the rhizoids and extending into the lowest layers of the compact tissue; he thinks the fungus-bearing plants are larger and thicker than others. GOLENKIN (12) reports "endotropic mycorrhiza" in five liverworts, and thinks they are "for storing water." NĚMEC (15) implies the entrance of the fungi through the rhizoids, and describes a pseudoparenchyma formed by them on the wall of the cells of the thallus. GARJEANNE (10) also finds them entering through the rhizoids and thinks the relation may be accidental, a case of true parasitism, or a case of true symbiosis. Miss CLAPP (7) is the only one who has traced the history of the infection back to the very early stages of the sporeling. She finds fungi in as young a plant as the 4-celled stage, and states that development is hastened by the presence of the fungus. According to her, infection of rhizoids occurs from the thallus. I am inclined to think that both methods of infection of the rhizoids may happen; that the plant may become infected at any stage of development; when considerable mycelium has developed, the hyphae may grow out through the rhizoids; and when the infection occurs late the hyphae may enter through the rhizoids. In my material the fungi are only in the older parts of the thallus, and when they occur in rhizoids seem to be always growing toward the thallus (fig. 7); but in living material of *Marchantia* and *Fegatella* I have found the hyphae passing out through the rhizoids. I find no "pseudoparenchyma" or balling up of hyphae, described by NĚMEC.



Cells secreting mucilage and resinous oils appear singly in thallus, receptacles, and scales; sometimes there is a layer of enlarged mucilage cells on the lower surface. Mucilage hairs are common about the receptacles and in the antheridial cavities. The middle lamella of the radial walls of the epidermal cells shows a tendency to become mucilaginous. Pitted cells occur in both the compact and loose tissue; they are not elongated more than other cells (fig. 8).

### Development

Growth takes place by divisions of a wedge-shaped apical cell (fig. 9), as described by LEITGEB. From the lower segments scales are formed almost immediately, but rhizoids not until later. The epidermal cell giving rise to a rhizoid is often larger than the resulting rhizoid, forming a bulbous base. Division in the lower part of the thallus is more rapid than in the upper, indicated by the pulling backward of the bottoms of the air cavities. LEITGEB'S theory of the origin of air cavities, as due to depressions in the surface and the upgrowth of adjacent parts, was combated by BARNES and LAND (1) and by PETSCH (16), but was upheld by Miss BLACK (2) in regard to *Riccia Frostii*. My material leaves no doubt as to their schizogenous origin (fig. 10). LEITGEB thought the spaces in *Plagiochasma* became partitioned by the outgrowth of cell plates. CAMPBELL (4) also says that the original air chambers become divided by the development of partial diaphragms into secondary chambers. The cavities at first are always deep and narrow, as noted by BARNES and LAND, but they soon become wide, irregular chambers by the stretching and tearing of tissues between neighboring chambers, as shown by the irregularity of the resulting surfaces and by torn cells, the tearing being due to the differences in tension between the upper and lower parts of the thallus. This leaves projecting plates of cells, appearing as filaments in section, which LEITGEB and CAMPBELL interpreted as new growth dividing the original chambers. Perhaps these plates add to their length by further growth. In fig. 11 projecting filaments *a* and *b* are attached in the next section.

The receptacles are formed in a direct line behind the growing point. LEITGEB noted that they are not complete branches of



the thallus, but only dorsal outgrowths. As the apical cell goes on dividing, the receptacles come to stand on the back of the thallus in a row along the median line, the antheridial appearing first, the archegonial later. Occasionally antheridial receptacles are again formed after the archegonial. Several rows of scales and mucilage hairs, dorsal outgrowths also, surround both receptacles (fig. 12).

The first indication of a receptacle is a slight elevation caused by a rapid division of the cells. My material has no early stages of the antheridial receptacle; when mature it is without a stalk and does not rise much above the surface of the thallus (fig. 12); it is cordate in shape, with the notch toward the growing point (fig. 1). The surface is markedly papillate, caused by the upward growth of tissue about the antheridia, which agrees with LEITGEB'S description. The deep cavities in which the antheridia stand, open to the surface by simple air pores, resembling those of the thallus except that at times there is greater projection (fig. 13). The archegonial receptacle appears in an early stage (fig. 14) as a small, bulbous outgrowth of compact, rapidly dividing cells in which are numerous chloroplasts containing starch. The cells of the under part divide radially as well as tangentially, with such regularity that a row of cells can be followed for some distance, dividing into two rows, and these two later dividing again. In the lower portion the divisions are tangential only, but the cells increase both in length and in numbers. The lower part therefore forms the stalk, while the upper part continues bulbous. The cells of the thallus below the receptacle remain compact, while those on each side form porous tissue, growing rapidly and arching up around, so that the receptacle stands in a slight depression (fig. 12) until after the archegonia are mature. Fertilization probably takes place very easily. Later the stalk elongates and lifts the receptacle above the surface; it may attain the length of 3 or 4 mm.

Air cavities appear early in the developing receptacle, starting about the same time as the archegonia, the origin being like that of the cavities of the thallus. The split occurs first at the juncture of epidermal and hypodermal cells (fig. 10), between cells of different segments of the apical cell, cells derived from the same segment



remaining attached for a longer time. The split may extend almost immediately to the surface (fig. 15) or be delayed until the formation of the pore (fig. 16). The structure of the pore is more elaborate than in cavities of the thallus, as noted by CAMPBELL (3) in archegonial receptacles in general. The cells destined to form the margin become evident by an increase in size (fig. 15); segments are cut off from the inner side, generally by oblique walls (fig. 17); more divisions occur until 3-5 rows of cells form a ring extending down into the enlarging cavity (fig. 18); then segments are cut off from the outer part of the cells of the margin, walls being again oblique, followed by another division, so that a projecting ring of cells three layers thick is formed (fig. 19). The cells of the last row shrink and become highly cutinized, giving a beaklike effect in section (fig. 20), as noted by DEUTSCH (8) in *Targionia*. I find no such thickening of the walls as LEITGEB shows in surface view, but only such an effect as appears in fig. 21, taken from the older part of the thallus. Of course my material may have grown under conditions entirely different from his. With the increase in size of the cavity the pore spreads and becomes a barrel-like opening. The development is not complete until fertilization has taken place and the receptacle has increased greatly in size.

### Sex organs

The development of the antheridium is probably such as is general in the Marchantiaceae, but my material has no early stages. Occasionally the antheridium has a long stalk; less frequently the upper end is beaked; but the usual form is short-stalked and conical. About the antheridium are glandular hairs, and among the cells forming the wall of the pit are mucilage cells, the secretions from which probably assist the dispersal of the sperms. The antheridia are produced in acropetal succession, so that the younger are toward the apex (fig. 12).

The archegonia are reported by CAMPBELL (5) to be 3 or 4 in number, the one to the rear developing first, the lateral ones next, and the one in front last. My material confirms the statement in general, but 5 archegonia may occur. They begin development near the top of the receptacle (fig. 14), but are carried under



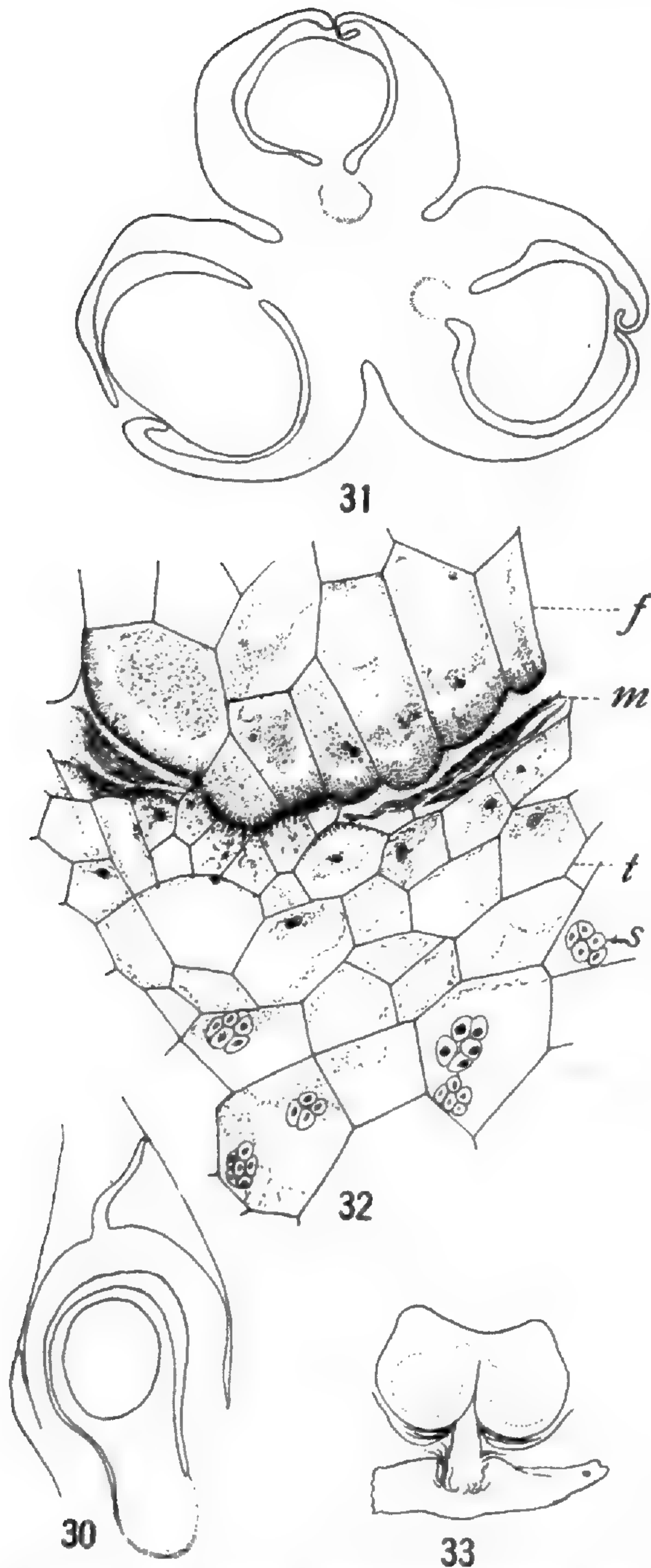

FIGS. 30-33.—Fig. 30, vertical section of a young sporogonium within the calyptra,  $\times 132$ ; fig. 31, transverse section of an archegonial receptacle, cutting obliquely through three sporogonia within their involucres which show the vertical opening; fig. 32, section through the region of contact of foot and thallus (*f*, foot; *t*, thallus; *m*, mucilaginous remains; *s*, starch),  $\times 667$ ; fig. 33, sketch of archegonial receptacle indicating the position of the sporogonia.

by the rapid growth of the tissue above (fig. 12). The stages of development that appear indicate the sequence usually given. In 1897 GAYET (II) claimed that he had demonstrated in *Marchantia*, *Preissia*, and other Hepaticae, that division in the cover cell by intersecting quadrant walls does not take place until a late period, and that before it occurs repeated segments are cut off its lower face, which add to the length of the neck. Figs. 24, 26, and 27 leave no room for doubt that in *Aytonia* a quadrant division occurs early in the cover cell, and that the neck lengthens by divisions lower down. The neck cells divide simultaneously until 8 cells are formed (fig. 27), showing greater regularity than is commonly reported. The egg has a large nucleus but no "receptive spot"; it fills the cavity of the venter up to the time that fertilization is to take place; then the cells forming the wall of the venter divide rapidly, parallel to the surface of the egg; at the same time there is an increase in the size of the cavity or



else the egg shrinks, so that there is considerable space between the egg and the upper part of the venter. The egg then generally contains large, perfectly spherical globules that stain deeply red with safranin; the shape suggests a fatty food substance. The breaking down of the canal cells leaves the egg invested with a great amount of striated mucilaginous substance which often fills more than half the venter (fig. 28). When the first division of the embryo occurs, all the cells of the venter have divided. Growth continues in the stalk, the venter, and the lower part of the neck until an extraordinary amount of tissue is developed about the embryo and the neck is greatly elongated, curving up above the cushion of the receptacle (fig. 29).

### Sporogonium

The embryo develops in the usual way, beginning with a transverse wall. At first the seta appears as of considerable length when compared to the whole body (fig. 30), but later the capsule and foot develop more rapidly, so that the seta comes to be inconspicuous (figs. 31 and 33). The foot is well developed as an absorbing organ, the cells next to the thallus being large and slightly rhizoidal in shape. Just within the walls of these cells and of the adjoining cells of the thallus there is a granular deposition, probably related to the passage of nutrient material from the thallus to the parasitic sporogonium. The cells of the thallus respond to the invasion of the foot by dividing, as is shown by the cells nearest the foot being smaller than elsewhere. As the cells break down, a mucilaginous deposit remains, marking the limit between foot and thallus (fig. 32). As the sporogonium matures, the starch contained in the cells of the thallus near the foot disappears, and in all the cells of the receptacle it is scantier than in earlier stages.

The history of the development of the capsule and of the involucre, resembling the valves of a clam shell, has been described by LEITGEB. It might be added that a few cells at the base of the capsule remain sterile, but there is no regular elaterophore.



### Summary

1. Two appendages may be present on the ventral scales.
2. Rhizoids are absent among the first pairs of ventral scales.
3. Old rhizoids are often replaced by new ones that form within them.
4. Fungi are prevalent in the compact tissue of the thallus. They enter through the rhizoids and may also pass out through them. No "pseudoparenchyma" was found.
5. The secretion of mucilage seems to have nothing to do with the "protection" of the growing point, but to be most pronounced about the egg and the antheridia.
6. Pitted cells show no tendency to become trachea-like.
7. The origin of air chambers in the thallus and receptacles is schizogenous. The horizontal increase in the size of the chambers is due to a tearing of the tissues. The pore of the chambers of the thallus and of the antheridial receptacle is simple, but that of the archegonial receptacle has an elaborate margin.
8. The development of the sex organs follows the Marchantiales type. The archegonia form early in the history of the receptacle and parallel the increase in size of the receptacle by great increase in length of the neck. Following fertilization an exceedingly massive venter is developed about the embryo.
9. Five archegonia may begin to develop on one receptacle, but no more than three come to maturity.
10. The condition of the cells of the foot and of the adjacent parts of the thallus indicate the parasitic nature of the sporogonium. No elaterophore appears.

Most cordial thanks are due Dr. W. J. G. LAND, who furnished the material for this study and followed the work with interest and encouragement.

MOUNT HOLYOKE COLLEGE

### LITERATURE CITED

1. BARNES, C. R., and LAND, W. J. G., Bryological papers I. The origin of air chambers. *BOT. GAZ.* 44:197-213. 1907.
2. BLACK, CAROLINE A., The morphology of *Riccia Frostii*. *Ann. Botany* 27:511. 1913.



3. CAMPBELL, D. H., The structure and development of mosses and ferns. New York. 1905 (p. 42).
4. ———, *op. cit.* p. 48.
5. ———, *op. cit.* p. 56.
6. CAVERS, F., On saprophytism and mychorhiza in Hepaticae. *New Phytol.* 2:30-35. 1903.
7. CLAPP, GRACE L., The life history of *Aneura pinguis*. *BOT. GAZ.* 54:177-193. 1912.
8. DEUTSCH, H. D., A study of *Targionia hypophylla*. *BOT. GAZ.* 53:492-503. 1912.
9. DIXON, H. H., Notes from the Botanical School of Trinity College, Dublin. 14 (p. 141).
10. GARJEANNE, ANTON J. M., Über die Mykorrhiza der Lebermoose. *Beih. Bot. Centralbl.* 15:470-482. 1903.
11. GAYET, L. A., Recherches sur le développement de l'archegone chez les Muscinées. *Ann. Sci. Nat. Bot.* 8:161-258. 1897.
12. GOLENKIN, M. I., Die Mykorrhiza-ähnlichen Bildungen der Marchantiaceen. *Flora* 90:209. 1902.
13. GOTTSCHÉ, C. M., De mexikanske Levermosser. *Det Kongelige Danske Vidensk. Selsk. Skrift.* 6:99-382. 1867.
14. LEITGEB, H., Untersuchungen über die Lebermoose. *Die Marchantieen* 5:6. 1874-1882.
15. NĚMEC, B., Die Mykorrhiza einiger Lebermoose. *Ber. Deutsch. Bot. Gesells.* 17:311. 1899.
16. PETSCH, W., Entwicklungsgeschichte des vegetativen Thallus, insbesondere der Luftkammern der Riccien. *Flora* 103:347-384. 1911.
17. WEINERT, H., Untersuchungen über Wachstum und tropistische Bewegungserscheinungen der Rhizoiden thallöser Lebermoose. *Bot. Zeit.* 67:201-230. 1909.

#### EXPLANATION OF PLATES I-IV

- FIG. 1.—Sketch of monoecious thallus, dorsal view.
- FIG. 2.—Sketch of thallus, ventral view.
- FIG. 3.—Sketch of ventral scales with appendages.
- FIG. 4.—Sketch of rhizoids;  $\times 470$ .
- FIG. 5.—Longitudinal section of an old rhizoid with a new one developing within.
- FIG. 6.—Section of compact tissue by the thallus with fungal hyphae passing through the walls and destroying the protoplasm;  $\times 450$ .
- FIG. 7.—Fungal hyphae entering a thallus through a rhizoid.
- FIG. 8.—Surface view of a pitted cell;  $\times 687$ .
- FIG. 9.—Vertical longitudinal section of a thallus through the apical cell, showing the origin of ventral scales (*s*) and air chambers (*a* and *b*);  $\times 375$ .



FIG. 10.—Vertical section of developing air cavities in an archegonial receptacle;  $\times 750$ .

FIG. 11.—Vertical section of an air pore of the thallus;  $\times 667$ .

FIG. 12.—Vertical longitudinal section of a thallus with two archegonial receptacles and one antheridial.

FIG. 13.—Vertical section of a pore in an antheridial receptacle.

FIG. 14.—Vertical section of an early stage of an archegonial receptacle;  $\times 67$ .

FIGS. 15–20.—Stages in the development of an air pore of the archegonial receptacle.

FIG. 21.—Surface view of an air pore of the thallus.

FIGS. 22–27.—Stages in the development of the archegonium before the formation of the egg; fig. 25 shows also the origin of a scale and of the involucre (*i*).

FIG. 28.—Vertical section of a venter after fertilization; *n*, nucleus; *g*, spherical globule;  $\times 667$ .

FIG. 29.—Vertical section of an archegonium inclosing a young embryo;  $\times 470$ .



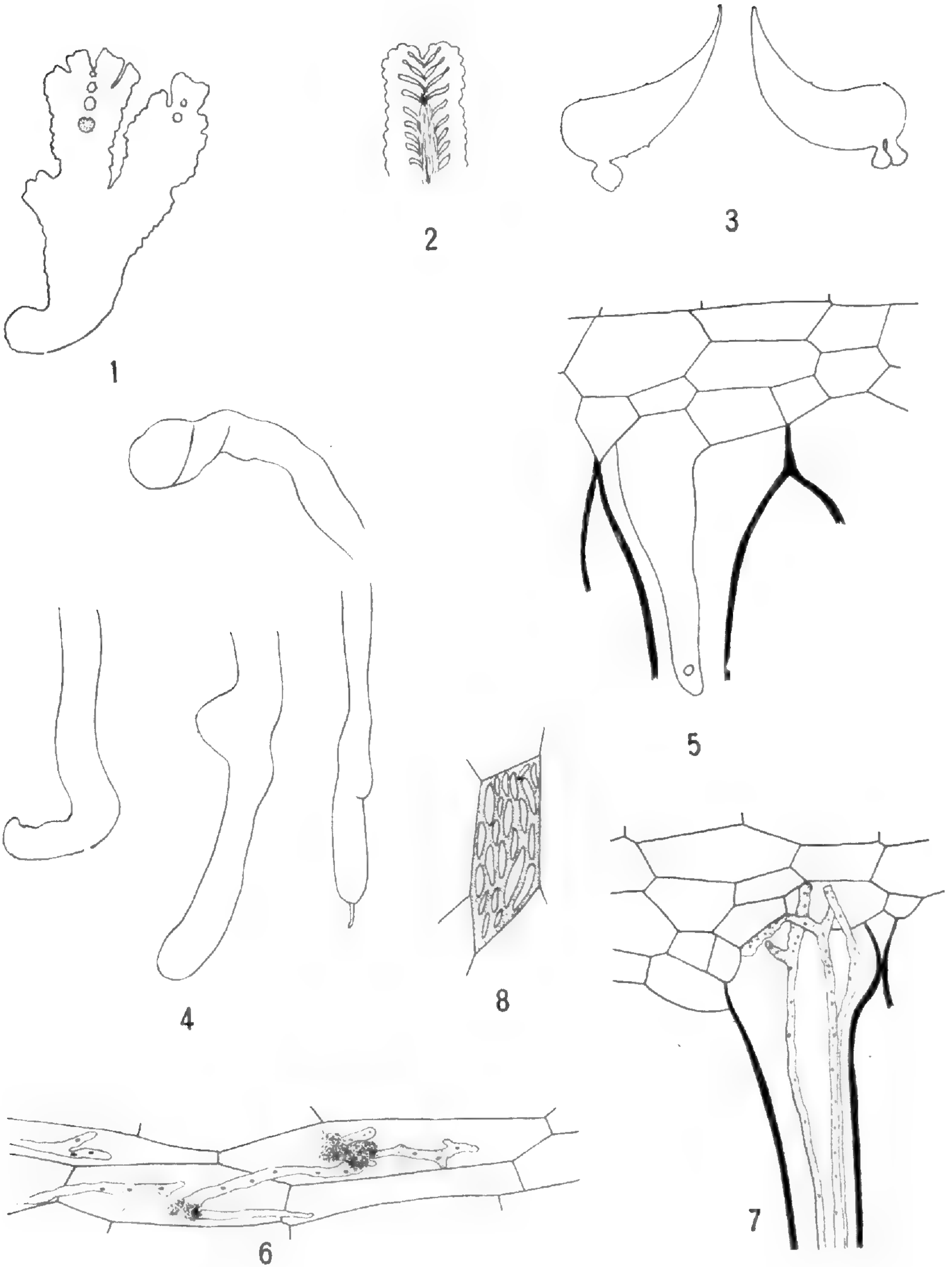

STARR on AYTONIA



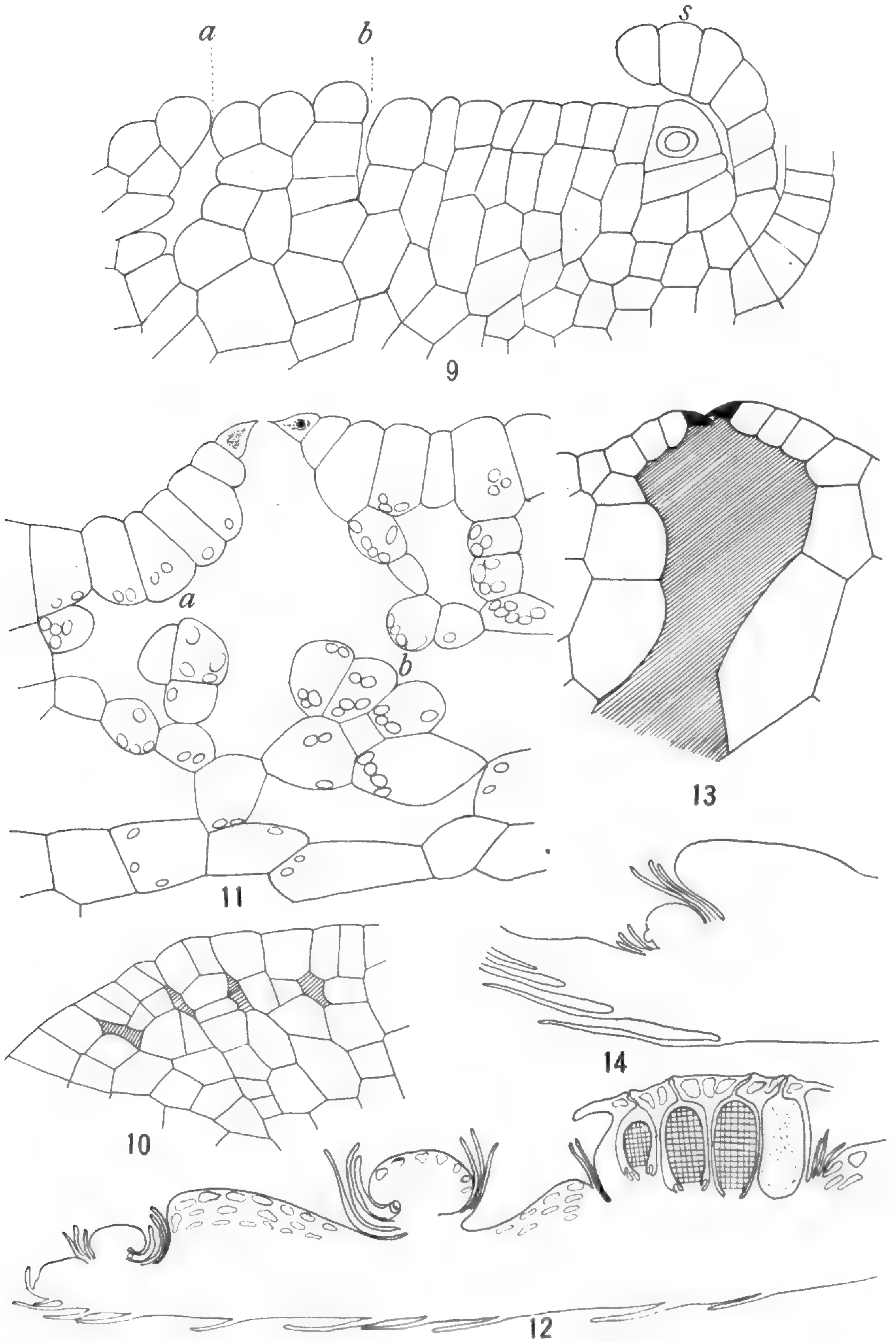

STARR on AYTONIA



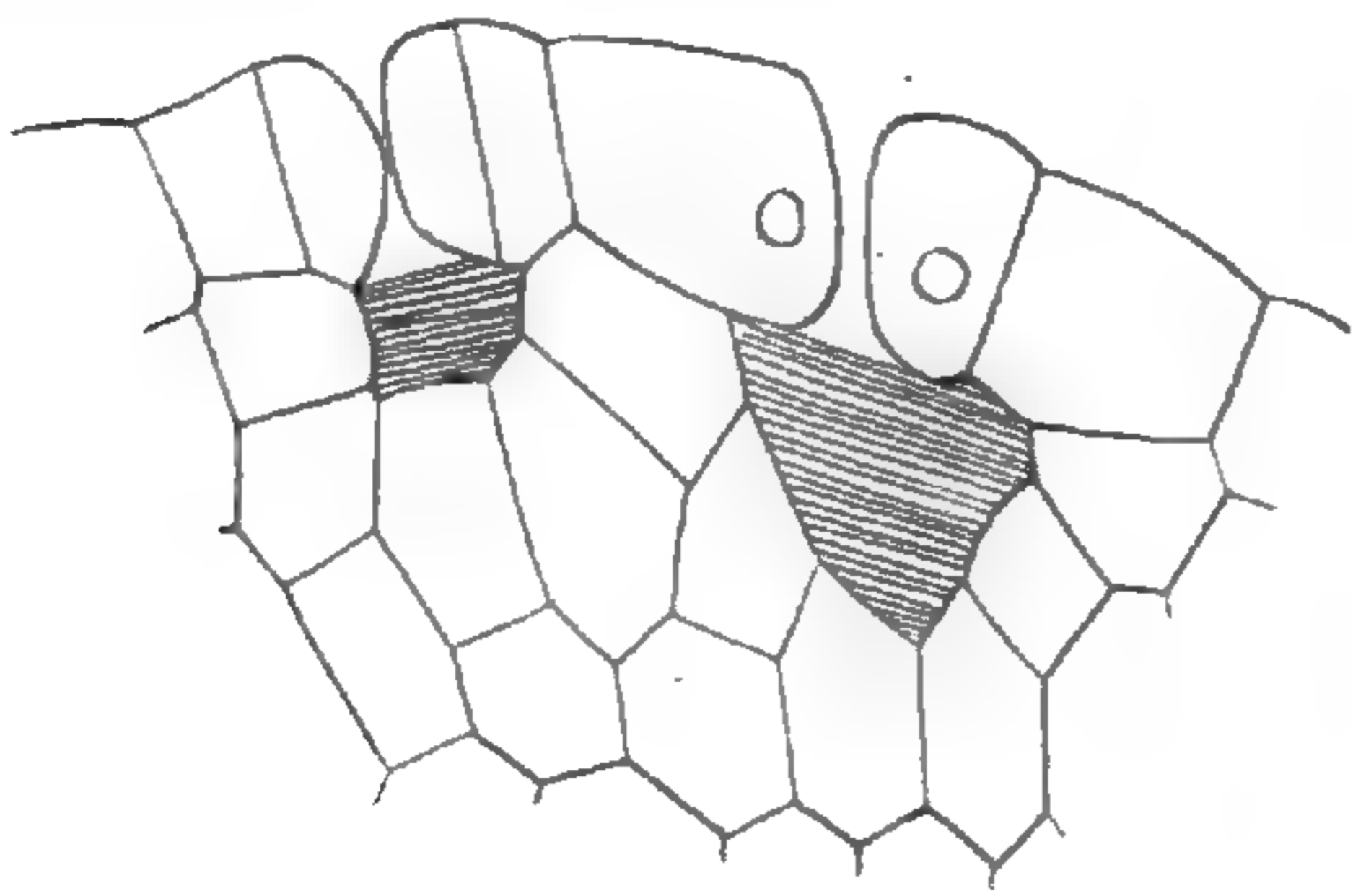

15

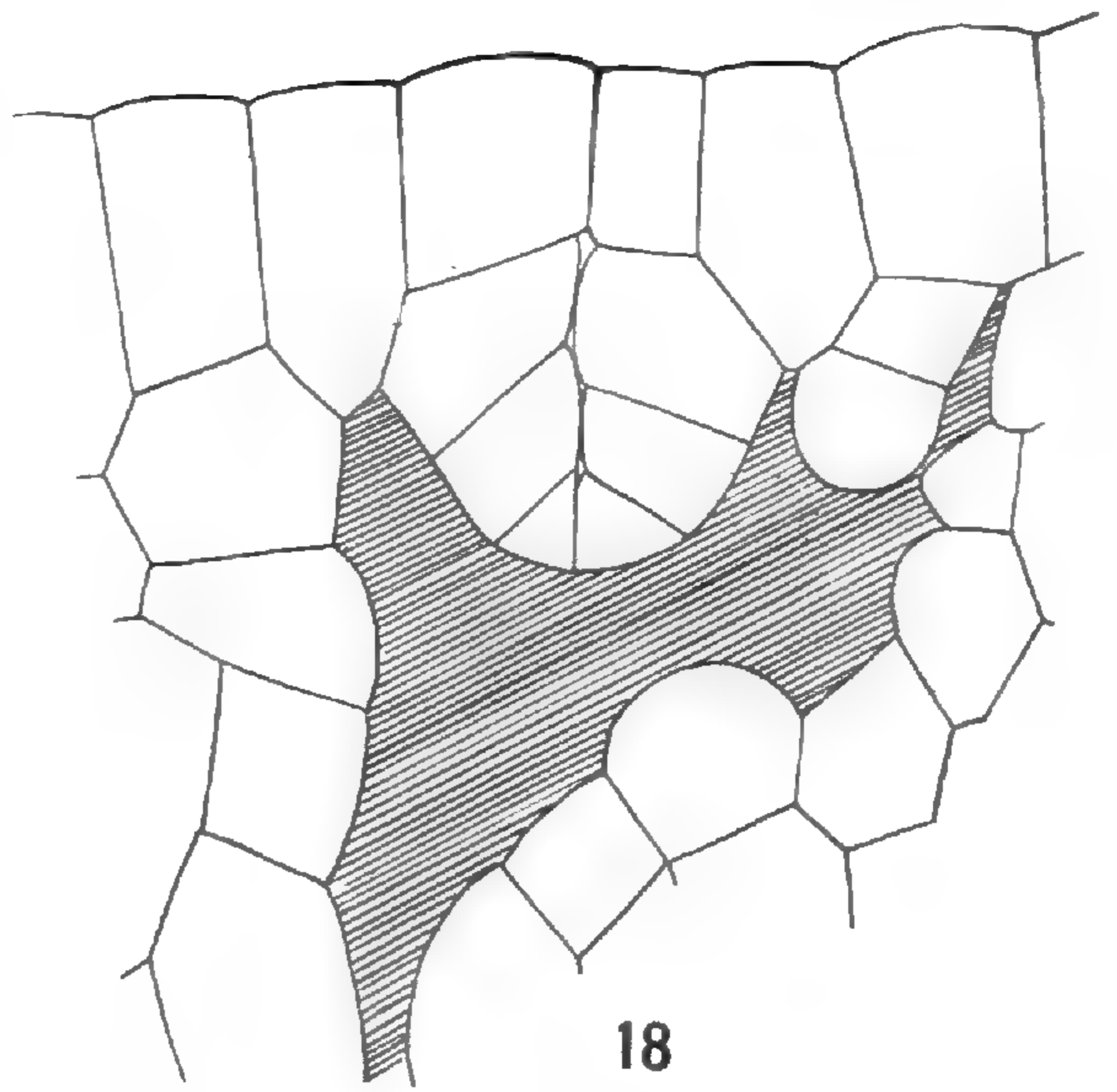

18

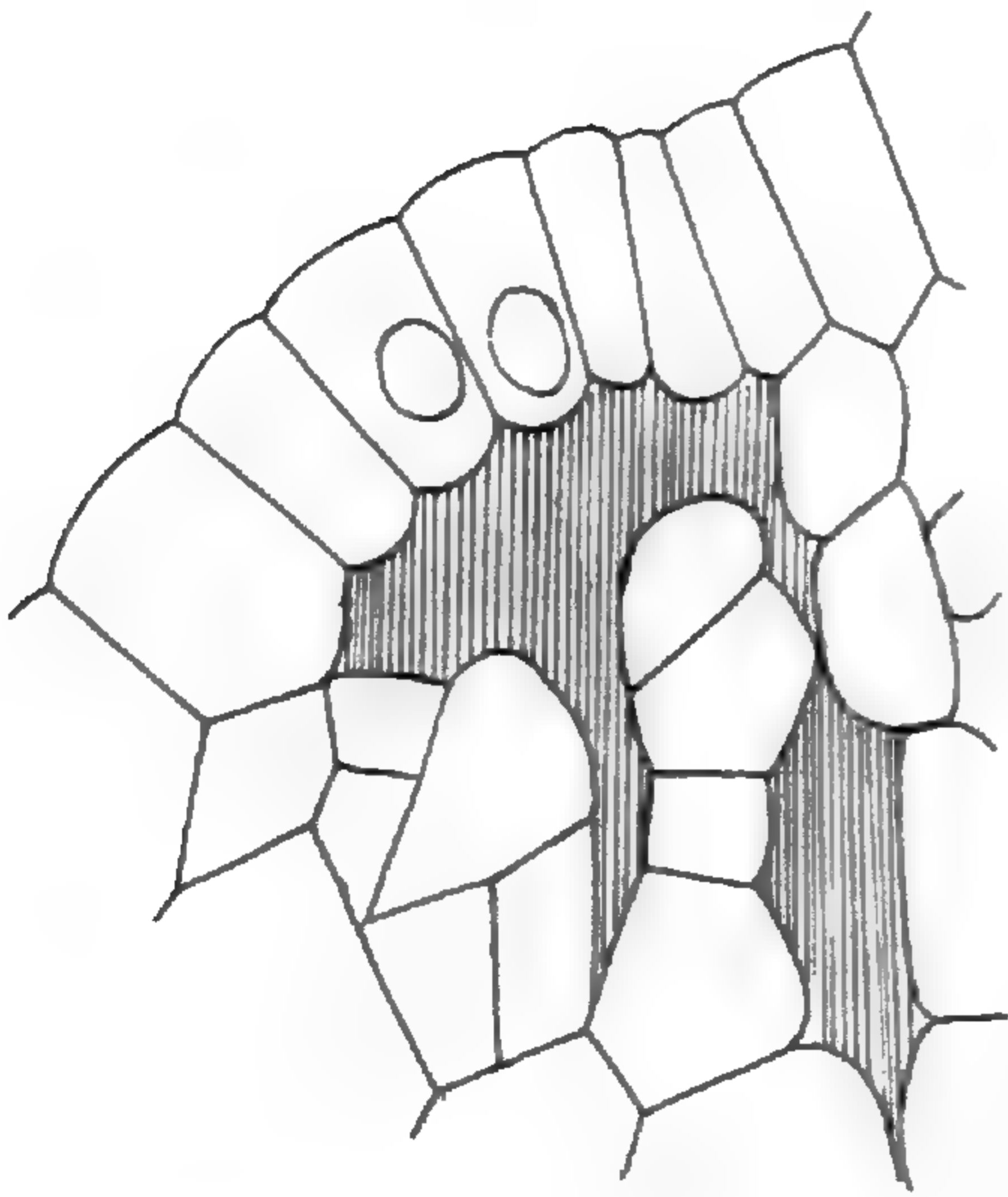

16

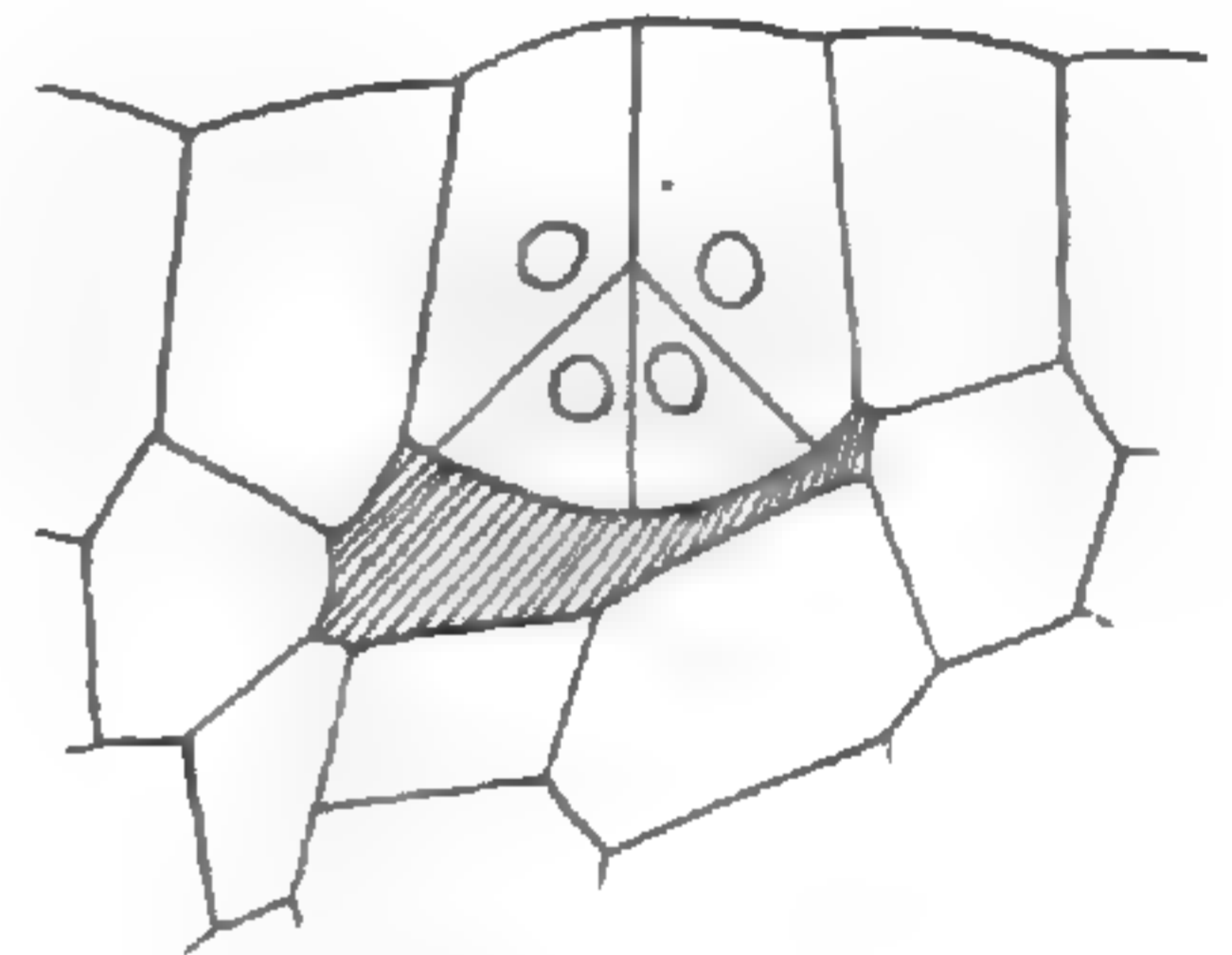

17

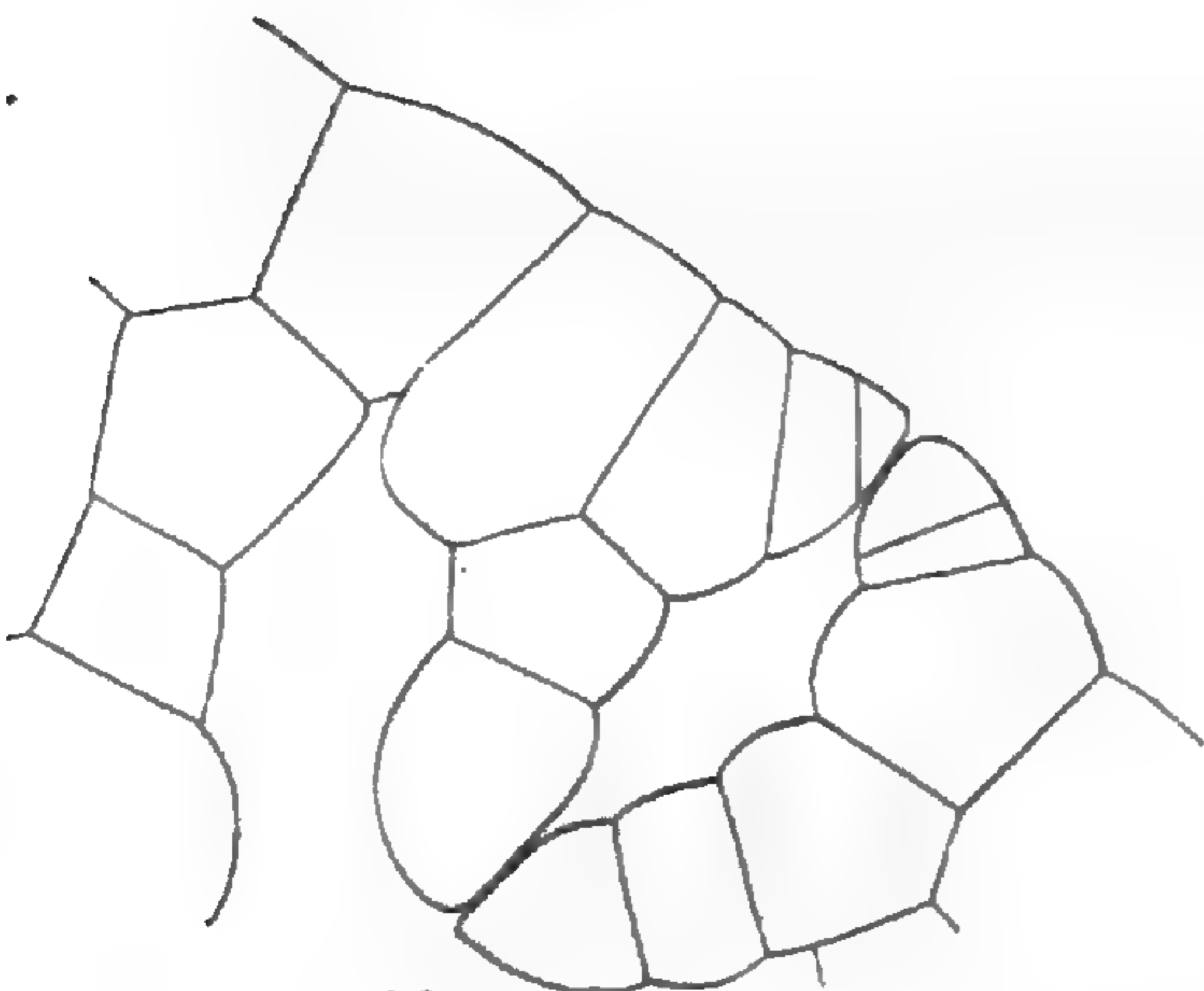

19

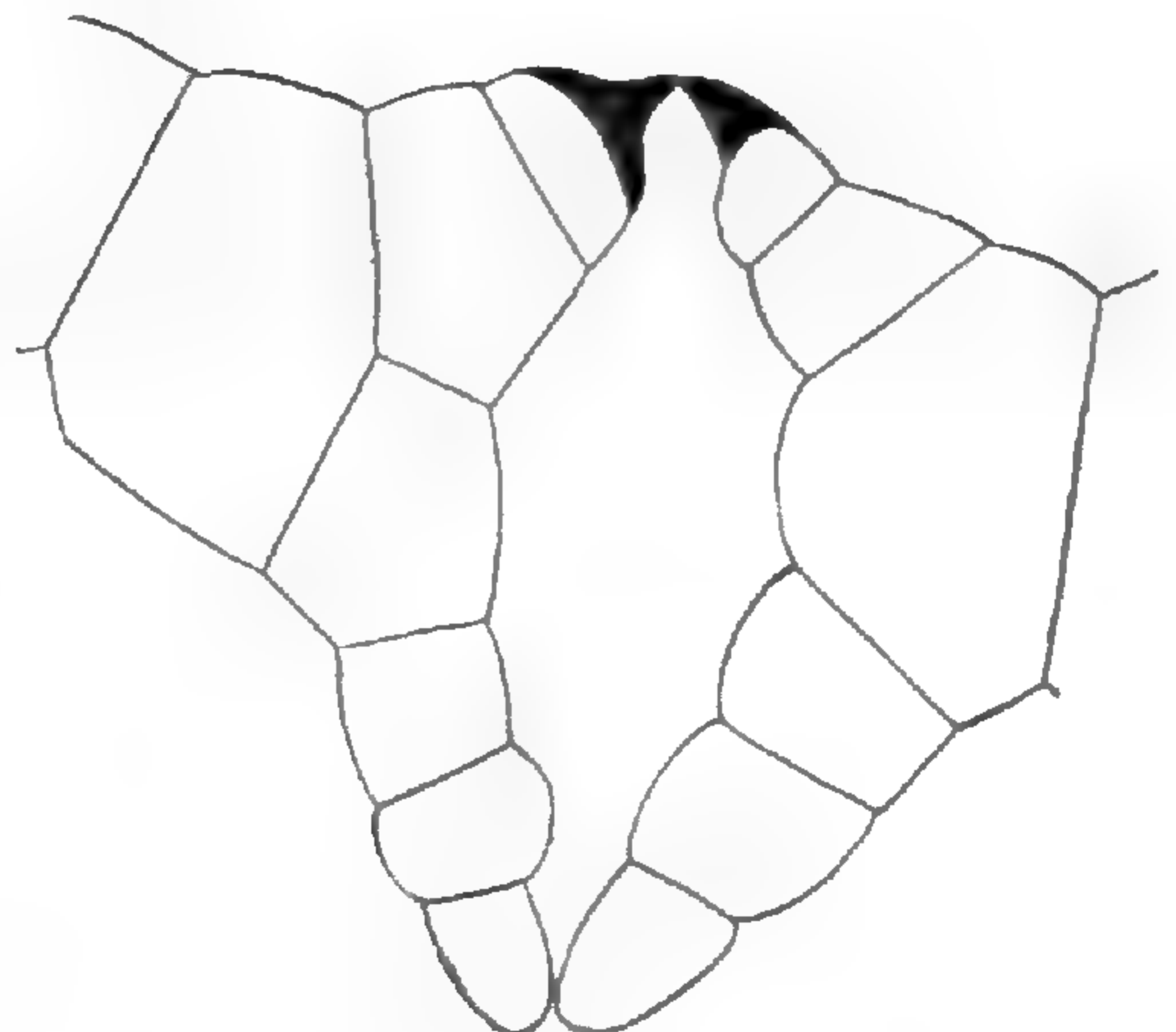

20



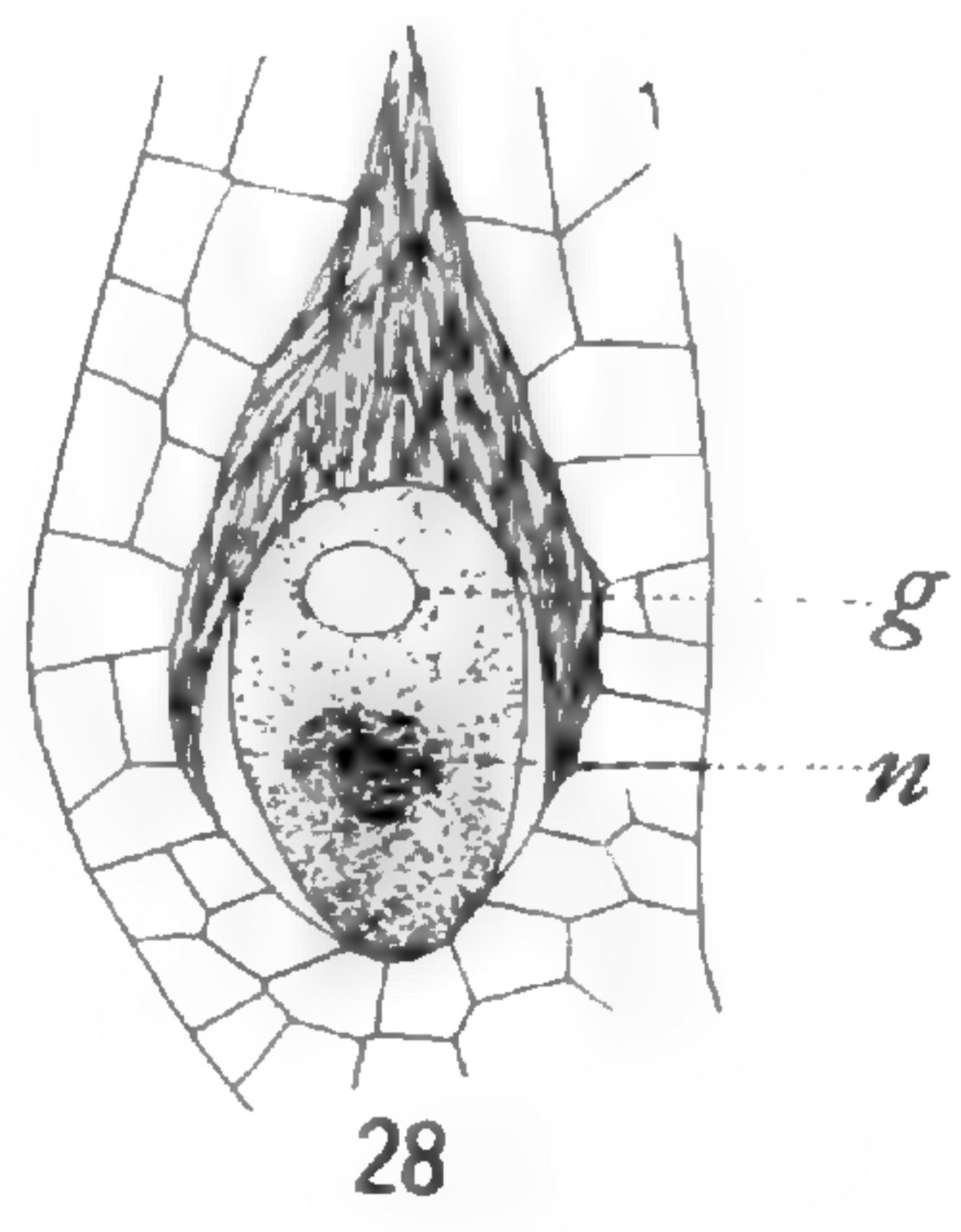
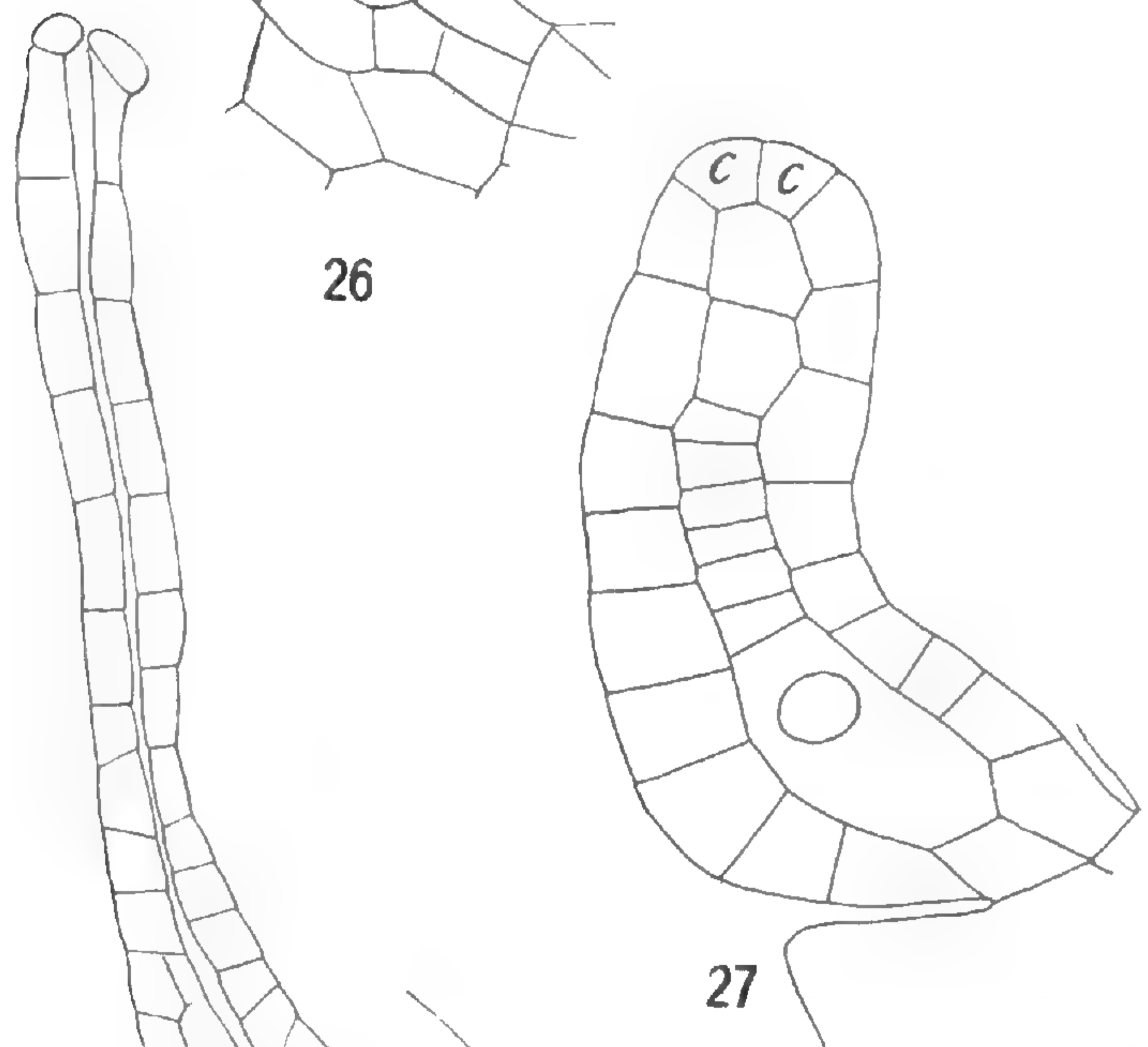
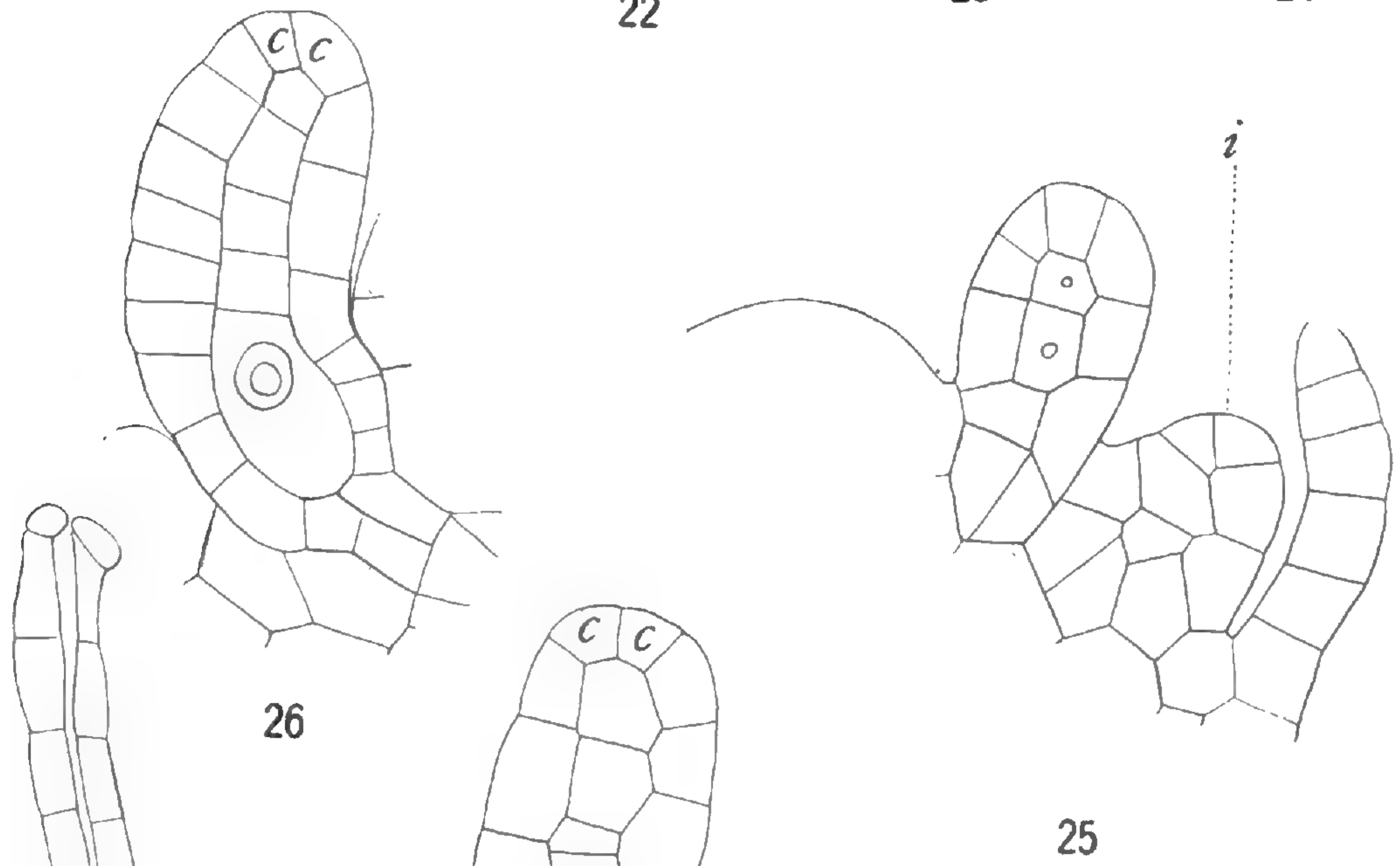
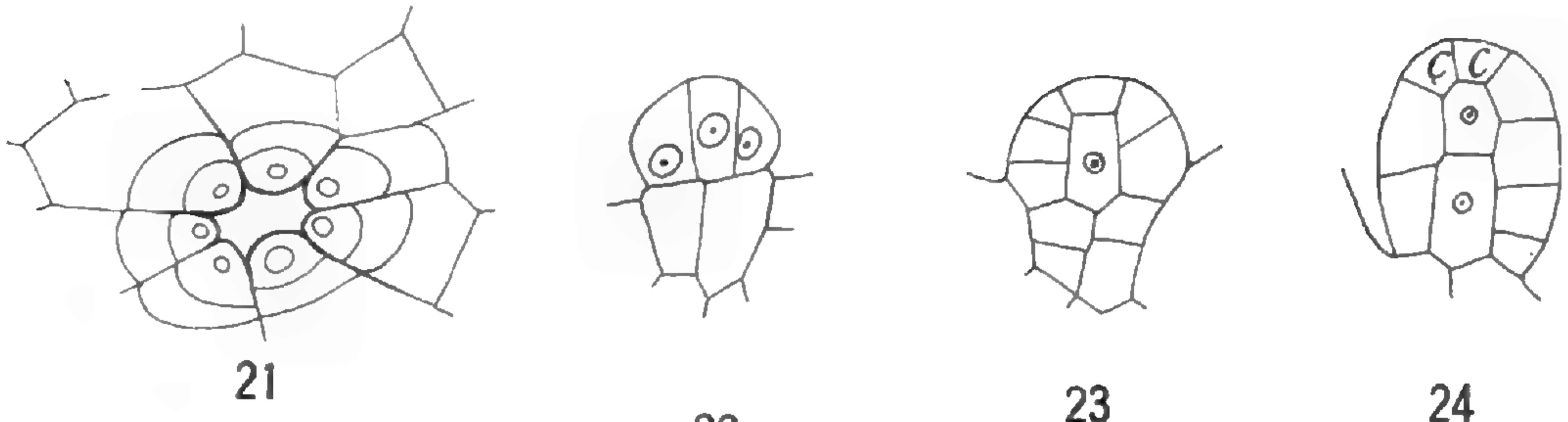

STARR on AYTONIA



## NOTES ON SUCCESSION FROM PINE TO OAK

BARRINGTON MOORE . . .

Recent developments in the study of vegetative succession have changed ideas about the factors causing pine forests and oak forests. Formerly, even after the advent of the dynamic point of view, pine was supposed to grow only on sandy soils and oak only on soils containing clay. Now there is a strong tendency to consider pine as merely an earlier stage in the evolution from simpler associations to the climatic climax of the region, though the effect of the soil in hastening the process of evolution is recognized. The work in the region of the Great Lakes, particularly south of Lake Michigan,<sup>1</sup> has done much to bring this about. The ideas developed by these and other workers are widely disseminated through the literature dealing with vegetation and environment. But TAYLOR<sup>2</sup> has lately found, on the strength of geological facts which geologists admit are incontrovertible, and of phytogeographic evidence which appears at least convincing, that the pine barrens of New Jersey are not a new, but a very ancient, vegetation.

The attitude toward pine forests, therefore, may have to undergo revision. This does not mean necessarily that the work of COWLES and his associates is in error, but that possibly their conclusions have been too widely applied. It must be remembered that our knowledge of the factors which influence plants, especially of the

<sup>1</sup> COWLES, H. C., The physiographic ecology of Chicago and vicinity; a study in the origin, development, and classification of plant societies. *BOT. GAZ.* 31:73-108, 145-182. 1901.

———, The causes of vegetative cycles. *BOT. GAZ.* 51:161-183. 1911.

WHITFORD, H. N., Genetic development of the forests of northern Michigan; a study in physiographic ecology. *BOT. GAZ.* 31:289-325. 1901.

FULLER, G. D., Evaporation and plant succession. *BOT. GAZ.* 52:193-208. 1911.

———, Evaporation and soil moisture in relation to the succession of plant associations. *BOT. GAZ.* 58:193-233. 1914.

LIVINGSTON, B. E., The relation of soils to natural vegetation in Roscommon and Crawford counties, Michigan. *BOT. GAZ.* 39:22-41. 1905.

<sup>2</sup> TAYLOR, NORMAN, Flora of the vicinity of New York. *Mem. N.Y. Bot. Garden* 5: 1915, especially pp. 8-25.



physics, chemistry, and bacteriology of soils outside of cultivated lands, and of the response of plants to their environment, is yet in a very rudimentary stage. Hitherto the tendency has been to consider one or two factors as an integration of many others, and to measure quantitatively only these two. For example, evaporation has been measured as an integration of all climatic factors, and soil moisture as an integration of all soil factors. It would not be surprising, therefore, if future progress should reveal some important factor which had been unavoidably overlooked. In view of the present uncertainty concerning the relation between pine and oak, the following notes on the pine and oak of Long Island may be of interest. They are based only on observation, without quantitative measurements, and lay no claims to definite conclusions.

The locality in which these observations were made is that part of the outwash plain about four miles east of Hempstead and four miles south of Hicksville. Here are found a number of different kinds of forests: a small body of pitch pine (*Pinus rigida* Mill.), practically untouched except for the usual fires, stands of mixed oak and pine, an oak forest, and more stands of pine. On this small area of not over 80 acres are exhibited more interesting problems than it has ever been the writer's good fortune to see on an area of the same size.

The first piece of forest which attracts attention is the body of pitch pine in its natural condition except for fires. The stand is composed of pure, even-aged pine, much damaged by fire. The trees, though about mature, as indicated by the flattening crowns, are only about 12 inches in diameter at breast height, by about 30 feet high. The understory is predominantly scrub oak (*Quercus nana* Sarg.), which is dense where the pine is open, diminishing where the canopy is more complete. In the scrub oak is a scattering of white oak (*Q. alba* Linn.), scarlet oak (*Q. coccinea* Moench.), black oak (*Q. velutina* Lam.), and post oak (*Q. minor* [Marsh.] Sargent). These oaks do not reach up into the main canopy and are short and limby. There was no pine reproduction, probably on account of the fires; fire-killed pine seedlings were found, and it is likely that many more had been entirely consumed.



The soil is a light brown, pebbly sand of coarse texture, with the upper 2-3 inches darkened by humus. The glacial origin of this soil is attested by the planed surfaces of the pebbles. In one place where the pine bordered an open field, a small piece, not over 50 by 100 feet, had been clear-cut sometime ago, perhaps 15 or 20 years. Here the ground has been taken possession of by aspen, on the field edge of which is a little gray birch (*Betula populifolia* Marsh.), considerable white oak and black oak, and a little post oak; scrub oak is mixed thickly with the aspen. The soil here was found to contain a considerable amount of clay or fine silty material.

That the clay or fine silty material is the cause of the aspen cannot be stated definitely, for the pine was there before the aspen, and might again take possession, as shown by pine seedlings on spots which had escaped fire. Furthermore, in another part of the forest, where the pine formed a fairly full stand except for occasional small openings made by trees which had been weakened by fire and then killed by insects, occur young aspen, gray birch, and sycamore (*Platanus occidentalis* Linn.). The soil here, at least down to 10 inches in depth, is the same coarse sand without clay as was found under the other parts of the pine forest; but, owing to the closer canopy of pine, there was a better mulch of needles, and a considerable quantity of humus in the first 4 inches of soil. It might be deduced that the extra mulch and humus here served the purpose of the clay, but it is dangerous to jump at conclusions from such observations. Clay might lie at various depths, being near enough to influence the vegetation in some places and not in others. Clay 2 feet below the surface would be sufficient to account for this second case of aspen and other deciduous trees. Judgment in this case must be withheld, therefore, until after further investigation.

Not far from this first body of pine, separated from it by a cultivated field, we find an open stand of pitch pine in which are scattered mature white oak trees, the understory being scrub oak. The white oak appears to be about the same age as the pine, but less numerous. The original stand, before fires became so frequent, was probably chiefly pine with a scattering of white oak. Here is what might appear at first sight to be an indication of



succession, the oak replacing the pine; but the soil, though still a coarse sand, has a distinct trace of clay which could account for the presence of the oak.

A short distance from the pine and scattering oak just noticed, we find an open stand of short limby white oak with an occasional pitch pine. There is an understory of scrub oak, which is, however, far less dense than on the areas where the pine predominates. To all appearances this could be another stage in the succession from pine to oak, a stage somewhat later than the one noticed just previously, for here the oak predominates instead of the pine, while the pine now occurs only sparsely, as the oak had done in the other place. This idea finds support in the first examination of the soil, which proves to be the same coarse sand as that found under the first forest of pure pine; but deeper digging shows that only the first 6 inches are sand, while below the sand is clay. This clay amply accounts for the presence of the oak, and probably the surface layer of sand accounts for the scattering pine.

Adjoining the white oak and scattered pine just described is a typical oak forest. The trees are scarlet oak and white oak, chiefly the former, with a little black oak, an occasional small hickory, and in certain parts of the forest a little chestnut oak (*Quercus prinus* Linn.). There is no chestnut (*Castanea dentata* Marsh.). One old pitch pine (probably about the same age as the oaks) and a pine stub, which could easily have been taken for relicts of a former pine forest, were seen. There is also a little pine reproduction which probably will not come up unless the canopy is opened.

The soil on which this oak forest is growing consists predominantly of clay or fine silty material. While not a very heavy soil, it was clearly one of moderately high moisture-retaining capacity. The precise nature of the differences between this soil and the coarse sand on which the pure pine was found cannot of course be stated without thorough analysis, but it is sufficiently clear that decided differences exist. This soil, so far as could be determined, strongly resembles that under the forest of oak with scattering pine, except that it lacks the surface layer of sand. It is significant that the layer of sand ends where the typical oak forest begins.



In this case, at least, the conclusion appears unavoidable that the occurrence of pine and oak is attributable largely, if not primarily, to the occurrence of distinctly different soils. This does not mean that the factors tending to bring about a succession from pine to oak are absent, but merely that these factors appear in this case to be distinctly subordinate to the character of the soil. Only the most thorough quantitative investigation can begin to unravel all the factors involved, and final conclusions cannot be expected until further progress has been made in the sciences on which the investigation must be based, particularly in plant physiology and in physics, chemistry, and bacteriology of soils, all of which deal with the phenomena which go to make up the vegetative cover as we find it.

There is in this same locality another kind of succession, different from the physiographic one<sup>3</sup> above referred to; this is a succession started by the interference of man.<sup>4</sup>

At the edge of the oak forest above described was found a patch of young pitch pine about 20 years old. The soil proved to be more gravelly than under the oaks, but with still a considerable proportion of clay or fine silty material. It might appear offhand from this that the clays do not necessarily support oaks; but the true explanation fails to corroborate this idea, and is very simple. Further examination revealed old, almost obliterated furrow marks, showing that this land had formerly been cleared and cultivated. That it originally supported oak was indicated by a strip of oak standing between the pines and a field still used for growing hay, and still further by a sharp line of demarcation between an old forest of oak and the young pine. There is but little scrub oak among the pines, and the better oaks, scarlet oak, black oak, and white oak, are coming in on the edges. It is obvious, therefore, that the pine is merely a temporary cover which has taken possession of the land after the oaks had been completely cleared off (not merely clear-cut), and the land later abandoned. If further evidence that pine is a forerunner of the forest on cleared and

<sup>3</sup> COWLES, H. C., A textbook of botany. Vol. II. Ecology, p. 940. New York. 1911; also citations under note 1.

<sup>4</sup> ———, *op. cit.*, p. 958.



abandoned land in this locality were needed, it is furnished by a few seedlings of pine in the neighboring hay field.

The indications are that this entire locality was once covered with pine, and that on the better soils (those with more clay) the pine soon gave way to oak. Unquestionably the oak stage was reached on these better soils many years ago, probably not long after the oak forest had become established on the near-by hills to the north. But when, through the interference of man, the oaks are completely destroyed, as in clearing land for farming, and when the land is again abandoned, pine takes possession. The reason is probably to be found in the more rapid methods of seed dissemination possessed by the pine as compared with the oaks. This would account for the presence of gray birch, and occasionally aspen, on lands beginning to revert to forest.

When the forest is cut for wood, and the stumps are left to coppice, the pine has another but far less favorable opportunity to establish itself. From observations on other areas, it seems that after cutting, provided no fire occurs, a considerable number of pine seedlings come in, but with a few exceptions are unable to develop on account of the more rapidly growing oak sprouts. The exceptions are probably seedlings which happen to grow in larger openings among the sprouts, or near old stumps which fail to sprout. Such exceptions readily account for the pines which, as noted above, might have been considered as relicts in the oak forest; for this forest, or rather the generation preceding it, had unquestionably been cut over for wood some 50 years ago.

It is evident then that we have here two forms of pine forest: (1) a temporary form which will be replaced by an oak forest in a comparatively short time, roughly 150-300 years or possibly longer, depending a great deal on the size of the area; and (2) another form of which much less is known. The temporary form occurs on soils containing clay; the other form on sands. The question is: Will this second form occurring on sands be replaced by oaks through an amelioration of edaphic conditions brought about by the pine forest itself? The tendency, on the strength of all the quantitative investigations of the subject to date, would be to answer yes. Such an answer would be most unfortunate in creating a bias in



future investigations; and it is just this feature of the situation which needs emphasis. Conclusions from one locality should not influence investigations in another locality, except in creating a desire to test the conclusions. The answer should be: We do not, and cannot, know until after thorough quantitative study of all factors which so far as now understood may have a bearing on the question.

Meanwhile, until such an investigation is made, several features of the situation, so far as they can be determined by observation without detailed study, may be noted. It is conceivable that, if conditions were left undisturbed for a sufficient length of time, the pine would, by a gradual accumulation of humus, render the soil favorable to the oaks,<sup>5</sup> which would then crowd out the pine. But in nature, conditions, at least in forests, are never left undisturbed indefinitely, for if man does not start fires lightning will, and fire tends to produce a deadlock between the pine and the oak. It favors the oak against the pine in that the oak seedlings which are killed can come up again from sprouts, whereas the pine seedlings cannot. On the other hand, it favors the pine against the oak by destroying the physical conditions, especially the litter and humus,<sup>6</sup> favorable to the oak. The result is that a worthless form of oak, the scrub oak (*Quercus nana*), which both is fire-resistant and can grow on sandy soil, takes possession of the ground. Above the scrub oak is seen an occasional pine or an oak, most frequently a white oak, owing to its greater power of fire-resistance.

It might be noted here that the scrub oak, owing to its dense habit of growth, protects the soil against leaching out, as well as serving as an excellent accumulator of humus. It appears to be analogous to the snowbrush and manzanita in the northern and central Sierras of California. These species and their associates, which should not be confused with the true chaparral farther south, form a dense cover of brush about 4–8 feet high, which keeps the soil and lower atmospheric strata favorable for the establishment

<sup>5</sup> By oaks is meant the forest-forming species, not the scrub oak (*Quercus nana* Sarg.).

<sup>6</sup> It has been found by R. C. HAWLEY by quantitative experiments that repeated fires actually burn not only the surface mulch, but the humus which is in the soil.



of the white fir (*Abies concolor*). This tree, owing to its ability to endure shade, persists under the brush, eventually forces its way through, shades out the brush, and reestablishes forest conditions. The difference is that the region in question possesses no trees as tolerant of shade as the white fir. At the same time, the scrub oak is never as dense as the Sierra brush, and offers in between clumps openings in which the pine or better oaks can come up. The pine, owing to its wider area of seed dissemination, has more opportunity than the oaks to take advantage of these openings, provided seed trees remain. On the other hand, the oak, when once it starts, stands a better chance of becoming established on account of its power to sprout after being killed by fire.

The foregoing, though by no means covering the whole case, seems sufficient to show that the problem of succession so far as pine and oak are concerned is extremely complex. It is of the utmost importance that each case be considered by itself. So many complex and interacting factors, such as the previous history of the region (as emphasized by TAYLOR), the surrounding vegetation, and the soil and moisture conditions, enter into each case that the conclusions of one locality may be wholly misleading when applied to another locality only a few miles distant.

NEW YORK CITY



## THE PATHOLOGY OF ORNAMENTAL PLANTS

MEL. T. COOK

The rapid development of plant pathology in America has resulted in giving a far better understanding of the diseases of certain groups of plants than of others. While we find a rather extensive literature on diseases of field crops, fruits, and vegetables, we find a very meager literature on the diseases of ornamental plants.

In that period which preceded the rise of plant pathology the mycologists devoted their attention primarily to the study of the taxonomy, morphology, and life history of the parasite, and it must be admitted that the work of these men was superior in many ways to much of that which has come from the more recent students in the new school of plant pathology.

The treatment of plant diseases was the first real step in plant pathology following the work in taxonomic mycology, but with the advance of the subject it soon became evident that the plant pathologist should give a great deal of attention to the symptoms and progress of the diseases. This involves a knowledge of the physiology of both the host and the parasite, and also a knowledge of the chemistry of the plant and of the fungicides to be used.

The efforts of the plant pathologists were very naturally directed to those crops which produced food and clothing, and more especially to those crops which required a maximum amount of personal attention on the part of the grower. Consequently, we find a rapid advancement of the science in the studies of the diseases of fruits and vegetables, closely followed by studies on field crops, forest trees, and shade trees.

The apparent neglect of the diseases of ornamental plants is due to three causes: (1) most people do not look upon ornamental plants as being of economic importance; (2) many of the growers of ornamental plants have received little or no satisfaction from the plant pathologist and have therefore developed many methods which they frequently hesitate to make public; (3) the plant



pathologist frequently finds the work with ornamental plants unsatisfactory and complicated by physiological problems and difficulties which make the returns uncertain.

1. The growing of ornamental plants is of very great importance and involves millions of dollars annually. The most casual observer must be impressed by the large number of greenhouses in the vicinity of large cities, the great quantities of cut flowers displayed in city markets, and the fine plantings in public gardens and parks. To these must be added the private conservatories and gardens.

2. It is very evident that plant pathologists are not well informed concerning the diseases of ornamental plants and therefore cannot give as ready answers to the inquiries from the growers as they can to the growers of other kinds of plants, and for reasons stated in topic 3 find the study of diseases of ornamentals unsatisfactory. Furthermore, pathologists usually have all they can attend to in studying the diseases of fruits, vegetables, and field crops. The growers of ornamentals have many empirical rules for their work, some of which are very carefully guarded. However, when we find them mistaking fungus spots on leaves and stems for scale insects and treating their plants with insecticides when they should be treated with fungicides, we begin to realize that studies and publications along this line are very necessary.

3. This work falls into two divisions, outdoor and indoor plants. In the first of these we know very little beyond the treatments for chrysanthemum rusts and mildews, and a very few other diseases. The root diseases, which are carried back and forth between the greenhouses and the outdoor plots and which are frequently intensified by the fertilizers, present some of the most profitable lines of research. These problems very naturally blend to some extent into the seed bed and truck crop problems.

The indoor problems are by far the most complicated and the most difficult. Some of them are influenced by the character of the fertilizers, and by very slight variations in temperature, humidity, sunlight, and air currents. They are in many respects problems in physiology rather than pathology. It also occurs that two related varieties may require slightly different environmental conditions to protect them from the same parasite. However, many of the



problems of the greenhouses are comparatively simple, but require the service of trained men to bring about their solution. The difficulties in this work are also increased by the fact that many of the greenhouses are large instead of being properly partitioned into smaller apartments, and that numerous varieties of plants are kept in single large apartments. It will be readily seen that many of these problems merge into the problems involved in the growing of winter vegetables under glass.

There is a prevailing belief in many places that plant pathology must be confined to the agricultural colleges and experiment stations. But here is a line of investigation which can be carried on to advantage by other institutions, many of which are much better prepared to do the work than are the agricultural colleges and experiment stations. Many of our large universities are located in or near large cities and can get in close contact with ornamental plant industry; they can choose their own lines of work instead of such lines as may be dictated to them by the constituency of the agricultural colleges and experiment stations; they are frequently provided with far better mycological collections than are found in the above-named institutions; they have good corps of workers in taxonomy, morphology, and physiology, and are well prepared to investigate the various phases of the problems involved. If these institutions feel the necessity of giving a comprehensive course in plant pathology, they will find an abundance of material in the orchards and truck farms of the vicinity and in the local fruit and vegetable markets for every phase of work except the treatment of diseases. There is still another phase of the work which must prove very interesting and profitable to the departments of botany in our large universities, and that is the study of the fungi which are brought in on tropical plants and which persist unknown to many of our northern botanists.

RUTGERS COLLEGE  
NEW BRUNSWICK, N.J.



## BRIEFER ARTICLES

EDWARD LEE GREENE

(WITH PORTRAIT)

In the passing away of Dr. EDWARD LEE GREENE we have lost one of our most eminent botanists. As a correspondent writes: "A gap is thus made in the ranks of American botanists that can never be filled. His investigations during his long period of activity have added greatly to the knowledge of North American plants." His death occurred

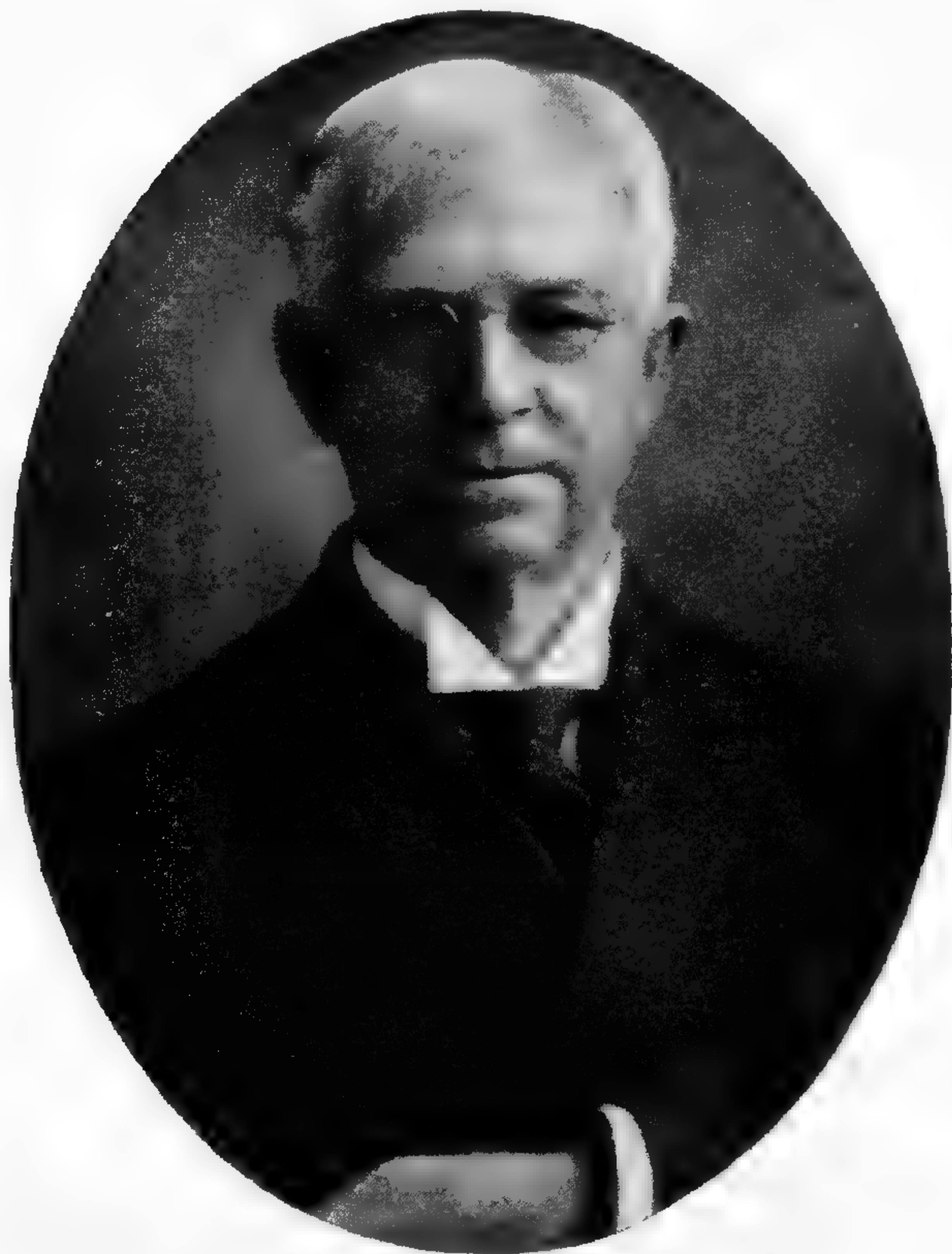

*From photograph by Bachrach, Washington, D.C.*

in Providence Hospital, Washington, D.C., November 10, 1915, after a long illness. He was born in Hopkinton, Rhode Island, in 1843, and was therefore seventy-two years old at the time of his death. He graduated from Albion College, in Wisconsin, in 1866, and was educated for the ministry, being for fourteen years an Episcopal clergyman. In 1885, however, he gave up his parish and joined the Catholic church. From 1885 to 1895 he taught botany in the University of California. From 1895 to 1904 he was professor of botany in the

Catholic University of America, at Washington, D.C.; and from 1904 until his death was associate in botany in the United States National Museum. He served his country during the Civil War and was a member of the Grand Army of the Republic.

For many years he was simply a collector of plants, sending his specimens to others to name or describe, although occasionally he sent



short notes to botanical publications, one of which was published in this journal as early as 1876. About 1888 he began to write extensively, describing especially new genera and species, and this he continued without interruption until the time of his death. The number of species which he has described may safely be estimated at considerably over 3000.

For many years he was a vigorous advocate of nomenclature reform, and while many of his ideas were good, he was always considered radical and he had few if any disciples. He had extreme views on the limitations of species, which led someone to describe him as a second RAFINESQUE, a sobriquet which sometimes pleased and sometimes irritated him, depending on his mood. He was indeed a man of many moods and fancies; was often shy but never timid; always had many friends and many enemies. He was egotistical, sometimes to the point of being ludicrous, and yet to many of us who knew him well he was always a delight and an inspiration. He was fond of music and cards, was a charming host, and a welcome guest in many homes. He lived a quiet life, usually alone with his pets, often doing his own cooking and housework. He was wont to take long walks alone in the fields and woods. In early life he tramped over a good part of Colorado and California in search of rare plants. He loved plants for their own sake and grew many of the wild flowers in his garden. He was a keen observer, and as he was so familiar with plants in their native haunts, his observations and conclusions were always worthy of consideration.

DR. GREENE'S education had been thorough, his knowledge of the classics profound, and of the early botanical writers simply marvelous. His botanical writings, while extensive, were chiefly made up of short papers. He preferred to write strong forceful reviews, to monograph small genera, or to publish a few pages of new species. His early papers on the botany of the Pacific Islands are little gems. He delighted in coining original and striking generic names, like *Lilaeopsis* and *Ibervillea*; he was original in everything he did. His style was often quaint, but pure. The names of his publications were often unique and have often been imitated. His full bibliography would fill several pages of this journal. This will doubtless be prepared and published later; but his most important works were *Pittonia*, a series of papers relating to botany and botanists (five volumes); *Leaflets* (two volumes); *The West American oaks*; and *The landmarks of botanical history*. His "Carolus Linnaeus," an address delivered on the two-hundredth anniversary of the birth of LINNAEUS, is one of his best short papers. In December, 1914,



he began a new serial, *Cybele Columbiana*, but only one number appeared. His name is commemorated in the genus *Greenella* and in many specific names.—J. N. ROSE, *Smithsonian Institution, Washington, D.C.*

## THE POLLINATION OF ASCLEPIAS CRYPTOCERAS

(WITH ONE FIGURE)

*Asclepias cryptoceras* is one of the largest flowered asclepiads of the Rocky Mountain region, and although it has a large range over Colorado, Utah, Wyoming, and Idaho, it is seldom common. It is not easily for-



gotten when once seen growing on a loose, barren hillside, with its deep red and pale green flowers, with their wonderful fragrance and bizarre form, resembling nothing so much as a jewel in a setting. Because of this peculiarity of structure I propose the vernacular name of "jewel milkweed" as being appropriate. The unusual form is of course due to peculiar insect relations.

The general mechanism of a milkweed flower is well known and a brief recapitulation is all that is necessary here. The asclepiadaceous flower appears externally to consist of the usually reflexed petals and sepals and of the so-called "column," which is surrounded by five "hoods" out of which usually arise five hornlike processes. Between the hoods and on the side of the column are five slits which are usually wedge-shaped, having the larger and open end toward the bottom of the column. The small black bodies which are visible externally at the upper end of the slits are known as corpuscula, and to them are fastened by means of hidden bands the adjacent pollen masses or pollinia of two neighboring anther cells, one on either side of the slit. A corpusculum may be likened to a paper clip and has a wedge-shaped opening on the lower end.



In order that an insect may effect pollination it is necessary for it to wedge its foot in the slit of the column when climbing about over the flower or scrambling to reach the nectar in the hoods. This is usually not a difficult thing to do, and when once it is caught a sharp pull is necessary to extricate the foot. When the insect is free we find, if we examine its leg, a corpusculum firmly fastened to it by means of the cliplike arrangement, and to the corpusculum we find the pollinia attached. If the insect now goes on with its work of gathering nectar, it is usually not long until it is again caught in the slit. This time it draws into it the pollinia previously obtained and with another vigorous pull it breaks the bands connecting the pollinia with the corpusculum and escapes. The pollinia left in the slit are now in contact with the stigmatic surface. By these processes pollination is effected.

The jewel milkweed differs from the typical asclepiad in several important respects. The flowers are nodding instead of erect, and, as a direct adaptation to this, the hoods are closed except for a small opening at the apex; the horn is small and included or hidden within the hood; the lips of the slit are firmly closed, and instead of offering an easy entrance to their trap seem to make the entrance difficult. In many kinds of milkweed the hoods and the upper part of the column are borne on a pedicel several millimeters in length. The hoods are sessile in *Asclepias cryptoceras*.

The pollination of the jewel milkweed, in southwestern Colorado at least, is apparently accomplished by only one species of insect, a huge bumblebee (*Bombus Morrisoni* Cressn.).<sup>1</sup> This huge bee is a full match for the large flower, yet it has a rather difficult time obtaining the nectar. Since the flowers are nodding and since the pedicel is absent, there are no footholds offered, and the bumblebee must continually scramble to keep its position. The hoods guide its feet to the slits, and the bee forces them open, and in order to free itself loosens the corpusculum and drags out the pollinia firmly fastened to its feet. When they dry they are in a convenient position to enter the next slit that chances to open in the bee's scrambling for a foothold.

The fragrance of the flowers is so intense that one would imagine many insects would be attracted, yet such is not the case. In my observation of this plant during the spring of 1914 in southwestern

<sup>1</sup> My thanks are due Professor COCKERELL of the University of Colorado for the determination of this species.



Colorado, I saw but few insects visiting the flowers except the species of bumblebee mentioned. Occasionally a fly or a bee would alight on them, but was capable neither of obtaining nectar nor of dislodging the pollinia. The bumblebees, however, on warm spring days, were actively at work on them; there was no hesitation in their work; they knew where the honey was stored and how to get it. I found pollinia and corpuscula attached to the legs of all bumblebees I caught on *Asclepias cryptoceras*.—  
EDWIN PAYSON, *University of Wyoming, Laramie, Wyo.*



# CURRENT LITERATURE

## BOOK REVIEWS

### Mesozoic plants

The present contribution<sup>1</sup> is a continuation of the admirable catalogues of mesozoic plants, published from time to time, by the authorities of the British Museum. One notes with pleasure in the 350 odd pages and over 30 plates that the anatomy of the forms discussed is somewhat fully dealt with. Excluding algae and fungi, which have been described in a previous volume, the authoress begins with the ferns, the most interesting of which is the genus *Tempskya*, illustrated mainly from the Russian species *T. rossica*, recently figured for both habit and anatomy by KIDSTON and GWYNNE-VAUGHAN.

The Cycadophyta are represented by species of *Bennettites*, *Cycadeoidea*, and a new genus *Colymbetes*, all showing vegetative structure and anatomically illustrated. *Cycadeoidea* and *Colymbetes* are of great interest because they manifest the reduplication of the vascular ring so common in living cycads, but hitherto not described for *Bennettites* and its allies.

In the case of the conifers, a number of woods as well as a few twigs and cones are described. In the course of her descriptions of woody coniferous structures, the writer devotes herself frequently to somewhat caustic criticisms of the reviewer's anatomical publications on mesozoic conifers. Significantly enough she describes no araucarian woods for the Greensand. These important conifers seem to have had practically no anatomical representatives in the Lower Cretaceous and the Jurassic, an interesting fact for those who accept the orthodox view that the conifers have originated from the Cordaitales through the araucarian line. Dr. STOPES's interesting if not convincing point of view can perhaps as well be illustrated from her references to the genus *Sequoia* of the Mesozoic, as otherwise. Dr. HOLLICK and the reviewer have brought forward anatomical evidence from the study of correlated external form and internal organization that the supposed sequoias of the American Mesozoic are in reality araucarian conifers, and do not belong at all to the genus which they superficially simulate. Dr. STOPES admits that our material is not *Sequoia*, and this is at first sight an indication of rare and pleasing open-mindedness, but we are surprised to learn that the mesozoic remains universally included under *Sequoia* and *Geinitzia* by competent American systematic paleobotanists are in reality wrongly referred to those genera and do not cor-

<sup>1</sup> STOPES, Dr. MARIE, British Museum catalogue of mesozoic plants. Part 2. Lower Greensand (Aptian) plants of Britain. London. 1915.



respond with the similar European forms. This attitude appears to be of very dubious value indeed, in view of the completeness of the agreement never before questioned between the American genera and even species and those of Europe as long recognized by distinguished students of both floras. This position in regard to American supposed mesozoic sequoias and their European counterparts is not the less surprising in view of the meagerness and bad state of preservation of her material, in contrast to the abundance and perfection of that from American deposits.

The volume closes with anatomical descriptions of the woody dicotyledonous genera *Cantia*, *Woburnia*, *Sabulia*, *Hythia*, and *Aptiana*, which present no feature of interest beyond vouching anatomically for the presence of the dicotyledons in the early Cretaceous.—E. C. JEFFREY.

### Hydrogen ion concentration

MICHAELIS<sup>2</sup> is the author of the first of a series of *Monographs on plant and animal physiology*. The series, which is edited by CZAPEK and PARNAS, is to bear somewhat the same relation to its realm as the well known *Monographs on biochemistry* bear to their more restricted field. Many of the proposed numbers promise to be of the greatest interest to plant physiologists. The present volume deals with hydrogen ion concentration, its significance in biology, and the methods for measuring it. In the introduction the author points out the importance of the "actual" reaction of the medium in determining the course of chemical changes in organisms, and cites instances of the misinterpretation of experimental results due to failure to consider this factor.

The monograph is divided into three parts. In the first the theoretical significance of hydrogen ion concentration is discussed. Following a development of the general principles and formulae for the dissociation of water, acids and bases, and amphoteric electrolytes, these are applied to the special cases of proteins and enzymes. By combining the results of experiments on the influence of hydrogen ion concentration on enzyme activity, and the results of transfer experiments on the same enzymes, some interesting conclusions are drawn as to the chemical nature of the enzymes studied. Invertase, for instance, is considered an amphoteric electrolyte of which only the undissociated part of the "invertase acid" is effective, and only the cations of pepsin are effective in hydrolyzing proteins.

The second part of the monograph is a statement of present knowledge as to the hydrogen ion concentration at which physiological processes go on in organisms, the variations of this factor that occur, and the means the organism possesses for regulating the acidity of its body fluids. In general, if a body fluid is characterized by a specific enzyme, the hydrogen ion concentration of the fluid corresponds to the optimum for that enzyme. The variations are

---

<sup>2</sup> MICHAELIS, L., Die Wasserstoffionenkonzentration, ihre Bedeutung für die Biologie und die Methoden ihrer Messung. Berlin. 1914.



usually small. The reaction is regulated by the salts of weak acids and bases present, and by the removal of acids by the lungs and kidneys.

The methods for measuring hydrogen ion concentration are taken up in the third part. Those based on the measurement of reaction velocity are omitted, as they are practically useless in biological work. The gas chain method is treated very thoroughly from the theoretical and practical points of view, and the formulae and tables given make the book an excellent laboratory guide for carrying out these measurements. The discussion of the indicator method is somewhat less complete. Methods for preparing solutions of a definite hydrogen ion concentration, a method for carrying out transfer experiments with colloids, and a complete bibliography are appended.

The work done in this field has been limited almost entirely to animal processes. Undoubtedly this factor is of importance in the plant as well, and investigations in this direction should furnish valuable additions to our knowledge of plant processes.—THOMAS G. PHILLIPS.

### NOTES FOR STUDENTS

**Current taxonomic literature.**—O. AMES (Philipp. Jour. Sci. Bot. 9:11-16. 1914) under the title "Orchids of Guam" has published 8 new species.—H. ANDRES (Oesterr. Bot. Zeits. 64:232-255. 1914) in continuation of his studies on the Pirolaceae records further important data on this group.—G. ARNAUD (Bull. Soc. Myc. France 30:355-360. pls. 17-19. 1914) in an article discussing the genus *Henriquesia* characterizes a new genus (*Castagnella*) of the Dothideaceae, which is found on branches of *Quercus coccifera*.—E. G. BAKER (Jour. Linn. Soc. 42:241-246. pls. 9-14. 1914) gives a synopsis of the "African species of *Crotalaria*." The author recognizes 309 species, several of which are new to science.—I. W. BALFOUR and W. W. SMITH (Notes Roy. Bot. Gard. Edinb. 8:191. 1914) have published a new genus (*Kingdonia*) of the Ranunculaceae from China.—H. H. BARTLETT (Cybele Columbiana 1:37-56. pls. 1-5. 1914) characterizes 12 new elementary species of *Onagra*.—O. BECCARI (Webbia 4:293-385. 1914) under the title "Studio sui Borassus" includes the description of a new genus of palms (*Borassodendron*) based on *Borassus Machadonis* Becc. from the Malayan Peninsula.—R. E. BENEDICT (Bull. Torr. Bot. Club 41:291-410. pl. 20. 1914) presents a revision of the genus *Vittaria* in which 7 species are recognized, 2 being new to science.—A. BENNETT (Philipp. Jour. Sci. Bot. 9:339-344. 1914) records one new species of *Potamogeton* and a new hybrid from the Philippine Islands.—A. BÉQUINOT and N. BELOSERSKY (Atti de' Lincei.—Mem. Cl. sc. fisiche ecc. Ser. 5<sup>a</sup>. 9:595-734 [1-144]. pls. 1-12. 1913) have published a monographic revision of the genus *Apocynum*, recognizing 26 species of which 4 from the eastern United States are described as new.—E. P. BICKNELL (Bull. Torr. Bot. Club 41:411-427. 1914) in continuation of his studies on the flowering plants of Nantucket includes the Clethraceae, Pyrolaceae, and Ericaceae. New species are recorded



in *Hypopitys* and *Vaccinium*.—G. BITTER (Abh. Nat. Ver. Brem. 23:114–163. 1914) in continuation of his studies on the Solanaceae describes a new species of *Grabowskia* (*G. Sodiroi*) from Ecuador.—J. W. BLACK (Trans. & Proc. Roy. Soc. S. Australia 37:1–5. pl. 1. 1913) describes and illustrates a new genus (*Pectinella*) of the Potamogetonaceae, a salt water plant of Australia. The same author (*ibid.* 121–124. pls. 4, 5) under the title “Additions to the flora of South Australia” characterizes a new genus (*Griffithia*) of the Compositae.—S. F. BLAKE (Jour. Bot. 52:169. 1914) has published a new *Chimaphila* (*C. domingensis*) from Santo Domingo.—F. BOEDEKER (Monatschr. für Kakteenk. 24:52–55. 1914) describes and illustrates a new cactus (*Mamillaria Gürkeana*) from Mexico.—L. BOLUS (Ann. Bolus Herb. 1:20, 21. 1914) has described a new genus (*Pillansia*) of the Iridaceae, based on *Tritonia Templemanni* Baker of Cape Colony.—G. BONATI (Bull. Soc. Bot. Genève II. 5:297–316. 1914) has published several new species of the Primulaceae, Solanaceae, and Scrophulariaceae, and includes a description of a new genus (*Centrantheropsis*) of the last family.—F. BORGESSEN (Dansk Bot. Ark. 2:1–66. 1914) in an article entitled “The marine algae of the Danish West Indies. Part 2. Phaeophyceae” includes the descriptions of several new species and one new genus (*Rosenvingea*).—J. BRIQUET (Ann. Conserv. et Jard. Bot. Genève 11:326–403. 1914) under the title “Decades plantarum novarum vel minus cognitarum” has published upward of 50 new species of flowering plants mostly from Mexico and South America.—N. L. BRITTON (Bull. Torr. Bot. Club 41:1–24. 1914) under the title of “Studies of West Indian plants” has described 26 new species.—N. E. BROWN (Bull. Kew 1914, p. 156) has published a new species of *Chamodora* (*C. nana*) indigenous to Costa Rica. The same author (*ibid.* 168) records a new genus (*Metaporana*) of the Convolvulaceae from Africa, and (*ibid.* 208) describes a new species of *Cotyledon* (*C. paraguayensis*) from Paraguay.—F. BUBÁK (Bot. Közlemények 13:94–96. 1914) describes and illustrates a new genus (*Moesszia*) of the Hyphomycetes, found on leaves of the oak at Budapest, Hungary. The same author (Ann. Mycologici 12:205–220. pt. 8. 1914) under the title of “Beitrag zur Pilzflora von Tirol und Istrien” has described several new species of fungi and proposes the following new genera: *Basilocula*, *Cystodendron*, *Stigmopsis*, *Piricanda*, and *Verticilliodochium*.—B. F. BUSH (Am. Mid. Nat. 3:352, 353. 1914) has published 2 new species of *Antennaria* from Missouri.—E. J. BUTLER and A. H. KAHN (Mem. Dept. Agr. India 6:181–208. pls. 1–6. 1914) on “Some new sugar cane diseases” include the description of a so-called “collar rot” to which is given the scientific name *Hendersonia Sacchari* Butl.—J. CARDOT (Rev. Bryol. 41:37, 38. 1914) has described a new moss to which he gives the generic name *Philiber-tiella*; it is related to *Ditrichium*.—R. CHODAT (Bot. Jahrb. 52, Beibl. no. 115. pp. 70–85. 1914) under the title “Polygalaceae novae” has published 30 new species of *Polygala* of which about one-half are from Mexico, Central and South America.—C. CHRISTENSEN (Am. Fern Jour. 4:77–83. 1914) describes two new American species in *Dryopteris* and records further data toward his



monograph of this genus.—L. DAMAZIO (Bull. Soc. Bot. Genève II. 6:171–172. 1914) describes and illustrates a new fern (*Elaphoglossum Beauverdii*) from central Brazil.—C. DE CANDOLLE (Bull. Soc. Bot. Genève II. 6:107–126. 1914) describes new species in *Piper*, *Cabrlea*, *Gaurea*, *Cedrela*, and *Begonia* from Paraguay. The same author (Not. Syst. 3:38–44. 1914) has published several new species of *Piper* and *Peperomia*, including 4 from Mexico, and (Rep. Sp. Nov. 13:304–311. 1914) describes 16 additional species in these genera from Bolivia.—L. DIRLS (Philipp. Jour. Sci. Bot. 8:157–158. 1913) has published three new species of Menispermaceae from the Philippine Islands.—S. T. DUNN (Notes Roy. Bot. Gard. Edinb. 8:153–171. 1913) in an article entitled “Notes on Chinese Labiatae” describes several species new to science and proposes a new genus, namely *Parlamium*, based on specimens collected in Yunnan by Mr. HENRY.—A. ENGLER (Bot. Jahrb. 51:225–471. 1914) in cooperation with several specialists has published “Beiträge zur Flora von Afrika xliii.” Approximately 200 new species and varieties of flowering plants are described, and the following new genera are proposed: *Rhodohypoxis* Nel of the Amaryllidaceae, *Melliniella* Harms of the Leguminosae, *Gilglochloa* Pilger of the Gramineae, and *Neosloetiopsis* Engler of the Moraceae.—A. W. EVANS (Bull. Torr. Bot. Club 41:577–616. pl. 21. 1914) under the title “Report on the Hepaticae of Alaska” includes the description of two new species of *Plagiochila* and one of *Radula* from Alaska.—J. S. GAMBLE (Philipp. Jour. Sci. Bot. 8:203–206. 1913) under the title “Some additional bamboos of the Philippine Islands” records further data concerning this group of plants and adds a new species from Mindanao.—L. S. GIBBS (Jour. Linn. Soc. 42:1–240. pls. 1–8. 1914) under the caption “A contribution to the flora and plant formations of Mount Kinabalu and the highlands of British North Borneo” has published an important contribution to our knowledge of the flora of Borneo. Prominent specialists have cooperated in the identification of the plants and upward of 80 species are described as new to science. The following new genera are proposed: *Phyllocrater* and *Cowiea* Wernham of the Rubiaceae, *Sigmatochilus* Rolfe of the Orchidaceae, and *Lophoschoenus* Stapf of the Crepyaceae.—J. M. GREENMAN.

**Phenomena of parasitism.**—Differences in the behavior of *Monilia cinerea* and *Botrytis cinerea* are brought out by the studies of COOLEY and of BROWN. These fungi represent the two sections of the genus *Sclerotinia* the members of which have frequently furnished material for investigations designed to throw light on the phenomena of parasitism. While the apothecial organs of these fungi are much alike, their conidial fructifications are widely different; but more interesting from a biological standpoint is the difference in the mode of formation of sclerotia with which the contrasting behavior brought out in the two papers can perhaps be correlated. COOLEY,<sup>3</sup> who investigated the be-

<sup>3</sup> COOLEY, J. S., A study of the physiological relations of *Sclerotinia cinerea* (Bon.) Schröter. Ann. Mo. Bot. Gard. 1:291–326. 1914.



havior of *Monilia* (*Sclerotinia*) *cinerea* with reference to its parasitism, finds that the spores are incapable of infecting young green plums whose skin is uninjured, but that such fruits are easily attacked by grown mycelium applied to their surfaces. The ripening fruits, however, are readily infected through the unbroken skin by spores. The acidity of the fruit, the author finds, increases as ripening progresses. The fungous hyphae penetrate the fruit in all directions, but they do not follow the middle lamellae, nor is there a general disintegration of the host tissue due to the action of the fungus on the middle lamellae. From histological observations it appears that the host cells are not injured in advance of the penetrating hyphae. The observation that the juice of much decayed plums had no cytolytic action on the flesh of sound plums seems to be in accord with the observation on the action of the hyphae themselves, yet it can scarcely be doubted that if a sufficiently concentrated extract of the young mycelium had been prepared, more positive results would have been obtained, for, as the author himself states, it is probable that the juice was too dilute to be effective. Other objections to the use of the juice of decayed fruit are obvious. In agar tubes containing cellulose prepared from the plums by different methods, very slight action on the cellulose was observed, but filter paper cellulose was readily dissolved. In tubes containing pectin a coagulation was produced by *Monilia*, but in tubes containing suspensions of calcium pectinate without soluble carbohydrates the fungus made little growth and the pectinate was not hydrolyzed. In expressed fruit juices in which the fungus had grown, oxalic acid was found in small quantities, and also in peaches inoculated with *Monilia*, but not in others inoculated with *Penicillium* and *Aspergillus*. The fungus grows best in acid media.

BROWN<sup>4</sup> investigated the less strictly parasitic fungus *Botrytis cinerea*. By using large quantities of germinating spores, he was able to prepare extracts whose enzymatic activity was much greater than that of the extracts used by DEBARY, WARD, and others who investigated the cytolytic action of extracts of this or closely related species of *Botrytis*. The extracts prepared by BROWN brought about a rapid disintegration in the tissues of roots, tubers, fruits, leaves, and petals of various plants. Thin discs (1-1.25 cm. X 0.5 mm.) of potato, turnip, beet, apple, etc., were disorganized in 15-90 minutes. The tissues of bryophytes and filaments of algae appear not to be affected. The process of disorganization begins with solution of the middle lamella, as a result of which the tissue loses its coherence. Finally, the cell wall itself is disintegrated and the tissue is completely disorganized. The death of the cells does not take place until some time after the cells have been separated by the solution of the middle lamella. The activity of the extract is destroyed by heat and by shaking, the toxic action being destroyed simultaneously. When the extract was dialyzed by means of collodion thimbles, the dialysate showed

---

<sup>4</sup> BROWN, W., Studies in the physiology of parasitism. I. The action of *Botrytis cinerea*. Ann. Botany 29:313-348. 1915.



neither cytolytic nor toxic activity, nor did it contain any trace of oxalic acid or oxalates to which the toxic action of *Botrytis* extract has sometimes been attributed. The enzyme acts only in acid media. In neutral solution its activity is greatly retarded, and in slightly alkaline media the activity is inhibited. Here again the toxic properties of the extract are affected in the same manner as the cytolytic properties. The extract may be reactivated by the addition of acid to the neutralized or alkaline medium. From the impossibility of separating, by any of the means described above, the toxic and the cytolytic properties of the extract, the author is inclined to believe that both are due to the same substance or group of substances.

The most striking difference in the physiological behavior of these two fungi is seen in the extent of their cytolytic action. By reason of its greater virulence in this respect, *Botrytis cinerea* is adapted to live as a saprophyte on dead plant tissues poor in soluble carbohydrates, while *Monilia*, possessing the power of hydrolyzing cellulose only to a slight extent, is restricted in its existence to ripening fruits and other tissues rich in soluble sugars. Correlated with this difference in the mode of life of the two fungi is the method of production of sclerotia. The tissues invaded by *Botrytis* are completely destroyed, consequently the sclerotia are formed as well defined free bodies outside of the invaded substance, while in *Monilia* the sclerotia are formed within the mummified tissues of the host, which are sometimes involved in the process.—H. HASSELBRING.

**Notes on gymnosperms.**—THOMAS<sup>5</sup> has discovered the staminate strobilus of *Williamsonia gigas* from the Jurassic of Yorkshire. The strobilus consists of 18–20 microsporophylls united into a cuplike structure. THOMAS is inclined to believe that these sporophylls were not associated with the ovule-bearing region, but that they represent an independent staminate strobilus.

SAHNI<sup>6</sup> has discovered in the pollen chamber of some young ovules of *Ginkgo* certain winged pollen grains which are very different from those of *Ginkgo*. About a dozen such ovules were examined, and 8 contained these foreign pollen grains, characterized by prominent wings. Furthermore, not only did these ovules contain foreign pollen from as many as three distinct species, but one of the pollen grains was in an advanced stage of germination. The interesting suggestion is made that if a similar example were found in a fossil, "it would in all probability lead to a reference of the pollen grains and ovules to the same species." Since this has been done already, the caution is well taken.

---

<sup>5</sup> THOMAS, H. HAMSHAW, On some new and rare Jurassic plants from Yorkshire: the male flower of *Williamsonia gigas* (Lind. and Hutt.). Proc. Cambridge Phil. Soc. 18:105–110. pl. 6. figs. 2. 1915.

<sup>6</sup> SAHNI, BIRBAL, Foreign pollen in the ovules of *Ginkgo* and of fossil plants. New Phytol. 14:149–151. pl. 2. 1915.



PEARSON<sup>7</sup> has been studying the morphology of *Gnetum*, and has recorded some interesting observations. He finds four types of strobili in *G. Gnemon*, which constitute a sequence from the strictly monosporangiate to the bisporangiate condition. He also finds that the endosperm develops in many details as that of *Welwitschia*, especially in the multinucleate character of the primitive tissue. The nuclei in each "compartment" in the chalazal region fuse; while in the micropylar region there is no septation. It seems, therefore, that the primary endosperm of the two genera is alike in all respects. PEARSON sees in this endosperm a new structure which is neither sporophyte nor gametophyte, but which he designates as "trophophyte," and it is further suggested that the endosperm of angiosperms is a highly specialized form of this trophophyte. The interesting suggestion is made that the fusing polar nuclei of angiosperms may be morphologically the representatives of the fusing nuclei of *Welwitschia* and *Gnetum*.

BOODLE<sup>8</sup> has discovered concretescent leaves on a tree of *Pinus Laricio* growing in the Royal Botanical Gardens, Kew. These leaves are produced every year in considerable numbers. It is suggested that the double needles of *Sciadopitys* may be morphologically similar to those of *P. Laricio*, that is, they may represent two foliage leaves fused by their margins. The orientation of the leaves of the double needles of the Austrian pine, however, is not constant, cases being found with fusion by the adaxial margins, by the abaxial margins, and by obliquely placed leaves.—J. M. C.

**Endemic flora of Ceylon.**—In connection with the revision of his catalogue of the Ceylon flora, WILLIS<sup>9</sup> has reached some interesting conclusions in reference to geographical distribution and evolution. The conclusions are derived from the use of statistical methods and the classification of the Ceylon species into a series of six groups, graded from "very rare" to "very common." He observes that the rarest plants are local endemics, and the commonest are those of widest distribution. The conclusion is that "local endemic species have not been developed in any kind of advantageous response to local conditions." That the endemic genera should show greater rarity than do the endemic species as a whole cannot be explained by any such theory of adaptation. Graphically WILLIS' observations would "run in the exact reverse direction all through to that demanded by the theory of natural selection." A second conclusion is that on the average the commonness of the species depends upon its age locally, species developing "quite indifferently to local conditions, though possibly because of those conditions."

<sup>7</sup> PEARSON, H. H. W., Notes on the morphology of certain structures concerned in reproduction in the genus *Gnetum*. Jour. Linn. Soc. 43:55-56. 1915.

<sup>8</sup> BOODLE, L. A., Concretescent and solitary foliage leaves in *Pinus*. New Phytol. 14:19-22. figs. 4. 1915.

<sup>9</sup> WILLIS, J. C., The endemic flora of Ceylon, with reference to geographical distribution and evolution in general. Phil. Trans. Roy. Soc. London B 206:307-342. 1915.



WILLIS suggests that all Ceylon species have arisen as single mutations, and that subgenera and genera may arise similarly. Some of the endemics of Ceylon, which are and always have been very restricted, would indicate that the same mutation need not go on appearing in order to become established. However well a species may be locally adapted, it will be in great danger of extermination until it has gotten beyond the degree of commonness represented by "very rare." "Having reached the maximum height [in the scale of commonness] that it is going to reach, a species will ultimately descend, and will sooner or later become extinct, though there is no evidence that as yet many or any species are on the downward road." The statistical facts brought out "support very strongly the hypothesis that the whole tree of descent of a family may exist on the earth at the present moment, and that the area occupied is in general an indication of the age of a species or a genus, if it has not already attained its maximum."—MERLE C. COULTER.

**The mosaic disease of tobacco.**—ALLARD<sup>10</sup> has given an account of the mosaic disease of tobacco that will be of much interest to all who desire to become acquainted with the chief features of this interesting and destructive disease. The most characteristic external feature of the disease is a mottling of the leaf, due to partial chlorosis. The disease is communicable to a number of the Solanaceae, but appears to be distinct from the very similar mosaic disease of *Phytolacca*. The mosaic virus permeates all parts of the plant, but does not infect the embryo; hence seeds of diseased plants produce healthy individuals. The disease seems to be incurable and no plants of susceptible species seem to be immune. The origin and distribution of the disease are mysterious, and the author's experiments lead him to oppose the more commonly current theory that the disease is associated with unbalanced enzymatic activities and physiological toxins. ALLARD thinks that the disease is parasitic and that it is communicated from plant to plant by certain aphids. No organisms that might be responsible for the disease have yet been isolated. This disease seems to have the characteristics of infectious chlorosis, as described by BAUR.

Further studies of the mosaic disease, also by ALLARD,<sup>11, 12</sup> have to do with interesting special features. It is found that the dilution of the virus to 1 part in 1000 results in no impairment of infection, though dilution to 1 part in 10,000 results in an effective attenuation of the virus activity. While the

---

<sup>10</sup> ALLARD, H. A., The mosaic disease of tobacco. U.S. Bureau of Plant Industry, Bull. 40. pp. 33. pls. 7. 1914.

<sup>11</sup> ———, Effect of dilution upon the infectivity of the virus of the mosaic disease of tobacco. Jour. Agric. Research 3:295-299. 1915.

<sup>12</sup> ———, Distribution of the virus of the mosaic disease in capsules, filaments, anthers, and pistils of affected tobacco plants. Jour. Agric. Research 5:251-255. pl. 1. 1915.



virus does not permeate to the embryo if has been traced to the ovule integuments.—H. C. COWLES.

**Leaf anatomy of *Veronica*.**—The xerophytic, shrubby species of *Veronica* indigenous to New Zealand have long excited the interest of ecologists, and now they have been made the subject of a careful anatomical study by ADAMSON.<sup>13</sup> He investigated 39 species, the material being obtained from plants grown in England, although comparison was made with herbarium material. Most of the species are indigenous to the eastern part of the southern island where the rainfall and temperature are low and the wind high. While these species seem admirably fitted for life in such a climate, they show remarkably little plasticity in cultivation. Six ecological groups are recognized as follows: (1) with the large or elongated, not particularly xerophytic, leaves; (2) with leaves similar in aspect, but thick and leathery; (3) with small, spoon-shaped, somewhat xerophytic leaves; (4) with leaves similar in form, but much more leathery and often glaucous; (5) with leaves much reduced and either small and spreading or appressed and imbricate; (6) with leaves toothed and petioled. The most characteristic xerophytic structural features are reduction of leaf surface and of intercellular spaces and high cutinization. In some of the more xerophytic forms there are curved cuticular expansions arching over the stomata, forming an outer vestibule. Hydathodes, usually more characteristic of hygrophytes, are found in some of these species. In general, the increasing xerophytism noted in the first five groups above is correlated with increasing xerophytism of habitat, culminating in the famous whip-cord species, which show a striking resemblance to certain conifers.—H. C. COWLES.

**Upper cretaceous and eocene plants.**—Only the points of interest to botanists need be considered in this contribution by BERRY.<sup>14</sup> In the cretaceous flora the author describes a number of conifers and angiosperms. In the case of the former, he records his belief that the material identified by HOLLIICK and described anatomically by the reviewer as species of the recognized mesozoic *Sequoia*, do not in reality belong to this genus. This is a most interesting statement in view of the fact that some of the reviewer's specimens came from and were identified by BERRY himself. Dr. STOPES in her recent continuation of the catalogues of mesozoic plants of the British Museum, being in possession of some of the reviewer's material, admits that it does not belong anatomically to the genus *Sequoia*. There thus arises a very interesting situation indeed. What BERRY systematically identifies as *Sequoia* is according to Dr. STOPES anatomically not *Sequoia* at all. One wonders if the paleobotanists of the Mesozoic will be as slow to admit that they may be deceived by the external

<sup>13</sup> ADAMSON, R. S., On the comparative anatomy of the leaves of certain species of *Veronica*. Jour. Linn. Soc. Bot. 40:247-274. figs. 17. 1912.

<sup>14</sup> BERRY, E. W., The Upper Cretaceous and Eocene floras of South Carolina and Georgia. Professional paper 84, U.S. Geol. Survey. 1915.



form of their material as were formerly their confreres of the Paleozoic, who needed nearly a hundred years to recognize that many of the arboreal forms of the carboniferous forests were not seed plants but vascular cryptogams, a view long urged by the anatomists and finally admitted on every hand. The flora of the Middle Eocene of Georgia is chiefly interesting because of the fact that it clearly marks, in the opinion of the author, a warmer climate for that epoch than for the early Eocene.—E. C. JEFFREY.

**Phylogenetic taxonomy of angiosperms.**—Professor BESSEY for many years was interested in a phylogenetic scheme of classification, especially with reference to the angiosperms. In a series of papers he has developed his point of view, and his final paper was presented in connection with the twenty-fifth anniversary celebration of the Missouri Botanical Garden.<sup>15</sup> An interesting feature of the paper is the definite formulation of the principles of classification as applied to flowering plants. These principles are given in the form of 28 “dicta,” 7 of them of general application, and the remainder having special reference to flowering plants. These dicta announce the primitive and derived condition in reference to numerous structures, some of them generally accepted, and some of them under discussion. The author then applies these numerous dicta to the taxonomic complexities of angiosperms. He substitutes “Oppositifoliae” and “Alternifoliae” for the old names dicotyledons and monocotyledons, on the theory that dicotyledons are primitively opposite-leaved, as shown by their cotyledons; and by the same sign monocotyledons are essentially alternate-leaved. With this start, and in this way, the whole sequence of angiosperms is presented in 300 families, beginning with Alismataceae and ending with Lactucaceae (the Compositae being presented as 14 families). It is a very laborious assembling of material on the basis of assumed phylogenetic sequences, quite comparable with Engler’s *Syllabus*, and useful in the same way.—J. M. C.

**Amoeboid movements of chromatophores.**—The large epidermal leucoplasts of mature leaves of *Orchis latifolius* and *O. incarnatus*, according to KÜSTER,<sup>16</sup> display amoeboid changes of form, having the power to put out and take in processes resembling pseudopodia. Also these leucoplasts at times break up into a large and small portion, which in turn may again fuse. KÜSTER does not accept the idea of SENN that there is a peristromium surrounding the chromatophore, holding rather that the pseudopodia belong to the chromatophore itself. Sometimes the chromatophore as a whole moves in the direction taken by a pseudopodium, thus exhibiting active movement. More commonly, however, a leucoplast suffers no change in position, following a pseudopodial

<sup>15</sup> BESSEY, CHARLES E., The phylogenetic taxonomy of flowering plants. *Annals Mo. Bot. Gard.* 2:109–164. *fig. 1.* 1915.

<sup>16</sup> KÜSTER, ERNST, Über amöboide Formveränderungen der Chromatophoren höherer Pflanzen. *Ber. Deutsch. Bot. Gesells.* 29:362–369. *figs. 4.* 1911.



movement. KÜSTER believes that the usual movement of chromatophores is passive, these organs being carried in the direction of protoplasmic streaming, whatever the direction taken by the pseudopodia. From these studies it is concluded that the chromatophores in question are fluid. It is suggested that other chromatophores, as those in *Listera* and *Iris*, may have the characteristics of the *Orchis* chromatophore.—H. C. COWLES.

**Parthenogenesis in *Nicotiana*.**—GOODSPEED<sup>17</sup> has made some very interesting experiments in connection with parthenogenesis in *Nicotiana*, suggested by a strain of *N. Tabacum* in which Mrs. R. H. THOMAS reports parthenogenesis. Over 500 attempts to produce parthenogenetic seed from a number of species and varieties of *Nicotiana* yielded negative results. These experiments included crossing and propagation through several generations. In the case of the parthenogenetic strain referred to, however, approximately 800 experiments resulted in over 100 normally matured fruits. In the majority of these parthenogenetic fruits empty seeds were produced in great numbers, and for this type of seed production, either with or without pollination, GOODSPEED suggests the term "phenospermy," referring to the seed condition usually described as "abortive" or "empty." Approximately 50 seeds occurred in nine of the parthenogenetic fruits, some of which showed mature endosperm and embryos. A small proportion of the seed from the parthenocarpic fruits was neither parthenogenetic nor phenospermic, but contained traces of endosperm only.—J. M. C.

**Bactericidal substances.**—That the juices of plants may contain bactericidal substances which figure in protecting the plants against the attacks of certain organisms has been shown by WAGNER.<sup>18</sup> Varying numbers of bacteria of the non-parasitic species *Bacillus vulgatus*, *B. asterosporus*, and *Bacterium putridum* were injected into the tissues of potato tubers, beet roots, and the leaves and roots of *Sempervivum Hausmannii*. The injected organisms proved parasitic only when present in enormous numbers (3000–8000), and in that case were able to bring about the decay of the injected tissues. When injected in smaller numbers, the bacteria are destroyed. In case of the potato and of *Sempervivum*, the freshly expressed juice was found to possess bacterolytic and agglutinating properties, but from the sugar beet no bactericidal juice could be obtained. The active substances were found to be contained in the protein fraction of the juice. When the fresh filtered juice containing enzymes, carbohydrates, and salts is allowed to stand for two days, its bactericidal power is destroyed, probably by the action of oxidases and other enzymes.—H. HASSELBRING.

<sup>17</sup> GOODSPEED, THOMAS H., Parthenogenesis, parthenocarpy, and phenospermy in *Nicotiana*. Univ. Calif. Pub. Bot. 5:249–272. pl. 35. 1915.

<sup>18</sup> WAGNER, R. J., Über bakterizide Stoffe in gesunden u. kranken Pflanzen. I. Mitteilung: Die gesunde Pflanze. Centralb. Bakt. II. 42:613–624. 1914.



**Rafflesia and its host.**—BROWN<sup>19</sup> has made a study of the relation of *Rafflesia manillana* to its host, a species of *Cissus*. It is parasitic on the roots, the base of the flower being imbedded in a vase-shaped mass of tissue formed from the root of the host. The vegetative portion of *Rafflesia* consists for the most part of rows of cells, which occur in the xylem, medullary rays, cambium, phloem, and sclerenchyma of the host. The flowers originate from rows of cells which usually cross the cambium. The presence of the parasite causes an excessive growth of both the xylem and the bark of the host, resulting in the formation of the vase-shaped mass of tissue in which the base of the shoot is imbedded. The differentiation of the growing point takes place before the shoot breaks through the bark of the host, but the enlargement of the parasite finally produces cracks in the bark, through which the parasite grows.—J. M. C.

**Sex determination.**—WILSON<sup>20</sup> has studied material of *Mnium hornum* in which an axis bears heads of "mixed organs" and also female heads. Some of the organs resembled antheridia, others archegonia, while a complete series of intermediate forms also occurred. Since the spermatogenous cells of the normal antheridia possess six chromosomes, the normal gametophyte number, the plant could not have been produced aposporously. The conclusion is suggested that sex determination is not bound up with mitosis, but is brought about "by metabolic processes which operate in the organism over a considerable part of its life history." This relation between the sexual condition and the conditions of living is a point of view which is becoming more and more established as the facts of sexuality accumulate.—J. M. C.

**Cladophora in deep water.**—In studying certain curiously corroded limestone slabs, known locally as "honeycomb rock," occurring in the deeper waters of Lake Ontario, KINDLE<sup>21</sup> found some of them covered by a green alga. Since these specimens were obtained from a depth of 150 feet, the determination of the alga was of considerable interest. Upon reference to COLLINS and BRAND, the alga proved to be *Cladophora profunda* Brand, a species occurring in the lakes of the Bavarian highlands, but at no greater depth than 15 meters. BRAND characterized the Lake Ontario material as "forma *ima*." The species has not been recorded hitherto in America, and the depth at which it occurs is three times as great as any before known.—J. M. C.

---

<sup>19</sup> BROWN, W. H., The relation of *Rafflesia manillana* to its host. Phil. Jour. Sci. Bot. 7:209-226. pls. 12-21. 1912.

<sup>20</sup> WILSON, MALCOLM, Sex determination in *Mnium hornum*. Ann. Botany 29: 443-440. pl. 20. 1915.

<sup>21</sup> KINDLE, E. M., Limestone solution on the bottom of Lake Ontario. Amer. Jour. Sci. 39:651-656. figs. 3. 1915.



**Monograph of Senecio.**—In 1902, GREENMAN published the first part of a monograph of the North and Central American species of *Senecio*.<sup>22</sup> The second part, beginning the synoptical presentation of species, has now appeared.<sup>23</sup> Two subgenera are recognized: *Eusenecio* Hoffm. and *Pseudogynoxis* Greenm., the latter including the single section CONVOLVULOIDEI. Not only are the full bibliography and descriptions of each species given, but exsiccatae are cited freely, particularly such as occur in American herbaria. In the present part 32 species are presented, representing 5 of the 22 sections. Two new species are characterized, namely *S. Townsendii* from northern Mexico and *S. hypotrichus* from central Mexico.—J. M. C.

**Carboniferous plants.**—This memoir<sup>24</sup> consists of 150 pages and 30 superb plates, which are far superior to anything we are accustomed to find in geological publications on this side of the Atlantic. The authoress devotes herself to the study of the plants of the well known reefs containing paleozoic plant remains which lie to the west of St. John. She points out that the forms represented in the ledges are distinctly carboniferous, and as a consequence the view of Sir WILLIAM DAWSON, which has been followed by many others, that these deposits are of Devonian age, can no longer be maintained. In her attitude in this respect she agrees with WHITE of the United States Geological Survey.—E. C. JEFFREY.

**Trees of Texas.**—LEWIS<sup>25</sup> has published an illustrated manual of the native and introduced trees of Texas, intended chiefly for those who do not have access to the more technical manuals. The descriptions are much simplified, and this fact, together with the numerous illustrations, should bring the woody plants of Texas within easy reach of all those who are interested in them. Over 200 species are included, *Quercus* being much the largest genus, with 25 species.—J. M. C.

**Malayan ferns.**—Capt. VAN ALDERWERELT VAN ROSENBURGH<sup>26</sup> has described 73 new Malayan ferns, representing 23 genera. The genera represented by 5 or more new species are as follows: *Pleopeltis* (10), *Dryopteris* (8), *Polypodium* (8), *Phegopteris* (7), *Hemitelia* (5), *Hymenophyllum* (5), *Lindsaya* (5). In addition to the ferns new species are described in *Lycopodium* (3) and *Selaginella* (21).—J. M. C.

<sup>22</sup> Engl. Bot. Jahrb. 32:1-33. 1902.

<sup>23</sup> GREENMAN, J. M., Monograph of the North and Central American species of the genus *Senecio*. Part II. Ann. Mo. Bot. Gard. 2:573-626. pls. 17-20. 1915.

<sup>24</sup> STOPES, Dr. MARIE, The fern ledges' carboniferous flora of St. John, New Brunswick. Department of Mines, Geol. Survey of Canada. Memoir 41. 1915.

<sup>25</sup> LEWIS, ISAAC M., The trees of Texas. Bull. 22. Univ. Texas. pp. vi+169. figs. 48. 1915.

<sup>26</sup> VAN ROSENBURGH, Capt. C. R. W. K. VAN ALDERWERELT, New or interesting Malayan ferns 6. Bull. Jard. Bot. Buitenzorg 10: no. 16. pp. 60. pls. 10. 1914.



THE  
BOTANICAL GAZETTE

FEBRUARY 1916

ORIGIN AND DEVELOPMENT OF THE LAMELLAE  
IN COPRINUS

GEO. F. ATKINSON

(WITH PLATES V-XII AND SIX DIAGRAMS)

**Introduction**

Members of the Agaricaceae thus far studied present two types in the origin and development of the lamellae. In one of these types,<sup>1</sup> which for the present we may speak of as the *Agaricus* type, the origin of the lamellae has been clearly described. It is preceded by the formation of a palisade layer of hyphae representing a young stage in the development of the hymenophore on the under side of the young pileus. This palisade layer of the hymenophore is either accompanied by, or, in many of the forms described, preceded by a more or less well developed, general, annular cavity. This cavity is, therefore, when present in the forms described, prelamellar. It is formed by differences in tension on the tissue

<sup>1</sup> In the following examples of the *Agaricus* type, the origin of the lamellae has been clearly described: *Agaricus carneotomentosus* (*Panus torulosus*) by HOFFMANN (19, p. 145); *Cantharellus tubaeformis*, *C. aurantiacus*, *Panus stipticus*, *Pleurotus tremulus*, *Omphalia umbellifera*, *O. pyxidata*, *Marasmius epiphyllus* by HOFFMANN (20); *Collybia velutipes*, *C. fusipes*, *Hygrophorus chlorophanus*, *Galera mycenopsis*, *Hebeloma mesophaeus*, *Coprinus fimetarius*, *Paxillus involutus*, *Entoloma sericeum*, and others by HOFFMANN (21); *Mycena vulgaris*, *Collybia dryophila*, *Nyctalis parasitica*, *Clitocybe cyathiformis*, and *Cantharellus infundibuliformis* by DEBARY (14, 15, 16, the latter two in conjunction with WORONIN); *Coprinus lagopus* by BREFELD (12, p. 127); *Agaricus campestris* by ATKINSON (5); *Hypholoma* by Miss ALLEN (1) and by BEERS (11); *Stropharia ambigua* by ZELLER (23); *Agaricus arvensis* and *A. comtulus*, and *Armillaria mellea* by ATKINSON (6, 7).



of the young basidiocarp, due to the more rapid growth of the pileus and stem primordium, and the less rapid growth of the fundamental plectenchyma below the pileus primordium, in the angle between it and the stem. The fundamental plectenchyma is thus torn apart, and in those cases where this annular cavity is well formed prior to the origin of the palisade layer of the young hymenophore, the surface of the cavity is very ragged from the loose hyphae projecting to different distances in the cavity. This ragged appearance disappears over the roof of the cavity as the palisade layer is established.

The cavity and the palisade layer<sup>2</sup> first appear near the stem fundament. The pileus primordium is at this time comparatively limited in extent. The margin is younger than the portion next to the stem. As growth continues, there is centrifugal growth of the pileus at the margin, and this is accompanied by the centrifugal extension of the annular cavity, followed by the centrifugal extension of the palisade layer. In this way the elements are younger toward the margin of the pileus and older toward the stem.

In the forms described, belonging to this type, the lamellae originate in the form of downward projecting ridges or folds of the palisade layer. These ridges or folds begin at or near the stem, the newer, younger, radial extensions of them proceeding centrifugally; while the lamella increases in width downward by increase of the elements of its surface, and growth of the trama hyphae extending from the pileus above. The first evidence of a downward projecting ridge, or fold, which is the fundament, or early stage of the lamella, is the result of the increase in size and number of the elements of the palisade layer of the young hymenophore in a line radiating from or near the stem outward, or by the more rapid elongation of the trama hyphae of the young pileus along this line and next to the palisade layer, or by both processes combined. These elongating trama hyphae, as they pass into the gill salient, form the beginning of the trama of the lamella.

<sup>2</sup> FISCHER (81, p. 505) describes the origin of the young level palisade hymenophore, in *Armillaria mucida*, as growing inwardly toward the stem from the margin of the pileus, being a continuation of the palisade layer forming the surface of the pileus.



The second type in the origin of the lamellae has been observed in certain of the Amanitae, in *Amanita muscaria* by BREFELD (12), in *A. rubescens* by DEBARY (14, 15, 16), and in *Amanitopsis vaginata* by the writer (ATKINSON 10). Here the first evidence thus far observed of the origin of the lamellae is a series of bars or trabeculae, radiating from the stem outward, and attached to both the stem and the under surface of the pileus. These bars appear at first faintly differentiated. The tissue from which they are differentiated is evidently that which is formed by the growth of the primordium of the hymenophore from the under surface of the pileus toward the stem, apparently through the ground tissue of the young basidiocarp. There is no general, annular, prelamellar cavity, not even a weakly developed one. On the lateral surfaces of these radiating bars which are the fundamentals of the lamellae, the hymenium is organized, the lamellae begin to separate more and more from each other, and gill cavities or chambers appear between them, while the lamellae are still attached to the stem.

Just how this growth of the hymenophore primordium advances through the fundamental tissue between the pileus and stem has not been as yet satisfactorily observed, and the same may be said of the organization of the hymenium on the lateral surfaces of the lamellae. It cannot, therefore, be stated at present to how great a degree this "*Amanita*" type differs from the "*Agaricus*" type.

In the forms thus far studied which represent the first type, or *Agaricus* type, the size of the general annular gill cavity often increases as the plant ages, and the gills are usually quite free from the stem up to maturity. Since in species of *Coprinus* the gills are attached to the stem at maturity, and separate from it during the later expansion of the plant and the shedding of the spores, the question arose during my study of *Amanitopsis*, as to whether the origin of the lamellae in such species of *Coprinus* was like that presented by the *Amanita* type or not.

Not only in *Coprinus*, but in other members of the Agaricaceae the origin of the lamellae presents, at this time, additional interest because in the July number of the *American Journal of Botany*, on the basis of a peculiar structure observed in *Coprinus micaceus*, the statement is made that one of the problems yet to be worked out in



the Agaricaceae is the origin of the lamellae (see LEVINE 22); and this notwithstanding the fact that in a number of species several different persons have clearly and accurately described the origin of the lamellae.<sup>3</sup> It is further stated in the paper just referred to, after describing the peculiar structure observed in *Coprinus micaceus*, that "There is no general annular gill cavity as described by HOFFMANN, DEBARY, ATKINSON, and others, and no annular hymenial primordium" (LEVINE 22, p. 352). Since DEBARY (14, p. 69) is the only person who has ever announced the existence of a general annular gill cavity in *Coprinus micaceus*, this ambiguous statement can be interpreted only as a denial of the existence of a general, annular, prelamellar cavity in *Agaricus campestris*, and other species of this genus, and other genera in which it has been described.

According to the peculiar situation said to precede the origin of the lamellae in *Coprinus micaceus* (LEVINE 22), there first appear, isolated in the fundamental elements, radiating ridges of short converging hyphae. These ridges are said to split, and approximate halves of adjacent ridges unite to form the lamellae. It is also stated that there is no general palisade layer of the young hymenophore preceding the formation of the lamellae. So far

<sup>3</sup> HOFFMANN, more than half a century ago (19, p. 145), correctly described the origin of the lamellae in *Agaricus carneotomentosus* (*Panus torulosus*). The unequal growth of the young, even, palisade hymenophore gives rise to radiating folds which later become the lamellae. Later he observed the same method of origin in *Collybia velutipes* and more than a dozen other forms (20, 21).

In DEBARY'S (13, pp. 386 and 394) first contribution to the origin of the gills, the palisade layer of the young hymenophore in *Nyctalis asterophora* and *parasitica* was said to present radial folds from its earliest appearance, that is, it was not a level or even layer. This interpretation of the early form of the hymenophore was shown by HOFFMANN (20, p. 402) to be wrong. The later study of a number of other forms, both gymnocarp and angiocarp, led DEBARY (14, p. 63; 15, pp. 58 and 312; 16, pp. 55 and 289) to the conclusion that the same course of development as described by HOFFMANN prevailed in most of the Agaricaceae. He now recognizes the earliest stage of the young palisade hymenophore to be level or smooth, even if only for a brief period. A very clear description is also given of the origin of the lamellae as downward growths of the young, level, palisade hymenophore along radial areas, commencing next the stem, progressing centrifugally, and broadening downward. An exception was made in the case of those forms with a true volva (*Amanita*, etc.). See the examples cited in the footnote on the first page of this article, in which the origin of the lamellae has been correctly described.



as the species of *Agaricus*, *Armillaria*, and *Lepiota* studied by the writer are concerned, it can be most positively reaffirmed, that, first, there is a general, annular, prelamellar cavity; second, a general palisade layer over the roof of this cavity precedes the origin of the lamellae; and third, the first radiating ridges or folds of the hymenophore are the fundamentals of the lamellae themselves. The primary ridges or folds do not split to form the lamellae between them by the union of approximate halves of adjacent ridges. From the plants already studied, the writer has never formulated any generalizations as to what the situation may be in any other species or genera, in regard to the presence, either of a general annular gill cavity, of a palisade layer, or the origin of the gills. Without any bias, therefore, we may proceed to the interpretation of the situation in the three species of *Coprinus* which are the subject of the present paper.

### Material

The material for study was collected in September 1914, all of it, with the exception of a few not very young specimens of *Coprinus atramentarius*, on the campus of Cornell University. It was fixed in chromacetic acid.

*Coprinus comatus*.—Two different collections were made of this species. The first lot of material was collected early in September in comparatively new made ground by the edge of a small bed of recently planted shrubs at the west end of Roberts Hall. A single plant had just emerged from the soil, and the aspect of the surroundings indicated that the colony was new and young. The mycelium was abundant and extended through the soil, partly in the cultivated portion, and partly in the newly made sod, for an area of less than 1 m. in extent; 20–25 young fruit bodies were collected from this area. The second lot of material was collected the latter part of September in a grassy plot east of Sage College. Here a number of mature plants had sprung up, but several very young ones were found scattered on the mycelium in the soil some distance from the old specimens.

The specimens were not growing in clusters, but scattered on the strands of mycelium. In the young material it was impossible



to observe external evidence of a differentiation into stipe and pileus. The plants were in the form of irregular tubercles, oval to elongate, the larger ones 1-1.5 cm. long by 3-5 mm. in diameter. Some of the larger ones in longitudinal freehand sections presented evidence of a differentiation in the upper part where the pileus and stem develop from the distal portion of the tubercle. When the material was microtomed and stained it was found that all stages were present, from a condition prior to any differentiation of the hymenophore up to quite an advanced stage of development, and often details of structure could be made out quite clearly by microscopic examination immediately after the paraffin ribbons were smoothed out on the slide.

*Coprinus atramentarius*.—The first material was collected early in September on the ground in a small park (Washington Park, Ithaca), but this material was not very satisfactory, since it was rather old and the compact soil was difficult to remove without damage to the fruit bodies. During the latter part of September some fine material was found growing on a very rotten stump on the campus quadrangle. The stump had been cut quite close to the ground, so that there was a sufficient amount of moisture, and yet the surface of the stump was free from soil except dust particles lodged from the air. The young fruit bodies were thus in an excellent condition for preservation, free from soil particles which might interfere with the knife in sectioning. There were several different clusters growing on this stump. The cluster which attracted my attention was about one-third grown, and careful examination in the rotten wood revealed several other clusters of very young fruit bodies from which the material was selected. In this species there is no large tubercle formed, but internal differentiation occurs when the basidiocarps are quite small, and oval or more or less pyriform in shape.

*Coprinus micaceus*.—This material was also collected from a very rotten stump on the campus quadrangle. Several years ago, as the elm trees were becoming too crowded on the campus, a large number were removed by thinning out the stand, the stumps being sawed off close to the ground. For several years enormous masses of this species have appeared on these stumps, and from their root



systems successive crops coming during rainy periods from spring until late autumn. While the fruit bodies usually appear in dense clusters, one can find clusters in different stages of development at almost any time during this season. From young clusters the basidiocarps of *C. micaceus* were collected.

I have thus gone into the details in regard to the collection of material for this study, in order to make it very clear that the basidiocarps grown in the open, under normal conditions, on their normal substratum, collected from young clusters, or scattered on the mycelium (*C. comatus*), were undergoing normal development. In these species it is fortunate that it is not necessary to grow them in the laboratory, upon artificial agar media, in order to obtain the young stages for study.

### Study of *Coprinus comatus*

THE GENERAL, ANNULAR, PRELAMELLAR CAVITY.—It has not been the object of this investigation to study the origin and differentiation of the pileus and stem fundaments. The internal differentiation of these fundaments has taken place before the fundaments of the lamellae appear. The earliest stage yet studied in *C. comatus* is represented in fig. 1, from a section of the distal portion of a young basidiocarp, the great bulk of the tubercle having been removed. The young pileus is represented by the dark staining central zone, bordered above and on the sides by a distinct zone of radiating threads. The evidence appears to indicate that the system of radiating threads has its origin at the stem end of the tubercle as described by BREFELD (12) for *C. lagopus*, and that the fundament of the pileus proper is differentiated soon afterward. The outer zone of radiating threads is homologous with that which I have termed the blematogen (ATKINSON 8), and which BREFELD (12) calls the pileus volva ("Hutvolva"). But in *C. comatus* it remains "concrete" with the pileus, not separating from it as in the true or finished volva (*teleoblem*) of the Amanitae. Within the fundamental elements of this system of radiating threads, toward its center of origin, the pileus primordium becomes organized. The lateral portions, that is, the margin of the primordium, which is nearer the fundament of the hymenophore, appears to be differentiated



first, and this indicates that the primordia of hymenophore and pileus margin may arise from a fundament common to both. The further organization of the pileus consists in the growth of new elements, as well as in the incorporation of the elements of the inner zone of radial hyphae.

At the stage represented in fig. 1 there is no evidence either of an annular gill cavity or of the fundaments of the lamellae. The next stage in the differentiation of the basidiocarp is the appearance of a general, annular, prelamellar cavity. This is formed as a result of tensions due to unequal growth. The more rapid growth and expansion of the pileus fundament and the more rapid elongation of the stem fundament next the pileus bring into strong tension the less rapidly growing tissue in the angle between the pileus and the upper part of the stem, so that this tissue is torn apart. Prior to and at the time this tearing apart of the tissue occurs, the hyphae of the lower part of the pileus fundament are growing downward. When the rift first takes place the dome of this cavity, that is, the under surface of the exposed pileus fundament, is very irregular and "frazzled" from the numerous loose hyphae which project downward into the cavity, exactly as described for *Agaricus campestris* by the writer (ATKINSON 5). The lower surface of the cavity also presents in its early formation numerous loose hyphae on the surface of the stem and fundament of the partial veil.

The more active growth of the pileus, where the hyphae are richer in protoplasmic content and stain more deeply, is at some distance from the stem, near the outer portion of the annular cavity. It is along this under surface of the pileus that the palisade layer is first formed as the dome of the cavity smooths out and acquires a more even contour. At the extreme outer margin of the cavity, however, the surface is still irregular, due to the fact that the formation of the cavity and the organization of the palisade layer on the under surface of its roof are centrifugal, thus following up the centrifugal growth and extension of the pileus margin. The elements, therefore, not only of the pileus but also of the young hymenophore, are younger toward the margin of the pileus because of this centrifugal order of development.



It seems almost needless to state how the presence of a general, annular, prelamellar cavity is determined, when the fundamental principle of determining not only the extent, but the continuity and conformation of structure by serial sections, is so generally known; but inasmuch as the presence of such a cavity in the development of any of the Agaricaceae has been denied, it may be stated that its presence has been determined by serial longitudinal sections of basidiocarps, that is, sections parallel with the axis of the stem. Beginning on one side of the basidiocarp, as the sections enter the region of the annular cavity, there is but one cavity in each section which is more or less transversely elliptical in form. As the sections pass through the stem, there will appear two cavities symmetrically placed, one on either side of the stem; then as the sections pass beyond the stem through the opposite side of the basidiocarp, there is but one cavity, as on the entering side (see diagram I).

ORIGIN OF THE LAMELLAE.—*Coprinus comatus* is an exceedingly interesting form in which to study the origin of the lamellae. The "posterior" ends of the lamellae are not only "free" from the stem, but they are quite distant from it. In their origin, therefore, the question is not complicated by certain difficulties sometimes met with in studying the origin of lamellae which are "adnexed" or "adnate," or even where they are free at maturity but very close, or adnexed, to the stem in the very young stages. In *C. comatus* there is a circular area on the under surface of the pileus immediately surrounding the apex of the stem, over which the fundament of the hymenophore is not formed, at least in all the specimens which I have examined thus far. This accords with the earliest formation of the palisade layer, which, as previously stated, begins at some little distance from the stem and then proceeds

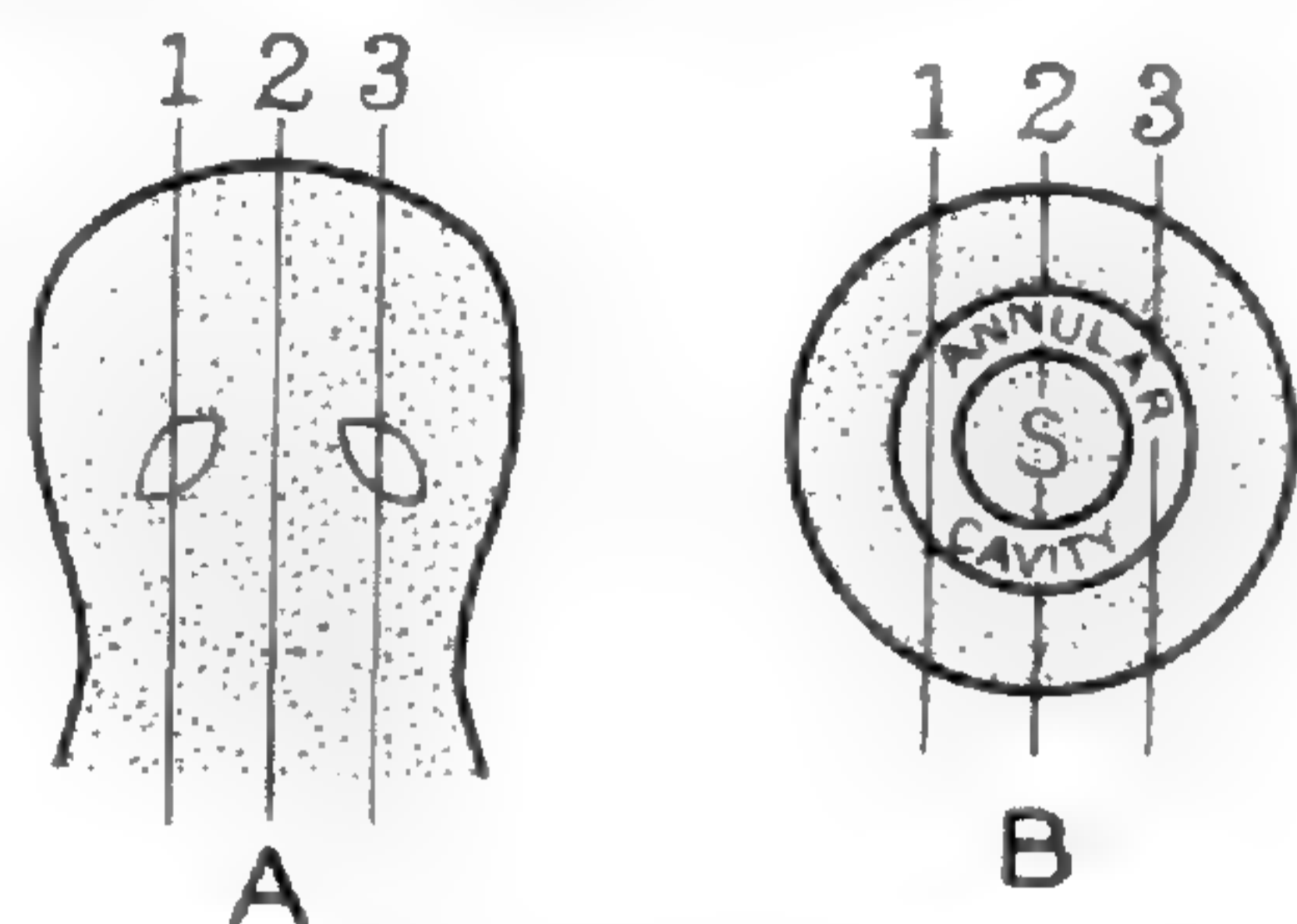

DIAGRAM I.—A, lateral view through young basidiocarp of *C. comatus*; longitudinal sections parallel with axis of stem, traveling from left to right; sections at 1 show single transversely elongated cavity; at 2 they would show two cavities symmetrically disposed, one on each side; at 3 they would show cavity similar to that in sections at 1; B, zenith view through same, showing relation of sections to annular cavity at 1, 2, and 3; see figs. 2, 3, 9, 10.



centrifugally. The origin of the lamellae begins on the earlier or older portions of the palisade layer of the young hymenophore, and likewise proceeds in a centrifugal direction.

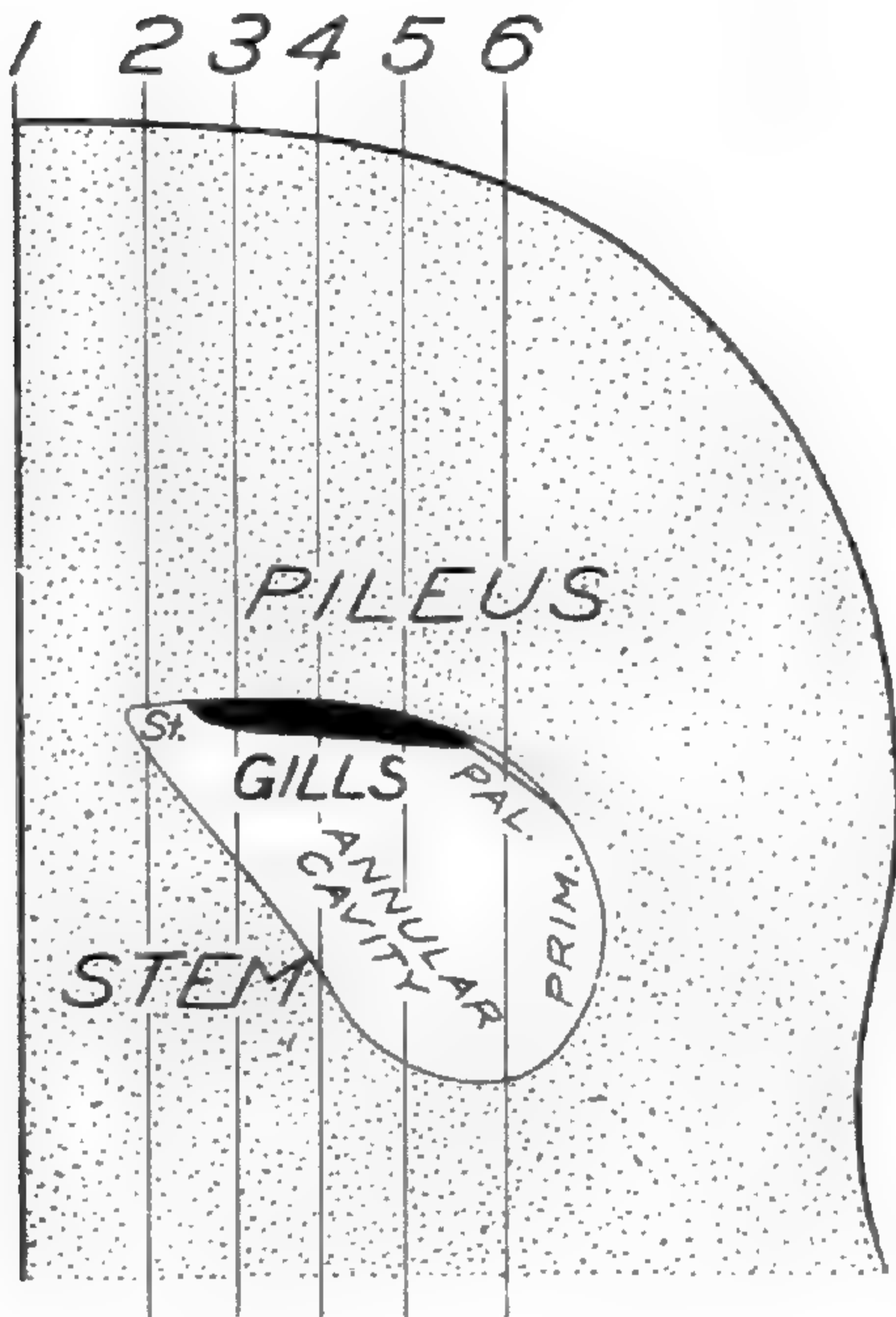

DIAGRAM II.—Lateral view through one side of basiodicarp of *C. comatus*, showing sectional view of annular cavity, and various stages in centrifugal development of young hymenophore; face view perpendicular to young gill; *st.*, sterile area next stem; gills, broad black area; *pal.*, palisade area; *prim.*, primordial area before formation of palisade; a section at 1 would show structures as in face view of diagram (see fig. 11, opposite side); sections at 2 would show sterile area in middle (see fig. 15); sections at 3, 4, or 5 would show cross-cuts of young lamellae at middle (see figs. 13, 14); sections at 6 would show palisade area over middle and primordial area at each side (see fig. 12).

Since the lamellae thus originate at some little distance from the stem, on the lower surface of the roof of a well defined and relatively large annular gill cavity, their origin is determined with comparative ease. In the majority of the fruit bodies examined at the time of the origin of the lamellae, the area over which the first portion of the palisade layer extends and where the first salients, or fundaments, of the lamellae appear, is slightly convex and stands out nearly or quite perpendicular to the axis of the stipe. Sections parallel with the axis of the stipe, but tangential through this area, on either side of the stipe, cut the lamellae fundaments transversely and parallel with their, at this time, downward direction of growth (see diagram II, which illustrates the position of the sections).

As the sections approach the stem on the near side, they gradually pass into the sterile circular area surrounding the stem. Through this field the sections show a middle area devoid of the salients. In passing through the stem a sterile area is presented on either side of the stem, but the origin of the lamellae is not so clearly observed here as in completely tangential sections, since the salients are cut in a strongly oblique direction, or parallel



with their axes (through or between them) in the median plane. Also, as the sections pass out of the stem, on the far side, the middle area is devoid of the salients, as on the near side, until the sterile area between the stem and young hymenophore has been passed.

In the tangential sections, therefore, far enough away from the stem to clear this sterile area, the salients over the middle portion are cut squarely in a transverse direction, while those on either side are slightly oblique, those at the extreme ends (sides) being slightly more so than those nearer the middle. But the salients are so small and narrow, and at this time extend radially to such a short distance, that it is very difficult, if not impossible, to appreciate the differences in the direction of the cut. At this earliest stage in the origin of the lamellae, the salients do not extend to the extreme margin of the cavity. From the area of salients there is a gradual transition in a centrifugal direction to the plain palisade area, and from this to the frazzled area at the extreme margin. For this reason the tangential sections through the area of the salients at this time show that the salients are confined to the middle portion, and the transition outward toward the margin on both sides passes into the palisade area and then into the frazzled area at the extreme margin (figs. 13, 15).

The first salients, or ridges, which appear in the young hymenophore are short, radial, downward projecting folds of the palisade layer. They are the fundamentals of the primary lamellae themselves. They are formed by the increase and enlargement of the elements of the palisade layer along radiating lines. The increased pressure thus brought about in the palisade area causes a downward arching of these radial areas of the palisade, accompanied by the downward growth of the trama hyphae of the pileus along these radial areas, thus forming the trama of the young lamellae. The trama hyphae of the young lamellae are rather weakly developed, in contrast with the strong development of the hyphae of the palisade layer, being more slender, of less protoplasmic content, and forming a rather loose mesh.

The origin of the lamellae is very clearly shown in figs. 13-16. Fig. 14 is from a section just passing out of the sterile area on the



far side of the stem; fig. 13 is from a section just before passing from the area of salients to the palisade area; while fig. 12 is through the palisade layer beyond the gill salients. At either extremity of the series of salients in figs. 13 and 14, and on the left of fig. 16, it can be seen that the folds become less and less marked, finally presenting, as it were, only very slight undulations of the surface in the

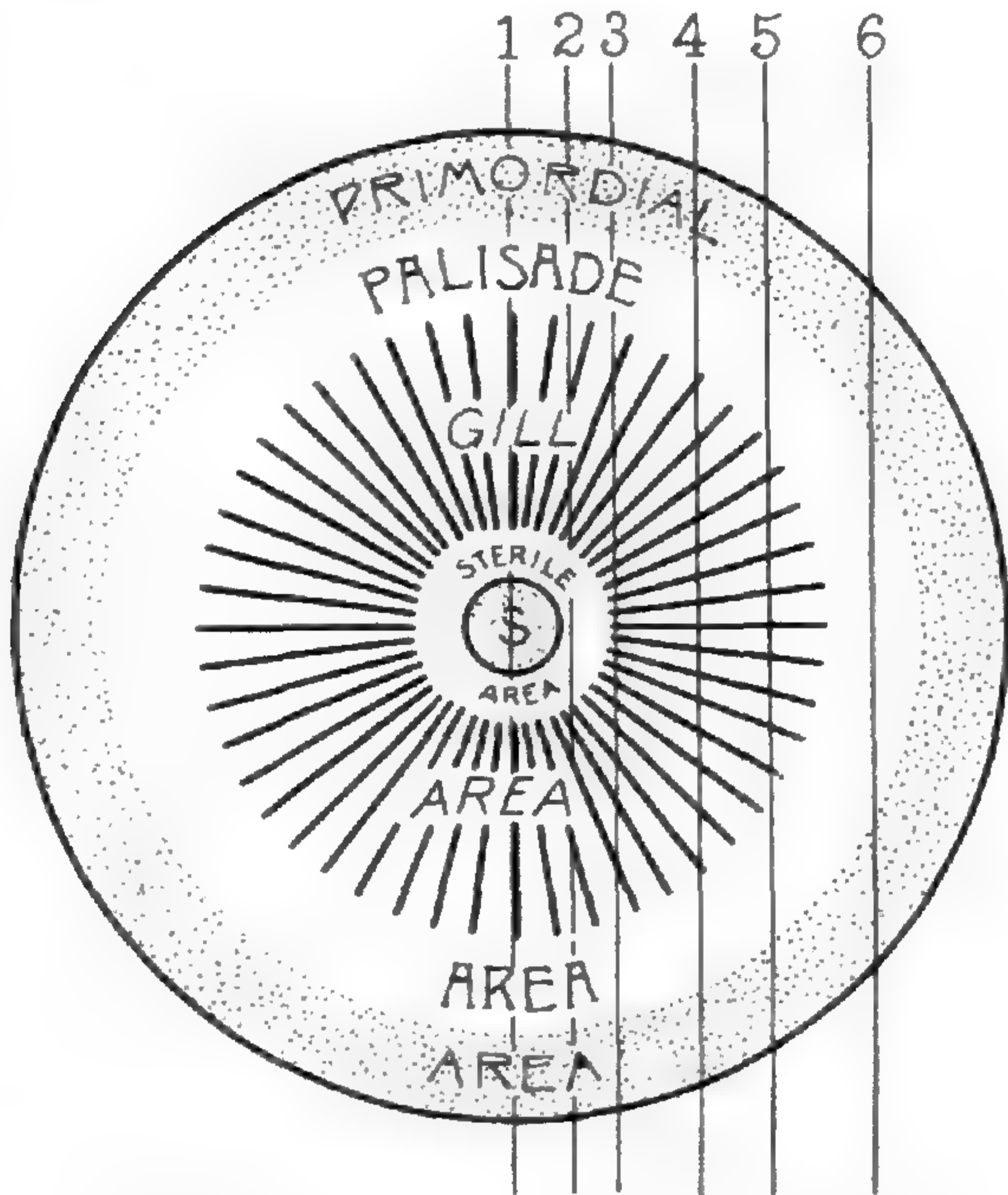

DIAGRAM III.—Zenith view through young basidiocarp of *C. comatus* at same stage as represented in diagram II; sections at 1 would be parallel with gills; at 2 they pass through sterile area, and gills on each side are cut obliquely (fig. 15); at 3, 4, and 5, gills in median portion of sections cut transversely, those on each side obliquely; on each side of gills is palisade area, and centrifugal to this the primordial area (see figs. 13, 14); character of sections at 6 shown in fig. 12.

transition to the palisade area. These slight undulations, or salients, shown at the extreme ends of the series, are the distal ends of the lamellae fundamentals. Tangential sections through a series of such radial salients which diverge slightly from a common center, and traveling from the stem toward the margin of the pileus, would pass through the distal ends of the salients on either side of the middle area before the ends of those over the middle area were reached (see diagram III). And, since the development of the pileus and the successive phases of the hymenophore are radial and centrifugal, the very low salients, or "undulations," are the very earliest stages in the origin of the lamellae fundamentals. Fig. 16 is somewhat more highly magnified in order

to bring out more distinctly the transition from the plain palisade phase of the hymenophore through the phase of weak salients to the more pronounced fundamentals of the lamellae.

In some basidiocarps, at the time of the origin of the lamellae, or just prior thereto, the young hymenophore is relatively farther from the stem, and the plane of its surface, or rather a plane tangent



to its convexity, is not approximately perpendicular to the axis of the stem, but its outer portion is strongly depressed (see diagram IV), because the strong epinastic growth of the margin of the pileus causes it to curve downward. In such cases the sections, to be transverse to the salients and also parallel with their direction of growth, must be more or less strongly oblique to the axis of the stem. It can be seen readily that in such cases the young lamellae would be cut parallel with their direction of growth in width, only on one side of the basidiocarp, unless the latter had previously been cut into two longitudinal halves. Obviously this situation cannot well be determined in advance; but if entire basidiocarps are used, the situation can be interpreted, after cutting through the near side of the object, by an examination of the median sections parallel with the stem axis. The remaining half can then be oriented in such a way as to make the sections in the desired direction. If longitudinal halves of basidiocarps are used, however, a few sections can first be made on the stem side in order to determine the orientation of the young hymenophore.

The further development of the lamellae consists in the radial extension of the salients originating in the downward folding of the palisade area, progressing in a centrifugal direction until the margin of the pileus is reached. The broadening of the lamellae, that is, their increase in breadth, is brought about not only by increase in size of the elements now present, and by continued growth of the trama hyphae of the young lamellae, but also by the increase in number of the elements of the hymenium and subhymenium throughout.

As the young basidiocarps become older, in order to obtain sections perpendicular to the origin of the lamellae, or parallel with their direction of growth, the cuts must be made more and more oblique to the axis of the stem, or finally perpendicular to it. This

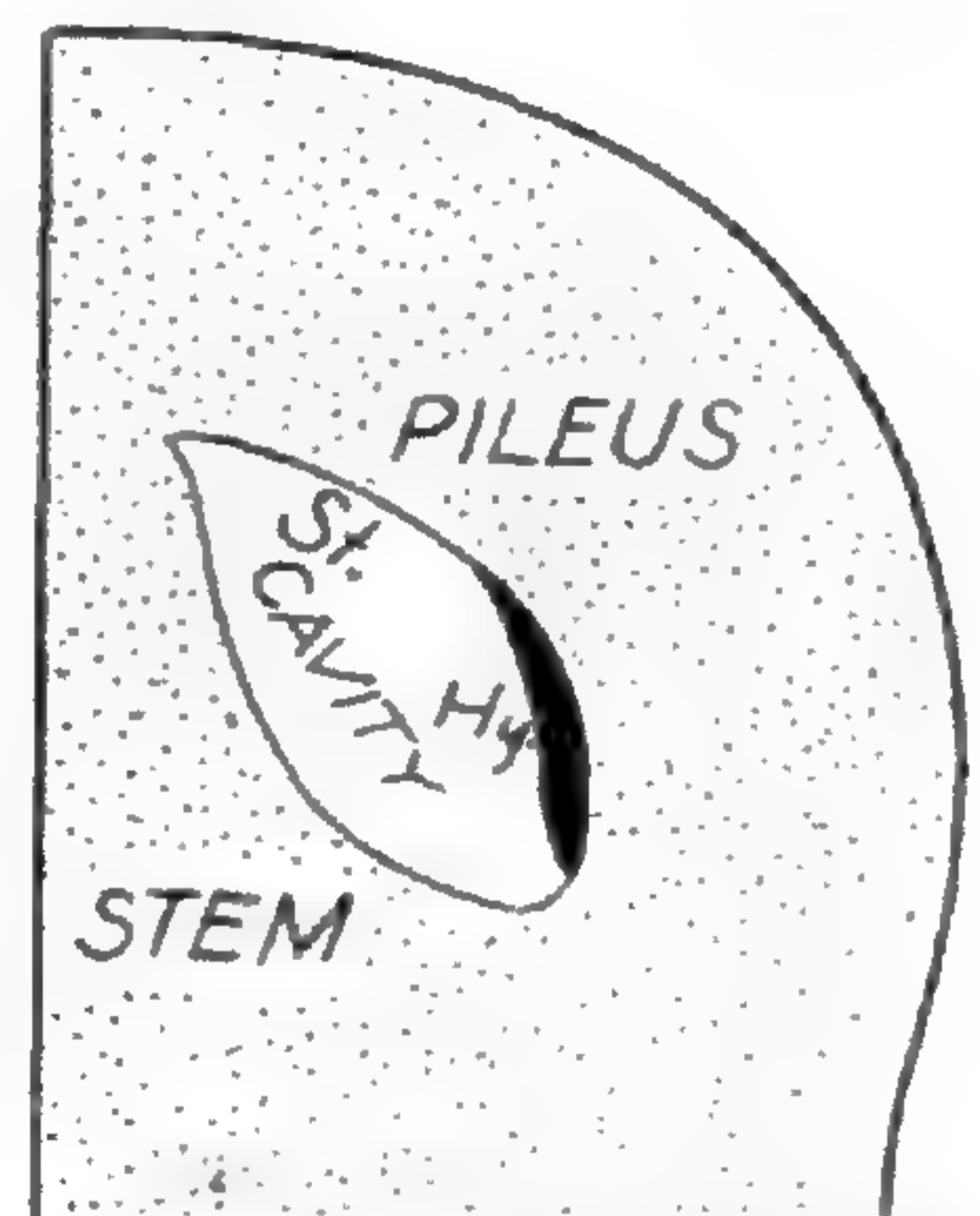

DIAGRAM IV.—Lateral view through one side of young basidiocarp of *C. comatus*, showing sectional view of annular cavity with surface of young hymenophore (*hy*) nearly parallel with axis of stem; *st*, sterile area next stem.



results from the change in the relative position of the pileus during its growth, the pileus after a time approaching a position nearly or quite parallel with the axis of the stem. Figs. 23 and 24 are from sections perpendicular to the stem axis.

ATTACHMENT OF THE LAMELLAE TO THE STIPE.—Before the plants are fully mature the margins of the lamellae become attached to the stipe. The age of the lamellae when this attachment takes place probably varies in different plants, and even in the same plant, depending on the size of the annular gill cavity and the distance which the lamellae must grow in width before the margins come in contact with the stipe. For example, in some cases the younger portions of the lamellae at the extreme margin of the pileus may become attached to the stem before the older portions do, because of the narrower space between the margin of the pileus and the stem and the cramped situation in which the lamellae are immediately following their origin or at the time of their origin. Where the gill must cross an open space before it comes in contact with the surface of the stipe, the edge is evenly rounded and furnished with the closely parallel clavate cells forming the palisade layer which is continuous with the similar palisade layer on the sides forming the hymenium. When the lamellae come in contact with the stipe they press more and more firmly against it as growth continues. This pressure tends more and more to spread many of the palisade cells of the margin laterally, and thus bring the trama cells more or less in direct contact with the surface of the stem. This is well shown in fig. 23, where the three lamellae show different phases of this process. The one at the left shows the strong spreading of the marginal palisade cells with trama hyphae in contact with the stem. In the middle one the marginal cells are only partially spread, there being in this section two clavate cells which still keep the trama hyphae separated from the stem surface. In the lamella at the right the marginal cells have only just begun to spread laterally.

While the marginal cells of the lamellae are thus spreading laterally, and afterward, a few of these cells as well as branches from the trama hyphae, by growth, interlace more or less with the loose open plectenchyma of the stem surface and the junction is



thus effected. Because of the changing tensions to which the plant is subject more or less during growth, the lamellae may likely come in contact with the stem, the edges become more or less flattened out, then become free, and then again come in contact with the stem surface, and finally make the connection permanent, until expansion of the plant begins at maturity. In fig. 24 the lamella at the right, which had crowded slightly into the surface of the stem, and whose marginal cells are only slightly spread, has been slightly withdrawn from the stem during the smoothing out of the paraffin ribbon.

As the lamellae become more firmly crowded against the stem, the portion in direct contact loses the deep staining quality which the marginal palisade cells in common with the palisade cells of the hymenium on the sides possess. This is due to the fact that the greater part of the marginal palisade cells are squeezed out laterally, while the few which remain take on a more vegetative function, and, with the new growth of the trama hyphae here, form the interlacing and rather loose connection with the stem.

There is another interesting feature in the origin and development of the lamellae which requires a clear exposition, because it is present not only in the three species of *Coprinus* treated here, but also in the vast majority of the agarics, and perhaps with very few exceptions in all. Unless clearly analyzed, the situation might be misleading and result in an incorrect interpretation of the origin of the gills. The situation is presented in fig. 20, where the gills both to the left and right show the trama distinctly continuous with the tissue above and below. This situation may, and does often, occur even in quite young phases of the origin of the lamellae. This figure is of a tangential section parallel with the axis of the stem but near the margin of the pileus. Epinastic growth of the pileus margin causes it to curve in more toward the stem. Since the lamellae originate as radial salients on the inner side of the pileus and grow in breadth perpendicular to the surface of their origin, sections parallel with the axis of the stem but through the margin of the pileus would be parallel to a tangent of the pileus curve in this region. When the sections are made with the knife traveling from the stem through the far side of the basidiocarp, at the extreme left



and right of the hymenophore the sections will soon begin to present this relation of the lamellae (if the hymenophore is sufficiently

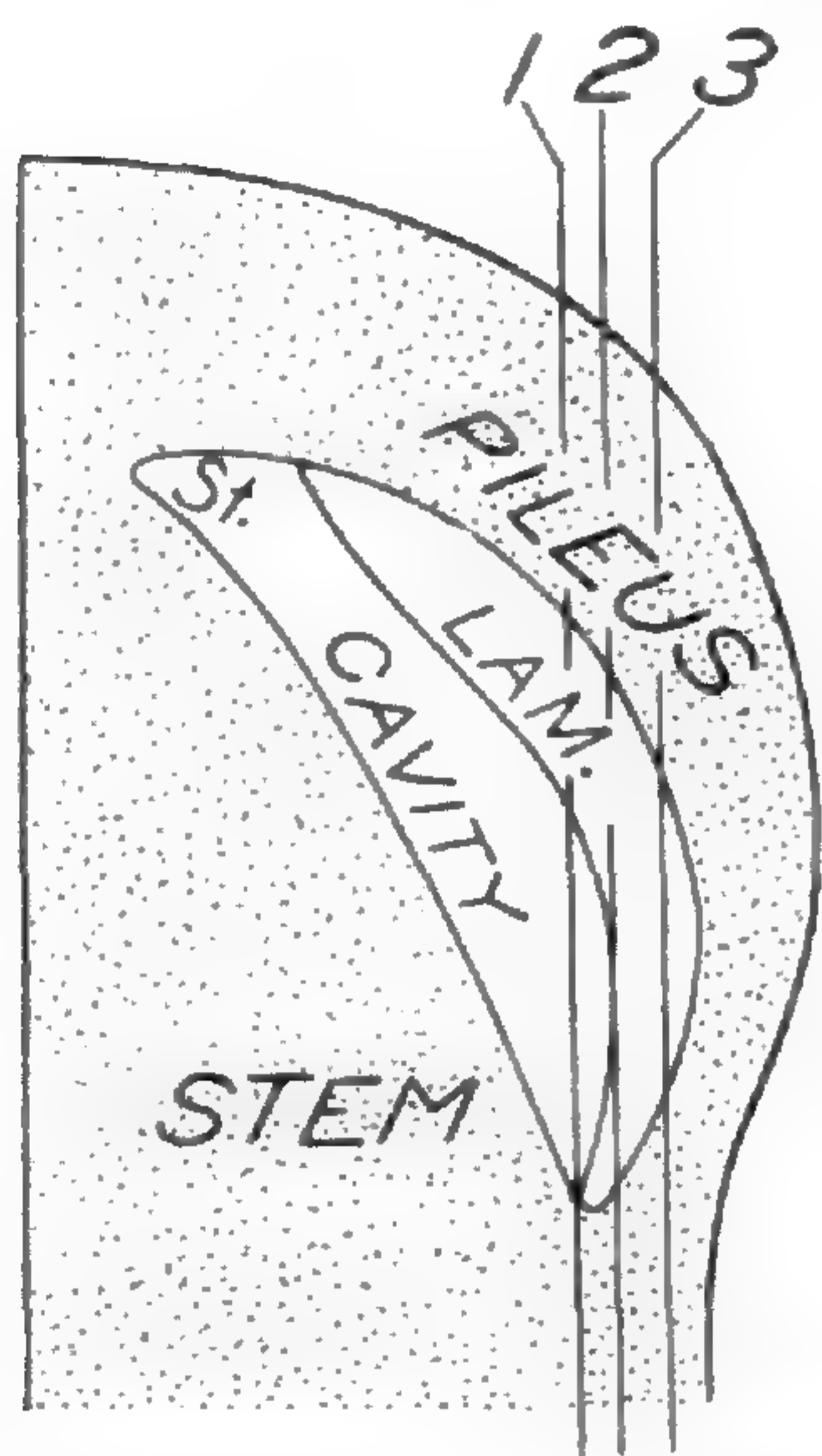

DIAGRAM V.—*C. comatus*: lateral view through one side of medium aged basidiocarp, showing sectional (cross) view of annular gill cavity, side view of lamella, epinastic curvature of pileus and hymenophore; in sections at 1, 2, or 3 gills will be free from stem in all cases; their free margins will show in middle of sections at 1, but those on each side will be cut parallel with surface of pileus, and will show attachment both “above and below” to pileus at point of their origin (see fig. 20); sections at 2 and 3 will show all gills attached both “above and below” to pileus at their points of origin; sections here run through dorsum of gills (or near) and parallel with surface of pileus (see figs. 21, 22).

yet been made to study the earlier stages presented by the earliest differentiation of the pileus and stem, since the primary object of

advanced in age) even before the middle portion of the sections has reached the margin of the pileus. This is the situation presented in fig. 20. As the middle of the sections pass through the margin of the pileus (when the fertile portion has been reached), all of the lamellae will show the trama continuous with the tissue below as well as above (figs. 21 and 22). The attachment of the gills with the tissue “below” in the sections is at their point of origin from the *inner* surface of the pileus, exactly as in their attachment above. The sections under such conditions merely present the situation of the trama of the lamellae being continuous with the trama of the pileus at their point of origin. The connection “below” in such cases is not with the tissue of the stem, but with that of the pileus. Great care is necessary to avoid confusing such situations with those in which the gills become attached to the stem, for both situations may occur in the same sections. Diagram V illustrates the position, form, and relation of parts, and direction of the cut in obtaining the sections for figs. 20–22.

### Study of *Coprinus atramentarius*

The youngest specimens of *Coprinus atramentarius* studied were in the phases of development just prior to and during the origin of the lamellae. No attempt has



the present study has been the origin and development of the lamellae. In the earliest stages examined the fundament of the pileus was distinctly organized, especially the marginal and lower portion. It is organized within the zone of radiating hyphae characteristic of many species of *Coprinus* which have been studied. The zone of radial hyphae external to the pileus is broad. It forms the blematogen, and is not separated as a distinct free volva or teleoblem, since it remains concrete with the surface of the pileus. The relation of the pileus and blematogen is very well shown in figs. 26, 27, and 38.

THE GENERAL, ANNULAR, PRELAMELLAR CAVITY.—In contrast to the pronounced and distinct annular gill cavity in *C. comatus*, the annular cavity in *C. atramentarius* is weak, often very weakly formed, but it was, nevertheless, present in all specimens examined. Since it is formed as a result of the tensions caused by difference in the rate of growth of the pileus, stem, and adjacent tissue, as described for *C. comatus*, *Agaricus campestris*, etc., the tissue underneath the pileus fundament and surrounding the stem is torn apart. Since the cleavage, as already described for *C. comatus*, *A. campestris*, etc., is not an even one, the tissue is "shredded" more or less, so that free ends of hyphae project into the cavity from below and above. But since the cavity is here a weak one, there are scattered hyphae which have not become severed, but extend across the cavity from above downward or vice versa.

THE PALISADE LAYER OF HYPHAE.—The palisade layer of hyphae is present at this time, or even earlier, but the hyphae at first are slender. In the development of the pileus within the system of radiating threads, the hyphae on the margin and on the under surface which form the fundament of the hymenophore are parallel and rather closely compacted, so that the young fundament of the hymenophore has a palisade structure even before the tearing apart or shredding of the fundamental plectenchyma below, into which the hymenophore is progressing by growth. This fundament of the hymenophore stains more deeply than the fundamental plectenchyma below, or the pileus above, or the enveloping blematogen (figs. 26–35).



ORIGIN OF THE LAMELLAE.—The first evidence of the origin of the lamellae are radial salients of the hymenophore fundament, just described, which project downward (figs. 28, 31, 32, 34, 35, and 37). These salients are formed not only by the more rapid increase of the elements of the palisade layer but also by the elongation of the subadjacent trama cells of the pileus which support or bear them. The continued growth of these trama cells gives rise to the trama of the lamellae. In the early stages of the origin of the lamellae there is a striking difference in the character of the trama cells in *C. atramentarius* and those of *C. comatus*. In *C. comatus* the rather weak development of the trama hyphae in the very young lamellae, and the rather open mesh which they form, contrasts strongly with the compact tissue formed by the elongation of the trama extending from the pileus into the young gill salients of *C. atramentarius*. The compactness of the trama tissue at this time, together with the evidence of the elongation of its cells in the direction of the growth of the salients, gives the impression that this is a factor in the origin of the salients, which assists in thrusting or shoving downward the palisade tissue along the radial areas on which the young lamellae arise. The elongation of these trama cells of the pileus, subadjacent to the salients, is recognized not only by the form of the cells, but also from the fact that they stain less deeply than the intervening trama cells of the pileus subadjacent to the hymenophore (figs. 32 and 37).

Figs. 27-32, 34, and 35 are from the same basidiocarp, the sections all being parallel with the axis of the stem. Fig. 27 is from a median section; fig. 28 is tangential on one side where the young gill salients are quite distinct; fig. 29 is from the opposite side of the basidiocarp where the young hymenophore is still in the palisade condition before the appearance of the salients; fig. 31 is from the gill side, but nearer the margin of the pileus; and fig. 32 is the same more highly magnified. Fig. 34 is from a portion of the same, still more highly magnified to show the details of the palisade layer with the very earliest evidence of gill salients, 3 of which are shown. Fig. 35 is from the area of fig. 34 including the middle salient but still more highly magnified. In both figs. 34 and 35 the palisade layer of cells is very clearly shown, particularly so in fig. 35. The



ORIGIN OF THE LAMELLAE.—The first evidence of the origin of the lamellae are radial salients of the hymenophore fundament, just described, which project downward (figs. 28, 31, 32, 34, 35, and 37). These salients are formed not only by the more rapid increase of the elements of the palisade layer but also by the elongation of the subadjacent trama cells of the pileus which support or bear them. The continued growth of these trama cells gives rise to the trama of the lamellae. In the early stages of the origin of the lamellae there is a striking difference in the character of the trama cells in *C. atramentarius* and those of *C. comatus*. In *C. comatus* the rather weak development of the trama hyphae in the very young lamellae, and the rather open mesh which they form, contrasts strongly with the compact tissue formed by the elongation of the trama extending from the pileus into the young gill salients of *C. atramentarius*. The compactness of the trama tissue at this time, together with the evidence of the elongation of its cells in the direction of the growth of the salients, gives the impression that this is a factor in the origin of the salients, which assists in thrusting or shoving downward the palisade tissue along the radial areas on which the young lamellae arise. The elongation of these trama cells of the pileus, subadjacent to the salients, is recognized not only by the form of the cells, but also from the fact that they stain less deeply than the intervening trama cells of the pileus subadjacent to the hymenophore (figs. 32 and 37).

Figs. 27–32, 34, and 35 are from the same basidiocarp, the sections all being parallel with the axis of the stem. Fig. 27 is from a median section; fig. 28 is tangential on one side where the young gill salients are quite distinct; fig. 29 is from the opposite side of the basidiocarp where the young hymenophore is still in the palisade condition before the appearance of the salients; fig. 31 is from the gill side, but nearer the margin of the pileus; and fig. 32 is the same more highly magnified. Fig. 34 is from a portion of the same, still more highly magnified to show the details of the palisade layer with the very earliest evidence of gill salients, 3 of which are shown. Fig. 35 is from the area of fig. 34 including the middle salient but still more highly magnified. In both figs. 34 and 35 the palisade layer of cells is very clearly shown, particularly so in fig. 35. The



fundamental plectenchyma. In fig. 36, which is from near the margin of the young hymenophore, in a few places very slight salients are shown, but the lighter colored trama tissue is seen slightly projecting into some of them. Fig. 37 is from a section nearer the stem, where the salients have reached their greatest development in this particular basidiocarp. Here some of the salients are quite pronounced, but the palisade layer is continuous over and between them. There is no continuity of the trama of the pileus through the salients with the fundamental plectenchyma below, but the loose threads of the shredded fundamental tissue below connect indifferently with the margin of the salients or with the portions of the hymenophore between them. In the figures just cited and also in figs. 34 and 35 it is very clear that the first salients, or ridges, of the hymenophore are the fundamentals of the lamellae themselves. They do not split, and approximate halves of adjacent ridges unite to form the lamellae, as has been said to be the case in *C. micaceus* (LEVINE 22).

ATTACHMENT OF THE LAMELLAE TO THE STEM.—Since the gill cavity is weak, the lamellae become attached to the stem at quite an early stage. At or near maturity they are quite firmly attached to the stem, or the fundamental plectenchyma surrounding the stem, the edge of the lamellae for its entire thickness being very closely and compactly pressed against the surface of the stem, while the hyphae from both structures are more or less interlaced. A rather loose floccose layer of fundamental plectenchyma clothes the young stem, to which the lamellae become attached. This loose layer of irregularly interwoven hyphae is present in the mature plants, but becomes more compacted, probably because of the pressure to which it is subjected between the lamellae and stem. As the plants age, this zone of fundamental plectenchyma clothing the stem contrasts strongly with the stem structure, as seen in figs. 43 and 44.

The loose shredded character of this fundamental plectenchyma in the young basidiocarps is very favorable for the interlocking with it of the slender hyphae which grow out from the edges of the young lamellae. This interlocking of hyphae is shown in figs. 41 and 42, which represent different stages. The slender hyphae on the edge of the lamellae, pushing their way into the mesh of the



fundamental tissue, is well shown. The connection of the lamellae with the stem is still frail in these stages of development, and the distinctness of the lamellae as independent structures is very evident when considered in relation to the first salients which appear on the under surface of the hymenophore.

In the older stages the edges of the lamellae become so firmly pressed against the stem that the round edge is somewhat compressed, as shown in figs. 43 and 44. The hyphae on the extreme margin, which stain deeply in the younger stages where the connection with the stem is loose, are now crowded to one side or have lost their rich protoplasmic content, which now resides in the cells of the hymenium, with the exception of the cystidia. In order to free the lamellae from the stem, one preparation was purposely overheated in smoothing out the paraffin ribbon. The result is shown in fig. 44. In some of the lamellae the palisade layer of cells, at the point where this section was made, still extends entirely over the margin in the position which they occupied at an earlier period. In others these palisade cells have been crowded to the side. Either one or the other situation may occur on the same lamella at different points, according to location of the section, since the edge of the lamella varies throughout its length in this respect.

DECEPTIVE APPEARANCE OF SECTIONS WHERE THE FUNDAMENT OF THE HYMENOPHORE EXISTS ALSO AROUND THE UPPER END OF THE STEM.—Where the fundament of the hymenophore extends for a short distance down around the upper end of the stem, a situation is presented which may lead to error in the interpretation of the origin of the lamellae. Tangential sections parallel with the axis of the stem (or slightly oblique) made very close to the upper end of the stem present a very deceptive appearance. Such a section is shown in fig. 40, and perhaps represents a situation similar to that presented by LEVINE (22) in his figs. 13 and 14, pl. 39, of *Coprinus micaceus*. Such sections, even at a much younger stage, could very well give the impression that the trama of the gills at this time consisted of fundamental elements connected both with the pileus and stem; that the ridges or pockets between them gave rise to the hymenium, the latter structures splitting along a median line and approximate halves of adjacent ridges or pockets uniting to



form the gills. An examination of this situation, however, shows that, since the fundament of the hymenophore descends a short distance on the stem, when the first salients of the primary lamellae arise, they are present on the stem and continue over the angle on the under surface of the pileus. As these salients broaden into the young lamellae, little "stalls" or pockets lie between them in the angle between the apex of the stem and pileus. Longitudinal sec-

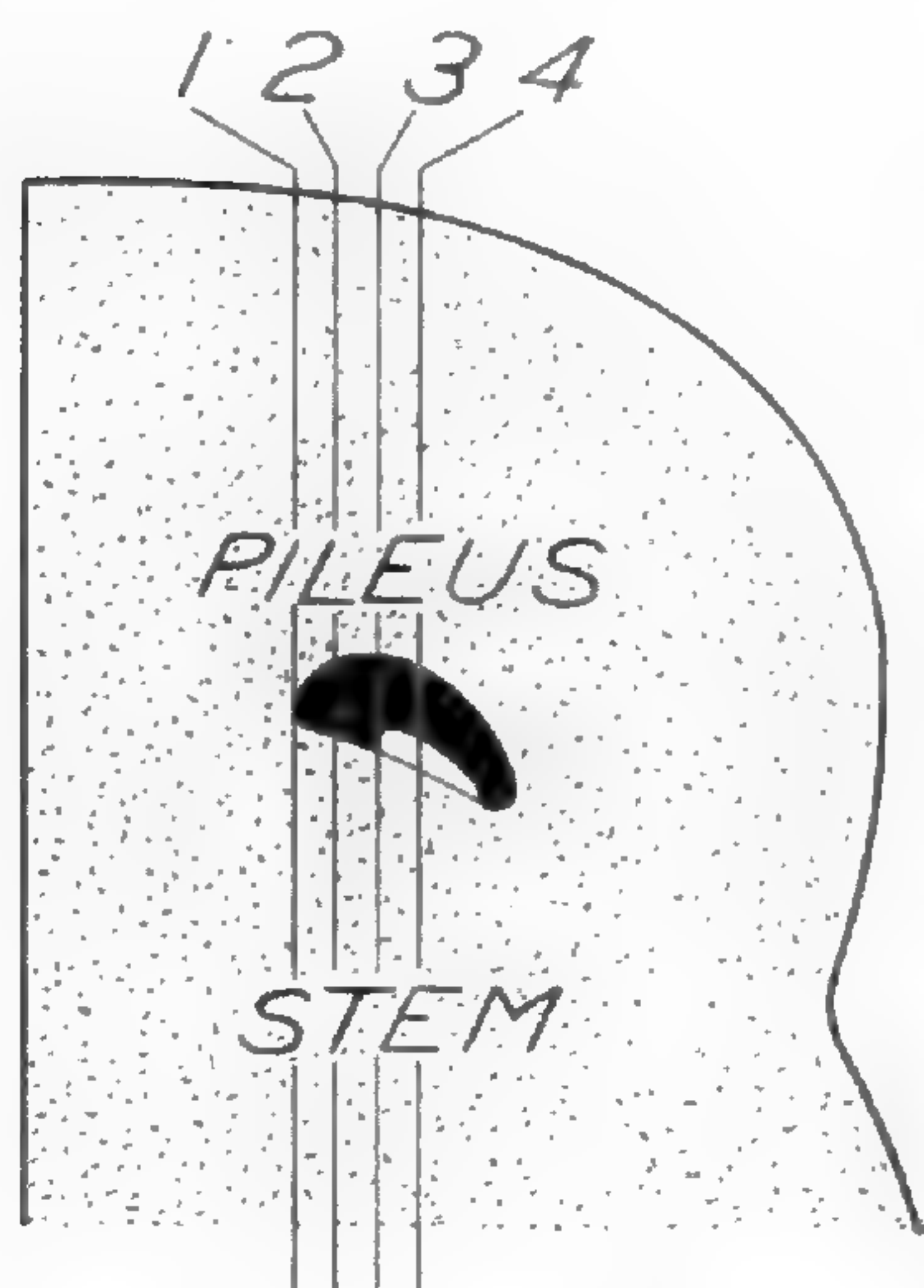

DIAGRAM VI.—Lateral view through one side of young basidiocarp of *C. atramentarius* with "adnate" gills; gill origins extend down on apex of stem, leaving little "stalls" or pockets between them in angle between apex of stem and pileus; sections at 1, 2, and 3 are across these "stalls" but through gill origins both "above and below" (see fig. 40).

the same situation is present in some individuals of *Agricus rodmani*.

CYSTIDIA.—No special effort has been made to study the cystidia, but their presence and relation in sections of medium and nearly mature plants was so striking as to excite interest and some observation. When the lamellae are quite well advanced, but still moderately young, the cystidia are quite numerous and

tions in this region will cut across the "stalls," and at this stage, when the stem surface slopes outward strongly, will be parallel to a tangent of the curved or angled lamellae, and will show the attachment of the trama not only to the pileus above but to the stem below. Such sections are perpendicular to the origin and direction of growth of the lamellae. Diagram VI illustrates the situation in question. Plants with adnate or decurrent lamellae are very favorable subjects for obtaining such deceptive sections. As stated previously therefore, *C. comatus* is a very favorable object for studying the origin of the lamellae, since the gills in all stages of development are so distant from the apex of the stem. A situation similar to that represented in fig. 40 may even be presented by species with "free" gills, since there is often variation in individuals in respect to "free" or "adnexed" gills.

In another paper I shall show that



very close together in the hymenium, as shown in fig. 42. At this stage of development the approximate hymenia of two adjacent lamellae are still more or less separated, showing distinct gill chambers, but the numerous cystidia already project above the level of the young basidial hymenium. At certain places two cystidia from opposite hymenia meet head on and the pressure sometimes results in a deformity of one or both. Even at this stage of development it can be seen that many of the cystidia originate below the subhymenium. In this respect my observations do not agree with those of BULLER (12a), who describes and figures the cystidia of *C. atramentarius* as arising from the small subhymenial cells at the same level as the origin of the basidia.

In older stages of the lamellae (figs. 44 and 45) the approximate hymenia of adjacent lamellae become very closely crowded together, so that the gill chambers are entirely obliterated. The hymenia are very compact and deeply stained, while the trama presents a loose open mesh and is lightly stained. One of the striking features at this stage is the appearance of the cystidia in cross-sections of the gills. With low magnification they appear as quite regularly spaced clear areas, oblong or elliptical in outline, lying directly across the two approximate hymenia. With low magnification it is often difficult or impossible to determine from which lamellae a given cystidium originates. With higher magnification one can readily determine the lamella from which they arise. Now it is very clear that many of them, at least, originate from hyphae of the trama below the subhymenium. I have not examined the situation thoroughly enough to make any general statement. It is possible that some of them may arise from subhymenial cells on a level with the origin of the basidia, as BULLER states, but it is very certain that many of them originate in the trama. In fig. 45 a cystidium is shown which originates from the middle of the trama.

During the growth of the cystidia they push their way into the hymenium of the adjacent lamella, according to my observations, much farther than illustrated by BULLER. The one shown in fig. 45 has pushed through the hymenium of the adjacent gill. Many of them reach this distance and some even extend into the



subhymenium or trama. As BULLER has stated, their hold upon the adjacent lamella is so strong that it is difficult or impossible to separate the lamellae without tearing. In an endeavor to separate the lamella in the paraffin ribbon at the stage of development shown in fig. 45, while smoothing it out on the slide, I have tried overheating the ribbon. In all cases the lamellae were torn open through the trama, the adjacent hymenia remaining as firmly bound together as ever. While at this stage of development the adjacent hymenia are in close contact so that the gill chambers are obliterated, at the time of shedding the spores the lamellae are spaced and the gill chambers are again apparent. The moving apart of the gills is very likely brought about by the elongation of the cystidia, for they are very much longer at maturity than at the stage shown in fig. 45.

### Study of *Corpinus micaceus*

The very young basidiocarps are oval or oboval in form. In the youngest ones sectioned, the young lamellae were already present as slight salients of the hymenophore extending from the stem outward to near the young hymenophore margin. As shown in figs. 46-49, the relation of the pileus and blematogen is of the *Coprinus* type, the blematogen covering the pileus consisting of radiating hyphae whose cells have swollen mostly into globose forms. As they age the hyphae fall apart, forming a more or less powdery material which adheres in small flocculent masses or flakes, and in the light glisten to such an extent that they have suggested the glistening of mica flakes, which easily fall away by friction from foreign substances.

FORMATION OF A PALISADE LAYER ON THE OUTER SURFACE OF THE PILEUS.—At quite an early stage in the development of the pileus, the hyphae on the upper surface grow in an irregularly radial direction within the inner portion of the blematogen. This can be seen in basidiocarps of the stage presented in fig. 68, which is a somewhat more highly magnified photomicrograph of a section from the same basidiocarp as fig. 46. On the surface of the pileus can be seen faint indications of the radiating, more deeply stained, hyphae. In a slightly older stage (fig. 69) they form a more com-



pact even layer. In fig. 70, from a still older basidiocarp, it can be very clearly seen that the surface hyphae of the pileus form a compact palisade layer below the zone of large blematogen cells, though the ends of the hyphae are not yet aligned into such an even surface as they present later. Many of these hyphae represent new growth and branching of the earlier elements of the inner, but not well defined, zone of radiating threads, and possibly some of these older elements are incorporated in the palisade layer. Whether any of them take part in the formation of the mature palisade by abscission of the distal portion at the level of the palisade surface, however, or whether all are compressed between the broadening cells of the forming palisade and are thus merely pinched off, as stated below, has not been determined. The incorporation of some of the older hyphae into the palisade does not seem improbable.

The surface of the pileus is already beginning to show the strong folds with intervening depressions ("striations") over certain of the older lamellae, which is clearly presented in the nearly, or quite, mature plant. At the completion, or maturity, of the palisade layer on the outer surface of the pileus, the cells are clavate, very closely packed side by side, the free ends slightly convex or nearly truncate (fig. 71). In this figure the broad folds with the narrow intervening depressions are clearly brought out in cross-section, the depressions, or "striations" as they are called, correlated in their position with the trama of the older, or primary, gills, so characteristic a feature of many species of *Coprinus*.

**SHEDDING OF THE BLEMATOGEN LAYER.**—In the shedding of the blematogen layer the greater part of the mass of rounded cells is freed by the frail connection between the cells, perhaps due to a weakening of the middle lamella accompanied by the rounding of the cells and constriction between them. The chains of rounded cells are formed on filaments of a few slender cells, some of which project from between the cells of the palisade layer (a few can be seen near the middle of fig. 69). As the palisade layer approaches maturity, the crowding of the cells into the compact layer very probably pinches off these slender supporting hyphae. A thorough study of the shedding of the blematogen has not been made, but it



is clear that the process is different from that which occurs in *Amanitopsis vaginata* (see ATKINSON 10) and *Amanita volvata* Peck, where the outer surface of the pileus primordium, by gelatinization, or other means of disintegration in *A. volvata*, forms a cleavage layer, thus freeing the blematogen, which then becomes the volva or teleoblem. In *Amanita muscaria* a similar cleavage layer is formed by gelatinization of the outer layer of the pileus, as described by BREFELD (12, p. 125).

The method of separation of the blematogen from the pileus in *C. micaceus* is different, therefore, from that in the species of *Amanitopsis* and *Amanita* just mentioned, and very likely in many other species of *Amanita* which as yet have not been studied in respect to this feature. The method of separation of the blematogen in other species of *Coprinus* and *Amanita* should be examined, particularly viscid species of *Coprinus*, and species of *Amanita* with a dry powdery volva. In some of the latter the pileus is viscid when fresh, and it is likely that a cleavage layer is formed by the gelatinization or other method of disintegration of the outer layer of the pileus.

THE GENERAL, ANNULAR, PRELAMELLAR CAVITY.—The general annular gill cavity in *C. micaceus* is formed in the same way as described for *C. atramentarius*. It is also weakly developed as in that species. The tensions resulting from the differences in growth tear apart and shred the ground tissue immediately below the fundament of the hymenophore. Scattered threads here and there extend across the cavity, connecting with the palisade layer of the hymenophore fundament not only at points where the first salients of the lamellae arise but also between them.

ORIGIN OF THE LAMELLAE.—Since the organization and development of the fundament of the hymenophore and of the lamellae origins proceed in a centrifugal direction following the centrifugal growth of the pileus margin, the presence of the palisade layer of the hymenophore fundament, as well as the origin of the lamellae, can be observed near the margin of the pileus in tangential sections parallel with the axis of the stem. The older stages of the gills can then be traced in the serial sections passing up to the stem. The youngest basidiocarp studied is represented in longitudinal



section through the stem (parallel with its axis) in figs. 46 and 47. Fig. 46 is from a section near the middle of the stem, while fig. 47 is near the surface of the stem at its junction with the hymenophore, but still including a considerable portion of the stem at this place. The young lamellae in fig. 47, therefore, are cut somewhat obliquely, but the margins present their relative position in relation to the gill cavity and the fundamental plectenchyma below clothing the stem.

Four serial sections beginning near the margin of the hymenophore and traveling toward the stem are shown. Fig. 52 is near the margin of the young hymenophore, and shows not only the palisade layer of the same but the general gill cavity preceding the origin of the lamellae. In fig. 53 the first evidence of the salients or fundaments of the lamellae are seen, resulting in a slight undulation of the palisade surface of the young hymenophore. A few of the stray hyphae extending across the general gill cavity are connected with some of the gill salients, while others are connected with the portion of the hymenophore between the salients. Above a few of the salients the hyphae of the trama are lighter colored because of their lessened protoplasmic content resulting from their elongation, which assists in pushing down the salient. In fig. 54 the salients or ridges are still more prominent. Portions of loose threads from the shredded fundamental plectenchyma below are loosely connected with some of the salients, and others with the palisade portion of the hymenophore between them, especially the younger portions at either side of the section. Fig. 55 represents a still older stage of the young lamellae. In this section the margins of the lamellae show a feature which is quite characteristic of the very young lamellae of *C. micaceus*. This is the lateral spreading or fan-tailing of the margin, caused by the outward curving of the hyphae, and particularly by the swelling of the marginal cells into subglobose or pyriform bodies, which is probably largely responsible for this fan-tailing of the young gill margins. These swollen cells form cystidia.

As the lamellae become broader they press more and more upon the loose fundamental tissue beneath. The swollen cells on the margin of the young lamellae, pressed against the loose tissue



below, simulate fundamental elements, and if care is not used in searching for younger stages of the lamellae, might easily lead one into error in the interpretation of their origin. All of these features are more strongly emphasized in figs. 56-63, from an older basidiocarp, which represent somewhat older stages of development of the lamellae. The lighter coloring of the trama, the fan-tailing of the lamellae, and numerous swollen cystidia on and near their margins are very clearly shown. At this stage of development one might be misled as to the true origin of the lamellae unless the origin of these structures was sought in earlier stages.

From a study of the situation presented by these figures it is very clear that the first salients, or ridges, on the under side of the pileus, are from the young hymenophore palisade layer, just as they are in *C. comatus* and *C. atramentarius* previously described. The first ridges which appear are the fundamentals of the lamellae themselves. They do not arise as isolated ridges of cylindrical or clavate cells, in the fundamental plectenchyma, and then split, the halves separating and those of adjacent ridges then uniting to form the gills, as described for *C. micaceus* by LEVINE (22). The photomicrographs represented in his figs. 13 and 14 present very strong evidence of being sections through the adnate portions of the lamellae close to the stem, as I have already described for *C. atramentarius* and represented in fig. 40. At this stage in the development of the basidiocarp, the outer surface of the stem is strongly oblique or nearly horizontal, and several serial sections in this region would present the appearance shown in the figures in those cases where the gill origins are on the apex of the stem as well as on the under side of the pileus. At any rate, these figures represent an old stage in the development of the lamellae, and if this peculiar structure had been traced to its origin, the origin of the lamellae would have been found. Even if there were no general, annular, prelamellar cavity formed in certain individuals, or if it should be insisted that the weak cavities where, in the shredding of the ground tissue, some scattered hyphae or loose strands extend across, are not general, annular, prelamellar cavities, the first ridges or salients to appear are nevertheless the fundamentals of the lamellae; in other words, they are the gill origins. BREFELD was



right when he said in regard to the origin of the lamellae of *C. lagopus* that they arise as new, free vegetation points on the under surface of the pileus and continue through apical growth (12, p. 127). It should be said, however, that growth continues throughout the width of the lamellae and of the palisade layer.

Besides the clear evidence just presented as to the origin of the lamellae in *C. micaceus*, there are other considerations which support the conclusion just arrived at. These are (1) the method of origin of the secondary lamellae; (2) the lack of fundamental elements in the trama; and (3) the freedom of the primary and secondary lamellae, under normal conditions, from each other, during all stages of development.

ORIGIN OF SECONDARY LAMELLAE.—By “secondary” lamellae is meant those which arise later than the primary or first lamellae. The secondary lamellae are the shorter ones which are inserted in the space formed by the divergence of the primary ones as they extend farther from the stem. Because of the centrifugal growth and organization of the pileus, young hymenophore, and gill origins, by which the younger, or later, origins of these morphological elements appear successively in a centrifugal direction, and thus farther and farther from the stem, it will be seen that the secondary and later lamellae originate later than the primary ones, provided they are appreciably shorter than the latter. In comparatively young basidiocarps cross-sections of the hymenophore with young lamellae usually show that the secondary lamellae are narrower throughout their entire length than the primary lamellae. Some of them later become connected with the stem, while others do not.

A series of tangential sections perpendicular to the lamellae and parallel with the axis of the stem, in a comparatively young basidiocarp, the knife traveling away from the stem toward the margin of the pileus, will show the origin and different stages of development of a secondary lamella. The ends of the secondary lamellae toward the stem are arrested in development because the space is here more cramped than farther away where the primary lamellae are farther apart. Figs. 56–61 are from 6 such serial sections. A “landmark,” or indicator, was selected, so that in making the photomicrographs the two primary lamellae between which



the secondary one arises could be readily located. The landmark selected is at the right in fig. 56, where there is a primary lamella and at its left a secondary one quite well developed but close to it. Following this in the successive figures up to fig. 61, it will be seen that the two become closer and closer, until both have the same trama at their junction with the pileus and appear like a double lamella, since in this region the secondary lamella evidently sprouted out of the base of the primary one. Now the area which we wish to observe for the origin of a secondary lamella, as the primary ones diverge more and more, is between the second and third primary lamella to the left of this "double" lamella. This space is between the two primary lamellae at the left of the figure. The secondary lamella originates as a salient from the palisade layer of the hymenophore between the two primary lamellae. In fig. 57 this space is broader. In fig. 58 there is seen a slight salient, some of the marginal cells of which have swollen into cystidia. Then in figs. 59, 60, and 61 it is more and more pronounced, showing the same features as the primary lamellae, but is much narrower, and because of the greater width of the primary lamellae its margin is held away from the fundamental plectenchyma below, except in figs. 60 and 61, where it is coming in contact with a few loose threads.

THE LACK OF FUNDAMENTAL PLECTENCHYMA IN THE TRAMA OF THE LAMELLAE.—If the lamellae originated as described for *C. micaeus* (LEVINE 22), by the splitting of primary structures which form a series of radiating ridges isolated by fundamental plectenchyma or elements, then, as the approximate halves of two adjacent ridges turn toward each other to form a lamella, they would inclose some of these fundamental elements between the pileus trama and the trama of the lamella. There would be small islands of fundamental plectenchyma extending along the entire length in the base of each lamella. This is not the case. On the other hand, all the evidence goes to show that the trama is newly formed tissue and grows downward from the trama of the pileus into the lamella, and this is evident from the earliest origin of the first salients or ridges, the trama lying in the ridges, not between them. For this reason we may find, when we come to study carefully the origin of the lamellae in *Amanita* and *Amanitopsis*, that the *method of origin* is not



so very different from that presented by what I have spoken of as the *Agaricus* type. The trama of the gills suggests that the primordial trabeculae, which have thus far been the earliest observed structures, in the differentiation of the hymenophore, may originate as parallel, closely approximated thin areas of hyphal growth which remain very closely side by side until the sharper differentiation in the hymenophore appears with the formation of the palisade layers.

THE PRIMARY AND SECONDARY LAMELLAE ARE FREE THROUGHOUT THEIR DEVELOPMENT, UNDER NORMAL CONDITIONS.—If in the origin of the lamellae they were preceded by a series of isolated radial ridges with intervening areas of fundamental elements, the fundamental plectenchyma, or elements, would be continuous around these isolated ridges. Then in the later formation of the lamellae, by the splitting and parting of these ridges, tangential sections parallel with the axis of the stem would show the "trama" of the forming secondary lamellae continuous with that of the adjacent primary lamellae, as well as with the stem, until a stage of development was reached in which these connections were torn free. Such a condition is never found in normally developed plants. The secondary lamellae are free from the primary ones in all stages of development where the lamellae are normal. It not infrequently happens that the tramae of two adjacent lamellae are connected at or near the pileus, as when a secondary lamella sprouts out from the side of the base of a slightly older lamella, as shown in fig. 60, instead of sprouting out midway between two adjacent lamellae. But in these cases, also, there is no communication between the tramae of adjacent secondary and primary lamellae through their margins, as there would be at certain stages of their development if the lamellae originated as described by LEVINE.

ATTACHMENT OF THE LAMELLAE TO THE STEM.—The attachment of the lamellae to the stem in *C. micaceus* takes place in very much the same manner as described for *C. atramentarius*. The variation in details can be ascribed to specific differences. At the early origin of the lamellae the margin of the salients in cross-sections may be entirely free, or may be connected by isolated hyphae, or loose strands, across the weak annular gill activity, with the fundamental plectenchyma below on the surface of the stem, as previously



described. A spreading or fan-tailing of the margins of the lamellae immediately takes place, largely due to a swelling of the marginal palisade into cystidia-like structures. It is this fan-tailing of the gills, accompanied by the swelling of the marginal palisade cells of the young salients into cystidia-like structures, which leads to the situation observed by LEVINE (22, p. 351) in his fig. 8, of which he says that the palisade cells do not inclose the edge of a gill, but form an arched palisade layer in each "gill chamber" (22, p. 356). Exactly such a situation is shown in figs. 56-63 of the present article. The palisade layer no longer is present over the margins of these gills because at an early stage of the gill origins the palisade cells inclosing the edges of the salients become swollen into cystidia. Figs. 8, 13, and 14 of LEVINE'S paper represent quite old stages in the development of the gills.

Because of the weak annular gill cavity, the broadening of the lamellae by growth soon brings them in closer contact with the stem, or the rather thin layer of fundamental plectenchyma which clothes the stem. Because of the loose and shredded character of this fundamental plectenchyma, the loose hyphae readily interlock with the swollen marginal cells of the lamellae, and with isolated hyphae which grow down from the marginal trama of the lamellae. The frazzled layer of fundamental plectenchyma on the surface of the stem is much thinner in *C. micaceus* than in *C. atramentarius*. For this reason the round or angular cells of the stem surface very soon come in contact with the trama of the lamellae as the surface cells are spread laterally by the increasing pressure of contact. There is, therefore, a wedging together, to a greater or less extent, of the trama and stem cells which often presents the appearance of pseudoparenchyma. The different stages are represented in figs. 55-63 and 65-67.

The attachment of the lamellae to the stem, therefore, is a gradual process, proceeding from the young to the older stages of the lamellae and basidiocarp. It is interesting to note that LEVINE'S fig. 8 represents the weak annular gill cavity, below the margins of the gills, which are loosely connected by isolated hyphae or loose strands extending across the cavity to the stem, or the layer of fundamental plectenchyma on its surface. It represents very



much the same situation as is presented by my fig. 50, except that the latter is nearer the stem, so that a few of the lamellae in the middle of the figure are in close contact with the stem. If the gills originated as described by LEVINE, then they could remain firmly connected with the stem until in age they become free with the expansion of the plant. They would not show during the young stage the loose connection across a weak, general annular gill cavity which is evident from his fig. 8. In fig. 51 the elements of the margins of the primary lamellae are interlocking with the fundamental plectenchyma on the stem surface, better shown in figs. 56-63, more highly magnified. The later stages are shown in figs. 65-67. Fig. 64 is from a section of the entire fruit body at quite an advanced stage of development, when the gills are finally firmly connected with the surface of the stem. The stem here shows a number of lysigenous cavities. Figs. 66 and 67, more highly magnified, from the same basidiocarp, show the close connection of the trama with the stem.

### Summary

I. GENERAL ORGANIZATION OF THE BASIDIOCARP.—In the young basidiocarps the pileus is organized in the region of the convergence of radially growing hyphae which arise from the apex of the basidiocarp fundament. The primordium of the pileus also grows in a radial direction, both upward and in a lateral and slightly downward direction, over the broad and nearly horizontal surface of the young stem fundament. The growth of the pileus is more rapid in the lateral centrifugal direction, and the hyphae here are richer in protoplasmic content. The zone of radial hyphae enveloping the pileus is the blematogen. In *Coprinus comatus* and *C. atramentarius* the radial hyphae of the blematogen layer retain their filamentous character and the blematogen is persistent, being concrete with the pileus, and therefore does not separate as a distinct volva or teleoblem. In *C. micaceus* the radial hyphae of the blematogen change at a very early period into branched chains of oval and globose cells. Profuse disarticulation of the chains takes place, forming a somewhat powdery material on the surface of the pileus. The outer surface layer of the pileus forms a



distinct palisade zone of cells which at maturity become so compactly crowded together that any remaining slender supporting hyphae of the chains of rounded cells are pinched off. The blematogen in *C. micaceus*, therefore, becomes free from the pileus in the form of mica-like flakes, which are easily removed; but the blematogen is set free in a different manner from the cleavage process occurring in species of *Amanita* and *Amanitopsis* which have been studied with respect to this feature. In *C. micaceus* the outer surface of the pileus remains intact, and the blematogen is freed by scaling off, or "desquamation" as interpreted by DEBARY.

2. THE GENERAL, ANNULAR, PRELAMELLAR CAVITY is formed by a tearing apart of the fundamental plectenchyma in the angle between the pileus and stem fundaments, due to tension resulting from differences in rapidity of growth. For this reason the tissue surrounding the cavity is at first more or less shredded. The cavity is relatively large in *C. comatus*, and weak or very weak in *C. atramentarius* and *C. micaceus*. In the two latter species, during the tearing or shredding of the fundamental plectenchyma, isolated hyphae or loose strands of a few hyphae extend across the cavity here and there because of its weakness.

3. THE PALISADE LAYER OF THE YOUNG HYMENOPHORE begins its formation near, at, or upon the apex of the stem, and then proceeds outward in a centrifugal direction over the under surface of the pileus, following the centrifugal growth of the latter. In *C. comatus* the palisade layer begins some distance from the apex of the stem, since there is a circular sterile area on the under surface of the pileus next to the stem. In *C. atramentarius* and *C. micaceus* it begins at the apex of the stem fundament and then proceeds outward in a centrifugal manner. In some cases it extends a short distance down the surface of the stem apex. In these species it may be organized before or at the time of the formation of the weak gill cavity.

4. THE LAMELLAE ORIGINATE AS DOWNWARD PROJECTING SALIENTS of the palisade hymenophore fundament, in a series radiating outward toward the margin of the pileus, the younger portions of the salients being toward the margin of the pileus and continuing



to arise in a centrifugal direction, following up the progressive development in the same direction of the palisade hymenophore, cavity, and pileus margin. The salients are formed by increase and enlargement of the elements of the palisade layer along these radial areas and by the downward growth of the subadjacent trama cells of the pileus. The lamellae increase in width by apical and also by intercalary growth.

5. THE ATTACHMENT OF THE GILL MARGINS TO THE STEM takes place after the origin of the gills. It begins when the gill margins come in contact with the stem, or the fundamental plectenchyma surrounding the stem. The age and breadth of the lamellae when the attachment begins varies in the different species and in different individuals, according to the strength of the general gill cavity and the proximity of the gill to the margin of the nearly mature pileus, where the space may be more cramped.

In *Coprinus comatus* the lamellae may become quite broad before they begin their attachment, except at the extreme margin of the pileus. Before they begin to form the attachment with the stem, the palisade layer is continuous over the margin, the palisade cells here not being differentiated from those on the sides. After they have been in contact with the stem surface for some time many of the marginal cells are spread laterally by the pressure. Others, together with short hypha from the end of the trama, interlace lightly with the open meshed plectenchyma on the surface of the stem.

In *Coprinus atramentarius*, since the general gill cavity is weak, the young salients, as well as the intervening spaces, are connected here and there by isolated hyphae, or loose hyphal strands which were not ruptured during the tearing apart of the fundamental plectenchyma below the young hymenophore palisade. The palisade layer extends over the margin of the young salients. As the lamellae broaden, the margins press against and into the loose ragged surface of the fundamental plectenchyma on the surface of the stem. Short slender threads from the margins grow outward and interlock with this fundamental plectenchyma. As the pressure becomes greater, many of the palisade cells are pressed laterally so that there is a partial connection of the trama ends with



the fundamental plectenchyma on the surface of the stem. Since the gill origins are more or less adnate to the stem in different individuals, sections parallel with the axis of the stem and passing through these origins on the apex of the stem, in the angle between pileus and stem, may lead to error in the interpretation of the gill origins, since the trama, arising here from the stem as well as from the pileus, is attached to both. The sections then present pockets or "stalls," with the palisade layer converging toward their centers. As soon as the sections pass beyond the portions arising from the stem apex, the relation of the gills to the pileus presents the normal appearance.

In *Coprinus micaceus*, because of the weak, general gill cavity, isolated hyphae and loose strands remain attached here and there, not only to the gill origins but to the portion of the hymenophore between them in the early stages of the salients, or gill origins. The palisade layer of the hymenophore is continuous over their margins, but very soon the marginal cells swell into globose or broadly clavate cystidia, and by the crowding of these cells the margins of the gills spread laterally, or fan-tail. The protoplasmic content in the marginal cells being thus diluted, the margin of the gill does not stain deeply. The gill margins soon press against the thin layer of fundamental plectenchyma on the surface of the stem. There is an interlocking of hyphae and also an interwedging of the marginal cells of the gills and trama with the surface cells of the stem.

6. THE CYSTIDIA have not been thoroughly examined in this study, since they did not come within the limits of the special problem undertaken at this time. Furthermore, their thorough study would require examination also of material in the fresh condition, at the time of the separation of the gills from the stem. But it has been observed that many at least of the cystidia in *Coprinus atramentarius* arise from cells of the trama beneath the subhymenium.

CORNELL UNIVERSITY  
ITHACA, N.Y.

#### LITERATURE CITED

1. ALLEN, CAROLINE L., The development of some species of *Hypholoma*. *Ann. Mycol.* 4:387-394. pls. 5-7. 1906.



2. ATKINSON, GEO. F., Studies of American fungi, mushrooms, edible, poisonous, etc. 1st ed. I-VI. 1-275. pls. 76. figs. 223. Ithaca, N.Y. 1900.
3. ———, *ibid.* 2d ed. I-VI. 1-322. pls. 86. figs. 250. Ithaca, N.Y. 1901.
4. ———, *ibid.* New York. 1903.
5. ———, The development of *Agaricus campestris*. BOT. GAZ. 42:241-264. pls. 7-12. 1906.
6. ———, The development of *Agaricus arvensis* and *A. comtulus*. Amer. Jour. Bot. 1:3-22. pls. 1, 2. 1914.
7. ———, The development of *Armillaria mellea*. Mycol. Centralbl. 4:112-121. pls. 1, 2. 1914.
8. ———, Homology of the universal veil in *Agaricus*. Mycol. Centralbl. 5:13-19. pls. 1-3. 1914.
9. ———, The development of *Lepiota clypeolaria*. Ann. Mycol. 12:346-356. pls. 13-16. 1914.
10. ———, The development of *Amanitopsis vaginata*. Ann. Mycol. 12:369-392. pls. 17-19. 1914.
11. BEER, R., Notes on the development of the carpophore of some Agaricaceae. Ann. Botany 25:683-689. pl. 52. 1911.
12. BREFELD, O., Botanische Untersuchungen über Schimmelpilze 3: Basidiomyceten I. I-IV. 1-226. pls. 1-11. 1877.
- 12a. BULLER, A. H. R., The function and fate of the cystidia of *Coprinus atramentarius*, together with some general remarks on *Coprinus* fruit bodies. Ann. Botany 24:613-629. pls. 50, 51. 1910.
13. DEBARY, A., Zur Kenntniss einiger Agaricinen. Bot. Zeit. 17:385-388, 393-398, 401-404. pl. 13. 1859.
14. ———, Morphologie und Physiologie der Pilze, Flechten, und Myxomyceten. Leipzig. 1866.
15. ———, Vergleichende Morphologie und Biologie der Pilze, Mycetozen, und Bakterien. 1884.
16. ———, Comparative morphology and biology of the fungi, mycetozoa, and bacteria. Oxford. 1887.
17. FAYOD, V., Prodrome d'une histoire naturelle des Agaricinées. Ann. Sci. Nat. Bot. VII. 9:181-411. pls. 6, 7. 1889.
18. FISCHER, C. C. E., On the development of the fructification of *Armillaria mucida* Schrad. Ann. Botany 23:503-507. pl. 35. 1909.
19. HOFFMANN, H., Die Pollinarien und Spermatien von *Agaricus*. Bot. Zeit. 14:137-148, 153-163. pl. 5. 1856.
20. ———, Beiträge zur Entwicklungsgeschichte und Anatomie der Agaricinen. Bot. Zeit. 18:389-395, 397-404. pls. 13, 14. 1860.
21. ———, Icones Analyticae Fungorum, Abbildungen und Beschreibungen von Pilzen mit besonderer Rücksicht auf Anatomie und Entwicklungsgeschichte. pp. 105. pls. 24. 1861.



22. LEVINE, M., The origin and development of the lamellae in *Coprinus micaceus*. Amer. Jour. Bot. 1:343-356. pls. 39, 49. 1914.
23. ZELLER, S. M., The development of *Stropharia ambigua*. Mycologia 6:139-145. pls. 124, 125. 1914.

### EXPLANATION OF PLATES V-XII

Pl. VI is not reduced; the other plates are reduced as follows: pl. VII to  $\frac{1}{11}$  of the diameter of the photomicrographs; pls. IX, X, and XI to  $\frac{2}{3}$ ; pls. V, VIII, and XII to  $\frac{5}{7}$ . Magnifications are given in connection with descriptions of figures. The photomicrographs were made by the author, 9 of them with Spencer Lens Co. 16 mm. photo lens and Zeiss camera, the remainder with Zeiss microscope and Leitz simple camera stand.

#### PLATES V-VII

FIGS. 1-25.—*Coprinus comatus*.

FIG. 1.—One side of section of upper end of young basidiocarp before formation of annular gill cavity and young hymenophore; constriction at right indicates delimitation of pileus and stem; no internal differentiation apparent, but radiating system of threads marks blematogen;  $\times 30$ .

FIG. 2.—Another basidiocarp representing an older stage, the section being median or nearly so, and parallel with axis of stem; annular cavity, therefore, present in section as two cavities, one on each side of stem; deeply staining tissue above cavity is young hymenophore before formation of palisade layer; *p*, pileus; *b*, blematogen;  $\times 30$ .

FIG. 3.—Tangential section from same basidiocarp in which annular gill cavity shows as a transversely elongated opening a few threads of the shredded tissue extending across;  $\times 30$ .

FIG. 4.—Tangential section of another basidiocarp parallel with axis of stem; annular gill cavity showing as transversely elongated cavity; palisade layer not yet formed over any portion of surface, and surface still in frazzled condition, resulting from tearing apart of fundamental plectenchyma; fundament of hymenophore indicated by more deeply staining tissue above at each side;  $\times 50$ .

FIG. 5.—Left side of fig. 4 more highly magnified;  $\times 80$ .

FIG. 6.—Still more highly magnified detail of frazzled roof of cavity in another section from same plant; loose hyphae of fundamental plectenchyma below;  $\times 500$ .

FIG. 7.—One side of median longitudinal section of a basidiocarp in which palisade layer is forming; blematogen at right; young palisade hymenophore above annular gill cavity;  $\times 50$ .

FIG. 8.—Same from another section slightly more magnified; a few threads from shredded tissue extending across cavity; young hymenophore above; dark area at right represents surface of pileus, with blematogen at its right;  $\times 80$ .

FIG. 9.—Tangential and longitudinal section of same basidiocarp just passing out of stem surface with some frazzled fundamental plectenchyma on



surface of stem showing in middle portion; young hymenophore palisade above on each side;  $\times 50$ .

FIG. 10.—Tangential section of same basidiocarp, but farther from stem, showing young hymenophore palisade above;  $\times 135$ .

FIGS. 11–16.—Longitudinal sections of another basidiocarp, parallel with stem axis; see text diagrams for position of sections.

FIG. 11.—One side of median section showing large annular gill cavity; roof at right (next stem) sterile; over center the primordia of lamellae forming (details shown in figs. 13–16); left of center young hymenophore palisade which also extends downward; *p*, pileus; *b*, blematogen;  $\times 45$ .

FIG. 12.—Tangential section through palisade portion beyond gill salients, that is, toward margin of pileus; by their radial or centrifugal growth gill salients would later push down from this palisade;  $\times 45$ .

FIG. 13.—Tangential section nearer stem, showing over middle portion cross-sections of young gill salients; on each side palisade layer, farther from stem, over which gill salients appear later;  $\times 45$ .

FIG. 14.—Tangential section still nearer stem; gill salients over middle portion less prominent than those on each side; section passing through them at point where they originate just beyond sterile area next stem; toward margin of pileus on each side is young hymenophore palisade;  $\times 45$ .

FIG. 15.—Tangential section still nearer stem, middle portion passing through sterile area; on each side, farther from stem, young gill salients, and nearer margin of pileus young hymenophore palisade;  $\times 45$ .

FIG. 16.—Portion of tangential section near that of fig. 13 showing details, on one side, of young hymenophore palisade and young gill salients;  $\times 160$ .

FIG. 17.—Median longitudinal section of another and slightly older basidiocarp, somewhat tangential to middle line, so that young gill salients are cut somewhat obliquely; note large gill cavity; *p*, pileus; *b*, blematogen;  $\times 50$ .

FIG. 18.—Tangential section of same beyond stem, showing cross-section of young gill salients;  $\times 35$ .

FIG. 19.—Portion of still older basidiocarp, nearly transverse to stem, showing at one side transition from gill salients to young hymenophore palisade and frazzled stage of young hymenophore next margin of pileus; note palisade layer extending over margin of gill salients as it does in all younger stages;  $\times 200$ .

FIGS. 20–22.—Tangential sections parallel with axis of stem, but through curvature of pileus, and “back” or dorsum of the gills, lateral portion of pileus at this stage being nearly parallel with stem, the margin curved inward by epinasty; in fig. 20 section is nearer stem, so that middle gills are free at lower extremity; in figs. 20 and 22, successively nearer pileus, all gills are cut through dorsal portion;  $\times 40$ .

FIGS. 23, 24.—Sections nearly transverse to stem of basidiocarp, showing method of attachment of margin of gills to stem; pressure of margin of gills against stem, or fundamental plectenchyma on its surface, presses some marginally palisade cells laterally, while others, as well as some trama cells,



interlock with open mesh of stem surface or covering; in fig. 24 one gill has slightly withdrawn;  $\times 300$ .

FIG. 25.—Portion of section from nearly mature basidiocarp showing attachment (below) of gill margins to stem;  $\times 35$ .

PLATES VIII AND IX

FIGS. 26–45.—*Coprinus atramentarius*.

FIG. 26.—Slightly oblique section through stem and pileus at stage of young hymenophore palisade, showing weak general annular gill cavity on each side; blematogen very distinctly marked off from pileus; in this basidiocarp surface of young hymenophore rises at oblique angle from axis of stem;  $\times 40$ .

FIG. 27.—Median longitudinal section showing weak general annular gill cavity; *p*, pileus; *b*, blematogen;  $\times 70$ .

FIG. 28.—Tangential section of same, showing gill origins on this side of plant;  $\times 70$ .

FIG. 29.—Same plant, but section on other side of stem where hymenophore is younger and in palisade stage; note weak gill cavity;  $\times 70$ .

FIG. 30.—Same but tangential section through surface of stem;  $\times 70$ .

FIG. 31.—Same plant; section entirely tangential, showing hymenophore palisade at left, and very slight gill origins at right;  $\times 70$ .

FIG. 32.—Same section more highly magnified;  $\times 115$ .

FIG. 33.—Tangential section of younger basidiocarp, showing weak general annular gill cavity with shredded fundamental plectenchyma, some hyphae extending across to young hymenophore palisade;  $\times 700$ .

FIG. 34.—Portion at left of fig. 32 more highly magnified to show details of palisade layer, etc.; note the three very slight salients, fundamentals of lamellae arising by pushing down of palisade cells by elongation of subadjacent trama hyphae; note weak general gill cavity and loose threads of torn fundamental plectenchyma extending across indefinitely to young palisade salients and to palisade portions between them;  $\times 400$ .

FIG. 35.—Portion of same still more highly magnified, showing single palisade gill salient with even palisade portion of young hymenophore on either side;  $\times 700$ .

FIG. 36.—Section slightly oblique to axis of stem, but tangential and perpendicular to surface of young hymenophore which rises at angle (as in fig. 26), but more highly magnified; note weak gill cavity and shredded fundamental plectenchyma;  $\times 105$ .

FIG. 37.—Another section of same basidiocarp, but close to stem, showing slight gill salients (over middle portion) which are very broad, as origins extend part way down on stem as in species with adnate or adnexed gills;  $\times 105$ .

FIG. 38.—Tangential section, but parallel with axis of stem, showing margins of gills beginning attachment to stem; note distinctness of pileus and blematogen zones;  $\times 40$ .

FIG. 39.—Tangential section close to stem; middle lamellae well attached to stem, because space in angle between pileus and stem is less than at greater



distance, and also because of adnate or adnexed gills the salients arise from upper part of stem as well as from pileus;  $\times 40$ .

FIG. 40.—Tangential section, very close to stem, of a basidiocarp with adnate gills; over middle portion the dark bars are gill origins attached to stem as well as to pileus, that is, they grew out from upper surface of stem as well as downward from pileus; farther toward margin of pileus the margins of gills are just beginning attachment to stem surface;  $\times 40$ .

FIG. 41.—Section transverse to stem of older basidiocarp, showing method of attachment of gill margins to stem; note interlocking of marginal cells of gills with loose fundamental plectenchyma on stem;  $\times 215$ .

FIG. 42.—Slightly older stage, also transverse to stem, showing interlocking of marginal cells and fundamental plectenchyma on stem surface; note numerous cystidia on sides of gills;  $\times 215$ .

FIG. 43.—Older stage; section transverse to stem; margins of gills well attached; note rather broad zone of fundamental plectenchyma between gill margins and distinctive stem tissue;  $\times 215$ .

FIG. 44.—Still older stage; section transverse to axis of stem; paraffin ribbon slightly overheated to cause gills to separate from stem; note gills bound closely together by hymenial surfaces; in one gill original palisade cells still extend over margin; in others they are spread laterally; portions of fundamental plectenchyma cling to gill margins; broad zone of fundamental plectenchyma on distinctive stem surface;  $\times 215$ .

FIG. 45.—Portion from same ribbon not overheated; note hymenial surfaces (deeply stained) closely joined; loose mesh of trama; in center large cystidium which arises from middle of trama and projects into hymenium of adjacent gill;  $\times 215$ .

#### PLATES X-XII

FIGS. 46-71.—*Coprinus micaceus*.

FIG. 46.—Section of young basidiocarp parallel with axes of stem and nearly median, showing weak annular gill cavity; very distinct blematogen zone external to pileus;  $\times 105$ .

FIG. 47.—Same, but section near surface of stem, showing very young lamellae cut obliquely; general gill cavity below margin of salients, some of latter still connected with a few loose threads of fundamental plectenchyma;  $\times 105$ .

FIG. 48.—Median longitudinal section of slightly older basidiocarp; section between gills on each side so that cavity appears larger;  $\times 65$ .

FIG. 49.—Section of same basidiocarp and near that shown in fig. 48, but through gills on each side so that full width of gills is shown; weak general annular cavity between margin of gills and surface of stem, with scattered threads of shredded fundamental plectenchyma extending across cavity; in figs. 48 and 49 note blematogen zone enveloping pileus and stem;  $\times 65$ .

FIG. 50.—Tangential section of same basidiocarp just in angle where stem and pileus join; gills in middle adnate to stem, giving appearance of margins



firmly attached to stem; on each side a few scattered threads of torn fundamental plectenchyma extending across weak general annular gill cavity and connected with margins of gills;  $\times 65$ .

FIG. 51.—Tangential section of another basidiocarp; gills beginning their attachment to stem;  $\times 65$ .

FIGS. 52–55.—Serial tangential sections of a young basidiocarp, from near margin of pileus toward stem; weak general annular gill cavity; shredded fundamental plectenchyma below, torn in formation of cavity; fig. 52, near margin of pileus, shows young hymenophore palisade above cavity forming an even layer; in fig. 53 weak salients are fundamentals of lamellae; these more pronounced in fig. 54; in figs. 53 and 54 note palisade layer continuous over margins of gill salients; a few scattered hyphae of fundamental plectenchyma extend across to salients and also to palisade layer between; in fig. 55 gill salients more pronounced and at this young stage marginal palisade cells swelling to form cystidia; in figs. 53–55 note lighter color of trama tissue where it is pushing down as trama of gills, due to elongation of cells;  $\times 400$ .

FIG. 56–63.—Tangential sections parallel with axis of stem and perpendicular to pileus and lamellae, showing independent origin of a secondary lamellae (figs. 56–61) rising between two primary lamellae at left; cells on margins of secondary lamellae also swell into cystidia; in all figures cystidia on margins of gills as well as for some distance back; note elongation of cells in trama of lamellae and subadjacent tissue of pileus with decrease in absorption of stain, due to the growth by elongation which pushes gill fundamentals down from even palisade layer of young hymenophore; cells of gill margins interlock with frazzled fundamental plectenchyma on surface of stem;  $\times 400$ .

FIGS. 64–67.—Further stages in attachment of gills to stem.

FIG. 65.—Rounded edges of gills crowding into thin zone of loose fundamental plectenchyma on surface of stem; cells interlocking and interwedging;  $\times 230$ .

FIGS. 64, 66, 67.—Transverse section of nearly mature basidiocarp; fig. 64, arrangement of gills and their complete attachment to surface of stems; lysigenous cavities in stem; depressions (“striae”) above primary gills;  $\times 30$ ; figs. 66 and 67, details of union of gill margins and stem surface;  $\times 230$ .

FIGS. 68–71.—Organization of palisade layer on surface of pileus.

FIG. 68.—Surface of young pileus marked by irregular threads projecting a short distance in large-celled zone of blematogen.

FIG. 69.—Slightly older stage, showing more compact arrangement of surface elements of pileus.

FIG. 70.—Still older stage, showing distinct but rather irregular palisade zone forming surface of pileus next blematogen zone.

FIG. 71.—Nearly mature plant (same as fig. 64), showing details of pileus structure in transverse section; very distinct and well organized palisade layer of surface; note indentations (cross-section of “striae”); blematogen entirely shed by desquamation.





ATKINSON *et al.* COPRINUS COMATUS



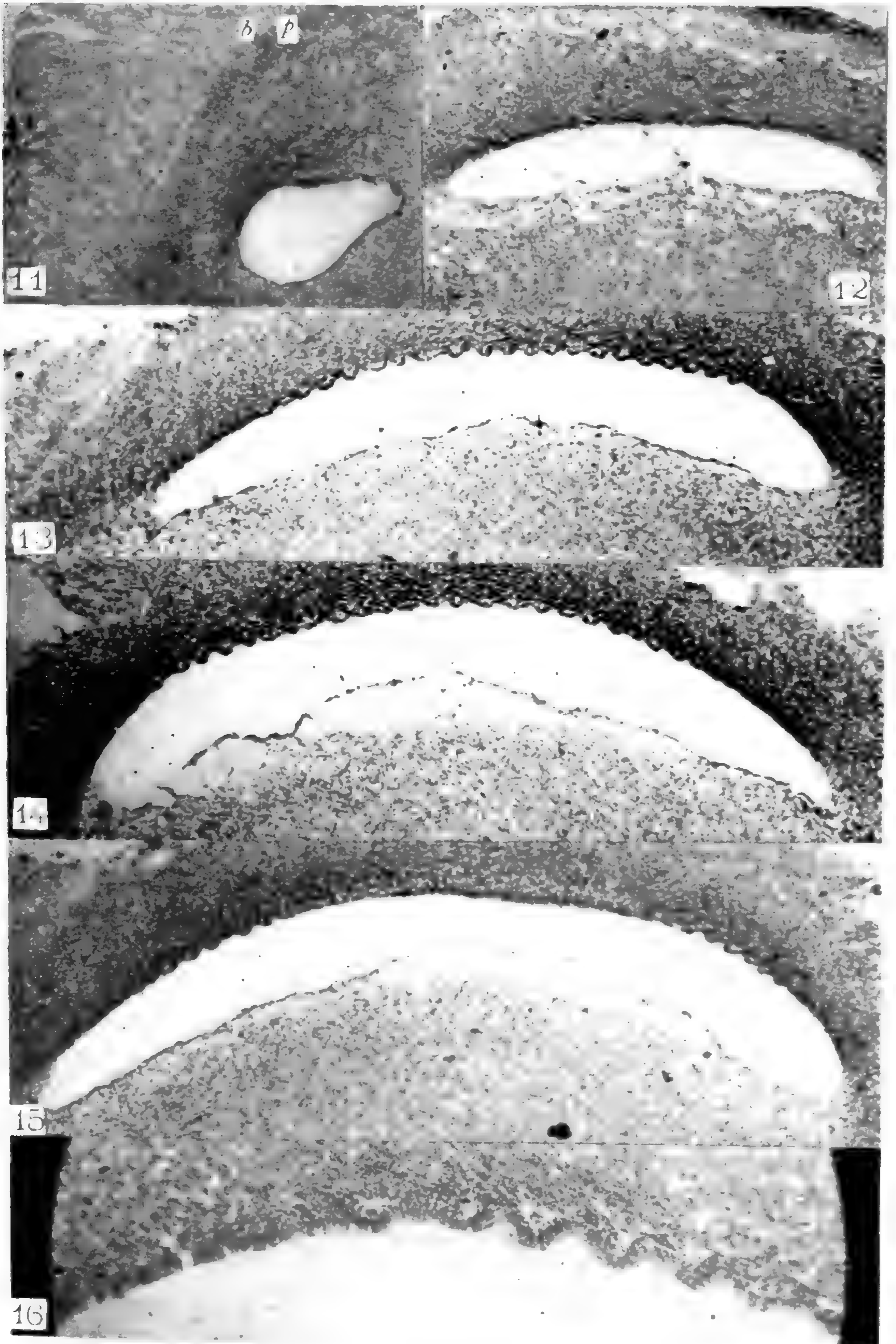

ATKINSON on COPRINUS COMATUS



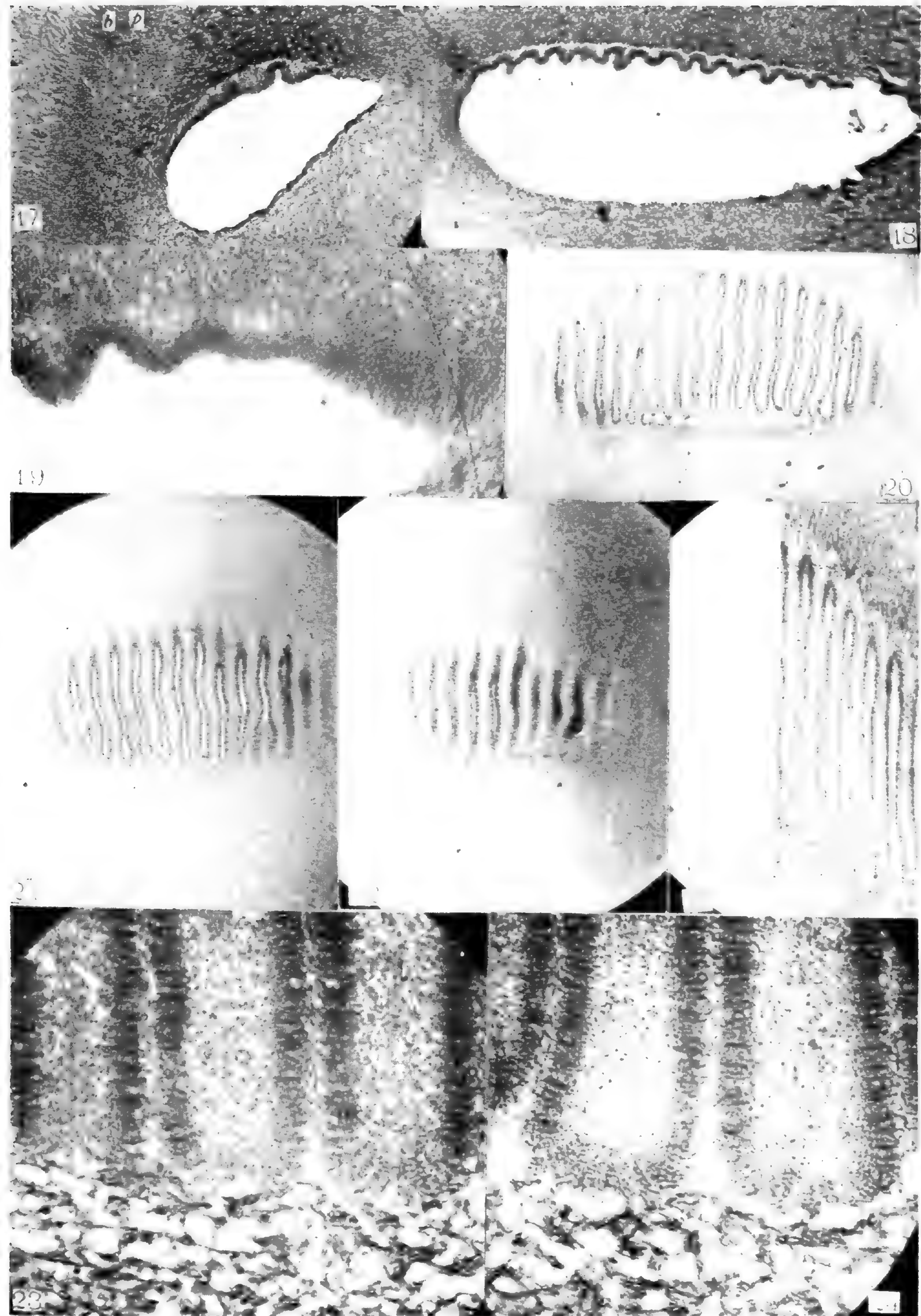

ATKINSON on COPRINUS COMATUS



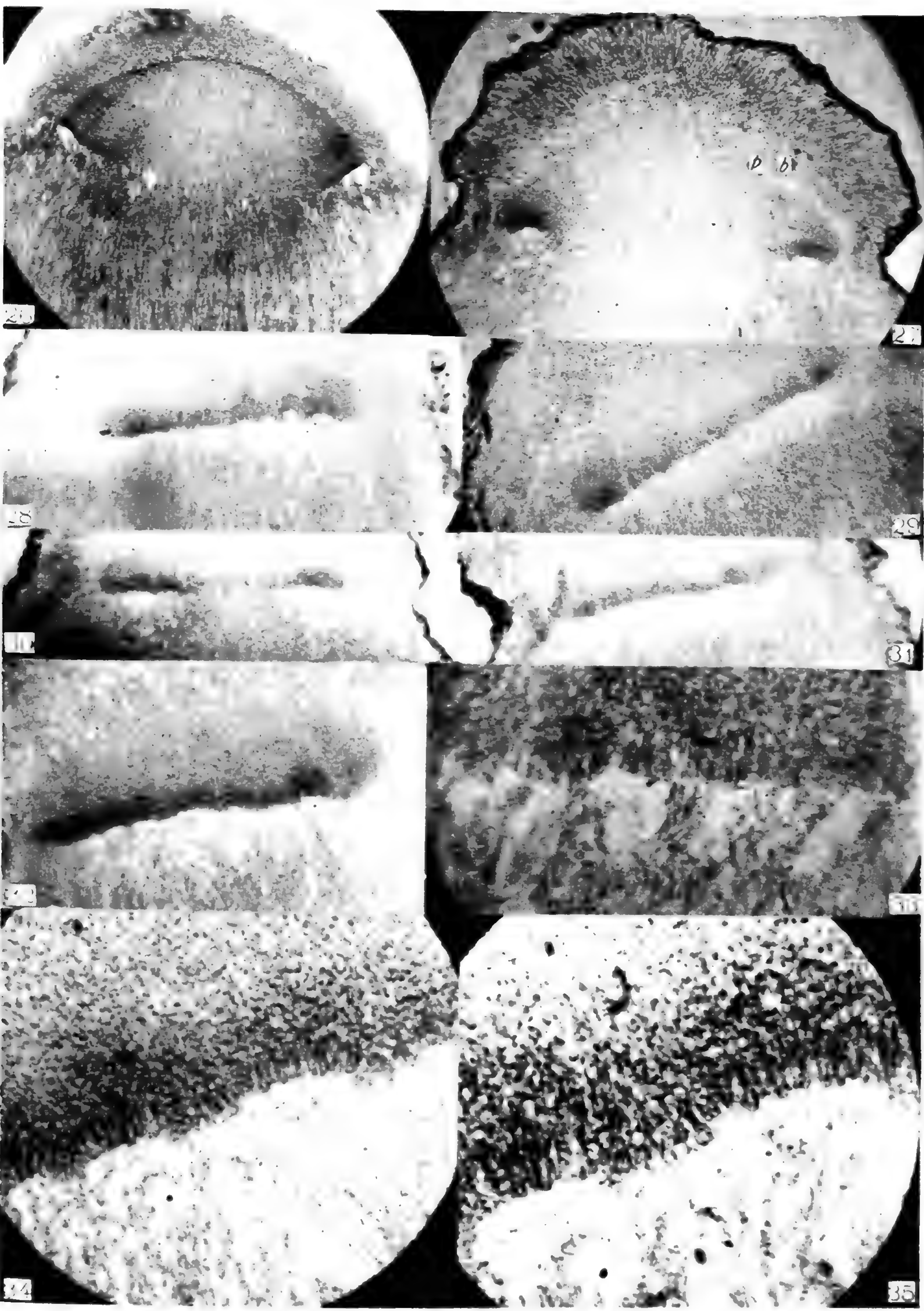

ATKINSON on COPRINUS ATRAMENTARIUS



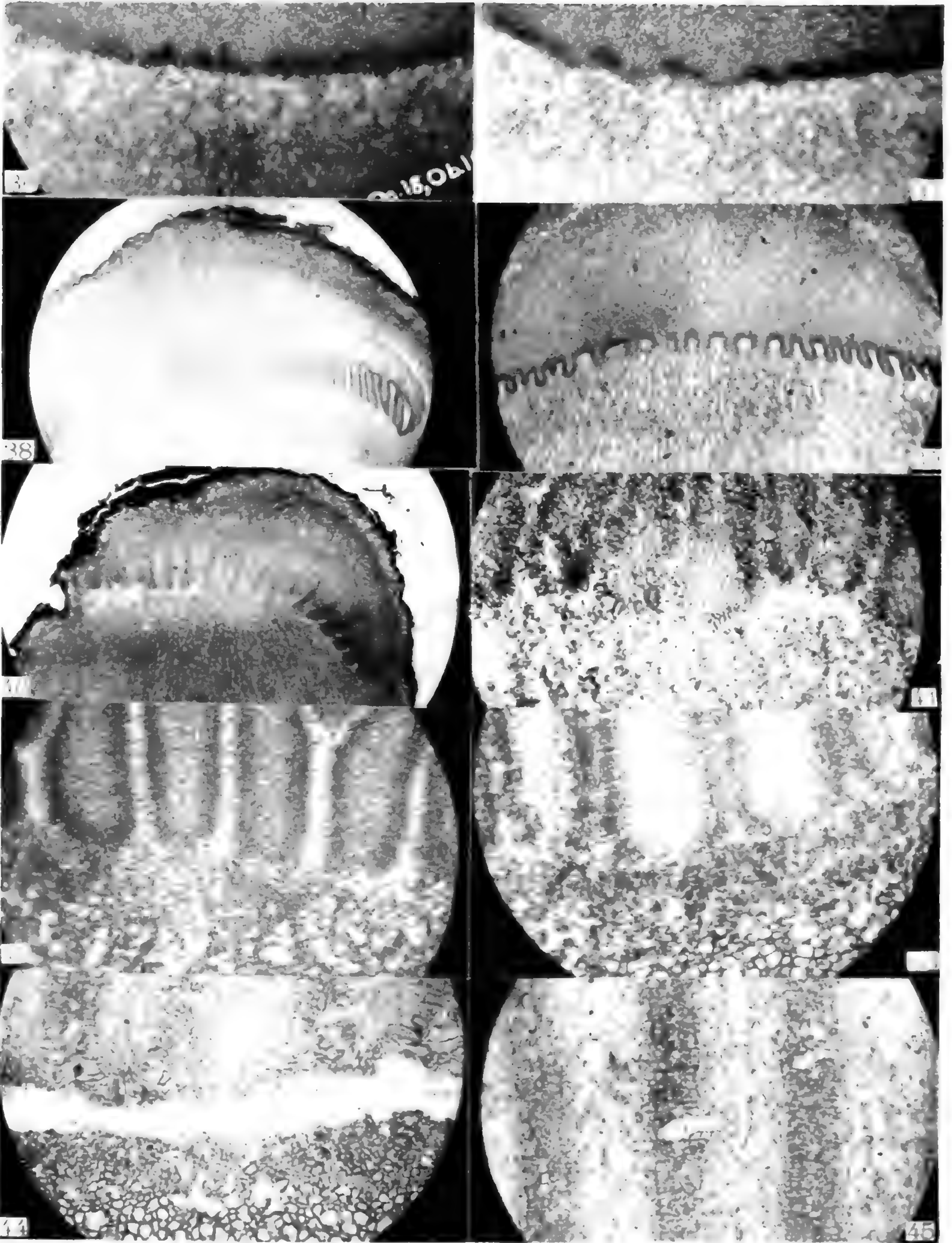

ATKINSON on *COPRINUS ATRAMENTARIUS*



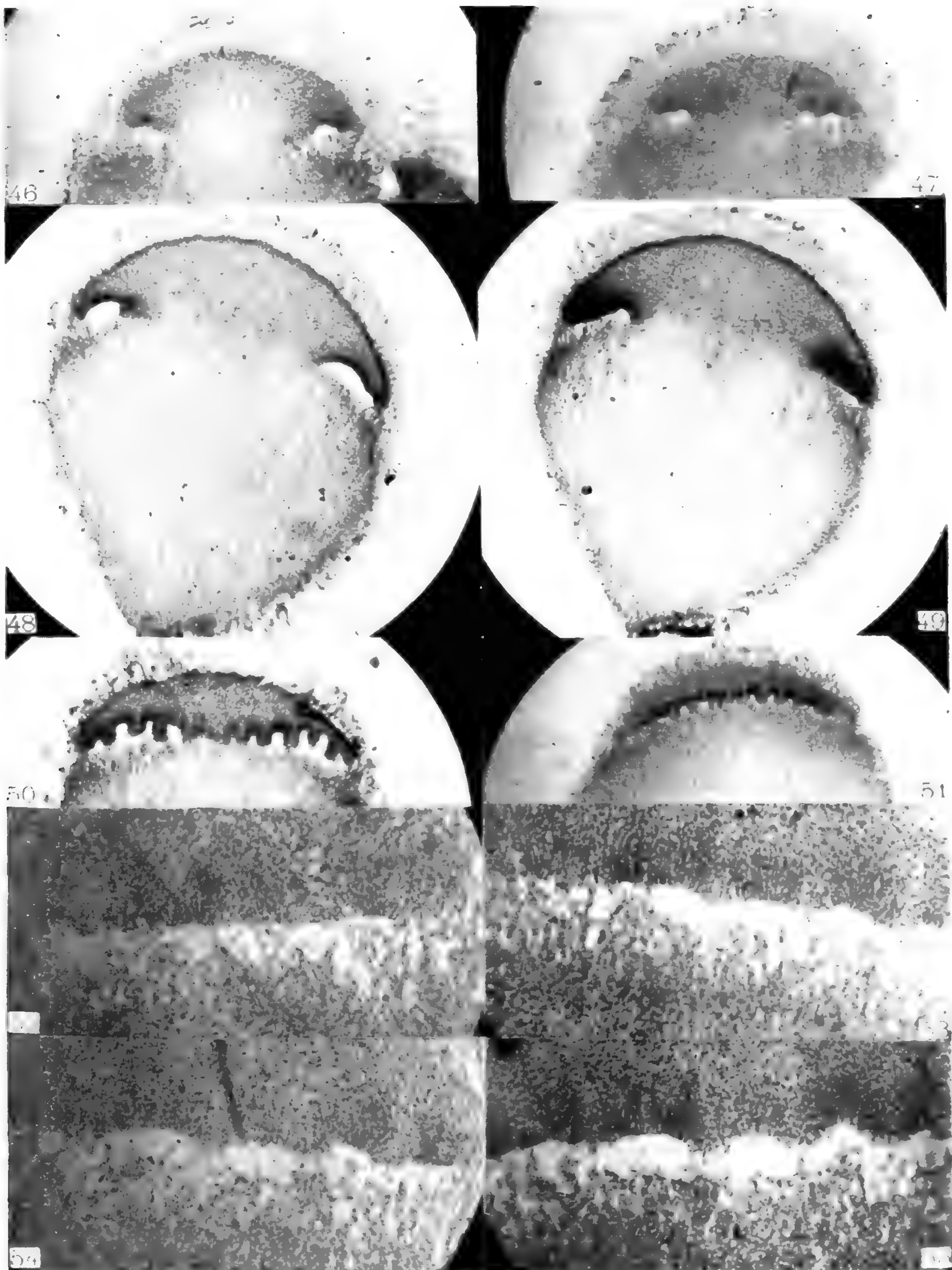

ATKINSON on COPRINUS MICACEUS



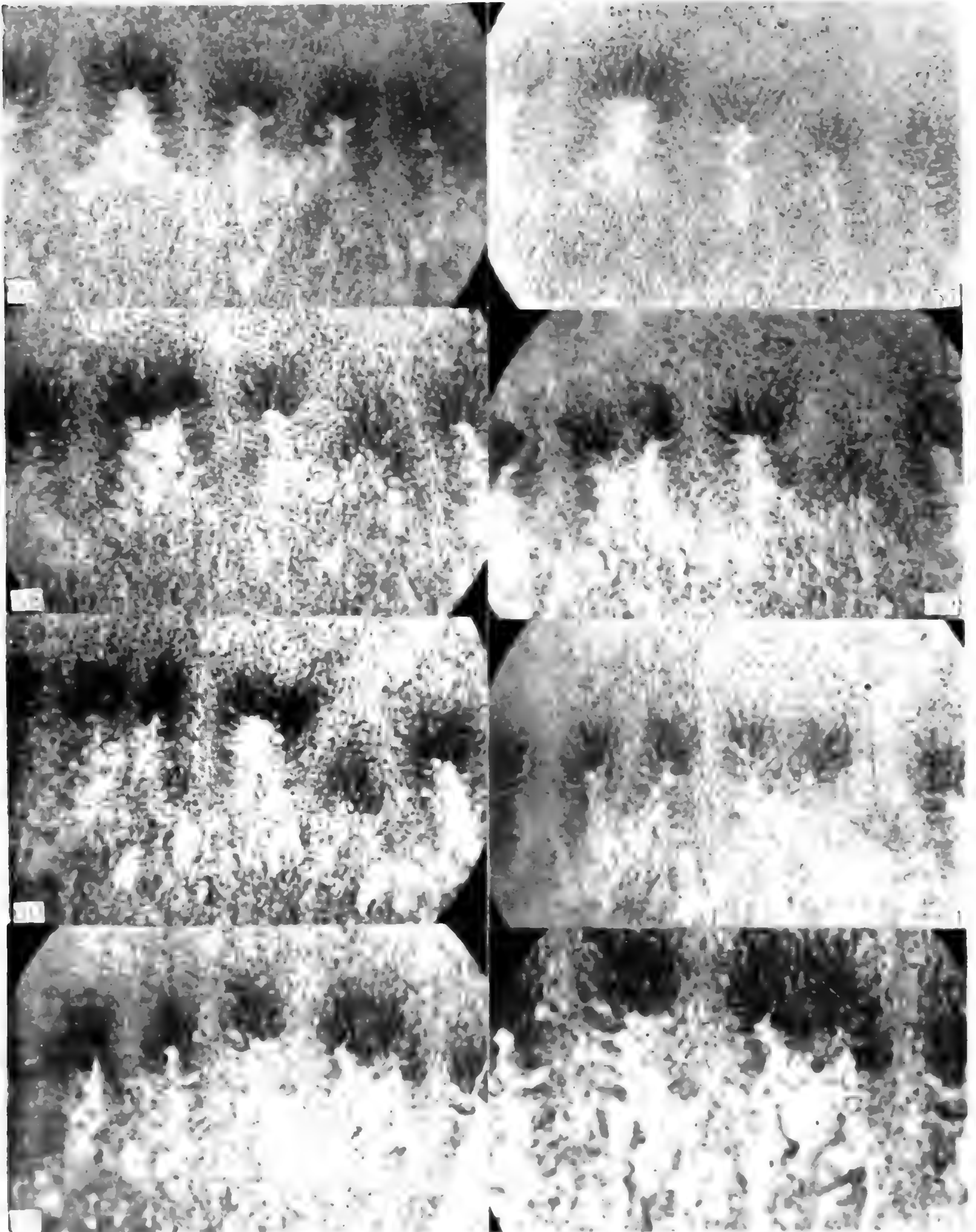

ATKINSON on COPRINUS MICACEUS



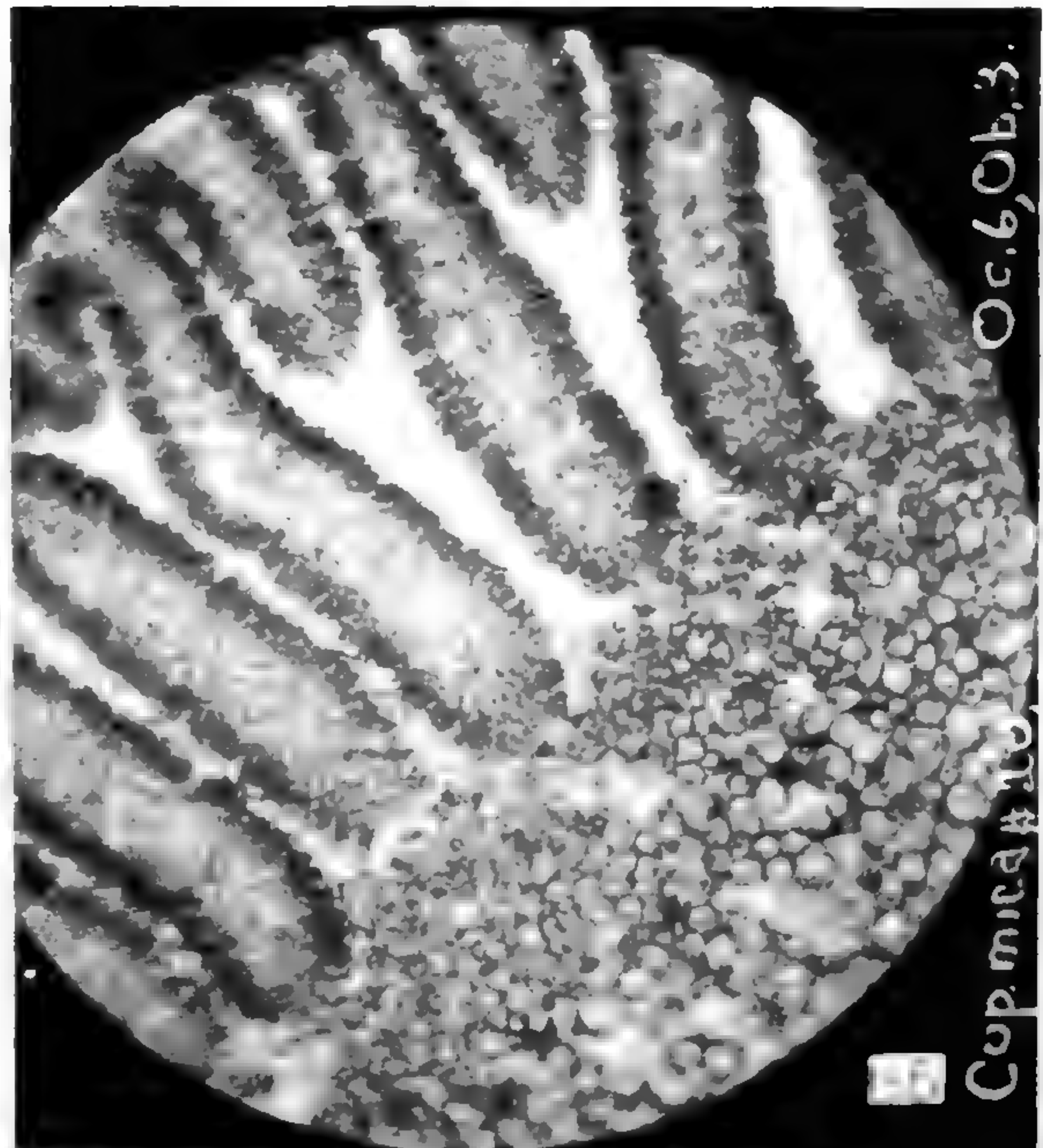
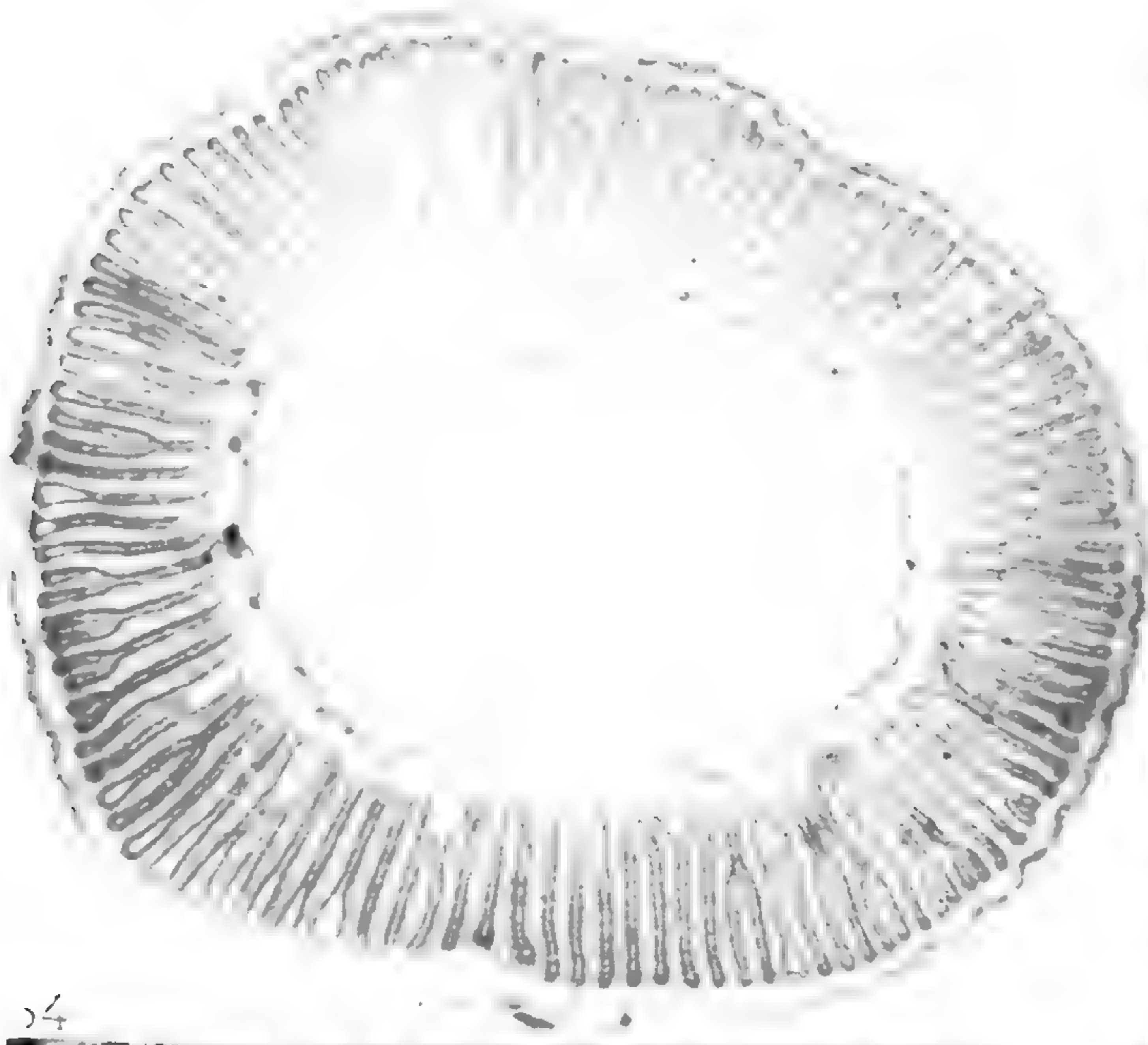

0060b.3.

Cop. micaceus

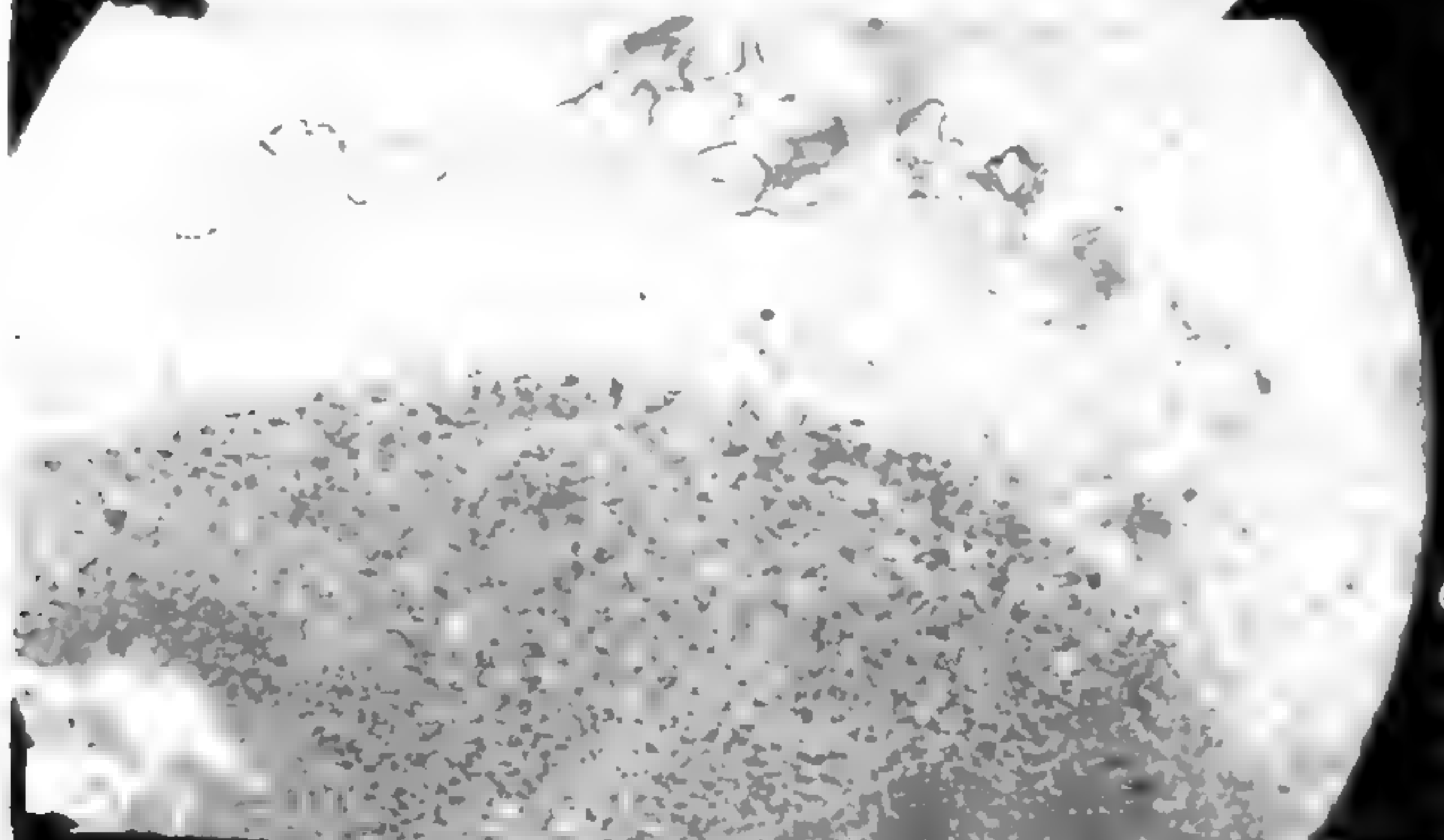
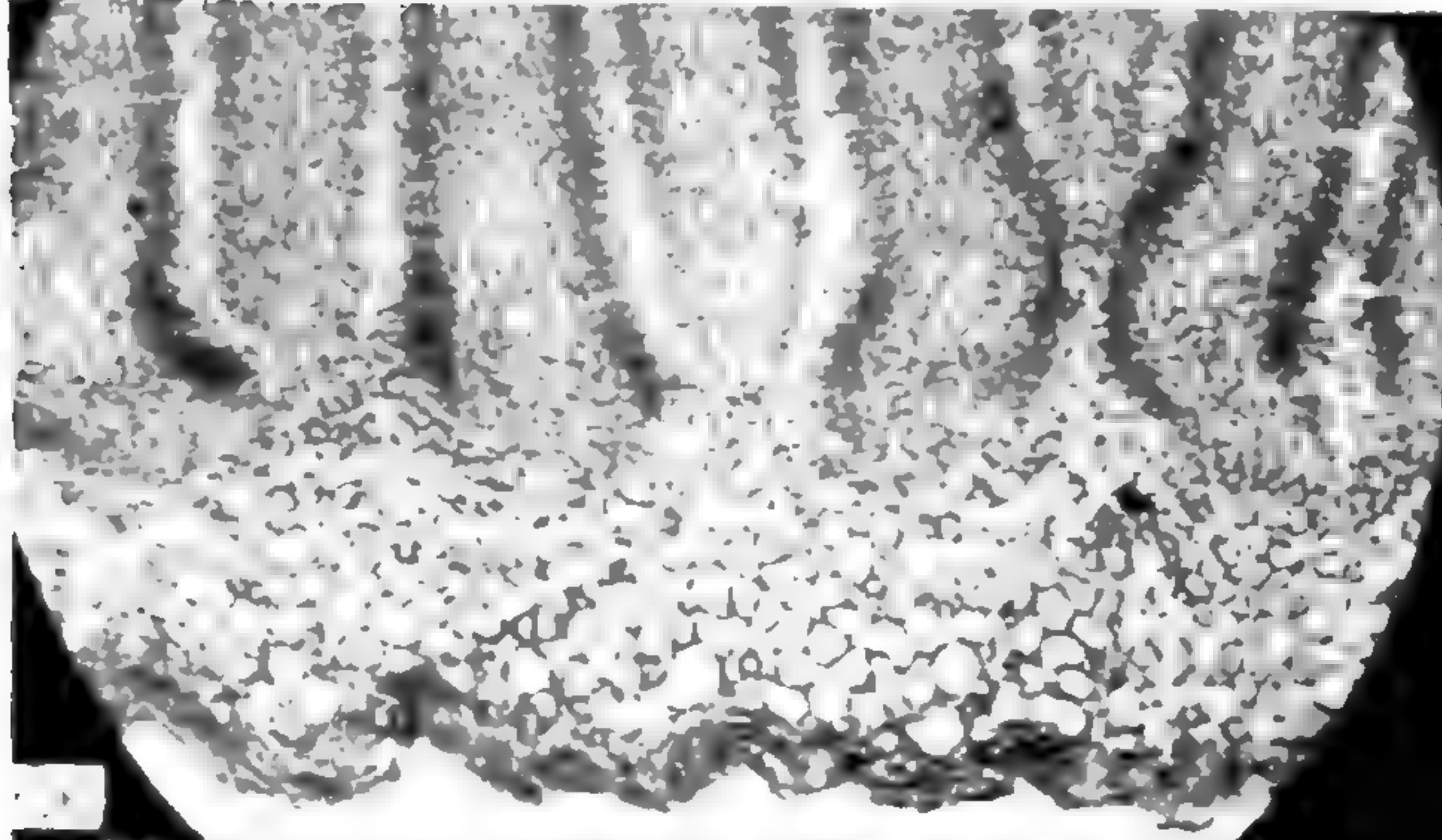

006  
micaceus

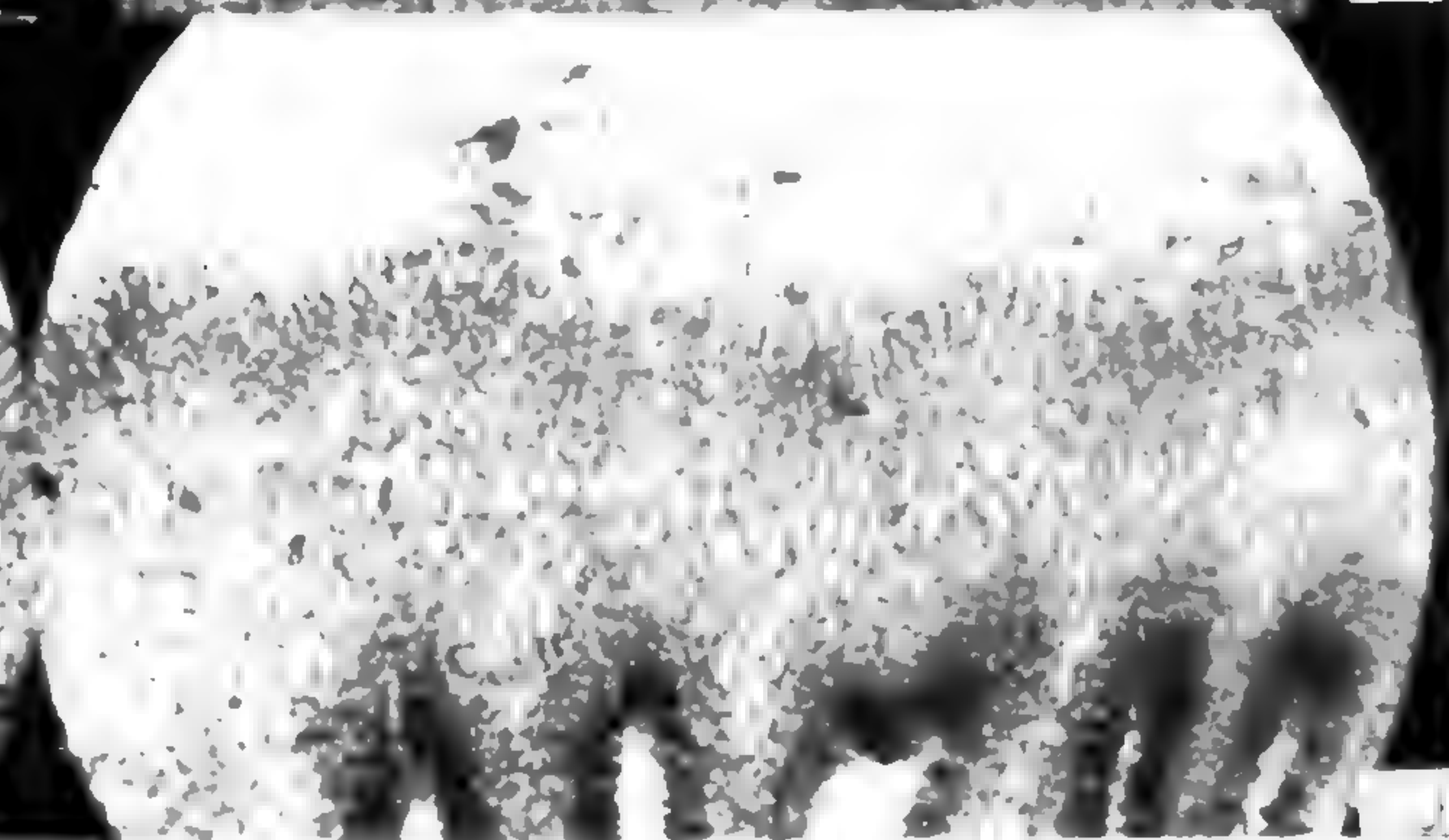
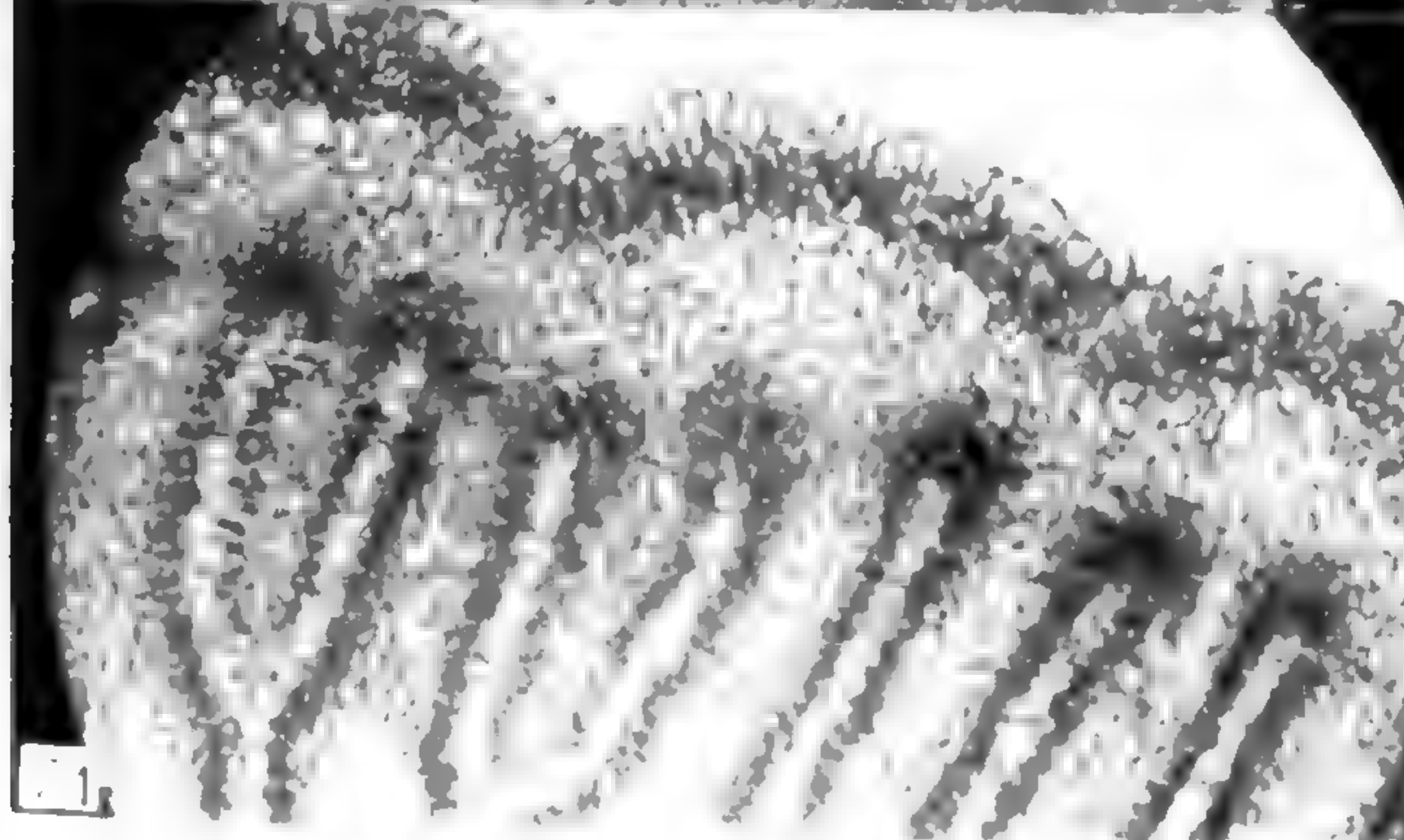

ATKINSON on COPRINUS MICACEUS



## ON THE GERMINATION OF THE POLLEN GRAINS OF APPLE AND OTHER FRUIT TREES

J. ADAMS

The following observations were made at Dublin, Ireland, in 1913, and were of a preliminary nature only. It was hoped to base a much more complete series of experiments in 1914 on the information gained in the previous year. Owing to unforeseen circumstances this was not possible, and as no opportunity for continuing the investigation is likely to arise in the near future, the results so far gained are given in the hope that others may find them useful for comparison.

There is much connected with the question of pollination that is still obscure. For instance, it is known that a russet apple produces seeds plentifully, while a Newton pippin contains only a few seeds. In both cases the fruit is equally well developed. Is there any relation between the number of seeds in the fruit and the number of pollen grains that reach the stigma? Presumably there is, but one would imagine that the chances of pollination are the same in both varieties.

Failure of an individual flower to produce fruit may be due to a variety of causes. The flower may not have been pollinated; it may have been pollinated from another flower of the same variety; it may not have been sufficiently pollinated, that is, the stigma may have received only a small number of pollen grains; it may have been pollinated too late, the stigma having ceased to be receptive; the pollen grains may have been rudimentary and incapable of germination; the temperature may have been too low for the pollen grains to germinate; or the ovary or stigma may have been injured by frost, either before the flower opened or subsequently. It seems obvious that a full understanding of all these matters is of fundamental importance to all engaged in fruit growing or seed production.

The following observations relate to the germination of the pollen grains in a cane sugar solution, their behavior when placed



on the stigma of the same or another variety not being investigated. Attempts were made to answer the following questions: (1) what strength of sugar solution gives the most rapid germination; (2) how is the germination of the pollen grains affected by temperature; (3) what is the rate of growth of the pollen tube; (4) how long, under the most favorable conditions, do the pollen grains retain their vitality?

Most of the following facts and figures relate to the apple, but a few observations were made also on other fruits.

### Apple

The pollen grains when dry were ellipsoidal, and comparatively little variation in size was found in the varieties examined. While some were longer and narrower, and others shorter and broader than the figures given, the average dimensions were as follows: Bramley's seedling  $45 \times 24 \mu$ , Wyken pippin  $45 \times 24 \mu$ , Duchess of Oldenburgh  $42 \times 27 \mu$ , Warner's King  $46.5 \times 25.5 \mu$ , Cox's orange pippin  $45 \times 25.5 \mu$ , Nelson  $43.5 \times 24 \mu$ , Bismarck  $45 \times 24 \mu$ . When the pollen grains were wet, they swelled up so as to become more globular in shape. For instance, the pollen grains of Bramley's seedling when wet measured  $45 \times 39 \mu$ . This preliminary swelling appears to be the first stage in the germination of the pollen grain.

### SERIES I

For the first set of observations, solutions of cane sugar of 5, 10, 15, 20, 25, 30, 40, and 50 per cent strength were made. These were preserved in stoppered bottles for subsequent use, but it was found that after taking out a drop of the solution with a glass rod and replacing the cork, an abundant growth of mycelium of *Penicillium* developed in the bottles. Accordingly a fresh stock of solutions had to be made, and after taking a drop out of any of these the bottle was invariably brought to the boiling point. It was found that by so doing the sugar solutions could be kept indefinitely.

As a general rule, dry pollen grains were taken from an anther which had recently dehisced, and these were dusted on to a clean glass slide. A drop of the sugar solution was placed on the pollen



grains, and the drop was stirred with needles so as to make sure that the surface of the pollen grains was wet and that they were distributed uniformly through the solution. It was found in later experiments that the pollen grains germinated much more rapidly if a very thin layer of liquid was spread on the slide than if a large hemispherical drop was used, the reason being presumably that oxygen was more readily obtained by the pollen grains in the former case. Cover glasses were not used, as they prevented germination except along the edges. The prepared slides were then placed on the surface of damp blotting paper in Petri dishes and the cover replaced. In other cases a larger number of slides was placed on blotting paper in a glass dish with flat bottom and a glass plate was used as a cover. The presence of the damp blotting paper served to diminish evaporation of the sugar solution.

On May 6, 1913, two sets of cultures were started at 4:00 P.M. One was kept in the laboratory, the temperature of which at this time was 14°.5 C., the other being placed on the window ledge outside, which faced toward the north, so that direct sunshine could not reach it. The temperature outside at the time of starting the culture was not observed. The cultures were examined daily during the next 3 days. It was found impracticable to keep them going longer than 3 days, owing to the occurrence of *Penicillium*. The strengths of sugar solution, as stated above, were: (a) 5, (b) 10, (c) 15, (d) 20, (e) 25, (f) 30, (g) 40, and (h) 50 per cent. The results were as follows:

A<sub>1</sub>.—Inside cultures: 1:00 P.M., May 7; temperature 13° C.: (a) nearly every pollen grain had germinated; some had quite long tubes, while others had shorter tubes; (b) almost every pollen grain had germinated and formed a very long tube; (c) many had germinated and formed short tubes; (d) a considerable number had germinated and formed short tubes; (e) and (f) same as (d); (g) none had germinated; (h) none had germinated and very few of the pollen grains had swelled.

B<sub>1</sub>.—Outside cultures: 1:00 P.M., May 7; temperature 10°.5 C.: (a) many had produced long pollen tubes, while others showed no signs of germination; the sugar solution was partly evaporated and therefore was stronger than 5 per cent; (b) a very few had



germinated and the growth was much less than in (*a*); considerable evaporation had taken place; (*c*) a considerable number had germinated but the growth was less than in (*a*); some evaporation had taken place; (*d*) some had germinated and formed fairly long tubes; some evaporation had taken place; (*e*) a very few had formed short pollen tubes; very little evaporation; (*f*) same as (*e*); (*g*) only one pollen tube observed; evaporation very slight; (*h*) none had germinated; evaporation very slight.

A<sub>2</sub>.—Inside cultures: 10:15 A.M., May 8; temperature 15° C.: (*a*) some had produced very long tubes and appeared to have almost exhausted the reserves in the pollen grain; there were a few which did not germinate; (*b*) same as (*a*); (*c*) pollen tubes mostly short; a very considerable number had not germinated at all; (*d*) these had formed much longer pollen tubes than in (*c*); the pollen grains were larger than those in (*c*) and may have been obtained from a different variety; some did not germinate; (*e*) same as (*d*); (*f*) many had formed comparatively long pollen tubes, although a considerable percentage did not germinate; (*g*) a number had formed pollen tubes of variable length, although the majority did not germinate; (*h*) three were observed with short pollen tubes.

B<sub>2</sub>.—Outside cultures: 11:00 A.M., May 8; temperature 9° C.; temperature at 3:00 P.M., when they were examined, was 11° C.: (*a*), (*b*), and (*c*) same as on previous day; (*d*) a considerable number had formed short pollen tubes, but many had not germinated; (*e*) and (*f*) same as on previous day; (*g*) an extremely small number had formed short pollen tubes; (*h*) none of the pollen grains had germinated and very few of them had swelled.

A<sub>3</sub>.—Inside cultures: 3:35 P.M., May 9; temperature 18° C.: (*a*) same as on previous day; (*b*) a considerable number had not yet germinated; (*c*), (*d*), (*e*), (*f*), and (*g*) same as on previous day; (*h*) a considerable number had formed fairly long pollen tubes.

B<sub>3</sub>.—Outside cultures: 3:55 P.M., May 9; temperature 12° C.: (*a*), (*b*), and (*c*) same as on previous day; (*d*) a considerable number had formed pollen tubes of moderate length; (*e*), (*f*), (*g*), and (*h*), same as on previous day.

In all cases the pollen grains appeared to have 3 germ pores.



## SERIES II

May 8, 1913.—A single flower of Bismarck apple was used for this set of experiments. It rained the whole day. Of the 20 stamens in the flower 13 had dehisced and all the pollen was washed off by the rain. Of the remaining 7, 5 were kept in a corked bottle over night and 2 were teased in 5 per cent and 10 per cent sugar solution respectively, and the cultures were placed outside in the garden at 9:30 P.M., the temperature being 4°5 C.; the minimum temperature during the night was 3°5 C., and the temperature on the following morning (May 9) at 8:50 A.M. was 7° C. The cultures were examined at 9:30 A.M. A few of those in the 5 per cent sugar solution had formed pollen tubes, but the majority had not germinated. In the 10 per cent solution one pollen grain was observed with a very short pollen tube.

May 9, 1913.—Three of the 5 stamens kept over night were teased in (a) water, (b) 5 per cent sugar, and (c) 10 per cent sugar solution respectively, and the cultures were placed at 12:15 P.M. in an incubator at a temperature of 20–21° C. The other two stamens were teased in (d) 5 per cent and (e) 10 per cent sugar solution respectively, and the cultures were placed on the window ledge outside the laboratory at 12:15 P.M. The temperature outside the window at 3:00 P.M. was 12°5 C. The 5 cultures were examined at 4:15 P.M. on the same day, with the following results: (a) some of the pollen grains had formed tubes of considerable length; (b) several pollen grains had formed short pollen tubes; (c) a few pollen grains had germinated and in some cases the pollen tubes were of considerable length; (d) a number of pollen grains had formed short pollen tubes; (e) only a very few had formed pollen tubes of moderate length.

## SERIES III

May 13, 1913.—Six cultures of pollen of Bramley's seedling apple taken from the same anther were prepared, namely, (a) in water, (b) 2.5, (c) 5, (d) 10, (e) 15, and (f) 20 per cent sugar solution respectively. The pollen grains were collected on May 10, 1913, and were kept dry. The cultures were started at 4:30 P.M.



on May 13, the temperature being  $17^{\circ}$  C., and they were kept in the dark.<sup>1</sup>

May 14, 1913.—The cultures were examined at 12:20 P.M., the temperature being  $16^{\circ}.5$  C.: (a) very few had germinated; one had a pollen tube  $58.5 \mu$  long and another a pollen tube  $309 \mu$  long between perpendicular lines; (b) very few had germinated; one had a pollen tube  $167 \mu$  long; (c) very few had germinated; one had a pollen tube  $150.3 \mu$  long; (d) very few had germinated; one had a pollen tube  $58.5 \mu$  long and another a pollen tube  $108.5 \mu$  long; (e) no pollen tubes observed; (f) only a few had formed short pollen tubes, which were covered with short knoblike excrescences and did not seem to be healthy.

May 15, 1913.—The temperature at 4:00 P.M. was  $16^{\circ}$  C.; the results of examination were as follows: (a) an extremely small percentage had germinated; (b) no change; the culture was overrun with yeastlike cells of *Penicillium*; (c) and (d) same as (b); (e) two pollen tubes observed; *Penicillium* plentiful; (f) no change; *Penicillium* abundant.

#### SERIES IV

May 15, 1913.—A flower of Warner's King apple was pulled this morning. On examination some of the pollen grains showed short pollen tubes which had been formed inside the anther. Five cultures of the pollen grains were made, namely, (a) in water, (b) 2.5, (c) 5, (d) 10, and (e) 15 per cent sugar solution respectively. They were put into an incubator at  $22.5-23^{\circ}$  C. at 10:40 A.M. the same day and examined at 4:35 P.M. The results were as follows: (a) most of the pollen grains had formed long pollen tubes; one measured  $451 \mu$  and another  $384 \mu$ , and these were about the average lengths; (b) almost every pollen grain had produced a long tube; the average length of the pollen tubes was  $634.6 \mu$ ; (c) only a few had germinated and the pollen tubes were of short, irregular, tuberculate growth; (d) only a few had formed pollen tubes of irregular growth; (e) two or three pollen grains had formed very short pollen tubes of irregular growth.

<sup>1</sup> In measuring the length of pollen tubes in this and subsequent series, as the course of the pollen tube was usually very tortuous, it was found much more convenient to measure the distance between two lines drawn at right angles to the general direction of the pollen tube.



## SERIES V

May 19, 1913.—Pollen grains of Bramley's seedling apple collected on May 10, 1913, and kept dry, were started in the laboratory at 4:45 P.M. on May 19, 1913. The temperature was 14°5 C. Six cultures were made, namely, (a) water, (b) 1, (c) 2, (d) 4, (e) 8, and (f) 16 per cent solution of cane sugar. They were examined on May 20 at 3:30 P.M., when the temperature was 14°5 C. and the results were as follows: (a) only a few had germinated; one had a pollen tube 150.3  $\mu$  between perpendiculars and there were others still longer; (b) only two short pollen tubes observed; (c) a few had formed short pollen tubes; (d) only a very few had formed short pollen tubes; the longest seen was 81  $\mu$  long and had a cauliflower-like growth at the end; (e) a small number had formed short pollen tubes; (f) an extremely small percentage had formed short pollen tubes.

On May 22 at 3:50 P.M., the temperature being 14°5 C., the cultures were again examined, with the following results: (a) only a few had germinated, but they had formed fairly long pollen tubes; one measured 300.6  $\mu$ ; (b) a very few had formed short pollen tubes; (c), (d), (e), and (f) same as on May 20; an abundant growth of *Penicillium* had occurred in these four. This series of cultures was kept continually in the dark.

## SERIES VI

May 20, 1913.—Pollen grains of Bramley's seedling apple which were collected on May 10 and kept dry were put into the incubator at 22° C. at 10:10 A.M. Six cultures were made, namely, (a) water, (b) 1, (c) 2, (d) 4, (e) 8, (f) 16 per cent sugar solution. The results at 4:10 P.M. the same day were as follows: (a) and (b) none had germinated; (c) one pollen tube was 250.5  $\mu$  long, another 384  $\mu$  long; several others with pollen tubes of various lengths were observed, but only a small percentage altogether had germinated; (d) only a very few had formed short pollen tubes; (e) a fair percentage had formed long pollen tubes, one being 651.3  $\mu$  long; (f) a considerable number had formed pollen tubes, one being 200.4  $\mu$  long.

The results on May 21 were as follows: (a) two pollen tubes were observed but they did not seem to be healthy; (b) one pollen



tube, 300.6  $\mu$  long, was seen; hardly any other pollen grains had germinated; (c) only a very small number altogether had germinated; (d) no change; (e) a considerable number had formed long pollen tubes, the average length being 1336  $\mu$ ; (f) a considerable number had formed pollen tubes of medium length, but the results were not so good as in (e).

#### SERIES VII

June 5, 1913.—Pollen grains of Warner's King apple collected on May 10, 1913, were put into the incubator at 21° C. at 4:15 P.M. Three cultures were made, namely, (a) 4, (b) 8, and (c) 16 per cent sugar solution. The cultures were examined at 12:45 P.M. on June 6, with the following results: (a) a considerable number had formed short pollen tubes, some being 50.1  $\mu$  long; (b) many had germinated, forming pollen tubes 200.4  $\mu$  long; some were as much as 317.3  $\mu$  long; (c) many had germinated, some of the pollen tubes being 300.6  $\mu$  long.

#### SERIES VIII

June 16, 1913.—Pollen grains of Cox's orange pippin, which were collected on May 10 and kept dry, were started in the laboratory at 4:10 P.M., the temperature being 17° C. Three cultures were made, namely, (a) 8, (b) 16, and (c) 20 per cent sugar solution. They were examined at 12:45 P.M. on June 17, the temperature being 18° C., with the following results: (a) and (b) a few short pollen tubes were observed in each; (c) the pollen tubes were considerably longer than in (a) and (b). The cultures were again examined at 10:30 A.M. on June 19, the temperature being 16° C., but no further development of pollen tubes had taken place.

#### SERIES IX

June 26, 1913.—Pollen grains of Bismarck apple collected on May 10 were started in the laboratory at 4:55 P.M., the temperature being 16.5° C. Three cultures were made in (a) 16, (b) 20, and (c) 40 per cent sugar solution. The cultures were examined at 12:10 P.M. on June 27, the temperature being 16° C., with the



following results: (a) two long pollen tubes were observed; (b) a few were beginning to germinate; (c) no pollen tubes were observed.

On June 28 at 10:35 A.M., the temperature being 16°5 C., the results were as follows: (a) a few more were beginning to germinate; (b) a few had formed pollen tubes; (c) no pollen tubes were observed. On June 30 at 10:30 A.M., the temperature being 18° C., no further growth in any of the cultures had taken place.

#### SERIES X

August 6, 1913.—Pollen grains of several varieties of apple which were collected on May 10 and kept dry were started at 5:00 P.M., the temperature of the laboratory being 16° C. The following were the varieties and strengths of sugar solution used: (a) Nelson 4 per cent, (b) Wyken pippin 16 per cent, (c) Warner's King 20 per cent, (d) Bramley's seedling 4 per cent, (e) Duchess of Oldenburgh 16 per cent, (f) Bismarck 20 per cent, (g) Cox's orange pippin 16 per cent. The cultures were examined at 4:45 P.M. on August 7, the temperature being 16° C. The results were as follows: (a) two short pollen tubes were observed; (b) and (c) no pollen tubes; (d) several short pollen tubes; (e), (f), and (g) no pollen tubes.

They were examined again at 5:00 P.M. on August 8, the temperature being 16° C., with the following results: (a), (b), (c), (d), and (e) no change; (f) a considerable number of short pollen tubes were seen; (g) no change.

#### Pear

The variety used was Doyenne du Comice. The dry pollen grains were elliptical and measured  $42 \times 25.5 \mu$ .

#### SERIES I

May 29, 1913.—Pollen grains which were collected on May 27 were started at 11:05 A.M. in the incubator at 21° C. Three cultures were made, namely, (a) 4, (b) 8, and (c) 16 per cent sugar solution. They were examined the same day at 4:40 P.M., with the following results: (a) many had germinated, some of the pollen tubes being  $551.1 \mu$  long between perpendiculars; (b) several had



formed pollen tubes  $617.9 \mu$  long; (c) many had germinated, but the pollen tubes were short, being  $133.6 \mu$  or less in length.

#### SERIES II

June 12, 1913.—Pollen grains which were collected on May 27 and were started at 3:50 P.M. in the laboratory, the temperature being  $15^{\circ}$  C. As in all other experiments, they had been kept dry since the date of collecting. Three cultures were made, namely, (a) 4, (b) 8, and (c) 16 per cent sugar solution. They were examined at 4:20 P.M. on June 13, the temperature being  $15^{\circ}$  C. The results were as follows: (a) many had germinated, some of the pollen tubes being  $601.2 \mu$  long; (b) many had germinated, the growth being better than in (a); some of the pollen tubes were  $701.4 \mu$  long; (c) many had germinated, some of the pollen tubes being  $551.1 \mu$  long.

#### SERIES III

August 6, 1913.—The cultures were started at 5:00 P.M., the temperature in the laboratory being  $16^{\circ}$  C. The pollen grains had been collected on May 27, 1913. They were in 4 per cent sugar solution and were examined at 4:45 P.M. on August 7, the temperature being  $16^{\circ}$  C., but none had germinated. On examination at 5:00 P.M. on August 8, the temperature being  $16^{\circ}$  C., it was found that a few short pollen tubes had been formed.

### Strawberry

#### SERIES I

An open flower was plucked on May 27, 1913, the weather having been dry for several days. The flower was kept dry until May 29, but still the anthers did not open. On teasing the anther on a slide no pollen grains escaped, but when the anther was teased in water small pollen grains were found which were sub-globular in shape, but more or less shriveled and about  $18 \mu$  in diameter. Cultures in 4, 8, and 16 per cent sugar solution were started at 11:05 A.M. on May 29 in an incubator at  $21^{\circ}$  C., but at 4:40 P.M. none had germinated.



## SERIES II

June 2, 1913.—Pollen grains from a different variety were collected on this date. When dry these were elliptical in shape, measuring  $37.5 \times 19.5 \mu$ . Three cultures were made, namely, (a) 4, (b) 8, and (c) 16 per cent sugar solution. They were started at 4:45 P.M. the same day, the temperature of the laboratory being  $16^{\circ} \text{C}$ . They were examined at 9:45 A.M. on June 4, the temperature being  $15^{\circ}.5 \text{C}$ ., with the following results: (a) only a few had produced pollen tubes of medium length, and of these several were tuberculate at the tip; (b) and (c) similar to (a).

They were examined again at 11:00 A.M. on June 5, the temperature being  $15^{\circ}.5 \text{C}$ ., with the following results: (a) nearly all of the pollen tubes formed were short and of irregular growth, and many of the pollen grains were small and apparently rudimentary; the longest pollen tube seen measured  $267.2 \mu$ ; (b) the pollen tubes were a little more regular in their growth than in (a); one measured  $250.5 \mu$ ; (c) similar to (a); a pollen tube measured  $300.6 \mu$ .

## SERIES III

June 6, 1913.—Pollen grains were collected from a seedling strawberry plant on this date. Three cultures were made, namely, (a) 4, (b) 8, and (c) 16 per cent sugar solution. The cultures were started at 4:00 P.M. in the laboratory, the temperature being  $15^{\circ}.5 \text{C}$ . They were examined at 3:50 P.M. on June 9, the temperature being  $14^{\circ}.5 \text{C}$ ., with the following results: (a) no proper healthy pollen tubes were observed; (b) numerous long pollen tubes were observed, one measuring  $1169 \mu$ ; (c) two short pollen tubes were seen, but the vast majority had behaved like those in (a).

## SERIES IV

Pollen grains were collected on June 2, 1913, and started in 10 per cent sugar solution at 5:00 P.M. on August 6, the temperature being  $16^{\circ} \text{C}$ . At 4:45 P.M. on August 7 none had germinated. At 5:00 P.M. on August 8 the result was the same.

**Loganberry**

Dry pollen grains elliptical,  $43.5 \times 22.5 \mu$ . June 2, 1913. Pollen grains were collected on this date and started in the laboratory at



4:45 P.M., the temperature being  $16^{\circ}$  C. Three cultures were made, namely, (a) 4, (b) 8, and (c) 16 per cent sugar solution. They were examined at 9:45 A.M. on June 4, the temperature being  $15^{\circ}.5$  C., with the following results: (a) many had germinated and formed long pollen tubes; (b) most of the pollen grains had attempted to germinate, but the pollen tube, as a rule, was short, being no longer than the diameter of the pollen grain, and irregular and tuberculate. A few had formed fairly long, properly developed tubes; (c) same as (b).

At 10:45 A.M. on June 5, the temperature being  $15^{\circ}.5$  C., they were again examined: (a) a pollen tube measured  $1052.1 \mu$  long; (b) these had made little further growth from the previous day; a pollen tube measured  $250.5 \mu$ ; (c) similar to (b) for the most part; a pollen tube was  $467.6 \mu$ .

An attempt was made on August 6 to germinate some of the pollen grains collected on June 2 in 4 per cent sugar solution, but no pollen tubes developed.

### Raspberry

Dry pollen grains elliptical,  $33 \times 21 \mu$ , globular when wet. On June 5, 1913, pollen grains were collected and put into the incubator at  $21^{\circ}$  C. at 4:15 P.M. Three cultures were made, namely, (a) 4, (b) 8, and (c) 16 per cent sugar solution. They were examined at 12:45 P.M. on June 6, with the following results: (a) contents of the pollen grain had protruded slightly, but no proper pollen tubes were observed; (b) mostly similar to (a), but in a very few cases fairly well developed pollen tubes were found; (c) a considerable number had formed pollen tubes, one of which measured  $317.3 \mu$  between perpendiculars. An attempt was made on August 6 to germinate some of the pollen grains collected on June 5 in 16 per cent sugar solution, but without success.

### Black currant

Pollen grains when dry spherical,  $30 \mu$  in diameter, in water spherical,  $42 \mu$  in diameter, with a number of germ pores.



## SERIES I

May 22, 1913.—Pollen grains which were collected on May 19 were put into the incubator at 22° C. at 10:25 A.M. Four cultures were made, namely, (a) water, (b) 4, (c) 8, and (d) 16 per cent sugar solution. They were examined at 4:20 P.M. the same day, with the following results: (a) a small percentage had germinated, the average length of the pollen tube being 66.8  $\mu$ ; (b) a large number had formed pollen tubes which were fairly straight, the average length being 250.5  $\mu$ ; one measured 317.3  $\mu$ ; (c) a large number had formed long pollen tubes, the average length being 634.6  $\mu$ ; (d) a large number had germinated and formed pollen tubes 668  $\mu$  long or more.

## SERIES II

June 6, 1913.—Pollen grains which were collected on May 19, were started in 8 per cent sugar solution at 4:00 P.M., the temperature of the laboratory being 15°5 C. They were examined at 3:50 P.M. on June 9, the temperature being 14°5 C. Some had germinated, one pollen tube being 434°2  $\mu$  long.

## SERIES III

Pollen grains collected on May 19 were tested in 16 per cent sugar on August 6, 1913, being examined on each of the two following days, but none had germinated.

## Discussion

As regards the most suitable medium for germinating pollen grains, there is great diversity shown by different species of plants. Some pollen grains when immersed in ordinary tap water swell up and burst. This happens in *Geranium sanguineum*, *Convolvulus arvensis*, *Valeriana officinalis*, and *Scabiosa succisa*. MARTIN (5) states that the pollen of *Trifolium pratense*, *T. hybridum*, and *T. repens* bursts almost instantly when dropped into water. He found that the same thing happened in various sugar solutions. His results obtained in germinating the pollen grains of *Trifolium* were not at all uniform. He found that they germinated best on wet parchment paper or hog's bladder, the amount of moisture



present having an effect on germination. He further adds that microchemical tests of the papillae on the stigma showed no sugar or starch present, but an oily emulsion such as was found in the pollen. His general conclusions are as follows:

From these observations it appears that the stigma secretes nothing that has any effect on germination or the direction of the pollen tube. The behavior of the stigma in the experiments at least indicates that its function in the germination of the pollen is to regulate the water supply.

Confirmation of these results is very much to be desired, as the experience of other workers in the case of various other species of plants is quite contradictory. The stigma in most plants has a secretory function; the amount of this secretion and its chemical composition will very probably vary to some extent with the amount of water absorbed by the roots, and with the relative humidity of the atmosphere, but from the morphological structure of the style and stigma it is extremely improbable that there is any special mechanism for controlling the water supply.

JOST (2) germinated pollen grains on starch paste made with only one or two parts of water, and also on parchment paper soaked with a sugar solution. This, it must be admitted, seems a more natural method of germinating the grains than immersion in a liquid medium, and resembles closely the condition found on the surface of the stigma. It has the drawback, however, of being more difficult to observe under the microscope. His general conclusions are as follows. He finds that germinating pollen grains may be placed in three classes: (1) those requiring nothing but water for germination, much mineral matter being injurious; to this group belong grasses, which can only germinate in minute quantities of pure water; (2) those requiring a very dilute solution of a definite chemical substance which is contained in the stigma; in a few cases this substance is levulose, in others organic acids, but in most cases it is unknown; (3) those which germinate only in a sugar solution of definite concentration.

According to PFEFFER (1), certain pollen grains will germinate only in the stigmatic fluid. MOLISCH (1) ascribes the curving of the pollen tube to the stigma to a chemotropic reaction. He adds further that pollen tubes curve toward water poorer in oxygen.



In my experiments, on the other hand, I found that absence of oxygen prevented the germination of the pollen grains. MIYOSHI (1) found that cane sugar, grape sugar, and dextrin exerted especially strong chemotropic attraction on pollen tubes, and that the first penetration of the stigma by the pollen tube was induced by chemotropic stimulation aided by the hydrotropism of the pollen tube, and possibly also by aerotropic and other stimuli.

SANDSTEN (3) carried out an extensive series of experiments with pollen grains. He found starch, diastase, and invertase in all the pollen grains which he examined. He also found diastase and invertase in the tissues of the style and stigma. He used hanging drop cultures of saccharose in almost every case. For the species of plants that he experimented with he found the optimum strength of sugar solution to lie between 5 and 35 per cent, but 20 per cent was the rule in the majority of instances. He found the range of concentration of the cane sugar for any given species of pollen to be large, indicating differences of degree of the concentration of the juices of the stigma. For instance, pollen of *Narcissus Tazetta* germinated in 1 per cent solution of cane sugar and also in a 60 per cent solution. He says that bursting of pollen takes place in masses of apple and plum pollen during warm spring rains, while in distilled water the contents protruded a distance equal to the diameter of the pollen grain, but made no further growth. I found a somewhat similar protrusion of contents in some of the sugar solutions used, but should hesitate to regard this as true germination. SANDSTEN further states that most pollen grains are negatively aerotropic and chemotropic, and that the direction of growth of the pollen tube is away from the light. Elsewhere he states that sunshine had little or no effect on the germination of the pollen or upon the growth of the pollen tube in most plants. In my experiments I found no difference in germination in the case of pollen grains kept in total darkness as compared with others exposed alternately to darkness and light.

Regarding the relation of the pollen grains to temperature, the temperature of the laboratory in SANDSTEN'S experiments varied from 15 to 36° C. He found the optimum degree of temperature for the germination of apple, pear, and plum pollen to be 24° C.



At 20° C. the average rate of growth of the pollen tube of apple was 280  $\mu$  for the first hour and 420  $\mu$  for the second hour. These rates of growth were much more rapid than any observed by me, but the optimum temperature agrees with my results, although 23° C. was the highest that I experimented with. SANDSTEN found that after exposure to a temperature of -1.5° C. for 6 hours there was only a slight falling off in the germination of apple, pear, and plum pollen, while in cherry and peach the falling off in the germination was much more marked.

CHANDLER (6) exposed the pollen of Jonathan apple to a temperature of -3° C. for 18 hours and found that in a 10 per cent solution of sugar it gave a germination of 33 per cent. After exposure of dried pollen of the same variety to a temperature of -13° C. for 18 hours it gave a germination of 20 per cent. SANDSTEN found that exposure of the stigmas of the five species mentioned above to a temperature of -1.5° C. for 6 hours caused the death of almost all of them.

Finally, as regards the length of time during which pollen grains can retain their vitality, SANDSTEN states that a small percentage of apple pollen retained its vitality for 6 months, while but few pollen grains of plum retained their germinating powers for this length of time. Both were kept dry at a temperature ranging between 7 and 26° C. In my experiments a few pollen grains of apple germinated after nearly 3 months, and of pear after 2 months, but no tests were made after longer intervals than these. It is very probable that SANDSTEN's definition of what constitutes germination was different from mine. CRANDALL (4), taking fruit setting as the basis for determining the vitality of pollen, found that the maximum age at which pollen was successfully used was 11 days for apple and about 16 days for strawberry.

### Summary

1. The following species were used for experiment: apple, pear, strawberry, loganberry, raspberry, black currant.
2. The culture medium was cane sugar and the strengths that gave the best germination were as follows: apple 2.5-10 per cent, pear 4-8 per cent, strawberry 8 per cent, loganberry 4 per cent, raspberry 16 per cent, black currant 16 per cent.



3. Some pollen grains of apple germinated in tap water and also in various strengths of sugar solution up to 50 per cent; the pollen grains of black currant germinated in tap water and also in 4, 8, and 16 per cent sugar solution.

4. Some pollen grains of apple germinated in 12 hours, the temperature ranging between 3°5 and 7° C.

5. The quickest growth of the pollen tube observed was 651.3  $\mu$  in 6 hours in apple, and 668  $\mu$  in 6 hours in black currant, as measured between perpendicular lines.

6. Some varieties of the same species appeared to have more vigorous pollen grains than others.

7. The pollen grains germinated alike in light and darkness.

8. Of the temperatures employed, 21–23° C. gave the quickest germination.

9. A few pollen grains of apple formed short pollen tubes after being kept dry for about 3 months, and of pear after 10 weeks. The pollen grains of strawberry, loganberry, and raspberry were all dead after 2 months, and of black currant after 11 weeks.

CENTRAL EXPERIMENTAL FARM  
OTTAWA, CANADA

#### LITERATURE CITED

1. PFEFFER, W., Physiology of plants. Eng. ed. 3 vols. 1900–1906.
2. JOST, L., Zur Physiologie des Pollens. Ber. Deutsch. Bot. Gesells. 23: 504–515. 1906.
3. SANDSTEN, E. P., Some conditions which influence the germination and fertility of pollen. Univ. Wisc. Agric. Exper. Sta. Research Bull. 4:149–172. 1909.
4. CRANDALL, C. S., The vitality of pollen. Proc. Soc. Hort. Sci. 9:121–130. 1912.
5. MARTIN, J. N., The physiology of the pollen of *Trifolium pratense*. BOT. GAZ. 56:112–126. 1913.
6. CHANDLER, W. H., The killing of plant tissue by low temperature. Univ. of Missouri Agric. Exper. Sta. Research Bull. 8:141–309. 1913.



# THE DECREASE OF PERMEABILITY PRODUCED BY ANESTHETICS

W. J. V. OSTERHOUT

(WITH SIX FIGURES)

A number of writers hold the view that anesthetics increase permeability, while others believe that anesthetics bring about a decrease of permeability.<sup>1</sup> It appears that the removal of this uncertainty is a necessary step toward a satisfactory theory of anesthesia.

It occurred to the writer that the cause of the discrepancy might lie in the fact that anesthetics produce both an increase and a decrease of permeability, and that quantitative methods might clear up the confusion. An investigation showed that this was the case. It also demonstrated that the characteristic effect of anesthetics is a decrease in permeability.

The investigations were begun in 1912. A brief announcement of some of the principal results has already appeared.<sup>2</sup> The present paper gives the details of these and of later researches and contains additional facts of importance.

Since ether, chloroform, and alcohol deteriorate on standing, especially when in contact with metal or with cork stoppers, special care was taken to obtain pure reagents.<sup>3</sup> Those used were Kahlbaum's or Squibb's.

The experiments were made on tissues of the marine alga *Laminaria saccharina*. The permeability was measured by determining the electrical resistance of the tissues by a method which had been previously described.<sup>4</sup> The method may be illustrated by describing a typical experiment. A lot of tissue which had a net

<sup>1</sup> Cf. HÖBER, *Physikalische Chemie der Zelle und der Gewebe*, Vierte Auflage. 1914. pp. 466, 597; LILLIE, *Amer. Jour. Physiol.* 29:372. 1912; 30:1. 1912; 31:255. 1913; *Science N.S.* 37:959. 1913; LEPESCHKIN, *Ber. Deutsch. Bot. Gesells.* 29:349. 1911; RUHLAND, *Jahrb. Wiss. Bot.* 51:376. 1912.

<sup>2</sup> *Science N.S.* 37:111. 1913.

<sup>3</sup> Cf. BASKERVILLE, C., *Science N.S.* 34:161. 1911.

<sup>4</sup> *Science N.S.* 35:112. 1912.



resistance<sup>5</sup> of 750 ohms in sea water was transferred to a mixture consisting of 990cc. sea water+10cc. ether+5cc. sea water

TABLE I  
ELECTRICAL RESISTANCE OF *Laminaria saccharina*

Time in minutes	In sea water containing 0.099 M ether (solution not renewed)	In sea water
0.....	750	750
10.....	850	.....
20.....	870	.....
40.....	770	750
60.....	750	.....
80.....	740	.....
200.....	730	.....
480.....	720	740
1500.....	690	690

All readings were taken at 18° C. or corrected to this temperature.

concentrated by evaporation until its conductivity was about double that of ordinary sea water. This mixture contained approximately 1 per cent by volume of ether (=0.099 M) and had the same conductivity as ordinary sea water. In 10 minutes the resistance had risen to 850 ohms; in 10 minutes more it had fallen to 870 ohms. It continued to fall until it reached 740 ohms, after which it fell very slowly, at about the same rate as the control. The fact that it fell 10 ohms below the starting point is not necessarily to be attributed to any injury, but rather to the fact that the evaporation of the ether increases the conductivity of the sea water which is contained in the apparatus, and in the interstices between the protoplasmic masses. The results are shown in table I and fig. 1.

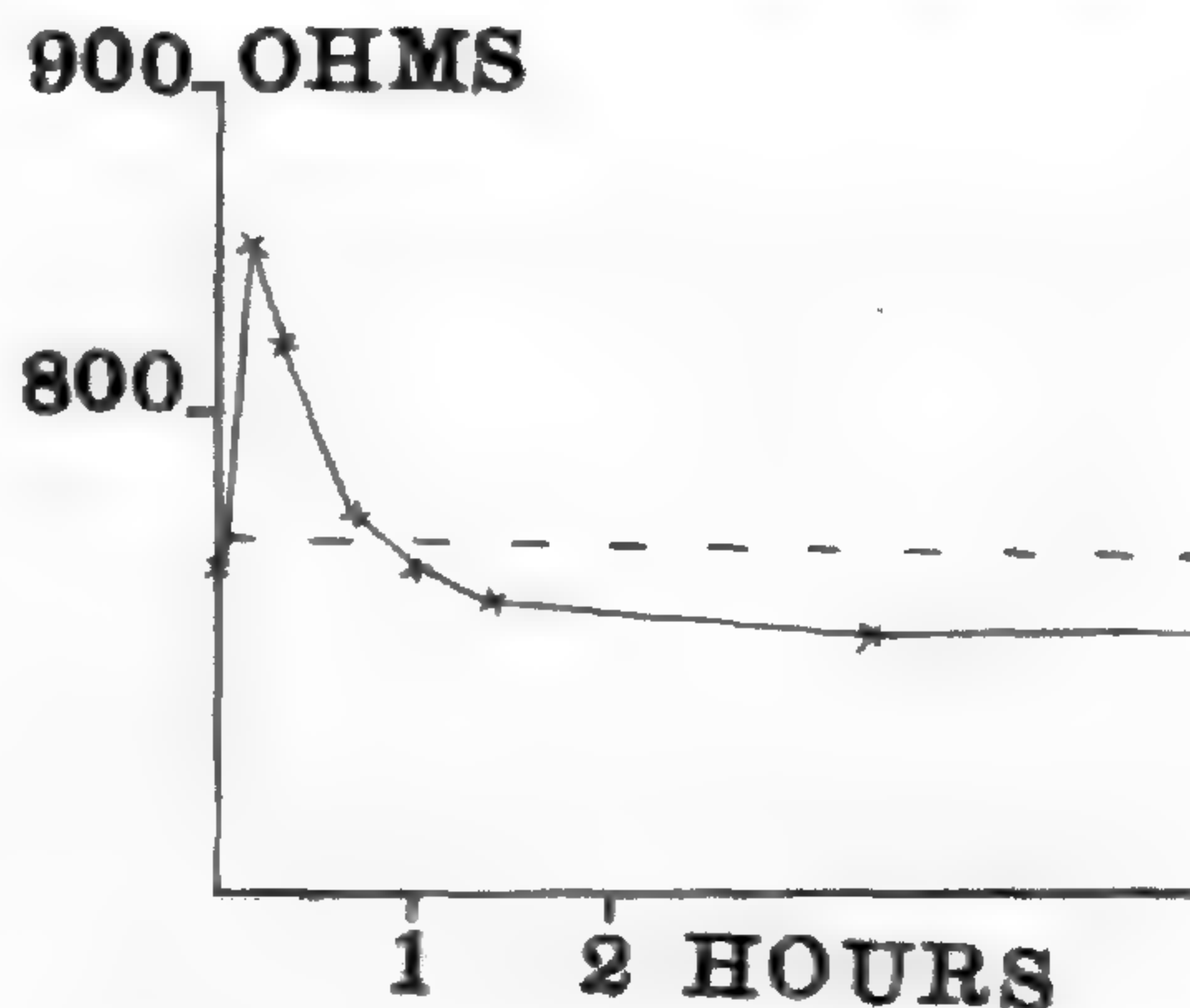

FIG. 1.—Curve showing decrease in permeability (increase in electrical resistance) of *Laminaria saccharina* under the influence of ether (0.099 M in sea water = 1 per cent by volume): the solution was not renewed (the effect of renewing the solution is seen in fig. 2); the dotted line shows the resistance of a control in sea water.

<sup>5</sup> The new resistance is the total resistance minus the resistance of the apparatus; it is therefore the resistance of the tissue taken by itself. The resistances given in this paper are all net resistances.



The permeability may be regarded as equal to the conductivity, or, for convenience, as equal to the conductance. Hence the permeability at the start was  $1 \div 750 = 0.001333$ . After treatment

TABLE II  
ELECTRICAL RESISTANCE OF *Laminaria saccharina*

Time in minutes	In sea water containing 0.099 M ether (solution renewed every 5 minutes)	In sea water
0.....	740	850
10.....	850	.....
20.....	850	.....
40.....	850	850
60.....	850	.....
80.....	840	850
140.....	830	850
200.....	820	850

All readings were taken at 18° C. or corrected to this temperature.

with ether it was  $1 \div 870 = 0.001149$ . The decrease in permeability was  $0.001333 - 0.001149 = 0.000184$ , or 13 per cent.

In order to see how the evaporation of the ether from the solution influenced the result, another experiment was performed in which the solution was renewed every 5 minutes during the first 60 minutes, and thereafter every 15 minutes. In this way the concentration of ether was kept more nearly constant. It was then found that the resistance rose as before, but did not fall during the first 80 minutes, and after this fell very slowly, so that after 300 minutes it was still 80 ohms above that of the control. At this point the experiment was discontinued. The results are shown in table II and fig. 2.

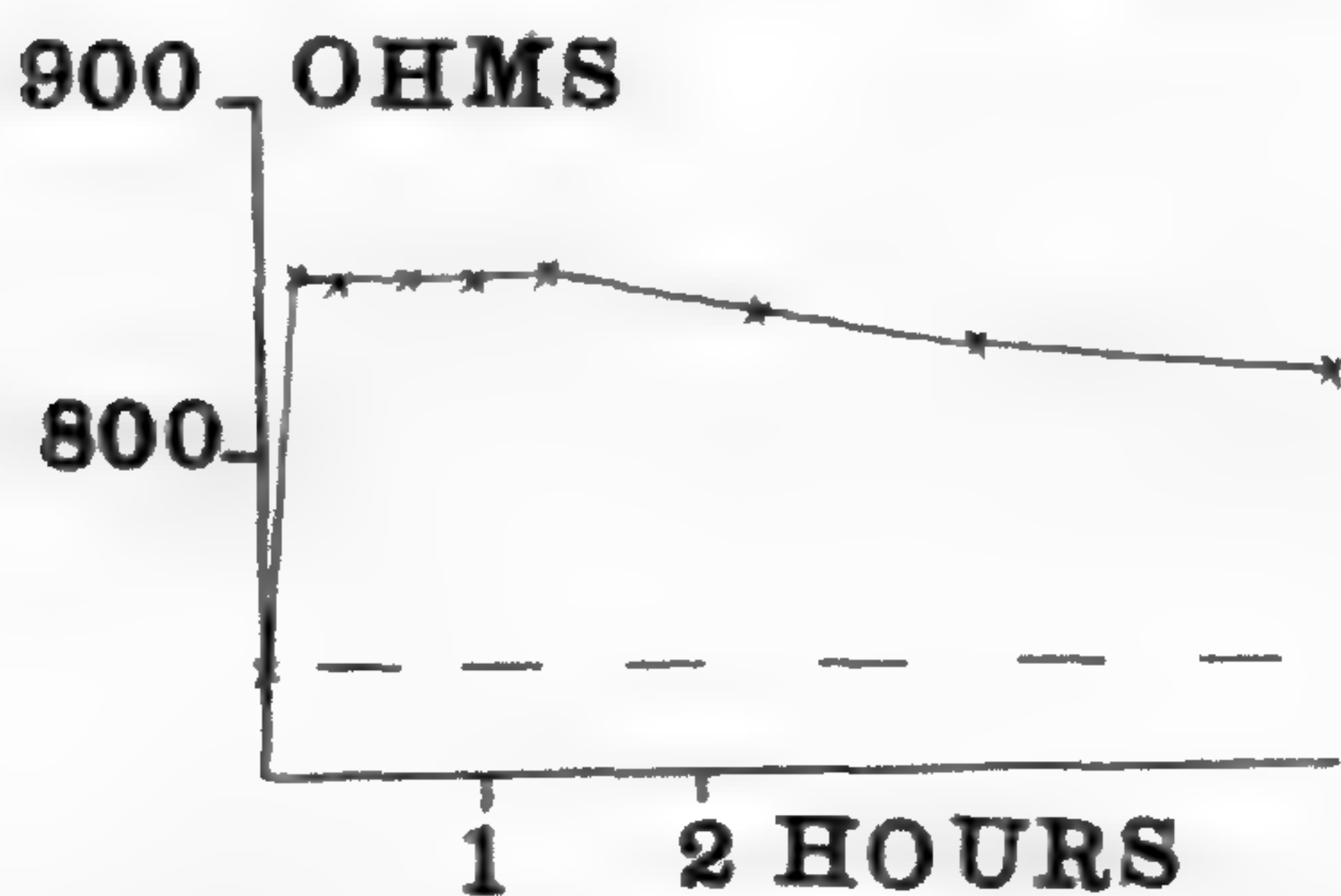

FIG. 2.—Curve showing the decrease in permeability (increase in electrical resistance) of *Laminaria saccharina* under the influence of ether (0.099 M in sea water = 1 per cent by volume): the solution was renewed every 5 minutes; the dotted line shows the resistance of a control in sea water.

In order to see whether the effect of the anesthetic could be quickly reversed, some tissue was kept in sea water containing 0.099 M ether for 50 minutes (the solution being renewed every



5 minutes). During this time the resistance rose from 800 to 910 ohms. It was then placed in sea water. At the end of 10 minutes resistance had fallen to 800 ohms. It was left in sea water for 110 minutes and again placed in sea water containing 0.099 M ether (the solution being renewed every 15 minutes). The resistance promptly rose to 910 ohms and remained there for an hour; 240 minutes later, when the experiment was discontinued, the resistance was 890 ohms. The results are shown in table III and fig. 3.

The effect of higher concentrations of ether was next investigated. Tissue which had a net resistance of 760 ohms in sea water was placed in a mixture of 970 cc. sea water + 30 cc. ether + 15 cc. of concentrated sea water, which was added to make the conductivity of the mixture equal to that of sea water. The concentration of the ether was

therefore 2.96 per cent by volume (= 0.293 M). In the course of

TABLE III  
ELECTRICAL RESISTANCE OF *Laminaria saccharina*

Time in minutes	Resistance	Solution	Resistance of control in sea water
0.....	800	Sea water containing 0.099 M ether	780
10.....	910		
30.....	910		
50.....	910		
60.....	800		
170.....	800	Sea water	.....
180.....	910	Sea water containing 0.099 M ether	760
200.....	910		
220.....	910		
240.....	910		
480.....	890		

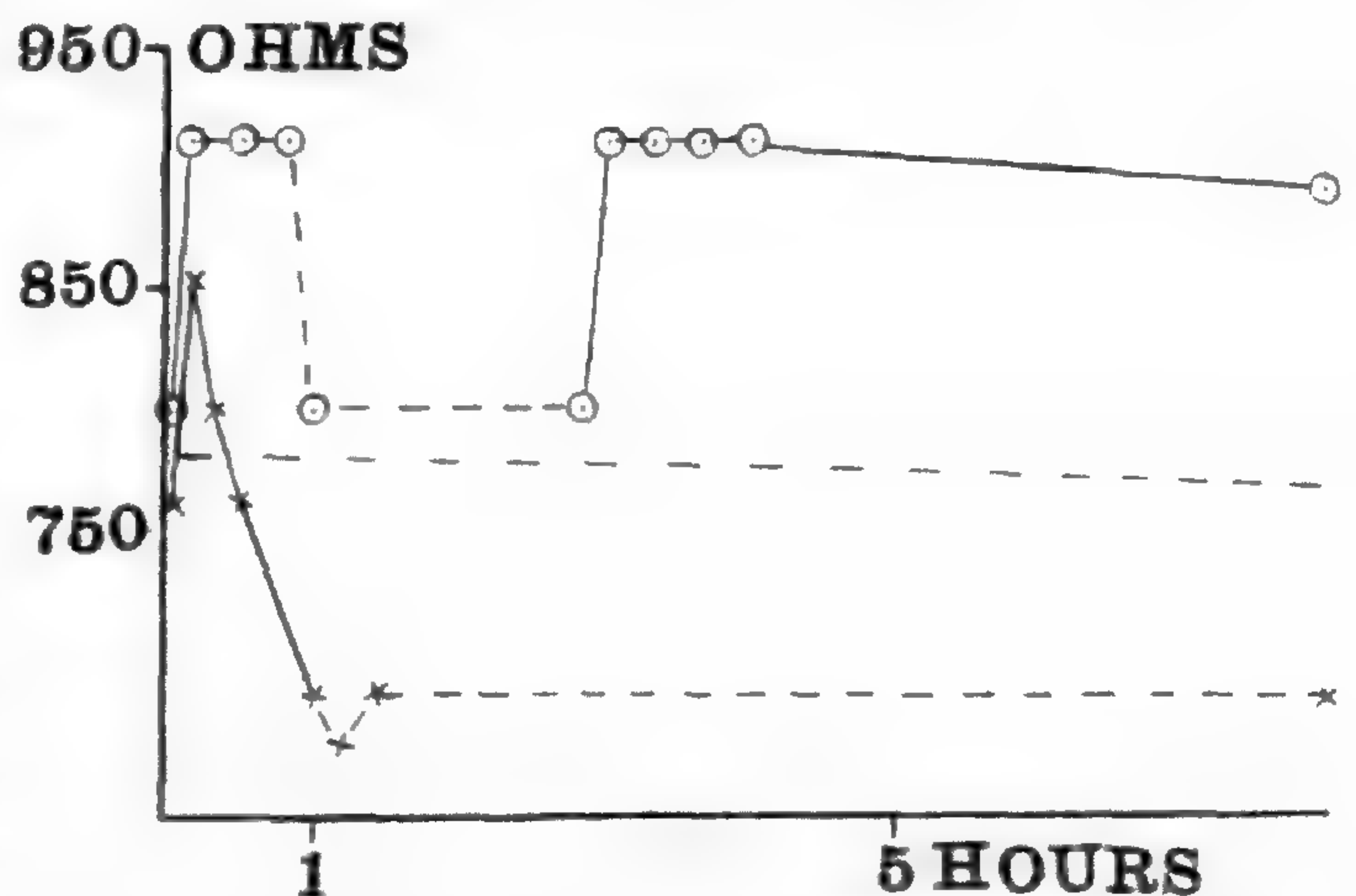

FIG. 3.—The upper curve shows the decrease of permeability (increase of electrical resistance) of *Laminaria saccharina* under the influence of ether (0.099 M in sea water = 1 per cent by volume), followed by a rapid return to normal when replaced in sea water (dotted portion of curve), and the rapid decrease of permeability when again placed under the influence of ether: the lowest curve shows the effect of a higher concentration of ether (0.293 M = 0.296 per cent by volume); there is a decrease of permeability followed by an increase (fall of electrical resistance) and subsequent slight rise when transferred to sea water (dotted portion of curve); the middle curve (dotted line) shows the electrical resistance of a control in sea water.



10 minutes the resistance rose to 850 ohms; during the next 10 minutes it fell to 800 ohms; it continued to fall rapidly during the next 40 minutes, reaching 680 ohms at the end of this period. The tissue was then placed in sea water; in the next 10 minutes the resistance fell to 660 ohms. This fall in resistance was doubtless due to the continued action of the ether, which required time to diffuse out of the tissue. During the next 10 minutes there was a rise of 20 ohms, which was probably due, either wholly or in part, to the fact that the resistance of the sea water was greater than that of the mixture from which the ether had partly evaporated.<sup>6</sup> During the next 400 minutes no rise occurred. The results are shown in table IV and fig. 3.

TABLE IV

ELECTRICAL RESISTANCE OF *Laminaria saccharina*

Time in minutes	Resistance	Solution	Resistance of control in sea water
0 .....	760	Sea water containing 0.293 M ether	780
10 .....	850		
20 .....	800		
30 .....	760		
60 .....	680		
70 .....	660		
80 .....	680	Sea water	760
480 .....	680		

All readings were taken at 18° C. or corrected to this temperature.

This outcome is very significant, for it shows that the increase of permeability produced by ether is not reversible; while, as we have seen, the decrease of permeability is easily reversed. Since the essential characteristic of an anesthetic is the reversibility of its action, we must associate anesthesia with the reversible decrease of permeability and not with the irreversible increase of permeability.

In view of the importance of this result the experiment was repeated many times, the fall of resistance (before placing in sea water) varying from 50 to 200 ohms, but always with practically the same result. On placing in sea water there were sometimes irregular fluctuations amounting to 20 or 30 ohms but no recovery.

<sup>6</sup> This rise was not always observed, but it might easily have been overlooked when observations were taken only once in 10 minutes.



This result is the more striking inasmuch as material of which the resistance has fallen as much as 150 ohms in NaCl recovers completely when placed in sea water, and may even undergo this treatment daily for several days in succession without injury.<sup>7</sup>

TABLE V  
ELECTRICAL RESISTANCE OF *Laminaria saccharina*

Time in minutes	In sea water containing 0.0064 M chloroform (solution renewed every 5 minutes)	In sea water
0.....	830	850
10.....	910	.....
20.....	920	.....
40.....	920	.....
60.....	920	850
80.....	920	.....
200.....	910	.....
300.....	900	850

All readings were made at 18° C. or corrected to this temperature.

The fall of resistance below the normal may be taken as a measure of the toxicity. The toxicity increases with the concentration, and it should be noted that it is greatly decreased if the material is allowed to stand in an open dish, owing to the evaporation of the ether. If the material be placed in a closed jar, oxygen must be supplied. The other alternative, frequent renewal of the solution, is usually preferable.

A series of investigations on chloroform gave similar results, the chief difference being that chloroform is much more toxic, and that the concentration necessary for long continued decrease of permeability is much lower, being about 0.05 per cent by volume, or 0.064 M. This is shown by table V and fig. 4, which are the results of an experiment with a mixture containing 999.5 cc. sea

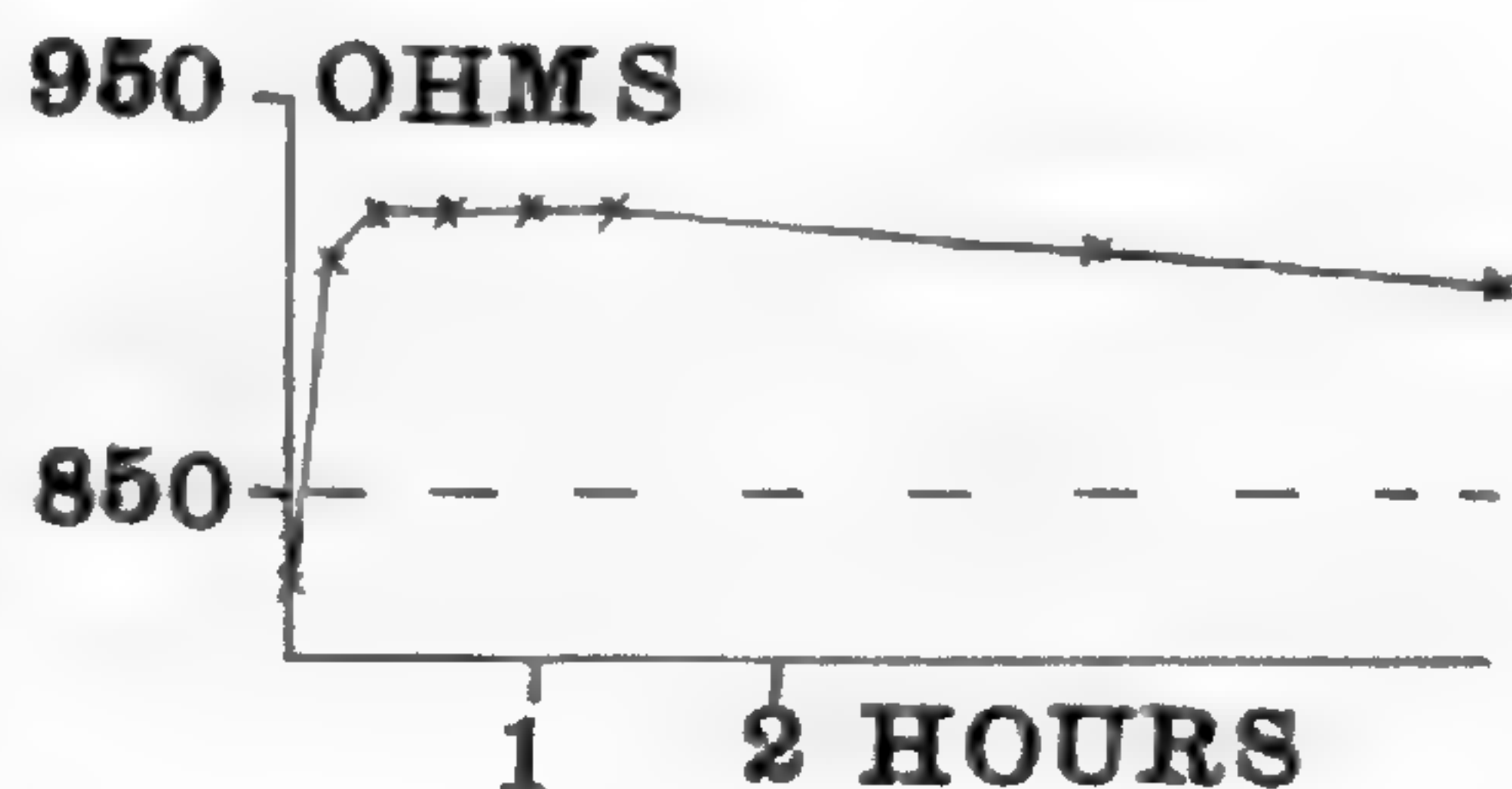

FIG. 4.—Curve showing the decrease in permeability (increase in electrical resistance) of *Laminaria saccharina* under the influence of chloroform (0.0064 M = 0.05 per cent by volume): the dotted line shows the electrical resistance of a control in sea water.

<sup>7</sup> Science N.S. 36:350. 1912; BOT. GAZ. 59:242. 1915.



water + 0.5 cc. chloroform + 0.25 cc. concentrated sea water (this mixture had the same conductivity as sea water). In this

TABLE VI  
ELECTRICAL RESISTANCE OF *Laminaria saccharina*

Time in minutes	Resistance	Solution	In sea water
0.....	760	Sea water containing 0.0128 M chloroform (solution renewed every 5 minutes)	730
10.....	840		
20.....	760		
40.....	720		
70.....	670	Sea water	730
80.....	660		
100.....	650		
120.....	640		
150.....	630		
200.....	620		
300.....	610		720
			710

All readings were taken at 18° C. or corrected to this temperature.

experiment the solution was renewed every 5 minutes during the first 80 minutes, and every 15 minutes thereafter. It will be seen

that the result is very similar to that obtained with 0.009 M ether.

If we increase the concentration of chloroform to 0.1 per cent by volume (=0.0128 M), the result is quite similar to that obtained with 0.293 M ether. This is shown in table VI and fig. 5, which gives the results of an experiment with a mixture containing 999 cc. sea water + 1 cc. chloroform + 0.5 cc. concentrated sea water (this mixture had the conductivity of sea water). The solution was renewed every 5 minutes during the first 80 minutes, after which it was

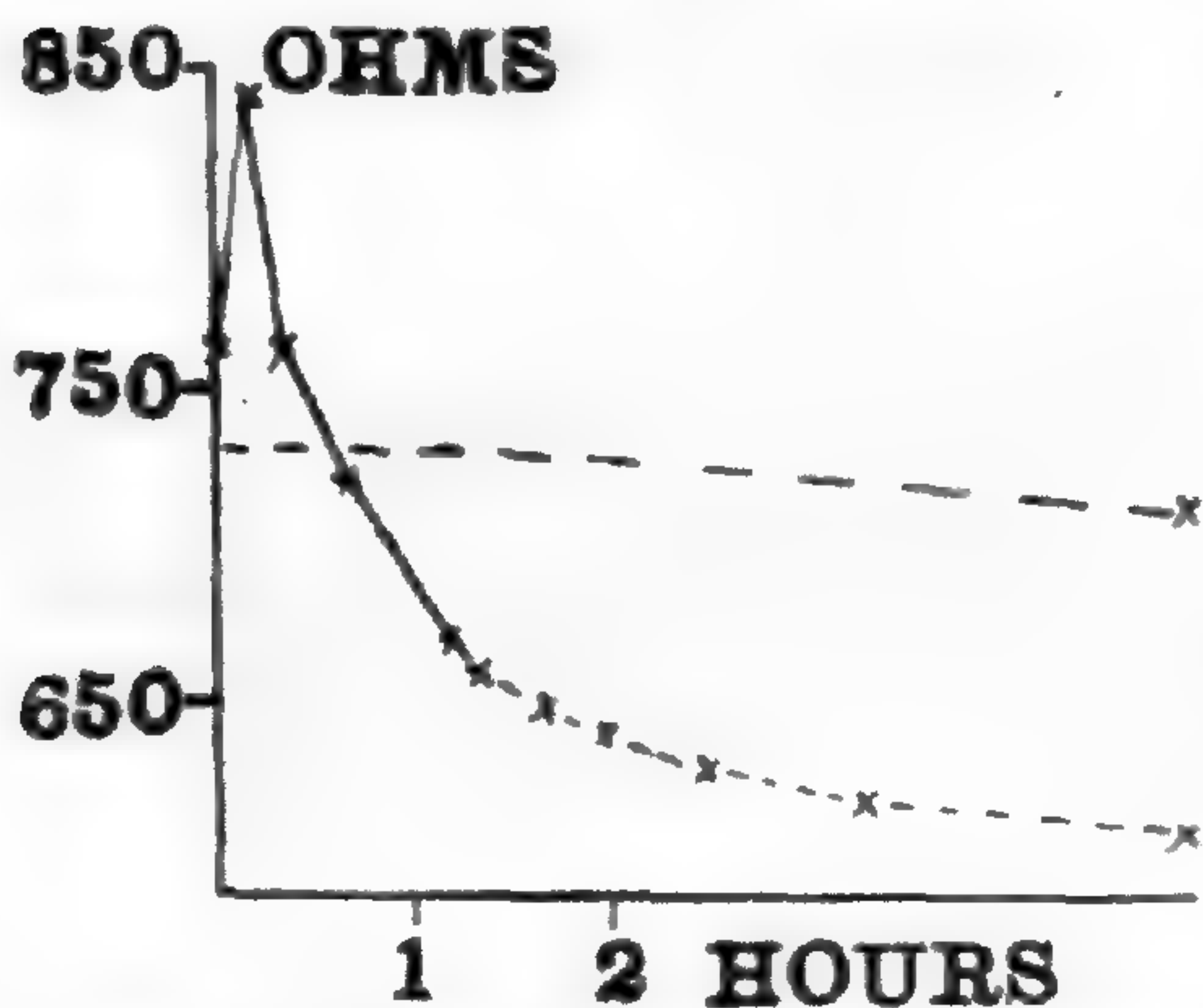

FIG. 5.—Curve showing the rapid decrease followed by an increase of permeability of *Laminaria saccharina* under the influence of chloroform (0.0128 M = 0.1 per cent by volume) and the subsequent failure to recover when replaced in sea water (dotted portion of the curve): the dotted line shows the electrical resistance of a control in sea water.

kept in sea water. There is no indication of recovery after the tissue is replaced in sea water.



Experiments with chloral hydrate gave results very similar to those obtained with chloroform, the corresponding effects being produced in both cases by approximately the same percentage concentrations,<sup>8</sup> that is, chloral hydrate 0.1 per cent (=0.006 M) acts similarly to chloroform 0.1 per cent by volume (=0.0128 M).

The experiments with alcohol lead to somewhat different results. In the first place, alcohol is not as toxic as ether, chloroform, or chloral hydrate, and higher concentrations must be used to produce the same effects on permeability. In sea water containing alcohol 0.051 M or 2.955 per cent by volume (the solution being renewed every 15 minutes) the results were much the same as in 0.099 M ether (the solution being renewed every 5 minutes), except that the rise in resistance took place more slowly, sometimes occupying 30 minutes or more. It was found that 0.2385 M or 13.875 per cent by volume is decidedly toxic.

An interesting feature of the results with alcohol is that the increase of permeability is reversible. If the increase be carried too far it is not reversible (or to a much smaller extent); in the first experiments this condition was unintentionally realized and lead the writer to suppose that alcohol behaves like ether. The course of a typical experiment is shown in table VII and fig. 6. The tissue was first placed in a mixture containing 970 cc. sea water + 30cc. Squibb's absolute alcohol + about 15cc. concentrated sea water. This mixture had the conductivity of sea water; the concentration of alcohol was 0.051 M (2.96 per cent by volume). The net resistance rose from 800 to 880 ohms in the course of 40 minutes. The tissue was then placed in sea water containing 0.2385 M alcohol (13.875 per cent by volume), and in the course of 20 minutes the resistance fell to 700 ohms. The tissue was then placed in sea water and the resistance again rose to 800 ohms.

The facts that recovery occurs in alcohol, and that irregular fluctuations are often observed in experiments on recovery from ether, suggest that the difference between the behavior

<sup>8</sup> No effort was made to find the exact percentages which would produce given effects, as this was not the primary object of the investigation. The actual concentration of chloral hydrate may have been somewhat lower than those given, owing to the presence of water in the chloral hydrate.



of alcohol and the other anesthetics investigated is only one of degree. It is probable that there is some recovery in ether,

TABLE VII  
ELECTRICAL RESISTANCE OF *Laminaria saccharina*

Time in minutes	Resistance	Solution	In sea water
0.....	800	Sea water containing 0.051 M alcohol (solution renewed every 10 minutes)	820
20.....	840		
30.....	860		
40.....	880		
50.....	760	Sea water containing 0.2385 M alcohol (solution renewed every 10 minutes)	820
60.....	700		
80.....	800	Sea water	820
200.....	800		

All readings were taken at 18° C. or corrected to this temperature.

chloroform, and chloral hydrate, but that it is so slight and so transitory as to be difficult of observation.

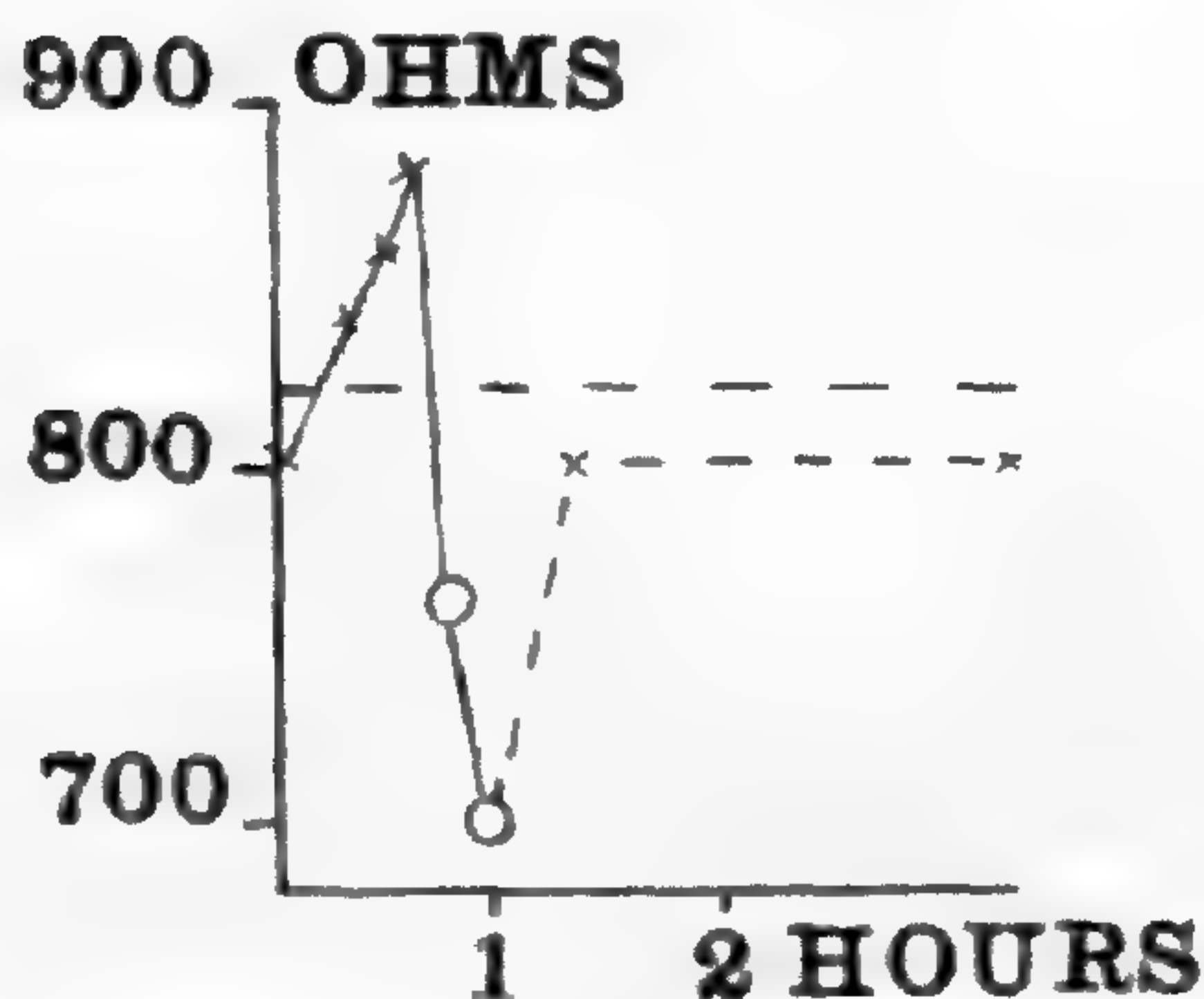

FIG. 6.—Curve showing the decrease of permeability of *Laminaria saccharina* under the influence of alcohol (0.051 M in sea water = 0.269 per cent by volume), followed by a rapid increase in permeability when placed in a stronger concentration of alcohol (0.2385 M = 13.875 per cent by volume) (portion of curve with circles), followed by recovery when replaced in sea water (dotted portion of curve): the dotted line shows the electrical resistance of a control in sea water.

It is evident that suitable concentrations of anesthetics produce a marked decrease of permeability, which may amount to 15 per cent or even more.<sup>9</sup> This condition may be maintained for a long time if the concentration is not too high; with higher concentrations the period is shortened and may become so short as to be observed with difficulty. This decrease of permeability can be easily and quickly reversed by replacing the tissue in sea water. It does not seem to produce any injury if the concentration be not too high. The relative concentrations necessary to produce this result correspond closely with those required

<sup>9</sup> The amount depends somewhat on the condition of the material. Material in poor condition in general shows less rise in resistance than good material.



to produce anesthesia,<sup>10</sup> being least for chloral hydrate and largest for alcohol.

On the other hand, the increase of permeability (except in the case of alcohol, within certain limits) produces permanent injury and is not reversible. It cannot be regarded, therefore, as the characteristic effect of the anesthetic. The characteristic effect must be regarded as in some way connected with decrease of permeability.

It is easy to see how a decrease of permeability to ions must hinder the production and the transmission of stimuli in so far as these are dependent on the movement of ions in the tissues, and there is abundant evidence that stimulation is always accompanied by such movements of ions in the protoplasm. It seems clear, therefore, that a decrease in permeability may result in the decrease of irritability, which is the characteristic effect of an anesthetic.

These investigations are of interest in view of the fact that MEYER'S theory of anesthesia, which has found wide acceptance, states that anesthesia is the result of an increase of permeability. MEYER supposes that anesthetics act on the lipoids of the cell in such a way that they become more permeable.

On the other hand, LILLIE<sup>11</sup> has developed a theory according to which anesthetics act by rendering the plasma membrane more refractory to changes of permeability either by decreasing its permeability or in some other way. LILLIE has observed that anesthetics antagonize the action of NaCl. This, however, does not by itself tell us anything regarding the action of anesthetics on permeability under normal circumstances, as for example when added to sea water. LEPECCHKIN,<sup>11</sup> on the bases of plasmolytic investigations, states that the entrance of dyes and of KNO<sub>3</sub> into the cell is hindered by anesthetics, but this is disputed by RUHLAND.<sup>11</sup>

Since the announcement of the writer's investigations,<sup>2</sup> similar experiments have been undertaken in HÖBER'S laboratory, with

<sup>10</sup> See, for example, the recent investigations of V. KÖRÖSY, *Zeit. Physik. Chemie* 93:145. 1914. He finds that the reversible action of chloroform on cell division in fish embryos and photosynthesis in *Elodea* is confined to practically the same concentrations as those which produce reversible effects in the permeability of *Laminaria* (about 0.0062 M).

<sup>11</sup> Pringsheim's *Jahrb. Wiss. Bot.* 51:376. 1912.



the result that they have been completely confirmed.<sup>12</sup> These experiments were made on red blood corpuscles, the permeability being determined by means of electrical measurements.

It is easy to imagine a mechanism which would respond to the action of anesthetics by a decrease of permeability. Since salts are less soluble in ether, alcohol, and chloroform than in water, it is evident that the presence of these substances in the plasma membrane in sufficient concentration would diminish the solubility of salts in the membrane and consequently hinder their penetration. The anesthetics might become more concentrated in the plasma membrane than in the surrounding solution either by chemical combination, by solution, or by absorption. It should be remembered that such salts as Mg, Ca, Al, and La also cause a decrease of permeability, and this suggests that chemical combination or coagulation, rather than mere accumulation of an anesthetic, is responsible for the effect. Moreover, the mere accumulation of an anesthetic at the plasma membrane (without chemical combination or coagulation) could not explain the increase of permeability. The best assumption is that the anesthetic combines chemically<sup>13</sup> with the protoplasm, the effect on permeability changing after a certain amount has combined. Good analogies are offered by cases in which chemical combination with a small amount of substance produces an effect which is reversed as soon as more combines. These analogies seem fairly satisfactory in the present condition of our knowledge.

LABORATORY OF PLANT PHYSIOLOGY  
HARVARD UNIVERSITY

<sup>12</sup> Deutsche medicinische Wochenschrift. no. 10. 1915.

<sup>13</sup> Under the term "chemical combination" coagulation is included.



# BRIEFER ARTICLES

## PHYSICAL CONDITIONS IN SPHAGNUM BOGS

The experimental data collected by Professor HENRY J. COX<sup>1</sup> of the United States Weather Bureau in regard to frost and temperature conditions in cranberry marshes do not seem to have received attention from reviewers of botanical literature, and their bearing on the causes of the peculiar flora of sphagnum bogs seems to have been overlooked. With a view to protecting the cranberry crop in cultivated marshes by predicting frost and thus enabling the growers to avoid danger to the crop by flooding the marshes, he conducted a very thorough investigation of frost and temperature conditions in the bogs of Wisconsin. He also secured some data on bogs in Massachusetts, New Jersey, and Washington. The following facts, which seem to have an important bearing on the possible causes of the inhibition from sphagnum bogs of plants other than bog xerophytes, have been summarized from his bulletin.

### A. AIR TEMPERATURES

1. *Comparison of bog with hard land.*—The mean minimum temperatures of the air at station 2 (in the bog over a dense growth of saturated sphagnum) and at station 9 (over sandy loam in a garden at the border of the bog, elevation of the surface of the soil approximately 10 feet above the surface of the bog) for May, June, July, August, September, and October 1907, at Mather, Wisconsin, were as follows (table 18, p. 81):

	Station 2	Station 9
Surface . . . . .	41.9	45.6
2½ inches above surface . . . . .	40.4	44.7
5 inches above surface . . . . .	40.2	44.8
7½ inches above surface . . . . .	40.7	44.9
10 inches above surface . . . . .	40.9	44.9
12 inches above surface . . . . .	40.9	44.9
15 inches above surface . . . . .	41.2	44.9
36 inches above surface . . . . .	43.3	45.1

<sup>1</sup> COX, HENRY J., Frost and temperature conditions in the cranberry marshes of Wisconsin. Bulletin T, U.S. Dept. Agric., Weather Bureau. 1910.



2. *Comparison of sphagnum with bare peat.*—The mean minimum temperatures of the air at station 7 (bare surface of peat in the center of a scalped area 10 feet square in an uncultivated portion of the bog) and at station 7a (over sphagnum moss at a distance of 5 or 6 feet from station 7) for September 1906, at Mather, Wisconsin, were as follows (table 4, p. 46):

	Station 7	Station 7a
Surface.....	49.0	43.4
5 inches above surface.....	44.2	43.7

#### B. SOIL TEMPERATURES

The mean minimum temperatures of the soil for May, June, July, August, September, and October 1907, at Mather, Wisconsin, were as follows:

1. *Comparison of bog with hard land* (table 19, p. 82).—

	Station 2	Station 9
At depth of 3 inches at 6 P.M.....	54.4	64.8
“ “ “ 3 “ “ 7 A.M.....	52.7	54.7
“ “ “ 6 “ “ 6 P.M.....	53.3	63.9
“ “ “ 6 “ “ 7 A.M.....	53.3	56.2

Cox (p. 119) says “frost remains in the soil of an unflooded bog until comparatively late in the season, and there have been found instances of frost in the soil in marshes as late as July 4.”

2. *Comparison of sphagnum moss with bare peat* (table 4, p. 45) for September 1906, at Mather, Wisconsin.—

	Station 7	Station 7a
At depth of 3 inches at 6 P.M.....	65.8	61.3
“ “ “ 3 “ “ 7 A.M.....	59.7	61.1



C. DIFFERENCES BETWEEN TEMPERATURE OF AIR AND OF SOIL ON BOG AND HARD LAND (Mather, Wisconsin, May 13—October 31, 1907)

1. *Mean temperature of soil obtained by averaging the mean at 6 P.M. with that at 7 A.M. (table 19, p. 82).—*

	Station 2 (sphagnum)	Station 9 (loam)
a) 3-inch depth.....	53.5	59.7
b) 6-inch depth.....	53.3	60.0

2. *Mean temperature of air obtained by averaging the mean maximum with the mean minimum in each case.—Data from table 17, p. 78, table 13a, p. 69, and a letter to the reviewer from Professor Cox.*

	Station 2	Station 9
c) Surface of soil.....	62.8	64.8
d) 5 inches above surface....	61.1	62.2
e) 36 inches above surface...	61.0	60.5

3. *Comparison of differences.—*

	Station 2	Station 9
a and c.....	9.3	5.1
a and d.....	7.6	2.5
a and e.....	7.5	0.8
b and c.....	9.5	4.8
b and d.....	7.8	2.2
b and e.....	7.7	0.5

It thus appears that in all possible comparisons there was a much greater difference between the temperature of the air and that of the soil on the bog than on the neighboring hard land.

D. WIND VELOCITY

The following facts regarding the mean velocity of the wind over the upland and over the marsh in miles per hour for the



months of May, June, July, August, September, and October 1907, at Mather, Wisconsin, are given in tables 15 and 15*a*, p. 74.

Upland.....	9.0
Marsh .....	4.5

Anemometer on warehouse (upland) 32 ft. 7 in. above ground. Anemometer on marsh 4 ft. 7 in. above ground (station 4). Anemometer on warehouse 50 ft. 5 in. above surface of marsh at station 4. Difference between elevation of anemometers, 45 ft. 10 in.

#### E. RELATIVE HUMIDITY

The following are the data for Mather, Wisconsin, May 13—October 31, 1907 (table 21, pp. 98–112). At 7 P.M. the mean relative humidity for the month was higher on the bog than on the upland for every month, the mean excess of the bog over the upland being 9.5 per cent. At 7 A.M. the mean was greater on the bog than on the upland for every month except June, when the two were equal. Considered by days the relative humidity of the bog at 7 A.M. was greater than that of the upland on 67.9 per cent of the days of the whole season, and equal to it on 8.7 per cent of the days. At 7 P.M. it was greater on the bog on 88.9 per cent of the days and equal on 4.7 per cent.

#### CONCLUSIONS

1. The temperature conditions in both soil and air are less favorable for plants in the bog than on the neighboring hard land.

2. Temperature conditions are less favorable for plants in sphagnum moss than in bare peat.

3. In so far as a difference of temperature between air and soil is unfavorable for plants, the conditions in a sphagnum bog are much less favorable than in the neighboring hard land.

4. The conditions, so far as relative humidity is concerned, were less favorable for transpiration on the bog than on the neighboring hard land.



5. While the difference in wind velocity would also tend to indicate less favorable conditions for transpiration on the bog than on the neighboring hard land, the difference in the height of the two instruments must be taken into account.

The conclusions are those of the reviewer. Some of the data have also been rearranged in order to bear on the problem of the possible factors in the general inhibition from sphagnum bogs of plants other than bog xerophytes.—GEORGE B. RIGG, *University of Washington, Seattle, Wash.*



# CURRENT LITERATURE

## BOOK REVIEWS

### Senescence and rejuvenescence

Professor CHILD<sup>1</sup> has made a most thoughtful attempt to solve a fundamental biological problem; for the book contains not only an explanation of the phenomenon of growing old, or senescence, a process of much human interest, but it also contains the foundation of an even more important theory of an entirely novel kind on the problem of animal forms, regeneration and inheritance. The great value of the book is due not only to these philosophical and illuminating explanations, but also to the very large amount of original, experimental observations recorded in it. The author, as is well known, has been engaged for many years in the experimental study of the general problems of regeneration and morphogenesis in animals; in this treatise he presents not only the more important of the observations he has made but also the general conclusions to which this work has led. The book is full of material of fact, presented in a logical and convincing manner, to support the general theory of the nature of the process of senescence, the nature and extent of rejuvenescence, the significance of sexual reproduction and maturation, and the nature of the processes at work in the phenomena of regeneration, growth, and the determination of form in animals and plants. It thus contains the basis of a new theory of animal and plant forms, and a resulting new theory of the process of inheritance which is to be the subject of a separate treatise, shortly to appear. Not the least valuable feature of the book is that it treats of these general processes as they occur both in plants and animals, and the essential identity of the processes in the two living kingdoms is clearly revealed. Zoology and botany thus mutually illuminate each other, and the conclusions must arouse the keenest interest of both zoologists and botanists. The theories are so far reaching and fundamental that if substantiated they will profoundly alter many prevalent conceptions of biology. The book represents, therefore, one of the most original and important constructive contributions made by an American biologist.

The thesis of the author is that senescence is a universal attribute of living organisms, plants as well as animals. Where it appears to be absent, as in the infusoria and some plants, this is not due to its actual absence, but to a rejuvenescence taking place in more or less irregular rhythms by which the results of

<sup>1</sup> CHILD, C. M., *Senescence and rejuvenescence*. 8vo. pp. 481. University of Chicago Press. 1915. \$4.00.



senescence are overcome and the animal or plant returned to its youthful state. This process of rejuvenescence is not limited to lower forms of animals and to the plants, but occurs also, to some degree, in the higher animals as well, and even in man a limited rejuvenescence, at least in some tissues, is possible. One sees the process of senescence everywhere in living nature and it appears under various guises. Thus in the higher forms, and indeed in all forms, the process of sexual or gametic reproduction and the life cycle are in reality nothing but expressions of processes of senescence and rejuvenescence. The sex cells are senescent cells, which by uniting with each other accomplish their rejuvenescence and form a new, young individual. This conception is in sharp contrast with the current WEISMANN-GALTON view of a perennially young germ plasm, separate from the soma. Instead of the germ plasm being young and retaining its constitution unchanged in the soma, as such a theory requires, the germ cells are the most highly differentiated and oldest cells of the body, and they grow old in their development, just as the soma grows old. They are indeed parts of the soma, and the influence of the environment on these cells is just as pronounced as upon the soma cells, and there is no theoretical objection to the inheritance of acquired characters.

The first chapter of Part I is an especially clear and readable statement of the various theories of the constitution of the organism, and the author points out that the neo-vitalistic theory of the present day is a logical outcome of the corpuscular theories of inheritance.

“An orderly progressive development of a definite character is inconceivable in an organism composed of a very large number of independent ultimate units, each capable of growth and reproduction, except under the influence of some controlling and directing principle, entelechy, distinct from the ultimate units themselves. If such theories represent the last word of science concerning the physico-chemical constitution of the organism, then we must all be vitalists, whether we admit it or not.”

The corpuscular theories necessitate an entelechy to arrange the corpuscles, as DRIESCH and others have seen. It is the corpuscular theory of living matter which is attacked in the book from cover to cover. There are taken up in turn in this chapter, the corpuscular, the chemical, and finally the physico-chemical theory of life phenomena, based on the colloidal substratum of living matter. Of the last theory a particularly clear account is given, and the organism compared most happily to a river.

“Neither water alone nor the banks and the bed alone constitute the system which we call a river; and in nature the banks, the bed, and the current have been associated from the beginning. Here, also, structure and function are connected as in the organism: the configuration of the channel modifies the intensity and course of the current, and the current in turn modifies the morphology of the channel by deposition at one point, giving rise to structures such as bars, islands, flats, and by erosion at another.”

Just so in the organism the metabolic stream raises bars and dams of sediment, and the current is thereby turned aside, or it may be narrowed and deep-



ened. The essential cause of senescence is this deposit of colloidal material in the bed of the living stream, a deposit which becomes optically visible in the progressive differentiation of the protoplasm. This simple principle of the guiding of the living stream by its erosions and sediments is at the bottom not only a senescence and differentiation of cell protoplasm, but of all that differentiation of the organism in embryonic development, which results finally, as the living stream flows on, in the considerable chemical differences between different organs and in the gradual and necessary aging of the individual. Thus from a very simple germ a very complex organism is evolved, and quantitative, not qualitative, differences in rate of metabolism produce eventually a differentiation in kind of metabolism.

The work is the outcome of the discovery of a particularly favorable material for the study of the problem of senescence and rejuvenescence, together with the discovery of a method of testing the degree of aging or youth. The material discovered is the flatworm *Planaria* and related species. These animals often do not reproduce sexually, but detach a part of the body which undergoes dedifferentiation and rejuvenescence to a young animal. Such pieces emerge from encystment young animals. In them, therefore, there is a regular series of senescences and rejuvenescences taking place in a brief time, and experiments may be tried on the control of the process to determine its nature. From these forms one can interpret the similar phenomena shown by other organisms. The method of study consists in the discovery of several simple ways of determining the degree of youth, or, in other words, the degree of metabolism, for the metabolism of the young is keener than that of the old. One method is by the use of potassium cyanide. The susceptibility to this poison is a direct measure of the speed of metabolism, if animals of the same kind but different ages are compared. In addition to potassium cyanide the susceptibility to anesthetics, or the power of acclimatizing to very weak doses of anesthetics such as alcohol, also furnishes a criterion of youth or age, or rather of youthful metabolism. These methods have been controlled by the direct measurement of the amount of carbon dioxide exhaled per gram of tissue as determined by TASHIRO in his biometer, and these measurements have completely confirmed the observations on the cyanides. By observing the animals in cyanide solutions, it is found that the parts of the animal which have the higher rate of metabolism die first, the death changes being very clear and easily perceived. It became possible thus to study the rate of metabolism in different parts of the animal and under various conditions of age, temperature, after injury, etc., and a large number of very striking and instructive experiments on many different forms have been recorded. Chapters 3, 4, 5, and 6 of Part II deal with the method, with the phenomena of the susceptibility to cyanide, and the rate of metabolism occurring in the reconstitution of new organisms from pieces of *Planaria*, whether these pieces are sexual cells, or cysts, or pieces cut from the adult worm. The process of reconstitution of the animal form is always a process of rejuvenescence, of a dedifferentiation, and the restoration



of youthful, in the place of old, protoplasm. However, the new animal is produced, it is found to become young, in its metabolism, as if it came from an egg. Chapter 6 shows that this same process occurs also in agamic reproduction in other forms, such as certain annelids, in protozoa, coelenterates, etc.

Chapter 7 deals with the artificial control of rejuvenescence apart from reproduction. It is found possible by starving in these animals to bring about dedifferentiation and complete rejuvenescence. By starvation the obstacles to metabolism are removed and the metabolic rate rises to just the same degree as it does in a young individual formed by sexual reproduction.

In Part III is recorded a very fundamental discovery which has been made the basis of the author's explanation of the attainment of animal forms and the development of a highly elaborated adult from a simple germ, without assuming that the germ has almost as complex a character as the adult, due to the number of units or pangenes in it. This fundamental discovery is that of the axial gradient of metabolism, and the dominance and subordination of parts during development in relation to this gradient. The author had found that the head end of an animal, or that part where the nervous system lies, or is to lie, has a higher rate of metabolism than the parts lying behind it. There is in the body of *Planaria*, and in other animals as well, a metabolic gradient from before backward, and from the midline toward the sides, and sometimes from back to belly. These are three coordinate axes. The parts which are most active metabolically exercise an inhibitory power on the less active parts in a manner exactly analogous to the control exercised by the growing tip of a plant on the older parts. It is this control of the more rapidly metabolizing parts which controls the development, and differentiation, and dedifferentiation. This conclusion is proved by experiments showing that if in any way the control of the dominant region is removed, the subordinate parts may attain to dominance in their turn and start a new head, and by a resulting reorganization of the materials cause the appearance of a new individual. The development of any part of the growing organism is determined by the position the part occupies in its relation to these coordinate axes of metabolic gradients. If, for example, one removes the head, the parts behind it are now released from the inhibition exercised by a more rapid metabolism in front of them, the rate of the anterior margin at once rises and dominates the parts behind, the material is reorganized from this new head and a new individual produced. This discovery, which is established by a very large amount of experimental observations, enables one to control the processes of regeneration and morphogenesis. It explains a vast number of facts of regeneration morphogenesis, teratomas, and so forth, for which there has been hitherto no explanation at all. It is brought into this book because, with the release of metabolic control of anterior regions, rejuvenescence occurs, and dedifferentiation. Animals thus show themselves to be in essentials, so far as their morphogenesis is concerned, like plants, in which the dominance of the growing tip has



long been recognized. The nature of the control is not specified, but it is suggested that it is in the nature of nerve impulses.

In this part, also, is considered senescence in the higher forms, in man himself, and the various changes in the tissues are pointed out. Various theories are criticized and the evidence examined, showing that here, also, the accumulation of colloidal material in some of the cells is probably the cause of senescence. By fasting a limited degree of rejuvenescence is possible. Various theories of the cause of the length of life are examined.

Part IV brings the sexual or gametic reproduction of animals and plants into the discussion. A great number of cases are examined, particularly in plants, where the conditions are especially illuminating. The phenomena of the conjugation of the gametes is interpreted from the same point of view. The gametes are highly differentiated cells; they are, therefore, old cells, and are among the most senescent in the body. In this the author agrees with MINOT. By conjugation, rejuvenescence is produced and a young individual formed. The fact of this rejuvenescence is demonstrated by the study of the rate of metabolism of quite a number of larvae and embryos at various stages of their life history; and the progressive rejuvenescence is followed not only by the change in structure of the protoplasm but by the increasing rate of metabolism; and the point where the tide turns and senescence begins is noted.

Part V is theoretical and critical, and in this the conception that senescence is due to any relation of the amount of nuclear to cytoplasmic matter, or that growth is an autocatalysis, is criticized adversely. Finally, the problem is raised whether there is not also a progressive senescence in the protoplasm as a whole, a growing old of races as well as individuals, and whether this is not the cause of the progressive evolution of living things. A few quotations will make clear the author's standpoint and also illustrate the interesting and thoughtful style of the book.

“Physiological or natural death is not something which has originated in the course of evolution from the lower to the higher forms. All organisms, from the lowest to the highest, from the simplest to the most complex, undoubtedly die of old age, unless senescence is compensated by rejuvenescence. In the lower forms the death point may never be attained under the usual conditions, because the low stability of the substratum and the consequent degree of individuation permit the frequent occurrence of a high degree of rejuvenescence. In the higher forms death becomes inevitable and necessary because the capacity for rejuvenescence is limited by the greater stability of the substratum. For his high degree of individuation man pays the penalty of individual death, and the conditions and processes in the human organism which lead to death in the end are the conditions and processes which make man what he is. The advance of knowledge and of experimental technique may make it possible at some future time to bring about a greater degree of rejuvenescence and retardation of senescence in man than is now possible, but when we remember that the present condition of the protoplasmic substratum of these organisms is the result



of millions of years of evolutionary equilibration, we cannot but admit that this task may prove to be one of considerable difficulty."

"Senescence and rejuvenescence do not include special processes, they are merely certain aspects of the relations between the metabolic reactions and the protoplasmic substratum. Senescence means the greater stability of this substratum; rejuvenescence, its greater instability."

"Moreover, the course of development of the gametes bears every indication of being a progressive differentiation and senescence, not fundamentally different from that of other organs of the body, and the fully developed gametes are physiologically old, highly differentiated cells which are rapidly approaching death and in most cases actually do die soon after maturity, unless fertilization occurs. These cells must be dedifferentiated or undergo rejuvenescence before they can enter on a new period of development. In the plants this may occur to a greater or less extent without fertilization in the development of the gametophyte, but in the gametes of animals, with the exception of parthenogenetic eggs, dedifferentiation and rejuvenescence occur only after fertilization."

"From this point of view gametic reproduction differs from agamic only in the greater degree of specialization of the reproductive cells and the special conditions necessary to initiate the process of dedifferentiation and rejuvenescence. The same periodic changes, the same life cycle and age cycle occur in both. We can dispense entirely with that remarkable conception, the germ plasm of the WEISMANN theory, and say that germ plasm is any protoplasm capable under the proper conditions of undergoing dedifferentiation and reconstitution into a new individual of the species."

Physiologists should be particularly interested in this theory. For the first time we have an explanation of the processes of morphogenesis which is essentially physiological, and which may be tested by physiological methods. The control of the growing tip, or the rapidly metabolizing head end of the animal, is supposed to be exerted on the parts less active by means of something of the nature of nerve impulses spreading from one region to the other. This conception will undoubtedly appeal to the majority of physiologists. Similarly, for the first time we have at least the foundation of a physiological explanation of the manner in which, from a simple germ, a highly differentiated adult will and must arise. The morphological conception of pangenes is entirely abandoned. The book is thus essentially constructive, and not a destructive criticism only of such views. To the pharmacologist the discovery of the cause of the sensitivity of the nervous system to drugs of all kinds and its relation to metabolism is a matter of very great interest and importance. To the ordinary man of a philosophical temperament this book must appeal for its solid thoughtfulness, clear exposition, and cautious conclusions. The large number of well executed illustrations greatly adds to the ease of following the text. Zoologists and botanists have here a theory which offers an explanation of the most interesting and obscure of their phenomena. It presents a possible and apparently a practicable means of escape from neo-vitalism.—  
A. P. MATHEWS.



## MINOR NOTICES

**Plankton studies.**—HANS BACHMANN<sup>2</sup> has issued a volume that combines his studies on Lake Lucerne and other Swiss lakes with a general account of the plant plankton of fresh water. The author follows SCHRÖTER in limiting the use of the term plankton to those organisms whose own locomotion is powerless to drive them against waves and currents. A contrast is made between the plankton of lakes (limnoplankton), small ponds (heleoplankton), and rivers (potamoplankton). Following chapters on plankton technique and the physical constitution of the water is a chapter, making up the body of the volume, dealing with the plankton constituents. The groups treated are the flagellates, Peridineae, diatoms, Cyanophyceae, desmids, Protococcaceae, and Volvocaceae. Owing to the minute descriptions, taking account of both ordinary forms and variations, and ample keys, this work will be of great value to all students of the phytoplankton. It will be of particular value as a manual for the identification of many of our common fresh water forms.—H. C. COWLES.

**Flora of India.**—The government of Madras has published a flora of a region of India prepared by Professor FYSON<sup>3</sup> of Presidency College. The plants included are the wild and more commonly introduced flowering plants in the neighborhood of the hill-stations of Ootacamund, Kotagiri, and Kodaikanal. Nearly 500 species are described, 430 of which are indigenous, and nearly half of these are restricted to the mountains of South India and Ceylon. Only 40 of them occur in China and Japan. The analytical keys, the remarkably full descriptions, and the volume of illustrations make this manual exceedingly serviceable to botanical students in a special region of India, and also to botanists everywhere who are interested in the composition of the Indian flora.—J. M. C.

**Fresh water flora of Germany, Austria, and Switzerland.**—This very compact and well illustrated manual of the fresh water flora of this region, under the editorship of PASCHER, is planned to appear in 16 small volumes, 7 of which have been published and noticed in this journal. The eighth volume to appear (volume 5 of the series)<sup>4</sup> deals with Tetrastiales and Protococcales of the Chlorophyceae, and is prepared by E. LEMMERMANN (Bremen), JOS. BRUNNTHALER (Wien), and A. PASCHER (Prag).—J. M. C.

<sup>2</sup> BACHMANN, HANS, *Das Phytoplankton des Süßwassers mit besonderer Berücksichtigung des Vierwaldstättersees*. 8vo. pp. 213. *figs.* 29. *pls.* 15. Jena: Gustav Fischer. 1911. \$1.25.

<sup>3</sup> FYSON, P. F., *The flora of the Nilgiri and Pulney hill-tops (above 6500 feet)*. 2 vols. 8vo. Vol. I. pp. xxvi+475; Vol. II. *pls.* 286. Madras: Government Press. 1915.

<sup>4</sup> PASCHER, A., *Die Süßwasser-Flora, Deutschlands, Österreichs, und der Schweiz*. Vol. V. Chlorophyceae 2 (Tetrastiales, Protococcales). pp. 250. *figs.* 402. Jena: Gustav Fischer. 1915.



## NOTES FOR STUDENTS

**Current taxonomic literature.**—E. L. GREENE (Rep. Sp. Nov. 13:320-324. 1914) has published 12 new species of flowering plants from western United States. The same author (Am. Mid. Nat. 3:333-335. 1914) describes 4 new species of *Ranunculus* from eastern United States, and (Cybele Columbiana 1:7-33. 1914) characterizes 2 new species of *Viola* from the District of Columbia; also (*ibid.* 33-36) under the heading "Manipulus Malvacearum" describes 5 new species of *Sidalcea*.—R. HAMET (Bot. Jahrb. 50: Beibl. no. 114. pp. 25-27. 1914) has published two new American species of *Sedum*.—H. HARMS (Rep. Sp. Nov. 13:419, 420. 1914) records two new species of *Inga* from Central America.—E. HASSLER (*ibid.* 237-239) describes a new species of *Melochia* with two varieties from Argentina.—W. HERTER (*ibid.* 296) has published a new species of *Lycopodium* (*L. Sydowiorum*) from Brazil.—G. HIERONYMUS (Leaf. Philipp. Bot. 6:1987-2064. 1913) under the title "Selaginellarum species Philippinenses" records 36 species of *Selaginella* from the Philippine Islands, 16 of which are new to science. The same author (Hedwigia 55:325-375. 1914) in an article entitled "Beiträge zur Kenntnis der Gattung *Pteris*" has published several new species and varieties of this genus from the Philippine Islands.—M. A. HOWE (Mem. Torr. Bot. Club 15:1-185. pls. 1-66. 1914) has published an important contribution to our knowledge of the marine flora of South America. The paper is entitled "The marine algae of Peru," and it includes 123 species of which 29 are described as new to science. One new genus (*Lobocolax*) of the Nemalionaceae is proposed.—J. HUBER (Bull. Soc. Bot. Genève II. 6:179-212. 1914) under the title "Plantae Duckeanae Austro-Guyanenses" has published 45 new species and varieties of flowering plants from southern Guiana. One new genus (*Humirianthera*) of the Icacinaceae is included. The same author (*ibid.* 215) describes a new species of *Wedelia* (*W. paraensis*) from Brazil.—A. HUE (Ann. Mycologici 12:509-534. 1914) under the title "Lichenes novos melius cognitos" describes several new species and includes one new genus (*Nylanderella*), based on *Siphula medioxima* Nyl. from New Zealand.—J. HUTCHINSON (Bull. Kew 1914. p. 355) has published a new genus (*Triplotaxis*) of the Compositae from Africa.—C. A. KOFOID (Univ. Calif. Publ. Bot. 6:35-40. pl. 7. 1914) gives an account of a new alga which was found in a local reservoir at Berkeley, California, to which he gives the generic name *Phytomorula* and provisionally refers it to the Coelastraceae.—F. KRÄNZLIN (Philipp. Jour. Sci. Bot. 8:163-179. 1913) under the title "Cyrandraceae novae Philippinenses" has published 25 new species in this family from the Philippine Islands.—K. KRAUSE (Bot. Jahrb. 50:343-348. 1914. Supplement-Band) describes and illustrates a new genus (*Englerophytum*) of the Sapotaceae from Africa.—J. G. KUHLMAN (Rep. Sp. Nov. 13:393, 394. 1914) has described two new species of *Biovularia* and proposes a new genus (*Saccolaria*) of the Lentibulariaceae from Brazil.—C. LAUTERBACH (Bot. Jahrb. 52:19-176. 1914) in cooperation with several specialists has published an important contribution to our knowledge of the flora of Oceania under the title "Beiträge



zur Flora von Papuasien IV." Approximately 80 species new to science are described and the following new genera are proposed: *Kania* and *Discogyne* Schltr. of the Saxifragaceae, *Aistopetalum*, *Betchea*, *Kaernbachia*, *Stollaea*, *Opocunonia*, and *Pullea* Schltr. of the Cunoniaceae, and *Buergersiochloa* Pilger of the Gramineae. The same author (Rep. Sp. Noy. 13:239-242. 1914) describes several new species of flowering plants from Kaiser-Wilhelms Land and includes a new genus (*Keysseria*) of the Compositae.—H. LÉVEILLÉ (*ibid.* 257-266) has published several new species of flowering plants from China and includes a new genus (*Hoyopsis*) of the Celastraceae.—J. LUNELL (Am. Mid. Nat. 3:343-345. 1914) in continuation of his studies of the flora of North Dakota records 3 new species and 3 new varieties of flowering plants.—K. K. MACKENZIE (Torreya 14:125-127. 1914) has described a new sedge (*Carex oklahomensis*) which has a range from southwestern Missouri to Texas. The same author (*ibid.* 155-159) characterizes a new species of *Carex* (*C. cryptolepsis*) from the northeastern states and adjacent Canada.—T. MAKINO (Tokyo Bot. Mag. 28:20-30. figs. 1-3. 1914) under the title "Observations on the flora of Japan" includes descriptions of the following new genera: *Physalias-trum* of the Solanaceae, *Shibataea* and *Hakonechloa* of the Gramineae.—U. MARTELLI (Webbia 4:399-435. pls. 1-43. 1914) presents an important paper on the Pandanaceae, describing and illustrating 48 species and varieties new to science of which several are from the Philippine Islands.—E. D. MERRILL (Philipp. Jour. Sci. Bot. 8:207-250. 1913) begins a series of articles entitled "Studies on Philippine Melastomaceae" in which 13 new species are described in *Memecylon*, and 26 in *Medinilla*. The same author (*ibid.* 9:17-95. 1914) has begun the publication of "An enumeration of the plants of Guam; the first article includes the lower groups and the flowering plants to the Zygomphyllaceae; and (*ibid.* 261-292) in a tenth article on "New or noteworthy Philippine plants" describes 37 species new to science, and includes a new genus (*Worcesterianthus*) of the Olacaceae; (*ibid.* 293-337) under the same heading adds upward of 50 more species of flowering plants new to the Philippines; and (*ibid.* 353-389) under the title "Plantae Wenzelianae" has published upward of 40 new species of Spermatophyta from the Philippine Islands.—E. B. COPELAND (*ibid.* 443-459) describes 17 new species of flowering plants collected on Luzon Island by Father M. VANOVERBERGH; and (*ibid.* 461-493) in continuation of his studies on the Euphorbiaceae records 35 new species in this family; and (*ibid.* 517-541) has published 16 new species of the Dilleniaceae and 11 of the Meliaceae from the Philippine Islands; and (*ibid.* 435-441) presents an article on Hawaiian ferns collected by M. l'Abbé U. FAURIE, describing 7 new species.—R. MEYER (Monats. für Kakteenk. 24:113, 114. 1914) describes a new variety of *Echinopsis* (*E. rhodotricha* var. *robusta*) from Argentina.—C. MEYLAN (Bull. Soc. Bot. Genève II. 6:86-90. 1914) under the title "Myxomycetes du Jura" has described a new genus *Barbeyella*.—C. F. MILLSPAUGH (Field Mus. Nat. Hist. Bot. Ser. 2:383-397. 1914) in continuation of his studies in the Euphorbiaceae has described 7 new



species in *Chamaesyce*. Several new combinations are made.—A. H. MOORE and S. MOORE (Jour. Bot. 52:263-265. 1914) have published three new species of Compositae from Peru.—S. MOORE (*ibid.* 89-98. *pl.* 530) has published several new species of the Vernoniae from Africa and includes a new genus (*Muschleria*). The same author (*ibid.* 146-151. *pl.* 530B) has described a number of new flowering plants from South Africa and includes a new genus (*Rhamphogyne*) of the Compositae from Rodriguez Island; and (*ibid.* 333-337) under the title "Alabastra diversa" has published several new species of flowering plants including a new *Acalypha* (*A. Forbesii*) from Peru.—J. M. GREENMAN.

**Chemistry of diseased beets.**—The composition of sound and of diseased sugar beets has been investigated by BODNÁR<sup>5</sup> for the purpose of determining if any differences were discoverable which might account for a predisposition to bacterial root-rot on the part of the diseased plants, and thus throw some light on SORAUER'S view that this disease is induced by abnormal metabolism by which the way is paved for inroads by bacteria. In the preparation of a mash from the diseased beets BODNÁR apparently used the whole of each beet without a separation of the sound and the diseased portions, except in a few instances when sound and diseased tissues of the same beet were compared. He found that the diseased beets contained less water and less cane sugar, but more acid and more invert sugar than the sound beets. The invert sugar content of the sound portion of diseased beets was higher than that of normal beets, but not as high as that of the diseased portion of the same beet. Invertase was shown to be present in both the sound and the diseased portions of diseased beets, but absent in sound beets. The ash content of both the sound and the diseased tissue of diseased beets was higher than that of sound beets, and the ash was unusually rich in aluminium. That the conditions found in the diseased beets can be regarded as determining factors predisposing the plants to disease is unlikely, since the conditions were found after the plants had been invaded. The high acidity of the diseased beets, as well as the loss in cane sugar and increase in invert sugar, can be attributed directly to the metabolic activity of the bacteria. Even the increased ash content may indicate merely a proportionate loss of organic matter. It is interesting, however, and worthy of further investigation that in partly diseased beets invertase is present in both the sound and the diseased tissues, and that both are characterized by a higher ash content than normal beets. These conditions seem to indicate an effect of the disease beyond the tissues actually invaded.—H. HASSELBRING.

**Alcohol oxidation in seed plants.**—Two views have been proposed to explain why alcohol which is produced in plant tissues under conditions of

---

<sup>5</sup> BODNÁR, J., Biochemische Untersuchungen der Rübenschwanzfäule der Zuckerrübe. Biochem. Zeitschr. 69:245-256. 1915.



imperfect aeration does not occur under conditions of normal respiration. It was at first assumed that alcohol was an intermediate product in normal respiration, but did not accumulate because it was utilized as soon as formed. Later, GODLEWSKI suggested that the alcohol produced under anaerobic conditions is a secondary product which does not occur among the intermediate products of respiration under normal conditions. With a view of throwing some light on this problem, ZALESKI<sup>6</sup> investigated the utilization of alcohol by higher plants. Etiolated seedlings of *Vicia Faba* and *Lupinus albus* and seeds of *Medicago* and wheat were floated for 24–48 hours in solutions containing 1 per cent of alcohol, or were kept for a time under anaerobic conditions. Thereupon, the alcohol was determined in one portion of the plants immediately and in the other after 24 hours, during which loss of alcohol by evaporation was prevented. The experiments showed that 27–72 per cent of the absorbed alcohol disappeared from the plants in the course of 24 hours. These experiments show that higher plants are capable of oxidizing alcohol when it is present in their tissues, but, as the author points out, it does not necessarily follow that alcohol is actually an intermediate product in normal respiration.—H. HASSELBRING.

**Multinucleate cells.**—The occasional occurrence of multinucleate cells in the higher plants is well known, but recent investigations indicate that it may be a very common phenomenon. BEER and Mrs. ARBER<sup>7</sup> have been making an extensive study of the subject, and have concluded that in the cortical and medullary parenchyma of stems there is a stage between the meristematic and mature conditions in which each cell characteristically contains more than one nucleus. This stage may be prolonged, or it may be so brief as to be easily overlooked. They are inclined to believe that this binucleate or multinucleate phase may be a universal phenomenon.

Miss PRANKERD<sup>8</sup> has investigated a wide range of forms, and finds that such cells (usually binucleate) occur in different tissues of various young organs, and suggests that their occurrence is characteristic of regions of active growth. In some cases these nuclei are probably produced by amitosis, followed by wall formation, and it is maintained that these processes are a means of tissue formation in rapidly growing organs.—J. M. C.

**Phylogeny of Filicales.**—In continuing his studies of the phylogeny of Filicales, BOWER<sup>9</sup> has investigated *Cheiropleuria bicuspis*, a monotypic fern

<sup>6</sup> ZALESKI, W., Über die Alkoholoxydation durch die Samenpflanzen. Biochem. Zeitschr. 69:289–293. 1915.

<sup>7</sup> BEER, RUDOLF, and ARBER, AGNES, On the occurrence of binucleate and multinucleate cells in growing tissues. Ann. Botany 29:597, 598. 1915.

<sup>8</sup> PRANKERD, T. L., Notes on the occurrence of multinucleate cells. Ann. Botany 29:599–604. figs. 8. 1915.

<sup>9</sup> BOWER, F. O., Studies in the phylogeny of the Filicales. V. *Cheiropleuria bicuspis* (Bl.) Presl, and certain other related ferns. Ann. Botany 29:495–529. pls. 24, 25. 1915.



of the Malayan region, and other related ferns. *Cheiropleuria* exhibits an unusual mixture of primitive and advanced characters, being thus a remarkably synthetic form. Its characters connect it on the one hand ("downward") with *Dipteris*, and on the other hand with *Platycerium*. The relatively primitive characters are the hairy investment, protostelic cylinder, undivided leaf trace, and frequently bifurcate leaf. The relatively advanced characters are reticulate venation and a "mixed" sorus. BOWER claims that "the mixed characters which this fern shows are one of the clearest examples of non-parallelism of progression in the several criteria used for comparison among ferns." An interesting situation is that probably *Platycerium* is a derivative from the *Dipteris* stock, "specialized for epiphytic habit." Other interesting connections are pointed out, and the details of the investigation are full of suggestion.—J. M. C.

**Endoconidia.**—BRIERLEY<sup>10</sup> has investigated the "endoconidia" of *Thielavia basicola*, a well known parasitic fungus referred to the Perisporiaceae. These interesting cells are described by ZOPF as formed in acropetal succession, and as emerging successively through the differentiation of their lateral walls into two layers, the outer forming a sheath which is left behind. BRIERLEY finds that these conidia are not endospores formed by free cell division within an "endoconidial" cell, but are abstricted "acrogenously" from the conidiophore. The first conidium is liberated by the differentiation of its walls into an inner wall and a sheath, and by rupture of the latter at its apex. The later conidia grow out through the sheath of the first, and are freed by the splitting of their basal walls. The author thinks that this kind of conidial development is probably that of all "endoconidia."—J. M. C.

**Hybridization and water requirement.**—In breeding plants for drought resistance it is desirable to know whether there is a definite relationship between efficiency in the use of water in the hybrid and in the parents. This question has been investigated by BRIGGS and SHANTZ,<sup>11</sup> using corn and wheat hybrids and their parent strains, with the result that the hybrids were found to range in water requirement from 10 per cent below to the same amount above the parental mean, while the chances are even that a corn hybrid will not, in its water requirement, depart more than 6 per cent from the parental mean.—GEO. D. FULLER.

**Parasitic fungi of Wisconsin.**—DAVIS,<sup>12</sup> in continuation of his studies of the parasitic fungi of Wisconsin, has issued three papers supplementary to his

<sup>10</sup> BRIERLEY, WILLIAM B., The "endoconidia" of *Thielavia basicola* Zopf. Ann. Botany 29:483-493. pl. 23. 1915.

<sup>11</sup> BRIGGS, L. J., and SHANTZ, H. L., Influence of hybridization and cross-pollination on the water requirement of plants. Jour. Agric. Research 4:391-402. 1915.

<sup>12</sup> DAVIS, J. J., Notes on parasitic fungi in Wisconsin. Trans. Wisc. Acad. Sci. 18:78-92, 93-109, 251-271. 1915.



"List of parasitic fungi of Wisconsin," published in 1912. In these lists many species are presented, either unreported before, more critically studied, or on additional hosts, and 23 new species are described in the following genera: *Ascochyta* (2), *Cercospora* (6), *Cercosporella* (4), *Colletotrichum* (2), *Cylindrosporium*, *Diplodia*, *Fusarium*, *Phyllosticta*, *Ramularia* (2), *Septoria* (3).—J. M. C.

**Secretory tissues of Marattiaceae.**—WEST<sup>13</sup> has investigated the two kinds of secretory tissues that characterize the Marattiaceae, namely the mucilage canals and the cells or ducts containing tannin. He discovered lysigenous mucilage canals in every genus and species examined. The tannin cells are widely distributed through the tissues, occurring either as isolated sacs or grouped together in series.—J. M. C.

**Seeds of Ginkgo.**—Miss AFFOURTIT and Miss LA RIVIÈRE<sup>14</sup> have discovered considerable variation in the ribbing in the seeds of *Ginkgo*. They have been described in general as having two ribs and occasionally three. A large number of seeds from a single tree growing in a garden near Rotterdam showed 2, 3, or 4 ribs, and also many gradual transitions.—J. M. C.

**Flora of New Guinea.**—A new fascicle of the Dutch exploration of the flora of New Guinea has appeared.<sup>15</sup> Previous parts have been reviewed in this journal.<sup>16</sup> The fascicle consists of the beginning of a critical presentation of the orchid flora by J. J. SMITH. The present fascicle contains 152 species in 45 genera.—J. M. C.

**A fossil moss.**—LIGNIER<sup>17</sup> has reported the discovery of a fossil moss from the silex of Grand 'Croix, referred to the Stephanian, in which the structure has been preserved with remarkable distinctness. The specimen is regarded as representing a new species, which is named *Muscites Bertrandi*.—J. M. C.

**Zygnemales.**—TRANSEAU<sup>18</sup> has made a study of Zygnemales, chiefly North American. The 36 species presented are distributed among the 3 genera as follows: *Debarya*, 3 species, 2 of which are new; *Zygnema*, 7 species, 1 of which is new; *Spirogyra*, 26 species, 8 of which are new.—J. M. C.

<sup>13</sup> WEST, CYRIL, On the structure and development of the secretory tissues of the Marattiaceae. *Ann. Botany* 29:409-422. *pl.* 18. *figs.* 14. 1915.

<sup>14</sup> AFFOURTIT, Miss M. F. A., and LA RIVIÈRE, Miss H. C. C., On the ribbing of the seeds of *Ginkgo*. *Ann. Botany* 29:591-595. *fig.* 1. 1915.

<sup>15</sup> Nova Guinea. Résultats de l'expédition scientifique Néerlandaise à la Nouvelle-Guinée en 1912 et 1913 sous les auspices de A. FRANSSEN HERDERSCHEE. Vol. XII. Botanique. Livraison III. 4to. pp. 173-272. *pls.* 55-99. Leide: E. J. Brill. 1915.

<sup>16</sup> BOT. GAZ. 49:464. 1910; 55:462. 1913; 57:342. 1914; 59:335. 1915.

<sup>17</sup> LIGNIER, O., Sur une mousse houillère à structure conservée. *Bull. Soc. Linn. Normandie* VI. 7:128-131. *fig.* 1. 1914.

<sup>18</sup> TRANSEAU, E. N., Notes on the Zygnemales. *Ohio Jour. Sci.* 16:17-31. 1915.



THE  
BOTANICAL GAZETTE

*MARCH 1916*

ON PAIRS OF SPECIES

REGINALD RUGGLES GATES

(WITH TWELVE FIGURES)

Our growing knowledge of the definiteness of variation makes it desirable that botanists should begin to apply this knowledge to a more detailed study of the relationships of particular species. With this end in view I have endeavored to begin such a study by the examination of the various relationships between pairs of species in the same genus. Every botanist knows numbers of such cases, and it occurred to me that it would be worth while to analyze several such pairs as regards their differential characters, habitats, and distribution, to discover whether any light can be thrown in this way on the probable origin of the species in question. How have these differences arisen in the light of our present views of variation?

Again, various rules of distribution have been proposed, such as JORDAN'S law that related species occupy adjacent areas. It is not the purpose of this paper to discuss questions of distribution at any length, but it will be seen incidentally that a species and its next of kin may occupy (1) the same locations, (2) adjacent areas, or (3) widely separated regions. They may overlap, or the distribution may be practically coterminous. From such facts as these it might appear that JORDAN'S law as applied to plants is more honored in the breach than in the observance; but when applied to the variations or tendencies to variation within the taxonomic species, every botanist knows how usually it holds as modified by



topographical conditions. In passing from east to west or from north to south of the continent, the succession of species often seems to form a graded series, though more or less disturbed and modified by the incidence of mountain ranges, plains, etc., a fact which is relied upon in many ways by systematic botanists in their pursuits.

This preliminary study of the relationships and distribution of pairs of species is perhaps of more value for its suggestiveness than for any direct contribution of facts; at least it is to be hoped that such is the case, for the species I have chosen are all familiar forms in the North American flora. Nevertheless, from the material I have examined in this study it has been necessary to describe several new and hitherto unrecognized varieties, and certain others will be described in another connection.

Notwithstanding the great amount of speculation, and more recently of experimental work, on the factors of evolution, scarcely any attempt has been made hitherto to show how one living wild species has been derived from another particular species, or from the common ancestor of both. No doubt systematists frequently have such questions in mind when delimiting species, but, if the methods of experimental evolution are sound, they should enable us by now to begin the application of the ideas so gained to the solution of simple examples taken from wild nature. Even though the historical relationships of many species must remain obscure, yet there exist cases in which the course of events is simple and to some extent within our present powers of analysis.

The pairs I have chosen have been taken at random. In a subsequent study I may make a more methodical selection. In some instances of species pairs the genus is bitypic; in others the two species may stand apart from the others in the genus, either in their structure or their distribution. Some of the cases of real pairs, however, are not obviously pairs at all, and are only found to be such by a study of their internal structure. On the other hand, some species which form an apparent pair in a given region are not very closely related to each other, and have only become paired through the vicissitudes of altering distributions. Such instances show that the mere taxonomic comparison of species, un-



less supplemented by histological or experimental investigations, may lead to quite erroneous ideas concerning the relationships of the species within a genus. There needs to be developed a taxonomy based upon the anatomical and cytological structure of plants, as well as upon the traditional comparison of their external morphology. This need has often been emphasized, and it appears now to be time to begin to put the principle into practice. If the present paper leads to the closer scrutiny of known species from this aspect its purpose will have been accomplished.

An instructive example of the value of cytology in determining relationships has recently been furnished by *Spiranthes* (*Gyrostachys*) *cernua* (L.) Richard. Reasoning by analogy from the case of *Oenothera gigas*, Miss PACE<sup>1</sup> found that it is a true cell giant, having twice as many chromosomes as *S. gracilis* (Bigel.) Beck, and a corresponding increase in cell size and stature. The two species are shown in fig. 1. *S. cernua* is conspicuously larger in all its parts, having larger flowers, stouter stems, and longer, though usually narrower, leaves.<sup>1a</sup> There is variation particularly in the length of the spike and the width and shape of the basal leaves.

ANDREWS<sup>2</sup> observed three distinguishable forms of *S. cernua* in a meadow at Williamstown, Massachusetts. The type is pure white and fragrant. A variety which was the common form in this meadow differed in having cream colored or yellow flowers which were not fragrant, a shorter, broader, and more rounded or 2-lobed lip, and leaves also distinct in shape and structure. A second variety, found in one spot some distance away, was white flowered, but otherwise agreed with the yellow variety. Similar forms are recorded from Manchester, New Hampshire, and from Mount Desert Island, Maine. A var. *ochroleuca* (Rydb.) Ames has also been described, having greenish, cream colored or white flowers, longer floral bracts, growing in dry ground, and blooming somewhat later. The tetraploid *S. cernua* would thus appear

<sup>1</sup> In *S. gracilis*  $2x=30$ , while in *S. cernua*  $2x=60$ . PACE, LULA, Two species of *Gyrostachys*. Baylor Univ. Bull. 17. no. 1. pp. 16. figs. 50. 1914.

<sup>1a</sup> Figures of these species are also found in TORREY, Fl. N.Y. 2: 282. pl. 129. 1843.

<sup>2</sup> ANDREWS, LEROY, On some variations of *Spiranthes cernua*. Rhodora 1: 110-111. 1899.



to be more variable than other species, such as *S. gracilis* and *S. praecox*. Indeed, it is stated in GRAY'S *Manual* to be "very variable in size and foliage." This is interesting because of the fact that *Oenothera gigas* is also more variable, particularly in foliage, than the other, non-tetraploid, mutants. The increased variation, which is of a remarkable kind in *O. gigas*, is probably concerned with new distributions of the quadruple chromosome series in meiosis.



FIG. 1.—*Spiranthes gracilis* (three plants on the left) and *S. cernua* (plant on the right).

Another interesting feature of *S. cernua*, which apparently has not been reported in the other species of *Spiranthes*, is the prevalence of apogamy and polyembryony. LEAVITT<sup>3</sup> found that an abundance of seed is set when fertilization is excluded, and that 1-5 or 6 adventive embryos occur. They vary greatly in shape, from

<sup>3</sup> LEAVITT, R. G., Polyembryony in *Spiranthes cernua*. *Rhodora* 2:227-228. 1900.

———, Notes on the embryology of some New England orchids. *Rhodora* 3:61-63, 202-205. *pl.* 33. 1901.



spherical to elongate, irregular, or lobed. In a few plants of this species the embryo sac develops normally, followed by fertilization and the production of embryos, but the embryos always possess an apical protuberance which is lacking in the polyembryonic embryos of apogamous plants. The exact manner of origin of the apogamous embryos was not determined, but it appears that individual plants produce embryos which are either all apogamous or all resulting from fertilization. This matter is worthy of further study. No other orchid is known to exhibit this type of polyembryony, although twin embryos occur in many species; but the latter are believed to result from a doubling of the embryo sac followed by fertilization by two pollen tubes. These facts are of interest because it is known that tetraploid species are frequently apogamous.<sup>4</sup>

It has also been observed<sup>5</sup> that a peculiar form of vegetative multiplication takes place in *S. cernua*, in which young plants are produced from the root tips, but in this case a similar development was reported by STRASBURGER in *Neottia* sp.

Another interesting point is the manner in which light is thrown on relationships by cytological study. The mutation theory is destined in this way to modify many current taxonomic conceptions of relationship. *Spiranthes cernua* in the manuals is separated from *S. gracilis* by several other species, yet it must have been derived at some time from this or possibly from one of the other diploid species. It is even possible, as Miss PACE suggests, that *S. cernua* may still be arising by sporadic mutations from *S. gracilis*. Both species have much the same range, from Nova Scotia to Manitoba, Florida, and Texas. The borders of distribution of this pair of species are nearly, if not quite, coterminous.

CLINTONIA BOREALIS (AIT.) RAF. AND *C. UMBELLULATA*  
(MICHX.) TORR.

As regards distribution, *Clintonia borealis* is more northerly and much more widely distributed than *C. umbellulata*. It occurs

<sup>4</sup> See GATES, R. RUGGLES, The mutation factor in evolution. London: MacMillan and Co. 1915 (pp. 197 ff.).

<sup>5</sup> HALL, J. G., Vegetative reproduction in *Spiranthes cernua*. *Rhodora* 7:49-50. fig. 1. 1905.



from Newfoundland to Minnesota, and south in the mountains to North Carolina. *C. umbellulata*, on the other hand, is confined to the region from New York to Georgia and Tennessee. A comparison of the species shows the following differences:

<i>C. borealis</i> <sup>6</sup> (fig. 2)	<i>C. umbellulata</i> (fig. 3)
Scape 1.5-4 dm. high	Scape 2-4.5 dm. high
Umbel 3-6-flowered, pedicels stouter	Umbel several to many-flowered, pedicels shorter, pubescent
Flowers greenish-yellow, 8-10" long	Flowers white, odorous, often purple dotted, 4-5" long
Ovules numerous, in 2 rows in each cavity	Ovules 2 in each cavity
Berry oval, several-seeded	Berry globose, few-seeded

There is apparently no constant difference in the foliage or pubescence, though *C. umbellulata* frequently has larger leaves and is usually more pubescent. *C. umbellulata* has, on the average, a somewhat taller scape; its flowers are more numerous but only half as large as in *C. borealis*; the pedicels are also shorter, more slender, and more pubescent, and the ovules and seeds fewer. In both species the leaves have ciliate margins. In *C. borealis* the scape is nearly glabrous, the pedicels more pubescent; in *C. umbellulata* the scape is pubescent and the pedicels densely so. Summing up the differences, we find them chiefly quantitative, and yet the species do not overlap and there is never any difficulty in distinguishing them, unless it be in the region where they both occur. Here it is possible that there may be intercrossing, giving rise to intermediate forms; but it seems clear, as BATESON<sup>7</sup> has pointed out in similar cases, that such intermediates are, at least in many instances, secondary and not primary in origin. They appear where the two species come in contact, and result from crossing rather than from original variations.

Although *C. umbellulata* averages larger in size, its flowers are conspicuously smaller, and white in color. It is evident that all

<sup>6</sup> In drawing up the contrasting characters I have frequently consulted GRAY'S *Manual* and BRITTON and BROWN'S *Flora*.

<sup>7</sup> BATESON, WM., *Problems of genetics*, p. 158 and elsewhere. Yale University Press. 1913.



of these changes could not have arisen through a single mutation, so it becomes necessary to postulate a common ancestor for the two species. Such an ancestor we may suppose threw off a series of



FIG. 2.—*Clintonia borealis* (Ait.) Raf.

mutations which again continued to mutate in new directions, as we know to happen in other forms from genetic experiments. The surviving forms which we now know as *C. borealis* and *C. umbellulata* might easily represent a differential of not more than three or





FIG. 3.—*Clintonia umbellulata* (Michx.) Torr.



four mutations. The various other mutants and combinations we may suppose to have been eliminated by selection or by their own instability. The fact that *C. umbellulata* is odorous, while *C. borealis* has no marked odor, is by no means unique. Similar cases occur in various other genera, including *Oenothera* and the variation in *Spiranthes cernua* recently mentioned. They find their parallel and no doubt their basis in organic chemistry, where a change of an atom or even a rearrangement of the atoms in a molecule produces an odorous compound from an odorless one.

STREPTOPUS AMPLEXIFOLIUS (L.) DC. AND *S. ROSEUS* MICHX.

In comparing these well known species we find a more marked series of differences. As regards distribution, *S. amplexifolius* is boreal and circumpolar, occurring in Europe and Northern Asia, Greenland, Newfoundland, Labrador to Alaska, and south to North Carolina and California. *S. roseus* is not found in Europe or Asia, but occurs from Newfoundland and Labrador to Alaska, and southward to North Carolina and Oregon.

FERNALD<sup>8</sup> has made a careful study of the differences between the two species, which may be briefly set forth as follows:

<i>S. amplexifolius</i> (fig. 4)	<i>S. roseus</i> (fig. 5)
Stem whitish and glabrous above	Stem greenish and usually ciliate-hispid above
Leaves strongly glaucous, amplexicaul, glabrous	Leaves green, scarcely amplexicaul, conspicuously ciliate
Perianth segments spreading widely and quickly recurved	Perianth segments slightly divergent, only the tips becoming recurved
Anthers lance-subulate, entire, many times longer than the filaments	Anthers narrow-ovate, bifid, about the length of the filaments
Stigma subentire or merely shallow-lobed	Stigma deeply 3-cleft

These two common and widespread species thus exhibit a number of conspicuous unit differences, which are unlike the differences in the pair of species of *Clintonia* previously examined. The

<sup>8</sup> FERNALD, M. L., The genus *Streptopus* in eastern America. *Rhodora* 8:69-71. 1906.





FIG. 4.—*Streptopus amplexifolius* (L.) DC.





FIG. 5.—*Streptopus roseus* Michx.



most conspicuous of these differences would appear to be probably quite independent of each other, and we cannot imagine them all having originated at one stroke. Thus, the leaves of one are (1) glaucous and amplexicaul, of the other beautifully ciliate; (2) the perianth segments of one are widely spreading and recurved, of the other campanulate; (3) the anthers of the one are entire on long filaments, of the other forked and on short filaments; (4) the stigma of the one is nearly entire, of the other 3-cleft. These four main differences are probably not correlated with each other, and may have originated through several independent changes in the common ancestor. This hypothetical ancestor we may suppose threw off a series of new forms differing from each other in various unit characters, just as mutations are known to occur in *Oenothera*, *Drosophila*, and other genera today. The forms exhibiting these unit differences intercrossed, and, certain of the resulting combinations proving more stable than others, two of the more extreme combinations finally survived, while the others gradually disappeared. This is of course only one of the possible hypotheses to account for the occurrence of two such species.

A hybrid between these two species has been described by FERNALD<sup>9</sup> from the Gaspé Peninsula under the name of *S. oreopolus*. This form has leaves less ciliate than in *S. roseus*, and flowers like those of *S. amplexifolius* but deep claret-purple in color. There is thus some evidence that the various character differences do behave independently of each other, and it is also a significant fact that the hybrids are sterile. In this connection I should like to point out the possibility that the elimination of intermediate unit steps between such species as these may be due not only to the instability of certain combinations (since they would split in their offspring), but to the sterility of certain combinations; or, in other words, their inability to produce any offspring. There is evidence, which I need not detail here, to show that sterility in crosses is a condition which may originate relatively suddenly in connection with a series of mutations. In other words, sterility has probably not arisen gradually as the species became farther differentiated, but certain forms are doomed to be sterile with certain other forms

<sup>9</sup> FERNALD, M. L., *Rhodora* 8:70. 1906; 9:106. 1907.



from the moment of their origin, just as certain chemicals will react with each other while others will not.

It seems highly improbable that the specific differences between *S. amplexifolius* and *S. roseus* are directly of selective value to their possessors. We are beginning to learn that natural selection must often act in more roundabout ways, through sterility, etc., and not directly as arbitrator between the possessors of one or other of a pair of differential characters. The character differences themselves must often be innocuous as regards the economy of the plant.

MAIANTHEMUM DILATATUM (WOOD) NELSON AND MACBRIDE<sup>10</sup>  
AND *M. CANADENSE* DESF.

The genus *Maianthemum* has been variously considered as having one, two, or three species. *M. bifolia* DC. in Europe and *M. canadense* Desf. in North America are now regarded as distinct, and a giant form variously known as var. *kamtschaticum* Gmel. and var. *dilatatum* Wood has been attached to the former species. It is clear that *M. bifolium* and *M. canadense* are distinct, and there seems no doubt that this "variety" should be recognized as a third species. NUTTALL first recognized it as such. It is found in Western America, from California northward to Alaska, and apparently in adjacent Asia.

This species is essentially a giant *M. canadense* except that the leaves have nearly the peculiar shape of *M. bifolium*. In view of our knowledge of the relation between *Oenothera Lamarckiana* and *O. gigas*, it would not be at all surprising if this also proved to be tetraploid. It is to be hoped that some one will make a cytological comparison of these two species. Their differences are shown in fig. 6. *M. dilatatum* is not only stouter, with larger inflorescence and larger leaves, but the leaves also differ in shape, being broader and with conspicuous basal lobes. This is not at all incompatible with tetraploidy, as we know from the case of *Oenothera gigas*, in which the leaves are very much broader and obtuse pointed.

<sup>10</sup> *Maianthemum dilatatum* (Wood) Nelson and Macbride, BOT. GAZ. 61:30. 1916. *Maianthemum bifolium* var. *dilatatum* Wood, Proc. Acad. Phila. 1868: 174; *Smilacina dilatata* Nutt. ex Baker, Jour. Linn. Soc. 14:563. 1875; *Convallaria bifolia* var. *kamtschaticum* Gmel. Cham. and Schlecht. Linnaea 6:587. 1831.



In the examination of a considerable amount of herbarium material, I have seen no intermediates between *M. dilatatum* and *M. canadense* or *M. bifolium*, although even if such occur it by no means diminishes the possibility that *M. dilatatum* originated from *M. bifolium* or *M. canadense* through a single mutation, for when *O. gigas* crosses with *O. Lamarckiana*, intermediate hybrids are



FIG. 6.—*Maianthemum canadense* Desf. (on the left) and *M. dilatatum* (Wood) Nelson and Macbride (on the right; a portion of one leaf was accidentally broken in taking the photograph).

produced, and these again when crossed back with either parent species produce new intermediate stages. *O. gigas* is also very variable in foliage, probably as a result of the tetraploid condition. If these two classes of variants were found in a population of typical wild *O. gigas* and *O. Lamarckiana*, they would prove very confusing from the systematic point of view, but from the genetic



standpoint their occurrence in no way obscures the relationship of the two species; and the same is true of all other tetraploid species when they come to be known as such.

There seems to be a tacit recognition of *M. dilatatum* as peculiarly related to one of the other species, for it has been classed as a variety, although it is easily as distinct from either *M. bifolium* or *M. canadense* as these are from each other.

If this supposition with regard to this pair of species of *Maianthemum* proves to be correct, then their relationship to each other is very different from that found in our pairs of *Clintonia* or of *Streptopus*, for in the latter cases we found it necessary to assume that pairs had arisen through several divergent steps, accompanied no doubt by free intercrossing of the various forms produced by these successive mutations. In *Maianthemum*, however, we assume one species to have given rise directly to the other, and any intermediates to have arisen later through crossing.

The specimens of *M. dilatatum* examined show little variation in foliage, and this may perhaps be taken as an indication that the species is not tetraploid, although in any case its cells may be expected to be conspicuously larger than in *M. bifolium* or *M. canadense*.<sup>11</sup> Since its leaf shape agrees with that of *M. bifolium*, it is probably best considered as a giant of that species, although it agrees with *M. canadense* in being glabrous. *M. dilatatum* thus bears features of both the other species, although it is entirely distinct from either. We may reasonably assume that it originated from a glabrous variety of *M. bifolium*, which had itself arisen from the type through a negative mutation in loss of pubescence.

#### RANUNCULUS ABORTIVUS L. AND R. ALLEGHENIENSIS BRITT.

My attention was directed to this pair of species by Dr. J. M. GREENMAN. *R. abortivus* has much the wider range, occurring from Labrador and Nova Scotia to Manitoba, and south to Florida, Arkansas, and Colorado; while *R. allegheniensis*, a segregate

<sup>11</sup> Unless, perchance, it is not a cell giant at all. The well known frequency with which Pacific coast species are conspicuously larger than their more eastern congeners makes one doubt the possibility that they are all cell giants. Their greater vigor may result perhaps from an effect of climate. Only a cytological examination can determine these matters.



described by BRITTON, has been found only from Vermont, eastern Massachusetts, and New York to the mountains of North Carolina. The relative distribution of these species is similar to that of the species of *Clintonia* previously considered, although in this case *R. allegheniensis* occurs wholly within the range of the other species. The specific differences may be tabulated as follows:

<i>R. abortivus</i> Linn.	<i>R. allegheniensis</i> Britton
Stem leaves divided into oblong or linear, somewhat cuneate lobes	Stem leaves divided into linear acute segments
Petals pale yellow, shorter than the small reflexed calyx	Stem glaucous
Styles very short, curved	Petals pale yellow, minute
	Styles subulate, hooked, nearly half as long as the achene

The main distinguishing feature of these two species is the conspicuous recurved beaks of the achenes in *R. allegheniensis*. The other differences are very inconspicuous and in themselves scarcely noticeable. It seems reasonable to suppose that this species has arisen from *R. abortivus* through a single positive mutation. The idea that these conspicuous beaks might have been gradually developed through natural selection might have been readily accepted at the end of the last century, but has since lost its plausibility. All the facts, both of characters and distribution, are more reasonably explained on the mutation hypothesis. An increased length of beak is, so far as I know, of no considerable use to the plant, although it is possible that the large hook might aid the seeds in transportation by attachment to animals. In distribution, however, the plant, while locally abundant, is restricted in area, and *R. abortivus* surrounds it on all sides except where they both reach the Atlantic coast. This points, not to its having an advantage over *R. abortivus* in the struggle for existence, but more probably to its having originated from that species relatively recently through a mutation, and having since propagated itself and spread with no conspicuous advantage or disadvantage in competition with the parent form.

The wide northerly distribution of *R. abortivus* makes it appear probable that it is the older species and has given rise to *R. alle-*



*gheniensis*. Only if the distributions were reversed would it appear probable that *R. allegheniensis* had given rise to *R. abortivus*, through a negative mutation in the nearly complete loss of the beak.

ACTAEA ALBA (L.) MILL. AND A. RUBRA (AIT.) WILLD.

In the genus *Actaea* the species are all remarkably similar in foliage and habit, almost the only sharply contrasting characters being found in the thickness of the pedicels and the color of the berries. All the American forms were formerly treated as varieties of the European *A. spicata* L., but it has become customary to treat them as species. *A. alba* and *A. rubra* constitute a conspicuous pair of these species in eastern North America. They have both been considered varieties of *A. spicata*, but are no doubt worthy of specific recognition. We may first compare them, and then we shall find it profitable to examine the whole genus *Actaea*.

<i>Actaea alba</i> (L.) Mill. (fig. 7)	<i>Actaea rubra</i> (Ait.) Willd. (fig. 8)
Leaflets generally more incised, teeth and lobes acute or acuminate	Leaflets ovate, or the terminal one ovate, toothed or somewhat cleft, the teeth mainly rounded or mucronate, or acutish
Raceme oblong	Raceme ovoid
Petals truncate, slender, like transformed stamens	Petals rhombic-spatulate, much shorter than the stamens
Fruiting pedicels thick	Fruiting pedicels slender
Berries ellipsoid (globular-ovoid, Gray's <i>Manual</i> ), white often with a purplish spot at the end	Berries oval (ovoid-ellipsoid, Gray's <i>Manual</i> ), red
Flowering a week or two later	
More common westward and southwestward	
N.S. and Anticosti to Ga., west to Minn. and La.	N.S. to N.J. and Pa., west to S.Dak. and Neb.; also Idaho

*A. rubra* varies in foliage from forms scarcely if at all distinguishable from the typical *A. spicata*, to forms having larger, coarsely



serrate, and less pointed leaves; but the European *A. spicata* L. shows a very similar series of variations, so it is very doubtful if



FIG. 7.—*Actaea alba* (L.) Mill.

there is any constant distinction between these species in foliage. The same must be said of *A. rubra* and *A. alba*. The conspicuous



differences between these species are two: (1) the berries red or white, (2) the pedicels in fruit slender or stout. The latter differ-



FIG. 8.—*Actaea rubra* (Ait.) Willd.

ence is clearly shown in figs. 7 and 8, which also show the great similarity in foliage.

As we shall see, several of the species may produce either white- or red-berried individuals, while the pedicels remain slender, so



that the color of the fruits and the thickness of the pedicels are independent pairs of unit characters, and we may consider *A. alba* as perhaps having originated from *A. rubra* through two mutations, in one of which the chief change was in the color of the berry, while in the other it was in the thickening of the pedicels. If there are two Mendelian pairs here, however, it is difficult to see why the two combination types, (1) white berries and thin pedicels and (2) red berries and thick pedicels, are not of more frequent occurrence. Crossing experiments, if they could be carried out, would doubtless throw light on the situation and would be of very great interest. Red berries perhaps would be dominant over white berries, but since a red tip remains to some at least of the white berries, the white may be dominant and the plants with red-tipped berries heterozygous. Whether there would be any dominance of slender or thick pedicels is impossible to say.

A more careful analysis, however, discloses other differences besides those mentioned. Thus LLOYD<sup>12</sup> describes the differences between the fruits of *A. rubra* and *A. alba* as follows: *A. alba* has its fruit (1) on thickened pedicels, (2) smaller, (3) with a larger tip, (4) with a much thicker "integument," (5) without pulp, (6) with larger and fewer seeds (6 instead of about 12), whose sides are more slanting and their surface smooth (not roughened). They also cite observations of Mrs. STOWELL, who found that in *A. alba* the pedicels were much harder, firmer, and darker, and with much larger starch grains.<sup>13</sup> These authors cite the occasional occurrence

<sup>12</sup> LLOYD, J. U. and C. G., *Drugs and medicines of North America*. 1884-1885 (p. 232).

<sup>13</sup> Hand sections of the pedicels from dried material of these two species show that she failed to note the essential differences. The ring of wood is the same in structure and diameter in both cases, but in *A. alba* the pith fills the center, while in *A. rubra* it contains an irregular cavity frequently extending as a slit across the diameter of the xylem ring. The increase in thickness of the pedicel in *A. alba* is due to the much greater thickness of the cortical tissue, which is composed of about 7 rows of enormously larger cells than in *A. rubra*. In the latter not only are these cells very much smaller, but the number of rows of cells is only 3 or 4. No differences in the size or shape of the starch grains in the two species were observed, but the large cells in the cortex of *A. alba* contain a great amount of starch, while the small cells of *A. rubra* contain very little. With these structural differences, it might be supposed that the pedicels of *A. alba* would be less firm and rigid than those of *A. rubra*. This point should receive further study.



of plants having white berries on slender pedicels or red berries on thick pedicels, and give it as their opinion that such forms are sports and not hybrids.

MERRIAM<sup>14</sup> has also made observations on the differences between these two species. He found that *A. rubra* has very delicate green pedicels, three-quarters of an inch in length, and berries a half larger than *A. alba*, the pedicels being *hollow*, so that they are easily crushed between thumb and finger. In *A. alba* the pedicels are very thick, red, half an inch in length, the berries small (one-third inch), the pedicels being *solid* or nearly so and not easily crushed. Sometimes the berries in *A. alba* are red, the difference in color being the only change. This suggests that the white of *A. alba* may be dominant to red.

Earlier observations on these species were made by BIGELOW,<sup>15</sup> who described *A. alba* independently under the same name,<sup>16</sup> not knowing that MILLER had described it previously.<sup>17</sup> He points out several other distinctions between *A. rubra* and *A. alba* in his descriptions, which may be summarized as follows:

<i>A. alba</i> Bigelow	<i>A. rubra</i> Willd.
Stems and leaves somewhat larger and smoother	
Raceme oblong, twice the length and half the breadth of <i>A. rubra</i>	Raceme hemispherical or half ovate
Pubescence of peduncles and pedicels more sparse than usually occurs in <i>A. rubra</i>	Peduncles round, smooth, slightly pubescent at top
Pedicels shorter and thicker	Pedicels pubescent, largest at the extremities
Sepals 4, oblong, white, concave, caducous	Sepals 4, oblong, green, striate, concave, caducous
Petals 4-8, white, oval, dilated upward, truncated, deciduous	Petals often 8 or 10, white, oval, acute unguiculate, deciduous
Filaments as long as the petals	Filaments nearly twice as long as petals

<sup>14</sup> MERRIAM, J. S., Bull. Torr. Bot. Club 3:43. 1872.

<sup>15</sup> BIGELOW, JACOB, Fl. Boston. 2d ed. 1824 (p. 211).

<sup>16</sup> In EATON, AMOS, Manual of Botany. 3d ed. 1824 (p. 155).

<sup>17</sup> Also RAFINESQUE, C. S., Amer. Monthly Mag. 2:266. 1818.



*A. alba* Bigelow*A. rubra* Willd.

Berries milk white, tipped with red, smaller, about 8-seeded, on short, red, incrassated pedicels as large as the common peduncle

Berries shining, cherry red, about 16-seeded, on long filiform pedicels, one-fourth as large as the common peduncle

Flowers a week or two later

To the differences mentioned on p. 193 we may add therefore (1) greater pubescence of the raceme in *A. rubra*, and (2) filaments nearly twice as long as in *A. alba*. Differences which I have not verified are (3) berries of *A. rubra* with about twice as many seeds, (4) petals more numerous, and (5) sepals green instead of white.

From these facts it is clear that the differences between *A. rubra* and *A. alba* are numerous and affect the fundamental structure of the plant. It becomes a question whether all of these differences could be determined by only two mutations, and this is a matter on which only breeding experiments can throw any light. Of course, it is possible that the quantitative decrease in the pubescence of *A. alba* may be correlated with the increase in thickness of the pedicels, both being structural expressions of the same inner germinal change. Similarly, it is possible, although perhaps scarcely probable, that such changes as smaller size of berries, lack of pulp, larger and fewer seeds, and truncate petals in *A. alba* are all aspects of the same change which made the berries white. The minor differences in shape of berries and leaves have also to be taken into consideration if they are not mere fluctuations.

The frequent occurrence of such vanishing distinctions as those just mentioned affords one of the main difficulties of taxonomic work, and the presence of the "residua" of characters in superposing one species upon another has been thought to offer serious difficulties in explaining the origin of one species directly from another. A careful examination of known mutations, however, shows that similar conditions occur here. Thus, in *Oenothera brevistylis* the main distinctions from *O. Lamarckiana* are in the very short styles and sepal tips and the misshapen stigmas. But minor differences of a quantitative sort are found throughout the plant, notably in the more obtuse tips to the leaves, a feature which shows quantitative variation in the foliage of each individual.



Hence the occurrence of such minor differences in addition to the conspicuous ones is not a difficulty which requires to be explained by the assumption often tacitly made, namely that inherited environmental effects have led to these slight divergences.

We may now examine briefly the whole genus *Actaea* as it stands at present. Taxonomically considered, the species are as follows:

1. ACTAEA ALBA (L.) Mill.

*Actaea spicata* var. *alba* L. Sp. Pl. 504. 1753.

*Actaea alba* Mill. Gard. Dist. ed. 8. 1768; Icon. Corn. Canad. t. 77.

*Actaea americana* var. *alba* Pursh, Fl. Am. Sept. 1:366. 1814.

*Actaea brachypetala* var. *alba* DC. Reg. Veg. 1:385. 1818.

*Actaea brachypetala* var. *microcarpa*<sup>18</sup> DC. Reg. Veg. 1:385. 1818.

*Actaea pachypoda* Ell. Sketch 2:15. 1824.

*Actaea alba* Bigelow, Fl. Bost. ed. 2. 211. 1824.

*Christophoriana americana* Park. Theatr. Bot. 379. 1640.

*Christophoriana americana, racemosa, baccis niveis et rubris* Morison, Hist. Univ. Oxon. 8. s.1. t.2. f.7. 1680.

2. ACTAEA RUBRA (Ait.) Willd.

*Actaea spicata* var. *rubra* Ait. Hort. Kew 2:221. 1789.

*Actaea rubra* Willd. Enum. Hort. Berol. 561. 1809.

*Actaea longipes* Spach, Hist. Vég. Phan. 7:388. 1839.

*Actaea brachypetala* var. *rubra* DC. Reg. Veg. 1:385. 1818.

*Actaea americana*  $\beta$  *rubra* Pursh, Fl. Am. Sept. 2:367. 1814.

Said by GREENE<sup>19</sup> to differ from the European *A. spicata* L. in that (1) the lowest leaf is inserted high above ground (not radical), and (2) the berries are cherry red, not black. As noted by PURSH and embodied in the name of DECANDOLLE, the American species also has shorter petals, the petals of *A. spicata* L. being as long as the stamens. According to SPACH, however, they are sometimes shorter.

A variety of the European *A. spicata* under the names *A. erythrocarpa* Fisch. and *A. rubra* Ledeb. differs in having red instead of black berries, presumably a simple unit change.

2a. ACTAEA RUBRA DISSECTA Britton, having decomposed leaves and incised leaflets, has been recorded from Lincoln County, Ontario, in BRITTON and BROWN, Ill. Fl. 2:55. 1897.

<sup>18</sup> "Baccis parvis albis subrubellis, pediculis incrassatis." This is apparently the pink-berried form sometimes mentioned.

<sup>19</sup> Pittonia 2:108. 1890.





FIG. 9.—*Actaea rubra* var. *gigantea* Gates



2b. *ACTAEA RUBRA* var. **gigantea**, n. var. (fig. 9).—A forma typica differt, grandior omnibus partibus; caule crasso, 3–4 mm. in diametro; foliolo terminale 10–13 cm. longo, latitudine maximo 6–12 cm., grossē dentato, dentibus ad basin 1 cm. aut plus diametro; subtus rugosē-venoso; pedicellis gracilibus sed quam iis typi crassioribus, 14–20 mm. longis; baccae rubrae, 7–14 mm. longae.

This striking giant variety is represented by several specimens and is very distinct, being much larger and coarser in all its parts. It is not improbably a sporadic tetraploid mutation, and it is to be hoped that some one will examine the size of its cells and the number of its chromosomes in comparison with *A. rubra* when the opportunity offers. To be quite consistent, this should be recognized as a species, but there is some advantage at present in regarding it as a variety of *A. rubra* and so indicating its obvious relationship. It forms with *A. rubra* a "pair of species" (cf. figs. 7 and 8). Of the specimens cited later, one (DODGE, 1896) is considerably smaller in all its parts, and perhaps represents an intermediate hybrid between *gigantea* and *typica*, such as we should expect to find where the forms intercross.

The length of the type specimen of *gigantea* from the base of the peduncle to the tip of the central leaflet is about 28.5 cm., while the corresponding length in typical specimens of *rubra* is about 17.5 cm.

Specimens: *J. Fowler*, Fredericton, New Brunswick, July 20, 1892, Herb. Mo. Bot. Gard., type; *E. L. Sturtevant*, Framingham, Massachusetts, July 8, 1890; *Pammel* and *Ball* 236, Ames, Iowa, August 1896; *Chas. K. Dodge*, near Port Huron, Michigan, August 2, 1896 (in part).

A cultivated specimen from Halle in Herb. Mo. Bot. Gard. indicates that the European *A. spicata* L. also probably has a variety *gigantea*.

Hand sections of the pedicels of *A. rubra* were compared with var. *gigantea*. A series of 21 measurements of cortical cells gave in the former case an average diameter of 7.6  $\mu$ . A similar series from var. *gigantea* gave an average of 9.4  $\mu$ , from which it would appear that the cells are larger, although the difference is not a conspicuous one.

3. *ACTAEA NEGLECTA* Gillman, in Lloyd, *Drugs and medicines of N.Amer.* 235. 1884–1885.

*Actaea rubra* forma *neglecta* Robinson, *Rhodora* 10:66. 1908.

The distinctions of this form from *A. alba* are stated by GILLMAN as follows: *pedicels green and slender*, leaves 4-ternately compound, racemes ovate, peduncles longer, berry (white) larger, seeds few (about 4) and much rougher, very slightly grooved. By contrast *A. alba* is said to have thick red pedicels, leaves 3-ternately compound, racemes oblong, peduncles much shorter, berries smaller, seeds more numerous (5–7) and nearly smooth, with deep grooves.



4. ACTAEA ARGUTA Nutt. in Torr. and Gray, Fl. N.Amer. 1:35. 1838.

*Actaea spicata* var. *arguta* Torr. Pacif. R.R. Rep. 4:63. 1856.

*Actaea rubra* var. *arguta* Greene, Pittonia 2:108. 1890.

*Actaea californica* Greene, Ottawa Nat. 16:36. 1902.

This western species differs from *A. rubra* chiefly in (1) being larger and stouter, (2) having spherical berries; the leaves are also less divided. Its distribution is from British Columbia to Montana, Idaho, the Black Hills of South Dakota, New Mexico, and California.

*A. californica* Greene is stated to be very distinct from *A. arguta* Nutt. in its "rhombic ovate acute petals (commonly 3 or 4), its peculiarly broad and almost obtuse leaflets, which are also not much incised," stems often several from the same rootstock as in *A. viridiflora* Greene. The description is inadequate to determine the characters.

So far as can be judged from specimens, *A. arguta* is not so large or stout as *A. rubra* var. *gigantea*.

4a. ACTAEA ARGUTA var. EBURNEA Ckll. in Daniels, Fl. Boulder, Colorado. 119. 1911.

*Actaea eburnea* Rydb. Mem. N.Y. Bot. Gard. 1:153. 1900.

*A. eburnea* was described by RYDBERG from Montana. It closely resembles *A. rubra* in size and form of fruit (ellipsoid, 9-12 mm. × 6 mm.) and the form of petals, but the berries are perfectly white, the plant taller, leaflets broader and more acuminate, and the teeth sharper. It is nearer to *A. arguta* in habit, but differs in color and size of fruit and somewhat in the form of the petals. The berries are about 12-seeded, the seeds obliquely pear-shaped, triangular with a rounded back. Its distribution is given as Idaho and Utah to the Black Hills of South Dakota, and also on Mount Mackay, Ontario, and Willoughby Mountains, Vermont. The relationships of this form require further study.

4b. ACTAEA ARGUTA var. ALABASTRINA Lunell, Am. Midland Nat. 2:123. 1911. North Dakota.

This variety has berries spherical or subspherical, 8-10 mm. in diameter, differing from *A. arguta* only in color. Apparently it occurs sporadically. It is possible that *A. eburnea* with ellipsoidal berries should be classed with *A. neglecta*. It differs from var. *alabastrina* in the shape of the berries.

4c. ACTAEA ARGUTA var. **pauciflora**, n. var.—A forma typica decedit, foliorum supra rarē et minutissimē pilosa; inflorescentia 3-4-florā, bracteis obsoletis, petalis duo ellipticis, paulatim in unguiculam abientibus.



Plant large, leaflets 6.5 cm. long, 4-5.5 cm. broad, ovate to oblong, often obscurely 3-lobed, acuminate, rather coarsely incised-dentate, not caudate, upper surface sprinkled with minute shining hairs as in *A. caudata*, lower surface almost completely glabrous except for sparse minute hairs along the main veins; inflorescence composed of only 3 or 4 flowers on short slender pedicels 3-5 mm. long, bracts very small and inconspicuous; petals 2 on the flowers observed, blade elliptic, passing gradually into a claw of nearly equal length reaching nearly to the ends of the filaments; stamens 3-6 mm. in length; pedicels and upper part of peduncle fine pubescent; berries unknown.

Type specimen: *Trelease* and *Saunders*, Harriman Alaska Expedition 3785, Juneau, Alaska, June 8, 1899, Herb. Mo. Bot. Gard.

5. *ACTAEA VIRIDIFLORA* Greene, *Pittonia* 2:108. 1809.

Described from open rocky places, Arizona, in flower July 10, 1889. Since collected in New Mexico (*O. B. Metcalfe* 305, 372) and in southern Colorado (*Baker, Earle, and Tracy* 235). The latter, however, has longer and stouter pedicels<sup>20</sup> and is evidently a different thing. The following specimen is also referred to this species: *C. F. Baker* 681, Black Canyon, Colorado, 1901.

This species appears to be well characterized by the following features: (1) stems a cluster from a clump of roots; (2) flowering very late, leaves less developed at time of flowering; (3) racemes reaching 5-6 inches long, particularly narrow, elongated and dense; (4) pedicels all of equal length, shorter (6-13 mm.); and (5) "remarkably short greenish stamens." The petals are said to be "rather numerous," ovate to nearly lanceolate, usually acutish, little shorter than the stamens.

*A. viridiflora* also occurs in two varieties having respectively red and white berries, but apparently differing in no other particular. The latter might be known as *A. viridiflora* var. *alabastrina*. The white variety presumably originates through a mutation, being found interspersed with the red.

5a. *ACTAEA VIRIDIFLORA* var. **Clementiorum**, n. var.—A forma typica differt, folioliis angustioribus, saepe ad basim cuneatibus; inflorescentiā perbreve et floribus paucioribus; stamina flavis.

This variety would be recognized as a separate species if it were sharply marked off from the type of *A. viridiflora*, but in all characters, except perhaps the color of the stamens, there is a gradual transition series. In the extreme form of the variety the leaves are much divided, and both the terminal and lateral leaflets are for the most part cuneate at base, the teeth serrate. The terminal leaflet is 5-6 cm. in length and 12-30 mm. in width at the widest part.

<sup>20</sup> The flowering pedicels are longer and not so stout as in *A. alba*. All other known forms have slender pedicels.



The inflorescence is short (15–35 mm.) and narrow, pedicels short (5–10 mm.) and slender, densely pubescent in anthesis. The petals number about 4, very broadly ovate, sharply narrowed to a claw of equal length; stamens yellow, short but exceeding the petals. These differences may be summarized as follows: (1) leaves highly decomposed, the leaf segments narrower, often cuneate at base, (2) raceme short, containing fewer flowers, (3) stamens yellow.

Specimens: *F. E. and E. S. Clements* 239, Jack Brook, Colorado, June 20, 1901 (two sheets; fruit red), Herb. Mo. Bot. Gard., *type*; *C. F. Baker* 318, near Pagosa Peak, Colorado, August 1899, fruit white.

A photograph of the Jack Brook Station by CLEMENTS shows a dense group of the plants, so that several stems probably arise from one rootstock, as in *A. viridiflora*. The racemes in this group vary considerably in length and most of them bear white berries, but in a few the berries are red. Evidently there is free intercrossing of the type and the variety in Colorado, with blending in foliage and length of raceme, while the red and white berries form a sharply alternating character.

#### 6. *ACTAEA CAUDATA* Greene, *Ottawa Nat.* 16:35. 1902.

Described from Chilliwack Valley, British Columbia (*J. M. Macoun* 33550 in part). This species is insufficiently known and needs further study. *A. caudata* seems to be chiefly characterized by (1) young petioles and leaflets minutely villous, the latter along the veins beneath; (2) upper face sprinkled with minute, rigid shining appressed hairs; (3) leaflets with a long lance-linear perfectly entire acumination; (4) petals 2 or more, two-thirds the length of the stamens, blade elliptic with a flattened claw of the same length. The berries are unknown.

Specimen: *Shaw*, *Selkirk Flora*, 279. 1904.

#### 7. *ACTAEA ASPLENIFOLIA* Greene, *Ottawa Nat.* 16:35. 1902.

Described from Yakutat Bay, Alaska (*Funston* 14, 1892), and another specimen collected in Alaska by *A. W. Gorman*. It agrees closely with *A. caudata* in the pubescence of leaves and stems, the caudate tips to the leaflets,<sup>21</sup> and the presence of usually two petals. The main distinguishing features are (1) leaflets deltoid-lanceolate, incisely lobed to a greater degree than in other species, the lobes serrate; (2) raceme very short and few-flowered; (3) petals less than half the length of stamens, blade round-obovate or almost orbicular, claw equally short.

Specimens: *Trelease and Saunders*, *Harrison Alaska Expedition* 3786, Yakutat Bay, Alaska, June 20, 1899; *E. C. Smith*, Seattle, Washington, April 23, 1889; *Mrs. Moore*, Montana, 1894;<sup>22</sup> *Frank H. Lamb* 1353, Baldy

<sup>21</sup> This feature is apparently not constant.

<sup>22</sup> This specimen has a larger inflorescence than the type, and the leaf tips are not caudate.



Peak, Chehalis County, Washington, 3500 ft. elevation, July 24, 1897;<sup>23</sup> *G. E. Coghill* 151, Pecos River, T.R., New Mexico, August 5, 1898;<sup>24</sup> *Fendler* 12, New Mexico, 1847.<sup>24</sup>

It seems obvious that in studying the species of such a genus as *Actaea* the variations which lead from one species to another have, at least in many cases, not been gradual or continuous, but definite and in certain well defined directions. It seems clear that the nature of these variations has been determined by the internal structure of the germ plasm, the environment acting for the most part merely as a releasing stimulus.

#### SPIRAEA TOMENTOSA L. AND S. ALBA DUROI

*Spiraea alba* DuRoi<sup>25</sup> (fig. 11) is better known under the name of the European species *S. salicifolia* L. It has a diagonal distribution across North America from North Carolina, New York, and Ontario to Saskatchewan, Iowa, and Missouri, and is also found in Siberia. The members of this pair of species are evidently much less closely related than in the other pairs I have mentioned. Fossil predecessors of *S. tomentosa* (fig. 10) show that the tomentose group of species has long been separated from the non-tomentose group. In other words, the characteristic tomentum on the ventral leaf surfaces appeared in these forms long ago, and heredity has handed it down since that time. It is only the accident of distribution, therefore, that makes *S. tomentosa* and *S. alba* a pair. Indeed, we could better consider the group a trio, for in its more eastern range in the Atlantic states and eastern Canada *S. tomentosa* is paired with *S. latifolia* (Ait.) Borkh. (fig. 12). The latter species is still frequently known under the name *S. salicifolia*. Certain more recent segregates from *S. salicifolia*, such as *S. corymbosa* Raf. and *S. virginiana* Britton, which are more restricted in their distribution, also occupy portions of the range of *S. tomentosa*.

<sup>23</sup> The foliage is transitional to *A. arguta*, but the inflorescence and pubescence agree with *A. asplenifolia*.

<sup>24</sup> Resembles *A. asplenifolia* in foliage, but has less pubescence along the veins.

<sup>25</sup> *Spiraea alba* DuRoi = *S. salicifolia* var. *alba* Ehr. *S. alba* is distinguished from the European *S. salicifolia* (1) slightly in leaf shape, (2) the inflorescence is a conic not a narrow panicle, (3) the sepals are triangular not ovate, (4) the petals are not pink and are more nearly orbicular.





FIG. 10.—*Spiraea tomentosa* L. var. *rosea* (Raf.) Fernald





FIG. 11.—*Spiraea alba* DuRoi



The range of *S. latifolia* is stated to be from Newfoundland to Saskatchewan, western Pennsylvania, and Virginia. Judging from specimens, the Newfoundland form is probably distinct. *S. tomentosa* occurs from Nova Scotia to Manitoba and south to Arkansas and Georgia. The eastern portion of its range, therefore, is covered by *S. latifolia* and the more western part by *S. alba*.

The present tomentose group is represented by *S. tomentosa*, *S. Douglasii* Hook., and *S. dasyantha* Bge.<sup>26</sup> *S. Douglasii* occurs in western America from British Columbia to California. It differs from *S. tomentosa* chiefly in (1) leaves slightly different in shape and serrate only above the middle; (2) tomentum on ventral leaf surfaces always white, never rusty; (3) follicles glabrous, not divergent. *S. dasyantha* occurs in China and Japan. The fossil species *S. Andersoni* Heer, from Alaska, is considered most nearly related to *S. tomentosa*.<sup>27</sup> A somewhat variable condition of *S. tomentosa* has been segregated as var. *rosea*.<sup>28</sup> It differs from the type in having a less compact inflorescence, and the follicles, though tomentose, are not lanate, becoming glabrate as they mature. The type is generally confined to the coastal plain and the Atlantic states, while this variety is found farther south and west in Wisconsin, West Virginia, and North and South Carolina. The variety merges gradually into the type of the species and the two features, (1) degree of compactness of inflorescence and (2) amount of pubescence on the follicles, appear to vary independently.

*S. tomentosa* and *S. alba* must then be looked upon as a spurious pair, while either *S. tomentosa* and *S. Douglasii* or *S. alba* and *S. latifolia* constitute real pairs. The tomentose character itself not improbably originated by a step, although it may have increased in amount later. Since *S. tomentosa* and *S. latifolia*

<sup>26</sup> RYDBERG (Fl. N.Amer. 22:251. 1908) has described two other "species," *S. tomentosula* from Washington and *S. subcanescens* from South Carolina, both of which are considered to be probably hybrids, the former of *S. Douglasii* and *S. lucida* Dougl., the latter of *S. tomentosa* and *S. alba*.

<sup>27</sup> See MAXIMOWICZ, C. J., Adnotationes de Spiraeaceis. Acta Horti Petropol. 6:105-261. 1879.

<sup>28</sup> FERNALD, M. L., The inland variety of *Spiraea tomentosa*. Rhodora 14:188-190. 1912. *S. tomentosa* L. var. *rosea* (Raf.) Fernald; Fluk. Alm. 393. pl. 321. fig. 5; RAFINESQUE, New Flora 3:62. 1836.





FIG. 12.—*Spiraea latifolia* (Ait.) Borkh.



occupy much the same habitat, it can scarcely be supposed that the tomentum is a character which determines survival, although of course it is conceivable that a change in its physiology renders necessary this extra protection. Possibly experiments in removing the tomentum from young leaves, if it could be done without injury, might answer this question.

Before leaving this genus I wish to point out a condition in another species of *Spiraea* which can only be supposed to have originated suddenly through a mutation. It is very difficult to conceive a gradual and continuous transition from the foliage of such species of *Spiraea* as we have been considering to that of *S. millefolia* Torr., now known as *Chamaebatiaria millefolium* (Torr.) Maxim., which occurs from Idaho to Arizona and southern California. In this species and the related *C. glutinosa* described by RYDBERG<sup>29</sup> from Nevada, the leaves are pinnately divided and the primary divisions are again divided, as in many ferns. Various other features separate this genus from *Spiraea* proper, but the finely bipinnate type of leaf must have been derived from leaves which were nearly entire, and it is easiest to conceive this as having occurred in a few well marked steps. Complete continuity in such a process is out of the question.

### Summary and conclusions

In this paper, which is an attempt to apply the concepts of mutation to the practical discrimination of species and the understanding of their relationships, I have selected for consideration several pairs of species and their relatives. It is found that these pairs bear very different relationships to each other, both as regards their characters and their distribution. They may occupy the same territory or adjacent areas, they may overlap, or be widely separated. Again, one species may be a giant of the other, or may differ by a few sharp differences which have probably originated as units, or may show differences which cannot be externally analyzed in this way.

Thus, *Spiranthes cernua* is a tetraploid giant of *S. gracilis* or a related species. *Maianthemum dilatatum* is perhaps a cell giant

<sup>29</sup> Fl. N. Amer. 22:258. 1908.



of *M. bifolium*; and *Actaea rubra* var. *gigantea* is probably a cell giant of *A. rubra*, from which it has apparently arisen by a mutation. In the case of *Clintonia borealis* and *C. umbellulata*, the peculiarities of the latter probably represent a differential of three or four definite and independent variations. In this way would arise a series of forms, all of which have been extinguished except the two remaining. This hypothesis differs from the Darwinian theory of natural selection only in assuming that the inherited variations are usually not infinitesimal, but bold and definite strokes. We are merely applying the conceptions gained from the facts of experimental breeding.

The pair *Streptopus amplexifolius* and *S. roseus* presents a similar problem. There are four main pairs of character differences between these species. They may be assumed to have arisen through a series of mutations from a common ancestor. Inter-crossing would lead to various combinations and in some cases blends of these mutant characters. Many such combinations would be gradually eliminated through their own instability or their sterility in producing offspring, leaving finally the present pair of species as survivors. The differences between *Ranunculus abortivus* and *R. allegheniensis* are such that the latter, which is more limited in its distribution, may be reasonably assumed to have arisen from the former through a single positive mutation. It is very difficult, if not impossible, to believe that the conspicuous beak of the achene, which is the main peculiarity of *R. allegheniensis*, could have been developed gradually through natural selection. It is much more probable that the character has no selective value and is merely inherited because it has appeared as a germinal variation.

In *Actaea*, after a somewhat detailed analysis of the differences between *A. rubra* and *A. alba*, it was found desirable to consider the whole genus as it now stands, and incidentally three new varieties were described. The differences between *A. rubra* and *A. alba* are much more numerous than might have been anticipated, yet two mutations are perhaps sufficient to account for the origin of the latter from the former. The thickening of the pedicels in *A. alba* was found to be due to the fact that the rows of cortical cells are



more numerous and the cells themselves enormously larger. The minor differences, as shape of berries and leaves, in which the distinctions are of the vanishing order, are not at variance with the mutation hypothesis, for they are also found when known mutations are compared with their parent forms; for example, in *Oenothera rubrinervis* the foliage characters are not sharply differentiated from those of *O. Lamarckiana*, but are quantitatively separated.

Finally, *Spiraea tomentosa* and *S. alba* constitute a spurious pair of species. In reality *S. tomentosa* is paired with *S. alba* in one part of its distribution and with *S. latifolia* in another part; but *S. tomentosa* has itself been derived from a tomentose ancestor represented by a fossil form from Alaska. Hence its relation to the other two species is more remote, and it only forms a pair with either of them through the accident of their present distribution.

It seems clear that the mutation conception can be applied with advantage to the consideration of all such species relationships, but, of course, crossing experiments and cytological investigations provide the only final answer to the specific questions involved, and it is to be hoped that such investigations will be undertaken, at least in some of the genera discussed in this paper.

The photographs which illustrate this paper were kindly taken by Mr. C. H. THOMPSON. They are all from specimens in the herbarium of the Missouri Botanical Garden, and all specimens cited in this paper are from the same source. I am indebted to the Director, Dr. GEORGE T. MOORE, for the facilities provided for making these observations, and to Dr. J. M. GREENMAN for much kindly help in connection with the work in the herbarium.

UNIVERSITY OF CALIFORNIA  
BERKELEY, CAL.



# ABSCISSION IN MIRABILIS JALAPA

FRANCIS E. LLOYD

(WITH PLATE XIII AND TWO FIGURES)

## The purpose of this investigation

Although the phenomenon of abscission has received no small amount of attention, a study of the literature fails to discover any real uniformity of opinion as to the precise steps involved. This divergence I have already indicated in an earlier paper.<sup>1</sup> As I shall take occasion at a future time to attempt a general critique of the whole subject, my present purpose is a restricted one, namely, the consideration of a more recently published account of abscission in the common "four o'clock" (*Mirabilis jalapa*), by E. HANNIG.<sup>2</sup> My curiosity touching the matter, so far as this plant is concerned, was aroused by HANNIG's statement that the mode of abscission, which is common only to *Mirabilis* and *Oxybaphus*, does not accord with any previously observed accounts, and is made by him, therefore, to represent a new type, while his figures appeared to me not to support his contention. It seemed to me rather that a more exhaustive study of even the published drawings of LOEWI<sup>3</sup> and of TISON<sup>4</sup> alone would have led HANNIG to see a strong resemblance between those and his own figures. Before material of *Mirabilis* was available for my own observation, I ventured therefore to believe that he was not justified<sup>5</sup> in formulating a new type of abscission. Since then I have obtained an abundance of material, and after a careful study of the process in question in both stems and leaves, I find myself unable to alter my opinion.

<sup>1</sup> Abscission. *Ottawa Nat.* 28:41-52; 61-75. 1914.

<sup>2</sup> Untersuchungen über das Abstossen von Blüten, etc. *Zeitschr. Bot.* 5:417. 1913.

<sup>3</sup> Blattablösung und verwandte Erscheinungen. *Proc. Vienna Acad.* 1:166-983. 1907.

<sup>4</sup> Recherches sur la chute des feuilles. *Mém. Soc. Linn. Normandie* 20:125, 1900.

<sup>5</sup> LLOYD, *loc. cit.*, p. 72.



The purpose of this paper is to support a challenge of the correctness of HANNIG's views and of the evidence brought to support them, and to substitute evidence to show that abscission in *Mirabilis* does not represent a new type. To do this will entail a detailed account of the process as understood by me, and to compare this with that of HANNIG as exhaustively as possible.

### Digest of Hannig's view

HANNIG recognizes in general two methods of abscission of flowers (that is, of the supporting axis), namely, (*a*) by the solution of the middle lamella of the cells of the abscission zone; and (*b*) by the complete dissolution of an entire layer of cells. The latter constitutes the new type in question, and is, according to HANNIG, "of a very peculiar sort." His account runs as follows:

Two or three cell layers of the abscission zone, which is 12–20 cells thick, are destroyed and go completely over into solution. This destruction proceeds first by the thinning of the membranes of the affected cells. These membranes become more strongly refringent, while the cell contents take on a granular character. The process is first recognized by the absence of intercellular spaces, followed by granular degeneration of the cell, ending finally in the liquidation of the whole layer of tissue. The process begins at a particular point under the epidermis, which is soon broken. The tear then extends around the whole cortex and finally inwardly into the pith. The vascular bundles appear to be broken across mechanically. The persistence of starch in the abscission cells, while the surrounding tissues, except the endodermis, lose it, is asserted, but even those cells which are reduced to extremely thin membranes, simply because of their too rapid destruction, also retain it. Starch in the abscission cells is therefore of no particular significance. HANNIG was unable to find any evidence, by means of suitable reagents, of chemical alteration of the cell walls to distinguish them from those of neighboring cells. From these conclusions the further one is drawn that the entire cells of the abscission layer, without recognizable previous alteration of the cell membranes, go into solution (p. 430).



He further holds that there is present in all plants which shed their leaves in laboratory air a preformed primary abscission zone ("Trennungsschicht") which is more or less sharply set off from the neighboring tissues. It is pronounced in some species (*Salvia*, *Fuchsia*, *Impatiens*, etc.), but less so in *Begonia* and *Mirabilis*. This zone is to be seen also at the base of the internode. It is the less marked the older and thicker the internode, but still can be recognized, since the cells are smaller and display new transverse cell walls. In *Impatiens*, however, these new walls are so infrequent that the abscission zone is recognizable thereby with difficulty. The manner of separation is the same in leaf, stem, and flower (pedicel, peduncle).

The larger nodes offering the best opportunities for observation, HANNIG further says that it is not the entire abscission zone which is dissolved, but a layer ("Lösungsschicht") of a few cells which are not distinguishable beforehand in any way. This dissolved layer is placed usually in the middle, but sometimes toward the base of the abscission zone, and without reference to the direction of the cell layers. Contrasting *Mirabilis* with forms like *Impatiens* (in which the cells of the abscission zone are set free by the dissolution of the middle lamella), it is pointed out that, while in these the abscission surfaces exposed after rupture are granular or pulverulent in appearance, due to loosened cells, those in *Mirabilis* are mucilaginous. In this plant then the abscission zone is only a more or less broad band of tissue, in the approximate middle of which the separation layer ("Lösungsschicht"), itself not in any way differentiated as to its cells, occurs. This zone is conceived by HANNIG only as a zone of tissue capable of choristic response, to adopt FITTING'S term.

### The present account of abscission in *Mirabilis*

The preceding account, being a digest of HANNIG'S statement, has been set out with some fulness and detail in order to obviate the possibility of a criticism which may be in any way superficial or gratuitous. HANNIG'S resulting contention that in *Mirabilis* (and in the allied *Oxybaphus*, which I have not examined), a type of abscission obtains which is "quite new and distinct," is



presently examined in the light of the facts as they are now to be presented.

#### THE ABSCISSION ZONE

While it is known that abscission in the internode occurs, in general, near its base, it is impossible to connect it with visible structural peculiarities, preformed specifically with respect to the process. HANNIG says as much in admitting that, although frequently or usually delimited by the smallness of the cells or the occurrence of transverse divisions, these marks are not always to be discovered.

In very young internodes there is nothing at all to enable one beforehand to fix upon the tier (usually one only) or tiers of cells which become involved later. In older structures the configuration of the cells for a short distance *both above and below* the node is practically identical, and, although transverse walls are plentiful in the prosenchyma, one cannot regard these as having any more definite relation to abscission than the still older walls. Just as abscission sets in one can frequently recognize the evidence of a renewal of cellular activity in a zone of several tiers of cells, for in these may occur many new, very thin transverse walls ("secondary meristem" of earlier authors). Abscission finally intervenes usually at the upper limit of this zone (pl. fig. 4), and not in the middle or below, although several tiers of cells may finally take part. There is no other structural zone which deserves designation in this connection. Since, however, even such a zone as this occurs only sometimes in older organs, in which a general rejuvenescence then appears to be demanded before abscission can supervene, it can hardly enable us to delimit or define a reactive zone. This zone of rejuvenescence is the "Folgermeristem" of VON MOHL, in which his "Trennungsschicht" arises, and, as WIESNER<sup>6</sup> has pointed out, the latter does not always arise in a secondary meristem. KUBART<sup>7</sup> took the trouble to point out the proper use of these terms, and there appears to be no good reason to change their usage.

<sup>6</sup> Über Frostlaubfall, etc. Ber. Deutsch. Bot. Gesells. 23:49. 1905.

<sup>7</sup> Die organischen Ablösung der Korollen, etc. Sitz. Akad. Wiss. Wien. 115: 1491. 1906.



Evidence, however, will be furnished to show that a zone of tissue, here designated the abscission zone, composed of a number (in large internodes about 10–12) of tiers of cells *below* the separation layer, but not above, shows enough visible alteration, quite aside from cell divisions and distinguishable by optical and chemical means, to warrant the conclusion that it constitutes a physiologically active zone concerned in abscission. It is not simply a secondary meristem, if by this term is implied a renewal of transverse cell division, since this does not always occur, but a mass of cells going through the initial steps, consisting most obviously of chemical alteration of the cell wall, leading to abscission, and of which only some cells finally conclude the process. These latter, which are sufficiently active to go far toward and many of them finally to conclude separation, constitute the separation layer. A secondary meristem may or may not intervene.

#### THE CENTERS OF ABSCISSION ACTIVITY AND THE DIRECTION OF ITS PROPAGATION

According to HANNIG, abscission begins under the epidermis (which soon tears) and travels around the cortex, finally passing through the vascular bundles and into the pith.

The fact appears to be that the first step in abscission (separation) in internodes takes place in the innermost cells of the cortex at two points in a plane normal to the plane of the opposed leaves. From these points the process is propagated outwardly, inwardly, and around the stem, but more rapidly toward the center of the pith than toward the epidermis. Indeed, separation is usually completed in the pith before the epidermis is ruptured (pl. figs. 2, 4). Because of the longitudinal growth of the separation cells, there is a considerable displacement (0.1–0.2 mm.) of the parts to be separated, and there is a synchronous rupture of the passive portions of the xylem. We therefore find the vascular tissues to be in an advanced state of disruption (text fig. 2*d*; pl. fig. 14) before the epidermis is ready to break. When this finally occurs, the fracture of the separation layer is most easily accomplished.



In young stems and leaves the same procedure seems to be followed, although, because of the delicacy of the organs and the rapidity with which abscission is consummated, it is more difficult to follow. There is undoubtedly, however, a great deal of irregularity. Instances have been seen in which the epidermis was fractured and the wound gaped open, in the manner suggested by HANNIG'S fig. 9, before the separation was completed in the pith.

#### CHEMICAL ALTERATION IN THE WALLS OF THE ABSCISSION CELLS

Proof that separation is preceded by a chemical alteration in the cell wall is the following.

(1) If a section (preferably a fairly thick one) is treated with strong KI/I, the walls of the abscission cells will appear to have an indefinite pale greenish hue. If the reagent is washed away gradually, as the yellow of the iodine disappears, the walls show a pale blue, which fades away as the washing is prolonged. An open diaphragm is necessary. This color reaction<sup>8</sup> is much more pronounced if the section is first boiled for a minute in weak (4 per cent) HCl, which, because of a previous alteration of the cell walls, attacks them but does not affect the remainder. Not merely the cells actually involved in separation, but *all the cells below the separation plane for a distance of 0.5 mm.* (in a large node) show the blue reaction, but in less and less degree the farther from the separation plane. Above this the transition is sudden, only a portion of the adjacent cell walls of the cells immediately above being altered.

(2) In earlier stages of abscission, however, the blue reaction is not visible, but an indication of chemical alteration is to be seen in the failure as compared with the adjoining, unaltered cells, to color strongly with iodine.

(3) The staining capacity of the wall of the separation cells is obviously reduced. They will not hold Bismarck brown (pl. fig. 9), so that they become almost colorless, while the unaltered

<sup>8</sup> The reaction was observed under circumstances of evident physiological significance by GREEN (The soluble ferments and fermentation, p. 97) and by myself (Development and nutrition of the embryo . . . . in the date). Ann. Rep. Mo. Bot. Gard. 21:103. 1910.



walls remain deeply stained. The relation is the same to ruthenium red, but not so markedly.<sup>9</sup> One must distinguish between the staining capacity of the entire wall of the abscission cell before elongation sets in, and that of the delicate membranes which continue to invest the protoplast during and at the culmination of elongation. The latter seem to stain readily, at least more so than the former.

(4) The optical quality of the walls is clearly altered, since, with the iris diaphragm at a given opening, a much more narrowly outlined object picture is obtained than in the case of an unaltered cell. HANNIG states that this condition obtains (pp. 428-429).

(5) There is a readily appreciable amount of swelling of the cell walls, most marked in those which are thicker. Consequently, the thick-walled cells of the collenchyma and prosenchyma sheath are most favorable for observation. This phase appears to be passed through quite quickly. Transverse sections display this condition most abundantly (text figs. 1, *a, b*; 2, *a, b, c*; pl. figs. 5, 6, 12, 13).

(6) Following this the walls become altered to such an extent that, when successfully stained with ruthenium red, the substance of the wall appears as a flocculated mass, separated from the protoplasm by a delicate membrane (pl. figs. 6, 13). Whether the flocculation is due to the preservation in alcohol or to the action of ruthenium red<sup>10</sup> matters less than the fact that the walls are in a condition either of flocculation or in one which allows it. When in this condition the walls frequently show breaks of such character that they can be explained only on the supposition that it is in the condition of a gel. As abscission nears completion, this granular matter is much reduced in amount, apparently by hydrolysis. The product may be absorbed by the abscission cells, for which it may very well be regarded as a source of energy. It is not superfluous to insist that this granular matter is not cytoplasm, although it may easily be mistaken for it, especially as displacements of the

<sup>9</sup> Successful differential staining is obtained best by means of quite dilute solutions.

<sup>10</sup> I have noticed that ruthenium red flocculates the pectic (?) mucilages derived from ripe fruits of *Diospyros*, but have been unable to see any flocculation in fresh, unstained material of *Mirabilis*.



delicate cell walls confuse the microscopic picture. That the cells whose walls are thus being changed are not degenerating, witness the fact that cell divisions may be taking place, and the condition of the nucleus and cytoplasm.

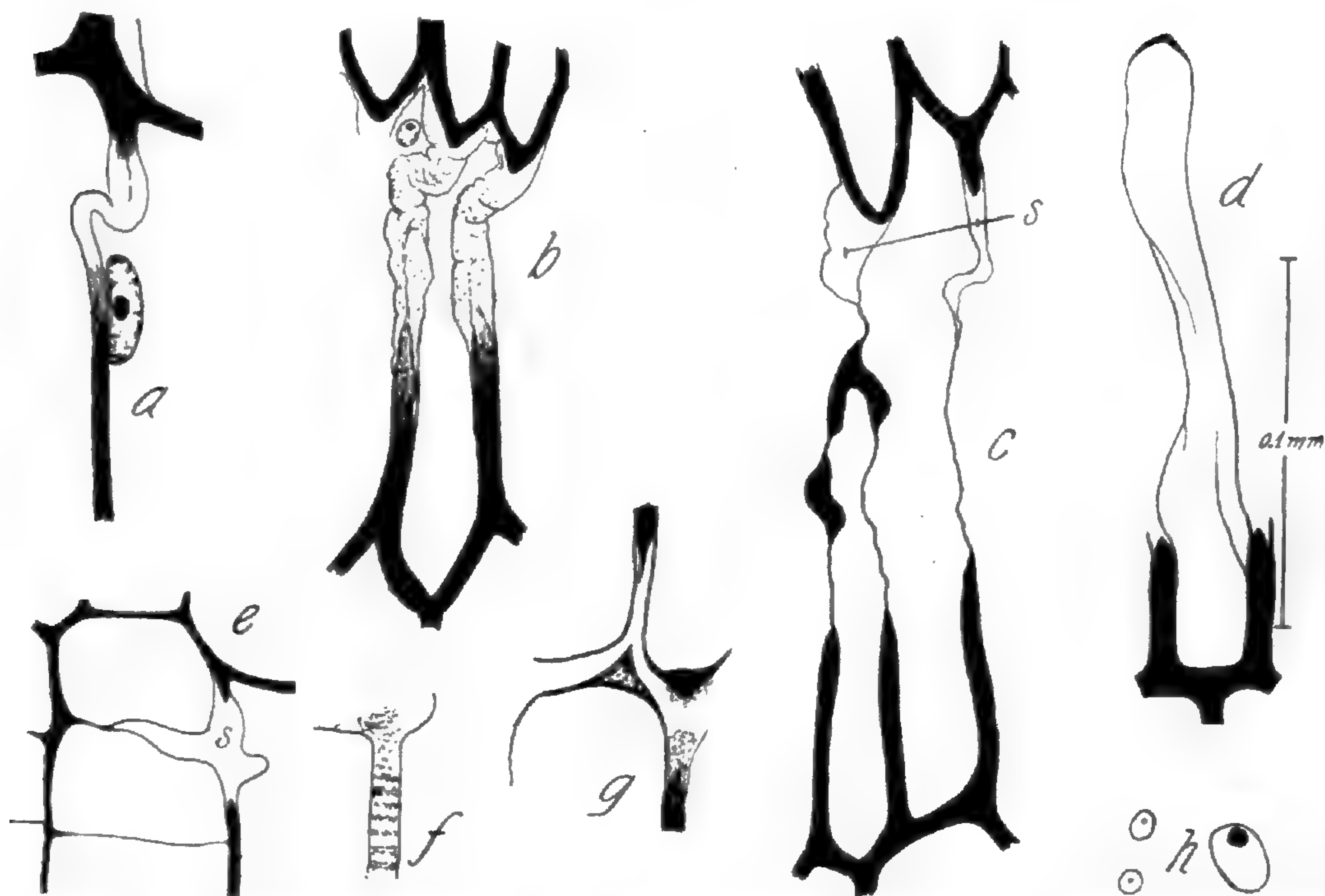

FIG. 1.—*a*, Longitudinal wall of a cell undergoing abscission, showing softening in a restricted zone, near which the nucleus lies (cf. pl. fig. 9); *b*, more advanced condition, in which the walls are very much altered, but remain bounded by a delicate tertiary membrane (cf. pl. figs. 5, 6, 12, 13); *c*, condition of extreme extenuation of the tertiary membranes, seen separated in the upper part of the figure; portion of unaltered wall remains suspended in these membranes (cf. pl. fig. 10, a portion of which was selected for this figure; also pl. fig. 11); *d*, cell after separation, the tertiary membrane intact and evidently disarticulated at its upper end from two more distal cells (cf. pl. fig. 8); *e*, partially separated pith cells, the tertiary membranes remaining intact; *f*, the flocculated remains of a hydrolyzed membrane held between, and broken up by, the extending tertiary membranes in the pith; this condition may be seen in preparations represented by pl. fig. 7; *g*, mutual disarticulation of the ends of adjacent cells; *h*, small nuclei from parenchyma cells near the abscission layer, but not taking part in abscission; and a large one from an abscission cell in an advanced stage; drawn to identical scale.

#### THE SEPARATION LAYER; ITS COMPOSITION

Only one tier of cells may be involved in the act of separation (pl. figs. 5, 7), this usually in smaller, younger leaves and internodes, except that in young leaves there is a tendency to increase the number of layers involved. In larger nodes, in which there



is considerable thickening of the walls of certain tissues (especially the prosenchyma sheath and cortex), from one to four or five tiers of cells (pl. figs. 3, 4, 15) may undergo some of the changes in form leading to separation, although it is seldom that the cells of more than one tier actually complete the process. This is usually the uppermost, although occasionally one below this may conclude separation, but in a restricted region only. In no case, however, do all the superimposed separation tiers pass entirely across the stem, for in the pith usually one tier only is engaged, only occasionally more. The maximum number of tiers activated is to be

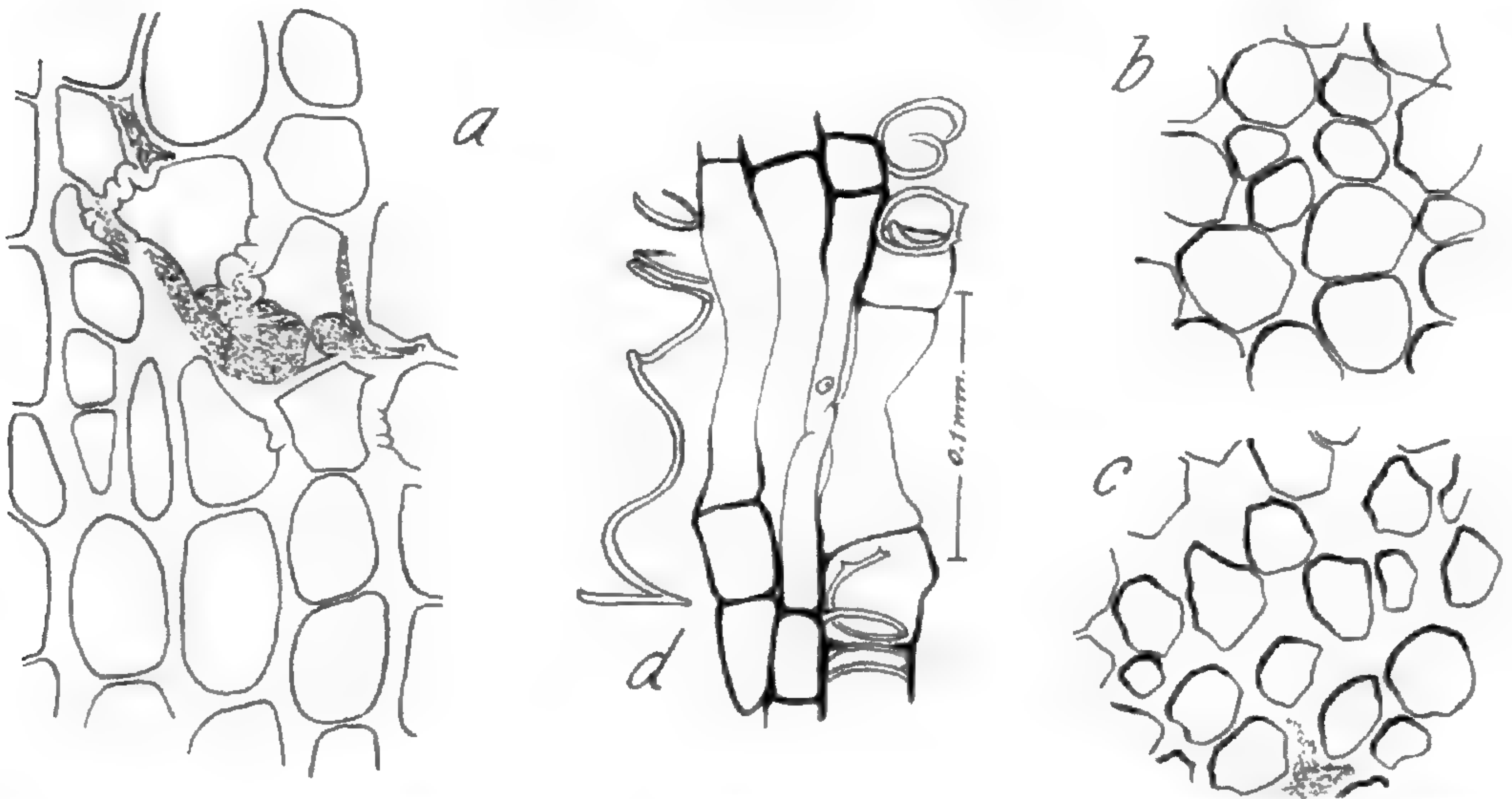

FIG. 2.—*a*, Transverse section through a portion of the prosenchyma sheath, showing swollen walls; *b*, *c*, transverse sections through cortex; in *b* the walls are unaltered, in *c* they are swollen, but still incompletely hydrolyzed; *d*, longitudinal view of a few wood parenchyma cells ready for separation, with adjacent wood vessels fractured (cf. pl. fig. 14).

found in the prosenchyma sheath, where the resistance against longitudinal growth is greatest, due to the thickness of the cell walls and to the presence of the vascular tissues.

The mechanical resistances doubtless affect also the direction taken by the separation layer. Although, broadly speaking, this follows the direction of the tiers of cells, it tends to depart from it, and, as the epidermis is approached, to pass into the cell tiers below (pl. figs. 3, 4), as if the tendency to lie normal to the abscission cell axes was to some extent overcome by the tendency to lie normal to the stem axis. The maximum irregularities in direction



occur where there is the greatest heterogeneity of structure or maximum mechanical resistance, namely, in the oldest stems and in the vascular tissues, so markedly indeed that I have frequently observed in some plants an entire misdirection of the plane of abscission, in that it comes to lie parallel with the vascular bundles for some distance. Conversely, the greatest regularity is seen in the pith and medullary rays, where, however, in spite of the homogeneity of the tissues, minor local departures from the ideal path may be observed (pl. figs. 1-4).

#### CYTOLOGICAL BEHAVIOR OF ABSCISSION CELLS

a) THE RÔLE OF STARCH.—Previous to abscission, there is an abundance of starch in the general region below the separation layer, while it is withdrawn from above it except from the starch sheath. As abscission progresses, the starch disappears below, from the middle of the pith last. From this point it has disappeared usually by the time abscission is well advanced throughout its whole extent. In the early stages of abscission starch is to be found within all the separation cells themselves, but it largely or entirely disappears as abscission is completed. The place where the absence of starch is first to be noted is in the prosenchyma sheath next to the starch sheath. The latter also loses starch in the vicinity of the abscission tissues. When abscission is complete, I have observed in some cases various but always small amounts of starch, a few large grains in the middle of the pith and a very few scattered grains elsewhere or none. The fact therefore appears to be that, as abscission progresses, the starch in the abscission cells decreases until it is very materially reduced in amount or entirely disappears. The inference is that it is used by them as a source of energy, expended in the active growth leading to separation.

HANNIG described the abscission layer as being marked by a transverse band of starch grains, but adds that those cells which are reduced to extremely thin membranes and are more or less collapsed still contain starch. He suggests that this is due to the rapid autolysis of these cells; but the purpose of this essay is to



show that such autolysis does not occur, and, if this be true, HANNIG'S inference is not justified. The appearance of collapse or compression is accidental, and that the abscission cells in *Mirabilis* should appear so is not to be wondered at, in view of the facts presented in this paper. While some starch grains may indeed persist even until after abscission is completed, the granules are quite obviously very much reduced in size, so that, in a particular plastid, the stroma enveloping the granules may readily be seen between them, and the granules of starch may appear as minute points.

To draw a sure inference from the presence of starch in, or its absence from, separation cells is at best precarious. For example, the separation cells in *Hydrangea*, in which "maceration" occurs as in *Impatiens*, retain their starch; while the immediately neighboring cells lose it. But, when abscission is complete, the separation cells, while entirely loosened from each other, are quite alive. In such a case as this the starch may not be used at all, and may be retained because the loosening of the cells prevents its movement (this being essentially HANNIG'S explanation), or it may have been secreted in amount much in excess of that needed. But it is, in any event, doubtful if the loosening of the cells would prevent the movement of starch.

b) THE BEHAVIOR OF THE CELL WALL.—Evidence has already been brought forward to show that, previous to any changes in the dimensions of the cells involved in abscission, there occurs an alteration of the cell walls. The degree of alteration appears not to be the same throughout the whole of the cell wall, judging by its behavior during those steps preceding separation. For the sake of simplicity, I take an ideal case, that of a fairly thick-walled cell of the prosenchyma sheath, in which the physiological activity proceeds in a plane normal to the axis of the cell (pl. fig. 15), it being premised that this plane may lie in any oblique direction (pl. fig. 10) passing through any of the walls. The changes observable are presented seriatim.

(1) The cell wall is softened in the previously described manner, most completely, however, in a narrow zone nearer the upper



end of the cell and therefore nearer the plane of final separation, in the event that this supervenes (text fig. 1, *a*, *b*).

(2) The cell grows longitudinally, the maximum extension of the walls occurring where the maximum softening has taken place, and concurrently with it. The length of the cell may increase four or fivefold. The total length of the longest cells in the prosenchyma sheath at the time of separation has been found to be 0.2 mm. or slightly more (text fig. 1, *c*, *d*).

The protoplasmic utricle also becomes greatly extenuated during this period of growth and the cytoplasmic membrane is most delicate. The nucleus is disposed in the transverse zone of elongation, usually increases in size, and remains perfectly normal in appearance until the completion of separation and even still later (text fig. 1, *h*). It may lie against the wall or be suspended in or near the axis of the cell. Occasionally a very delicate transverse wall is laid down just previous to or at the time of elongation. Transverse walls may have been formed still earlier, but the fact that the cellular activity may take this form during the process leading to separation must be taken as evidence of vigor rather than of degeneration. Further, it is not possible to suppose that this behavior is consonant with a loss of turgor, supposed by HANNIG to occur, while the disappearance of the starch suggests a constant accession of solutes for maintaining turgor.

#### FURTHER ANALYSIS OF THE CHANGES WHICH OCCUR IN THE CELL WALL

It is of prime importance, in view of the purpose of this paper, to analyze fully the changes undergone by the walls which display elongation. These are more readily appreciable in the thickest of them. The wall shows first of all evidence of chemical alteration resulting in a physical change which allows it to be drawn out.<sup>11</sup> There is no evidence that the middle lamella alone is altered, but rather does it appear that the whole wall, excepting only a delicate membrane limiting the lumen of the cell, is softened,

<sup>11</sup> For a review of various accounts of the way in which the cellulose membrane is affected by enzymes, see JONES, L. R., Pectinase, etc. N.Y. Agric. Exp. Sta. Techn. Bull. 11. Nov. 1909.



probably by hydrolysis (text fig. 1). This remaining membrane<sup>12</sup> it is which continues, during elongation of the cell, to invest the protoplasm, and which, because of the disappearance of the remainder of the wall, comes into intimate contact with those of neighboring cells (text fig. 1, *c*). Being very soft and delicate membranes, on coming into contact with each other they cling together and appear as a single membrane, which is optically scarcely resolvable as double, so that its composition must be argued from the occasional separation of its components (pl. fig. 11), and from their conjoint greater thickness. These changes are for obvious reasons, more prolonged where the walls, or portions of the walls, are most thickened, as in the collenchyma and prosenchyma sheath, and are therefore more readily seen in such tissues (pl. figs. 5, 6, 12, 13).

Not only are these thin membranes proper to neighboring cells separate from each other, but they become separated also at their upper ends (in some cases at their lower ends) from the thick membrane of the cells in the next tier above, only the lower ends of which are chemically altered, but enough for this. The iodine reaction demonstrates this to be the case. That this separation of walls actually obtains can be proved by taking rather thick sections of suitable material and, after a slight treatment with 5 per cent sodium hydrate, or weak hydrochloric acid,<sup>13</sup> pulling the portions separated by the abscission layer apart on the slide, when the separation cells pull away in many cases without breaking. Investing their free ends one usually finds a thicker portion of wall (pl. fig. 8) evidently derived from the chemically altered but unstretched membranes with which the ends of the abscission cells were in contact (text. fig. 1, *d*, *g*). It is more difficult to

<sup>12</sup>These membranes investing the protoplasts of the abscission cells were seen by TISON. His sketches, however, do not convey an accurate conception of their appearance, nor does he seem to have followed their genesis closely; for example, he recognizes no growth. LOEWI, on the other hand, saw the elongation of the walls, without following the changes in the walls themselves, or comprehending the nature of the thin walls consequent on these changes.

<sup>13</sup>One is not compelled to use these or any reagents, but they facilitate the obtaining of particularly fine preparations. Since the treatment is not sufficient to hydrolyze even the thinnest of the membranes, it cannot be objected to.



demonstrate that these membranes are free by means of untreated sections, although not at all impossible.

The result of all this is to produce a separation cell, the ends of which are invested by thicker, physically relatively unaltered walls (text fig. 1, *d*) with a transverse zone between them, narrow at first, but becoming quite wide at length, of extremely thin membrane. Viewed *en face*, the thicker portions of the wall show their shallow pits, well seen in the prosenchyma sheath, and between them and the thin portions the pits are seen to disappear and the membrane itself to show the granulation or flocculation due to the chemical alteration (pl. fig. 15). If, as has been premised, the thinning out has proceeded in irregular, more or less oblique zones, very various topographic conditions (pl. fig. 10) ensue without any violation of principle.

Although the above view of the nature of the thin walls seems to accord entirely with the facts, it remains true nevertheless that they could be accounted for by supposing that, as the old walls become softened and broken down, entirely new thin walls are laid down by the growing protoplasm. This is TISON'S view. While it is altogether possible, or even probable, that some new wall material is being laid down, the optical evidence is against the idea that the wall is entirely new. One can, if with some difficulty, resolve a relatively unaltered membrane in contact with the protoplast in the portions of the cell which are not elongated, and can determine its continuity with the thin membranes in the zone of elongation. The continuity comes out clearly when the chemical alteration of the rest of the wall is far enough advanced so that the optical differences presented by the primary and secondary membranes on the one hand and the tertiary membrane on the other are obvious (pl. figs. 6, 13; text fig. 1, *b, f*).

The process as described is the same for all living elements, for example, cambium cells and wood parenchyma. The xylem vessels are fragmented in one or more transverse planes, according to the number of tiers of cells involved in abscission. Tyloses in various degrees of development and in various numbers are to be seen both above and below the abscission plane, but, as SWART<sup>14</sup> has shown experimentally, they cannot effectually hinder the

<sup>14</sup> SWART, N., Die Stoffwanderung in ablebenden Blättern. Jena. 1914.



passage of water, since they are not sufficient either in size or numbers, and are not present at all in many vessels. The formation of tyloses appears to be rather a wound response, more or less incomplete at the time of rupture of the leaf, since the greater development, if incomplete, is found below the abscission plane, that is, the tyloses appear in the general region and at the same time as the general wound response.

The younger phloem elements, those quite near the cambium cells and with difficulty distinguishable from them, appear to behave the same as the latter. The older, on the other hand, which show a development of callus (though whether this is synchronous with the development of tyloses, as TISON holds, I cannot at present say) show indications that they behave in a quite passive manner. One can detect no definite zone of thinning in the wall, but, if stretched at all, they act merely as a soft yielding material, becoming thin throughout their whole length, quite as a soft india-rubber band behaves, and finally break. The very small size of the elements makes it difficult to be quite sure of this conclusion, but I have seen no evidence which would lead to any other.

The abscission cells of the epidermis behave as do the parenchyma cells, except for a certain asymmetry due to the unyielding cuticle, which merely breaks at last, after being loosened by alteration of the adjacent cellulose membrane.

The final condition of the active abscission cells is then as follows. The walls are locally, and it may be very irregularly, much extended and extremely thin. The thin membrane of each cell is distinct from that of any neighboring cell, and also from the proximal end walls of the cells above. The cytoplasm consists of a correspondingly delicate membrane, but shows no alteration in the direction of degeneration. The same is equally true of the nucleus, which is in appearance quite the same as evidently normal nuclei elsewhere, but that it is frequently much larger. When this condition has been reached, abscission may be regarded as complete. After the cuticle is broken, the abscission cells near by quickly collapse, while the shrinkage of the parts above, due to curtailment of water caused by local evaporation and by the severance of the vascular elements, produces a shearing and rupture of the abscission cells. At a slight touch, the whole layer of weakened



cell wall cells gives way, partly by pulling away the entire thinned walls (pl. figs. 5, 8) and partly by tearing them. The resulting wound surfaces of the separated parts seem, both to sight and touch, mucilaginous, as HANNIG observes, but this is not due to the entire dissolution of abscission cells, but to the fact that, on account of the thinness of the walls, many of them break, allowing their mucilaginous contents, accompanied by protoplasm, to ooze out on to the exposed wound surface. The contrast, in this respect, with the analogous surfaces of other plants (notably for example, in *Parthenium* and *Impatiens*) cannot be adduced as evidence of the nature of the process leading up to it. The only thing we might say of it is that it would lead one to examine the antecedent facts more closely, in order to detect essential differences, should they obtain. In this case I believe there are none.

### Summary

1. Previous to abscission activity proper there is no antecedent structural indication of the position of the abscission zone. In young organs usually only one tier of cells is involved, while in old ones (internodes) evidence of physiological activity is to be seen in 10-12 tiers (the *abscission zone*) approximately. The greatest activity is to be seen in 1-5 tiers of cells, constituting the *separation layer*, at the upper limit of the abscission zone. Here new transverse walls occur in varying numbers, giving rise to the "Folgermeristem" of VON MOHL. The parenchyma at the base of a mature internode shows many transverse walls, which, however, have nothing to do with abscission, and do not constitute the criterion of an abscission zone. HANNIG'S "Lösungsschicht" and the "separation layer" of this paper may be regarded as identical, while his "Trennungsschicht" does not coincide with the "abscission zone" as here conceived.

2. Abscission begins in the internode near its base at two points which lie in a plane normal to that of the opposed leaves, and in the innermost part of the cortex. From these two points it is propagated outwardly toward the epidermis, and inwardly toward and into the pith. When more than one tier of cells is engaged, the changes which overtake them usually progress most rapidly in the uppermost (most distal) tier.



3. The walls of all the cells of the abscission zone, as defined in this paper, are altered chemically during abscission. The greatest degree of alteration takes place in the cells which are actually involved in separation (namely, those of the separation layer), in which the alteration, by hydrolysis, proceeds so far as to procure the complete digestion of a part of the primary and secondary walls, thus allowing a great extenuation of the tertiary walls, their separation from each other, and from the only partially altered primary and secondary walls of the next distal tier of cells.

4. The separation layer is composed of one tier of cells only in very young organs, and from 1 to 5 in older. Of these tiers, usually only the uppermost proceeds to complete separation. Mechanical resistances, which are greater in older parts, appear to influence the direction of the plane of separation.

5. The behavior of starch in the separation layer and adjoining tissues during abscission indicates that it is a source of energy for the separation cells during their growth.

6. The final separation results from the digestion of portions of the primary and secondary cell walls of the separation cells, leaving the protoplasts invested by a tertiary membrane which grows independently of adjoining membranes, from which it is quite free.

7. Neither the cytoplasm, nor the nuclei, nor any part thereof, displays degeneration changes. On the contrary, cytoplasm, nuclei, and nucleoli bear evidence of greater physiological activity, and are quite alive and normal when separation is achieved. There is meanwhile no loss of turgor.

### Conclusion

From the foregoing facts it is concluded that abscission in *Mirabilis* is not procured by a separation resulting from the complete solution and destruction of a layer of tissue, as held by HANNIG, and does not therefore constitute a new type of abscission. Contrariwise, the mode of abscission accords wholly, as to all essential details, with that which has been shown to occur in such forms as *Gossypium*, *Aristolochia*, etc.



## EXPLANATION OF PLATE XIII

FIGS. 1-4.—Longitudinal sections through the bases of internodes, displaying variations in the regularity of form and number of separation layers; in fig. 1, a single tier of cells, in fig. 2, two tiers for a limited distance, in fig. 3, three tiers, and in fig. 4, four or even five tiers of cells are involved.

FIG. 5.—A small portion of the separation layer in the cortex in which abscission is complete; the abscission cells are more or less distorted, but those in the middle of the figure but little, and in these the normal nuclei can be seen; 3 cloudy masses can here be seen, and these are shown on a larger scale in fig. 6.

FIG. 6.—Longitudinal walls in a swelled and partly hydrolyzed condition; they can be seen to alternate with the protoplasts in position; ruthenium red; compare with figs. 11-13.

FIG. 7.—Abscission cells in the pith, when separation is readily possible; on the left of the central cell, the altered cell wall has broken, the tertiary membranes alone remaining intact; the protoplasm and nucleus are clearly normal.

FIG. 8.—The intact membranes of abscission cells remaining after separation has been procured; this preparation was secured by pulling apart a section such as that in fig. 5; at the free ends of the cells the membranes are seen to be somewhat thicker (cf. text fig. 1, *d*).

FIG. 9.—Cortical tissue in a very early stage of abscission, showing the reduced staining capacity of the walls of the cells proceeding toward abscission; Bismarck brown; there is no reduction in the thickness of these walls at this time.

FIG. 10.—A more advanced condition, in which the walls are thin and drawn out; there is further shown the transfer of the abscission plane from one cell tier to another; small, relatively unaltered portions of cell walls are seen suspended by the thin membranes.

FIG. 11.—Between the two protoplasts may be seen an oval intercellular space inclosed by two delicate tertiary membranes; these have been set free by the complete hydrolyzation of the remainder of the wall, of which nothing more is to be seen.

FIG. 12.—Medullary ray cells in abscission, in which the cell walls are hydrolyzed so far that they now appear granular or flocculated; only the wall in the center of the figure shows this well; this has been further magnified and is shown in fig. 13, in which can be seen the tertiary membrane on the right of the altered cell wall; ruthenium red.

FIG. 14.—The fragmentation of the wood vessels by the wood parenchyma and cambium cells which undergo active abscission; tyloses may be seen.

FIG. 15.—Medullary ray tissue, in which several tiers of cells are in a somewhat advanced stage of abscission; thicker walls show pits *en face*; the great delicacy of the thinned out membranes is well brought out here.



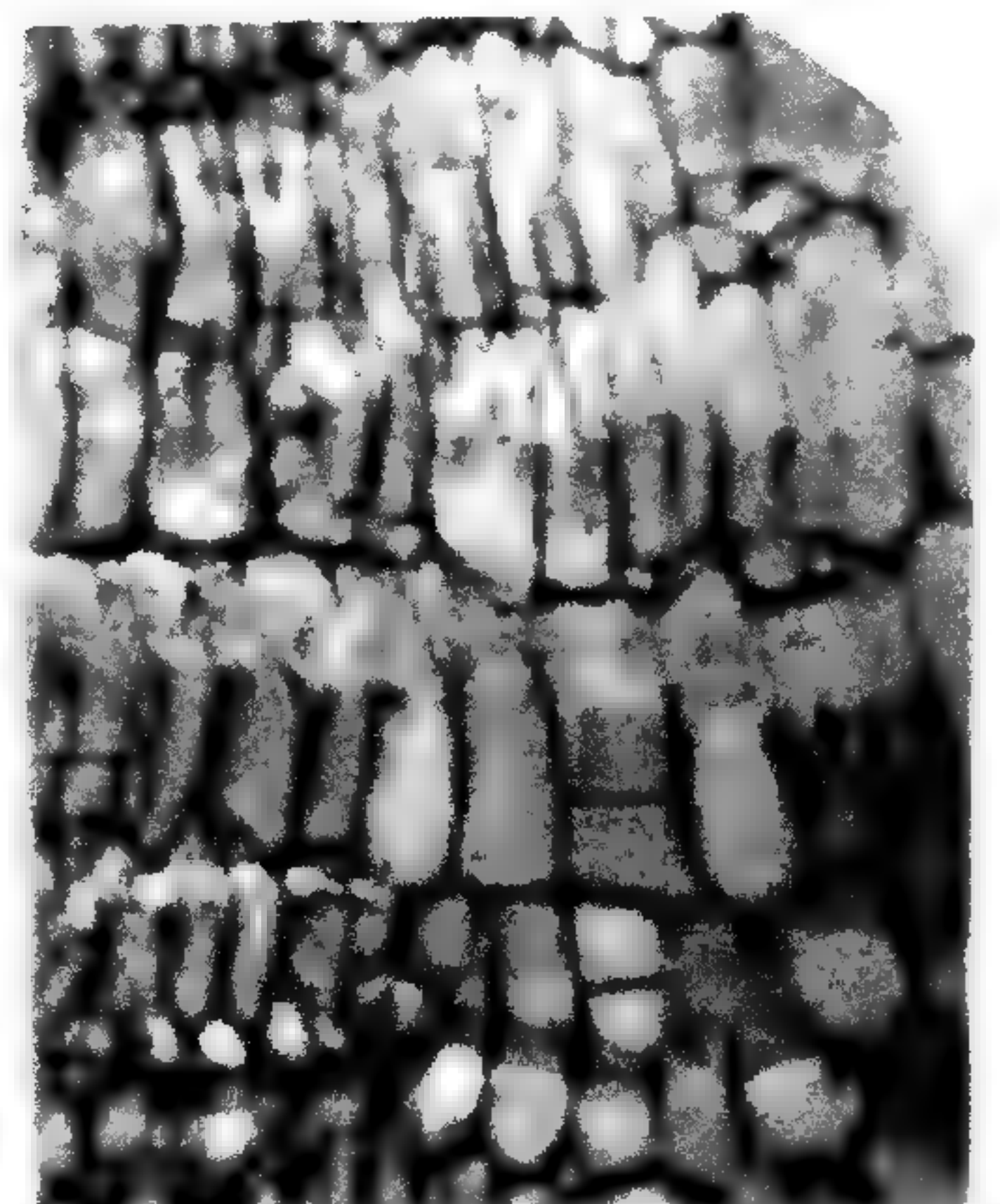
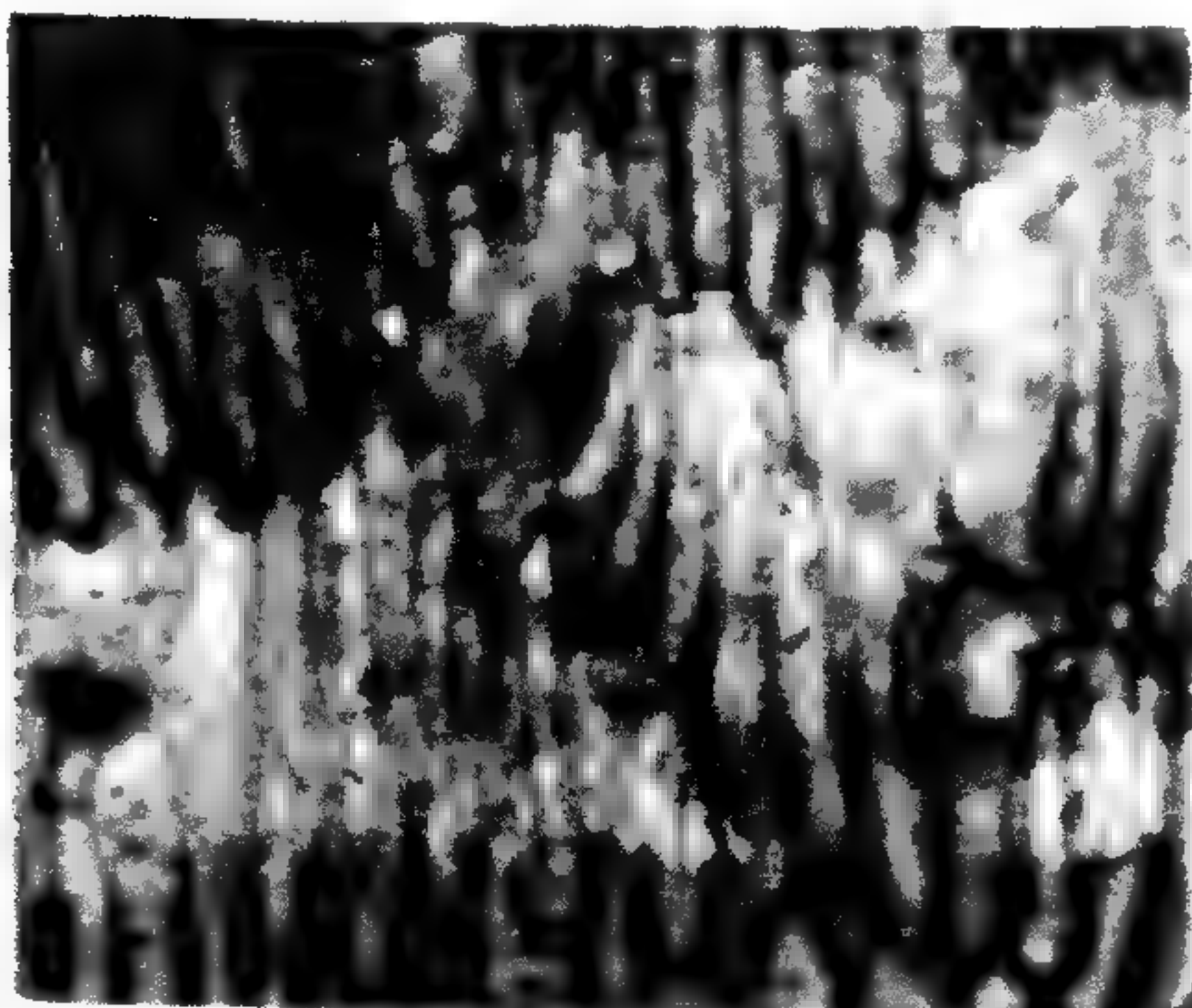
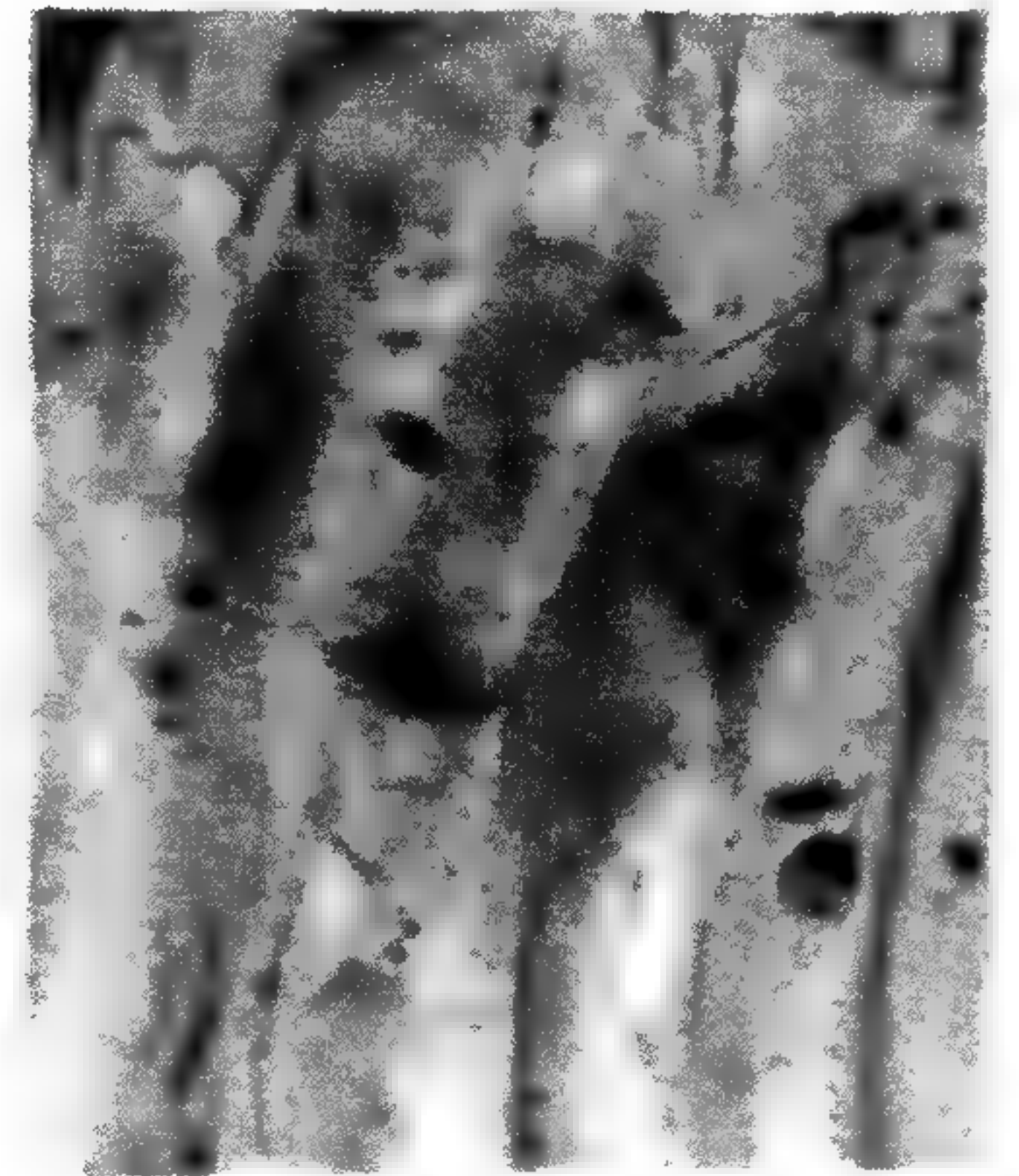
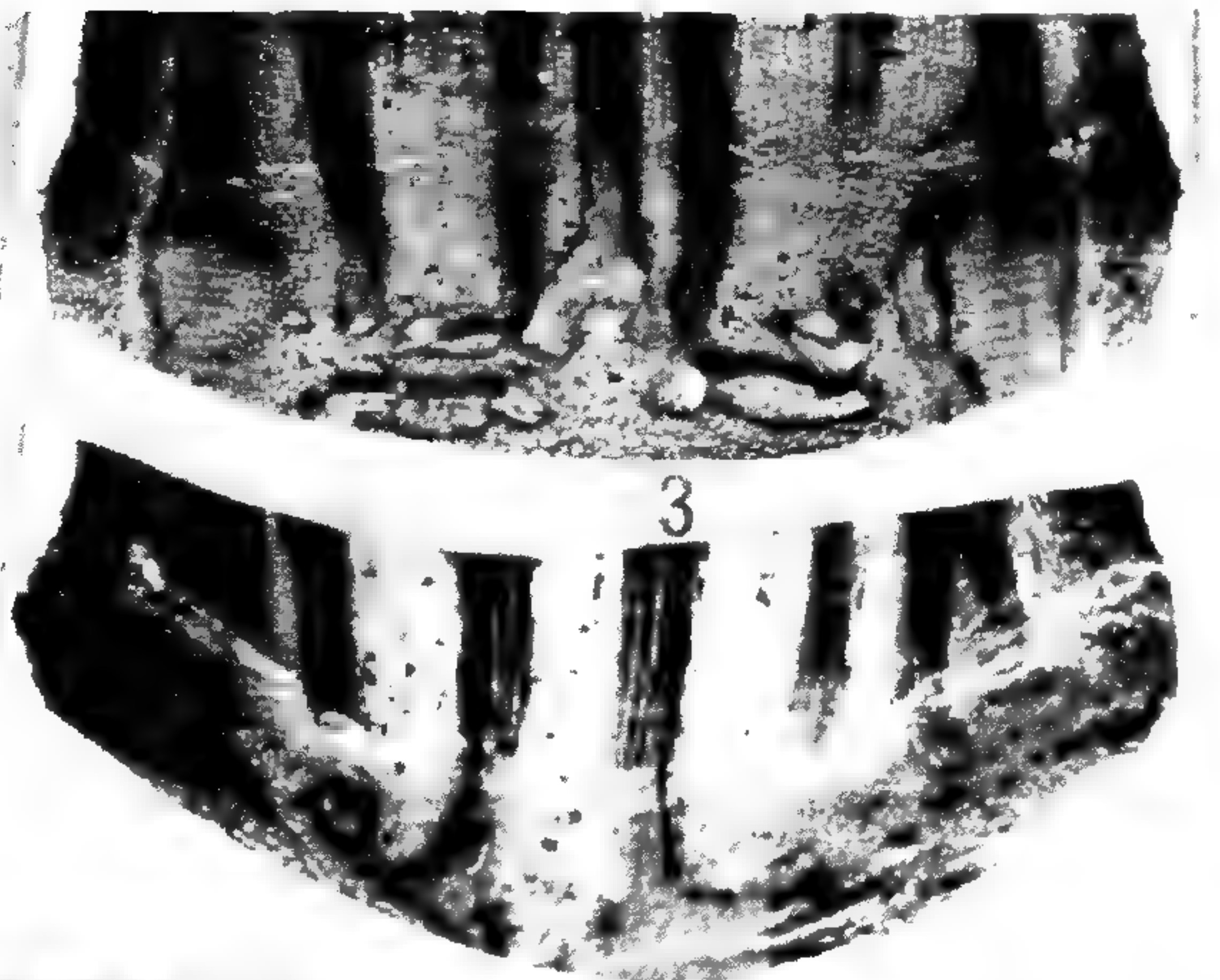
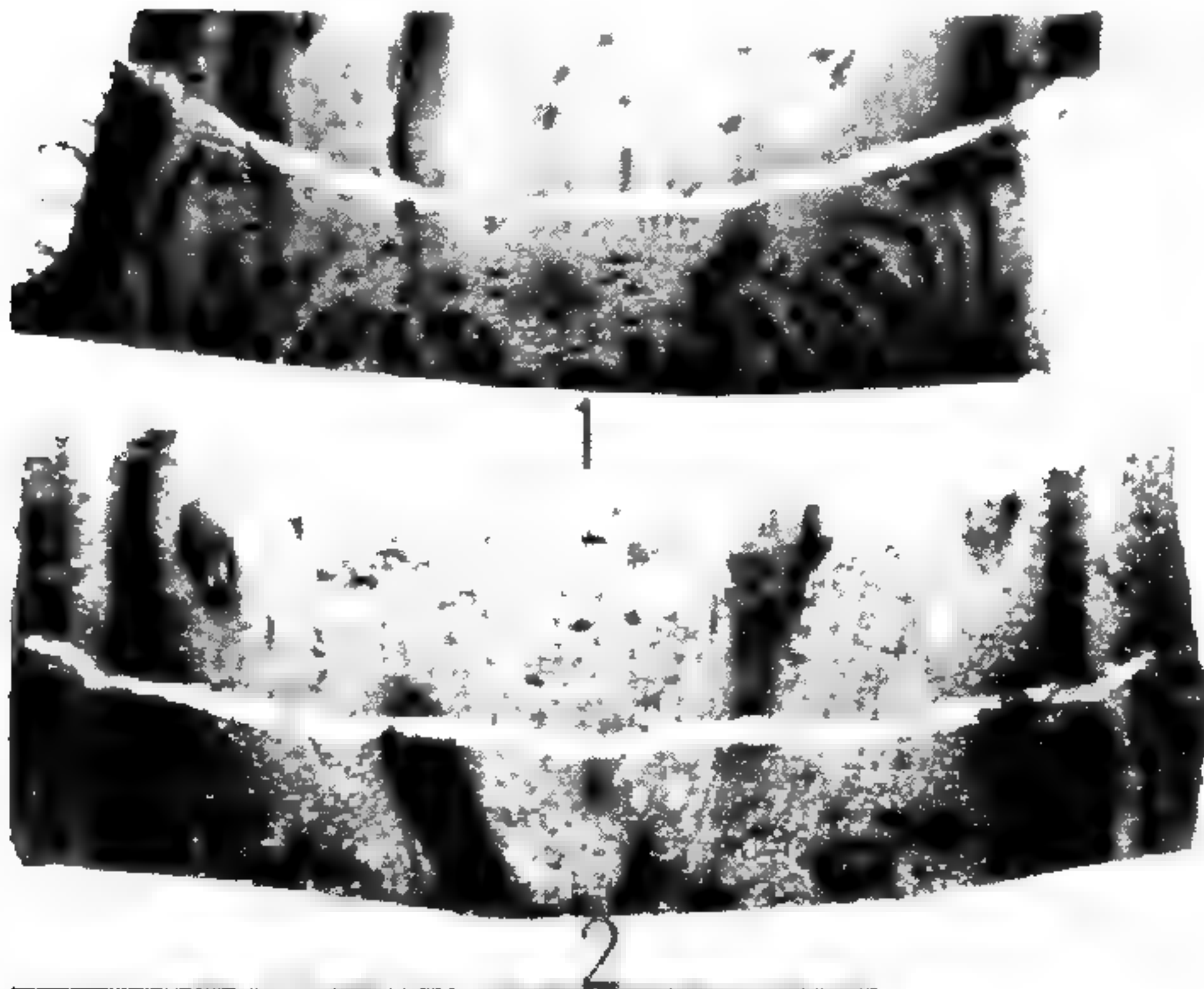

5

7

4

6

8

11

9

12

14

10

13

15



THE DEVELOPMENT OF THE CONCEPTACLE IN FUCUS  
CONTRIBUTIONS FROM THE HULL BOTANICAL LABORATORY 212

MABEL LEWIS ROE

(WITH PLATES XIV-XVII)

**Introduction**

When engaged upon a study of *Splachnidium rugosum*, the writer was forced to work out a new theory for the development of the conceptacle, since methods previously described did not offer sufficient explanation for what was found in *Splachnidium*. It seemed probable that such might also be the case in more advanced members of the Fucaceae, particularly *Fucus*, and it was with this in mind that a re-examination of this well-known form was undertaken. The results have proved interesting enough to warrant the reinvestigation.

**Material and methods**

For the material the writer is greatly indebted to Professor CHARLES J. CHAMBERLAIN, who had at his disposal paraffin cakes of young tips of *Fucus edentatus* Delapyl. and Kjellman (*F. furcatus* Agardh et al.) and of *Fucus vesiculosus* L., of which he had also mature tips containing ripe conceptacles. In addition, he furnished the writer entire plants of *Splachnidium rugosum* Grev., collected by him at Glen Cairn, near Cape Town, South Africa. To Professor JOHN M. COULTER the writer is indebted for material of *Fucus serratus* L., which was collected at Pictou, N.S., by Mr. J. CRERAR McDONALD, at the request of Professor W. G. FARLOW. All the material, except that used for fig. 20, was cut 5-8  $\mu$  in thickness, parallel to the long axis and at right angles to the flat surface of the thallus. Material for fig. 20 was cut 15  $\mu$  thick. The sections were stained with Haidenhain's iron alum haematoxylin and given a light touch before mounting with Grübler's Lichtgrün dissolved in equal parts of absolute alcohol and clove oil. The former stain brought out nuclear and cytoplasmic detail, while the latter gave in sharp relief all cell walls and layers of mucilage.



### Previous work

The first attempt at detailed, histological description of the origin of the conceptacle was that of KÜTZING in 1843 (13). He speaks there (p. 92) of the appearance on the surface of the thallus of small circular depressions, "Fasergrübchen" (cryptostomata), which have a raised border and contain finely septate ("gegliederte") hairs. He says that in their structure they resemble conceptacles ("Hüllenfrüchte") and seem to have a certain relation to them, although present in certain forms which do not possess conceptacles. Moreover, they appear on sterile as well as on fertile plants. He reports them sometimes lacking on *Fucus vesiculosus*, although usually present. He offers an ingenious explanation of the use of hairpits to the plant, describing a fusion of hairs developing a new plantlet as an adventitious shoot upon the parent.

He calls the conceptacle a closed-over sorus ("eingestülpter Sorus") and says (p. 98) that the layer forming the inner wall of the cavity is nothing other than a slight modification of the superficial layer of the cortex which becomes covered over and bears antheridia and paraphyses ("Samen und Nebenfäden trägt"). This cover conforms in structure to that of the superficial layer ("Rindenschicht") of the thallus.

AGARDH in 1848 (2) describes in the Fucoideae (p. 2) superficial cells prolonged into hairs, which project freely beyond the surface of the frond, either scattered or massed in a small bundle; this bundle is bounded by an elevated margin of adjacent cells. Such a body he calls a "cryptostomatum." The conceptacles ("scaphidia") he describes as suspended in the anastomosing filaments in the interior of the thallus, and hollowed out beneath the surface (p. 181). In the same place he mentions the occurrence of hairpits ("cryptae minutae") on sterile portions of the frond which are analagous to conceptacles on fertile parts ("scaphidiis in parte fertili analogae"), but that such "crypts" are often lacking. He describes a thin membrane in the early stage covering the mouth of the cavity which is a portion of the superficial layer ("quae tantum pars strati superficialis est"), but that the mouth of the cavity is later always open ("sed demum eadum semper evadunt ostiolo hiantia").



SACHS in 1875 (26) says (p. 227) of the conceptacle of the Fucaceae:

“These conceptacles are not formed in the interior of the tissue, but as depressions in the surface which become walled in by the surrounding tissue, and so overgrown that at length only a narrow channel remains, opening outward. The layer of cells which clothes the hollow is thus a continuation of the external epidermal layer of the thallus, and since the filaments which produce the antheridia and oogonia sprout from these, these latter are, morphologically, trichomes.”

In the same year REINKE (21) published an account of *Fucus vesiculosus*, followed a year later by a much more inclusive record of investigations (22) of a large number of closely related genera. In each paper he discusses the origin and development of both hairpits (“Fasergrübchen”) and conceptacles. On p. 337 he gives the details. The first indication of a pit is noticed on the lip close to the growing point, where a few neighboring epidermal cells separate themselves from other tissue (comparable to formation of resin ducts in conifers) and form between them an intercellular space filled with mucilaginous substance. Also the cortical cells, just beneath, are involved in this separation, and the cavity thus developed widens into flask-form, wherein the original meristematic cells take on the usual character of the border cells. These border cells develop first into papillae, and by subsequent division into hairs which project beyond the mouth of the pit.

The conceptacle is regarded by REINKE as a structure comparable to the flower of angiosperms, and is a metamorphosed thallus apex and branches. In this metamorphosis hairpits are changed into conceptacles (p. 338). The details of development are about as in the hairpit (p. 339). On the exterior the cavity is rendered firm by the epidermis and a few layers of cortical tissue. The epidermis stops short at each side of the ostiole; the walls are formed by small, nearly isodiametric cells corresponding to the cortex. Hairs spring from the base of the cavity and project beyond the ostiole. Because of the place of origin (close to the growing point) and similarity in method of development (separation of groups of cells from adjacent external cells, etc.), he considers the conceptacle the homologue of the hairpit (p. 340), and



that up to a certain stage there is no recognizable difference between the two ("auf dieser Stufe giebt es keinen erkennbaren Unterschied zwischen Fasergrübchen und Conceptaculum; wir haben es mit der Erscheinung zu thun dass ein der Anlage nach identisches Organ sich in einem Fall zu vegetativen, im anderen Fall zu reproductiver Thätigkeit entwickelt").

The next important contribution to this subject was the paper by BOWER in 1880 (6), whose work has been generally accepted since. In his introduction he gives a very brief résumé of previous work, given in the foregoing in greater detail. He first describes the development of the conceptacle and then compares it with that of the hairpit, which he regards "as an incomplete sexual conceptacle" (p. 37). He agrees with ROSTAFINSKI (25) as to behavior of segments of the apical cell, namely, that each segment divides first by a wall parallel to its free surface; the outer cell again divides in two planes at right angles to each other and to the first wall, thus giving four cells which may repeat the same method of segmentation as the original segment. A slight modification of this behavior initiates a conceptacle (or hairpit). Upon completion of a linear series of cells, activity in horizontal division ceases, leaving the terminal ("initial") cell in a depression as surrounding tissue continues active growth. This "initial" first loses its internal tension and later shrinks back against the basal segment beneath. Later segments of this basal portion (cortical in origin) line the bottom of the cavity, whereas the sides are derived from the limiting tissue (external layer) and from subjacent cortical tissue. This is the method for *Fucus*.

In *Himanthalia* (pp. 46, 48), the lining of the cavity is derived entirely from limiting tissue. In *Halidrys* he finds (p. 45) that

"The basal cell divides at first by walls strongly inclined to one another. The cells thus produced do not at any early stage divide by walls parallel to the surface of the cavity. The result is that the conceptacle usually appears . . . as though lined by a layer of cells continuous with the limiting layer; but as part, at least, of this tissue is derived from the basal cell, this conclusion is inadmissible. Meanwhile the initial cell (or group of cells) has been completely thrown off by the swelling of the wall dividing it from the basal cell. Later, as in other plants of this group, the cells of the lining tissue put forth papillae which develop further into hairs."



BOWER pays considerable attention to the "central column."

"The change of the substance filling the cavity has advanced so far that the unaltered portion immediately surrounding the remnants of the initial cell forms a central column of irregular outline. This stretches from the basal cell to the neck of the conceptacle, and is connected with the walls of the conceptacle by thin strings, which, like itself, have remained as yet unchanged" (p. 40).

He offers as an explanation that there are three substances present: (a) a swollen form of cell wall, which is not true cellulose, but is similar to the central portion of older cell walls of the tissue of the larger tangles; (b) a substance coincident with mucilage; and (c) a substance akin to cuticle. Later the connecting strings are ruptured.

In conclusion (p. 47), BOWER states that

"In all the cases described, the formation of the conceptacle is preceded by the decay of one or more cells which occupy a central position with regard to the changes which follow. The number of the cells thus removed is various, and the manner of their distribution is not constant. . . . A point which is not so obvious, but which appears of similar constancy, is that the cell or cells which decay are in all cases members of a linear series. It depends upon the activity of division, in a direction tangential to the surface of the thallus, how this series is characterized; whether, as in *Fucus*, where the division is slow and even ceases, the apical cell of the series hangs behind the surrounding tissue; or whether, as in *Himanthalia*, where the division is often repeated, the series is elongated, and, protruding beyond the surface of the thallus, is called a hair"; and (p. 48): "This variation in activity of tangential division accounts for the want of uniformity in number of the cells thrown off in different species, and even in the same species. . . . The differences in mode of development (in the early stages at least) depend upon the difference in activity of tangential division of the cells of the central series."

BOWER regards the hairpit as an incomplete conceptacle, but that "The homology of the two structures is so clearly proved that I shall be justified in proposing . . . the name 'neutral conceptacle' (p. 44). I think it is important to convey at once the relation which appears to exist between them and the true conceptacle."

VALIANTE in 1883 (29) describes the method of development for *Cystoseira* and related genera. Primordia develop in the apical grooves of ultimate branches, a hollow being formed just as in



early stages of hairpits. In either case, one or more peripheral cells at some point on the inner surface of the groove lose their power to increase in size and are left in a small cavity by active growth of surrounding cells. The initial (or initials) do not disintegrate, but by transverse divisions grow into hairs which project beyond the mouth of the conceptacle. He says he can find no traces, in his material, of decay of elements preceding formation of a cavity, as described by BOWER for *Fucus*. He finds hairpits developed among the conceptacles at apices of fruiting branches, but that in such cases the cavity is less pronounced than usual. He considers these a convincing proof of the close relationship between hairpits and conceptacles.

OLTMANN'S (19, 20) considers that the method as described by BOWER is essentially constant for all the Fucaceae, with very unimportant exceptions, namely, that the cells abutting on the "initial" have the chief work in organizing a conceptacle, sharing this with the "basal" cell, whereas the "initial" seldom remains intact, but either disintegrates or else grows into a hair ("überall kommt ihr zweifellos irgend eine nennenswerthe Funktion nicht zu"; 20, p. 516). OLTMANNS regards the conceptacles and hairpits as homologous structures, but takes exception to BOWER'S conclusion that hairpits are "neutral (sterile) conceptacles," for he believes that the hairpits have become sexual (19, p. 82).

BARTON in 1891 (3) made the next contribution, in her study of *Turbinaria*. She found the conceptacles and hairpits developed in essentially the same way as described by BOWER, VALIANTE, and OLTMANNS, the "initial" cell being persistent. "The initial cell divides longitudinally, and both cells, after again dividing transversely near the top, grow into hairs, the upper division of the initial forming the swollen base of the mature filament. These filaments fill the fully grown conceptacle" (p. 224).

She objects decidedly to BOWER'S terms "neutral" and "sterile conceptacle" as "conveying an idea of abortive growth" (p. 223). Her view is that the two bodies are of "equal antiquity" and "a later development in the ancestors of the Fucaceae than the reproductive organs." "I consider neither form a development of the other, and the fact that one conceptacle contains reproductive



organs, the other nothing but paraphyses, is an interesting point, but does not bear on the phylogenetic history of the conceptacles themselves." She then proposes the term "vegetative conceptacle" as meaning "those cavities in the thallus which have been developed only in a vegetative direction." In commenting on BARTON'S theory, MURRAY (18) says (p. 60) "I know so little about the ancestors of the Fucaceae, that I must be content with a respectful attitude toward this statement."

In their research upon *Splachnidium*, MITCHELL and WHITTING in 1892 (17) find that the conceptacle is developed by alteration of one of the epidermal cells, close to the apical cell, which becomes peculiarly modified but is inconsequential; however, they consider it the homologue of BOWER'S initial, although it takes no further part in developing the conceptacle, the real work falling to the neighboring cells.

In interesting connection with work on the conceptacle is that on hairtufts and sori in groups outside the Fucales.

MITCHELL in 1893, in a study of *Hydroclathrus* (16), finds groups of hairs analagous to "Fasergrübchen" (cryptostomata) of the Fucaceae. In development they certainly resemble the conceptacles, and her description recalls REINKE'S work. She speaks of an isolated cell or group of cells which become separated from surrounding epidermal tissue. Transverse division results in formation of hairs from these isolated cells. Meanwhile growth of the thallus leaves the isolated portion in a slight depression. Later, the sporangia which are developed in close proximity around the hairpits mature, and after liberation of the spores the sporangial walls disappear and the basal cells originate new growth. Finally, all the sporangia disappear and these hairtufts, with central depressions, are left scattered over the thallus, persisting throughout the life of the plant. MITCHELL concludes that although not a true conceptacle, such as in the Fucaceae, yet the growth of both hairs and reproductive organs is initiated by alteration in form and subsequent division of epidermal cells which might with truth be called "initial" cells. "My observations do not exclude the possibility of the initiative being taken by a small group of initial cells dividing simultaneously, instead of a single one."



MURRAY (18) states that the development of both cryptostomata and conceptacles follow the method described by BOWER. He quotes BOWER and then adds "These words appear to me to be the true guide of those who investigate the development of such bodies" (p. 60). In conclusion he states that comparison of the conceptacle of the Fucaceae with cryptostomata either in the heart of a sorus, as in *Adenocystis* and *Hydroclathrus*, or apart from the sorus, as in *Alaria* and *Sacchorhiza*, and with the situation in *Asperococcus*, in Cutleriaceae and in Dictyotaceae "points very significantly to a possible origin of cryptostomata. I anticipate, from further research into the development of these bodies, evidence that may enable us to dispense with the ancestors of the Fucaceae, of which, however, I would speak with respect" (p. 63).

BARTON in 1898, in a study of *Soranothera* (4), *Colpomenia*, and *Chnoospora* (5), found an interesting development of reproductive bodies in connection with cryptostomata, giving further evidence along the line already noted by MURRAY in his study of *Adenocystis*. In each case a saucer-like depression initiated the central portion of a cryptostoma and later of a sorus with reproductive sacs, whether these latter be plurilocular or unilocular. The important fact is that both portions of the sorus always originate as modifications of the superficial layer of the vegetative body.

HOLTZ in 1903, in his work with *Pelvetia* (11), describes a method of development little different in essentials from BOWER'S. Several epidermal ("initial"?) cells cut off a series of segments beneath to form a sort of pad of meristematic cells; then the external portions break down more or less, forming a cavity. The inner portions line the base of the cavity and later give rise to paraphyses and sex organs. Meanwhile unaffected epidermal cells continue division and cut off basal segments which become part of the cortex. "This new cortical growth stops abruptly at the conceptacle. In this way the cavity is deepened and a neck is formed, this neck being composed of epidermis-like cells. Original cortical rows are slightly deflected around the forming cavity, but later become deeply invaginated and thus aid in deepening the conceptacle" (pp. 35-36).



SIMONS in 1906, in a study of *Sargassum* (27), claims a development of conceptacle "At variance with all the prominent characteristics . . . . of the conceptacle as described by BOWER." The initial does not break down, but is an active cell producing the entire conceptacle. Adjacent cortical tissue is in no way involved in the process (p. 169). "Both the conceptacles and cryptostomata originate in a single flask-shaped initial which develops the entire structure. The first division of the initial results in two unlike segments: a large lower cell which develops the walls of the conceptacle and cryptostoma; and an upper cell, the tongue cell, which either remains inactive, divides to form a short filament, or degenerates. The "initial" cell of BOWER is apparently the tongue cell, a product of the true initial cell. The conceptacle and cryptostoma are undoubtedly homologous structures. Every stage of development in both structures is the same, from the appearance of the similar initial cells to the development of paraphyses in the cryptostomata and sexual organs in the conceptacle" (p. 179).

#### Summary of literature

The various theories described in the foregoing seem to resolve themselves into three categories: (1) the conceptacle or hairpit is a slight modification of the external layer of the thallus; this theory was held by KÜTZING, SACHS, and LUERSEN (15); (2) the conceptacle is a product of one or more initials, which do or do not disintegrate; their basal segments form the basal portion, whereas adjacent cortical tissue completes the sides of the structure; this theory was held by REINKE, BOWER, VALIANTE, OLTMANN, BARTON, MITCHELL, WHITTING, MURRAY, HOLTZ, FALKENBURG (7), and others; (3) the conceptacle is a product of a single initial whose segments develop the entire body; this is the theory of SIMONS. All of these workers agree, more or less, that conceptacles and hairpits are homologous structures.

#### Description

In a study of three species of *Fucus* and of *Splachnidium rugosum* and a rather superficial examination of *Sargassum filipendula* and *Hormosira*, the writer found evidence which supports the early



claim that the conceptacle is merely a slight modification of the original external layer of the thallus.

Following segmentation of the apical cell, in *Fucus*, some segment on the inner lip of the apical groove, close to the apical cell itself, ceases activity, and through failure to continue growth for a time is left in a depression by the active growth of abutting tissue. This inactive segment may then begin to break down in its external portion, without cutting off a transverse segment beneath to give a "basal cell" (figs. 1-4, 5c). Again, a basal segment may be cut off (figs. 5b, 6, 11-15), or even two segments may behave in a similar fashion (figs. 8, 9, 10). As the surrounding tissue comes to surpass the original inactive segment, the cells immediately abutting begin to break down in their external portions, as did the original segment (figs. 1-15). By continued involving of outer segments the cavity is gradually enlarged, and since the adjacent segments are always more active and therefore have greater turgor, the neck of the structure is narrow, whereas the basal part is broad.

Meanwhile, more and more of the outer portions of the cells involved break down, becoming mucilaginous and often showing several layers when stained with Lichtgrün (figs. 4, 6, 8, 10, 12, 14, 15). Ultimately, all except the portion immediately surrounding the nucleus having disintegrated, the original segments are left as mere lumps of tissue lining the cavity (figs. 6-15). *These basal portions never lose their meristematic activity*, but after a period of quiescence begin to put forth papillae as the cavity enlarges (figs. 16, 17). These papillae develop into hairs by basipetal segmentation, and finally become mature, multicellular, unbranched hairs which fill the cavity and project beyond the opening, out over the surface of the thallus (figs. 15-18).

Some time after maturity of the hairpit, these hairs are shed, and from the basal portions (*of the original segments*) new papillae put forth, this time to develop into hairs of a more delicate and fragile nature, often lost very shortly after (figs. 18, 19). Up to this stage there is no appreciable difference between hairpit and conceptacle. Moreover, further development merely offers a means of distinguishing antheridial from oogonial conceptacles,



if the species happens not to be monoecious. Immediately upon loss of the fragile hairs described in the foregoing, or from basal portions which failed to develop them, new papillae develop which by their subsequent behavior indicate whether antheridia or oogonia are to come. In the former case, segmentation may continue until an elaborately branched and complicated structure bearing numerous antheridia is formed. In case of formation of oogonia, the papillae segment once, cutting off the pedicels and oogonia proper (fig. 20). Further development up to blocking off of 8 eggs (fig. 20) is as already described by many writers (FARMER and WILLIAMS 9, OLTMANN'S 19 and 20, STRASBURGER 28, YAMANOUCHI 30, SIMONS 27, and others).

In *Splachnidium rugosum* the cavity is initiated by disintegration of an entire row of the thallus (and a terminal hair as well in some cases), pressure of active cells on each side reducing the disintegrating row to a long filiform structure which is left free subsequently by withdrawal of abutting cortical tissue in its effort to keep pace with active tissue toward the exterior. The abutting tissue at the external surface continues division and active growth, leaving the original initial row in a depression. Reproductive organs succeed a loss of hairs in the pit, just as in *Fucus*, except that here there are no evident antheridia or oogonia, but merely reproductive sacs.

Examination of *Hormosira* and *Sargassum* material seems to show the same behavior.

### Discussion

It will be noted from the foregoing description that the sex organs appear after maturity of the hairpit, and, moreover, they appear in the hairpit itself. In other words, the hairpits and the conceptacles are certainly homologous structures, as already admitted by many, since one, the hairpit, is the juvenile stage of the other, the conceptacle. All hairpits, therefore, are potentially capable of producing reproductive organs.

Moreover, sex organs have actually been seen in hairpits, described by SIMONS (27) as a "peculiar condition" (p. 173). She finds papillae and stalked cells like those which precede male



organs in a conceptacle or like the male organs themselves. She considers this condition a proof that hairpits are derived from the conceptacle (p. 174).

The writer is strongly inclined to the belief that those forms which are reported to possess hairpits only, with no evident connection to reproductive organs, will, upon further investigation, show closest relationship to reproductive activity, as already proved in research upon forms of Ectocarpaceae, Laminariaceae, Dictyotaceae, and Cutleriaceae. To the writer the resemblance of *Hydroclathrus* (16) to Fucaceae, where it is reported that after shedding sporangia basal cells originate new growth, is startling. In all the cases where similar sori are described, the origin is constantly from modification of the external layer, even when the writers themselves do not emphasize this fact. BOWER'S description of *Halidrys* and *Himanthalia* (6) seems to the writer good evidence against his own theory, and the writer is inclined to the opinion that with technique as it is developed today, BOWER would find the conceptacle of *Fucus* of quite the same origin as in *Halidrys* and *Himanthalia*. Even as it stands, several of BOWER'S drawings (pl. 5, figs. 2, 5, 11) show a possibility of interpretation quite like that of the writer.

Sections made by the writer of the same species of *Sargassum* cast some doubt on the explanation offered by SIMONS (27). Moreover, sections of young tips of *Fucus vesiculosus* give almost identical stages like those shown in her drawings of *Sargassum* (pl. 10, figs. 1, 3, 5, 6, 12, 17, etc.). However, sections of later stages show subsequent behavior to be quite different from that described by SIMONS, and to be as described by the writer for *Fucus*. It remains for further investigation to prove whether SIMONS is entirely accurate in her description. It seems to the writer that what SIMONS interprets as segments of the basal portion of the "initial" are really the basal portions of original segments of the apical cell, similar in nature and behavior to the "initial."

As to the various terms suggested, BOWER'S "neutral conceptacle" ("sterile conceptacle") and BARTON'S "vegetative conceptacle" are equally unhappy; if the body is a true conceptacle it cannot be "neutral," "sterile," or "vegetative." Since the



modern trend is for simplicity rather than complexity, and since the hairpit is simply an early stage of the conceptacle, the writer is strongly inclined to reject both BOWER'S and BARTON'S terms and retain the simpler term "hairpit," an exact translation of the early German use of "Fasergrübchen." BOWER'S "central column" is explained by examination of figs. 13-15. The old walls become mucilaginous and sometimes several layers of mucilage are seen between the meristematic portion and the "column."

### Conclusion

There seems a clear line of advance from forms with continuous patches of hairs and reproductive organs, as *Nereocystis* and allied forms, to distinct sori, where the hairpit is the center of a reproductive group, as in some Ectocarpaceae, Laminariaceae, Cutleriaceae, and Dictyotaceae, to distinct conceptacles scattered over the entire vegetative body, as *Splachnidium*, *Hormosira*, etc., to a final distinct grouping at the apex of a shoot, as in *Fucus*, *Pelvetia*, and other Fucaceae, or on special side branches, as in *Sargassum*, *Turbinaria*, etc. Similar lines of advance are already commonly accepted for bryophytes and pteridophytes, in the one restricted to arrangement of sex organs, in the other to arrangement of sporangia. A striking parallel to *Fucus* is seen in *Corsinia*, *Riccia*, and allied forms, where, step for step, the development of the dorsal groove and subsequent appearance of sex organs (and even hairs) from the basal portion repeats the history of the development of the conceptacle of *Fucus* from an original segmentation of the apical cell. In this one sees a forceful illustration that plants again and again duplicate behavior in given conditions, even though in one case the plant may be a gametophyte and in the other a sporophyte.

### Summary

1. The conceptacle originates as a slightly modified continuation of the external layer of the thallus, being segments of the apical cell whose basal portions are constantly meristematic and *never entirely breaking down*.

2. The hairpit is a juvenile stage of the conceptacle, the sex organs appearing in the same cavity as the mature hairs, but after their loss.



3. A distinct phylogenetic series is seen in advance from continuous patches of hairs and reproductive bodies, to scattered sori, to scattered conceptacles, and finally to apically placed conceptacles or to conceptacles on specially developed side branches. All of these structures originate through modification of the superficial layer of the thallus.

Acknowledgment is due to Professors COULTER and CHAMBERLAIN for their many helpful criticisms throughout the progress of this work.

UNIVERSITY OF CHICAGO

#### LITERATURE CITED

1. AGARDH, C., *Species Algarum*. 1. Gryph. 1823-1828.
2. AGARDH, J. G., *Species, genera, et ordines Algarum*. 1. London. 1848.
3. BARTON, E. S., A systematic and structural account of the genus *Turbinaria*. *Trans. Linn. Soc. London II Bot.* 3:215-226. *pls.* 14, 15. 1891.
4. ———, On the structure and development of *Soranothera*. *Jour. Linn. Soc. Bot.* 33:479-486. *pls.* 23, 24. 1898.
5. ———, On the fruit of *Chnoospora fastigiata*. *Jour. Linn. Soc. Bot.* 33:507-508. *pl.* 28. 1898.
6. BOWER, F. O., On the development of the conceptacle in the Fucaceae. *Quart. Jour. Micr. Sc.* 20:36-49. *pl.* 5. 1880.
7. FALKENBURG, P., *Die Algen im weitesten Sinne*. *Schenk's Handbuch der Botanik* 2:159-314. Breslau. 1912.
8. FARLOW, W. G., List of marine algae of the U.S. *Proc. Amer. Acad.* 10:35iff. 1875.
9. FARMER, J. B., and WILLIAMS, J. L., Contributions to our knowledge of the Fucaceae; their life history and cytology. *Phil. Trans. Roy. Soc. London B* 190:623-645. *pls.* 19-24. 1898.
10. GREVILLE, R. K., *Algae britannicae*. Edinburgh. 1830.
11. HOLTZ, F. L., Observations on *Pelvetia*. *Minn. Bot. Studies* 3:23-45. *pls.* 7-12. 1903.
12. KJELLMAN, in ENGLER und PRANTL, *Die natürlichen Pflanzenfamilien* 1<sup>2</sup>: 1897.
13. KÜTZING, F. T., *Phycologia generalis*. Leipzig. 1843.
14. LEITGEB, H., *Untersuchungen über die Lebermoose, Heft IV. Die Ricieen*. *pls.* 1-9. 1879.
15. LUERSSEN, C., *Handbuch der Syst. Bot.* 1:1879.
16. MITCHELL, M. O., On the structure of *Hydroclathrus*. *Phyc. Mem.* 2: 53-56. *pl.* 14. 1893.



17. MITCHELL, M. O., and WHITTING, F. G., On *Splachnidium rugosum* Grev., the type of a new order of algae. Phyc. Mem. 1:1-10. pls. 1-3. 1892.
18. MURRAY, G., On the cryptostomata of *Adenocystis*, *Alaria*, and *Sacchorhiza*. Phyc. Mem. 2:59-63. pl. 16. 1893.
19. OLTMANN, F., Beiträge zur Kenntniss der Fucaceen. Cassel. 1889.
20. ———, Morphologie und Biologie der Algen. Jena. 1905.
21. REINKE, J., Über *Fucus vesiculosus*. Bot. Zeit. 33:463-470. 1875; Nachricht K. Gesells. Wiss. Göttingen. 230-241. 1875; Jahrb. Wiss. Bot. 10:317. 1876.
22. ———, Beiträge zur Kenntniss der Tange. Jahrb. Wiss. Bot. 10:317-382. 1876.
23. ———, Entwicklungsgeschichte Untersuchungen über die Dictyotaceen des Golfs von Neapel. Nov. Act. Leopold 50:1878.
24. ———, Atlas deutscher Meeresalgen. Berlin. 1889-1892.
25. ROSTAFINSKI, J. T., Beiträge zur Kenntniss der Tange. 1. Leipzig. 1876.
26. SACHS, J., Lehrbuch der Botanik. Eng. ed. Oxford. 1875 (pp. 226-229).
27. SIMONS, E. B., Morphological study of *Sargassum filipendula*. BOT. GAZ. 49:161-182. pls. 10, 11. 1906.
28. STRASBURGER, E., Kerntheilung und Befruchtung bei *Fucus*. Jahrb. Wiss. Bot. 30:351 seq. 1897.
29. VALIANTE, R., Le Cystoseirae del Golfo di Napoli. Fauna und Flora. Leipzig. pls. 1-15. 1883.
30. YAMANOUCHI, S., Mitosis in *Fucus*. BOT. GAZ. 47:173-197. pls. 8-11. 1909.

#### EXPLANATION OF PLATES XIV-XVII

The drawings were all made with the aid of the Abbé camera and reduced one-half in reproduction. For figs. 1-18, the original magnification was 1050; for figs. 19-20, the original magnification was 535. Figs. 1-19 are of *Fucus edentatus*; fig. 20 is of *Fucus vesiculosus*.

FIGS. 1a-20a.—Sketches to show topography.

FIG. 1.—The inactive segment of the apical cell; the external portion already shows a breaking down; adjacent cells also show inactivity in a similar way.

FIGS. 2-4.—Further breaking down.

FIG. 5.—(b) Original segment which has cut off a basal segment; (c) original segment with no such segment cut off.

FIGS. 6, 7.—Further stages of figs. 1-3.

FIGS. 8-10. Two or more arrested segments.

FIG. 11.—Further stage of figs. 1-7; basal portions about nuclei very distinct.

FIG. 12.—Further breaking down; involving of abutting cells especially clear.

FIGS. 13, 14.—Showing how old walls are attached to "central column."



FIG. 15.—Fragments in center due to disintegration of walls still attached to column in figs. 13, 14.

FIG. 16.—Young hairs developed from meristematic basal portions of original segments.

FIG. 17.—Older stage of same.

FIG. 18.—Mature hairpit; meristematic portions of segments seen on side with papillae.

FIG. 19.—Older pit; long hairs falling off; meristematic portions of segments putting forth papillae and delicate hairs.

FIG. 20.—Mature conceptacle; delicate hairs being shed; oogonia in all stages from one-celled to complete blocking off of 8 eggs, developed by papillation and subsequent segmentation from meristematic portions of original segments; old hairs still seen about the ostiole, as well as fragments scattered through the cavity.



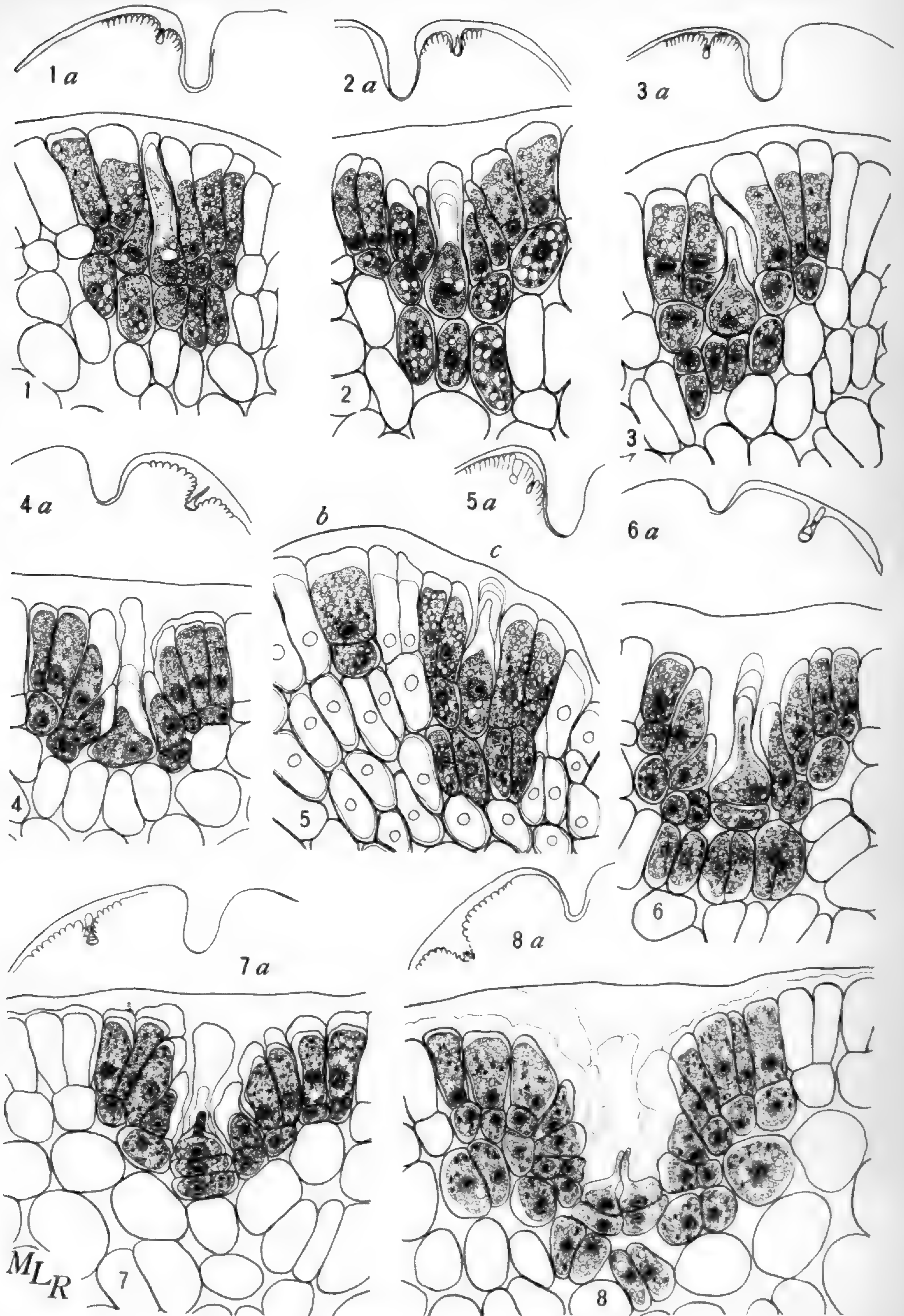

ROE on CONCEPTACLE OF FUCUS



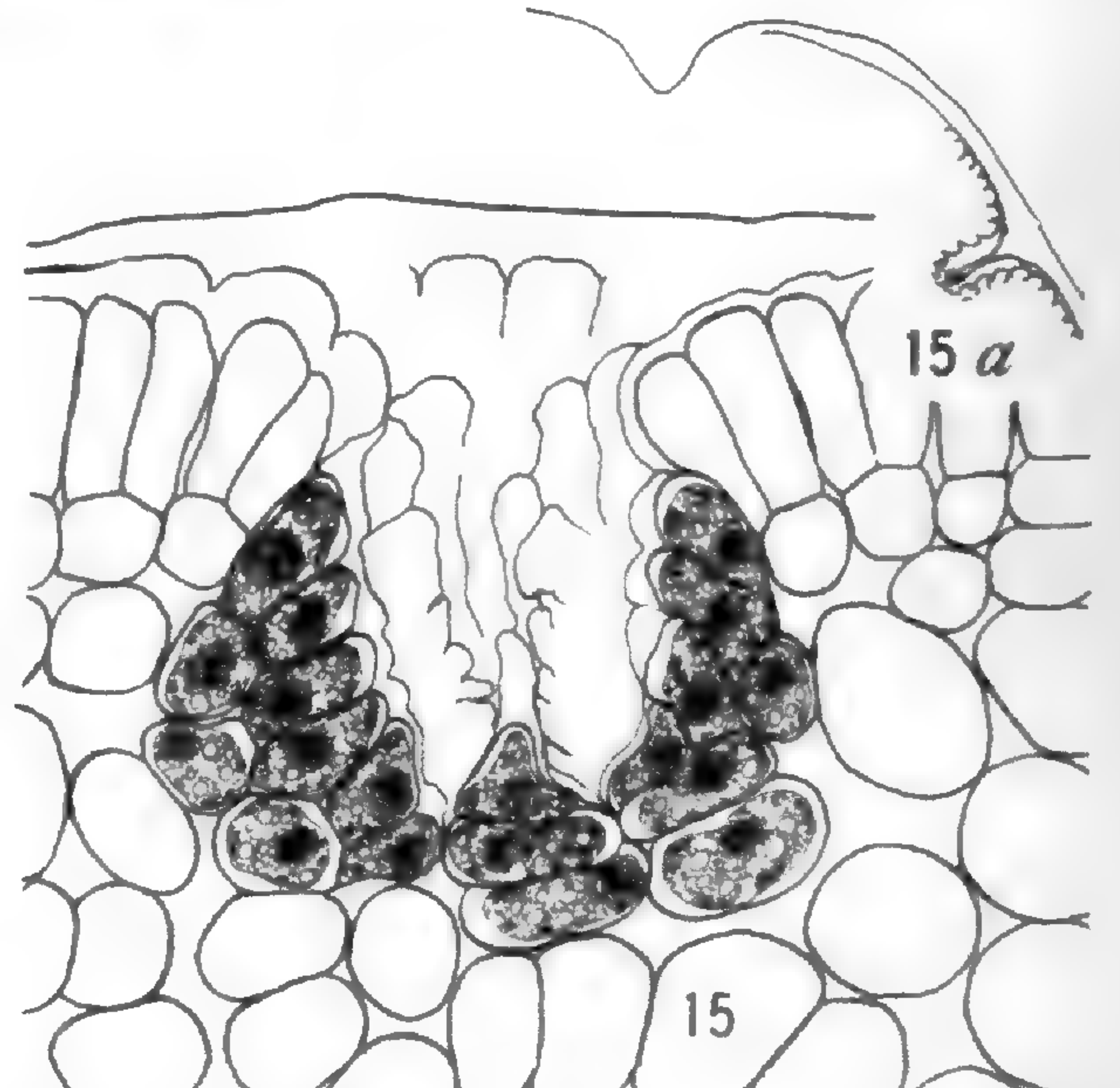
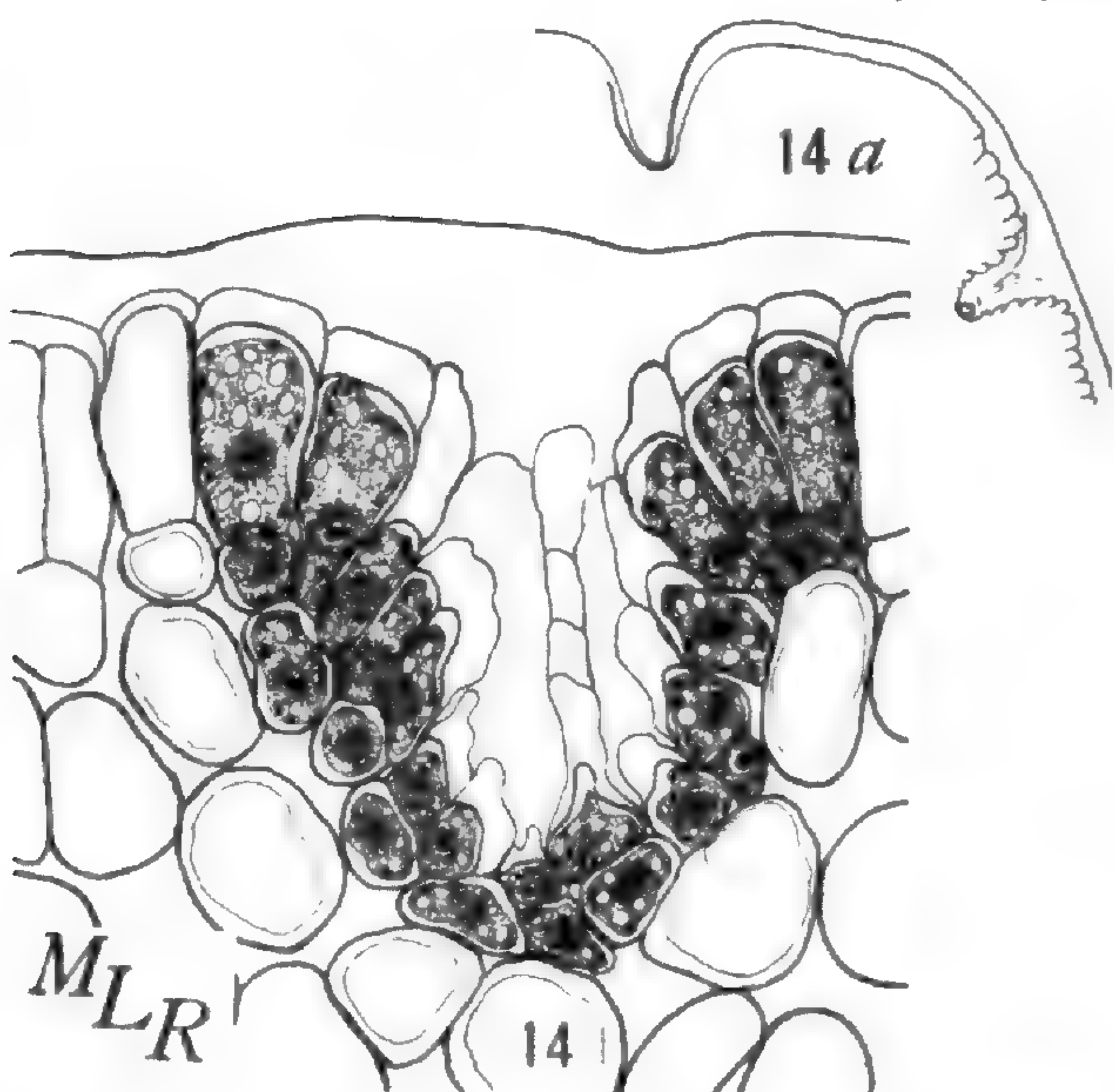
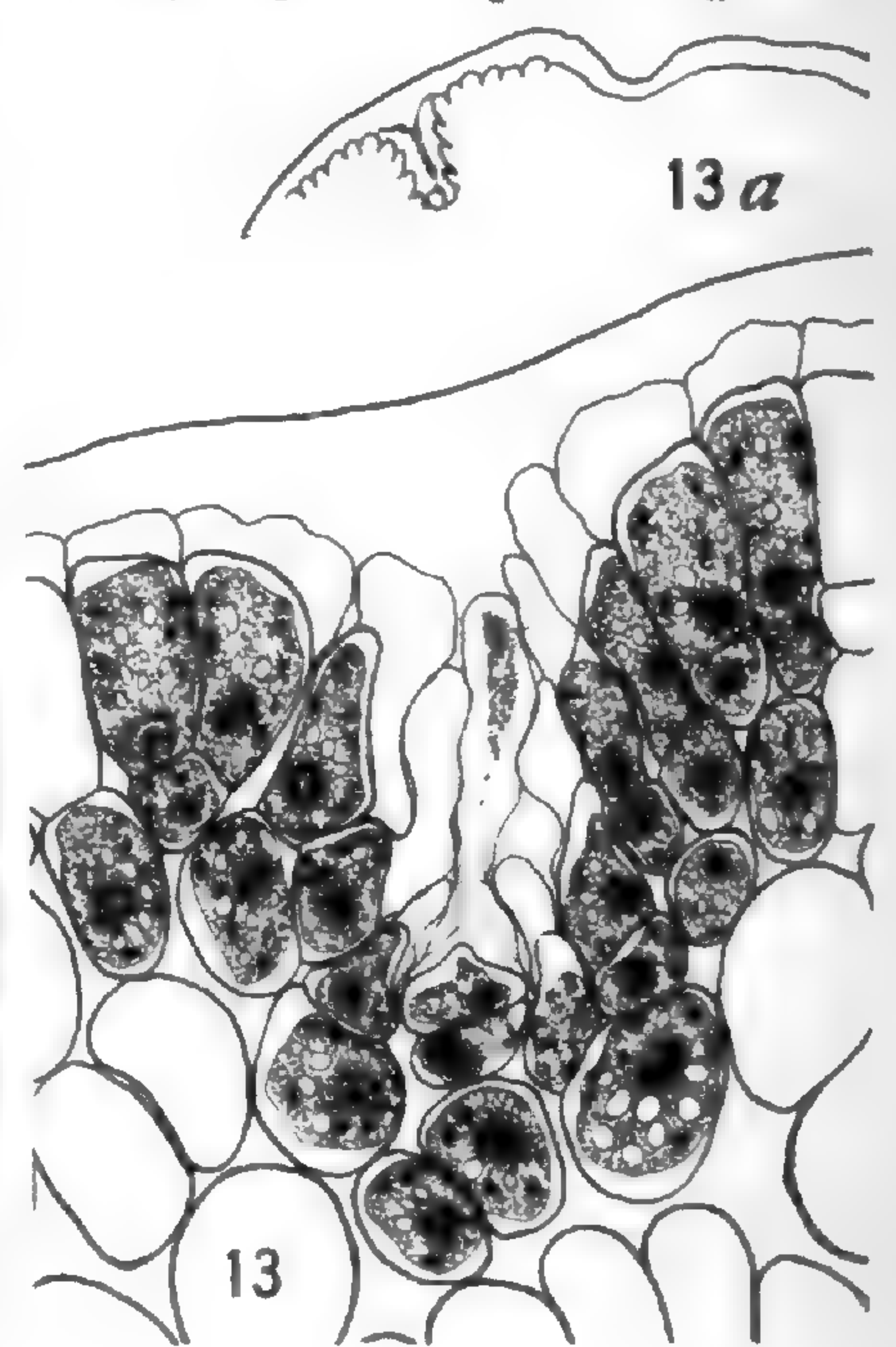
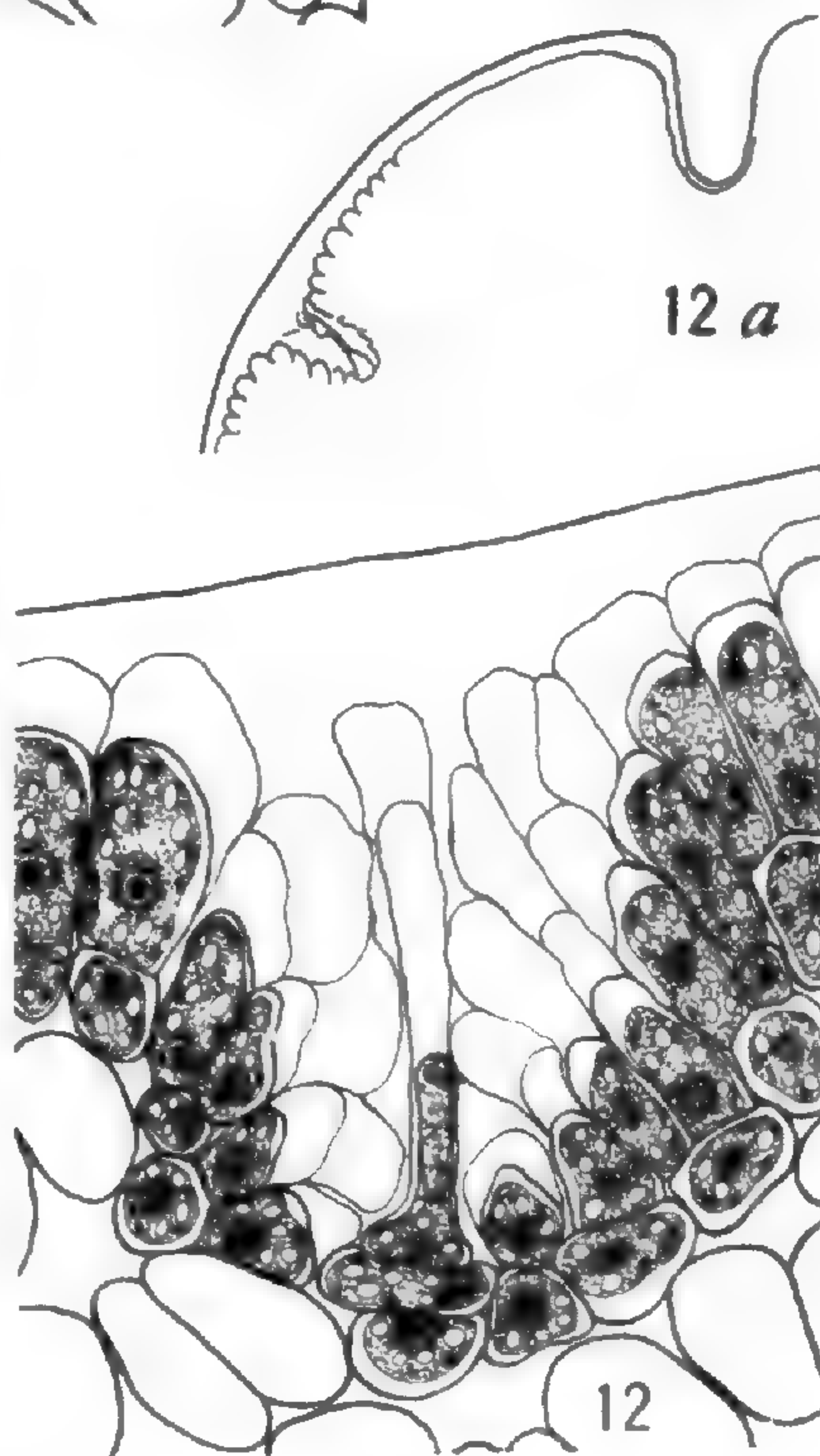
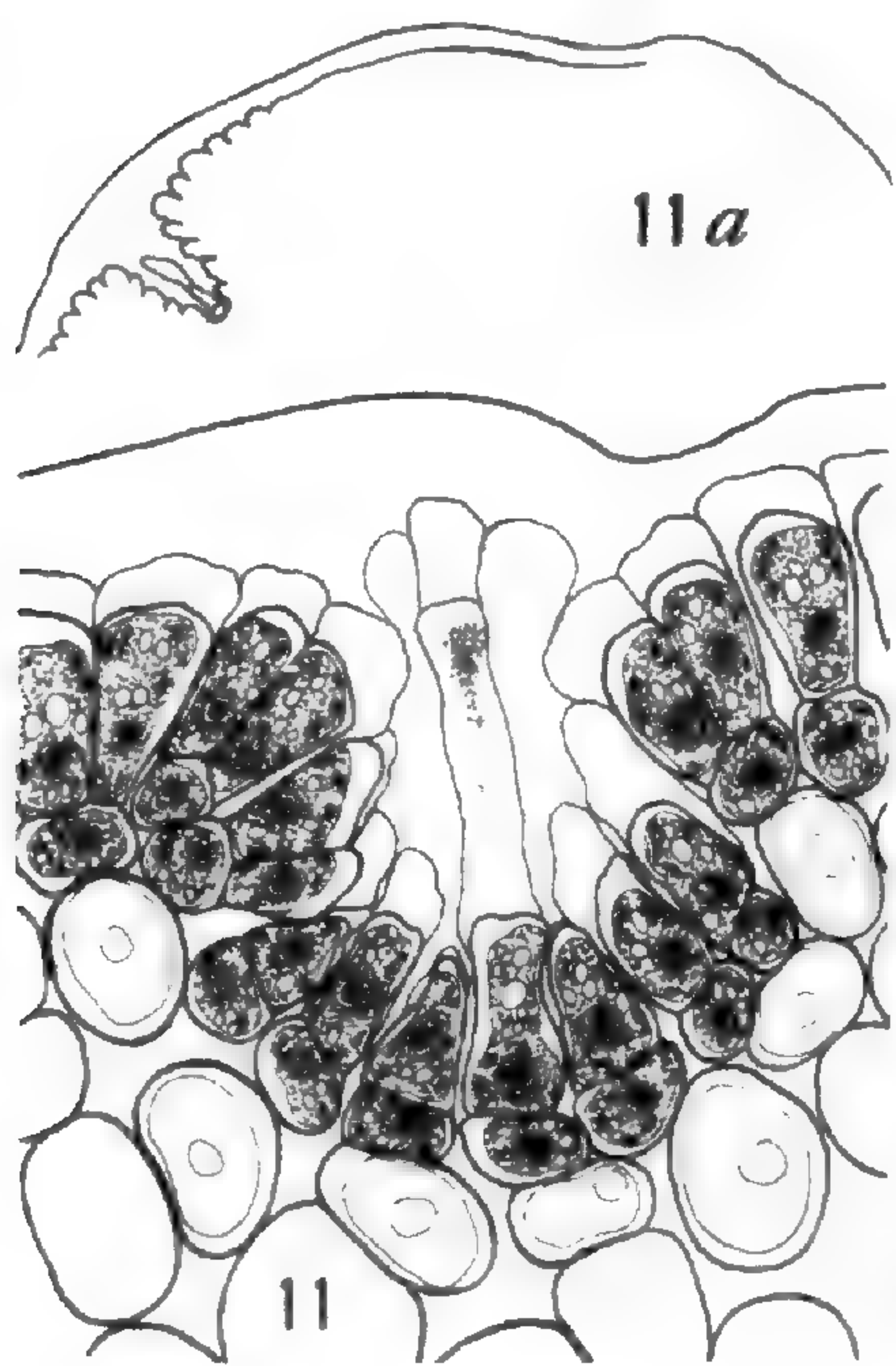
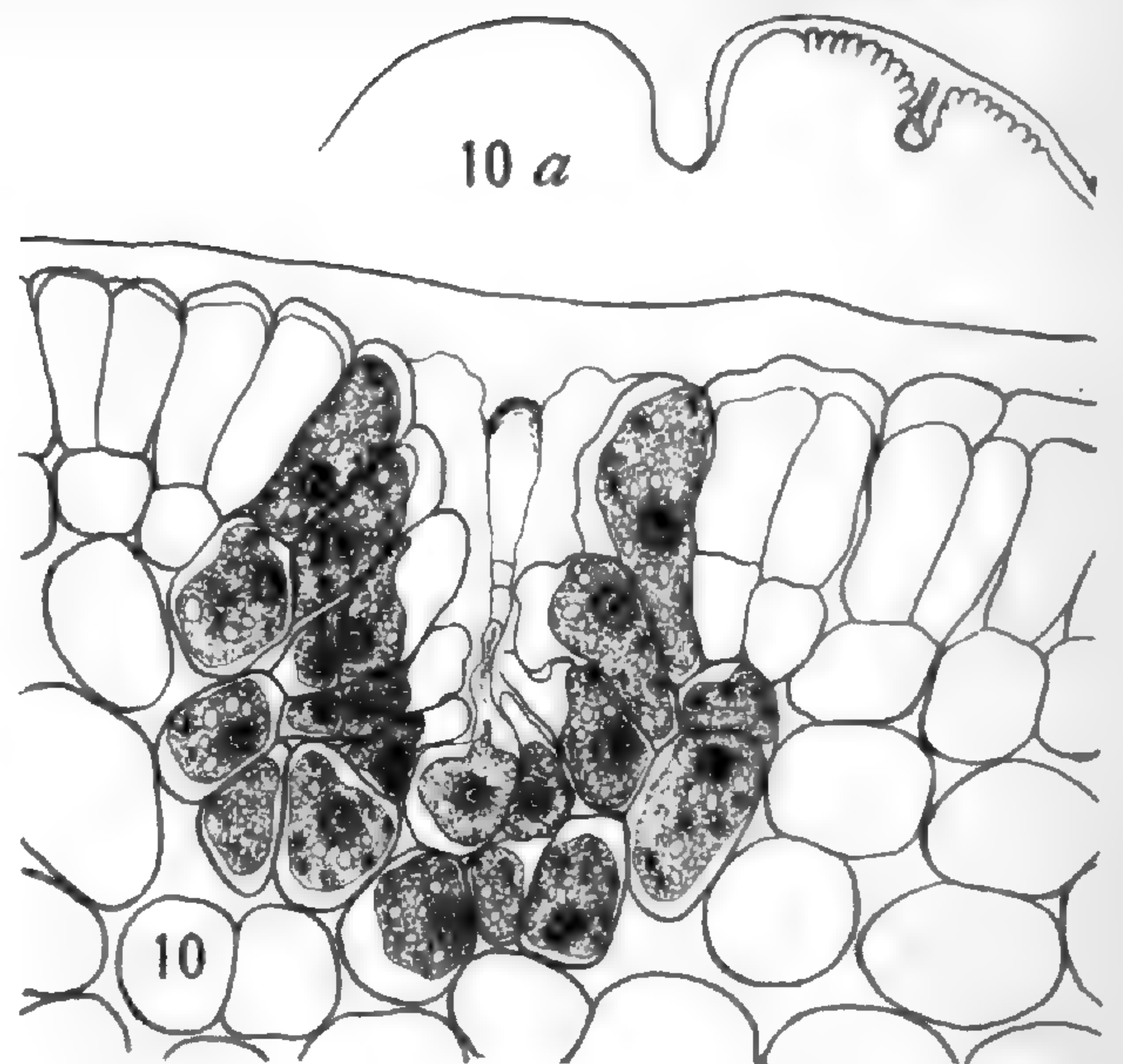
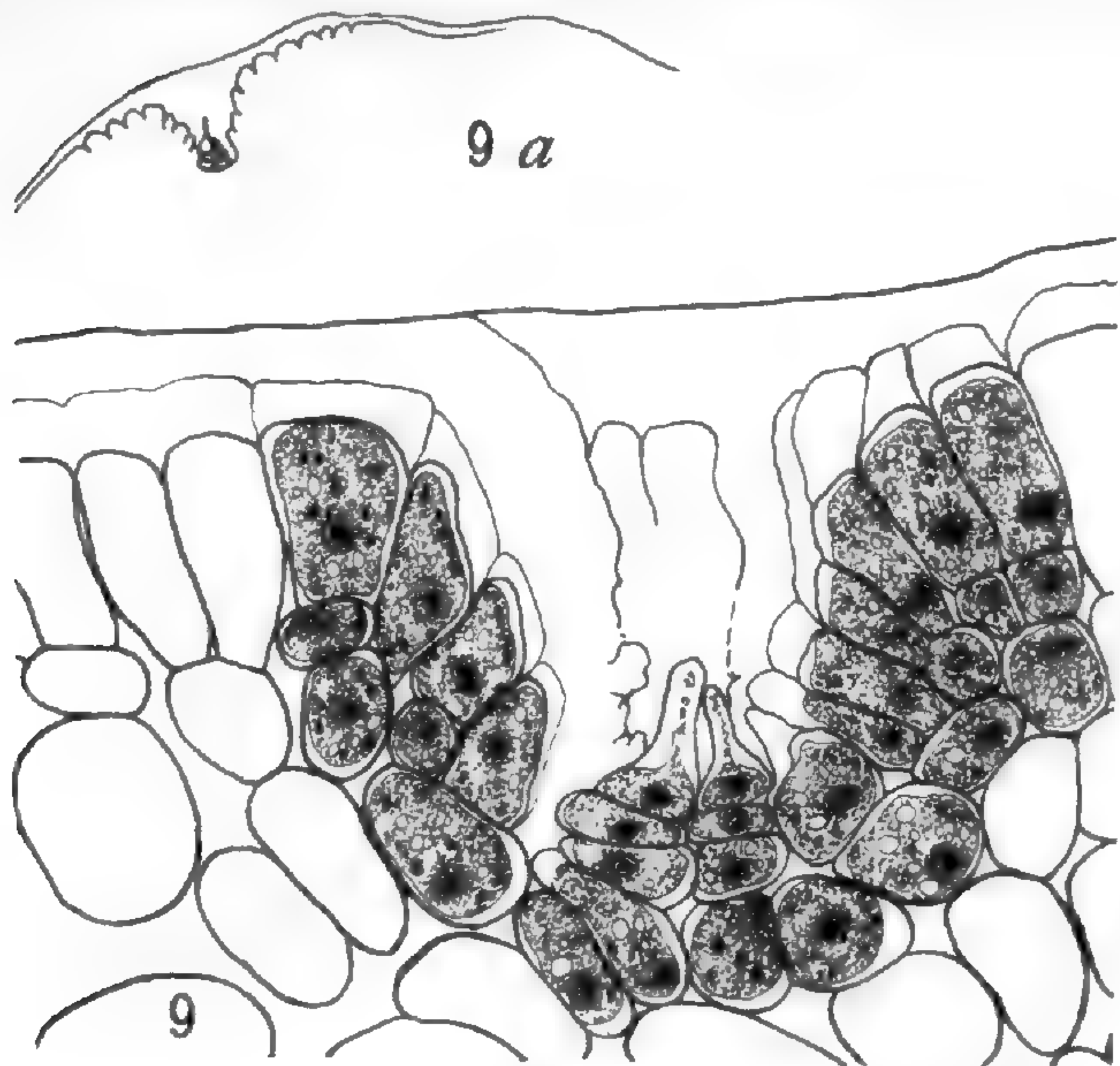

ROE on CONCEPTACLE OF FUCUS



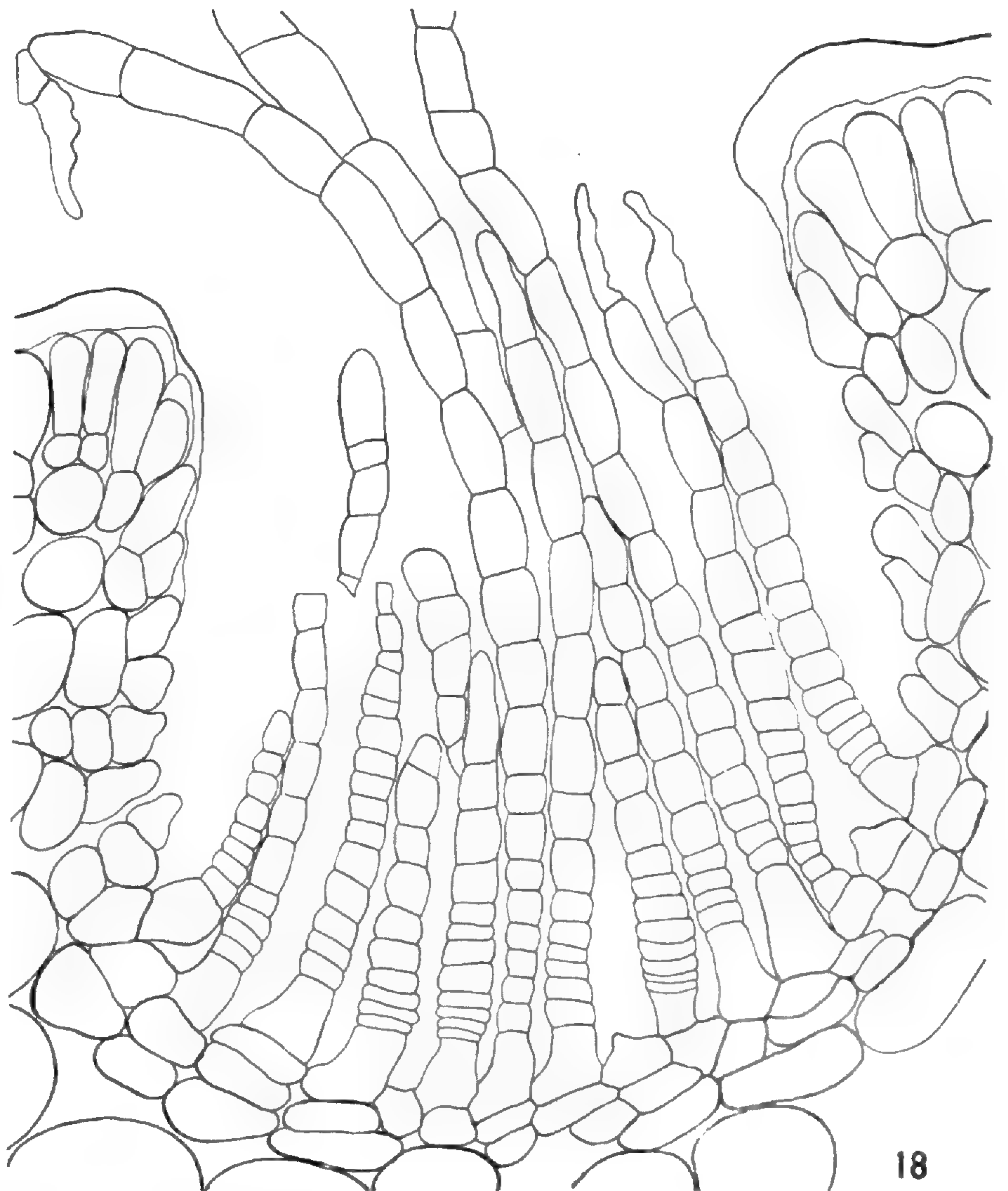
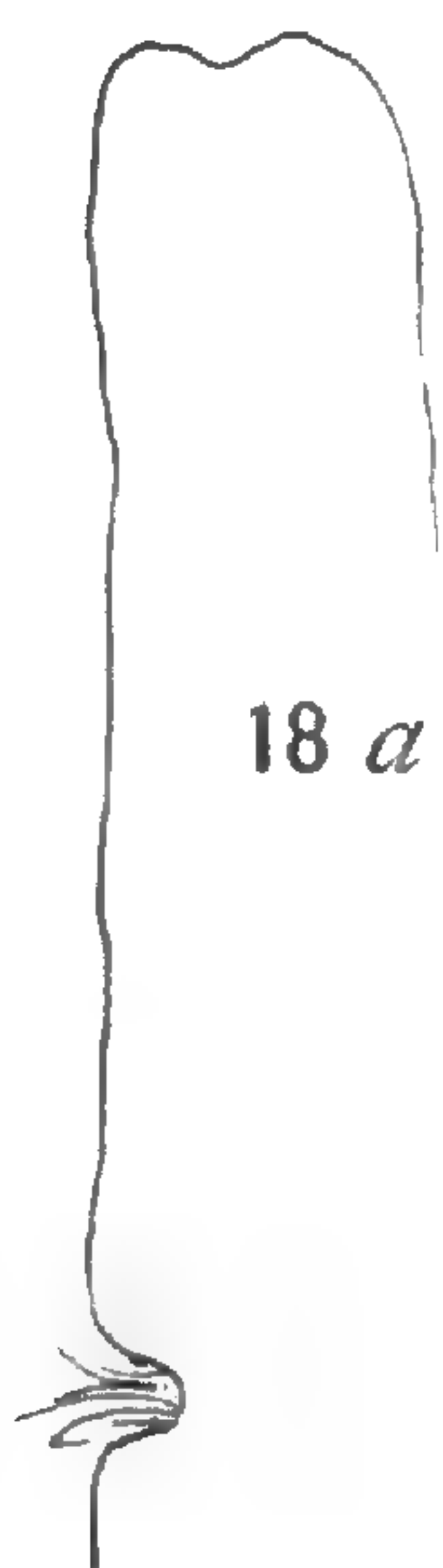
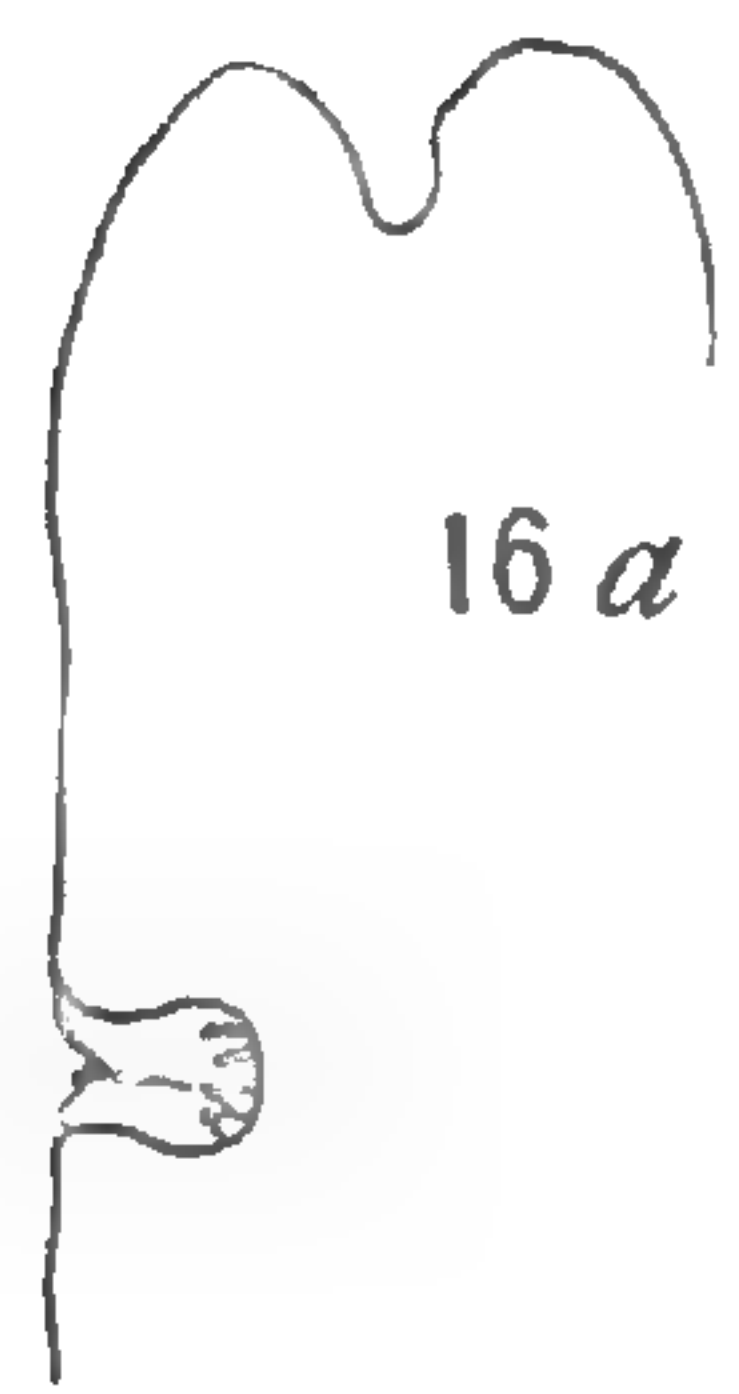
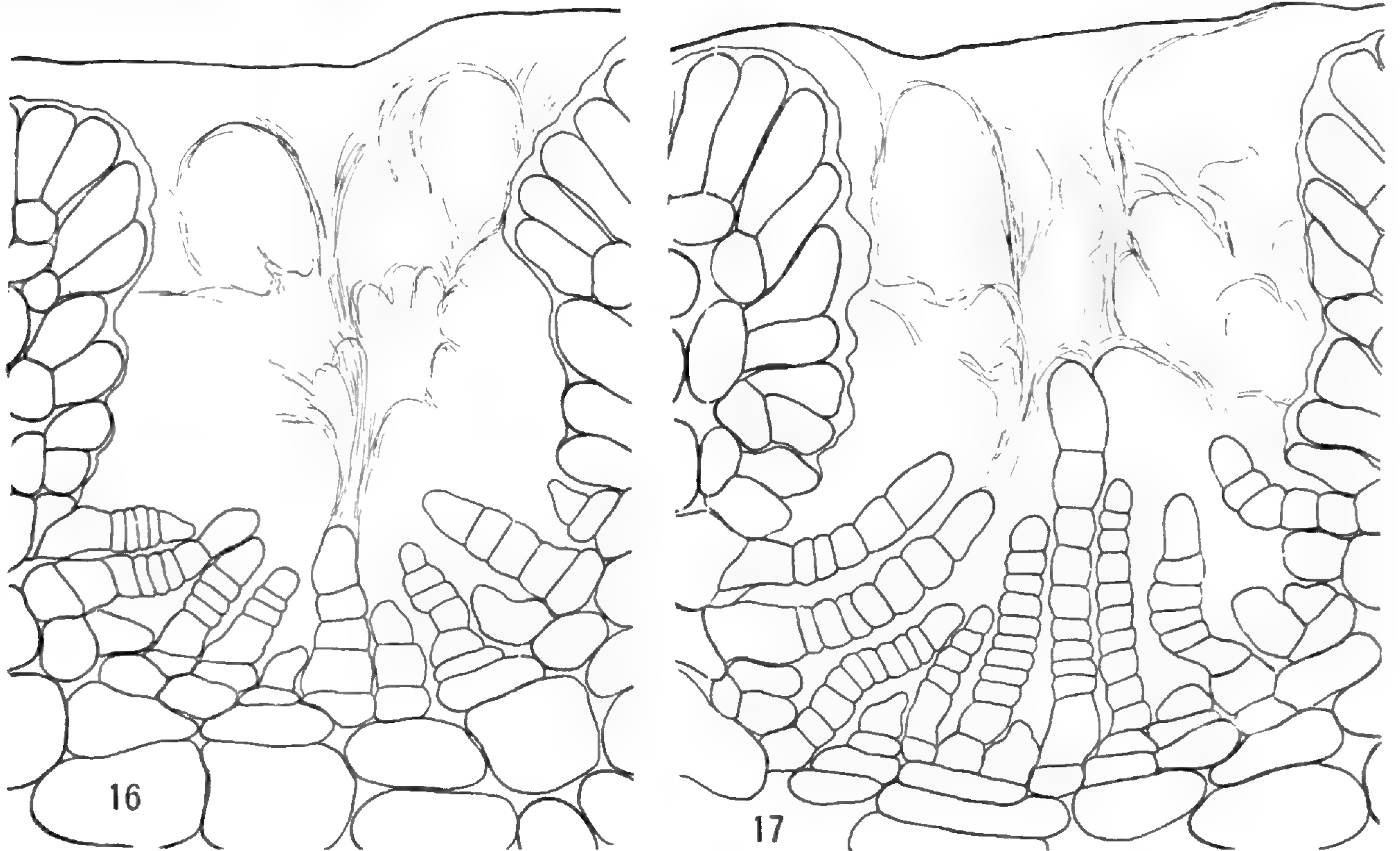

*M<sub>L</sub>R*

ROE on CONCEPTACLE OF FUCUS



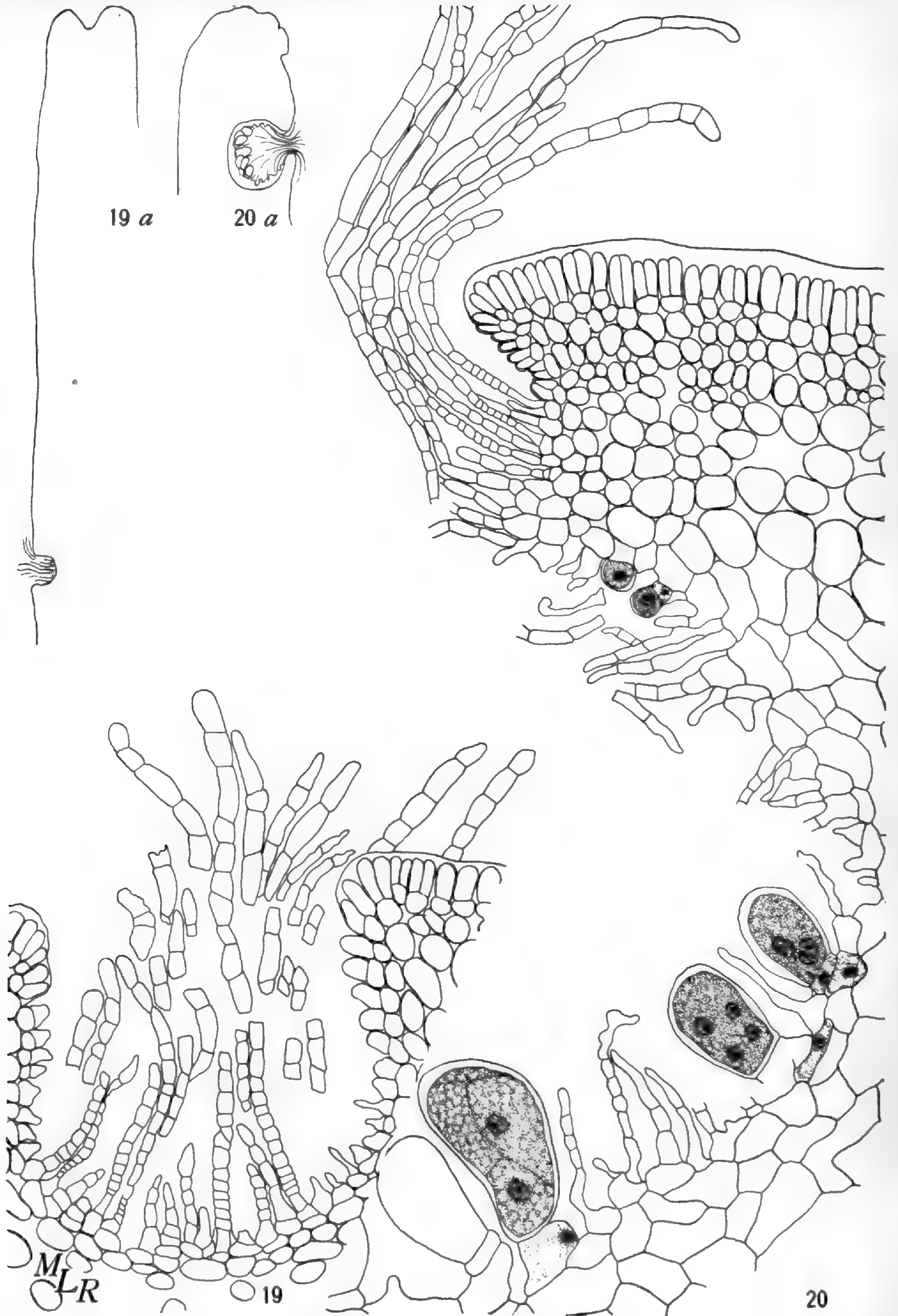

ROE on CONCEPTACLE OF FUCUS



## A NEW METHOD OF SEPARATING FUNGI FROM PROTOZOA AND BACTERIA

NICHOLAS KOPELOFF, H. CLAY LINT, AND DAVID A. COLEMAN

The investigations of RUSSELL and HUTCHINSON,<sup>1</sup> GOODEY,<sup>2</sup> CUNNINGHAM and LÖHNIS,<sup>3</sup> and others have stimulated the development of a new branch of soil biology, namely, soil protozoology. A problem of considerable interest in this field is the determination of the effect of soil protozoa upon soil bacteria. RUSSELL and HUTCHINSON maintain that soil protozoa have a marked influence on bacterial activity, and consequently soil protozoa may be regarded as one of the limiting factors in soil fertility. The criterion for measuring the effect of soil protozoa on bacterial activity has commonly been the production of ammonia and nitrates.

In pursuing this problem, some preliminary experiments, one of which was concerned with soil fungi, were carried on by the writers. In view of the fact that fungi are capable of producing ammonia,<sup>4</sup> their presence might mean an additional factor not accounted for in measuring the effect of soil protozoa on soil bacteria. So far as we have been able to ascertain, neither RUSSELL and HUTCHINSON nor other investigators dealing with similar problems have taken into consideration the possible value of this factor. Fungi are capable of producing ammonia, and until it has been established that they do not alter the results of ammonia production in the presence of bacteria in such experimental work, it would seem a priori that their presence is undesirable. Since a survey of the literature bearing on the subject offered neither suggestions nor a solution of the difficulty, the authors attempted to devise a method for the elimination of this factor.

<sup>1</sup> RUSSELL and HUTCHINSON, *Jour. Agric. Sci.* 3:111. 1909; 5:152. 1913.

<sup>2</sup> GOODEY, *Proc. Roy. Sci. London* 84:165. 1911.

<sup>3</sup> CUNNINGHAM and LÖHNIS, *Centralbl. f. Bakt. II.* 39:596. 1913; 42:8. 1914.

<sup>4</sup> MÜNTZ and COUDON, *Compt. Rend.* 116:395. 1893.

MARCHAL, *Bull. Acad. Sci. Belg. III.* 25:727. 1893.

MCLEAN and WILSON, *N.J. Bull.* 270. 1915.



The method finally devised and tested is based upon the principle of dilution, in such a manner as to reduce the possibilities for the occurrence of fungi in the cultures. Poured agar plates were used for this purpose. The method of procedure was as follows:

**SERIES 1.**—Plates of 10 different agar media suitable for growing fungi were poured in duplicate. They were potato, oat, cornmeal, rice, bean, raisin, apple, synthetic (LIPMAN and BROWN, N.J. Ann. Rep. 1908. p. 133), soil extract agar (prepared by adding 15 gm. agar to 1000 cc. Löhnis soil extract), and Cook's fungi medium no. II (Del. Bull. 91. p. 10).

After cooling, a block of each medium about 2 cm. square was cut out with a sterile knife, and 1 cc. of sterile soil extract was introduced by means of a sterile pipette into the cavity formed. A platinum loopful of a 3-day old culture of soil organisms in soil extract, known to contain numerous bacteria, protozoa, and fungi, was then carefully rinsed off in the medium. This soil extract was prepared according to Löhnis' directions by heating 1 kg. of good soil with 1 liter of water at 15 lbs. pressure in the autoclave half an hour. It was then removed, mixed with a generous quantity of talc, shaken thoroughly, and the liquid filtered through a double thickness of filter paper, until a clear solution was obtained. The moist residue of soil in the flask was pressed out to remove any solution still remaining. The solution was made up to a volume of 800 cc. and 0.05 per cent  $K_2HPO_4$  added.

**SERIES 2.**—This served as a check on series 1, consisting of poured plates each inoculated with one loopful of the same 3-day old culture of organisms, and made at the same time, using the 10 different media previously mentioned.

**SERIES 3.**—After one week, poured plate cultures were made, using the same media and inoculating with one loopful of the solution taken from the cavities of the agar plates of series 1, in order to make doubly certain that fungi were not present.

The results in series 1 show that on the plates where a portion of the agar was removed and 1 cc. of soil extract substituted, the bacteria and protozoa developed in enormous numbers, which might be due to the fact that a large surface is exposed for such a relatively small quantity of media. The important point, however,



which is to be noted from this experiment, is that despite the fact that media were furnished for the growth of fungi none was evident, even after 30 days' incubation.

From the observation of the poured plate cultures of series 2, made from the same 3-day old culture as series 1, it was noted that fungi appeared after 4 days upon 3 out of 10 plates; namely, Cook's no. II, Lipman and Brown's synthetic, and raisin agar. The predominating fungi were species of *Penicillium*, *Alternaria*, and *Fusarium*. On the poured plate cultures of series 3, inoculated with the solution in the cavities of the agar plates in series 1, no fungi developed. This experiment was repeated and corroborated the previous results. Thus it appears that although fungi were present in the original culture, the process of high dilution was responsible for their elimination in the specially prepared cavity on the agar plates in series 1.

Another method with the same object in view, namely, the separation of fungi from bacteria and protozoa, was employed, the procedure of which was as follows: Poured plate cultures of the 10 different media (as before) were made from the same 3-day old culture of soil extract known to contain numbers of bacteria, protozoa, and fungi, and the plates were watched carefully throughout the period of one week's incubation for the appearance of any fungi. As soon as their presence was discerned, the fungous growths were removed with a sterile scalpel. At the end of one week, at which time it was reasonably certain that the fungi had ample opportunity to develop, a portion of the agar, about 1 sq. in. in size, was removed with a sterile scalpel from each of the 10 plates, placed in 50 cc. of soil extract, and the flask thoroughly shaken to disintegrate the agar. For 4 days a microscopic observation was made and a few small flagellates and small ciliates were discovered on the preparation from raisin agar, and a few small ciliates and numerous small flagellates on the apple agar. No large ciliates were noted.

### Summary

1. The dilution method followed by the peculiar manner of plating as outlined makes it possible to separate fungi from bacteria and protozoa.



2. As a result of this separation it is possible to eliminate fungi from experiments involving the effect of protozoa upon bacterial activity, by making a subculture from the fungi-free solution of bacteria and protozoa (in the cavity of the agar plate).

3. The second method described, that of removing the fungi from the plates as they appeared, is undesirable for our special investigation, for the reason that the bacteria are allowed to multiply easily, while the protozoa have no such favorable conditions; consequently, on transferring such a culture to the soil, the protozoa would be at a considerable disadvantage, and their activity would be seriously inhibited if not entirely suppressed. The suggestion may be offered, however, that this method might be employed for obtaining cultures of single types of protozoa, as for example small flagellates or small ciliates.

This paper represents one phase of the preliminary work undertaken in connection with an investigation of the effect of soil protozoa upon the activity of soil bacteria. Further results on experimentation and a bibliography on soil protozoa and soil sterilization are awaiting publication.

RUTGERS COLLEGE  
NEW BRUNSWICK, N.J.



## BRIEFER ARTICLES

---

### CHLOROFORM AS A PARAFFIN SOLVENT IN THE IMBEDDING PROCESS

In a recent number of this journal LAND<sup>1</sup> describes an improved method of replacing the paraffin solvent with paraffin, in which he calls attention to certain difficulties encountered in the use of xylol as a solvent, and offers some suggestions by which these difficulties may be overcome.

The writer is somewhat surprised to find that xylol is so extensively used as a paraffin solvent in the process of infiltration, and for this reason he is tempted to describe the method that he has used for a number of years. In the first place, judging from the writer's experience, the best way, or at least one of the best ways, to avoid the difficulties mentioned by LAND in the use of xylol is to do away with the xylol altogether. Nineteen years ago the writer discarded the use of xylol. In its place he used chloroform, and he has been convinced that this solvent is superior to xylol. His method is as follows: We assume that the material has been carefully and thoroughly dehydrated by passing through the grades of alcohol, beginning with very low percentages, depending upon the character of the tissue. In dehydrating very soft objects one may begin by adding a few drops of alcohol at a time until a strength of 10 or 15 per cent has been reached. I have found this a safe thing to do in the case of objects like the seaweed *Champia parvula*. Some objects, however, may be placed directly from water into 20 per cent alcohol. It does not seem that standing overnight in any of the weaker grades of alcohol injures the tissues in the least.

After the specimens have been thoroughly dehydrated (I refer chiefly to material for morphological and cytological purposes), they are placed in a mixture of equal parts of absolute alcohol and chloroform, where they should remain for 2-3 hours or longer. When thrown into this fluid the specimens float, but in a short time they sink to the bottom of the vessel. No injury results if the specimen be allowed to remain in the chloroform and alcohol overnight or longer. Next the specimens are placed in pure chloroform, where they remain for 2-12 hours, depending upon the size of the specimens, the nature of the tissue, and to some

<sup>1</sup> LAND, W. J. G., Microtechnical methods. BOT. GAZ. 59:397-401. 1915.



extent upon the composition of the fixing or killing reagent. Generally the material is left in the pure chloroform 2 hours, or until it sinks to the bottom of the vessel. Material such as root tips or lily anthers fixed in chromo-osmic-acetic acid or chromo-osmic acid will sink in pure chloroform within 2 or 2.5 hours, but if chromo-acetic acid, absolute alcohol, or reagents that do not contain osmic acid are used as killing reagents, the specimens sink slowly or not at all. In the case of material fixed in chromo-acetic acid, for example, the specimens are left in the pure chloroform overnight or longer if necessary.

The specimens are now changed to a fresh quantity of pure chloroform, and shavings of paraffin (melting point  $42-45^{\circ}$ ) are added until at room temperature no more paraffin will dissolve. It will be seen that the paraffin floats at the surface of the fluid, while the specimens, in case they have sunk, are at the bottom. The chloroform surrounding the objects becomes gradually saturated, therefore, at room temperature. If the objects have not sunk in the chloroform, they do so gradually as the paraffin is dissolved. The degree of saturation of the solution may be increased slowly by adding paraffin a little at a time, but the writer has not found any special care necessary. When the chloroform is saturated at room temperature, the vessel is placed upon the paraffin oven and a little more paraffin is added if desired. The vessel, which is still closed with a stopper, remains on the oven 2-12 hours. The contents are now poured out into an open dish (usually a small porcelain dish) and covered by only a slip of paper to keep out dust, and this dish remains upon the oven until so much chloroform evaporates that the paraffin congeals slightly at the edge of the dish or over the whole surface. This requires usually one night. The dish is then placed inside the oven and allowed to remain until all the chloroform has evaporated, as determined by taste. The specimens are now transferred to melted paraffin of  $52-55^{\circ}$  melting point, or that of a higher melting point if necessary, in which they remain 10 minutes to 2 hours or longer before imbedding. They are then imbedded in this or similar paraffin.

Although chloroform is expensive, this is not necessarily a costly process. The paraffin ( $45^{\circ}$  melting point) used in making the chloroform-paraffin solution may be used over again two or three times, and 8 cc. of chloroform in each vessel is sufficient for a quantity equal to 10 or 15 root tips of onion or lily anthers.

It is understood, of course, that chloroform should be kept out of direct sunlight, preferably in a dark place.—D. M. MOTTIER, *Indiana University, Bloomington, Ind.*



In the Hull Botanical Laboratory, after a long series of rigid comparative tests of the various paraffin solvents in general use, it was found that xylol when carefully used gave uniformly better results than any other solvent. Cedar oil was rejected because it is almost if not quite impossible to eliminate the oil in the final stages of imbedding. It is true that hard material cuts somewhat better after cedar oil, but the same end may be attained in a far better way by soaking the imbedded material in water.

Chloroform was abandoned because in transferring from alcohol to chloroform it was found that, even when a much closer series than the one recommended by Professor MOTTIER is used, some plasmolysis results. Also we have found that paraffin does not seem to penetrate the tissues as readily after chloroform as after xylol. These results should be expected when we remember that the specific density of chloroform is nearly twice that of either alcohol, xylol, or paraffin. In STRASBURGER'S laboratory chloroform was practically abandoned for xylol about 15 years ago. We have in this laboratory preparations of root tips as well as of *Lilium* anthers showing reduction division, which, from the maker's name, we assume were made exactly as described by Professor MOTTIER. These preparations are certainly inferior to those in which xylol was used as a solvent. Dr. L. W. SHARP, one of the most successful workers in the peculiarly difficult field of modern cytological technique, always uses xylol as a solvent.

If all stages in cytological technique received equal care, published results would undoubtedly be in closer accord than they are at present.—  
W. J. G. LAND, *University of Chicago*.

---

## BESSEYOSPHAERA, A NEW GENUS OF THE VOLVOCACEAE

Two new species of the Volvocaceae were described by POWERS<sup>2</sup> without names or assignments to taxonomic positions. They were designated "first form of *Volvox*" and "second form of *Volvox*." The former was subsequently further described and named *Volvox spermato-sphaera*.<sup>3</sup> The "second form" is intermediate between *Pleodorina* and *Volvox* in the scale of differentiation, and its assignment to either genus would involve so great an extension of the conception of the

<sup>2</sup> POWERS, J. H., New forms of *Volvox*. Trans. Amer. Mic. Soc. 27:123-149. 1907.

<sup>3</sup> ———, Further studies in *Volvox*. Trans. Amer. Mic. Soc. 28:141-175. 1908.



genus as to be undesirable. Its nearest affinity may be considered to be *Pleodorina californica*, originally described by the writer<sup>4</sup> and more completely described by CHATTON.<sup>5</sup> I now propose to treat this "second form" as the type of a new genus, dedicated under the name *Besseyosphaera*, to the memory of the late Professor CHARLES E. BESSEY.

This new genus is distinguished from *Pleodorina* chiefly by having the gonidia scattered among the vegetative cells, instead of being developed from all the cells of the reproductive area. It differs from typical *Volvox* in having no protoplasmic connections between the cells, and in the lateness of the first visible differentiation of the gonidia, which does not appear until after birth. A study, now in progress, of several species of *Volvox* collected in the Philippine Islands leads us to anticipate that species lacking the intercellular protoplasmic connections may be properly removed from *Volvox*, some ranking below and some above *Volvox* in the scale of development. One or more of these may prove to belong properly in the same genus with the subject of these notes. For the present, however, it is convenient to treat our new genus as monotypic. Taking as a basis the facts stated by POWERS,<sup>6</sup> and making assumptions which seem to be warranted by the use of the name *Volvox* for this organism, the following diagnosis is offered.

**Besseyosphaera**, gen. nov.—Body a hollow spherical "coenobium" of greenish biciliate cells which lie in the periphery of a gelatinous matrix surrounded by a common hyaline envelope. Gonidia developed from cells distributed among the vegetative cells. No intercellular protoplasmic filaments. Daughters born before differentiation of gonidia. Sexual reproduction not known.

**B. Powersi**, sp. nov.—*Second form of Volvox*, J. H. POWERS, Trans. Amer. Mic. Soc. 27: 140-144. pl. 14. figs. 19-24. 1907.—Number of cells in the body about 1000 ("often below," "seldom much above"). Maximum diameter of body about 2000  $\mu$  (1800-2500  $\mu$  recorded). Vegetative cells about 12  $\mu$  in diameter; separated by 50-200  $\mu$ . Gonidia 10 or more to 78 or more; distributed in two-thirds or four-fifths of the surface of the body; differentiated in the daughters after birth. Daughters less than 150  $\mu$  in diameter at birth. Sexual reproduction not known. Habitat not stated (presumably a fresh water pond in Nebraska, United States).—WALTER R. SHAW, *University of the Philippines, Manila, P.I.*

<sup>4</sup> SHAW, W. R., *Pleodorina*, a new genus of the Volvocineae. BOT. GAZ. 19: 279-283. 1894.

<sup>5</sup> CHATTON, E., *Pleodorina californica* à Banyul-surmer: son cycle évolutive et sa signification phylogénétique. Bull. Sci. France et Belg. 44: 309-331. 1911.

<sup>6</sup> *Loc. cit.* 1907.



## A METHOD FOR THE DEHYDRATION OF HISTOLOGICAL MATERIAL

A combination of the glycerine dehydration method with the paraffin imbedding method in preparing histological material has given such satisfactory results that, while there is nothing new in the method itself, its advantages seem to justify bringing it to the attention of botanists, since the combination of the two is not in general practice. For some time the writer has been using glycerine in dehydration instead of alcohol in the preparation of small objects such as the megaspores and microspores of *Marsilia* and *Selaginella*, and has recently attempted using it on larger objects such as leaf tissue, ovulate and staminate sporophylls of the conifers, and anatomical material generally. It has uniformly given good results and indicates possibilities of more general application.

The method is exactly the same as is given for the glycerine dehydration in the preparation of glycerine and Venetian turpentine mounts of algae and fungi. The material to be imbedded is first killed with some of the usual killing agents, such as Fleming's solution or chromo-acetic acid solution 1:1:100 diluted to one-third or one-fourth strength at a temperature of 50–60°C. After killing for 12–24 hours the usual washing with water should follow. When free from acid the material is placed in a shallow open container, as a watch glass or a Petri dish, and covered with a 10 per cent glycerine solution in sufficient quantity to more than cover the material. The dish is allowed to stand open, but protected from the dust and subjected to the ordinary evaporation of the laboratory air, insuring a steady rapid dehydration by the evaporating of the water from the glycerine solution which gradually becomes concentrated. Within two or three days the glycerine is fully concentrated and the material is at about the same stage of concentration it would have been had it been "run up" through grades of alcohol to about 95 per cent.

The glycerine should be rather carefully removed by washing the material in 95 per cent alcohol. Specific manipulation for this particular process may be devised for each kind of material. Large pieces of material may often be removed from the glycerine with forceps or needles, or frequently the glycerine may be poured off the material. In any event, it is important to remove all of the glycerine by repeated washings in 95 per cent alcohol, since the presence of the former seems to interfere in the further processes of imbedding. Absolute alcohol is used to complete the dehydration, and any of the standard methods of substituting a paraffin solvent for the alcohol may follow from this point.

The advantages of the method are as follows: (1) dehydration is accomplished uniformly, rapidly, and with a minimum of work and



attention on the part of the operator; (2) when imbedded by this method material seems to cut better, since glycerine seems to harden less than alcohol; (3) material may be stored in the concentrated glycerine if it be desirable to postpone the imbedding processes.—J. BEN HILL, *Pennsylvania State College, State College, Pa.*

## BISPORANGIATE CONES OF LARIX

(WITH ONE FIGURE)

In the early spring of the present year (1915), in the vicinity of Missoula, Montana, abnormal cones were observed among normal

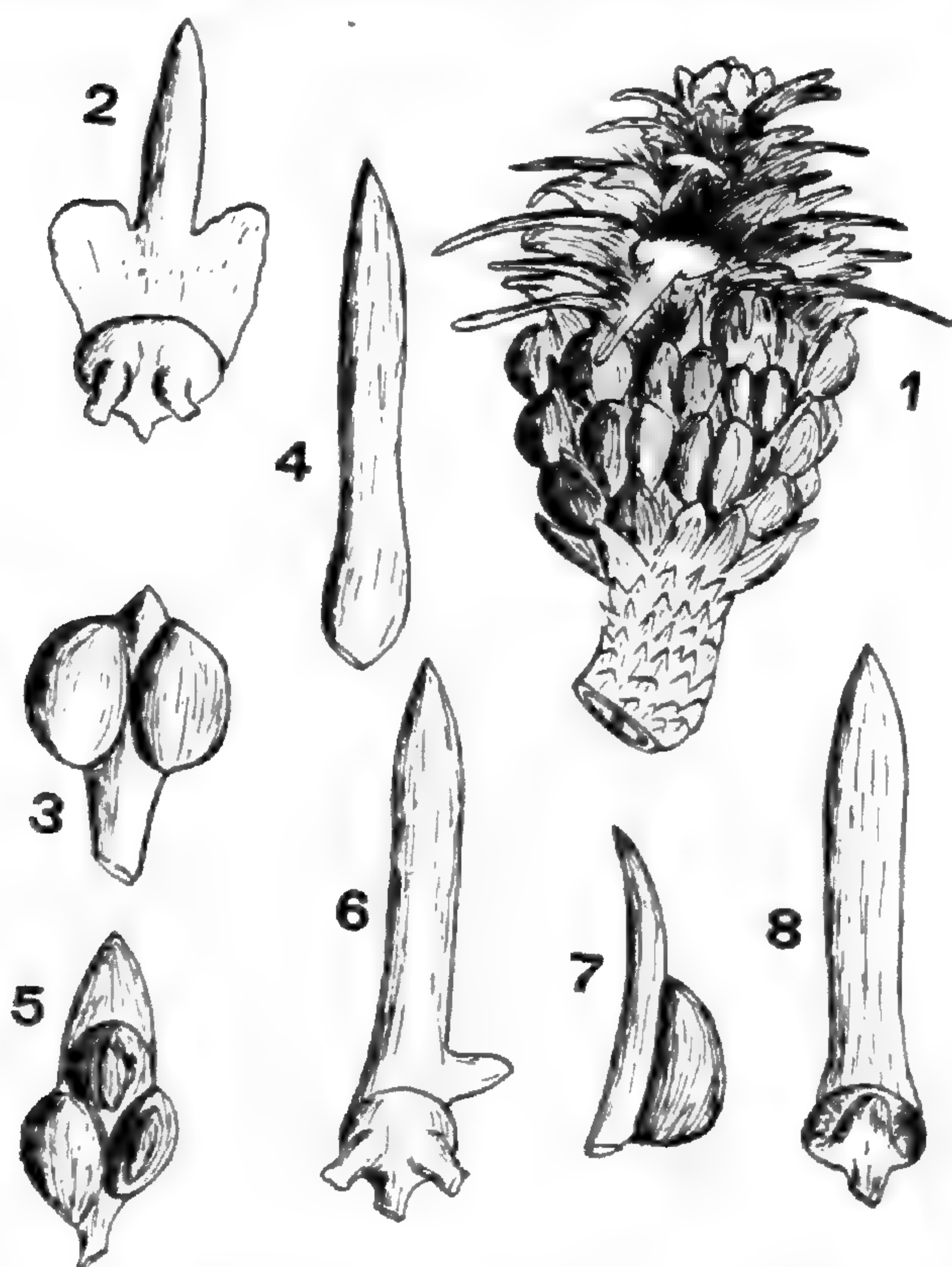

FIG. 1.—*Larix occidentalis*: 1, abnormal or bisporangiate cone,  $\times 3\frac{1}{3}$ ; 2 and 3, normal sporophylls and bract from the cone at 1; 4-8, abnormal bracts; 2-8  $\times 6\frac{2}{3}$ .

ones on a single tree of *Larix occidentalis*. The abnormal cones were about the same size as the normal ovulate cones of the species, and consisted of two parts; the lower half of the cone presented the normal appearance of the staminate cone with the total absence of the scale, the upper half presented the typical condition of the macrostrobilus with bract and scale. The scales bore two ovules, to all external appearances normal. Between the lower and the upper portions of the cone were a few transitional structures representing abortive bracts and scales.

Some of these structures are shown in the accompanying figure.

The pollen produced in the bisporangiate cone, on those sporophylls where the sporangia were apparently perfect, in its microscopic structure appeared to be the same as the pollen formed in the normal staminate cone on the same branch, except that it was somewhat smaller, measur-



ing on an average  $93 \mu$  in the diameter of the grain, as contrasted with an average of  $100 \mu$  in the latter case. In the abnormal sporophylls the pollen was sometimes in lumpy masses and imperfect.

Similar cones have been described in the case of *Picea*, *Sequoia*, and *Pinus*,<sup>7</sup> and have been interpreted as indicating a homology between the bract of the ovuliferous cone and the stamen, a conclusion which seems supported here.—J. E. KIRKWOOD, *University of Montana, Missoula, Mont.*

<sup>7</sup> COULTER, JOHN M., and CHAMBERLAIN, CHARLES J., *Morphology of gymnosperms*. Chicago. 1910.



# CURRENT LITERATURE

## BOOK REVIEWS

### Books on coal

In view of the increasing importance of the botanical sciences in connection with the fundamental problems, a general statement in regard to the status of plants in relation to coal will not be without interest to the readers of this journal. Taking first the conservational aspect of the subject, the results of the geological congress held in 1913 in Toronto, Canada, have appeared in three magnificent quarto volumes and a large folio atlas.<sup>1</sup>

Although the coal resources of the world are still abundant and exhaustion is in general hundreds of years in the future, still, prudent exploitation of the coal fields is necessary. The account of the coal resources of the various countries of the world are given authoritatively by their geological surveys and bureaus of mines. It is particularly fortunate that this should have happened before the great war has exacerbated international relations to such an extent that cooperation of the kind manifested in this gigantic work is for a long time to come impossible. The summary of the results is made by members of the Geological Survey of Canada. Of particular interest to North Americans is the enormous richness of our coal resources, which, if we include both the United States and Canada, are nearly twice as great as all of the rest of the world combined. In view of the absolutely fundamental relation of coal to modern industrial development the significance of the statistical situation for the northern America continental area can scarcely be overestimated.

The most important recent work on the historical aspects of coal investigation is unquestionably that of STEVENSON.<sup>2</sup> The author has had prolonged personal experience in connection with the coal deposits of the eastern United States, and has visited a number of the more interesting European formations. The summary of the literature on the subject is admirable, and enables one to realize what an enormously large amount of scientific effort has been expended on the investigation of coal during the past hundred years or more. Two main hypotheses of coal formation have held the ground during that period, namely the autochthonous or *in situ* hypothesis, which attributes to coal the same conditions of formation as ordinary peat; and the allochthonous or transport hypothesis, which regards coal as a sedimentary rock formed in

<sup>1</sup> The coal resources of the world. Toronto: Morang & Co. Ltd. 1913. \$25.00.

<sup>2</sup> STEVENSON, J. J., Formation of coal beds. Lancaster (Penn.): New Era Printing Co. 1911-1913. \$3.50.



open water. The first hypothesis is almost universally accepted by geologists and has received its main support from German investigations. The transport theory of the origin of coal has always been strongly held in France. The author is clearly in favor of the peat hypothesis (*in situ* or autochthonous theory) and supports his views not only by a summary of the literature, commendable on account of his generous fairness, but also as a result of his own observations carried on during many years in the eastern United States.

We may next consider a work on the recent formations of vegetable deposits comparable to coal at once monumental in extent and in view of the recent decease of its author actually a monument.<sup>3</sup> POTONIÉ divides recent deposits into the so-called Spropelites, the Humus-Bildungen, and the Liptobioliths. The first are deposits formed under open water by wind and water transport, and correspond to the lacustrine deposits of the allochthonous hypothesis of the origin of coal. The author is far from denying the actual existence of large amounts of vegetable material laid down in open water, and frankly admits that in the tropics, where the ravages of fungi in the case of plant matter not permanently submerged are extremely rapid, such accumulation is the only method of importance. In the case of temperate regions, however, as represented by northern Europe, the true peat (Humus-Bildungen) predominates, constituting extensive bogs, moors, and tundras. POTONIÉ has made a considerable study of the plant population of peat moors, and his results will doubtless be of great interest to students of plant geography and ecology. Liptobioliths are the persistent, resinous, waxy, or cutinous remains of plants which survive under the most unfavorable conditions as a result of their resistance to the organisms of decay. The author comes to the conclusion, as a result of his studies of recent accumulations of vegetable matter, that coal has been formed for the most part from autochthonous peat (Humus-Bildungen), and thus puts himself in line with the hypothesis most generally acceptable to geologists at the present time.

An American work dealing with the subject of coal of quite unusual interest and significance is a recent bulletin of the United States Bureau of Mines.<sup>4</sup> This work represents the cooperation, as rare as it is desirable, of a geologist, a botanist specially qualified in connection with the study of peat, and a histologist trained in the laboratories of the University of Chicago, who has given special attention to the actual organization of coal. The plates accompanying the article are numerous and represent a degree of progress in the difficult technique of the study of coal hitherto not found in any governmental publication. On account of the different points of view of the authors the results are not altogether harmonious. Perhaps the most interesting data,

---

<sup>3</sup> POTONIÉ, H., Die rezenten Kaustobiolithe und ihre Lagerstaetten. 3 vols. Berlin. 1908, 1911, and 1912. M. 8, 10, and 14 respectively.

<sup>4</sup> WHITE, DAVID, DAVIS, C. A., and THIESSEN, R., The origin of coal. Bull. 38, U.S. Bureau of Mines. 1915.



next to those put forward by THIESSEN in connection with the microscopic study of coal, are those of WHITE in regard to the formation of anthracites as the result rather of thrust action than of heat devolatilization, and of DAVIS as to the origin of vegetable accumulations in the United States, which he considers to have been formed mainly under open water. DAVIS' conclusions in regard to the origin of our peat accumulations are all the more interesting as he accepts the orthodox geological view of German origin in regard to the formation of coals from humic matter or peat. It is apparently not without significance that in a country of the extent of the United States, which today is neither extremely cold toward the north nor extends into the tropical regions in the south, the most important accumulations of vegetable matter in nature are not in peat bogs, but in the depths of open waters. A stronger argument derived from the conditions of the present for the aquatic origin of combustible minerals could scarcely be advanced.

It seems clear that improvements in botanical technique have brought within sight the settlement of the long dispute in regard to the mode of origin of what must be regarded both as the most valuable and the most abundant of all minerals. Coal is the universal industrial energy-producing and deoxidizing agent, since it is the only considerable mineral substance of natural occurrence which is not combined with large quantities of oxygen. It will be of interest to follow the investigations, now rendered possible, which will tend to establish a relation between the organization of coal and its industrial utilization in connection with the development of power, the manufacture of oil, gas, coke, dyes, antiseptics, high explosives, lampblack, electric carbons, etc.—E. C. JEFFREY.

### NOTES FOR STUDENTS

**Current taxonomic literature.**—J. A. NIEUWLAND (Am. Mid. Nat. 3:265-270. 1914) has described 4 new species of *Lythrum* from the Central and Southern states.—V. NORLIND (Rep. Sp. Nov. 13:401-403. 1914) has published two new species of *Polygala* from Brazil.—F. OSTERMEYER (*ibid.* 395) records a new *Cochlospermum* (*C. Zahlbruckneri*) from Argentina.—N. PATOUILLARD (Bull. Soc. Mycol. France 30:345-354. 1914) under the title "Contribution à la Flore Mycologique hypogée du Jura" proposes a new genus (*Stephanospora*) based on *Hydnangium carotaecolor* Berk. & Br.—J. PERKINS (Eng. & Prantl. Nat. Pflanzenf. Ergänzungsheft III, zu II-IV für die Jahre 1905-1912, p. 94. 1914) has proposed the name *Carnegieodoxa* for *Carnegia* Perk., not Britt. & Rose.—F. PETRAK (Ann. Mycologici 12:471-479. 1914) under the title "Beiträge zur Pilzflora von Mähren und Österr.-Schlesien" includes the description of two new genera, namely *Herpotrichiella* and *Leptomassaria*.—R. PILGER (Notizblatt Königl. Bot. Gart. u. Mus. Berlin 6:109-212. 1914) in cooperation with several specialists under the title "Plantae Uleanae novae vel minus cognitae" has published about 130 new species of Pteridophyta and Spermatophyta from South America based primarily on the collections of



E. ULE from the region of the Amazon. The following new genera are proposed: *Sohnreyia* Krause of the Rutaceae, *Spirotheca* Ulbrich of the Bombaceae, and *Lychniothyrsus* Lindau of the Acanthaceae.—H. PITTIER (Rep. Sp. Nov. 13:312-320. 1914) has published 12 new species of Malvales from Central America. Two new genera are included, namely *Goethalsia* of the Tiliaceae and *Gyranthera* of the Bombacaceae.—J. A. PURPUS (Monats. für Kakteenkunde 24:65, 66. 1914) describes and illustrates a new species of *Echeveria* (*E. leucotricha*) from Mexico.—L. QUEHL (*ibid.* 114-118, 158) describes and illustrates two new species of *Mamillaria* from Mexico.—L. RADLKOFFER and J. F. ROCK (Terr. Hawaii, Board of Agr. and Forestry, Div. Forest. Bot. Bull. no. 1, pp. 1-14. 1911) under the title "New and noteworthy Hawaiian Plants" have published several new species of orchids and include a new genus (*Hibiscadelphus*) of the Malvaceae.—R. A. ROLFE (Kew Bull. 1914. p. 210) has published 3 new species of flowering plants from Costa Rica and Peru. The same author (Curtis' Bot. Mag. *pl.* 8551. 1914) describes and illustrates a new orchid (*Epidendrum profusum*) from Mexico.—C. O. ROSENDAHL (Bot. Jahrb. 50:375-397. 1914. Supplement-Band) presents a revision of the genus *Mitella*, recognizing 12 species, one of which is new to science.—W. E. SAFFORD (Jour. Wash. Acad. Sci. 4:356-368. 1914) presents a paper on "*Acacia cornigera* and its allies" and describes 10 new species.—J. H. SCHAFFNER (Ohio State Univ. Bull. 18:127-247. 1914) has issued a "Catalog of Ohio vascular plants" in which he lists 2065 species for the state of Ohio.—J. SCHILLER (Sitzungsber. K. Akad. Wiss. 122:621-630. 1913) under the title "Vorläufige Ergebnisse der Phytoplankton Untersuchungen auf den Fahrten S.M.S. Najade in der Adria" describes several species new to science and proposes a new genus (*Cymbomonas*) of the Chlorophyceae.—R. SCHLECHTER (Rep. Sp. Nov. 13:279-287. 1914) gives a discussion of *Philibertia* and *Funastrum* and makes several new combinations in these genera pertaining mostly to Mexican and South American species. The same author (*ibid.* 438-443) has published 11 new species of Asclepiadaceae from Bolivia, based on collections of TH. HERZOG, and (Orchis 8:18-19, 131-137. *pls.* 3, 4. 1914) describes and illustrates new species of orchids of which 4 are from America.—B. SCHRÖDER (Hedwigia 55:183-223. 1914) in a concluding article on the "Zellpflanzen Ostafrikas" proposes the following new genera of the Scenedesmaceae: *Schmidleia*, *Schroederiella*, and *Victoriella*.—O. E. SCHULZ (Bot. Jahrb. 50:176-187. 1914. Supplement-Band) under the title "*Bidens chinensis* (L.) Willd. und verwandte Arten" includes a new species of *Bidens* from Costa Rica.—W. A. SETCHELL (Univ. Calif. Publ. Bot. 6:79-152. *pls.* 10-16. 1914) under the title "The *Scinaia* assemblage" presents a synoptical revision of this group. The author recognizes 11 species of *Scinaia* of which 5 are new and 7 species of *Gloiophloea* of which 4 are new to science. One new genus is proposed, namely *Pseudoscinaia*, to which two species are referred, one from California, the other from New Holland.—M. SLOSSON (Bull. Torr. Bot. Club 41:307-309. *pl.* 7. 1914) records a new fern (*Adiantum*



*rimicola*) from Utah.—J. J. SMITH (Bull. Jard. Bot. Buit. II. no. 14, pp. 1-56. 1914) under the heading "Die Orchideen von Java" describes several new species and characterizes a new genus (*Abdominea*).—O. STAPF (Bull. Kew 1914, p. 326) records a new species of *Crataegus* (*C. Lindenii*) from Chiapas, Mexico.—T. STUCKERT (Ann. Conserv. et Jard. Bot. Genève 17:278-309. 1914) under the general heading of "Beiträge zur Kenntnis der Flora Argentinens" in cooperation with the eminent agrostologist Prof. E. HACKEL has published a fourth article on the grasses of Argentina in which several species new to science are recorded.—H. and P. SYDOW (Philipp. Jour. Sci. Bot. 8:265-285. 1913) under "Enumeration of Philippine Fungi" describe 37 new species and raise *Tephrosticta*, hitherto regarded as a subgenus of *Teichosporella*, to generic rank. The same authors (Ann. Mycologici 12:158-165, 195-204, 545-576. 1914) have published a number of new species of fungi and characterize the following new genera: *Nematostoma* of the Sphaeriaceae found on leaves of *Artemisia vulgaris* L. in northern Japan, and *Theissenula*, *Rizalia*, *Meliolina*, *Pycnoderma*, *Angatia*, *Odontoschizon*, *Manilaea*, *Exotrichum*, and *Psalidosperma* from the Philippine Islands.—F. THEISSEN (Ann. Mycologici 12:63-75. pls. 6, 7. 1914) in an article entitled "Über *Polystomella*, *Microcyclus*, u. a." characterizes the following new genera of fungi: *Polyclypeolum*, *Microcyclella*, *Cyclothea*, *Cryptopus*, and *Ellisiodothis*; also (Broteria Ser. Bot. 12:13-33. 1914) a new genus (*Phaeoschiffnerula*) is added to the fungus flora of Brazil. The same author with H. SYDOW (*ibid.* 176-194) under the heading "Dothideazeen-Studien" in addition to critical notes on several species describes 8 additional new genera, namely *Trichodothis*, *Phragmodothis*, *Trabutiella*, *Pyrenobotrys*, *Stalagmites*, *Rehmiodothis*, *Phaeodothiopsis*, and *Parmulina*.—A. THELLUNG (Rep. Sp. Nov. 13:301-303. 1914) characterizes 6 new varieties and forms of *Lepidium bonariense* L. from South America.—C. TORREND (Broteria Ser. Bot. 12:53-71. 1914) lists the third century of his "Fungi selecti exsiccati"; several new species are described and one new genus, namely *Botryochora* of the Dothideaceae from Mozambique, is proposed.—A. E. TRAAEN (Nyt Mag. f. Naturv. 52:19-121. pl. 4. 1914) under the title "Untersuchungen über Bodenpilze aus Norwegen" includes the descriptions of two new genera, namely *Geomyces* and *Humicola*.—E. ULE (Bot. Jahrb. 50:Beibl. no. 114, pp. 1-18. 1914) under the title "Beiträge zur Kenntnis der brasilianischen Manihot-Arten" has published 15 new species.—I. URBAN (Rep. Sp. Nov. 13:444-459. 1914) has described 24 new species of flowering plants from the West Indies.—W. WEINGART (Monats. für Kakteenkunde 24:81-84, 123-127. 1914) has published a new species of *Phyllocactus* (*P. Ruestii*) from Honduras and a new *Cereus* (*C. acanthosphaera*) from Mexico.—H. F. WERNHAM (Bull. Kew pp. 63-69. 1914) enumerates the Rubiaceae collected by T. A. SPRAGUE in Venezuela and Colombia in 1898-99 and includes the descriptions of 11 new species. The same author (Jour. Bot. 52:225-227; 313-316. pl. 533. 1914) has published 17 new species of Rubiaceae from Central and South America. One new genus (*Neosabicea*) is added from



Columbia.—E. DE WILDEMAN (Rep. Sp. Nov. 13:369-384. 1914) has published 35 new species and varieties of flowering plants from Central Africa and characterizes two new genera, namely *Brieya* of the Anonaceae and *Giorgiella* of the Passifloraceae. The same author (Bull. Jard. Bot. Brux. 4:1-241. 1914) in cooperation with specialists has issued "Additions à la flore du Congo." Several species new to science are included and the following new genera are proposed: *Volutellopsis* and *Gilletia* Torrend of the Mucedinaceae.—G. W. WILSON (Mycologia 6:192-210. pls. 135, 136. 1914) in continuation of his studies on the Peronosporales describes several new species and propose as new genus (*Bremiella*) based on *Peronospora megasperma* A. Berlese.—L. WITTMACK (Bot. Jahrb. 50:539-555. 1914. Supplement-Band) has published 6 new species of *Solanum* from South America.—N. WORONICHIN (Bull. für Ang. Bot. 7:431-440. pl. 120. 1914) describes and illustrates a new fungus (*Plectodiscella piri*) found in the Caucasus. The genus is said to represent a new family, namely the Plectodiscelleae.—C. H. WRIGHT (Bull. Kew p. 330. 1914) has published a new species of *Hippeastrum* (*H. Elwesii*) from Argentina. The same author (Curtis' Bot. Mag. pl. 8553. 1914) describes and illustrates a new species of *Zephyranthes* (*Z. cardinalis*) from specimens growing in the Kew Gardens but presumably of American origin.—J. M. GREENMAN.

**Root nodules.**—BOTTOMLEY<sup>5</sup> has investigated the root nodules of *Ceanothus americanus*, to which attention was called by BEAL in 1890. He finds that the nodules are modified lateral roots which increase in size each year by the formation of endogenous outgrowths similar in structure to the primary branch. Each nodule when fully grown shows an apical meristematic zone, an infection zone, a bacterial zone, and a basal zone almost free from bacteria. The bacteria when isolated and grown in pure cultures can fix free nitrogen, and evidently belong to the *Bacillus radicumicola* group.

Miss SPRATT<sup>6</sup> has studied the well known root nodules or "coralline roots" of the cycads, and finds that all the genera produce them. They are developed primarily by infection with *Bacillus radicumicola*, and at the base of each nodule a whorl of lenticels or a continuous zone of parenchyma is produced. The outer cell walls become pushed apart, and are infected by *Azotobacter*, and under certain conditions by *Anabaena* also. The alga is said to stimulate the phellogen to produce other lenticels, from which a zone of tissue is produced that includes the original outer cells in which the alga and bacteria occur. The algal zone is continuous, and consists of a large air space containing *Anabaena* and *Azotobacter*, which is kept intact by papillate cells traversing it from both inner

<sup>5</sup> BOTTOMLEY, W. B., The root nodules of *Ceanothus americanus*. Ann. Botany 29:605-610. pl. 28. 1915.

<sup>6</sup> SPRATT, ETHEL ROSE, The root nodules of the Cycadaceae. Ann. Botany 29: 619-626. pl. 29. 1915.



and outer tissues. No algal zone has been observed in *Macrozamia*, *Zamia*, *Ceratozamia*, and *Bowenia*, but nodules are produced containing *Bacillus radicolica* and *Azotobacter*. The author states that the cycads are the only nodule-bearing plants known in which four organisms are in symbiotic relationship, namely, two nitrogen-fixing bacteria, an alga, and a cycad.—J. M. C.

**Sexual reactions of mucors.**—BLAKESLEE<sup>7</sup> has been hybridizing mucors and has secured some interesting results. His (+) and (−) strains have become familiar, and he has shown that the majority of mucors are dioecious. In the experiments presented in this paper he has crossed hermaphroditic species with the sexual races of dioecious forms. It seems that some of these hermaphrodites are heterogamic, showing a constant difference in the size of their gametes, the larger one being presumably female and the smaller one male. A sexual reaction was obtained between the (+) strain of a dioecious mucor and the smaller gamete of the hermaphrodite; and conversely, a similar reaction between the (−) strain of the dioecious form and the larger gamete of the hermaphrodite. The conclusion is obvious that the (+) strain of dioecious mucors is female and the (−) strain male.—J. M. C.

**Development of Pyronema.**—BROWN<sup>8</sup> has investigated a form of *Pyronema confluens*, which he calls var. *inigneum*, in which the trichogyne does not fuse with the antheridium. He finds also that the cultural conditions for the growth of the variety appear to differ from those for the normal form in that sterilization of the substratum is unnecessary. No fusion of nuclei was observed in the ascogonium or ascogenous hyphae, the only one occurring in the asci. The fact that a species and its variety differ from one another in the distinct occurrence of the sex act and its entire absence is a striking illustration of the relation between the dependent habit and the sexual apparatus.—J. M. C.

**Myxomycetes of Wisconsin.**—DEAN<sup>9</sup> has published a descriptive list of the Myxomycetes of Wisconsin, 74 species having been identified, representing 28 genera. The relatively large genera are *Physarum* (10), *Diderma* (6), *Comatricha* (5), *Arcyria* (5), and *Trichia* (5). The descriptions are full and accompanied by critical notes.—J. M. C.

<sup>7</sup> BLAKESLEE, A. F., Sexual reactions between hermaphroditic and dioecious mucors. Biol. Bull. 29:87-89. pls. 3. 1915.

<sup>8</sup> BROWN, WILLIAM H., The development of *Pyronema confluens* var. *inigneum*. Amer. Jour. Bot. 2:289-297. 1915.

<sup>9</sup> DEAN, ALLETTA F., The Myxomycetes of Wisconsin. Trans. Wisc. Acad. Sci. 17:1221-1299. 1914.



THE  
BOTANICAL GAZETTE

*APRIL 1916*

BIOCHEMICAL AND PHYSIOLOGICAL STUDY OF THE  
REST PERIOD IN THE TUBERS OF SOLANUM  
TUBEROSUM<sup>1</sup>

CHARLES O. APPLEMAN

(WITH TWO FIGURES)

**Introduction**

The cause and control of the rest period in plants have long been the subject of study, not only on account of their scientific interest, but also on account of the practical values which would accrue in many cases if the rest period were subject to control. Although many seeds have a rest period, this paper is concerned mainly with the rest periods in stems.

In spite of the immense amount of work that has been done on this problem, there still exist today two schools of thought, which stand directly opposed to each other on the first and most fundamental question involved, one school claiming that the rest period is a direct response to changing external conditions, while the other considers it to be the result of fixed, hereditary, internal causes. A middle ground is taken by others who attribute the rest period to a "cooperation of an hereditary tendency to rhythm, with the after effect of periodic repetition of reactions induced by external conditions." This diversity of opinion may be attributed largely to the variety of material used for the study of the problem and to the lack of exact and reliable experimental data.

<sup>1</sup> Contribution from the Laboratory of Plant Physiology, Maryland Agricultural Experiment Station. Published by permission of the Director.



### Historical

As examples of the extreme views in the older literature, we may mention those of *GRISEBACH* and *ASKENASY*. The former considered the yearly periodicity of plants of the temperate regions entirely a hereditary property, induced probably by physiological selection due to alternating external conditions through a long series of years; whereas the latter asserted that it is due directly to external conditions. *SACHS* believed that the rest period is caused by a deficiency of soluble food, and the cessation of the rest is due to a gradual production of enzymes. He does not state whether internal or external causes are responsible for the deficiency of food, nor does he suggest the nature of the process which increases the enzymes. *FISHER* (8) studied the carbohydrate transformations in woody stems during the rest period, and concluded that periodicity of growth is conditioned by a periodicity of the processes of food changes, which in turn rest upon a hereditary periodicity of certain properties of the protoplasm.

Coming now to the more modern literature, the studies of *MÜLLER-THURGAU* and *SCHNEIDER-ORELLI* (19-22) are of importance in the solution of this problem. They think the winter rest of plants is not conditioned by low temperature only, but the cessation of growth rests also upon the internal properties of the protoplasm of the meristem. These internal properties are inherited effects of winter cold on the growth process which after a long time become fixed in the protoplasm.

*HOWARD* (10) experimented with a large number of trees and shrubs, all deciduous species native to the temperate zone. He first tested their ability to grow in winter under favorable greenhouse conditions and then subjected to artificial treatments those which failed. Discussing the results of the foregoing experiments, the author states: "This shows conclusively that the majority of species, indigenous to the temperate climates, do not have firmly fixed winter rest periods from which they cannot be awakened." Although his observations were made on plants in winter rest, he includes also summer rest periods in his general conclusions. He thinks both forms of rest are caused by unfavorable external conditions. If these conditions, such as cold or drought, occur at regu-



lar intervals, a plant readily adapts itself to the new demands and the rest becomes a habit, which may continue to be repeated automatically for a longer or shorter period of time. The habit of rest thus induced is often very strongly fixed and is apparently transmissible.

EULER (7) attributes the rest period to internal self-regulatory processes and theorized in the following ingenious manner regarding the nature of these processes. The growth of a young cell shows two phases which follow each other by self-regulation. The first or stretching phase shows an increase of soluble osmotically active cell constituents; the second is characterized by the building up of the soluble materials into insoluble or colloidal molecules. Hydrolysis and synthesis, however, proceed simultaneously, and the two phases are characterized by an excess of the one process over the other. The synthesis of the second phase fixes the stretching of the first phase. What applies to the single cell applies also to the development of the entire organ and organism. In a number of cases, new cycles of stretching and condensation follow one another with unbroken regularity. In many other cases, a new cycle does not immediately follow upon the ending of a previous one. The stretching phase is prevented on account of an inability to dissolve the highly complex reserve materials. A short or long rest period must first take place. Finally a point is reached, and this point determines the length of the rest period, when the synthetic processes no longer hold the simultaneously occurring hydrolytic processes in equilibrium, and as a result internal osmotic pressures are increased. The resting organ is now physiologically ripe and begins to germinate, external conditions being favorable. As long as condensation processes predominate in the resting organ, germination is impossible. According to EULER, therefore, after-ripening would simply consist in certain changes during the rest period which weaken the synthetic processes. This theory, however, does not explain the origin and character of these changes.

The important observations of SCHIMPER (25) gave us the first real knowledge of the peculiar behavior of tropical vegetation in respect to growth and rest periods. In places where moisture and temperature conditions are favorable during the entire year, many



plants show a rhythmic alternation of periods of rest and activity of the growth processes. SCHIMPER states: "Internal causes are mainly or solely responsible for the alternation of rest and activity in a nearly uniform climate. Such a rhythmic change, however, is never abandoned, for it arises from the nature of the living organism and not from external conditions; its connection with external conditions is a secondary feature, an adaptation."

From the time of SCHIMPER'S observations, tropical vegetation has been favorite material for study in determining the relation of external conditions to rest periods. KLEBS (16) has made observations on the tropical vegetation of Java, where climatic conditions show little variation. Exact measurements of twigs were made to determine the amount of growth over a series of months. He also cultivated a number of European and Japanese plants in Java. Native plants of Java were likewise transplanted to Heidelberg and grown in a greenhouse under constant temperature and moisture conditions. These studies, which constitute his most recent research on this problem, led him to deny firmly a periodicity of growth which is independent of external factors, and to formulate the following hypothesis to account for this rest period in tropical trees: When the growth ability is weakened by a deficiency of one or more of the essential external growth factors, carbon assimilation proceeds at first at the normal rate, resulting in a storage of organic materials. These in turn render certain enzymes inactive and thus cause a rest period. All means available for shortening the rest period simply activate these enzymes. Great stress is laid upon salts as the causal agent in the rest periods of tropical plants, since the other three factors are constantly favorable for growth in Java.

VOLKENS (28, 29) made more extended observations on the tropical vegetation in its natural habitat. Trees were marked and observed for an entire year. Many new and interesting facts were added to our stock of knowledge regarding rest and activity in tropical plants. Although his observations were made in the same place as those of KLEBS and often on the same object, he reached a very different conclusion. He is unable to see any relation between the rest periods in tropical plants and external conditions;



they must be due to internal causes. He does not intimate, however, the nature of these causes.

It is true that VOLKENS does not include the factor of salts among the external conditions that may affect the growth processes; and besides, he and KLEBS do not seem to have quite the same conception of internal causes, so that their views may not be as antagonistic as first seems. According to VOLKENS, everything is conditioned by internal causes which cannot be brought into evident connection with external factors. The important thing to KLEBS is whether the rest is caused by the outer world or is an expression of an internal fixed "specific structure." VOLKENS does not discriminate between specific structure and internal conditions. It is conceivable that a slight external change may set into motion a chain of effects which would ultimately so change the internal conditions of the growing cell or its immediate environment that growth would be arrested and seem to be due to internal specific structure.

Attempts to shorten the rest period of buds and bulbs by artificial means are numerous and some have been successful. MÜLLER-THURGAU (20) claims to have shortened the rest period of potato tubers by one month's storage at 0° C. The use of ether and chloroform dates from the important work of JOHANNSEN (14), who succeeded by their means in forcing buds to open 3–6 weeks earlier than normally. He found, however, that these agents are effective only at the beginning and near the end of the rest periods. The warm bath has been used successfully in shortening the rest period. MOLISCH (18) caused an earlier opening of buds by immersing the shoots in water at 35° C. MÜLLER-THORGAU and SCHNEIDER-ORELLI (22) hastened the growth of lily-of-the-valley bulbs and potato tubers by warming them at a temperature of 38° C. and maintaining a germination temperature of 26° C. Warm air was equally as effective as warm water. In an endeavor to test KLEBS's conception regarding the importance of salts in bud growth, LAKON (17) stood cut twigs of trees and shrubs in Knop's solution and found that of a large number only one failed to show an earlier unfolding of the buds than normally. This does not prove, however, that the buds failed to germinate on account of the lack of salts any more than the lack of ether prevented germination in



JOHANNSEN'S experiments. JESENKO (12) found that hydrochloric, sulphuric, and tartaric acids, as well as alcohol and water saturated with carbon dioxide, hastened the germination of buds of a number of woody plants. He concluded that the applied solutions not only acted as a stimulus in the strict sense of the word, but also started certain chemical processes in the buds which produced favorable conditions for growth. JOST (13) observed that wounded potatoes, especially if they were cut into many pieces, showed an earlier germination of the buds than unwounded ones.

WISMEWSKI (31) experimented with the winter buds of certain aquatic plants. The rest period of the buds of *Hydrocharis Morsus-ranae* could be shortened by wounding and lengthened by darkness. *Hydrocharis* formed buds the entire winter when kept in darkness and immersed in rainwater or a nutritive solution. He concludes that neither the origin nor germination of these buds is conditioned by an inner rhythm of the plants. He also states that low temperature is not a necessary condition for the origin of buds.

Although the rest period may be shortened by artificial treatments, none has thus far been capable of entirely eliminating the rest period where it is well fixed. A great deal of work has been done on forcing resting stem structures into growth by artificial means, but comparatively little has been done to determine the character of the physiological and chemical changes effected by such treatments. Still less is known about these changes during the natural rest period.

MÜLLER-THURGAU and SCHNEIDER-ORELLI (21, 22) found increased respiration in potato tubers and lily-of-the-valley bulbs after the warm-bath treatment and also after etherizing.

IRAKLIONOW (27) also found a rise in respiration of potato tubers after treatment with warm water. At the end of a few days, however, it fell back to the normal rate and did not rise again until the beginning of germination. He assumes, in agreement with MOLISCH, that the breaking of the rest period by means of the warm bath is a simultaneous action of the high temperature and the water, and that the warm bath influences the enzymes, chiefly the oxidases.



BUTKEWITSCH (4) showed that the stored starch in the cortex and wood can be dissolved by the action of toluol and chloroform, and also by high temperature. He thinks the action is similar to cold and consists in a weakening of the plastids.

GRÜSS (9) investigated the chemical changes set up in the cells around the wound in potatoes, and found an increase in the oxidizing enzymes and in the diastase activity. There was some sugar accumulation in the subphellogen. MÜLLER-THURGAU (19) was probably the first to observe the accumulation of sugar in potatoes stored at low temperatures.

FISHER (8) studied the changes in the starch content of trees during the rest period. He found the maximum of starch from leaf fall to the beginning of November. Starch solution began in November and reduced the starch content to the minimum in the winter. Starch synthesis began in March and reached the maximum again in April, after which hydrolysis began and brought the starch content to the minimum during the latter part of May, or the time of the beginning of vegetative activity. Storage of starch occurred of course during the summer.

### Biochemical

It is obvious from the foregoing survey of the literature that there is little exact experimental data on the chemical and physical situation in stems which forces the growing cells into a period of rest. The same is true of the changes in the resting tissue or its immediate environment which are essential to the release of the growth processes at the end of the rest period. These latter changes will be spoken of as after-ripening, using the term in its broadest sense.

It is a well known fact that under normal conditions potato tubers will not sprout for several weeks after harvest. Rehobeth potatoes harvested on July 17 and planted immediately in the same field did not sprout until October, although good growing conditions prevailed during the entire period. McCormick potatoes harvested on November 11, and kept constantly under favorable growing conditions in the greenhouse, did not sprout until January 24; general sprouting did not occur until February. It has been gen-



erally conjectured that the after-ripening processes in tubers are metabolic in character; in other words, it has been supposed that chemical changes occur in the tubers during the rest period which render certain essential foods or other materials available for the growing bud. The first problem in the following study was to ascertain if there are metabolic processes occurring in the potato tuber during the rest period which are characteristic of after-ripening, and to determine their character as far as possible.

The tubers used in this investigation produce sprouts much earlier from the buds on the seed or terminal end when the tubers are left whole. In the majority of cases, the buds on the stem or basal end do not germinate at all unless those on the seed end are injured; therefore, tubers were cut in half at regular intervals during the rest period, and the following analyses made separately on the seed and stem halves with a view to detecting better the chemical changes characteristic of after-ripening. We are not justified in assuming that all chemical changes occurring in the whole tuber during the rest period must be peculiar to after-ripening.

**CARBOHYDRATES.**—In a previous chapter it was stated that storage at low temperature has been claimed to be capable of shortening the rest period of potato tubers. It has been proved that during such storage sugar accumulates in the tubers. These facts have led to the supposition that the rest period is caused by a deficiency of soluble carbohydrates, and that the cessation of the rest is due to a gradual production of the diastase. In order to determine if carbohydrate transformations are essential after-ripening processes, or simply due to changing temperature, analyses were made during after-ripening of tubers at a fairly constant and favorable growing temperature. At the same time analyses were made on tubers stored under variable low temperature in a potato vault. Samples of 8 tubers, each with a total weight of about one kilogram, were selected from both lots at intervals of 2 and 4 weeks. Each tuber was cut into two equal parts, the one part representing the terminal or seed end, the other, the basal or stem end. The seed ends of each sample were all grated together; likewise the stem ends. After being thoroughly mixed in a mortar,



both lots of pulp were sampled for determinations of moisture, starch, total sugar, reducing sugar, and diastase.<sup>2</sup>

The final carbohydrate results are calculated to original moisture basis. It is thus possible to record results in percentage of wet weight, as the possibility of apparent changes due to loss of water by evaporation is excluded. Apparent changes due to this water loss would also be excluded by calculating results to dry basis at the time of analysis, but these results might still show changes due to water taken up by hydrolysis, or to the accumulation of respiratory water, especially where evaporation is prevented. This method, however, does not take into account loss in dry matter through respiration. In the case of the vault-stored potatoes this would be negligible, since respiration is very low at the vault temperature.

Failure of growth in the buds during the rest period is not due to a lack of available sugar, since the percentage of both reducing and total sugars in the greenhouse-stored tubers was no greater when sprouting began than at the beginning of the rest period (tables I–IV); besides, the seed end at the time of sprouting did not contain a greater percentage of sugar than the stem end. *The carbohydrate transformations during the rest period are entirely dependent upon changing temperature, and must, therefore, not be considered after-ripening processes.*

DIASTASE.—Since the supply of soluble carbohydrates for the growing buds is dependent upon the important enzyme diastase, a gravimetric method was employed to determine the diastatic power of the juice from the two ends at intervals during after-ripening under greenhouse conditions. The determinations were made on the same samples used for the carbohydrate analyses.

The increase in total sugar after incubation was considered an index of the diastatic activity of the potato extract at the time of analysis. It may indicate simply the excess of the hydrolytic process over a simultaneously occurring synthetic process. On either basis, the potato extract contained active diastase at all times during the rest period. It was uniformly greater in the

<sup>2</sup> For detailed descriptions of methods, as well as additional tables and figures, see Bull. no. 183. Maryland Agric. Exper. Sta.



extract from the seed end, but there was no appreciable increase in the extract from either end during the rest period. It may be concluded, therefore, that the *cessation of the rest period is not due to a gradual increase of diastase activity.*

TABLE I

REDUCING SUGAR; McCORMICK POTATOES PLANTED IN WET SAWDUST IN GREENHOUSE;  
TUBERS SPROUTING ON MARCH 26

DATE OF ANALYSIS	RANGE OF TEMPERATURE BETWEEN ANALYSES	REDUCING SUGAR CALCULATED ON BASIS OF ORIGINAL MOISTURE		
		Seed end per cent	Stem end per cent	Whole tuber per cent
November 14.....	.....	0.287	0.320	0.304
December 14.....	20° C. to 22° C.	0.372	0.342	0.357
January 20.....	22° C. to 17° C.	0.478	0.481	0.479
February 3.....	20° C. to 22° C.	0.274	0.311	0.293
March 26.....	21° C. to 23° C.	0.385	0.401	0.393

TABLE II

REDUCING SUGAR; GREEN MOUNTAIN POTATOES STORED IN VAULT

DATE OF ANALYSIS	RANGE OF TEMPERATURE BETWEEN ANALYSES	REDUCING SUGAR CALCULATED ON BASIS OF ORIGINAL MOISTURE		
		Seed end per cent	Stem end per cent	Whole tuber per cent
November 28.....	..... to 5° C.	0.655	0.745	0.70
December 20.....	5° C. to 2° C.	0.972	1.40	1.19
January 13.....	2° C. to -1.5° C.	1.35	1.85	1.60
February 13.....	-1.5° C. to -1° C.	2.20	2.62	2.40

TABLE III

TOTAL SUGAR; McCORMICK POTATOES PLANTED IN WET SAWDUST IN GREENHOUSE;  
TUBERS SPROUTING ON MARCH 26

DATE OF ANALYSIS	RANGE OF TEMPERATURE BETWEEN ANALYSES	TOTAL SUGAR CALCULATED ON BASIS OF ORIGINAL MOISTURE		
		Seed end per cent	Stem end per cent	Whole tuber per cent
November 14.....	.....	0.663	0.667	0.665
December 14.....	20° C. to 22° C.	0.572	0.503	0.538
January 20.....	22° C. to 17° C.	0.663	0.626	0.645
February 3.....	20° C. to 23° C.	0.430	0.413	0.408
March 26.....	21° C. to 23° C.	0.537	0.553	0.545



TABLE IV

TOTAL SUGAR; GREEN MOUNTAIN POTATOES STORED IN VAULT

DATE OF ANALYSIS	RANGE OF TEMPERATURE BETWEEN ANALYSES	TOTAL SUGAR CALCULATED ON BASIS OF ORIGINAL MOISTURE		
		Seed end per cent	Stem end per cent	Whole tuber per cent
November 28.....	..... to 5° C.	1.02	1.19	1.10
December 20.....	5° C. to 2° C.	1.48	1.76	1.62
January 13.....	2° C. to -1.5° C.	1.94	2.26	2.10
February 13.....	-1.5° C. to -1° C.	3.84	4.04	3.94

OXIDASE.—The juice from new potatoes shows less ability to accelerate the oxidation of pyrogallol than the juice from tubers at the end of the rest period. The juice from the seed half causes no greater acceleration of this oxidation than that from the stem half, even after sprouting (tables VI–VIII).

TABLE V

ACTION OF GLYCERINE EXTRACT OF POTATO PULP ON SOLUBLE STARCH SOLUTION; McCORMICK POTATOES STORED IN WET SAWDUST IN THE GREENHOUSE

DATE OF ANALYSIS	RANGE OF TEMPERATURE BETWEEN ANALYSES	INCREASE IN MILLIGRAMS OF SUGAR IN 24 HOURS AT 40° PER 100 GM. OF POTATO PULP					
		Reducing sugars			Total sugar		
		Seed end	Stem end	Whole tuber	Seed end	Stem end	Whole tuber
November 14 .....	.....	65.0	58.0	61.5	65.6	60.0	62.8
December 14.....	20° C. to 22° C.	63.2	56.0	59.5	86.3	72.0	79.0
January 20.....	22° C. to 17° C.	91.0	67.2	79.1	72.1	60.5	66.3
February 3.....	20° C. to 22° C.	84.0	66.4	76.8	78.4	63.9	71.1

NITROGEN.—A general survey of the different combinations of nitrogen in the tuber was made at intervals during the rest period in order to determine if protein hydrolysis or other transformations of the nitrogen-containing substances occur during the rest period as necessary antecedents to sprouting. The following determinations were made: total nitrogen, water-soluble nitrogen, nitrogen coagulated by heat, nitrogen precipitated by tannic and by phosphotungstic acids. It was assumed that the nitrogen coagulated by heat represented the protein nitrogen, and the difference between



TABLE VI

OXIDATION OF PYROGALLOL BY JUICE FROM IMMATURE TUBERS JUST HARVESTED AND BY JUICE FROM TUBERS OF THE SAME VARIETY AT THE END OF THE REST PERIOD, BUT NOT SPROUTING

ELAPSED TIME	TEMPERATURE AT THE TIME OF READING	MANOMETER READINGS EXPRESSED IN CENTIMETERS OF MERCURY	
		New tuber	Old tuber
Hours			
3.....	33°8 C.	-0.65	-0.7
22.....	33.8	-1.55	-1.9
25.....	34.0	-1.70	-2.2

TABLE VII

OXIDATION OF PYROGALLOL BY JUICE FROM NEW TUBERS AND FROM TUBERS OF THE SAME VARIETY AT THE END OF THE REST PERIOD, BUT NOT SPROUTING

ELAPSED TIME	TEMPERATURE AT THE TIME OF READING	MANOMETER READINGS EXPRESSED IN CENTIMETERS OF MERCURY		
		New tuber	Old tuber	Old tuber calculated to moisture of new tuber
Hours				
5.....	34°6 C.	-0.4	-0.6	-0.55
26.....	34.6	-0.8	-1.15	-1.05
46.....	34.6	-0.85	-1.35	-1.24
71.....	34.6	-1.50	-2.00	-1.83
125.....	34.6	-3.05	-3.4	-3.02

TABLE VIII

OXIDATION OF PYROGALLOL BY JUICE FROM THE SEED AND STEM HALVES, JANUARY 10

ELAPSED TIME	TEMPERATURE AT THE TIME OF READING	MANOMETER READINGS EXPRESSED IN CENTIMETERS OF MERCURY	
		Seed half	Stem half
Hours			
4.....	34°6 C.	-0.75	-0.75
6.....	34.7	-1.45	-1.45
48.....	34.5	-2.85	-2.90



this and the nitrogen precipitated by tannic acid, the proteose, and the peptone nitrogen. The nitrogen not precipitated by phosphotungstic acid was considered the nitrogen of monoamino acids and their amide derivatives, while the difference between this and the nitrogen not precipitated by the tannic acid was considered the nitrogen of diamino acids and other bases. It is not claimed that the foregoing precipitation method gives absolutely the true proportion of nitrogen in the various forms of binding, but it yielded valuable comparative results under the conditions employed in the determinations.

The nitrogen determinations were made on Green Mountain potatoes harvested on November 4 and planted at once in wet sawdust on the floor of the greenhouse. The temperature variation in the sawdust was slight and the tubers were constantly under favorable growing conditions. Sprouts began to appear on this lot of potatoes on January 19. The set of analyses made on January 18, therefore, shows the nitrogen situation just at the end of the rest period. The tubers used for the last set of analyses bore sprouts from one-eighth to one inch in length. As soon as sprouting began, the tubers were placed in a moist chamber, which was buried in the sawdust; therefore nothing was absorbed by the roots except possibly a little water. Each sample contained 6 tubers with a total weight of about 800 gm. The variation in total weights was not more than 5 gm. The samples were all weighed the day after the potatoes were harvested, and kept separate during the storage in the wet sawdust. This makes possible the calculation of results to percentage of original weight, and thus apparent changes due to loss in dry substance through respiration and also through changes in water content are avoided.

On the above basis of calculation the different forms of nitrogen in the whole tuber showed no general change until the tubers began to sprout. During the rest period the stem half always showed a higher percentage of nitrogen, calculated to percentage of total nitrogen, in the following forms: monoamino acids and amides, diamino acids and other bases, proteoses, and peptone. The seed half contained a slightly higher percentage of both water-soluble and water-insoluble protein nitrogen (tables IX–XI). *The slight*



variation in the relative magnitudes of the above forms of nitrogen during the rest period was no greater than would be expected in different biological samples; in most cases it was well within the experimental error.

TABLE IX

NITROGEN OF THE WHOLE TUBER CALCULATED TO PERCENTAGE OF TOTAL WEIGHT OF EACH SAMPLE ON NOVEMBER 8; TUBERS SPROUTING ON FEBRUARY 12

Date of sampling	Total nitrogen	Water-soluble nitrogen	Nitrogen not coagulated by heat	Nitrogen not precipitated by tannic acid	Nitrogen not precipitated by phosphotungstic acid
November 10...	0.430	0.365	0.232	0.217	0.205
November 29...	0.432	0.371	0.234	0.222	0.210
December 13...	0.429	0.369	0.225	0.211	0.198
December 27...	0.428	0.367	0.234	0.222	0.213
January 18.....	0.424	0.345	0.229	0.217	0.205
February 12....	0.428	0.381	0.239	0.228	0.223

TABLE X

DISTRIBUTION OF NITROGEN IN PERCENTAGE OF TOTAL NITROGEN; TUBERS SPROUTING ON FEBRUARY 12

DATE OF ANALYSIS	WATER-SOLUBLE PROTEIN NITROGEN			WATER-INSOLUBLE PROTEIN NITROGEN			NON-PROTEIN NITROGEN		
	Seed end	Stem end	Whole tuber	Seed end	Stem end	Whole tuber	Seed end	Stem end	Whole tuber
November 10.....	31.95	29.98	30.96	15.04	14.98	15.01	53.01	55.04	54.02
November 29.....	32.41	30.77	31.59	14.49	13.75	14.12	53.10	55.48	54.29
December 13.....	32.78	31.68	32.23	15.01	13.71	14.36	50.12	54.61	52.36
December 29.....	30.74	31.18	30.96	15.58	12.87	14.22	53.68	55.95	54.31
January 18.....	32.83	28.40	30.61	14.02	13.82	13.92	53.15	57.78	55.46
February 12.....	32.82	30.62	32.81	11.96	10.68	11.30	55.24	58.70	56.97

TABLE XI

DISTRIBUTION OF NITROGEN IN PERCENTAGE OF TOTAL NITROGEN; TUBERS SPROUTING ON FEBRUARY 12

DATE OF ANALYSIS	PROTEOSE AND NEPTONE NITROGEN			NITROGEN OF DIAMINO ACIDS AND OTHER BASES			NITROGEN OF MONOAMINO ACIDS AND AMIDES		
	Seed end	Stem end	Whole tuber	Seed end	Stem end	Whole tuber	Seed end	Stem end	Whole tuber
November 10.....	2.54	3.51	3.02	2.33	3.28	2.80	48.14	48.25	48.19
November 29.....	2.49	3.50	3.00	2.32	2.79	2.56	48.29	49.19	48.72
December 13.....	2.99	3.31	3.15	2.11	3.40	2.75	47.11	47.90	47.51
December 29.....	.....	.....	.....	2.08	3.10	2.59	48.42	50.71	49.56
January 18.....	2.10	3.46	2.78	2.04	3.95	2.99	49.01	50.37	49.69
February 12.....	3.71	3.69	3.70	1.11	1.80	1.45	50.43	53.21	51.75



PHOSPHORUS.—Phosphorus is an essential element of two of the most important constituents of the cell, the nucleoproteins and the lipoids. Protein, lipid, and extractive phosphorus were determined at intervals during the rest period with a view to ascertaining if certain gradual transformations of the phosphorus combinations occur during the rest period in order to render phosphorus available in the proper form for the growing buds.

TABLE XII

EXTRACTIVE; PROTEIN AND LIPOID PHOSPHORUS CALCULATED TO PERCENTAGE OF TOTAL PHOSPHORUS; McCORMICK POTATOES PLANTED IN WET SAWDUST IN THE GREENHOUSE; TUBERS SPROUTING ON MARCH 26

DATE OF SAMPLING	EXTRACTIVE P			PROTEIN P			LIPOID P		
	Seed end	Stem end	Whole tuber	Seed end	Stem end	Whole tuber	Seed end	Stem end	Whole tuber
November 14.....	49.1	47.57	48.33	44.34	45.90	45.12	6.65	6.54	6.58
December 14.....	50.50	46.76	48.63	43.50	47.13	45.31	6.003	6.099	6.006
January 20.....	50.20	44.90	47.55	42.88	48.36	45.62	6.915	6.763	6.840
February 3.....	50.81	44.60	47.70	41.14	48.11	44.62	8.056	7.29	7.673
March 26.....	52.83	50.08	51.45	37.99	41.99	39.99	9.198	7.93	8.514

TABLE XIII

INORGANIC PHOSPHORUS IN PERCENTAGE OF TOTAL PHOSPHORUS; GREEN MOUNTAIN POTATOES STORED IN WET SAWDUST IN THE GREENHOUSE; TUBERS SPROUTING ON FEBRUARY 12

DATE OF ANALYSIS	INORGANIC PHOSPHORUS		
	Seed end	Stem end	Whole tuber
November 29.....	34.23	33.90	34.06
December 13.....	35.75	34.59	35.17
December 27.....	33.22	33.08	33.15
January 18.....	32.71	34.11	33.41
February 12.....	32.00	34.30	33.15

Calculated to percentage of total phosphorus, it was found that the percentage of extractive phosphorus was consistently higher in the seed end than in the stem end; the percentage of protein phosphorus, on the other hand, was always less in the seed end. *The percentages of all the phosphorus combinations were practically constant throughout the rest period (tables XII and XIII).*



### Physiological

Immature potatoes have a thin, slightly suberized skin, which is quite permeable to both water and gases. As the tubers mature, the skin becomes more suberized and more adherent to the underlying tissue. The rapidity and degree of suberization, however, is greatly influenced by moisture; dry conditions favor the process, while moisture retards it. As the skin becomes suberized, its permeability to water and gases is greatly reduced. It occurred to the writer that the skin may very soon become a sufficient barrier between the internal tissues and the external agents to check growth in the buds. This might be due to an external agent becoming a limiting factor in the completion of the growth mechanism in the new tuber, or in the growth itself. The following experiments were planned to test this hypothesis:

The fall crop of McCormick potatoes furnished material for the experiments here recorded, except where otherwise noted. All the experiments, however, were repeatedly confirmed with the summer crop of both Green Mountain and Rehobeth potatoes. The regular mature crop of the McCormick potatoes was harvested on November 4. Tubers were at once planted in the greenhouse in soil, sawdust and sphagnum, but in no case did sprouting occur until January 18; general sprouting did not begin until February. These results were confirmed by similar plantings of McCormick potatoes in 3 successive years. The rest period of McCormick potatoes under natural planting conditions, therefore, is about 90 days from the time the mature crop is harvested at this station. If they are harvested earlier, the rest period is much longer. Immature tubers harvested on September 20, and immediately planted in the greenhouse, did not sprout until February 2.

**EFFECT OF REMOVING THE SKIN.**—Simply removing the skin from potato tubers at any stage of the rest period will bring about sprouting within 10 days, if favorable external conditions prevail. A number of methods were employed in order to supply the most favorable conditions for sprouting; but the best among those tried consisted in planting the stem ends in wet soil or sawdust and covering the seed ends with 2 or 3 inches of excelsior, kept constantly wet. This method exposes the terminal buds to the maximum partial oxygen



pressure of the atmosphere. The mere greening of the tubers in the subdued light affords considerable protection against decay. Under the foregoing condition the degree of previous corking of the skin greatly influenced the time before the tubers with the skin intact began to sprout.

Tables XIV–XVI record typical experiments which show the facts given above. The temperature of each pot was recorded

TABLE XIV

EFFECT OF REMOVING THE SKIN; IMMATURE TUBERS HARVESTED ON SEPTEMBER 20 AND PLANTED THE SAME DAY; 12 TUBERS IN EACH LOT

STEM ENDS PLANTED IN	SEED ENDS COVERED WITH	SKINS	PERCENTAGE SPROUTED AFTER						AVERAGE LENGTH OF SPROUTS AFTER 35 DAYS
			10 days	20 days	35 days	85 days	110 days	135 days	
Soil . . . . .	Soil	On	0	0	0	0	23	70	0
Soil . . . . .	Excelsior	On	54	62	77	77	.....	85	4 mm.
Soil . . . . .	Excelsior	Off	38	100	100	100	100	100	20 mm.
Sawdust . . . . .	Sawdust	On	0	0	0	0	0	42	0
Sawdust . . . . .	Sawdust	Off	75	75	100	100	100	100	5 mm.
Sawdust . . . . .	Sawdust	Off	57	85	100	100	100	100	10 mm.

TABLE XV

EFFECT OF REMOVING THE SKIN; MATURE TUBERS HARVESTED ON OCTOBER 28 AND PLANTED ON OCTOBER 31; MEDIUM CORKED SKINS; 12 TUBERS IN EACH LOT

STEM ENDS PLANTED IN	SEED ENDS COVERED WITH	SKINS	PERCENTAGE SPROUTED AFTER			
			10 days	20 days	35 days	95 days
Soil . . . . .	Soil	On	0	0	0	16
Soil . . . . .	Excelsior	On	0	0	20	100
Soil . . . . .	Soil	Removed	0	0	25	82
Soil . . . . .	Excelsior	Removed	25	83	100	100

TABLE XVI

EFFECT OF REMOVING THE SKIN; MATURE TUBERS HARVESTED ON NOVEMBER 4 AND PLANTED ON NOVEMBER 22; HEAVILY CORKED SKINS

STEM ENDS PLANTED IN	SEED ENDS COVERED WITH	SKINS	PERCENTAGE SPROUTED AFTER			
			10 days	20 days	45 days	72 days
Sawdust . . . . .	Excelsior	On	0	0	0	43
Sawdust . . . . .	Excelsior	Removed	50	100	100	100



twice daily. The bulb of the thermometer was placed on a level with the terminal bud of the tubers. The variation among the different pots was always less than a degree. The average temperature one inch below the surface of the soil in pot 1, table XIV, was 18°.5 C. for the 135 days.

The elimination of the rest period by removing the skin is not due to water absorption from the exterior, as tubers with the skins removed will sprout even in dry storage much earlier than those with skins intact; see table XVII.

TABLE XVII

EFFECT OF REMOVING THE SKINS AND STORING IN A DRY PLACE; MATURE TUBERS HARVESTED ON NOVEMBER 4; SKINS REMOVED ON NOVEMBER 7 AND PLACED IN MOIST CHAMBER 4 DAYS, THEN IN PAPER SACKS; STORED IN LABORATORY CUPBOARD

SKINS	PERCENTAGE SPROUTED AFTER		
	45 days	64 days	85 days
On.....	0	30	100
Removed.....	80	100	100

EFFECT OF CUTTING THE TUBERS IN HALF.—All the experiments so far reported were conducted with whole tubers, in which case sprouting always began first from the eyes on the seed end. The reverse is true, however, when the tubers are cut in half transversely to the long axis, separating the seed from the stem end. This applies only to tubers forced to sprout during the natural rest period. At the end of the rest period there seems to be little difference, in respect to time of sprouting, between the eyes on the seed and stem ends if the tubers are cut in half.

On October 31 the skin was removed from tubers harvested on October 28. They were then cut in half. The halves were stood upright on wet soil and covered with wet excelsior. On November 15 all the stem halves bore sprouts from eyes located near the cut surface.

Two lots of 4 tubers each were selected from McCormick potatoes harvested on November 4. On November 8 the tubers were cut in 4 pieces in the manner shown in fig. 1. In addition the skins





FIG. 1.—Effect of cutting tubers in half; skins removed; stem ends at bottom, bud ends at top; tubers harvested November 4; experiment started November 8, photographed December 5.



were removed from the pieces in one lot; both lots were then placed on wet soil in pots and covered with excelsior, which was kept constantly wet. Within 10 days all the stem pieces with skins removed bore sprouts from eyes near the cut surface. The stem pieces with skins on began to sprout on the 20th day. Figs. 1 and 2 show the growth of sprouts on the 24th day. It will be seen from this experiment that even with the skin intact the buds near a cut surface begin to sprout much earlier than normally, provided the exposed surface is kept moist and suberization thereby retarded. The buds on the pieces with skins removed not only sprouted still earlier, but the sprouts also grew much faster.

On November 13, tubers harvested on November 4 were cut in half transversely to the long axis. The stem halves were then divided into two lots of 5 each. The cut surfaces of one lot were immediately dipped into warm paraffin. When the paraffin cooled, forming a thin layer over the surface, both lots were placed in paper sacks and stored in a dark, dry laboratory closet. On December 18 all of the paraffined halves bore sprouts from buds near the cut surface. The surface underneath the paraffin was still moist and the cell walls very little suberized. The paraffin in drying cracked from the edges sufficiently to allow free access of air. The cut surfaces of those not dipped in paraffin were dry and heavily corked; these did not begin to sprout until a month later. It seems very probable that the surfaces kept moist by paraffin and not allowed to suberize admitted something to the near-by buds which was not so freely admitted through the heavily corked surfaces. It could not be water, as the sprouting occurred in a dry atmosphere. The other alternative is oxygen. The earlier sprouting in the case of the paraffined pieces was not the result of heat applied to the cut surface by the warm paraffin; this was proved when the experiment was repeated, using a third lot which was dipped in paraffin, the paraffin being removed as soon as cold. This lot sprouted no earlier than the one not treated.

**EFFECT OF LIGHT.**—Planting tubers with the stem ends in soil and covering the seed ends with wet excelsior exposes the latter to subdued light; it is sufficient, however, to induce rather rapid greening of the exposed part of the tuber. It soon became evident by



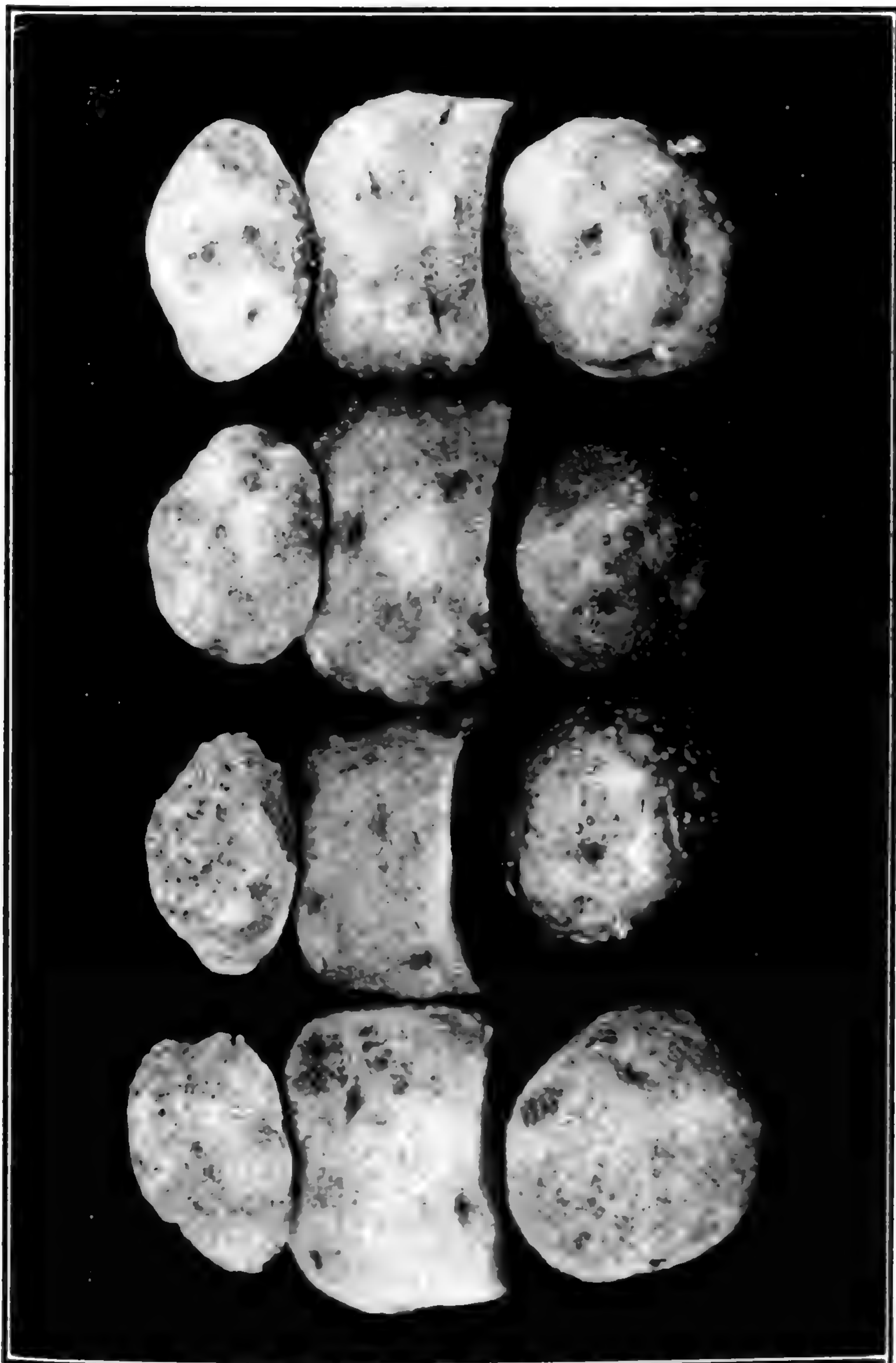

FIG. 2.—Effect of cutting tubers in half; skins not removed; check on fig. 1; also shows early sprouting from buds on the stem ends located near the cut surface.



the use of this method for sprouting tubers that light exercises an influence on the growth processes in the buds. Immature tubers with slightly suberized skins produce sprouts under the influence of subdued light and moisture almost as quickly as they do with the skins removed; see tables XIV and XVIII.

TABLE XVIII

EFFECT OF SUBDUED LIGHT ON IMMATURE TUBERS WITH SLIGHTLY SUBERIZED SKINS;  
8 TUBERS IN EACH LOT

SEED HALVES COVERED WITH	PERCENTAGE SPROUTED AFTER			
	20 days	30 days	40 days	50 days
Excelsior.....	43	43	51	100
Excelsior and black cloth....	0	0	14	43

The foregoing light effect is entirely balanced when the skins are removed; for sprouting occurs just as early in the dark as in subdued light, other conditions being comparable (table XIX).

TABLE XIX

EFFECT OF LIGHT WHEN THE SKINS ARE REMOVED; 12 TUBERS IN EACH LOT HARVESTED ON OCTOBER 28 AND PLANTED ON OCTOBER 31

STEM ENDS PLANTED IN	SEED ENDS COVERED WITH	PERCENTAGE SPROUTED AFTER		
		10 days	20 days	35 days
Soil.....	Excelsior and black cloth	25	83	83
Soil.....	Excelsior	25	83	100

Four lots of 5 tubers each were chosen from immature McCormick potatoes harvested on September 20 and immediately planted in pots with the stem ends in the soil. The projecting seed ends of the 4 lots were covered as follows: (1) a double-walled bell glass filled with a solution of ammoniacal copper sulphate; (2) a similar bell glass filled with a nearly saturated solution of potassium dichromate; (3) a clear bell glass; (4) a black-walled bell glass. By means of bent tubes the air under the bells was in free communication with that on the outside. Through these tubes water was added daily to each pot in sufficient amounts to maintain under the



bells a nearly saturated atmosphere. Equal quantities were added to each pot. Thermometers were placed inside the bell glasses and the temperatures recorded early in the morning and in the afternoon. The temperatures ran practically the same under all the bells, except the clear one, which showed an average of 1-2° higher than the others (table XX).

TABLE XX

EFFECT OF LIGHT ON SPROUTING; IMMATURE TUBERS WITH SLIGHTLY SUBERIZED SKINS

STEM ENDS IN	SEED ENDS COVERED WITH	PERCENTAGE SPROUTED AFTER			AVERAGE LENGTH OF SPROUTS AFTER 35 DAYS
		10 days	20 days	35 days	
Soil.....	Clear bell	100	100	100	8 mm.
Soil.....	Red bell	20	100	100	5
Soil.....	Blue bell	0	0	20	1
Soil.....	Black bell	0	0	0	0

The experiment recorded in table XX shows not only the stimulating effect of light on the growth processes in the buds, but also suggests that this effect is due to a greater oxygenation of the tissues by photosynthesis. The chief evidence for this conclusion lies in the fact that the tubers under the blue bell glass sprouted very little earlier than those under the black bell glass. Although the tubers under the blue bell glass soon became green, little photosynthesis would be expected, on account of the slight energy for this process in the actinic rays. Subdued light does not hasten the sprouting of the tubers with well suberized skins; the effect is rather one of slight retardation. The rest period of tubers with heavily suberized skins may be considerably extended by thorough greening in full light.

EFFECT OF HYDROGEN PEROXIDE.—If the skin is in any degree permeable to hydrogen peroxide, the abundance of catalase in potato tubers would decompose it, liberating free oxygen. Earlier sprouting would then be expected if oxygen is a limiting factor for growth under normal conditions. Experiments to test this hypothesis were conducted as follows: Tubers were wrapped in cotton saturated with dioxygen, then stored in moist chambers, which were buried in wet sawdust underneath a greenhouse bench.



Untreated tubers were planted in the sawdust just outside of the moist chambers. The sawdust was kept constantly wet (table XXI).

TABLE XXI

EFFECT OF WRAPPING TUBERS IN COTTON SATURATED WITH HYDROGEN PEROXIDE;  
6 TUBERS IN EACH LOT

Cotton saturated with	100 per cent sprouted after
3 per cent dioxygen.....	28 days
100 per cent dioxygen.....	43
Untreated.....	76

Table XXI is typical of a number of experiments that were performed with new potatoes. Such treatment failed, however, to shorten the rest period of tubers with heavily suberized skins; this alteration of the skin doubtless renders it impermeable to hydrogen peroxide. Numerous attempts to control these experiments by wrapping tubers in cotton saturated with distilled water usually failed on account of the decay of the tubers. It may be assumed, however, that the partial oxygen pressure in the wet sawdust would not be less than that under saturated cotton.

RESPIRATION.—It has been shown that the rest period of potato tubers can be either entirely eliminated or greatly shortened by means which would seem to facilitate the oxygenation of the internal tissues. That a great increase in oxygen absorption actually occurs is proved conclusively by the effect of the various treatments on respiration, the rate of which was determined by the amount of carbon dioxide expired from the tubers. Ten tubers, with a total weight of about 1500 gm., were used for each determination, which was allowed to run 24 hours at room temperature. The control determinations were made at the same time and under exactly the same conditions.

The amount of carbon dioxide expired from new potatoes with thin, slightly suberized skins is much greater than that from the same tubers after the skins have become well corked and adherent to the underlying tissues. When the latter character of the skin is attained, the rate of respiration under uniform conditions remains fairly constant until the beginning of sprouting. Table XXII is a typical experiment which will suffice to show this fact. Immature



Rehobeth potatoes grown in the greenhouse and harvested on January 21 furnished the material for this experiment. The tubers were stored in a dry, warm laboratory drawer.

TABLE XXII

## RELATION OF RESPIRATION TO SKIN SUBERIZATION

Date of determination	Thermograph average of room temperature	Milligrams of CO <sub>2</sub> per kilo per hour
January 21.....	20°3 C.	24.7
January 26.....	20.0	22.4
February 2.....	21.1	12.3
February 26.....	22.2	8.26
March 3.....	22.0	8.08

Removal of the skin from mature tubers more than doubles the rate of respiration; it falls again with the formation of a new thoroughly corked skin to that of unpared tubers (table XXIII).

TABLE XXIII

## EFFECT OF REMOVING THE SKIN

DATE OF DETERMINATION	MILLIGRAMS OF CO <sub>2</sub> PER KILO PER HOUR		RATIO
	Untreated	Skins removed	
November 7.....	14.94	34.7	1:2.32
November 10.....	12.02	26.37	1:2.19
December 2.....	10.9	11.8	1:1.08

MCCALLUM (17a) found ethyl bromide especially effective in forcing the resting buds of potatoes into growth. The writer studied the effect of this treatment on respiration in the tuber and found that it has about the same accelerating effect as removing the skin (table XXIV).

It has been shown that the rest period can be shortened by wrapping the new tuber in cotton saturated with hydrogen peroxide. This treatment also accelerates the rate of respiration in new tubers (table XXV).

It is obvious that the elimination or abbreviation of the rest period under the conditions employed in this work is correlated with



greater oxygen absorption. It does not necessarily follow, however, that sprouting was brought about by the greater energy release resulting from the increased respiration. The facts seem to indicate that this was not the case. It is more probable that under normal conditions the skin becomes suberized before the completion of

TABLE XXIV

EFFECT OF TREATMENT WITH ETHYL BROMIDE GAS

DATE OF DETERMINATION	MILLIGRAMS OF CO <sub>2</sub> PER KILO PER HOUR		RATIO
	Untreated	Ethyl bromide gas— 30 minutes	
January 18.....	7.26	28.54	1:3.93
January 21.....	7.08	27.85	1:3.83

some growth mechanism requiring oxygen. The rate of oxygen diffusion through the suberized skin then determines the time, the natural rest period, required for the perfection of the growth mechanism.

TABLE XXV

EFFECT OF TREATMENT WITH HYDROGEN PEROXIDE; NEW TUBERS

EXPERIMENT	MILLIGRAMS OF CO <sub>2</sub> PER KILO PER HOUR	
	Lot 1	Lot 2
1.....	Untreated.....22.41	Untreated.....24.65
2.....	Wrapped in sterilized cotton saturated with sterilized water.....22.9	Wrapped in cotton saturated with 50 per cent dioxygen.....39.3

The rôle of oxygen in plant physiological processes is very complex and at the present time quite obscure. However, several cases are noted in the literature which show the wide range of oxygen influence in growth processes. IVANOFF (11) claims that oxygen is necessary for the transformation of zymogen into zymase. ZALESKI (32) has shown that protein synthesis is influenced by oxygen, etc.



### Summary and conclusions

Under normal planting conditions potato tubers will not sprout for several weeks after harvest. During this rest period certain changes must occur in the chemical or physical situation of the buds or their immediate environment which are essential to the release of the growth processes. These changes are spoken of as "after-ripening," using the term in its broadest sense.

The carbohydrate transformations during the rest period are dependent entirely upon changing temperature.

Active diastase and invertase are present at all stages of the rest period, but show no increase under normal growing conditions until the tubers begin to sprout.

The juice from tubers at the end of the rest period causes a greater acceleration of the oxidation of pyrogallol than the juice from new immature tubers of the same variety. The seed and stem halves show no difference in the ability to oxidize pyrogallol even after sprouting from the seed end.

After-ripening does not involve protein hydrolysis. There is no change during the rest period in the relative magnitudes of the following forms of nitrogen: proteose and peptone; diamino acids and other bases; monoamino acids and amides.

Protein, lipoid, organic extractive, and inorganic phosphorus calculated to percentage of total phosphorus, each remains constant up to the time of sprouting.

The magnitudes of the substance studied are not all identical in the seed and stem halves. The relative composition, however, remains practically constant during the rest period in spite of the fact that sprouting begins much earlier on the seed end.

Metabolic changes involving the above forms of nitrogen and phosphorus begin rather suddenly and are concurrent with sprouting. The same is true of diastase.

Drying causes rapid suberization of new skin and exposed surfaces.

Suberization greatly reduces the permeability of the skin to water and gases.

Potatoes may be sprouted at any time during the rest period by simply removing the skins and supplying the tubers with favorable



growing conditions, which include in this case the maximum partial oxygen pressure of the atmosphere. The elimination of the rest period by this means is not due to water absorption from the exterior, as tubers with skins removed will sprout, even in dry storage, much earlier than those with skins intact.

If tubers are cut in half transversely or cut into half-inch slices, the buds on the stem half located near the exposed surface will sprout much earlier than normally, provided suberization of the surface cells is prevented. This may be accomplished by laying them on wet soil, or, better still, sawdust, and covering with wet excelsior. Sprouting in this case also was not due to water absorption, because the rest period of these buds may be greatly shortened in dry storage if drying of the exposed surface is prevented by covering it with a thin layer of paraffin.

The earliest sprouting occurred when the skins were removed and the tubers also cut in the manner described above.

Subdued light stimulates growth in buds on new tubers with slightly suberized skins. The evidence at hand makes it highly probable that this effect is due to greater oxygenation of the tissues by photosynthesis. The light influence entirely disappears when the skin is removed. Subdued light does not stimulate growth in the buds on tubers with highly suberized skins; the effect is rather one of retardation.

The rest period of new potatoes may be shortened by wrapping the tubers in cotton saturated with hydrogen peroxide. The abundance of catalase in potato tuber decomposes the hydrogen peroxide diffusing through the thin skin, liberating free oxygen. This treatment had no effect on old tubers on account of the impermeability of the heavily suberized skin to the hydrogen peroxide.

All the foregoing treatments greatly accelerate the rate of respiration. It may be safely concluded, therefore, that the elimination or abbreviation of the rest period under the conditions employed in this work is correlated with increased oxygen absorption.

The rest period of the potato tubers is not firmly fixed and hereditary. It is not of internal origin due to autogenic metabolic changes, as it can be entirely eliminated by means which maintain a proper adjustment between the bud tissues and external agents,



chiefly oxygen. In nature the oxygen supply to the internal tissues is regulated by skin characters, which are greatly influenced by moisture regulations.

MARYLAND AGRICULTURAL EXPERIMENT STATION  
COLLEGE PARK, MD.

#### LITERATURE CITED

1. ASKENASY, E., Über die jährliche Periode der Knospen. *Bot. Zeit.* 37: 366, 367. 1877.
2. ———, See PFEFFER, *Pflanzenphysiologie* 11:260. 1904.
3. APPLEMAN, CHARLES, Physiological behavior of enzymes and carbohydrate transformations in after-ripening of the potato tuber. *BOT. GAZ.* 52:306-315. 1911.
4. BUTKEWITSCH, W. L., Zur Frage über die Umwandlung der Stärke in den Pflanzen und über den Nachweiss der amylolytischen Enzyme. *Biochem. Zeit.* 10:314. 1908.
5. CROCKER, WILLIAM, Rôle of seed coats in delayed germination. *BOT. GAZ.* 42:265-291. 1906.
6. CHRISTENSEN; P., Chemical researches of bulbs in the later phases of the rest period. *Bull. Acad. Roy. Dänemark (Copenhagen)*, p. 44. 1908.
7. EULER, H., *Grundlagen und Ergebnisse der Pflanzenchemie*. Braunschweig. 1909.
8. FISHER, ALFRED, Beiträge zur Physiol. der Holzewachse. *Jahrb. Wiss. Bot.* 22:73. 1891.
9. GRÜSS, J., Enzymwirkungen aus Wundrand der Kartoffelknolle. *Zeit. Pflanzenkrank.* 17:69-70. 1907.
10. HOWARD, W. L., An experimental study of the rest period in plants. The winter rest. *Research Bull. 1, Agric. Exper. Sta. Univ. Mo.* 1910.
11. IVANOFF, L., Über die sogenannte Atmung der zerriebenen Samen. *Ber. Deutsch. Bot. Gesells.* 29:563-570. 1911.
12. JESENKO, E., Einige neue Verfahren der Ruheperiode des Holzewachse abzukurzen. *Ber. Deutsch. Bot. Gesells.* 29:273-283. 1911.
13. JOST, L., Wachstum während der Ruheperiode. *Bot. Zeit.* 51:100. 1893.
14. JOHANNSEN, W., Das ather Verfahren beim Fruhtreiben. *Jena.* 1906.
15. KLEBS, G., Über die Rhythmik in der Entwicklung der Pflanzen. *Sitz. Heidelb. Akad. Wiss.* 23:1-84. 1911.
16. ———, Die periodischen Erscheinungen tropischer Pflanzen. *Biol. Centralbl.* 32:257-285. 1912.
17. LAKON, GEORGE I., Die Beeinflussung der Winterruhe der Holzgewachse durch die Nahrstoffe. *Zeitschr. Bot.* 4:561-582. 1912.
- 17a. MCCALLUM, W. B., Twentieth Ann. Rep. Univ. Ariz. Agric. Exper. Sta. p. 586. 1909.



18. MOLISCH, H., Über ein einfaches verfahren Pflanzen zu treiben (Warmbad Methode). Sitz. Kais. Akad. Wiss. 117:87-117. 1908.
19. MÜLLER-THURGAU, H., Beiträge zur Erklärung der Ruheperiode der Pflanzen. Landw. Jahresber. 11:751-828. 1882.
20. ———, Beiträge zur Erklärung der Ruheperiode der Pflanzen. Landw. Jahrb. 14:859-863. 1885.
21. MÜLLER-THURGAU, H., und SCHNEIDER-ORELLI, O., Beiträge zur Kenntniss der Lebensvorgänge in ruhender Pflanzen. Über den Einfluss der Vorerwarmens und einiger anderer Faktoren. Flora 101:309-372. 1910.
22. ———, Beiträge zur Kenntniss der Lebensvorgänge in ruhenden Pflanzenteilen. Flora 104:386-446. 1912.
23. SCHMID, B., Über die Ruheperiode der Kartoffelknollen. Ber. Deutsch. Bot. Gesells. 19:76. 1901.
24. SIMON, S., Untersuchungen über das Verhalten einiger Wachstumsfunktionen, sowie der Atmungstätigkeit der Laubholzer während der Ruheperiode. Jahrb. Wiss. Bot. 43:1-35. 1906.
25. SCHIMPER, A. F. W., Pflanzengeographie auf physiologischer Grundlage. Jena. 1898.
26. URSPRUNG, A., Zur Periodicität des Dickenwachstums in den Tropen. Bot. Zeit. 62:189-210. 1904.
27. IRAKLIONOW, P. P., Über den Einfluss des Warmbads auf die Atmung und Keimung des ruhenden Pflanzen. Jahrb. Wiss. Bot. 51:515-539. 1912.
28. VOLKENS, G., Der Laubwechsel tropischer Bäume. Gartenflora 52:591-598. 1903.
29. ———, Laubfall und Lauberneuerung in den Tropen. Berlin. 1912.
30. WEBER, F., Über die Abkürzung der Ruheperiode der Holzgewächse durch Verletzung der Knospen beziehungsweise Injektion dieselbe mit Wasser. Kais. Akad. Wien 10:182-183. 1911.
31. WISMEWSKI, P., Beiträge zur Kenntnis der Keimung der Winterknospen der Wasserpflanzen. Bull. Inter. Acad. Sci. Cracovie B. pp. 1045-1060. 1912.
32. ZALESKI, W., Zur Kenntnis der Stoffwechselprocess in reifenden Samen. Beih. Bot. Centralbl. 27:63-82. 1911.



## DECAY AND SOIL TOXINS

CONTRIBUTIONS FROM THE HULL BOTANICAL LABORATORY 213

GEORGE B. RIGG

The decomposition products of a specific plant organ and their effects on the growth of other plants furnished the point of attack for the work on toxicity reported in this paper. The material used was the rhizomes of *Nymphaea advena* Ait. and *N. polysepala* Greene. This material was obtained at intervals from July 1912 to October 1915, at various places in the vicinity of Chicago, Illinois, and Seattle, Washington.

### Review of literature

#### RELATED WORK ON TOXICITY

The organic constituents of soils have been under investigation by workers in the United States Bureau of Soils for 10 years. LIVINGSTON (12, 13) found toxic substances, probably organic, in an unproductive soil. SCHREINER (21) and his co-workers have isolated from soils more than 25 organic compounds differing widely in chemical character. Some of these (for example, dihydroxystearic acid) have proved harmful to growing plants; some (for example, nucleic acid) have been found beneficial; and some have not been shown to have any effect on the growth of plants. BOTTOMLY (3) has found that certain aerobic organisms grow well in peat and form from it compounds that are beneficial to the growth of plants. He suggests that very small amounts of accessory organic substances may be necessary for the growth of plants.

Humic acid has been much discussed as a possible factor in plant growth. Not only the effects of this so-called humic acid, but also the constitution and nature of the substance are in doubt. SCHREINER (21) regards it as a mixture of substances. WIELER (29) takes the view that humic acids in soils are inorganic acids resulting, for example, from the chemical decomposition of salts.

BAUMAN and GULLY (2) have suggested that the acidity of bog water is due to the fact that the cell colloids of the disintegrating



plant tissues retain chiefly the basic ions of the salts dissolved in the cell contents of the plant tissues before they began to decay, thus freeing the acid ions. SKENE (24) has found that various species of *Sphagnum* thrive best in acid solution because mineral solutions, although usually physiologically harmless, may be ecologically harmful.

Work by LIVINGSTON (14), DACHNOWSKI (6, 7), the writer (19), and others (20), indicates that the inhibition from sphagnum bogs of plants other than bog xerophytes is not due to acidity, or to low surface tension, or to high osmotic pressure of the soil solution, but is due in part to the presence of toxic substance or substances in the soil solution.

Many workers (8, 9, 15-18, 25-27) have found that cultivated crops and plants grown in cultures have a favorable or an unfavorable influence on other plants growing in the same substratum either at the same time or subsequently. Food supply and toxins have been suggested as means through which this influence may be exerted. CZAPEK (5) finds that the roots of plants are injured when the surface tension of the bathing solution is lower than 0.66.

SHERFF (23) found in Skokie marsh near Chicago that where the rhizomes of *Sagittaria latifolia* had penetrated the decaying rhizomes of *Nymphaea advena*, they themselves had begun to decay.

#### STERILE CULTURES OF SEED PLANTS

More or less success has been attained by various workers in attempts to grow seed plants under sterile conditions. HARRISON and BARLOW (11) tried sterilization by dry heat, moist heat, sulphuric acid, calcium hydrate, formaldehyde, and mercuric chloride, and abandoned all of these means. They succeeded in getting sterile cultures of certain legumes by treating the unopened pods with mercuric chloride, opening them with flamed forceps, and transferring the seeds to a very small quantity of boiling water in sterile test tubes.

WILSON and HARDING (30) tried alcohol, formaldehyde, and mercuric chloride as a means of sterilizing alfalfa seeds, but found that when the seeds were sterile, the germination was very low.



Using a modification of HARRISON and BARLOW'S method, they got alfalfa seedlings which grew in sterile cultures for 4 months.

BROWN (4) found that barley seeds take up water from a fairly strong solution of sulphuric acid and remain uninjured. SCHROEDER (22) found silver nitrate to be a good means of sterilizing wheat. He found that hand-picked wheat endured soaking in a 5 per cent solution of this substance for 24 hours without injury, and for 72 hours with but slight injury. Threshed wheat, however, because of the rupture of semipermeable membranes by the machinery, would not stand such prolonged treatment. ARCHICHOWSKY (1) got a large percentage of sterile cultures of seed plants by the use of formaldehyde and other antiseptic agents on peas, pumpkins, and other seeds.

### Solutions and preparations

Both of the species of *Nymphaea* used produce branched rhizomes 3–15 cm. thick and sometimes reaching as great a length as 3 m., although they are more commonly 1 m. or less. The older portions of these rhizomes decay. SHERFF (23) found these rhizomes decaying to within a short distance of the growing apex. The writer has found the decay only in older portions of the rhizome. Sound pieces of the rhizome were collected and the following solutions were made up quantitatively, each solution having a volume of 1600 cc. and containing the solutes obtained by the methods described from 1000 gm. of fresh rhizome. An average of 3 tests on the water contents of the fresh rhizome gives 88 per cent of water. The tests were made by cutting 500 gm. of the fresh material into small pieces and drying it at 105° C.

*Solution 1A.*—This was the liquid resulting from the decay of 1000 gm. of fresh *Nymphaea* rhizome in redistilled water, freed from solid matter by filtering through cheesecloth, and diluted to 1600 cc. with redistilled water. Molds continued to grow on the surface of this solution. It was amber colored.

*Solution 1B.*—This was the solution remaining after a duplicate of 1A had been extracted by shaking with an equal volume of ether in a separatory funnel. The ether that dissolved in the water solution was removed by heating to 40° C. and subjecting to



a suction of 2 cm. of mercury with an aspirator. Molds continued to grow on the surface of this solution. It had a slightly darker color than 1A.

*Solution 1C.*—The ether used in extracting 1B was allowed to evaporate spontaneously. The solid remaining was reddish-brown, and only partially soluble in water. This solution consists of 1600 cc. of redistilled water, and all the residue from the ether extraction that would dissolve in that quantity of water at 40° C. No molds grew on this solution, and no scum or turbidity or other evidence of bacterial activity appeared.

*Preparation 1D.*—This was the solid remaining from filtering 1A. This solid was ground with an equal volume of sand.

*Solution 2A.*—This was the distillate under reduced pressure (2 cm. pressure), at 40° C., of the liquid and solid products of the decay of 1000 gm. of *Nymphaea* rhizome in redistilled water. This was a clear liquid having the appearance of water. No molds grew upon it, and it showed no evidence of bacterial activity.

*Solution 2B.*—The solid remaining from the distillation of 2A was dried in an oven at 30° C. and then ground in a mortar. It was then black powder. This was extracted in a Soxhlet apparatus with ether. When the ether was allowed to evaporate spontaneously, a sticky, semi-solid, reddish-yellow substance remained. This was only partially soluble in water. This solution represents 1600 cc. of redistilled water, with all of the ether extract that would dissolve in it at 40° C. It had a light reddish-yellow color. No molds grew upon it, and no evidence of bacterial activity appeared.

*Solution 2C.*—The solid remaining from the extract of 2B was exposed to air until all odor of ether had disappeared. It was then extracted for 2 hours with 1600 cc. of redistilled water. It was perfectly clear. No molds or evidence of bacterial growth appeared.

*Preparation 2D.*—This represents the solid remaining from the extract of 2C, ground in a mortar with an equal volume of sand to form a soil.

*Solution 3A.*—One kg. of fresh *Nymphaea* rhizome was cut into pieces, ground in a meat grinder, and the juice pressed out in a fruit press. The solid remaining was extracted with ether, and



afterward exposed to the air until the odor of ether disappeared. It was then allowed to decay in redistilled water. The liquid resulting from this decay was strained through cheesecloth and diluted with redistilled water to 1600 cc.

*Solution 3B.*—The juice squeezed out in preparing solution 4A was extracted by shaking with an equal volume of ether in a separatory funnel, which was then freed from ether by heating to 40° C., and subjecting to suction (2 cm. of mercury) by means of an aspirator for 24 hours. This, when diluted 1600 cc., constituted solution 3B.

*Solution 3C.*—The ether used in extracting 3A was combined with that used in extracting 3B. This was allowed to evaporate spontaneously and as much of the residue as possible was taken up in 1600 cc. of redistilled water at 40° C.

*Preparation 3D.*—The solid matter remaining on the cheesecloth in the preparation of 3A was air-dried and ground with an equal volume of sand to form a soil.

*Solution 4A.*—This was the water extract of the fresh rhizome made under sterile conditions. The rhizome was cut into small pieces and placed in flasks with water. These flasks were stoppered with cotton and sterilized in an autoclave. This solution stood sterile for 11 months before its toxicity was tested.

*Solution 5A.*—This was the water solution of the ash from the fresh rhizome.

All sand used in the previous preparations and in the following experiments was either no. 2½ quartz or "Ottawa test." In all cases it was washed in 10 per cent HCl, freed from acid by washing in running water, and finally rinsed with redistilled water.

The "Knop's solution" had the following composition: 1 part KNO<sub>3</sub>; 1 part K<sub>2</sub>HPO<sub>4</sub>; 1 part Mg SO<sub>4</sub>; 4 parts Ca(NO<sub>3</sub>)<sub>2</sub>. This was made up to 0.1 per cent.

Where "tap water" is mentioned, the water used was Chicago city water. Where "Cedar River water" is mentioned, the water used was Seattle city water, which is piped from the river near its origin in a snow-fed lake. Where "Lake Washington water" is mentioned, the water is that supplied from Lake Washington to the botany laboratories at the University of Washington.



### Experiments and results

In order to determine the relative toxicity of these various solutions to *Tradescantia*, cuttings of the plant were placed in various dilutions of each solution with redistilled water. In this way the percentage of the solution (that is, the number of cc. diluted to 100 with redistilled water) that would allow the formation of roots but inhibit the production of root hairs was determined.

All of the solutions except 5A were acid to both litmus and phenolphthalein. Their acidity was determined by titrating with N/10 NaOH, using phenolphthalein as an indicator.

Table I gives the toxic limits of these solutions to *Tradescantia* (as previously defined) and their acidity, together with the relative rank of each solution as to toxicity and acidity and the ratios of these.

TABLE I

Solution acidity	Toxicity (per cent)	Rank as to acidity	Rank as to toxicity	Ratio of acidity to toxicity
1A N25/1000.....	7.5	1	1, 2, or 3	0.27
1B N24/1000.....	7.5	2	1, 2, or 3	0.25
1C N11/1000.....	7.5	4	1, 2, or 3	0.12
2A N22/1000.....	10.0	3	4	0.24
2B N6 /1000.....	50.0	7	7	0.12
3A N9 /1000.....	12.5	5	5	0.10
3B N7 /1000.....	15.0	6	6	0.08
3C N5 /1000.....	75.0	8	8	0.06

All of the solutions mentioned in table I, except 3B, were neutralized to phenolphthalein with N/10 sodium hydrate, and the effect of both the acid and the neutral solution was tried on *Tradescantia* cuttings. Table II shows the results of the dilutions named on *Tradescantia* cuttings.

TABLE II

Solution	Strength (per cent)	Acid	Neutralized
1A.....	7.5	Root hairs none	Root hairs normal
1B.....	5.0	" " slightly stunted	" " "
1C.....	5.0	" " " "	" " normal
2A.....	7.5	" " none	" " slightly stunted
2B.....	60.0	Roots none	Roots 3-10 mm. long
3A.....	12.5	Root hairs none	Root hairs slightly stunted
3C.....	10.0	" " slightly stunted	" " normal



The toxicity of the first 4 of these solutions when undiluted was not perceptibly lowered by neutralization with sodium hydrate.

A 20 per cent solution of 1A was shaken in a large flask 5 times a day for 10 minutes each time, for 3 days in order to aerate it, and then filtered through a filter paper. Tests on *Tradescantia* indicated that its toxicity was not decreased by this treatment.

A 20 per cent solution of solution A in tap water was shaken with animal charcoal and filtered. The filtrate was colorless and odorless. The solution before this treatment had an amber color and a foul odor. Cuttings of *Tradescantia* were placed in this. In all cases they grew well and produced good roots with normal or only slightly stunted root hairs.

The animal charcoal with which this solution was shaken was used as a soil for cultures of alfalfa seed. Controls of animal charcoal shaken with tap water were run. The growth in the controls was twice as great as the growth in the cultures.

The toxicity of preparation 2D to *Tradescantia* cuttings was tested by planting the cuttings in the preparation in small flower pots. This preparation was further diluted also by grinding with half its volume of sand. For convenience this further dilution is referred to in table III as preparation 2Dx. Controls were run

TABLE III

Medium	Roots	Plants
2D.....	None	Dying
2Dx.....	Normal	Healthy
Potting soil.....	Normal	Healthy

in potting soil. All of the pots in a set were placed together in a large glass dish, so that they stood in about one-fourth of an inch of tap water and thus were all watered alike. Table III shows the results at the end of 14 days.

Preparation 3D was tried in the same way with similar results. Preparation 1D was tried in the same way with corn and did not prove toxic. Preparations 2D and 3D are not at all toxic to alfalfa.

The toxicity of solutions 1A, 1B, 1C, and 2A to unsterilized corn was tested by planting the seeds in 200 cc. of sand watered with 25 cc. of solution. The cultures were in 500 cc. Erlenmeyer



flasks, stoppered with cotton. Controls watered with Knop's solution were run. All of the solutions tested proved toxic, but 2A was found to be less toxic to corn under these conditions than the others. The toxicity of the solutions was shown in the injury to the root tips, causing a great decrease in the total length of root produced as compared with the controls, and thus eventually killing the plants.

The effect of the 8 solutions listed in table I was tried on unsterilized alfalfa in sand. They were all found extremely toxic, many of the plants dying as they emerged from the sand, and the best of them attaining only one-fifth of the height attained by controls watered with tap water.

It was found by tests that tomato seeds did not germinate at all in solution 1A in sand, while controls in sand watered with tap water grew vigorously.

An attempt was made to secure sterile cultures of corn in 500 cc. Erlenmeyer flasks in order to determine whether the presence of organisms in the cultures was a factor in the toxicity of these cultures. The sterility of the cultures was tested by making bouillon cultures from various portions of the sand and the seeds at the end of the experiment; 65 per cent of the cultures proved sterile.

Three problems were to be solved in working out a method of securing sterile cultures of seed plants: (1) the sterilization of the flasks and contents; (2) the sterilization of the seeds; (3) the transfer of the sterile seeds to the sterile flasks under sterile conditions.

The cotton-stoppered flasks, containing 200 cc. of sand and 20 cc. of the solution, were sterilized for 1 hour at 15 lbs. pressure in the autoclave. A solution of silver nitrate was used as a means of sterilizing the seeds. It was found by experiment that corn would germinate well after treatment for 1 minute with  $N/300$   $AgNO_3$  and subsequent washing with water. As a means of making the transfer of the seeds to the flask, the box previously used by JENSEN (11a) was used. When the lid of the box was closed, the operator could thrust his hands into the gloves and work without danger of contaminating the cultures from any source outside of the box. Since the entire top and part of the front of



the box were of glass, all articles inside of the box could be seen readily by the operator.

The entire inside of the box, including the side of the gloves and sleeves exposed to the air of the box, and the outside of all flasks and other articles placed in the box, were treated thoroughly with a 15 per cent solution of glycerine saturated with carbolic acid. All of the cultures prepared were thus more or less exposed to carbolic acid fumes. This solution was applied by means of a sponge attached to a short stick. It was found that flasks and dishes stuck to the paint treated with this mixture, so that a false bottom of glass was placed in the box. The stoppers of the sterilized flasks (including 2 of sterile water) were flamed, and the flasks placed in the box. Four tall stenders with ground glass covers were sterilized in an oven for 5 hours at 120° C., and placed in the box. A bottle of N/300 AgNO<sub>3</sub> was also placed in the box, as were also a pair of 10-inch brass forceps and a waste jar containing a little of the glycerine carbolic acid solution. Everything in the box having been treated with the antiseptic solution, the cover of one of the stenders was removed and dry corn placed in the stender and the cover quickly replaced. In selecting corn for this purpose, care had been taken to secure smooth kernels that would offer little opportunity for the lodgment of air bubbles in the dent or elsewhere.

The box now remained closed over night, to allow any organisms in the air to settle to the bottom of the box and be held by the glycerine solution. In the morning the operator thrust his hands into the gloves, poured AgNO<sub>3</sub> on the seeds, left it on for 1 minute, poured it off into the waste jar, and then washed the seeds in several changes of sterile water, finally allowing them to soak in it for several hours, and rinsing them again. The tips of the forceps now were washed thoroughly in the sterile water and the transfer of the seeds was made. In some cultures the seeds were thrust down into the sand by means of these forceps, and in some cases they were left on the surface. After 2 or 3 cultures had been made, the forceps were placed in the antiseptic solution for a few minutes and again rinsed in sterile water. After the cultures were prepared, they were removed from the box and placed near a window in the laboratory.



The results showed that solutions 1A, 1B, 1C, and 2A (these were the only ones tried) are just as toxic under these conditions as when organisms were known to be present in abundance. Since 65 per cent of these cultures were shown (by bouillon cultures from them at the close of the experiment) to be sterile, it is evident that the presence of organisms is not a necessary condition of the toxicity of these solutions.

Solutions 1A, 1B, and 1C likewise proved toxic to alfalfa in cultures prepared as previously described for corn. The same precautions for securing sterility were observed, but tests of sterility were not made.

The toxicity of solution 4A to *Tradescantia* cuttings was tested as follows: wide-mouth 50 cc. bottles were filled with dilutions of the following strength: 20, 15, and 10 per cent. Into each of these was placed a cutting of *Tradescantia*. The mouths of the bottles were left open. At the end of 16 days no root hairs had formed on any of these plants and all of the plants were showing signs of death. The controls in Lake Washington water all had abundant root hairs and were in healthy condition.

Other sets of bottles were prepared as previously described, except that the mouths were stoppered with cotton and the bottles containing the liquids were sterilized in the autoclave. The dilutions were as follows: undiluted, 20, 15, and 10 per cent. Each cotton stopper was then displaced just enough to allow a cutting of *Tradescantia* to be placed in the liquid. None of these plants developed normal root hairs. All of them except those in the 10 per cent dilution showed signs of death at the end of 16 days. Turbidity due to the action of organisms was evident in all of these, and molds grew on some of them.

Flasks (500 cc.) were prepared, cotton-stoppered, each containing 180 gm. of sand and 18 cc. of solution. These were autoclaved at 12 lbs. pressure for 1 hour. Solution 4A was used pure and also in the following solutions: 20, 15, and 10 per cent. Controls with tap water were also run. Corn was treated with N/100 silver nitrate for 2 minutes, then with sterile forceps 5 kernels were placed in each flask. At the end of 16 days the growth was noticeably greater in all of the controls than in any of the solutions. All



of the flasks except 2 (one control and one 15 per cent) had molds growing in them. Bouillon and also agar cultures were made from each of these, and the 15 per cent flask proved to be sterile. The other was not sterile. These 2 flasks were kept a week longer and the growth in the control was much better than that in the 15 per cent solution.

The transfers of the corn in these cases were made in the laboratory, without the use of the sterile box just described. It is hoped that by autoclaving the flasks at a higher pressure, and treating the seeds with the silver nitrate for a longer period, a larger number of sterile flasks could be obtained.

Solution 1A was filtered and the fresh filtrate was immediately saturated with ammonium sulphate. The sulphate was added gradually and the solution was shaken after each addition. No precipitate appeared at once, but when it had stood over night a considerable amount of a brownish precipitate was present. Some of the precipitate was at the surface of the liquid, some had settled to the bottom, and some particles were in suspension in the liquid.

The precipitate was filtered off and redissolved in a volume of Cedar River water equal to the original volume of the solution. Both filtrate and precipitate were then dialyzed in dialyzing tubing in running water for 11 days. At the end of this time they showed no precipitate with barium chloride. The filtrate and the precipitate were then tested for toxicity by placing *Tradescantia* cuttings in them. Root hairs were formed in both, but their development was poorer in the solution of the precipitate than in the filtrate.

In preparing solution 5A, 2.83 gm. of ash were obtained from 500 gm. of fresh rhizomes. This is 4.7 per cent of the dry weight. Approximately half of this went into solution when shaken with 800 cc. of Cedar River water at 18° C. The solution was basic to litmus. In all cases tried with 5A and its duplicates the toxicity to *Tradescantia* cuttings was so marked that practically no root hairs developed and the plants soon died. When dilutions were tried it was found that all dilutions down to 10 per cent (10 cc. solution to 90 cc. water) inhibited root hair production; in 5 per cent dilution root hairs developed normally.



A solution was prepared from each of the following substances, by allowing a quantity of it to decay in redistilled water: potato, turnip, rhizome of *Castilia odorata*, and rhizome of *Typha latifolia*. These solutions approximated the strength of solution 1A prepared from *Nymphaea*. They all proved toxic to *Tradescantia* cuttings, but to a less degree than 1A did. Their toxicity was in the order named.

### Discussion

It is evident from the data given that even very dilute solutions of the products of the decay of *Nymphaea* rhizomes are toxic to *Tradescantia* cuttings in water cultures and the seedlings of tomato, alfalfa, and corn in sand cultures.

Although the products of the decay of the subterranean parts of other plants proved toxic, the toxicity of the products of the decay of *Nymphaea* rhizomes was considerably greater than that of any other plant parts experimented on. While it is possible that toxicity from decay is rather common, *Nymphaea* seems to merit particular attention in this regard. The dilution of solution 1A that entirely inhibited the formation of root hairs on *Tradescantia* cuttings contained in each cc. the products of the decay of 4.7 mg. of fresh rhizome. Since only 12 per cent of the fresh rhizome is solid matter, the amount of solid whose decay contributed to the solutions in each cc. of the toxic solution was 0.56 mg.

The fact that the solutions listed in table I were all acid, and that their toxicity was largely destroyed by neutralization with sodium hydrate, would seem to suggest acidity as a large factor in the toxicity. The toxicity is not proportional to the acidity as determined by the titration method. It may be proportional, however, to the H ion concentration, or some other factor may be effective. The fact that the toxicity of 1A, 1B, 1C, and 2A when undiluted was not reduced by neutralization with sodium hydrate seems to emphasize further the presence of some other factor. It is possible that the osmotic pressure of such a concentrated solution was high enough to cause injury, although it has been shown elsewhere (20) that this is not the cause of the toxicity of the very dilute solutions. Antagonistic action on permeability might also



be a possible factor in the lowering of toxicity on the addition of sodium hydrate.

The fact that the toxicity of solution 1A was not destroyed by the aeration here reported does not necessarily mean that the toxicity cannot be removed by oxidation.

The removal of the toxicity from solution 1A by shaking it with animal charcoal is probably to be explained as an absorption phenomenon.

The only importance attaching to the toxicity of the soils (preparations 1D, 2D, and 3D) is that not all of the water-soluble toxic materials had been washed out of them by the treatments to which they had been subjected.

The products of the decay of *Nymphaea* rhizomes are toxic, not only to *Sagittaria* and *Tradescantia*, but also to agricultural plants. Apparently the toxicity of solution 1A to tomato, alfalfa, and corn is in the order named.

While the box used for transferring the sterile seeds to sterile flask cultures is fairly efficient, the method is somewhat slow and tedious, and it is believed that fairly good results may be obtained without its use. It seems very desirable to extend our knowledge of the growth of seed plants in the absence of other organisms.

In the one case mentioned, the toxicity of the products of this rhizome to corn seemed to be independent of the presence of organisms, either at the time of dissolving the toxin from the rhizome, or at the time of its action on the growing plants.

The fact that the toxicity of solution 1A, even when undiluted, can be removed by precipitation with ammonium sulphate seems to suggest that the presence of colloidal matter may be a considerable factor in toxicity of that solution.

An alkaloid similar to nupharin is reported by WEHMER (28) in the rhizome of *N. alba*. He also reports fat and organic acids. These also represent possible factors in the toxicity. It seems possible that the toxicity may be due partly to products formed during decay and partly to products merely released by this decay.

The toxicity of the water extract of the ash is possibly accounted for on the basis of the presence of one or more basic substances. WEHMER states that the rhizome of *Nymphaea alba* contains



9.86 per cent of ash with the following composition: CaO, 8.2 per cent; Cl, 15.2 per cent; Na<sub>2</sub>O, 48.47 per cent; K<sub>2</sub>O, 9.86 per cent; P<sub>2</sub>O<sub>5</sub>, 14.36 per cent. The presence of sodium hydroxide or of sodium carbonate in the water solution of this ash seems probable.

There seemed to be 5 possibilities as to the cause of the toxicity of the products of the decay of this rhizome: (1) the presence of the organisms; (2) toxicity due to ionization; (3) the presence of toxic molecules; (4) high osmotic pressure of the solutions; and (5) low surface tension of the solutions. Of these, (1) seems to be practically eliminated by the work here reported. Apparently the presence of organisms, either at the time of the formation of the solution or at the time of their action on growing plants, is not a condition necessary for their toxic action. Work elsewhere reported (20) disposes of (4) and (5). This leaves ionization and toxic molecules as probable causes of the toxicity. The relative importance of these two is not fully determined by the work here reported. It is evident, however, that the entire toxicity cannot be ascribed to one substance. If we should suppose that the toxicity of all of the solutions obtained from this rhizome was due to only one substance, it would have to have the following properties: (1) soluble in water; (2) soluble in ether; (3) volatile at 40° C., 20 mm. pressure; (4) stable at 250° C., 15 lbs. pressure; (5) absorbed by animal charcoal; and (6) precipitation by ammonium sulphate.

It seems probable that there are at least 3 classes of substances here that are somewhat toxic: (1) colloids, (2) very volatile substances, and (3) certain bases.

### Summary

1. The products of the decay of *Nymphaea* rhizomes are toxic to *Tradescantia* cuttings, and to tomato, alfalfa, and corn, even in very dilute solutions.

2. All of the solutions prepared except the one from the ash were acid, but the amount of acidity was not proportional to the degree of toxicity.



3. The toxicity of the very dilute solutions (but not of the strong solutions) was nearly destroyed by neutralization with sodium hydrate.

4. The toxicity of solutions resulting directly from the decay of the rhizome is destroyed by shaking them with animal charcoal.

5. The water extract of the fresh rhizome made under 15 lb. pressure in an autoclave is toxic to growing plants.

6. The rhizome and the products of its decay contain some ether-soluble toxic material.

7. Some of the toxic material in the products of the decay of these rhizomes is volatile at 40° C.

8. The toxicity of even concentrated solutions resulting directly from the decay of these rhizomes can be removed by precipitation with ammonium sulphate.

9. The water extract of the ash from these rhizomes is basic and toxic.

10. The products of the decay of potatoes, of turnips, and of the rhizomes of *Castalia odorata* and *Typha latifolia* are also toxic to *Tradescantia*, but slightly less so than those of *Nymphaea*.

UNIVERSITY OF WASHINGTON  
SEATTLE, WASH.

#### LITERATURE CITED

1. ARCHICHOVSKY, V., Die Wirkung der Giftstoffe verschiedener Konzentrationen auf die Samen. *Biochem. Zeit.* 50:233-244. 1913.
2. BAUMAN, A., and GULLY, E., Über die freien Humussauren des Hochmoors. *Mitt. K. Bayr. Moorkulturanst.* 4:31-56. 1910; see also *Science N.S.* 40:492. 1914.
3. BOTTOMLY, W. B., The significance of certain food substances for plant growth. *Ann. Botany* 28:531-540. 1914.
4. BROWN, A. J., The selective permeability of the covering of the seeds of *Hordeum vulgare*. *Proc. Roy. Soc.* 81B:82-93. 1909.
5. CZAPEK, F., Über eine Methode zur direkten bestimmung der Oberflächen-spannung der Plasmahaut, von Pflanzenzellen. *Jena.* 1911.
6. DACHNOWSKI, A., Bog toxins and their effect upon soils. *BOT. GAZ.* 47:389-405. 1909.
7. ———, Physiological properties of bog water. *BOT. GAZ.* 39:348-355. 1905.
8. DANDENO, L. B., Mutual interaction of plant roots. *Report Mich. Acad. Sci.* 11:24-25. 1909.
9. *Exper. Sta. Record* 15:780. 1903-1904.



10. FITTING, H., Die Wassersorgung und die osmotischen Druckverhältnisse der Wüstenpflanzen. *Zeitsch. Bot.* 3:209-275. 1911.
11. HARRISON, F. C., and BARLOW, B., The nodule organization of the Leguminosae. *Bakt. Centralbl.* 19:264-272, 426-441. 1907.
- 11a. JENSEN, G. H., Toxic limits and stimulation effects of some salts and poisons on wheat. *BOT. GAZ.* 43:11-44. *figs.* 34. 1907.
12. LIVINGSTON, B. E., Studies on the properties of an unproductive soil. *Bull.* 28, Bur. of Soils, U.S. Dep. Agric. 1905.
13. ———, Further studies on the properties of unproductive soils. *Bull.* 36, Bur. of Soils, U.S. Dep. Agric. 1907.
14. ———, Physical properties of bog water. *BOT. GAZ.* 37:383-385. 1904.
15. LYON, T. L., and BIZZELL, J. A., Is there a mutual stimulation of plants through root influence? *Jour. Amer. Soc. Agron.* 5:38-44. 1913.
16. MOILLARD, M., Sur la secretion par les racines de substances toxiques pour la plantes (note préliminaire). *Bull. Soc. Bot. France.* 1914.
17. NIKITINSKY, J., Beeinflussung der Entwicklung einiger Schimmelpilze durch ihre Stoffwechselprodukte. *Jahrb. Wiss. Bot.* 40:1-67. 1904.
18. RAHN, O., Über den Einfluss der Stoffwechselprokte auf das Wachstum der Bakterien. *Centralbl. Bakt. II.* 16:417-429, 609-617. 1906.
19. RIGG, G. B., The effect of some Puget Sound bog waters on the root hairs of *Tradescantia*. *BOT. GAZ.* 55:314-326. 1913.
20. RIGG, G. B., TRUMBULL, H. L., and LINCOLN, MATTIE, Some physical properties of certain toxic solutions. To be published in the *BOTANICAL GAZETTE*.
21. SCHREINER, O., The organic constituents of soils. *Science* 36:577-587. 1912.
22. SCHROEDER, H., Über die Einwirkung von Silbernitrat auf die Klimfähigkeit von Getreidkornern. *Biol. Centralbl.* 35:8-24. 1915.
23. SHERFF, E. E., The vegetation of Skokie marsh, with special reference to subterranean organs and their interrelationships. *BOT. GAZ.* 53:415-435. 1912.
24. SKENE, MACGREGOR, The acidity of sphagnum and its relation to chalk and mineral salts. *Ann. Botany* 29:65-87. 1915.
25. SKINNER, J. J., Illustration of the effect of previous vegetation on a following crop. *Plant World* 16:342-346. 1913.
26. SULLIVAN, M. X., The passage of nucleic acid from plant to medium. *Science* 39:958. 1914.
27. WEHMER, C., Kleinere mykologische Mitteilungen. *Centralbl. Bakt. II.* 3:102-108. 1897.
28. ———, Die Pflanzenstoffe. Jena. 1911.
29. WIELER, A., Pflanzenwachstum und Kalkmangel im Boden. 8vo. pp. vii+235. *figs.* 43. 1912.
30. WILSON, J. K., and HARDING, H. A., Method of keeping bacteria from growing plants. *Science* 33:544-545. 1911.



# NUCLEAR DIVISION OF SPIROGYRA

## II. NUCLEAR DIVISION IN *S. BELLIS*

MABEL L. MERRIMAN

(WITH PLATES XVIII-XX)

In investigating the nuclear division of *Spirogyra* three modes of procedure were used. Study of whole mounts fixed and stained gives a better idea of disposition of chromatic material, whereas a study of sections gives a better idea of its structure. For estimating duration of phases in karyokinesis and relative activity of parts of nucleus and boundaries of nucleus and cytoplasm, it is necessary to study living nuclei.

Although many species have been worked upon, none has yet been found that presents favorable material for all these methods. If nuclei are large, as in *S. crassa*, and so adapted for dissection from whole mounts or for sectioning, then in a living cell close winding of the chromatophores prevents a view of the nucleus in karyokinesis. Hence the study of *S. crassa* (8) was confined to the study of sections and entire nuclei dissected from the threads. In the studies of *S. bellis* a correlation was attempted of nuclear division stage by stage as seen in living cells with similar stages fixed the same evening. The nucleus of this species is plainly visible when living, and when stained its density is not so great but that its structures may be seen readily without sectioning. The stains used were safranin and gentian violet; Haidenhain's hematoxylin with iron alum; and anilin blue with eosin. Since gentian violet stains the cell sheath as well as the chromatic material, the last two combinations of stains gave the best results.

Material in good condition was obtained from three different sources. It is of interest that in these materials from widely separated localities uniform variations existed, yet all can be included under one type, a type differing markedly from that of *S. crassa*, already published, and from that of *S. dubia* and *S. ternata* now in preparation. In regard to the nuclear division of *S. dubia*, the discovery of 5 chromosomes was made, while in *S.*



*ternata* 4 chromosomes were found. This would seem to be the lowest number yet found in plants. The following quotation from DIGBY'S (3) investigation on *Crepis virens* states: "*Crepis virens*, as has been shown by ROSENBERG, possesses only 6 somatic chromosomes, the lowest number hitherto recorded in plants." Six chromosomes are also recorded by WISSELINGH (12) in *S. setiformis*, and by KARSTEN (5) in *S. jugalis*. The number of chromosomes in *S. bellis* agrees with that found by the writer (8) in *S. crassa*, namely, 14. Since a single genus of plants, as shown in *Spirogyra*, exhibits such striking differences in the number of chromosomes, there is no foundation for the assumption that nuclei in plants of a similar genus will show similar morphological organization. Morphological variation in the nucleus obtains in different species, just as variations occur in the number and winding of chromatophores and in cell dimensions.

In the 3 varieties of *S. bellis* also minor variations were seen in karyokinesis. So far as known to the writer, such variations in nuclear division have not been worked out in detail and established for any particular plant. MITZGEVITSCH (10), working on *S. subaequa* and *S. jugalis*, found differences in the distribution and origin of chromatic material in the prophase; but to establish distinctions in nuclear division, varieties in species as well as many species for comparison should be worked upon.

The dimensions of the vegetative cells of these 3 varieties of *S. bellis* Hass., and conforming to *S. bellis* as described by COLLINS (2), are as follows:

Var. *A.*—Vegetative filaments 57  $\mu$  in diameter, 95  $\mu$  in length, 3 or 4 spirals in the filament. This was gathered from the margin of a brook in which was intermingled *S. longata*, *S. inflata*, *S. gracilis*, at Northfield, Massachusetts.

Var. *B.*—Vegetative filaments 64  $\mu$  in diameter, 220  $\mu$  in length, 5 spirals in the chromatophore, the latter markedly dentate; border of river in Needham, Massachusetts. This was not a pure culture of *Spirogyra*, but intermingled were various filamentous desmids and *Mougeotia*.

Var. *C.*—Vegetative filaments 60  $\mu$  in diameter, 220  $\mu$  in length, uniformly longer than *B* and much longer than *A*; some threads



with 4 spirals, others with 5; fertile cells not swollen, zygosporc oval. It also resembles *S. majuscula* Wolle. This material grew in pure culture in a swamp in a low-lying pasture.

Preparations of the 3 varieties show essentially the same structures. *C* was noteworthy for great variation in number and size of nucleoli. The 3 varieties show striking uniformity in formation and appearance of chromatic disks in approximately the same numbers. It was found advisable to make sketches of nuclei not at equal intervals of time, but at those periods when changes in the form and density of the component parts were more manifest. As some of these changes took place with great rapidity, others only appearing as a slow evolution, many rough sketches were made, not only following one nucleus throughout its changes, but also in different nuclei, studying particular phases repeatedly where changes were most rapid, to confirm interpretations made upon one. This seemed necessary, as many of the appearances were at variance with published results of other investigators. The rapidity of the changes in the living material explains why we get such variation in the fixed material.

From the appearance of the first change in the nucleus until the close of the reconstruction of the daughter nuclei, about an hour elapses; in some cases, 80 minutes. As the phases merge into one another, it is difficult to give precise time, but the following schedule may be taken as a typical example: prophase 15 min., metaphase 5 min., early anaphase 15 min., late anaphase and telophase 30–45 min. The changes in the nuclei are most marked and rapid in the first 3 phases. In late anaphase and telophase, although changes in translucency and shape occur, they do not result in such great differences in position; hence frequent sketches with constant comparison of observations were necessary to be assured of these changes. Since the structural organization of the nucleus is but the result of fixation of colloidal materials seen in living cells, effort was made to find in the living cells the homologue of the stained structure.

The quiescent nucleus contains a central spherical body (fig. 1), or more often in variety *C* two or more such bodies. This body may appear bluish or slightly opalescent as compared with the



more translucent rim that extends into the suspensors. It may be subtended by a similar appearing but crescent-shaped mass (fig. 2) likewise surrounded by a translucent rim. In fixed material the central body of the quiescent nucleus shows still greater variations in appearance. One or more vacuolar-like appearances may be seen within, or these may be lacking, the space being filled with substances differentiated in the double staining. Sometimes the central body may be composed of many small granules uniformly deeply stained, although double staining in the cell has differentiated parts of the chromatophore.

That such a body, generally termed the nucleolus, is a nucleolus in every species of *Spirogyra* appears very doubtful to the writer. The position and relative amount of cytoplasm suspending the nucleus and forming a border to the same, the extent of nuclear plasm, nucleolus, and nucleolar vacuole exhibit great variations in the different species. Hence the suspicion arises that some of the discrepancies in results obtained by investigators such as TRÖNDLE (11) and ZACHARIAS (13), working on the microchemical reactions of the central body, may be due to the fact that in some species the central body is a nucleus, the considerable space about it being cytoplasm; while in other species only a narrow border of cytoplasm exists, the nucleus with the contained nucleolus comprising all. The limits of this paper will not permit the extended comparisons of different species that would serve to establish such a view. The term central body will be used in preference to that of nucleolus, the main object here being to present certain new details in the history of the chromatic figure.

### Prophase living

Although the central body appears to become diffused in enveloping plasm, as preliminary to this process an infusion of cytoplasmic substance flowing in through the suspensors must have taken place to account for the enlargement of the mass. This inflowing substance mixes with the nuclear plasm and denser substance in the spherical body, causing the sudden overflow as it were of the boundaries of the sphere. This change takes place with great rapidity, as shown by comparison of figures, beginning



with one drawn at 8:50 P.M., where a nucleus with its barriers still unbroken can be seen, the larger granules vibrating above and below, with the same nucleus drawn 10 minutes later, where the previously spherical body has become completely diffused in the enveloping plasm. While this change takes place, the merged mass of central body and enveloping plasm is no longer spherical, but exhibits amoeboid movements (figs. 3, 4, 14), the various parts appearing to change constantly in density. In some cases there seemed to be no streaming of the larger granules, the latter appearing either stationary or oscillatory. The overflow of nuclear content is but the manifestation of the disturbance of the ratio of nuclear mass to cytoplasm advanced by HERTWIG (4) as the cause of karyokinesis. This enlargement of the nucleus is coincident with the increase on all sides in the size of the suspensors (fig. 4). This appearance suggests that the suspensors act as the main channels, enlarged now as inlets for the superabundant assimilatory products derived from the chain of pyrenoids with which they are connected.

Finally, those suspensors which attach the nucleus to the chromatophores in the long axis of the cell appear to enlarge more rapidly than the others, showing that the main currents are now diverted in this direction. Meanwhile the large vesicles, gathered above the nucleus and appearing to aggregate there in a plane through the short axis of the cell, show active Brownian movements.

During this constant amoeboid movement of the more or less spherical mass, the turbidity which before extended through the mass to the bordering translucent rim now appears to clear in certain regions (fig. 5). It is to be noted, however, that in this turbid mass there is no trace of organization. Regions where changes take place are indicated in the drawings, where turbidity is shown by the gray shading. Lessening of the turbidity is to be seen, not at the equator, but at the lighter areas at some distance and also in the regions near the bordering rim.

Meanwhile, this whirlpool-like activity shapes the spherical mass into that of an ellipsoid. The granular folds of protoplasm that were constituents of the suspensors, and that lay at the margin of the more homogeneous protoplasm enveloping the



central body, appear to be pushed back on either side by the interior expansion of the mass, finally to take up a position at the poles of the spindle (figs. 15, 16).

### Prophase fixed

Since each preparation could exhibit only the particular phase of activity at the instant of fixation, and since this period averages 15 minutes, it would be difficult to find two series of precisely equivalent stages. The differences manifested upon fixation of the turbid spherical mass can best be explained by references to the figures. These all show with the enlargement of the nucleus the unequal increase of the suspensors as the spindle begins its evolution. In all of the cells the beginning of the formation of the cell plate is to be seen before the dissolution of the nuclear membrane. No attempt is made to present the figures in sequence, as there is no evidence as to whether one stage follows another or as to whether in other nuclei a different disposition of substance may not obtain at corresponding intervals of divisions.

The chromatic granules, as in fig. 28, may be scattered on the main suspensor as well as over the central mass of granules. All of the chromatic substance may be gathered in a sphere to one side of the enlarged nucleus. This substance is in the form of granules (fig. 27) or of filaments and granules (fig. 25). In fig. 26 chromatic granules are connected by a finer network and distributed all over the enlarged nucleus. In the center lighter granules may be seen, suggesting a decomposing nucleolus. Fig. 29 shows lighter stained granules equally distributed over the mass. Scattered among them are short filamentous bodies. Finer granular masses in the center indicate the remains of a nucleolus. In figs. 31 and 33 is seen a somewhat contracted spherical mass, evidently both nucleolus and nuclear plasm, and consisting of granules both lightly and deeply stained. These are connected with the nuclear membrane by delicately stained strands. This and fig. 25 might be considered as a stage in synapsis. In fig. 24 no finer granular material is seen within the nuclear membrane, but there are chromatic masses ranging from tetrahedral forms to that of vesicles. Fig. 35 shows similar chromatic masses imbedded in or



overlying a less deeply stained material. Other figures show minor variations from those previously mentioned. In comparison, all that these stages appear to have in common is the increasing tendency of the material, chromatic and non-chromatic, to be peripherally arranged on a sphere.

### **Metaphase living**

As the enveloping protoplasm gradually becomes more tenuous, adding substance to the retreating folds, the ellipsoid mass changes and becomes cylindrical. This appears to be due to the accumulation of denser portions on the surface and the gradual penetration of more liquid material to the interior. This may be forced out at the poles as the denser materials assume the form of a disk (figs. 5, 15, 16). The cylinder as it elongates loses progressively its turbid appearance. As the turbidity diminishes, the equatorial part retains the gray tint, forming gradually a dark band (fig. 17), while light bands by degrees evolve, encompassing the cylinder one on either side of the equator (figs. 16, 18). These bands as they assume concrete form acquire a translucent appearance. They condense into two disks connected by fragments of cords of a similar translucent appearance. It is to be seen, therefore, that instead of a sharp splitting and consequent clear-cut separation of equatorial masses of the cylinder occurring, no actual narrow rift was perceptible, although many nuclei at this stage were closely scrutinized for the expected splitting. There is no evidence in living material of these two disks having arisen from the splitting of discrete chromatic bodies. It is as if a gradual accumulation and rearrangement of materials had taken place, until finally the dense materials, appearing as jelly-like disks, are moving to the poles of the spindles, while vestiges of cords drag behind (figs. 19, 20).

### **Metaphase fixed**

Figs. 34 and 35 represent transitional stages where the nuclear membrane has dissolved. Here the mass of stained material is beginning to lose its spherical shape; and the suspensors change, some in the long axis of the cell increasing and appearing as lines of granules directed, not as before, away from the margin of the



nucleus, but from the darkly stained mass. Around each of the deeply stained bodies a faintly defined areola can be seen (fig. 36). In subsequent stages, instead of being disposed without order on the periphery of the mass, they seem rather to form an equatorial band around the cylinder (figs. 37, 38). Those which seem to be well defined, and hence possibly properly called chromosomes, average 14 in number. They may become looped and arranged in such manner that ends of the loops may present an appearance as if constituting a single row of granules (fig. 40). The other granular material composing the cylinder now shows a tendency to longitudinal striation (figs. 41, 42, 43); later it takes the form of pyramids (figs. 46, 47, 48). When the masses take the form of pyramids the apices of the pyramids point to the poles of the spindle. The edges of the pyramids may stain almost as black with chromatin stains as the other bodies (figs. 46, 47). Comparison of living materials with stages showing pyramidal arrangement of chromatic substance suggests that the pyramids, with their apices always pointing to the spindle poles, are but fixations of the streams emanating from the oppositely charged jelly-like opalescent disks. A spindle inclined by pressure shows, as the mass condenses, small thickenings of chromatin appearing at the edge of the substance (fig. 39); hence the thickenings are not confined to the denser filaments in the bands. Again, in many sections the pyramidal appearance of the chromatic material suggests in its orientation an incompletely formed spireme (fig. 47). At this stage the pyramidal masses discharge droplets of material from the edge of the equatorial band (figs. 47, 52).

A gradual amalgamation and condensation of the two substances next occurs. The looplike nature of the lighter stained material and the pyramidal appearance are brought out in figs. 46 and 47. Analyses of these figures show that as they amalgamate they form groups, each group consisting of 4 masses inclosing a vacuole. Such structure of groups is like that described for groups making up chromosomes in *Allium* (9). Comparison of fixed cytoplasm shows that granules in the cytoplasm often assume this form. Its frequent occurrence shows that we have not a splitting of materials; hence such appearances could play no important part in theories



as to the reduction of chromosomes. This is probably, as LILLIE (6) suggests in regard to tetrad groups of *Ascaris* described by BRAUER, a purely physical phenomenon, a grouping due to precipitation of oppositely charged colloidal masses. These groups in turn are connected with each other by strings of less dense substance. A side view of them gives the impression of short dark bodies subtended by loops of lighter substance. They may present the same pyramidal appearance as seen before the separation of the disks. Pressure on the cover glass on turning the disks to full polar view shows the disks to be of no appreciable depth, and to consist approximately of 4 rows of tetrads (figs. 56, 57). As the disks exhibit a tendency to be attracted to the poles they become cone-shaped, the apex pointing in the long axis of the cell.

A gradual pulling apart of the amalgamated material follows, until, as in figs. 53-57, two opposing disks are seen. The position of these disks, their shape, and consequent behavior in pulling apart, show them to be but the fixed and stained masses which constitute the jelly-like bands seen in living material evolving from the turbid mass. The turbid mass corresponds to the fixed spherical mass composed of irregularly disposed filaments or granules. These disks of material as seen in fixed specimens are not preceded by the splitting of chromosomes in prophase, as stated by MITZGEVITSCH (10), BERGHS (1), and others. It is the amalgamated masses just as in *S. crassa* (8), the amalgamated spireme that appears to be pulled apart, forming two opposing networks in which no distinction of material now is apparent, unless it be in the linin-like connections of the groups.

With the formation of these networks, the space between the two becomes very clear. All the granules making up the spindles are absent, the intervening space between the networks being crossed by a few strands (figs. 51, 52) which in later stages appear to become attenuated and then disappear. These strands are identical with the translucent cords which in living material connect the separating jelly-like disks. Studies of living material raise the question whether the matter in the disks may not move more often to the poles in strands or streams not cohering in a disk, but reassembling in the form of disks when the poles are reached.



The network as it passes to the poles is seen to be not a uniform disk, but to become concave (fig. 55), the concavity pointing to the poles, indicating the direction of the attractive force. In some cases the concavity appears as a cone of granular material on a base of deeply stained tetrahedral masses (fig. 58). Arrived at the poles the network now converges to a spherical shape (figs. 59, 60), the chromatic material tending to become peripheral in position (fig. 62). Irregular masses of it later may be discharged. Fig. 67 illustrates the intimate connection of chromatic substance with pyrenoids. Figs. 62–68 show that as many variations mark the beginning of telophase as were seen in prophase. The chromatic masses become reduced in size, while the nucleolus as a reserve body appears in their midst.

Since the increase in size of the nucleolus is correlative with the reduction in chromatic masses, it is probable that it is not to be considered a karyosome, but derived indirectly from them.

### Anaphase living

Returning to the study of living material, we find that this can be correlated step by step with that seen in fixed material. The movement of denser portions of disks away from each other does not always occur at once, as strands of the translucent substance connect the separating masses and also strands soon form connecting the granular polar masses (figs. 7, 17–20). These dense strands show no evidence of being composed of homogeneous bodies arranged as strings of beads. This accords with the observations on living material made by LUNDEGARDH (7).

While the translucent disks that we may term *a* and *b* are evolving and gradually retreating from one another, a similar (in appearance) jelly-like substance *c* and *d* appears at either end of the cylinder as it assumes the typical spindle form (fig. 7). Disks are represented by light areas. These evidently are not directly derived from the disks, as they are of considerable size before the approach of the latter; also, the disks do not appear to diminish as the strands bordering the cylinder increase. The ends *c* and *d*, partly under the chromatophore, show the same optical density, and are translucent and opalescent, while all else is grayish. The



substances *c* and *d* are evolved about 5 minutes later than the first appearance of *a* and *b*. Upon examining many kinds of fixed material, stages were found, as shown in figs. 38, 53, and 55, where polar chromatic disks similarly appear in metaphase and anaphase. In some cases only chromatic granules, in place of disks, are present, reminding one of centrosomes (fig. 50).

These substances appearing at the ends of the spindle may have been originally either at the border of the turbid mass seen in prophase (fig. 5), or else may be the accumulations discharged from the disk in metaphase as separate droplets (see fig. 62, from fixed material). Whether of cytoplasmic or nuclear origin, they appear to be of the same consistency as the disks having similar indices of refraction. The ends of the spindle are now lost to view in aggregations of granular matter that appear identical with the earlier suspensors. As the disks *a* and *b* approach the poles, a border of similar material appears, connecting them with disks *c* and *d* (fig. 8). This results in two irregularly shaped figures inclined to the quadrilateral, the jelly-like substance on the rim, the interior grayish.

This blending takes place before the two gels in their retreat have reached the polar granular masses. The substance in *c* then, probably contributed by the cytoplasm, rejuvenates the chromatic substance, and with this blending the disks likewise lose strands of their material to the cytoplasm. The changes in form and translucence of all substances in this stage take place with great rapidity. This accounts for the great variability and amorphous appearance of the separating disks as seen in prepared slides. The many kaleidoscopic shiftings of these masses, as illustrated in figs. 8–11 and 20–22, result in the appearance of a nucleolus within the grayish interior of each quadrilateral, while the gel forms the rim or daughter nuclear plasm. As movements subside, a reversal of optical refraction ensues, the central body appearing to increase in density, while the nuclear plasm becomes optically more like the hyaline cytoplasm (figs. 12, 13).

The daughter nucleus has manifestly received accessions from the cytoplasm at two periods in the karyokinesis: (1) when the sphere enlarges and becomes turbid; and (2) when disk *c*, apparently



from the cytoplasmic material, blends with *a* from the equatorial disk. Since disk *c* with *a* plays an important part in the reconstruction of the nucleus, and only disk *a* seems to coincide with the amalgamated chromatic material seen on the slides, it would appear that *Spirogyra* lends support to the views of those who believe that the chromosomes are not the sole containers of hereditary substances. It cannot be said that the material of the mother nucleus is equally divided between the two daughter nuclei, for all of the material in the two nuclei is not from the mother nucleus; while again, some of the colloidal material of the mother nucleus passes into the cytoplasm before the two daughter nuclei are formed. These observations also suggest that karyokinesis is no longer to be considered merely as a process of division, but as a process made up of alternating phases of addition, combination, and withdrawal of protoplasmic substances from nuclear centers.

### Summary

Instead of a spireme, as in *S. crassa*, a disk arises from material condensing within the mass of nuclear plasm and central body. This disk is discernible in both living and stained material.

No trace of organization is to be seen in the living disk, but fixed material shows it to arise from aggregations of variable appearance and staining qualities. These aggregations are not the chromosomes. The more deeply stained of these bodies arise from the nuclear plasm, the less deeply stained appear to come from the decomposing central body.

This sphere of aggregated material gradually changes in shape, becoming a cylinder. The more deeply stained masses become arranged upon it as an equatorial band. This band is homologous with the disk seen in living material. As the disk evolves, chromatic bodies, averaging 14 for this species, are to be seen on the band, while other irregular masses of chromatic material project as loops or pyramidal masses from its edge. These loops or masses represent material from nuclear plasm and central body that has partially amalgamated.

No rift appears in the living disk to indicate a sharp splitting of components, but instead the changes in appearance indicate a



thinning in the center, while parts reassemble at either pole. The chromatic bodies in the fixed disks appear as viscous masses that, as they amalgamate, elongate, while other disconnected chromatic masses are discharged into the cytoplasm as the disk separates into the halves passing to the poles.

The living disks may be seen sometimes to pass *en masse* to the poles, but more usually they divide their substance into a few continuous strands, to reassemble as disks at the poles of the anaphase. These strands cannot be identified as moving chromosomes, since no units can be discerned in them. As the disks approach the poles, they appear to blend with similar disks apparently evolved from cytoplasm.

Each daughter disk thus arising upon fixation consists of a series of about 4 rows of tetrahedral masses. In living material the same appears as a translucent rim surrounding a less dense interior. The translucent rim becomes the nuclear plasm, while the central body takes shape within the less dense interior.

*Spirogyra*, as exemplified in *S. bellis* and *S. crassa*, may be characterized as having chromatic substance of a polymorphous nature; in the one a disk, in the other a spireme. The nucleolus does not fragment directly into chromosomes, as upheld by so many investigators, but only contributes the less dense substance seen at metaphase, which eventually may be discharged or become partially amalgamated with the chromatin. Hence *Spirogyra*, as regards the constitution and behavior of its nucleolus, need not be placed in a different category from the remainder of the green algae or from that of higher plants.

HUNTER COLLEGE  
NEW YORK CITY

#### LITERATURE CITED

1. BERGHS, J., Le noyau et la cinèse chez le *Spirogyra*. *La Cellule* 23:53-86. 1906.
2. COLLINS, F. S., The green algae of North America. *Tufts College Studies* 2: no. 3. 1910.
3. DIGBY, L., A critical study of the cytology of *Crepis virens*. *Archiv Zellforsch.* 12:—, pls. 8-10.



4. HERTWIG, R., Über Korrelation von Zell und Kerngrösse und ihre Bedeutung. Biol. Centralbl. 23: 49-62, 108-119. 1903.
5. KARSTEN, G., Die Entwicklung der Zygoten von *Spirogyra jugalis*. Flora 99: 1-11. pl. 1. 1908.
6. LILLIE, R. S., The physiology of cell division. Amer. Jour. Physiol. 15: 46-84. 1905.
7. LUNDEGARDH, H., Die Kerntheilung bei höheren Organism nach Untersuchungen an lebenden Material. Jahrb. Wiss. Bot. 21: 236-281. 1902.
8. MERRIMAN, M. L., Nuclear division in *Spirogyra crassa*. BOT. GAZ. 56: 319-330. pls. 11, 12. 1913.
9. ———, Vegetative cell division in *Allium*. BOT. GAZ. 37: 178-207. pls. 11-13. 1904.
10. MITZGEVITSCH, L., Über die Kerntheilung bei *Spirogyra*. Flora 75: 81-124. 1898.
11. TRÖNDLE, A., Der Nukleolus von *Spirogyra* und die Chromosomen von höheren Pflanzen. Zeitschr. Bot. 4: 721-747, figs. 11. 1912.
12. VAN WISSELINGH, C., Über Kerntheilung bei *Spirogyra*. Flora 86: 353-377. 1900.
13. ZACHARIAS, E., Die chemische Beschaffenheit von Protoplasma und Zellkern. Prog. Rei. Bot. pp. 67-257. 1910.

#### EXPLANATION OF PLATES XVIII-XX

All figures, except those of living nuclei, were drawn with the Abbé camera lucida, Leitz objectives, and Zeiss compensating oculars; drawings reduced one-half.

FIGS. 1-13.—Living nuclei of var. C: figs. 1 and 2, quiescent nuclei; fig. 3, early prophase at 9:07 P.M.; fig. 4, same at 9:15 P.M.; fig. 5, at 9:20 P.M.; fig. 6, at 9:25 P.M.; fig. 7, at 9:32 P.M.; fig. 8, at 9:36 P.M.; fig. 9, at 9:40 P.M.; fig. 10, at 9:44 P.M.; fig. 11, at 9:48 P.M.; fig. 12, at 9:52 P.M.; fig. 13, at 9:55 P.M.

FIGS. 14-23.—Living nuclei of var. A: fig. 14, at 7:45 P.M.; fig. 15, at 7:50 P.M.; fig. 16, at 7:55 P.M.; fig. 17, at 8:00 P.M.; fig. 18, at 8:07 P.M.; fig. 19, at 8:10 P.M.; fig. 20, at 8:12 P.M.; fig. 21, at 8:25 P.M.; fig. 22, at 8:28 P.M.; fig. 23, at 8:33 P.M.

FIGS. 24-68.—From preparations fixed in chromo-acetic; figs. 36, 46-48, 51, 52, and 56  $\times 3000$ ; all others  $\times 1800$ .



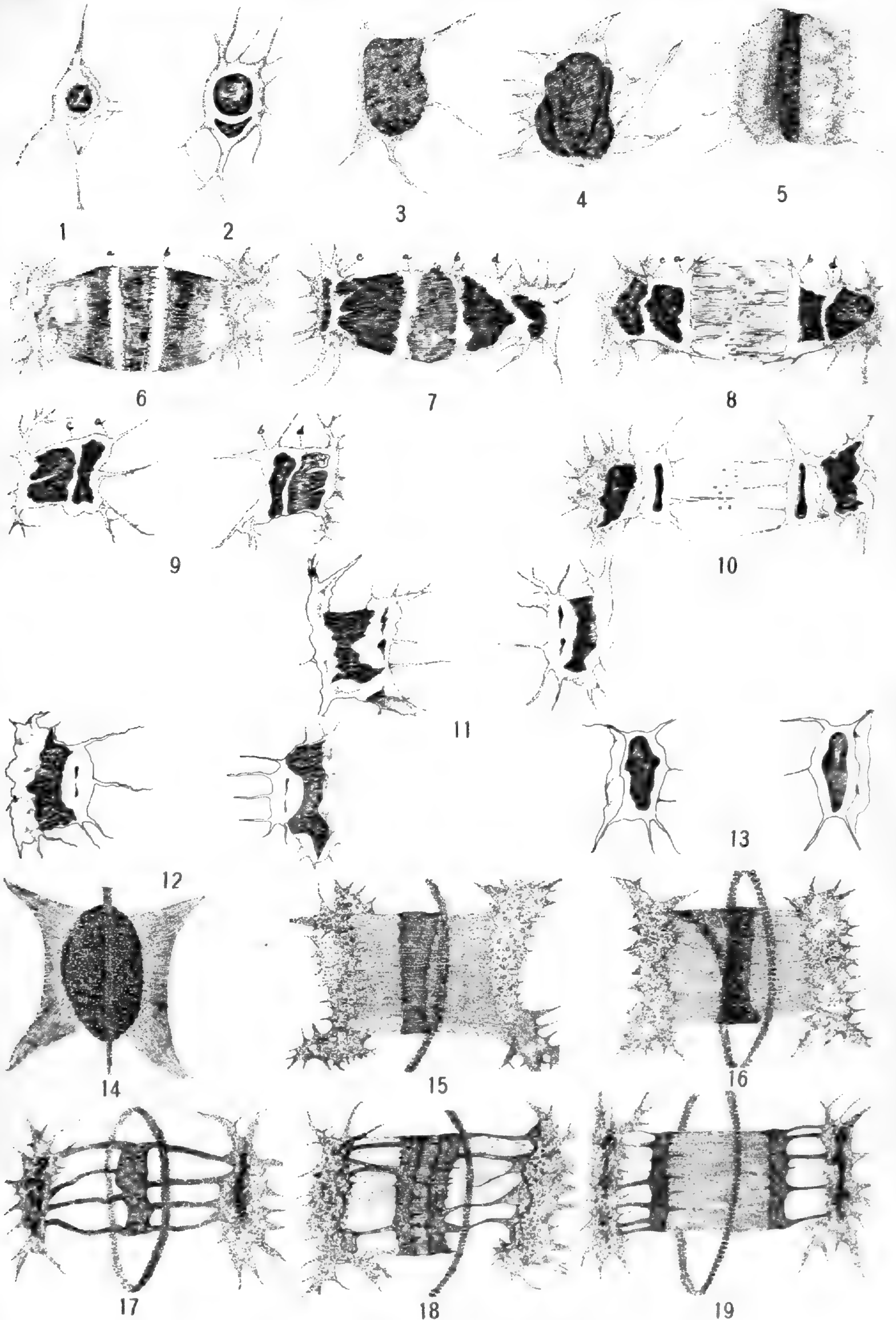

MERRIMAN on SPIROGYRA BELLIS



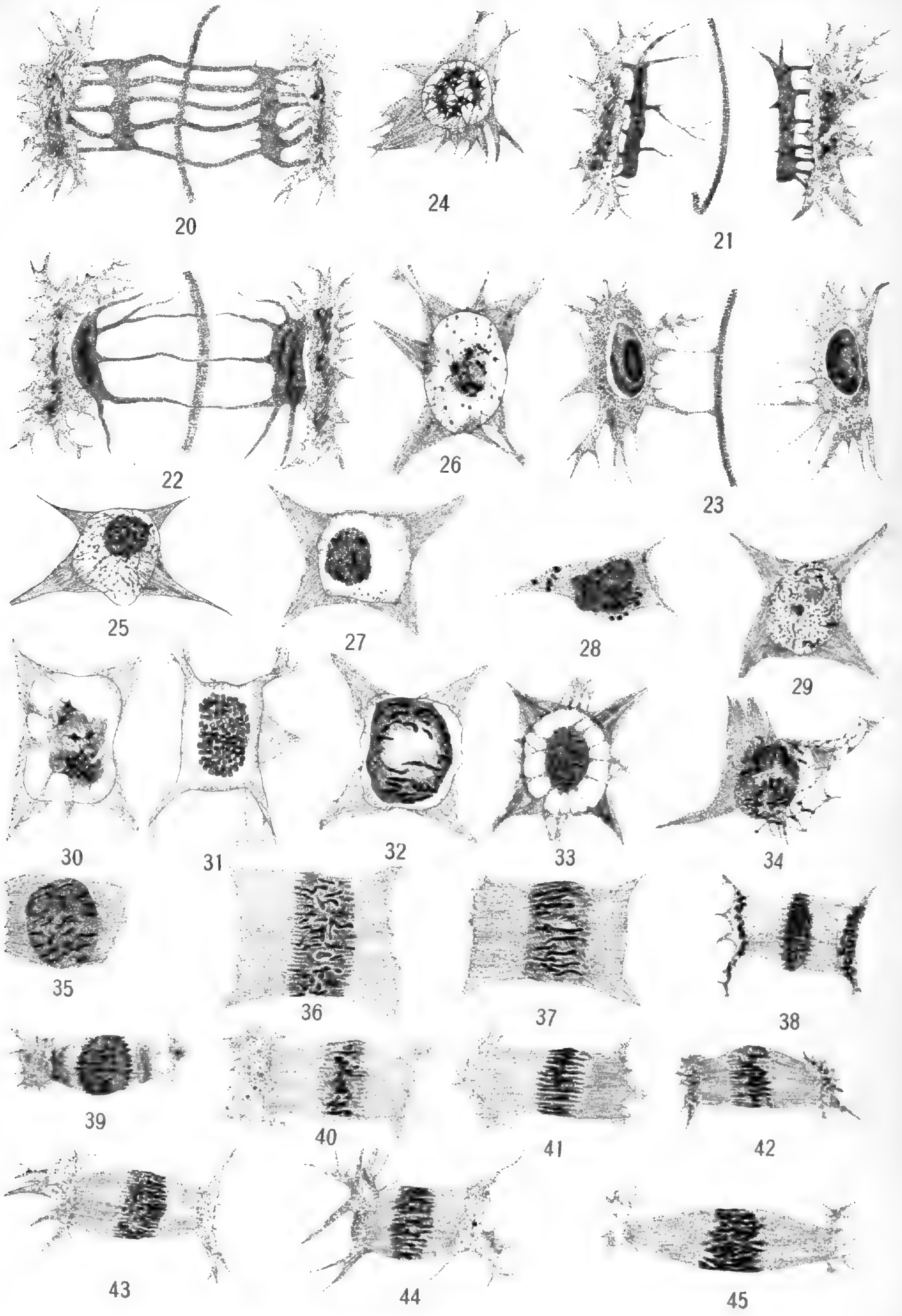



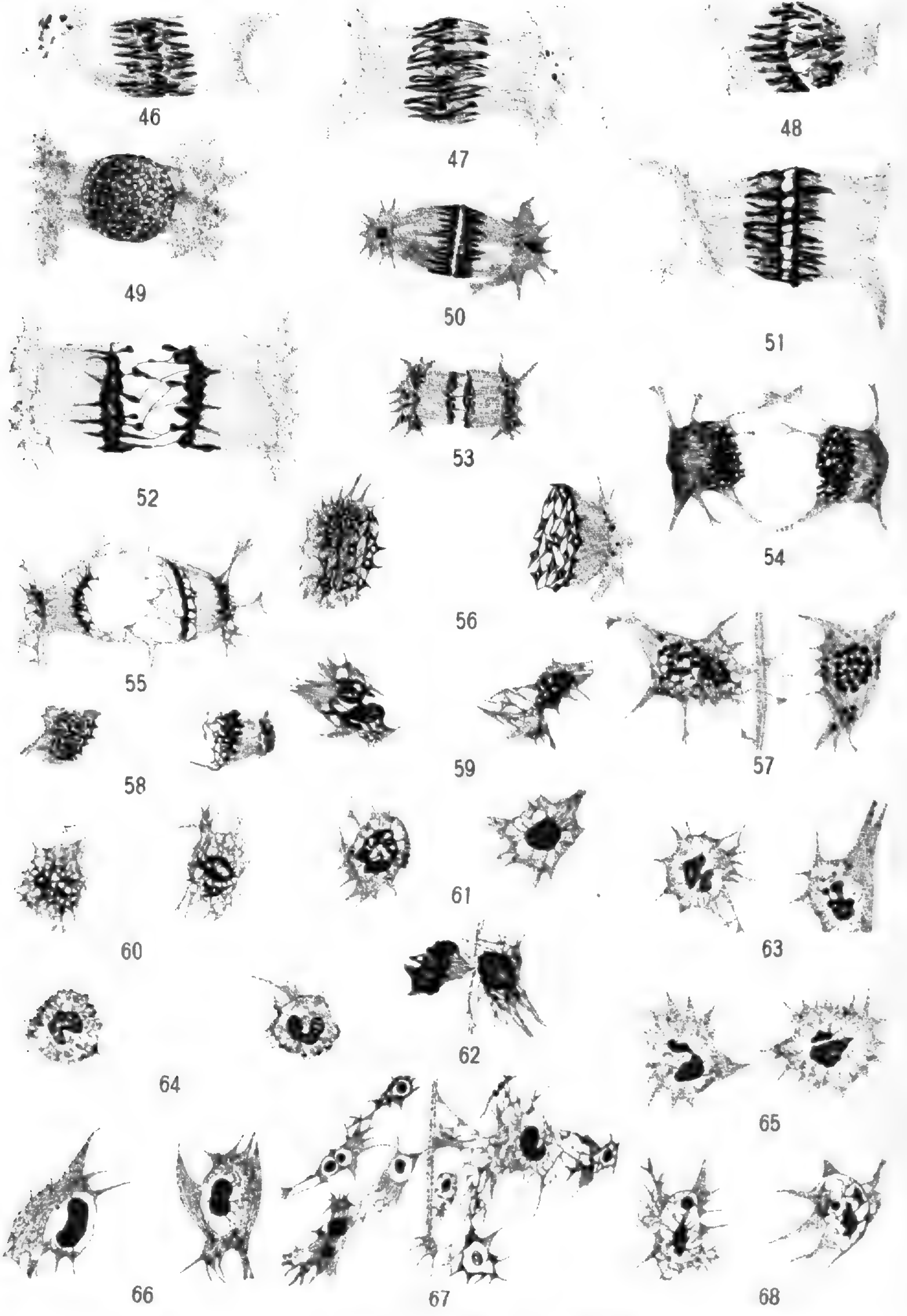

MERRIMAN on SPIROGYRA BELLIS



# THE EMBRYO SAC OF RICHARDIA AFRICANA KTH.

MARGARET R. MICHELL

(WITH PLATES XXI-XXIII)

Up to the end of last century very little was known of the embryo sacs of the different genera of the Araceae. Since then, however, several American botanists have contributed to our knowledge of the subject, with the result that now we do know something of the development of the embryo sacs. Yet in spite of this work, our knowledge of the family is by no means satisfactory. Perhaps this may be due to the fact that much of the material worked upon has been collected in greenhouses, where conditions are far from normal. The difference in habit between the plants of *Richardia africana* growing in their home in South Africa and those found in greenhouses in England is most striking, and it is possible that conditions which can affect the outward appearance of the plants to such a large extent may be effective in producing abnormalities in the embryo sac.

While this investigation was in progress, Gow (7) published a short account of the embryo sac of *Richardia*. His results differ from mine in so many respects, however, that it seems advisable to publish my results, particularly as my material was obtained from plants in their native habitat.

*Richardia africana* is a native of Cape Colony and St. Helena (5), and flowers freely in damp open places in the Cape Peninsula, where the material for this investigation was collected. The plants are in full flower in August, although young inflorescences may be obtained as early as April.

The chief fixatives used were an alcoholic solution of corrosive sublimate and picric acid, made according to JEFFREY'S formula: Carnoy's fluid and a mixture of three parts of absolute alcohol to one part of glacial acetic acid. A certain amount of shrinking took place in all cases, though in the very young ovaries fixed in the absolute acetic mixture this was practically negligible. Chrom-acetic solutions gave very poor results. The chief stain used



throughout was Haidenhain's iron-haematoxylin, as this gave excellent differentiation in all stages. Good results in the post-fertilization stages were obtained with carthamine (gossypimine) and picric-aniline blue. Many other stains were tried, but none of them was as good as the two already mentioned.

### Ovule and embryo sac

The ovary usually consists of 3 carpels and is trilocular, each loculus containing about 4 not very definitely anatropous ovules arranged in an axile manner. These ovules have the massive basal part of the outer integument so characteristic of the Araceae. The inner integument closes about the time that the megaspore mother cell shows signs of the first division leading to the formation of the embryo sac. The outer integument remains open until endosperm development is well under way.

The two integuments show numerous changes throughout their course of development. The inner one does not attain any great thickness, never being more than 2 or 3 cells thick. Before fertilization, the cells of the innermost layer of this integument, especially those cells in the region round the lower part of the embryo sac, grow rapidly in a plane at right angles to the axis of the ovule (fig. 11*a*). After fertilization, cells of this layer again grow rapidly and gradually lose their flattened form, although they still remain conspicuous by reason of their large size. The chief feature of the outer integument is its great thickness in the chalazal region. It is composed of small uniform cells, with here and there a large cell containing raphides. These large cells are in every way similar to those found in the ovary wall. As the seed matures, intercellular spaces appear in the integument, and the outer surface becomes lobed, particularly at the micropylar end.

The nucellus, as in most other Araceae, is not very permanent tissue, and by the time the egg is ready for fertilization all that remains of it is a cap above the embryo sac and a few cells at the base.

The archesporial cell is differentiated early, before the origin of the second integument. It is easily distinguishable by its denser protoplasm and somewhat larger nucleus. Soon after the appear-



ance of the rudiment of the outer integument, the nucleus of this cell goes into synapsis. Fig. 1 shows the spireme loosening itself from the synaptic knot. The synaptic knot in *Richardia* is a very tight one, and in many ovules in this stage no trace of the spireme could be detected emerging from it. Fig. 2 shows a further stage in the heterotypic division, 12 bivalent chromosomes being arranged on the equatorial plate. The homotypic division follows, thus giving rise to a row of 4 megaspores. Fig. 3 shows stages in the anaphase of this division. In the nuclei represented in this figure it is interesting to note that in the upper nucleus the two halves of one chromosome have not separated, but have remained attached by one end. As a rule sluggish divisions of this type were not observed.

Of the 4 megaspores, only the lowest gives rise to the embryo sac. Fig. 4 shows an ovule in which the uppermost megaspore is beginning to degenerate. In certain cases in which the uninucleate embryo sac is a little larger than the one in this figure, only the remains of 2 megaspores could be detected. It is possible that in these cases only 3 megaspores were formed, although none of my preparations of stages before degeneration shows fewer than 4 megaspores.

Gow (7) states that the spore mother cell develops directly into the embryo sac and that a row of megaspores is not formed. In my material I found that a row of megaspores is invariably formed, and in no case is there anything to lead one to suppose that the embryo sac has originated directly from the megaspore mother cell.

The development of the embryo sac is perfectly normal. In the majority of cases there is a marked polarity. Fig. 5 shows the first division in the embryo sac. In the section represented, only 2 of the degenerating megaspores are to be seen, but a third is present in the next section. Fig. 6 shows the binucleate stage of the embryo sac, and fig. 7 the 4-nucleate stage. Fig. 8 represents the division of these 4 nuclei. It is unfortunate that this was the only case obtained in which the 4 nuclei were dividing, as the polarity so generally met with is absent, and it is not known whether this is the usual state of affairs or not. In subsequent stages shown in my preparations the embryo sac is markedly bipolar.



Fig. 9 shows the upper polar nucleus beginning to move toward the chalazal end of the embryo sac. The next stage is shown in fig. 10, in which the antipodals are showing signs of disintegration. The synergids have not assumed their mature form, but nevertheless may be distinguished from the egg by their position. Early degeneration of the antipodals is usually marked in *Richardia*, although in a few cases they persist, although somewhat degenerate in appearance, up to the time of endosperm formation. In nearly all my preparations showing the mature embryo sac, all that remains of the antipodals is a dark mass of degenerating cells which are hardly distinguishable from the nucellar cells, which at this period often show signs of breaking down. It was not until younger stages were procured that it could be clearly demonstrated that the embryo sac had 8 nuclei, and not 5, as CAMPBELL (4) has described for certain species of *Aglaonema*. However, the stages figured in figs. 8 and 10 prove conclusively that at one period the embryo sac has 8 nuclei.

The stage most commonly met with, and one which evidently persists for some time, is the 5-nucleate one, shown in fig. 11(a, b, c). Here the synergids are quite distinct from the egg, as the cytoplasm of the egg is very much finer. The 2 polar nuclei are imbedded in dense granular protoplasm at the base of the embryo sac, and these nuclei are by far the most conspicuous nuclei in the embryo sac, owing to their larger size and deeper staining capacity. The degenerate antipodals are to be seen at the base of the embryo sac. Figs. 11a and 11b show the halves of 2 of the 3 antipodals, while fig. 11c shows the third.

The 2 polar nuclei fuse some time before fertilization. Fig. 12 shows this fusion taking place in an embryo sac where the 2 nuclei are somewhat smaller than is usually the case.

The position of the polar nuclei at the base of the embryo sac is a constant feature of *Richardia*, and in over 300 slides showing the embryo sac in this stage, none shows the polar nuclei in any position save that at the base of the embryo sac. Gow (7) in fig. 39 of his paper depicts a mature embryo sac which is quite unlike anything that I have come across in my preparations. At the time of maturity the embryo sac has the appearance shown in



fig. 11a. As fertilization has been demonstrated at this stage, it is safe to conclude that the embryo sac is mature. It is possible that Gow's figure was taken from a younger ovule.

### Fertilization

The process of fertilization is rather difficult to demonstrate in *Richardia*. Quite possibly it does not occur in the majority of ovules, as even in its native habitat *Richardia* does not set seed freely. It appears that this failure to set seed is seldom due to a lack of organization of the embryo sac, or to sterility of the pollen grains, but probably may be accounted for by the absence from the plants of an efficient pollinating agent. In this connection it is significant to note that it is rare to find one pollinated ovary alone on an inflorescence. If pollination has occurred, usually most of the ovaries have been pollinated.

CHURCH (5) has reported that small flies and green aphids visit the inflorescence when in cultivation in England, but adds that they do not seem to be of much service in pollination. The same thing, if earwigs be added to the list, occurs in the Cape Peninsula, where the remains of these insects are to be found at the base of inflorescences which obviously have not been pollinated.

A large number of ovaries were collected from inflorescences of widely differing ages. The embryo sac is mature by the time the spathe opens, and persists in this stage for an indefinite length of time. It has even been found in an ovary taken from an inflorescence whose spathe was withering.

Even if fertilization does not occur, the ovaries enlarge. It has not been possible, through lack of opportunity of proving it experimentally, to demonstrate whether the egg is capable of being fertilized the whole time the spathe is open, or whether the fertilization period is restricted to a longer or shorter time dating from the opening of the spathe.

Only one case of undoubted fertilization has been observed. This is shown in fig. 13, in which the pollen tube is seen passing through a synergid and the male nucleus is fusing with the egg nucleus. "Double fertilization" has not been observed. In the lower part of the ovule in which fertilization is being effected, the



primary endosperm nucleus has already divided, and thus there is no means of detecting whether a male nucleus took part in its formation or not. This early stage in endosperm formation is shown in fig. 4, where the antipodals are still distinct.

### Sterile ovules

Gow (7) has reported that in *Richardia* as observed in the Cedar Rapids greenhouses, a large number of ovules are congenitally sterile, producing no embryo sac. In my South African material this does not seem to be the case. In a few ovules no functional embryo sacs were found, but judging from the fact that a group of degenerate cells could be distinguished in the nucellus in each case, it seems probable that an embryo sac had been formed and had collapsed.

### Development of the embryo

Owing to the fact that fertilization had occurred in very few cases, ovules showing young embryos were only occasionally found. Endosperm development precedes that of the embryo, and by the time the small spherical embryo consists of 32 cells, the embryo sac is filled with endosperm.

In one case a 2-celled structure, which had every appearance of being an embryo, had developed at the chalazal end of the embryo sac (fig. 15a). Its protoplasm is fine and dense, making a marked contrast with the coarsely granular protoplasm around the endosperm nuclei which are found in the next section (fig. 15b). The position of the antipodals is indicated by the degenerating cells shown in figs. 15a and 15b. This was the only case in which an embryo was found in any but the normal position, and its origin is not known. In this embryo sac an egg was organized (fig. 15c), although it has evidently not been fertilized.

In all the other ovules the proembryos seen had at least 32 cells and were spherical in shape. Fig. 16 shows a somewhat oblique section passing through an embryo with over 32 cells. The embryo conforms to the type described by both CAMPBELL and GOW for the Araceae.



### Endosperm formation

Endosperm formation proceeds from the base upward. Exactly when cell walls first appear has not been ascertained, but from a comparison of different stages in endosperm development it seems probable that they appear soon after the first 2 or 3 nuclear divisions. Fig. 14, which represents the chalazal end of the embryo sac in which fertilization has been demonstrated, shows the 2 nuclei resulting from the division of the primary endosperm nucleus. Fig. 15*b* shows the division of the lower of these nuclei. Fig. 15 shows the antipodals which have by this time lost all semblance of active cells. Perhaps it is hardly fair to quote this as an instance of the complete disorganization of the antipodals after endosperm formation, as in this embryo sac an abnormal embryo has been formed, but the same thing is seen in fig. 11 (*a, b, c*) and in fig. 17, which represents a slightly later stage in the development of another embryo sac, and in every preparation of embryo sacs made at this stage. It is clear that the antipodals disorganize rapidly, and in the embryo sacs shown in figs. 18 and 19 they are no longer recognizable.

The basal endosperm cells usually have a striking appearance. Three to five of these cells become much larger than any other endosperm cells, and may be seen with the naked eye (figs. 18 and 19). The protoplasm and nuclei of these cells also undergo some change. The protoplasm becomes coarsely granular and has a honeycombed appearance. All nuclear outline is lost, while the nucleolus hypertrophies, shows great vacuolization, and finally fragments, spreading its substance over practically the whole cell. The nuclei of the neighboring endosperm cells often imitate those of the giant cells in behavior. One thing is certain, and that is that these cells are true endosperm cells and have nothing to do with the antipodals.

The function of these cells is not clear. It is interesting to compare them with the antipodal cells described in *Tricyrtis hirta* by IKEDA (10). IKEDA believes that the cytological features exhibited by the antipodals in *Tricyrtis* bear a relation to their nutritive activity. This seems to be true for these endosperm cells of *Richardia*. Everything points to the conclusion that these



cells have a nutritive function. CAMPBELL has suggested that the massive basal part of the outer integument in the Araceae may be physiologically considered as perisperm. As both the inner walls of the outer integument and the embryo sac wall, except at its base, are cutinized, it is obviously impossible for food to pass into the embryo sac except through the enlarged endosperm cells. By the time the embryo is mature these cells have disappeared and much of the food material in the basal part of the integument has been absorbed.

It is a well known fact that cells which are active in nutrition possess nuclei which differ from nuclei in the ordinary resting condition in their larger size, their chromatin aggregations, and appearance of lack of organization. HUIE (8, 9) and ROSENBERG (12) have described this phenomenon in the gland cells in the tentacles of *Drosera*, while MAGNUS (11) has shown that the same thing occurs in the digestive cells of certain orchids having endotrophic mycorrhiza. These facts seem to indicate that a nutritive function is to be ascribed to these basal endosperm cells.

### Discussion

Great variety in development of the embryo sac, even within a single species, has been reported for the Araceae, and it was with a view to finding out in what respects *Richardia africana* resembled the other members of the family that this investigation was undertaken. *Richardia africana*, or *Lantedeschia aethiopica* as ENGLER (6) calls it, belongs to the Philodendroideae, to which group also belong *Homalonema*, *Philodendron*, *Aglaonema*, and *Dieffenbachia*.

According to CAMPBELL and GOW, all these genera, with the exception of certain species of *Algaonema*, show a normal 8-nucleate embryo sac. In a series of papers on the subject, CAMPBELL (1, 2, 4) has dealt with 4 species of *Aglaonema*. He finds that the embryo sac of *A. commutatum* may contain 4-12 nuclei, and shows little uniformity in arrangement. This species has a group of cells at the base of the endosperm bearing some resemblance to that in *Richardia*. In 1900 CAMPBELL suggested that these might originate by division of the antipodals, but later in 1903 inclined to the view that they were of endospermic origin. Gow (7), however, in



1913, without reference to the later paper, confirmed CAMPBELL'S view of 1900.

In 1912 CAMPBELL (4) published the results of his researches on *A. simplex* and *A. modestum*. He believes that there are only 5 nuclei in the embryo sac in these species, this stage arising from the further division of one of the micropylar nuclei in the 4-nucleate stage. The obstacle in the way of accepting CAMPBELL'S view is that he has never been able to demonstrate the supposed nuclear division. My investigations on the embryo sac of *Richardia*, which about the time of maturity has every appearance of being 5-nucleate, have led me to doubt the division of one only of the 4 nuclei.

In many cases the antipodals degenerate almost as soon as formed, and are indistinguishable from the nucellar cells, which also show signs of degeneration. However, it has been possible to show that in *Richardia*, at least, the embryo sac is at one stage 8-nucleate; and in the absence of definite proof to the contrary one cannot but feel that the same may be true for *Aglaonema*. In the fourth species *A. pictum*, CAMPBELL records the presence of cells which look like antipodals, although in the light of his work on *A. modestum* and *A. simplex*, he is inclined to believe that they are of nucellar origin.

In a comparison of *Richardia* with the other genera of the Araceae, mention must be made of *Spathicarpa*, the development of which has been studied by CAMPBELL (2). At the time when the embryo sac is filled with endosperm, it bears a striking resemblance to that of *Richardia*, but in *Spathicarpa* CAMPBELL derives the large cells at the base of the endosperm from the antipodals, which up to the time of fertilization are inconspicuous. In *Richardia* this is not the case, the antipodals being evanescent in character.

### Summary

1. The ovary of *Richardia africana* is usually trilocular and has axile placentation. Four ovules are borne in each loculus.
2. The ovule is not very decidedly anatropous and has two integuments.



3. By the time the embryo sac is mature only a few cells at the apex and base of the nucellus remain.

4. The primary sporogenous cell gives rise directly to a row of 4 megaspores. The embryo sac is derived from the lowest of these.

5. An 8-nucleate embryo sac develops in the normal way.

6. The antipodals usually degenerate early, and when the embryo sac is mature often cannot be distinguished from the nucellus, which also undergoes a certain amount of degeneration.

7. The embryo sac persists for a long time in the stage when only 5 nuclei are distinguishable. The egg apparatus is normal and the 2 large polar nuclei lie in a mass of granular protoplasm at the base of the embryo sac.

8. The proembryo is spherical, with a minute suspensor.

9. In one ovule a 2-celled structure looking like a young embryo was found at the chalazal end of the embryo sac.

10. The endosperm develops from the base upward, and is probably accompanied by wall formation.

11. A few cells at the base of the endosperm are much larger than the rest. They possess hypertrophied nuclei and granular protoplasm. Their function is probably that of passing up food material to the young endosperm and embryo.

In conclusion I am glad to take this opportunity of thanking Dr. PEARSON for suggesting the work and for handing over to me his material and some preparations he had made. I am also indebted to Professor SEWARD for kind permission to carry on this investigation at the Cambridge Botany School, and to Mr. GREGORY for helpful criticism of this paper. I also wish to thank Miss E. L. STEPHENS, who verified certain points for me in connection with the pollination.

THE BOTANY SCHOOL  
CAMBRIDGE, ENGLAND

#### LITERATURE CITED

1. CAMPBELL, D. H., Studies on the Araceae. *Ann. Botany* 14: 1-25. 1900.
2. ———, Studies on the Araceae. II. *Ann. Botany* 17: 665-687. *pls.* 30-32. 1903.



3. ———, Studies on the Araceae. III. *Ann. Botany* 19: 329-349. *pls. 14-17*. 1905.
4. ———, The embryo sac of *Aglaonema*. *Scot. Bot. Rev.* 1912.
5. CHURCH, A. H., Types of floral mechanism. Part I. Oxford: Clarendon Press. 1908.
6. ENGLER, A., und PRANTL, K., Die Natürlichen Pflanzenfamilien 2<sup>3</sup>: 1889.
7. GOW, J. E., Morphology of aroids. *BOT. GAZ.* 56: 127-142. *figs. 47*. 1913.
8. HUIE, L., Changes in the cell organs of *Drosera rotundifolia* produced by feeding with egg albumen. *Quart. Jour. Micr. Soc.* 39: 387-425. 1897.
9. ———, Further study of cytological changes produced in *Drosera*. Part II. *Quart. Jour. Micr. Sci.* 42: 203-222. 1899.
10. IKEDA, T., Studies in the physiological functions of antipodals and the phenomena of fertilization in Liliaceae. *Bull. Coll. Agric. Tokyo* 5: 1902.
11. MAGNUS, W., Studien über die endotrophen Mycorrhiza von *Neottia Nidus-avis* L. *Jahrb. Wiss. Bot.* 35: 205-272. 1900.
12. ROSENBERG, O., Physiologische-cytologische Untersuchungen über *Drosera rotundifolia* L. Upsala. 1899.

## EXPLANATION OF PLATES XXI-XXIII

### PLATE XXI

FIG. 1.—Young ovule showing megaspore mother cell with nucleus just coming out of synapsis;  $\times 1210$ .

FIG. 2.—Formation of equatorial plate in heterotypic division;  $\times 1210$ .

FIG. 3.—Homotypic division;  $\times 1210$ .

FIG. 4.—Row of 4 megaspores;  $\times 520$ .

FIG. 5.—First division of embryo sac nucleus; two degenerating megaspores seen above it;  $\times 520$ .

FIG. 6.—Two successive sections (*a*, *b*) showing the 2-nucleate embryo sac;  $\times 520$ .

FIG. 7.—Four-nucleate embryo sac;  $\times 520$ .

FIG. 8.—Successive sections (*a*, *b*, *c*) showing the division of the nuclei in the 4-nucleate embryo sac;  $\times 520$ .

### PLATE XXII

FIG. 9.—Upper part of embryo sac showing polar nucleus moving down;  $\times 520$ .

FIG. 10.—Successive sections (*a*, *b*, *c*, *d*) showing 8-nucleate embryo sac after upper polar nucleus has moved down;  $\times 520$ .

FIG. 11.—Successive sections (*a*, *b*, *c*) showing mature embryo sac with egg (*e*) and 2 synergids (*syn*), the two polar nuclei (*p*), and 3 degenerating antipodals (*ant*);  $\times 520$ .

FIG. 12.—Fusion of polar nuclei;  $\times 520$ .



FIG. 13.—Fertilization; pollen tube (*pt*) seen in protoplasm of one of the synergids and male nucleus fusing with egg nucleus;  $\times 1210$ .

FIG. 14.—Endosperm after first nuclear division;  $\times 650$ .

PLATE XXIII

FIG. 15*a*.—Young embryo (*emb*) at the chalazal end of the embryo sac; degenerating antipodals (*ant*) below it;  $\times 520$ .

FIG. 15*b*.—Division of the lower of the two endosperm nuclei in the same embryo sac;  $\times 520$ .

FIG. 15*c*.—Unfertilized egg in the same embryo sac;  $\times 520$ .

FIG. 16.—Young proembryo;  $\times 520$ .

FIG. 17.—Two successive sections (*a*, *b*) showing early stage in endosperm development;  $\times 520$ .

FIG. 18.—Endosperm showing enlarged basal cells;  $\times 122$ .

FIG. 19.—Same, in which ordinary endosperm cells have imitated the appearance of the giant cells.



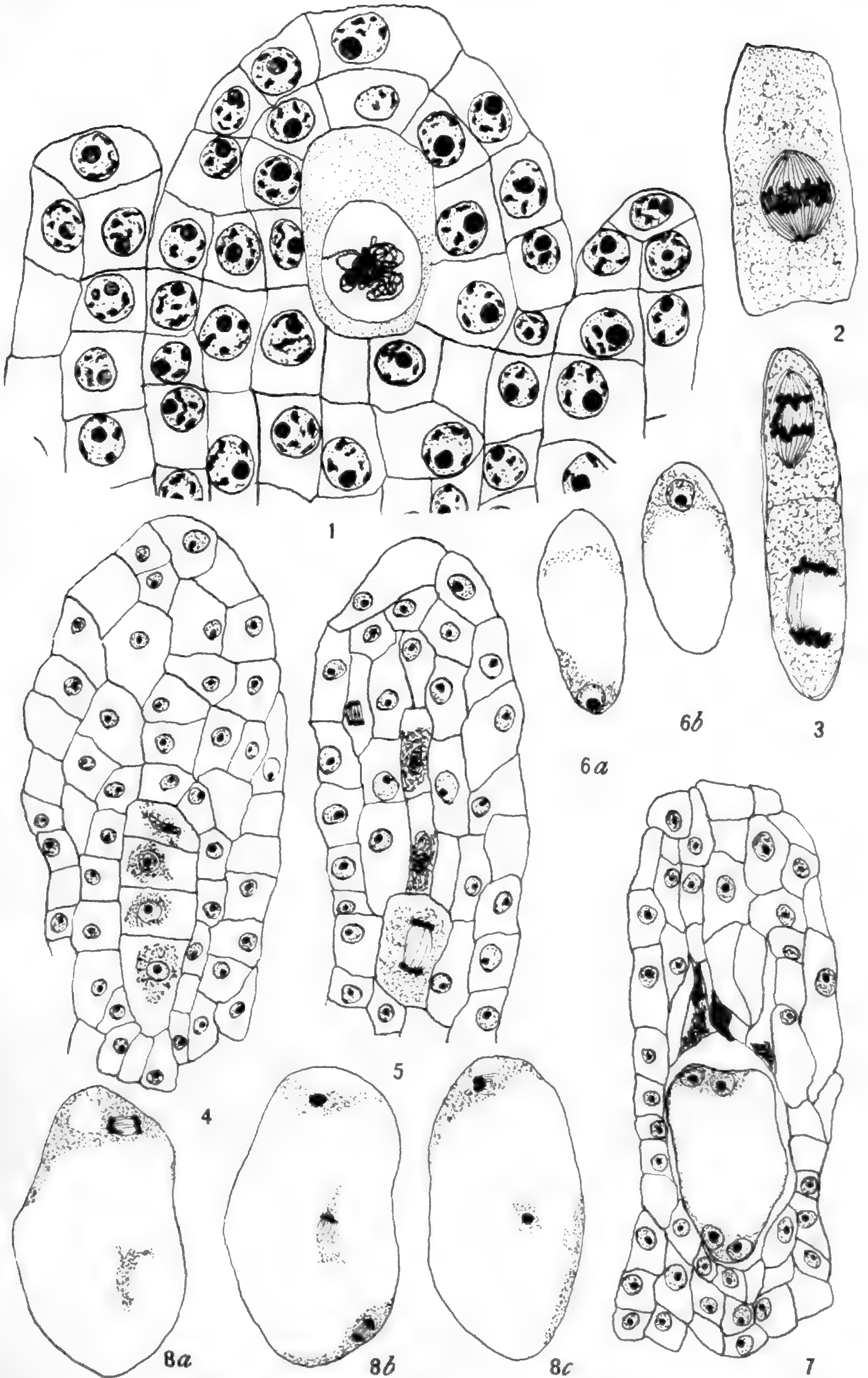

MICHELL on RICHARDIA



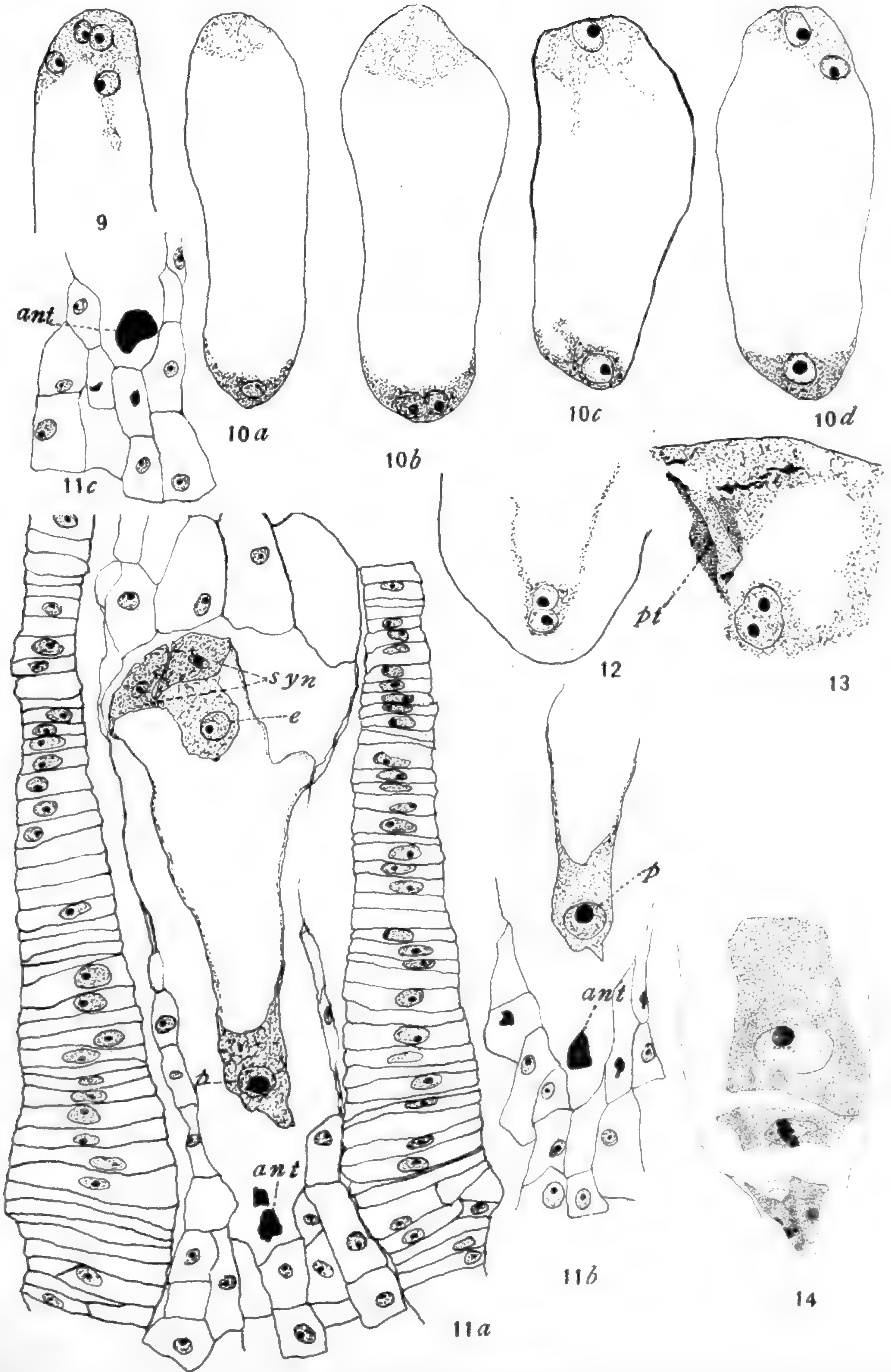



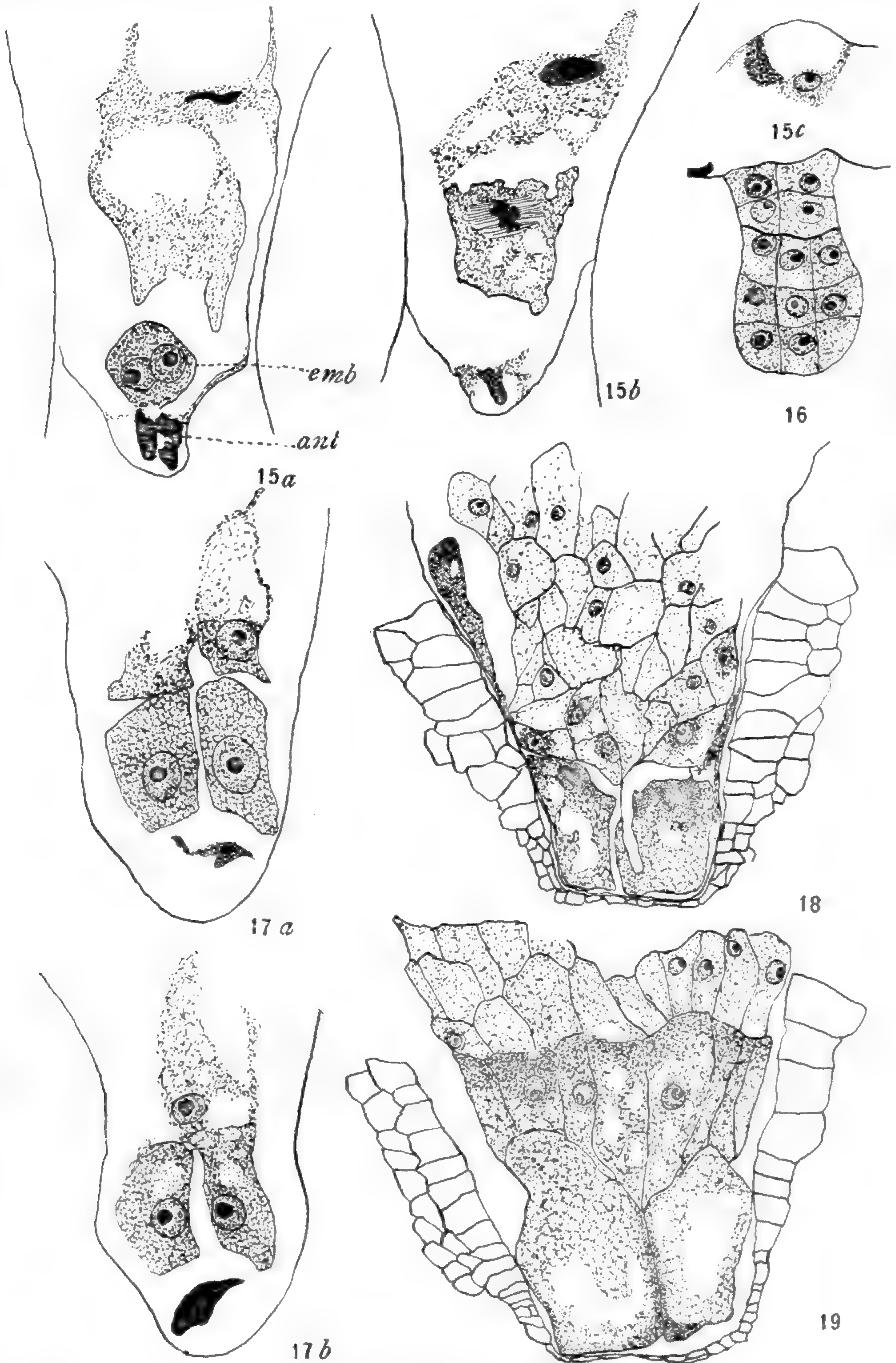



# BRIEFER ARTICLES

---

## PREPARATION OF COPY

In response to many inquiries from contributors, the following directions for the preparation of copy for the *BOTANICAL GAZETTE* are published. If the directions are followed, most of the troubles of contributor and editor will be eliminated.

### **Preparation of text**

Little need be said in reference to the effective method of presentation, selection of material, and style, for in these matters each contributor is a law unto himself. The difference between a clutter of details and a proper laying of emphasis should be recognized. Omitting the obvious is hard for beginners to learn, but they should keep in mind that the audience is made up of professional botanists.

The only practical direction that can be given, therefore, in reference to the preparation of text copy, concerns its form for publication, and this relates to two points. Before the text is prepared, the style of the *BOTANICAL GAZETTE* should be investigated. Each contributor can find some such paper as he proposes to publish, and should note at least three things: (1) the use of capitals, (2) the use of italics, and (3) the styles of section headings. The chaotic condition of many manuscripts in reference to these features is appreciated by editors but not by contributors. The second point deals with citations, which represent usually the worst feature of a manuscript. In citations the *BOTANICAL GAZETTE* follows the general style adopted by international agreement, and any list of "Literature cited" shows the style. The purpose of the style is to give the reader exact and full information in the least space. To recast a list of citations is needless editorial labor, when with a little observation the list can be prepared in proper form by the contributor.

Attention may be called to the fact that legends for text cuts should never be written on the figures, but listed at the end of the paper. The printer and engraver are different persons, and their copy must be kept separate. The insertion of figures in the manuscript simply makes work for the editor. The necessary space for editorial annotations should be



kept in mind; manuscripts should not merely be typewritten (never carbon copies), but they should be double spaced and have liberal margins.

### Preparation of illustrations

Illustrations in research papers are often disappointing because the author has failed to recognize difficulties which confront the engraver. The following suggestions have been prepared as a general answer to inquiries, and also in the hope that they may enable contributors to secure more effective reproductions of their drawings and photographs. Ten years ago, nearly all illustrations were in the form of plates, but in recent years the text cut has gained in favor, especially in journals printed upon paper suited to the reproduction of photographs and black-and-white drawings. Whether illustrations are to be text cuts or plates, it is recommended that the copy be about twice as large as the desired reproduction. In the case of text cuts, the available space is  $4\frac{1}{8}$  inches in width, and, including the legend,  $6\frac{1}{2}$  inches in length. The size recommended for plates is  $5 \times 7\frac{1}{2}$  inches, exclusive of the space used by the publisher for the volume number, plate number, and title. These proportions should be maintained, whatever the reduction may be. If the illustrations are to be reduced one-half, the copy for text cuts may be  $8\frac{1}{4}$  inches in width, with a maximum length of 13 inches, and plates should be  $10 \times 15$  inches.

If the separate features of an illustration are to be grouped in a text cut, or are to be arranged in a plate, do this work yourself. Paste the separate figures on a stiff, white cardboard, and paste in the proper places the numbers and any explanatory letters. Suitable numbers and letters for various reductions can be furnished by this office.

The following modes of reproduction have been used by the BOTANICAL GAZETTE: zinc etching, photolithograph, lithograph, heliotype, and half-tone. Of these, only the zinc etching and the half-tone are available for text figures.

*Zinc etching.*—This type is recommended for graphs, line drawings, and all other black-and-white drawings which do not have extremely fine lines or extremely small dots. For the copy, use smooth, perfectly white paper, preferably Bristol board, and dead black, indelible ink. Lines or dots made after the pen is nearly dry, so that they appear gray in the copy, are sure to disappoint the author. A good example of line drawing, reproduced by zinc etching, at a reduction of one-half, may be found in BOT. GAZ. 42:412. 1906. For an example combining lines and dots, see 56:15. 1913; for a graph, see 54:425. 1912; for a plate, see 35: pl. 7.



1903. For an example of zinc etching, made without reduction, see BOT. GAZ. 61: *pl.* 22. 1916. The contrast between a zinc etching at a one-half reduction and one reproduced without reduction may be seen by comparing figs. 14 and 13 of the plate just mentioned. The originals for the two figures were drawn in the same style, but fig. 14 was reduced one-half and fig. 13 was reproduced without reduction. Such a procedure involved needless expense, since a negative had to be made from fig. 14, reducing it one-half; then a print from this negative had to be pasted in its place among the original drawings. Contributors often send in graphs on co-ordinate paper, ruled in various shades of red, yellow, or blue. The engraver can "screen" out the colored lines so that they do not appear at all, but he cannot reproduce them satisfactorily. Reproduction of such graphs by the half-tone method is very unsatisfactory. If white paper ruled in black is unobtainable, get a ruling pen and do your own ruling. The graph referred to above was made in this way.

*Photolithograph.*—This mode of reproduction is good for fine lines and fine dots. The paper must be smooth and perfectly white, and the ink must be dead black. The soft effect of a lithograph can be secured by the printer, who can use an ink of lithograph color. Pencil drawings or washes cannot be reproduced by this method. This is strictly a photographic method, and is popular with investigators who can draw, since it cannot be modified like a lithograph. See BOT. GAZ. 42: *pls.* 19–28. 1906.

*Lithograph.*—This method is expensive and somewhat uncertain, since it involves redrawing by the lithographer. A crude drawing will be improved by this method, but if the investigator can draw better than the lithographer, the reproduction will suffer. No really satisfactory lithographs have been made in this country, and there is great delay, sometimes more than a year, in getting them from abroad.

*Heliotype.*—This method is good for photomicrographs and general work in black and white, but is rather expensive. In the preparation of copy, different colors should not be used, but various shades of black may be obtained by diluting the ink, so that there may be a range from dead black to pencil color. The ink may be used as a wash. It is better not to combine ink and pencil work in a drawing, for while the copy looks well, the ink and pencil do not behave exactly alike when photographed. If photographs or photomicrographs are to be reproduced, use a glossy paper; even then, a skilful squeegee will improve the copy. Since the reproduction will lose a little in contrast, use a contrastypaper and



developer. With properly prepared copy, it is never necessary to use this method for line drawing or stippled work.

*Half-tone.*—This method is almost universally used for the reproduction of photographs of landscapes, models, and portraits. It is also used for photomicrographs. With properly prepared copy it is very satisfactory; but it must be remembered that the screen used by the engraver makes black lines through every white portion, and white lines through every black portion, thus reducing the contrast. Consequently, if the copy is only a fine artistic photograph, the reproduction will be flat and lifeless. In making the negative, use a contrasty plate, develop with a contrasty developer, print on a glossy paper, and squeegee the print. Contrast should be so over-emphasized in the copy that the reproduction, rather than the copy itself, shall represent what the author desires. If the figure is to appear as a text cut,  $4\frac{1}{8}$  inches in width, it will be much more satisfactory to use a  $5 \times 7$  copy than a  $3\frac{1}{4} \times 4\frac{1}{4}$ . An enlargement of the copy by this method, or by any other, is wholly unsatisfactory.

## THE STRUCTURE OF THE SPIKELET OF APHANELYTRUM (WITH ONE FIGURE)

In ENGLER and PRANTL'S *Pflanzenfamilien*<sup>1</sup> HACKEL proposes *Aphanelytrum* as a subgenus of *Brachyelytrum*. He bases the subgenus on a single species from Ecuador, *Brachyelytrum procumbens* Hack., differentiating it from *Eubrachyelytrum* by its glumes, minute, "often wanting," and by its thinner, shorter-awned lemmas. The grass was first listed, without description, as *Aphanelytrum procumbens* Hack. in SODIRO'S enumeration,<sup>2</sup> based on HACKEL'S identification of his collections of the grasses of Ecuador. Later HACKEL described<sup>3</sup> the plant as a new genus, discussed its relationship and the structure of its inflorescence, and gave a figure of the supposed spike with three spikelets.

In 1914, among South American grasses received for identification from the Royal Botanical Garden at Petrograd was a specimen collected by JAMESON (no. 168) in Ecuador, which proved to be referable to *Aphanelytrum*. The peculiar spike of three sessile spikelets, the upper two with glumes obsolete, described by HACKEL, is found to be a single 3-flowered spikelet with very long rachilla joints. In the generic description HACKEL says that the 1-flowered, distichous spikelets are alternate and subterminal along the branches of the subsimple panicle,

<sup>1</sup> Nachträge 2:42. 1897.

<sup>2</sup> Ann. Univ. Quito Ser. 3:480. 1889.

<sup>3</sup> Oesterr. Bot. Zeitschr. 52:12. 1902.



the primary branches bearing 3, the secondary 2 or 1 spikelets, the lateral ones sessile, the branchlet with its spikelets forming 2-3-merous



FIG. 1.—*Aphanelytrum procumbens* Hack.: *a*, panicle, nat. size; *b*, spikelet,  $\times 4$ ; *c*, copy of HACKEL'S figure.

spikes, of which the axis, articulate above the sterile glumes of the individual spikelets, is produced into a pedicel beyond the uppermost spikelet; that the two glumes are very minute or in the upper spikelets wholly



obsolete, the upper glume (of the lowest spikelet) lying outside of the internode of the axis, both glumes persistent.

In the discussion following the description, HACKEL states that while he had regarded *Aphanelytrum* as a subgenus of *Brachyelytrum* only, further study had convinced him that it was a valid genus. He lays particular emphasis upon the character of the inflorescence:

The primary branch bears, as it appears constantly, 3 sessile lateral spikelets, the axis extended as a stipelet beyond the uppermost, thus forming a spike, but of so remarkable a structure that I know of no second example among the grasses. Of the two very small glumes which can always be found distinct only on the lowermost spikelet, those of the two upper mostly being wholly aborted, only the lower is found on the same side of the spike axis as the spikelet, the upper being found on the opposite side of the axis. This position is contrary to the conception of this spike as a monopodium, as the spike of the *Hordeae*, etc., doubtless is; one must rather assume the axis of the spikelet to be the continuation of the spike axis internode below it, and the internode next above to represent a branch in the same direction as that below put forth from the axil of the second glume, the whole spike, then, forming a sympodium. Whether this admits of another explanation later study of more material will decide, but the facts of the case, as the accompanying figure shows, are without doubt. As to the upper members of the spike these can only be understood from analogy to the lower, since in these the glumes are wanting or reduced to minute vestiges.

When this structure is recognized as a single spikelet, the necessity for assuming it to be a sympodium is obviated; the position of the second glume is seen to be the normal one; and, except for the elongated rachilla joints, the spikelet is seen to be in no way anomalous. The minute vestiges of glumes below the upper florets referred to by HACKEL must be the rather prominent callus of the floret.

Among plants recently received from Colombia were several specimens of *Aphanelytrum procumbens* collected along a trail at 3100 meters by Freres APOLLINAIRE and ARTHUR (no. 717). From these specimens the accompanying figure and the following emendation of the generic description are drawn.

#### APHANELYTRUM Hack. emended

Inflorescence a few-flowered panicle, the remote capillary, flexuous, simple or subsimple branches in fascicles of 2-4 or the upper solitary; spikelets on slender flexuous pedicels, perfect, 2 or 3-flowered, articulate above the minute glumes; rachilla joints capillary, flexuous, from half



to three-fourths as long as the erect or spreading florets, prolonged beyond the uppermost floret; stamens 3.

A specimen of this collection was sent to HACKEL, together with notes on the structure of the spikelet. In reply he writes: "It agrees exactly with the type. . . . After careful weighing of the evidence I must agree that this explanation is more satisfactory than the one proposed by me, especially because thereby the position of the glumes becomes entirely natural and comprehensible."

The 3-flowered spikelets place this genus in the tribe Festuceae, but where it should be placed in that tribe I am not prepared to say; it is not closely related to any other known genus. In the National Herbarium it is placed for the present between subtribe Meliceae and subtribe Centotheceae. The name *Aphanelytrum*, referring doubtless to invisible glumes, is not so inept, fortunately, since the glumes are very small.—  
AGNES CHASE, *Bureau of Plant Industry, Washington, D.C.*



# CURRENT LITERATURE

## BOOK REVIEWS

### American trees

Books on trees, most of them of a popular or semi-scientific character, have been produced abundantly within recent years, and many, limiting their scope to some particular region of our country, have successfully met an increasing demand, and have contributed materially to furthering the interests of botanical science. In a recent publication MATHEWS<sup>1</sup> has attempted to include within the limits of a single volume, not only all the trees of the continent that would be likely to interest the informal student of nature, but also the shrubs as well. This is a difficult, if not an impossible task, and it is not surprising that the result, while in many respects excellent, is open to some unfavorable criticism.

One of the first difficulties would naturally be to make a wise selection of the number of species to be included. That this number is large is shown by the inclusion of 25 species of pine, 2 of them European; the same number of oaks; 31 willows; 11 shad bushes; 13 maples; and, still more surprising, 24 species of *Vaccinium*, 15 of *Viburnum*, and 69 of *Crataegus*; while many other genera have been treated with equal generosity. For example, it is hard to see why the white birch should be separated into 7 species and varieties for other than a strictly technical botanical audience. The same criticism would apply with even greater force to *Salix*, *Amelanchier*, and *Crataegus*, especially as the descriptions, although on the whole excellent, are not sufficiently exact and critical to enable even a well-trained botanist to identify a doubtful specimen within these genera. The difficulties are here accentuated by the entire absence of all adequate keys. This is perhaps the most serious fault of the book, and were it not for the extensive series of excellent drawings of leaves and fruit, identification by its aid would be a hopeless task. These drawings, on the contrary, are among the best that have yet appeared, and covering 128 full-page figures and about five times that number of species they seem quite worth the price of the volume. The 66 plates of habit studies of individual trees, 16 of them in color, do not appeal to the reviewer as at all equal to the figures, and could be omitted without serious detriment to other than the possibly artistic value of the book. Other commendable features are the good descriptions of most of the species, the extensive and accurate data as to their distribution, supplemented by some 80 small maps, on each of which the areas

---

<sup>1</sup> MATHEWS, F. S., Field book of American trees and shrubs. 8vo. pp. xvii+465. pls. 128. New York: Putnam. 1915. \$2.00.



occupied by 2 to 4 different species are plotted. These things, together with the convenient size of the volume, make the book, in spite of its evident defects, a desirable addition to our non-technical botanical handbooks.—GEO. D. FULLER.

#### Texts on colloid chemistry

The plant is made in the main of colloids. Notwithstanding this fact, until recently, so far as we have tried to explain its activity on the chemical basis at all, it has been largely in accordance with laws of homogeneous systems. Lately we are coming to realize that the laws of colloids are of first importance in answering many questions concerning the plant, its environment, and the interrelation of the two.

With the translation of the first half of OSTWALD'S *Grundriss der Kolloidchemie*<sup>2</sup> we have an excellent statement of a portion of the principles of the subject available in English. OSTWALD was turned into colloid chemistry by certain problems met in biology, and the translator is an animal physiologist dealing with very fundamental problems in the colloidal side of his subject. These facts should especially interest biologists in the book. It is to be regretted that the second half has not yet appeared in German, and is therefore not available for translation; but one sees the rapidity of the growth in colloid chemistry when he recognizes that the first half passed through three editions without opportunity for writing the second half.

OSTWALD, with his attractive way of presenting a subject, hardly needs an introduction to an American scientific audience, following his recent extensive lecture tour in this country. The translator says "WOLFGANG OSTWALD'S writings represent in colloid chemistry what those of CHARLES GERHARDT represent in organic, JUSTUS LIEBIG in agricultural, and WILHELM OSTWALD in physical chemistry." Notwithstanding the fact that many phases of the subject of greatest interest to physiologists are still to be treated in the second half, the volume is a much-needed reference book for plant workers.

TAYLOR'S<sup>3</sup> book upon colloids is a far less exhaustive statement, but offers a good general outline of the subject. Part I (163 pp.) deals with general properties of colloids; part II (56 pp.), with methods of preparation; part III (42 pp.), with surface phenomena or adsorption; and part IV (56 pp.), with applications of colloid chemistry (semi-colloids, dyeing, tanning, soil, purification of sewage, and applications to biology). Those interested only in the general principles of the subject will find this little book most satisfactory.

---

<sup>2</sup> OSTWALD, WOLFGANG, A handbook of colloid chemistry. 1st Eng. ed. translated from 3d Ger. ed. by MARTIN H. FISCHER, with the assistance of R. E. OESPER and L. BERMAN. 8vo. pp. xii+278. Philadelphia: P. Blakiston's Son & Co. 1915. \$3.00.

<sup>3</sup> TAYLOR, W. W., The chemistry of colloids and some technical applications. pp. vi+328. New York: Longmans, Green, & Co. 1915. \$2.00.



The reviewer, however, feels that there is no other statement on colloids so significant and helpful to biologists as the chapters dealing with this and related topics in HÖBER'S<sup>4</sup> work (chaps. vi, vii, and many points in later chapters).—WM. CROCKER.

#### An elementary textbook

The textbooks of botany for elementary students are multiplying so rapidly that every conceivable method of presentation will soon be available. It is no longer a question as to the facts to be presented, but as to the method of presentation. An interesting organization of the fundamental facts of botany for the benefit of elementary students is the recent text by THODAY,<sup>5</sup> who says that the book is intended primarily for use in connection with the "Senior Cambridge local examinations." No previous knowledge of botany is assumed, so that the presentation is intended to be strictly elementary.

Without questioning the facts, the interesting feature of the book is its testimony as to the requirements in botany in the examinations referred to. The book is divided into five sections, whose titles sufficiently indicate the contents. After an introductory chapter, pointing out such conspicuous organs of plants as may be shown by a comparison of sunflower, grass, dandelion, and horse-chestnut, the first section deals with "The functions of plant organs" and "The food of plants." The first contact, therefore, is physiological, before any knowledge of structure has been developed. This follows in the second section, under the title "Form and structure," which is an outline of anatomy. The third section bears the title "Reproduction," but it is merely reproduction by seed plants, dealing with flowers, fruits, seeds, and germination. "The classification of plants" is the title of the fourth section, and this also is restricted to seed plants. The principal chapter is entitled "Evolution and the principles of classification as illustrated by the buttercup family." This section is really an introduction to some of the important families of angiosperms. The last section is ecological, under the title "Plants in relation to their environment," the five chapter headings illustrating the treatment as follows: fitness, trees, climbing plants, water plants, the distribution of plants and the factors which govern it.

The notable feature of the book, aside from the order of presentation, is the elimination of all plants except flowering plants. It is not a question as to the importance or unimportance of the cryptogams, but as to any intelligent appreciation of flowering plants apart from some perspective of the plant kingdom as a whole.—J. M. C.

---

<sup>4</sup> HÖBER, R., *Physikalische Chemie der Zelle und das Gewebe*. pp. xviii+808. Berlin: Wilhelm Englemann. 1914. \$5.50.

<sup>5</sup> THODAY, D., *Botany; a textbook for senior students*. 8vo. pp. xvi+474-figs. 205. Cambridge: University Press. 1915. 5s. 6d.



### Plant histology

The third edition of CHAMBERLAIN'S<sup>6</sup> *Methods in plant histology* has been entirely rewritten, and so much new matter both in text and illustrations added that it is essentially a new book. A chapter on the making of photomicrographs and lantern slides has been added, and the directions are so lucid and complete that anyone should be able to do good work, even with inexpensive and improvised apparatus.

Perhaps in no field of microtechnique has the advance been greater than in the paraffin method during the past ten years. The later methods are fully set forth. The chapter on special methods has been much enlarged and brought up to date. Many of the time-honored formulae and methods have disappeared; only those which have stood the most rigid tests have survived in the third edition. Many new methods and formulae are presented for the first time.

Much attention has been given to collecting and keeping material alive in the laboratory. The directions for collecting, killing, and fixing material for research are most thorough, for the author keenly realizes how difficult it is to get material properly prepared for critical research. His experience has been such that he knows that many otherwise competent collectors entirely fail to understand or can be made with difficulty to realize the supreme importance of properly killing, fixing, and preserving material intended for research.

Specific directions are also given for making such preparations as are needed by teachers and those who wish to get a comprehensive view of the plant kingdom from the lowest to the highest forms. The book is indispensable to those who wish to be in touch with the latest advances in modern microtechnique.—  
W. J. G. LAND.

### MINOR NOTICES

**Amino acids.**—UNDERHILL'S<sup>7</sup> little book on the physiology of amino acids is an interesting and simple general statement of the present status of our knowledge on this subject. The chapter headings give an idea of the nature and scope of the treatment of the topic. They are as follows: (1) The proteins and their derivatives, the amino acids; (2) digestion and bacterial activity in relation to the amino acids; (3) the absorption of proteins and amino acids; (4) in what forms does ingested protein enter the circulation; (5) theories of protein metabolism; (6) the further fate of amino acids; (7) the amino acids in relation to the specific dynamic action of proteins; (8) the amino acids and simpler nitrogenous compounds as foodstuffs; (9) the specific rôle of amino acids in nutrition and growth. The book is most attractively written and

<sup>6</sup> CHAMBERLAIN, CHARLES J., *Methods in plant histology*. pp. xi+314. The University of Chicago Press. 1915.

<sup>7</sup> UNDERHILL, F. P., *The physiology of amino acids*. pp. 169. *figs.* 13. Yale University Press. 1915. \$1.35.



thoroughly suited to the audience addressed. While the subject is treated entirely from the side of mammalian physiology as a basis of comparison, the book bears much of interest to plant physiologists. The limited power of mammals to manufacture amino acids, especially lysine and tryptophan, the inadequacy of certain plant proteins (zein and gliadin) as a nitrogen source for mammals because of the absence of one or both of these amino acids, and the idea that amino acids play a specific rôle in metabolism and perhaps growth, aside from their use as source of energy and building material, are all suggestive to the plant physiologist, and contrast with the situation more generally met by him.—WM. CROCKER.

**A new manual.**—PIPER and BEATTIE<sup>8</sup> have published a manual of the flora of the region described as "lying between the summit of the Cascade Mountains and the Pacific Ocean from the 49th parallel of latitude across the southern portion of Vancouver Island, south to the headwaters of the Willamette River." There are four life zones represented: humid transition zone, including the great forests of Douglas spruce; Canadian zone, not sharply limited; Hudsonian zone, indicated by subalpine fir, Alaska cedar, black hemlock, and white-bark pine; and arctic zone, consisting of the alpine flora above timber line. It is a most interesting floral region, not hitherto represented in a suitable manual. The material upon which the work is based is mainly to be found in the herbarium of the State College of Washington.

The usefulness of a manual can be judged only by its use; but so far as organization and appearance go, this manual promises to be all that can be desired. The size of the volume indicates a rich and varied flora, and the summary states that 1617 species and subspecies are presented, representing 550 genera and 100 families. New species are described in *Arctostaphylos*, *Godetia*, *Panicularia*, *Populus*, and *Solidago* (2), and 14 new combinations are proposed. A useful glossary and a full index complete the volume.—J. M. C.

**Botanical technique.**—The second volume of the *Praktikum* of MÖBIUS<sup>9</sup> deals with thallophytes, bryophytes, pteridophytes, and gymnosperms. The descriptions and directions are in general good, but the quality of the illustrations is very variable. Some are excellent, others are so faithfully drawn that the carelessness of the technician is very apparent, as shown by the figure of a cross-section of the stem of *Lycopodium complanatum*. A figure of a young antheridium of *Pellia epiphylla* shows that the illustrator did not know he was drawing from an oblique section. In any text, especially one intended for beginners, accuracy and clearness of statement should be paramount. In addition to an intimate knowledge of the subject, an author should also be

<sup>8</sup> PIPER, CHARLES V., and BEATTIE, R. KENT, Flora of the northwest coast. 8vo. pp. xiii+418. Lancaster (Pa.): The New Era Printing Co. 1915. \$1.75.

<sup>9</sup> MÖBIUS, M., Mikroskopisches Praktikum für systematische Botanik (II). 8vo. pp. v+314. figs. 123. Berlin: Gebrüder Borntraeger. 1915.



able to interpret a section correctly and to know when there is a glaring fault in his technique.—W. J. G. LAND.

**Illustrations.**—A series of lectures dealing with the illustration of botanical papers was delivered at the University College, London, in 1913, by T. G. HILL. In response to various requests, these lectures are now published in book form.<sup>10</sup> The various forms of intaglio, plane surface, and relief printing are described, and their limitations noted. Suggestions are given for the preparation of copy suited to the various types of reproduction. The descriptions of processes are interesting, and, combined with the practical hints, should enable investigators to furnish more effective copy. There is no effort to give instruction in drawing.—C. J. CHAMBERLAIN.

**North American Flora.**—The third part of Vol. 17 continues the presentation of the Poaceae, and includes the genus *Panicum* by HITCHCOCK,<sup>11</sup> who recognizes 211 species distributed among 46 tribes. No new species are described, but it is interesting to note that HITCHCOCK'S name is associated with 32 of the species. Other diligent students of the species have been NASH (30 species), SCRIBNER (25 species), and ASHE (16 species).—J. M. C.

## NOTES FOR STUDENTS

**Anthocyanins.**—WILLSTÄTTER<sup>12</sup> and his students have made an extensive study of the anthocyanins of various flowers and fruits. The findings are certain to prove of great importance to plant workers, especially breeders and physiologists. The work puts this previously little understood group of plant pigments among those most thoroughly worked. All such matters as methods of extraction, purification, and quantitative estimation, general chemical constitution, general chemical characters, empirical and structural formulae, and

<sup>10</sup> HILL, T. G., The essentials of illustration. 8vo. pp. xii+95. London: Wesley & Son. 1915.

<sup>11</sup> North American Flora 17:part 3. pp. 197-288. Poales: Poaceae (pars), by G. V. NASH and A. S. HITCHCOCK. New York Botanical Garden. 1915.

<sup>12</sup> WILLSTÄTTER, R., Über Pflanzenfarbstoffe. Ber. Chem. Gesells. 47:2831-2874. 1915; WILLSTÄTTER, R., and NOLAN, T. J., II. Über den Farbstoff der Rose. Ann. Chem. 408:1-14. 1914; WILLSTÄTTER, R., and MALLISON, H., III. Über den Farbstoff der Preiselbeere, *ibid.* 15-41; WILLSTÄTTER, R., and BOLTON, K., IV. Über den Farbstoff der Scharlachpelargonie, *ibid.* 42-61; WILLSTÄTTER, R., and MIEG, W., V. Über ein Anthocyan des Rittersporns, *ibid.* 61-82; WILLSTÄTTER, R., and ZOLLINGER, E. H., VI. Über die Farbstoffe des Weintraube und der Heidelbeere, *ibid.* 83-109; WILLSTÄTTER, R., and MARTIN, K., VII. Über den Farbstoff der *Althaea rosea*, *ibid.* 110-112; WILLSTÄTTER, R., and MIEG, W., VIII. Über den Farbstoff die wilder Malve, *ibid.* 122-135; WILLSTÄTTER, R., and NOLAN, T. J., IX. Über den Farbstoff die Päonie, *ibid.* 136-146; WILLSTÄTTER, R., and MALLISON, H., X. Über Variationen der Blütenfarben, *ibid.* 147.



the cause of variation in the color of flowers bearing these pigments, have been established or made very probable.

The anthocyanins are characterized as nitrogen-free substances of amphoteric nature. Their strong basic character is due to the fact that with acids they form oxonium salts with tetravalent oxygen. This character forms the best basis for their isolation and purification, since on this basis they form good crystalline bodies with various organic and inorganic acids. The chlorides were most used. The acid character of the anthocyanins is due to their polyphenolic nature. This was formerly used as the basis for isolation by the precipitation as lead salts, but it is undesirable, since many other substances fall out with the pigments. The acid salts are red, the neutral anthocyanins violet, and the alkali salts (for such anthocyanins as form them) are blue. In neutral and still more frequently in alkaline condition the anthocyanins become colorless. This is due to an isomerization, and not to a reduction, as is generally assumed. This is suggestive in explaining the loss of color by flowers under certain conditions.<sup>13</sup> Upon acidulation the color returns. In plants the anthocyanins exist entirely or nearly so as glucosides. Brief heating of the anthocyanins with 20 per cent HCl splits them into glucose and the corresponding anthocyanidins. The following are some of the studied anthocyanins and their splitting products.

Anthocyanin	Isolated from	Anthocyanidin +
Cyanin ( $C_{27}H_{31}O_{16}Cl \cdot 2\frac{1}{2}H_2O$ )	<i>Centaurea cyanus</i>	Cyanidin ( $C_{15}H_{11}O_6Cl + 2$ glucose)
Pelargonin ( $C_{27}H_{31}O_{15}Cl \cdot 4H_2O$ )	<i>Pelargonium zonale</i>	Pelargonidin ( $C_{15}H_{11}O_5Cl + 2$ glucose)
Delphinin ( $C_{41}H_{39}O_{21}Cl \cdot 12H_2O$ )	<i>Delphinium consolida</i>	Delphinidin ( $C_{15}H_{11}O_7Cl + 2$ glucose + 2 p oxybenzoic acid)
Önin ( $C_{23}H_{25}O_{12}Cl \cdot 4H_2O$ )	Deep colored wine grape	Önidin* ( $C_{17}H_{15}O_7Cl + 1$ glucose)
Malvin ( $C_{29}H_{35}O_{17}Cl \cdot 8H_2O$ )	Wood malva	Malvidin* ( $C_{17}H_{15}O_7Cl + 2$ glucose)

\* Önidin and malvidin are dimethyl ethers of delphinidin.

Several physical constants (crystal shape and color, melting or decomposition points, solubility in various reagents, isomerization with soda, and reaction with iron chloride and iron picrate) of these anthocyanins and anthocyanidins have been tabulated. These, with the methods of extraction and purification, put significant methods into the hands of plant breeders of moderate chemical training.

Variations in the color of flowers bearing these pigments are due to one or more of four causes: (1) various anthocyanins in the same flower or species; (2) great variation in the anthocyanin content; (3) chemical reaction of the

<sup>13</sup> FITTING, H., Über eigenartige Farbanderungen von Blüten und Blütenfarbstoffen. Zeitschr. Bot. 4:81-106. 1912.



cells; (4) mixtures with yellow pigments. The following are a few illustrations of the significance of these factors: (1) The dark purple-red flowers of *Centaurea cyanus* bear cyanin, the rose-red flowers pelargonin; a violet-red variety of *Pelargonium* bore mainly cyanin with a slight amount of pelargonin. This is said to be the first plant in which a mixture of anthocyanins was found in the same flower. (2) The bright red and dark red garden rose both bear cyanin with a great difference in concentration. The flower of the field *Centaurea cyanus* contains 0.65–0.70 per cent dry weight of alkaline cyanin, while a dark purple double garden variety bears 13–14 per cent. (3) Blue flowers of *Centaurea* contain potassium salts of cyanin, violet flowers of *Delphinium* neutral delphinin, and scarlet flowers of *Pelargonium* tartrate of the anthocyanin. (4) The following yellow pigments may act with anthocyanins in determining the flower color: (a) neutral carotinoids, carotin and xanthophyll; (b) the glucosidic flavone pigments; (c) the little-known anthochlors of the cell sap. It is found that the green color shown by a crude extract of anthocyanin of alkaline reaction results from the mixture of the blue of the alkali salts of the anthocyanin and a yellow pigment. Some of the flavone dyes, also the pseudobases of anthocyanin, are almost colorless in neutral and acid solutions, but intensely yellow in alkaline solution. This is suggestive to breeders dealing with yellow and white flowers.

We are coming to know something of the substances from which the anthocyanins originate, and the reactions by which they are produced. There are many facts to suggest a close relationship between the yellow pigments of plants of the flavone or flavonol type and the anthocyanins. COMBES<sup>14</sup> has made probable that this is a genetic relationship in obtaining anthocyanin by the reduction of yellow pigments extracted from plants; and EVEREST<sup>15</sup> brings still more evidence for the view that the anthocyanins originate from the flavonol yellow pigments by a simple process of reduction. He has produced anthocyanins by reducing flavonol glucosides and similarly anthocyanidins by reducing the sugar-free flavonol derivatives. The following formulae express his idea of the relation between the yellow flavonols and the chlorides of the anthocyanidins:

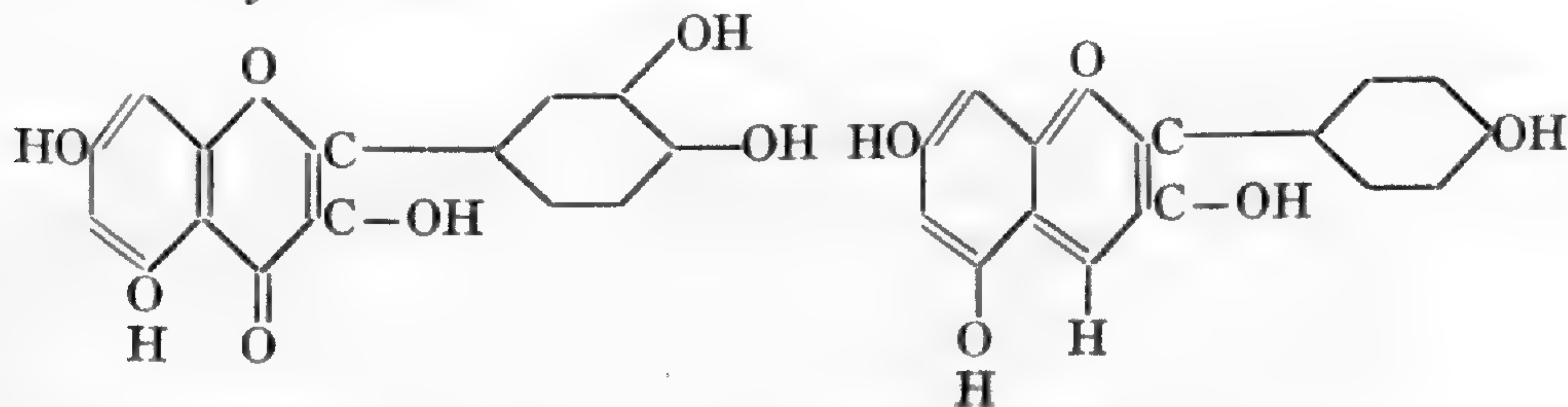

Quercetin,  
a flavonol derivative

Cyanidin chloride,  
an anthocyanidin

<sup>14</sup> Compt. Rend. Acad. Sci. Paris 158: 272–274. 1914; Ber. Deutsch Bot. Gesells. 31: 570–578. 1914.

<sup>15</sup> Jour. Genetics 4: 361–367. 1915.



These formulae will also serve to give an idea of the constitution of the anthocyanidins. The flavonols and flavones are well known yellow pigments of plants. Our thorough knowledge of the chemistry of these pigments is partly due to their extensive use in the dyeing industry. WHELDALE<sup>16</sup> has suggested that anthocyanins originate from the flavonol glucosidic pigments by a process of hydrolysis followed by oxidation, and she questions EVEREST's ideas as set forth above, so far as they apply to the origin of anthocyanins in plants, since the drastic reagents used by EVEREST are not available for the plant. It would seem that her protest is rather poorly grounded.

Almost every point established concerning the anthocyanins is of great immediate significance to plant breeders and physiologists. WILLSTÄTTER and his students have done much to put our knowledge of this group of pigments on solid foundations, as they previously did for the pigments of the chloroplast.—WM. CROCKER.

**Anatomy of Isoetes.**—LANG,<sup>17</sup> in continuing his studies of *Isoetes*, has analyzed the stele of *I. lacustris*, with the help of apical development. The contradictory interpretations of the stem of *Isoetes* have arisen from complications due to the occurrence of crowded leaves upon a very slightly elongating axis, accompanied by the continued growth of the cortex. The summary of the analysis is as follows, proceeding from within outward: (1) central column of primary xylem (the strictly cauline region of the stem); (2) peripheral zone of xylem, consisting of bases of leaf traces connected with the central cylinder and radially arranged xylem between the entering leaf traces; (3) parenchymatous xylem sheath, continuous with similar region in leaf trace; (4) primary phloem, continuous with phloem of leaf trace; (5) secondary prismatic tissue, consisting of tracheids, sieve tubes, or parenchyma; (6) meristem of secondary prismatic tissue; (7) cortical tissue. LANG states that such an analysis of the stele of *Isoetes* "not only affords points for comparison with the Lepidodendreae, but promises to be of interest from the standpoint of general stelar morphology."—J. M. C.

**Espeletia.**—This is a genus of the Asteraceae, restricted so far as known to the high cordilleras of Colombia and Venezuela. The genus is among the most conspicuous of the composites, the leaves and inflorescences in most of the species being closely invested by long wool. The genus has just been revised by STANDLEY,<sup>18</sup> who recognizes 17 species, 6 of which are described as new.—J. M. C.

<sup>16</sup> Jour. Genetics 4:369-376. 1915.

<sup>17</sup> LANG, WILLIAM H., Studies in the morphology of *Isoetes*. II. The analysis of the stele of the shoot of *Isoetes lacustris* in the light of mature structure and apical development. Mem. and Proc. Manchester Lit. and Phil. Soc. 59:29-56. pls. 4. figs. 7. 1915.

<sup>18</sup> STANDLEY, PAUL C., The genus *Espeletia*. Amer. Jour. Bot. 2:468-485. figs. 6. 1915.



THE  
BOTANICAL GAZETTE

MAY 1916

STANGERIA PARADOXA

CONTRIBUTIONS FROM THE HULL BOTANICAL LABORATORY 214

CHARLES J. CHAMBERLAIN

(WITH PLATES XXIV-XXVI AND ONE FIGURE)

*Stangeria* is the most fernlike of all the cycads; in fact it was described originally as a species of *Lomaria*, one of the Polypodiaceae, and the mistake was not corrected until the cones were discovered. The genus may be monotypic, with *Stangeria paradoxa* as its single polymorphic species. That its general habit, as it appears in the field, is extremely variable is beyond question; and that under cultivation in conservatories and botanical gardens it becomes quite different from the wild form is also apparent.

A plant called *Stangeria eriopus* in the New York Botanical Garden has produced fine crowns of leaves, surpassing anything one is likely to find in the field, and it has had at least one ovulate cone (10). A specimen of *S. paradoxa* in the Botanic Garden at Sydney, Australia, had in 1911 a fine display of leaves and 8 staminate cones; while another plant in the same garden had 5 ovulate cones and an equally fine display of leaves. In the Sydney plants the leaves were not in a single crown, but on subterranean branches with only a few leaves on a branch. In both the Australian and the African gardens *Stangeria* produces leaves and cones more freely than in the field, and both cones and leaves are larger than in field specimens. The cultivated specimens are more beautiful and luxuriant, and differ so much from plants in the field, that some



observers might make new species of them. In the Botanical Garden at Durban, South Africa, Mr. WYLIE showed me a vigorous *Stangeria* with leaves a meter long. The leaflets were 45 cm. long, and so deeply incised that they were almost pinnate. Some taxonomists, doubtless, would regard this plant as a distinct species. In *Dioon* and *Bowenia* the character of the leaf margin is so rigidly fixed and so persistently transmitted from one generation to another that it is entitled to rank as a specific character; but in *Stangeria* the character of the margin is so fluctuating that even the almost bipinnate Durban plant should not be regarded as specifically different from forms with entire leaflets.

### Field observations

My field observations on *Stangeria* began at Ngoye, near Mtunzini in Zululand, about 100 miles north of Durban, and extended to East London, about 275 miles south of Durban. *Stangeria* certainly extends farther north, just how much farther I was not able to determine; and its western limit is west of East London. I did not find it at Port Elizabeth, about 150 miles west of East London, or even at Grahamstown, or Trapps Valley, about half-way between East London and Port Elizabeth; but Mr. GEORGE RATTRAY, of Selborn College, East London, has reported it from Port Elizabeth, and he regards this as about the western limit of its range. His extensive knowledge of South African cycads in the field enables him to speak with authority upon their geographical distribution.

In the field, *Stangeria* presents two forms, one growing on the open grass veldt and the other in the shade of bushes or trees, the shaded form being much larger and resembling more nearly the cultivated specimens. PEARSON (9) has contrasted the two forms as *Stangeria paradoxa*, the species originally described from the shaded Natal form, and *Stangeria* sp., the open grass veldt form; but he had seen both forms in the field, and consequently hesitated to give a specific name to the second form. RATTRAY, who lives in a *Stangeria* region, and who has studied the genus throughout its range, believes there is only one species. Before I left South Africa, I had come to the same conclusion. I dug up



several plants from the East London grass veldt and sent them to our greenhouse at the University of Chicago, where after three years of the usual unnatural conditions they are producing leaves and cones as large as those of the bush veldt form.

Near Mtunzini in Zululand the grass veldt stretches for miles, rolling and hilly, broken by huge rocks of granite and gneiss, and



FIG. 1.—*Stangeria paradoxa* growing in the grass veldt at Ngoye, near Mtunzini, Zululand.

occasionally with exposed surfaces covered only with *Selaginella* and lichens. The grass is 30–40 cm. high, and appearing above it are the leaves of *Stangeria* (fig. 1). The leaves are larger and more numerous than in the East London district, three or four leaves being common, and some stems having fine crowns of five or six leaves.

The plants are fairly abundant, as many as 20 being in sight at one time; but the specimens are scattered, with no crowded masses like the thickets of *Macrozamia spiralis* and *Bowenia serrulata* in Australia. Although adult plants are numerous, cones are



rare. At the time of my visit, the middle of January, 1912, the staminate cones had rotted or dried up, and the ovulate cones were falling to pieces. The few seeds which were secured showed embryos in early suspensor stages.

In the Mtunzini bush, which is particularly dense and rich in ferns, only a few plants of *Stangeria* were seen, but they were vigorous, with three or four leaves about twice the size of those in the open grass veldt. Not a single cone or seed was found in the bush. It is said that baboons are very fond of the seeds and carry them away as soon as the cones reach their full size.

Associated with *Stangeria* in the Ngoye grass veldt is *Encephalartos brachyphyllus*, a species with small cones and tuberous, subterranean stems. I saw one tall specimen of *E. Altensteinii bispinosus*, which is called also *E. Woodii*. It is said that there is not another plant of this species within 50 miles. I did not see a single specimen of any species of *Encephalartos* in the Ngoye bush veldt.

On the grass veldt at East London, *Stangeria* is not nearly so large or so abundant as in Zululand, but its appearance is the same, the leaves projecting a little above the grass, so that most of the plants within a distance of 100 m. can be seen. In this region *Stangeria* is associated with *Encephalartos Altensteinii* and *E. villosus*, while *E. cycadifolius* grows within a few miles.

The stem of *Stangeria* is tuberous and entirely subterranean, with a strong main root and weak branches. It grows in soil so hard and stony that both care and labor must be given to secure an uninjured specimen. The stem is quite smooth, the whole leaf breaking off so cleanly that there is never any armor of leaf bases.

Nearly all the plants dug up in the East London region showed more or less branching, a feature already noted by PEARSON and by RATTRAY. Occasionally the stem is simple, but usually it bears 1-4 branches arising from the lower part of the stem, rarely from the upper part. Often the stem and branches are so nearly alike that it is difficult to distinguish which is the main stem and which is the branch. Sometimes the branching condition is betrayed by the leaves, which may be too scattered to belong to a single crown and too crowded to belong to different plants; but



it may happen that only a single branch will bear a leaf, and in that case the branching is not discovered until the soil is removed.

The stem is monoxyletic, with a single very narrow zone of wood between the large pith and cortex. A stem 9 cm. in diameter had a zone of xylem only 2 mm. wide, and even in this zone the bundles were separated by a large amount of parenchyma. That this plant was an old one was evident, not only from its size, but also from the fact that it had borne several cones. In the field, cones are not abundant, about one coning plant in six being a liberal estimate. No observations have been made to show at what age *Stangeria* begins to bear cones, but some 5-year old seedlings in our greenhouse are only 2 cm. in diameter. We did not see any cones on plants less than 5–6 cm. in diameter, and we should judge that the specimen must have been at least 30 years old, perhaps much older. The display of woody tissue is the scantiest I have ever seen in any cycad of even approximately equal age.

Cone domes are numerous and are of the type already noted for *Dioon*, *Zamia*, and *Ceratozamia* (13). The main stem, therefore, is a sympodium, as are any branches which have borne more than one cone.

### Sporangia

Although cones are rather infrequent, material can generally be secured in localities where the plants are abundant.

MEGASPORANGIUM.—The ovulate cone looks like that of *Dioon spinulosum*, only very much smaller, the similarity being due to the densely hairy surface and the thin rounded border of the blade portion of the sporophyll. The ovules, during earlier stages of development, are almost completely inclosed by outgrowths of the sporophyll, suggesting the angiosperm condition; but later the ovules grow rapidly and soon protrude beyond the outgrowths, which do not develop much after the ovules reach a length of 4–5 mm. At maturity the ovules have a rich orange color which is quite characteristic.

Early stages in the development of the ovule have been studied by LANG (5), and its vascular anatomy has been described in detail by WORSDELL (4) and by MATTE (7).



**MICROSPORANGIUM.**—The staminate cones are long and slender and very symmetrical. They vary greatly in size, those growing on the dry grass veldt sometimes being as short as 8–9 cm. in length, while those in the shaded bush veldt may reach a length of 20 cm., exclusive of the stalk, which may be more than 5 cm. in length. The sporophylls are small and the number of sporangia averages only about 150, which is lower than in any cycad except *Bowenia* and *Zamia*.

We have already stated that *Stangeria* was originally described as a fern, because the leaves so strikingly resemble those of *Lomaria*. The microsporangia are equally fernlike and bear a particularly close resemblance to those of *Angiopteris*. The wall of the microsporangium consists of an outer layer of very thick-walled cells, a very scanty tapetum, and 3–5 intervening wall layers. The thickening of the outer cells is most pronounced at the base, diminishes gradually on the sides, and at the top becomes so thin that it easily breaks, forming a pore through which the dense cell contents escape shortly before the dehiscence of the sporangium.

The earlier stages in the development of the microsporangium and in the origin and development of sporogenous tissue have been so thoroughly described and illustrated by LANG (2) that we have not felt it necessary to deal with this phase of the subject; but on account of the peculiar or at least newly described behavior of the chromatin at fertilization, the reduction divisions in the pollen mother cells would have been studied if material in this stage had been available.

### Gametophytes

**MALE GAMETOPHYTE.**—The microspore is formed before any of the wall cells of the microsporangium begin to break down, but before the nucleus of the microspore divides the wall cells begin to disorganize and the tapetum becomes almost indistinguishable. During the two mitoses which result in the formation of prothallial cell, generative cell, and tube cell, the tapetum and the wall cells, with the exception of the hard outer layer, break down and form a dry, homogeneous membrane about the pollen grains, holding them together in one spherical mass. At the time of dehiscence, the



grains are dry and powdery, but are still confined by the thin membrane, which often holds them together even after they fall out from the sporangium. Most of the pollen, however, is in condition for wind pollination. Staminate cones of cycads are very frequently infested by insects, both before and after the pollen has been shed, but I have never seen anything to indicate that pollination was being affected by their agency. Besides, the ovules exude a large pollination drop, as in the case of gymnosperms known to be wind-pollinated.

When I reached Zululand, about the middle of January, 1912, the pollen tubes had already discharged; in fact, embryos were beginning to show suspensors. Although the season is somewhat later farther south, I did not find any cones in which the pollen tubes had not discharged. Accordingly, I am under great obligation to other people for material of pollen tube structures.

On January 6, 1910, Professor W. C. WORSDELL, whose extensive researches have so materially advanced our knowledge of the anatomy of cycads, visited Zululand and fixed for me some material showing pollen tubes with the sperms already formed. Mr. W. T. SAXTON, formerly of the South African College, but now of the Institute of Science at Ahmedabad, India, made several collections in the Transkei, and arranged with Miss SARAH VAN ROOYEN, of Kentani in the Transkei, for a close series of stages. The carefully prepared material furnished by Miss VAN ROOYEN yielded an excellent series of stages from the body cell, through the development of the sperm, and up to early suspensor stages in the embryo. The collections also included ripe seeds with mature embryos. Seedlings have been grown both from Professor WORSDELL'S and from Miss VAN ROOYEN'S collections.

The date of pollination was not determined definitely, but material collected in the Transkei on July 17, 1907, showed uniu-  
nucleate pollen grains with exine and intine well developed. This would indicate that pollen is shed late in July. Plants from that region, now growing in our greenhouse, shed the pollen in January 1916. The sporophylls of an ovulate cone loosened at the same time, just as they do normally at the pollination period. This wide difference is due doubtless to greenhouse conditions and not



to the transfer from one hemisphere to another, for *Stangeria* in the Botanic Garden at Sydney was shedding in December 1911. The pollen at the time of shedding shows a prothallial cell, a generative cell, and a tube cell, a condition which I have now observed in all the 9 genera of the family.

Early stages in the development of the pollen tube were not observed, but later stages indicate that they do not differ essentially from the course already described in detail for *Dioon edule* (11). A characteristic view of the pollen tube structures after the pollen chamber has extended entirely through the nucellus is shown in fig. 2. In the tube at the right the body cell has divided, but in the rest the division has not yet taken place. The tube nucleus is regularly near the body cell. The haustorial end of the tube extends in a straight line a few layers of cells below the epidermis, scarcely ever showing any branching, and there are no basal haustoria like those of *Ceratozamia*. While the pollen tube structures of the cycads present many similarities, the differences are probably sufficient for a determination of the genera.

By comparing figs. 2 and 3, which are drawn to the same scale, it is evident that in the later development both the tubes and the sperms increase greatly in size. It is during this rapid increase in size that the spiral band with its immense number of cilia develops from the blepharoplast. The cycad sperm is the largest and most complicated motile cell in either plants or animals. While the series of stages in *Stangeria* is quite satisfactory, the series in *Ceratozamia* is even more complete, thanks to Mr. ALEXANDER M. GAW, of Jalapa, Mexico, who for 10 years has been sending material to supplement my own collections. Besides, the blepharoplast of *Ceratozamia* is larger. Consequently, a more detailed study of the development of the sperm will be reserved for this genus; but some of the more obvious features, as they appear in *Stangeria*, will be presented here.

While the body cell remains elongated during the early stages in the development of the tube, the two blepharoplasts occupy the fore and aft positions; but as the basal end of the tube enlarges and the body cell becomes spherical, the blepharoplasts rotate 90°, so that their axis becomes transverse to the long axis of the tube.



At first, the blepharoplast is a solid, homogeneous body, but as it increases in diameter it becomes vacuolate and soon appears to be little more than a shell containing droplets of liquid (fig. 4). This stage is reached before the body cell divides. During the division of the body cell, the vacuolate blepharoplast breaks up into hundreds of small granules which, for a short time, occupy the space previously occupied by the blepharoplast (fig. 5). The daughter nuclei immediately after the division of the body cell are smaller than the blepharoplasts; but the nuclei increase rapidly in size, while the group of granules remains stationary until it begins to form the ciliated band. The beginning of the band takes place during a rapid increase in the size of the sperm (fig. 6). Many of the granules become elongated and have a distinct tendency to arrange themselves in rows, forming a band one layer of granules in thickness (fig. 7). From the entire surface of one side of this band, stiff bristle-like cilia grow out. The young band is variously twisted and curved, so that the bristles point in every direction, some of them even toward the nucleus, but the band soon turns so that all the bristles face outward (fig. 8). As the band nears the surface, the bristles prick through the cytoplasm and the growth of the cytoplasm at this point is checked, so that a spiral groove results. After piercing the cytoplasm, the bristles grow out into long, slender cilia, which at first are compressed by the wall of the sperm mother cell, but later extend outward and vibrate vigorously when this wall breaks down. The mature sperm varies from 150 to 190  $\mu$  in diameter, and its dense nucleus constitutes most of its mass, the diameter of the nucleus being usually only about 20  $\mu$  less than that of the entire sperm, so that the cytoplasm containing the spiral band is only a thin sheath. The number of turns in the spiral varies from 5 to 7, but one peculiar sperm was found with a long, narrow apex and 10 turns of the band (fig. 10).

**FEMALE GAMETOPHYTE.**—In the young nucellus LANG (5) found an axial row of 3 cells, the lowest of which became the functioning megaspore. In my own material the earliest stages showed archegonia shortly before the division which gives rise to the ventral canal nucleus and the egg. The figure for this division was observed only once, but it was not difficult to determine the



number of chromosomes as 12. Several preparations show that no wall is formed between the two nuclei, and that the ventral canal nucleus soon disorganizes, while the egg nucleus increases rapidly in size as it moves toward the center of the egg.

Some irregularities were noted. In two cases there were 4 neck cells instead of 2, in one of the two cases the two original cells having divided longitudinally, and in the other transversely. In several cases the central cell of the archegonium had not continued its development and was no larger than the tissue cells of the gametophyte, but the two neck cells were as large and turgid as those of a normal archegonium.

### Fertilization

The archegonial chamber at the time of fertilization is moist, but no droplets of fluid can be seen, even with a 16 mm. objective. On the other hand, the pollen tubes are turgid, and as they discharge furnish enough fluid for a limited movement of the sperms. After the nucellus has been removed from the ovule, it is easy to see the sperms swimming in the pollen tube, but practically impossible to observe them, under natural conditions, in the archegonial chamber. The entrance of the sperm into the egg is probably effected as already suggested for *Dioon edule* (12). The liquid discharged from the pollen tube is of high osmotic pressure, and consequently draws some liquid from the turgid neck cells, and the lowered turgidity of these cells allows a portion of the upper part of the egg to escape, thus forming a vacuole which draws the sperm into the egg. The careful experiments of MIYAKE (8) have shown that the cycad sperm does not respond to chemotactic stimuli, being indifferent even to the material of the egg.

It is quite common for more than one sperm to pass through the neck of the archegonium, but rare for more than one to enter the egg itself (figs. 10, 11, 13). In one case 7 extra sperms had passed through the neck; in another case 4; in several cases 3; and in many cases 2 or 1. The apex of the extra sperm is usually directed toward the main body of the egg, and in such cases the sperm becomes more or less imbedded, doubtless on account of the movements of the cilia; but when the axis is not directed in this way,



the sperm is not likely to cause so deep a depression (figs. 10, 11, 13). The ciliated band is so conspicuous and persists so long that a complete series of sections will show, even to the close of the free nuclear period, whether more than one sperm has entered the egg. The photomicrograph (fig. 24) shows a part of the spiral band of the sperm whose nucleus has fused with that of the egg; and also shows two more sperms which have passed through the neck, one of which has become almost completely imbedded in the egg.

The behavior of the chromatin during fertilization has not yet been described for any cycad, but WEBBER (6) figured and described the sperm nucleus of *Zamia* imbedded in the egg nucleus, and IKENO (3) found the same condition in *Cycas*. In *Stangeria* the behavior is the same (fig. 9). Both nuclei, at this stage, are in the resting condition. Whether they continue in this condition as fusion proceeds, or break up into two groups of chromosomes, as in *Pinus* and several other conifers, has not been observed as yet. However, the structure of the first mitosis of the fertilized egg indicates that the resting condition is soon followed by the formation of chromosomes by each of the fusing nuclei. The number of chromosomes, as counted at the equatorial plate stage of the first mitosis, is 12; but later free nuclear divisions and also mitoses in root tips show that 24 is the diploid number; further, the mitosis at the formation of the ventral canal nucleus and egg shows 12 chromosomes, proving that this is the haploid number. With the conspicuous spiral band indicating the entrance of a sperm, parthenogenesis is out of the question. HUTCHINSON'S (14) recent study of fertilization in *Abies*, from an abundance of material in critical stages, which it has been my privilege to examine, furnishes an explanation of this apparently haploid, but really diploid condition. HUTCHINSON (14) finds that the spirems of the two conjugating nuclei segment into chromosomes, as has been described for various conifers; but, after the segmentation, the chromosomes unite in pairs, just as in the prophase of the heterotypic mitosis. Each pair then segments transversely and the two longitudinal parts separate, so that 4 chromosomes are formed from each pair and the diploid number is established. In *Stangeria*, 4 eggs were found which showed the first mitosis, all of them in the early



equatorial plate stage. In all of these the number of chromosomes is 12, but the double character of the chromosomes is evident; and since 12 and 24 are the haploid and diploid numbers, I believe that there is a pairing of chromosomes at fertilization, as described by HUTCHINSON (14) for *Abies*.

### Embryogeny

FIRST MITOSIS.—At the first division in the fertilized egg, the mitotic figure is surrounded by a remarkable display of achromatic structures, arranged in irregular nets or grouped into cones resembling half-spindles (figs. 10, 11, 25). This achromatic area easily identifies the first mitosis, even when a second sperm has entered and divided, since the achromatic area surrounding the dividing sperm is much smaller (fig. 11). The division of an extra sperm was observed in two cases, and in both the mitotic figure showed 12 chromosomes. After the first mitosis the achromatic display gradually diminishes, but is still quite conspicuous as late as the fourth or fifth division. After the first mitosis, however, the display consists almost entirely of slender threads like the spindle fibers (fig. 26).

FIRST FREE NUCLEAR PERIOD.—According to previous accounts of the embryogeny of cycads and *Ginkgo*, there is a regular series of free nuclear divisions, so that the nuclei at the successive divisions number 2, 4, 8, 16, 32, 64, 128, 256, 512, and in some cases 1024, with only such variations as might be expected from the occasional failure of a nucleus to divide. In *Dioon edule* (12) it was noted that the 8th, 9th, and 10th mitoses were irregular, especially in the upper part of the proembryo, so that the number of nuclei beyond the 256-nucleate stage was likely to vary widely from the theoretical estimate.

In *Stangeria*, irregularities begin to appear earlier and are more pronounced. The first 4 mitoses, giving rise to 2, 4, 8, and 16 nuclei, are likely to be strictly simultaneous and regular, and the 32-nucleate stage was observed in two cases; but after the 16-nucleate stage (fig. 12), the number of nuclei not only varies from the anticipated 32, 64, 128, etc., but the discrepancies are great. An examination of a large number of cases showed that the



free nuclei in the upper half of the proembryo were often smaller and more numerous than those in the lower half. The explanation was soon found, for the nuclei in the upper half may divide simultaneously, while those in the lower half remain in the resting condition (fig. 14). This would double the number of nuclei in the upper part, and naturally the nuclei would be smaller. A counting of nuclei in several complete series of sections indicated that such a division had taken place. When the lower nuclei divide, the upper ones divide also, even if they are already much more numerous (fig. 13). There is one important exception to this statement which will be considered later.

While such nuclear conditions are frequent, they are not universal, for two series showed approximately 512 nuclei of uniform size and uniformly distributed throughout the egg, thus indicating that there had been 9 simultaneous divisions. With the 9th or sometimes the 10th nuclear division the free nuclear period comes to a close.

At any time after the 7th division there may be an evanescent segmentation of the protoplasm, especially in the upper part of the proembryo (fig. 15). We have already described such a condition in *Dioon edule* (12), and while we have not yet published the details, we may state that in *Macrozamia*, *Encephalartos*, and *Cycas* the segmentation is much more complete than in *Stangeria* or *Dioon*, and is more permanent, since cellulose walls are formed.

As already stated, the haploid and diploid numbers of chromosomes are 12 and 24. The number 24 is fairly stable in the lower part of the proembryo; but in the upper part there are frequent and extreme variations, the numbers ranging from the theoretical 24 down to a single chromosome. If many of the figures should show just 12 chromosomes, the number could be explained by the continued division of an extra sperm, the first division of which has already been noted; but no such cases were observed. The cause of the irregularity was not determined.

**POLARITY.**—A striking feature of the free nuclear period is the frequency of a definite polarity. During the earlier divisions, the nuclei may be fairly evenly distributed, but still in two recognizable groups (fig. 12). Very often, however, the grouping is conspicuous, with a considerable space separating the upper and lower



groups (fig. 13). Sometimes the middle third of the proembryo is entirely free from nuclei; sometimes the nuclei are distributed throughout, but are smaller and more numerous above; sometimes the nuclei are dividing above but resting below, and later they divide below while the nuclei above are resting; there may be evanescent segmentation above, but no trace of it below; later, there is a migration of nuclei toward the base, followed by segmentation below, with none above; the embryo is formed below, while the upper region furnishes nutrition. In fact, there is a constant manifestation of polarity from the appearance of the archeogonium initial throughout the life of the plant. The source of nutrition is probably the cause of a part of these phenomena, but much is still to be explained.

CAUSE OF FREE NUCLEAR PERIOD.—Why the cycad embryogeny should begin with a period of free nuclear division is not hard to imagine. It would seem a physical impossibility for the small mitotic figure of the first division to segment the comparatively immense mass of the egg. Further, the large amount of nutritive material doubtless causes the nuclear divisions to follow in rapid succession. That they do follow in rapid succession is shown by the fact that the 2-, 4-, and 8-nucleate stages are very rarely found; and also by the fact that nuclei which have reached the resting condition are not likely to be found before the 16-nucleate stage. Further, a glance at the illustrations accompanying this paper will show that the mitotic figures, nearly 100, are all in the equatorial plate stage, a fact which indicates that other phases are comparatively rapid.

The small size of the mitotic figure, the great mass of the egg, and the rapid succession of mitoses doubtless cause the free nuclear period which characterizes not only cycads, but nearly all living gymnosperms. As the divisions proceed and the mass of the nucleus approaches that of the surrounding cytoplasm, segmentation, which may be more or less evanescent, appears; and later permanent segmentation with the formation of cellulose walls takes place. In the Bennettitales and earlier cycadophytes the seeds were much smaller than in any of the living cycads yet studied. It would be interesting to know the embryogeny of these forms.



An examination of the tiny *Zamia pygmaea* might show a comparatively short free nuclear period, but I have not yet been able to secure it. *Ginkgo*, with its comparatively small eggs, has only 7 free nuclear divisions, the walls appearing with the 8th division. *Selaginella* and *Isoetes* have a short period of free nuclear division at the germination of the megaspore, but none of the living heterosporous pteridophytes has any free nuclear division in the embryogeny. These stages have not yet been described in any fossil heterosporous pteridophyte, but some of the paleozoic forms had megaspores much larger than those of *Isoetes* or *Selaginella*. Doubtless, with the increase in the size of the egg, a free nuclear period became established, becoming more and more extensive as the egg became larger, until it reached its maximum in some of the living cycads, which have eggs 5 or 6 mm. in length, and which may have more than 1000 free nuclei before wall formation begins. Among the coniferophytes, *Ginkgo* has the most extended free nuclear period yet known. While we believe that the *Ginkgo* condition represents a culmination, it is not so clear that genera with less and less extended free nuclear periods in the embryogeny represent a reduction series, ending in forms like *Sequoia*, in which a cell wall follows the first mitosis in the fertilized egg. This may seem rather speculative, but we believe enough has been observed to warrant our theory that the origin and development of the free nuclear period has been due to a progressive increase in the size of the egg.

**MIGRATION OF NUCLEI.**—As soon as the first free nuclear period has come to a close, many of the nuclei in the upper and middle portions of the proembryo migrate to the bottom (figs. 16, 17, 18, 27). That nuclei actually move to the basal region is shown by the structure of the cytoplasm and arrangement of the nuclei, and also by the relative numbers of nuclei in the upper and lower parts of the proembryo. The cytoplasm becomes vacuolated in the lower portion, before any movement of the nuclei begins (fig. 15); but during the movement and in succeeding stages the vacuolated condition extends throughout. As the nuclei move to the base of the proembryo, the cytoplasm at that point becomes denser and denser, until it contrasts rather sharply with the vacuolated structure above (fig. 18).



SECOND FREE NUCLEAR PERIOD.—After the migration of nuclei, there is a second period of simultaneous free nuclear division at the base of the proembryo, but the nuclei above do not divide (fig. 19). The mitotic figures of this division were observed in only two cases, but in two others there was evidence that such a division had recently occurred. Since so few cases were observed, the extent of this free nuclear period could not be determined, but early stages in the cellular period would indicate that there are probably only two or three simultaneous mitoses before wall formation begins. The cause of this second period is probably the dense basal accumulation of cytoplasm during the migration of nuclei. The embryo, the suspensor, and some cells which remain within the limits of the egg are all formed from cells resulting from the second free nuclear period, the nuclei and cytoplasm above being resorbed by the growing embryo.

IKENO (3), in his classic account of *Cycas revoluta*, described free nuclear mitoses at the base of the proembryo, with amitotic divisions above, but did not give any further description of the embryogeny. His investigation dealt chiefly with the pollen tube structures and oogenesis. TREUB (1), who had previously made a study of *Cycas circinalis*, did not mention such a stage.

FORMATION OF WALLS.—At the close of the second free nuclear period, with the last simultaneous mitosis, there is a simultaneous formation of cell walls (fig. 20). At the middle of the cellular region there are about three layers of cells with cellulose walls, and at the edges only one layer. Above these cells with cellulose walls there is a segmentation of the cytoplasm, but the walls do not reach the cellulose stage and are weak and evanescent. Within the cellular region, mitoses are no longer simultaneous, and each nuclear division is followed by the formation of a wall. The region soon becomes sharply marked off from the cytoplasm above (fig. 21). Later, the peripheral walls of the cells bordering upon the cytoplasm become thickened, so that the cellular region is still more sharply defined (fig. 23). The thickening is mucilaginous. The free nuclei in the cytoplasm may undergo occasional divisions, giving rise to numerous small nuclei (fig. 21), while the cytoplasm bordering upon the cellular region becomes denser, losing more or



less completely its vacuolated appearance as it is resorbed by the rapidly developing embryo. Before the appearance of cotyledons, the young embryo has resorbed all the cytoplasm and nuclei of the free nuclear region, which becomes an empty shell, maintaining its contour only by the rigidity of the tough egg membrane. All the structures of this region, however, are finally crushed by the backward thrust of the suspensor, which is stopped only by the stony coat of the seed.

**DIFFERENTIATION OF CELLULAR REGION.**—Differentiation of the cellular region begins almost as soon as it is marked off from the free nuclear region above it. At first there is seen a differentiation into two general regions: the upper, in contact with the free nuclear region, consisting of larger cells; while the cells of the lower are much smaller, but denser and more numerous (fig. 21). Some of the upper cells, especially in the center, increase greatly in size and become actively haustorial; it is through these that the contents of the free nuclear region pass down to the developing embryo (fig. 23).

The smaller, denser cells then become differentiated into two regions, the lower consisting of a single layer of large cells which looks like a dermatogen, and above it several layers of small, dense cells (fig. 22). Most of the outer cells become haustorial, especially at the center. These cells partly digest and partly crush the egg membrane, and the young embryo begins to advance into the endosperm (fig. 23). Only a small portion of the egg membrane is ruptured, and the advancing embryo is extremely narrow in comparison with those of cycads previously described. The region of small, dense cells contributes most of the suspensor and all of the periblem and plerome of the embryo.

Stages in the development of the body regions of the embryo are still lacking in my material, but will doubtless be found in collections now being made in South Africa. From the mature embryo up to seedlings with several leaves the series is fairly complete, and some account will be given at another time in connection with a study of seedlings of other genera.

This paper, like several earlier papers on cycads, is largely descriptive. Since material is in hand for a fairly complete study



of all the genera, it seems wiser to reserve theoretical considerations until the available evidence has been examined.

### Summary

1. *Stangeria* is probably monotypic, with *S. paradoxa* as its single polymorphic species.

2. At fertilization there is a pairing of chromosomes resembling the pairing in the heterotypic mitosis, so that the number during the metaphase of the first division is apparently haploid, although really diploid.

3. There are two free nuclear periods in the embryogeny, the first comprising 9 or 10 simultaneous mitoses and extending throughout the proembryo, and the second with only 2 or 3 mitoses and confined to the lower part of the proembryo. The embryo and suspensor are formed from the second series.

4. There is an evanescent segmentation of the entire egg, as in *Dioon*.

5. The young embryo is very narrow and its haustorial structures are more conspicuous than in any other cycad yet described.

6. Polarity, which may appear even at the beginning of embryogeny, becomes more and more marked as development proceeds.

UNIVERSITY OF CHICAGO

### LITERATURE CITED

1. TREUB, M., Recherches sur les Cycadées. 3. Embryogénie du *Cycas circinalis*. Ann. Jard. Bot. Buitenzorg 4:1-11. pls. 1-3. 1884.
2. LANG, W. H., Studies in the development and morphology of cycadean sporangia. I. The microsporangia of *Stangeria paradoxa*. Ann. Botany 11:421-438. pl. 22. 1897.
3. IKENO, S., Untersuchungen über die Entwicklung der Geschlechtsorgane und der Vorgang der Befruchtung bei *Cycas revoluta*. Jahrb. Wiss. Bot. 32:557-602. pls. 8, 9. 1898.
4. WORSDELL, W. C., The vascular structure of the sporophylls of the Cycadaceae. Ann. Botany 12:203-241. pls. 17, 18. 1898.
5. LANG, W. H., Studies in the development and morphology of cycadean sporangia. II. The ovule of *Stangeria paradoxa*. Ann. Botany 14:281-306. pls. 17, 18. 1900.
6. WEBBER, H. J., Spermatogenesis and fecundation of *Zamia*. Bull. no. 2. Bur. Pl. Ind., U.S. Dept. Agric. pp. 100. pls. 7. 1901.



7. MATTE, H., Recherches sur l'appareil libéro-ligneux des Cycadées. pp. 233. *pls. 16. figs. 264.* 1904.
8. MIYAKE, K., Über die Spermatozoiden von *Cycas revoluta*. Ber. Deutsch. Bot. Gesells. 24:74-83. *pl. 6.* 1906.
9. PEARSON, H. H. W., Notes on South African cycads. I. Trans. South African Phil. Soc. 16:341-354. *pls. 6-8.* 1906.
10. NASH, G. V., A rare cycad. Jour. N.Y. Bot. Gard. 10:163, 164. 1909.
11. CHAMBERLAIN, C. J., Spermatogenesis in *Dioon edule*. BOT. GAZ. 47:215-236. *pls. 15-18.* 1909.
12. ———, Fertilization and embryogeny in *Dioon edule*. BOT. GAZ. 50:415-429. *pls. 14-17.* 1910.
13. ———, The adult cycad trunk. BOT. GAZ. 52:81-104. 1911.
14. HUTCHINSON, A. H., Fertilization in *Abies balsamea*. BOT. GAZ. 60:457-472. *pls. 16-20.* 1915.

#### EXPLANATION OF PLATES XXIV-XXVI

Most of the sections were cut at  $5\ \mu$ ; none was thicker than  $10\ \mu$ . With the exception of figs. 4-8, the drawings were reconstructed from two or more sections. Figs. 12 and 13 are reconstructed to show all the nuclei of these proembryos.

FIG. 1.—Text cut, showing *Stangeria* in the field.

FIG. 2.—Nucellus with pollen tubes showing prothallial cell, stalk cell, body cell with blepharoplasts, and tube nucleus; in one tube (at the right) the body cell has divided;  $\times 50$ .

FIG. 3.—Later stage: mature sperms are about to be shed;  $\times 50$ .

FIG. 4.—Blepharoplast, much vacuolated, shortly before breaking up into granules; the body cell has not yet divided;  $\times 365$ .

FIG. 5.—The blepharoplast has broken up into an immense number of small granules; the nucleus of the young sperm is smaller than the blepharoplast of the preceding figure; the median portion of the spindle can still be seen;  $\times 365$ .

FIG. 6.—The granules have increased in size and number and are becoming arranged into a flat band; note the great increase in the size of the nucleus;  $\times 365$ .

FIG. 7.—Transverse section of a band at the stage shown in fig. 6;  $\times 365$ .

FIG. 8.—The bristle-like cilia beginning to develop from the band; some are directed toward the nucleus;  $\times 365$ .

FIG. 9.—Fertilization: the sperm nucleus entering the egg nucleus; the ciliated band remains at the top of the egg;  $\times 42$ .

FIG. 10.—First mitosis in the fertilized egg: at the top, 3 sperms which have passed through the neck, but have not entered the egg; the ciliated band of the sperm which effected fertilization is easily seen;  $\times 42$ .



FIG. 11.—First division of fertilized egg: a second sperm has entered and is dividing in the upper part of the egg; two more sperms which have almost entered the egg are seen at the top;  $\times 42$ .

FIG. 12.—The fourth simultaneous free nuclear division;  $\times 42$ .

FIG. 13.—At the bottom, 8 approximately equal nuclei are dividing; at the top, the division is also simultaneous, but the number of nuclei is large and they are irregular in size; there is a very marked polarity;  $\times 42$ .

FIG. 14.—The nuclei of the lower half are large and are in the resting condition, while those of the upper half are smaller and are dividing simultaneously; the polarity is evident;  $\times 42$ .

FIG. 15.—Evanescence segmentation: the nuclei of the lower part are larger and the cytoplasm is becoming vacuolated;  $\times 42$ .

FIG. 16.—Many nuclei have migrated to the bottom and the cytoplasm of the entire proembryo is vacuolated; the ciliated band is still evident at the top;  $\times 42$ .

FIG. 17.—Slightly later stage: many nuclei have amoeboid shapes;  $\times 42$ .

FIG. 18.—Nuclei with dense cytoplasm at the base of the proembryo, just before the second free nuclear period;  $\times 140$ .

FIG. 19.—Free nuclear division of the second free nuclear period;  $\times 140$ .

FIG. 20.—Segmentation at the close of the second free nuclear period;  $\times 140$ .

FIG. 21.—The cellular region is differentiated from the free nuclear region and there is some differentiation within the cellular region itself;  $\times 100$ .

FIG. 22.—An outer layer of dermatogen-like cells has been differentiated; the dense cells just above are to produce the periblem, the plerome, and most of the suspensor;  $\times 100$ .

FIG. 23.—The upper cells of the cellular region are distinctly haustorial, and the slender tip, which has just broken through the egg membrane, is composed largely of haustorial cells;  $\times 100$ .

FIG. 24.—Photomicrograph: upper part of fertilized egg, showing a part of the ciliated band and two sperms which have almost entered the egg;  $\times 80$ .

FIG. 25.—Photomicrograph: first mitosis in fertilized egg, showing the mototic figure and the conspicuous kinoplasmic area about it;  $\times 86$ .

FIG. 26.—Photomicrograph: one of the mototic figures of the fourth simultaneous free nuclear division;  $\times 517$ .

FIG. 27.—Proembryo, showing the migration of nuclei toward the bottom;  $\times 33$ .



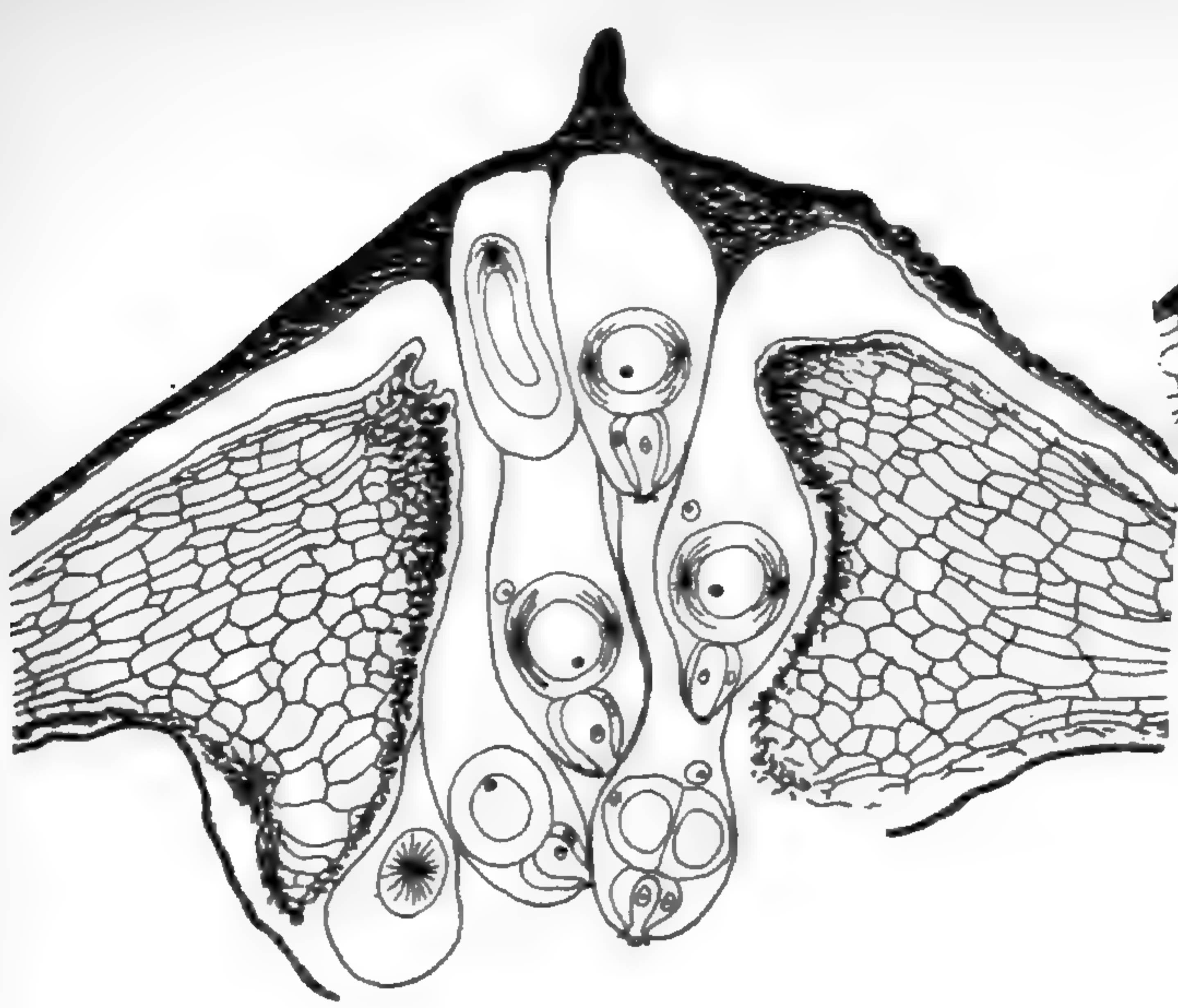

2



3

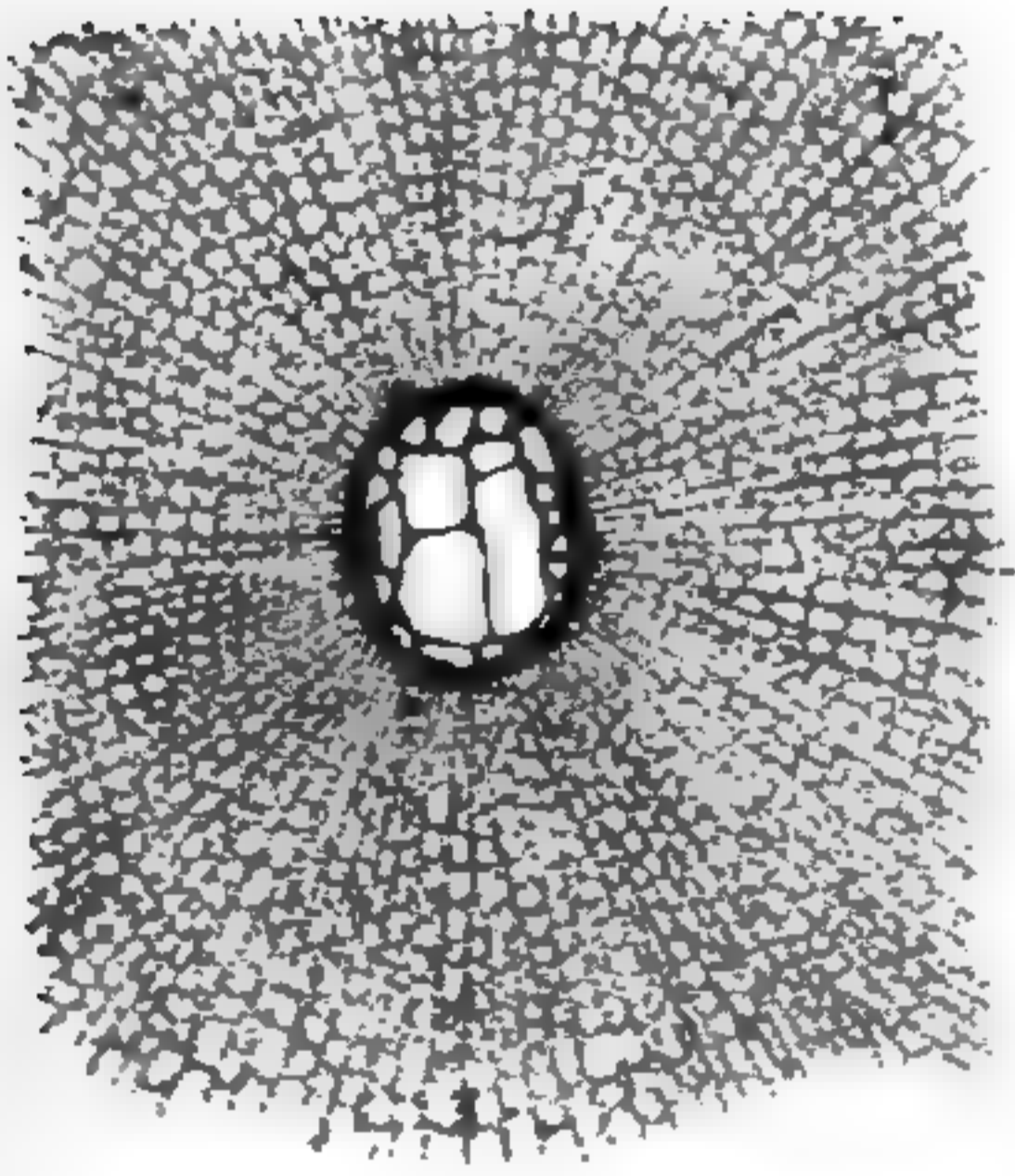

4

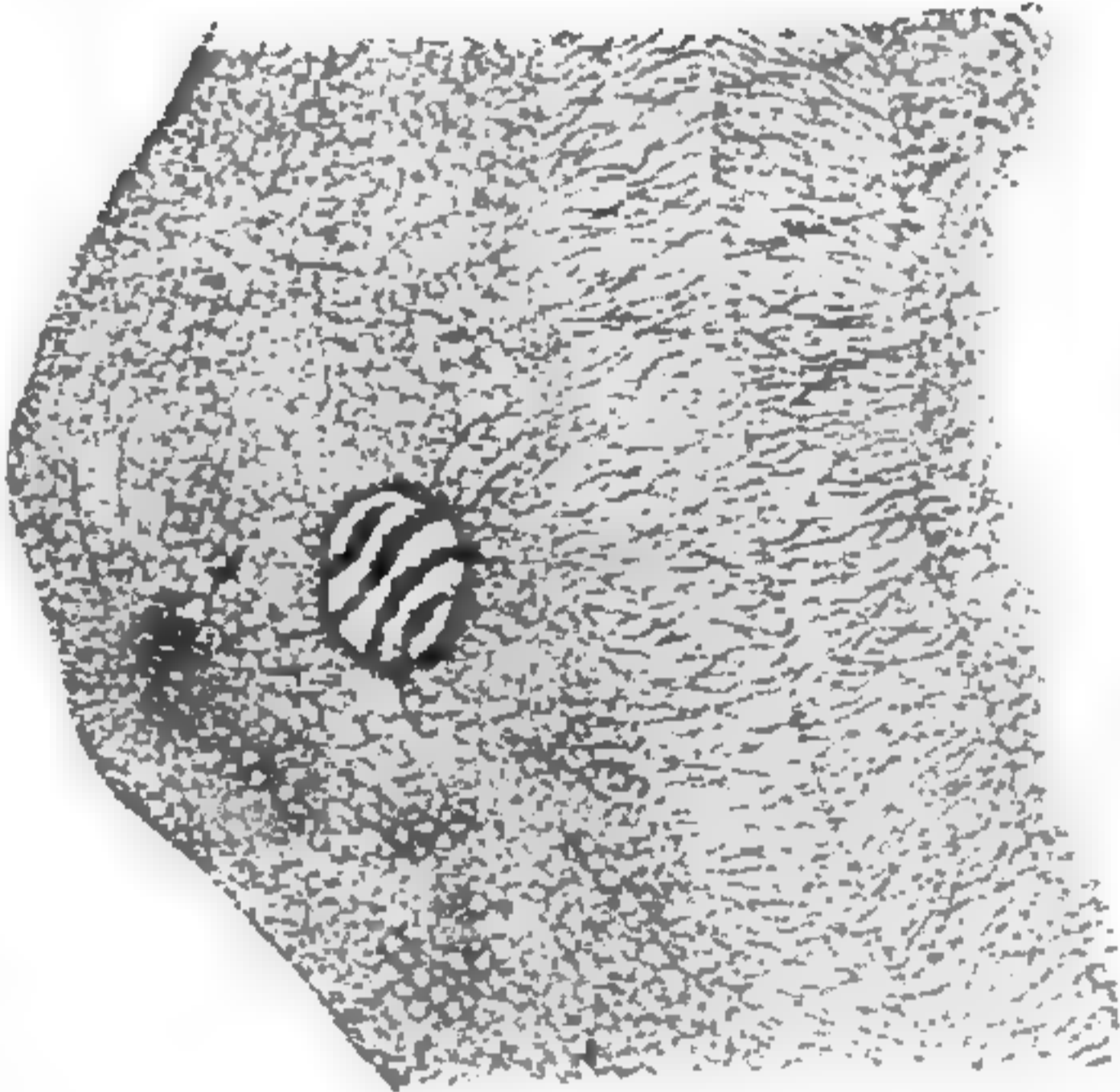

5

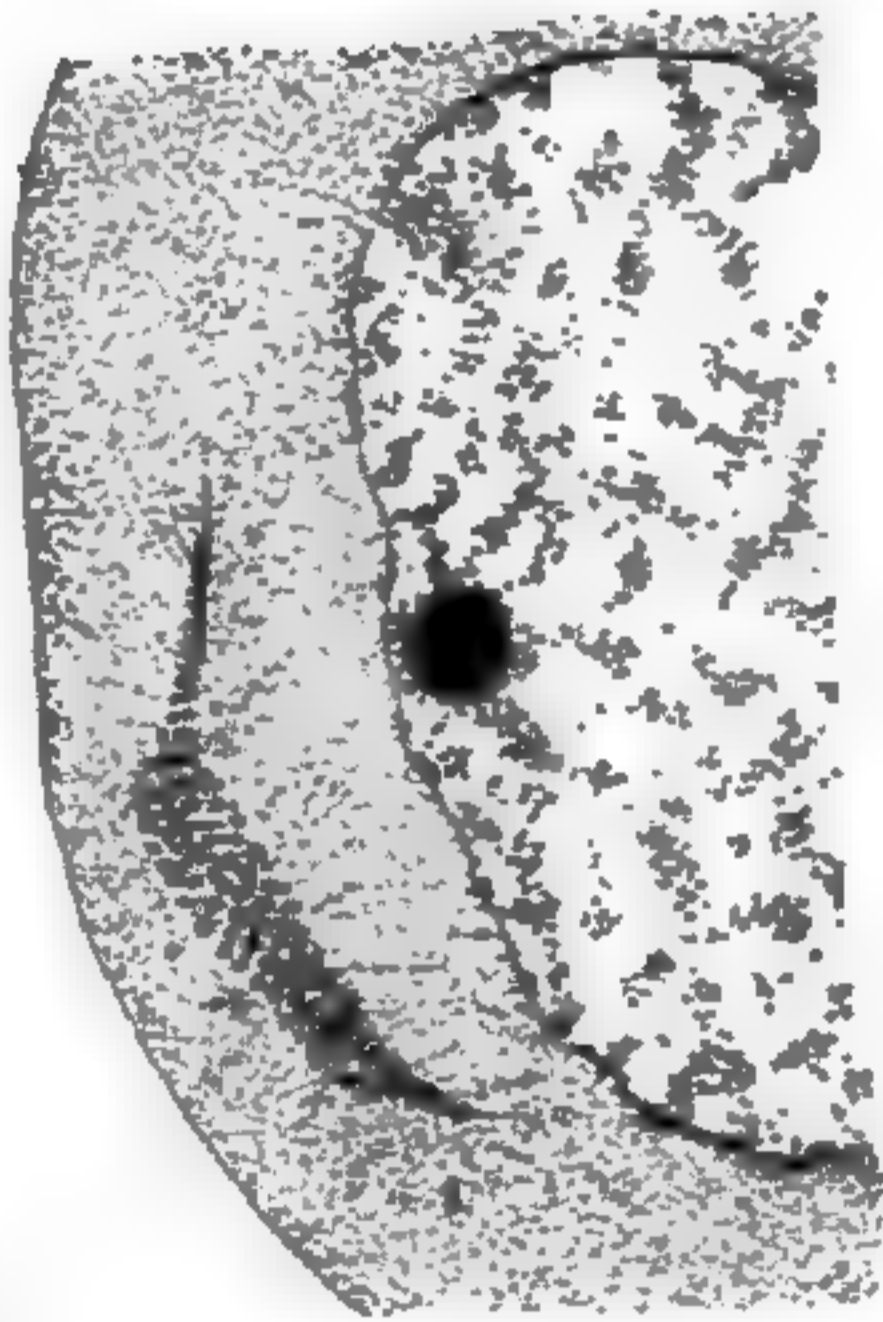

6

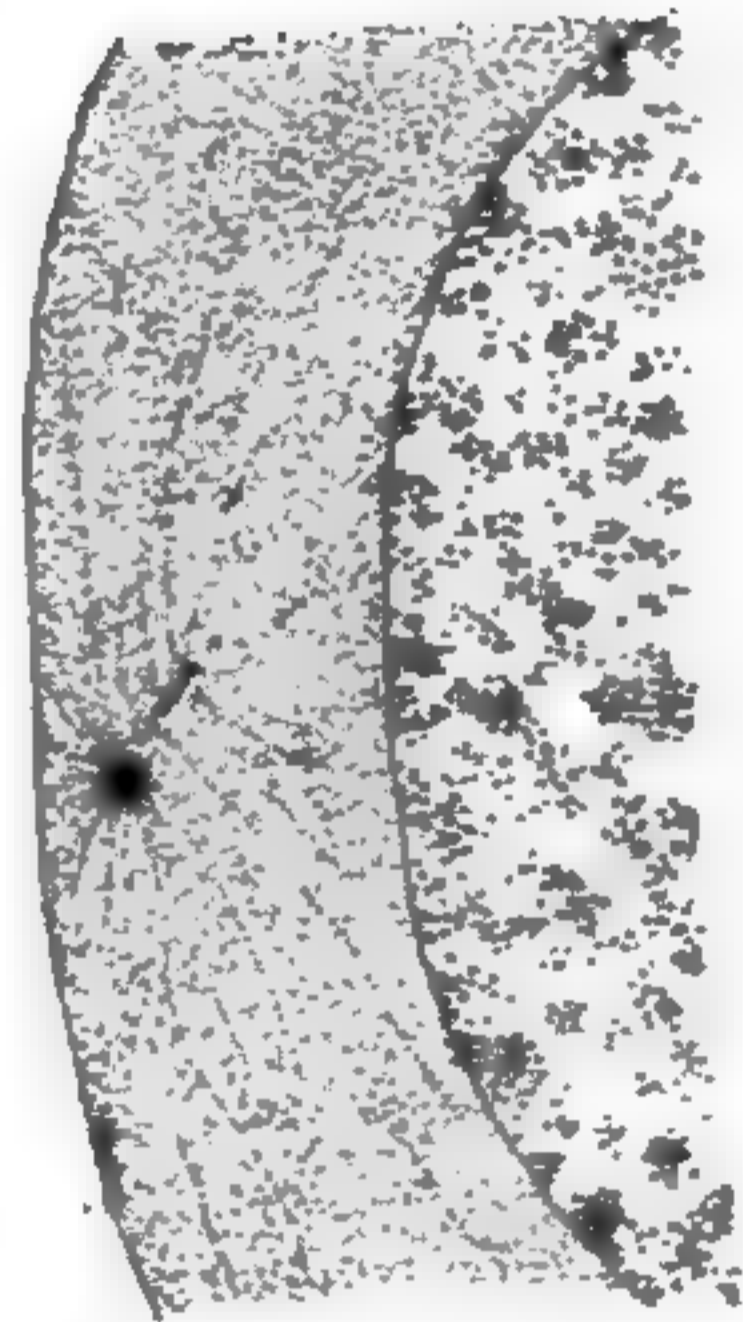

7

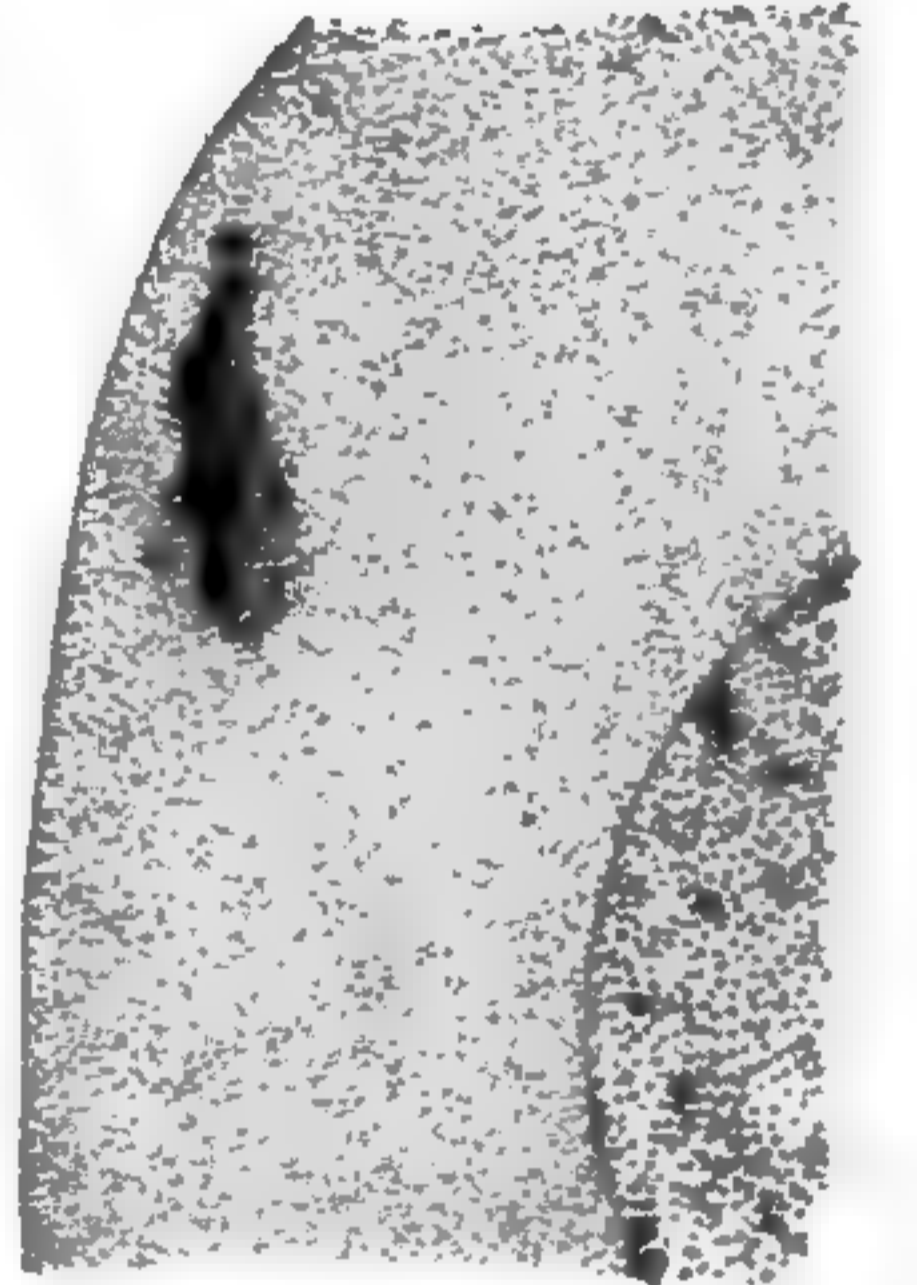

8

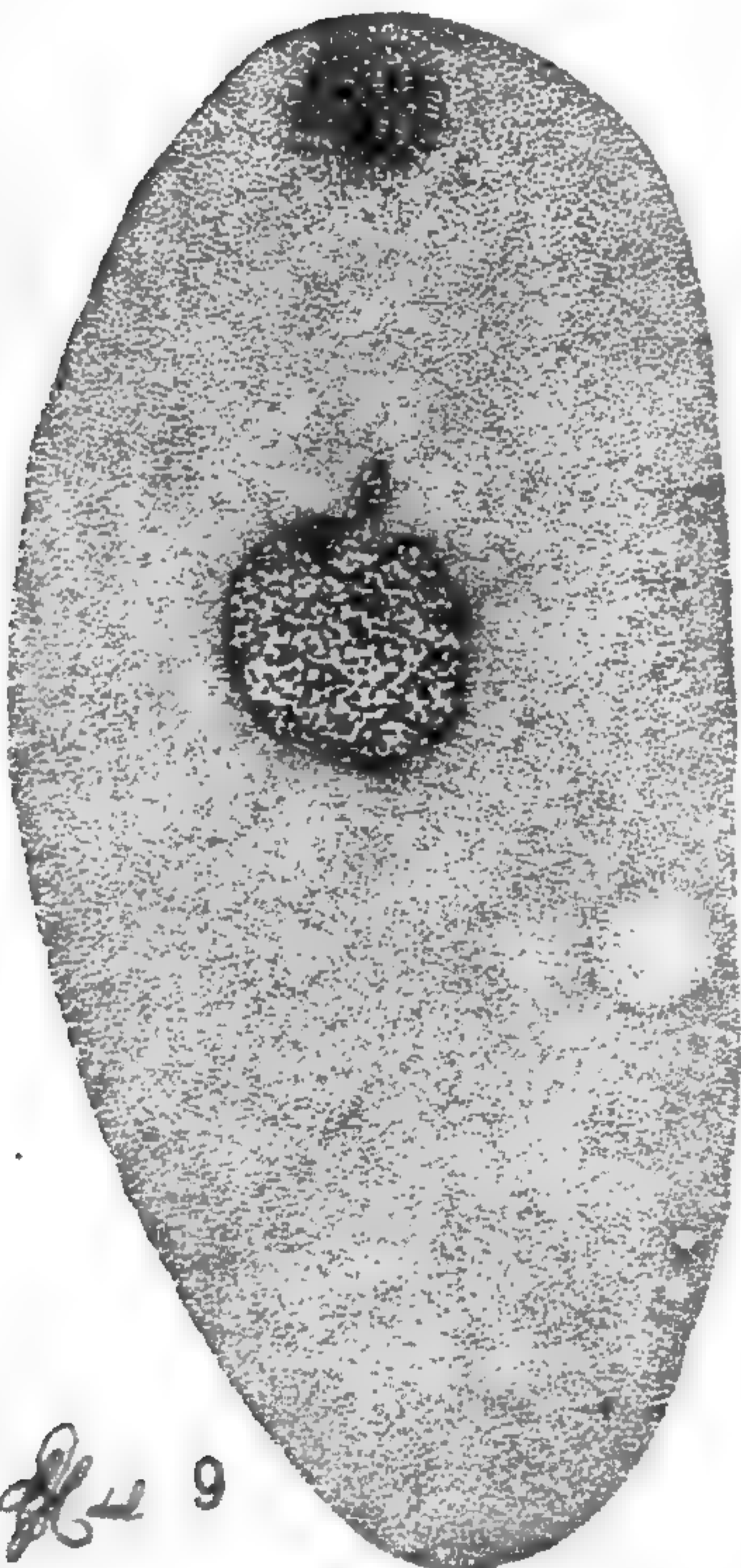

H. 9

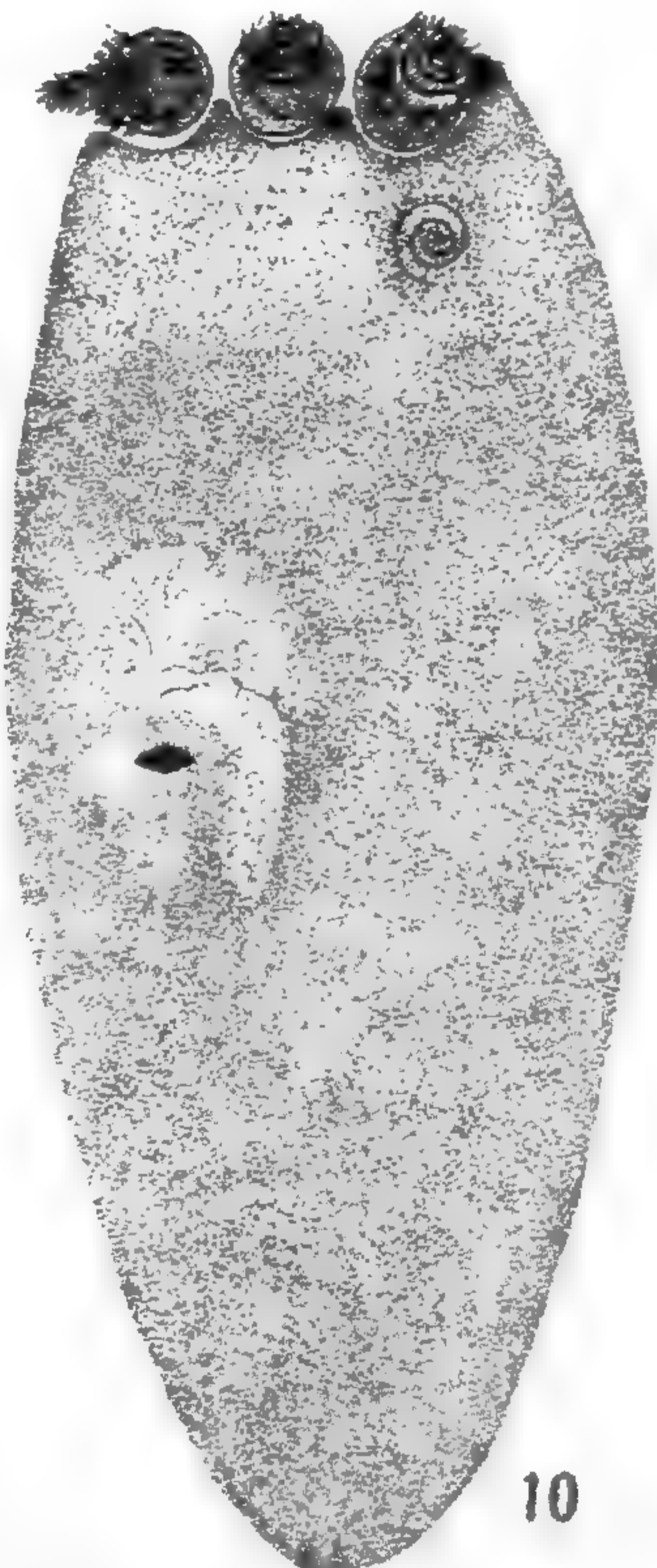

10

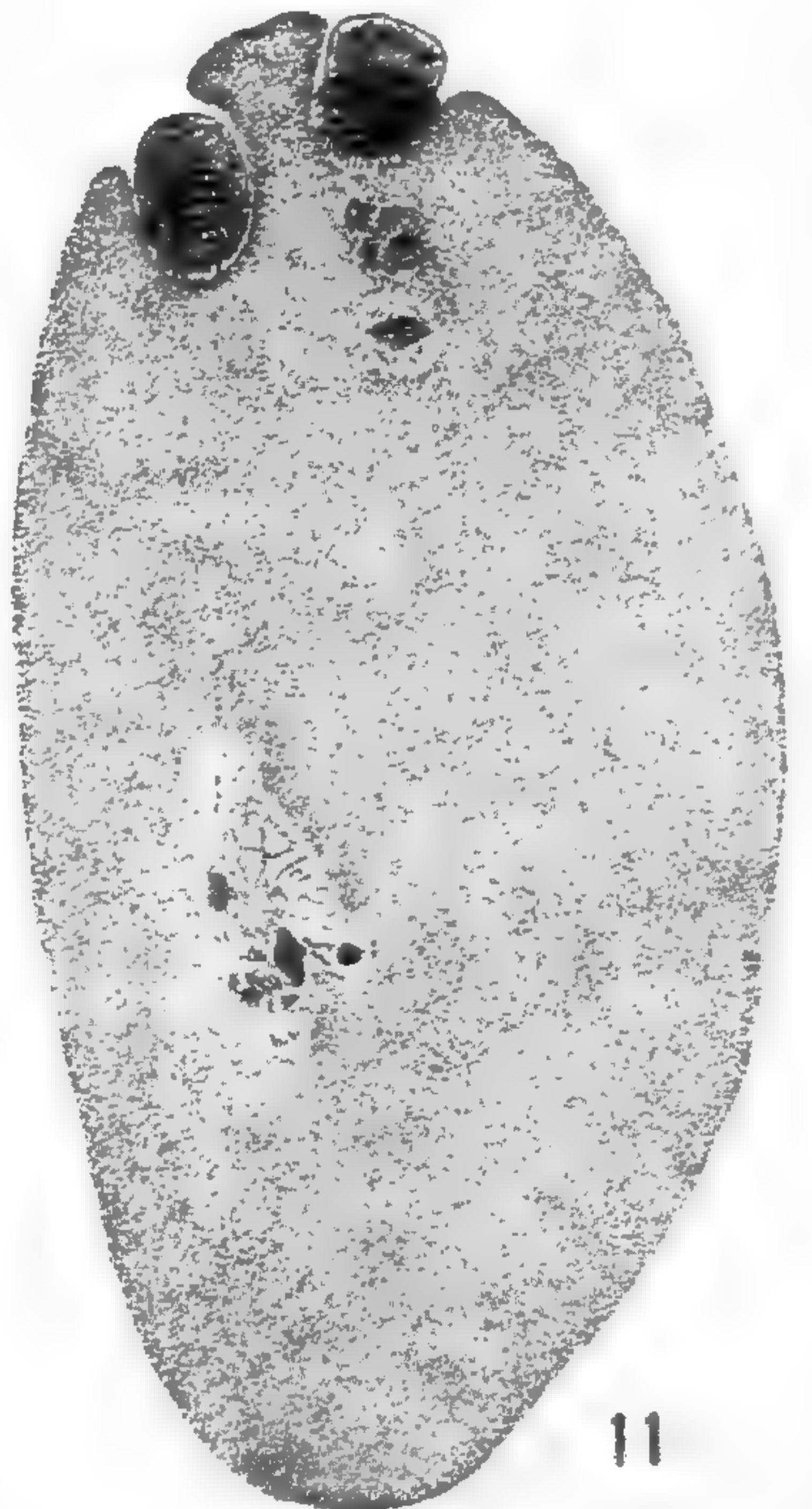

11



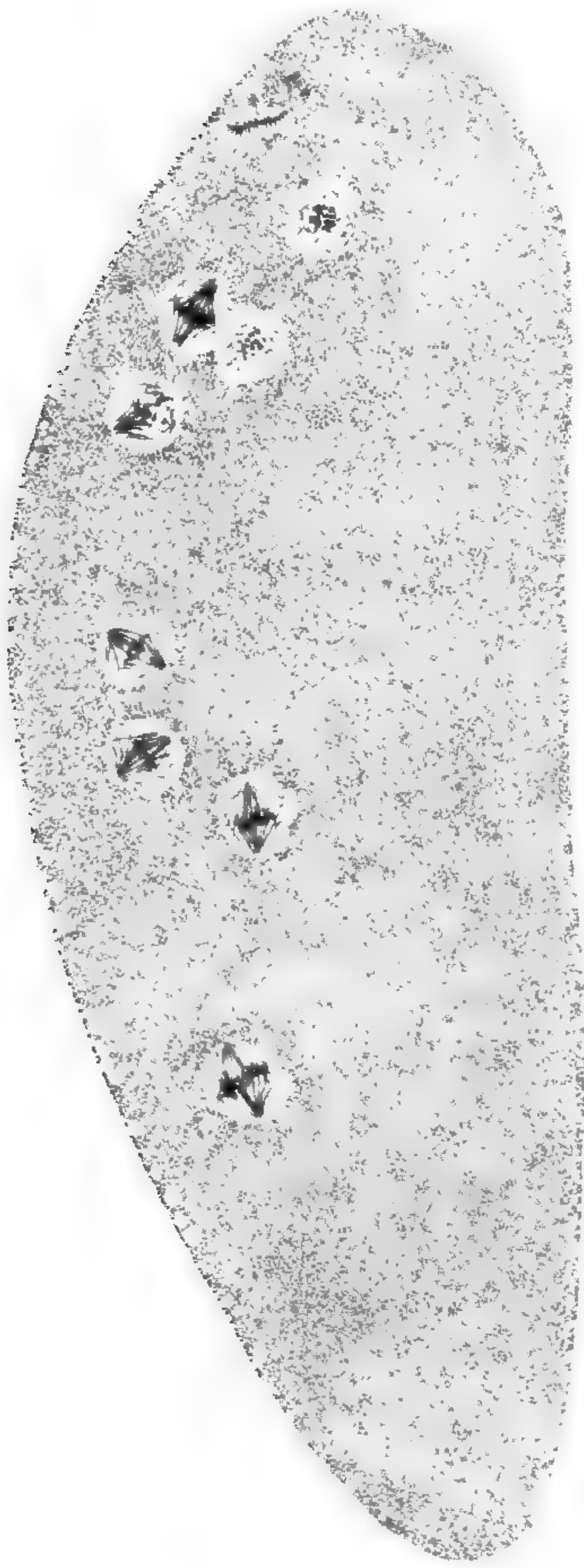

12

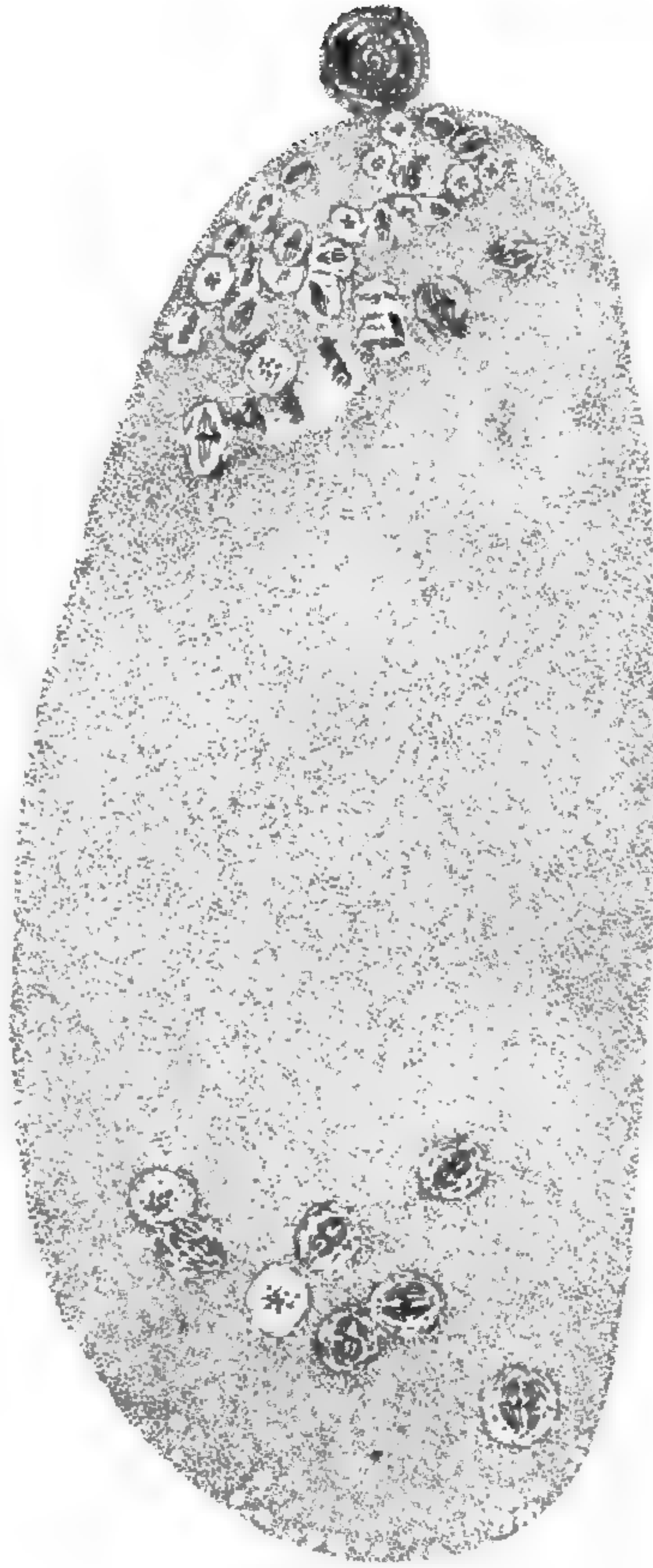

13

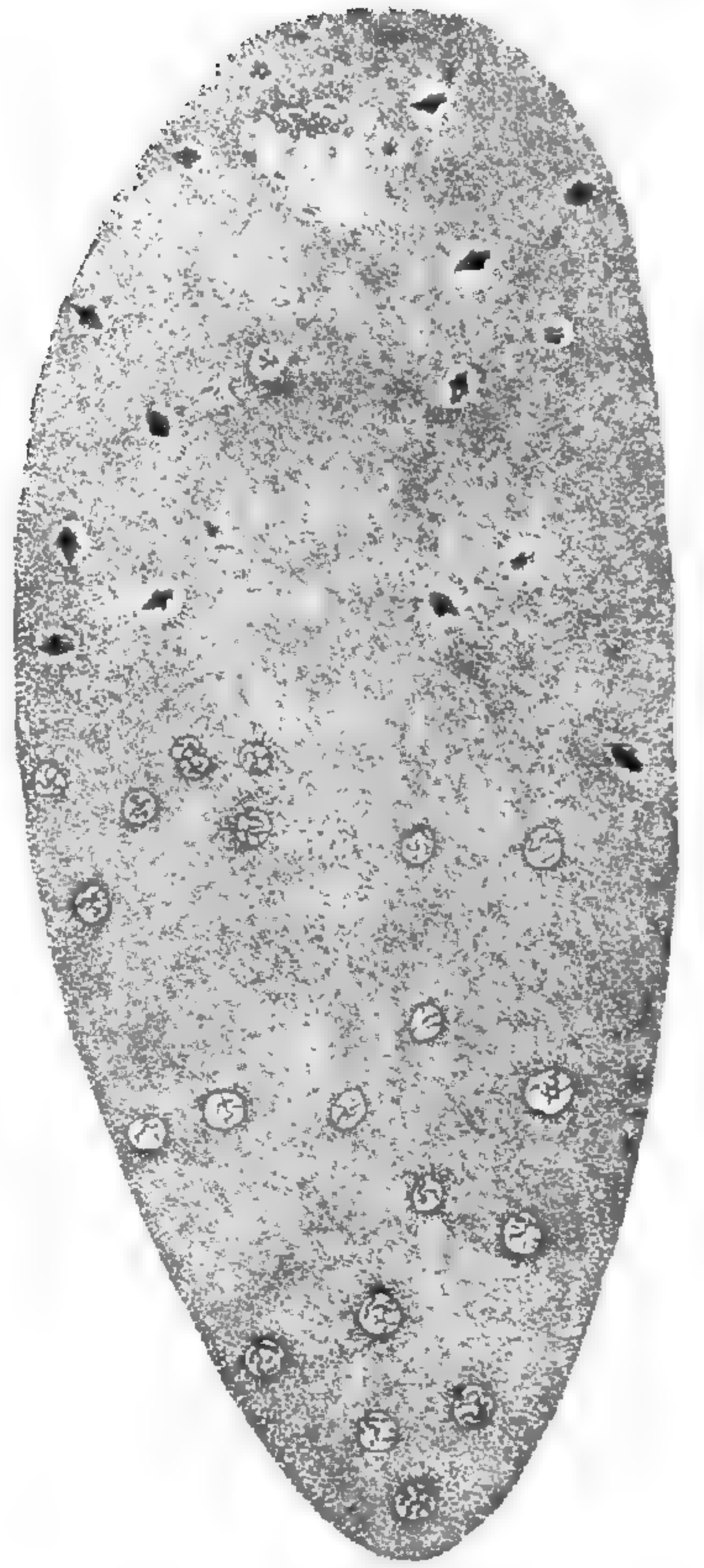

14

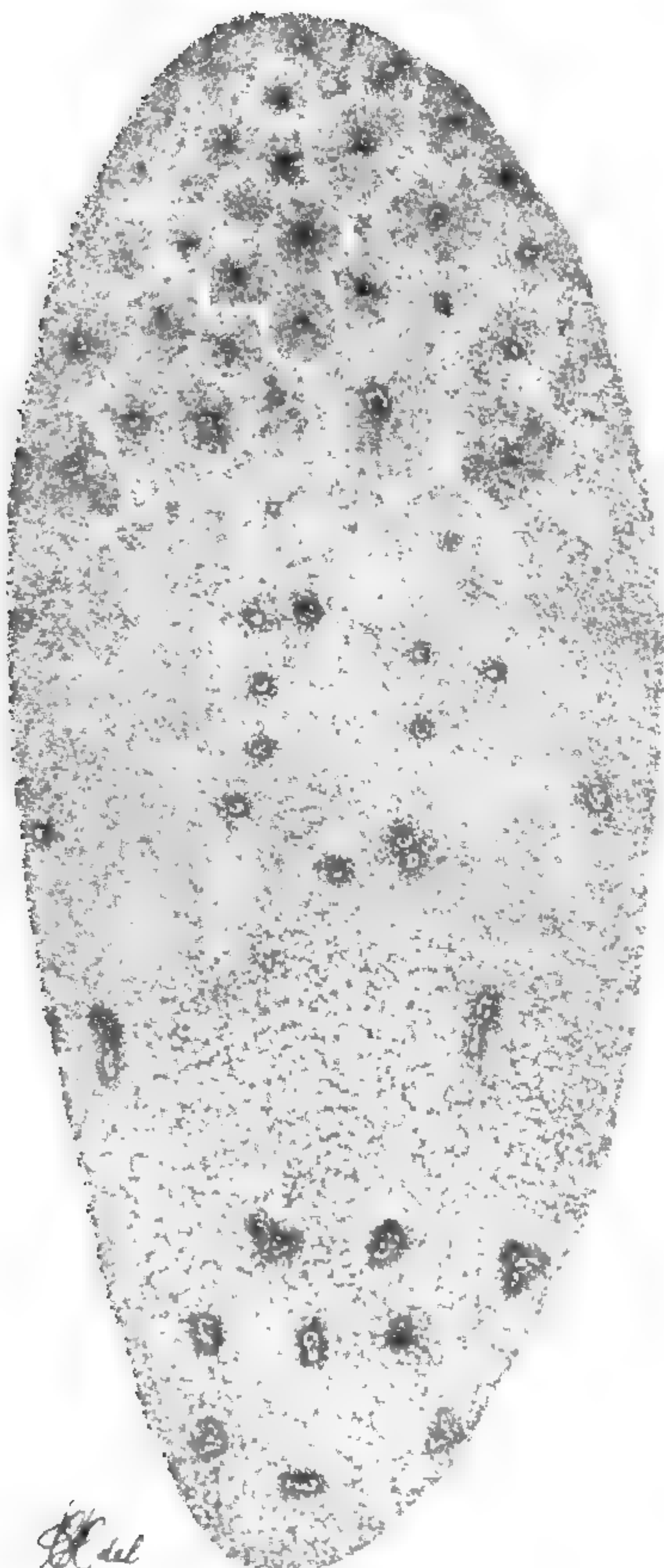

15

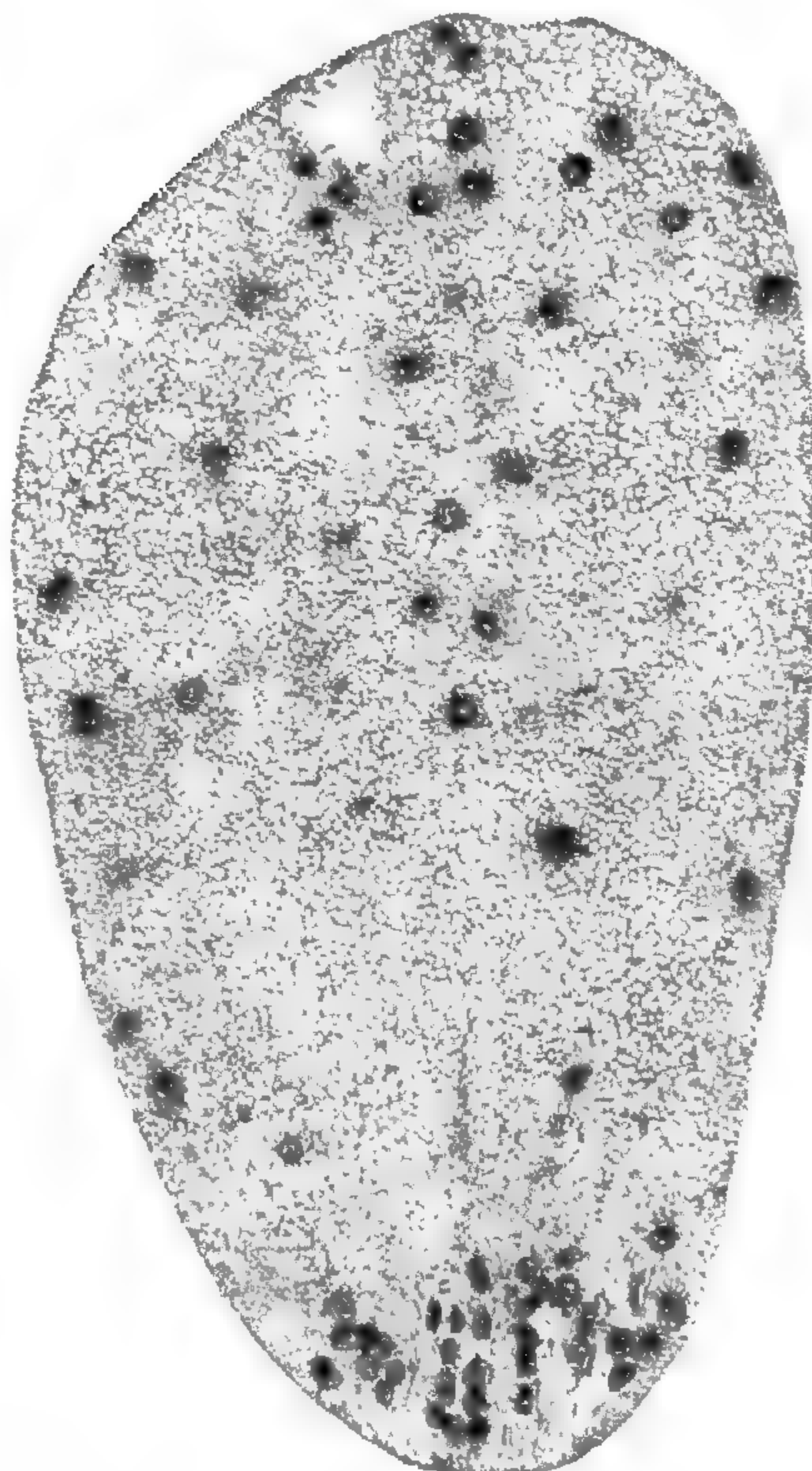

16

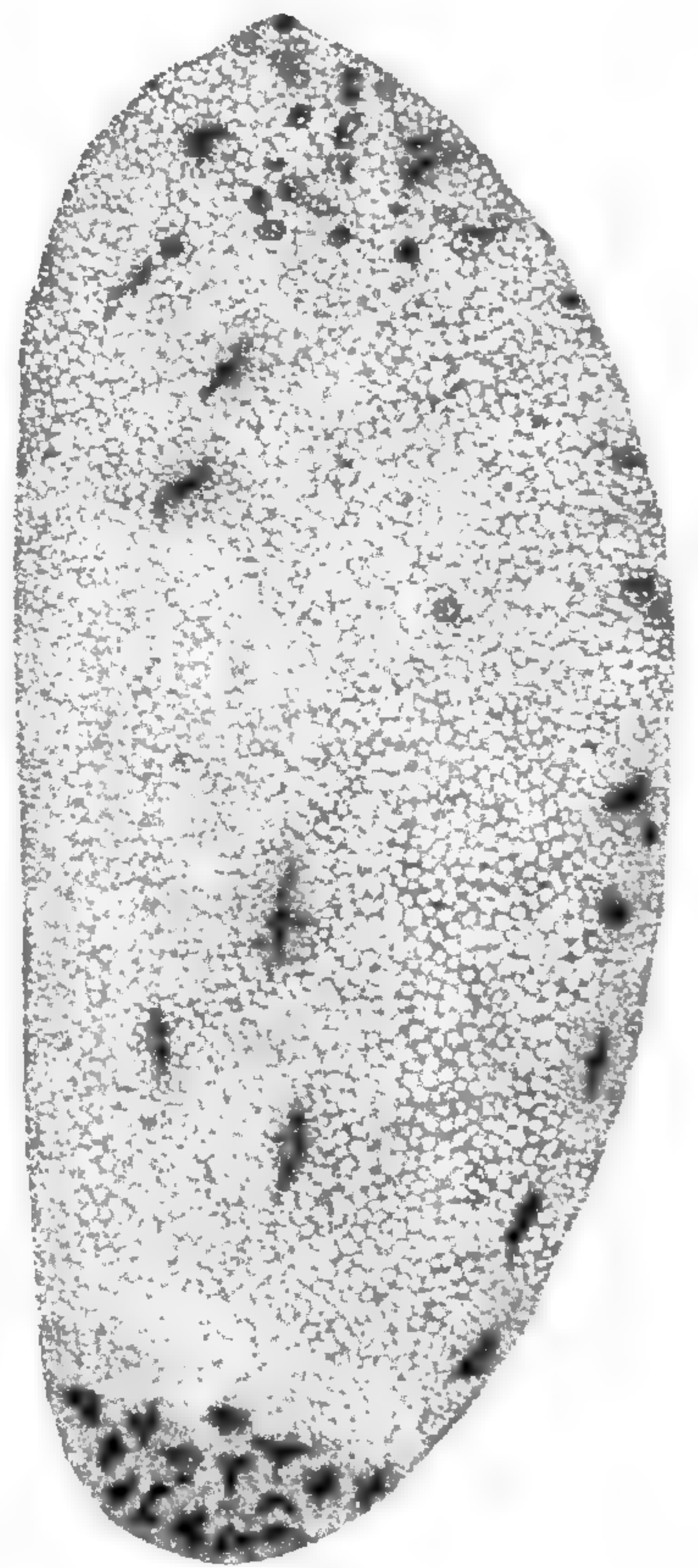

17

*H. del.*



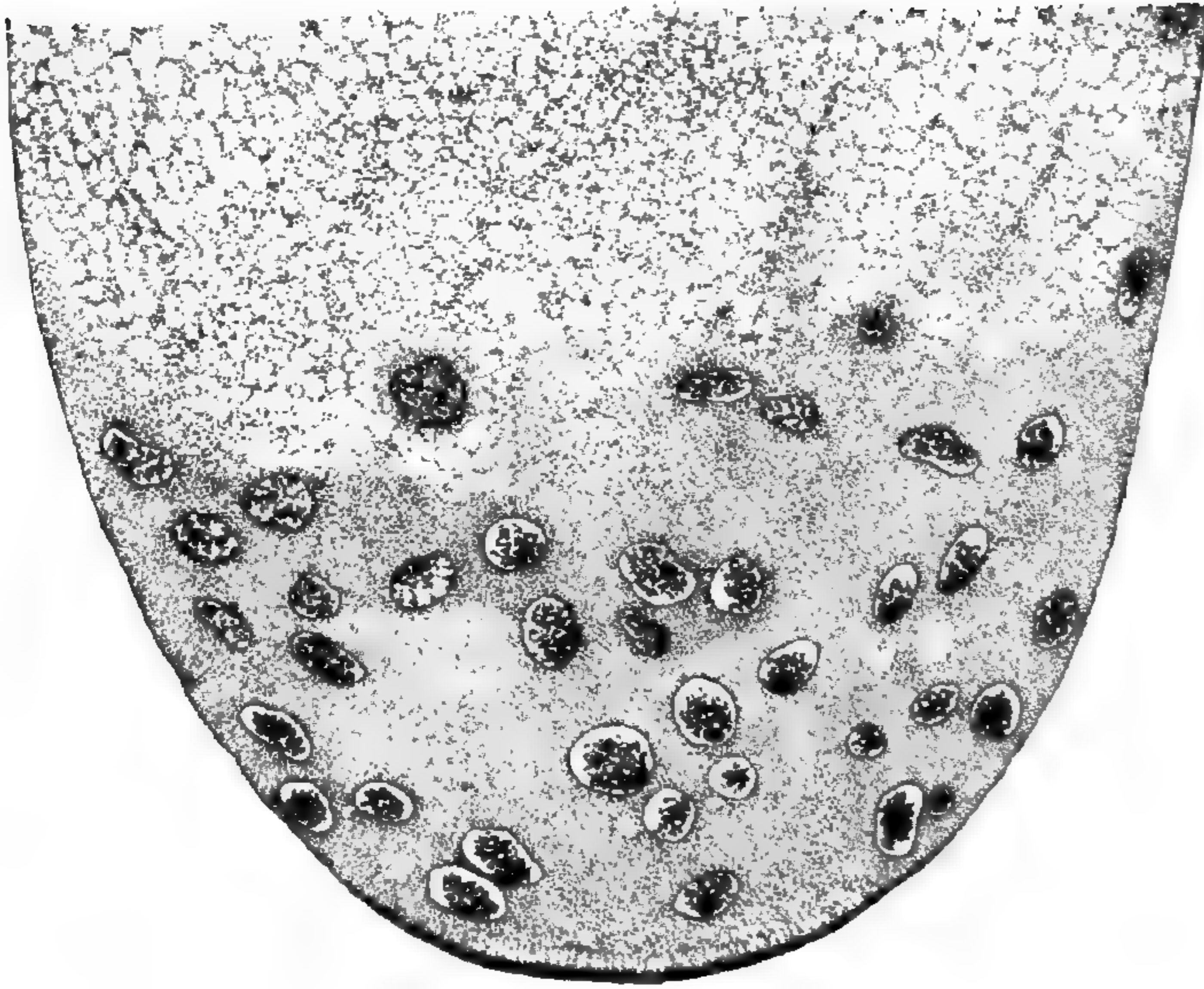

18

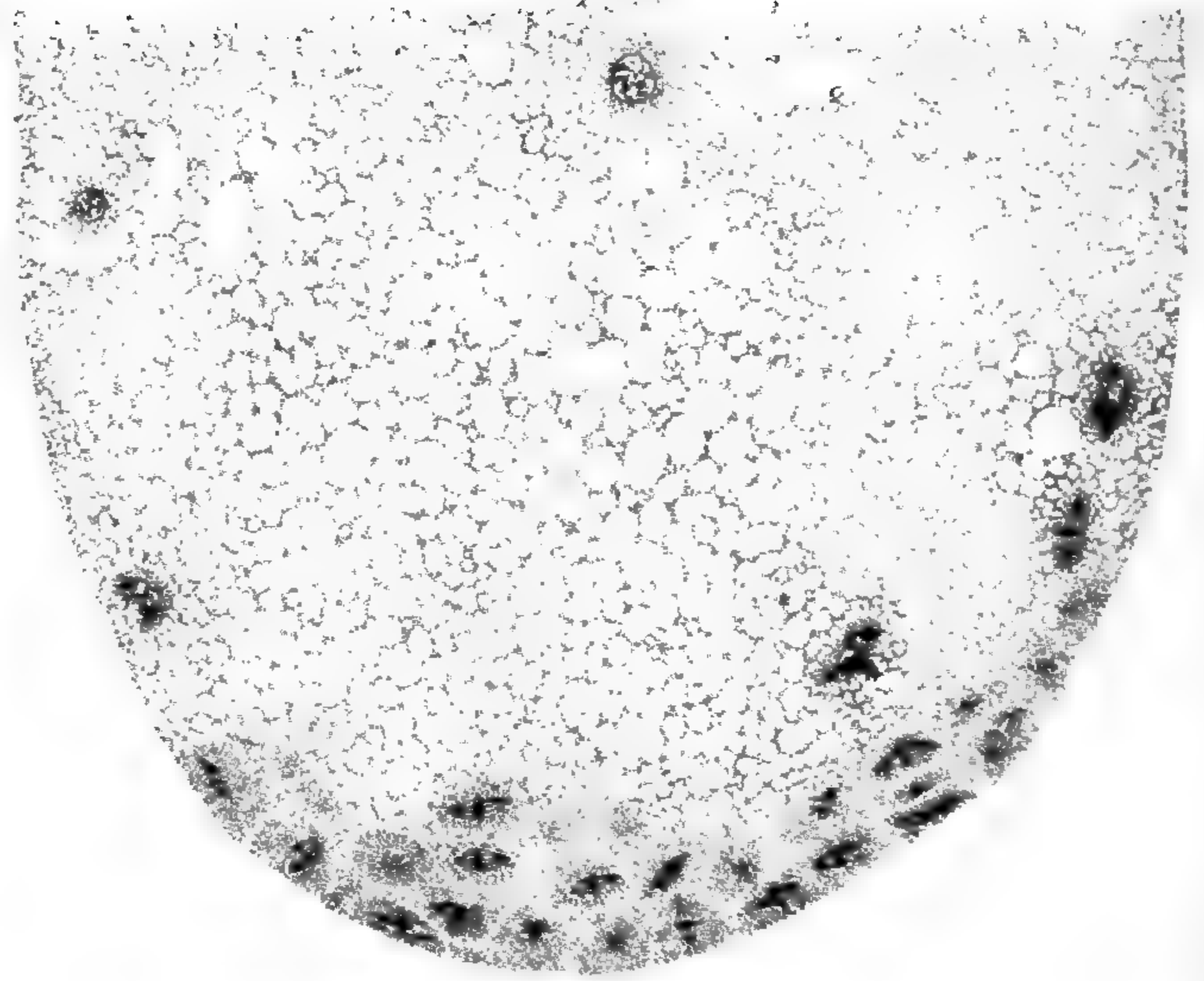

19

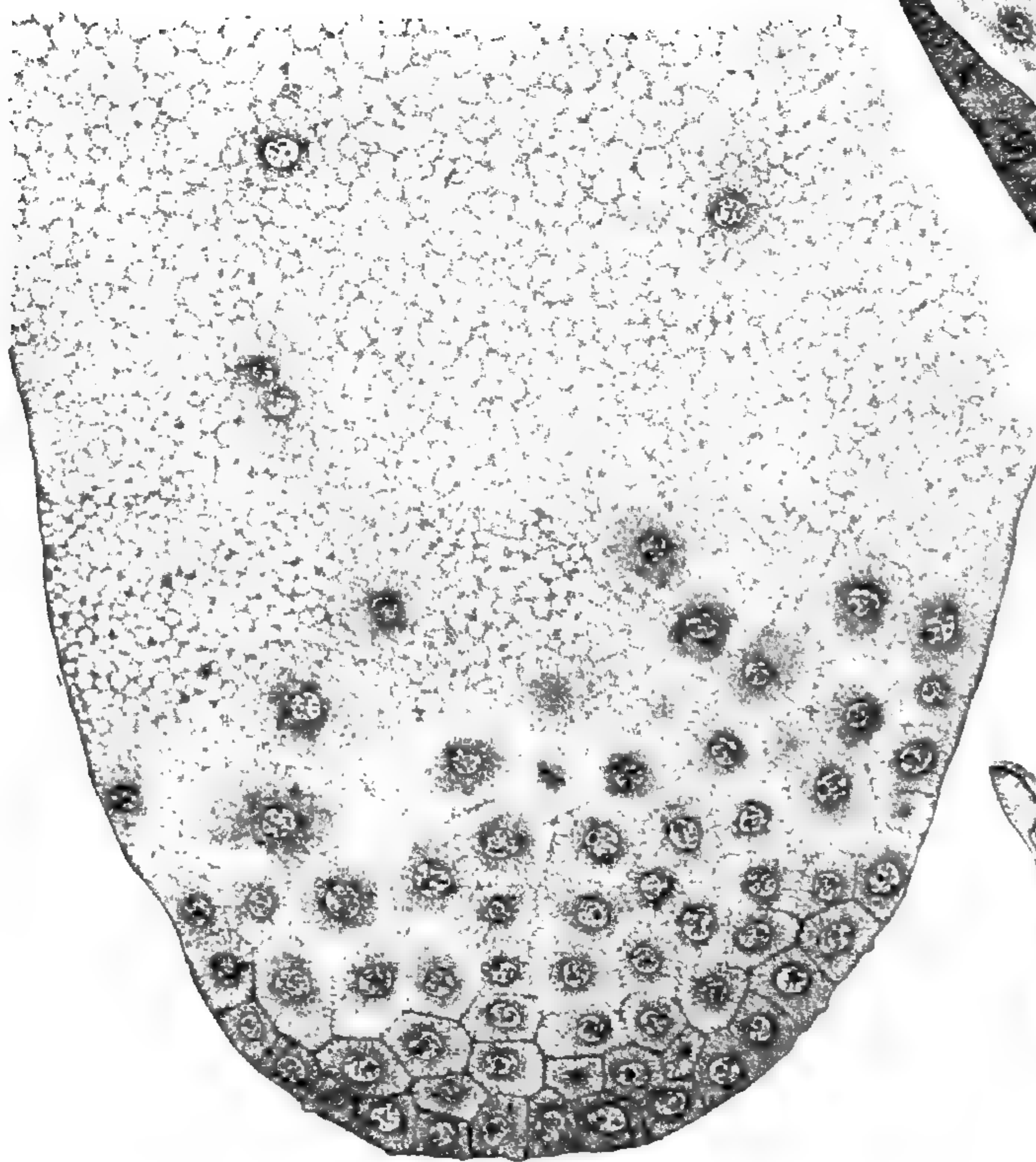

20

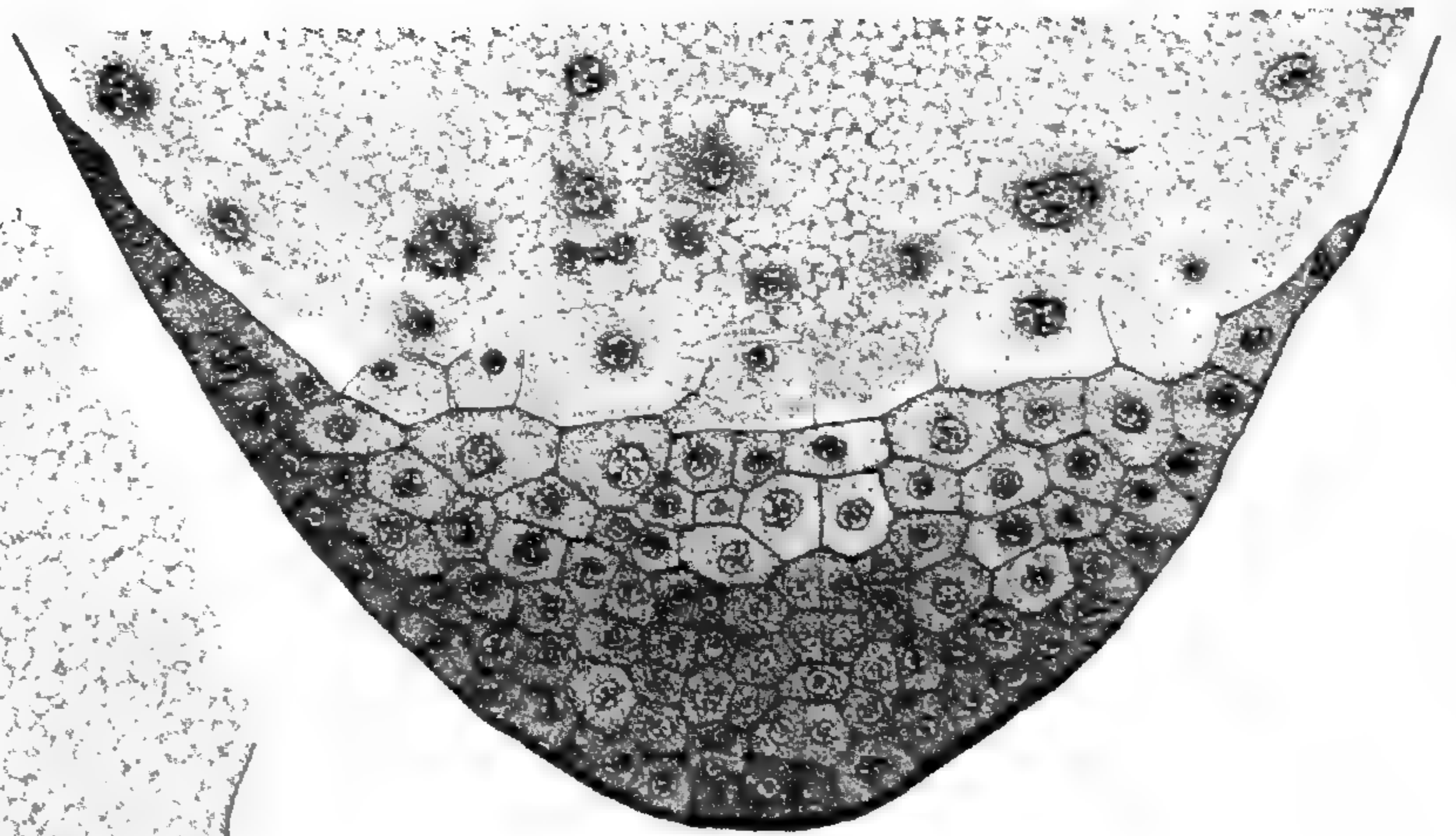

21

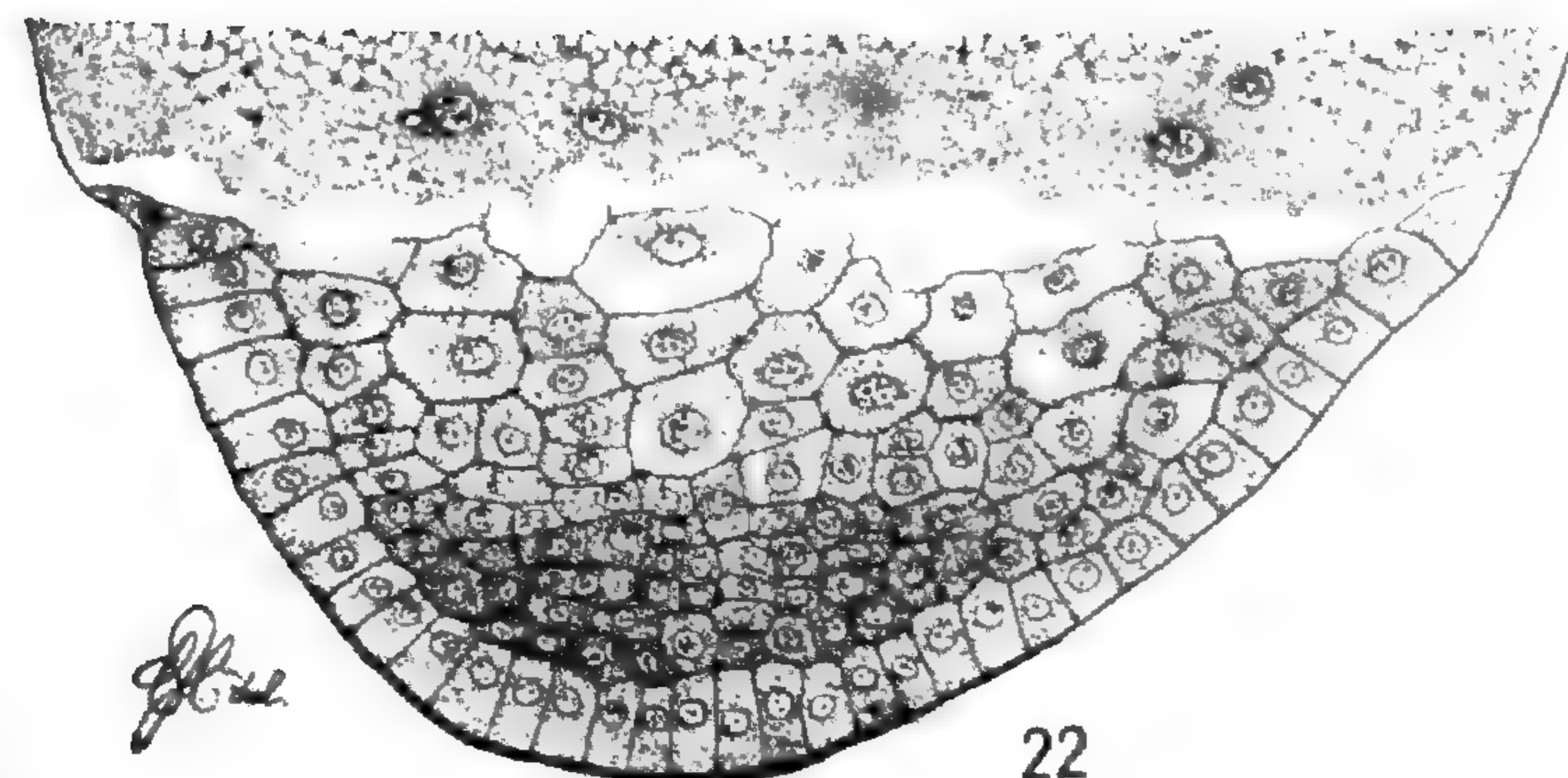

22

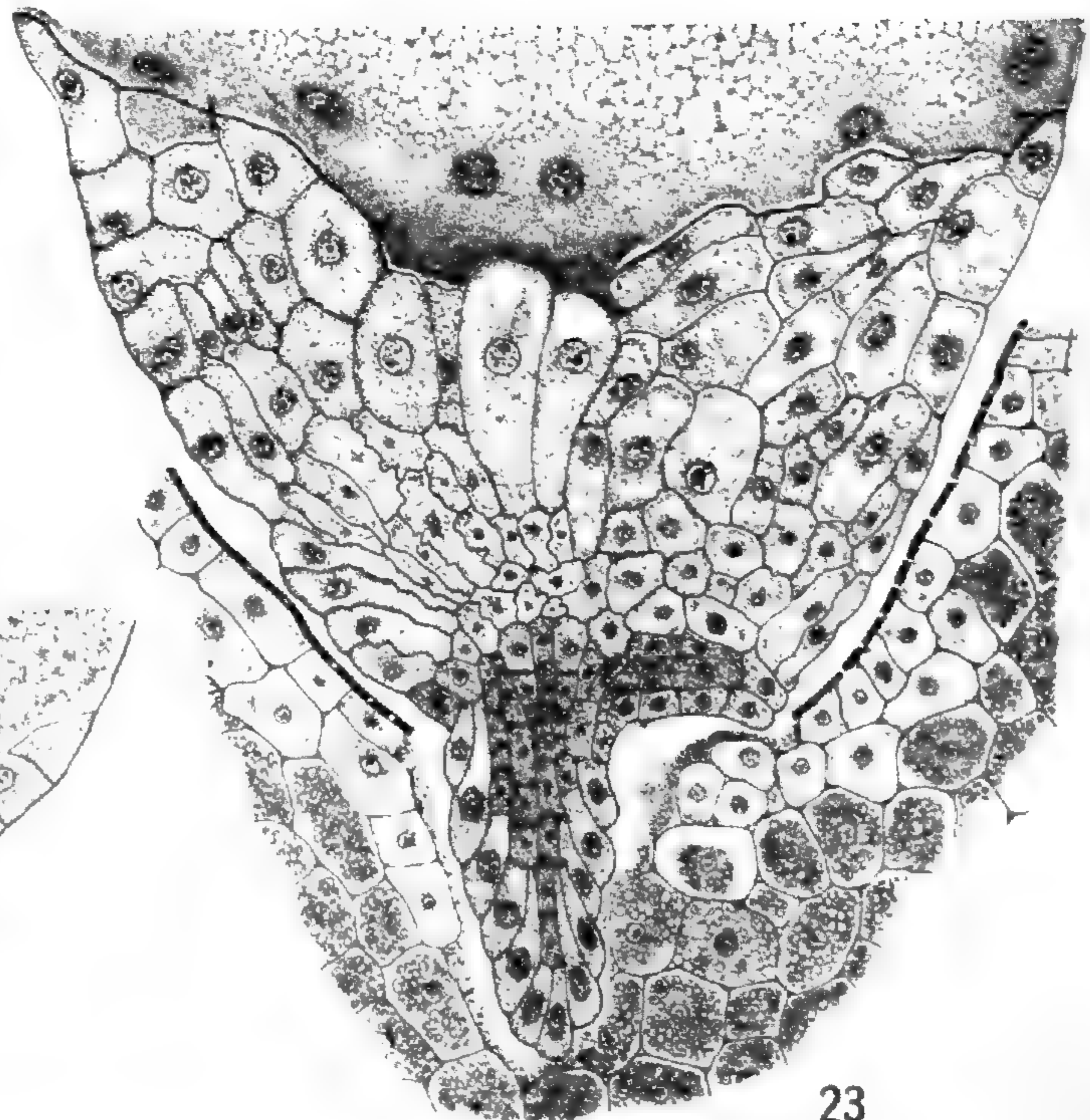

23

*Chamberlain*





24

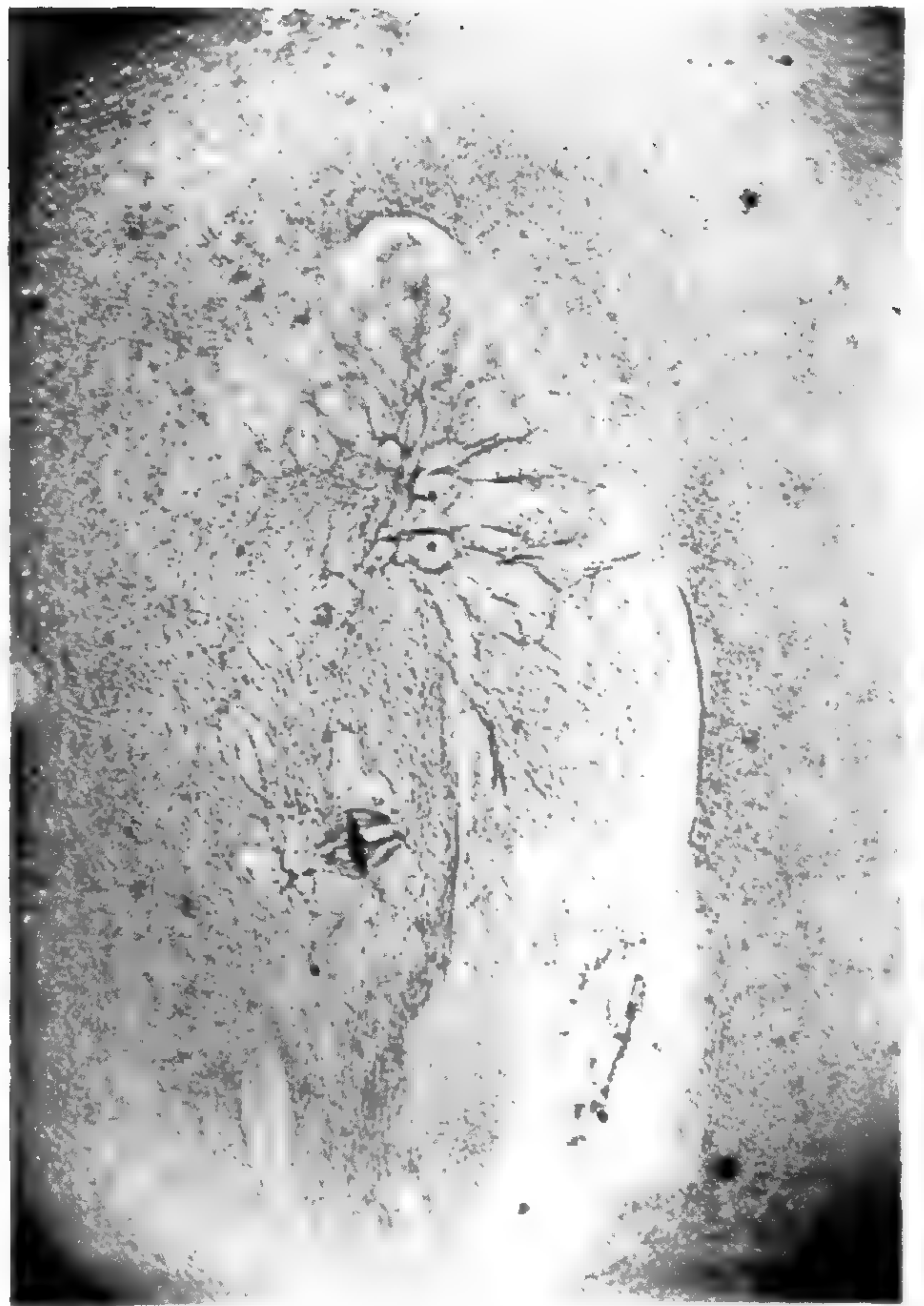

25



26



27

CHAMBERLAIN on STANGERIA



UNDESCRIBED PLANTS FROM GUATEMALA AND  
OTHER CENTRAL AMERICAN REPUBLICS

XXXIX<sup>1</sup>

JOHN DONNELL SMITH

**Celastrus vulcanicolus** Donn. Sm.—Folia coriacea nitida oblongo-elliptica apice acuminata basi cuneata subintegra. Racemi singuli simplices laxiflori, pedicellis medio articulatis ibidem ebracteolatis basi deltoideo-bracteatis, floribus minimis. Petala oblonga obtusa genitalibus longiora. Stamina sub disco inserta, antheris cordatis. Ovarium triloculare, loculis uniovulatis. Capsula late ellipsoidea monosperma.

Frutex omnibus in partibus glaberrimus, ramulis lenticelligeris, novellis racemisque angulatis purpureo-fuscescentibus. Folia 6–8 cm. longa 2–3 cm. lata calloso-apiculata supra medium subobsolete calloso-appressoque-serrulata, costa supra subimmersa subtus robusta prominente, nervis lateralibus utrinque 6 nonnisi subtus conspicuis, petiolis 3–4 mm. longis canaliculatis, stipulis ciliiformibus aegre perspiciendis deciduis. Racemi 8–12-flori, floriferi 1.5–2 cm. longi, fructiferi 3.5–4.5 cm. longi, pedicellis 4 mm. longis, bractea 0.5 mm. longa. Calyx basi cupularis incrassatus, segmentis jam in alabastro ovoideo 2 mm. longo liberis ovatis obtusis 0.75 mm. longis. Petala imbricata 1.5 mm. longa. Stamina 1 mm. longa. Discus prominens pentagonus 2 mm.-diametralis. Ovarium liberum depresso-globosum 1 mm. altum, ovulis erectis, stylo vix ullo, stigmātibus 3. Capsula nondum satis matura clausa calyce persistente fulta tenuiter coriacea 1.6–2 cm. longa basi contracta unilocularis, valvis loculicide cohaerentibus intus medio septicide late alatis, semine nonnisi juvenili viso capsulam inflatam parum implente, arillo purpurascente.—Ad *C. racemosam* (Reiss.) Loes. et ad *C. Pringlei* Rose proxime accedens.

In declivibus ad Volcán de Fuego, Depart. Zacatepéquez, Guatemala, alt. 1900 m., Mart. 1892, *John Donnell Smith*, n. 2549 ex Pl. Guat. etc. quas edidit Donn. Sm.

**Gilibertia diplostemona** Donn. Sm.—Folia simplicia integra coriacea elliptica tenuiter acuminata in petiolum angustata. Stipulae obsoletae. Umbella terminalis solitaria pedunculata pluriradiata ter quaterve irregulariter decomposita densiflora

<sup>1</sup>Continued from BOT. GAZ. 57:427. 1914.



pubescens. Calycis margo subinteger. Petala 4-5 calyptratim decidua. Stamina 8-10. Styli 2-3 in columnam connati.

Frutex scandens absque umbella glaberrimus, ramulis sulcatis striatis rufescentibus linea elevata interpetiolarum circumdatis defolatione insigniter cicatrisatis, internodiis superioribus 4-4.5 cm. longis. Folia 14-17 cm. longa 5.5-8 cm. lata, costa sicut nervi laterales utrinque 7-8 subtus robusta, areolis minutis, petiolis 15-17 mm. longis basi incrassatis, cicatricibus obovatis 4 mm. longis foveolato-punctatis. Pedunculus 2.5 cm. longus 4 mm. crassus sulcatus striatus rufescens medio et supra medium linea elevata circumdatus apice sub insertione radiorum in pulvinum dilatatus, umbella tota cum floribus rubicunda (cl. *Pittier* in schedula), semiglobosa 4 cm. alta 6 cm. lata, radiis primariis 12-13 circiter 1.5-2.5 cm. longis, umbellulis paucius et inaequaliter radiatis, pedicellis 1-3 mm. longis ebracteolatis, floribus cum pedicello continuis congestis. Calyx obpyramidalis 1 mm. longus atque latus margine undulatus. Petala valvata oblongo-ovata 2.5 mm. longa acuta apice cohaerentia. Stamina per paria petalis opposita, filamentis in alabastro inflexis per anthesin erectis, antheris filamenta subaequantibus ellipticis 1.25 mm. longis bis longioribus quam latioribus basi affixis didymis viridulis. Discus in columnam stylorum 0.75 mm. longam abiens. Fructus deficit.—Secundum clavem specierum Centrali-Americanarum in BOT. GAZ. 55:436. 1913 ad inflorescentiam adumbratam haec juxta *G. querciti* Donn. Sm. inserari debetur, differt tamen umbella decomposita.

In silvis ad fundum *Tuis* dictum, Prov. Cartago, Costa Rica, alt. 700 m., Dec. 1900, *H. Pittier* (sine numero).

**ISERTIA DEAMII** Bartlett, var. **stenophylla** Donn. Sm.—Folia lanceolata 4-plo et ultra longiora quam latiora deorsum longe attenuata pernumerose nervata. Thyrsus foliis fulcientibus aequilongus lanceolato-ovoideus. Calyx denticulatus. Corolla flava.

Folia 28-35 cm. longa medio 6.5-8.5 cm. lata, nervis lateralibus utrinque circa 25-26. Thyrsus pedunculo aequilongo adjecto 26 cm. longus, rhachi 9 cm. longa, cincinnis inferioribus usque ad 4 cm. longis tortuosis 6-floris, floribus flavis (ex cl. *Pittier*). Calycis denticuli breves lati acuti.

In planetibus prope Boca Culebra, Comarca de Puntarenas, Costa Rica, alt. 50 m., Jan. 1898, *H. Pittier*, n. 11989.

**Hoffmannia nesiota** Donn. Sm.—Folia generis inter maxima elliptica acuminata in petiolum subtriplo breviora longe attenuata coriacea glabra. Pedunculi 2-4-ni petiolo subduplo superati, cymis corymbiformibus laxifloris, pedicellis gracilibus. Calycis tubus pyramidalis acute trigonus dentibus 4-triangularibus dimidio



longior. Corolla triente fida. Ovarium triloculare. Bacca maxima globosa.

Frutex in dumetis confertim crescens (ex cl. *Pittier*), ramulis subteretibus fistulosis lenticellatis glabris linea interpetiolarum elevata notatis, stipulis ignotis. Folia 22–26 cm. longa medio 10.5–11 cm. lata in petiolum 7.5–8 cm. longum decurrentia, costa cum nervis lateralibus utrinque 14–16 supra subimpressa subtus prominente, areolis crassis. Cymae unilaterales (sicut inflorescentiam praebent monochasiam omnes congenerae ut videtur), pedunculo 3.5–5 cm. longo lenticellato glabro adjecto 5–8 cm. longae 5–10-florae cum floribus pube patente fusca sparsim pilosiusculae, bracteis bracteolisque obsoletis, pedicellis 6–10 mm. longis, floribus 15–16 mm. longis. Calyx 5 mm. longus eglandulosus. Corolla 11 mm. longa fuscescens, segmentis 4 linearibus levissime imbricatis. Stamina 4 faucibus corollae inserta, antheris subsessilibus linearibus 5.5 mm. longis conectivo fusco producto apiculatis. Discus elevatus pulvinaris. Ovarium anthesi peracta oblongo-obovoideum bis longius quam latius subtetragonum, stylo 12 mm. longo, stigmatis lobis subconnatis oblongo-ovatis 1.5 mm. longis. Bacca 1 cm.-diametralis dentibus calycinis haud accrescentibus coronata trilocularis 4-costata, seminibus ellipsoideis 0.5 mm. longis foveolatis rubellis.—Ad. *H. Pittieri* Standley foliis accedens ab ea inflorescentia recedit.

In humidis ad *Wafer Bay*, Insula Cocos in mari Pacifico, Costa Rica, Jun. 1898, *H. Pittier*, n. 12387.

**Rudgea** (§ NOTACANTHAE K. Sch.) **thyrsiflora** Donn. Sm.—Folia glabra lanceolato-elliptica sursum tenuiter deorsum brevius acuminata, stipulis in vaginam utrinque bisetosam inter setas aculeoligeram connatis. Thyrsus foliis 3–4-plo brevior anguste conicus densiflorus ferrugineo-pubescentibus, floribus cymulosim confertis subsessilibus. Calycis lobi tubum subaequantes. Corolla tubus urceolatus lobos calycinos bis superans segmenta propria filiforme corniculata aequans.

Rami teretes ferrugineo-pubescentes. Folia membranacea 19–23 cm. longa 6–8 cm. lata, costa cum nervis lateralibus utrinque circiter 13 subtus prominente et fusco-puberula, venis transversis crebris, petiolis 8–15 mm. longis, stipularum ferrugineo-pubescentium vagina 5 mm. longa margine aculeis cartilagineis 1 mm. longis munita, setis 10–13 mm. longis rigidis. Thyrsus pedunculo 1.5 cm. longo adjecto 5.5 cm. longus basi 1.5 cm. latus, ramis alternis approximatis, inferioribus 3 mm. longis, superioribus vix ullis, cymulis trichotomis aggregatis, bracteis linearibus 6–10 mm. longis basi saepe subulato-bidentatis, bracteolis linearibus florem paene aequantibus, floribus 4–5-meris. Calyx 2 mm. longus, lobis ovatis. Corolla cum calyce extus sparsim ferrugineo-strigillosa, tubo 2 mm. longo, segmentis prope basin



cucullatis et cornu 2 mm. longo appendiculatis. Antherae tubi medio barbato insertae inclusae. Discus pulvinatus ovarium aequans. Stylus corolla fauces attingens, ramis linearibus. Fructus ignotus.

In silvis ad Tsâki, Talamanca, Comarca de Limón, Costa Rica, alt. 200 m., m. Apr. 1895, *Ad. Tonduz*, n. 9579.

**Cephaelis** (§ PLEIOCEPHALEAE Muell. Arg.) **tetragona** Donn. Sm.—Folia oblongo- vel obovato-lanceolata stipulis utrinque binis triangularibus basi connatis. Capitula in paniculam corymbiformem sessilem bis trichotomam disposita inconspicue pedunculata multiflora, bracteis scariosis, exterioribus orbicularibus calycem aequantibus, interioribus brevioribus ovato-lanceolatis, intimis rudimentariis vel obsoletis, floribus bracteas bis et ultra superantibus. Drupa maxima tetragona, pyrenis dorso acutis facie ventrali sulcatis.

Arbusculus praeter paniculae axes sordide pubescentes bractearum apicem ciliolatum corollae fauces barbatus omnibus in partibus glaber, ramis teretibus, internodiis 2–4 cm. longis, stipulis 4 mm. longis, foliis pergameneis 11–21 cm. longis 4–5 cm. latis apice saepius contracto-acuminatis basi acutis vel acuminatis, nervis lateralibus utrinque 12–14, petiolis 5–7 mm. longis. Paniculae floribus ademptis 4–6 cm. longae rami primarii 1.5–2.5 cm. longi secundarii 3–5 mm. longae bracteis foliaceis 10–14 mm. longis fulti, capitulis 6–12-floris, bracteis discretis basi dilatatis concavis nervosis, exterioribus 9–10 mm. longis, floribus 5-meris. Calyx sessilis turbinatus 9–10 mm. longus, lobis rotundatis 1.5 mm. longis. Corolla tenuiter tubulosa 25–28 mm. longa luteola exannulata, lobis 10 mm. longis, ore staminifero. Antherae exsertae lineares 5 mm. longae infra medium affixae. Discus annularis crenulatus. Stylus inclusus. Drupa nigra ellipsoidea 11–13 mm. longa 8–9 mm. lata calyce coronata tenuiter carnosae acute tetragona angulis septalibus bicostata, pyrenis osseis, semine 10 mm. longo 7 mm. lato 3 mm. crasso.

In silvis ad Tuís, Prov. Cartago, Costa Rica, alt. 650 m., Oct. 1897, *Ad. Tonduz*, n. 11352.—In silvis apud *Las Vueltas*, Tucurrique, Prov. Cartago, Costa Rica, alt. 600–700 m., Feb. 1899, *Ad. Tonduz*, n. 12997.

**Zexmenia thysanocarpa** Donn. Sm.—Folia minima ovata. Involucrum hemisphaericum, bracteis 3-seriatis membranaceis mucrone herbaceo apiculatis, exterioribus orbiculari-ovalibus, interioribus longioribus ellipticis. Receptaculum conicum, paleis in aristam nigram contractis. Achenia radii exalata 3-aristata, disci niveo-pectinatoque-alata, alis sursum auriculato-productis, aristis nullis squamellis obsoletis.

Fruticulus decumbens e basi ramosus, ramulis cano-pubescentibus ad apicem versus cano-villosis. Folia 10–12 mm. longa 7–8 mm. lata obtusa



basi rotundata vel subcordata subintegra utrinque pilis bulbosis canis adspersa, nervis lateralibus praeter basales subobsoletis, petiolis 2–3 mm. longis. Capitula terminalia solitaria sessilia foliis 4 fulta, foliis interioribus reductis 5–6 mm. longis. Involucri bracteae circiter 18 concavae nervatae, exteriores 4 mm. longae, interiores 5–6 mm. longae. Receptaculi paleae 6 mm. longae. Flores radii circiter 13, ligulis 6 mm. longis bidentatis flavis. Flores disci paleas aequantes. Achemia glabra tuberculosa, in radio triquetra nervata oblonga 4 mm. longa, aristis subaequalibus 2–3 mm. longis, in disco oblanceolata absque auriculis 1 mm. longis 2.5 mm. longa nigra, alis e basi 0.5 mm. latis conspicue pectinato-fimbriatis ciliolatis. Semen in radio obovato-oblongum 2.5 mm. longum subtriquetrum, in disco elongato-pyriforme 2 mm. longum. Achenia nonnulla interdum vacua tenuiter alata, auriculis ad aristas reductis.

San Jerónimo, Chiapas, Mexico, 1907, *G. N. Collins* et *C. B. Doyle*, n. 27.—Exemplum typicum in herbario Musei Nationalis sub numero proprio 693246 vidi.

**Physalis porphyrophyssa** Donn. Sm.—Frutescens. Folia lanceolato-elliptica vel -oblonga utrinque acuminata integra supra glabrescentia subtus praesertim nervis strigilloso-pubescentia. Pedicelli 4-fasciculati. Calyces fructiferi maximi oblongo-ellipsoidei purpurei. Bacca calyce 4–5-plo superata.

Frutex 2–3-metralis (cl. *Pittier* in schedula), ramulis lignosis stramineis striatis glabrescentibus, ad apicem versus tetragonis et pube simplice vestitis. Folia tantum superiora suppetentia 4–6.5 cm. longa 1.2–2 cm. lata in petiolum 7–11 mm. longum pubescentem decurrentia, nervis lateralibus utrinque 6 subtus fuscis. Pedicelli solum fructiferi visi plerumque 4-fasciculati rarius singuli 1.4–1.7 cm. longi retroflexi pubescentes. Calyx fructifer membranaceus 4–5 cm. longus 1.7–2 cm. latus basi intrusus pentagonus 10-costatus reticulatus saturate purpureus, dentibus porrectis orificium claudentibus triangularibus 4 mm. longis muticis margine pubescentibus. Bacca aurantiaca 11 mm.-diametralis, seminibus numerosis obovato-compressoque-globosis leviter rugosis. Flores desiderantur.—Species ob inflorescentiam fasciculatam anomala.

Prope oppidulum Zacapa, Depart. Zacapa, Guatemala, alt. 200–400 m., Dec. 1906, *H. Pittier*, n. 1754.—Typus in herbario Musei Nationalis numero proprio 578148 signatus asservatur.

**Diastema micranthum** Donn. Sm.—Folia ex ovali ovata acuta basi rotundata crenulata supra sparsim bulboso-pilosa subtus nervis neglectis glabrescentia. Pedunculi axillares 2–3-ni petiolo longiores florem subaequantur uniflori, floribus minimis. Corollae tubus segmenta calycina lanceolata bis superans basi aequalis subrectus lobis propriis aequalibus pluries longior.



Repens decumbens stoloniferum dichotomo-ramosum. Caules ascendentes 4–5 cm. longi uti petioli pedunculi calyces pilis hyalinis articulatis villosi. Folia 3.5–6 cm. longa medio vel infra medium 2–3 cm. lata subtus pallidiora, nervis subtus fusco-pilosis, lateralibus utrinque 8–9, petiolis 4–8 mm. longis. Pedunculi basi bracteis binis foliaceis 3 mm. longis fulti 6–9 mm. longi, communi obsoleto. Calycis segmenta 4 mm. longa acuta tubo bis longiora. Corollae (in sicco pallidae) tubus 9 mm. longus supra ovarium leviter contractus sursum parum ampliatus vix pilosus, lobis 1.5 mm. longis foris pilosis. Stamina inclusa, antheris liberis transversim ovalibus, loculis orbicularibus. Disci glandulae lineares ovario semiadnato paulo breviores. Stylus corollae aequilongus, stigmatis lamellis ovalibus 1 mm. longis. Capsula semi-infera globosa 3 mm.-diametralis subglabra.

In collibus apud Jérico, Llanuras de Santa Clara, Costa Rica, alt. 400 m., Jul. 1899, *H. Pittier*, n. 7602 ex Pl. Guat. etc. quas ed. Donn. Sm. (n. 13420 herb. nat. Costaricense).

**Episcia** (§ CYRTODEIRA Benth.) **acaulis** Donn. Sm.—Caulis obsoletus. Folia ad nodos radicales pluriconferta ex ovato oblongo-elliptica acuta basi rotundata vel acuta crenulata subtus vinicoloria utrinque versicoloria. Pedunculus solitarius uniflorus. Calycis colorati obliqui segmenta 4 breviter oblonga, quintum deflexum lineare. Corollae tubus basi saccatus rectus sursum sensim ampliatus, limbi patentis lobi inaequales suborbiculares tubo dimidio breviores.

Caespitosa (ex *Tonduz*), prostrata repens dichotomo-ramosa aequae ac petioli et pedunculi pilis fuscescentibus articulatis glanduliferis villosa. Folia plerumque usque ad 7–9 in rosulam conferta 3–5 cm. longa 2–2.5 cm. lata supra bullata utrinque sparsim breviterque bulboso-pilosa in area media utriusque paginae argenteo-picta, nervis lateralibus utrinque circa 7, petiolis 1–1.5 cm. longis. Pedunculus 16 mm. longus. Calycis segmenta vinicoloria sejuncta 7 mm. longa obtusa integra, posticum 1.5 mm. latum ceteris dimidio angustius. Corollae fere glabrae in sicco albidae tubus 26 mm. longus in saccum 4 mm. longum deorsum productus basi 3 mm. latus faucibus intus puberulis 8 mm. latus, limbus lobis 13 mm. longis 16 mm. latis computatis 3.5 cm.-diametralis. Stamina ad 6 mm. supra basin corollae inserta, filamentis 11–13 mm. longis, antheris oblongis 2 mm. fere longis 1 mm. latis. Disci glandula unica 1.5 mm. longa emarginata. Ovarium oblongo-ovoideum pilosum. Stylus stigmatis lamellis 2 ellipticis vix 1 mm. longis additis 19 mm. longus. Capsula ignota.—*E. lilacinae* Hanst. floribus peraffinis differt praesertim habitu.

Ad ripas fluminis Las Vueltas, Tucurrique, Prov. Cartago, Costa Rica, alt. 635 m., Mart. 1899, *Adolfo Tonduz*, n. 13167.



EPISCIAE clavis species Centrali-Americanas ad facile dignoscendas.

I. Fruticosae.

- A. Calycis lacinae lanceolatae . . . . . *E. lanceolata* Hanst.  
 B. Calycis lacinae lineares  
 1. Petiolus lamina pluries brevior . . . . . *E. congesta* Hanst.  
 2. Petiolus laminae aequilongus . . . . . *E. longipetiolata* Donn. Sm.

II. Herbaceae.

- A. Acaulis . . . . . *E. acaulis* Donn. Sm.  
 B. Decumbens  
 1. Flores sessiles . . . . . *E. punctata* Hanst.  
 2. Flores pedunculati  
 a) Corolla coccinea . . . . . *E. cupreata* Hanst.  
 b) Corolla lilacina  
 †Folii pagina utraque unicolor . . . . . *E. Fendleriana*. O. Ktze.  
 ††Folii pagina utraque versicolor  
 \*Corollae lobi integri . . . . . *E. lilacina* Hanst.  
 \*\*Corollae lobi dentati . . . . . *E. chontalensis* Hook.

**Besleria** (§ PARABESLERIA Hanst.) **congestiflora** Donn. Sm.—  
 Folia disparia oblique lanceolata utrinque attenuato-acuminata  
 calloso-serrulata pilosa. Pedicelli in axillis plurifasciculati bracteis  
 linearibus sanguineis subaequilongi calyce breviores. Corollae  
 decurvae tubus calyci aequilongus vix gibbus ventricosus lobis  
 subtriplo longior. Discus exannularis uniglandularis.

Omnibus fere in partibus adpresse pilosa. Ramuli teretes ad apicem  
 versus 5 mm. crassi rubiginosi, internodiis superioribus 2.5–4.5 cm. longis.  
 Folium alterum altero triente majus 8.5–11 cm. longum 2.3–3.3 cm. latum  
 tenuiter coriaceum subtus flavicans, nervis lateralibus validis utrinsecus  
 4 sub angulo angusto longe ascendentibus, petiolis 1.5–2.5 cm. longis canaliculatis supra glabris et sanguineis. Pedunculus nullus, pedicellis compluribus 3–8 mm. longis, bracteis 5–7 mm. longis acutis supra glabris. Calycis partiti segmenta erecta aequalia 10 mm. longa 2.5 mm. lata acuta integra supra glabra. Corolla sanguinea 12 mm. longa, tubo basi supra ovarium contracto 2 mm. lato faucibus 5 mm. lato, limbo subobliquo, lobis suborbicularibus, duobus posticis altius connatis quam ceteri 3 mm. longi triente minoribus, antico crenulato. Stamina ad 1.5 mm. supra basin corollae inserta 6 mm. longa, antheris 1 mm. latis, loculis basi conniventibus, connectivo ovali. Discus ad glandulam oblongam 2 mm. longam reductus. Ovarium pilosum, stylo 5 mm. longo rubicundo glabro, stigmatate stomatomorpho. Fructus ovoideus 5 mm. longus glandulam bis excedens glabrescens, seminibus saturate sanguineis 1.5 mm. longis, funiculis brevissimis.—*B. pycnosuzygiae*



Donn. Sm. ob inflorescentiam proxima ab omnibus congeneribus disco differt.

In silvis ad La Palma, Prov. San José, Costa Rica, alt. 1459 m., Sept. 1898, *Adolfo Tonduz*, n. 12658.

**Besleria** (PARABESLERIA Hanst.) **trichostegia** Donn. Sm.—Folia leviter disparia ex elliptico oblanceolata acuminata in petiolum brevem angustata integra. Pedicelli in axillis paucifasciculati et petiolo et calyci subaequilongi. Calycis segmenta linearia filiforme attenuata subaequalia. Corollae vix decurvae tubus calyce subduplo longior basi subaequalis parum ventricosus lobis sexies longior. Discus ovarium semicingens.

Ramuli angulati glabrescentes 3–4 mm. crassi, superiores cum petiolis pedunculis calycibus patenter pilosi, novelli cum axillis pallide villosi, internodiis superioribus 2–2.5 cm. longis. Folia 10.5–14 cm. longa supra medium 3.5–4.5 cm. lata leviter inaequilateralia herbacea utrinque sparsim bulbosopilosa, nervis lateralibus utrinsecus 7–9 cm. et costa subtus purpurascens, petiolis 6–10 mm. longis. Pedunculus obsoletus, pedicellis ebracteatis circa 8 mm. longis. Calycis partiti segmenta erecta 5–6 mm. longa herbacea conspicue ciliata. Corolla rubra 13 mm. longa supra ovarium 2.5 mm. lata faucibus 3.5 mm. lata, limbo subobliquo, lobis suborbicularibus, duobus lateralibus maximis 2 mm. longis. Stamina ad 4 mm. supra basin corollae inserta 4–5 mm. longa, antheris orbicularibus 1 mm.-diametralibus, connectivo orbiculari. Discus semiannularis crassus. Ovarium ovoideum 2 mm. longum pilosum, stylo 5 mm. longo, stigmatate stomatomorpha puberulo. Fructus globosus 7 mm.-diametralis pilosiusculus, seminibus sanguineis orbicularibus vix 0.5 mm.-diametralibus.

In silvis ad Tsâki, Talamanca, Comarca de Limón, Costa Rica, alt. 200 m., Apr. 1895, *Adolfo Tonduz*, n. 9558.

**BESLERIA TRIFLORA** Hanst., var. **subcorymbosa** Donn. Sm.—Pedicelli 3–7 subcorymbosi pedunculo triente longiores, fructiferi remoti.

Pedunculi 1.5 cm longi, pedicellis plerumque 4–7 interdum usque ad 3–5 mm. inter se remotis, axe tortuoso. Ceteroquin cum forma typica optime congruens.

La Palma, Prov. San José, Costa Rica, alt. 1460 m., Sept. 1898, *Adolfo Tonduz*, n. 7453 ex Pl. Guat. etc. quas ed. Donn. Sm. (n. 12659 herb. nat. Costaricense).—Costa Rica, 1899, *Adolfo Tonduz* (nec loco accuratiore nec numero in schedula adnotato).



BESLERIAE clavis species Centrali-Americanas ad facile dignoscendas.

I. Pedunculi uniflori

A. Corolla basi subaequalis

1. Folia supra laevia . . . . . *B. barbensis* Hanst.

2. Folia supra scabrido-bullata . . . . . *B. princeps* Hanst.

B. Corolla calceiformis . . . . . *B. pansamalana* Donn. Sm.

II. Pedunculi pluriflori

A. Pedunculus pedicellis longior

1. Corolla erecta

a) Corolla calycem vix superans . . . . . *B. macropoda* Donn. Sm.

b) Corolla calycem bis superans

† Calycis segmenta subulato-lanceolata . . . . . *B. laxiflora* Benth.

†† Calycis segmenta orbiculari ovalia . . . . . *B. imbricans* Donn. Sm.

2. Corolla prona

a) Corolla cylindrica . . . . . *B. Wendlandiana* Hanst.

b) Corolla infundibularis . . . . . *B. acropoda* Donn. Sm.

B. Pedunculus pedicellis brevior

1. Discus annularis . . . . . *B. acutifolia* Benth.

2. Discus biglandularis . . . . . *B. triflora* Hanst.

III. Pedunculus obsoletus

A. Pedicelli bracteati

1. Bracteae oblongo-ovatae . . . . . *B. pycnosuzygia* Donn. Sm.

2. Bracteae lineares . . . . . *B. congestiflora* Donn. Sm.

B. Pedicelli ebracteati

1. Corolla calyce paulo longior

a) Calycis segmenta integra . . . . . *B. robusta* Donn. Sm.

b) Calycis segmenta dentata . . . . . *B. columneoides* Hanst.

2. Corolla calyce bis vel ultra longior

a) Segmenta filiforme linearia . . . . . *B. trichostegia* Donn. Sm.

b) Segmenta acute ovata . . . . . *B. costaricensis* Hanst.

c) Segmenta obtuse ovalia

† Segmenta nervosa . . . . . *B. hirsuta* Hanst.

†† Segmenta enervia . . . . . *B. glabra* Hanst.

GESNERACEARUM sequuntur quaedam species Austro-Americanae ineditae.

DIASTEMA PLATYLOMATUM Donn. Sm.—Folia dimorpha, altero oblongo-ovato alterum orbiculari-ovatum bis superante, supra bullato-scabrida subtus versicoloria. Pedicelli filiformes in axillis bini vel in pedunculo communi terminali 4-ni. Calycis segmenta



oblonga. Corollae tubus calyce bis longior basi aequalis late cylindraceus parum ampliatus lobis 3 posticis maximis bis longior. Capsula tota fere infera glandulis superata.

Repens decumbens, caule 9–13 cm. longo simplice sicut petioli pedunculi pedicelli calyces fusco-hirsuto, internodiis pluribus 0.5–5 cm. longis. Folia acuta vel acuminata basi cuneata vel obtusa crenulata subtus pilosa foveolata vinicoloria areis lateralibus albida, altero generis maximo 7–14 cm. longo 5–9 cm. lato, petiolo 3–7 cm. longo, altero 3–6 cm. longo 2.5–5 cm. lato, petiolo 1–2 cm. longo, nervis lateralibus utrinque 6–7. Pedunculus communis 1.5 cm. longus, pedicellis 2–4.5 cm. longis, bracteis obsoletis. Calycis segmenta 4 mm. longa obtusa tubo turbinato bis longiora. Corolla (in sicco dilute coccinea) pilosa 1.5 cm. longa erecta, lobis 3 posticis suborbicularibus 5 mm. longis anticos semiorbiculares bis superantibus. Stamina subinclusa, antheris per paria conniventibus ovalibus, loculis oblongo-ellipticis. Disci glandulae oblongae 2 mm. longae. Ovarium ultra medium adnatum villosum, stylo 8 mm. longo pubescente, stigmatis lamellis 1 mm. longis. Capsula obconica vertice libero convexa.

Corazón, Río Pilatón, Ecuador, alt. 1000–1800 m., Jan. 1881, *F. C. Lehmann*, n. 409<sup>a</sup>.—Río Pilatón, Ecuador, alt. 1000–1800 m., Jan. 1881, *F. C. Lehman*, n. 481<sup>a</sup>.

**Isoloma** (§ BRACHYLOMA Benth.) **pycnosuzygium** Donn. Sm.—Folia generis inter minima internodiis pluries longiora ovato-elliptica sursum subsensim basi contractius acuminata crenulata. Calycis segmenta linearia. Corolla calyce bis longior e basi aequali cylindraceo-infundibuliformis, lobis aequalibus. Capsula subquadrivalvis.

Frutex metralis (ex schedula Eggersiana), ramis subtetragonis uti folia subtus et petioli longe denseque ravo-villosis, internodiis 0.5–2 cm. longis. Folia in eodem jugo aequalia 4–6 cm. longa 2–2.5 cm. lata supra sericea margine erubescencia, nervis lateralibus utrinque 6–7, petiolis 0.5–1 cm. longis. Calyx turbinatus 1 cm. longus, lobis tubo dimidio longioribus erubescens. Corolla coccinea sparsim pilosa 2 cm. longa recta basi 3 mm. lata ore 6 mm. lata, lobis semiovalibus 2 mm. longis. Stamina ima basi corollae affixa exerta, antheris liberis ovalibus, loculis parallelis. Disci glandulae oblongae. Ovarium semiadnatum villosum, stylo 16 mm. longo pubescente, stigmate stomatomorpho. Capsula semi-infera ellipsoidea 8 mm. longa 5 mm. crassa rostrata tota septicide dimidio libero loculicide dehiscens.

Los Chorros, Venezuela, Jul. 1891, *H. F. A. Eggers*, n. 13078.

**Isoloma** (§ BRACHYLOMA Benth.) **vulcanicum** Donn. Sm.—Folia internodiis pluries longiora disparia lanceolato-elliptica tenuiter acuminata basi acuta crenulata. Pedunculi solitarii



uniflori foliis breviores florem subaequantes. Calycis lobi semi-orbiculares. Corolla calyce 5-plo longior recta cylindracea basi oreque subaequalis, lobis aequalibus puncto-maculatis. Disci glandula postica ceteris bis latior.

Suffrutex decumbens ut videtur. Caules teretes 2-4 mm.-crassi uti folia petioli pedunculi flores fusco-pilosi, internodiis 1-1.5 cm. longis. Folia ad apicem versus caulis conferta, majore quam alterus pro rata latius dimidio longiore 7.5-9 cm. longo 3-4 cm. lato, nervis lateralibus utrinque 9-10, petiolis 8-12 mm. longis. Pedunculi floriferi 5-6 cm. longi fructiferi 8 cm. longi. Calyx late campanulatus 1 cm. longus, lobis 4 mm. longis 7-9 mm. latis herbaceis. Corolla in sicco nigricans 5 cm. longa dorso et ventre leviter arcuata basi 6 mm. lata ore 9 mm. lata medio 16 mm. lata, lobis suborbicularibus 5 mm. longis, duobus posticis altius connatis. Stamina ima basi corollae inserta exserta, antheris late cordato-ovatis in orbem 6 mm.-diametralem cohaerentibus, loculis utrinque conniventibus. Disci glandulae 2 mm. longae dentatae. Ovarium duabus partibus adnatum globosum villosum, stylo glabrescente exserto, stigmatem stomatomorpha 2 mm. lato. Capsula ignota.

Ad Los Motilones, Volcán Sotará, Cauca, Colombia, alt. 3000 m., Feb. 1884, *F. C. Lehmann*, n. 3681.

**Isoloma** (§ BRACHYLOMA Benth.) **oblanceolatum** Donn. Sm.—Folia disparia anguste oblanceolata acuminata in petiolum sensim attenuata serrulata subtus vinicoloria. Pedunculi folia subaequantes pedicellis 4-5-nis triplo fere longiores, floribus pedicellos paulo superantibus fusco-tomentosis. Calycis segmenta ovata acuta intus vinicoloria. Corolla calyce 4-plo longior basi obliqua declinata, limbo obliquo, lobis punctato-maculatis, postico maximo orbiculari.

Ramuli subteretes et petioli pedunculi pedicelli flores pilis glandularibus nigrescentes. Folium alterum altero dimidio majus 9.5-13 cm. longum 2.5-3 cm. latum supra bulboso-pilosiusculum subtus nervis venisque fusco-pubescens, nervis lateralibus utrinque 7-8, petiolis 1-2 cm. longis. Pedunculi validi 6.5-9 cm. longi, pedicellis 2.5-3.5 cm. longis. Calyx campanulatus duabus partibus partitus, segmentis 7 mm. longis nervatis. Corolla 4 cm. longa vix ventricosa dorso convexa basi oreque 5 mm. lata medio 1 cm. lata, lobo postico 5 mm.-diametrali, ceteris semiorbicularibus. Stamina ima basi corollae affixa exserta, antheris late obtuseque triangularibus in quadram cohaerentibus, loculis apice conniventibus. Disci glandulae oblongae. Ovarium alte adnatum ovoideum cum stylo 3.5 cm. longo pilosum, stigmatem stomatomorpha. Capsula ignota.

Poblazón prope Popayán, Cauca, Colombia, Mart. 1884, *F. C. Lehmann*, n. 3682.



**Gesnera** (§ CORYTHOLOMA Benth.) **Lehmannii** Donn. Sm.—  
Folia ex obovato-elliptico oblongo-elliptica apice acuta vel obtusa in petiolum brevem attenuata crenulata supra bulboso-scabridiuscula subtus tomentosa. Pedunculi in racemo utrinque bini flore triente breviores. Calyx semilobatus, lobis subdeltoideis. Corolla calyce 3-plo longior, labio superiore lobis inferioris 4-plo longiore orbiculari. Disci annularis dimidium posticum productius.

Suffrutex e basi radicante erectus simplex 6–7 dm. altus, caule terete rubido et racemo et calycibus pubescentibus, internodiis 6–14 cm. longis. Folia 5–7.5 cm. longa 2–3 cm. lata subtus flavicantia, nervis lateralibus utrinque 6–7, petiolis 3–5 mm. longis tomentosis. Racemus corollis exemptis 7 cm. longus foliaceo-bracteosus, bracteis infimis 3.5 cm. longis, superioribus 2–0.5 cm. longis, internodio infimo 4 cm. longo, superioribus 1–0.5 cm. longis, pedunculis basi minute bracteolatis, altero florifero 2 cm. longo, altero juniore 5 mm. longo. Calyx sanguineus campanulatus 1 cm. longus, lobis parallele nervatis. Corolla coccinea ut videtur puberula 3.2 cm. longa basi gibbosa cylindracea dorso et ventre aequaliter leviterque ampliata, labio superiore erecto 5 mm.-diametrali emarginato, inferiore crenato-trilobo, lobis vix 1.5 mm. longis. Stamina exserta, antheris in quadram cohaerentibus. Disci annulus 1.5 mm. altus emarginatus. Ovarium breviter adnatum ovoideum cum stylo 22 mm. longo pubescens, stigmatate stomatomorpho. Bacca desideratur.

Plantae F. C. Lehmannianae in Colombia et Ecuador collectae, n. 7903, loco haud accuratius addicto.

**Gesnera** (§ CORYTHOLOMA Benth.) **Eggersii** Donn. Sm.—  
Folia ovato-elliptica apice obtusa basi acuminata crenulata utrinque praesertim subtus pilosa. Pedunculi in verticillis approximatis racemi utrinque 2–4-ni flore 4-plo breviores. Calyx obpyramidalis semilobatus, lobis acuminato-triangularibus apiculatis. Corolla calyce 4-plo longior, labio superiore lobos inferioris 3-plo superante latiore quam longiore.

Frutex bimetralis (ex cl. Eggers), rhizomate ignoto, ramulis obtuse tetragonis uti petioli et racemus rubiginoso-pubescentibus, internodiis 7–12 cm. longis. Folia 6–9 cm. longa 3–4.5 cm. lata subtus rubiginoso-reticulata, nervis lateralibus subtus tantum conspicuis utrinque 7–8, petiolis 0.5–1.5 cm. longis. Racemus corollis exemptis 3.5–5 cm. longus foliaceo-bracteosus, bracteis infimis 2.5–3 cm. longis, superioribus 1.5–0.5 cm. longis, internodio infimo 1.8–2.3 cm. longo, superioribus 5–3 mm. longis, pedunculis 9–10 mm. longis basi minute bracteolatis. Calyx sanguineus pubescens 1 cm. longus, lobis retinerviis. Corolla coccinea ut videtur puberula 4 cm. longa basi gibbosa cylindracea subrecta dorso magis quam ventre ampliata, labio supe-



riore erecto transversim ovali 6 mm. longo 8 mm. lato emarginato, inferiore arcuatim trilobo. Stamina exserta, antheris ovalibus in quadram 3 mm. longam atque latam cohaerentibus. Disci glandula postica 1.5 mm. longa bis latior, additis 3 parvis dissitis. Ovarium leviter adnatum oblongo-conicum pilosum in stylum 2.5 cm. longum attenuatum, stigmate stomatomorpho. Capsula non suppetit.—Species praecedenti proxima.

El Valle, Venezuela, Jul. 1891, *H. F. A. Eggers*, n. 13124.

**Columnea** (§ ORTHOLOMA Benth.) **dictyophylla** Donn. Sm.—Folium alterum altero 10–12-plo longius sessile lineari-lanceolatum acuminatum basi obliqua obtusum integrum supra bullatum subtus sanguineum nervis venisque stramineo-sericeis reticulatum. Calycis segmenta linearia corollae trientem aequantia. Corolla gibbosa reclinata, limbo valde obliquo, lobis lateralibus galeae alte adnatis, antico lineari.

Ramuli subteretes rufo-villosi, internodiis inferioribus 3–6 cm. longis, superioribus 1–1.5 cm. longis. Folium in eodum jugo majus cum altero nano 13–17 mm. longo conforme 12–18 cm. longum 2.5–4 cm. latum e medio utrinque subsensim angustatum inaequilaterale subfalcatum coriaceum discolor supra strigillosum utroque latere circa 20–25-nervatum subtus pulchre minuteque reticulatum et foveolatum. Pedunculi solitarii 2.8–3 cm. longi sericei. Calycis partiti segmenta aequalia 1.8 cm. longa acuta stramineo-villosa. Corolla rosea pilis adpersa 5.3–5.7 cm. longa geniculatim gibbosa supra ovarium 4 mm. lata vix ventricosa dorso convexa faucibus haud contractis 10 mm. lata usque ad trientem labiata, galea quadrata 5 mm. longa atque lata emarginata, lobis lateralibus ultra dimidium galeae adnatis angulo recto acutis, antico porrecto 12 mm. longo 2–2.5 mm. lato obtuso. Genitalia galeae aequilonga pubescentia. Filamenta in vaginam 4 mm. longam liberam connatis, antheris quadratis 2 mm. longis ac latis. Disci glandula unica subquadrata 2 mm. longa emarginata. Ovarium ovoideum 4 mm. longum villosum, stigmate bilobo. Fructis ignotus.—*C. Warscewiczianae* Klotz. et Hanst. proxima; illa tamen differt foliis pro rata latioribus laevibus obsolete retinerviis denticulatis, calycis segmentis lanceolatis brevioribus, corollae lobis parum inaequalibus, antico elliptico.

Antioquia, Colombia, Sept. 1884, *F. C. Lehmann*, n. 4017.

**AEGIPHILA FASCICULATA** Donn. Sm. in BOT. GAZ. 57:425. 1914.—Ope exempli fructiferi infra citati diagnosi adde: Calyx fructiferus auctus cupuliformis coriaceus verrucosus drupam globosam semi-includens, pyrenis abortu 3, seminibus ovoideis.

Ramuli digitulum crassi subtetragoni fistulosi albescentes cum foliis cymisque aetate proveciore glabrescentes. Cymae fructiferae densae semi-globosae, baccis 8–10 circiter 1 cm.-diametralibus, seminibus 5 mm. longis.



Ad fundum *Sepacuite*, Depart. Alta Verapaz, Guatemala, Apr. 1902, O. F. Cook et R. F. Griggs, n. 521.—Specimen in herbario Musei Nationalis numero proprio 408225 signatur.

**Salvia** (§ BRACHYANTHAE Benth.; *Angustifoliae* Benth.) **Collinsii** Donn. Sm.—Glabra. Folia ovato-lanceolata utrinque acuminata calloso-serrulata discoloria. Spicae subramosae, bracteis bracteolisque lineari- vel ovato-lanceolatis subulato-attenuatis flores subaequantibus persistentibus, verticillastris absque infimo imbricatis multifloris. Calycis labia ovata acuta mutica, posticum integrum, anticum bidenticulatum. Corolla calyce triente longior, tubo incluso.

Fruticulus 1.25–1.5-metralis dichotomo-ramosus, ramulorum internodiis 1–2 cm. longis. Folia 8–11 cm. longa 2.5–4 cm. lata sursum tenuiter deorsum brevius acuminata glaberrima subtus pallida venulis pellucidis minute areolata, nervis lateralibus utrinque 6, petiolis 1.5–2 cm. longis. Spicae pedunculo 1–1.5 cm. longo computato 6–8 cm. longae basi ima breviter ramosae bracteis lineari-lanceolatis 1.8 cm. longis costatis retinerviis fultae, bracteolis verticillastra fulcientibus ovato-lanceolatis 1.5 cm. longis parallelinerviis sicut bracteae herbaceis amplexicaulibus puberulis, floribus 1.5 cm. longis. Calyx sessilis obovoideo-tubulosus 9 mm. longus 12-nervius puberulus, labiis 3 mm. longis, denticulis anguste acutis 1 mm. longis. Corolla albida praeter galeam extus cano-pubescentem glabra 12 mm. longa, tubo ventricoso faucibus contracto. Stylus superne unilateraliter barbatus, lobo antico 1 mm. longo posticum bis superante.—Ad *S. Kellermanii* Donn. Sm. proxime accedens ab ea bracteis bracteolis floribus praesertim recedit.

Prope Pantepec, Chiapas, Mexico, Jan. 1907, G. N. Collins et C. B. Doyle, n. 213.—Typus in herbario Musei Nationalis sub numero proprio 574326 adest.

**Neea** (§ EUNEEA Heimerl.) **amplifolia** Donn. Sm.—Folia maxima elliptica vel oblongo-obovatoque-elliptica apice cuspidatim basi sensim acuminata herbacea supra glabrescentia subtus praesertim costa nervisque ferrugineo-pubescentia. Corymbi longe pedunculati, ramis alternis ad apicem versus congestifloris, pedicellis brevibus. Perianthium masculinum in genere longissimum anguste tubulosum infra medium ampliatur, dentibus 5 faucium diametrum fere aequantibus. Stamina 8 diadelphia, 4 longioribus ad medium perianthium attingentibus cetera bis superantibus.

Frutex 0.5–1-metralis, ramulis uti petioli paniculae perianthia ferrugineo-pubescentibus. Folia opposita, dichotomalia quaterna, per paria aequalia



19–27 cm. longa 8–9 cm. lata in cuspidem tenuem 10–13 mm. longam contracta basi breviter vel longe acuminata in petiolum 2–3 cm. longum decurrentia, nervis utrinque lateralibus 10–12 arcuatim ascendentibus subtus tantum perspicuendis, interjectis aliis minoribus. Pedunculi e dichotomiis oriundi 6–12 cm. longi, corymbis cymosis 4.5–7 cm. longis, ramis infimis 3.5–4.5 cm. longis patulis, bracteis cymulas fulcientibus oblongo-ovatis 2 mm. longis, pedicellis 1–3 mm. longis, bracteolis sub flore 3 ovatis 1 mm. longis persistentibus. Perianthium nonnisi masculinum cognitum in vivo latericium (cl. *Pittier* in schedula) 10–11 mm. longum dimidio superiore 2 mm. latum inferiore 3 mm. latum, dentibus oblongo-triangularibus 1.5 mm. longis. Stamina majora 5 mm. longa, minora 2–2.5 mm. longa, antheris auranteis 1 mm. longis, loculis obliquis. Ovarii rudimentum obsoletum.—Perianthium femininum et anthocarpium desiderantur.

In silvis ad ripas fluminis *Hondo* prope Madre de Dios, Comarca de Limón, Costa Rica, alt. 200 m., Nov. 1896, *H. Pittier*, n. 10356.—In silvis apud *Las Vueltas*, Tucurrique, Prov. Cartago, Costa Rica, alt. 650–700 m., Feb. 1899, *Adolfo Tonduz*, n. 13020.

***Pleuropetalum tucurriquense* Donn. Sm.**—Folia lanceolato-elliptica utrinque acuminata integra. Paniculae fusco-pubescentes, floribus pedicellatis. Perianthii segmenta ovato-orbicularia. Stamina 6–7 disci margini inserta, filamentis liberis complanatis elongato-triangularibus. Ovarium globosum, stylo obsoleto, stigmatibus 4. Semina obovato-orbicularia.

Arbusculus, ramulis glabris uti paniculae axes fusco-pubescentes sulcatis striatis lineolatis. Folia tenuiter herbacea supra vix puberula subtus glabra et pallidiora 11–18 cm. longa 4.5–6.5 cm. lata apice contracto-acuminata in petiolum 2–3 cm. longum angustata, nervis utrinque lateralibus fortioribus 12–14 subtus tantum conspicuis. Paniculae terminales et ex axillis foliorum superiorum reductorum oriundae pedunculo subaequilongo computato 3.5–6 cm. longae densiflorae, bracteis ovatis 1.5–2 mm. longis pedicellos subaequantibus, bracteolis sub flore 2 ovatis 1 mm. longis, floribus in vivo flavescentibus (cl. collector in schedula). Perianthii segmenta 2.5 mm. longa 2 mm. lata, fructifera erecta. Stamina plerumque 6, filamentis 1.5–2 mm. longis basi 0.7–0.9 mm. lata, antheris cordato-ovatis 0.5 mm. longis. Discus 1.5 mm.-diametralis. Ovarium 1.5 mm. altum obtusum, stigmatibus brevibus erectis. Bacca in vivo coccinea (cl. collector in schedula) 5 mm. diametralis, seminibus compressis 1.5 mm. longis basi obliquis funiculum subaequantibus.—Species *P. costaricensi* Herb. Kew. ex Hemsl. arcte affinis videtur.

In silvis apud *Las Vueltas*, Tucurrique, Prov. Cartago, Costa Rica, alt. 650–700 m., Mart. 1899, *Adolfo Tonduz*, n. 13017.



# NOTES ON THE ANATOMY OF THE YOUNG TUBER OF IPOMOEA BATATAS LAM.<sup>1</sup>

FLORENCE A. MCCORMICK

(WITH EIGHT FIGURES)

Aside from the interest in it as an economic plant and in the diseases which are so destructive to it, sweet potato (*Ipomoea Batatas* Lam.), like many of the Convolvulaceae, has an unusual structure in its thickened roots. The anatomy of certain thickened stems and roots has been investigated; but, so far as the writer has been able to discover, *Ipomoea Batatas* has received little attention.

## Historical

The sweet potato has many scientific names (1, p. 323), among which *Ipomoea Batatas* Lam. (6), *Batatas edulis* Choisy (1), and *Convolvulus Batatas* Linn. (5 and 12) are the most familiar. The origin of *I. Batatas* is unknown (7), but records of its history in early literature have been written by DECANDOLLE (4), GRAY and TRUMBULL (8), and STURTEVANT (19).

DECANDOLLE (4) cites TURPIN (20) as having produced convincing figures showing that the thickened underground parts of *I. Batatas* are roots and not stems. The figures are those of entire tubers, both young and old, and they are given for comparison with the stem tubers of *Solanum tuberosum* and *Helianthus tuberosus*. With the rarest exceptions, the tubers of the sweet potato have been considered roots, but KAMERLING (10) has recently taken up the question anew. He reviews the literature in which the sweet potato is mentioned as having thickened roots, and names HAAK as a writer who considers these tubers thickened stems. Though KAMERLING did not investigate the young tuber, he regards the tuber of the sweet potato as a thickened stem and not a root, and gives figures upholding this view. Following KAMERLING, TUYIHUSA (21) essentially agrees with him.

<sup>1</sup> Contribution from the department of Agricultural Botany, Nebraska Agricultural Experiment Station.



This is the extent of the literature bearing directly on the anatomy of the tuber of *I. Batatas*, but other species of the Convolvulaceae have been studied, and in addition fleshy roots in other families, some of which to a certain degree resemble structurally the fleshy root of *I. Batatas*.

In 1870, VAN TIEGHEM (22) studied the roots of *Convolvulus tricolor*. He states that there are 4 rays of xylem, and that the lateral roots are formed in 4 rows corresponding to these rays. He describes and figures a tetrarch root and also the secondary tissues which are formed later. Here, also, there is a separation of the vessels by thin-walled parenchyma cells, such as may be seen in the early stages of thickening of the root of *I. Batatas*.

SCHMITZ (15), in his extensive study of the roots of the Convolvulaceae, omitted *I. Batatas*. Of those which he investigated, *Radix Scammonia*, the fleshy root of *Convolvulus Scammonia*, and *I. Turpethum* most closely resemble *I. Batatas*. He discusses the laticiferous vessels and states that they develop directly from the cambium and not from sieve tubes, as stated by A. VOGL.

WEISS (23) did not consider the Convolvulaceae in his studies of fleshy roots, but his descriptions and figures of *Bryonia dioica* show a concentric arrangement of cambium around strands of xylem, similar to that found in the thickened root of *I. Batatas*.

PETERSON (13) investigated *I. Batatas* as to the bicollateral structure of the stem; but he did not discuss the root. He mentions the internal phloem of the stem as being strongly developed, and this feature is also characteristic of the older roots.

DEBARY (3) reviews SCHMITZ'S work, but adds nothing of importance concerning the anatomy. He makes a distinction between the laticiferous tubes, such as are found in the Euphorbiaceae, and the resin sacs of the Convolvulaceae.

SCOTT (16), in his paper on the anatomy of *Ipomoea versicolor*, considers chiefly the anomalous structure found in the transition region between the bicollateral stem and the root.

CZAPEK (2) reviews the literature on the laticiferous system in the Convolvulaceae. He studied the development of the system in many species, and, with the exception of *Dichondra*, he found cross-walls always present.



SOLEREDER (18) likewise refers to the work of SCHMITZ, and he gives a figure of the cross-section of the root of *Convolvulus Scammoniae*, which also has concentric layers of cambium surrounding strands of xylem.

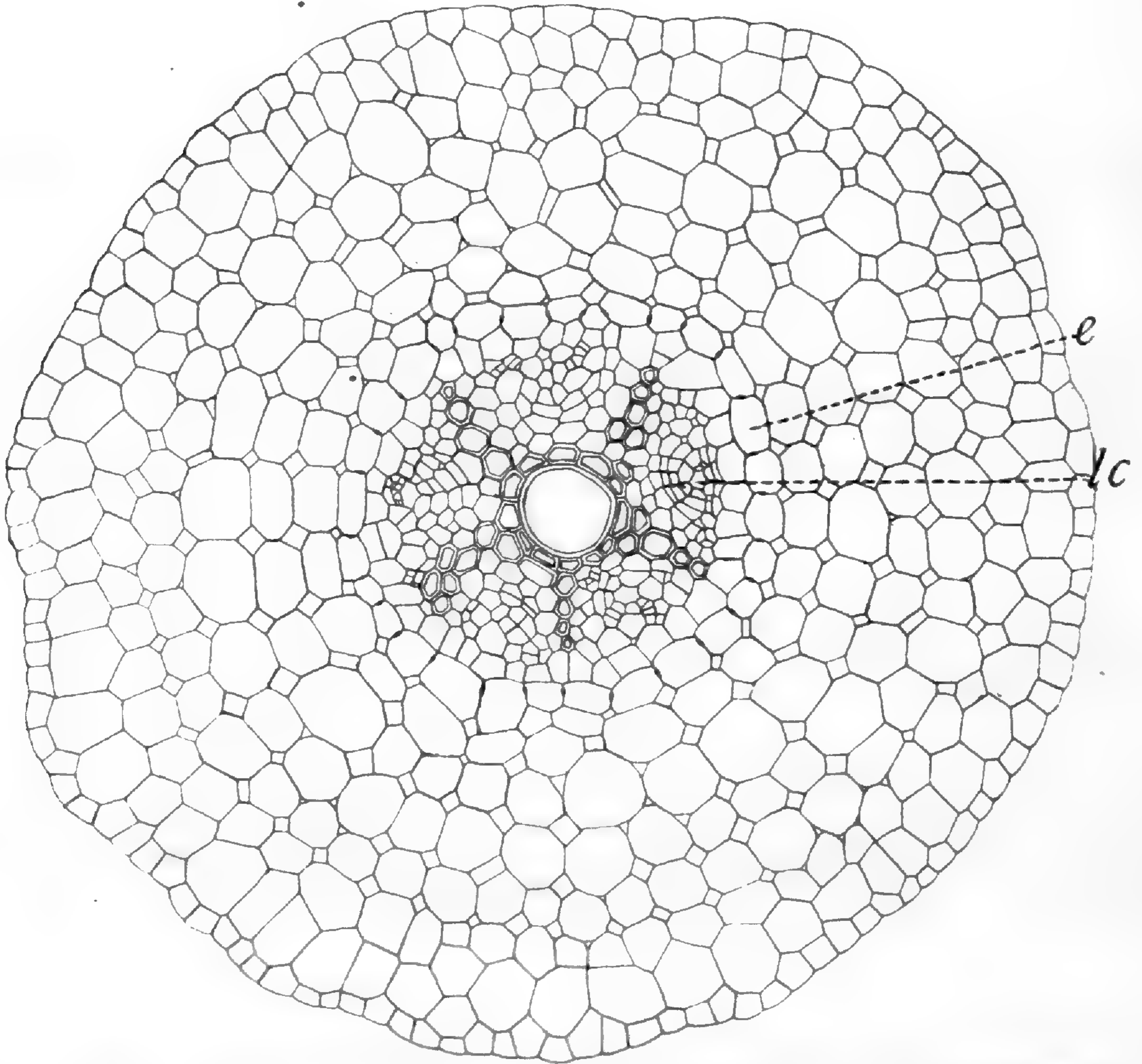

FIG. 1.—Transverse section of young root: *e*, endodermis; *lc*, laticiferous cell; X188.

HABERLANDT (9) cites CZAPEK'S work, and in brief he characterizes the laticiferous tubes of the Convolvulaceae as follows: "Ihr Inhalt besteht aus einem Plasmaschlauch und Milchsaft von unbekannter Zusammensetzung. Nach beendetem Langswachstum des betreffenden Internodiums werden die Schlauchreihen entleert und zusammengedrückt."



REED (14), in his studies of tubers, considers only the stem tubers of *Solanum tuberosum* and *Helianthus tuberosus*.

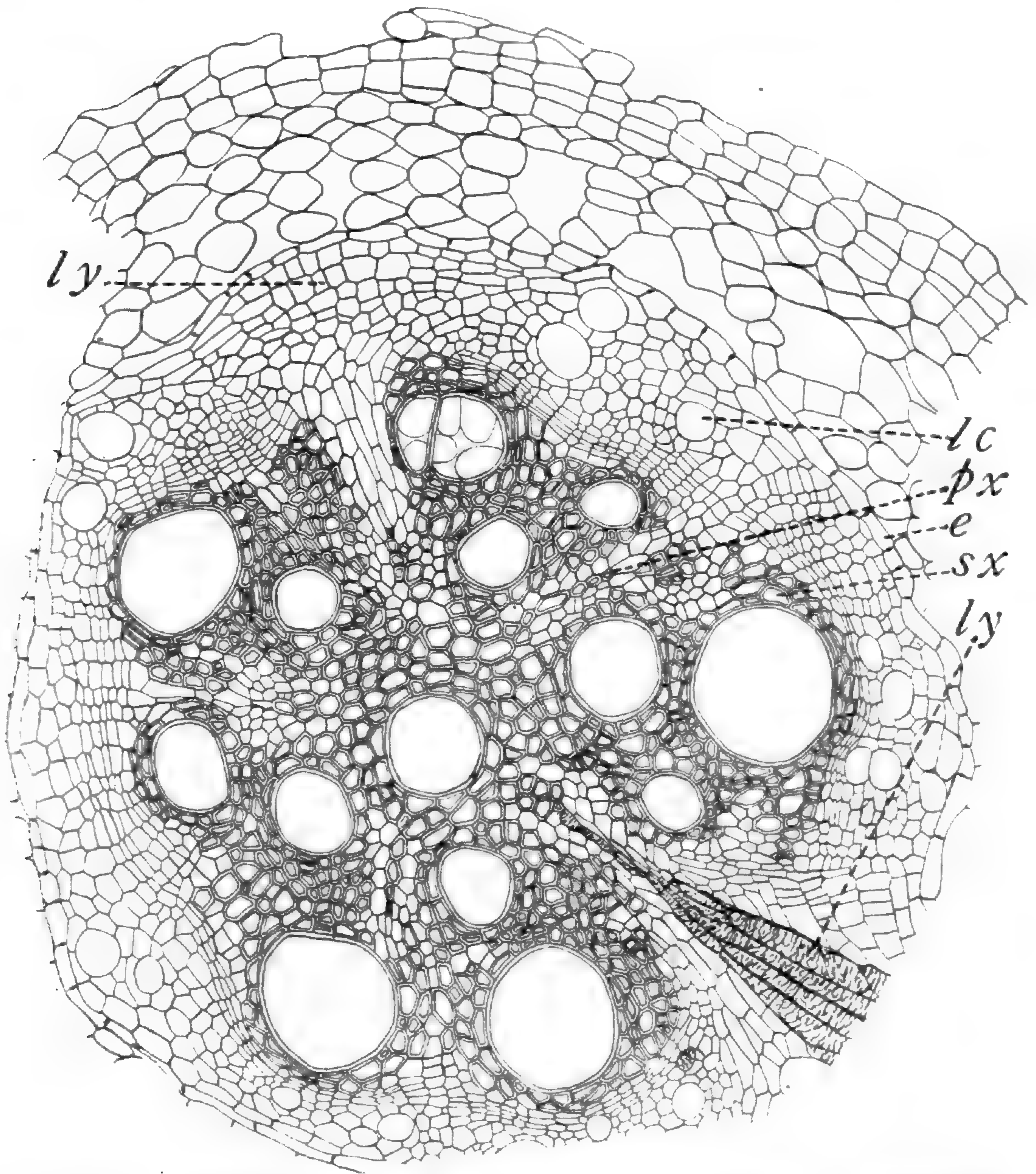

FIG. 2.—Transverse section of root showing secondary thickenings: *e*, endodermis; *lc*, laticiferous cell; *px*, protoxylem; *sx*, secondary xylem; *ly*, lateral root;  $\times 155$ .

KOKETSU (11) is one of the most recent investigators of laticiferous vessels and cells, and, though the paper itself was not at hand, a review states that his results uphold those of former workers. He also gives a chemical analysis of the lactic fluid.



### Investigation

Sections from many varieties of the sweet potato were examined, but the present study is confined to the Yellow Jersey. Although a comparative study was made of all stages of roots, from

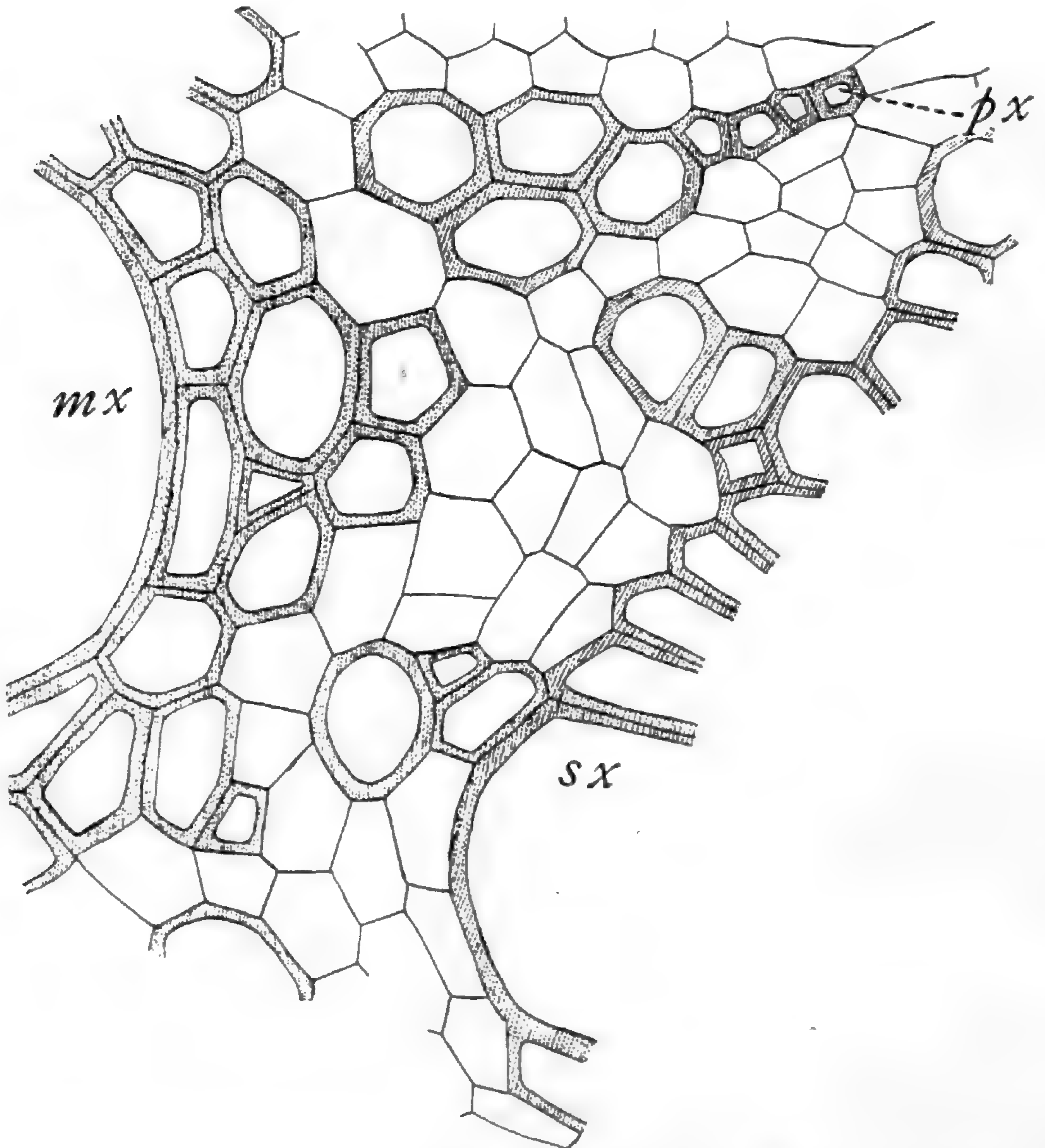

FIG. 3.—Part of transverse section of root showing beginning of activity of parenchyma: *px*, protoxylem; *mx*, metaxylem; *sx*, secondary xylem;  $\times 810$ .

those showing no thickening whatsoever to the mature tuber, only the young tubers are important, for through them alone may one expect to be able to interpret the structure of the mature potato. Fig. 1 represents a freehand section of a living root; but, with that



exception, the material was killed in chromo-acetic and imbedded in paraffin. Young tubers were cut in serial sections, beginning at the stem and extending beyond the region of greatest thickening of the root. With the exception of fig. 1, all figures are

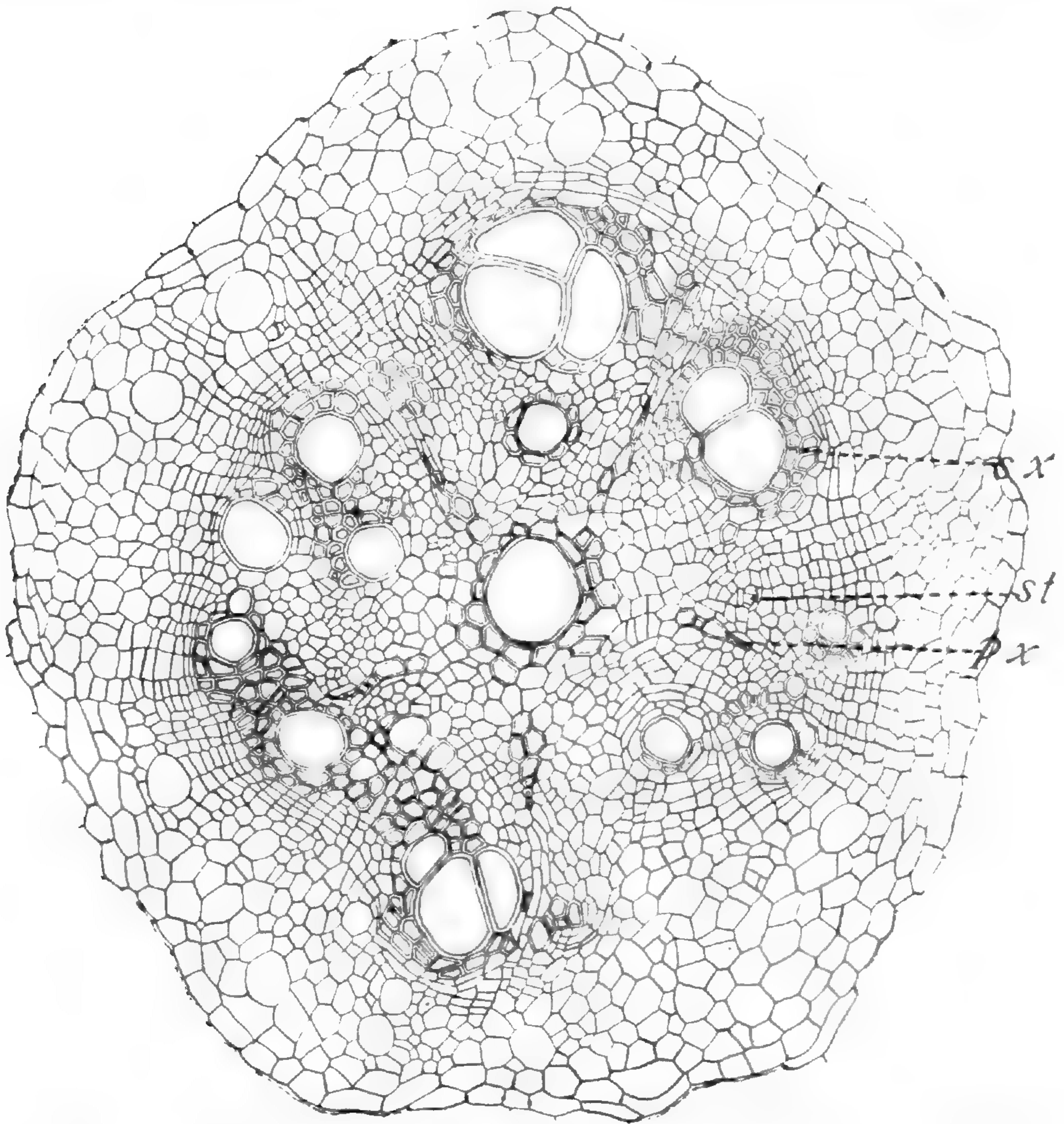

FIG. 4.—Transverse section of stele of root showing separation of xylem by parenchyma: *px*, protoxylem; *st*, sieve tube; *sx*, secondary xylem;  $\times 155$ .

intentionally from the same tuber, but sections from many other tubers verify the essential features of the results here given. Some distortion must necessarily accompany such localized and greatly increased amount of thickening, but in that respect only does the structure of the fully matured tuber differ from that shown in



fig. 8. In this study no attempt was made to trace the relationship between the vascular system of the stem and that of the root, as has been done by SCOTT and BREBNER (17) and others in some plants having bicollateral stems.

PRIMARY STRUCTURES.—The smallest roots of *I. Batatas* are frequently triarch or tetrarch; but the large roots are polyarch, chiefly pentarch or hexarch. In the young root there is usually a solid arrangement of vessels with no thin-walled parenchyma between them, and the phloem is well defined between the rays. Laticiferous cells are early distinguished (fig. 1, *lc*). The pericycle consists of a single layer of cells. The endodermis has sharply defined Casperian bands, and the remaining cells of the cortex are large and have conspicuous intercellular spaces between them.

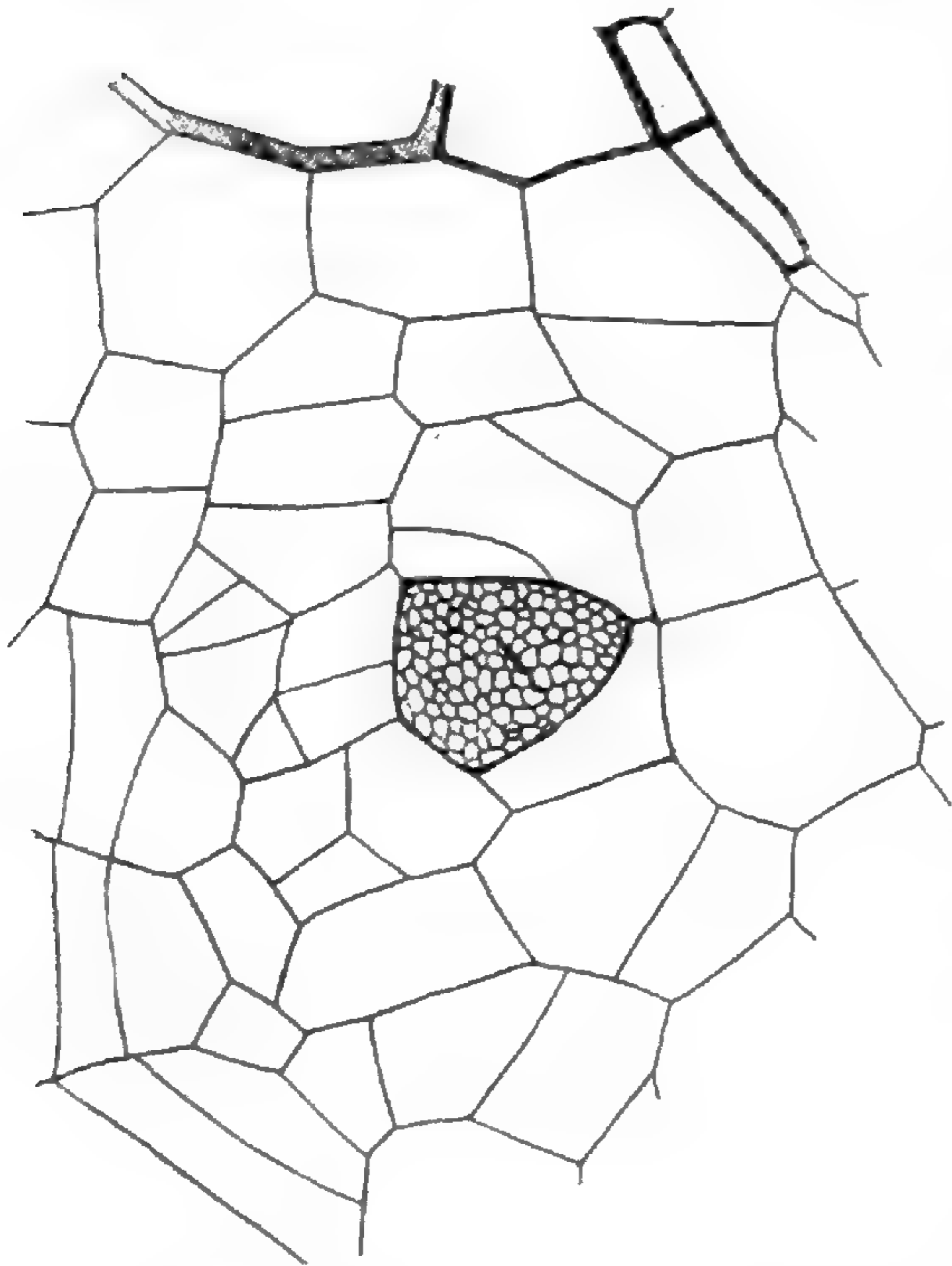

FIG. 5.—Phloem showing a horizontal sieve plate;  $\times 1680$ .

SECONDARY STRUCTURES.—Cambium is organized very soon, and there is formed an extensive secondary growth which in every respect is like the secondary growth common in roots (fig. 2). The secondary xylem forms solid masses around the primary xylem; but wherever a lateral root has been formed, there is a break in the secondary xylem directly opposite the ray, for the lateral roots connect directly with the protoxylem points. These breaks, like greatly widened medullary rays, extend for some distance on each side of the place of attachment of the lateral root. It was long ago shown (22) that there may be as many rows of lateral roots as there are protoxylem points, and this explains the definite rows of lateral roots seen even in the fully matured potato. The amount of the secondary xylem probably is largely dependent upon conditions for growth. One root, which had grown above ground



and was quite green, had an excessive amount of secondary xylem compactly arranged around primary xylem. The structure, such as shown in fig. 2, extends in this particular root about 6 cm. beyond the place of attachment of the root of the stem, but within

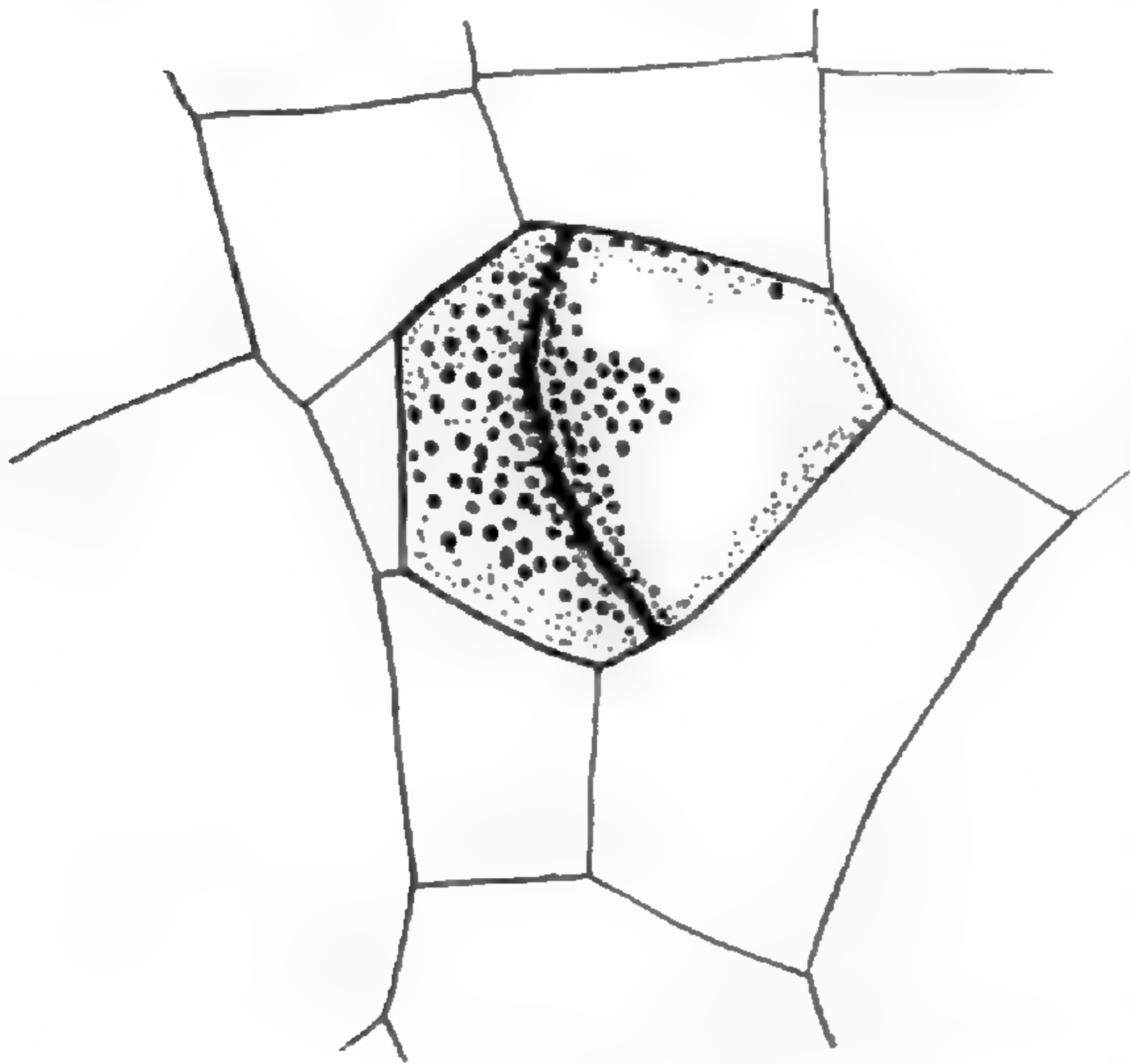

FIG. 6.—Sieve tube with inclined sieve plate;  $\times 1680$ .

the primary cambium has not in the meantime become wholly inactive, but throughout the growth of the root continues forming scattered strands of xylem and phloem, each of which in turn becomes surrounded by a cambium. Tyloses are common and often the vessels are completely filled with them.

**PHLOEM.**—The phloem is rich in sieve tubes with prominent companion cells. The sieve plates are horizontal (fig. 5) or sharply inclined, so that in transverse sections they may be readily overlooked (fig. 6). Interxylary phloem appears very soon after the thin-walled parenchyma becomes active between the vessels, and apparently it may be formed before a definite cambium is organized (fig. 5). Even in

a short distance from this point thin-walled parenchyma between the vessels becomes active (fig. 3). The parenchyma rapidly increases in amount and separates the xylem more and more into strands, consisting of one to several vessels in a strand (fig. 4). Around each strand the parenchyma is organized into concentric layers of cambium. These secondary cambiums are capable of forming both xylem and phloem, though

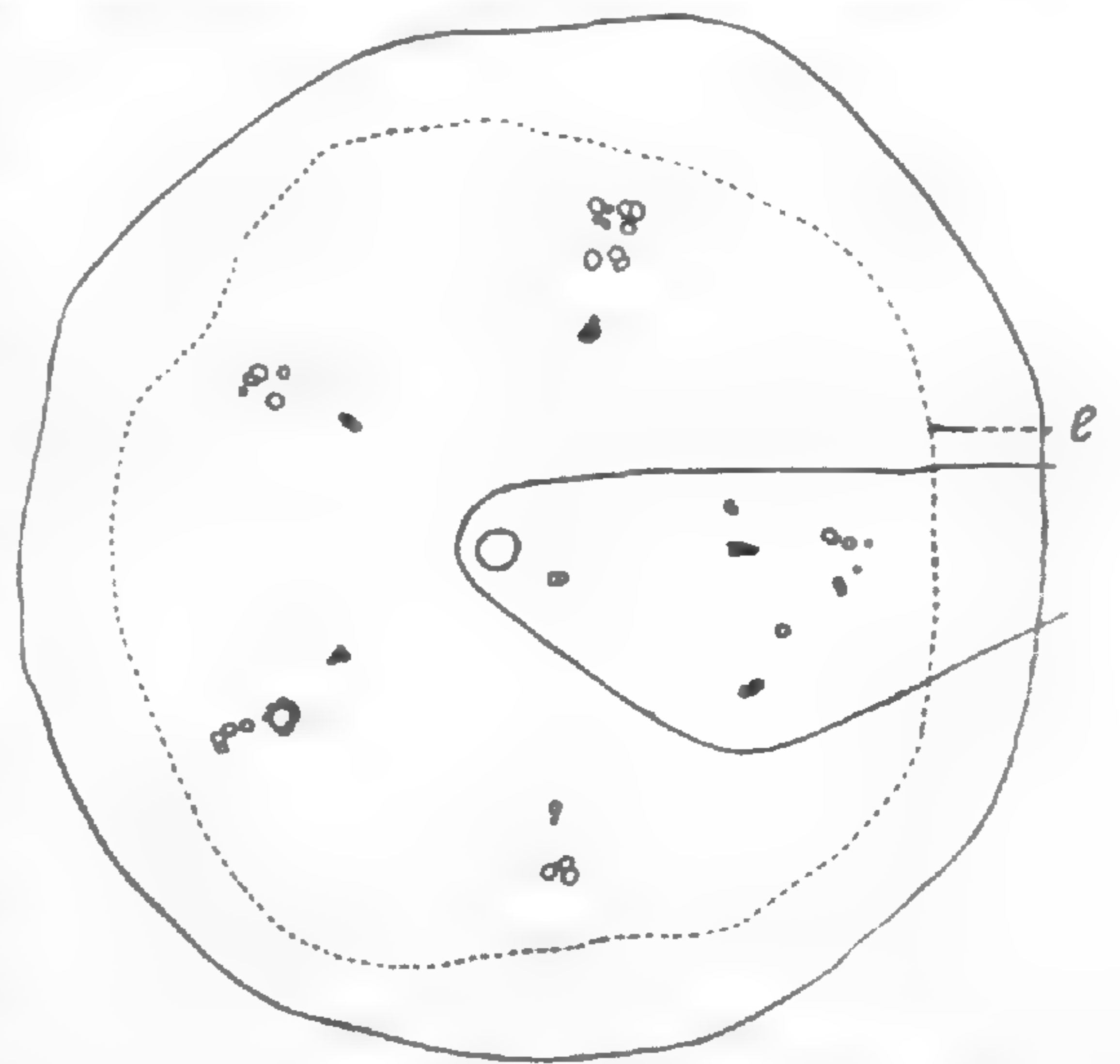

FIG. 7.—Outline of transverse section of root showing the region of fig. 8: *e*, endodermis;  $\times 35$ .



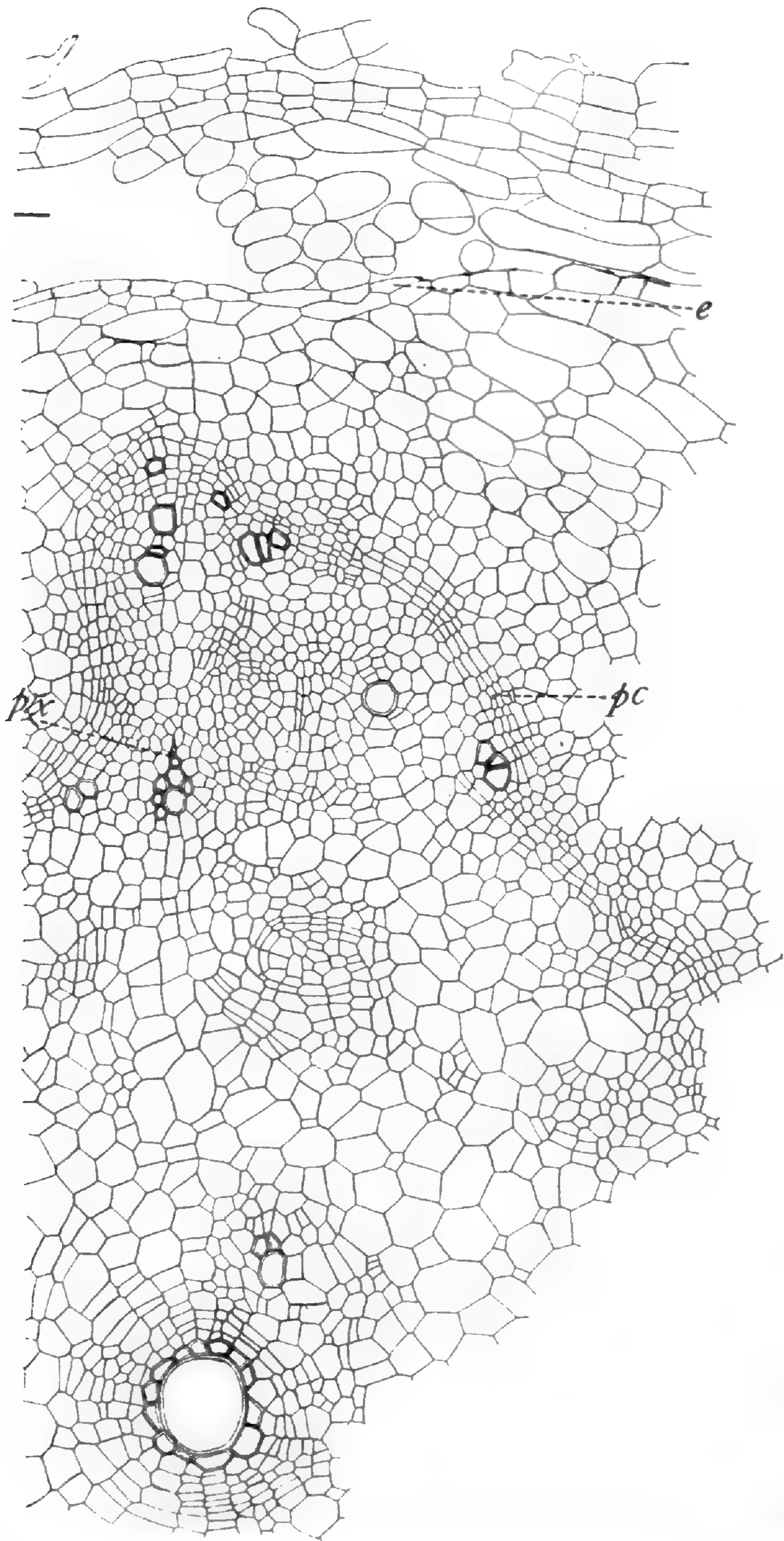

FIG. 8.—Part of transverse section of root at greatest diameter: *e*, endodermis; *px*, protoxylem; *pc*, primary cambium;  $\times 155$ .



a mature tuber strands of phloem unaccompanied by xylem are common.

In the young roots of *I. Batatas* the laticiferous cells are sharply delimited; but in the older tubers, in which the parenchyma cells are larger, they are not readily distinguished. The cross-walls are numerous and are not resorbed.

### Summary

1. The larger roots of *Ipomoea Batatas* Lam. are polyarch, chiefly pentarch and hexarch.

2. Secondary thickenings occur in the usual way and there is formed a massive structure of secondary xylem.

3. Secondary cambiums are organized around strands of xylem and phloem which are separated by thin-walled parenchymatous cells. The primary and secondary cambiums are capable of forming xylem and phloem in isolated strands. One may reasonably expect that, if the conditions for growth are especially favorable, the secondary cambiums may be organized earlier.

4. A section of a mature tuber shows a structure consisting chiefly of parenchyma, and mingled with the parenchyma are strands of xylem, which consist of one to several vessels, and may or may not be accompanied by phloem. Each strand is surrounded by a cambium. There may also be seen strands of phloem unaccompanied by xylem. This structure may be definitely traced back to the radial protosteles.

The writer wishes to express acknowledgments to Dr. W. J. G. LAND for some valuable help given at the beginning of the investigation.

AGRICULTURAL EXPERIMENT STATION  
LINCOLN, NEB.

### LITERATURE CITED

1. CHOISY, J. D., DeCandolle's Prodr. 9:338. 1845.
2. CZAPEK, F., Zur Kenntniss des Milchsafsystems der Convolvulaceae. Sitzungsber. K. Akad. Wiss. Wien 103:87-121. 1894.
3. DEBARY, A., Comparative anatomy of phanerogams and ferns. 1884.
4. DECANDOLLE, ALPH., Origin of cultivated plants. 1885 (p. 54).



5. EATON, AMOS, Manual of Botany. 1822 (p. 249).
6. ENGLER, A., and PRANTL, K., Die Natürlichen Pflanzenfamilien 4<sup>3</sup>:31. 1897.
7. GRAY, A., Synoptical flora of North America. 1888 (p. 211).
8. GRAY, A., and TRUMBULL, J. H., Review of DECANDOLLE'S Origin of cultivated plants, with annotations upon certain American species. Amer. Jour. Sci. 25:246-248. 1883.
9. HABERLANDT, G., Physiologische Pflanzenanatomie. Leipzig. 1909 (p. 315).
10. KAMERLING, G., Sind die Knollen von *Batatas edulis* Choisy Wurzeln oder Stengel? Ber. Deutsch. Bot. Gesells. 27:352. 1914.
11. KOKETSU, R., Lactiferous vessels and cells. Jour. Coll. Sci. Tokyo 35:1-57. 1913.
12. LINNAEUS, C., Systema vegetabilium 1:607. 1825.
13. PETERSON, O. G., Über das Auftreten bicollateral Gefässbündel in verschiedene Pflanzenfamilien und über den Werth derselben für die Systematik. Englers Jahrb. 3:383. 1882.
14. REED, T., On the anatomy of some tubers. Ann. Botany 24:537. 1910.
15. SCHMITZ, FR., Über die anatomische Structur der perennirenden Convolvulaceen Wurzeln. Bot. Zeit. 42:677. 1875.
16. SCOTT, D. H., On some points in the anatomy of *Ipomoea versicolor*. Ann. Botany 5:173-179. 1891.
17. SCOTT, D. H., and BREBNER, G., On internal phloem in the root and stem of dicotyledons. Ann. Botany 5:259. 1891.
18. SOLEREDER, H., Systematische Anatomie den Dicotyledonen. 1899 (p. 646).
19. STURTEVANT, E. L., The sweet potato. Amer. Nat. 25:698-699. 1891.
20. TURPIN, P. J. F., *Solanum tuberosum* et *Helianthus tuberosus*. Mem. Muséum d'Hist. Nat. 19: pls. 1, 2, 5. 1830.
21. VAKANO TUYIHUSA, Are the bulbs of *Batatas edulis* Choisy roots or stems? Bot. Mag. 28:475. 1914.
22. VAN TIEGHEM, PH., Symétrie de structure des plantes. Ann. Sci. Nat. Bot. V. 13:246. pl. 13. 1870.
23. WEISS, J. E., Anatomie und Physiologie fleisschig verdickter Wurzeln. Flora 63:81-89; 113-123. pls. 3, 4. 1880.



## XEROFOTIC MOVEMENTS IN LEAVES

FRANK C. GATES

(WITH EIGHT FIGURES)

DEFINITION.—The word *xerofotic*, expressing the ideas of dryness and light, gives a clue to the meaning the word is intended to connote, namely, dryness caused by light. Xerofotic movements, therefore, are paratonic movements resulting from certain drying effects produced through the action of light. They are manifested by an upward bend in the leaflets or a curling or rolling upward of the blade.

MECHANISM.—The side of a structure facing the sun becomes warmer than the opposite side. Under these conditions, other things being equal, there is a relatively greater loss of water from the exposed side. When the water is not replenished as fast as it evaporates, a greater lowering of the turgidity in the cells of the upper side ensues. The greater pressure exercised by the more turgid cells of the lower side causes the structure to bend or roll in the direction of the exposure. In the case of the most conspicuous examples, the leaflets of leguminous plants, the result of this action of light is an upward movement of the leaflets. The base of the leaflet is the seat of the differential turgidity.

No amount of heat or rapid transpiration is sufficient to cause the xerofotic movement unless there is also a difference in turgidity caused by one-sided illumination. This movement is entirely distinct from the collapse or wilting caused by too great a drying, and from the photeolic, or so-called sleep, movements.

CLASSIFICATION.—Two kinds of xerofotic response were observed: the *localized* response, in which the differential turgidity is largely confined to a small region, as, for example, the pulvini of leguminous leaflets; and the *generalized* response, in which the differential turgidity is spread over the leaf, causing the blade to curl or roll upward. Cases in which the leaves roll downward or underneath must be considered as wilting and not as xerofotic responses.



OCCURRENCE.—Examples of the generalized response were noted in the monocotyledonous families Poaceae, Araceae, Marantaceae, and Zingiberaceae. At different times the leaves might be rolled in either direction. Whenever the rolling is upward it should be considered as a xerofotic response, when downward, the result of wilting. Examples of the localized response, with which this article deals, were furnished by all the Leguminosae under observation. Such response is not limited to this family, however,



FIG. 1.—*Leucaena glauca*, showing leaflets in the horizontal position, the normal day position; Los Baños, P.I., July 18, 1914.

but is shown by *Ipomoea Pesca-prae* of the Convolvulaceae, and as well in a few other families of plants, particularly those whose species have compound leaves, as in the Meliaceae and Oxalidaceae. While xerofotic responses were noted also in *Abrus precatorius*, *Acacia farnesiana*, *Aeschynomene indica*, *Albizia procera*, *Bauhinia malabirica*, *Bauhinia* sp., *Caesalpinia pulcherrima*, *Canavalia ensiformis*, *C. lineata*, *Clitoria ternata*, *Delonix regia*, *Derris elliptica*, *Desmodium gangeticum*, *D. laxiflorum*, *D. pseudotriquetrum*, *D. triflorum*, *Enterolobium saman*, *Erythrina indica*, *Mezoneurum glabrum*, *Mucuna nigricans*, *M. longipedunculata*, *Pithecolobium dulce*, *P. subacutum*, *Pterocarpus indicus*, *Sesbania grandiflora*, *S. cannabina*, *Tamarindus indica*, *Teramnus labialis*, *Vigna lutea*,



and *Voandseia subterranea*, all belonging to the Leguminosae, the following were selected for study on account of their suitability and convenience: *Gliricidia sepium* of the subfamily Papilionatae, and *Leucaena glauca* and *Mimosa pudica* of the subfamily Mimosatae.

AMOUNT OF MOVEMENT.—As the normal day position of the leaflets of legumes is a plane at approximately right angles to the light, the amount of movement can easily be expressed as



FIG. 2.—*Leucaena glauca*, showing leaflets in the xerofotic position, assumed under stimulation of direct sunlight; Los Baños, P.I., July 29, 1914.

the amount of divergence from the horizontal. Whether the night position of the leaflets is erect or drooping, the xerofotic position is between  $45^{\circ}$  and  $70^{\circ}$  above the horizontal (figs. 1 and 2). When the night position of the leaflet is above the horizontal, as is the case with many members of the Mimosatae, the xerofotic position differs in not exceeding  $70^{\circ}$  above the horizontal and in the absence of a forward movement often a part of the photoleic response. The horizontal position is assumed always between the xerofotic and the night positions.

INEQUALITY AND IRREGULARITY OF THE MOVEMENT.—Generally speaking, the upward bend is equal in each leaflet of a pair and likewise in a series of pairs. The exceptions noted in nature and



produced by experiment make the general nature of the phenomenon clearer. As the intensity of the sun in the east increases, the west leaflets of a leaf, oriented north and south, usually exhibit the xerofotic movement before the east leaflets. It was demonstrated experimentally that in this response the paired condition of the leaflets is of less importance than in other movements. Even in the very sensitive *Mimosa pudica*, one leaflet of a pair is frequently bent more in xerofotic response than the other; while



FIG. 3.—*Leucaena glauca* against the sky, showing amount of light cut off by leaflets in the horizontal position; compare with fig. 4; Los Baños, P.I., July 29, 1914.

in the disturbance of turgidity caused by shock, the pairs act equally and simultaneously. This suggests that xerofotic conditions of unequal turgidity are very little, if at all, transmitted. All the leaflets of a compound leaf do not necessarily respond equally. Sometimes there is an obvious reason, for the basal leaflets are shaded. In other cases, only the hypothesis that the basal leaflets are better and more quickly supplied with water to equalize the turgidity seems to explain the discrepancies in movement.

SEASONAL RELATIONS.—This movement is not peculiar to any season, but is present throughout the year. In the dry season the xerofotic position is regularly assumed a short time after the sun



has been shining directly on the leaflet. In exposed plants the movement is nearly certain to have taken place by 8:30 in the



FIG. 4.—*Leucaena glauca* against the sky, showing amount of light cut off by leaflets in the xerofotic position; compare with fig. 3; Los Baños, P.I., July 20, 1914.



FIG. 5.—*Gliricidia sepium* shortly after a rain; the majority of the leaflets are in the horizontal position; a few in the upper and in the right-hand part of the figure are resuming the xerofotic position; Los Baños, P.I., July 20, 1914.

morning. During the rainy season, since the sun is out less, the assumption of the xerofotic position is less frequent.



RESULTS AND ADVANTAGES.—The obvious result of the xerofotic position is to decrease the amount of direct radiant energy received per unit area of leaf. This reduces the harmfulness of too great sunlight upon the chlorophyll, as well as reducing the transpiration during the critical time of day. Its frequency is undoubtedly a valuable asset to the family Leguminosae, one of the most important plant families and the richest in species in the tropics.



FIG. 6.—*Ipomoea Pes-caprae* growing in the shade, showing leaves in spread-out position; Taal Volcano, P.I., March 7, 1915.

The assumption of the xerofotic position permits a great deal more light to come through the leaf layer. This is admirably shown in figs. 3 and 4 of *Leucaena glauca*, taken on the same day from the same spot; fig. 3 when the leaflets were in the horizontal position; and fig. 4 three hours later, after the leaflets had assumed the xerofotic position.

EXPERIMENTATION.—That this class of movements might not rest solely on observation, a number of experiments were performed at Los Baños, Philippine Islands, during 1913 and 1914. Screens were interposed between the sun and plants of *Gliricidia sepium*, *Leucaena glauca*, and *Mimosa pudica*, whose leaflets were in the xerofotic position. In every case the leaflets fell back to the horizontal position. Occasionally as short a time as 5 minutes



was sufficient to bring about the change, but usually it took about 20 minutes. Upon taking away the screen the xerofotic position was gradually resumed. When the sun was very hot a little upward curling of the outer end of the leaflet was noticed before the complete assumption of the xerofotic position.

While the screen experiments clearly indicated that drying effects dependent upon exposure to sunlight were fundamental, other experiments sought to produce drying effects independently



FIG. 7.—*Ipomoea Pes-caprae* growing on the open strand, showing leaves in the xerofotic position, assumed during the hours of strong sunlight; Taal Volcano, P.I., April 18, 1914.

of the sunlight. Two of the common laboratory drying agents, absolute alcohol and xylol, were employed. Several legumes were experimented with, but in the majority of cases, the delicateness of the rachis and the small size of the pulvinus made the experiments a failure. At length, however, a suitable plant was found in *Gliricidia sepium*, in which the leaflets, rachis, and pulvini are large and coarse (fig. 5). In successive experiments, both absolute alcohol and xylol were carefully applied to the upper side of the pulvinus with a small pointed brush. As the drying agent withdrew water locally from the upper cells of the pulvinus, the xerofotic position of the leaflet was gradually assumed. The experiments



were conducted both out of doors and in the laboratory, with the leaf right side up and upside down. In each case the effect of the local withdrawal of water was the assumption of the xerofotic position.

In additional experiments, branches of trees were cut away so that shade leaves, in which no previous xerofotic movement had been noted, were exposed to the full sun. In all such cases the xerofotic position was soon taken. A burning-glass, used to intensify

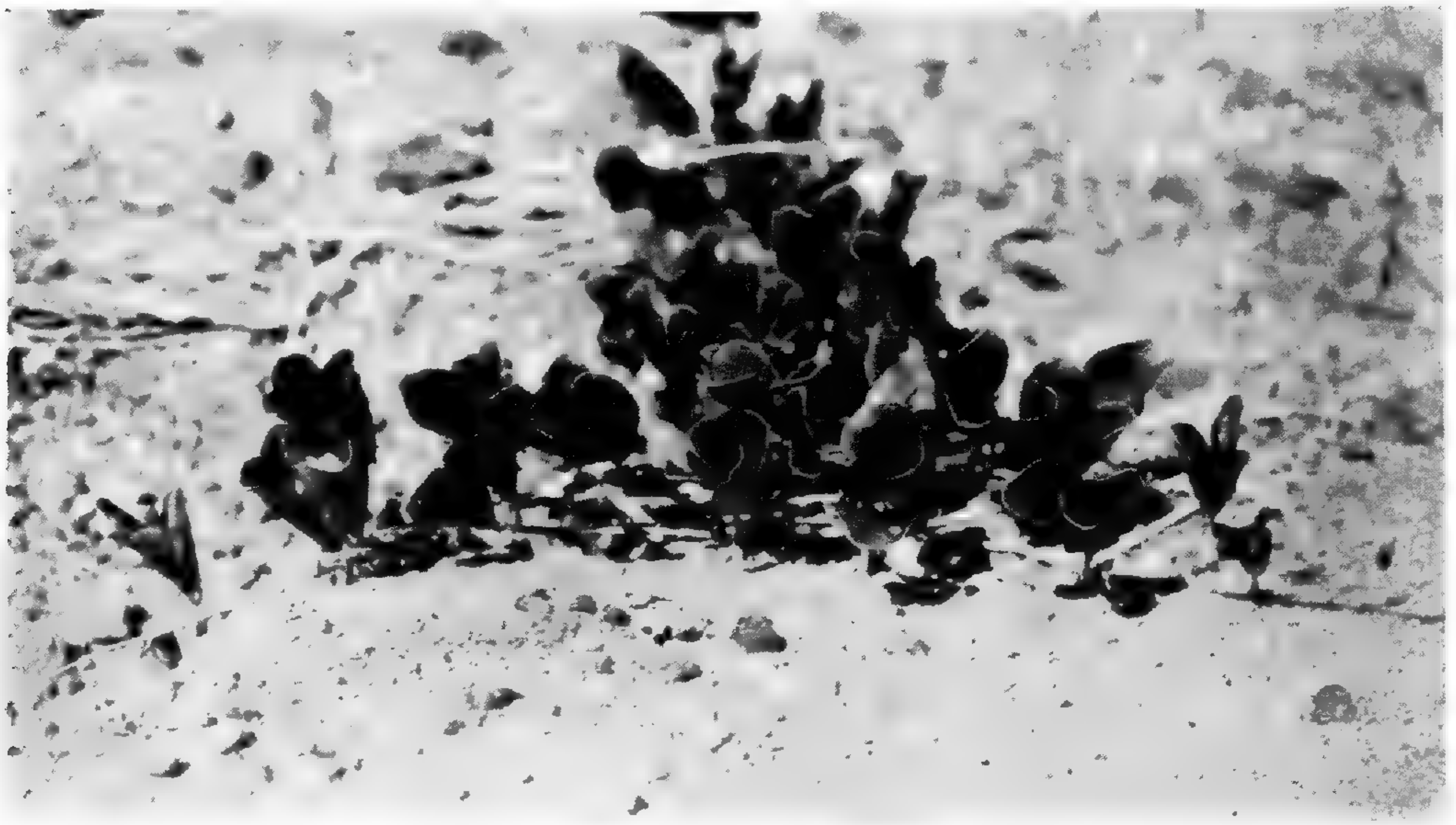

FIG. 8.—*Canavalia lineata* growing on the strand, showing leaflets in the xerofotic position; Taal Volcano, P.I., March 7, 1915.

the action of the sun on leaflets which had been artificially shaded, brought about a more rapid assumption of the xerofotic position.

Both shade and xylol experiments were conducted upon the convolvulaceous *Ipomoea Pes-caprae*, growing on the strand of Taal Volcano, Philippine Islands (figs. 6, 7, and 8). In this case the clam-shaped simple leaf spread out under the dense shade of a screen and spread out leaves folded nearly together soon after xylol was applied to the upper part of the midrib.

### Summary

1. Xerofotic movements are paratonic movements, caused by unequal drying effects in direct sunlight, manifested by an upward bend in leaflets or a curling upward of the blade. Greater turgor



of the cells of the lower side causes a movement in the direction from which the desiccating energy comes. The xerofotic position decreases the amount of direct radiant energy received per unit area of leaf, reducing the harmful action of intense sunlight upon the chlorophyll as well as checking transpiration.

2. Two classes of xerofotic response were noted. In the localized type the differential turgidity acts in a limited region, such as in the pulvini of leguminous leaflets. In the generalized type the difference in turgidity is between the upper and lower part of the blade. The localized response was characteristic of all observed species of Leguminosae, but is not limited to that family. The generalized type was noted particularly in the monocotyledonous families Poaceae, Araceae, Marantaceae, and Zingiberaceae.

3. In nature the response was brought about by direct stimulation from the sun. It was artificially simulated by the action of the chemical desiccating agents, absolute alcohol and xylol, on *Gliricidia sepium* and *Ipomoea Pes-caprae*.

4. The amount of movement varied between  $45^{\circ}$  and  $70^{\circ}$  above the horizontal. Movement took place under suitable conditions at any season. The amount of response, even in leaflets of a pair, varied under different conditions of exposure.

CARTHAGE COLLEGE  
CARTHAGE, ILL.



# PHYSICAL PROPERTIES OF SOME TOXIC SOLUTIONS

GEORGE B. RIGG, H. L. TRUMBULL, AND  
MATTIE LINCOLN

This paper deals with the osmotic pressure and the surface tension of (1) water obtained from sphagnum bogs of the Puget Sound region and Alaska, (2) solutions obtained by allowing the rhizomes of *Nymphaea polysepala* Gr. to decay in water.

## Osmotic pressure

The difference between the freezing point of each solution and that of pure water was determined with the Beckman apparatus. From this lowering, the osmotic pressure at 0° C. was calculated in two ways: (1) from a consideration of the relation between molar concentration and osmotic pressure<sup>1</sup> established directly by MORSE (6); (2) by substitution in the ordinary formula based on thermodynamic reasoning, namely,  $P = 12.05 \times dt$  atmospheres at 0°.

TABLE I  
OSMOTIC PRESSURE OF BOG WATERS

Sources	Sample obtained	Sample tested	<i>dt</i>	<i>P</i> (Morse)	<i>P</i> (Nernst)	<i>M</i>
1. Henry bog sample 1 . . .	Dec. 22, 1914	Jan. 19, 1915	0.008	80.48	73.15	0.004301
2. Henry bog sample 2 . . .	Dec. 22, 1914	Jan. 21, 1915	0.008	80.48	73.15	0.004301
3. Maltby bog sample 1 . . .	Feb. 22, 1915	Mar. 3, 1915	0.008	80.48	73.15	0.004301
4. Maltby bog sample 2 . . .	Feb. 22, 1915	Mar. 3, 1915	0.008	80.48	73.15	0.004301
5. South Mud Lake bog . . .	Mar. 6, 1915	Mar. 13, 1915	0.009	90.55	82.40	0.004839
6. Henry bog . . . . .	Feb. 23, 1915	Mar. 13, 1915	0.000	.....	.....	.....
7. Cordova (Alaska) bog . . .	May 23, 1913	Mar. 13, 1915	0.006	60.37	54.94	0.003226
8. North Mud Lake bog . . .	Mar. 13, 1915	Mar. 27, 1915	0.002	20.12	18.31	0.001074
9. Fauntleroy bog . . . . .	Aug. 30, 1915	Sept. 7, 1915	0.002	20.12	18.31	0.001074
10. North Mud Lake bog . . .	Sept. 1, 1915	Sept. 7, 1915	0.002	20.12	18.31	0.001074
11. Henry bog . . . . .	Aug. 28, 1915	Sept. 7, 1915	0.003	30.18	27.46	0.001611
12. South Mud Lake bog . . .	Sept. 1, 1915	Sept. 7, 1915	0.004	40.25	36.63	0.002148

In table I, *dt* represents the lowering of the freezing point in degrees centigrade; *M* represents the molar concentration of a solution of any non-electrolyte which shows the same lowering of the freezing point; *P* represents the osmotic pressure in millimeters

<sup>1</sup> These investigators found that 0.1 M sugar solutions at 0° C. give 2.462 atmospheres osmotic pressure. This corresponds to 0° 186 depression of the freezing point.



of mercury. The data are put into such form that they may be compared with the data given by LIVINGSTON (5) for bog waters of central and eastern United States.<sup>2</sup>

Duplicate series of determinations of the freezing point lowering were made for each sample reported in table I. Owing to the low concentrations of the solutions, the maximum or freezing-point temperatures remained surprisingly constant, and were read at one-minute intervals from 6 to 10 times. The deviation from the mean in each series was usually about  $0^{\circ}.001$ , seldom as high as  $0^{\circ}.002$ , the estimated reading error of the thermometer. The means of the two series agreed with each other in all cases within  $0^{\circ}.001$ , and in four cases they were identical. A hand lens (aplanatic triplet) was used in reading the scale, and care was taken to avoid parallax. The temperature of the outer bath in all of the tests except 3 was between  $3^{\circ}.5$  C. and  $3^{\circ}.8$  C. In the three exceptions the temperatures were  $3^{\circ}.4$ ,  $4^{\circ}.0$ , and  $4^{\circ}.5$  C.

Samples 1–8 inclusive were obtained during the rainy season or soon after its close. Each sample was obtained by cutting out the sphagnum to a depth of 30–45 cm. and dipping up the water that collected. Samples 9–12 were obtained just at the close of the dry season. Samples 9 and 11 were obtained by squeezing the water from handfuls of sphagnum obtained at 50–200 mm. below the surface of the bog. This method was used because at that time no water accumulated in a hole 1.5 m. deep in half an hour. Samples 10 and 12 were dipped up from holes cut in the sphagnum 40 cm. deep. In both of the Mud Lake bogs the height of the water table is evidently determined by the level of the adjoining lake. There is no lake adjoining either the Fauntleroy bog or the Henry bog.

The general characteristics of the sphagnum bogs of the Puget Sound region and of the Alaska coast have been described by RIGG (7, 8). Descriptions of the Henry bog, the Fauntleroy bog, and the Cordova bog are included in the papers cited. Maltby bog is situated in Snohomish County, Washington, about a mile

<sup>2</sup> LIVINGSTON'S osmotic pressures are computed for  $25^{\circ}$  C.; those of the writers' are for  $0^{\circ}$  C., hence should be multiplied by  $\frac{273}{298}$  for comparison with LIVINGSTON'S pressures.



south of the town of Maltby. It has an area of some 60 acres. Mud Lake is situated on the west side of Lake Washington, just north of the city limits of Seattle. It is separated from Lake Washington by a narrow wave-built ridge of gravel. South Mud Lake bog is a small patch of sphagnum situated within the southern portion of the lake. North Mud Lake is larger (perhaps 15 acres in area) and lies adjacent to the north and west sides of the lake.

For comparison, the lowering of the freezing point of the waters from some lakes and springs was determined. The results are shown in table II.

TABLE II  
OSMOTIC PRESSURE OF THE WATERS FROM SOME PUGET SOUND LAKES AND SPRINGS

Sources	Sample obtained	Sample tested	$dt$	$P$ (Morse)	$P$ (Nernst)	$M$
1. Crystal Lake.....	Feb. 22, 1915	Mar. 3, 1915	0.007	70.42	64.08	0.003763
2. Mud Lake.....	Mar. 6, 1915	Mar. 13, 1915	0.001	10.06	9.16	0.000537
3. Lake Washington.....	Mar. 6, 1915	Mar. 13, 1915	0.002	20.12	18.31	0.001074
4. Spring no. 1.....	Mar. 6, 1915	Mar. 13, 1915	0.000	.....	.....	.....
5. Spring no. 2.....	Mar. 11, 1915	Mar. 13, 1915	0.002	20.12	18.31	0.001074
6. Mud Lake.....	Sept. 1, 1915	Sept. 7, 1915	0.004	40.25	36.63	0.002148
7. Lake Washington.....	Sept. 1, 1915	Sept. 7, 1915	0.004	40.25	36.63	0.002148
8. Spring no. 2.....	Sept. 1, 1915	Sept. 7, 1915	0.004	40.25	36.63	0.002148

Crystal Lake is located in the center of Maltby bog. It is entirely surrounded by sphagnum, and has, at least at the surface, no contact with other soil. The lake has an area of about 10 acres. The water from this lake is scarcely distinguishable in appearance from that of the bog. The location of Mud Lake has already been given. Its water resembles bog water somewhat and contrasts strongly with the clear water of Lake Washington. Samples 3 and 7 were collected from Lake Washington at a point near Mud Lake. Spring no. 1 is just north of the city limits of Seattle. It is near East 65th Street and 40th Avenue N.E. It is in logged-off land which is not under cultivation. Spring no. 2 is at the head of a ravine on an unused portion of the campus of the University of Washington. It is situated in logged-off land.

The difference between the freezing point of pure water and that of solutions resulting from the decay of rhizomes of *Nymphaea polysepala* was also determined with the Beckman apparatus. The



standard solution used was that resulting from the decay of 500 gm. of the rhizome in 800 cc. of water. Table III shows the results of the test on three different solutions thus prepared.

TABLE III

LOWERING OF FREEZING POINT OF STANDARD SOLUTIONS  
FROM THE DECAY OF *Nymphaea* RHIZOMES IN WATER

Solution	Date of test	Lowering of freezing point
1.....	Feb. 24, 1915	0.097
2.....	Feb. 24, 1915	0.156
3.....	Mar. 13, 1915	0.142

The osmotic pressure of 10 per cent (1 volume of solution to 9 volumes of water),  $7\frac{1}{2}$  per cent, and 5 per cent solutions of these standard solutions was calculated from the results shown in table III. These computed values are shown in table IV.

TABLE IV

CALCULATED OSMOTIC PRESSURES OF SOLUTIONS FROM DECAY

Solution	$dt$	$P$ (Morse)	$P$ (Nernst)	$M$
Sample 1, 10 per cent.....	0.010	100.63	91.6	0.005376
Sample 1, $7\frac{1}{2}$ per cent.....	0.007	70.42	64.08	0.003763
Sample 1, 5 per cent.....	0.004	40.25	36.63	0.002148
Sample 2, 10 per cent.....	0.016	161.0	146.4	0.008601
Sample 2, $7\frac{1}{2}$ per cent.....	0.011	110.7	100.7	0.005913
Sample 2, 5 per cent.....	0.007	70.42	64.08	0.003763
Sample 3, 10 per cent.....	0.014	140.9	128.2	0.007527
Sample 3, $7\frac{1}{2}$ per cent.....	0.010	100.6	91.6	0.005376
Sample 3, 5 per cent.....	0.007	70.42	64.08	0.003763

These particular dilutions are suggested because these (and in some cases greater) dilutions proved toxic to plants grown in them by RIGG (9).

### Surface tension

Tests of the surface tension of bog waters were made by the Jolly method. The results are shown in table V.



TABLE V

## SURFACE TENSION OF BOG WATERS

Liquid	Surface tension in dyne cm.	Surface tension in percentage of surface tension of pure water
Pure water.....	72.7	100
Ronald bog, sample no. 1, un- filtered.....	70.3	96*
Ronald bog, sample no. 2, un- filtered.....	72.3	99*
Ronald bog, sample no. 1, fil- tered.....	65.7	92*
Maltby bog.....	67.5	94*

\* Computed from the data in column 1 on the basis of the surface tension of pure water given in Smithsonian table no. 141 p. 128. Rev. ed. 1897. ●

Tests of surface tension by the Jolly method were also made on solutions resulting from the decay of *Nymphaea* rhizomes in water. The standard solution used was that resulting from the decay of 500 gm. of the rhizome in 800 cc. of water. Table VI shows the results of the tests. Unless otherwise noted, the tests are on the standard solution. Dilutions of 10 per cent (9 volumes of water + 1 volume of solution), 7½ per cent, and 5 per cent are so designated in the table.

TABLE VI

SURFACE TENSION OF SOLUTIONS RESULTING FROM THE DECAY OF  
*Nymphaea* RHIZOMES

Liquid	Surface tension in dyne cm.	Surface tension in percentage of surface tension of pure water
Sample 1.....	64.2	88.0
Sample 1 diluted to 10 per cent....	66.9	93.0
Sample 1 diluted to 7½ per cent....	73.1	101.0
Sample 1 diluted to 5 per cent....	72.3	99.0
Sample 2.....	60.6	84.0
Sample 3.....	62.9	87.0

In order to compare surface tension results obtained by the writers by the Jolly method with the results obtained by CZAPEK (3) with his apparatus, a series of alcohols were tested.



The results are compared in table VII. The first two columns show the writers' results, while the third shows CZAPEK's results.

TABLE VII  
SURFACE TENSION OF ALCOHOLS

Alcohol	Surface tension in dyne cm.	Surface tension in percentage of surface tension of pure water	Surface tension from Czapek
7 per cent ethyl.....	55.7	76	76
13 per cent ethyl.....	48.9	67	65
15 per cent ethyl.....	45.6	63	62
15 per cent methyl.....	53.1	73	73
20 per cent methyl.....	45.6	64	67

The surface tension of 13 per cent ethyl alcohol was tested with a duplicate of CZAPEK's apparatus. The average of the tests made was 66, which lies between the results given by CZAPEK and the results obtained by the writers with the Jolly apparatus. It was thought best to use the Jolly apparatus rather than this duplicate of CZAPEK's apparatus, since in general more dependable results would thus be obtained. There are at least three sources of error in CZAPEK's apparatus: (1) the difference in the height of the water in the two sides of the manometer cannot be read any closer than 1 mm., owing to the irregular meniscus and the necessity of taking the readings just as a sudden change of height is taking place; (2) the capillary tube is immersed so slightly in the liquid that a small error in the depth to which it is immersed would make a relatively large error in the result; (3) it is an indirect method, the value for each liquid being compared with the value for pure water determined with the same apparatus, thus giving a double chance for error.

### Discussion

LIVINGSTON (5) has published data which he summarizes as follows: "bog waters do not have an appreciable higher concentration of dissolved substances than do the streams and lakes of the same region." The following are the averages of the results of all tests of the lowering of the freezing point of bog waters and of other surface waters reported by LIVINGSTON (*loc. cit.*), and of



the results of all tests made by the writers on such waters: LIVINGSTON'S tests on bog waters, 0.009; tests by the writers on bog waters, 0.005; LIVINGSTON'S tests on other surface waters, 0.007; tests by the writers on other surface waters, 0.003. In so far as the data given can be taken to be representative of the regions, it seems that the osmotic pressure of all waters tested is lower in the region worked in by the writers than in the region in which LIVINGSTON worked. The difference between the average for bog waters and for other surface waters in the two regions is exactly the same.

LIVINGSTON (*loc. cit.*) found "practically no difference in osmotic pressure corresponding to the season." The average of the determinations made by the writers on bog waters during the rainy season and during the dry season is as follows: rainy season, 0.006; dry season, 0.002. Here, as elsewhere in this paper, figures beyond the third place are not considered significant.

FITTING (4) has concluded that xerophytism and difficulty in absorption do not seem to be correlated with high osmotic pressure (the writers have not seen this paper).

Whatever conclusions the writers would be justified in drawing from their data would be in substantial agreement with those of LIVINGSTON and of FITTING. That is, high osmotic pressure is not the cause of the toxicity of the waters of sphagnum bogs.

Omitting Crystal Lake (since the properties of its waters seem practically identical with those of bog waters), the comparison of the lowering of the freezing point of lake and spring waters for the wet season and the dry season<sup>3</sup> is as follows: average for the wet season, 0.001; average for the dry season, 0.004. This is too small a number of tests to be made the basis of any generalization as to seasonal variation in osmotic pressure in this region. The average of the limited data here cited, however, is just the opposite of the average of the data secured by TRANSEAU (11) for central Illinois in 1913, when there were no rains of consequence from the middle of April to the middle of September. He found that the highest osmotic pressures were recorded during the spring, when the water levels were highest, and that the lowest records were during the

<sup>3</sup> There was no rain for 45 days preceding the time of collection of the samples for the dry season.



middle of September, when the levels for the year were the lowest. He found that the osmotic pressure of the waters tested (expressed in mm. of mercury) varied from 59 to 407. Those tested by the writers (table II) varied from 0 to 70. The waters of the Puget Sound region are soft, possessing very little of even temporary hardness.

In so far as the data given in this paper are concerned, the seasonal variation of osmotic pressure in the waters of the sphagnum bogs in the Puget Sound region seems to be the opposite of that of the waters of springs and lakes.

The surface tension of bog water was measured in order to determine whether it might be low enough to cause exosmose from the root cells of plants growing in the bogs. BLACKMAN (1) and CZAPEK (2) find that when liquids having a surface tension of 0.66 or less (pure water being taken as 1.00) are applied to plant cells most of the cells are injured and die. The results shown in table III show surface tensions so far above 0.66 that there seems to be no reason whatever for supposing that low surface tension could be a factor in the toxicity of the waters of sphagnum bogs.

It has been noted in the field by SHERFF (10) that rhizomes of *Sagittaria* are killed when they grow into the decaying portion of the rhizomes of *Nymphaea advena*. It has also been found by RIGG (*loc. cit.*) that solutions resulting from the decay of *Nymphaea* rhizomes are toxic to *Tradescantia* cuttings and to agricultural plants, even in very dilute solution.

There is no indication in the data here published that either high osmotic pressure or low surface tension can be a factor of any importance in the toxicity of the solutions resulting from the decay of *Nymphaea* rhizomes in the extreme dilutions which proved toxic to *Tradescantia* cuttings and to agricultural plants.

### Summary

1. The osmotic pressure of bog water in the samples tested was higher during the rainy season than at the close of the dry season.
2. The osmotic pressure of the waters tested from lakes and springs was lower during the rainy season than at the close of the dry season.



3. There is no indication that either high osmotic pressure or low surface tension is an important factor in the toxicity of bog water or of very dilute solutions resulting from the decay of *Nymphaea* rhizomes.

The writers wish to express thanks to Dr. F. A. OSBORN for advice on the surface tension determinations.

UNIVERSITY OF WASHINGTON  
SEATTLE, WASH.

#### LITERATURE CITED

1. BLACKMAN, F. F., The plasmatic membrane and its organization. *New Phytol.* 11:180-195. 1912.
2. CZAPEK, F., Chemical phenomena in life. New York. 1911.
3. ———. Über eine Methode zur direkten Bestimmung der Oberflächenspannung der Plasmahaut von Pflanzenzellen. Jena. 1911.
4. FITTING, H., Die Wassersorgane und die osmotischen Druckverhältnisse der Wustpflanzen. *Zeitsch. Bot.* 3:209-275. 1911.
5. LIVINGSTON, B. E., Physical properties of bog water. *BOT. GAZ.* 37:383-385. 1904.
6. MORSE, HOLLAND, and MYERS, *Amer. Chem. Jour.* 45:561. 1911.
7. RIGG, G. B., The effect of some Puget Sound bog waters on the root hairs of *Tradescantia*. *BOT. GAZ.* 55:314-326. 1913.
8. ———, Notes on the flora of some Alaskan sphagnum bogs. *Plant World* 17:167-182. 1914.
9. ———, Decay and soil toxins. *BOT. GAZ.* 61:295-310. 1916.
10. SHERFF, E. E., The vegetation of Skokie marsh with special reference to subterranean organs and their interrelationships. *BOT. GAZ.* 53:415-435. 1912.
11. TRANSEAU, E. N., Seasonal variations of the osmotic pressure of pool, pond, and stream waters. *Science N.S.* 39:260. 1914.



## FIVE UNDESCRIBED SPECIES OF RAVENELIA

W. H. LONG

The five species described in this article were collected during 1914 and 1915. Three of them are from Texas, one is from Florida, and one from Arizona.

There are known now to occur in Texas 11 species of *Ravenelia*, including 3 of the new species described in this paper, namely, (1) *Ravenelia arizonica* Ellis and Ev. on *Prosopis juliflora*, (2) *R. versatilis* (Peck) Dietel on *Acacia greggii*, (3) *R. igualica* Arthur on *Acacia filiculoides*, (4) *R. texensis* Ellis and Gall. on *Acacia jamesii* and *A. acuminata*, (5) *R. fragrans* Long on *Mimosa fragrans*, (6) *R. cassiaecola* Atk. on *Chamaecrista multipinnata* (?), (7) *R. longiana* Syd. on *Cassia roemeriana*, (8) *R. papillifera* Syd. on *Cassia lindheimeriana*, and the 3 species here described: (9) *R. roemerianae* on *Acacia roemeriana*, (10) *R. morongiae* on *Morongia uncinata*, and (11) *R. thornberiana* on *Acacia constricta paucispina*. The types of 7 of these species (*R. texensis*, *R. roemerianae*, *R. thornberiana*, *R. fragrans*, *R. longiana*, *R. papillifera*, and *R. morongiae*) were collected in Texas, while the type locality of the last 4 named is Austin, Texas.

Many Mexican species of this genus undoubtedly will be found in southwestern Texas, especially in the territory lying between El Paso and Brownsville along the Rio Grande. *R. cassiaecola* is reported for the first time west of the Mississippi River, the writer having collected it at Denton, Texas.

Two closely related genera, *Neoravenelia* and *Pleoravenelia*, are also represented in this state, the former by *N. Holwayi* (Dietel) Long on *Prosopis juliflora*, and the latter by *P. Hieronymi* (Speg.) Long on *Vachellia farnesiana*. *P. epiphylla* (Schw.) Long should be found also in the northeastern part of the state, since the writer has recently collected this species in southern Arkansas near the Texas border.



**Ravenelia roemerianae**, sp. nov.

O. Pycnia unknown.

II. Urediniospores intermixed with the teliospores, oval, obovate to obovate-oblong,  $13-18 \times 28-37 \mu$ , average for 10 spores  $15.4 \times 32.2 \mu$ ; walls thin,  $1-1.5 \mu$ , slightly thicker above, prominently but sparsely echinulate; spinules very sparse to almost wanting on upper third of spore, upper half golden brown to wine color, lower half paler or almost colorless; germ pores 8, equidistant in two zones of 4 each, one zone in equator, the other between equator and base of spore; paraphyses abundant, intermixed with the spores, clavate to clavate-capitate,  $35-50 \mu$  long, average length for 10 paraphyses  $44.4 \mu$ , heads  $8-13 \mu$  broad, average for 10 heads  $10 \mu$ , apex of head thickened about  $3 \mu$ , pale fulvous, stipe solid to thin-walled, semi-hyaline.

III. Telia epiphyllous, rarely hypophyllous, scattered, soon naked; subcuticular, blackish, shining,  $0.3-1$  mm. across, irregularly oval, ruptured cuticle moderately noticeable; teliospore heads chestnut brown,  $5-7$  cells across,  $67-86 \mu$ , average for 10 spores  $75.2 \mu$ , verrucose, each spore bearing  $6-10$  colorless warts about  $2 \mu$  high by  $3 \mu$  broad; cysts  $6-8$ , flattened and appressed beneath the head, extending from periphery to pedicel, ovoid to oblong-ovate, slow to burst in water, united laterally; pedicel short, colorless, deciduous.

On Mimosaceae. Type collected on *Acacia roemeriana* at San Marcos, Texas, November 1, 1915, by *W. H. Long* (no. 5498). This rust is probably distributed throughout southwestern Texas within the range of its host, but at present is known only from the type locality.

*Ravenelia roemerianae* is closely related to *R. versatilis*, but differs in its smaller and verrucose teliospore heads and in the fact that it does not form witches' brooms as does *R. versatilis*. Only a few urediniospores of *R. roemerianae* were seen. The urediniospores of both species are very similar in size, shape, color, and in the number and arrangement of the germ pores. These are the only two species of *Ravenelia* so far known which have two rows of germ pores, one in the equator and the other near the base of the spore.

**Ravenelia morongiae**, sp. nov.

O. Pycnia unknown.

II. Uredinia amphigenous and caulicolous, perennial in tissues of host, often causing early shoots to become swollen and some-



what abortive, but not forming distinct witches' brooms, thickly covering large areas, sometimes confluent or scattered or in circling groups, oval to irregularly orbicular on leaves, or oblong and often confluent on the branches, subcuticular, early naked, light cinnamon brown, pulverulent, ruptured cuticle inconspicuous; paraphyses very numerous, intermixed with the spores or in separate sori, very variable in shape and size, ranging from clavate to subcapitate or even bladdery,  $40-60 \times 12-20 \mu$ , usual length  $50 \mu$ , head and stipe about equal in length, heads  $12-20 \times 20-25 \mu$ , walls of head very thin, about  $1 \mu$  thick, except at apex where the walls are about  $3 \mu$  thick, apex pale fulvous to cinnamon brown, strongly colored for  $5-7 \mu$  as if thickened, remainder of head semi-hyaline, stipe hyaline, sometimes solid,  $2-4 \mu$  thick,  $22-30 \mu$  long, many of the paraphyses collapse to a hypha-like shape; urediniospores broadly oval to globose,  $14-18 \times 15-20 \mu$ , average for 10 spores  $16.5 \times 17.6 \mu$ ; walls  $1.5-2 \mu$ , fulvous, densely verrucose-spinulose, concolorous, germ pores 8-12, scattered.

III. Telia hypophyllous, small, scattered, sparse, very inconspicuous, irregularly oval, blackish, shining, pulverulent, subcuticular, soon naked, ruptured cuticle inconspicuous; teliospore heads chestnut brown, strongly convex above, 4-6 cells across, 6-12 peripheral cells,  $50-70 \mu$ , average for 10 heads  $61.7 \mu$ , smooth; cysts few, about as many as peripheral spores of head, closely appressed to under side of head around the stipe, slowly swelling in water to a globular shape and bursting; pedicel very short, hyaline, deciduous.

On Mimosaceae. Type for uredinia collected on *Morongia uncinata* at Austin, Texas, May 23, 1915, by *W. H. Long* (no. 5398). Type for telia collected in same locality and on same host October 29, 1915 (no. 5474, *W. H. Long*).

Although this host is very common and widely distributed, ranging from Virginia to Florida along the Atlantic coast and from South Dakota through Arkansas and Texas to the Gulf of Mexico, this is the first time a species of *Ravenelia* has been reported on it. For 15 years the writer has carefully examined any plants of *Morongia* seen on every field trip, but never with any success until this past year. The rust was found in one of the cemeteries at Austin and was limited to an area about 20 feet in diameter, although the host was widely distributed in that immediate vicinity.

An abundance of uredinia was present on the host in May, but no telia were found. A second collection from the same spot in July by Dr. I. M.



LEWIS still showed only uredinia. In October Dr. LEWIS and the writer again visited the same area and found telia sparingly present. Only an occasional leaf on each plant showed any telia, and then usually only one or two sori to a leaflet. The rust is very inconspicuous, even when the host is thoroughly infected with the uredinial stage, and it is almost impossible to find in the telial stage.

**Ravenelia thornberiana, sp. nov.**

O. Pycnia unknown.

II. Uredinia amphigenous, caulicolous and fruticolous, usually forming small witches' brooms 3–6 cm. long by 2–4 cm. broad, consisting of a rather dense interwoven mass of abortive branches, petioles, and young pods, thickly covering large areas, often confluent on stems and pods, irregularly orbicular to elliptical or on the branches oblong, very small, 0.2–0.5 mm. in diameter, subcuticular early naked, cinnamon brown, ruptured cuticle noticeable; paraphyses abundant, intermixed with the urediniospores, clavate to subcapitate,  $10-13 \times 35-57 \mu$ , heads  $10-13 \times 13-17 \mu$ , average for 10 heads  $11.6 \times 15.8 \mu$ , apex of head fulvous, lower one-third semi-hyaline, walls 2–3  $\mu$  thick, rarely slightly thicker at apex, stipe attenuate, hyaline, 2–4  $\mu$  thick by 20–40  $\mu$  long, average for 10 stipes  $3 \times 31.4 \mu$ ; urediniospores obovate, pyriform or oval,  $16-18 \times 20-27 \mu$ , average for 10 spores  $17 \times 23.5 \mu$ , walls 1.5–2  $\mu$  thick, sometimes slightly thicker at base, densely and evenly verrucose, cinnamon brown, concolorous, pores 8–12, in two transverse zones of 4–6 pores each, equidistant from the equator.

III. Telia amphigenous and caulicolous, small, 0.2–0.5 mm. in diameter, irregularly oval, scattered, or often confluent on the petioles and stems, subcuticular, chestnut brown, ruptured cuticle noticeable; teliospore heads chestnut brown, 70–90  $\mu$  in diameter, average for 10 heads 80  $\mu$ , 4 or 5 spores across, 8–14 marginal spores, smooth; paraphyses present, stipe often not attenuate and solid, otherwise as in the uredinia; cysts delicate, numerous beneath entire head, in two irregular rows around stipe, subappressed, easily swelling and bursting in water, becoming pendent and subglobose in water; pedicel short, hyaline, deciduous.

On Mimosaceae. Type for uredinia collected on *Acacia constricta paucispina* at El Paso, Texas, August 7, 1915, by *W. H. Long* (no. 5505). Type for telia collected in same locality and on same host December 20, 1915 (no.



5506, *W. H. Long*); also collected at Tucson, Arizona, on *Acacia constricta paucispina* (nos. 5507 and 5508, *W. H. Long*).

On a recent trip to Tucson, the writer's attention was called by Professor THORNBUR, of the University of Arizona, to a species of *Ravenelia* on *Acacia constricta paucispina* which formed small witches' brooms. The host was growing on the grounds of the University of Arizona immediately adjacent to a tree of *Acacia greggii* which has heavily infected with *R. versatilis*. The close proximity of the two host trees and the fact that both bore witches' brooms suggested the possibility of the *Ravenelia* on *Acacia constricta paucispina* being *R. versatilis*. However, a microscopic examination of the rust revealed marked differences in the urediniospores which easily separated it from *R. versatilis*. On this trip, the writer revisited a locality at El Paso, Texas, where he had collected a *Ravenelia* in August 1915 on an unidentified host. This host proved to be *Acacia constricta paucispina*, and the *Ravenelia* on it was identical in every way with that collected on the same host at Tucson, Arizona. The specimens of *R. thornberiana* collected at Tucson had only fresh telia intermixed with old and weathered uredinia. The collection of this rust made by the writer at El Paso in August 1915 consisted of fine uredinial material, while that made from the same trees at El Paso in December 1915 was good telial material. For this reason, the material collected at El Paso is made the type for the species.

The number of species of *Ravenelia* previously described whose uredinia or telia cause pronounced witches' brooms is limited to 4 species, namely, *R. versatilis* on *Acacia greggii*, *R. fragrans* on *Mimosa fragrans*, both American species; and two African species, *R. volkensis* P. Henn. on *Acacia* sp. (only the teliospores of which are known), and *R. natalensis* Syd. and Evans on *Acacia hirtella* (which has aecia as well as uredinia and telia). Of these 4 species, *R. versatilis* is the only one which has urediniospores with two rows of germ pores, but this species has one row at the equator and the other near the base of the spore, while *R. thornberiana* has its two rows of germ pores equidistant from the equator. The lower halves of the urediniospores of *R. versatilis* are hyaline, while the urediniospores of *R. thornberiana* have walls uniformly colored.

There are only two described species of *Ravenelia* with germ pores in two rows equidistant from the equator, namely, *R. siliquae* Long on *Vachellia farnesiana* and *R. acaciae-pennatulae* Dietel on *Acacia pennatula*. *R. thornberiana* differs from *R. siliquae* in having very small uredinia and in the shape and size of its urediniospores. It differs from *R. acaciae-pennatulae* in having smooth teliospore heads.

### ***Ravenelia reticulatae*, sp. nov.**

O. Pycnia unknown.

II. Uredinia hypophyllous, scattered, punctiform to elliptical, very small, 0.25–0.5 mm. across, subcuticular, tardily naked,



light cinnamon brown in herbarium material, ruptured cuticle noticeable; paraphyses present but not abundant, intermixed with the urediniospores, clavate to spoon-shaped,  $10-13 \times 40-70 \mu$ , average for 10 paraphyses  $12 \times 47 \mu$ , wall thickened above,  $5-8 \mu$ , heads fulvous, stipe hyaline, solid; urediniospores globoid,  $16 \times 16-19 \mu$ , average for 10 spores  $16 \times 16.9 \mu$ ; walls pale fulvous,  $1-1.5 \mu$  thick, concolorous, densely verruculose, pores 6-10, scattered.

III. Telia amphigenous, scattered, large compared to uredinia, oval to orbicular, 0.5-1.5 mm. across, subcuticular, early naked, ruptured cuticle noticeable, chestnut brown; paraphyses few; teliospore heads light chestnut brown,  $65-105 \mu$  in diameter, average for 10 heads  $82.4 \mu$ , 7-9 cells across, 15-24 peripheral cells, each spore  $14-16 \mu$  across, smooth; cysts appressed to underside of head around the stipe, about one to each peripheral teliospore, swelling rather slowly and bursting in water, apparently not coherent with each other, not continuous with stipe; stipe short, hyaline, deciduous.

On Mimosaceae. Type collected on *Calliandra reticulata* at Divide, Lower Trail, Rincon Mountains, Arizona, September 12, 1909, by J. C. Blumer, at an altitude of 7,200 feet (no. 5510, W. H. Long). This species of *Ravenelia* was found by the writer in the herbarium of the University of Arizona on "*Calliandra reticulata*, plants of the Rincon Mountains, Arizona, no. 3341, J. C. Blumer collection."

Including the species above described, there are now 7 species of *Ravenelia* known to occur on *Calliandra*. Five of these occur in South America, namely, (1) *R. lagerheimiana* Dietel on *Calliandra* sp., (2) *R. echinata* Lagh. and Dietel on *Calliandra* sp., (3) *R. pazschkeana* Dietel on *Calliandra* sp., (4) *R. dieteliana* P. Henn. on *Calliandra microcephala*, and (5) *R. affinis* Syd. on *Calliandra turbinata*. One species, *Ravenelia mexicana* Tranz on *Calliandra grandiflora*, is found in Mexico; while the species described here, *R. reticulatae* on *Calliandra reticulata*, is the only one known from the United States on this host genus.

*Ravenelia dieteliana* and *R. affinis* are the only species previously described on *Calliandra* which have smooth teliospore heads. Both of these species are subepidermal and have urediniospores with germ pores (4) situated in the equator of the spores, while *R. reticulatae* is subcuticular and has 6-10 germ pores which are scattered. *R. reticulatae* also has other material differences which separate it from either of the two species having smooth teliospore heads.

*R. reticulatae* is closely related to *R. texensis* on *Acuan jamesii*, but differs from this species in having an entirely different host and in having smaller and thinner-walled urediniospores, while practically all of its telial characters are different.



**Ravenelia annulata**, sp. nov.

O. Pycnia unknown.

II. Uredinia epiphyllous, very sparingly present, elliptic to irregularly oval, small, less than 0.5 mm. in diameter, subepidermal, tardily naked, ruptured, epidermis very noticeable; paraphyses sparingly present, clavate to subcylindrical,  $8-16 \times 36-70 \mu$ , apex thickened  $5-7 \mu$ , light chestnut brown, stipe subhyaline, walls rather thick; urediniospores ovate to ovate-fusiform, asymmetrical, usually prominently acuminate,  $17-23 \times 27-37 \mu$ , average for 20 spores  $19.5 \times 31.4 \mu$ ; walls  $2 \mu$  thick, cinnamon brown, sparsely but prominently echinulate, with a broad hyaline band or ring around the equator  $7-10 \mu$  wide, often abruptly narrowed into a short subcylindrical base, which is hyaline for  $4-7 \mu$ , occasionally with remnants of pedicel attached, the walls of which are hyaline and minutely verruculose; germ pores 6, small, in hyaline equatorial belt.

III. Telia epiphyllous, not seated on pallid spots, small, narrowly elliptical to irregularly oval,  $0.125-0.5 \times 0.5-1.0 \mu$ , subepidermal, light chestnut brown, tardily naked, ruptured epidermis very conspicuous; paraphyses numerous, inconspicuous, surrounding the telia, same in shape, size, and coloring as those found in the uredinia, apparently no paraphyses situated among the teliospores; teliospore heads light chestnut brown, very irregular in size and shape, irregularly oval, flattened, smooth,  $50-73 \times 53-87 \mu$ , average for 10 heads  $62.0 \times 72 \mu$ , 4-7 cells across, 8-16 cells around margin of head, 12-34 spores or cells in each head; cysts hyaline, few, about one to each peripheral spore, appressed, extending from pedicel to periphery, united laterally, easily bursting in water; pedicel colorless, short, deciduous.

On Mimosaceae. Type collected on *Lysiloma latisiliqua* at Miami, Florida, March 12, 1914, by *W. H. Long* (no. 4623).

This *Ravenelia* is rather common on small bushes (4-10 feet high) of this host, especially along the railroad tracks traversing the hammocks near Miami.

The strongly acuminate urediniospores with their broad, hyaline, equatorial zones and cylindrical hyaline bases make *R. annulata* a very unique species. It is closely related to *R. lysilomae*, but differs from this species in its smaller and differently-shaped sori, in its acuminate urediniospores with



hyaline cylindrical bases and 6 germ pores, and in its smaller and very irregularly-shaped teliospore heads with only about one-half as many spores to each head as *R. lysilomae*.

The writer has carefully examined mounts made from the type collection of *R. lysilomae*, and found some 30-40 urediniospores intermixed with the teliospores. None of the urediniospores seen was acuminate, all had only 4 germ pores which were rather large and prominent. The teliospore heads measured 60-100×65-120  $\mu$  in diameter, average for 10 heads 86×92  $\mu$ , 7-10 cells across, 12-20 peripheral cells and 26-50 cells to a head.

OFFICE OF INVESTIGATIONS IN FOREST PATHOLOGY  
BUREAU OF PLANT INDUSTRY  
ALBUQUERQUE, N. M.



# A STUDY OF THE LIFE HISTORY OF TRILLIUM CERNUUM L.

MARGARET HEATLEY

(WITH PLATE XXVII)

The following study of the origin and development of the female gametophyte of *Trillium cernuum* has been made with a view to a more detailed cytological and embryological study of *T. cernuum* and *T. grandiflorum* and their possible hybrids. It was undertaken at the suggestion of Dr. FERGUSON, to whom I am greatly indebted for helpful discussion and criticism.

ATKINSON<sup>1</sup> has given a careful description of microsporogenesis in *T. grandiflorum*. ERNST<sup>2</sup> has published a very brief and as yet uncompleted account of chromosome reduction, development of the embryo sac, and fertilization in *T. grandiflorum*. GRÉGOIRE and WYGAERTS<sup>3</sup> have used *T. cernuum* and *T. grandiflorum* as a basis for detailed studies on the reconstruction of the nucleus and the formation of chromosomes. As yet, however, no account of the life history of *T. cernuum* has been given.

*Trillium cernuum* is a native of Massachusetts and grows in sufficient abundance in the vicinity of Wellesley College to furnish plenty of material for investigation. The work of collecting was done in 1911 and 1912. From the first week in April until the end of May, material was gathered once or twice each day. The fixing was generally done in the field. The most satisfactory fixing agent was a weak solution of Flemming's chromo-acetic-osmic fluid. Of the several stains tried, Haidenhain's iron-alum-hematoxylin and Flemming's triple stain gave the best results.

<sup>1</sup> ATKINSON, G. F., Studies on reduction in plants. BOT. GAZ. 28:1-24. pls. 3-6. 1899.

<sup>2</sup> ERNST, A., Chromosomenreduction, Entwicklung des Embryosackes, und Befruchtung bei *Paris quadrifolia* und *Trillium grandiflorum*. Flora 91:1-36. pls. 1-6. 1902.

<sup>3</sup> GRÉGOIRE, VICTOR, and WYGAERTS, A., La reconstitution du noyau et la formation des chromosomes dans les cinèse somatiques. La Cellule 21:7-76. pls. 2. 1904.



By the end of September the flower buds are well formed and the parts of the ovules are clearly differentiated (fig. 1). An arche-sporial cell immediately below the epidermis has divided and given rise to a primary parietal and a megaspore mother cell (fig. 2). In some ovules the primary parietal cell remains undivided (fig. 2), while in others it divides longitudinally (fig. 1). ERNST (*loc. cit.*) finds no formation of primary parietal tissue in *T. grandiflorum*.

During the winter, the megaspore mother cell of *T. cernuum* is in a resting state and is easily distinguishable from the surrounding cells because of its larger size and its larger and more deeply staining nucleus (figs. 1, 2). If meiosis is accepted as the criterion for spore formation, the fact that this cell later undergoes the reduction divisions proves it to be a megaspore mother cell. The physiologically analogous cell of *T. grandiflorum* is called by ERNST (*loc. cit.*) the embryo sac mother cell. He says: "Die Embryo-sackmutterzelle differenzirt sich in der subepidermalen Zellschicht unmittelbar unten dem Scheitel des Nucellus." Since, as in *T. cernuum*, this cell does not give rise directly to the embryo sac, it cannot be the true embryo sac mother cell, and this terminology should be discarded.

With the resumption of growth in late March or early April, active cell division may be observed in all parts of the flower. The resting reticulum of the megaspore mother cell gradually loses its netlike structure and resolves itself into a dense synaptic mass (fig. 3). Later stages show the chromatin threads to have thickened, shortened, and segmented transversely into distinct chromosomes (fig. 4). After a second contraction of the nuclear material (fig. 5) the separate chromosomes soon become arranged at the nuclear plate, while delicate spindle fibers can be distinguished in the cytoplasm (fig. 6).

Anaphase and telophase are quickly passed through, as ERNST (*loc. cit.*) has reported for *T. grandiflorum*, and each of the resulting daughter nuclei becomes invested with a delicate nuclear membrane. The chromosomes of each nucleus seem to fuse end to end to form a long, thick, loosely wound band, but there is no evidence from the material studied that they completely lose their identity at this time and form a reticulum. During this short resting



period, the cell plate gradually becomes heavier and extends across the entire cell as a dividing wall (fig. 7). Every step of this division clearly indicates that it is the heterotypic phase of meiosis.

Although the daughter cells are at first apparently similar in all respects, the chalazal one gradually shows signs of greater vitality, and by more rapid growth encroaches upon the micropylar cell (figs. 8–13). In no case have I found the outer cell giving evidence of being the more vigorous. It may disintegrate immediately (fig. 8); it may pass through one or more phases of the homotypic division (figs. 9–11); or it may even complete meiosis before disorganizing (figs. 12–14). A study of many ovules shows that no cell wall is ever laid down, and that even though the spores may be formed they never become functional, but disintegrate early (fig. 15).

At the completion of the homotypic division in the chalazal cell, no cell wall is formed, and the resulting 2 nuclei undergo a period of rest lasting 2 or 3 days. The cell increases rapidly in size and becomes very vacuolate (fig. 16). The formation of a large, central vacuole soon forces the 2 nuclei to opposite ends of the cell. It is very evident that this structure is a young embryo sac, and thus the female gametophyte is derived from 2 megaspores. ERNST states that 2 megaspores enter into the formation of the embryo sac of *T. grandiflorum*. COULTER and CHAMBERLAIN<sup>4</sup> describe an axial row of 4 megaspores for *Trillium* and report that in *T. recurvatum* the embryo sac is derived from the chalazal megaspore. A study of CHAMBERLAIN'S figures for *T. recurvatum* reveals striking resemblances to those for *T. grandiflorum* and *T. cernuum*. As in the last two named species, there is an axial row of 2 binucleate cells which have resulted from the "second division of the nucleus of the mother cell." No sketch of the 4-celled axial row mentioned in his text is given. The next stage illustrated is that of the young 2-celled embryo sac capped at the micropylar end by a dense, contracted mass, "the remains of the other 3 megaspores." Fig. 15 of this paper shows a very similar embryo sac, but an examination of the preceding stages illustrated makes it clear that the

<sup>4</sup> COULTER, J. M., and CHAMBERLAIN, C. J., Morphology of the angiosperms. Chicago. 1901.



disintegrating masses of tissue represent the remains of only 2 megaspores. Even though it may be true that the number of cells in the axial row varies in closely related species of the same genus, this does not seem to be the case for the 3 species of *Trillium* under discussion. The close resemblance of the series of figures given for each of the 3 species and the fact that CHAMBERLAIN does not figure a 4-celled axial row make it highly probable that *T. recurvatum*, like *T. grandiflorum* and *T. cernuum*, has an axial row of 2 binucleate cells, and that the first 2 cells of its embryo sac represent 2 megaspores. During a summer session which I spent at the University of Chicago in 1912, Dr. CHAMBERLAIN very kindly examined my slides covering these stages and agreed with this interpretation.

After a period of growth of the young embryo sac, the 2 nuclei divide rapidly to form a 4-nucleate, and then an 8-nucleate, embryo sac (figs. 17-19). These phenomena and those attending the maturation of the embryo sac agree so closely with the account already given by ERNST for *T. grandiflorum* as to make further comment on them unnecessary.

From the foregoing account it may be seen that *T. grandiflorum* and *T. cernuum*, the 2 species to be used in the work of hybridizing, agree in all important respects regarding the origin and the development of the embryo sac. The chief points of difference in the two accounts are as follows: (1) one row of primary parietal tissue is formed in the ovules of *T. cernuum*, while in *T. grandiflorum* primary parietal tissue is entirely wanting; (2) in *T. cernuum* the 2 nuclei resulting from the heterotypic division do not form resting reticula.

WELLESLEY, MASS.

#### EXPLANATION OF PLATE XXVII

An Abbé camera lucida was used for all of the drawings. The figures are oriented with the micropylar end toward the upper edge of the page. The abbreviations used in labeling the drawings are as follows: *m.m.c.*, megaspore mother cell; *p.p.c.*, primary parietal cell.

FIG. 1.—Longitudinal section of a young ovule;  $\times 73$ .

FIG. 2.—Same as fig. 1;  $\times 430$ .

FIG. 3.—Megaspore mother cell in synapsis;  $\times 430$ .



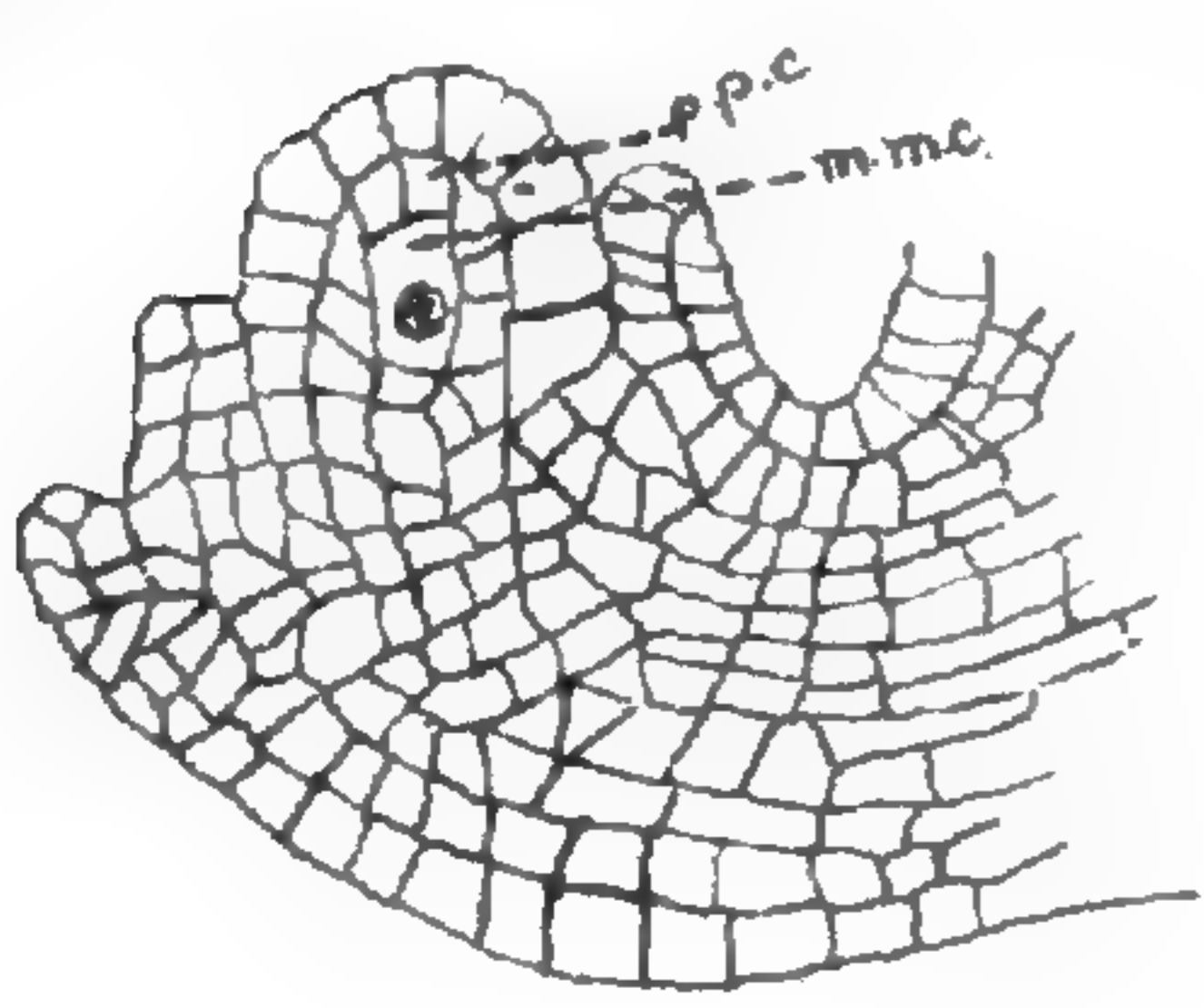

1

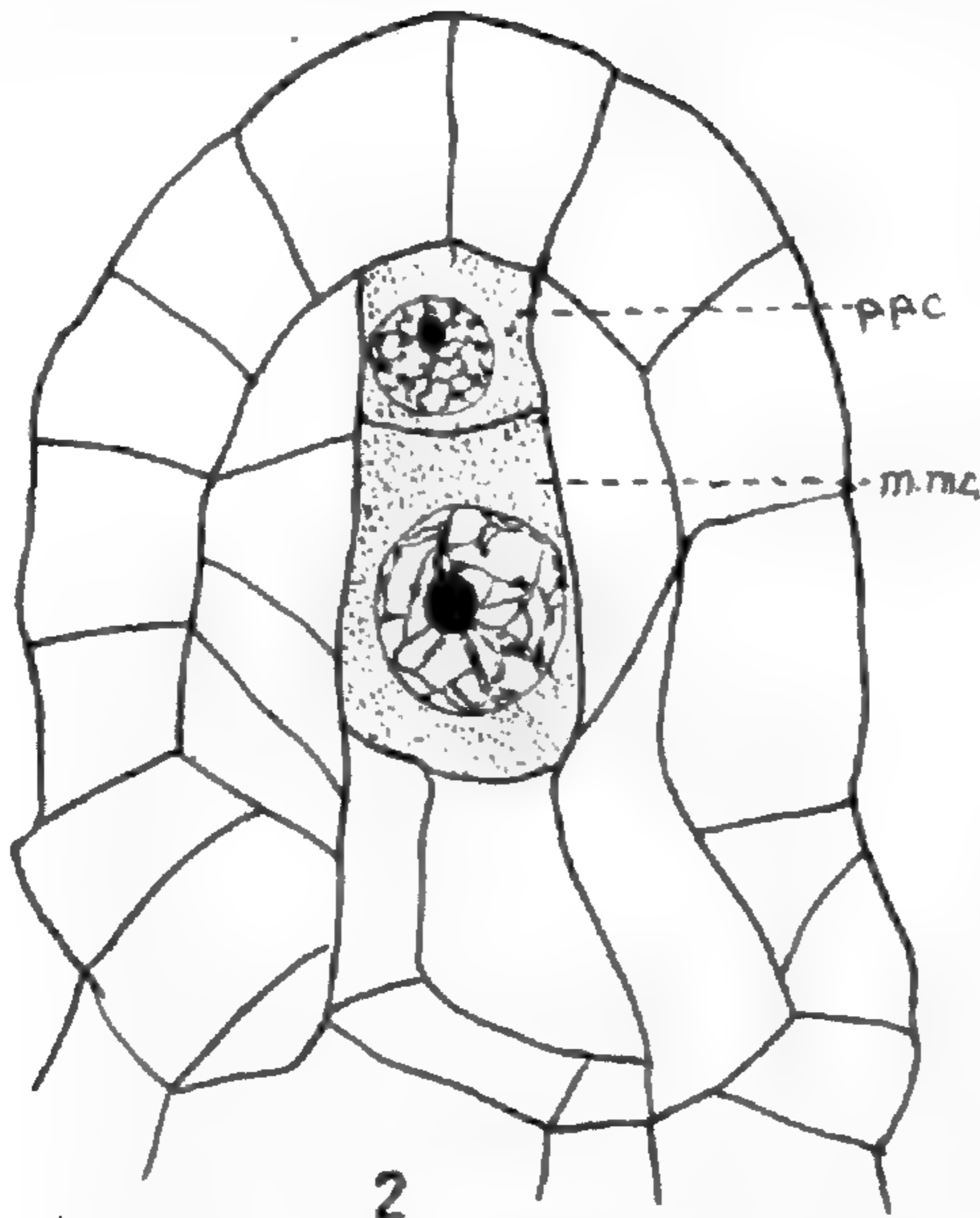

2



5

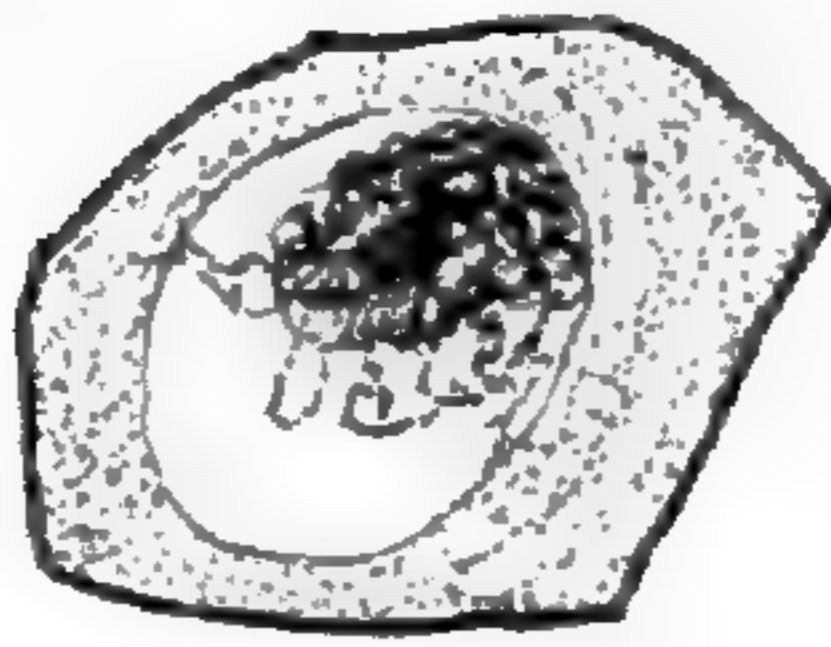

3



6

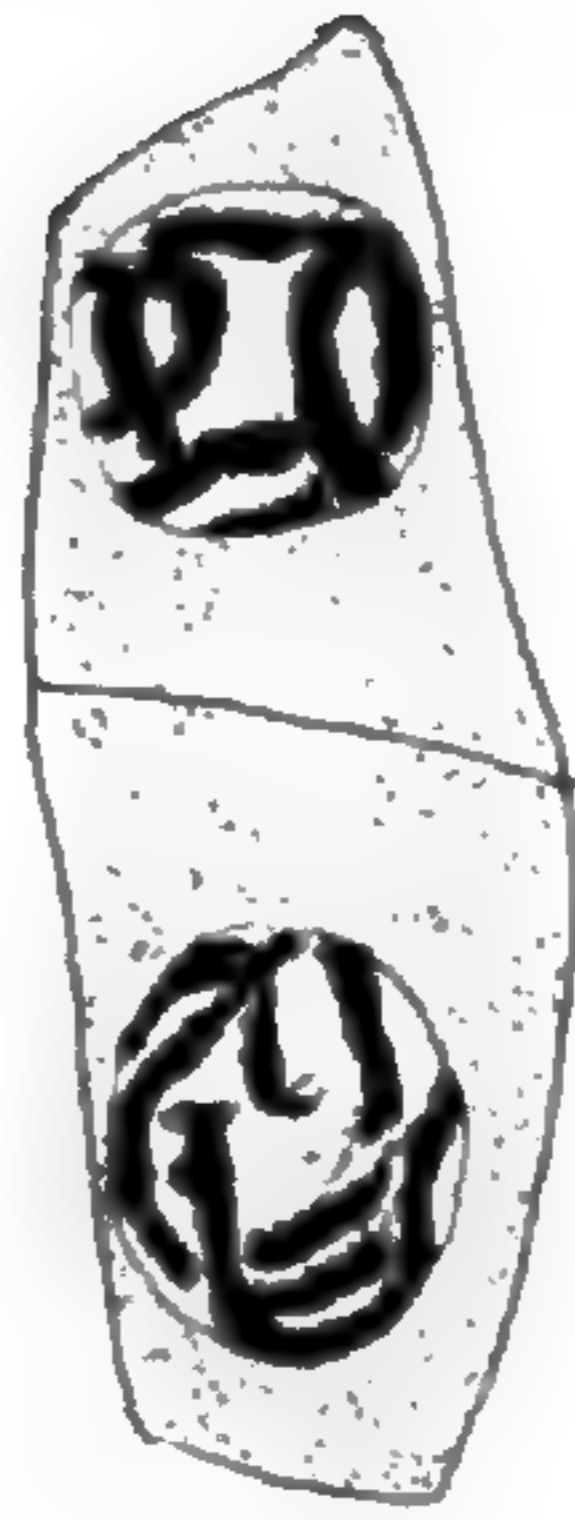

7

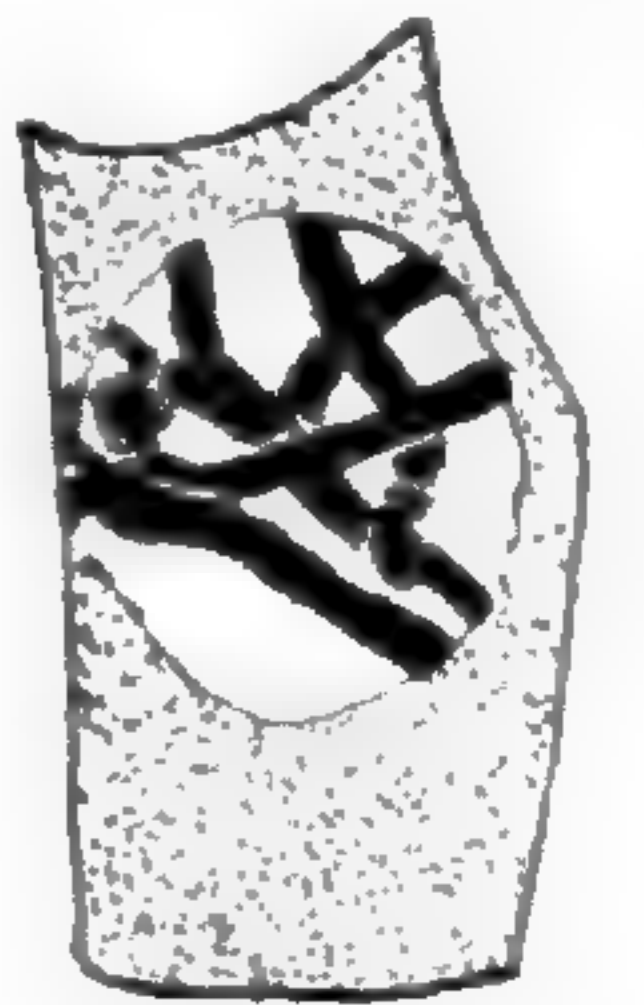

4



9

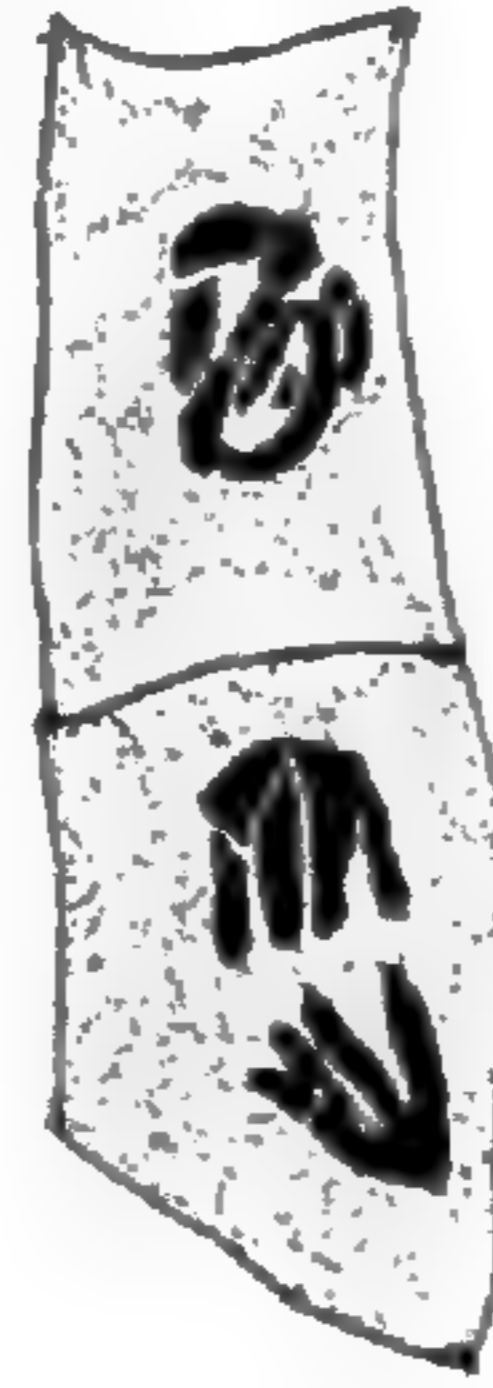

10



8



11



12

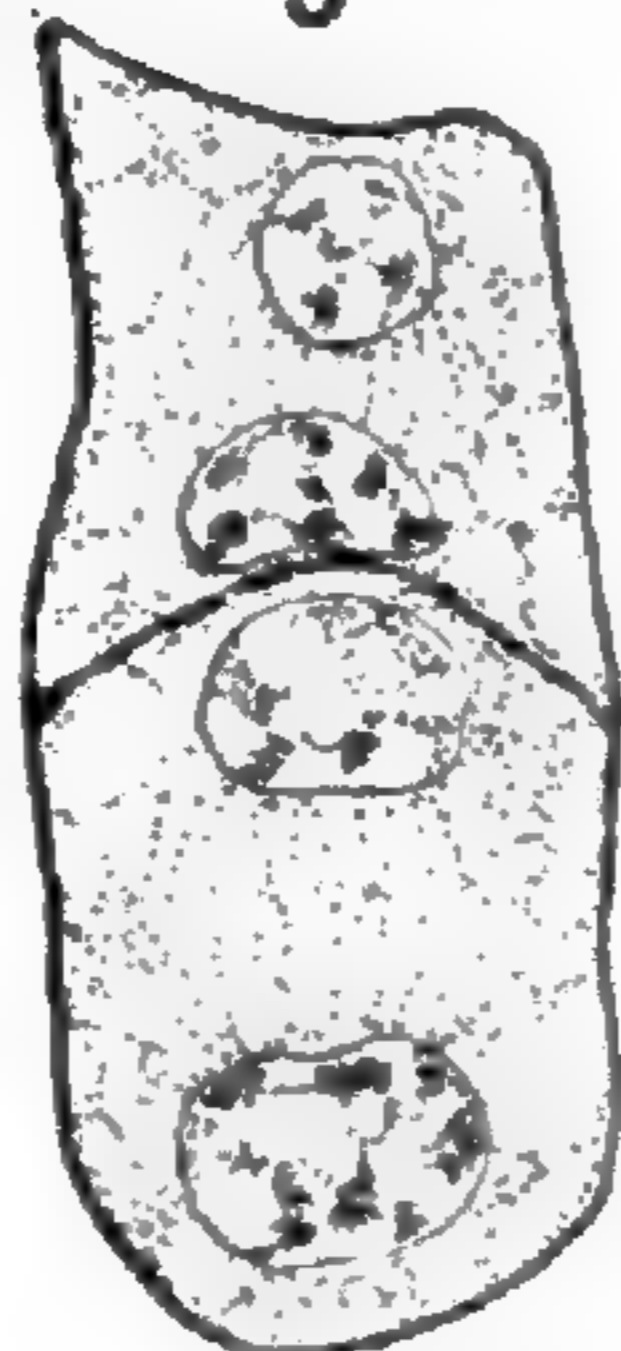

13

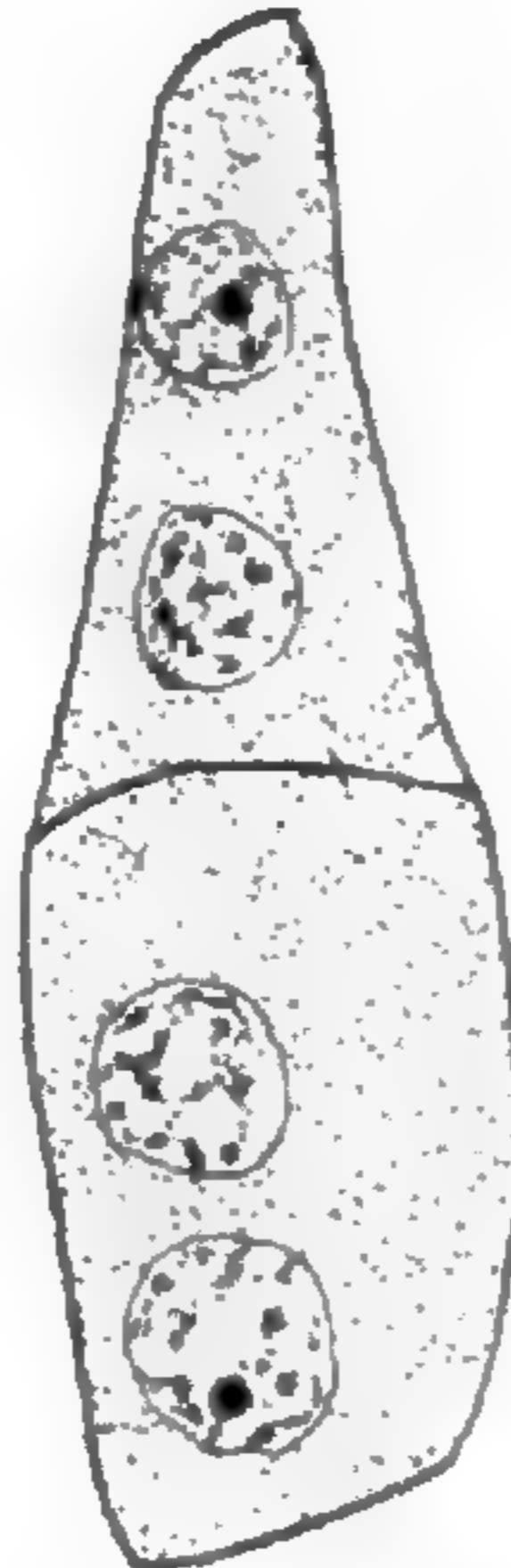

14

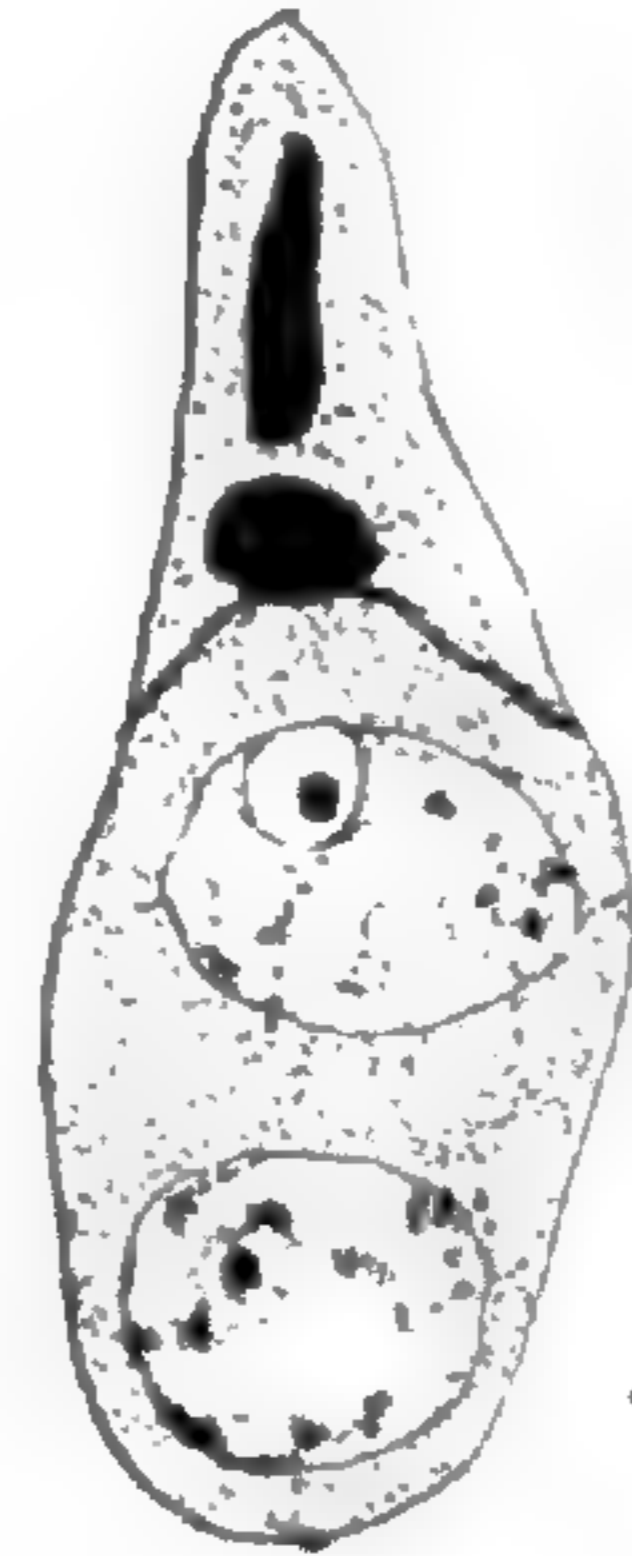

15

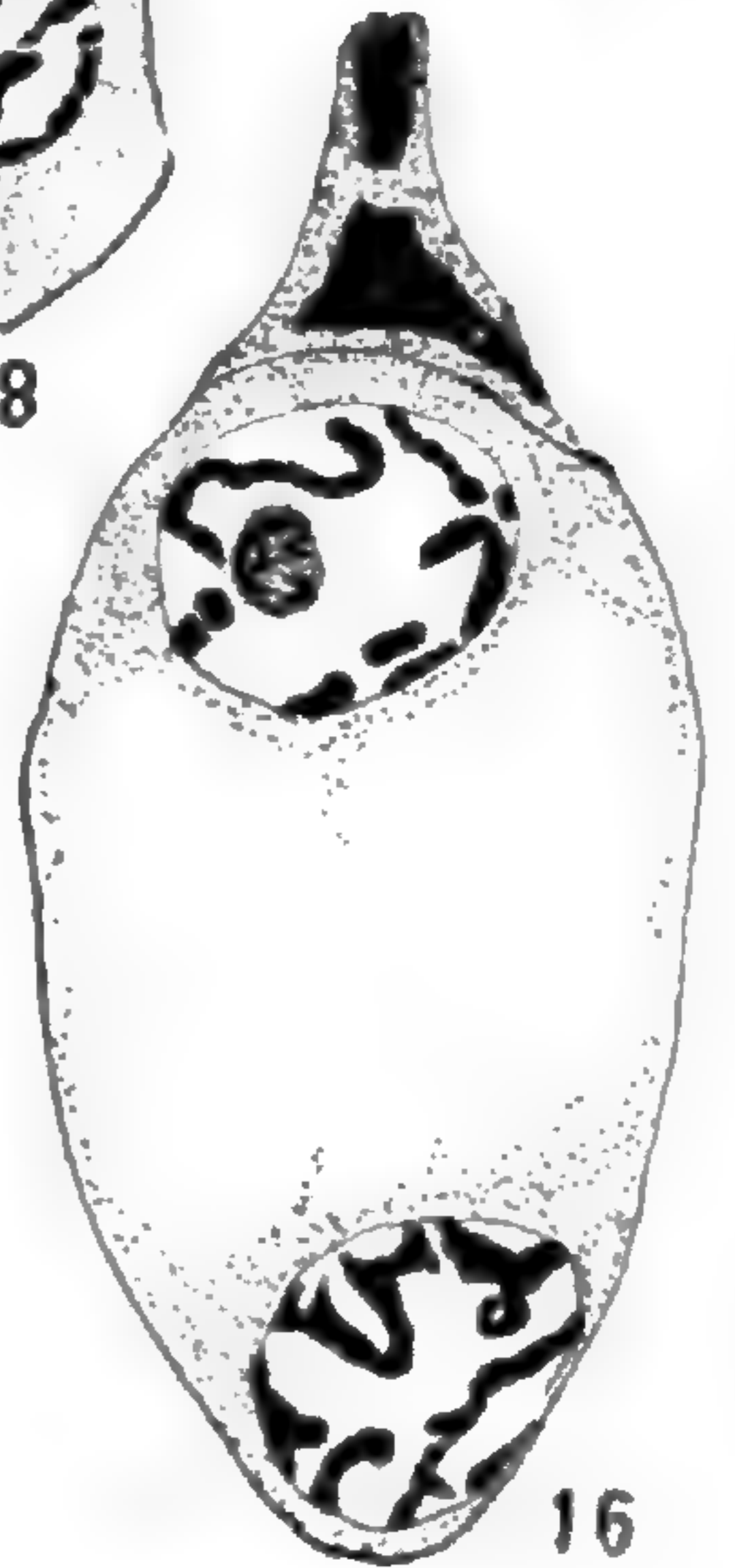

16



17

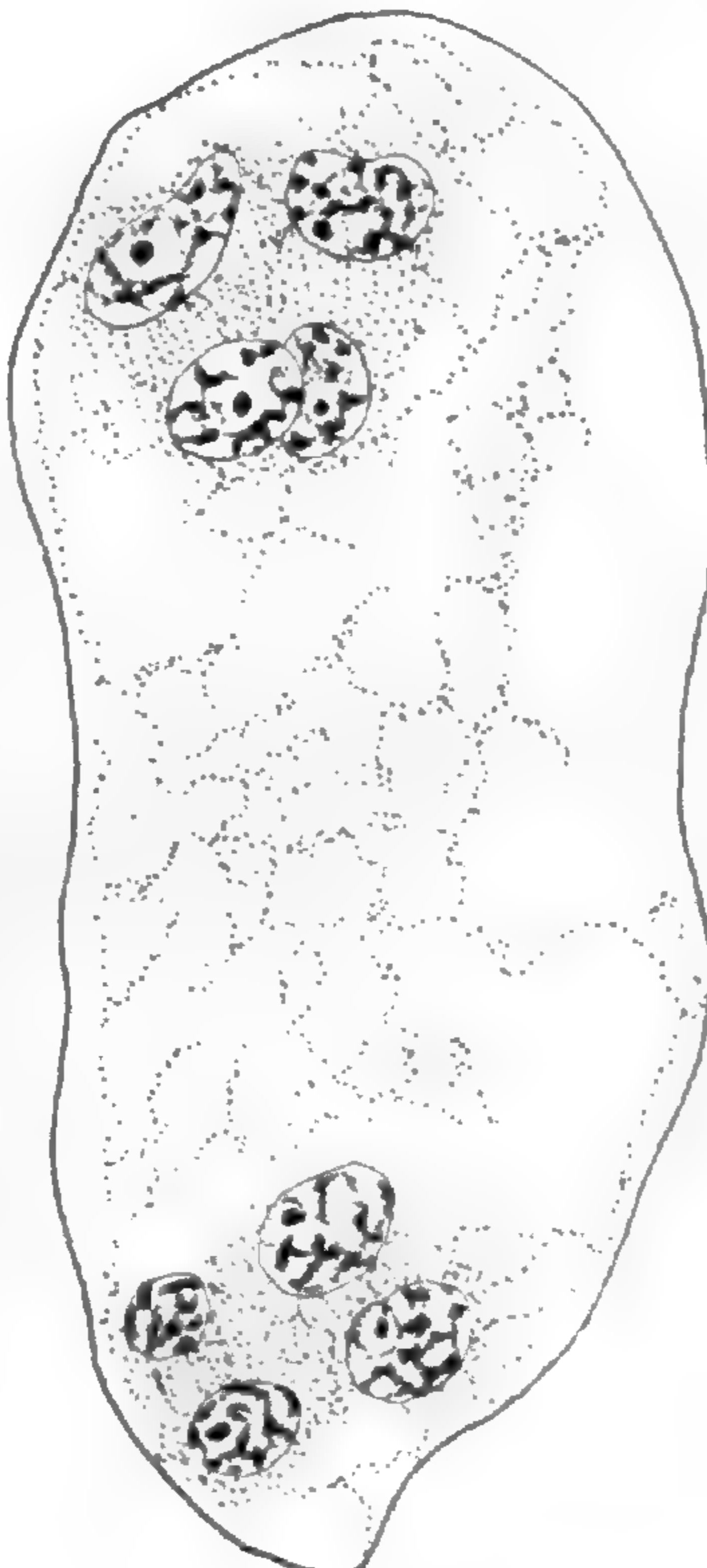

18

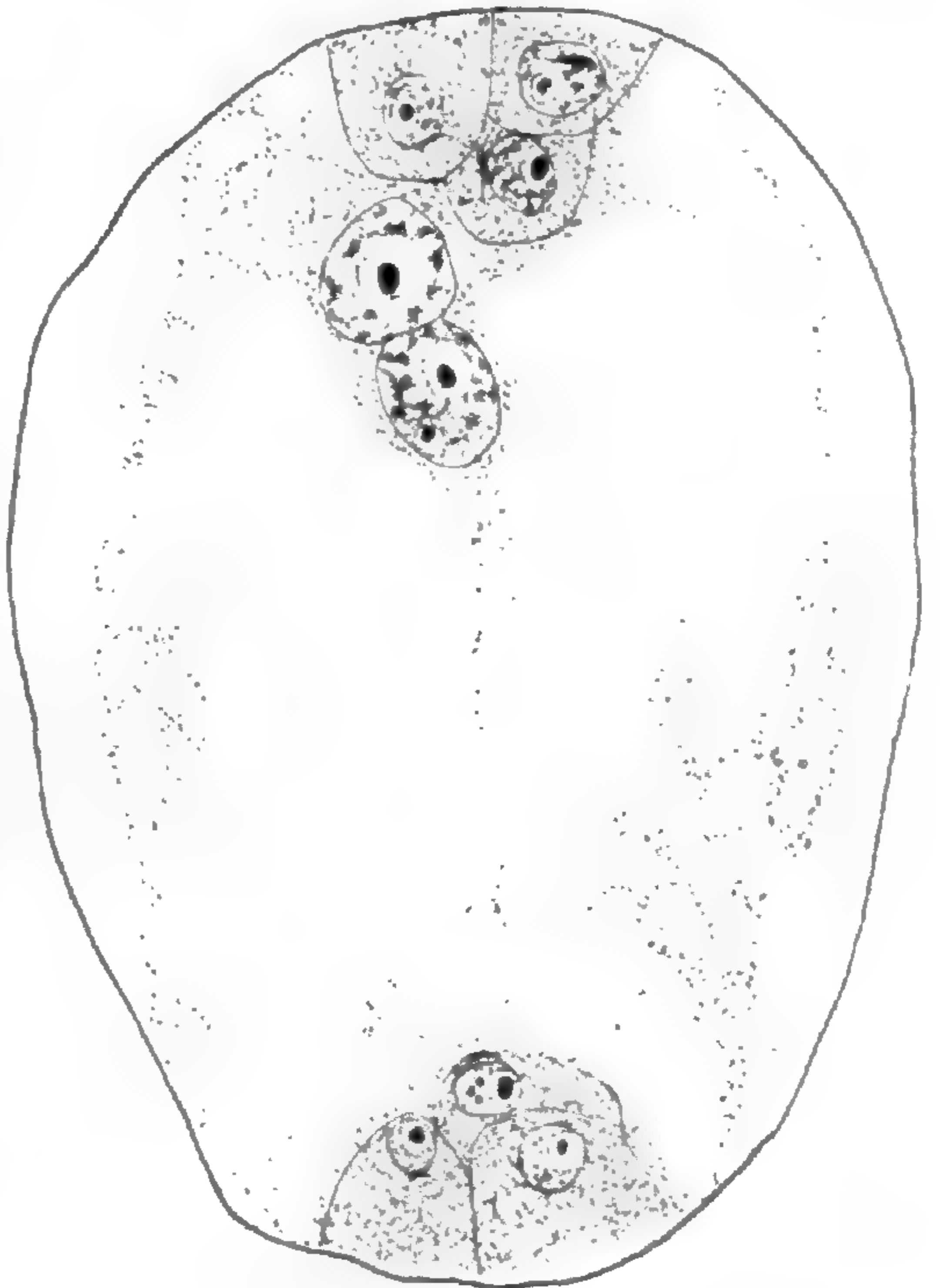

19

M. Heatley del.



FIG. 4.—Post-synaptic stage of megaspore mother cell;  $\times 430$ .

FIG. 5.—Second contraction in megaspore mother cell;  $\times 430$ .

FIG. 6.—Megaspore mother cell in anaphase of heterotypic division;  $\times 430$ .

FIG. 7.—The daughter nuclei separated by a heavy cell wall and giving evidence of formation of continuous spirems;  $\times 430$ .

FIG. 8.—Continuous spirem in chalazal daughter nucleus; early disintegration of micropylar daughter nucleus;  $\times 430$ .

FIGS. 9-12.—Micropylar daughter cell unable to organize a spindle; chalazal daughter cell in various phases of the homotypic division;  $\times 430$ .

FIGS. 13-14.—Homotypic division completed in both daughter cells, resulting in axial row of 2 cells, each containing 2 megaspores;  $\times 430$ .

FIG. 15.—Outer 2 megaspores disintegrated;  $\times 430$ .

FIG. 16.—Chalazal daughter cell with its 2 megaspores functioning directly as a 2-nucleate embryo sac;  $\times 430$ .

FIG. 17.—Four-nucleate embryo sac;  $\times 430$ .

FIG. 18.—Eight-nucleate embryo sac;  $\times 430$ .

FIG. 19.—Mature 8-nucleate embryo sac with egg apparatus, antipodals, and polars differentiated;  $\times 430$ .



## THE SIGNIFICANCE OF COLOR CHANGES IN OXIDASE REAGENTS

G. B. REED

Our knowledge of the oxidases has been derived almost entirely from the study of their action upon compounds which change color on oxidation. It is customary to employ for this purpose compounds which do not oxidize spontaneously (or do so very slowly) when exposed to the air in dilute solutions, but which when brought into contact with living tissues (or extracts of tissues) exhibit a change of color.

The formation of such colored compounds as a result of oxidase action has afforded a ready method of determining the distribution of these ferments. The behavior of the various indicators when placed in contact with different tissues has also led to the conclusion that the oxidases may be divided into several more or less definite classes.

The rate of oxidase action and the relative efficiency of different preparations of oxidases have also been determined by measuring the intensity of the color produced in solutions of such indicators.<sup>1</sup>

Valuable as these methods have been, they have given no indication of the amount of oxidation which has taken place. Thus, when an oxidase causes a change of color in one of these reagents we have no idea of the amount of oxidation which this reaction represents. Moreover, it often has been assumed that the appearance of a definite color in any of these reactions, acted upon by the oxidases, represents similar amounts of oxidation. For example, an oxidase capable of bringing about sufficient oxidation to give a distinct blue color in a solution of gum guaiac has been considered about as efficient as one capable of producing enough purpurogallin to give a distinct yellow color in a solution of pyrogallol.

Inasmuch as the greater part of the results obtained by workers on oxidase reactions depend upon these color changes, it is important

<sup>1</sup> The various methods employed in colorimetric determinations of the rate of oxidase action have recently been reviewed by FOA, *Biochem. Zeit.* 2:382-399. 1908; and also by BUNZELL, Bull. no. 238. Bur. Pl. Ind., Washington. 1911.



to have a clear conception of their quantitative as well as of their qualitative meaning. The following experiments present such quantitative values.

Solutions of a number of the oxidase reagents in most common use were made up in equivalent concentrations, 0.1 M in water (in the case of aloin and alpha naphthol in 50 per cent alcohol, as they are only slightly soluble in water). As gum guaiac consists of a number of compounds in unknown proportions, a 2 per cent solution of the resin in 50 per cent alcohol was taken.

Two beakers, each containing 100 cc. of one of these solutions, were placed in a uniform light in such a position that the colors of the solutions could be accurately compared. A standard potassium permanganate solution<sup>2</sup> was then added to one beaker in sufficient amount to cause a definite change in color due to oxidation, as compared with the beaker to which no addition was made.<sup>3</sup>

Table I indicates the amount of permanganate required to produce the first perceptible change of color in the several reagents tested. The last column of the table also gives the amount of oxygen used in the oxidation as calculated from the amount of permanganate required.

TABLE I

Solution; 100 cc. 0.1 M	Amount (cc.) of standard KMnO <sub>4</sub> required to produce a definite color	Gram atoms of oxygen required to produce a definite color
Aloin.....	1	$1.2 \times 10^{-6}$
Alpha naphthol.....	2	$2.5 \times 10^{-6}$
Alpha naphthol and paraphenylene diamine.....	2	$2.5 \times 10^{-6}$
Benzidine.....	3	$3.7 \times 10^{-6}$
Dimethyl paraphenylene diamine.....	0.5	$5.1 \times 10^{-6}$
Gum guaiac*.....	trace	trace
Hydrochinone.....	10	$1.2 \times 10^{-5}$
Paraphenylene diamine.....	1	$1.2 \times 10^{-6}$
Paracresol.....	1	$1.2 \times 10^{-6}$
Pyrogallol.....	9	$1.1 \times 10^{-5}$

\* A 2 per cent solution was used, as the molecular weight is not known.

<sup>2</sup> Of this solution 80 cc. was exactly sufficient to oxidize 10 cc. of 0.1 M oxalic acid.

<sup>3</sup> Since in the oxidation of these reagents the potassium permanganate is reduced to a colorless condition, its color can appear only after a sufficient amount is added to oxidize all of the reagent. Since this condition is not reached, the permanganate produces no color to obscure the color of the compounds produced by the oxidation.



Similar results were obtained in the oxidation of the naturally occurring chromogens, although they cannot be stated in as definite a form. Equal amounts (25 gm. of fresh material) of tissue of apple, of potato, and of the stems of *Vicia Faba* were each crushed in 100 cc. of water and filtered rapidly. Enough of the standard permanganate was then added to each solution to give the first appearance of the chromogen color. Table II indicates the amounts of permanganate required and the amounts of oxygen which they represent.

TABLE II

Water extract; 100 cc.	Amount (cc.) of standard $\text{KMnO}_4$ required to produce chromogen color	Gram atoms of oxygen required to produce chromogen color
Potato.....	9	$1.1 \times 10^{-5}$
Apple.....	6	$7.5 \times 10^{-6}$
Vicia Faba stems.....	4	$5.0 \times 10^{-6}$

These results indicate that the amount of oxidation necessary to produce the colored appearance in either the ordinary oxidase reagents or in the plant chromogens is exceedingly small. This, however, does not indicate that the oxidases are capable of producing only a small amount of reaction, for after the color appears the oxidation may continue without necessarily changing the color.

These observations also clearly indicate that the amount of oxidation necessary to produce a color in the various reagents varies over a wide range. But by this very simple method the different reagents may be calibrated so that the effects of the oxidases may be measured, and the oxidation necessary to produce a change of color in the presence of oxidases may be expressed in grams of oxygen required.



# BRIEFER ARTICLES

## COUNT SOLMS-LAUBACH<sup>1</sup>

(WITH PORTRAIT)

By the death of HERMANN, Graf zu SOLMS-LAUBACH, on November 24, 1915, Germany has lost the most distinguished of her botanists and the world of science one of its most impressive figures. Count SOLMS was born on December 23, 1842, and had thus nearly completed his seventy-third year. He came of one of the most ancient of German families, who were sovereign in their own domains down to the year 1806. He himself devoted his life wholly to science, holding the professorship of botany first at Göttingen and afterward at Strassburg. He resigned the latter post a few years ago, but continued to live in the town, surrounded by his university friends.

His work extended to every department of botany. Beginning with an important series of researches on parasitic phanogams, he subsequently monographed several natural orders, including the screw pines. His interest in the morphology of flowering plants continued in later years; in 1900 he described the remarkable crucifer *Capsella Hegeri*, with indehiscent fruits, regarding it as a mutant of the common *C. Bursa-pastoris*. He was always interested in variation, and carried out important investigations on the history of cultivated plants, such as the fig, the pawpaw, wheat, tulips, and strawberries. In embryology



<sup>1</sup> From a biographical sketch published in *Nature*, January 13, 1916.



he showed that in certain monocotyledons the growing point of the embryo is terminal, as in dicotyledons.

In addition to the flowering plants, his systematic researches extended to every class of cryptogams. One of his most remarkable works in this field is his monograph of the Acetabulariaceae, a family of calcareous algae with an ancient fossil history. This was published in 1895 in the *Transactions of the Linnean Society*, and was his only paper written in English. His book on the *Principles of Plant Geography* (1905) treats in an original manner of the leading conceptions in this great subject.

Perhaps the most important of all his work was that on fossil botany. His *Einleitung in die Paläophytologie*, published in 1887 and translated for the Oxford Press in 1892, was of the utmost importance in bringing home to botanists the value and significance of the geological record as affecting plants. Among his special papers may be mentioned his brilliant work on the Isle of Wight fossil *Bennettites Gibsonianus* (1890; translated 1891), the type of the mesozoic cycadophytes; on the Cycadofilices *Protospitys*, *Medullosa*, etc.; on plants of the Devonian and Lower Carboniferous of Germany; and on *Psaronius*. In a quite recent paper on the last-mentioned group he elucidated, for the first time, the true nature of the root zone. The remarkable recent progress of paleobotany is in a great degree due to his researches.

Count SOLMS became a foreign member of the Linnean Society in 1887, of the Royal Society in 1902, and of the Geological Society in 1906. He received the gold medal of the Linnean Society in 1911, and was made a Sc.D of the University of Cambridge at the Darwin Celebration in 1909. He was a striking and original personality, of rare intellectual power, and a born leader of men.—D. H. SCOTT, *Royal College of Science, London*.



# CURRENT LITERATURE

## NOTES FOR STUDENTS

**Age changes in leaves.**—An interesting and important paper by BENE-DICT<sup>1</sup> is an attempt to answer the question whether general progressive age changes occur during the vegetative life of a woody perennial, and constitutes, so far as the reviewer's knowledge goes, the first positive evidence based on exact observation for an affirmative answer to the question. The author approaches his subject with a brief résumé of the physiological and morphological age changes in animals, pointing out that much more attention has been paid to the phenomena of senescence in animals than in plants, there being as regards plants practically no really conclusive data at hand. He emphasizes both the scientific and the practical importance of the question whether plants actually grow old, and notes that in view of the great differences in length of life in different animal species the very great length of life attained by certain trees does not constitute any real answer to the question.

As the chief material for his own study of senescence in plants the author has chosen the leaves of the wild grape (*Vitis vulpina* L.) for various excellent reasons noted in the paper, and his observations concern primarily the size of the aggregations of photosynthetically active cells, the vein islets in the meshes of the network of veinlets, or in other words the size of these meshes. Briefly stated, the chief results of the paper are these: The size of the vein islets is essentially the same in different regions of the same leaf and in leaves of different size and thickness from plants of the same or nearly the same age, and differs but slightly with ordinary differences of light and shade. A comparison of minimum and maximum areas of the vein islets in different leaves of the same plant also shows much less variation than the areas and thicknesses of the leaves themselves. All these facts indicate that the size of the vein islets is governed by some internal characteristic of the plant as a whole, or more specifically of the meristematic tissue. The ground being thus cleared, the next step is the comparison of the size of the vein islets in the leaves of plants of different ages, age being determined by the number of rings in the main trunk or in some extreme cases by the size of the trunk. The very extensive series of measurements show beyond question that the size of the vein islets is greatest in the youngest plants and undergoes a progressive decrease with advancing age. This difference in size holds good for immature as well as for mature leaves, and also for cuttings from plants of different age as well as for the plants

---

<sup>1</sup> BENE-DICT, H. M., Senile changes in leaves of *Vitis vulpina* L. and certain other plants. Cornell Univ. Agric. Exp. Sta. Memoir no. 7. pp. 281-370. 1915.



themselves; that is, vegetative propagation does not bring about rejuvenescence in this respect. The rate of decrease in the size of the vein islets is highest in the earlier years of life of the vine and decreases in later years, and when plotted as a curve shows a decrease in steepness and approach to horizontal with advancing age. The identity of type of this curve with the curve of decrease in pulse rate in human beings and the decrease in rate of growth in guinea-pigs is strikingly shown by graphic comparison.

These observations on *Vitis vulpina* are supplemented by less complete data on other woody perennials: *V. bicolor*, *Tecoma radicans*, and a number of trees, including species of *Salix*, *Castanea*, *Quercus*, *Tilia*, *Ulmus*, *Carya*, *Acer*, *Platanus*, and *Fraxinus*, all of which lead to the same conclusions, as do also observations on several pedigreed varieties of grape which have been propagated by cuttings for known different lengths of time. Other age changes determined in the leaves of *Vitis* are decrease in rate of CO<sub>2</sub> production, decrease in imbibition of water by powdered leaves, decrease in acidity, increase in number and decrease in size of stomata, and probably a decrease in size of palisade cells and an increase in the proportion of cytoplasm to nucleus.

In the discussion particular attention is called to the significance of these facts in connection with the question of the deterioration and running out of cultivated fruits and other plants propagated by vegetative means, and then, after criticism of some of the various theories of senescence based primarily on zoological data, BENEDICT concludes that a decrease in permeability of the cells will best account for the observed facts. With this decrease in permeability of the photosynthetic cells, diffusion of water and salts through them is retarded, and the results obtained by various investigators indicate that lack of water in the cells of the leaf stimulates the production of veinlets. He points out, however, that this decrease in permeability with advancing age is itself dependent upon the properties of colloids, and that the fundamental factors of senescence are to be found in the properties of the protoplasmic colloids.

The reviewer welcomes this paper, not only for its scientific and practical significance, but also as affording in general confirmatory evidence for his own conclusions based on an experimental study of certain simple animals, and for certain suggestions concerning senescence and rejuvenescence in plants. It seems worth while to point out, however, that changes in the meristematic tissue, such as BENEDICT has discovered, are not the only age changes in the plant. The cells which differentiate from the meristematic tissue undoubtedly grow old much more rapidly than the meristematic tissue. The changes in the meristematic tissue of *Vitis* which determine the decrease in size of the vein islets must be at most only the earliest stages of senescence. Differentiation in any appreciable degree is not yet present in this tissue, but that is no reason why it may not become an important factor in more advanced stages of senescence. Protoplasmic differentiation is undoubtedly of less significance in this respect than in animals, where its relation to senescence is evident.



It may also be pointed out that a period of senescence which seems when viewed superficially to be uniformly progressive may be made up of many alternating periods or cycles. There is evidence that in at least many cases the cell undergoes changes in the direction of senescence between divisions, and in the direction of rejuvenescence at division. It may be that the very slow aging of the meristematic tissues of plants, as compared with that of cells which cease to divide, is associated with the frequent occurrence of division. Likewise, the localization and outgrowth of a new growing tip, even in meristematic tissue, must involve, at least often, a slight rejuvenescence of the cells concerned. Thus the progressive senescence of the meristematic tissue in such a case as that of *Vitis* may consist of innumerable periods of alternate slight senescence or retardation and rejuvenescence or acceleration, in which the latter does not quite balance the former. In many of the lower plants, as in certain of the lower animals, such changes apparently do balance each other, at least under some conditions, and vegetative or agamic reproduction or propagation may be continued indefinitely. In general, the evidence seems to indicate that this balance is more complete in the simpler organisms, and that rejuvenescence becomes more and more limited to gametic reproduction as evolution advances.

BENEDICT finds that the rate of decrease in size of the vein islets becomes lower with advancing age in *Vitis*. This suggests the possibility that sooner or later a balance between the shorter periods of senescence and rejuvenescence may be reached, and if such a possibility is ever realized the period of "maturity" may continue indefinitely.

BENEDICT is inclined to minimize the importance of the accumulation of relatively inactive components in the protoplasm as a factor in senescence and to lay chief stress on decrease in permeability. While decrease in permeability is undoubtedly an important factor in senescence, the reviewer has pointed out elsewhere that such a change is merely the surface expression of changes in the colloids or in the protoplasmic substratum, and that similar changes on other limiting surfaces or throughout the substratum may determine differentiation, accumulation of structural substance, and decrease in metabolic rate. In short, decrease in permeability seems to be merely one expression of the great variety of changes concerned in bringing about the decrease in metabolic rate characteristic of senescence. Moreover, it was pointed out above that the changes with which BENEDICT is concerned can be only the earliest stages of senescence in the meristematic tissues. Decrease in permeability may very possibly be one of the chief expressions of these early changes, but certainly in later stages various other factors play important parts.

On the basis of BENEDICT'S conclusions, the changes in permeability of the photosynthetic cells in the leaf must not only interfere with diffusion from cell to cell, but also must decrease metabolic activity within each cell. This



being the case, the question must at least be raised whether the demand for water and nutrients is greater or less in the older than in the younger vein islets. It seems not impossible that the decreasing metabolic activity with advancing age in the vascular tissues themselves may be a factor in determining the increase in the veinlets. The reviewer has shown that the spatial relations of successively arising parts may vary directly with the metabolic rate, and it is perhaps allowable to suggest that in this case the more frequent branching of the veinlets in the older leaves may be to some extent associated with a lower metabolic rate in each new branch, and consequently a lower limit of distance within which it inhibits the development of new veinlets.

In conclusion, it must be noted that BENEDICT'S use of the terms "senile" and "senility" is at least unusual. These terms are commonly used only with reference to the extreme stage of senescence preceding death in man and the higher animals, where actual atrophy, degeneration, and necrosis of cells occur, but BENEDICT speaks of senile changes occurring in the early stages of development. To substitute "senile" and "senility" for "aging" and "senescence" is simply to give the former terms a new meaning. To speak of meristematic tissue or of a plant in "vigorous maturity" as senile is to a zoologist or animal physiologist little less than a contradiction in terms. Moreover, the increase in vascular tissue in the leaf with advancing age of the plant is scarcely comparable to the replacement of atrophied organs by connective tissue in man and the higher animals, but resembles rather the increase in stable morphological structure which occurs during development in animals. Criticism of such points, however, does not detract from the interest and significance of BENEDICT'S evidence for the occurrence of a gradual, progressive change, slight, but apparently in the direction of senescence, in the meristematic tissues during vegetative life.—C. M. CHILP.

**Cecidiology.**—American botanists will be interested in a posthumous paper on American insect galls by THOMPSON.<sup>2</sup> In part I, the galls are classified under the generic names of the host plants, with subordinate grouping based on the host plant. The descriptions are very brief, in most cases restricted to a single line, but give the specific names of the host plants and statements as to anatomy. This first part will prove very useful to botanists. Part II groups the galls with reference to the insects causing them and gives a list of host plants for each. This part also includes a bibliography and a lengthy supplemental list which includes a few fungus galls. The illustrations are good and the entire publication will prove very helpful.

American botanists will also be interested in a paper by STEWART<sup>3</sup> on the anatomy of *Gymnosporangium* galls. This paper is summarized as follows:

---

<sup>2</sup> THOMPSON, M. T., An illustrated catalogue of American insect galls. pp. 66. pls. 21. 1915. Edited by Dr. E. P. FELT.

<sup>3</sup> STEWART, ALBAN, An anatomical study of *Gymnosporangium* galls. Amer. Jour. Bot. 2:402-417. 1915.



"*Gymnosporangium juniperi-virginianae* and *G. globosum* cause the formation of large galls on the younger branches of *Juniperus virginiana*. The galls arise from the axils of the leaves and are evidently transformed axillary buds. Young galls have two distinct fibrovascular systems, one of which is a leaf trace bundle, and the other a stem. The more or less modified stem which enters the base of the older galls gradually breaks up and radiates outward, deeper in the gall tissue. Leaf tissue is also involved in gall formation, and remains of it are usually to be found adhering to the older galls. Normal stems sometimes appear to have grown out from the surface of the older galls. Accessory stem structures occur, which probably originate by a branching of the main stem in the gall. Broad, raylike masses of parenchyma, surrounded by tracheids, are of rather common occurrence. Irregularly twisted masses of fibrovascular tissue occur which are similar in many respects to like structures in traumatic wood. Cells which are transitional between parenchyma and tracheids are quite abundant. The irregularly running bundles in the gall are composed largely of scalariform tracheids."

Another very interesting contribution to our American literature is by PING<sup>4</sup> on the well known and very conspicuous round gall of the golden rod. This paper is more entomological than botanical, but contains much that is interesting to the botanist. The author describes the gall which is restricted to *Solidago canadensis* and caused by the larva of *Eurosta solidaginis* Fitch. The adult insects emerge in May, deposit their eggs on the surface of the growing plant, where they hatch in a short time, and the larva immediately penetrates the host. The author gives the life history of the insect, which extends throughout the following winter, and also gives the life history of the beetle (*Mordellistina unicolor* Lec.) which inhabits the gall, and a list of other insects found associated with the gall. It may be too much to expect the entomologist to give a discussion of the histology and development of the gall, but in connection with the study of the larva, it would certainly have added much to the paper if the author had given some attention to the host tissues to which the stimulation was applied.

An interesting paper is one by COBB<sup>5</sup> on a nematode disease of sugar cane and banana. The author calls attention to the outbreaks in Fiji, Hawaii, and Jamaica, describing the symptoms of the disease and the causal organism.

Another very valuable paper is by FELT,<sup>6</sup> who has made extensive studies of the gall midges in recent years. Although this paper is primarily entomological, it contains descriptions of many galls, some of which are rather difficult to classify.

---

<sup>4</sup> CHI PING, Some inhabitants of the round gall of the golden rod. Jour. Ent. and Zool. 7:161-179. 1915.

<sup>5</sup> COBB, N. A., *Tylenchus similis*, the cause of a foot disease of sugar cane and banana. Jour. Agric. Research 4:561-568. 1915.

<sup>6</sup> FELT, E. P., A study of gall midges, III. 30th Report State Entomol. New York. Museum Bull. 180:127-288. 1916.



Among the important foreign contributions is a paper by WADSWORTH<sup>7</sup> on the knapweed gall. This gall is most common on *Centaurea nigra* L., a very troublesome pasture weed, but also occurs *C. scabiosa* L., *C. montana* L., *C. paniculata* L., *Carduus nutans* L., *C. crispus* L., *C. anthoides* L., *Cirsium lanceolatum* L., *Serratula tinctoria* L., etc. The gall is caused by a dipterous insect which was originally described in 1758. The adults emerge during a period of about two weeks in June and deposit eggs on the young flower heads early in July. The author gives synonymy, historical discussion, description, life history, and distribution of the insect. The effect of this falling is to reduce the seed production to about 50 per cent. Of the seeds that are produced only 60.5 per cent germinate.—MEL. T. COOK.

**Australian vegetation.**—In a country of vast extent and consequent widely differing conditions it is difficult to gain any accurate concept of the most striking characters of the vegetation or of the principal affinities of the flora. Such a characterization was prepared by MAIDEN<sup>8</sup> in connection with the recent visit of the British Association to Australia. In reviewing the main natural divisions of the country he calls attention to the "geocols," broad depressed areas running east and west and separating wide plateaus, and to their possible influence upon plant distribution. Interesting botanical statistics show among other things that one family, the Leguminosae, is represented by 1275 species, while the Myrtaceae, Proteaceae, and Compositae show over 500 species each. Among remarkable prominent genera are *Acacia* with 412 species, and *Eucalyptus* with 230 species. Incidentally it would seem that the largest specimens of the latter of which authentic measurements exist are about 326 ft. in height and 25 ft. 7 in. in circumference, 6 ft. from the ground, dimensions excelled by the sequoias of America.

Some attention is given to introduced plants, many of which are of vast importance in the weed problems of the agricultural areas. The most remarkable instance cited is that of the prickly pear, *Opuntia inermis*, introduced from Rio de Janeiro in 1789 as food for the cochineal insect, which is now badly infesting an area of 30,000,000 acres, to which about 1,000,000 acres are being added annually by its natural increase.

The flora is analyzed rather effectively and its various affinities demonstrated. Finally, concise sketches are given of the flora and vegetational types of the various individual states. It is impossible to summarize these already condensed characterizations, but it may be of interest to note the attention directed to Victoria, the most carefully studied areas of which are

---

<sup>7</sup> WADSWORTH, J. T., Some observations on the life history and bionomics of the knapweed gall fly *Urophora soltitia* Linn. *Annals Appl. Biol.* 1:142-169. 1914.

<sup>8</sup> MAIDEN, J. H., Australian vegetation. Federal handbook on Australia. pp. 163-209. 1914. Issued in connection with the visit of the British Association for the Advancement of Science to Australia. 1914.



rich forests of the beech, *Fagus Cunninghamii*, and of the various species of *Eucalyptus*.

With the above it is interesting to compare the impressions of a visitor, as given by SAUNDERS<sup>9</sup> reporting the tour of the British Association in Australia. More detailed studies of limited areas are those of OSBORN and HARDY,<sup>10</sup> the latter giving an interesting account of a scrub vegetation termed "mallee," as it occurs in a portion of Victoria with 12-20 in. annual precipitation. This seems to be a semi-desert association of woody plants growing 6-10 ft. high, at times forming a rather open stand, but often almost impenetrable thickets. Shrubby species of *Eucalyptus* with vegetative habits of reproduction predominate with the almost leafless "broom mallee," *Exocarpus spartium*, upon sandy ridges.

OSBORN<sup>11</sup> describes the climatic conditions of the region about Adelaide which possesses a winter rainfall, 70 per cent of the total annual precipitation being between the months of May and October. Evidences remain that the plains upon which the city of Adelaide now stands were originally well wooded with various species of *Eucalyptus*, while the low sandy flats separating the plains from the sea show associations of the mangrove, *Avicennia officinalis*, and of shrubby species of *Salicornia*. Portions of the coast have in addition low sand dunes with grasses and shrubs. Notes upon other associations of the plains and mountains are also given, while not the least interesting is the brief study of the remarkable similarity of leaf forms existing in widely separated families, notably the sickle-shaped leaves of certain species of *Eucalyptus* and *Acacia*.—GEO. D. FULLER.

**Meiotic divisions.**—Owing to views put forward by LAWSON<sup>12</sup> as the result of an investigation of *Smilacina*, Miss WOOLERY<sup>13</sup> has investigated similar stages in a species of the same genus, and her conclusions do not agree in the main with those of LAWSON.

In the resting nucleus, the chromatin granules are found to be held in the meshes of a so-called fine linin network. This network, though perhaps not so extensive as it appears, is not altogether a fanciful structure. At no time in the early prophase was the individuality of the chromosomes apparent,

<sup>9</sup> SAUNDERS, E. R., The Australian meeting of the British Association. I. Botanical excursions. *New Phytol.* 14:50-62. 1915.

<sup>10</sup> HARDY, A. D., The mallee: Ouyen to Pinnaroo. *Victorian Nat.* 30:148-167. 1914.

<sup>11</sup> OSBORN, T. G. B., Notes on the flora around Adelaide, South Australia. *New Phytol.* 13:109-121. 1914.

<sup>12</sup> LAWSON, A. ANSTRUTHER, The phase of the nucleus known as synapsis. *Trans. Roy. Soc. Edinburgh* 47:591-604. 1911.

<sup>13</sup> WOOLERY, RUTH, Meiotic divisions in the microspore mother cells of *Smilacina racemosa* (L.) Desf. *Ann. Botany* 29:471-482. 1915.



though this seems to be due partly to a misunderstanding of the term "maintenance of the individuality of chromosomes." The single spireme, which results from the fusion of chromomeres upon the linin thread, enters into the synaptic stage. In accord with LAWSON, Miss WOOLERY has found by measurements, which she records, that there is an enlargement of the nuclear cavity; but, contrary to the former's conclusions, the space occupied by the chromatin material is found by actual measurement, which she also records, to be less. During synapsis there is a shortening and a thickening of the thread to form the uniform spireme which later emerges from the synaptic ball. Unfortunately, there are no drawings to show the thread at the time of greatest contraction. During second contraction the first appearance of the split spireme is recorded, though the double structure spoken of in figs. 11 and 12 may possibly have been an earlier appearance of this condition. In several places considerable emphasis has been placed upon the fact that portions of the spireme are in connection with the nuclear membrane. The question would arise here, whether these were connections of any significance or merely portions of the chromatin that were tardy in movement. Reduction is by means of cross segmentation at the periphery of the radiating loops, as found during second contraction; this act being followed by a side-to-side approximation of the limbs of the loops or of separate portions of the thread, thereby forming the bivalent chromosomes. Evidences of spindle formation do not bear out LAWSON'S theory that the fibers are expressions of lines of tension due to the contraction of the nuclear membrane.

The idea that the resting nucleus is composed of two substances, chromomeres and linin, is still held by this investigator. Before definite conclusions can be drawn concerning the structure of the resting nucleus and the formation of the spireme from the resting condition, a closer series during the early pro-phases and the late telophase of the last division of the sporogenous tissue must be made. The careful measurements of the nuclear cavity and the chromatin mass at the time of the first contraction cannot fail to show fallacies in the view put forward by LAWSON.—MILDRED NOTHNAGEL.

**Periodicity in mitosis.**—In a paper on embryonal growth and its diurnal period, KARSTEN<sup>14</sup> deals with the periodicity of cell division. He calls attention to the fact that many algae shed zoospores in the early forenoon, and therefore must have undergone cell division during the night; and he cites the work of investigators who have shown positively that *Spirogyra*, *Zygnema*, diatoms, and desmids divide at night, most of them between 9:00 P.M. and midnight. He was not able to find similar records for the higher plants. The work of KELLICOTT<sup>15</sup> on the periodicity of mitosis in *Allium* was overlooked. KARSTEN

<sup>14</sup> KARSTEN, G., Über embryonales Wachstum und seine Tagesperiode. Zeitschr. Botanik 7:1-34. 1915.

<sup>15</sup> KELLICOTT, W. E., The daily periodicity of cell division and of elongation in the root of *Allium*. Bull. Torr. Bot. Club 31:529-550. 1904.



had already noticed that temperature affects the rate of cell division, and consequently he carried on his experiments in a large thermostat at a constant temperature of 25°. The most extensive investigation was made upon the root tips of seedlings of *Vicia Faba*. From 7:00 P.M. to 11:00 P.M. mitoses are slightly more frequent, and about 4:00 P.M. there is some diminution in the number. Roots of *Zea Mays* showed a uniform rate of mitosis throughout the 24 hours. Stem tips of seedlings of *Pisum sativum*, grown in the dark at a temperature of 25°, showed a larger number of mitoses between 9:30 P.M. and 1:30 A.M. By 3:00 A.M. the mitoses were much less frequent, and continued to diminish until the minimum was reached at 6:00 A.M. Stem tips of seedlings of *Zea Mays*, grown under the same conditions, begin to show an increase in the number of mitoses about 10:00 P.M. and a maximum is reached at 4:00 A.M., after which the number diminishes, reaching the minimum at about 8:00 A.M. When the stem tips were lighted from 6:00 A.M. to 6:00 P.M., by an electric light, the behavior was practically the same; but when they were lighted from 6:00 P.M. until 6:00 A.M. and kept in the dark from 6:00 A.M. until 6:00 P.M., the periodicity was accentuated; while continuous lighting made the periodicity less conspicuous.

The general conclusion is that, so far as mitosis is concerned, roots have no periodicity, but stems show it in a marked degree, with the maximum period in the night. It is evident that this investigation suggests further work by those who, like KARSTEN, have facilities for isolating and controlling factors. While so many observations have been made upon growth, and so many curves have been plotted, the literature does not seem to contain any curves for mitosis. Growth and cell division are two distinctly different phenomena which are often confused, or it might be more nearly correct to say that the cell division has been altogether disregarded.—C. J. CHAMBERLAIN.

**Strobilus of *Gnetum*.**—PEARSON<sup>16</sup> has made a careful study of the puzzling inflorescence of the Gnetales, and has added much to our knowledge of the facts. Not only have the structures involved been confusing, but the terminology as well, for how to apply the terms strobilus and flower has been perplexing. Calling the unit structure a "flower," and the whole cluster therefore an "inflorescence," the following statement of PEARSON'S results may be made. He finds that wide differences occur within the same species in the number of staminate flowers produced in basipetal succession at each node, in *G. scandens* the number of such flowers in a single inflorescence sometimes being as many as 3000. The "antherophore" apparently elongates rapidly just before dehiscence of the anthers, freeing them from the envelope. In *G. Gnemon* the staminate inflorescence "usually bears one or more complete female flowers," and in some material these ovulate flowers are more abundant in old inflorescences, from which some or all of the staminate flowers have fallen. In *G. scandens*,

<sup>16</sup> PEARSON, H. H. W., A note on the inflorescence and flower of *Gnetum*. Ann. Bolus Herbarium 1:152-172. pls. 24-26. 1915.



on the other hand, incomplete ovulate flowers, which are very small and always concealed by the staminate flowers, occur in the staminate inflorescence. It is suggested, therefore, that *G. scandens* represents a reduction stage of ovulate flowers in an inflorescence which is becoming staminate, a pure staminate inflorescence being reached in *G. africanum* and *G. Buchholzianum*. Naturally this situation suggests that the present monosporangiate inflorescence of *Gnetum* has been derived from a bisporangiate inflorescence. It is suggested further that the ovulate inflorescence was probably derived "by the arrest of the nodal meristem by which the later formed staminate flowers are produced." Since a terminal ovulate flower is of common occurrence, such a flower replacing the barren tip of the axis, it is suggested that the primitive inflorescence consisted of "an axis bearing a cupule, a ring of male flowers, and a terminal female flower or a group of which one is terminal," which is certainly suggestive of the strobilus of the Bennettitales. Further evidence is presented to indicate that the staminate flower, commonly thought of as a reduced staminate strobilus ("anthostrobilus"), probably has no such relationship.—J. M. C.

**Plant pathology in the tropics.**—Those who have followed this branch of botany must be impressed by the large amount of work accomplished in the past five years. In an interesting paper by ASHBY<sup>17</sup> we find a discussion of (1) bud diseases of the coconut, in which the author expresses the opinion that the bud rot attributed by JOHNSON (U.S. Bur. Pl. Ind. Bull. 228) to *Bacillus coli* may be due also to other species of bacteria; other species found associated with the bud rot were connected to the type groups *B. carotovous*, *B. aerogenes*, and *B. typhi*; (2) a bud decay of the coconut caused by *Thielaviopsis paradoxa*, which is also the cause of diseases of bananas, sugar cane, pineapple, and stem of the coconut; (3) another bud decay apparently caused by a species of *Phytophthora*; (4) several leaf diseases due to *Diplodia epicocos* Cooke, *Pestalozzia palmarum* Cooke, and other fungi; (5) several other fungous diseases of the root and stem of the coconut; (6) diseases of the cocoa; (7) diseases of the banana; (8) diseases of the orange. The author gives good descriptions of the diseases and of the organisms.

The Department of Agriculture of Jamaica has issued a bulletin on "Diseases of plants," in which are given laws in regard to the introduction and spread of plant diseases, and orders concerning the "Panama disease" or "wilt" of the banana. This is followed by a description of the disease which causes a breaking down of the leaves, with or without previous yellowing, beginning with the oldest. The trunk is sometimes split and the fruit ripens prematurely and is dry, pithy, and without flavor. Internally will be found many dark red streaks extending from the base upward through stems and leaves. This condition is followed by a stinking soft rot. The disease is attributed to a *Fusarium*, very similar in morphology and habit to *F. vasinfectum* Atk. It is

<sup>17</sup> ASHBY, S. F., Notes on diseases of cultivated crops observed in 1913-1914. Bull. 8, Dept. Agric. 2:299-327. 1915.



a soil organism which gains entrance through wounds and readily passes from the parent plant to the suckers. It spreads by diseased plants, infected soils, by farm implements, and on the clothing and boots of the laborers.—MEL. T. COOK.

**Permeability.**—STILES and JORGENSEN<sup>18</sup> have measured the effect of temperature on the rate at which hydrogen ions of hydrochloric acid are absorbed by the tissue of potato tuber. Disks of potato tubers 1 cm. in diameter, weighing about 0.5 gm., were immersed in HCl of concentration 0.0011 N. This low concentration was used in order to avoid injury to the tissue. Experiments were carried out at temperatures of 0° C., 10° C., 20° C., and 30° C. At intervals up to 8 hours the quantity of the hydrogen ions absorbed was measured by determining the loss of hydrogen ions in the bathing solution. The hydrogen ion content of the latter was measured by a hydrogen electrode, a description of which the authors give.

The rate of absorption was increased by a rise of 10° C. as follows: from 0° to 10°, 2.22 times; from 10° to 20°, 2.17 times; from 20° to 30°, 2.18 times. This is in agreement with the Van't Hoff law for the effect of temperature upon the rate of chemical reaction, and the authors conclude that "the study of the effect of temperature on the absorption of the hydrogen ion would seem to indicate that the absorption is controlled by some chemical action in the cell, and is not the result of simple diffusion through the plasma membrane, or of mere absorption by the cell protoplasm." Their view is that the acid reacts with some substance in the potato, that this substance is either present in large quantity as compared with the amount of acid fixed, or that the resulting compound is broken down again almost as soon as formed. As to the identity of the substance that reacts with the acid, they state it is "presumably the plasma membrane, or some part of it." The reviewer is not convinced yet, however, that in their experiments they were dealing primarily with the permeability of the plasma membrane. The title of the paper expresses the situation more exactly.—F. E. DENNY.

**The humidity of a ravine.**—It has long been commonly accepted that both the atmospheric humidity is greater and the supply of soil moisture more abundant in a narrow ravine than upon the adjacent upland, but no quantitative data have been available to confirm these observations. To supply these deficiencies ULLRICH<sup>19</sup> measured the evaporating power of the air at 15 different points in a clay ravine, and determined the range of soil moisture for a corresponding number of stations for a period of four months, from the beginning

---

<sup>18</sup> STILES, WALTER, and JORGENSEN, INGVAR, Studies in permeability. II. The effect of temperature on the permeability of plant cells to the hydrogen ion. *Ann. Botany* 29:611-618. *figs. 4.* 1915.

<sup>19</sup> ULLRICH, F. T., The relation of evaporation and soil moisture to plant succession in a ravine. *Bull. Ill. State Lab. Nat. Hist.* 12:1-16. *pl. 18.* 1915.



of July 1913. The results of both series of determinations are plotted graphically, and furnish many interesting details regarding the conditions for plant life in such a habitat. The variations in soil moisture, although considerable, do not indicate that this is the factor of most importance in promoting the greater mesophytism of the ravine habitat as compared with the upland. Evaporation differences show more contrast in these two habitats, as may be shown by a few examples. The average daily rates of evaporation from the standard atmometer for the open upland, the forested upland, the south-facing slope, the north-facing slope, and the bottom of the ravine were respectively 16.3, 8.7, 7.9, 6, and 4.7 cc. This shows very definitely that the more or less confined atmosphere of the lower parts of rather narrow ravines has frequently only about one-half the evaporating power possessed by more freely circulating air of the forested upland. Maps of the region north of Chicago in which the ravine is located and of the ravine itself, together with the tabulation and plotting of data and photographs of the vegetation at the various stations, add to the value of the paper.—GEO. D. FULLER.

**New Zealand vegetation.**—A non-technical but truly scientific description of the vegetation of any land is interesting and useful, even to botanists, in forming a general concept of the plant growth of that region. In such an article COCKAYNE<sup>20</sup> has sketched the flora of New Zealand, and has managed to include many facts within the limits of a few pages. Analyzing the composition and affinities of the flora, he finds 74 per cent endemic, while Malayan, Australian, and subantarctic elements follow in decreasing importance, and the final touch is given by a remarkable element composed of species either closely related to or identical with those of the northern hemisphere.

Among the various plant communities characterized are the rain forest, the southern beech forest, the tussock steppe, the swamp, and the subalpine fell-field. The first of these originally covered all the lowland and montane regions of North Island, and considerable portions of the west and south of South Island. This rain forest was remarkable for the abundance of conifers in such genera as *Dacrydium*, *Podocarpus*, and *Agathis*, mingled with broad-leaved evergreens, woody climbers, ferns, mosses, and liverworts in luxuriant profusion. Very different from the rain forest, but quite as distinctive, was the tussock steppe, dominated by large grasses of the tussock habit of growth. The principal species were *Danthonia Raoulii*, *Poa caespitosa*, and *Festuca novae-zealandiae*. Somewhat less attention is devoted to the beech forest with five species of *Nothofagus*, the heath thickets, swamps, sand dunes, and mountains; while the article closes with some statistics of plant families, genera, and species.—GEO. D. FULLER.

<sup>20</sup> COCKAYNE, L., The primitive vegetation of New Zealand. Jour. Agric. (New Zealand) 9:401-410. 1914.



**Taxonomic notes.**—MIYABE and KUDO<sup>21</sup> are investigating and recording material for a flora of Hokkaido, Japan, and five small fascicles have been published. In these fascicles 60 species are presented, new species being described in *Luzula*, *Eriophorum*, *Tofieldia* (3), and *Dactylostalix* (an orchid). In addition to new species there are several new names and combinations.

MIYAKE<sup>22</sup>, in connection with a study of fungi from China, includes in his published list of 56 species descriptions of 4 new species of Fungi Imperfecti, representing the following genera: *Coniothyrium*, *Melophia*, *Marsonia*, and *Cercospora*.

MAKINO,<sup>23</sup> in continuation of his studies of the flora of Japan, has published new species in *Scleria* (2) and *Utricularia*.

BLAKE<sup>24</sup> has described the following new genera of Compositae, chiefly Mexican: *Haplocalymma* (based on *Viguiera microcephala* Greenm.), *Phoebanthus* (to include *Helianthella grandiflora* T. and G. and *H. tenuifolia* T. and G.), and *Pionocarpus* (based on *Helianthella madrensis* Wats.); and also new species in *Gymnolomia*, *Viguiera* (2), *Perymenium* (3), and *Chrysactinia*.

ROBINSON<sup>25</sup> has described new species from Cuba, Mexico, and Guatemala in *Eupatorium* (5), *Brickellia*, *Verbesina*, and *Liabum*, in addition to new varieties, forms, names, and combinations.

MACBRIDE,<sup>26</sup> in connection with a study of the Borraginaceae of the Gray Herbarium, has found it necessary to make a number of new names and combinations, and has also described two new species of *Heliotropium*, both from Mexico.—J. M. C.

**Morphology of Treubia.**—CAMPBELL,<sup>27</sup> studying material of *Treubia insignis* collected at the original station near Tjibodas on Mount Gedeh, Java, finds that the archegonia, which occur in groups up to a dozen, have as many as 9 neck cells; that there is no clear line of demarcation between the deck and the ventral region; and that as many as 8 neck canal cells are sometimes present. GRÜN, studying the same form, reports as many as 16 neck canal

<sup>21</sup> MIYABE, K., and KUDO, Y., Materials for a flora of Hokkaido. Pts. 2, 3, 4, 5. Trans. Sapporo Nat. Hist. Soc. 5:37-44, 65-80, 145-152; 6:1-9. 1915.

<sup>22</sup> MIYAKE, I., Studien über chinesische Pilze. Bot. Magazine 27:45-54. 1913.

<sup>23</sup> MAKINO, T., Observations of the flora of Japan. Bot. Magazine 27:55-60. 1913.

<sup>24</sup> BLAKE, S. F., Compositae new and transferred, chiefly Mexican. Proc. Amer. Acad. 51:515-526. 1916.

<sup>25</sup> ROBINSON, B. L., New, reclassified, or otherwise noteworthy spermatophytes. Proc. Amer. Acad. 51:527-540. 1916.

<sup>26</sup> MACBRIDE, J. FRANCIS, Certain Borraginaceae, new or transferred. Proc. Amer. Acad. 51:541-548. 1916.

<sup>27</sup> CAMPBELL, DOUGLAS HOUGHTON, The archegonium and sporophyte of *Treubia insignis* Goebel. Proc. Nat. Acad. 2:30-31. 1916.



cells. The lack of demarcation between neck and venter, always notable in *Jungermanniales*, is here most pronounced. This character, taken in connection with the large number of neck canal cells, seems to suggest that the archegonium is primitive; that while other structures have made rapid strides forward, the archegonium has stood still, relatively speaking. The earliest stages of the embryo were not seen, but in the youngest stage a prominent haustorium, derived most probably from the hypobasal half of the fertilized egg, was present. The foot is not sharply delimited from the seta; this is, of course, a primitive character. The wall of the capsule is 3-layered and the apex is thickened into a pronounced beak, an advanced condition phylogenetically. CAMPBELL considers that *Treubia* is nearer the acrogynous liverworts than is any other anacrogynous form.—W. J. G. LAND.

**Botanical microtechnique.**—SMITH<sup>28</sup> gives a résumé of botanical microtechnique from the time of HOOKE to the present time, and treats the subject under three heads: from HOOKE to 1800; the technique of the English microscopists and the German botanists from 1800 to 1875; modern microtechnique from 1875 to the present time. For the first time the pioneer work of JOHN HILL has received the recognition it merits. HILL was one of the very few workers in botany during the exceptionally barren eighteenth century, and many of his methods were "rediscovered" after nearly 75 years. HILL successfully used maceration methods, and in a crude way fixed and hardened his material. He is beyond doubt the first botanist to use staining as an aid to determine structure, the stain being an alcoholic tincture of cochineal. He also understood and used mordants, injected vessels by boiling pieces of wood in green sealing wax, cut sections on a microtome, and cleared them in spirits of turpentine. The credit of first using paraffin for interstitial imbedding is given to FRANCOTTE, that of soap to PFITZNER, and that of celloidin to BUSSE. The history and evolution of the microtome is traced from 1770 to the present time, but no mention is made of the marvelously accurate rotary microtome which has succeeded that of MINOT.—W. J. G. LAND.

**Influence of nutrition on development of sex organs.**—NAGAI<sup>29</sup> has investigated the influence of nutrition on the development of the sex organs of *Osmunda regalis japonica* and *Asplenium Nidus*. Previously he had shown that factors of environment play important rôles in the sexual development of the gametophytes of *Ceratopteris thalictroides* and other ferns.<sup>30</sup> In the present

<sup>28</sup> SMITH, GILBERT MORGAN, The development of botanical microtechnique. *Trans. Amer. Microsc. Soc.* 34:71-129. *figs.* 18. 1915.

<sup>29</sup> NAGAI, ISABURO, On the influence of nutrition upon the development of sexual organs in the fern prothallia. *Jour. Coll. Agric. Univ. Tokyo* 6:121-164. *pl.* 10. *figs.* 7. 1915.

<sup>30</sup> NAGAI, ISABURO, Physiologische Untersuchungen über Farnprothallien. *Flora* 106:281-330. 1913.



investigation he has attempted to show quantitatively the influence of nutrition. In the two ferns investigated, he found that the development of the two sex organs could be controlled by certain concentrations of Knop's solution. In general, the number of antheridia decreases as the concentration decreases. In both species archegonia are formed only above 0.175 per cent Knop's solution, which was the optimum concentration for *Asplenium*; but 0.35 per cent was the optimum for *Osmunda*. In many of the prothallia of *Asplenium* the two sex organs appeared only successively. The prothallia of *Osmunda* remained almost completely sterile when grown in solutions lacking calcium or magnesium salts. Numerous combinations of conditions were used, with varying results, and the evidence all indicated that the production of sex organs is a response to factors in the environment.—J. M. C.

**Indiana Academy.**—The Proceedings of the Indiana Academy of Sciences for 1914 contains the following contributions of interest to botanists: An apparatus for aerating culture solutions, by PAUL WEATHERWAX; Antagonism of *B. fluorescens* and *B. typhosus* in culture, by P. A. TETRAULT; Notes upon the distribution of forest trees in Indiana, by STANLEY COULTER; Mosses of Monroe County, Indiana, by MILDRED NOTHNAGEL and F. L. PICKETT; A new enemy of the black locust, by GLENN CULBERTSON; A new leaf spot of *Viola cucullata*, by H. W. ANDERSON; Oat smut in Indiana, by F. J. PIPEL; Plants new or rare to Indiana, by C. C. DEAN; Some peculiarities in *Spirogyra dubia*, by PAUL WEATHERWAX; Report on corn pollination, by M. L. FISHER; Stomata of *Trillium nivale*, by F. M. ANDREWS; The primrose-leaved violet in White County, by L. M. HEIMLICH; Continuous rust propagation without sexual reproduction, by C. A. LUDWIG; Correlation of certain long-cycled and short-cycled rusts, by H. C. TRAVELBEE; Some species of *Nummularia* common in Indiana, by C. E. O'NEAL; The genus *Rosellinia* in Indiana, by G. B. RAMSEY; Some large botanical problems, by J. C. ARTHUR.—J. M. C.

**A new genus of Bennettitales.**—THOMAS<sup>31</sup> has described a new genus of Bennettitales (*Williamsoniella*) based upon material obtained from mesozoic beds in Yorkshire. It is represented by buds, mature strobili ("flowers"), microsporophylls, and the ovulate portions of the strobili. The strobilus is bisporangiate and very small, with no ensheathing sterile bracts; 12-16 wedge-shaped microsporophylls, each bearing 4-6 synangia; sessile ovules, "very similar in external appearance to the interseminal scales"; and the sterile tip of the strobilus axis terminating in "a characteristic corona-like structure" (which suggested the specific name, *W. coronata*). In all probability these strobili were borne in the forks of dichotomously branching stems, whose leaves had been known as *Taeniopteris vittata*. A "flower bud," thought to belong to the same genus, is named *W. roseberriensis*. The marked features

<sup>31</sup> THOMAS, H. H., On *Williamsoniella*, a new type of Bennettitalean flower. Phil. Trans. Roy. Soc. London B 207:113-148. pls. 12-14. 1915.



of this new form, as compared with the long-known forms, are the simple microsporophylls and sessile ovules. The author concludes that there is no evidence of any connection between Bennettiales and angiosperms.—J. M. C.

**Atmometry and the porous cup.**—With the increasing attention now being given to the quantitative determination of ecological factors, it is fortunate to have the technique of one of the most fruitful fields of investigation reviewed and summarized by the worker most prominently connected with it from the beginning. Such a review of the instruments and methods of measuring the evaporating power of the air by LIVINGSTON<sup>32</sup> has recently appeared, including descriptions of the various forms of atmometers and their operation and standardization. Prominent among the recent improvements in this field is the rotating table for standardizing the porous cups, already noted in this journal,<sup>33</sup> and the improved form of the non-absorbing porous atmometer devised by SHIVE<sup>34</sup> to provide against errors caused by the absorption of water by the atmometer during rainfall. The various difficulties encountered by LIVINGSTON and other workers during the ten years since he invented the present form of porous cups are discussed in a way that makes the work invaluable to all workers in this field.—GEO. D. FULLER.

**Evaporation in a marsh.**—In a marsh upon the borders of Lake Erie, where zonation was well marked, SEARS<sup>35</sup> has measured the rate of evaporation in the different associations for a period of four weeks following June 29, and found the highest rate above the open water in the *Scirpus* association, with the lowest in one dominated by *Calamagrostis canadensis*. The comparative values for associations dominated by *Calamagrostis*, *Typha*, *Phragmites*, *Pontederia*, *Sparganium*, *Castalia*, and *Scirpus* are correspondingly 100, 102, 113, 125, 137, 343, and 413. It is to be regretted that the observations did not extend over a longer period, and that SEARS has not reduced his results to the unit commonly used by other workers in this field, that is, to loss per day from the standard atmometer. However, it is an important addition to the data now gradually accumulating of the evaporating power of the air in various habitats.—GEO. D. FULLER.

**Rachiopteris.**—Miss BANCROFT<sup>36</sup> describes a large amount of material from various sources, which is referred to *Rachiopteris cylindrica*. Two types

<sup>32</sup> LIVINGSTON, B. E., Atmometry and the porous cup. *Plant World* 18:21-30, 51-74, 95-111, 143-149. 1915.

<sup>33</sup> BOT. GAZ. 55:263. 1913.

<sup>34</sup> SHIVE, J. W., An improved non-absorbing porous cup atmometer. *Plant World* 18:7-10. 1915.

<sup>35</sup> SEARS, P. B., Evaporation and plant zones in the Cedar Point marsh. *Ohio Jour. Sci.* 16:91-100. *figs.* 5. 1916.

<sup>36</sup> BANCROFT, N., Contributions to our knowledge of *Rachiopteris cylindrica* Will. *Ann. Botany* 29:531-565. *pls.* 26, 27. 1915.



of branches, the *alpha* type and the *beta* type, are noted. The former are more vigorous, and the latter slender and with a lacunar cortex. The author connects these types with one another as part of the same individual, regarding the slender ramifications as possibly adapted to aquatic conditions. The organization of the vascular tissues is protostelic, characterized as exhibiting a central core of small, entirely tracheary tissue surrounded by an envelope of larger elements of the xylem. The author calls attention to the support furnished by *Rachiopteris* for the hypothesis put forward by BOWER, POTONIÉ, and others, for the branchlike origin of the leaf in ferns and their allies.—E. C. JEFFREY.

**The grass embryo.**—SARGANT and ARBER,<sup>37</sup> studying seedlings, and embryos of grasses at the dormant stage, find many variants within the family, which can be satisfactorily accounted for by deriving them from a hypothetical form. This imaginary form they designate as *X*, and the relationships of the various embryos and seedlings are worked out with much ingenuity. The reviewer believes that the problem of the actual relations of monocotyledons to each other and also to the dicotyledons will not be solved by erecting a hypothetical form, but that real progress can be made by a critical study of the earlier stages of the embryo, extending from the fertilized egg to the dormant stage of the embryo. A study of the literature of the subject shows how little is actually known of early embryogeny in angiosperms.—W. J. G. LAND.

**Medullary phloem.**—A recent paper by WORSDELL<sup>38</sup> is of considerable interest because it involves the deliberate application of general anatomical principles derived from the study of the gymnosperms, living and extinct, to the elucidation of the anatomical structure of the dicotyledons. Its author, as a result of a sojourn in South Africa, became possessed with a large amount of material of the Cucurbitaceae, a group well developed in this geographic region. He finds good reason for concluding from the study of the conservative peduncular and petiolar regions that internal phloem, a feature of the family, is not a primitive characteristic, but results from the fusion of inverted medullary strands with the inner surface of a normal cycle of bundles. Further studies from the same quarter will be awaited with interest.—E. C. JEFFREY.

**Potamogeton.**—While the economic aspect of the growth of various species of *Potamogeton* in ponds has been the prime object of investigation, Miss MOORE<sup>39</sup> has presented valuable data upon the habits of growth and reproduc-

<sup>37</sup> SARGANT, ETHEL, and ARBER, AGNES, The comparative morphology of the embryo and seedling in the Gramineae. *Ann. Botany* 29:161-222. *figs.* 35. *pls.* 9, 10. 1915.

<sup>38</sup> WORSDELL, W. C., The origin and meaning of medullary (intraxylary) phloem in the stems of dicotyledons. I. Cucurbitaceae. *Ann. Botany* 29:567-590. *figs.* 10. 1915.

<sup>39</sup> MOORE, EMMELINE, The *Potamogetons* in relation to pond culture. *Bull. Bur. Fisheries* 33:255-291. *pls.* 22-39. 1915.



tion in these plants. Emphasis is laid upon the propagation by tubers, tuberous rootstocks, winter buds, burs, and by fragments of stems. The economic aspect of the genus is inseparable from the ecology of the pond, for it deals principally with the food supply afforded a large number of animals, ranging from the larvae of Diptera to canvasback ducks. The paper is made more valuable by its numerous plates and by an extensive bibliography.—GEO. D. FULLER.

**Marine algae in fresh water.**—Experimenting with several species of marine algae, Miss BROWN<sup>40</sup> found that many soon died and disintegrated if placed in fresh water, or even in sea water with a larger admixture of fresh water. Other species, and notably *Enteromorpha intestinalis*, not only endured almost pure fresh water for a period of about 4 weeks, but also seemed to grow more rapidly in waters fresher than those of the sea. The factors involved in this tolerance were not further analyzed.—GEO. D. FULLER.

**Thelephoraceae.**—In continuing his studies of the Thelephoraceae of North America, BURT<sup>41</sup> presents *Exobasidium*, *Tremellodendron*, *Eichleriella*, and *Sebacina*, with a full historical discussion, synonymy, and citation of stations. The data in reference to the species are as follows: *Exobasidium*, 3 species; *Tremellodendron*, 7 species (2 new species and 3 new combinations); *Eichleriella*, 5 species (2 new species and 3 new combinations); *Sebacina*, 14 species (7 new species and 4 new combinations).—J. M. C.

**Species of Carex.**—MACKENZIE,<sup>42</sup> in continuing his studies of *Carex*, discusses *C. straminea* and some of its nearest allies, and also describes 8 miscellaneous new species, chiefly western, as follows: *C. festivella*, *C. Egglestonii*, *C. Lunelliana*, *C. bulbostylis*, *C. onustra*, *C. Sheldonii*, *C. exserta*, and *C. rugosperma*.—J. M. C.

**Polyporaceae.**—OVERHOLTS<sup>43</sup> has investigated certain critical forms of Polyporaceae, discussing characters and technique, and presents his conclusions in definitions of the 22 species considered.—J. M. C.

<sup>40</sup> BROWN, LOLA B., Experiments with marine algae in fresh water. Puget Sound Marine Sta. Publ. 1:31-34. 1915.

<sup>41</sup> BURT, EDWARD ANGUS, The Thelephoraceae of North America. IV and V. Ann. Mo. Bot. Gard. 2:627-658. pl. 21; 731-770. pls. 26, 27. 1915.

<sup>42</sup> MACKENZIE, K. K., Notes on *Carex*. IX. Bull. Torr. Bot. Club 42:603-621. 1915.

<sup>43</sup> OVERHOLTS, L. O., Comparative studies in the Polyporaceae. Ann. Mo. Bot. Gard. 2:667-730. pls. 23-25. 1915.



THE  
BOTANICAL GAZETTE

JUNE 1916

REDUCTION DIVISIONS IN THE POLLEN MOTHER  
CELLS OF *ALLIUM TRICOCCUM*

CONTRIBUTIONS FROM THE HULL BOTANICAL LABORATORY 215

MILDRED NOTHNAGEL

(WITH PLATES XXVIII-XXX AND ONE FIGURE)

**Introduction**

In accordance with a suggestion of Dr. D. M. MOTTIER made while the author was attending Indiana University during the summer of 1914, material showing the reduction divisions of *Allium tricoccum* was examined with the idea of comparing it with the results of a previous investigation of *Allium cernuum* (24). In many stages the results were the same, but a further investigation of other phases of the spore mother cell development has forced the author to change some views previously held.

The nuclei are large and the haploid number of chromosomes is only 8; consequently, individual members or portions of the spirem can be traced through various stages with less difficulty than is usually encountered.

Literature shows a great diversity of opinion as to whether or not the chromosomes visibly retain their individuality throughout the resting period; also concerning the structure of the resting nucleus; the state of the chromatin as it enters the synaptic ball; the actual time and method of reduction; and the origin of the spindle fibers. These questions the author has attempted to answer.



### Material and methods

The material was collected along the steep, damp, shady banks of Clear Creek, 6 miles south of Bloomington, Indiana. Collections were made 4 days and 5 days apart, from June 30 to July 27, and while some of the anthers at the earlier date failed to show differentiation of sporogenous tissue, many from the later collections were in the shedding conditions. Often all stages from resting to tetrad would be found in a single umbel.

Strong chromo-acetic acid was used for killing and fixing, and allowed to act 36 hours, the fluid being changed once or twice during that period, after which the material was washed 18–24 hours by means of repeated changes of water, slowly dehydrated, cleared in chloroform, and then imbedded in 52° paraffin.

Sections were cut 5–12  $\mu$  thick, varying with the stages sought. For the spindle and in some instances for the spirem, Flemming's modified triple stain was found to be preferable, although for all other phases, especially the early prophase, Haidenhain's iron-alum-haematoxylin gave the best results, lichtgrün in clove oil occasionally being used for a counter-stain.

### Description

#### PRESYNAPTIC AND SYNAPTIC STAGES

An attempt to determine the structure of the resting nucleus and the origin of the various stages that follow by first studying that resting condition would be difficult and indefinite. The investigation must begin with a stage concerning which there is little dispute, and from this may be traced the subsequent steps. Such a condition is to be found at late telophase of the last division in the sporogenous tissue, even though the chromosomes are more or less united by anastomoses, caused by considerable enlargement of the nucleus which followed the close association at early telophase (fig. 1). While still retaining this distinct individuality, although united with one another by anastomoses and at the same time slowly approximating end to end, a series of vacuoles appear along the median longitudinal portion of each chromosome (figs. 1–4), this being first made apparent by chromatin staining fainter



along that portion (figs. 2, 3). In the beginning the vacuoles are short, narrow slits (figs. 2, 3), but later, owing to their enlargement,

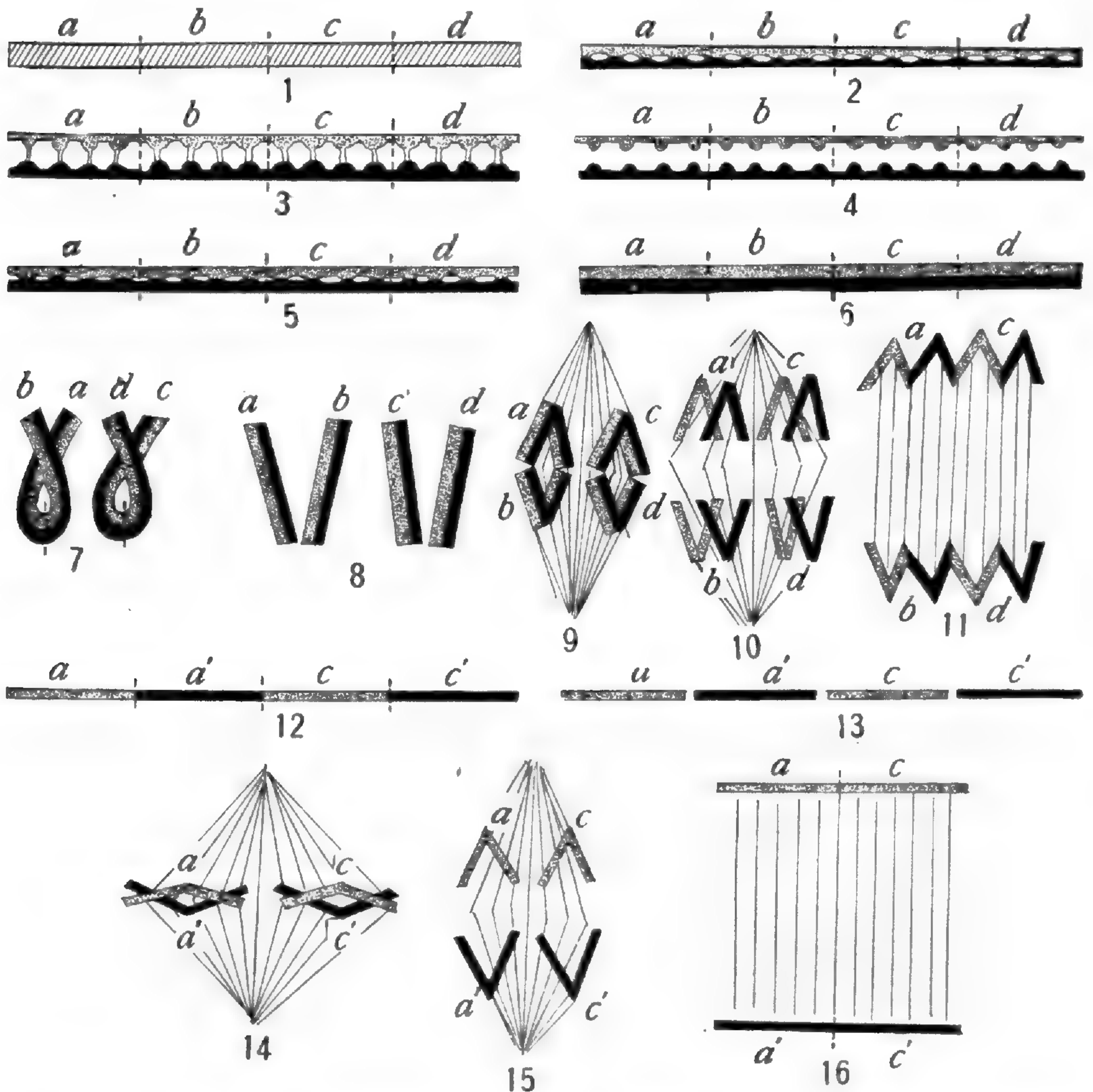

FIG. 1.—Diagram to illustrate reduction divisions as found in *Allium tricoccum*, 4 chromosomes only being shown: (1) telophase of last division of sporogenous tissue; (2) late telophase of same; (3) resting nucleus of pollen mother cell; (4) late resting condition; (5) going into synapsis; (6) condition of thread during synapsis and spirem; (7) segmented; (8) condition at time of third contraction and multipolar spindle; (9) metaphase; (10) anaphase; (11) telophase; (12) spirem of daughter nucleus; (13) segmented spirem of daughter nucleus; (14) metaphase; (15) anaphase; (16) tetrad or granddaughter nucleus.

the chromatin bordering the two sides of the vacuoles becomes more widely separated, although still joined together by portions or strands of chromatin that separate the vacuoles, resulting in



each chromosome having a ladder-like appearance (figs. 2-8). The rate of vacuolization is by no means uniform, as will be seen from an examination of figs. 2-5, and the distribution of chromatin over the ladder thread is very uneven, being heavier at the junction of the sides and the connecting strands. During this process several nucleoli appear in the comparatively large open spaces of the nucleus, each large nucleolus containing a relatively large oblong vacuole (figs. 5, 8).

It must be kept in mind that the ladder structures with their two sides and connecting strands have arisen from single somatic chromosomes, and are the result of a series of vacuoles along their median longitudinal axis. The so-called typical resting stage consists entirely of these structures, therefore, still joined more or less with one another by the anastomoses that arose at the last telophase (figs. 5-8). In the very early prophase the sides of the ladder are very fine (figs. 3, 4), but as the chromatin material increases, the threads become heavier and more uniform (figs. 5-8), while at the same time the anastomoses break down, and the connecting strands of chromatin between the two parallel sides grow finer and finer (figs. 7, 8) until they entirely disappear, leaving as a result two parallel threads (fig. 8), which are daughter halves of single somatic chromosomes.

As the parallel spirems, now entering synapsis, contract and condense, they gradually approach each other and approximate, at times twisting about one another (fig. 9) and resulting in a single thick spirem (figs. 10-13) which is the condition of complete synapsis, the heavy thread appearing as a homogeneous structure twisted and coiled about itself (figs. 11, 12), causing the mass to have a lumpy, granular appearance (fig. 12). At no time during this period, when sectioning and staining have been the best, is the thread lost to view (figs. 9-14); for even at the time of the greatest contraction, portions of the thread may be traced across the mass (fig. 11). This step in development is not necessarily uniform, for portions of the spirem in synapsis have been observed showing the double nature distinctly (fig. 10).

While these activities are going on, the nuclear cavity as well as the entire cell enlarges; although most of the growth is after the



chromatin material has contracted considerably. As the result of measuring many nuclei, only those being measured in which the entire nucleus was contained in the one section, the following statement may be made safely. Since the diameter of the contracted mass is considerably less than that of the nucleus just previous to contraction, or of the resting nucleus (figs. 7-12), synapsis is a true contraction. The synaptic mass lies almost or entirely against one side of the nuclear cavity, with the nucleolus just outside or partially held by a few strands of the spirem.

#### FORMATION OF BIVALENTS

As the synaptic mass loosens up, a comparatively thick, smooth thread may be seen twisting and winding about; and gradually loops free themselves, extending for various distances into the cavity (figs. 13, 14). It was stated that "a comparatively thick, smooth thread" was freed from the mass; while in fact the thread is irregular in outline and stains irregularly, the darker places being those denser chromatin aggregations seen in the ladder-like structure of the resting nucleus (figs. 3-9).

The spirem, although double in nature, is composed of single somatic chromosomes placed end to end, the double nature having arisen by the vacuolization or splitting of single chromosomes during late telophase of the last division of the sporogenous tissue.

When the spirem is entirely disentangled, loops of varying lengths are at first irregularly distributed within the nucleus (fig. 15); later, when they are peripherally arranged, the loops are longer and may be traced even entirely around the cavity, forming what is known as the hollow spirem (fig. 16). The double nature is rarely discernible during this latter period, since the thread has condensed and grown until it appears as a homogeneous structure staining uniformly throughout. Occasionally the halves of the thread separate (fig. 16) and may be seen even to twist about each other, the origin being in early synapsis (fig. 9, left side).

At the close of the hollow spirem stage the thread thickens and becomes entangled in the center (fig. 17), continuing until the typical second contraction results; which phase consists of the well known radiating loops that usually extend to the periphery



(fig. 18). The loops represent somatic chromosomes end to end which separate at the outer bend; that is, at the curve away from the entangled mass (figs. 19, 20, 21) rather than at the lower bend. Each radiating loop, therefore, does not represent the bivalents as seen in figs. 21*x*, *y*, 22. Instead, one arm of a loop pairs with and twists about an arm of a neighboring loop, this being plainly evident in the material. Fig. 19 illustrates such a condition, for here *a* and *a'* were formerly a continuous loop, likewise *b* and *b'*; but, following separation, *a* and *b* twist about one another, then opposite ends in all probability form a loop, resulting in *a*+*b* forming a bivalent, as seen in figs. 21*x*, *y*, 22, 23.

The bivalents of the aggregation continue to crowd together until only paired free ends extending from a dense mass can be recognized (fig. 20). When these segments loosen up, the chromosomes are found to be growing shorter and thicker. In case a misunderstanding should arise concerning the transition from fig. 21 to fig. 22, separate chromosomes have been drawn (figs. 21*x*, 21*y*). After the bivalents become dissociated and well distributed, eight are readily counted, each one representing 2 somatic chromosomes that formerly were end to end, although now they are twisted about each other. At times the 2 members of the bivalent are still continuous, that is, forming a loop; while in other cases they are not, causing the bivalent to be open at both ends. In either case it is not due to the splitting or to a separation of the halves of the spirem thread, since that spirem thread is composed of 16 somatic chromosomes with an end to end arrangement.

#### FROM THIRD CONTRACTION TO DAUGHTER NUCLEUS

About the time the bivalents are more or less distributed within the nuclear cavity, the fibers, which stain blue with Flemming's triple stain, appear outside the nuclear membrane (figs. 22, 23), running parallel to it, the ends extending out into the cytoplasm into which they merge (figs. 23, 24). While these are increasing in number and the nuclear membrane is disappearing, a peculiar behavior of the chromosomes has been noticed which seems to have a definite relationship to phases in the development of the spindle. The nuclear membrane slowly and unevenly disappears (fig. 23),



this being accompanied by further growth of fibers. These fibers gradually appear within the nuclear space even before the membrane is entirely gone (fig. 24). When this activity first begins, the chromosomes move slowly toward the center, so that by the time of the stage shown in fig. 25, where the membrane has entirely disappeared, the bivalents are tightly massed in the center, forming a *third contraction*. Step by step the kinoplasmic fibers encroach upon the chromosomes (figs. 25, 26), until they come in contact with them (fig. 27), this being immediately followed by the loosening up of the aggregation (figs. 28, 29). By this time there is a strong multipolar complex, which is apparent as early as the disappearance of the membrane. The number of poles may be many and irregularly arranged (figs. 28–31), and as the fibers are rearranged into sharper points, the chromosomes become more and more dissociated (figs. 28–31) and scattered upon the fibers. Those bivalents which formerly consisted of the two end to end somatic chromosomes and formed a loop (fig. 22) have separated transversely, making 16 chromosomes or 8 pairs (figs. 29, 30, 30x). Fastened to each member of a pair, approximately at the middle, is a group of kinoplasmic fibers (fig. 30x) extending to one of the several poles. As the multipolar spindle changes to the bipolar shape, the chromosomes that formerly were scattered irregularly upon the fibers (figs. 29–32) gradually arrange themselves upon the spindle's equator (figs. 32–35). During this latter period the chromosomes shorten considerably, having reached their largest size during multipolar phase, as well as slowly untwisting.

The forms that the pairs may assume now are various; some remaining slightly twisted, others form a U, while still others may become linked with one another, forming an X, or the ends of the pair may remain in contact, forming a ring. No form was found to be conspicuously dominant (fig. 31). Polar views of the spindle first show the chromosomes not to be peripherally placed (fig. 32), although before metaphase is completed they take that position (fig. 33). At this time the chromosome count again can be taken without difficulty.

The individual fibers that are attached to each chromosome may become so closely associated at the point of union with them



that the collection at first sight appears as a homogeneous mass and a part of the chromosome (fig. 34). These wefts retain their individuality for their full length and many times terminate in a very blunt pole (fig. 34).

During metakinesis, that is, just at the time when the paired segments separate, the dissociation of the two approximated halves, which originated in the resting stage (figs. 1-11), is finally completed (fig. 35), showing that the splitting or vacuolization of the somatic chromosomes in early prophase was in preparation for the homotypic division. There are now 16 chromosomes, for each half becomes entirely separated from its partner and does not again approximate (figs. 36-39). As the 16 members approach the poles, they shorten considerably, and as they crowd together an end to end formation results, thus forming an irregular spirem 16 chromosomes in length (figs. 37, 38). The crowding together continues until the entire chromatin mass is so closely associated that it is very difficult to distinguish the individual members; although, after the new nuclear membrane is formed, the looping spirem is again easily recognizable (fig. 39).

#### HOMOTYPIC MITOSIS

After the new membrane has been formed and the chromatin mass loosened up (fig. 39), anastomoses between portions of the looping spirem are everywhere evident. A coarse reticulum is formed as a result of the continual growth of the nucleus and the chromatin (fig. 40); but a resting stage is never reached. The spirem, which consists of 16 segments arranged end to end, will come directly from this reticulum (figs. 41, 42). This continuous spirem is quite regular in outline at first (fig. 41), but as the time for segmentation and formation of the multipolar complex approaches, the thread is more irregular and the outlines of the segments evident (figs. 42, 43); although it is not until the bipolar spindle is visible that the spirem separates into the 16 chromosomes (fig. 44). Simultaneous with this separation there is a pairing; so that 8 pairs of chromosomes come to lie upon the spindle fibers (figs. 44, 45). The paired chromosomes do not take the characteristic forms of the heterotypic mitosis, for at this time, although



there is a pairing, there is no twisting about of the members; but, instead, the tendency is to assume more elongated forms, such as hooks, rods, or wide U's. One member of each pair passes to a pole, where again there is an end to end approximation, as in heterotypic mitosis, of the 8 chromosomes or the haploid number (fig. 49). The tetrad, or 4 granddaughter nuclei, each containing 8 chromosomes, may all lie in one plane, although at times they occupy two planes.

### Discussion

#### PRESYNAPTIC AND SYNAPTIC STAGES

Since the investigation began with the examination of the late telophase of the last division of the sporogenous tissue while the individual chromosomes were still plainly evident, although joined together by anastomoses, it is clear to the author that there is not a pairing of somatic chromosomes in fig. 1, or that a previous approximation has taken place. If such were the case, 8 chromatin groups only would be visible. Even at this early phase the vacuoles are making their appearance along the median longitudinal line. The chromatin bordering these vacuoles could not be called linin, although the later enlargement of these forms the fine chromatin structure (figs. 2-8) that ALLEN (1), MOTTIER (21, 22, 23), STRASBURGER (30, 31), DIGBY (7), and others term linin. Furthermore, the heavier masses of chromatin granules are due to the nature of vacuole formation; for, as they enlarge, a greater amount of chromatin will be left at the angles between the vacuoles, thus giving rise to the so-called "chromomeres" strung along at irregular intervals on a linin thread.

BEER (2), MOTTIER (22, 23), and MOTTIER and NOTHNAGEL (24) find a single spirem formed from the network, in which condition it enters synapsis; while ALLEN (1), GRÉGOIRE (16), GRÉGOIRE and WYGAERT (17), BERGH (3, 4), YAMANOUCHI (32, 33), ROSENBERG (27), and OVERTON (25, 26) see a pairing of spirems either previous to or during synapsis, this act involving the pairing of somatic chromosomes, presumably maternal and paternal, after which they approximate and at metaphase of heterotypic mitosis separate. Nothing more than an inference or a suggestion has



been found in the literature showing that the double nature of the spirem of the heterotypic mitosis is due to the splitting or vacuolization of somatic chromosomes in the early prophase. In a paper on *Galtonia* by Miss DIGBY (7), the split for the division at metaphase of the somatic mitosis is shown to arise by the vacuolization in early prophase, thereby forming the split or the double thread. A similar condition is found in *Vicia Faba* by SHARP (28), and by FRASER and SNELL (12). As the result of the conditions found, Miss DIGBY says: "By taking a broad and comparative view of this heterotypic prophase in relation to the somatic prophase, one is forced to admit that the parallelism of the one is homologous with that of the other"; although in her conclusion she states that "the parallel portions in both represent longitudinal halves of somatic chromosomes, and are probably sister halves of the same chromosome, which are now severally coming together and condensing to form the somatic or univalent chromosome." The series of drawings are incomplete at this critical period, and any conclusion would have to be based upon her drawings 39*a* and *b*, and 40, none of which is later than the writer's figs. 3 and 5. Furthermore, steps illustrating the origin of these figures from figs. 30 and 31 have not been shown, and the gradual transition from the "beaded" resting nucleus (DIGBY 7, figs. 33, 36, 37) to the double condition of the spirem after synapsis appears to be more of a theory or an inference than a statement of observed facts.

In the early prophases of the heterotypic mitosis of *Vicia Faba*, Miss FRASER (11) finds conditions corresponding to those observed in *Allium tricoccum*. In this paper she describes diamond-shaped meshes that are due to the splitting of the somatic chromosomes in the early prophases; then later, that is, in synapsis, the cross-connections between the meshes breaking down, thus forming the spirem; and finally, in early anaphase, each chromosome splitting preparatory to homotypic mitosis, the origin of the split having been seen in the diamond meshes. The idea is very similar to that described by the author, but as in the paper by Miss DIGBY (7), Miss FRASER fails to have a series sufficiently close to demonstrate the origin of the split and the formation of the spirem from these



meshes. While the resting nucleus is said to consist of diamond-shaped meshes, it is in all probability the same as the ladder-like formation of *Allium tricoccum*.

As has been previously stated, the number of chromosomes in *Allium tricoccum* is small and the size large, so that the difficulty so often encountered in following the development is considerably lessened. Throughout these critical phases every precaution has been taken to prevent overlooking important stages. Since the pollen mother cells at the upper end of a loculus are a little earlier than those at the lower end in development, at least two consecutive stages could be found in a single section. In every case the later of the two stages observed has been found in the upper end of the loculus, where the third has been found and drawn, decreasing to a great extent the possibility of omitting critical stages or placing the wrong interpretation upon the origin of the double character found in the resting nucleus. Had figs. 5, 7, or 8 been the first nuclei observed after the telophase of the previous division, the conclusion could readily be drawn that the double thread arose by the pairing of somatic chromosomes; but, after seeing the beginning of vacuolization (figs. 1, 2) and following its development step by step (figs. 2-9), no other conclusion is possible than that the paired threads going into synapsis are the two halves of single somatic chromosomes, and not paired somatic chromosomes, as held by GRÉGOIRE (16) and YAMANOUCHI (32, 33).

Fig. 8 illustrates the breaking down of the connecting strands between the two sides of the ladder-like structures, and on the right side of this figure the act has been completed, leaving the halves completely separated except for the portion connecting them at the end. MOTTIER (22) states that "the delicate threads joining the chromatic masses may be found lying close to each other and parallel, but this does not signify that a double spirem is in process of formation"; although in his figures of this stage (MOTTIER 22, figs. 1, 17, 34) he shows nuclei very similar to that in fig. 5 of *Allium tricoccum*; and by tracing this further it is very probable that the origin of the double nature of the hollow spirem, as described by MOTTIER (21, 22, 23), might be found.



No suggestion of the spiral arrangement with the strands radiating from a "Chromatinknoten" as described by BONNEVIE (5) has been observed.

That the chromosomes retain their individuality and do not break up into a network is claimed by GRÉGOIRE (15), YAMANOUCHI (32, 33), SHARP (28), OVERTON (25, 26), STOUT (29), BONNEVIE (5), and LAWSON (19); this is also evident in *Allium tricoccum*. Although the chromosomes become considerably vacuolate and thus cause the net appearance, the individual members never lose their entire individuality, as can be seen from the description and drawings, and later, owing to a larger amount of chromatin material and a more even distribution of it, the chromosomes form a more or less continuous thread, the spirem.

Little growth occurs during the later stages of the resting nucleus, but when the chromatin mass starts to contract, it increases slightly in size, but not to the extent claimed by LAWSON (19); that is, that the appearance of the contracted mass is due to the growing away of the nuclear membrane. Comparison of figs. 8, 9, 10, and 11<sup>1</sup> will make this clear, as fig. 11 is a drawing of an entire nucleus, the dimensions of the chromatin mass being considerably less than that of figs. 7 or 8. It is not until the mass has contracted extensively that the large increase in size of the nuclear cavity occurs (figs. 10, 11). Were it but an apparent contraction, as LAWSON (18) states, due to the inflow of karyolymph into the nuclear cavity, the osmotic pressure would be decreased, not increased, and the increase in size would be the result of the larger amount of fluid that it must hold.

As synapsis approaches, the two halves of the spirem gradually approximate (figs. 9, 10, 11), the final step usually being accomplished during synapsis (fig. 11); although even as late as the stage shown in fig. 10 the act might not have been completed along the entire length. This process corresponds to that described by GRÉGOIRE (14, 15), YAMANOUCHI (32, 33), OVERTON (25, 26), and ALLEN (1), although these investigators claim it

<sup>1</sup> Figs. 1-12 were made with a magnification of 3500, while fig. 12 has a magnification of 2650, so that comparison of the latter with the former is not to be made where questions of size are concerned.



to be the approximation of whole somatic chromosomes, or pseudo-reduction.

#### FORMATION OF BIVALENTS

With close observation during early spirem, the double nature is still discernible, although it is rare that the two halves separate as found in *Allium cernuum* (MOTTIER and NOTHNAGEL 24), and as commonly found in *Lilium*. The lumpy condition of the thread at this time is due to the larger chromatin collections of the early prophase (figs. 5-9), this appearance being the basis of the statements of FARMER and MOORE (9), MOTTIER (22), and others who interpret such as dividing chromomeres, thereby initiating the longitudinal split. This dual nature has been seen in most cases, although it has been attributed to two sources. Those believing in pseudo-reduction in early prophase assert that it is the two spirems that have paired, while MOTTIER (21, 22, 23), STRASBURGER (30, 31), BEER (2), GATES (13), FARMER and MOORE (9), and FARMER and SHOVE (10) say that the spirem has split in preparation for the homotypic division. In this latter case, however, the split was not traced to its origin. The two halves soon approximate so closely that the spirem appears as a homogeneous structure (figs. 15, 16). Comparatively few ends are seen when sections are cut  $12\ \mu$  thick, and from all of those observed it appeared to be due to cutting. So far as the stages to follow are concerned, it would make little or no difference whether the spirem be continuous or non-continuous.

At first, as formerly stated, the spirem is irregularly placed within the nuclear cavity (figs. 14, 15), this being followed by a peripheral arrangement, thereby forming the typical hollow spirem as described by MOTTIER (21, 22), MOTTIER and NOTHNAGEL (24), and BEER (2); at which time the thread may be followed for a considerable distance. As it thickens and shortens, the second contraction period is entered upon, although OVERTON (26) fails to find such a stage in *Thalictrum purpurascens*, *Calycanthus floridus*, and *Richardia africana*; also GRÉGOIRE (16) fails to observe it at times in *Lilium speciosum*; both regarding such an act as of little significance in the reduction division. The author believes this step to be of considerable importance.



Up to and including the second contraction, a nucleolus is usually present (figs. 17, 18), although some of the drawings fail to show such, as it was either not included in that section, or it was purposely left out, owing to obscuring too great a portion of the other chromatin material.

During second contraction (fig. 8), the characteristic radiating loops extend from the tangled mass, the first sign of segmentation being seen at the peripheral end of the loop, resulting in the free ends being next to the nuclear membrane (figs. 19, 20). ALLEN (1) has reported a similar observation in *Lilium canadense*, but this is contrary to the reports of MOTTIER (21, 22, 23) and BEER (2), these investigators describing the radiating loop as forming the bivalent. With the loop segmenting at its outer bend, it necessarily follows that either the bivalent is continuous at the lower end, as stated in the description of this stage, or that segmentation occurs at both ends, followed by a pairing of single somatic chromosomes. During the period of segmentation and formation of bivalents, the chromatin thread contracts, although not suddenly (cf. figs. 18-24), resulting in 8 thick bivalents being fairly evenly distributed within the nuclear cavity.

All cytologists agree upon the point that in heterotypic mitosis a bivalent consists of 2 somatic chromosomes, but concerning the mode of formation there is a great difference of opinion. ALLEN (1), BERGH (3, 4), GRÉGOIRE (16), GRÉGOIRE and WYGAERT (17), OVERTON (25, 26), ROSENBERG (27), and YAMANOUCHI (32, 33), who claim there is a pairing of somatic chromosomes or spirems in early prophase, state that the bivalent is composed of 2 segments that in the spirem were side by side, reduction therefore occurring by the pairing of 2 spirems; while BEER (2), FARMER and MOORE (9), FARMER and SHOVE (10), and MOTTIER (21, 22, 23) demonstrate that it is formed by the twisting about of 2 somatic chromosomes that previously were end to end in the spirem, thus causing a transverse segmentation to be responsible for the reduction. *Allium tricoccum* confirms this latter view, and if the series here given be followed, it will be seen that the arms *b* and *a* of fig. 19 have not arisen from the separation of 2 approximated spirems of a previous stage (fig. 18), yet doubtless these 2 will



by a gradual thickening (figs. 20, 21, 21x, y, 22) form a bivalent (fig. 22).

Each bivalent, therefore, is composed of 2 somatic chromosomes, presumably maternal and paternal, that previously had an end to end arrangement in the spirem, and which may be open either at both ends or at one end. In the latter case a later segmentation will separate the two. So far as any result that is to follow is concerned, the author conceives it to be of little importance whether it be the one condition or the other. Some claim that the bivalents are always open at both ends, which would necessarily be the case were they derived from a paired spirem; but definite cases have been found where the bivalents were continuous at one end (figs. 22, 23), and in fig. 22, lying under another bivalent, will be seen one in which the two arms have not twisted about each other as yet, but are lying more or less stretched out in the cavity. Under such circumstances the bivalent could not have been formed as GRÉGOIRE (16), ALLEN (1), and YAMANOUCHI (32, 33) have claimed.

To repeat once more, each arm of a bivalent is necessarily of a double nature, owing to the approximation of the two halves of single somatic chromosomes in synapsis, so that in cross-section a bivalent has a tetrad arrangement.

#### FORMATION OF SPINDLE AND DAUGHTER NUCLEI

Nothing has been found in the literature describing the third contraction or its relationship to spindle formation.

LAWSON (18, 20) finds the web of fibers, these being transformed cytoplasm, outside the nuclear membrane as early as the spirem stage, although in *Allium tricoccum* they are not visible until segmentation.

After carefully studying the paper entitled "Nuclear osmosis as a factor in mitosis" by LAWSON (20), and then comparing the same with results found in *Allium tricoccum*, many points of disagreement were encountered. As has been pointed out by FARMER (8), LAWSON has used the term "permeable membrane" in describing the nuclear membrane, after which he continues to speak of osmotic systems and exosmosis. In this discussion, when speaking of the membrane in this connection, the term "semipermeable



membrane" will be used. Undoubtedly the nuclear membrane, which is the inner limiting layer of the cytoplasm formed there by the contact of cytoplasm and karyolymph, is a semipermeable membrane, and also, at the time of spindle formation, exosmosis is taking place, since the nuclear cavity is gradually decreasing in size (figs. 22-27) from the time of development shown in figs. 22 and 23, when the fibers are first evident outside the membrane. Since the membrane results from the contact of cytoplasm and karyolymph, the same chemical reaction would occur when the nuclear sap gradually diffuses into the cytoplasm. Such is the author's interpretation of the web of fibers outside the nucleus. The diffusion is gradual, and the precipitation would then be slight, resulting in the fine fibers. The cytoplasm is not forced to occupy more cubical space, as LAWSON claims, for karyolymph is steadily, though slowly, passing through this semipermeable membrane, and owing to the precipitation the fibers occupy the space left by the receding nucleus.

It is while the foregoing is occurring that the third contraction or massing of the chromosomes in the center of the cavity becomes so conspicuous (figs. 23-27), although as yet the fibers are not in contact with them; and furthermore, the membrane disappears previous to the filling up of the cavity by the fibers (figs. 24-26). If the plasma membrane completely invested the bivalents, as claimed by LAWSON, a cavity would be left between it and the fibers in the case of *Allium tricoccum* (figs. 25, 26), under which circumstances the fibers could not be moored to the membrane (LAWSON 20).

It was owing to the contact of the two chemically different substances that the heavy plasma membrane was precipitated, but with the kinoplasmic fibers now being formed between the membrane and the reticulate cytoplasm, this chemical antithesis is decreased, resulting in a decrease in the amount of precipitation. In other words, the membrane becomes thinner and thinner until it either disappears entirely or becomes a part of the spindle fibers. When the nuclear cavity is completely filled with the kinoplasmic threads, the chromosomes loosen up, probably owing to the completion of exosmosis from the cavity, as well as partially on account of the osmotic systems within each chromosome.



The bivalents are now open at both ends and not quite as large as formerly, decreasing from now on (fig. 24). When they first loosen up, fibers are not fastened to each chromosome apparently; but as the multipolar complex forms, a weft becomes moored to each one, in many instances so conspicuous (figs. 29-35) that it appears to be homogeneous structure at the point of attachment, owing to the thick fibers and also to their close association.

Each chromosome, as stated by LAWSON (20), is saturated with karyolymph and is an osmotic system; although this does not necessarily mean that the old membrane must surround each member in order to accomplish this. If such were the case, the membrane would have to break up into the proper number of pieces, wrap about each chromosome, and then become sealed; a process which is far more complex than ever before attributed to a nucleus. Each chromosome will have the power to develop its own membrane, owing to diffusion of the sap from it, and since each then will have the same osmotic power as the nucleus did as a whole, the same process will continue as it did with the nucleus, resulting in the formation of a weft of fibers from each individual. The fact that these wefts are distinct from the other fibers points strongly toward this idea.

LAWSON'S theory that the shift from multipolar spindle to bipolar spindle is an expression of "lines of tensions" appears to the author to have little or no foundation, since the reticulate cytoplasm is not forced to occupy less cubical space than formerly.

The paired chromosomes, which formerly were tightly twisted about each other, gradually come to lie upon the equatorial plate; the fibers formed outside the nuclear membrane extending from pole to pole and the individual tufts of fibers attached to the chromosomes extending to but one pole. At metaphase the separation of whole somatic chromosomes, that previously were end to end in the spirem, is completed, this reduction being immediately followed by the longitudinal separation of the halves (fig. 35) of each of these, the origin of which was seen in the resting nucleus (figs. 2-10). Those believing in the pairing of somatic chromosomes or spirems in early prophase or pseudo-reduction have little to say concerning the origin of this split; while those claiming that



the spirem is a single structure splitting during the spirem stage demonstrate that the separation during anaphase is the result of this former activity.

Contrary to most reports, the halves of the chromosomes in *Allium tricoccum* become entirely dissociated during anaphase, so that a polar view of such shows 16 individuals, or the  $2x$  number. These 16 remain distinct from now on, and at late anaphase or early telophase they join up end to end (fig. 38), after which the looping spirem becomes very much crowded. As some karyolymph still remains, this diffuses out and the nuclear membrane is formed about the densely crowded chromatin mass, as described by LAWSON (20) and YAMANOUCHI (32).

#### HOMOTYPIC MITOSIS

A spirem consisting of 16 segments, that approximated end to end at late anaphase of the previous mitosis (fig. 38), forms early in the daughter nucleus (fig. 42), since a resting condition does not intervene. In all reports read concerning the homotypic divisions, the spirem is interpreted as being  $x$  chromosomes in length and double, owing to the longitudinal separation during the previous anaphase. As the multipolar spindle appears, the spirem forms 16 segments (fig. 44) which immediately pair (fig. 45), forming 8 pairs of half chromosomes. It is probably owing to the rapidity of the pairing that previous investigators have claimed the longitudinal split to be completed at this time instead of during the heterotypic mitosis. Unless a close series had been followed and the end to end approximation of the half chromosomes been observed, the author would probably have made a similar interpretation. If each chromosome is to maintain its individuality, no other results could be expected.

All this goes to show that at metaphase of heterotypic division there is a reduction or separation of characters, but it is not until homotypic division that the reduction in number is actually accomplished.

#### Conclusion

In comparing the nuclei during the reduction division, as seen in *Allium tricoccum*, with the nuclei during somatic division, as described by SHARP (28) for *Vicia Faba* root tips, it is seen that



both have a similar structure during the early prophase. The first difference is evident when, apparently owing to some osmotic force, the thread contracts into the synaptic ball. During this contraction there is an increase in chromatin substance, preparatory to the two rapid divisions which follow. At the time of second contraction, this condition undoubtedly being due to osmotic activity again, bivalents are formed. Following the third contraction, where it has been pointed out plainly that exosmosis is the factor underlying spindle formation and massing of bivalents, the members of each pair separate for opposite poles. Seemingly this last contraction, or the 3 contractions taken together, hold in check the dissociation of the halves, which in somatic mitosis would have occurred at this time; for immediately following the separation of whole chromosomes, the halves move apart, join end to end, and, as soon as a new spindle is formed, go to opposite poles.

From this investigation it appears to the author that on account of these various contractions, a regular somatic mitosis, although started normally, is first varied and then checked for a time, resulting in the heterotypic division, and not until homotypic division is the typical mitosis completed.

### Summary

1. During late telophase of the last division of the sporogeneous tissue a row of vacuoles appears along the median longitudinal axis of each chromosome, these enlarging until each member is a ladder-like structure. Accompanying this there is an end to end approximation. Such is the condition of the resting nucleus.

2. The paired threads entering synapsis and there approximating are the two sides of the ladder, the connecting strands having broken down. This process does not represent the pairing of two spirems. Throughout this period the chromosomes have retained their individuality.

3. The spirem, which consists of 16 end to end chromosomes, will take the form of radiating loops during second contraction, segmentation occurring at the outer bend. Each of the bivalents so formed consists of two somatic chromosomes that were end to end in the spirem.



4. Spindle fibers are the result of exosmosis of karyolymph into the cytoplasm, these being formed after the same fashion as the nuclear membrane. The membrane, if it persists, will be a part of the fibers.

5. The third contraction which accompanies fiber formation consists of a balling up of the chromosomes previous to the complete filling up of the cavity with fibers.

6. Each chromosome is an osmotic system in itself and capable of forming its own weft of fibers after the sap from the nuclear cavity has been exhausted.

7. The heterotypic division or the reduction of characters results from a transverse separation of whole chromosomes.

8. During early anaphase the halves of the chromosomes, which originated in presynapsis, separate longitudinally and at early telophase approximate end to end, forming the looping spirem of the daughter nucleus,  $2x$  chromosomes in length. Division in homotypic mitosis, therefore, results originally from a longitudinal separation.

9. The transverse separation of the 16 segments during early metaphase of the homotypic mitosis is immediately followed by their pairing.

10. To all appearances a typical mitosis is begun, but is varied and delayed for a time by a heterotypic mitosis as the result of the various contractions, being finally completed in the homotypic division.

To Dr. J. M. COULTER and Dr. C. J. CHAMBERLAIN I wish to express my appreciation for their most helpful suggestions and criticisms during the progress of this work, and also to Dr. D. M. MOTTIER of Indiana University, under whom this work was commenced.

UNIVERSITY OF CHICAGO

#### LITERATURE CITED

1. ALLEN, C. E., Nuclear division in pollen mother cells of *Lilium canadense*. Ann. Botany 29:189-258. pls. 6-9. 1905.
2. BEER, R., Studies in spore development. II. On structure and division of the nucleus in the Compositae. Ann. Botany 26:705-726. 1912.



3. BERGH, JULES, La formation des chromosomes hétérotypiques dans la sporogénèse végétale. II. Depuis la sporogonie jusqu'au spirème définitif dans la microsporogénèse de *Allium fistulosum*. La Cellule 21: 383-397. 1904.
4. ———, La formation des chromosomes hétérotypiques dans la sporogénèse végétale. III. La microsporogénèse de *Convallaria majalis*. La Cellule 22:41-53. 1904.
5. BONNEVIE, K., Chromosomenstudien. III. Chromatinreifung in *Allium Cepa* (♂). Arch. Zellforschung 6:190-253. 1911.
6. DAVIS, B. M., Cytological studies on *Oenothera*. II. Reduction division of *Oenothera biennis*. Ann. Botany 24:631-653. 1910.
7. DIGBY, L., The somatic, premeiotic, and meiotic nuclear division of *Galtonia candicans*. Ann. Botany 24:727-758. 1910.
8. FARMER, J. B., Nuclear osmosis and meiosis. New Phytol. 12:22-28. 1913.
9. FARMER, J. B., and MOORE, J. E. S., The meiotic phase in animals and plants. Quart. Jour. Micr. Sci. 48:489-555. 1905.
10. FARMER, J. B., and SHOVE, DOROTHY, On the structure and development of the somatic and heterotypic chromosomes of *Tradescantia virginica*. Quart. Jour. Micr. Sci. 48:559-571. 1905.
11. FRASER, H. C. I., The behavior of the chromatin in the meiotic divisions of *Vicia Faba*. Ann. Botany 28:633-643. 1914.
12. FRASER, H. C. I., and SNELL, F., The vegetative division of *Vicia Faba*. Ann. Botany 25:845-855. 1911.
13. GATES, R. R., A study of reduction in *Oenothera rubrinervis*. BOT. GAZ. 46:1-35. 1908.
14. GRÉGOIRE, V., Les résultats acquis sur les cinèses des maturation dans les deux règnes. Premier mémoire Revue critique de la littérature. La Cellule 22:221-376. 1905.
15. ———, Les fondements cytologiques des théories courantes sur l'hérédité Mendélienne. Ann. Soc. Roy. Zool. et Malacol. Belgique 42:267-320. 1907.
16. ———, La formation des gémini hétérotypique dans les végétaux. La Cellule 24:369-420. 1907.
17. GRÉGOIRE, V., and WYGAERT, A., La reconstruction du noyau et la formation des chromosomes dans les cinèses somatique. I. Racine de *Trillium grandiflorum* et télophase homotypique dans le *Trillium cernuum*. La Cellule 21:7-76. 1903.
18. LAWSON, A. A., Studies in spindle formation. BOT. GAZ. 34:81-100. 1903.
19. ———, The phase of the nucleus known as synapsis. Trans. Roy. Soc. Edinburgh 47:591-604. 1911.
20. ———, Nuclear osmosis as a factor in mitosis. Trans. Roy. Soc. Edinburgh 48:137-161. 1911.



21. MOTTIER, D. M., Heterotypic chromosomes. *BOT. GAZ.* 40:171-178. 1905.
22. ———, The development of the heterotypic chromosomes in pollen mother cells. *Ann. Botany* 21:309-349. 1911.
23. ———, Mitosis in pollen mother cells in *Acer Negundo* L. and *Staphylea trifolia* L. *Ann. Botany* 28:115-135. 1914.
24. MOTTIER, D. M., and NOTHNAGEL, MILDRED, The development and behavior of the chromosomes in the first or heterotypic mitosis of pollen mother cells of *Allium cernuum* Roth. *Bull. Torr. Bot. Club* 40:555-565. 1913.
25. OVERTON, J. B., Über Reduktionsteilung in den Pollen Mutterzellen einigen Dikotylen. *Jahrb. Wiss. Bot.* 42:121-153. 1905.
26. ———, On the organization of the nuclei in the pollen mother cells of certain plants with especial reference to the permanence of the chromosomes. *Ann. Botany* 23:19-63. 1909.
27. ROSENBERG, O., Über die Reduktionsteilung im Droserai Neiddel. *Stockholms Högs. Bot. Inst. p.* 13. 1904.
28. SHARP, L. W., Somatic chromosomes in *Vicia*. *La Cellule* 29:297-333. 1913.
29. STOUT, A. B., The individuality of the chromosomes and their arrangement in *Carex aquatilis*. *Arch. Zellforschung* 9:114-141. 1912.
30. STRASBURGER, E., Reduktionstheilung. *Sitzungsber. Konigl. Preus. Akad. Wiss.* 18:587-614. 1904.
31. ———, Typische und allotypische Kernteilung. *Jahrb. Wiss. Bot.* 42:1-70. 1905.
32. YAMANOUCHI, S., Sporogenesis in *Nephrodium*. *BOT. GAZ.* 45:7-31. 1908.
33. ———, Chromosomes in *Osmunda*. *BOT. GAZ.* 49:1-13. 1910.

#### EXPLANATION OF PLATES XXVIII-XXX

All figures were drawn with the aid of a Spencer camera lucida with Bausch and Lomb  $\frac{1}{2}$  immersion and ocular 12, except figs. 1-11 inclusive, which were drawn with Bausch and Lomb  $\frac{1}{8}$  immersion and ocular 12. Magnification of figs. 1-11 inclusive  $\times 3500$ ; all others  $\times 2650$ . The plates are reduced to two-thirds the original size.

#### PLATE XXVIII

FIG. 1.—Late telophase of the last division of the sporogenous tissue, showing the anastomoses and the beginning of vacuolization along the median longitudinal axis.

FIG. 2.—A later stage, most of the chromosomes being vacuolate.

FIGS. 3, 4.—Early stages of the pollen mother cells, which consist of ladder-like structures that arose by vacuolization of the chromosomes; some of the chromosomes still entire, owing to unevenness of vacuolization.



FIG. 5.—Typical resting nucleus of the pollen mother cell; chromatin aggregations comparatively large, and the connecting strands very fine.

FIGS. 6, 7.—Somewhat later stages in which the anastomoses are disappearing, connecting strands between the parallel sides becoming very fine in structure, and the sides of the ladder growing more uniform.

FIG. 8.—Late resting stage; the connecting strands disappearing, leaving two parallel daughter spirems.

FIG. 9.—Early synapsis; the two parallel daughter spirems approaching each other and at places approximating.

FIG. 10.—A later stage; the double nature still plainly discernible in many places.

FIG. 11.—Complete synapsis, showing the coiled spirem in which approximation has been completed.

FIG. 12.—Same as above, but magnification not so great.

FIG. 13.—Coming out of synapsis.

FIG. 14.—Late coming out of synapsis, the double row of granules still visible, these being the remains of the larger chromatin aggregations as seen on the ladder-like structures.

FIG. 15.—Spirem; traces of the granules of early prophase showing.

FIG. 16.—Hollow spirem; granules evident and occasionally a split where approximation was not complete.

#### PLATE XXIX

FIG. 17.—Beginning of second contraction; the spirem very heavy.

FIG. 18.—Second contraction consisting of radiating loops.

FIG. 19.—Segmentation beginning at the outer bend of the loop; *a* and *a'* formerly being continuous, likewise *b* and *b'*; although at this time *a* and *b* are twisting about each other to form the bivalent.

FIG. 20.—Further contraction of the chromatin mass in which the free ends of the bivalents are radiating out from the mass.

FIG. 21.—Loosening up of the bivalents.

FIG. 21*x* and *y*.—Showing the gradual thickening of the bivalents.

FIG. 22.—Eight bivalents evenly scattered within the nuclear cavity in which some are seen to be open at both ends, others closed at one end, while still another, lying under the others, is seen to be stretched out instead of twisted.

FIG. 23.—Beginning of the fiber formation outside the nuclear membrane which accompanies the third contraction; also the disappearance of the nuclear membrane.

FIG. 24.—A slightly later stage; nuclear membrane apparently gone on one side of the nucleus.

FIG. 25.—Later; the fibers in contact with part of the chromosomes; nuclear membrane entirely disappeared; the multipolar complex begun.

FIG. 26.—A later stage.



FIG. 27.—Third contraction complete; fibers have completely filled the nuclear cavity.

FIG. 28.—Multipolar spindle; chromosome aggregation loosening up.

FIG. 29.—Formation of the individual wefts of fibers for each chromosome; the scattering of the bivalents upon the fibers; and a step farther in the transition from multipolar to bipolar spindle.

FIG. 30.—A later stage.

PLATE XXX

FIG. 31.—Bipolar spindle; bivalents stretched out upon the fibers.

FIG. 32.—Polar view of early metaphase.

FIG. 33.—Polar view of metaphase with bivalents peripherally arranged.

FIG. 34.—Metaphase in which the individual wefts of fibers are extending from each chromosome to the pole; also the fibers' massive organization at the point of attachment; to the left is a weft that has been broken from its chromosome.

FIG. 35.—Early anaphase; the longitudinal halves of each somatic chromosome that arose by vacuolation in early anaphase are again becoming apparent.

FIG. 36.—Anaphase; halves of the somatic chromosomes entirely separated.

FIG. 37.—Polar view of the same.

FIG. 38.—Late anaphase; 16 half chromosomes approximating end to end to form a spirem  $2x$  chromosomes in length.

FIG. 39.—Daughter nucleus after loosening up of chromosomes.

FIG. 40.—Daughter nucleus; irregular net appearance due to the anastomoses.

FIG. 41.—Daughter nucleus; spirem stage in which the fibers of previous mitosis have not disappeared.

FIG. 42.—Daughter nucleus; late spirem in which the outlines of the segments are discernible.

FIG. 43.—A later stage in which the multipolar complex has appeared.

FIG. 44.—Segmentation into 16 segments followed immediately by their pairing.

FIG. 45.—Polar view of metaphase of homotypic mitosis.

FIG. 46.—Late metaphase of the two daughter nuclei.

FIG. 47.—Same, but only one daughter nucleus in plane.

FIG. 48.—Anaphase of homotypic mitosis.

FIG. 49.—Telophase of homotypic mitosis; end to end approximation of 8 chromosomes just previous to organization of granddaughter nucleus.



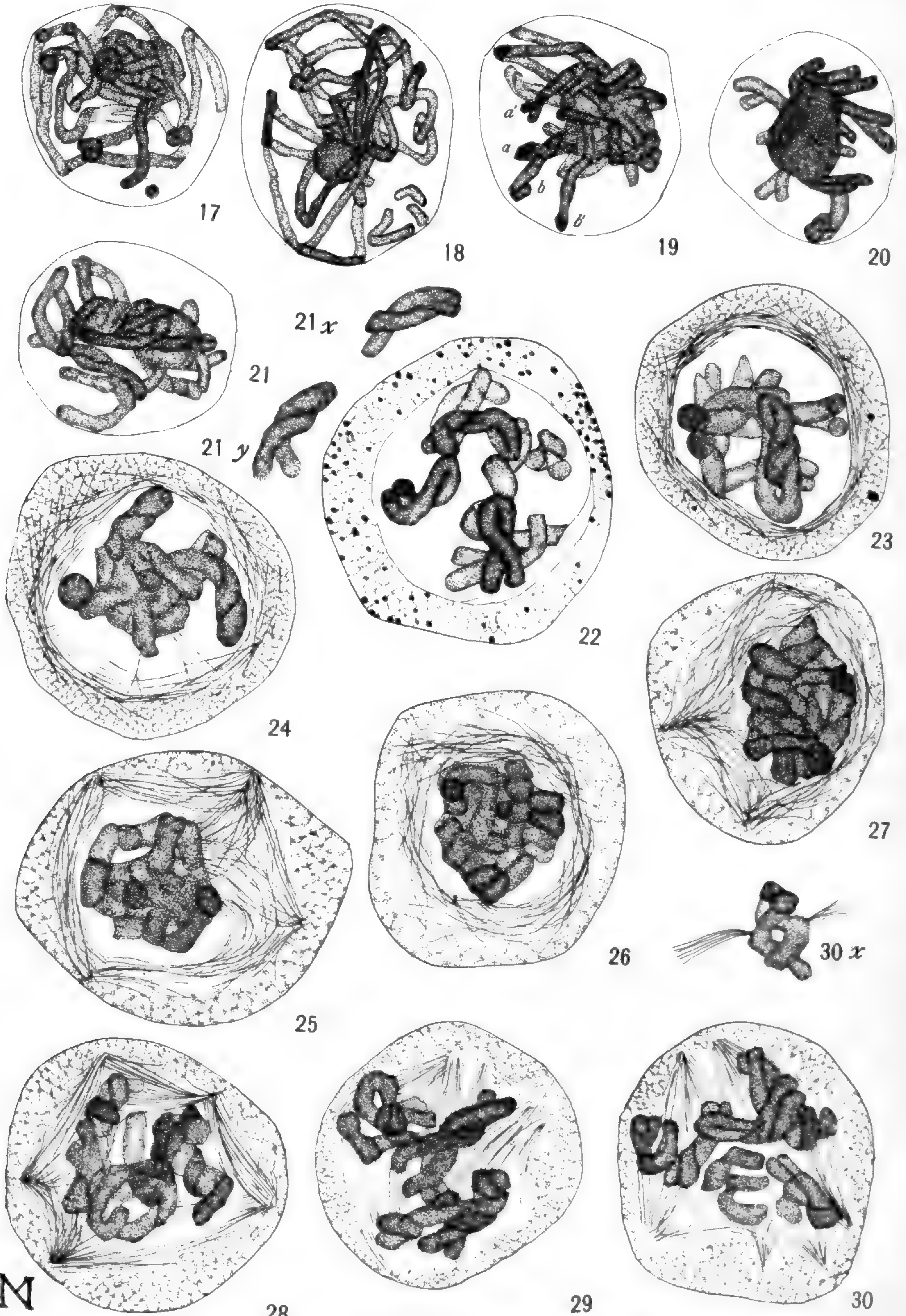

N



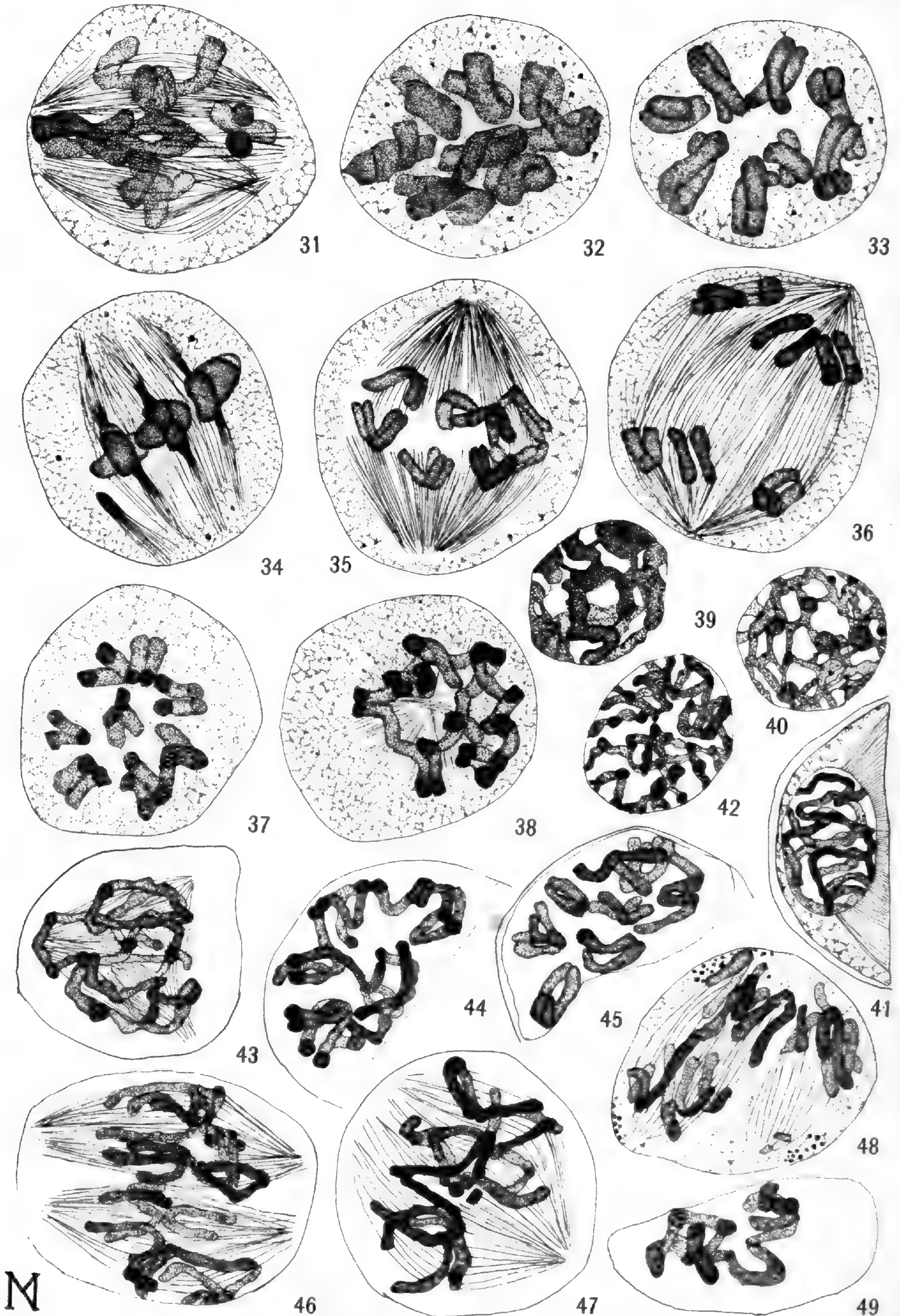

NOTHNAGEL on ALLIUM TRICOCCUM



# THE VEGETATION OF THE SELKIRKS<sup>1</sup>

CHARLES HUGH SHAW

(WITH MAP)

A most attractive region for the study of mountain vegetation is found in the vicinity of the Continental Divide in Western Canada. The mountains, glacier crowned and of the noblest order, are covered in their lower reaches by luxuriant forests. In the higher altitudes are extensive areas where a rich alpine vegetation finds its appropriate home. The region, therefore, is a most attractive field for the botanist, especially since the whole area is as yet practically undisturbed by man. During the last few years the writer has had considerable opportunity for observation there. Base camps have been established at spots thought favorable for the study of the plant life, and quasi-exploring expeditions have been made into districts remote from the railroad. Although only very moderate progress has been made toward a solution of the great questions which present themselves, it was thought that a description of the vegetation as it exists would be of some interest and of value as a record.

<sup>1</sup> This paper has been compiled from Dr. SHAW's notes by one of his students (Miss CAROLINE S. ROMER) who accompanied him on three of his six exploring trips in the Selkirks and who studied the vegetation of the region under his guidance during two of these trips.

As will be remembered by those botanists who are interested in the development of ecological botany in North America, Dr. SHAW, one of the most earnest and most promising of the younger ecologists, chose as his field of investigation the ecological problems presented by the vegetation of the little known Selkirk Mountains. His work was cut short by his lamentable death by drowning in Kinbasket Lake in July 1910. Extensive notes which he had made during June and July 1910 were unfortunately lost with him. The material that he left comprises, besides many specimens sent to several of the more important herbaria, the introduction to this paper in its present form, and numerous notes concerning the plant life of the Selkirks. To interpret these notes has been no light task. There are doubtless mistakes, errors in interpretation, but, as it seemed to Dr. SHAW's friends and to his fellow-botanists that his work should not be entirely lost, this record of his Selkirk studies has been made as nearly as possible like the record that he expected to make.



### Topography

The general topography of the region will be understood by keeping in mind the course of the Columbia River. The first 500 miles or so of its course are in the form of a huge acute angle whose apex is directed northwest and whose western arm extends southward. The upper or eastern arm flows northwest parallel to the Continental Divide, and the "bend" is just above  $52^{\circ}$  north latitude. The mountains east of the river and forming the Divide are the Rockies proper; those nearly surrounded by the Columbia, especially those above  $51^{\circ}$ , are called the Selkirks; while west of the river, and separating its basin from that of Fraser, is the Gold Range. It will thus be seen that the Columbia River rises in the midst of the continental mass of mountains, in the midst also of the cordilleran forest which at this latitude extends from the Great Plains to the dry interior of British Columbia. The area dealt with in the present paper is that of the Selkirks proper, taking  $51^{\circ}$  north latitude as an arbitrary southern limit; the rest of the boundary being formed, of course, by the river itself. The area thus delimited is practically untouched by human influences. The Canadian Pacific Railway indeed passes through it, and has opened up some wonderful spots to the traveler, but in most places the influence of the railroad has not made itself felt a gunshot from the tracks. North of the railroad there is neither wagon road nor village, store nor post-office, white woman nor child. A scattered line of settlements along the railroad, half a dozen or less inhabited cabins on the river, a mining camp or two, and a few wandering trappers or prospectors constitute the sum of its human influences. From the naturalist's standpoint these have no importance in relation to the broad leagues of wilderness. The phenomena of plant life which may now be seen represent, therefore, the results of conditions operating through a long series of generations, beginning with the last retreat of the ice.

The entire area is extremely mountainous, and in the character of its topography young. The mountains are lofty and precipitous, the streams narrow and swift. Innumerable snowfields and glaciers cover the high summits, tongues of ice not seldom reaching down into the forest. A certain roundness of contour of the lower



mountains contrasts sharply with the more jagged character of the Rockies, but the higher peaks are of the boldest. Although in

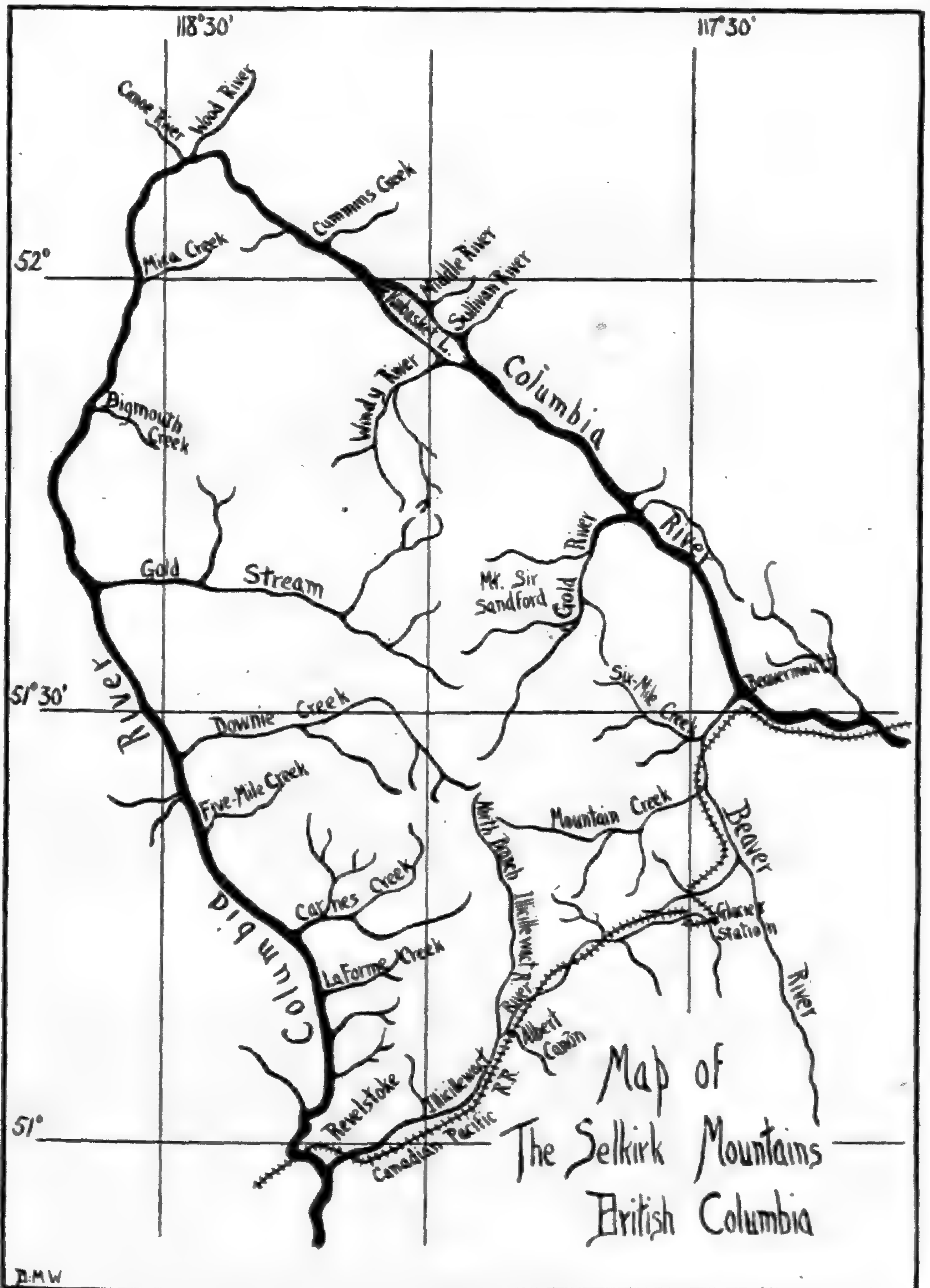

absolute altitude the Selkirks are surpassed by many ranges, in elevation of the summits above the valleys they are not easily



equaled. The river and its large tributaries are at altitudes of from 500 m. to nearly 1000 m. The peaks range from 2500 m. to nearly 4000 m. Mountain flanks with a rise of 1000 m. are common, and in certain cases a difference of as much as 2600 m. of altitude occurs within a horizontal distance of two or three miles. Needless to say, such a mountain side presents the most varied forms of vegetation, from tangled forests below to the dwarfed plants of the cold deserts above.

In obtaining an idea of the surface features of the country, it will be helpful to keep in mind again the course of the Columbia. The lakes in which it rises, as well as the first 100 miles of its course, lie in a broad and terraced valley, evidently the site of an ancient lake. Near Donald the river turns abruptly out of this valley into a narrow canyon, and from that point it completes its bend in a series of wild gorges, alternating occasionally with wider and more level valleys. Most interesting problems of captured drainage and reversed flow here await investigation. At one point some 30 miles above the bend, the river expands into Kinbasket Lake. The course of the smaller streams will be apparent from the map. For the most part they descend swiftly as torrents, but in a few places, notably on the Beaver, Downie, and Goldstream, there are portions that have been nearly base-leveled, and in these the activity of the beavers has given rise to extensive swamps.

### Climate

Adequate meteorological records have never been made, but the following may give some idea of climatic conditions.

TEMPERATURE.—This factor varies greatly, of course, in connection with altitude, exposure, etc. At the level of the river, summer temperatures of 33° C. are by no means rare, and once I recorded 38° C. At high altitudes, as is usual, temperatures are always low except at noonday in the direct sunlight.

In the season of 1908 two thermographic records were made on Mount Plainside near Beavermouth on the same hillside and exposure, at altitudes of 800 and 1700 m. respectively. The lower station was about 100 m. above the river level; the upper,



in the midst of the subalpine zone.<sup>2</sup> From these records it is evident that less daily variation occurs at high altitudes. The daily maxima are notably less than those at lower altitudes, the nightly minima only slightly so. This accords well with the general observations of meteorologists.

From records kept at Revelstoke throughout the year, it is possible to gain some idea of the temperature during the winter. The minimum of  $-50^{\circ}$  C., while striking, is probably without significance for vegetation. At higher altitudes, owing to inversion of temperature, the cold is probably much less severe. A registering thermometer was left over the winter of 1908–1909 on the top of Mount Grizzly (3000 m.). When found the following summer, it had every appearance of being in good working order and the recorded minimum was  $-1^{\circ}$  F. Of course, the rocks where the instrument was secured were deeply covered with snow during most of the year.

Occasional frosts occur even at river level in midsummer. Thus, on the night of July 20, 1905, there was a heavy frost in the valley of Goldstream (616 m.). I was unable to learn whether there was frost on the mountain flanks a little higher up or not, but suspect that the low temperature prevailed only in the floor of the valley (a case of temperature inversion).

At and above timber line snow may fall at any season. Each summer there are usually one or two storms in which "new snow" covers the mountains from timber line upward—quite the same phenomenon that is seen in the Alps. Aside from such storms and away from the immediate vicinity of the glaciers, nightly frosts are mostly light and irregular during July and the early part of August (light frost in the alpine meadows is often visible when the thermometer has failed to record freezing). After the middle of August the nights become notably cooler, the nightly frosts become sharper, and by the middle of September they are frequent at all altitudes.

PRECIPITATION.—The volume of precipitation appears to increase from the southeast to the northwest. In the terraced portion of the Columbia Valley, where there are a number of ranches, summer rainfall is so far from that desirable for crops that irrigation

<sup>2</sup> These records are unhappily lost.



will probably be necessary; and although the Selkirks and the Gold Range bear the reputation of being rain-soaked mountains, I suspect that sufficient information would place them in the summer-dry category.

My own data have been obtained in various places, and while on the march. Such items should be numerous and in long series in order to have much value, for showers are often of local occurrence and are more frequent in some localities than in others. A vivid impression of local differences is often conveyed from an outlook point where a wide expanse of peaks is visible. Over most of the landscape there may be sunshine, while Rogers Pass and the great peak in the north, variously called Cloud Summit, Sir Sanford,<sup>3</sup> and the Chieftain, are enveloped in dark rain clouds.

A rough summary of the weather in the growing season for a number of summers is given in table I.

The reputation which the Selkirks bear is probably due partly to the luxuriance of the vegetation, all the more striking to those who come from the thinly forested Rockies, and partly to the fact that very rainy summers have occurred. The accounts of the explorers who found the route for the railroad in the early eighties are tales of great hardship, in which tangled brush and incessant rain are prominent features. Witness also the memorable summer of 1907. So far as data are available, however, it would appear that summer precipitation is scanty, on the whole, and that the climate of the Selkirks resembles that of Puget Sound.

Whatever may be the fact in regard to rainfall, there is another form of precipitation, the regularity and abundance of which is not open to question. Light snows come and go about timber line occasionally during July and August, and more frequently during September and early October, until, by the first of November, the snow mantle is spreading rapidly downward into the forest. From November until the following spring, the whole surface of the earth is deeply covered. At Glacier, altitude 1260 m. as recorded by instrument, 75–150 cm. of snow falls annually. In the sub-alpine zone the packed snow becomes 2–3 m. deep, not to disappear until June; that at lower altitudes is somewhat less, the

<sup>3</sup> This name has since been adopted.



lightest occurring in the wide valley of the Columbia in the south-east. Such a layer of frozen water, annually renewed, slowly melting, setting free one portion of surface after another, and at the time

TABLE I

July and August	Number of days on which we met with rain	Comment
1904.....	11	Rains light, usually for a few hours only; in one case, at Rogers Pass, altitude 1300 m., clouds hung low, with nearly continuous drizzle for 4 days (August 21-26)
1905.....	9	Likewise mostly light rains and of short duration; one hail and two thunder storms at 2000 m. and one fall of about 20 cm. of snow August 5 at the same altitude
1906.....	.....	As stated by my brother, frequent showers but scarcely any heavy enough to cause one to seek shelter; two snows above timber line
1907.....	35	From August 3 to September 1 almost incessant rain, much of the time in copious volume; conditions general over the Selkirks, Rockies, and the Gold Range
1908.....	7	Only 3 or 4 short showers before August 25; most of the time uniformly fair; conditions general over the Selkirks, Rockies, and Gold Range
1909.....	13	Cloudy and rainy during early part of July but no copious precipitation; from July 18 to September 1 and after, prevailingly fair; a snowfall of about 35 cm. at timber line August 4 and 5, a <i>heavy</i> shower August 26
1910.....	4	A snowfall at timber line July 15; heavy rains July 21, 22, and 24; no other rains during July and early August

of its departure leaving the soil laden with all the water it can hold, must be, for vegetation, a most important factor in the physical environment.

### Vegetation

The plant covering of the area exhibits, of course, a wide series of variations growing out of the specific nature of the forms, and out of differences in the surrounding physical factors. How best to study and describe such a vegetation complex is a puzzling matter. Following the broad distinctions of SCHIMPER, we may



designate three formations in the Selkirks: forest, alpine grassland, and alpine desert. The first two interlock, the latter two grade imperceptibly into each other. Within the forest are streams with their distinct plant life, and occasional areas of swamp and bog, as well as cliffs and gravel slides which exhibit desert conditions and to some extent the same species as the alpine deserts. Above the forest there is every gradation, from alpine rivulet to barren cliff. To attempt to reduce all this to a classified and logically complete system of subformations, societies, etc., is a task in which the writer can see neither profit nor hope. The interesting facts and relations which may be observed will be brought out simply as facts.

**THE FOREST FORMATION.**—The forest covers the entire area up to the timber line at about 1900 m. The most striking feature in its general physiognomy is the increase in luxuriance westward. In the Rockies and southeastern portion of the Selkirks the trees are usually not more than 30–50 cm. in diameter, and 15–25 m. high. In the Columbia Valley from Quartz Creek and the Beaver northward, however, and on all the western slopes of the Selkirks, the forests attain a magnificent development. The trees of various species are commonly 100–150 cm. in diameter and 30–60 m. high, suggesting, though by no means equaling, the marvelous forests of the Puget Sound region. It is scarcely to be doubted that this greater development is bound up with a greater precipitation over the area named. Related facts in regard to the peculiar distribution of certain species will be brought out later.

The forest is further diversified by the effects of fire. Fires have occurred apparently from remote periods, and all phases of succession can be found, culminating in the climax type. The chief cause of the fires seems to be lightning. A tree with a mass of dead resinous branches is a highly inflammable object, and, as a matter of experience, an outlook from a vantage point after a sharp thunderstorm usually reveals one or more slender columns of smoke rising from the forest. Fortunately such fires often die out before much damage is done.

With respect to altitude, the forest is rather plainly composed of two zones, which, in accordance with a usage now happily becoming somewhat uniform, we may designate as the montane



zone and the subalpine zone, the latter beginning at about 1400 m. We shall give attention to the former first.

The montane zone exhibits considerable diversity. The differences between the eastern and the western portions of the area are so strongly marked that the two might easily be treated separately. The hemlock occurs only in the northern and western portions. Quite a series of herbaceous plants (*Lycopodium lucidulum*, *Chimaphila umbellata*, *Corallorhiza Mertensiana*, *Asarum canadense*, *Circaea alpina*) have been found together only in company with the hemlock, and with it they might be said to constitute a distinct "society" or "formation." But, taking a broader view, we see that, since all these species are found in different combinations in various regions, the fact that they occur together under the hemlocks in the Selkirks indicates no more than that they each respectively sustain a living relation with the physical factors prevailing there. Doubtless the hemlock is very efficient in bringing about the moist and shady conditions in which the others commonly thrive, but further than this it is not apparent how expressions indicating a social interrelationship throw any light on the physiological problems involved. At this point also the interesting fact comes in that almost all the "shade" plants, the ferns excepted, have been found growing in the burns, largely exposed to sunlight.

The following are lists of the more conspicuous or noteworthy species of the montane zone arranged approximately in order of their abundance:

Trees	Shrubs	<i>Corylus rostrata</i>
<i>Principal species</i>	<i>Alnus tenuifolia</i>	<i>Crataegus Douglasii</i> (?)
<i>Picea Engelmannii</i>	<i>Echinopanax horridum</i>	Herbs (including all low forms)
<i>Tsuga heterophylla</i>	<i>Salix</i> sp.	<i>Aspidium spinulosum dilata-</i>
<i>Thuja plicata</i>	<i>Vaccinium membranaceum</i>	tatum
<i>Pseudotsuga mucronata</i>	<i>Rubus parviflora</i>	<i>Cornus canadensis</i>
<i>Tsuga Mertensiana</i>	<i>Vaccinium ovalifolium</i>	<i>Kruhsea streptopoides</i>
<i>Pinus monticola</i>	<i>Lepargyrea canadensis</i>	<i>Vagnera amplexifolius</i>
<i>Populus balsamifera</i>	<i>Pachystima Myrsinites</i>	<i>Rubus pedatus</i>
<i>Minor species</i>	<i>Lonicera ciliosa</i>	<i>Linnaea borealis</i>
<i>Pinus Murrayana</i>	<i>Cornus stolonifera</i>	<i>Tiarella unifoliata</i>
<i>Abies lasiocarpa</i>	<i>Taxus brevifolia</i>	<i>Streptopus amplexifolius</i>
<i>Populus tremuloides</i>	<i>Ribes echinatum</i>	<i>Veratrum viride</i>
<i>Betula papyrifera</i>	<i>Ribes lacustre</i>	<i>Clintonia uniflora</i>
<i>Acer glabrum</i>	<i>Rubus strigosus</i>	<i>Mitella nuda</i>
	<i>Spiraea betulaeifolia</i>	



Herbs (including all low forms)—*Continued*

Streptopus curvipes	Chimaphila umbellata	Asarum canadense (acuminatum?)
Asplenium Filix-foemina	Fragaria glauca	Habenaria obtusa
Phegopteris Dryopteris	Equisetum sylvaticum	Habenaria orbiculata
Moneses uniflora	Lycopodium lucidulum	(Mosses and liverworts in abundance in the deeper forests)
Pyrola secunda	Circaea alpina	
Disporum majus	Equisetum arvense	
Pteridium aquilinum	Equisetum pratense	

A similar list of species found in an early phase of the reforestation of a burn will show the changes incident to fire:

Trees	Herbs	
<i>Leading species</i>	Pachystima Myrsinites	Cornus canadensis
Tsuga heterophylla (2)	Rubus strigosus	Apocynum androsaemifolium
Pinus Murrayana (8)	Alnus tenuifolia	Equisetum pratense
Populus tremuloides (10)	Vaccinium membranaceum	Pyrola secunda
<i>Less prominent</i>	Rubus parviflora	Pteridium aquilinum
Pseudotsuga mucronata	Cornus stolonifera	Vagnera amplexifolius
Picea Engelmannii	Ceanothus ovatus	Clintonia uniflora
Pinus monticola	Amelanchier florida	Pedicularis contorta
Thuja plicata	Lonicera involucrata	Pedicularis racemosa
Betula papyrifera	Spiraea betulifolia	Streptopus amplexifolius
Abies lasiocarpa	Ribes echinatum	Anaphalis subalpina
Populus balsamifera	Juniperus sibirica	Chimaphila umbellata
	Menziesia ferruginea	Galium boreale
	Viburnum pauciflorum	Poor specimens of
<i>Shrubs</i>		Phegopteris Dryopteris
Salix sp.		Thalictrum occidentale
Lepargyrea canadensis	Epilobium angustifolium	Disporum majus
	Linnaea borealis	

*Picea Engelmannii* is the most generally distributed species of the region. It occurs throughout the area, in the neighboring Rockies, and in the Gold Range, and extends upward into the subalpine. Its relative importance is greater in the southeast and in the Rockies, where it does not come into competition with the hemlock. In the southeast it is usually the most abundant species of the climax forest, although, like other trees in that quarter, mostly of 30–50 cm. diameter and a height of 15–25 m.

*Tsuga heterophylla*, on the other hand, is sharply limited in its distribution. It does not occur at all to my knowledge south or east of the Beaver and Columbia, being therefore quite absent from the Rockies. Within the bend, however, it at once becomes abundant and, growing luxuriantly as it does, may well be said to



dominate the vegetation in considerable areas; but it never entirely excludes the spruce, the mountain pine, and the Douglas fir. Within the area it is one of the most prominent trees of the burns, seeming in this respect like the lodgepole pine.

*Thuja plicata* is, at least in some respects, the monarch of plants in the Selkirks. Occurring sparsely in the Rockies and upper Columbia Valley, it finds its proper home in the deep moist valleys of the western arm of the Columbia. Here it not seldom reaches a diameter of 3 m. The trunk tapers rapidly, however, and is seldom over 50 m. high. Another fact which detracts from its timber value is that the trunks are usually decayed within, a large and sound tree being almost unknown.

*Pseudotsuga mucronata* shows ability to endure and to respond to a wide variety of conditions. As is well known, it reaches a huge development in the Puget Sound country, forming perhaps the most magnificent forests on the globe. Nevertheless, it endures conditions of dryness better than most of the other conifers. It extends south to Colorado and beyond, and in Canada, as one passes from the treeless plain to the foothills, it is one of the first trees to appear. In the region we are studying it is nowhere abundant, yet it occurs throughout. It grows largest on the western slopes of the Selkirks, making there a diameter of 2 m. and a height of 65 m. or more.

*Pinus monticola*, a large white pine, is scattered through the area, nowhere very abundant, but becoming a valuable timber tree in the hemlock district.

*Populus balsamifera* occurs constantly along the river, sometimes forming forests several hundred meters wide. It reaches a diameter of 1-2.5 m. and a height of 30-45 m.

*Pinus Murrayana*, the lodgepole pine, is remarkable both for its limited distribution and for the part it plays in reforestation. In all the region where it occurs it is the first tree to spring up after a fire. In the Rockies particularly, the burn forest is often almost purely lodgepole pine. Its range is sharply confined to the Rockies and the drier portion of the Selkirks, ceasing rather abruptly where the hemlock begins. The cause of the peculiar distribution is not wholly clear. Possibly it cannot survive in



competition with the hemlock, and is confined therefore to areas where the latter cannot flourish on account of dryness. Possibly, also, the lodgepole pine has not been able as yet to cross the central mass of the Selkirks, nor to make its way from burn to burn around the bend. It certainly would have little chance to invade the climax forest.

*Populus tremuloides* is another prominent member of the burn vegetation, universally distributed, growing in company either with the lodgepole or the hemlock, as the case may be.

*Abies lasiocarpa* occurs sparingly in the montane forest. It is rarely to be seen near the river, but is one of the 3 or 4 species forming the tree clusters on exposed ridges.

The birches, maples, buckthorns, and hazels are found only along the river and the lower waters of its tributaries, and are usually not abundant.

In the moist river-level forests, especially along the western arm of the river, and in such moist pockets as that found at the foot of Mount Cheops at Rogers Pass, certain shrubs grow in remarkable luxuriance. Among these the most conspicuous are: in the river-level forests, *Echinopanax horridum*, *Taxus brevifolia*, *Corylus rostrata*; in the moist pockets, *Vaccinium ovalifolium*, *Rhododendron albiflorum*, alders, and willows. In the moist, well shaded river-level forests, especially along the Columbia between Bigmouth and the great angle made by the Columbia, vegetation reaches a marvelous degree of luxuriance. Here careful measurement indicated that the following spermatophytes and pteridophytes reached a height of 2.50–3 m.: *Veratrum viride*, *Echinopanax horridum*, *Vagnera amplexifolia*, *Pteridium aquilinum*, *Aspidium spinulosum dilatatum*. Here also the mosses *Hylocomium proliferum* and species of *Thuidium* covered the rocks and fallen tree trunks with thick cushions of exquisite foliage.

THE ALPINE MEADOW FORMATION.—As previously stated, the alpine meadow and the forest formations interlock, the former frequently extending far down below the timber belt in the depressions, while the latter reaches upward on the exposed mountain flanks and ridges. The bulk of the alpine meadow vegetation lies between 1800 and 2500 m. The plant associations vary greatly,



of course, according to altitude, topography, exposure, and moisture content of the soil.

Almost as important as altitude in determining the character of the vegetation of a given area are topography and exposure to light. While crags and ridges may be free from snow in May or early June, the depressions between them frequently lie buried under snow until the middle or latter part of July. These masses of wet snow are apparently responsible for the drowning and suffocation of the trees and larger shrubs in these depressions, as I suggested in an earlier paper.<sup>4</sup> Other things being equal, the snow disappears first from the east-facing and south-facing slopes; these slopes therefore usually bear a more luxuriant and more varied vegetation than those facing the west and north. It would seem that, in the Selkirks, long-enduring snow masses, caused by heavy winter precipitations, topography, and exposure of the mountain slopes, are the most important single factor in determining the distribution of the alpine meadow and alpine desert vegetation.

Among the trees which reach in scattered groups into the alpine meadows, thus forming true "parklands," firs and spruces predominate. At 1800 m., in the lower portions of the belt, these retain their characteristic conical form and frequently reach a height of 7 m. They are found most abundantly and are grouped most effectively on slight elevations surrounding the numerous alpine tarns of this newly glaciated country. At higher elevations, reaching even to 2500 m., the firs and spruces exhibit the forms of wind and snow cripples. Here they are associated with dense thickets of juniper, and with occasional groups of the white-stemmed pine (*Pinus albicaulis*). The thickets often cover the broader mountain flanks, the gnarled cripples appearing in smaller groups or singly on crags and narrow "sawbacks." An examination of the rings of wood in the trunks of some of these cripples gave evidence, as was to be expected, of extremely slow growth. Thus a fir, 40 cm. in height and 2.5 cm. in diameter of trunk, cut near the summit of Glacier Crest, between the Illicillewaet and Asulkan glaciers, showed 62 wood rings.

<sup>4</sup> SHAW, C. H., The causes of timber line on mountains. *Plant World* 12: figs. 4. 1909.



Such shrubs as show any considerable length of stem commonly lie prostrate, thus giving evidence of the crushing effect of the masses of snow that cover the lower meadows during 9 or 10 months of each year. Of these *Rhododendron albiflorum* and *Vaccinium membranaceum* are most frequently met with on the lower slopes, especially on those threaded by rivulets originating in snow banks higher up. Farther up the slopes, and reaching quite to the alpine deserts, dwarf willows, *Arctostaphylos Uva-ursi*, *Cassiope Mertensiana*, *Empetrum nigrum*, *Bryanthus glanduliflorus*, *B. empetriformis*, *Gaultheria myrsinites*, *Kalmia glauca*, *Dryas octopetala*, and occasionally *D. Drummondii* are the dwarfed shrubs. These sometimes form small patches in the grassland; sometimes they form extensive carpets covering many square meters. Mats of *Cassiope* or of *Bryanthus* or *Dryas* form dry hummocks in comparatively wet meadows. As these mats enlarge year by year, the plants at the center die, thus bringing about the formation of rings of shrubby growth surrounding dead and blackened centers. This seems to bear out SCHROETER'S statement:<sup>5</sup> "Das dichte Heidekrautgestrüpp erzeugt einen ganz eigenartigen, schwarzen, nährstoffsarmen Humus, der eine Menge von Arten ausschliesst."

Moisture and the presence or absence of snow covering during the short growing season seem to be the principal factors determining the nature of the herbaceous vegetation of the alpine meadows. On very wet slopes and depressions, where the ground is continually soaked by water from the melting of the snow fields higher up, there are commonly either nearly pure stands or mixed associations of the following: *Ranunculus alpinus*, *Trollius albiflorus*, *Caltha Macounii*, *Lutkea pectinata*, *Valeriana Scouleri*, and *Erythronium grandiflorum*. With these are associated, in lesser quantities, *Mitella nuda*, *Petasites frigida*, *Oxyria digyna*, *Rumex crispus*, *R. acetosella*, *Parnassia parviflora*, *P. fimbriata*, *Saxifraga rivularis*, *S. Lyallii*, *S. nivalis*, *Thalictrum occidentale*, *Epilobium angustifolium*; numerous sedges and grasses, among them *Carex invisa*, *C. nigricans*, *C. livida*, *Poa arctica*, and *P. alpina*. The stretches of *Erythronium* and of *Trollius*, varied by very intruding plants of

<sup>5</sup> SCHROETER, C., Das Pflanzenleben der Alpen.



other species, are especially beautiful and interesting. Occasionally one comes upon fields, several acres in extent, consisting apparently of nothing but the swaying yellow bells of *Erythronium*. Some of the smaller basins, where the snows have but recently melted, are entirely filled with *Ranunculus alpinus*, which often blooms under the shallow snow water. Of the principal species, *Trollius*, *Valeriana*, and *Erythronium* are commonly found together; while *Lutkea*, *Ranunculus*, and *Caltha* form another and quite distinct association. As the slopes become drier, cushion plants of various species may be associated with these plants. Of these the most abundant are *Silene acaulis*, the two species of *Dryas*, the saxifrages, the heathers, sedges, and grasses.

On the mesophytic grasslands, *Pulsatilla occidentalis* is the dominant plant. Large fields and gentle slopes covering hundreds of square meters often bear *Pulsatilla* to the exclusion of all other vegetation. Where this condition obtains, its chief cause is always in evidence, namely, scores of burrows of the ground squirrels that delight to line their homes with the plumed fruits of the *Pulsatilla*, thus assuring the reproduction of the plant. When *Pulsatilla* does not form a pure stand, it is most frequently associated with several alpine grasses, *Poa alpina*, *P. arctica*, *P. Cusickii*, *Phleum alpinum*, with *Juncoides parviflora*, *Carex festiva*, and *C. marcida*; and with *Castilleia miniata* and *C. pallida* (running into numerous variations in color and form), *Lupinus perennis*, *Valeriana sitchensis*, *Erigeron jucundus*, *E. salsuginosus*, *Epilobium Hornemanni*, *E. anagallidifolium*; as well as with occasional clumps of heather (*Bryanthus* and *Cassiope*) and of dwarf willows. These plants commonly grow in remarkable luxuriance, and in August, when most of them are in bloom, the brilliant colors of species of *Castilleia*, *Erigeron*, *Epilobium*, and *Lupinus* give to the alpine fields a beauty not readily forgotten by anyone who has had the good fortune to see it.

On the gravel slopes and flats of the youngest terminal moraines a great variety of physical conditions obtains. As to moisture, the range is from wet areas where the glacial streams form pools or bogs, to the sun-baked flats no longer reached by these streams. Here the soil appears at the surface, there it is covered by gravel



and boulders to a depth of a meter or more. Exposure to light is almost invariably extreme. Many of the gravel slopes and flats come properly within the alpine meadow zone. Their vegetation varies, of course, with the physical conditions under which it must exist. The xerophytes grow always in isolated clumps or cushions; the hydrophytes and mesophytes either in clumps or in fairly extensive beds. The xerophytes most in evidence are: *Erigeron aureus*, *Antennaria lanata*, *Kalmia glauca*, *Arnica latifolia*, *Epilobium angustifolium*, *Potentilla emarginata*, *Gentiana prostrata*, *Dryas octopetala*, *D. Drummondii*, *Eriophorum polystichium*, *Calamagrostis purpurascens*, and *Cryptogramma acrostichoides*. A number of these species are found also on the alpine desert. This does not seem remarkable if one considers that, except for increased cold and snow, the conditions under which the desert plants exist are similar to those endured by the morainal xerophytes.

The hydrophytes and hydromesophytes of the moraines are numerous. They often form dense masses of vegetation along the streams, especially on the more level flats. The species found, named approximately in order of abundance, are as follows: *Trollius albiflorus*, *Claytonia lanceolata*, *C. parviflora*, *Rumex crispus*, *Oxyria digyna*, *Caltha Macounii*, *Ranunculus Eschscholtzii*, *Petasites frigida*, *Thalictrum occidentale*, *Parnassia fimbriata*, *Carex nigricans*, *Veronica Wormskjoldii*, *Castilleja miniata*, *Mimulus Lewisii*, *M. caespitosus*, *Epilobium latifolium*, *Eriogynia pectinata*, *Leptarrhena amplexifolia*, *Saxifraga Lyallii*, *S. rivularis*, *S. Nutkana*, *Tiarella unifoliata*, *Aquilegia columbiana*, *A. flavescens*, *Silene acaulis*, *Delphinium Menziesii*, *Anemone Drummondii*, *Parnassia parviflora*, *Erythronium grandiflorum*, *Veronica americana*, *Pedicularis bracteosa*, *P. racemosa*, *Pinguicula vulgaris*, *Epilobium Hornemanni*, *Erigeron jucundus*, *E. multiradiatus*, *E. salsuginosus*, *Comarum palustre*, *Myosotis alpestris*, *Cynoglossum boreale*, *Apocynum androsaemifolium*, *Gentiana glauca*, *Gaultheria humifusa*, *Ligusticum apiifolium*, *Valeriana sitchensis*, *Aster conspicuus*, *Habenaria hyperborea*, *Senecio triangularis*, *Veratrum pedicularis*, *Rhododendron albiflorus*, *Kalmia glauca*, *Elephantella groenlandica*, *Potentilla emarginata*, *Prunella vulgaris*, and *Sibbaldia procumbens*.



THE ALPINE DESERT.—Here low temperatures, snow, and the avalanches due to these are evidently the controlling ecological factors. It is necessary to distinguish between the deserts due to cold and snow, and those due to rock avalanches. The latter are either absolute deserts because recurring avalanches have covered the soil of the slopes with rock to such a depth that vegetation is impossible, or they show isolated plants or cushions of plants where rock covering chances to be shallow. These comprise very few species, *Gentiana prostrata*, *Erigeron aureus*, *Silene acaulis*, *Potentilla (emarginata?)*, *Epilobium latifolium*, and *Cryptogramma acrostichoides* being the only species found very commonly in these locations. All of these rock desert plants are, of course, extremely small, tough, and dry; their blossoms often impress one as being of unusual size and brilliancy in contrast with the dwarfed and dull green foliage and stems. Since these plants secure moisture only with difficulty, and endure the strong insolation and the desiccating winds of the exposed rock slides, they are to be designated without question as xerophytes, a designation usually supported by such structural characteristics as have just been suggested.

The snow and cold deserts of the high altitudes are peculiarly interesting. At the surface and immediately beneath the surface of the snow, especially on the more extensive snow fields, many thousands of plants of *Sphaerella nivalis* give to the snow exquisite rose and lavender tints. In the Selkirks the alga never has the green color which SCHROETER reports that it shows on the alpine snows. With *Sphaerella* there is frequently associated a fungus which spreads its dark brown, branched mycelium over the surface of the snow. Except for these two plants, the Selkirk snows seem to be truly bare of plant life.

On those high slopes where snow patches remain practically throughout the summer, and where the ground between the patches is free of snow during a few weeks only, a very definite succession is always to be discerned. Very near the snow, surrounding the melting snow patches, there is a black mud with knobby surface evidently covered with fungus mycelia; farther back from the edge of the snow, tiny patches of *Polytrichum* appear. As the clumps of moss increase in size, we find it associated with small bunches



of *Carex nigricans*, which increase in size as we recede from the snow until they form a continuous ground covering. Thus far the succession is invariable; but the plants that grow in scattered groups in the stretches of *Carex nigricans* at some distance from the snow patches may be *Carex invis*a, *Epilobium latifolium*, *Petasites frigida*, *Caltha Macounii*, *Oxyria digyna*, *Parnassia parviflora*, or a *Ranunculus*. When one or more of these plants have joined *Carex nigricans*, conditions no longer warrant the designation of "desert" to this association, but it merges into the hydrophytic or hydromesophytic group, for moisture from the melting snow patches is, of course, abundant in these situations. The term "desert" as applied to the fungus-moss-sedge association bears with it none of the usual suggestions of dryness and heat, but, on the contrary, connotes abundant moisture but physiological dryness due to extreme cold. It is to be remembered in this connection that the suffocating action of the snow, previously mentioned, is here a potent cause of the poverty of plant life.



## STUDIES IN THE GENUS *BIDENS*. III

CONTRIBUTIONS FROM THE HULL BOTANICAL LABORATORY 216

E A R L E. S H E R F F

(WITH PLATE XXXI)

➤ ***Bidens attenuata***, sp. nov.—Herba (annua?), +4 dm. alta; caule et ramis hispido-tomentosis, subtenuibus, subperspicue striatis, terētis (nisi caule infra angulato). Folia opposita (aut superiora alternata), petiolata, petiolo adjecto 1.5–6 cm. longa, bi- aut tri- (aut etiam quadri-) pinnata, subsparsim adpresso-hispida, hispidociliata; ultimis lobulis integris, linearibus, indurato-apiculatis, saepe convolutis, 0.3–0.7 mm. latis. Petioli 3–11 mm. longi, hispidi, ad basim connati. Capitula terminalia, ligulata, longe et tenuiter pedunculata, pedunculis 5–15 cm. longis. Involucrum basi hispidum; squamis duplici serie dispositis; exterioribus (circ. 6) linearibus, glabratis aut sparsim hispidis, 3–4 mm. longis; interioribus dimidio longioribus, dense hispidis, margine diaphanis. Ligulae flavae, striatae, elliptico-ovatae, ad apicem subdentatae aut integrae, 1.8–2 cm. longa. Paleae lineares, margine diaphanis. Achaenia (submatura) linearia, glabra, costata, biaristata aristis retrorsum hamosis (3–6 glochidiis), 5 mm. longa.

*Ghiesbrecht*, Chiapas, Mexico (type in Herb. Gray).

ASA GRAY had labeled this plant in the herbarium "*B. ferulaefolia* var.," but the true *Bidens ferulaefolia* DC. (*Coreopsis ferulaefolia* Jacq., Hort. Schoenb. 3:65. pl. 375. 1798) is a very different plant.

***Bidens Andrei***, sp. nov.—Herba (ad basim suffrutescens?), 1–2 m. alta, glabrata, caule tetragono et striato; ramis tetragonis, striatis, (superioribus) irregulariter arcuatis et in nonnullos ramulos (aut pedunculos) divisus. Folia opposita, petiolata, petiolo adjecto 2.5–7 cm. longa, bi- aut tri- (aut quadri-) pinnata, supra minute et non dense adpresso-hispida; ultimis segmentis linearibus, integris aut lobulatis, indurato-apiculatis. Petioli 0.3–2 cm. longi, basi connati. Capitula multa, tenuiter pedunculata, pedunculis 4–12 cm. longis, 0.4 cm. (ad anthesin) –1 cm. (in fructu)



alta, ligulata. Involucrum basi plus minusve hispidum; squamis duplici serie dispositis et demum reflexis; exterioribus (circ. 6) linearibus, apiculatis, subsparsim pubescentibus, 1-2 mm. longis; interioribus lanceolatis, membranaceis, 2-3 mm. longis, margine diaphanis. Ligulae (6 aut pauciores) lanceolatae, 4-5 striatae, apice integrae, 3-4 mm. longae, in sicco specimine subalbae. Paleae lineares, margine diaphanae. Achaenia attenuato-lineararia, supra sparsim hispida, biaristata aristis glabris aut retrorsum 1-3-hamosis, (interiora) demum 0.8-1 cm. longa.

*Ed. Andre* 2878, at altitude of 1250 m., Rio Juanambu, United States of Colombia, April 28, 1876 (type in Herb. Gray).

The 20-30 areolae on the old disks become prominent as the involucre reflex. There are 37 heads on the type specimen. The plant appears to be entirely herbaceous, but the label says "suffrutesc.," hence the lower part of the plant (not present on the sheet) may have been woody and perennial.

***Bidens mirabilis***, sp. nov.<sup>1</sup>—Herba volubilis glabra, caule subtereto, striato. Folia caulis petiolo adjecto 8-10 cm. longa, pinata, foliolis irregulariter 3- vel 5-partitis, segmentis (ad marginem sparsim hispidis) ovatis et integris aut ad apicem 1-5 dentatis, petiolis 3-3.5 cm. longis; folia ramulorum parva, integra aut ternata. Capitula (floribus flavescentibus e Sprucei inscriptione) multa, parva, dense paniculata, discoidea, 3-5 mm. lata, 4-5 mm. alta. Involucrum glabratum, squamis duplici serie dispositis; exterioribus lineare-lanceolatis, laciniato-ciliatis, 1.5-2.5 mm. longis. Paleae lineares, 4-5 mm. longae, marginibus diaphanis. Stilorum rami breves, crassi, plus minusve obtusi. Achaenia late cuneato-lanceolata, plana, margine lobulata, lobulis coronatis 1-4 longis pilis; constricta ad apicem cervicis crassa, 8-10-aristata aristis inaequalibus et retrorsum hamosis.

*Spruce* 6273, Huambalpa, Andes Mountains, Peru ("Andes Quitenses, loco Huambalo"), November 1857 (type in Herb. Kew). Plate XXXI.

This is a very strange species and one that might be taken by some to represent a new genus; indeed, I know of no other species of *Bidens* combining

<sup>1</sup> Dr. J. M. GREENMAN (now of the Missouri Botanical Garden), to whom I shall express more extended thanks later for having inspired my research upon the genus *Bidens* and directed it during its early stages, and Dr. B. L. ROBINSON (of Gray Herbarium) have very kindly assisted me with certain library and herbarium data for this species.



more diverse characters. The twining habit is to be met with in *B. rubifolia* and its allies; the large number of achene awns (very rarely so numerous in *Bidens*) suggests a certain African species of *Bidens*, to be treated later; the shape of the achenes is rather that of *B. tripartita* and its allies; but the thick, necklike constriction at the apex of the achenes and below the awns is so pronounced as to suggest a slight affiliation with *Heterospermum*,<sup>2</sup> in which genus the outer, *winged* achenes are frequently so constricted.

*BIDENS PILOSA* L. Sp. Plant. 832. 1753.—*Bidens hispida* H.B.K. Nov. Gen. 4:237. 1820; *Bidens andicola* H.B.K. var. *B.*, Wedd. Chlor. And. 1:70. 1855.

For many years, *Bidens hispida* H.B.K. appears to have remained a comparatively unknown form to botanists dealing with South American plants. WEDDELL'S treatment of it is short and arbitrary. No reasons are given by him for its reduction to *Bidens andicola* H.B.K.

The original type plant of *Bidens hispida*, as also that of *Bidens andicola*, remains in good preservation today (in Mus. Hist. Nat. Paris). In a very general way the two plants, both of them hispid, show a resemblance; but *Bidens hispida* is seen, on closer inspection, to have small heads and these, moreover, are discoid. Also, the lower part of the plant displays a wholly different foliage aspect from that found in more recent specimens of the yellow-rayed *B. andicola* (the lower part of the type for the latter species is lacking). The plant is seen to be merely a very hispid form of *B. pilosa* L. It is matched more or less exactly by many specimens in herbaria, particularly by some from Venezuela, Colombia, and Peru (for example, *Mr.* and *Mrs.* J. N. Rose 18740, Santa Clara, Peru, July 18, 1914, in U.S. Nat. Herb.).

*BIDENS ANTHRISCOIDES* DC. Prodr. 5:600. 1836.

DECANDOLLE'S description of this species, based upon *Berlandier* 1010 and 1152, is much too narrow not to mislead. Excellent specimens of *Berlandier* 1010 are in London (in Herb. Brit. Mus.),

<sup>2</sup> A genus very closely connected with *Bidens* through *Heterospermum Xanti* Gray, the type of which (in Herb. Gray) is matched by that of *Bidens Xantiana* Rose (in U.S. Nat. Herb.); a species best retained in *Heterospermum*, a view in accord with the treatment by BRANDEGEE (*Zoe* 1:309. 1890), who, moreover, has since *positively* corroborated (in litt. 1913) my equation of *Bidens Xantiana* Rose with *Heterospermum Xanti* Gray.



and these have some achenes 21 mm. long. *Berlandier* 1010 and 1152 both occur in Paris (in Herb. Mus. Hist. Nat. Paris and in Herb. E. Drake). These surpass the London specimens in that they show some of the heads to be radiate in anthesis (cf. DC. *l.c.*, "cephalis discoideis"). The flowering heads are small, about 9 mm. high and 4-5 mm. wide, or, including the rays, 1 cm. wide. The rays are small, strongly and definitely dark-roseate, about 5 mm. long (including the tube at base), broadly ovate-elliptic, somewhat 3-toothed at apex. The 8 outer bracts average about three-fifths of the length of the inner ones and tend to be indurate-tipped.

BIDENS NODIFLORA L. Sp. Plant. 832. 1753.—*Bidens nodiflora*, *brunellae folio* Dillen. Elth. 52. pl. 44. fig. 52. 1732: non *Bidens nodiflora*, *folio tetrahit*, *ibid.* 53. pl. 45. fig. 53.

A good specimen preserved in the Linnaean Herbarium matches the first figure of DILLENIIUS very closely and is a true *Bidens*. Recently, DRUCE (The Dillen. Herb. 161. 1907) has cited this figure erroneously, as representing, along with pl. 45. fig. 53 (Dillen. *l.c.*), *Synedrella nodiflora* (L.) Gaertn., a species treated by LINNAEUS (Amoen. Acad. 4:290. 1759) as *Verbesina nodiflora*, and which is not at all a *Bidens*. DRUCE, as is indicated by his use of an asterisk, had not seen a Dillenian specimen matching pl. 44. fig. 52, but he referred to the *Index Kewensis* as his authority. However, an examination of that work (Ind. Kew. 1:301 and 2:1025. 1895), with proper regard for the kinds of type there employed, shows that *Bidens nodiflora* and *Synedrella nodiflora* are retained as distinct species and are not equated.

BIDENS FRONDOSA L. Sp. Plant. 832. 1753.—*Bidens melanocarpa* Wieg. Bull. Torr. Bot. Club 26:405. 1899.

GREENE (Pittonia 4:246. 1901) has given a good survey of pre-Linnaean authors and their treatment of the plant finally named *Bidens frondosa* by LINNAEUS. As additional evidence of the accuracy of GREENE'S conclusions regarding the characters of true *B. frondosa* L., there are the three specimens of LINNAEUS (two in Herb. Linn. and one in Herb. Hort. Cliff. at Herb. Brit. Mus.) and one of VAILLANT (in Herb. Mus. Hist. Nat. Paris). The first one of these has a flowering head with 9 or 10 elongate, foliose, exterior



involucral bracts (cf. Linn. *l.c.*, "calycibus frondosis") and "*HU* 4, *frondosa*" is written on the sheet.<sup>3</sup> Pinned with this sheet is a second sheet having a plant without label, but which is coarser and has about 14 exterior involucral bracts on the largest head. The third specimen is among the *Hortus Cliffortianus* specimens and matches the first specimen, even to having the same elongate foliose type of exterior bracts. LINNAEUS clearly had the first or the third specimen, and probably both, in mind when he drew up his description of *B. frondosa* for the *Species Plantarum*. The second specimen is probably *B. vulgata* Greene, but it is not labeled, and has no historical significance. The fourth specimen is the one formerly in VAILLANT'S private herbarium. This last matches the two labeled Linnaean specimens perfectly. Bearing, as it does, in VAILLANT'S own handwriting, the early names<sup>4</sup> afterward cited by LINNAEUS as synonyms for *B. frondosa*, it shows that VAILLANT, himself a student of the genus *Bidens*, likewise understood this species to be the smaller headed, fewer bracted, less robust form (and not the *B. vulgata* of GREENE).

**BIDENS CHINENSIS** Willd. Sp. Plant. 3:1719. 1800.—*Bidens pilosa* L. var. *B* Murray, Syst. Veg. ed. 13. 610. 1774; *Agrimonia molucca*, Rumph. amb. 6:38. pl. 15. fig. 2. 1750; *Chrysanthemum chinense*, etc., Plukenet, Phytograph. pl. 22. fig. 4. 1691; *idem* Almag. Bot. 100 (excl. syn.). 1696; *Bidens cicutaeifolia* Tausch, Flora 19:395. 1836.

Recently, O. E. SCHULZ (Engl. Bot. Jahrb. 50: Suppl. 176. 1914) has presented a good historical summary of this species with a comprehensive mass of synonymy. He shows clearly that the name *chinensis* harmonizes in its application with the *chinense* of PLUKENET given over a century before. Evidently, however, he was unaware that the plate of PLUKENET'S *Phytographia* (*loc. cit.*) was the identical plate cited in 1836 by TAUSCH (*Flora, loc. cit.*) as the basis for *Bidens cicutaeifolia*; and that thus one of TAUSCH'S

<sup>3</sup> Dr. B. DAYDON JACKSON, of the Linnaean Herbarium, assures me that "HU" was used by LINNAEUS to indicate that the plant was raised "in Horto Upsalensi."

<sup>4</sup> I am indebted to Professor P. DANGUY (of the Herb. Mus. Hist. Nat. Paris) for comparisons made with VAILLANT'S known writing to verify the authenticity of these names. An extra label on the sheet "*Bidens frondosa* L." was written, according to Professor DANGUY, by LAMARCK.



ill-advised names, so long apparently enigmatic to botanists, is clearly reducible to synonymy.

*BIDENS HUMILIS* H.B.K. Nov. Gen. 4:234. 1820.—*Bidens decomposita hirsutior* C. B. Clarke, Compos. Ind. 141. 1876.

Clarke described his variety *hirsutior* from a single specimen collected by himself at an altitude of over 2200 m. in the Nilgiri Mountains of India. Later, he informed J. D. HOOKER (cf. Fl. Brit. Ind. 3:310. 1881) that he supposed it to be some cultivated plant. HOOKER admits having seen no specimen of it, but it happens that CLARKE'S own original specimen ("11207 . . . . 23 March 1870 . . . . coll. C. B. Clarke . . . .") was sent to Kew Herbarium in 1877 and is still there in good condition. The plant is very different from *Bidens decomposita* Wall., but differs from certain South American specimens of the highly variable *B. humilis* H.B.K. only in being rather villous. Yet in the same region Dr. WATT collected material (*Watt* 2160, Metapollium, Nilgiri Hills, Southern India, up to nearly 1000 m., June 1876, in Herb. Kew) that agrees with CLARKE'S specimen except that it is minutely pubescent as to leaves and glabrous as to stems. And, most fortunately, still two more specimens from this region occur (*Dr. Thomson*, Eclipse Exped., Nilgiris, December 1871, determined on sheet as "*Bidens humilis* H.B.K.," in Herb. Kew; and *R. H. Beddome* 4511, "introd. ? a common weed," Nilgiris, in Herb. Brit. Mus.), both glabrous and indistinguishable from *B. humilis*. A study of these several specimens, all collected in the same region at about the same time, and by two of the collectors suspected of being introduced, shows beyond doubt that they were merely forms of *B. humilis* H.B.K. brought, perhaps in ballast, from South America to the southwest shores of British India.<sup>5</sup>

*BIDENS CRITHMIFOLIA* H.B.K. Nov. Gen. 4:234. 1820.—*Bidens delphinifolia* H.B.K. *loc. cit.*

The two type specimens from which KUNTH described *B. crithmifolia* and *B. delphinifolia* are still extant in good condition (in Herb. Mus. Hist. Nat. Paris). They differ only in the slightly diverse

<sup>5</sup> Since the above was written, I have had access to the very recent work of FYSON (Fl. Nilgiri and Pulney Hill-tops above 6500 feet 1:237. 1915). It is most interesting to find that FYSON, though omitting historical details, lists *B. humilis* from South America as an introduction into the Nilgiri Hill region, thus adding unique corroboration to my own conclusions presented above.



foliage. The immature type of *B. crithmifolia* is matched exactly by *J. Triana* 1374 (*ibid.*), a specimen from Bogota, Colombia, which is superior in showing not only flowering heads but also numerous achenes. These achenes are mainly 2-aristate, but some are 3-aristate and so agree perfectly with achenes of *B. delphinifolia*.<sup>6</sup> Fortunately, I have found another specimen by *Triana* of the same number in the British Museum, and this shows the slightly different foliage of *B. delphinifolia*, thus removing all doubt as to the identity of *B. delphinifolia* with *B. crithmifolia*.

This species is exceedingly variable in foliage. *Triana* 1375 (in Herb. Brit. Mus.) shows one plant with leaves tripartite, the leaflets being incisely dentate, and another plant with simple, ovate-lanceolate leaves. In fact, the sheet of *Triana* 1374 in Paris bears another specimen (beside that cited above) which has similarly simple, ovate-lanceolate leaves, showing that in the field *TRIANA* considered the simple leaves and the finely divided leaves as belonging to the same species. More recently, further material has come from Colombia (*Herbert H. Smith* 1980, San Lorenzo ridges, Santa Marta, in Herb. Field Mus., Herb. New York Bot. Gard., etc.) which shows many leaves like those of the type of *B. crithmifolia*, but with leaf divisions narrower. A range of leaf outlines thus is shown that seems unbelievable, easily entitling *B. crithmifolia* to rank in this respect with such species as *B. heterophylla* Ort.

*BIDENS HIRTELLA* H.B.K. Nov. Gen. 4:232. 1820.—*Bidens procumbens* H.B.K. *loc. cit.*

The type of *B. procumbens* (in Herb. Mus. Hist. Nat. Paris) differs only in the slightest way from that of *B. hirtella* (*ibid.*). *KUNTH* (H.B.K. *loc. cit.*) admitted the two forms to be very close. Had he possessed the wide range of data concerning variations in the related species of *Bidens* that, during the century since then, have steadily accumulated, he would not have hesitated to treat these as specifically the same.

*Bidens chrysanthemifolia* (H.B.K.), comb. nov.—*Cosmos chrysanthemifolia* H.B.K. Nov. Gen. 4:239. 1820; *Cosmea chrysanthemifolia* Sprengel, Syst. Veg. ed. 16<sup>III</sup>. 615. 1826; *Cosmos*

<sup>6</sup> It is interesting to note that the mature head on the type of *B. delphinifolia* has at least one achene that is positively 2-aristate, showing no indication of a third awn ever having been present (cf. H.B.K. *loc. cit.*, "triaristata").



*chrysanthemoides* DC. Prodr. 5:607. 1836; *Bidens Kunthii* Schz. Bip. Seem. Bot. Voy. Herald 308. 1852-1857; *Bidens parvulifolia* E. E. Sherff, BOT. GAZ. 56:490. 1913.

This species was stated definitely by DECANDOLLE (*loc. cit.*) to come from Mexico, but KUNTH (H.B.K. *loc. cit.*) himself was uncertain as to its native country. DECANDOLLE, moreover, commented upon the closer affinity of the achenes with those of *Bidens* than with those of *Cosmos*. Whether he altered the specific name, however, through intent or through error, I am unable to say. But later, SCHULTZ BIPONTINUS (SEEM. *loc. cit.*), who frankly declared his belief that *Cosmos* was not a valid genus, used this altered name in citing it as a basis for his *Bidens Kunthii*, a name that, according to the Vienna Code, cannot stand.

ASA GRAY (Proc. Amer. Acad. 19:16. 1884) strongly suspected that this plant was merely *Bidens humilis* H.B.K. and suggested a reexamination of the type material. KUNTH (H.B.K. *loc. cit.*) had described the color of the rays as "violacea, basim versus sulphurea." This description is borne out, not only by the coloring in the plate cited (that is, in copies of KUNTH'S work having the plates colored, as in John Crerar Library, Chicago), but by the type specimen in Paris (Herb. Mus. Hist. Nat. Paris), clearly the one from which the plate was made. This specimen, though discolored as to its rays, shows at least that the proximal ends of the rays were colored differently from the remaining portions, which latter seem surely to have been some shade of red.

More recently, fine material has been collected in Guatemala (*Heyde* and *Lux* 6173, alt. 900 m., Fraijanes, Dept. Amatitlan, September 1893, in Herb. Univ. of Chicago and in Herb. Kew), which belongs here. Singularly enough, it had been determined by JOHN DONNELL SMITH as *Bidens humilis* (cf. Gray *loc. cit.*), but the roseate rays and more or less *Cosmos*-like aspect are very distinct. The color of the rays in the dry condition varies from a pronounced roseate to a faded yellowish color, rather than showing a distinct sulphureous color definitely located toward the base as described by KUNTH. Still further material from the same small district in Guatemala (*W. A. Kellerman* 6112, alt. about 2500 m., Vol. Pacaya, Dept. Amatitlan, January 6, 1907, in Herb. Field Mus.) has been collected and fortunately is in a more mature condition. The



mature achenes match the ovary figured by KUNTH and show that there is not the slightest tendency to become rostrate as in *Cosmos*.

An examination of the original description of *Bidens parvulifolia* (Sherff, *loc. cit.*) shows that the second cited specimen (which I had seen in the U.S. Nat. Herb.) was obtained by the same collectors at the same altitude, time, and locality as was Heyde and Lux 6173 (see foregoing). The dried ligules were yellowish, the leaves were pubescent, and all but the top pair were simple. Since then, however, I have found other specimens (Heyde and Lux 6162 and 6163) showing numerous intergradations between the simple, pubescent leaves and the compound, mainly glabrous leaves; also, variations to a roseate color are shown in the rays. Thus *Bidens parvulifolia*, incredible as it will seem to any botanist who does not have at hand the intermediate specimens, must be interpreted as merely a form of *Bidens chrysanthemifolia* having minute, mainly undivided leaves.

*BIDENS CERNUA* L. Sp. Plant. 832. 1753.<sup>7</sup>—*Bidens gracilentata* Greene, Pittonia 4:255. 1901; *Bidens prionophylla* Greene, *loc. cit.* 256; *Bidens glaucescens* Greene, *loc. cit.* 258; *Bidens lonchophylla* Greene, *loc. cit.* 258; *Bidens Macounii* Greene, *loc. cit.* 259; *Bidens leptopoda* Greene, *loc. cit.* 260; *Bidens marginata* Greene, *loc. cit.* 262.

In 1901, GREENE (*loc. cit.*) described a number of new species of *Bidens*. On examination of his types (mostly in U.S. Nat. Herb.) and cotypes (mostly in Herb. Gray and in Herb. Field Mus.) nearly three years ago, I was dismayed to find that most of these species represented what ordinarily had been regarded as mere ecological forms of *Bidens cernua* and *B. laevis*. Direct conversation with Dr. GREENE himself showed that back of his viewpoint regarding *B. cernua* (Greene *loc. cit.* 251–253) was the absolute conviction that the American specimens were native to America, and, being so, were hence specifically different from European specimens.<sup>8</sup> However, personal field study for the past four autumns, combined

<sup>7</sup> Here, as elsewhere in this series of articles, only the most relevant synonyms are cited, the others being left for a complete monographic treatment later.

<sup>8</sup> In emphasizing his views upon this subject, Dr. GREENE exclaimed: "I defy you to find a single species of Compositae that is native both to Europe and to North America." It is not my intention to discuss this opinion here, since it is quoted merely to show his viewpoint. I do desire, however, to acknowledge with gratitude the courtesies shown me by Dr. GREENE from time to time. For over two years we had been making field observations for each other upon various species of *Bidens*, but his recent death brought this mutual aid to an abrupt end.



with a careful examination of a vast amount of *B. cernua* material from different American and European stations, has convinced me only the more of the utter impossibility of separating the many forms as species. Scarcely a form occurs in the United States that is not duplicated by a precisely similar form in Europe. Even GREENE himself (*loc. cit.* 252) was compelled to declare "after careful and repeated comparisons made between European and American specimens of so-called *B. cernua*, 'I acknowledge inability to detect any strong technical characters upon which to separate them.'"

Again, in a single colony of *B. cernua*, frequently three or more dissimilar forms occur, with numerous intergradations. Thus in a single small colony north of Elgin, Illinois, many plants were diminutive, matching *B. minima* Huds.; some were tall and robust, matching *B. leptopoda* Greene (the type of which Professor J. M. MACOUN of the Canadian Geol. Surv. Herb. at Ottawa kindly permitted me to examine); and some were small plants grown from the rooting nodes of tall plants trampled down by cattle, and were practically identical with *B. marginata* Greene. In the same way, several of GREENE'S types are found on comparison with their cotypes in other herbaria to be merely slight variants from the standard form. In several of these cases, GREENE'S description was much too narrow to fit even the few cotypes examined.

*BIDENS AMPLISSIMA* Greene, *Pittonia* 4:268. 1901.

This species has been discussed already (Sherff, *BOT. GAZ.* 59:312. 1915). The name *Bidens elata* then proposed as a substitute has since been found, however, at variance with an example cited in the Vienna Code for a similar case. Hence *B. elata* cannot be retained as technically the valid name.

*BIDENS LAEVIS* (L.) B.S.P. Prelim. Cat. N.Y. 29. 1888.—*Helianthus laevis* L. *Sp. Plant.* 906. 1753; *Helianthus foliis lanceolatis serratis laevibus* Gronov. *Fl. Virg.* 1:104. 1739;<sup>9</sup> *Bidens chrysanthemoides* Michx. *Fl. Bor. Amer.* 2:136. 1803; *Bidens helianthoides* H.B.K. *Nov. Gen.* 4:230. 1820; *Bidens elegans* Greene,

<sup>9</sup> I could not find CLAYTON'S no. 195 among the Gronovian plants at the British Museum, and am unable personally to confirm this citation except from GRONOVIVS' description. But, in 1869, ASA GRAY (so Miss MARY A. DAY of Gray Herbarium has kindly ascertained for me) worked upon the Gronovian plants of the British Museum and listed CLAYTON'S no. 195 as "195 *Bidens chrysanthemoides!* (not *Heliopsis laevis*)."



Pittonia 4:254. 1901; *Bidens lugens* Greene, *loc. cit.*; *Bidens formosa* Greene, *loc. cit.* 264; *Bidens Parryi* Greene, *loc. cit.* 265; *Bidens persicae-folia* Greene, *loc. cit.* 266.

The types of *Bidens chrysanthemoides* Michx. and *B. helianthoides* H.B.K. (both in Herb. Mus. Hist. Nat. Paris) appear precisely the same. The original description of both species shows their achenes to have been 2-aristate in each case, although many specimens have since been gathered showing the achenes often 3 or 4-aristate. A study of numerous specimens from the United States and Mexico seems to indicate a slight tendency for the western specimens to be more often 2-aristate, the eastern ones more often 3 or 4-aristate. But the variations are so abundant as to defy all attempts at delimiting the separate forms or races in a specific way (cf. TORR. and GR. Fl. N. Amer. 2:353. 1842).

GREENE cites a single sheet for *B. formosa*, a plant from Delaware County, Pennsylvania. But in the Field Museum are 5 sheets of material (all by *J. K. Small*, Wetzel's Swamp, N. Harrisburg, September 1887) from the same state, and these show all gradations between *B. formosa* and *B. laevis*. Again, GREENE terms his *B. Parryi* an unwelcome species, "as uniting the habit of *B. cernua* and the fruit of the *Platycarpaea* group of species." But even if *B. Parryi* were a valid species, it would not be the first species to do this; for all the material of *B. laevis* that has flat, biaristate achenes does the same; and, moreover, *B. radiata* Thuill. (*B. platycephala* Oerst.) had long been noted as a species that likewise united *B. cernua* with *B. tripartita*, the latter a principal species of the *Platycarpaea* group (cf. G. SCHWEINFURTH, Verhand. Bot. Verein Prov. Brand. 2:145. 1861). Indeed, GREENE himself, on another occasion (*loc. cit.* 261) had been led to consider *B. radiata* in this same connection, having suspected his *B. leptopoda* as being this species. DECANDOLLE, in monographing the genus *Bidens* (Prodr. 5:594. 1836), defined the subgeneric section *Platycarpaea* with the evident purpose of admitting just such species as *B. cernua*, and actually classed *B. cernua* among the *Platycarpaea*.

Hence GRAY saw this plant and determined it personally. As his knowledge of this species was very keen, there is no question as to his accuracy. LINNAEUS' private specimen of *Helianthus laevis* L. (in Herb. Linn.) is *Heliopsis* (cf. GRAY, Synopt. Fl. 1<sup>11</sup>:255. 1884; also PERSOON, Synops. Plant. 2:473. 1807).



Several other species described by GREENE and based upon characters seemingly inconsistent or difficult at present to evaluate, are reserved for later treatment.

UNIVERSITY OF CHICAGO

#### EXPLANATION OF PLATE XXXI

*Bidens mirabilis*.—*a*, spray  $\times 0.7$ ; *b*, exterior bract  $\times 4$ ; *c*, interior bract  $\times 4$ ; *d*, palea  $\times 4$ ; *e*, floret  $\times 7$ ; *f*, anther  $\times 35$ ; *g*, pollen grain  $\times 350$ ; *h*, achene  $\times 11$ ; *i*, portion of leaflet  $\times 3$ ; all from type in Herb. Kew.



# THE OCCURRENCE OF BACTERIA IN FROZEN SOIL

E. C. HARDER

(WITH TWO GRAPHS)

## Introduction

The results of various investigators, notably CONN and BROWN, have shown that the actual number of bacteria in the soil often increases with a decrease in temperature. This phenomenon is not confined to a gain in the number of bacteria alone, but is accompanied by a stimulation of the activity of the microorganisms. Many bacteriological processes, as ammonification, denitrification, and free nitrogen fixation, have shown an increase in frozen soils.

Because of the practical importance of this problem for agricultural practice it was thought advisable to note the effect of cold and moisture on the number of bacteria in Madison soil. Here the variations in temperature are greater than those recorded by former investigators.

In order to study what effect these great variations would exert on the number of bacteria, a series of plate counts was made. If the number of bacteria in the soil increases with freezing, there should be a parallel increase in available plant food. Many questions arise. Do all soils when sampled in the winter show the same general increase? What effect does stimulation of bacteria have on soil fertility? It has been noted that an increase in bacterial activity results in an increase in food for higher plants. The increase in the number of bacteria during the winter probably plays an important part in soil fertility. This is decidedly at variance with the earlier idea that frozen soils are dormant.

## Previous work

The more recent experiments on the activity of bacteria in frozen soil were conducted by CONN<sup>1</sup> and BROWN and SMITH.<sup>2</sup>

<sup>1</sup> CONN, H. J., Bacteria in frozen soil. I and II. *Centralbl. Bakt.* 28:422-434. 1910; 32:70-97. 1911.

———, Bacteria of frozen soil. *N.Y. Agric. Exp. Sta. Tech. Bull.* 35. July 1914.

<sup>2</sup> BROWN, P. E., and SMITH, R. E., Bacterial activities in frozen soils. *Agric. Exp. Sta. Iowa State College of Agric. Research Bull.* 4. January 1912.



CONN'S experiments dealt mainly with the number of bacteria in frozen soils, which he compared with the number in the same soils when in an unfrozen condition. He worked both with field and with potted soils and reached the following conclusions: (1) "the increase in number of bacteria after freezing is not due to the increase in soil moisture which usually occurs in winter"; (2) "the same increase in germ content may take place in potted soil, where there is no possibility that the bacteria are carried up mechanically from lower depths during the process of freezing"; and (3) this phenomenon is probably "due to an actual growth of bacteria after the soil is frozen."

The experiments were performed with the samples of field soil taken from plates prepared for the purpose, both aerated and unaerated soils being examined. Each type of soil, therefore, probably had a nearly uniform bacterial content originally throughout its mass, and the changes that occurred in it from time to time must be ascribed to the effect upon it of changes in the atmosphere. Unfortunately, samples were taken only at irregular intervals, so that, while the results show a general higher content of bacteria in frozen soils during the winter, they are not sufficiently detailed to show definitely when such increases occurred and to what they were due.

It is suggested that possibly freezing may have the effect of breaking up compact colonies which under ordinary conditions would not separate into individuals, thus making the increase only an apparent one, owing to more individuals producing separate colonies on the plates. This view is discarded, however, because upon the thawing of the soil the number of bacteria again decreases to practically what it was before freezing. It is claimed also that the maximum number is reached several weeks after a frost.

CONN concluded, therefore, that the increase is due to actual multiplication, and the supposition is that such multiplication takes place in certain denser portions of the soil solution, which, as suggested by BROWN and SMITH (*loc. cit.*), probably do not freeze. It is suggested that conditions in these unfrozen portions may favor the growth of certain prolific kinds of bacteria and suppress



the growth of other varieties which at ordinary temperatures interfere with the growth of these prolific kinds.

An analogous hypothesis proposed by RUSSELL<sup>3</sup> for increases in the number of bacteria after partial sterilization by heat, frost, or other means is that by such partial sterilization the protozoa are killed, thus permitting the unhindered development of bacteria which under ordinary conditions is held in check by protozoa.

BROWN and SMITH (*loc. cit.*) in their investigations dealt mainly with the physiological activities of bacteria under conditions of low temperature and frost, although they also made some determinations of the number of bacteria in frozen soil. Their principal conclusions regarding the ammonifying, nitrifying, denitrifying, and nitrogen fixing powers of frozen soils are as follows: (1) that "frozen soils possess a much greater ammonifying power than unfrozen soils"; (2) that "during the fall season, the ammonifying power of the soil increases until the temperature of the soil almost reaches zero, when a decrease occurs, and this is followed by a gradual increase and the ammonifying power of the soil reaches a maximum at the end of the frozen period"; (3) that "the nitrifying power of frozen soils is weak and shows no tendency to increase with extension of the frozen period"; (4) that "frozen soils possess a decided denitrifying power which seems to diminish with the continuance of the frozen period"; (5) that "during the fall season, the denitrifying power of the soil increases until the soil freezes, after which a decrease occurs"; (6) that "frozen soils possess a nitrogen fixing power which increases with the continuance of the frozen period, being independent of moderate changes in the moisture conditions, but restricted by large decreases in moisture"; and (7) that "in the fall, the nitrogen fixing power of the soil increases until the soil becomes frozen, when it almost ceases, after which a smaller nitrogen fixing power is established."

The experiments on which these conclusions are based were conducted with air-dried soil of uniform texture and composition as a medium. This soil was enriched with suitable materials for ammonification, nitrification, denitrification, or nitrogen fixation.

<sup>3</sup> RUSSELL, E. J., The effect of partial sterilization of soil on the production of plant food. *Jour. Agric. Sci.* 5:152-221. 1913.



One-hundred gm. samples of soil thus prepared were then inoculated with infusions consisting of a mixture of the fresh soils to be tested and sterile water, 10 cc. of the infusion (containing in each case about 5 gm. soil) being added to each 100 gm. sample. The final moisture content of the soils during incubation was 20 per cent.

BROWN and SMITH assert that actual multiplication in the numbers of bacteria takes place in frozen soils, and that to this must be ascribed the increased numbers during the winter months. They present the hypothesis that, owing to the concentration of various salts in the film of hygroscopic water around soil particles, this film probably does not freeze under ordinary winter conditions, and bacteria may live and multiply in it.

### Present investigations

SUMMARY OF RESULTS.—During the winter of 1914-1915, the writer conducted a series of experiments with field and potted soils. The results obtained justify conclusions which are somewhat at variance with those obtained during the recent investigations by CONN at Ithaca and Geneva, New York, and by BROWN and SMITH at Ames, Iowa; and it seems advisable, therefore, to publish them. The principal results obtained were as follows:

1. It was found that the number of bacteria in surface soil increased markedly after heavy frosts and in general maintained a high average during the winter months. The increases and decreases, however, were found to bear a distinct relation to the moisture content.

2. The potted soils failed to show such marked increase in bacterial content after frosts. On the contrary, the enriched cultures showed a distinct retardation of bacterial growth when in a frozen condition.

3. The bacterial flora was more or less the same during the fall, winter, and spring, with the exception that after heavy frosts the small transparent colonies characteristic of water and of deeper soils formed a larger proportion of the growth on the plates.

From these results it seems reasonable to conclude that ordinary soil bacteria undoubtedly withstand cold to a marked degree, even to temperatures as low as 4° C. or more below zero. The increase



in numbers, however, seems to be due to mechanical transportation by moisture coming up from below during heavy frost, and where such transportation is not possible there is an actual retardation in growth as compared with that in unfrozen soils.

EXPERIMENTS WITH FIELD SOIL.—The investigations were begun during the latter part of October, and the samples were examined every week until the latter part of February, after which time the samples were examined at greater intervals.

A dark, medium rich, slightly sandy garden soil was studied. It was obtained from the university campus near the College of Agriculture, and care was taken to secure successive samples from exactly the same place. The soil was sampled to a depth of about 6 inches each time, thus giving an average of a surface layer to this depth. The temperature of the soil was taken roughly with an ordinary thermometer.

The entire sample was thawed, when necessary, and thoroughly mixed in a mortar, previously washed out with 95 per cent of alcohol. Twenty gms. of soil were then mixed with 400 cc. of sterile water, and from this 25 cc. were carried to a second 400 cc. sterile water blank, and so on to the fourth dilution. From the fourth or fifth dilution plates were poured and these were counted after an incubation period of 8 days at 28° C. Heyden Nährstoff agar was used as a culture medium.

It appears that in order to obtain conclusive results regarding the bacterial content of soils, samples should be investigated at short intervals of time, perhaps every few days, or even every day, as at times of heavy frost, or after rainfall. It was found that the bacterial content of soils is closely dependent on atmospheric conditions as regards temperature and precipitation. When atmospheric conditions vary rapidly the bacterial content of soils also may change rapidly. Table I shows the variations in the bacterial content of the soil from October 1914 to April 1915.

Table I shows the general close relation between the moisture content and the number of bacteria in the soil. This is also shown in graph 1. While slight discrepancies undoubtedly occur, the general correspondence is very marked. Graph 2 gives the curves of high and low daily temperature, as well as figures for the



precipitation during the period that the experiments were carried on.

It will be seen by an examination of table I that there was some variation in the bacterial content during the latter part of October

TABLE I

Date	Percentage of moisture content of soil	Temperature of soil	Average number of colonies per plate*	Bacteria per gm. dry soil	Remarks
1914					
October 26..	15.02	.....	168	19,420,800	Soil unfrozen
November 2..	11.83	.....	182	20,187,358	Soil unfrozen
9..	11.79	.....	114	12,692,786	Soil unfrozen
17..	25.64	-0.5C.	203	26,824,623	Soil frozen 4-5 inches
24..	20.98	0.0	100	12,434,800	{ Upper 1 inch thawed; below frozen
December 1..	17.02	+8.0	81	9,534,105	{ Soil completely thawed
8..	18.44	+1.0	62	7,469,450	Rain December 7
15..	30.05	-3.0	212	29,781,548	{ Frost December 9 Heavy frost Decem- ber 13
22..	23.48	-4.0	188	24,018,316	{ Snowfall December 20; continued frost
29..	24.48	-0.7	293	38,122,523	{ Heavy frost Decem- ber 25-26; heavy snowfall December 29
1915					
January 5..	21.52	-1.0	213	26,668,239	Mild temperature
14..	28.62	-1.0	115	15,830,555	Mild temperature
19..	29.24	-3.0	166	23,051,258	{ Thaw and subsequent frost
26..	26.87	-2.7	164	22,035,532	{ Cold weather January 21-24
February 3..	29.53	-1.0	168	23,425,080	{ Very severe frost January 27-28
9..	25.60	-3.0	153	20,206,710	{ Thaw and rain Febru- ary 4-5
23..	24.03	+1.0	76	9,824,216	{ Soil completely thawed
March 4..	24.10	-0.7	65	7,993,570	Upper 3 inches frozen
17..	24.00	+0.5	157	20,298,373	Upper ½ inch frozen
April 13..	18.40	+4.0	89	10,717,113	Completely thawed

\* Fourth dilution

and the first part of November, while the soil was still unfrozen. This variation seems to have been independent of the moisture content. On November 17, some days after the first frost, a distinct increase in the number of bacteria was shown, accompanied by a great increase in moisture. During the subsequent period of mild



weather continuing to December 9, the bacterial content of the soil gradually decreased to much below the original amount, the lowest count of the winter, 7,459,450 bacteria per gm. of dry soil, occurring during this period. At the same time the soil thawed and the moisture content decreased. The count of December 15, taken some days after the second frost, again showed a marked increase in bacterial numbers, as well as in moisture content. Following this there was a continuous cold period culminating in very heavy frost from December 25 to 27. On December 29, following this heavy frost, we had the highest bacterial count of the winter, 38,122,523 bacteria per gm. of dry soil. The next count, January 5, showed a considerable decrease with but a slight decrease in moisture content. This is probably to be explained

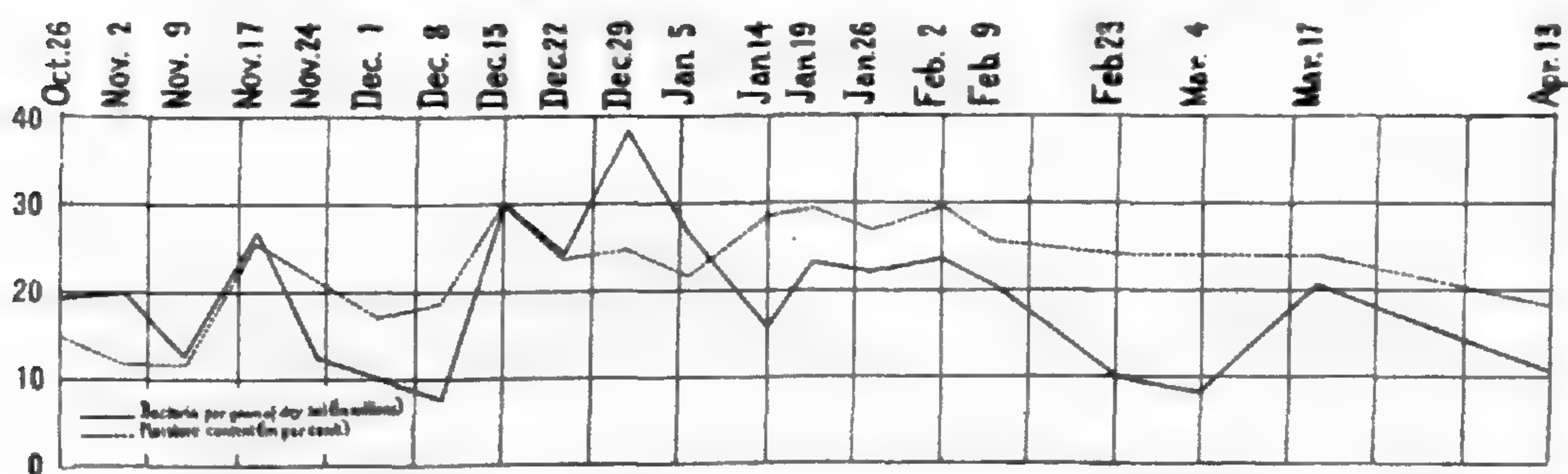

GRAPH 1.—Curves showing the bacterial and moisture contents of Madison soil from October 26, 1914, to April 13, 1915.

by the fact that the high count of December 29 included many forms that could not withstand the more severe cold to which they were exposed in the upper soil layer. The low count of January 14 accompanied by an increase in moisture is difficult to explain.

After this date there was no great variation in the bacterial content until February 23, when there occurred a marked decrease accompanying the complete thawing of the soil. During this thawing, however, there was only a slight decrease in soil moisture. The figure for April 13 shows the normal bacterial content of the soil during the spring.

EXPERIMENTS WITH POTTED SOIL.—In order to determine whether the high bacterial content of frozen soil was due to an actual increase in growth, or whether other factors brought about this phenomenon, two duplicate sets of potted soil were prepared.



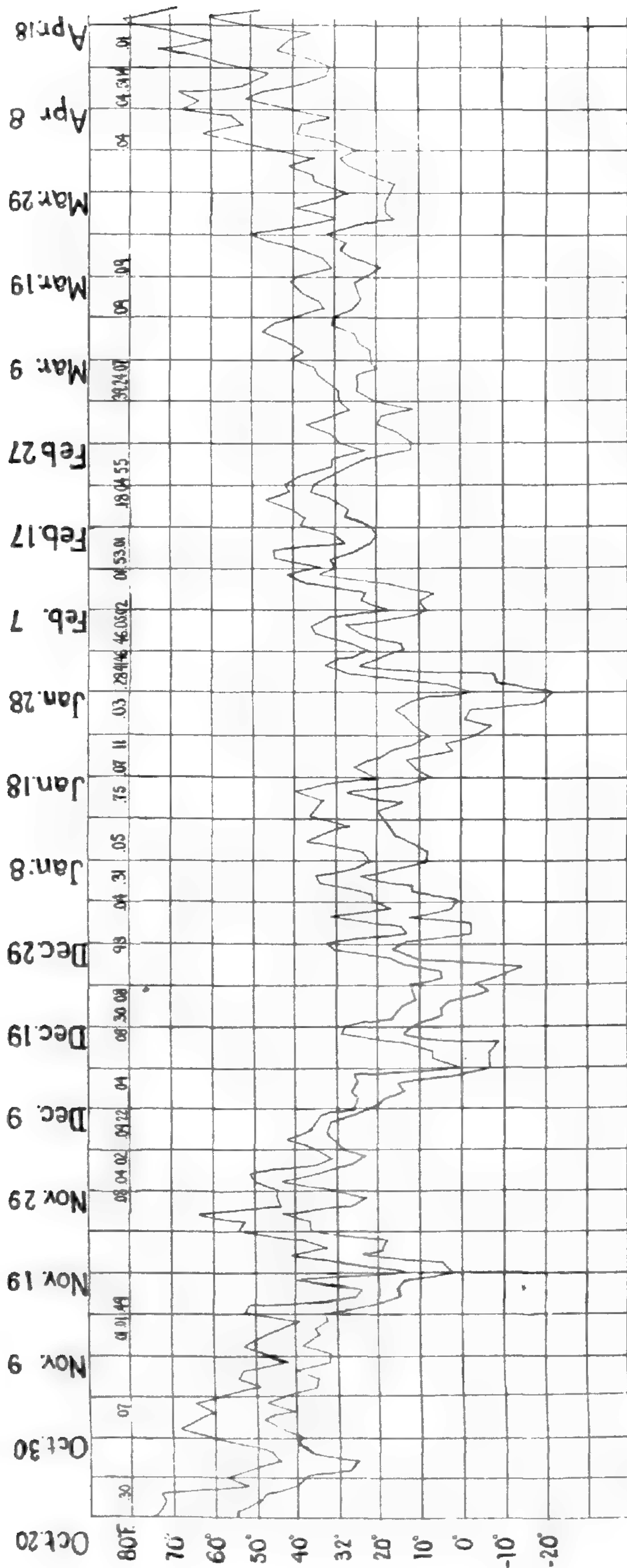

GRAPH 2.—Curves showing high and low daily temperatures at Madison, Wisconsin, and figures giving precipitation from October 20, 1914, to April 20, 1915.



One set was kept at room temperature and the other set was placed outside, subject to atmospheric temperatures.

Six jars (3 for each set) of glazed earthenware, holding about 1850–1900 gm. of soil, were used. These were filled with soil prepared as follows: nos. 1 and 2, Miami silt loam containing 23 per cent moisture; nos. 3 and 4, Miami silt loam containing 23 per cent moisture and 1 per cent dextrose; and nos. 5 and 6, Miami silt loam containing 28 per cent moisture.

The soil was thoroughly mixed and the moisture raised to the proper amount, care being taken to secure a uniform moisture content throughout the sample. Muslin was tied over the tops of the jars, which allowed free access of air but which excluded dust. Jars 2, 4, and 6 then were placed outside of a window, and protected from rain and snow by a large bell jar which allowed free circulation of the air. Jars 1, 3, and 5 were kept in a room at an average temperature of about 25° C. The jars were left untouched for a period of 18 days (February 16–March 6). The average daily temperatures for this period which affected the outside jars are shown in graph 2.

At the end of the period an average 20 gm. sample was taken from each of the jars and treated in the same way as the field soil samples previously described. Plates poured with Heyden Nährstoff agar and counted after 8 days gave the results indicated in table II.

TABLE II

No. of jar	Treatment	Percentage of moisture content of soil	Average number of colonies per plate*	Bacteria per gm. dry soil
1.....	23 per cent H <sub>2</sub> O.....	8.42	51	5,471,994
2.....	23 per cent H <sub>2</sub> O (frozen) ..	15.00	48	5,548,800
3.....	23 per cent H <sub>2</sub> O 1 per cent dextrose.....	9.99	261	28,491,543
4.....	23 per cent H <sub>2</sub> O 1 per cent dextrose (frozen).....	15.80	155	18,089,275
5.....	28 per cent H <sub>2</sub> O.....	9.31	61	6,609,167
6.....	28 per cent H <sub>2</sub> O (frozen) ..	17.48	51	6,073,131

\* Fourth dilution.

It should be noted that in the cases where the soil was kept in the room, the evaporation was much more rapid than in the soils



kept outside, so that while the original moisture content was the same, when the counts were made the amount of moisture present in the jars kept outside was nearly double that in the jars kept in the room.

The results recorded in table II show clearly the retardation in growth which was caused by cold and frost. In the case of jars nos. 1 and 2, the number of bacteria per gm. of soil is almost the same in the two samples, yet sample no. 2 has only slightly less than twice as much moisture as sample no. 1. Jars nos. 3 and 4 show the retardation even better. Here 1 per cent of dextrose was added so as to produce a rapid growth. No. 3 with a much lower moisture content than no. 4 shows a much greater increase in growth. This is the reverse of what might be expected to happen under ordinary conditions, and must be ascribed to the action of frost, since normally the bacterial content should rise with an increase in moisture. Jars nos. 5 and 6 gave results similar to jars nos. 1 and 2, the number of bacteria being slightly higher because of the higher moisture content.

In general these figures show that even a much higher moisture content was not sufficient to counteract the retarding in growth due to cold.

### **Types of bacteria in frozen soil**

No detailed study of the varieties of bacteria in the soil was made, since this would have required much more time than was at the writer's disposal. Nevertheless, general differences in the kinds of colonies present in successive counts were noticed.

Usually the plates contained a varying number of raised colonies of yellow, red, and fluffy white actinomycetes, a few spreaders of the *B. mycoides* type, some red or yellow chromogens, numerous small, slow-growing, transparent colonies, and many white or cream colored colonies without distinctive marks, some of them raised and others flat. Occasionally the plates showed a few opalescent colonies.

So far as could be noticed from the examination of colony growths, there was no distinct difference between the fall, winter, and spring floras. It was noticeable, however, that the relative



proportions of the different types sometimes changed markedly in successive counts. Thus it was found that after heavy frosts the small transparent colonies made up sometimes one-half or more of the total number of colonies on the plates. In subsequent counts they would gradually decrease in number.

The actinomycetes and the spreaders did not seem to be affected by the frost, being present on nearly every plate counted during the winter. The chromogens were more irregular in their occurrence and apparently were somewhat less abundant during very cold periods.

The writer wishes to express his indebtedness to Professor E. B. FRED, University of Wisconsin, for helpful suggestions and criticisms.

UNIVERSITY OF WISCONSIN  
MADISON, WIS.



# THE PROTHALLIA OF OPHIOGLOSSUM VULGATUM

NORMA E. PFEIFFER

(WITH FOUR FIGURES)

The gametophyte of *Ophioglossum* was found first by METTENIUS in material of *O. pedunculatum* Desv. in the botanical gardens at Leipzig, in 1856. Almost 50 years later, LANG collected prothallia of *O. pendulum* in Ceylon, in the Barrawa Forest Reserve. These were found to be developed in the humus between leaf bases of an epiphytic *Polypodium*, and, as in the case of METTENIUS, were found growing spontaneously, but were not developed in cultures from the spores. Later, CAMPBELL found similar prothallia in humus collected between leaves of *Asplenium nidus* in Java. In 1906 he also collected prothallia of *O. molluccanum* at Buitenzorg. In 1904, BRUCHMANN reported the finding of gametophytes of *O. vulgatum* in nature. He worked over a considerable period of time, free days from May to October, in isolating about 70 young prothallia, besides those with sporophytes, in a particularly favorable region in the Thuringian Forest. The area concerned was a depression surrounded by ash trees and alders. The occurrence of so many specimens was attributed partly to the protection against wind currents which might carry the spores away, although the depression was subject to overflows from rains, which might remove the spores also. CAMPBELL considers the latter of importance because of the possible effect of submergence upon germination of spores. It would seem likely that this process is favored by inundation. BRUCHMANN obtained the prothallia by arduous labor, working over the soil between the mature plants. That the prothallia are not numerous is evidenced by the small return of two prothallia per working day.

The situation in which the present growth of *O. vulgatum* occurs is practically the low prairie type previously described for *Thismia americana*.<sup>1</sup> The plants of *Ophioglossum* occur among the

<sup>1</sup> PFEIFFER, NORMA E., Morphology of *Thismia americana*. BOT. GAZ. 57:122-135. pls. 7-11. 1914.



prairie plants. Spots have been burned, and here the plants show very distinctly, owing to a partial elimination of the grasses and other plants which ordinarily tend to obscure the smaller *Ophioglossum* plants. Where there is much shade, *Selaginella apus* and *Aneura pinguis* occur, as in the *Thismia* patch, which is close at hand. The habitat is evidently low and wet, inundated in spring. Early in July, *Riccia fluitans* in small amounts was also found, and late in July 1915, after a rather wet month, some of the field was under water. There were, however, hummocks as well as more extensive little plots not submerged. Compared with the other situation in the Chicago region where *O. vulgatum* has been found, that is, near Gary, the present station in the southeast outskirts of Chicago seems wetter. The difference noted in the time of maturity of fertile spikes in the two areas is probably related to the difference in situation. In the moister place, some spikes were still unshed on July 24, whereas the spikes were already gone in the drier, less protected Gary situation, on July 15. Working on CAMPBELL'S theory that inundation favors spore germination, one may suppose that

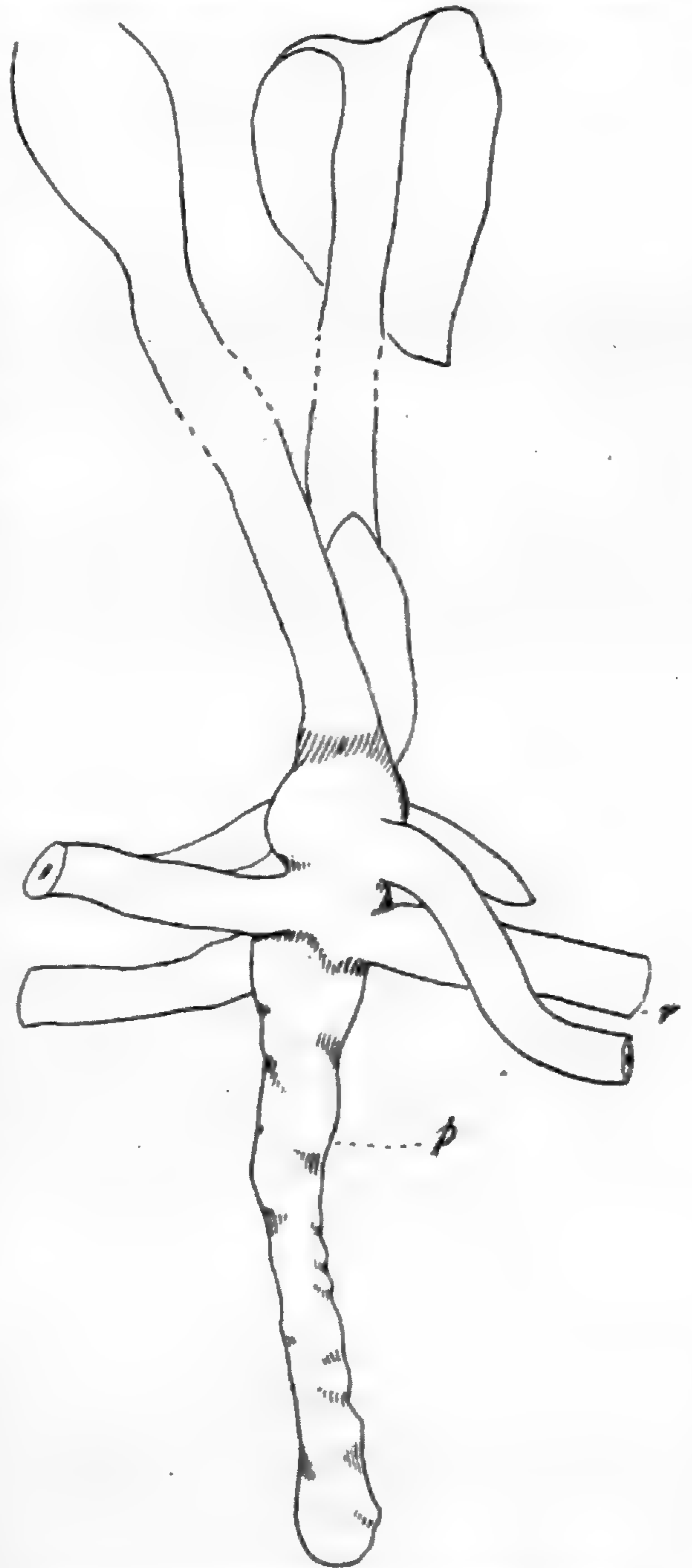

FIG. 1.—Old prothallium of *Ophioglossum vulgatum* with well developed sporophyte; *p*, prothallium;  $\times 3$ .



this difference would account for the finding of any prothallia here, whereas their occurrence in the Gary area has not been noted.

The gametophytes so far found have had attached sporophytes, either well developed

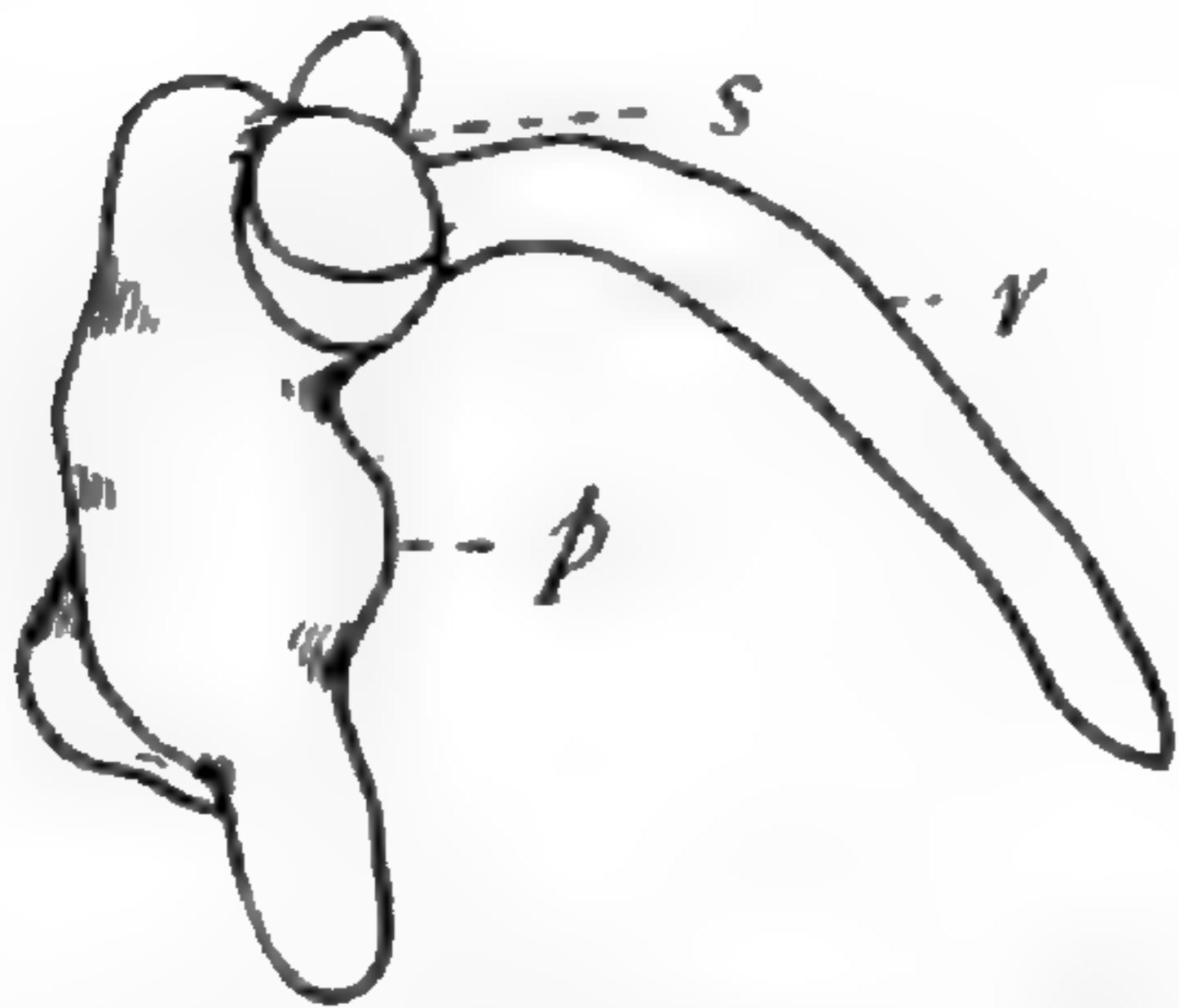

FIG. 2.—Prothallium with younger sporophyte; *s*, sporophyte base; *r*, first root; *p*, prothallium;  $\times 3\frac{1}{3}$ .

or very young. With more time at one's disposal, there is little doubt that younger prothallia could be found. Quite evidently, from the age of the sporophyte, the gametophytes remain attached for some seasons after fertilization has occurred. There remains to be done the mechanical labor of sorting until younger and younger material is obtained.

The appearance of prothallia is entirely similar to that described by BRUCHMANN. Most of them are simple (figs. 1 and 2), although branching

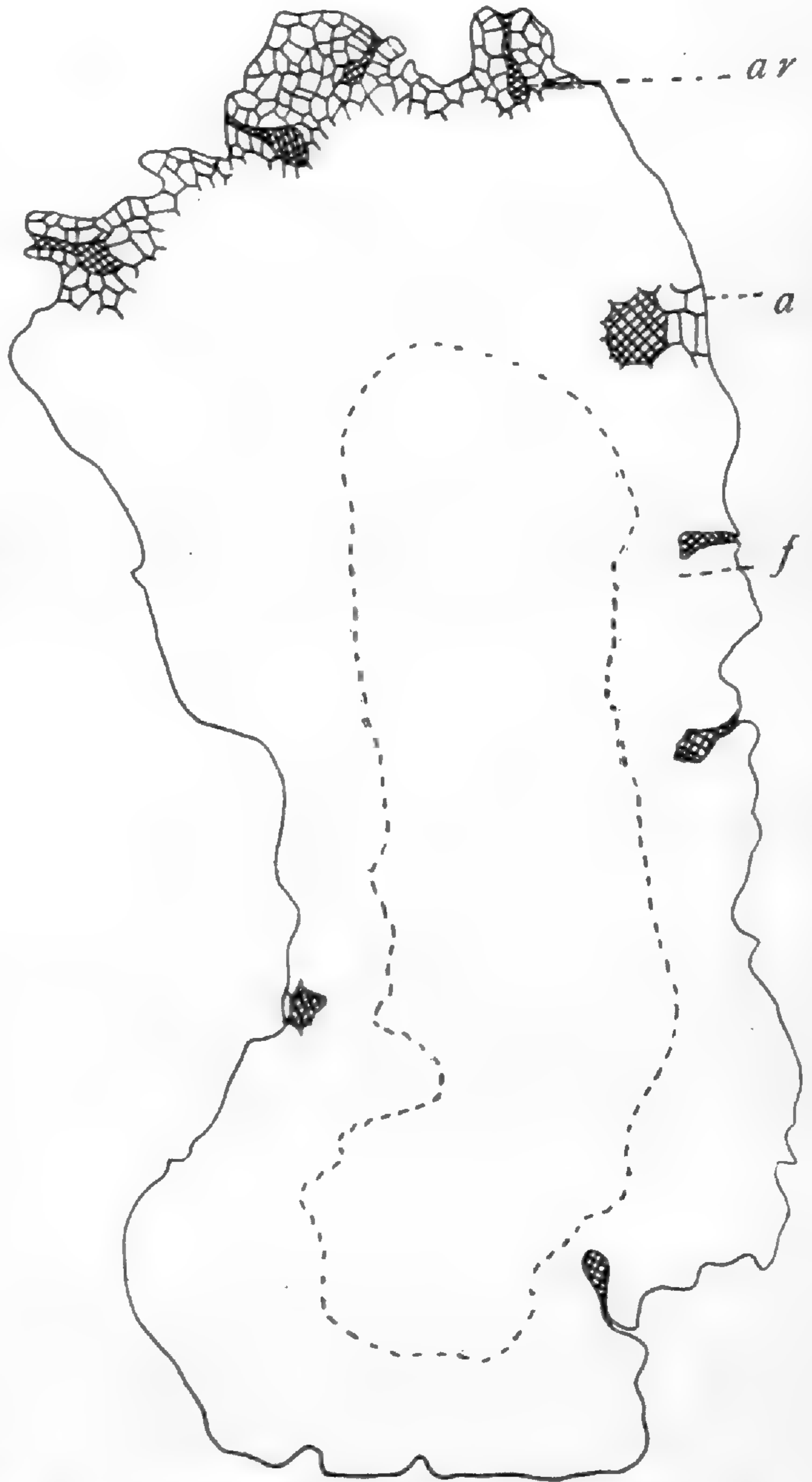

FIG. 3.—Longitudinal section of prothallium; *a*, antheridium; *ar*, archegonium; *f*, fungus-infected region;  $\times 33$ .



occurs. In external appearance the prothallium may be distinguished readily from roots by the irregular form and uneven surface it exhibits owing to the sex organs, as compared with the straight and very smooth roots or rhizomes. The end is more or less round or even tuberous, as indicated in BRUCHMANN'S figures, as compared with the pointed root tip. Usually in specimens with well developed sporophytes, the decided brown coloring of the prothallium is another distinguishing character, although here it is often difficult to distinguish sharply between the base of the sporophyte and the gametophyte. The younger material, as well as the growing region of older gametophytes, is lighter in color, however. As compared with the horizontal position of most of the roots, the prothallium is usually oriented with its long axis nearly vertical.

Sections of a prothallium with a young sporophyte attached show the surface to be well dotted with sex organs (fig. 3), as may be seen even in bulk material by use of a hand lens. The necks of old archegonia are conspicuous, as are the positions of antheridia. Occasionally there are antheridia still unshed, as shown on a small excrescence near the upper portion, where fungal hyphae had not yet entered (fig. 4). Here it is probable that there was continued production of sex organs after fertilization. Sufficient material for working through developmental stages was not at hand, but the stages found confirm BRUCHMANN'S conclusions regarding the sex organs.

The general topography does not differ from that figured by BRUCHMANN, except that there is usually only one cortical layer free from fungi. Within this is the region, 4-6 layers of cells deep, in which the fungus is conspicuous, and then the central region, staining more lightly because of the absence of mycelium in the



FIG. 4.—Section of prothallium showing young antheridia (*a*);  $\times 33$ .



cells. This region contains more or less reserve food in the form of starch grains.

There is little doubt that reproduction by vegetative spread is by far the more common method, but scattered among plants so produced are the far less numerous specimens arising after gametophyte production has occurred.

UNIVERSITY OF NORTH DAKOTA  
GRAND FORKS, N.D.



# THE MEASUREMENT OF OXIDATION POTENTIAL AND ITS SIGNIFICANCE IN THE STUDY OF OXIDASES

G. B. REED

(WITH TWO FIGURES)

In the course of a series of investigations on the rôle of plant oxidases, the writer has found it necessary to follow with accuracy the progress of various oxidation reactions. The best method of accomplishing this is found undoubtedly in the measurement of the oxidation potential of the solutions entering into the reactions. Since this method has never been employed in the study of biological processes, and has only a limited use in physical chemistry, a description of the apparatus as modified by the writer may be of interest.

According to electro-chemical conceptions, oxidation is the process of taking on positive charges of electricity or the giving up of negative charges of electricity. Hence if we have a measure of the tendency of a substance to take on or give up electrical charges, we may determine the oxidizability of that substance.

If we consider a hydrogen electrode, that is, a strip of indifferent metal, such as platinum, platinized to increase its surface and charged with hydrogen gas, dipping into a solution containing hydrogen ions, we see that there will be a potential difference between the electrode and the solution. The hydrogen on the electrode will give up to the solution positively charged hydrogen ions until equilibrium with osmotic pressure of the hydrogen ions in solution is reached. If two such electrodes dip into solutions containing hydrogen ions at different concentrations connected by a liquid (as through a siphon), the potential of the cell is equal to the algebraic sum of the two single potentials, and is expressed by the formula

$$E = \frac{RT}{2Q} \ln \frac{P}{P_1},$$



where  $P$  and  $P_1$  represent the concentrations of hydrogen ions in solution.<sup>1</sup> If the concentration of hydrogen ions in one solution is known, the concentration of the second may be calculated from the observed potential. In practice it is customary to substitute a standard half-cell (for example, a calomel electrode) for one of the hydrogen electrodes.

In a similar manner, when an oxygen electrode dips into a solution, the oxygen on the electrode tends to give up to the solution negatively charged oxygen ions until equilibrium is reached. The electrode, therefore, becomes positively electrified. If there be added to the solution an oxidizing agent (which, by definition, gives up positive charges), it will increase the positive charge on the electrode. In the case of potassium permanganate in acid solutions, the source of the positive charge may be represented by the equation

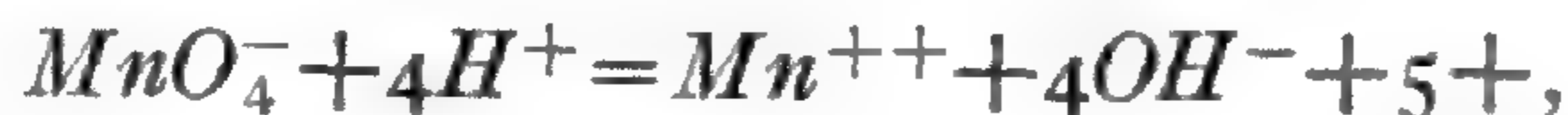

and the potential may be calculated from the formula<sup>2</sup>

$$E = \frac{RT}{5F} \ln K \frac{(MnO_4^-) \times (H^+)^4}{(Mn^{++}) \times (OH^-)^4}$$

Experimental complications are met with in using platinum as an electrode, since it appears that oxygen combines with platinum to form oxides.<sup>3</sup> These complications are of theoretical interest, but for practical purposes they may be neglected, since the platinum electrode, when charged with oxygen, gives satisfactory comparative values of the oxidizing and reducing ability of different compounds. This is true even when the manner in which the compound ionizes is not known.

The measurements recorded in this paper, and in investigations to be reported on later, were made with the apparatus illustrated by fig. 1. The reaction cell  $A$  consisted of a 200 cc. beaker containing the solution to be tested, into which the two electrodes dipped. The electrode  $B$  was made from a platinum crucible of

<sup>1</sup>LEBLANC, M., *Electro-chemistry*; translation by WHITNEY and GOWAN. New York. 1907 (p. 195).

<sup>2</sup>CROTOGINO, F., *Zeit. Anorg. Chem.* 24:225. 1902.

<sup>3</sup>SCHOCH, E. P., *Jour. Phys. Chem.* 14:665. 1910.



about 50 cc. capacity, platinized on both sides in the ordinary manner, and completely submerged in the solution. The other half of the cell was a standard calomel electrode (C) made up in a 150 cc. bottle with saturated KCl. To prevent contamination by diffusion of the reaction mixture into the electrode, connection was made by means of a siphon to a bottle (D) containing saturated KCl; and from this, by means of a second siphon, connection was made with the reaction cell A. To further prevent diffusion, this

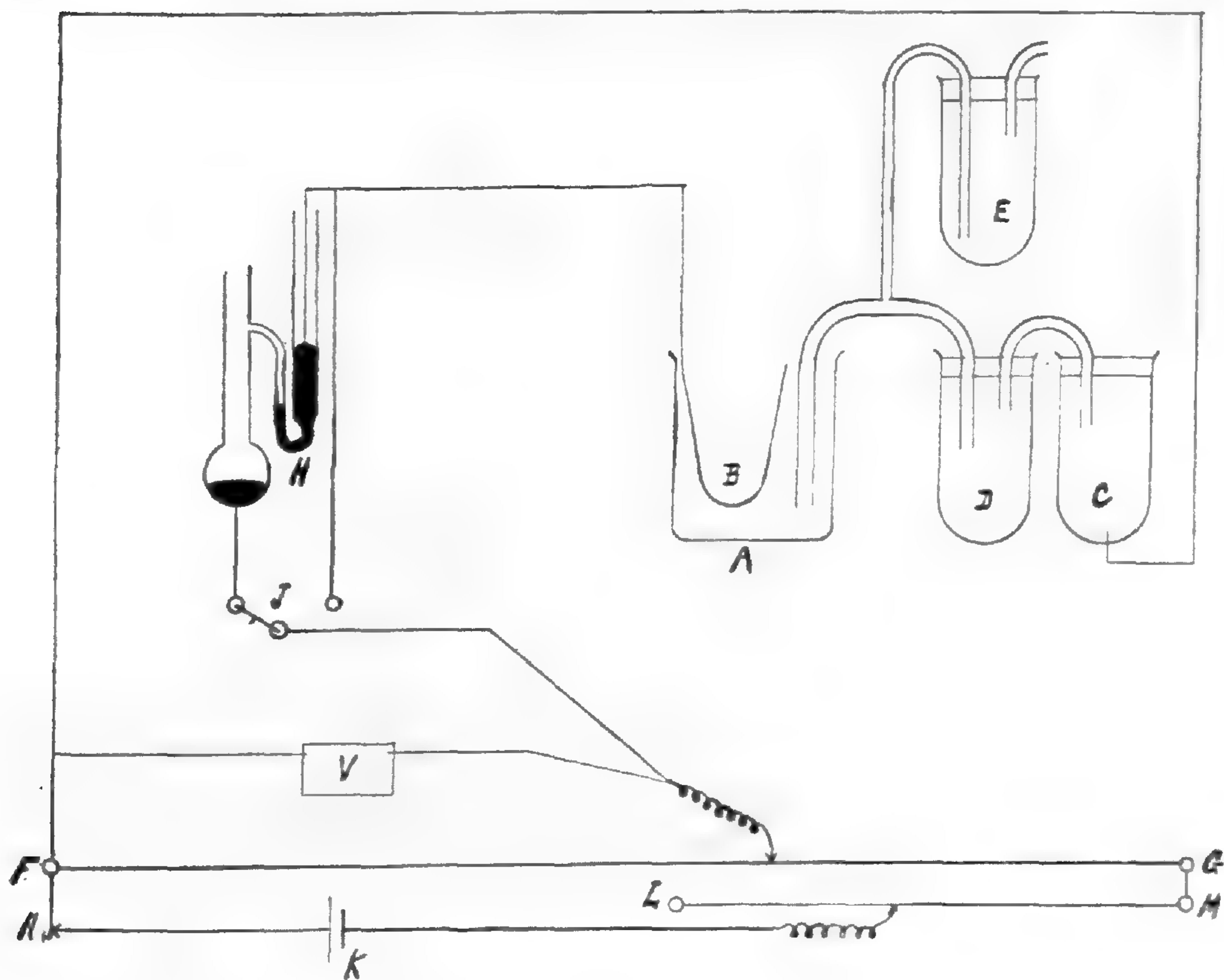

FIG. 1

second siphon contained a cotton wick for a part of its length, and was kept closed by means of a pinchcock (on a rubber section of the siphon), and finally terminated in a fine capillary which dipped into the reaction mixture. The reservoir of saturated KCl at E allowed the capillary to be washed out frequently without disturbing the electrode.

Measurement of the total potential of the cell (that is, the potential at the platinum electrode plus the known potential of the



calomel electrode as well as the exceedingly small contact potential between the KCl and the solution in *A*) was made by the Poggendorf compensation method, with the apparatus so arranged that the amount of current taken from the cell was reduced to a minimum.

The calomel electrode was connected with one end of a slide wire bridge (*FG*) and the platinum electrode was connected, through a zero instrument *H* with the sliding contact. A Lippman capillary electrometer (since it takes no current) was found more satisfactory as a zero instrument than a galvanometer, which is usually employed. To have the electrometer at zero at the beginning of a reading, it was kept short-circuited through itself by properly shifting the key *J*.

A potential was maintained along the wire *FG* by means of the battery *K* (3 dry cells in parallel). The variable resistance *LM* permitted this to be regulated to suit the requirements. By connecting a voltmeter *V* between the negative end of the bridge and the sliding contact, it is possible to read off the potential taken from the battery circuit at any time.<sup>4</sup>

In taking a reading, the battery circuit through the bridge was closed by the key *N*, and the circuit to be measured was immediately closed by the key *J*. The sliding contact was then adjusted so that the potential from the battery circuit was just sufficient to balance that produced in the reaction beaker *A*. When this condition was reached no current flowed and the electrometer was in equilibrium. The reading of the voltmeter then gave the potential of the cell.

The potential produced at the platinum electrode could then be determined by subtracting the positive single potential of the calomel electrode, usually referred to as 0.56 volt, from the total potential observed. For comparative purposes, however, since the potential of the calomel electrode was constant, the total potential of cell may often be used.

The curve of the oxidation of oxalic acid by acidified potassium permanganate, shown in fig. 2, illustrates the way in which a reaction may be followed by this method. On placing a platinized

<sup>4</sup>This use of a voltmeter, to avoid the use of a standard cell and potentiometer calculations, was suggested by HILDEBRANT, Jour. Amer. Chem. Soc. 35:869. 1913, in connection with measurements of H ion concentration.



electrode, connected as previously described, in dilute oxalic acid, the potential quickly drops to very nearly the minimum value. The potential may continue to drop for some hours (this slow drop amounting to 0.1–0.2 volt) if the electrode has previously been subjected to an oxidizing agent; but if the electrode is previously subjected to a reducing agent, a constant potential is reached much more quickly. When standardized potassium permanganate

(in this case 0.001 M) is added, the potential rises slowly until the concentration of positive ions becomes nearly equal to that of the negative ions, when a trace of permanganate causes a jump in the potential. The last trace of permanganate is sufficient to change the solution in contact with the electrode from a reducing agent to an oxidizing agent, that is, to one which gives up positive ions. It is evi-

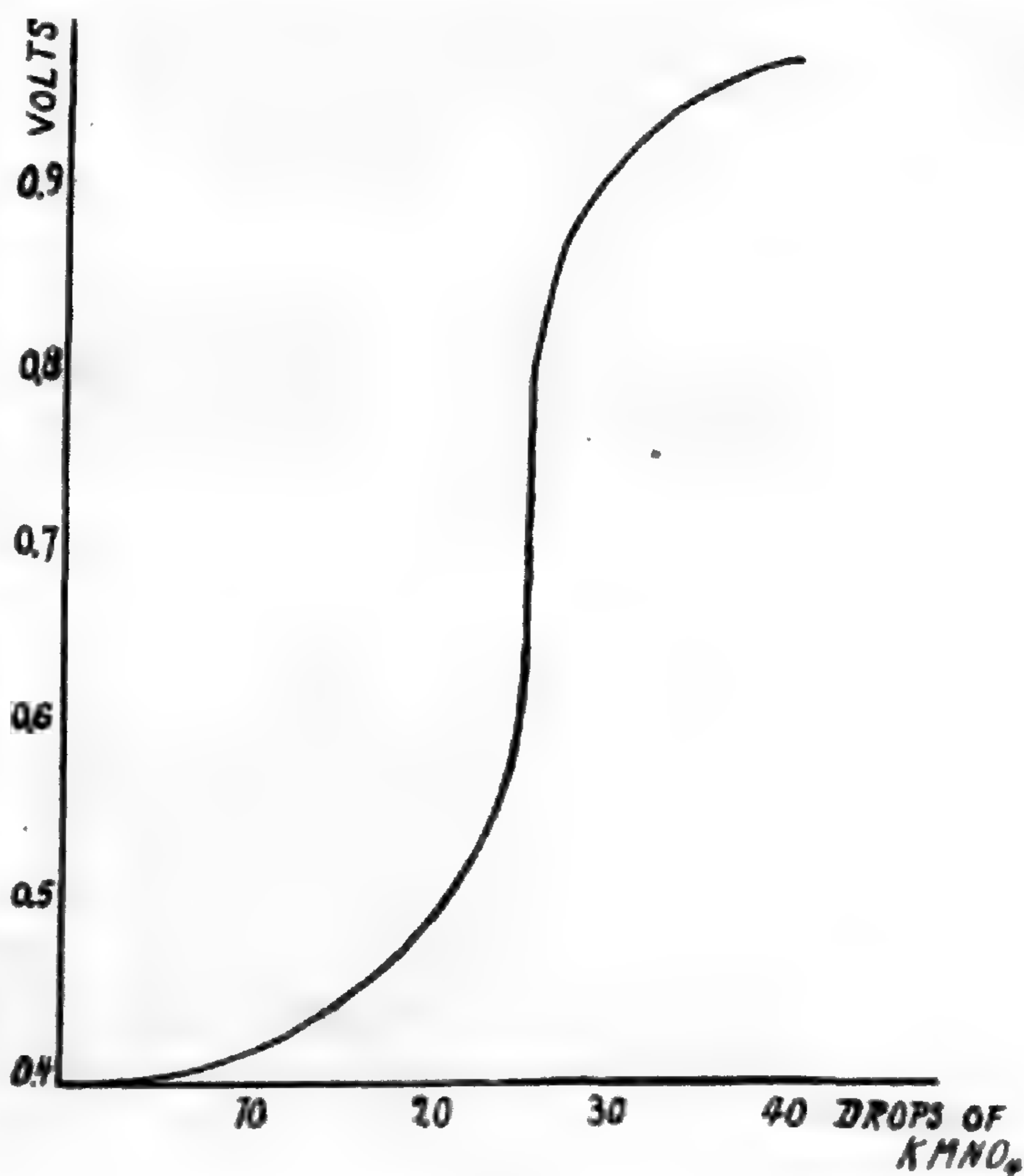

FIG. 2

dent that by this method the progress of an oxidation reaction may be followed with great accuracy.

The effect of a catalyzer in accelerating an oxidation reaction may be studied, in some cases at least, by this method with excellent results. The writer has begun some investigations of this character, in which various "inorganic ferments" have been used to catalyze the reaction with a view to utilizing the results in constructing a theory of oxidase action. These results will be described in subsequent papers.



## BRIEFER ARTICLES

CHARLES RENÉ ZEILLER

(WITH PORTRAIT)

It is an interesting coincidence that November 1915 should have marked the passing of the most distinguished paleobotanists of the two warring nations, France and Germany. Each was a leader hard or impossible to replace, and each saw the light in the forties of the last



century. To another has fallen the task of recording for American botanists the obituary of Count SOLMS-LAUBACH. The present notice deals with CHARLES RENÉ ZEILLER, a son of the lost province Lorraine. His early activities were as a member of the auxiliary corps of engineers in the Franco-Prussian war of 1870. On the scientific side he first busied himself with mineralogy and general geological work. Later he became more and more interested in paleobotany and in this connection is a high exemplification of the logical mind and catholicity of view which are the attributes of the Gallic race. Not only did he study many fossil floras of

diverse geological ages and geographical occurrence and give many new names to science, but he likewise wrote with distinction concerning the climates and phytogeographical areas of the past, as well as of the anatomy and evolutionary history of the types which came under his notice. His stratigraphic accomplishments were of a high order of merit also, in a field where plants have been thought by many to have less value as indicators of geological time.



Under his fostering care the collection at the École des Mines in Paris became the most important and best equipped in Europe, with the possible exception of that presided over by NATHORST in Sweden, claiming the interest of the scientific visitor to Paris rather than that at the Museum in the Jardin des Plantes, which has fallen somewhat into decay since the death of RENAULT. This care for details, accompanied by the much rarer quality of the broad outlook, characterized ZEILLER as they do his nation. For a number of years he performed the laborious task of summarizing the literature and results of paleobotany for the *Révue Générale de Botanique*, and in the writer's opinion no better account of the subject, for the times it covers, has ever been written.

ZEILLER was a delightful correspondent, and his discriminating praise of work done was a strong incentive to a later and less inspired generation to persevere in a science which only now is beginning to claim its proper place. His *Éléments de Paléobotanique*, although professedly only a compendium of the subject, may without exaggeration be characterized as the broadest and best work on the subject yet written. We of the newer continent join with France in paying tribute to one of her distinguished sons "dead on the field of honor."—E. C. JEFFREY, *Harvard University*.



# CURRENT LITERATURE

## MINOR NOTICES

**Genetics.**—This is the title of a new journal published by the Princeton University Press, whose initial number appeared in January 1916. The subtitle is "A periodical record of investigations bearing on heredity and variation." The editorial board comprises W. E. CASTLE, E. G. CONKLIN, C. B. DAVENPORT, B. M. DAVIS, E. M. EAST, R. A. EMERSON, H. S. JENNINGS, T. H. MORGAN, RAYMOND PEARL, and G. H. SHULL, the last named being the managing editor. Such an array of prominent geneticists insures a journal of first order. It is to be issued bimonthly. An annual volume approximates 600 pages, the subscription price being \$6.00. A most appropriate introduction is made by the publication of a hitherto unpublished portrait of MENDEL, being a photographic copy of an oil painting hanging in the parlor of the monastery at Brünn in which MENDEL was for 15 years the abbot. The three papers published are as follows: "Non-disjunction as proof of the chromosome theory of heredity," by CALVIN B. BRIDGES; "The numerical results of diverse systems of breeding," by H. S. JENNINGS; and "Hereditary anchylosis of the proximal phalangeal joints (symphalangism)," by HARVEY CUSHING.—J. M. C.

**Principles of plant culture.**—The eighth edition of GOFF'S *Principles of plant culture*, revised by MOORE and JONES,<sup>1</sup> has just appeared. The first edition was issued in 1897, with the statement that the book "is intended especially for students who have had little or no previous instruction in botany." The book has stood the test of use by many teachers and students for over 20 years. The titles of the chapters indicate the kind of information the book offers: seed germination and the plantlet, the growing plant, the root and the soil, leaves and buds and flowers, the fruit and the seed, decline of growth and the rest period, unfavorable temperature, unfavorable light and wind, unfavorable food supply, animal parasites, vegetable parasites and weeds, propagation, plant breeding. With the growing interest in the rational handling of plants for practical purposes, this little volume should meet a growing need.—J. M. C.

**Plant teratology.**—WORSDELL<sup>2</sup> has published the first volume of a work intended to succeed MASTERS' well known *Vegetable teratology*, published by

<sup>1</sup> GOFF, E. S., *The principles of plant culture*. 8th ed. Revised by E. G. MOORE and L. R. JONES. 8vo. pp. xxiii+295. New York: Macmillan. 1916.

<sup>2</sup> WORSDELL, W. C., *The principles of plant teratology*. Vol. I. 8vo. pp. xxiv+270. pls. 25. figs. 60. London: Ray Society. 1915.



the Ray Society in 1869. The older work has become naturally very incomplete, for during the last 50 years there has been an enormous increase in the knowledge of abnormal structures. The work will comprise two volumes, the first one containing the fungi, the bryophytes, and the root, stem, and leaf of the vascular plants. The algae are not included because they exhibit too few abnormalities to make description worth while. The second volume will deal with the flower. This bringing together of the great mass of material in convenient form will be a boon to those interested in teratology.—J. M. C.

**Western wild flowers.**—MARGARET ARMSTRONG,<sup>3</sup> in collaboration with J. J. THORNBURGH, has written a handy and well illustrated volume under this title, which, although primarily intended for lovers of wild flowers, will be useful to botanists as well. The wild flowers of Washington, Oregon, California, Idaho, Utah, and Arizona are dealt with, but those found only in the Rocky Mountains are not included. The key to families is an excellent feature, and the usefulness of the volume would be much greater had it been extended to species. The collaboration of Professor THORNBURGH insures the accuracy of the text.—W. J. G. LAND.

#### NOTES FOR STUDENTS

**Transpiration studies.**—The desirability of giving a quantitative turn to ecological description and classification, together with the recognition that the most useful of such classifications have been based upon the water relations, has led to efforts to measure the power of the plant (1) to absorb water from its surroundings, (2) to distribute this water within its body, and (3) to prevent the loss of water to its environment. To study the third feature of the water relation some means of measuring the resistance offered by leaves and other parts of plants to water loss, or, stated in other words, of measuring the relative transpiring power of plants, has been needed. A further requirement of such a system is that it shall be readily applicable to plants growing in open soil. In seeking to meet this need LIVINGSTON<sup>4</sup> has modified the cobalt paper method of STAHL, and adapted it to compare the transpiring power of a leaf with evaporation from a standard surface, namely, that of saturated blotting paper shown by RENNERT to evaporate water at the same rate as an equal area of free water surface. In a series of experiments he has shown that this new method is probably the most satisfactory known for comparing the same plant at different times, or for comparing different plants, in regard to the transpiring power of their surfaces. The ratio of the time required for color change of the standardized cobalt chloride paper exposed over the standard surface, to the

<sup>3</sup> ARMSTRONG, MARGARET, *Field book of western wild flowers*. 16mo. pp. xx+396. *figs.* 548. New York: Putnam. 1915.

<sup>4</sup> LIVINGSTON, B. E., The resistance offered by leaves to transpirational water loss. *Plant World* 16:1-35. 1913.



corresponding time required for the same change when the paper is applied to the plant surface, he has termed the "index of transpiring power."

BAKKE,<sup>5</sup> in making use of this method, has shown that the experimental error incurred in determining the time of color change is not large, and further that it may be possible so to standardize the hygrometric paper that the constant use of the standard surface may be dispensed with by making a correction of a given time coefficient according to air temperature. In his own experiments, however, he continues to use the standard surface. Testing the leaves of 43 different species growing under irrigated conditions at the University of Arizona, indices were obtained ranging from 0.9288 for *Dahlia variabilis*, 0.8473 for *Verbena hybrida*, and 0.7893 for *Medicago sativa*, to 0.2258 for *Olea europea*, 0.1676 for *Nerium oleander*, 0.0603 for *Chenopodium incanum*, and 0.0025 for *Atriplex elegans*. These data would seem to afford a most satisfactory basis for ecological classification, and he makes the tentative proposition of including under mesophytes plants with diurnal foliar indices of transpiring power above 0.70, and of terming xerophytes all with indices below 0.30, with the possibility of an intermediate critical point at the index 0.50; the desirability and designation of the groups thus formed to be determined by further study. BAKKE also shows that the method may well be applied to the determination of the daily march of foliar transpiring power, and gives some data upon the relation of position upon the plant and age of leaves to their transpiring power, making his paper a good example of the use of this new technique in its possible application to various problems.

More recently, in studying the vegetation of the Santa Catalina Mountains, SHREVE<sup>6</sup> has measured the transpiring power of some 20 species and has found that (1) while the indices of the transpiring power are similar within various groups of life forms, they are not so to the extent that they may be predicted from an examination of the foliage of the plant; (2) the indices are higher in plants which grow in flood plains with good moisture supply than in individuals of the same species upon arid slopes; and (3) the transpiring power of a given species is not unlike at different altitudes, but the maximum value for the day is reached at an earlier hour at lower than at higher elevations, while for some species at some 6000 feet, no check in the rate is manifested, and the maximum transpiring power and maximum evaporation are simultaneous.

Some of these results were to be expected from the former results of Mrs. SHREVE,<sup>7</sup> obtained in a very exact study of the actual amount of water lost by the desert shrub *Parkinsonia microphylla*, using both potted plants and

---

<sup>5</sup> BAKKE, A. L., Studies on the transpiring power of plants as indicated by the method of standardized hygrometric paper. *Jour. Ecology* 2:145-173. 1914.

<sup>6</sup> SHREVE, F., The transpiring power of plants as influenced by differences of altitude and habitat. *Science* 43:363. 1916.

<sup>7</sup> SHREVE, EDITH B., The daily march of transpiration in a desert perennial. *Carnegie Inst. Wash. Publ. no. 194. pp. 64. figs. 27. 1914.*



branches on larger individuals growing in the open passed into a closed chamber under a bell glass, where the amount of water given off by the plant was found from the gain in weight of calcium chloride exposed within the chamber. Her method of work, as described, seems to provide against any vitiating errors, and clearly demonstrates in this shrub, both when leafless and in leaf, a distinct drop and subsequent rise in actual and relative transpiration (transpiration divided by evaporation) in the morning before the time of maximum evaporation for the day. The maxima for relative transpiration for potted plants were found to vary directly with the soil moisture, and some evidence was obtained that the same variation exists in plants growing naturally in the desert region about Tucson, Arizona. It was also found that *Parkinsonia* plants in sunlight exhibit hourly changes in the relative transpiration rate, in the amount of opening of stomata, in water content of leaves and twigs, and in leaf temperature, and that these have evident interrelations which are held to be governed by the ratio of the demand to the available supply of water.

The transpiration absorption water balance in this woody perennial, as it grows at Tucson, seems to be adjusted with the coming on of the summer drought conditions by (1) the leaflets beginning to close earlier each day, until finally they remain open only for a few minutes at dawn and twilight; (2) the transpiration amount being lessened with the drying out of the soil; (3) the leaflets and later the rachis dropping; and (4) the twigs and small branches beginning to die. In addition to these seasonal changes, there is a daily closing of leaflets and a lessening of actual transpiration rate, while the evaporating power of the air is still increasing. This decrease is accompanied by a closure of stomata, a lowered water content of leaves and twigs, and a slight rise in leaf temperature. The drop is followed by a rise, which, however, does not equal the former maximum. Mrs. SHREVE'S investigation of *Parkinsonia* may serve as a model for the study in detail of the transpirational behavior of other similar and dissimilar plants in the accumulation of data necessary for the understanding of the relationship of vegetation to atmospheric and soil moisture. In attempting such studies, the investigators will do well to note her conclusion that relative transpiration rates were found to differ according to the previous environment of the plant, and hence that conclusions regarding the actual transpiration of plants *in situ* cannot be drawn from the measurement of losses from potted plants, but may be learned better from the measurement from small branches of the plant grown in its natural environment.

Among other recent contributions to our knowledge of transpiration is a study by GIDDINGS<sup>8</sup> of some excised leaves of *Silphium laciniatum*, where in a comparatively few experiments a comparison between rates of evaporation and transpiration showed that here also a check in the latter process occurred 1-3 hours before the daily maximum rate of evaporation was reached,

---

<sup>8</sup> GIDDINGS, L. A., Transpiration of *Silphium laciniatum*. Plant World 17:309-328. 1914.



somewhere between 1:00 and 3:00 P.M., showing the influence of internal factors upon transpiration. The rate of evaporation was determined by Piche atmometers and transpiration loss by weighing closed bottles of water in which the excised leaves were inserted. Leaves taken from the same plant at heights of 13, 47, 71, and 100 cm. showed relative transpirational losses per unit area of 100, 114, 103, and 86, or a somewhat smaller loss from the upper leaves than from the lower ones placed under the same conditions.

BURNS<sup>9</sup> has compared the transpiration of *Pinus Strobus* seedlings grown in nursery beds unshaded, half shaded, and full shaded, with the evaporation from black and white atmometers, and has found a closer relation between the transpirational losses and those from the black atmometer. The relative transpiration was here for the unshaded, half shaded, and full shaded plants respectively 0.0633, 0.0346, and 0.0088, from which he calculated the amount of water transpired to be proportionately 21, 8, and 1 parts. A further comparison showed the average green weight of the unshaded, half shaded, and full shaded plants to be respectively 0.304, 0.166, and 0.090 gm.; while the dry weight was 0.063, 0.034, and 0.010 gm.; that is, the dry weight of the shadeless plants was 6 times that of the full shaded, and twice that of the half shaded plants. On the other hand, the nitrogen content in percentage of dry weight was respectively 2.18, 2.70, and 6.89, or nearly 3 times as much in the full shaded plants as in either of the others, showing that a large amount of transpiration is not to be related to the absorption of ash constituents. BURNS concludes that his experiment indicates that differences in size and chemical composition of these white pine seedlings must be sought along the line of photosynthesis and assimilation, rather than through absorption and transpiration.—GEO. D. FULLER.

**Taxonomic notes.**—COTTON<sup>10</sup> has described collections of cryptogams made by Mrs. ELINOR VALLENTIN, in 1909–1911, on the western islands of the Falklands. An interesting account of the phytogeography of the region is followed by systematic lists of marine algae (138 spp.), freshwater algae (54 spp.), lichens (95 spp.), and fungi (36 spp.). The representation of the four groups of algae is as follows: Cyanophyceae, 4 spp.; Chlorophyceae, 26 spp. (one new); Phaeophyceae, 39 spp.; Rhodophyceae, 69 spp. (one new). The list of fungi includes descriptions of 6 new species.

FERNALD and WEATHERBY<sup>11</sup> have investigated the perplexing genus *Puccinella*, a group of species placed by some in *Glyceria* and by others in *Fes-*

---

<sup>9</sup> BURNS, G. P., The relative transpiration of white pine seedlings. *Plant World* 18:1–6. 1915.

<sup>10</sup> COTTON, A. D., Cryptogams from the Falkland Islands collected by Mrs. VALLENTIN. *Jour. Linn. Soc. Bot.* 43:137–231. pls. 4–10. 1915.

<sup>11</sup> FERNALD, M. L., and WEATHERBY, C. A., The genus *Puccinellia* in Eastern North America. *Rhodora* 18:1–28. pls. 114–117. 1916.



*tuca*. They distinguish 11 species from Eastern North America, including 4 new species, 4 new combinations, and a new variety. The full synonymy and extensive citations of exsiccatae should make the recognition of the species clear.

FOERSTE<sup>12</sup> has described a new genus (*Dictyophlois*) of rhizophores, related to those of *Stigmara ficoides*, from the Subcarboniferous of western Kentucky.

HALL,<sup>13</sup> in continuing his studies of Californian plants, has described new species in *Brodiaea*, *Cymopterus*, *Pentachaeta*, *Haplopappus*, *Aster*, *Erigeron*, and *Arnica*.

HAYATA<sup>14</sup> has concluded that *Viscum japonicum* Thunb. is not congeneric with the other species of *Viscum*, and has made it the type species of a new genus, *Pseudixus*.

KOIDZUMI,<sup>15</sup> in presenting a fascicle of new or little known plants of Japan, has described new species in *Abelia*, *Salix* (2 spp.), and *Saussurea*.

In a "commemoration number" of the *Botanical Magazine* of Tokyo,<sup>16</sup> dedicated to Professor J. MATSUMURA on the occasion of the twenty-fifth anniversary of his professorship, the following taxonomic contributions appear: V. F. BROTHERUS and SHŪTAI OKAMURA describe a new genus (*Ishibaea*) of mosses belonging to the Brachytheciaceae; TAKENOSHIN NAKAI publishes a synopsis of the Korean species of *Saussurea*, including 24 species, 5 of which are described as new; YŪSHUN KUDŌ publishes a synopsis of the species of *Cacalia* in Northern Japan, recognizing 11 species, 2 of which are described as new; YOSHITADA YABE discusses some new or little known plants from Northern China, describing new species in *Deschampsia*, *Listera*, and *Clematis*; TOMITARO MIKINO describes 2 new genera, namely *Matsumurella* and *Ajugoides*, both of the Labiales (Stachydeae).

OSTENFELD<sup>17</sup> has described a new species of *Ruppia* (*R. anomala*) from Porto Rico, which differs from *R. maritima* and the other species of the genus in the development of the stipe of the fruit. In other species each sessile pistil, after fertilization, develops as a stipitate fruit; while in *R. anomala*

---

<sup>12</sup> FOERSTE, AUG. F., *Dictyophlois reticulata*, gen. et sp. nov. Bull. Torr. Bot. Club 42:675-677. pl. 33. 1915.

<sup>13</sup> HALL, H. M., New and noteworthy Californian plants. II. Univ. Calif. Publ. Bot. 6:165-176. pl. 20. 1915.

<sup>14</sup> HAYATA, BUNZŌ, On *Pseudixus*, a new genus of Loranthaceae founded on the well known and widely distributed species *Viscum japonicum* Thunb. Bot. Mag. Tokyo 29:31-34. 1915.

<sup>15</sup> KOIDZUMI, GENICHI, Decades plantarum novarum vel minus cognitarum. Bot. Mag. Tokyo 29:309-315. 1915.

<sup>16</sup> Bot. Mag. Tokyo 29:161-283. 1915.

<sup>17</sup> OSTENFELD, C. H., *Ruppia anomala*, sp. nov., an aberrant type of the Potamogetonaceae. Bull. Torr. Bot. Club 42:659-662. pl. 32. 1915.



the stipes develop together as a common stipe, at the summit of which the drupelets "are placed in a starlike manner."

STANDLEY,<sup>18</sup> in continuing his studies of tropical American plants, under a variety of titles has described numerous new forms as follows: *Wercklea* and *Peltaea*, new genera of Malvaceae; new species in Cyperaceae (2), Amaranthaceae (18; 11 of which belong to *Iresine*), Allionaceae (3), Caesalpiniaceae (4), Mimosaceae (4), Fabaceae (6), Ebenaceae (5; 3 of which belong to *Diospyros*), and Rubiaceae (20); also new species in *Geranium* (2), *Malache* (4), *Waltheria*, *Styrax*, *Evea* (2), *Duggena*, *Arctophyllum* (3), and *Psychotria* (11).—J. M. C.

**Inheritance of awns and velvet chaff.**—Students of genetic problems in wheat have arrived at conflicting conclusions, owing, no doubt, to the existence of biotypes possessing diverse factorial constitutions with respect to the characters under consideration. The HOWARDS have shown<sup>19</sup> that the velvet chaff of wheat may be of two distinct kinds, characterized by different types of hairs. Each kind of hair is produced by a distinct Mendelian factor, and the two kinds are mingled on the glumes when both of these factors are present. Only in the absence of both velvet factors are the glumes glabrous. Selfing any hybrid in which both velvet factors are heterozygous produces a progeny consisting of 15 velvet chaff to 1 glabrous. This result has received further confirmation in a recent paper by the same authors,<sup>20</sup> which is devoted chiefly to the inheritance of awns. Most of the genetical studies which have been made with the latter characteristic have involved forms which are not completely awnless. The HOWARDS used, among others, completely awnless varieties, and demonstrated that two independent factors affect the extent and nature of the awning. One of these factors (*T*) produces short awns or "tips" only, which are developed most conspicuously in the distal portion of the spike, while the other (*B*) also produces short awns, which are distributed more uniformly over the spike. The combined action of both of these factors in the homozygous state is required to produce the fully bearded condition. With respect to both of these factors, the heterozygote is successfully distinguished from the homozygotes by a distinctly intermediate condition. Completely bearded wheats have the formula *TTBB*, and the completely beardless are *ttbb*; the complete ratio of forms produced in the  $F_2$  of a cross between awned and awnless forms,

<sup>18</sup> STANDLEY, PAUL C., Studies of tropical American Phanerogams. No. 2. Contrib. U.S. Nat. Herb. 18:87-142. 1916.

<sup>19</sup> HOWARD, A., and HOWARD, GABRIELLE L. C., On the inheritance of some characters in wheat. II. Mem. Dept. Agric. India 5:no. 1. 1912.

<sup>20</sup>———, On the inheritance of some characters in wheat. II. Mem. Dept. Agric. India 7:273-285. 1915.



therefore, is 1:4:2:2:1:2:1:2:1. The analysis was carried out on a commendably large scale and gave the following approach to expectation:

	<i>BBTT</i>	<i>BbTt</i>	<i>BbTT</i>	<i>BBTt</i>	<i>BBtt</i>	<i>Bbtt</i>	<i>bbTT</i>	<i>bbTt</i>	<i>bbtt</i>
Observed.....	16	54	40	33	15	22	13	24	13
Expected.....	15.4	61.6	30.8	30.8	15.4	30.8	15.4	30.8	15.4

It is clear that the results of this analysis will account for the discrepancies in the results of other investigators, since the short awned individuals may be classed on one basis with the awned, or on another basis with the awnless, and would naturally be classed either with the awnless, or as a distinct intermediate class, if a strictly awnless wheat had not been used in the cross.—

GEO. H. SHULL.

**“Amphiclinous” hybrids.**—By this term DE VRIES<sup>21</sup> designates those  $F_1$  hybrid progenies in which a portion of the individuals resemble the one parent, and the remainder resemble the other parent, a type of behavior which is not uncommon among crosses in the species of *Oenothera*. He describes such a cross between *O. Lamarckiana* and *O. Lamarckiana* mut. *nanella*. The percentage of *nanella* among the  $F_1$  offspring of this cross can be modified by the conditions under which the mother plant is grown, from nearly 0 per cent to nearly 100 per cent. When the *Lamarckiana* mother was grown as an annual, the average percentage of *nanella* was 22; and when the *Lamarckiana* was grown as a biennial, the average number of *nanella* among the offspring reached 65 per cent. Corresponding with this result there is also a much higher percentage of *nanella* from capsules developed early in the season, when the mother is in most vigorous condition, than from capsules produced later in the season when vegetative vigor is declining. For example, on 3 different biennial *Lamarckiana* plants used in these extensive crosses, capsules developing July 12–23 yielded 73–88 per cent of *nanella*, those produced between July 24 and August 4 yielded 61–67 per cent *nanella*, and between August 5 and 16 the capsules produced 48–57 per cent *nanella*.

Another experiment showed that the time of transplanting has a marked influence on the percentage of *nanella* offspring, those reset on April 15 yielding 50 per cent, while plants of the same culture set out on May 15 produced only 29 per cent *nanella*. In this case the *Lamarckiana* mothers were grown as annuals. Further experiments showed that keeping the plants well watered also resulted in an increase in the percentage of *nanella* plants among the  $F_1$  progeny.—GEO. H. SHULL.

<sup>21</sup> DE VRIES, H., Über amphikline Bastarde. Ber. Deutsch. Bot. Gesells. 33:461–468. 1915.



**Chromosomes of *Vicia*.**—SAKAMURA<sup>22</sup> has found in the nuclei of the root tip of *Vicia Faba* during metaphase 12 already split chromosomes, 2 of which are considerably larger (“M-Chromosomen”) and constantly showing middle and end constrictions (“m und e-Einschnürung”). In heterotypic mitosis these same constrictions are present in the one large bivalent (“M-Geminus”), which is believed to be composed of the two M-chromosomes. The fibers are attached at the end of the short chromosomes; but to the M-chromosomes and M-bivalent they are fastened at the middle, causing them to assume a V-shape when traveling to the poles. As a result, there are evident 14 arms in somatic anaphase, this feature probably being the cause of the 14-chromosome count; while in heterotypic mitosis, due to the splitting of each of the daughter chromosomes, there are 5 V’s and one double V. The chief theory accounting for the origin of the “Einschnürung” is that the M-chromosomes at first are without constrictions, and then under certain conditions constrictions arise. This mechanism is shown to be due to an uneven separation of the chromosomes and to the strain of the fibers above this point, causing a stretching of the chromatin, so that when they do dissociate completely there is this apparent constriction. Before the m and e-constrictions could become hereditary characters they must first have occurred in heterotypic anaphase. While the investigation strengthens the individuality theory of the chromosomes, it throws little light upon the cause of the closely related species and varieties, two points that the author has attempted to prove.—MILDRED NOTHNAGEL.

**Vegetative vigor and reproduction.**—PIETERS<sup>23</sup> has made an interesting contribution to our knowledge of the structural responses of plants to varying chemical and physical conditions. The work of KLEBS, indicating that the appearance of reproductive cells is a response to diminishing vegetative activity, and that structures in general represent expressions of the potentialities of an organism, called out by the prevailing conditions for metabolism, has set in train investigations which should be multiplied. PIETERS used two species of *Saprolegnia* and two of *Achlya* in his investigations, and a summary of his results is as follows. There is no necessary relation between vegetative growth and sexual reproduction when the available food exceeds the minimum concentration necessary for the species. This minimum concentration of food necessary varies with the species, but in general is in the neighborhood of 0.1 per cent peptone for the production of both sporangia and oogonia. While growing vegetatively, a mycelium may develop tendencies that may affect the number and character of the reproductive organs produced subsequently under different conditions. Of the carbohydrates used, maltose and levulose are especially useful for vegetative growth, and the latter is particularly effect-

<sup>22</sup> SAKAMURA, TETSU, Über die Einschnürung der Chromosomen bei *Vicia Faba* L. Bot. Mag. (Tokyo) 29:287-300. pl. 13, figs. 12. 1915.

<sup>23</sup> PIETERS, A. J., The relation between vegetative vigor and reproduction in some Saprolegniaceae. Amer. Jour. Bot. 2:529-576. 1915.



ive in the production of oogonia. Sucrose is probably not used by species of *Saprolegnia* or *Achlya*. Phosphates in the culture solution tend to increase the reproductive capacity of the fungus.—J. M. C.

**Life forms of New York vegetation.**—RAUNKIAER has devised a method of classifying plants according to the way in which they pass the unfavorable season of the year, and by means of a numerical arrangement of these forms, known as a "biological spectrum," the flora of one region may be compared with that of the world as a whole. This journal has commented favorably upon these methods,<sup>24</sup> but they have been neglected by American workers as a whole. It is therefore pleasing to see them applied by TAYLOR<sup>25</sup> to the flora of New York. From the very nature of such investigations, the results will be more significant and valuable as a larger number of similar studies are made. Compared with the normal spectrum, the New York flora is higher in percentages of aquatics, geophytes, and hemicryptophytes, and somewhat lower in percentages of chamaephytes and phanerophytes. No other area to which this method of analysis has been applied has shown such an abundance of deep-rooted perennials of the bulb and rootstock type, here termed geophytes. This is to be correlated with and is partly explained by the large proportion of monocotyledons in the portion of the pine barrens included in the area studied. TAYLOR points out that were it possible to base the spectra upon a census of individuals rather than one of species, different and probably more significant comparisons would result.—GEO. D. FULLER.

**Disease resistance.**—JONES and GILMAN<sup>26</sup> have published a very suggestive bulletin upon the control of the cabbage disease known as "yellows," caused by the soil fungus *Fusarium conglutinans*. It seems that on badly infected or cabbage-sick soil the loss ordinarily ranges from 50 to 95 per cent. Experimental work through five summers seems to justify the conclusion that no method of soil, seed, or crop treatment offers any hope for the control of the disease. On the other hand, the development of disease-resistant varieties by selection has given such promising results that "full reliance can be placed in it as a feasible method for the practical control of this malady." Control of various commercial varieties of cabbage showed that there are marked differences in susceptibility among them, and advantage is taken of this fact to discover a *Fusarium*-resistant strain. The method employed has been based on the observation that even in the worst diseased fields in the autumn there are occasional sound heads, and these have been selected for pedigree culture.

---

<sup>24</sup> BOT. GAZ. 44:393. 1907; 51:309-310. 1911.

<sup>25</sup> TAYLOR, NORMAN, The growth forms of the flora of New York and vicinity. Amer. Jour. Bot. 2:23-31. 1915.

<sup>26</sup> JONES, L. R., and GILMAN, J. C., The control of cabbage yellows through disease resistance. Agric. Exp. Sta. Univ. Wisconsin Bull. 38. pp. 70. figs. 23. 1915.



The results of this work have been so convincing that the cultivation of disease-resistant strains of our crop plants promises to be the final method of eliminating disease.—J. M. C.

**Ascospore expulsion of Endothia.**—HEALD and STUDHALTER<sup>27</sup> have published the results of an investigation of the chestnut blight fungus, which uncovers a very interesting situation. There is a remarkably prolonged perithecial activity, due, partly at least, to three important features in the development of the fungus. The asci mature successively through quite an extended period, the perithecia mature successively in a given stroma, and the stromata mature successively throughout the season. The practical result is that ascospores are available for expulsion at any time when the conditions favor. Expulsion "begins in the spring with the first warm rains, and increases to a maximum of activity as conditions become more favorable, to be followed by a decline in the fall when lower temperatures prevail, and ceases entirely during the cooler portions of the year."—J. M. C.

**Carpophores of pore fungi.**—ZELLER<sup>28</sup> has studied the development of the carpophores of *Ceratomyces Zelleri*, one of the pore fungi. He discovers that in this development there is a homogenous mass of tissue which is differentiated simultaneously into pileus and stipe by a cleavage plane which gives rise to an annular furrow, and that the hymenium, which is exogenous in origin, is formed in the roof of a furrow. This form proves to be gymnocarpic, since there is no marginal veil.—J. M. C.

**Morphology of Agaricus.**—ATKINSON<sup>29</sup> has described in great detail the development of *Agaricus Rodmani*, a species described by PECK in 1885. The four features which he considers are (1) the duplex character of the annulus, (2) the origin of the hymenophore fundament, (3) the differentiation of parts in the primordial ground tissue, and (4) the origin and development of the lamellae. The paper must be referred to for the numerous details involved.—J. M. C.

**New species of rust.**—In working over cultures of rusts in connection with their presentation in the *North American Flora*, ARTHUR and FROMME<sup>30</sup> have discovered and described 7 new species in *Uromyces* (2), *Puccinia* (4), and *Uredo*.—J. M. C.

<sup>27</sup> HEALD, F. D., and STUDHALTER, R. A., Seasonal duration of ascospore expulsion of *Endothia parasitica*. Amer. Jour. Bot. 2:429-448. figs. 6. 1915.

<sup>28</sup> ZELLER, SANFORD M., The development of the carpophores of *Ceratomyces Zelleri*. Mycologia 6:235-239. pls. 140, 141. figs. 12. 1914.

<sup>29</sup> ATKINSON, GEO. F., Morphology and development of *Agaricus Rodmani*. Proc. Amer. Phil. Soc. 54:309-343. pls. 7-13. 1915.

<sup>30</sup> ARTHUR, J. C., and FROMME, F. D., New species of grass rusts. Torreyia 15: 260-265. 1915.



## GENERAL INDEX

Classified entries will be found under Contributors and Reviewers. New names and names of new genera, species, and varieties are printed in **bold face** type; synonyms in *italic*.

### A

Abdominea 262  
Abscission in *Mirabilis jalapa* 213  
Acacia 261  
Acalypha 173  
*Actaea alba* 193, 199; *arguta* 202; *arguta alabastrina* 202; *arguta eburnea* 202; *arguta pauciflora* 202; *asplenifolia* 204; *caudata* 204; *neglecta* 201; *rubra* 193, 199; *rubra dissecta* 199; *rubra gigantea* 201; *viridiflora* 203; *viridiflora Clementiorum* 203  
Adams, J. 131  
Adamson, R. S., work of 84  
Adiantum 261  
*Aegiphila fasciculata* 385  
Affourtit, M. F. A., work of 176  
Agaricus, morphology of 540  
*Aistopetalum* 172  
*Ajugoides* 535  
Alcohol oxidation 173  
Allard, H. A., work of 83  
*Allium tricoccum*, reduction division in 453  
*Allocarya Cusickii jucunda* 36; *Scouleri hirta* 36  
American trees 344  
Ames, O., work of 77  
Amino acids 347  
*Amsinckia Menziesii* 36  
Anderson, H. W., work of 449  
Andres, H., work of 77  
Andrews, F. M., work of 449  
*Angatia* 262  
Angiosperms, phylogenetic taxonomy of 85  
Anthocyanins 349  
*Aphanelytrum* 342; spikelet of 340  
*Apocynum* 77  
Apple, germination of pollen 132  
Appleman, C. O. 265  
Arber, Agnes, work of 174, 451  
*Arenaria macra* 30  
Argentina, grasses of 262  
Armstrong, Margaret, "Western wild flowers" 531  
Arnaud, G., work of 77  
*Arnica* 535  
Arthur, J. C., work of 540  
Asclepiadaceae 261

*Asclepias cryptoceras*, pollination of 72  
Ashby, S. F., work of 444  
*Aster* 535  
Atkinson, G. F. 89; work of 540  
Atmometry and the porous cup 450  
Australian vegetation 440  
Awns and velvet chaff, inheritance of 536  
*Aytonia*, morphology of a Mexican 48

### B

Bachmann, H., "Das Phytoplankton des Süßwassers" 170  
Bacteria in frozen soil 507; separating from fungi 247  
Bactericidal substances 86  
Baker, E. G., work of 77  
Bakke, A. L., work of 532  
Balfour, I. W., work of 77  
Bancroft, N., work of 450  
*Barbeyella* 172  
Bartlett, H. H., work of 77  
*Basilocula* 78  
Beattie, R. K., "Flora of the northwest coast" 348  
Beccari, O., work of 77  
Beer, R., work of 174  
Beets, chemistry of diseased 173  
Belosersky, N., work of 77  
Benedict, H. M., work of 435  
Benedict, R. C. 77  
Bennett, A., work of 77  
Bennettiales, new genus of 449  
Béquinot, A., work of 77  
Berry, E. W., work of 84  
*Besleria congestiflora* 379; *trichostegia* 380; *triflora subcorymbosa* 380  
Bessey, C. E., work of 85  
**Besseyosphaera**, a new genus of Volvocaceae 253; **Powersi** 254  
*Betchea* 172  
Bicknell, E. P., work of 77  
*Bidens* 261; *amplissima* 504; **Andrei** 495; *anthriscoides* 497; *attenuata* 495; *cernua* 503; *chinensis* 499; **chrysanthemifolia** 501; *crithmifolia* 500; *frondosa* 498; *hirtella* 501; *humilis* 500; *laevis* 504; *mirabilis* 496; *nodiflora* 498; *pilosa* 497  
*Biovularia* 171



- Birbal, S., work of 81  
 Bitter, G., work of 78  
 Black, J. W., work of 78  
 Blake, S. F., work of 78, 447  
 Blakeslee, A. F., work of 264  
 Bodnár, J., work of 173  
 Boedeker, F., work of 78  
 Bolton, K., work of 349  
 Bolus, L., work of 78  
 Bonati, G., work of 78  
 Boodle, L. A., work of 82  
 Borassodendron 77  
 Borgesen, F., work of 78  
 Botryochora 262  
 Botrytis cinerea 80  
 Bottomley, W. B., work of 263  
 Bovie, W. T. 1  
 Bower, F. O., work of 174  
 Bremiella 263  
 Brickellia 447  
 Brierley, W. B., work of 175  
 Brieya 263  
 Briggs, L. J., work of 175  
 Briquet, J., work of 78  
 Britton, N. L., work of 78  
 Brodiaea 535  
 Brotherus, V. F., work of 535  
 Brown, Lola B., work of 452  
 Brown, N. E., work of 78  
 Brown, W., work of 80  
 Brown, W. H., work of 87, 264  
 Brunthaler, J., work of 170  
 Bubák, F., work of 78  
 Buergersiochloa 172  
 Burns, G. P., work of 534  
 Burt, E. A., work of 452  
 Bush, B. F., work of 78  
 Butler, E. J., work of 78
- C**
- Cacalia 535  
 Campbell, D. H., work of 447  
 Carboniferous plants 88  
 Cardamine cordifolia *Lyallii* 31  
 Cardot, J., work of 78  
 Carex 172, species of 452  
 Carnegieodoxa 260  
 Carpophores of pore fungi 540  
 Castagnella 77  
 Castilleja angustifolia *subcinerea* 45;  
     *confusa* 44; *confusa pubens* 45;  
     *miniata crispula* 45; *pilosa inverta* 44  
 Cecidiology 438  
 Celastrus *vulcanicolus* 373  
 Central America, new plants from 373  
 Centrantheropsis 78  
 Cephaelis tetragona 376  
 Cercospora 447  
 Cereus 262  
 Ceylon, endemic flora of 82  
 Chamaesyce 173  
 Chamberlain, C. J. 349, 353, 442;  
     "Methods in plant histology" 347  
 Chase, Agnes 340  
 Cheiroleuria 174  
 Child, C. M. 435; "Senescence and  
     rejuvenescence" 164  
 Chloroform as a paraffin solvent 251  
 Chodat, R., work of 78  
 Christensen, C., work of 78  
 Chromatophores, amoeboid movements  
     of 85  
 Chromosomes of *Vicia* 538  
 Chrysactinia 447  
 Cladophora in deep water 87  
 Clarkia 31  
 Clintonia borealis 181; *umbellulata* 181  
 Coal, books on 258  
 Cobb, N. A., work of 439  
 Cochlospermum 260  
 Cockayne, L., work of 446  
 Coleman, D. A. 247  
 Colloid chemistry, texts on 345  
 Collomia 34  
 Columnnea dictyophylla 385  
 Conceptacle, development of in *Fucus*  
     231  
 Coniothyrium 447  
 Contributors: Adams, J. 131; Appleman,  
     C. O. 265; Atkinson, G. F. 89; Bovie,  
     W. T. 1; Chamberlain, C. J. 349, 353,  
     442; Chase, Agnes 340; Child, C. M.  
     435; Coleman, D. A. 247; Cook, M. T.  
     67, 440, 444; Coulter, J. M. 81, 82, 85,  
     86, 87, 88, 170, 174, 175, 176, 263, 264,  
     346, 348, 349, 352, 443, 447, 448, 449,  
     452, 530, 534, 538, 539, 540; Cowles,  
     H. C. 83, 84, 85, 170; Crocker, W. 345,  
     347, 352; Denny, F. E. 445; Fuller,  
     G. D. 175, 344, 440, 445, 446, 450, 452,  
     531, 539; Gates, F. C. 399; Gates,  
     R. R. 177; Greenman, J. M. 77, 171,  
     260; Harder, E. C. 507; Hasselbring,  
     H. 79, 173; Heatley, Margaret 425;  
     Hill, J. B. 255; Jeffrey, E. C. 75, 84,  
     88, 258, 450, 528; Kirkwood, J. E.  
     256; Kopeloff, N. 247; Land, W. J. G.  
     253, 347, 348, 447, 448, 451, 531;  
     Lincoln, Mattie 408; Lint, H. C. 247;  
     Lloyd, F. E. 213; Long, W. H. 417;  
     McCormick, Florence A. 388; Mac-  
     bride, J. F. 30; Mathews, A. P. 164;  
     Merriman, Mabel L. 311; Michell,  
     Margaret R. 325; Moore, B. 59;  
     Mottier, D. M. 251; Nelson, A. 30;  
     Nothnagel, Mildred 441, 453, 538;  
     Osterhout, W. J. V. 148; Payson, E.  
     72; Pfeiffer, Norma E. 518; Phillips,  
     T. G. 76; Reed, G. B. 430, 523; Rigg,  
     G. B. 159, 295, 408; Roe, Mabel L.  
     231; Rose, J. N. 70; Scott, D. H. 434;  
     Shaw, C. H. 477; Shaw, W. R. 253;



- Sherff, E. E. 495; Shull, G. H. 536;  
 Smith, J. D. 373; Starr, Anna M. 48;  
 Trumbull, H. L. 408  
 Cook, M. T. 67, 440, 444  
 Cooley, J. S., work of 79  
 Copeland, E. B., work of 172  
 Coprinus, lamellae of 89  
 Copy, preparation of 337  
 Cordylanthus bicolor 45  
 Cotton, A. D., work of 534  
 Coulter, J. M. 81, 82, 85, 86, 87, 88, 170,  
 174, 175, 176, 263, 264, 346, 348, 349,  
 352, 443, 447, 448, 449, 452, 530, 534,  
 538, 539, 540  
 Coulter, S., work of 449  
 Cowiea 79  
 Cowles, H. C. 83, 84, 85, 170  
 Cox, H. J., work of 159  
 Crataegus 262  
 Cretaceous and eocene plants 84  
 Crocker, W. 345, 347, 352  
 Crotalaria 77  
 Cryptantha muricata 42; Torreyana  
 grandiflora 43  
 Cryptopus 262  
 Culbertson, G., work of 449  
 Currant, germination of pollen 142  
 Cyclotheca 262  
 Cymbomonas 261  
 Cymopterus 535  
 Cyrtandraceae 171  
 Cystodendron 78

## D

- Dactylostalix 447  
 Damazio, L., work of 79  
 Davis, J. J., work of 175  
 Dean, Alletta F., work of 264  
 Dean, C. C., work of 449  
 De Candolle, C., work of 79  
 Decay and soil toxins 295  
 Dehydration of histological material 255  
 Delphinium stachydeum 31, Menziesii  
 fulvum 30  
 Denny, F. E. 445  
 De Vries, H., work of 537  
 Diastema micranthum 377, platylo-  
 matum 381  
 Dictyophlois 535  
 Diels, L., work of 79  
 Discogyne 172  
 Disease resistance 539  
 Dodecatheon Jeffreyi 33; viviparum 33  
 Dunn, S. T., work of 79

## E

- Echeveria 261  
 Echinopsis 172  
 Ellisiodothis 262  
 Embryo sac of Richardia africana 325

- Endoconidia 175  
 Endothia, ascopore expulsion of 540  
 Engler, A., work of 79  
 Englerophytum 171  
 Eocene and cretaceous plants 84  
 Episcia acaulis 378  
 Erigeron 535  
 Eriophorum 447  
 Espeletia 352  
 Eupatorium 447  
 Euphorbiaceae 172  
 Evans, A. W., work of 79  
 Exotrichum 262

## F

- Falklands, cryptogams of 534  
 Felt, E. P., work of 439  
 Fernald, M. L., work of 534  
 Ferns, Malayan 88  
 Filicales, phylogeny of 174  
 Fisher, M. L. 449  
 Fitting, H., work of 350  
 Foerste, A. F., work of 535  
 Frasera nitida Cusickii 33  
 Fromme, F. D., work of 540  
 Frozen soil, bacteria in 507  
 Fucus, development of conceptacle 231  
 Fuller, G. D. 175, 344, 440, 445, 446, 450,  
 531, 539; work of 452  
 Funastrum 261  
 Fungi, separating from protozoa and  
 bacteria 247  
 Fyson, P. F., "Flora of the Nilgiri and  
 Pulney hill-tops" 170

## G

- Gaillardia crassifolia 46  
 Gamble, J. S., work of 79  
 Gates, F. C. 399  
 Gates, R. R. 177  
 Genetics, a new journal 530  
 Geomyces 262  
 Germination of pollen 131  
 Gesnera Eggersii 384; Lehmannii 384  
 Gibbs, L. S., work of 79  
 Giddings, L. A., work of 533  
 Gilglochloa 79  
 Gilia 34; achilleifolia Chamissonis 34;  
 floccosa filifolia 35; mazama 34;  
 tenella 34  
 Gilibertia diplostemona 373  
 Gilletia 263  
 Gilman, J. C., work of 539  
 Ginkgo, pollen grains 81; seeds of 176  
 Giorgiella 263  
 Gloiophloea 261  
 Gnaphalium Grayi 46; Ivesii 46  
 Gnetum, morphology of 82; strobilus of  
 443



Goethalsia 261  
 Goff, E. S., "Plant culture" 530  
 Goodspeed, T. H., work of 86  
 Grass embryo 451  
 Greene, Edward Lee, biographical sketch  
 70; work of 171  
 Greenman, J. M. 77, 171, 260; work of 88  
 Griffithia 78  
 Guam, flora of 172  
 Gymnolomia 447  
 Gymnosperms, notes on 81  
 Gyranthera 261

## H

Hackel, E., work of 262  
 Hakonechloa 172  
 Hall, H. M., work of 535  
 Hamet, R., work of 171  
 Hamshaw, T. H., work of 81  
 Haplocalymma 447  
 Haplopappus 535  
 Harder, E. C. 507  
 Hardy, A. D., work of 441  
 Hasselbring, H. 79, 173  
 Hassler, E., work of 171  
 Hayata, B., work of 535  
 Heald, F. D., work of 540  
 Heatley, Margaret 425  
 Heimlich, L. M., work of 449  
 Heliotropium 447; *curassavicum xero-*  
*philum* 35  
 Herpotrichiella 260  
 Herter, W., work of 171  
 Hibiscadelphus 261  
 Hieracium *cineritium* 47  
 Hieronymus, G., work of 171  
 Hill, J. B., 255  
 Hill, T. G., "Essentials of illustration"  
 349  
 Hippeastrum 263  
 Höber, R., work of 346  
 Hoffmannia *nesiota* 374  
 Horkelia *Tweedyi* 31  
 Howard, A., work of 536  
 Howard, G. L. C., work of 536  
 Howe, M. A., work of 171  
 Hoyopsis 172  
 Huber, J., work of 171  
 Hue, A., work of 171  
 Humicola 262  
 Humirianthera 171  
 Hutchinson, J., work of 171  
 Hybridization and water requirement 175  
 Hybrids, amphiclinous 537  
 Hydrogen ion concentration 76

## I

Illustrations 349; preparation of 338  
 Impomoea Batatas, tuber of 388  
 India, flora of 170

Indiana Academy 449  
 Inga 171  
 Isertia *Deamii stenophylla* 374  
 Ishibaea 535  
 Isoetes, anatomy of 352; *occidentalis*  
*Piperi* 30  
 Isoloma *oblanceolatum* 383; *pycnosuzyg-*  
*ium* 382; *vulcanicum* 382

## J

Jeffrey, E. C. 75, 84, 88, 258, 450, 528, 539  
 Jones, L. R., work of 539  
 Jorgensen, I., work of 445

## K

Kaernbachia 172  
 Kahn, A. H., work of 78  
 Kania 172  
 Keysseria 172  
 Kindle, E. M., work of 87  
 Kingdonia 77  
 Kirkwood, J. E. 256  
 Kofoid, C. A., work of 171  
 Koidzumi, G., work of 535  
 Kopeloff, N. 247  
 Kränzlin, F., work of 171  
 Krause, K., work of 171  
 Kudō, Y., work of 447, 535  
 Kuhlman, J. G., work of 171  
 Küster, E., work of 85

## L

La Rivière, H. C. C., work of 176  
 Lamellae of Coprinus 89  
 Laminaria, permeability in 148  
 Land, W. J. G. 253, 347, 348, 447, 448,  
 451, 531  
 Lang, W. H., "Studies in the morphology  
 of Isoetes" 352  
 Lappula *arida Cusickii* 41; *cenchr-*  
*soides* 38; *cupulata* 39; *cupulata*  
*foliosa* 40; *diffusa* 42; *echinata* 37;  
*Fremontii* 37; *Redowskii occidentalis*  
 38; *Redowskii patula* 39; *subdecum-*  
*bens* 42; *texana* 40; *texana coronata*  
 41; *texana heterosperma* 41; *texana*  
*homosperma* 41  
 Larix, bisporangiate cones of 256  
 Lauterbach, C., work of 171  
 Lawson, A. A., work of 441  
 Leaf anatomy of Veronica 84  
 Leaves, age changes in 435; xerofotic  
 movements in 399  
 Lemmermann, E., work of 170  
 Lepidium *bonariense* 262  
 Leptomassaria 260  
 Léveillé, H., work of 172  
 Lewis, I. M., work of 88  
 Liabum 447



Life forms of New York vegetation 539  
 Lignier, O., work of 176  
 Lincoln, Mattie 408  
 Lint, H. C. 247  
 Livingston, B. E., work of 450, 531  
 Lloyd, F. C. 213  
 Lobocolax 171  
 Loganberry, germination of pollen 141  
 Long, W. H. 417  
 Lophoschoenus 79  
 Ludwig, C. A., work of 449  
 Lunell, J., work of 172  
 Luzula 447  
 Lychniothyrsus 261  
 Lycopodium 171  
 Lythrum 260

## M

Macbride, J. F. 30; work of 447  
 Mackenzie, K. K., work of 172, 452  
 McCormick, Florence A. 338  
 Maianthemum canadense 189; dilatatum 189  
 Maiden, J. H., work of 440  
 Majanthemum dilatatum 30  
 Makino, T., work of 172, 447  
 Malayan ferns 88  
 Mallison, H., work of 349  
 Mamillaria 261  
 Manilaea 262  
 Marattiaceae, secretory tissues of 176  
 Marine algae in fresh water 452  
 Marsh, evaporation in 450  
 Marsonia 447  
 Martelli, U., work of 172  
 Martin, K., work of 349  
 Mathews, A. P. 164  
 Mathews, F. S., "Field book of American trees and shrubs" 344  
 Matsumurella 535  
 Meconella linearis 31  
 Medinilla 172  
 Meiotic divisions 441  
 Melastomaceae 172  
 Meliolina 262  
 Melliniella 79  
 Melochia 171  
 Melophia 447  
 Memecylon 172  
 Merrill, E. D., work of 172  
 Merriman, Mabel L. 311  
 Mesozoic plants 75  
 Metaporana 78  
 Meyer, R., work of 172  
 Meylan, C., work of 172  
 Michaelis, L., "Die Wasserstoffionen-konzentration" 76  
 Michell, Margaret R. 325  
 Microcyclella 262  
 Microseris nutans macrolepis 47  
 Microtechnique 448

Mieg, W., work of 349  
 Mikino, T., work of 535  
 Millspaugh, C. F., work of 172  
 Mimulus Langsdorfii microphyllus 44  
 Mirabilis jalapa, abscission in 213  
 Mitella 261  
 Mitosis, periodicity in 442  
 Miyage, K., work of 447  
 Miyake, I., work of 447  
 Mobius, M., "Mikroskopisches Praktikum" 348  
 Moeszia 78  
 Monilia cinerea 80  
 Moore, A. H., work of 173  
 Moore, B. 59  
 Moore, Emmeline, work of 451  
 Moore, S., work of 173  
 Mosaic disease of tobacco 83  
 Moss, a fossil 176  
 Mottier, D. M. 251  
 Mucors, sexual reactions of 264  
 Muhlenbergia setiglumis 30  
 Multinucleate cells 174  
 Muschleria 173  
 Myxomycetes of Wisconsin 264

## N

Nagai, I., work of 448  
 Nakai, T., work of 535  
 Neea amplifolia 386  
 Nelson, A. 30  
 Nematostoma 262  
 Neosabicea 262  
 Neosloetiopsis 79  
 New Guinea, flora of 176  
 New York vegetation, life forms of 539  
 New Zealand vegetation 446  
 Nicotiana, parthenogenesis in 86  
 Nicotiana Torreyana 43  
 Nieuwland, J. A., work of 260  
 Nolan, T. J., work of 349  
 Norlind, V., work of 260  
 North American flora 349  
 Nothnagel, Mildred 441, 453, 538; work of 449  
 Nuclear division of Spirogyra 311  
 Nylanderella 171

## O

Odontoschizon 262  
 Okamura, S., work of 535  
 Onagra 77  
 O'Neal, C. E., work of 449  
 Ophioglossum vulgatum, prothallia of 518  
 Opocunonia 172  
 Oreocarya cilio-hirsuta 43; salmonensis 43  
 Ornamental plants, pathology of 67



Osborn, T. G. B., work of 441  
 Osmotic pressure 408  
 Ostenfeld, C. H., work of 535  
 Osterhout, W. J. V. 148  
 Ostermeyer, F., work of 260  
 Oswald, W., "Colloid chemistry" 345  
 Overholts, L. O., work of 452  
 Oxidase reagents, color changes in 430  
 Oxidases 523  
 Oxidation, alcohol 173; measurement of potential 523

## P

*Pachylophus psammophilus* 32  
 Pairs of species 177  
 Pandanaceae 172  
 Papua, flora of 172  
 Parasitic fungi of Wisconsin 175  
 Parasitism, phenomena of 79  
*Parlamium* 79  
*Parmulina* 262  
 Parthenogenesis in *Nicotiana* 86  
 Pascher, A., "Die Süßwasser-Flora" 170  
 Pathology of ornamental plants 67  
 Patouillard, N., work of 260  
 Payson, E. 72  
 Pear, germination of pollen 139  
 Pearson, H. H. W., work of 82, 443  
*Pectinella* 78  
*Pedicularis contorta ctenophora* 44  
*Pellaea* 536  
*Pentachaeta* 535  
*Perideridia* 32; *americana* 33; ***Bolanderi*** 33; ***californica*** 33; ***Parishii*** 33; ***Pringlei*** 33; ***simplex*** 33  
 Perkins, J., work of 260  
 Permeability 445; decrease of by anesthetics 148  
 Peru, marine algae of 171  
*Perymenium* 447  
 Petrak, F., work of 260  
 Pfeiffer, Norma E. 518  
*Phacelia argentea* 34  
*Phaeodothiopsis* 262  
*Phaeoschiffnerula* 262  
*Philibertia* 261  
*Philibertiella* 78  
 Philippines, flora of 172; fungi of 262  
 Phillips, T. G. 76  
 Phloem, medullary 451  
*Phoebanthus* 447  
*Phragmodothis* 262  
*Phyllocactus* 262  
*Phyllocrater* 79  
*Physaliastrum* 172  
*Physalis porphyrophysa* 377  
*Phytomorula* 117  
 Pickett, F. L., work of 449  
 Pieters, A. J., work of 538  
 Pilger, R., work of 260  
*Pillansia* 78

Ping, C., work of 439  
*Pinus Laricio*, conrescent leaves of 82  
*Pionocarpus* 447  
 Pipel, F. J., work of 449  
 Piper, C. V., "Flora of the northwest coast" 348  
*Piricauda* 78  
 Pittier, H., work of 261  
 Plankton studies 170  
 Plant culture, principles of 530  
 Plant pathology in tropics 444  
*Plectodiscella piri* 263  
*Pleuropetalum tucurriquense* 387  
*Polemoniella antarcticum* 35; ***Gayanum*** 35  
 Pollen, germination of 131  
 Pollination of *Asclepias cryptoceras* 72  
*Polyclypeolum* 262  
*Polygala* 78, 260  
*Polypodium vulgare hesperium* 30  
 Polyporaceae 452  
 Pore fungi, carpophores of 540  
*Potamogeton* 451  
 Potonié, H., "Die rezenten Kaustobiolithe und ihre Lagerstaetten" 259  
 Pranker, T. L., work of 174  
 Protozoa, separating from fungi 247  
*Psalidosperma* 262  
*Pseudixus* 535  
*Pseudoscinaia* 261  
*Pteris* 171  
*Puccinella* 534  
*Puccinia* 540  
*Pullea* 172  
 Purpus, J. A., work of 261  
*Pycnoderma* 262  
*Pyrenobotrys* 262  
*Pyronema*, development of 264

## Q

Quehl, L., work of 261

## R

*Rachiopteris* 450  
 Radlkoffer, L., work of 261  
*Rafflesia* and its host 87  
 Ramsey, G. B., work of 449  
*Ranunculus* 171; *abortivus* 191; *allegeniensis* 191  
 Raspberry, germination of pollen 142  
*Ravenelia annulata* 423; ***morongiae*** 418; ***reticulatae*** 421; ***roemerianae*** 418; ***thornberiana*** 420  
 Ravine, humidity of 445  
 Reduction divisions in *Allium tricoccum* 453  
 Reed, G. B. 430, 523  
*Rehmiodothis* 262  
 Reproduction and vegetative vigor 538  
 Rest period in tubers of *Solanum tuberosum* 265



- Reviews: Armstrong's "Western wild flowers" 531; Bachmann's "Das Phytoplankton des Süßwassers" 170; Beattie's "Flora of the northwest coast" 348; Chamberlain's "Methods in plant histology" 347; Child's "Senescence and rejuvenescence" 164; Fyson's "Flora of the Nilgiri and Pulney hill-tops" 170; Goff's "Plant culture" 530; Hill's "Essentials of illustration" 349; Mathews' "Field book of American trees and shrubs" 344; Michaelis' "Die Wasserstoffionenkonzentration" 76; Möbius' "Mikroskopisches Praktikum" 348; Oswald's "Colloid chemistry" 345; Pascher's "Die Süßwasser-Flora" 170; Piper's "Flora of the northwest coast" 348; Potonié's "Die rezenten Kaustobiolithe und ihre Lagerstätten" 259; Stevenson's "Formation of coal beds" 258; Stopes' "Mesozoic plants" 75; Taylor's "Chemistry of colloids" 345; Thoday's "Botany" 346; Underhill's "Physiology of amino acids" 347; White's "The origin of coal" 259; Worsdell's "Plant teratology" 530
- Rhamphogyne 173  
 Rhodohypoxis 79  
 Richardia africana, embryo sac of 325  
 Ricinophyllum **horridum** 45  
 Rigg, G. B. 159, 295, 408  
 Rizalia 262  
 Robinson, B. L., work of 447  
 Rock, J. F., work of 261  
 Roe, Mabel L. 231  
 Rolfe, R. A., work of 261  
 Root nodules 263  
 Rose, J. N. 70  
 Rosenbingea 78  
 Rosendahl, C. O., work of 261  
 Rubiaceae 262  
 Rudgea **thyrsiflora** 375  
 Ruppia 535  
 Rust, new species of 540
- S
- Saccolaria 171  
 Safford, W. E., work of 261  
 Sakamura, T., work of 538  
 Salvia **Collinsii** 386  
 Sargent, Ethel, work of 451  
 Saunders, E. R., work of 441  
 Saussurea 535  
 Scenecio canus **celsus** 46; monograph of 88  
 Schaffner, J. H., work of 261  
 Schantz, H. L., work of 175  
 Schiller, J., work of 261  
 Schlechter, R., work of 261  
 Schmidleia 261  
 Schröder, B., work of 261  
 Schroederiella 261  
 Schulz, O. E., work of 261  
 Schumann rays, action on living organisms 1  
 Scinaia 261  
 Scleria 447  
 Scott, D. H. 434  
 Sears, P. B., work of 450  
 Seeds of Ginkgo 176  
 Selaginella 171  
 Selkirks, vegetation of 477  
 Senescence and rejuvenescence 164  
 Setchell, W. A., work of 251  
 Sex determination 87; influence of nutrition on organs 448  
 Shaw, C. H. 477  
 Shaw, W. R. 253  
 Sherff, E. E. 495  
 Shibataea 172  
 Shive, J. W., work of 450  
 Shreve, Edith B., work of 532  
 Shreve, F., work of 532  
 Shull, G. H. 536  
 Sidalcea 171  
 Sigmatochilus 79  
 Slosson, M., work of 261  
 Smith, G. M., work of 448  
 Smith, J. D. 373  
 Smith, J. J., work of 262  
 Smith, W. W., work of 77  
 Sohnreyia 261  
 Soil toxins and decay 295  
 Solanum 263; tuberosum, rest period in tubers of 265  
 Solms-Laubach, biographical sketch of 433  
 South America, new plants from 260  
 Species, pairs of 177  
 Spergularia **bracteata** 30  
 Sphagnum bogs, physical conditions in 159  
 Spiraea alba 205; tomentosa 205  
 Spirogyra, nuclear division of 311  
 Spirotheca 261  
 Spratt, Ethel R., work of 263  
 Stalagmites 262  
 Standley, P. C., "The genus Espeletia" 352; work of 536  
 Stangeria paradoxa 353  
 Stapf, O., work of 262  
 Starr, Anna M. 48  
 Stephanospora 260  
 Stevenson, J. J., "Formation of coal beds" 258  
 Stewart, A., work of 438  
 Stigmopsis 78  
 Stiles, W., work of 445  
 Stollaea 172  
 Stopes, Marie, "Mesozoic plants" 75; work of 88



Strawberry, germination of pollen 140  
 Streptopus amplexifolius 185; roseus  
 185; **streptopoides** 30  
 Stuckert, T., work of 262  
 Studhalter, R. A., work of 540  
 Succession from pine to oak 59  
 Surface tension 411  
 Sydow, H., work of 262  
 Sydow, P., work of 262

## T

Taylor, N., work of 539  
 Taylor, W. W., "Chemistry of colloids"  
 345  
 Technique 348  
 Tephrosticta 262  
 Teratology 530  
 Tetrault, P. A., work of 449  
 Texas, trees of 88  
 Text, preparation of 337  
 Theissen, F., work of 262  
 Thelephoraceae 452  
 Thellung, A., work of 262  
 Thiessen, R., "The origin of coal" 259  
 Thiessenula 262  
 Thoday, D., "Botany" 346  
 Thomas, H. H., work of 449  
 Thompson, M. T., work of 438  
 Tobacco, mosaic disease of 83  
 Tofieldia 447  
 Torrend, C., work of 262  
 Toxic solutions, physical properties of 408  
 Traaen, A. E., work of 262  
 Trabutiella 262  
 Transeau, E. N., work of 176  
 Transpiration studies 531  
 Travelbee, H. C., work of 449  
 Trees of Texas 88  
 Treubia, morphology of 447  
 Trichodothis 262  
 Trifolium **Kennediamum** 31  
 Trillium cernuum, life history of 425  
 Triplotaxis 171  
 Tropics, plant pathology in 444  
 Trumbull, H. L. 408

## U

Ule, E., work of 262  
 Ullrich, F. T., work of 445  
 Underhill, F. P., "Physiology of amino  
 acids" 347  
 Urban, I., work of 262  
 Uredo 540  
 Uromyces 540  
 Utricularia 447

## V

Vanoverbergh, M., work of 172  
 Van Rosenburgh, Capt. C. R. W. K.,  
 work of 88

Verbesina 447  
 Veronica, leaf anatomy of 84  
 Verticilliodochium 78  
 Vicia, chromosomes of 538  
 Victoriella 261  
 Viguiera 447  
 Viola 171  
 Vittaria 77  
 Volutellopsis 263  
 Volvocaceae, a new genus of 253

## W

Wadsworth, J. T., work of 440  
 Wagner, R. J., work of 86  
 Weatherby, C. A., work of 534  
 Weatherwax, P., work of 449  
 Wedelia 171  
 Weingart, W., work of 262  
 Wercklea 536  
 Wernham, H. F., work of 262  
 West, C., work of 176  
 White, D., "The origin of coal" 259  
 Wildeman, E. de, work of 263  
 Williamsonia gigas, staminate strobilus of  
 81  
 Williamsoniella 449  
 Willis, J. C., work of 82  
 Willstätter, W., work of 349  
 Wilson, G. W., work of 263  
 Wilson, M., work of 87  
 Wisconsin, myxomycetes of 264  
 Wittmack, L., work of 263  
 Woolery, Ruth, work of 441  
 Worcesterianthus 172  
 Woronichin, N., work of 263  
 Worsdell, W. C., "Plant teratology" 530;  
 work of 451  
 Wright, C. H., work of 263

## X

Xerofotic movements in leaves 399

## Y

Yabe, Y., work of 535

## Z

Zaleski, W., work of 174  
 Zeiller, C. R., sketch of 528  
 Zeller, S. M., work of 540  
 Zephyranthes 263  
 Zexmenia thysanocarpa 376  
 Zollinger, E. H., work of 349  
 Zygnemales 176