

MODELING THE RESPONSE OF MANGROVE ECOSYSTEMS  
TO HERBICIDE SPRAYING, HURRICANES, NUTRIENT  
ENRICHMENT AND ECONOMIC DEVELOPMENT

By

MAURICE GEORGE SELL, JR.

A DISSERTATION PRESENTED TO THE GRADUATE COUNCIL OF  
THE UNIVERSITY OF FLORIDA IN PARTIAL  
FULFILLMENT OF THE REQUIREMENTS FOR THE DEGREE OF  
DOCTOR OF PHILOSOPHY

UNIVERSITY OF FLORIDA

1977

"Let everyone who is concerned with interference of naturally occurring mangrove formations on exposed coasts take heed."

Fosberg (1971)

## ACKNOWLEDGMENTS

I would like to thank Dr. Howard T. Odum, chairman of my research committee, for his guidance in bringing this dissertation to completion. Many helpful suggestions were also received from my committee: Dr. Suzanne Bailey, Dr. Jackson L. Fox, Dr. Samuel C. Snedaker, and Dr. Ariel E. Lugo.

Tim Ahlstrom, Joan Browder, Bruce Heinly, Sanit Aksornkoe, and Mark Homer assisted with field measurements in an environment where they had to endure the relentless pursuit of sand flies and mosquitoes. Dr. Howard Teas and Jerry Kelly of the University of Miami initiated the herbicide experiments on Marco Island.

My wife, Jackie, also assisted in field measurements and exhibited great patience with me during the writing of this dissertation.

The research on the effect of herbicides on mangroves in South Vietnam was supported through a contract between the National Academy of Sciences and the systems ecology group of the Department of Environmental Engineering Sciences, H.T. Odum, principal investigator. Other support was provided by the South Florida study of the United States Department of Interior on contract with the Center for Wetlands, University of Florida.

## TABLE OF CONTENTS

	<u>Page</u>
ACKNOWLEDGMENTS. . . . .	iii
LIST OF TABLES . . . . .	vii
LIST OF FIGURES. . . . .	xiii
ABSTRACT . . . . .	xviii
INTRODUCTION . . . . .	1
Study Plan and Objectives. . . . .	6
Description of Study Areas . . . . .	8
South Vietnam Study Area. . . . .	8
Florida Study Areas . . . . .	12
REVIEW OF LITERATURE . . . . .	19
Ecosystem Modeling . . . . .	19
History of Herbicide Use in Mangroves. . . . .	22
Sewage Disposal in Wetlands. . . . .	26
Effects of Hurricanes. . . . .	29
Occurrence and Frequency of Hurricanes and Typhoons. . . . .	30
Economic Development in Mangroves. . . . .	31
METHODS. . . . .	34
Modeling and Simulation Techniques . . . . .	34
Development of Models and Equations . . . . .	35
Aggregation . . . . .	35
Calculation of Rate Coefficients. . . . .	36
Scaling of Equations. . . . .	38
Energy Calculations. . . . .	40
Energy Quality. . . . .	40
Energy Investment Ratio . . . . .	41
Field Studies. . . . .	43
Tree Growth . . . . .	44
Litter Fall . . . . .	44
Total Phosphorus in Water Column. . . . .	45
Phosphorus in Leaves and Wood . . . . .	46
Numbers of Green Leaves, Yellow Leaves, Live Seedlings, Dead Seedlings, Snails, and Crabholes . . . . .	46
Number of <u>R. mangle</u> Seedlings on Trees. . . . .	47

TABLE OF CONTENTS (continued)

	<u>Page</u>
RESULTS . . . . .	48
Evaluation and Simulation of Models . . . . .	48
Model of Herbicides and Mangroves in South Vietnam . . . . .	48
Model of Mangroves, Nutrients, and Hurricanes . . . . .	75
Model of Mangroves and Economic Development . . . . .	110
Energy Calculation Results . . . . .	135
Calculation of Energy Flows . . . . .	135
Calculation of Investment Ratios . . . . .	141
Field Study Results . . . . .	141
Sites Treated with Herbicide . . . . .	142
Sites Enriched with Sewage Effluent . . . . .	155
DISCUSSION . . . . .	198
Herbicide and Recolonization of Mangroves in South Vietnam . . . . .	198
Herbicide and Mangrove Succession in Florida . . . . .	209
Hurricanes and Mangrove Structure . . . . .	214
Undeveloped Area of Mangroves . . . . .	214
Developed Area . . . . .	216
Economic Development and Mangroves . . . . .	218
Role of Nutrients in Mangroves . . . . .	225
Role of Mangrove Litter Fall . . . . .	236
Role of Mangrove Detritus . . . . .	236
Energy Quality, Herbicide, Hurricane, and Nutrient Enrichment . . . . .	240
Mangroves and the Balance of Productive Potentials and Stresses . . . . .	241
Summarizing Guidelines for Management of Mangroves . . . . .	242
APPENDICES	
A    ENERGY LANGUAGE SYMBOLS USED IN DEVELOPMENT OF MODELS . . . . .	246
B    PROCEDURE TO ANALYZE FOR CONCENTRATION OF TOTAL PHOSPHORUS IN WATER SAMPLES . . . . .	250
C    SUPPLEMENTARY DATA FOR SIMULATION OF MODEL OF HERBICIDES AND MANGROVES SHOWN IN FIGURE 4 . . . . .	253
D    SUPPLEMENTARY DATA FOR SIMULATION OF MODEL OF HURRICANES AND MANGROVES SHOWN IN FIGURE 15 . . . . .	274

TABLE OF CONTENTS (continued)

APPENDICES	<u>Page</u>
E SUPPLEMENTARY DATA USED IN SIMULATION OF THE MODEL OF ECONOMIC DEVELOPMENT AND MANGROVES SHOWN IN FIGURE 28. . . . .	291
F DETAILED DATA COLLECTED AT THE SPRAYED PLOTS ON MARCO ISLAND, FLORIDA. . . . .	311
G DETAILED DATA COLLECTED ON RESPONSE OF MANGROVE FOREST TO NUTRIENT ENRICHMENT . . . . .	333
BIBLIOGRAPHY . . . . .	382
BIOGRAPHICAL SKETCH. . . . .	390

## LIST OF TABLES

<u>Table</u>	<u>Page</u>
1	Energy quality factors of several ecosystem work processes. . . . . 42
2	Initial and steady state simulated woodcutting rates for the mangrove forest of the Rung-Sat district in South Vietnam at two rates of primary production . . . . 62
3	Energy values for hypothetical cases of steady state residential development in a mangrove forest consisting of 1000 hectares . . . . . 136
4	Density of live and dead trees in the herbicide study sites on Marco Island, Florida, at the time of spraying and 2 years after spraying . . . . . 144
5	Mean tree diameter at breast height of each species of mangrove in the herbicide study sites at Marco Island, Florida. . . . . 145
6	Mean basal area per tree of each species of mangrove in the herbicide study sites at Marco Island, Florida. . 148
7	Density of trees in the sites receiving sewage effluent and at the control sites . . . . . 156
8	Density of <i>Rhizophora mangle</i> seedlings on parent trees at the sites receiving sewage effluent and at the control sites. . . . . 156
9	Mean tree diameter at breast height of each species of mangrove in the sites receiving sewage effluent and in the control sites . . . . . 158
10	Mean tree diameter at breast height of each species of mangrove in the sites receiving sewage effluent and in the control sites. . . . . 161

LIST OF TABLES (continued)

<u>Table</u>	<u>Page</u>	
11	Mean basal area per tree of each species of mangrove in the sites receiving sewage effluent and in the control sites. . . . .	163
12	Mean basal area per tree of each species of mangrove in the sites receiving sewage effluent and in the control sites. . . . .	165
13	Mean tree diameter at breast height, growth, and percent growth for September 1973 and 1974 in the mangrove forest receiving sewage effluent at Naples, Florida . . . . .	167
14	Mean tree diameter at breast height, growth, and percent growth for September 1973 and 1974 in the control forest at Naples, Florida . . . . .	169
15	Mean tree diameters at breast height, growth, and percent growth for September 1973 and 1974 in the mangrove forest receiving sewage effluent at Everglades City, Florida. . . . .	171
16	Mean tree diameter at breast height, growth, and percent growth for September 1973 and 1974 in the control forest at Everglades City, Florida. . . . .	173
17	Mean tree basal area, growth, and percent growth for September 1973 and 1974 in the mangrove forest receiving sewage effluent at Naples, Florida . . . . .	176
18	Mean tree basal area, growth, and percent growth for September 1973 and 1974 in the control forest at Naples, Florida. . . . .	178
19	Mean tree basal area, growth, and percent growth for September 1973 and 1974 in the mangrove forest receiving sewage effluent at Everglades City, Florida. . . . .	180
20	Mean tree basal area, growth, and percent growth for September 1973 and 1974 in the control forest at Everglades City, Florida . . . . .	182
21	Concentration of phosphorus in mangrove wood and leaves at the Naples and Everglades City study sites. . . . .	197
22	Time in years required for recolonization of land at five rates of spraying and three rates of mangrove primary productivity . . . . .	202



LIST OF TABLES (continued)

<u>Table</u>	<u>Page</u>	
23	Estimated biomass and growth of trees in the mangrove forests at the Naples and Everglades City study sites for September 1973, September 1974, and September 1976. . . . .	228
24	Comparison of estimated wood growth rates and biomass with those predicted by the model of Figure 15 and those found in the literature . . . . .	231
25	Rate of uptake of phosphorus in wood for the Naples and Everglades City study sites . . . . .	234
26	Comparison of measured annual litter fall at the Naples and Everglades City study sites with rates found in the literature. . . . .	237
27	Comparison of detritus amounts simulated by the model in Figure 15 with amounts reported in the literature . . . . .	239
C-1	Monthly averages of solar radiation data for Saigon from January 1964 to October 1967. . . . .	254
C-2	Descriptions and values for the outside driving forces, state variables, and pathways of the herbicide and mangrove model .	255
C-3	Data on density and weight of <u>Rhizophora mangle</u> seedlings at Rookery Bay, Florida. . . . .	263
C-4	Calculations of rate coefficients for the model simulating the effect of herbicide on the Rung-Sat mangroves in South Vietnam. . . . .	264
C-5	Scaled differential equations for the model simulating the effect of herbicide on the Rung-Sat mangroves in South Vietnam . . . . .	268
D-1	Descriptions and values for the driving forces, state variables, and pathways of the model simulating the relationship among hurricanes, nutrients, and mangroves. . . . .	275
D-2	Calculation of rate coefficients for the model simulating the relationship among hurricanes, nutrients, and mangroves . . .	281
D-3	Scaled differential equations for the model simulating the relationship among hurricanes, nutrients, and mangroves . . .	286
E-1	Descriptions and values for the driving forces, state variables, and pathways of the model simulating the relationship between economic development and mangroves. . . . .	292

LIST OF TABLES (continued)

<u>Table</u>	<u>Page</u>
E-2	Calculation of rate coefficients for the model simulating the relationship between economic development and mangroves . . . . . 300
E-3	Scaled differential equations for the model simulating the relationship between economic development and mangroves. . . . . 306
F-1	Number of fallen green leaves per m <sup>2</sup> occurring in the control, cleared, and sprayed areas near Marco Island, Florida, over a period of 26 months after aerial application of herbicide in December 1972 . . . . . 313
F-2	Number of fallen yellow leaves per m <sup>2</sup> occurring in the control, cleared, and sprayed areas near Marco Island, Florida, over a period of 26 months after aerial application of herbicide in December 1972 . . . . . 314
F-3	Number of dead seedlings per m <sup>2</sup> occurring in the control, cleared, and sprayed areas near Marco Island, Florida, over a period of 26 months after aerial application of herbicide in December 1972 . . . . . 315
F-4	Number of live seedlings per m <sup>2</sup> occurring in the herbicide study sites near Marco Island, Florida, over a period of 26 months after aerial application of herbicide in December 1972 . . . . . 317
F-5	Number of <u>Melampus coffeus</u> per m <sup>2</sup> occurring in the herbicide study sites near Marco Island, Florida, over a period of 26 months after aerial application of herbicide in December 1972 . . . . . 319
F-6	Number of crabholes per m <sup>2</sup> occurring in the herbicide study sites near Marco Island, Florida, over a period of 26 months after aerial application of herbicide in December 1972 . . . . . 320
G-1	Evaluation of species and populations of mangroves in two sites receiving sewage effluent and also two sites not receiving sewage effluent. . . . . 336
G-2	Population density of <u>Rhizophora mangle</u> seedlings on the parent tree at the two sites receiving sewage effluent and the two control sites . . . . . 338

LIST OF TABLES (continued)

<u>Table</u>	<u>Page</u>
G-3	Diameter, height, basal area and volume of individual trees in the mangrove forest receiving sewage effluent from the Naples, Florida, sewage treatment plant . . . . . 340
G-4	Diameter, height, basal area, and volume of individual trees in the control mangrove forest at Naples, Florida. . . . . 350
G-5	Diameter, height, basal area, and volume of individual trees in the mangrove forest receiving sewage effluent from the Everglades City, Florida, sewage treatment plant. . . . . 352
G-6	Diameter, height, basal area, and volume of individual trees in the control mangrove forest at Everglades City, Florida. . . . . 361
G-7	Leaf, wood, and seed fall during a 55-week period from September 6, 1973, to September 27, 1974, in the mangrove forest that occasionally received sewage effluent from the Naples, Florida, sewage treatment plant; and from June 21 to September 26, 1974, in the control mangrove forest . . . . . 366
G-8	Leaf, wood, and seed fall during a 55-week period from September 4, 1973, to September 27, 1974, in the mangrove forest that occasionally received sewage effluent from the Everglades City, Florida, sewage treatment plant . . . 368
G-9	Rate of leaf, wood, seed, and total litter fall during a 55-week period from September 6, 1973, to September 27, 1974, in the mangrove forest that occasionally received sewage effluent from the Naples, Florida, sewage treatment plant; and from June 21 to September 27 in the control mangrove forest. . . . . 370
G-10	Rate of leaf, wood, seed, and total litter fall during a 55-week period from September 4, 1973, to September 27, 1974, in the mangrove forest that occasionally received sewage effluent from the Everglades City, Florida, sewage treatment plant . . . . . 372

LIST OF TABLES (continued)

<u>Table</u>		<u>Page</u>
G-11	Concentrations of total phosphorus found in the Gordon River at Naples, Florida, at various sampling times from September 1973 to February 1975 . . . . .	374
G-12	Concentration of total phosphorus in the tidal canal at Everglades City, Florida, at various sampling times from September 1973 to February 1975 . . . . .	376
G-13	Calculation of mangrove forest biomass for the Naples and Everglades City, Florida, study sites . . . . .	378

## LIST OF FIGURES

<u>Figure</u>		<u>Page</u>
1	Model of the mangrove ecosystem . . . . .	4
2	Map of the Rung-Sat district in South Vietnam showing sprayed and unsprayed areas . . . . .	10
3	Map of southwest Florida showing the sites treated with sewage, the site treated with herbicide, and the sites where mangrove productivity and biomass were measured by Lugo and Snedaker (1974a) . . . . .	14
4	Model of the mangrove ecosystem of the Rung-Sat district of South Vietnam showing the interaction of herbicide, land, mangrove biomass, woodcutters, and mangrove seedlings. . . . .	50
5	Model of the mangrove ecosystem of the Rung-Sat district in South Vietnam with numerical values for the state variables, outside driving forces, and pathways. . . . .	54
6	Variation of simulated herbicide application rates during a five-year period of spraying . . . . .	58
7	Steady state levels of mangrove biomass attained by the Rung-Sat mangrove forest in South Vietnam at four simulated rates of primary production . . . . .	58
8	Simulated effect of woodcutting on the mangrove forest of the Rung-Sat district in South Vietnam . . . . .	61
9	Simulated effect of herbicide spraying on mangrove land and mangrove biomass in the Rung-Sat district in South Vietnam . . . . .	65
10	Simulated effect of herbicide spraying on mangrove land and mangrove biomass in the Rung-Sat district in South Vietnam . . . . .	67

LIST OF FIGURES (continued)

<u>Figure</u>		<u>Page</u>
11	Simulated effect of herbicide spraying on mangrove land and mangrove biomass in the Rung-Sat district in South Vietnam. . . . .	69
12	Simulated effect of herbicide spraying on mangrove land and mangrove biomass in the Rung-Sat district in South Vietnam . . . . .	72
13	Simulated effect of seedling availability on the rate of recolonization by the mangroves of the Rung-Sat district in South Vietnam . . . . .	74
14	Simulated effect of seedling planting by man on the rate of recolonization by the mangroves of the Rung-Sat district in South Vietnam . . . . .	77
15	Simplified model of a mangrove forest in Florida showing the interactions between the forest and nutrients, hurricanes, and tides . . . . .	79
16	Relationship between tangential wind velocity of a hurricane and the surface shear stress that results . .	83
17	Simplified model of a mangrove forest in Florida showing the values for the driving forces, compartments, and pathways. . . . .	85
18	Simulation of the effect of altering the nutrient flux into the mangrove forest when nutrient storage was initially high and runoff to sea was low. . . . .	88
19	Simulation of the effect of altering the nutrient flux into the mangrove forest when nutrient storage was initially low and runoff to sea was high. . . . .	90
20	Simulation of effect of tidal exchange between the estuary and the mangrove forest when nutrient storage was initially high. . . . .	93
21	Simulation of the effect of tidal exchange between the estuary and mangrove forest when nutrient storage was initially low . . . . .	95

LIST OF FIGURES (continued)

<u>Figure</u>		<u>Page</u>
22	Simulation of effect of hurricane on the mangrove forest when nutrient storage was initially high . . . .	97
23	Simulation of effect of hurricane on the mangrove when nutrient storage was initially high. . . . .	99
24	Simulation of the effect of hurricanes on the mangrove forest when nutrient storage was initially high. . . . .	101
25	Simulation of effect of hurricanes on the mangrove forest when nutrient storage was initially low. . . . .	104
26	Simulation of effect of hurricane on the mangrove forest when nutrient storage was initially low. . . . .	106
27	Simulation of the effect of hurricanes on the mangrove forest when nutrient storage was initially low. . . . .	108
28	Model of the interactions between a mangrove forest and economic development within the forest. . . . .	112
29	Model of the interactions between a mangrove forest and economic development. . . . .	116
30	Simulation of the impact of the amount of land development on mangrove forest biomass and economic structure. . . . .	119
31	Simulation of the impact of economic development on mangrove productivity and flow of goods and services. . . . .	121
32	Simulation of the impact of changing the price index on economic structure. . . . .	125
33	Simulation of the impact of one hurricane on mangrove biomass and economic structure. . . . .	127
34	Simulation of the impact of one hurricane on mangrove biomass and economic structure. . . . .	129
35	Simulation of the impact of two hurricanes within 10 years on mangrove biomass and economic structure. . . . .	132

LIST OF FIGURES (continued)

<u>Figure</u>		<u>Page</u>
36	Simulation of the impact of two hurricanes within 10 years on mangrove biomass and economic structure. . . .	134
37	Undeveloped and developed steady state energy flows for a hypothetical development of 1000 hectares of mangrove forest. . . . .	140
38	Variation with time in number of fallen green leaves; number of fallen yellow leaves; number of dead seedlings; number of live seedlings; number of snails and number of crabholes for the control site, the cleared site and the average of the three sprayed sites located in a mangrove forest on Marco Island, Florida . . . . .	151
39	Litter fall from September 1973 to September 1974 in a mangrove forest receiving sewage effluent from the sewage treatment plant in Naples, Florida. . . . .	185
40	Litter fall from September 1973 to September 1974 in a mangrove forest receiving sewage effluent from the sewage treatment plant in Everglades City, Florida. . .	187
41	Map of the study sites at Naples showing the average total phosphorus concentration in the waters of the Gordon River at the point of discharge of sewage effluent and other selected locations along the river. . . . .	192
42	Map of the study sites at Everglades City showing the average total phosphorus concentration in the waters of a tidal canal at the point of discharge of sewage effluent and other selected locations along the canal .	195
43	Simulation of effect of seedling availability on the recovery of sprayed mangroves in the Rung-Sat district and in the Camau peninsula of South Vietnam . . . . .	206
44	Model of the interaction between herbicide and the mangrove forest on Marco, Islando, Florida. . . . .	212
45	Variation in steady state economic structure and flow of purchased energies as the percent of land developed is increased from 0 to 100 percent. . . . .	221



LIST OF FIGURES (continued)

<u>Figure</u>		<u>Page</u>
46	Variation in steady state economic structure as the price index is varied from 0 to 1 . . . . .	224
C-1	Annual variation in solar radiation for Saigon, South Vietnam . . . . .	271
C-2	Analog circuit diagram for the model simulating the effect of herbicides on the mangroves of the Rung-Sat district in South Vietnam . . . . .	273
D-1	Analog circuit diagram for simulated model of nutrients, hurricanes and mangroves. . . . .	290
E-1	Analog circuit diagram of mangrove swamp and economic development system model. . . . .	310
F-1	Number of fallen green leaves per m <sup>2</sup> of study area in the Marco Island herbicide spraying experiment. . . . .	322
F-2	Number of fallen yellow leaves per m <sup>2</sup> of study area in the Marco Island herbicide spraying experiment. . . . .	324
F-3	Number of dead seedlings per m <sup>2</sup> of study area in the Marco Island herbicide spraying experiment. . . . .	326
F-4	Number of live seedlings per m <sup>2</sup> of study area in the Marco Island herbicide spraying experiment. . . . .	328
F-5	Number of snails per m <sup>2</sup> of study area in the Marco Island herbicide spraying experiment. . . . .	330
F-6	Number of crabholes per m <sup>2</sup> of study area in the Marco Island herbicide spraying experiment. . . . .	332

Abstract of Dissertation Presented to the Graduate Council of the  
University of Florida in Partial Fulfillment of the Requirements  
for the Degree of Doctor of Philosophy

MODELING THE RESPONSE OF MANGROVE ECOSYSTEMS  
TO HERBICIDE SPRAYING, HURRICANES, NUTRIENT  
ENRICHMENT AND ECONOMIC DEVELOPMENT

By

Maurice George Sell, Jr.

June 1977

Major Department: Environmental Engineering Sciences  
Chairman: Dr. H. T. Odum

Models of energy flow through mangrove forests were developed and simulated to assess the impact of tropical storms, herbicides, nutrient enrichment, and economic development.

Simulations of the effect of herbicide spraying on the mangrove forests in the Rung-Sat district of South Vietnam suggested that complete mangrove recolonization of sprayed areas may take 55 years to more than 100 years. Rates of recolonization were strongly dependent on the availability of seedlings and amount of woodcutting. Reforestation can be accelerated by planting seedlings.

Spraying of a mangrove forest on Marco Island, Florida, showed that white mangrove (Laguncularia racemosa) was the most susceptible of the three species present followed by red mangrove (Rhizophora mangle) and black mangrove (Avicennia germinans). The sprayed sites seemed to be recolonized at a slower rate than the harvested sites. Detritus-feeding snails were reduced in numbers after the spraying but

crab populations were little changed. Simulations of the effects of hurricanes on mangrove forests suggested that the growth cycle was adapted to recovery from major hurricanes that occur every 15-25 years. Rate of recovery was dependent on the concentration of nutrients available to the mangroves. Even when buildings are not directly damaged by hurricanes, the economy of a developed coastal area may be affected by damage to the mangrove forests that acted as a storm buffer, an input to fishery nurseries, and in other indirect roles of environmental support. The simulations suggested that destruction of mangrove vegetation by hurricanes might result in a reduction in the inflow of purchased energy, goods, and services to the developed area. Simulations of the relationship between economic development and mangroves showed a peak of growth returning to a lower steady state. At 1973 prices steady state economic structure was highest when 50% of the land was developed in the form of condominiums or residential finger canal estates. Half of 1% of the land could be developed in the form of condominiums at a density of 44 units/ha or only 1.2% of the land could be developed in the form of residential finger canal estates at a density of 10 units/ha.

Simulations of the effect of altering the nutrient flow into mangrove forests suggested roles for tidal exchange and freshwater runoff in developing biomass of mangroves. Field studies at Naples and Everglades City, Florida, indicated mangroves grew faster when bathed by tidal waters enriched with nutrients from sewage effluent. Estimated growth rates of wood during the three-year study were

4.6 g/m<sup>2</sup>·day at the Naples sewage-enriched site, 2.8 g/m<sup>2</sup>·day at the Naples control site, 2.8 g/m<sup>2</sup>·day at the Everglades City sewage-enriched site, and 1.3 g/m<sup>2</sup>·day at the Everglades City control site.

The management of mangroves for maximum contribution to the combined economy of nature and man requires maintaining access to nutrients and tidal exchange, abundant seedling supply after a killing stress, and a high ratio of mangrove land with the kind of economic developments that are attracted by the energy values of the estuarine zone.

## INTRODUCTION

This dissertation is concerned with the effects of various perturbations on the structure of mangrove forests. Studies were made on the impact of herbicides, hurricanes, nutrient enrichment, and economic development on mangrove forest. The study included three models and results of their simulation. Data for models and for validating simulation results were obtained with selected field studies.

The mangrove forest is a marine ecosystem in which the trees have evolved special adaptations enabling them to grow and prosper in salty or brackish water. These forests are very prevalent along the coastlines of the world between 25°N and 25°S latitude. The geographical distribution of mangroves is limited to those coastal areas that are not subjected to frequent hard frosts. The mangrove ecosystem absorbs the energies of tides, wind, and waves, especially those that result from tropical storms. In this way mangrove forests function as a natural buffer between land and sea. The mangrove forest is a highly productive ecosystem, which aids in supporting the neighboring estuarine communities. Food and shelter are provided for numerous coastal and marine animals and a nursery area is available for many species of marine organisms of commercial importance.

The mangrove forest also captures the nutrients in runoff and concentrates nutrients from tidal waters.

Figure 1 is a model of a mangrove ecosystem showing the coupling of the estuarine system with the ocean and upland areas. Fresh water is shown flowing into the estuary and carrying with it nutrients, organic matter, toxins, and silt. A two-way exchange of water, nutrients, organic matter, toxins, and salt occurs between the ocean and estuary. Silt in the estuary shades out phytoplankton and periphyton and may also interact with mangrove biomass to increase land area. Silt also settles and becomes part of the bottom sediment. Toxins in the estuary are shown as a flow to interstitial water in the sediments where they may be fixed by the sediments or taken up by the mangrove roots. Toxins such as heavy metals and oil spills are shown in the model as a stress on mangrove vegetation. Nutrients such as phosphates and nitrates are utilized by mangroves, periphyton, and phytoplankton. Nutrients are also fixed in the sediments. Filter feeders circulate estuarine water with its mix of ingredients and remove some of the organic matter and toxins. Saline concentrations as reported by Carter et al. (1973) act to decrease mangrove productivity. Heald (1971) noted that the rate of degradation of red mangrove leaves was faster in brackish water than in fresh water and that the slowest rate of degradation was under dry conditions.

Total mangrove productivity is influenced by sunlight, available land area, salinity, nutrient availability, evapotranspiration,

Figure 1. Model of the mangrove ecosystem.

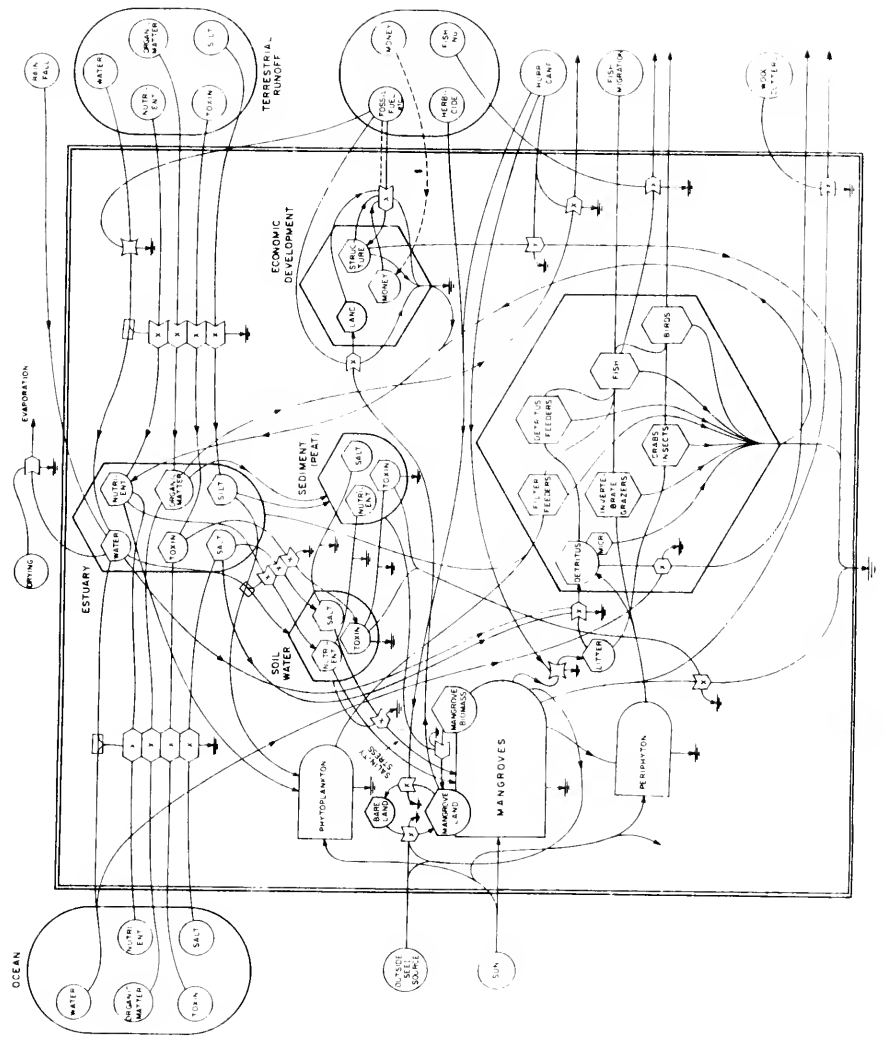



mangrove roots, leaves, and wood. Mangrove biomass contributes to litter fall, which may be degraded further into particulate detritus or grazed upon by crabs, snails, and other consumers. Some litter may also be incorporated into the sediments as peat. Roots also form a portion of the peaty sediments. Detritus in this model includes particulate fragments of litter fall and subsequent stages of degradation. Detritus is consumed by detritus-feeding organisms and filter feeders and is exported into the open estuary under tidal influence.

In the model hurricanes and herbicide spraying are shown as stresses on the mangrove forest. It was also felt that hurricanes play an important role in the shaping of the mangrove system. The effect of spraying herbicide is illustrated by the conversion of undisturbed land to bare land as described by the National Academy of Sciences (1974). Recolonization can occur from both local and outside seed sources.

In many areas of the tropics and subtropics the mangrove forests have been subjected to intense pressures of development from man-related activities. The concern here is related to whether these types of development are able to achieve maximum value from a mangrove forest. In southeast Asia the wood of the mangrove species, Rhizophora mucronata is made into a high grade charcoal. In West Africa many hectares of mangrove forests have been cleared for rice production. In the United States, Australia, and probably other parts of the world, mangrove forests are cleared and homes are constructed on the

cleared sites. Real estate development in the model occurs when both money and fossil fuel are available. The adjacent estuary can also be affected by impoundment or channelization of upland streams or by impoundment or dredge and fill of estuarine areas.

### Study Plan and Objectives

Modeling and simulation methods were used to help in understanding mangrove ecosystems and their responses to management alternatives. Knowledge from previous studies about important processes, components, and causal factors for mangroves was organized into general energy and material flow models (Figure 1). Then simplified models were developed to include only those features of the mangrove ecosystem believed to be major determinants in the situations studied. Equivalent mathematical equations were written and simulations were run on an analog computer. The simulation results were compared with results from field studies included as part of this dissertation and from results of field studies reported in the literature.

Since mangrove forests occur in locations that are desirable for economic development, management of land with both uses needs to be optimized. The development of predictive models which consider changes over time in the mangrove forest may aid the decision making process involving mangrove management. Such models will be needed if the impact of increasing human influence on mangroves is to be predicted. With this in mind, the objectives of this dissertation were

- (1) To demonstrate the usefulness of aggregated simplistic models to simulate the sensitivity of mangrove forests to environmental factors such as herbicide spraying, hurricanes, nutrient enrichment, and economic development.
- (2) To ascertain through computer simulations those variables that have a significant effect on the rate of recolonization of a mangrove forest that has been sprayed with herbicide.
- (3) To determine through computer simulations the response and rate of recovery of a mangrove forest subjected to hurricanes of varying intensity and frequency.
- (4) To assess the response of a mangrove forest to nutrient enrichment through computer simulations.
- (5) To determine through computer simulations the ratio of natural to developed land that will provide the maximum value to the region under development.
- (6) To observe through field studies the response of a mangrove forest to nutrient enrichment from sewage effluent and spraying of herbicide.

Development designs in the past have not always been beneficial to the mangrove ecosystem. What are the best ways to develop human settlements in an estuarine area? Should the mangrove ecosystem remain in a pristine condition or can the wastes and energy flow of man blend into the forest without destroying it? Should a mangrove

forest be used as a disposal area for domestic sewage effluent?  
What are the long-term effects on estuarine productivity when large areas of mangrove are destroyed by herbicide spraying or hurricanes?

### Description of Study Areas

Study sites were located in South Vietnam and in southwest Florida. The investigation was concerned with processes that occur in the mangrove forests of these regions.

#### South Vietnam Study Area

The area investigated in South Vietnam was the Rung-Sat district located about 40 kilometers south-southeast of Saigon in Gia Dinh Province (Figure 2). The Rung-Sat is an extensive delta of 105,000 ha formed by alluvial deposits from three rivers--the Saigon, Dong Nai, and Thi Vai. Vu Van Cuong (1964) listed the mangrove area of the Rung-Sat as 40,000 ha. Analysis of aerial photography taken by the National Academy of Sciences (1974) revealed that prior to herbicide application, the land use distribution was as follows: mangrove vegetation covered 51% of the Rung-Sat, open water 23%, cultivated land 8%, abandoned land 6%, bush 5%, bare ground 5%, and urban land 2%. Portions of the Rung-Sat are flooded twice daily by the tides and a normal high tide of 3.3 m will cover 85% of the area. When the highest tides occur in June-July and December-January, the entire Rung-Sat is inundated.

Figure 2. Map of the Rung-Sat district in South Vietnam showing sprayed and unsprayed areas. Sprayed areas are white, unsprayed areas are dotted, water areas are black.

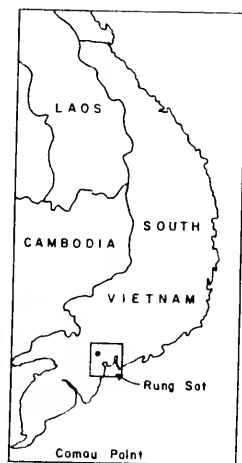
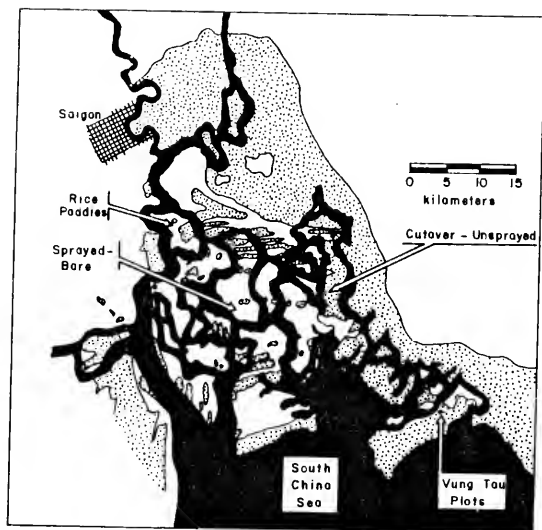

According to Chapman (1974) more than 20 species of plants were classified as mangroves in the Rung-Sat. Vu Van Cuong (1964) listed 84 species of plants found in mangrove associations in the Rung-Sat. Much of the mangrove vegetation formerly in the Rung-Sat was a secondary forest because of frequent cuttings. The dominant species occurring in the higher salinity outer zones of the Rung-Sat was Rhizophora mucronata which was harvested by the South Vietnamese for firewood or charcoal. Avicennia sp. dominated the inner zone which is influenced more by fresh water influx. Other species present included Sonneratia alba (thought to be a pioneer on newly formed land), Ceriops tagal, Bruguiera parviflora, R. apiculata, S. caseolaris, and a palm, Nypa fruticans.

During the period from 1965 to 1970, approximately 57% of the Rung-Sat district was subjected to extensive spraying with two herbicide mixtures known as "Agent White" and "Agent Orange." Agent White is a 4:1 mixture of the tri-iso-propanolamine salts of 2,4-dichlorophenoxyacetic acid (2,4-D) and 4-amino-3,5,6-trichloropicolinic acid (picloram) in water. Agent Orange is a 1:1 mixture of the n-butyl esters of 2,4-D and 2,4,5-trichlorophenoxyacetic acid (2,4,5-T). According to the National Academy of Sciences (1974), 3,730,000 liters of Agent Orange and 1,580,000 liters of Agent White were sprayed on the mangrove forests of South Vietnam. Spraying was halted in 1971 and the sprayed areas are slowly being recolonized by mangrove vegetation.

### Florida Study Areas

Three areas were chosen for study along the southwest coast of Florida (Figure 3). In one of the areas herbicide similar to the mixture known as "Agent White" in South Vietnam was applied by helicopter in an experiment designed and reported by Teas and Kelly (1974). In two other areas, the mangrove forest was covered with diluted sewage effluent at high tide.

Two of the three study areas were located in a region known as Ten Thousand Islands. In the Ten Thousand Islands region the mangrove strip is two to three miles wide with a mile wide lagoon behind the mangrove strip. Tanner, Evans, and Holmes (1963) reported that in southwest Florida the shoreline north of Cape Romano was a quartz-sand beach while the shoreline to the south of Cape Romano was a mangrove tree cluster barrier. The Ten Thousand Islands area seems to be one of low wave energy but relatively large tidal activity due to the shape of the shoreline. A concave shoreline such as the southern shore of southwest Florida causes waves to be refracted and tides to be funneled into the bay. Tidal range is from 2-4 feet in southwest Florida.

Lugo and Snedaker (1974b) listed five types of mangrove ecosystems as determined by local tidal patterns and upland surface water runoff. The fringe forest occurs along slightly sloping, protected shorelines of the mainland and larger islands. Tidal water movement is restricted to an in-out pattern. The riverine forest



Figure 3. Map of southwest Florida showing the sites treated with sewage, the site treated with herbicide, and the sites where mangrove productivity and biomass were measured by Lugo and Snedaker (1974a).

- (a) Map of the state of Florida.
- (b) Map of south Florida showing locations of study areas.
- (c) Map showing location of Naples study plots.
- (d) Map showing location of Everglades City study plots.
- (e) Map showing location of Marco Island study plots.

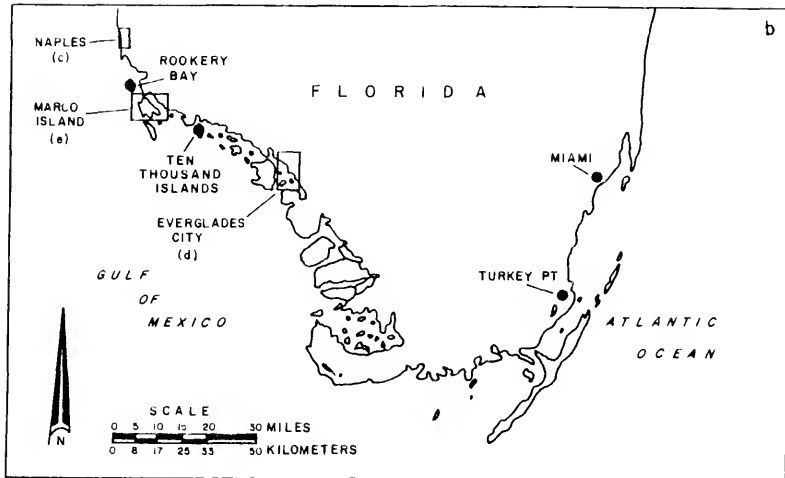
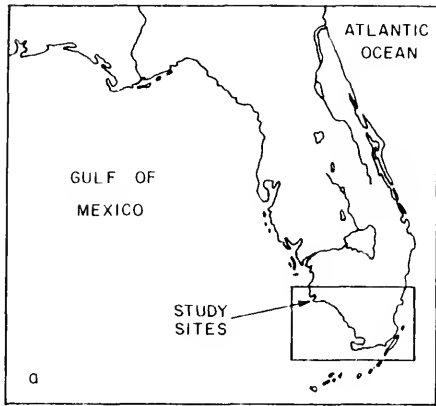

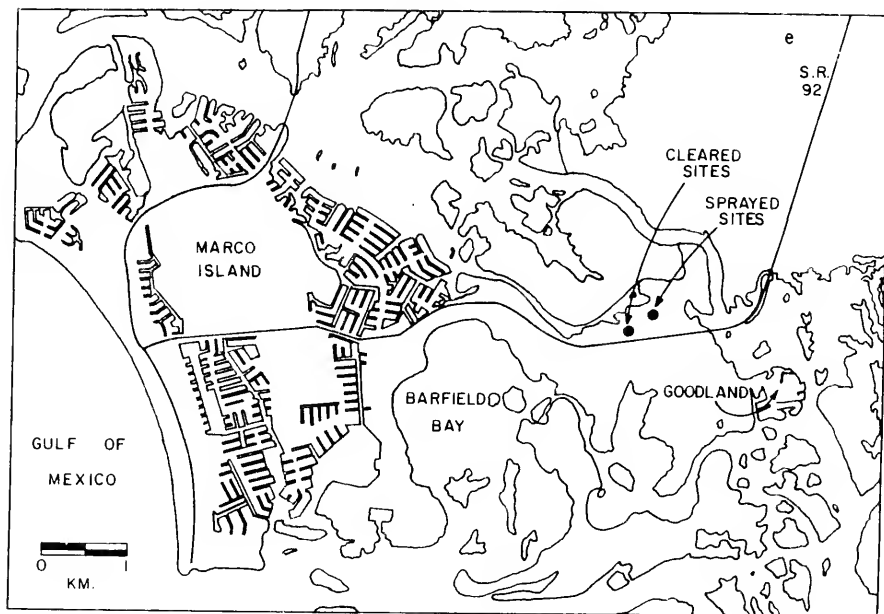
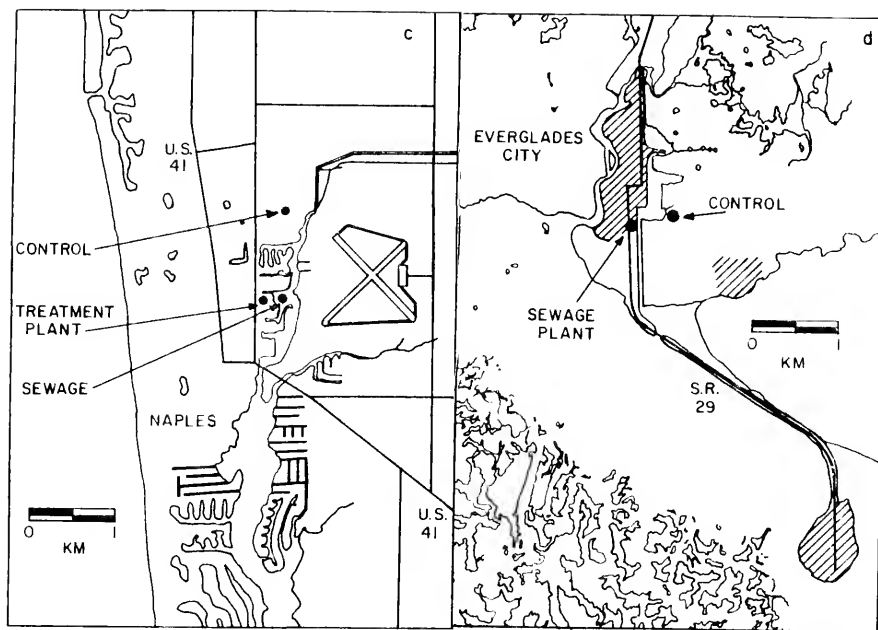

Figure 3 (continued)

is situated on the mainland in strand-like formations along river and creek drainages. Tidal flushing can be daily and flooding is caused by fresh water runoff and/or high tides. The overwash forest occurs on small islands and finger-like projections of larger land areas. Daily tidal water movement is through the forest and velocities are high enough to remove most of the debris. The basin forest occurs behind the fringe forest. The land is flat, water movement is slow and tidal flushing may be infrequent. Another type may be the dwarf mangrove forest, which occurs in flat coastal fringes where trees are < 2 m tall and may be nutrient limited or salt stressed. The mangrove hammock is a tree island surrounded by dwarf mangroves or sawgrass wetlands. Water flow is around the island and gives the hammock a tear-drop shape.

The forest sprayed with herbicide was located between the towns of Goodland and Marco Island along State Road 92 (Figure 3e). The sites nearest the road (farthest from tidal creek) were dominated by A. germinans while sites nearest the tidal creek were dominated by R. mangle. Scattered trees of the species Laguncularia racemosa were also located in the area. A small succulent, Batis maritima, was also present. Forests of the riverine and the basin type were found here.

The herbicide used on the sprayed sites was Tordon 101<sup>R</sup> manufactured by Dow Chemical Co. Tordon 101<sup>R</sup> is similar to Agent White and consists of a mixture of 0.24 kg/l of 2,4-D and 0.65 kg/l of picloram on an acid equivalent basis. The sprayed and control sites

measured 20 m by 40 m and the cleared sites measured 40 m by 40 m.

The study sites receiving nutrients from treated sewage effluent were located in Naples and Everglades City. In each site sewage effluent was not discharged directly into a mangrove forest. The contact of mangroves with sewage was limited to tidal flooding at high tide. The Naples study site (Figure 3c) was located along the Gordon River which meanders lazily through the town of Naples on its way to the Gulf of Mexico. The nutrient enriched study site was located on an island in the Gordon River about 100 m from the point of discharge of sewage effluent from the Naples sewage treatment plant. The plant was designed in 1966 to treat 9500 m<sup>3</sup>/day (Candeub, Fleissig, and Associates, 1973). This design capacity was increased to 19,000 m<sup>3</sup>/day in March 1975. Treatment consisted of contact stabilization, chlorination, and then retention in a stabilization pond before discharge into the Gordon River. The experimental study site consisted of an interior composed almost entirely of L. racemosa ringed by R. mangle growing at the water's edge. A control site was selected upstream from this site away from the influence of the sewage treatment plant. The dominant tree in the control site was L. racemosa with a few trees of R. mangle. These sites were usually inundated by tides twice each day. During the dry season, however, there were days when the tides did not reach this level. These forests are examples of the riverine type forest.

The Everglades City study sites (Figure 3d) were located along a tidal canal which discharges into Chokoloskee Bay. The experimental sites were located immediately upstream and downstream from the point where the sewage effluent is discharged into the canal. The treatment plant was designed to treat 100,000 gallons per day of sewage. Treatment consisted of extended aeration, chlorination and retention in a stabilization pond before discharge into the canal. A control site was selected farther upstream along a small tidal creek that emptied into the canal. The sewage site was composed of L. racemosa and R. mangle with a few A. germinans while the control site was dominated by R. mangle with a few L. racemosa and A. germinans. These forests are examples of the riverine type forest.

## REVIEW OF LITERATURE

This review will briefly discuss previous publications that relate to this dissertation. These include the problems of ecosystem modeling, modeling of mangrove forests, past use of herbicides on mangroves, effects of sewage effluent, effects of hurricanes on mangroves, and interactions with economic development in mangrove forests.

### Ecosystem Modeling

Modeling at the ecosystem level generally involves a simplification of the extremely complex processes and interactions within ecosystems. One approach is to try and model all details so as to emulate the real system. An analysis by O'Neill (1971) indicated that increased model complexity does not always bring about more accurate results that are more comparable to the real system. According to O'Neill, adding more parameters to an ecosystem model makes it necessary to quantify these additional parameters in field and laboratory experiments which have errors of measurement. Other approaches to understanding a system may deal with studying its parts--a reductionist approach that can have adverse effects on conclusions about the system. A third approach is to simplify by aggregating, a method used in this dissertation. Aggregating is a process of combining the details of a

base model into a less complex model so that simulations can be made. Combining species or parameters with comparable turnover times is one means of aggregating ecosystem models.

Burgess and Kern (1973) felt that the mathematical rigor of ecosystem modeling should result in greater efficiency and more precise structure in research programs. Modeling can also formalize insights and graphically highlight areas where progress was slowed due to missing data. Limitations to progress in modeling are the understanding of mechanisms and the ability to measure relevant parameters. Models provide a framework for synthesizing and comparing data. Ecosystem modeling may be a problem because of the uniqueness of each ecosystem. Levins (1966) pointed out that if this is true, data obtained from one ecosystem cannot be applied to another ecosystem.

Very little modeling has been done of mangrove swamps. Sell, in Odum et al. (1974), reported on preliminary simulations of mangroves recovery following herbicide spraying in South Vietnam. The complete results are in this dissertation. Miller, Ehleringer, Hynum, and Stoner (1974) have simulated the reforestation problem of the red mangroves in Vietnam by combining climatological, geological, and physiological characteristics of the Rung-Sat district in South Vietnam in order to understand the processes and interactions influencing regeneration of the mangrove forest. They tested two hypotheses as to the cause of slow mangrove regrowth: (1) low propagule availability and (2) growth of propagules and seedlings is stopped



because defoliation has increased temperature and salinity. Their model indicated that high temperatures and low availability of propagules are the major factors influencing regrowth and combined may play the major role in reforestation of mangroves on the Rung-Sat.

Zieman et al. (1972) developed a model to study natural succession in the mangrove swamps of Vietnam. Waterlogging of the soil, soil water salinity, frequency of tidal inundation, and shade were programmed as limiting factors in the model. The model looked at succession in drained soils and in waterlogged soils. Available nutrients and establishment of seeds were not considered because no data were available. In waterlogged soils S. alba grew first followed by R. mucronata at year 17 which peaked at year 59 with a biomass of about 23,000 g/m<sup>2</sup>. R. apiculata began growing at year 59 and reached a steady state biomass of about 39,000 g/m<sup>2</sup> at year 130. In drained soils, A. marina was the pioneer, followed by B. cylindrica in year 27, which was followed by B. gymnorhiza in year 53. B. gymnorhiza reached steady state biomass of about 72,400 g/m<sup>2</sup> in year 200. Increasing productivity did not have a large effect on biomass but did increase the rate of succession. These biomass values seem much too high because of the extremely high rates of net primary productivity used in this model. These authors also neglected hurricanes and woodcutting effects on biomass.

Miller (1972) also simulated a model of primary production and transpiration for various levels of a mangrove forest canopy in Florida. The simulation made use of an energy-budget equation of individual

leaves. For a red mangrove (R. mangle) forest, Miller (1972) calculated net primary production to be an average of  $3.4 \text{ g/m}^2 \cdot \text{day}$  in June and  $2.2 \text{ g/m}^2 \cdot \text{day}$  in January for a yearly average of  $2.8 \text{ g/m}^2 \cdot \text{day}$ . The model showed that primary production decreased with increasing air temperature and humidity. Increasing solar radiation increased primary production but at high levels, production was decreased. Transpiration was calculated to be 20% of the total water loss of the forest with the rest coming from the forest floor. Miller concluded that the canopy of the red mangrove forest was adapted to maximize net primary production under conditions of saturated water supply.

Lugo, Sell and Snedaker (1976) simulated a model of the overwash mangrove forest type in order to study the effects of upland runoff and tidal flushing on processes occurring within a mangrove system. They found that tidal flushing affected the storage of detritus in the forest and nutrient availability affected the productivity of the forest. Upland runoff reduction lowered the productivity of the mangrove forest. The model in Figure 15 of this dissertation is similar to that model but the stress of the occasional hurricane has been added.

#### History of Herbicide Use in Mangroves

The control of mangrove vegetation by the use of herbicides has been going on for about 20 years. Ivens (1957) reported that by applying either 2,4-D or 2,4,5-T at concentrations of 4-20% in diesel oil Rhizophora and Avicennia species could be killed. The Avicennia

species was found to be slightly more resistant than the Rhizophora species. Dixon (1959) reported that a 10% solution of 2,4,5-T in diesel oil applied with a brush to the bark of trees of B. parviflora in Malaya resulted in a 90% kill after three months. More desirable Rhizophora seedlings were planted immediately after the treatment and grew quite well. Truman (1961) found in Australia that A. marina was defoliated when solutions of 1,2, or 4% of 2,4,5-T were sprayed on the bark or leaves of trees of that species. He concluded that this mangrove species was very susceptible to these herbicides.

Nielands et al. (1972) reported that herbicide experiments made in South Vietnam during 1961 and 1962 were generally successful in killing most species of vegetation found in Vietnam. Minarik and Bertram (1962) reported that in September and October of 1962 the United States Army conducted a series of spraying operations on mangroves in Vietnam. These experiments were performed along several canals and roads in Camau peninsula served as transportation arteries and needed to remain open. Spraying was successful to the extent that 95% of the mangrove vegetation was defoliated at a spray concentration of three gallons of "Agent Purple" per acre. "Agent Purple" consisted of a 50:30:20 mixture of the n-butyl ester of 2,4-D and the n-butyl and isobutyl esters of 2,4,5-T. Its use was discontinued in 1964. Minarik and Bertram (1962) concluded that the spraying operation proved that defoliation of large areas of mangrove vegetation was technically and operationally possible.

Teas and Kelly (1974) assessed the impact of the herbicide, "Agent White" by spraying several small areas of mangroves near Marco Island, Florida. Defoliation was 100% for L. racemosa within five weeks after treatment. R. mangle was 90% defoliated within six weeks while A. germinans was only 25% defoliated after 16 weeks and was nearly recovered in 16 months. The trees of L. racemosa began to die at 24 weeks and the trees of R. mangle started dying at 30 weeks after spraying.

Lugo and Snedaker (1974b) manually defoliated R. mangle trees in South Florida. New leaves were put out by these trees even when the defoliation was repeated, suggesting that loss of leaves in this manner does not result in mortality of the trees.

Walsh, Barrett, Cook, and Hollister (1973) investigated in the laboratory the effects of a commercial formulation of 2,4-D and picloram on the seedlings of the red mangrove, R. mangle. Seedlings were treated with herbicide concentrations of 1.12, 11.2, and 112 kg/ha. A dosage of 1.12 kg/ha appeared to have very little effect on growth but at the higher dosages, seedlings died within 40 days.

The mangrove vegetation of the Rung-Sat has been very slow to recolonize bare areas that resulted from spraying. This slow recolonization has been noted in other mangrove swamps of the world. Macnae (1968) has referred to the general problem of mangrove recolonization in cleared mangrove areas and wondered why recently cleared areas often become deserts suitable only for salt production in regions with low or seasonal rainfall.

Meselson, Westing, Constable, and Cook (1970) reported that mangrove species in Vietnam showed no signs of recolonization of areas sprayed three or more years prior to inspection.

Westing (1971) noted that spraying mangrove vegetation with herbicide not only caused defoliation but also seemed to prevent re-establishment of any new plant community. Westing observed that six years after spraying there was no clear evidence of regeneration of mangroves.

Orians and Pfeiffer (1970) observed that the areas they visited in the Rung-Sat were still barren although spraying had occurred several years earlier. They concluded that re-establishment of mangroves may take more than 20 years because of the problems of seed dispersal into the sprayed areas and the possibility of herbicide residues in the soil. In order to determine if there was a herbicide residue problem the National Academy of Sciences (1974) conducted seedling planting experiments near VungTau in South Vietnam in 1972 to determine whether the presence of herbicide in the soil has any effect on seedling survival. The study indicated that the presence of herbicides in the soil made no difference in seedling survival. Tschirley (1969) estimated that an area of mangroves sprayed in 1962 in the Rung-Sat may reasonably be expected to take 20 years to return to prespraying conditions based on the regeneration he observed at that time.

Natural regeneration of mangroves may depend upon a number of factors, the most important being availability of adequate numbers of seedlings and seeds for dispersal into bare areas. If seedlings are

present, other factors such as pH of soil, salinity, nutrient levels, soil temperature, and predation by animals such as crabs may hinder regeneration of mangroves. Debris may prevent seeds and seedlings from reaching inland areas. Woodcutters also significantly deter the full recovery of mangroves by cutting the mangroves before they bear fruit. In Thailand Banijbatana (1957) felt that illegal cutting had a serious impact on natural regeneration of mangroves. Krishnamurthy (1974) estimated that it may take 80 years for a mangrove community to recover from destruction by man. Dixon (1959) noted that in Malaya clear cut areas required seven years for natural regeneration, while Wadsworth (1959) reported that after a mangrove forest in Puerto Rico was clearfelled, natural regeneration occurred within two years.

The studies of herbicide use reviewed here have indicated that the mangrove forest is very susceptible to herbicide and that complete recovery of the mangrove forests may be a long time coming in Vietnam. In fieldwork by H. T. Odum in VungTau in 1972 many cut stems were observed. Woodcutting of mangroves was the basis of a charcoal industry with export sales to Japan in the early 1970s.

#### Sewage Disposal in Wetlands

Nedwell (1974) has suggested the disposal of sewage effluent on mangrove land based on the ability of bacteria in the anaerobic mangrove sediments to reduce nitrate to gaseous nitrogen. No

previous studies have been located on the effects of nutrient enrichment on tree growth and litter fall in mangrove forests.

A few studies have been made on the response of salt marshes to treated municipal sewage effluent. Marshall (1970) assessed the effects of added nutrients on a Spartina salt marsh along the North Carolina coast. The discharge rate was 1900 m<sup>3</sup>/day of sewage into a tidal creek. The marsh receiving treated sewage effluent generally produced significantly greater weights of live Spartina than the control marsh. The number of stems per square meter was not significantly greater and the greater biomass in the sewage creek was accounted for by the increase in stem diameter. Phosphorus concentrations in July 1969 were 0.93 mg/l for the sewage creek and 0.078 mg/l for the control creek. The sewage marsh also had a higher net productivity than the control marsh as measured by the difference between the maximum and minimum standing crops during the growing season.

Valiela and Teal (1974) designed experiments to measure the response of salt marsh communities in Massachusetts to phosphorus and nitrogen enrichment. They found that nitrogen enriched plots had increased biomass of salt marsh plants while phosphate enrichment had negligible effect on the biomass as compared to control marshes. The conclusion was that levels of nitrogen were critical to the productivity of vegetation in their study marsh in Massachusetts. Valiela and Teal (1974) also found that after 3 years of applying sewage sludge to the salt marsh, primary productivity, decomposition and secondary productivity were higher than in a control.

Spangler, Sloey, and Fetter (1976) investigated the response of a fresh water marsh in Wisconsin to the discharge of municipal sewage effluent. The city of Brillion sewage treatment plant discharged effluent into a creek that flows into the marsh. Discharge of effluent ranged from 750 to 1500 m<sup>3</sup>/day. They found that the experimental sewage marsh produced lower standing crops than the control marshes. Measurements also revealed that with a multiple harvest during the year 0.83-1.62 g P/m<sup>2</sup> were removed from the sewage marsh while a single harvest removed only 0.6 g P/m<sup>2</sup> from the control marsh.

Odum, Ewel, Mitsch, and Ordway (1975) reported on the recycling of treated sewage through cypress wetlands in Florida and observed that at a loading rate of 10 cm/week only 4% of the phosphorus was removed but at a rate of 4 cm/week 75% of the phosphorus was removed from the sewage effluent. Mitsch (1975) used ecosystem modeling to help understand the impact on a cypress dome in Florida of high nutrient inputs from sewage. A computer simulation of the addition of sewage to a cypress dome indicated that in a 30-year period the production of cypress wood increased 25% at a loading rate of 2.5 cm/week and 50% when the loading rate was increased to 5 cm/week. Mitsch recommended that a loading rate of 3-5 cm/week would be best if cypress domes were to be used for disposal of sewage effluent.

Boyt (1976) reported on the responses of a mixed hardwood swamp to 20 years of receiving sewage effluent. Measurements indicated that 98% of the phosphorus influx was retained in the swamps. Growth rates for cypress trees during the 20-year period were 5.5 cm in the sewage



swamp and 3.9 cm in the control swamp. Ash trees had a 20% higher net productivity in the sewage swamp than in the control swamp. Understory vegetation in the sewage swamp was six times that of the control.

Wentz (1975) reported that wetlands in Michigan showed no significant changes in growth, productivity, or nitrogen and phosphorus concentrations following application of simulated sewage effluents and concluded that as nutrients accumulate, some species may show increased growth while others may show decreased growth.

#### Effects of Hurricanes

Winds and wind-produced tides and waves cause great damage when a hurricane passes, often covering roots with a deep layer of mud. Craighead (1971) noted that Hurricane Donna in 1960 did extensive damage to the mangrove forests in the Ten Thousand Islands coastal area. Many trees were sheared off completely while others lost many branches. Nearly all trees were completely defoliated. However, within four weeks new leaves appeared but six weeks later, the lowland mangroves were dead while those at slightly higher elevations continued to live. Craighead (1971) attributed this to a lack of gas exchange in the roots because they were covered by an impervious mud layer anywhere from 3-15 cm thick.

Sauer (1962) reported that in 1960 two strong cyclones struck the tiny island of Mauritius off the east coast of Africa. The first one passed near the island with winds gusting to 160-200 km/hr while a month later the second cyclone was a direct hit with winds of 240 km/hr. Although flooded to a depth of 2 meters the mangroves were only slightly damaged. Some older trees and seedlings were uprooted.

Glynn, Almodovar, and Gonzalez (1964) reported that Hurricane Edith passed by La Parguera in Puerto Rico but only slight defoliation of the mangroves occurred. Winds were not high enough to uproot or shear the mangroves along the coast.

Major hurricanes can do extensive damage when they occur, but the frequency of these great tropical storms is low and the total effects are relatively small when averaged over the years of frequency of hurricanes. Tanner (1961) estimated that the impact of Hurricane Donna in 1960 was equivalent to the work of 100 years of ordinary processes of moving sediments. The mangrove ecosystem appears to be adapted to and dependent on the infrequent occurrence of well-developed tropical storms.

#### Occurrence and Frequency of Hurricanes and Typhoons

Ludlum (1963) gave an account of early American hurricanes and stated that a hurricane in 1835 was probably the first major hurricane with documentation to pass through the Florida Keys. The storm was believed to have passed along the Florida west coast and may have affected the Ten Thousand Islands mangroves. In 1846, the worst hurricane since 1821 struck Havana, Cuba and then moved along the west coast of Florida. Riehl (1972) reported that a hurricane passed through the Ten Thousand Islands in 1876. Tannehill (1938) reported that hurricanes may have hit the Ten Thousand Islands in 1891, 1910, 1924, and 1935. The last major hurricane to hit this area was Hurricane Donna in 1960.

This brief history revealed that since 1835 possibly 8 major hurricanes have passed through the mangrove region known as the Ten Thousand Islands, a frequency of 1 major hurricane every 18 years. Lugo, Sell, and Snedaker (1976) reported a frequency of one hurricane every 20 years for Florida and every 24 years for Puerto Rico.

Hurricane records for Jamaica date back to 1689 and Fowler (1952) felt that 17 could be considered major which gave a frequency of one major hurricane every 15 years. Shellard (1971) estimated from wind speed data that a wind speed of 120 mi/hr (54 m/sec) would be expected to occur in Jamaica only once every 50 years. He also said that a well-developed hurricane with winds of 150-160 mi/hr (67-71 m/sec) should not be expected to occur again for more than 50 years.

Typhoons are frequent in Southeast Asia. Ramage (1971) gave a typhoon frequency for the Rung-Sat of about one every ten years. In 1948 a typhoon passed just north of the Rung-Sat. In 1950 and 1956 typhoons passed to the north of the mangroves in the Camau Peninsula. The intensity of these storms was not given.

#### Economic Development in Mangroves

Development of coastal mangrove areas has been occurring throughout the world's mangrove zone. Baines (1974) discussed the uncontrolled development of mangrove lands in Australia. Intense pressures were applied to convert the mangrove swamps into residential canal developments as is being done in the United States. Recent awareness of their value as a recreational and commercial fishery was evidenced in the

recommendation by the Australian Conservation Foundation (1972) that the relevant authorities should carefully study mangrove areas before allowing development and consider their value beside the proposed land use values.

Odum (1971) presented evidence that mangrove swamps are valuable, productive regions and indicated the importance of mangrove detritus in the estuarine food web. Removal of mangrove swamps for the purpose of economic development would in the long run reduce the estuarine productivity that originally attracted the development.

The effect of development on a mangrove forest will largely depend on the nature of the development. Tabb and Heald (1973) have proposed the use of an interceptor canal that would be constructed between the coastal mangroves and the upland development. Veri et al. (1973) proposed a resource buffer between upland development and the coastal mangroves. These developments were designed to preserve the coastal mangrove swamps. Finger canal developments have caused extensive damage to estuarine areas of Florida.

Steller (1976) evaluated alternative residential development plans in a coastal mangrove area of southwest Florida. Energy investment ratios (ratio of fossil fuel amplifying energies to resident natural energy flows) were evaluated for interceptor canal, resource buffer, finger canal, special treatment, and high density developments. Since the calculated investment ratios exceeded those for Florida and the United States, Steller (1976) concluded that these

developments may not be competitive. In order to be competitive, the land area developed needed to be much less for each development.

## METHODS

Modeling and simulation techniques were used in this dissertation as a means of developing an understanding of the responses of mangrove ecosystems to perturbations by man and nature. Energy flow calculations were used in the model of economic development and mangroves to assess the relationship between natural and fossil fuel energy flows. Field studies were used to provide additional information and to validate the simulated responses.

### Modeling and Simulation Techniques

Ecosystem models were conceptualized and simulated on analog computers to assess the effects of such factors as hurricanes, herbicides, economic development, and nutrients on the mangrove ecosystem. This section describes the procedure for developing a model, the writing of the equations that describe the model in mathematical terms, the use of model aggregation, the calculation of rate coefficients for the pathways of energy or material flow and the scaling of the equations.

### Development of Models and Equations

The modeling procedures in this dissertation involved determining the energy flows from outside the ecosystem being studied. Also, an assessment was made of those storages or compartments thought to be important within the ecosystem. Finally, the pathways, interactions and processes that are important in the ecosystem being studied were also determined. A qualitative diagram was then drawn of the simplified ecosystem. The symbols used in diagramming the models in this dissertation were those developed by Odum (1971). Each of the symbols is shown in Appendix A along with a description and also a mathematical equivalent where appropriate.

After a model was developed, the next step was to write the differential equations that describe each of the state variables or compartments of the model. The differential equation described the time rate of change in a compartment or state variable as it is affected by the flows entering and leaving the compartment. Each compartment in the model could thus be described by a differential equation. Use of these differential equations made it possible to simulate the model on computers. The output graphs show the trends with time that resulted for a particular model and its set of parameters.

### Aggregation

For the prediction of the overall response of an ecosystem model to various interactions, aggregation of parameters was an important

means of simplifying the model for better understanding. If many of the parameters were constant or small in their effect on the system, many of the internal details occurring in the mangrove ecosystem could be omitted. For example, the photosynthetic process produced organic matter used by the mangrove trees for their growth and metabolic processes. The process of photosynthesis actually included numerous steps or chemical reactions that eventually result in the production of this organic matter. Details of this nature were generally unnecessary in these simulation models since the primary concerns of the study involved events on a larger scale. The technique of aggregation or lumping is probably valid whenever the overall result of some process is desired rather than the intricate details. Whether a process is important or insignificant can be studied by trial and error or by estimating the relative magnitude of its effect on energy flows.

#### Calculation of Rate Coefficients

Each line or pathway that appears in the model diagram has a set of terms associated with the pathway along with a rate coefficient. If the value of this pathway was known and also the state variables or driving forces describing the pathway, then the rate coefficient could be calculated. The calculation of the rate coefficient involved setting the observed flow equal to the algebraic term for that flow where the rate coefficient was the only unknown parameter. An example



of the calculation is given below for the flow of organic matter into mangrove biomass (see Fig. 15). The equation for the flow is

$k_1 I_R Q_1 Q_3$  where

$k_1$  = rate coefficient

$I_R$  = solar radiation available for photosynthesis

$$= 8.0 \times 10^5 \text{ kcal/m}^2 \cdot \text{year}$$

$Q_1$  = initial amount of mangrove biomass =  $10,500 \text{ g C/m}^2$

$Q_3$  = initial amount of nutrients =  $1600 \text{ g/m}^2$

and the value for the flow is  $2820 \text{ g C/m}^2 \cdot \text{year}$ . Therefore,

$$k_1 I_R Q_1 Q_3 = 2820 \text{ g C/m}^2 \cdot \text{year}$$

or

$$k_1 = \frac{2820 \text{ g C/m}^2 \cdot \text{year}}{(8.0 \times 10^5)(10,500)(1600)(\text{kcal/m}^2 \text{ year})(\text{g C/m}^2)(\text{g/m}^2)}$$

$$k_1 = 2.10 \times 10^{-10} \text{ m}^4/\text{g} \cdot \text{kcal}$$

Calculations must be made for the rate coefficients of each pathway in the model. In this simulation method the assumption was made that these rate coefficients did not change during a simulation run. Although this may not be true in many instances, the lack of data

showing a change with time usually requires the researcher to make the above assumption.

### Scaling of Equations

Once the rate coefficients have been determined, the equations describing each compartment need to be scaled if an analog computer is used in the simulations. Scaling is the expression of equations as percent of full scale on output graphs. Scaling was necessary because the output from an analog computer is in terms of voltages. If a maximum voltage is exceeded, the results will be in error. Each variable was replaced by a quotient made by dividing by the maximum value expected. In this way the quotient was kept less than unity (full scale) and thus within the maximum scale chosen and the voltage range of the analog computer. Suppose we had an equation such as that given for the rate of change of mangrove biomass in Figure 15 where

$$\frac{dQ_1}{dt} = k_1 I_R Q_1 Q_3 - k_3 Q_1^2 - k_2 Q_1 - k_{16} Q_1 H \quad (1)$$

In order to scale this equation, one needs to know the maximum values that should be expected for the compartments ( $Q_1$ ,  $Q_3$ ) and the driving forces ( $I_R$ ,  $H$ ). In the model shown in Figure 15,  $Q_1$  was assigned a maximum value of  $3 \times 10^4$ ,  $Q_3$  a maximum value of  $10^4$ ,  $I_R$  a maximum value of  $2.43 \times 10^6$  and  $H$  a maximum value of 13. The next step was to divide each compartment and driving force in the equation

by its maximum value and to multiply at the same time as shown below.

$$\begin{aligned} \frac{dQ_1}{dt} = & k_1 (2.43 \times 10^6) \left[ \frac{I_R}{2.43 \times 10^6} \right] (3 \times 10^4) \left[ \frac{Q_1}{3 \times 10^4} \right] (10^4) \left[ \frac{Q_3}{10^4} \right] \\ & - k_3 (3 \times 10^4)^2 \left[ \frac{Q_1}{3 \times 10^4} \right]^2 - k_2 (3 \times 10^4) \left[ \frac{Q_1}{3 \times 10^4} \right] \\ & - k_{16} (3 \times 10^4) \left[ \frac{Q_1}{3 \times 10^4} \right] (13) \left[ \frac{H}{13} \right] \end{aligned} \quad (2)$$

Next, divide both sides of the equation by the maximum value of  $3 \times 10^4$  for  $Q_1$ . If the differential equation were for  $Q_2$ , then the maximum value for  $Q_2$  would be used. Equation 2 was then rewritten so that

$$\begin{aligned} \frac{dQ_1}{3 \times 10^4 dt} = & k_1 (2.43 \times 10^{10}) \left[ \frac{I_R}{2.43 \times 10^6} \right] \left[ \frac{Q_1}{3 \times 10^4} \right] \left[ \frac{Q_3}{10^4} \right] - k_3 (3 \times 10^4) \left[ \frac{Q_1}{3 \times 10^4} \right]^2 \\ & - k_2 \left[ \frac{Q_1}{3 \times 10^4} \right] - k_{16} \left[ \frac{Q_1}{3 \times 10^4} \right] (13) \left[ \frac{H}{13} \right] \end{aligned} \quad (3)$$

The calculated values for each rate coefficient were then substituted into equation 3 and the resulting numerical values represented the pot settings for the model pathways on the analog computer.

### Energy Calculations

Energy flow calculations were made in conjunction with the model assessing the relationship between economic activity and the mangrove ecosystem. The concepts of energy quality and investment ratio were used in the energy calculations and are discussed next.

#### Energy Quality

The value of a pathway within a system will vary according to the amount of useful work the pathway does for the good of the system. An energy flow low in heat content but high in the ability to feedback and to do useful work is said to be of high quality while an energy flow high in heat content but low in the ability to do useful work is said to be of low quality. Sunlight is of low quality because of the small amount of useful work performed per calorie of heat content. Electricity is of high quality because of the large amount of useful work performed per calorie of heat content. In order to compare the different abilities of pathways to do work for the system, the heat content energies must all be converted to a common energy quality denominator. In this dissertation the coal equivalent (CE) was used as the base. This means that for higher quality energy flows, the energy quality per calorie will be  $X$  coal equivalents where  $X$  is greater than one. Electricity is an example of this because of the requirement of 4 units of coal energy to produce 1 unit of electricity thus giving electricity an energy quality of four CE. For lower

quality energy flows, the energy quality per calorie will be  $Y$  coal equivalents where  $Y$  is less than one. Sunlight is an example of this because 2000 kcal of sunlight are required to make one CE, thus giving sunlight an energy quality factor of 0.0005. Energy quality might also be calculated from the energy needed to develop a flow without waste. Table 1 is a listing of the energy quality factors used in energy flow calculations contained in this dissertation. The reference source explaining the calculations is also given in Table 1.

Economic flows are often expressed as dollar flows. Odum and Odum (1976) calculated the energy basis of the United States for 1973 in terms of the ratio of kcal of coal equivalence to dollars spent. The value was 25,000 kcal/\$ and was used in this dissertation to calculate the contribution of goods and services and fuels to the development.

Tables were prepared showing the main energy flows of man and nature affecting kcal of heat equivalence and kcal of coal equivalence. Coal equivalent flows were obtained by multiplying the energy quality factor times the heat equivalent flows.

### Energy Investment Ratio

Energy investment ratio was defined by Odum and Odum (1976) as the ratio of high quality feedback energy flow investment to lower quality natural energy flow already present where both flows are expressed in kcal of coal equivalents. This theory suggests that

Table 1. Energy quality factors of several ecosystem work processes.

Energy	Coal equivalent factor <sup>a</sup>	Reference source
Sunlight	$5 \times 10^{-4}$	Odum, Kylistra, Alexander and Sipe (1976)
Photosynthetic products (uncollected)	0.05	Ibid.
Winds	0.13	Odum and Brown (1975)
Tides	0.4	Ibid.
Wood (still dispersed)	0.5	Ibid.
Goods	1.0	Ibid.
Fuel	1.0	Ibid.
Electricity	3.6	Ibid.
Food (in supermarket)	24.0	Miller (1975)
Dollar flow, 1973	25,000.0	Odum and Brown (1975)

<sup>a</sup>Coal assembled at its place of use.

systems better able to match the high quality feedback energies with more of the lower quality natural energies can charge lower prices for their exports. If an investment ratio for a system is higher than the ratios for surrounding systems, that system may not be able to successfully compete with the other systems. This theory probably applies only for those economies that have stopped growing. When energy is plentiful, a growing system may be able to out compete other systems even though the growing system has a higher investment ratio. High investment ratios suggest that a region is dependent on large amounts of energy from other areas. A low investment ratio suggests that natural energies account for a significant part of the total energy flow within the system.

Energy investment ratios were calculated for the hypothetical cases involving economic development within a mangrove forest. These results were compared to the average investment ratio for the United States given by Odum and Odum (1976).

#### Field Studies

Data were collected in the field to supply missing information needed for the models and also to validate results of the simulations. Field measurements included tree growth, litter fall, total phosphorus in water and in mangrove wood and leaves, number of live seedlings, number of dead seedlings, number of snails, number of crabholes, number of green leaves on the ground, number of yellow leaves on the ground, and number of seedlings on trees.

### Tree Growth

The growth of mangrove trees was measured at the Naples, Everglades City, and Marco Island study sites. This was accomplished by measuring the changes in trunk diameter over a period of time. At the time of initial diameter measurements the trees were marked with aluminum tags so that future identification would be possible. The usual procedure of measuring tree diameter at breast height (about 1.5 m above the forest floor) was followed for L. racemosa and A. germinans. However, for R. mangle the measurements were made at a level about 15 cm above the highest prop root. The level of the highest prop root was variable and ranged from less than 30 cm to greater than 2 m above the forest floor. Measurements were made with a diameter tape calibrated in metric units for those trees with diameters greater than 4 cm and calipers were used for trees having diameters less than 4 cm. Precision of measurement was to the nearest millimeter with the diameter tape and to the nearest 0.1 millimeter with the calipers. Diameters were measured in January 1973 and February 1974 at the Marco Island site and in September 1973, 1974, and 1976 at the Naples and Everglades City sites.

### Litter Fall

Baskets were placed at both the Naples and Everglades City study sites. Each basket had an area of  $0.25 \text{ m}^2$ . Ten baskets were



placed at each site. All of the baskets used at the Naples study site were initially located on the mangrove island near the Naples sewage treatment plant. Five of these baskets were located on the upstream side of the island close to the point of discharge of sewage effluent into the Gordon River. These remained in place for the duration of the study. The remaining five baskets were located on the downstream side of the island furthest from the discharge of sewage effluent. These baskets were removed after nine months and placed in the control site for the remaining time of the 12-month study. At the Everglades City study site five litter baskets were placed upstream from the point of sewage effluent discharge and five baskets were placed downstream from the point of discharge.

Litter fall was collected from these baskets at 4, 13, 21, 33, 40, 48, and 55 weeks after the baskets had been put out in the study sites in September 1973. Litter from each basket was brought back to the laboratory and separated into leaves, wood and seeds. The separated portions were dried to constant weight at 70°C (usually about 48 hours) and weighed. Rates of leaf, wood and seed fall were expressed in  $\text{g/m}^2 \cdot \text{day}$ .

#### Total Phosphorus in Water Column

Water samples were collected from the Naples and Everglades City sites and analyzed for total phosphorus. The center point of sampling in each case was the sewage effluent discharge point and

other sampling areas were located at increasing distances from this point. Water samples were collected in duplicate at each station in volumes of 25 ml. These samples were then brought to the laboratory for analytical determination of phosphorus. The procedure used follows that outlined by Menzel and Corwin (1965) which involves a molybdenum blue color with spectrophotometer readings at 900 mu using adsorption cells of 4 cm length. The procedure for determining total phosphorus in water is given as Appendix B.

#### Phosphorus in Leaves and Wood

Phosphorus concentration was measured in mangrove leaves and wood using the method for phosphorus determinations in the water column. Leaf and wood samples were collected from the Naples and Everglades City sites, dried, ground, and dissolved in hydrochloric acid prior to analysis for phosphorus.

#### Numbers of Green Leaves, Yellow Leaves, Live Seedlings, Dead Seedlings, Snails, and Crabholes

At the mangrove sites near Marco Island the number of green leaves and yellow leaves on the ground, live seedlings, dead seedlings, snails, and crabholes was determined at the control site, one of the cleared sites, and the three sprayed sites. These parameters were selected because changes in population density could be easily detected by simple measurements.

The initial measurements were made about 1 month after the sites were sprayed with Agent White on December 18, 1972. Subsequent data were collected 5, 8, 12, 20, and 26 months after spraying. The first set of data was collected using a circular hoop to enclose sampling areas of  $0.4 \text{ m}^2$ . All data were collected after that first time in sampling areas enclosed by a circular hoop with an area of  $0.77 \text{ m}^2$ . Ten areas were sampled in each study site and counts were made of each of the above mentioned parameters. These counts were then averaged and divided by the hoop area to give the values on the basis of numbers per  $\text{m}^2$ . The ten areas in each site were selected at approximately 5 m intervals moving in a zigzag manner through the plot. The sampled areas were different for each sampling period.

#### Number of R. mangle Seedlings on Trees

At Naples and Everglades City, the number of R. mangle seedlings on parent trees was measured using the  $0.77 \text{ m}^2$  circular hoop. Only portions of the tree over the waterway were considered in these measurements. This technique was also used in Rookery Bay to obtain seedling data that was applied to the simulation model of Vietnam.

## RESULTS

### Evaluation and Simulation of Models

Three models of mangrove ecosystems are presented with numerical evaluations of the outside energy sources, the compartments, and the pathways. The models were conceived as a means of showing the feasibility of modeling as a descriptive and to some extent, also a predictive tool in the management of mangrove ecosystems. Simulations looked at the effects of herbicides, the effects of hurricanes, the effects of nutrients, and the effects of economic development in mangroves. The results are presented in graphical form as families of curves that hopefully cover the range of conditions that could occur in a mangrove forest affected by management decisions or natural perturbations.

### Model of Herbicides and Mangroves in South Vietnam

Using the symbols described in Appendix A, a model (Figure 4) was constructed showing the relationship between herbicides, wood-cutting, land, mangrove biomass, and mangrove seedlings in the Rung-Sat district of South Vietnam. In the Rung-Sat R. muconata was the dominant species prior to spraying because of its value for charcoal. Therefore, the results of this model apply to this species.

Figure 4. Model of the mangrove ecosystem of the Rung-Sat district of South Vietnam showing the interaction of herbicide, land, mangrove biomass, woodcutters, and mangrove seedlings. The equations describing this model are shown below.

$$\dot{Q}_1 = k_{15}Q_2H - k_{16}Q_1(Q_4 + N)$$

$$Q_2 = A - Q_1$$

where A = total land area

$$\dot{Q}_4 = k_{11}Q_6 - k_{12}Q_4 - k_{13}Q_1Q_4$$

$$\dot{Q}_5 = k_3Q_2Q_R - k_6Q_5 - k_7Q_5 - CQ_5$$

$$\dot{Q}_6 = k_8Q_5 - k_{10}Q_6 - k_9Q_6$$

$$Q_R = J_0 - k_2Q_RQ_2$$

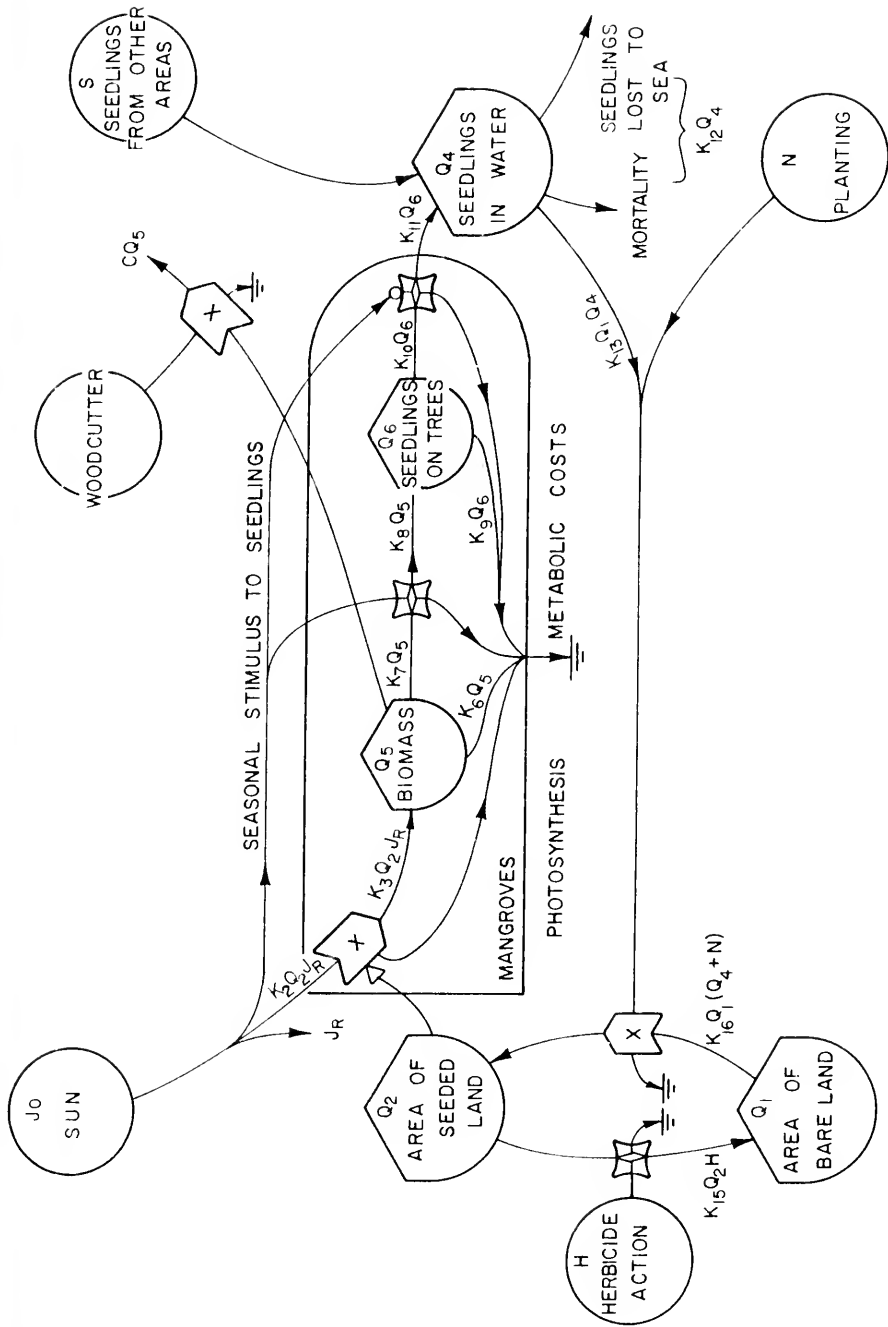

In Figure 4 the sun was an outside driving force that interacted with the amount of land covered by the mangrove trees. In this model the amount of solar energy available to the mangroves was 50% of the incoming solar radiation. Plants utilized the short-wave radiation portion of the energy spectrum in photosynthesis and shortwave radiation accounted for 50% of the total energy in electromagnetic radiation. The flow of the sun-land interaction was the primary production that contributed to measurable aboveground biomass. This pathway of organic matter production flowed into mangrove biomass and increased as more land was colonized by mangroves. The organic matter produced through photosynthesis was used by mangrove vegetation in growth and metabolic activities. Woodcutters once played an important role in the mangrove forests of the Rung-Sat. In the model woodcutters cut mangrove wood at a rate proportional to the amount of mangrove biomass and the number of woodcutters.

The flow of organic matter to the production of mangrove seedlings was simulated as a seasonal occurrence controlled by the sun (see Table C-1 and Figure C-1). The time of the year for seed production and seedfall was taken from Vu Van Cuong (1964). In May of each year a switch in the model was closed and the mangrove trees began to use some of the primary production to grow seedlings on the trees. The number of seedlings growing on that portion of the mangrove tree extending out over the waterway was chosen as a state variable. Growth of seedlings continued until about October when the growth switch was opened and another switch closed and the seedlings began

to fall from the trees. The dropping of seedlings was estimated to take about 60 days. When seedlings fell, some remained beneath the parent tree and the remainder were carried away by the tide. The number washed away varied with the tidal energy and the position of the tide at the time the seedlings fell. In the model seedlings carried by tidal or river currents to other areas were considered a state variable and were labeled as seedlings in the water. Some of these seedlings may eventually colonize an area devoid of mangroves. This process of colonizing was shown as an interaction between seedlings in the water and bare land to give a flow to land covered by mangroves. Seedlings from other areas were shown as a pathway into the storage of seedlings in water.

Extensive spraying with herbicide was shown as an outside driving force acting as a stress to convert land covered by mangroves to bare land because most or all of the mangrove vegetation was killed by the herbicide. Normally, the dead trees would remain standing and decay would gradually occur. However, in the Rung-Sat woodcutters generally harvested the dead trees and hauled them away, thus creating a landscape dotted with tree stumps. A pathway was also put in the model that represented planting of mangroves by man to accelerate the recovery of mangrove trees in the Rung-Sat. Figure 5 is identical to Figure 4 but includes the initial values used for the state variables, outside driving forces, and pathways of the model. The data and calculations are given in Table C-2. The values represent totals for the Rung-Sat. The model and its calibration were done as part of the



Figure 5. Model of the mangrove ecosystem of the Rung-Sat district in South Vietnam with numerical values for the state variables, outside driving forces, and pathways.

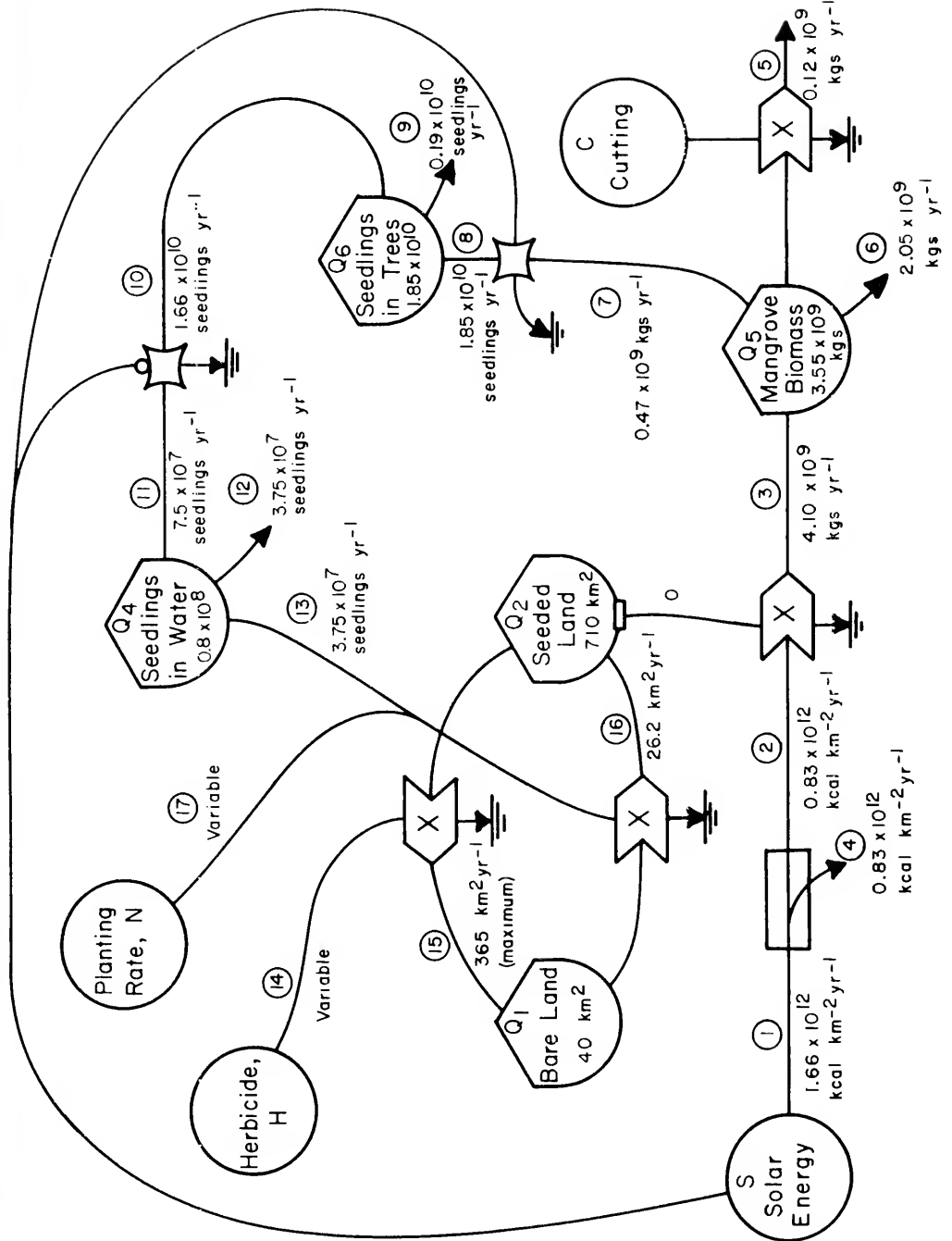

work of the committee contracted by the National Academy of Sciences to study the effect of herbicides in South Vietnam.

At the time this modeling was being done in the summer of 1972, the problem of security made it virtually impossible to obtain the field data in South Vietnam that was necessary for the simulation of this model. Therefore, values were obtained from previous mangrove studies and from the abbreviated field studies.

Mangrove biomass and productivity values needed for the simulation were obtained from research studies by Golley, Odum, and Wilson (1962) in Puerto Rico, since these forests seemed to be similar to the heavily managed Rung-Sat mangrove forests. Solar radiation, sprayed land area, water areas, and seasonal events of seedlings were available for the Rung-Sat district. Number and biomass values for seedlings in trees were measured in Rookery Bay, Florida, for this dissertation. Table C-2 presents the data used to compute the average values used in the herbicide and mangroves model (Figure 4).

The differential equations that describe the model are shown in the legend of Figure 4. The calculations of the rate coefficients are presented in Table C-4. The scaled differential equations are given in Table C-5. The analog circuit diagram for the simulation model is given in Figure C-2. The symbols will not be explained since many analog computer texts are available. Simulations were run on an Electronic Associates, Inc. analog computer, the EAI 680.

The impacts of variations in pathways on the amount of mangrove biomass were simulated. The pathways varied were intensity of

herbicide spraying, productivity, woodcutting rate, seedling availability, and reseeding rate.

#### Intensity of herbicide spraying

The effects of herbicide spraying were simulated using the forcing functions in Figure 6. Five intensities of herbicide spraying were simulated for a five-year period, approximately equivalent to the number of years of extensive spraying of the mangrove forests of South Vietnam (period from 1965 to 1970). Curve A simulated the highest intensity of spraying. At this level the maximum simulated rate of application for a given year was 1.1 million liters with 3.5 million liters over the entire five-year period. Other curves in Figure 6 illustrate lesser intensities of herbicide spraying. The actual amounts of herbicide sprayed on the mangroves in the Rung-Sat during each of the years were calculated and are plotted as circles in Figure 6. The highest actual rate of application for any one year was 1.58 million liters in 1968 and the total sprayed on the Rung-Sat was 3.9 million liters. Although curve A approximates the situation for the Rung-Sat, other curves of Figure 6 may approximate responses of other areas of mangroves in South Vietnam where lower amounts of herbicide were applied.

Figure 6. Variation of simulated herbicide application rates during a five-year period of spraying.

Figure 7. Steady state levels of mangrove biomass attained by the Rung-Sat mangrove forest in South Vietnam at four simulated rates of primary production (initial rate of wood-cutting was  $170 \text{ g/m}^2\cdot\text{year}$  and initial mangrove biomass was  $5000 \text{ g/m}^2$ ).

- A. Gross primary productivity was  $3.5 \text{ g/m}^2\cdot\text{day}$
- B. Gross primary productivity was  $7 \text{ g/m}^2\cdot\text{day}$
- C. Gross primary productivity was  $14 \text{ g/m}^2\cdot\text{day}$
- D. Gross primary productivity was  $19 \text{ g/m}^2\cdot\text{day}$

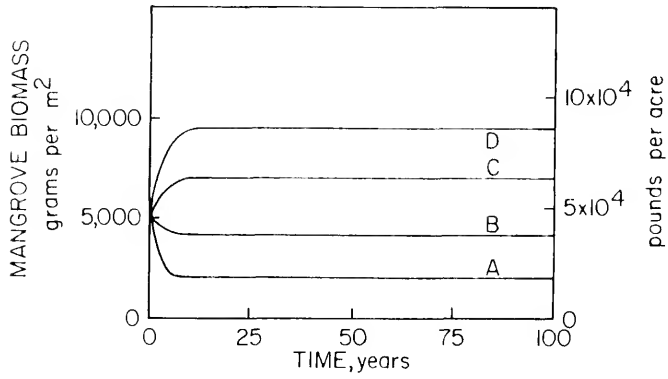
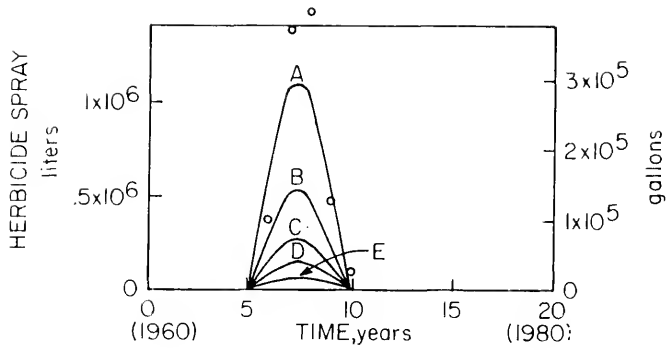

### Steady state levels

Figure 7 shows steady state biomass values attained by the mangroves without spraying and with woodcutters initially harvesting 3% of the primary production per year. Curves are given for four different rates of gross primary productivity (3.5, 7, 14, and 19  $\text{g/m}^2 \cdot \text{day}$ ). From an initial biomass of 5000  $\text{g/m}^2$ , steady state was reached within 12 years for the rates of gross primary productivity used in the simulations.

Figure 8 shows the effect on biomass values of changing the woodcutting rates. In Figure 8a a high rate of primary production was used and curves are given for five woodcutting rates. Without cutting mangrove biomass reached a steady state value of 7200  $\text{g/m}^2$ . Increasing initial cutting rates reduced the steady state biomass values. The highest rate of cutting reduced the biomass value to 1500  $\text{g/m}^2$  (Figure 7a curve E). In Figure 8b a low rate of primary production was used and without cutting biomass decreased to a steady state value of 4000  $\text{g/m}^2$ . The highest cutting rate reduced the steady state mangrove biomass value to 900  $\text{g/m}^2$ . Given in Table 2 are the initial and steady state cutting rates. Note that high cutting at the start was not sustained due to the decline in mangrove biomass.

Figure 8. Simulated effect of woodcutting on the mangrove forest of the Rung-Sat district in South Vietnam; (a) primary production was  $14 \text{ g/m}^2 \cdot \text{day}$ ; (b) primary production was  $7 \text{ g/m}^2 \cdot \text{day}$ .

- A. Initial rate of woodcutting was zero
- B. Initial rate of woodcutting was  $170 \text{ g/m}^2 \cdot \text{year}$
- C. Initial rate of woodcutting was  $1700 \text{ g/m}^2 \cdot \text{year}$
- D. Initial rate of woodcutting was  $3400 \text{ g/m}^2 \cdot \text{year}$
- E. Initial rate of woodcutting was  $17,000 \text{ g/m}^2 \cdot \text{year}$



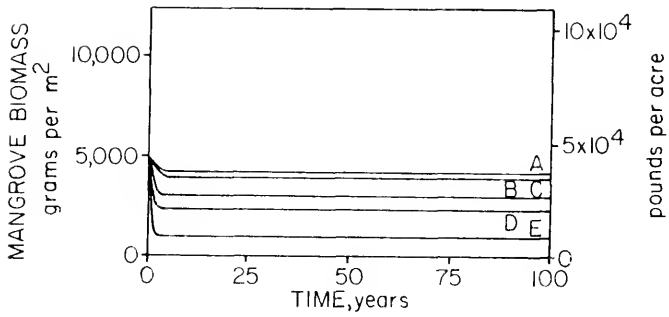
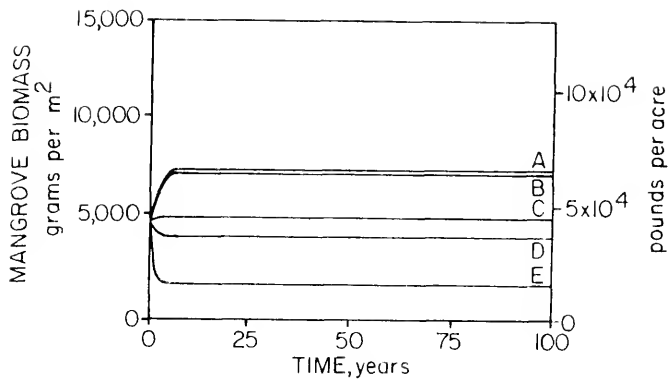

Table 2. Initial and steady state simulated woodcutting rates for the mangrove forest of the Rung-Sat district in South Vietnam at two rates of primary production (Figure 7a and 7b).

	Initial cutting rate, $\text{g/m}^2 \cdot \text{yr}$		Steady state cutting rate, $\text{g/m}^2 \cdot \text{yr}$	
	Productivity of $7 \text{ g/m}^2 \cdot \text{day}$	Productivity of $14 \text{ g/m}^2 \cdot \text{day}$	Productivity of $7 \text{ g/m}^2 \cdot \text{day}$	Productivity of $14 \text{ g/m}^2 \cdot \text{day}$
Curve A	0	0	0	0
Curve B	170	170	130	240
Curve C	1700	1700	1000	1700
Curve D	3400	2300	1500	2700
Curve E	17,000	17,000	3000	5000

### Effects of herbicide spraying

Figures 9, 10, and 11 show the effect of herbicide spraying on mangrove land areas and mangrove biomass at three rates of primary production. These rates were: Figure 9,  $3.5 \text{ g/m}^2 \cdot \text{day}$ ; Figure 10,  $7 \text{ g/m}^2 \cdot \text{day}$ ; Figure 11,  $14 \text{ g/m}^2 \cdot \text{day}$ . As expected, when spraying occurred, land covered with mangroves was converted to bare land. The extent of destruction varied with spraying intensity. With low intensity spraying the amount of bare land produced during five years of spraying was small. Reestablishment of the mangroves on bare land was much more rapid at the less intensive spraying rates and higher rates of primary production. Recovery was extremely slow at high spraying intensity and low primary production.

Figure 9a suggests that when rates of primary production were low, high intensity herbicide spraying (curve F) resulted in almost total devastation of the mangrove land. Ninety years after spraying stopped, 45,000 ha still had not recovered. Figure 10 shows that where mangrove primary production is twice the rate of Figure 9, the maximum spraying rate destroys 90% of the land, but recovery was complete 90 years after the halt of spraying. In Figure 11, primary production was doubled again causing the amount of destruction to remain the same but the speed of recovery was faster. Similar trends were noted for mangrove biomass as shown in Figures 9b, 10b, and 11b. For example, at the highest herbicide spraying intensity, recovery of mangrove biomass at a low primary production rate required more than 100 years (Figure 9b, curve F).

Figure 9. Simulated effect of herbicide spraying on (a) mangrove land and (b) mangrove biomass in the Rung-Sat district in South Vietnam (initial rate of woodcutting was  $170 \cdot \text{g}/\text{m}^2 \cdot \text{year}$  and rate of primary production was  $3.5 \text{ g}/\text{m}^2 \cdot \text{day}$ ).

- A. No spraying
- B. Total herbicide sprayed was  $0.16 \times 10^6$  liters
- C. Total herbicide sprayed was  $0.45 \times 10^6$  liters
- D. Total herbicide sprayed was  $0.89 \times 10^6$  liters
- E. Total herbicide sprayed was  $1.66 \times 10^6$  liters
- F. Total herbicide sprayed was  $3.50 \times 10^6$  liters

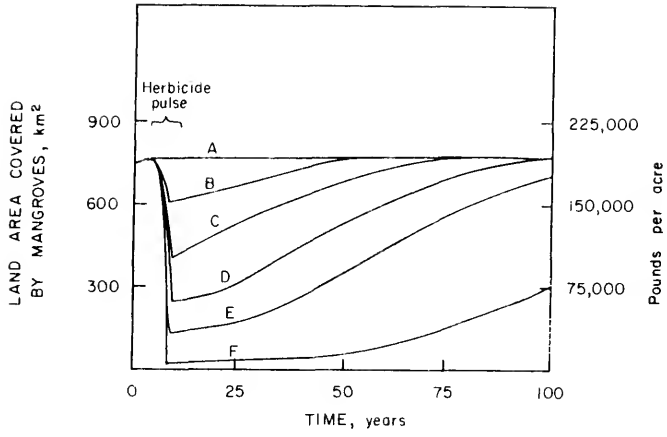

(a)

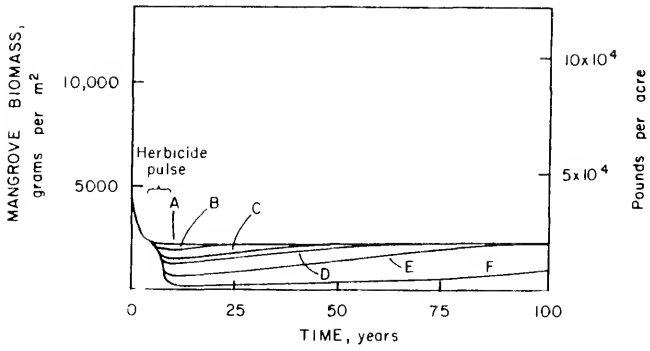

(b)

Figure 10. Simulated effect of herbicide spraying on (a) mangrove land and (b) mangrove biomass in the Rung-Sat district in South Vietnam (initial rate of woodcutting was  $170 \text{ g/m}^2 \cdot \text{year}$  and rate of primary production was  $7 \text{ g/m}^2 \cdot \text{day}$ ).

- A. No spraying
- B. Total herbicide sprayed was  $0.16 \times 10^6$  liters
- C. Total herbicide sprayed was  $0.45 \times 10^6$  liters
- D. Total herbicide sprayed was  $0.89 \times 10^6$  liters
- E. Total herbicide sprayed was  $1.66 \times 10^6$  liters
- F. Total herbicide sprayed was  $3.50 \times 10^6$  liters

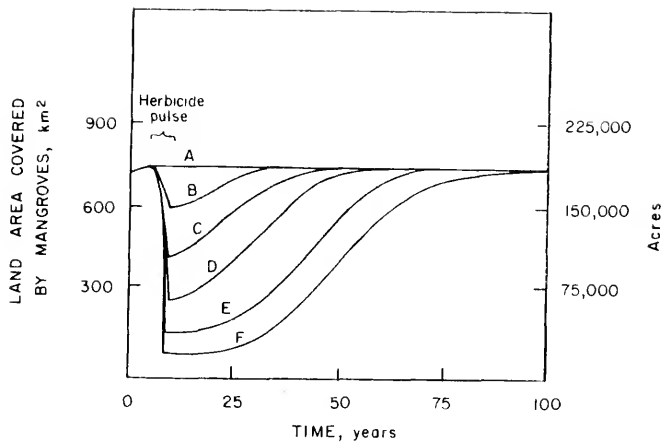

(a)

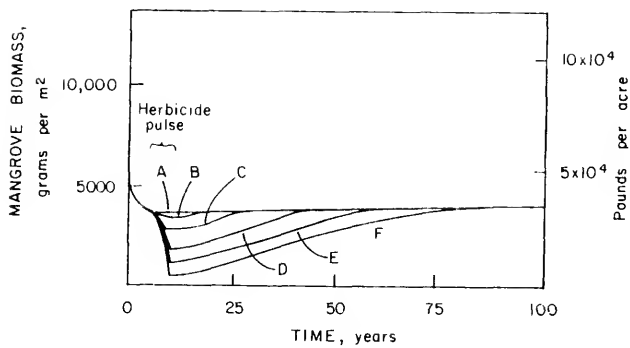

(b)

Figure 11. Simulated effect of herbicide spraying on (a) mangrove land and mangrove biomass in the Rung-Sat district in South Vietnam (initial rate of woodcutting was  $170 \text{ g/m}^2 \cdot \text{year}$  and rate of primary production was  $14 \text{ g/m}^2 \cdot \text{day}$ ).

- A. No spraying
- B. Total herbicide sprayed was  $0.16 \times 10^6$  liters
- C. Total herbicide sprayed was  $0.45 \times 10^6$  liters
- D. Total herbicide sprayed was  $0.89 \times 10^6$  liters
- E. Total herbicide sprayed was  $1.66 \times 10^6$  liters
- F. Total herbicide sprayed was  $3.50 \times 10^6$  liters



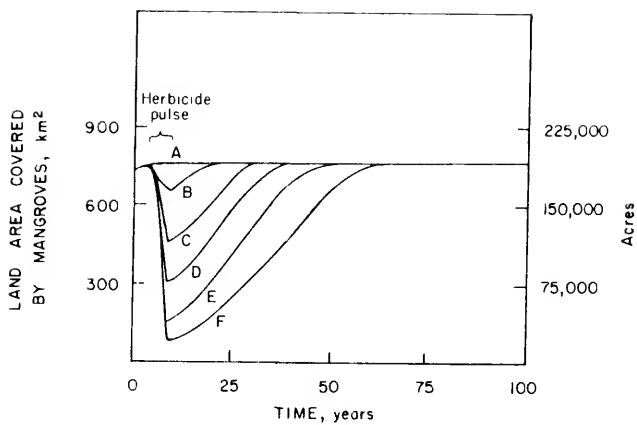

(a)

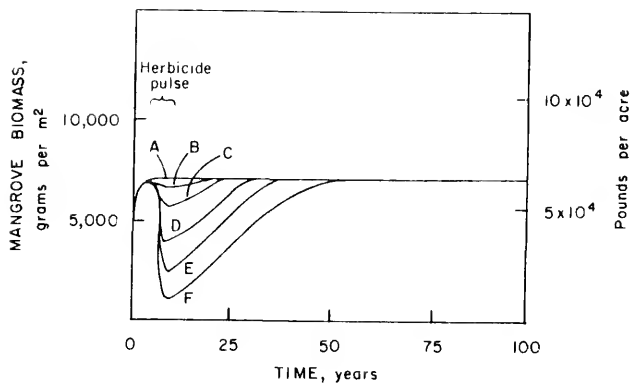

(b)

### Effect of woodcutting

Figure 12 shows the effect of a higher rate at which woodcutters harvest the mangrove trees using a high rate of primary production. The cutting effect on recolonizing the land area was not very large but mangrove biomass was reduced. Mangrove biomass values were lower at steady state and the time to return to steady state after spraying was halted was 20 years longer when woodcutting was increased from 170 to 1700  $\text{g/m}^2\cdot\text{year}$  (Figure 12b, curve F compared with Figure 11b, curve F).

### Effects of seedling availability

Figure 13 shows the effect of seedling availability on the rate of recovery at high intensity herbicide spraying and high rate of primary production. The time required for mangrove recovery was increased as seedlings were made less available during a given year.

Figure 14 shows the effect of artificial planting of seedlings on the recovery of sprayed mangrove land. Given are successful planting rates of 37 and 185 seedlings/ha $\cdot$ year in addition to natural regeneration. As expected, the model indicated that when mangroves were planted the recovery of the mangrove land to its original state was accelerated. Success in planting of mangrove seedlings was estimated to be 10% of the seedlings planted survived the first year after planting.

Figure 12. Simulated effect of herbicide spraying on (a) mangrove land and (b) mangrove biomass in the Rung-Sat district in South Vietnam (initial rate of woodcutting was  $1700 \text{ g/m}^2 \cdot \text{year}$  and rate of primary production was  $14 \text{ g/m}^2 \cdot \text{day}$ ).

- A. No spraying
- B. Total herbicide sprayed was  $0.16 \times 10^6$  liters
- C. Total herbicide sprayed was  $0.45 \times 10^6$  liters
- D. Total herbicide sprayed was  $0.89 \times 10^6$  liters
- E. Total herbicide sprayed was  $1.66 \times 10^6$  liters
- F. Total herbicide sprayed was  $3.50 \times 10^6$  liters

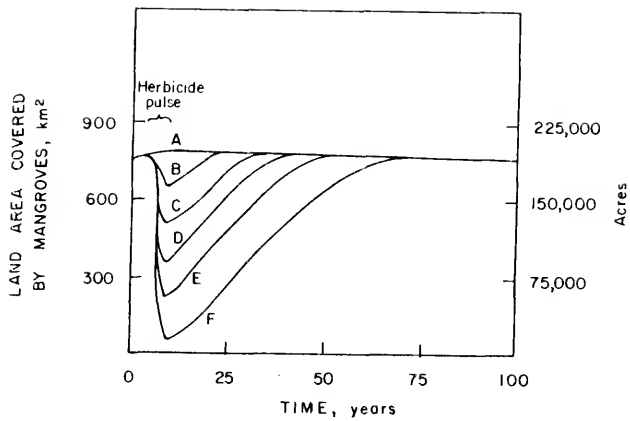

(a)

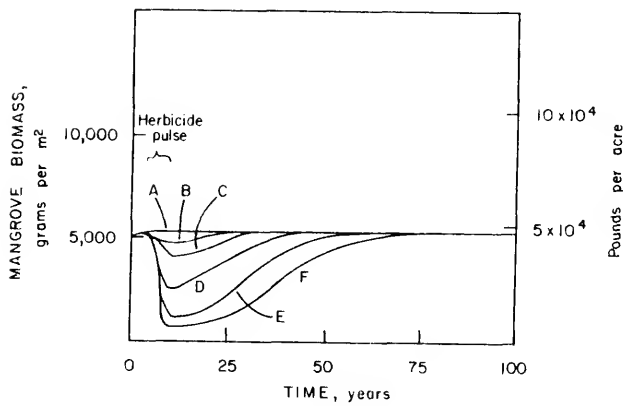

(b)

Figure 13. Simulated effect of seedling availability on the rate of recolonization by the mangroves of the Rung-Sat district in South Vietnam (rate of primary production was  $14 \text{ g/m}^2 \cdot \text{day}$  and total herbicide applied was 3.5 million liters).

- A. Normal seedling availability
- B. Seedling availability reduced 50%
- C. Seedling availability reduced 75%

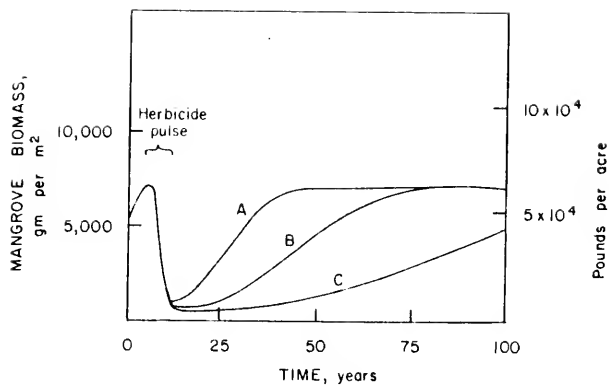

In Figure 14a the recovery time was reduced from 80 to 12 years by using a successful planting rate of 185 seedlings/ha·year. In Figure 14b, recovery time was reduced from 40 to 12 years with a successful planting rate of 185 seedlings/ha·year. In Figure 14c, at an increased woodcutting rate, the recovery time is reduced from 55 to 12 years with a successful planting rate of 185 seedlings/ha·year.

#### Model of Mangroves, Nutrients, and Hurricanes

A simplified model depicting the interactions of a mangrove swamp with tides, nutrients, and hurricanes is given in Figure 15. In the model solar radiation interacts with nutrients and mangrove biomass to produce organic matter for use by the mangrove trees. The rate of gross primary production was expressed in this model in units of  $g\ C/m^2 \cdot year$ .

The organic matter produced is partly respired by the trees and partly stored as biomass in the form of leaves, wood, flowers, seeds, and roots. Some of the biomass is shown depositing on the forest floor as detritus. In the model detritus was generated from mangrove litterfall. Detritus was also affected by export from the forest floor into the estuary due to tidal exchange, by grazing, by decomposition in situ or by accumulation as mangrove peat. Detrital decomposition occurred under both dry and wet conditions. Nitrogen and phosphorus were the nutrients included in the model. The major

Figure 14. Simulated effect of seedling planting by man on the rate of recolonization by the mangroves of the Rung-Sat district in South Vietnam; (a) initial rate of woodcutting was  $170 \text{ g/m}^2 \cdot \text{year}$ , rate of primary production was  $7 \text{ g/m}^2 \cdot \text{day}$  and total herbicide applied was 3.5 million liters; (b) same as (a) except that the rate of primary production was increased to  $14 \text{ g/m}^2 \cdot \text{day}$ ; (c) same as (b) except that the initial rate of woodcutting was increased to  $1700 \text{ g/m}^2 \cdot \text{year}$ .

- A. No planting
- B. Successful planting rate of 37 seedlings/ha·year
- C. Successful planting rate of 185 seedlings/ha·year



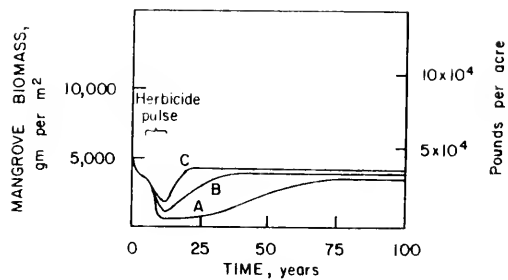

(a)

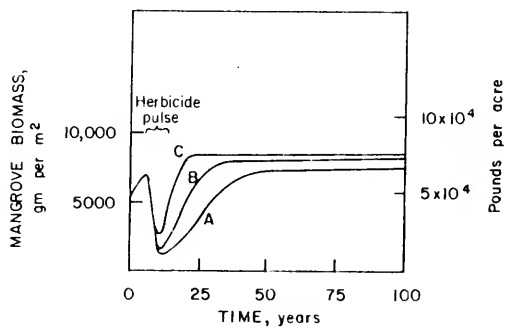

(b)

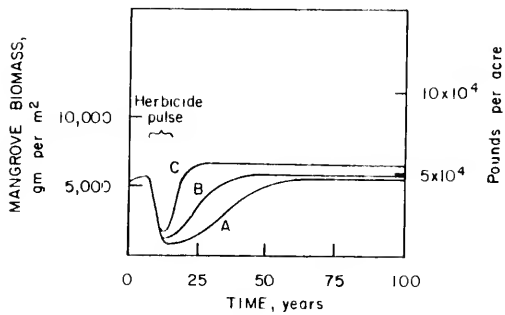

(c)

Figure 15. Simplified model of a mangrove forest in Florida showing the interactions between the forest and nutrients, hurricanes, and tides.

$$\dot{Q}_1 = k_1 I_R Q_1 Q_3 - k_3 Q_1^2 - k_2 Q_1 - k_{11} H Q_1$$

$$\dot{Q}_2 = k_2 Q_1 + k_{11} H Q_1 - k_8 Q_2 - k_6 Q_2 - k_5 Q_2 - k_{12} H Q_2$$

$$\dot{Q}_3 = N + k_6 Q_2 - k_9 Q_3 - k_{10} I_R Q_1 Q_3$$

$$I_R = \frac{I_0}{1 + k_R Q_1 Q_3}$$

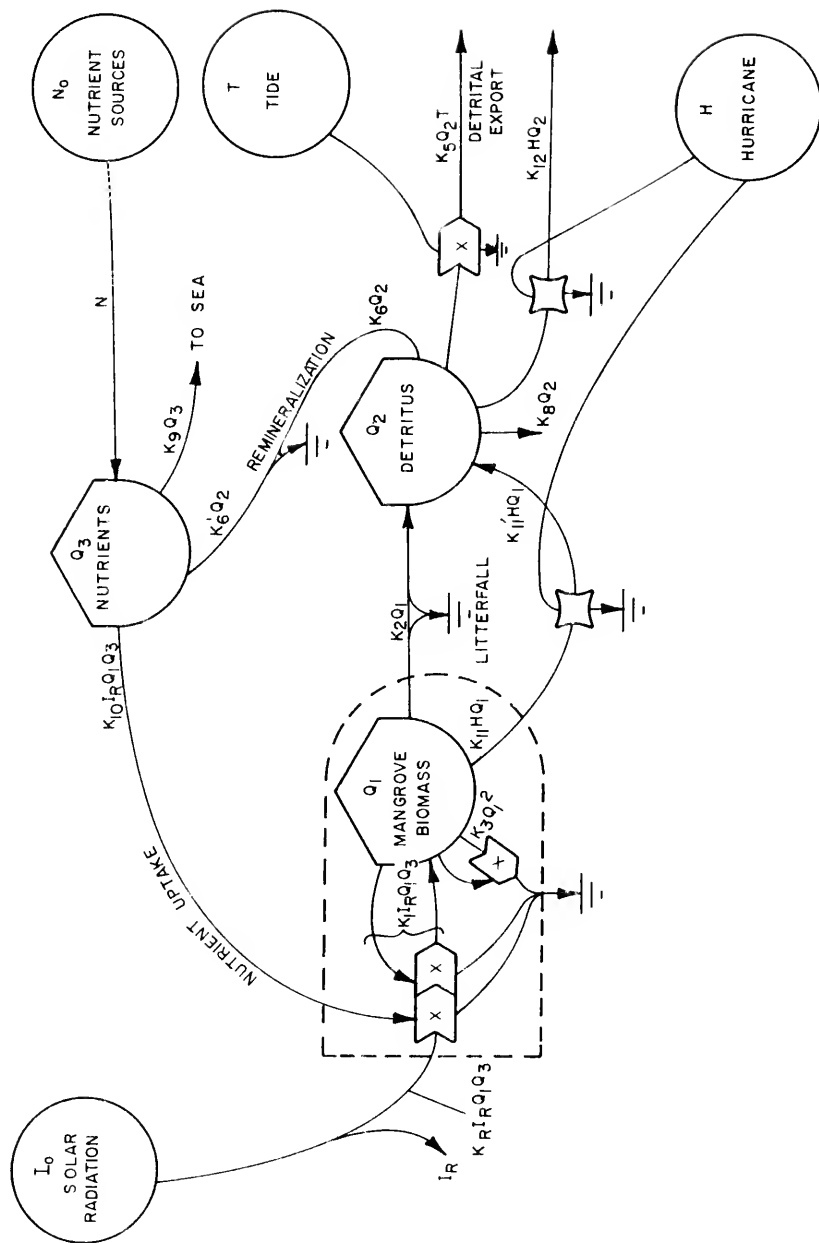

sources of these nutrients are terrestrial runoff, tidal exchanges twice a day, rainfall, and sediments. In the model these sources were all grouped as a single nutrient source. Some of the nutrients were not used by the mangroves because they were quickly bound to the soil either in the mangrove forest or in the open estuary. A portion of the remaining available nutrients was used during photosynthesis.

An important influence on the mangrove forest has been the periodic occurrence of the hurricane which affects the mangrove ecosystem through its often destructive winds and its high wave and tidal energies. High wind speeds strip leaves from the trees and may break or uproot trees. Hurricane tides inundate the prop roots making gas exchange between the root system and the atmosphere impossible and therefore killing the trees. Craighead and Gilbert (1962) reported that the effects of Hurricane Donna on the mangroves of south Florida were variable. In some areas 50-75% of the mature mangroves were killed. A forest that had sprouted in a mangrove area previously devastated by a hurricane in 1935 was wiped out. In the Ten Thousand Islands, the outer mangroves were the most severely damaged by Hurricane Donna. In the model a hurricane pulse was initiated one or more times during the simulation run. The modeled effect of the hurricane was to convert mangrove biomass into detritus and to export detritus into the open estuary.

The mangrove research project of Lugo and Snedaker (1974a) supplied productivity, biomass, and litter fall values. A study by

Carter et al. (1973) supplied some nutrient and detrital export data. The remaining data came from previous mangrove studies in the area. Hurricane information was obtained from the literature and is discussed next.

Malkus and Riehl (1960) gave values for the variation in surface shear stress due to wind speed with distance from the center of a hurricane of moderate intensity (maximum wind speed of 58 m/sec). As the distance from the storm center or "eye" decreased, tangential wind velocity and surface shear stress increased. The relationship between tangential wind velocity and surface shear stress for a moderate storm is given in Figure 16. For an intense storm (maximum wind speed of 90 m/sec) the curve in Figure 16 needed to be extrapolated. For the mangrove model a wind speed of 58 m/sec was used as a threshold level for inflicting significant damage on the mangrove forest. Woodley (1962) reported on damage suffered by forestry plantations in Ireland as a result of high surface winds. Wind speeds of 46 m/sec destroyed from 1-24% of the trees in the plantations. Wind speeds less than 46 m/sec caused very little damage to the trees.

Descriptions and values for the outside driving forces, state variables and pathways of the model in Figure 15 are given in Table D-1. The differential equations are given in the legend for Figure 15. Given in Figure 17 are the numerical values for each driving force, state variable and pathway of the model. The calculation of each rate coefficient is given in Table D-2. The scaled differential equations

Figure 16. Relationship between tangential wind velocity of a hurricane and the surface shear stress that results (Malkus and Riehl, 1960).

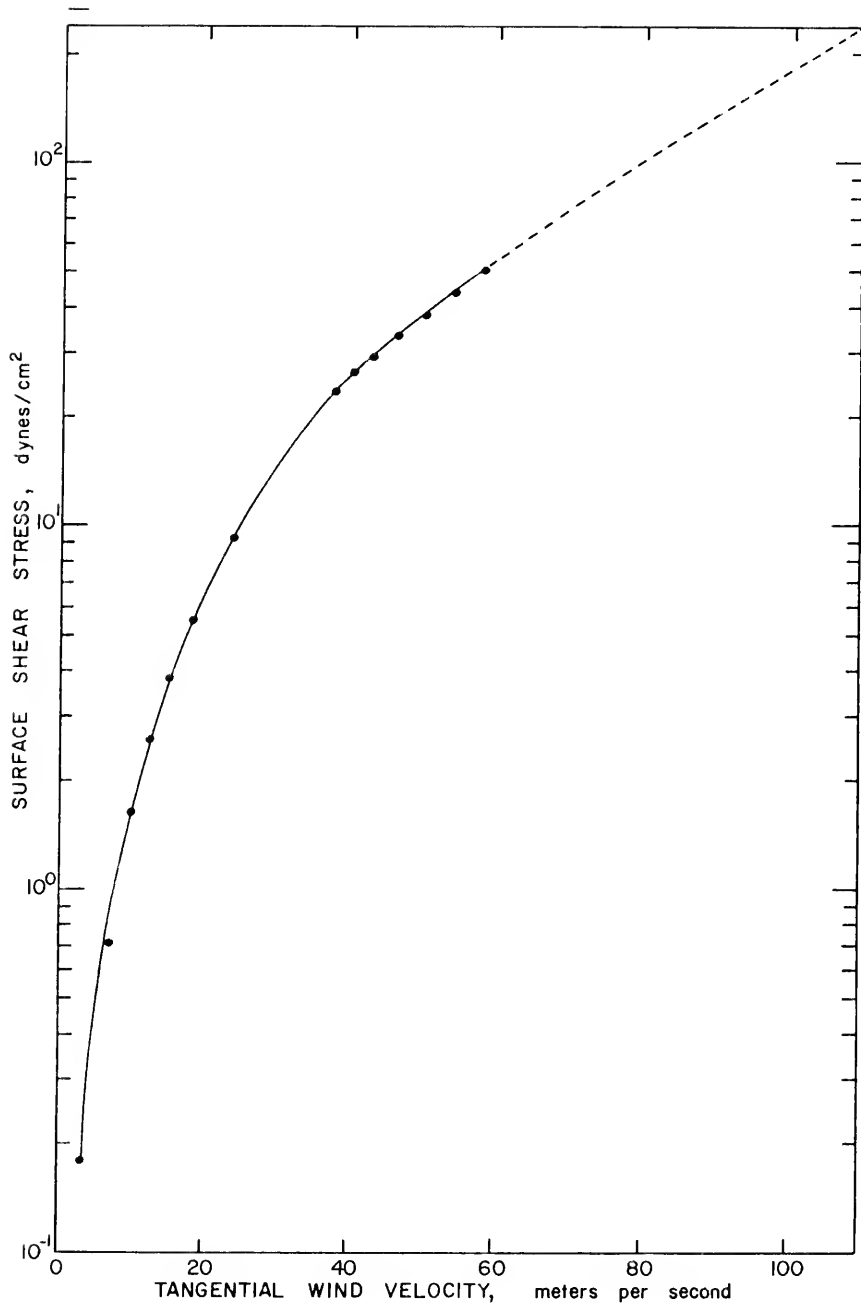
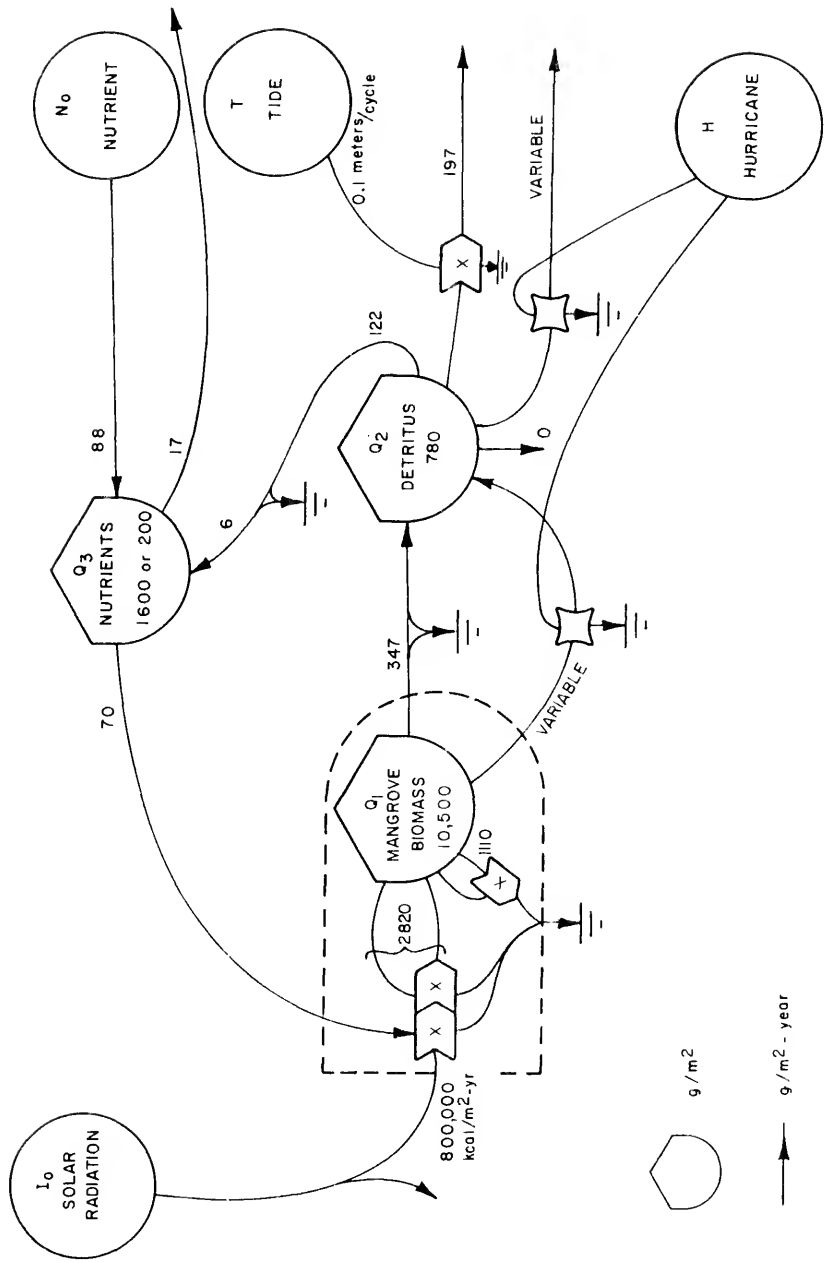

Figure 17. Simplified model of a mangrove forest in Florida showing the values for the driving forces, compartments, and pathways. Compartment values are in  $g\ C/m^2$  except for nutrients and pathway values are in  $g\ C/m^2\text{-year}$  except for nutrients and where noted on the model.





are given in Table D-3. The analog circuit diagram is given in Figure D-1 and simulation runs were made on two Electronic Associates, Inc. Miniac analog computers that were interconnected.

#### Effect of nutrients

Figure 18 shows the effect of altering nutrient flux into the mangrove swamp when soils were high in nutrients and a small amount of nutrients was lost to the sea. As nutrient input due to rainfall, freshwater runoff, and tidal exchange was reduced from the initial rate shown in Curve I, in Figure 18a, b, c, the amount of mangrove biomass (Figure 18a) decreased as did detritus (Figure 18b) and nutrients (Figure 18c).

When the only nutrient input was from rainfall and detrital decomposition, mangrove biomass increased initially, but soon declined sharply to a very low value after 75 years as did detritus and nutrient values.

When the nutrient input was increased to twice the initial rate given by Curve I in Figures 18a, b, c, the effects are given in Curve II. Mangrove biomass (Figure 18a) and detritus (Figure 18b) increased, but only slightly even though nutrients were steadily increasing as shown in Figure 18c.

Figure 19 shows the effect of altering the nutrient flux into the mangrove swamp when soils were low in nutrients and a higher percentage of nutrients was lost to the sea. In Figure 19a, Curve I,

Figure 18. Simulation of the effect of altering the nutrient flux into the mangrove forest when nutrient storage was initially high and runoff to sea was low; (a) nutrient standing crop; (b) detritus standing crop; (c) mangrove biomass.

- Case I - Nutrient flux due to rainfall, tidal exchange and freshwater runoff equals  $87.7 \text{ g/m}^2 \cdot \text{year}$
- Case II - Nutrient flux in case I doubled
- Case III - Nutrient flux in case I decreased by 1/3
- Case IV - Nutrient flux in case I decreased by 2/3
- Case V - Nutrient flux in case I eliminated except for rainfall

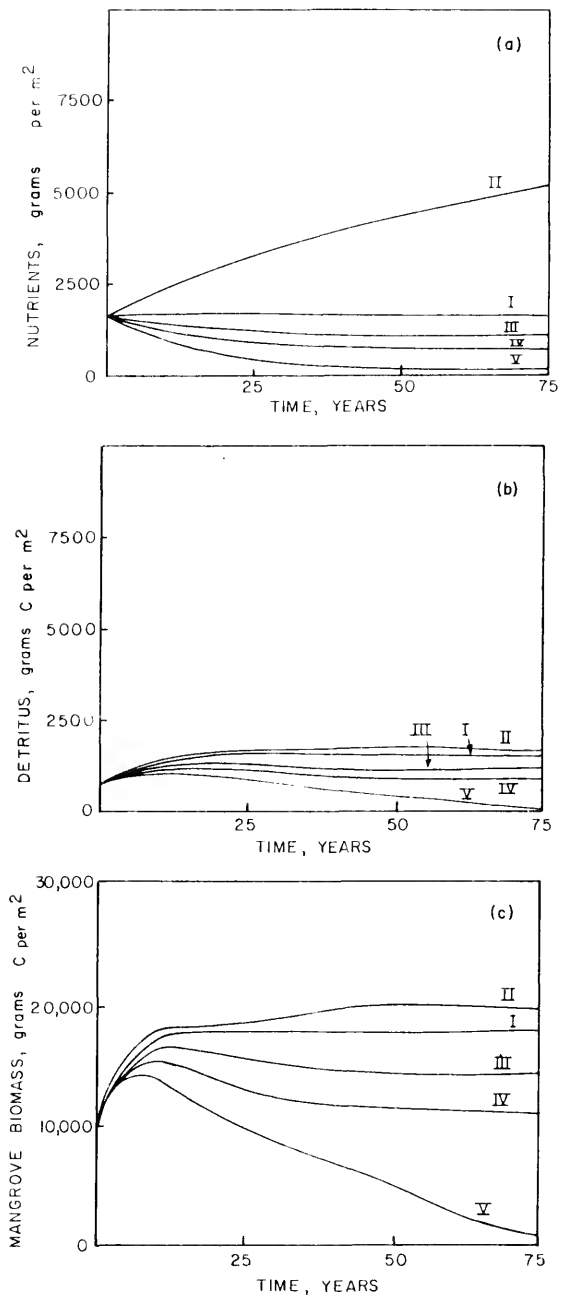
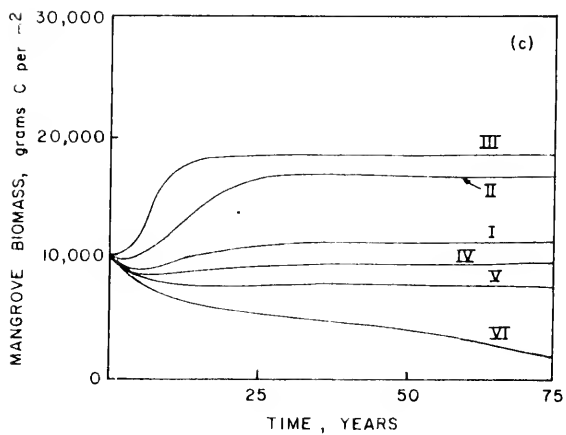
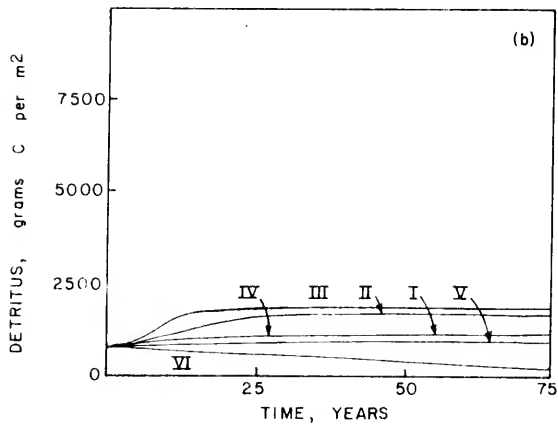
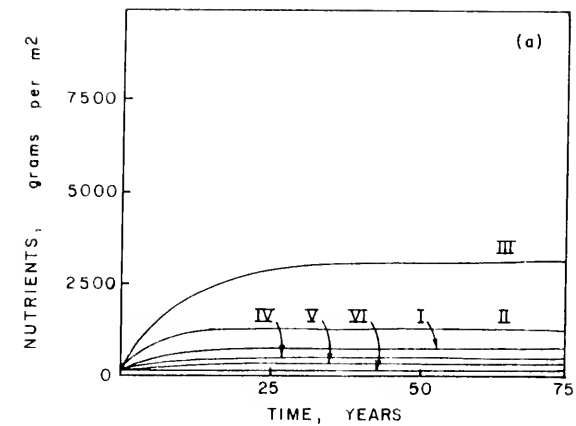

Figure 19. Simulation of the effect of altering the nutrient flux into the mangrove forest when nutrient storage was initially low and runoff to sea was high; (a) nutrient standing crop; (b) detritus standing crop; (c) mangrove biomass.

- Case I - Nutrient flux due to rainfall, tidal exchange, and freshwater runoff equals  $87.7 \text{ g/m}^2\text{-year}$
- Case II - Nutrient flux in case I doubled
- Case III - Nutrient flux in case I increased fourfold
- Case IV - Nutrient flux in case I decreased by  $1/3$
- Case V - Nutrient flux in case I decreased by  $2/3$
- Case VI - Nutrient flux in case I eliminated except for rainfall



mangrove biomass was much lower than that given in Figure 18a, Curve I. Increasing the nutrient flux (Curves II and III) caused a large increase in mangrove biomass (Figure 19a). Detritus and nutrients also increased as shown in Figures 19b and 19c. When nutrient flux was decreased, all of the state variables decreased as shown by Curves IV, V, and VI in Figures 19a, b, c).

#### Effect of tidal flushing

Figures 20 and 21 show the effect of altering the tidal exchange between the mangrove forest and the estuary. In Figure 20, a high initial value of nutrients was used. When no tidal exchange occurred (Figure 20a, Curve I), detritus increased substantially. As the tidal amplitudes were increased, detritus decreased and the rate of detritus export (Figure 20b) increased. The simulation also indicated that mangrove biomass (Figure 20c) increased or decreased slightly as tidal exchange decreased or increased. When the availability of nutrients was low (Figure 21), similar results were obtained although detritus and detritus export were lower, because of lower mangrove biomass.

#### Effect of hurricanes

Figures 22, 23, and 24 simulate the impact of the hurricane on the mangrove forest with high nutrients. In each case hurricanes temporarily lowered mangrove biomass. The effects on detritus were

Figure 20. Simulation of effect of tidal exchange between the estuary and the mangrove forest when nutrient storage was initially high; (a) mangrove biomass; (b) rate of detritus export; (c) detritus standing crop.

Case I - No tidal flooding

Case II - Average flooding depth was 2 cm

Case III - Average flooding depth was 10 cm

Case IV - Average flooding depth was 20 cm

Case V - Average flooding depth was 1 m



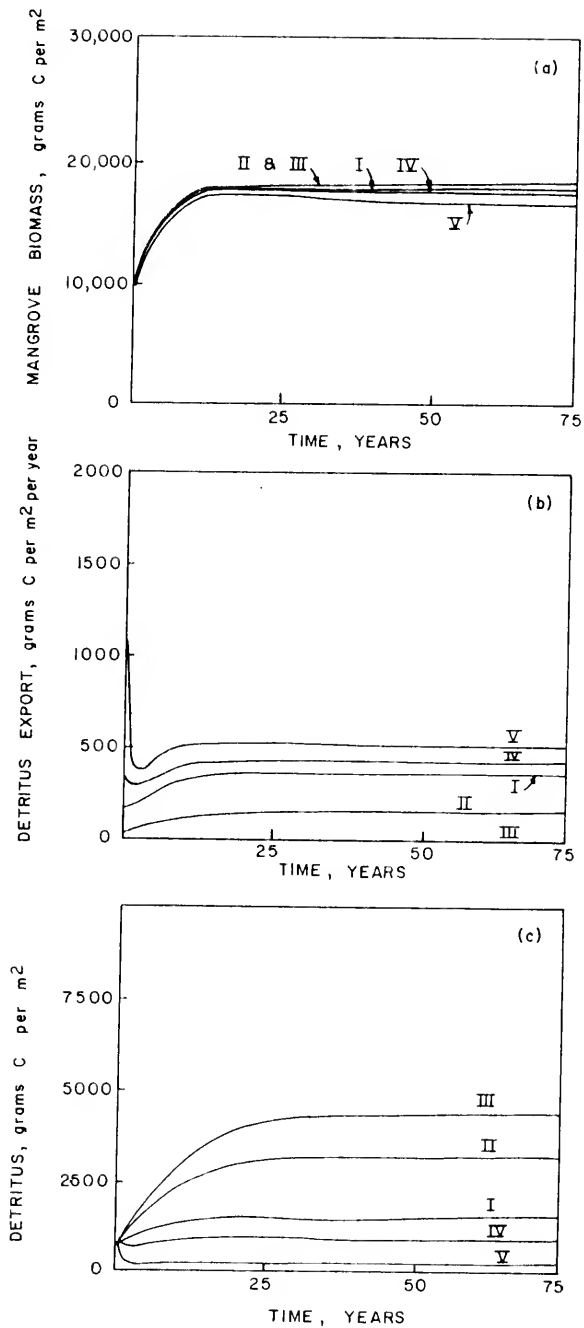

Figure 21. Simulation of the effect of tidal exchange between the estuary and mangrove forest when nutrient storage was initially low; (a) mangrove biomass; (b) rate of detritus export; (c) detritus standing crop.

Case I - No tidal flooding

Case II - Average flooding depth was 2 cm

Case III - Average flooding depth was 10 cm

Case IV - Average flooding depth was 20 cm

Case V - Average flooding depth was 1 m

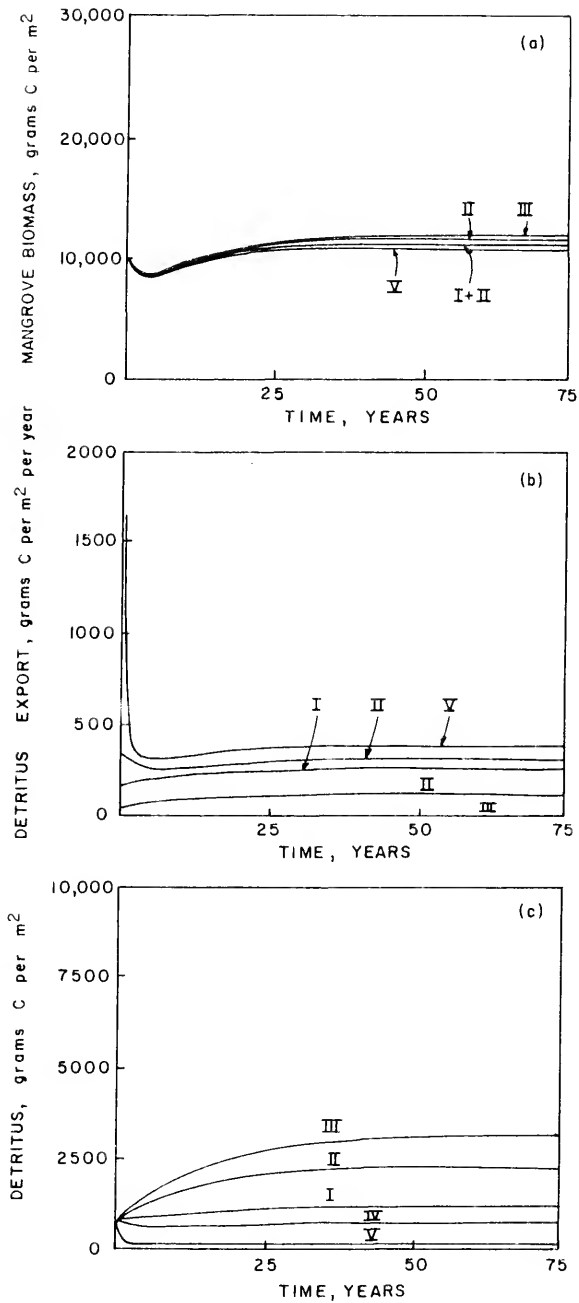

Figure 22. Simulation of effect of hurricane on the mangrove forest when nutrient storage was initially high. Hurricane frequency used in this simulation was at the rate of one every 40 years; (a) rate of detritus export; (b) detritus standing crop; (c) mangrove biomass.

Case I - Moderate hurricane with wind speeds up to 58 m/sec

Case II - Severe hurricane with wind speeds up to 90 m/sec but only moderate tidal damage

Case III - Severe hurricane with wind speeds up to 90 m/sec and severe tidal damage

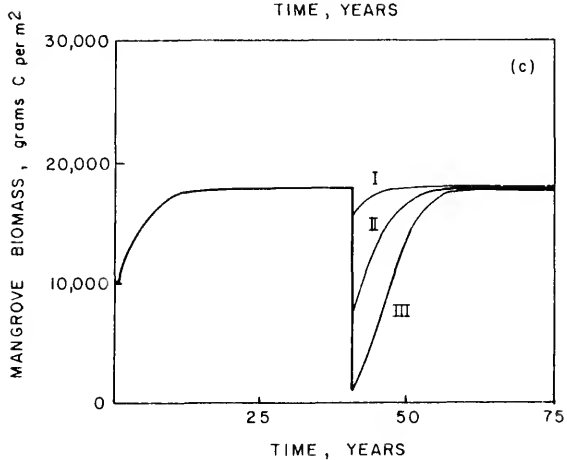
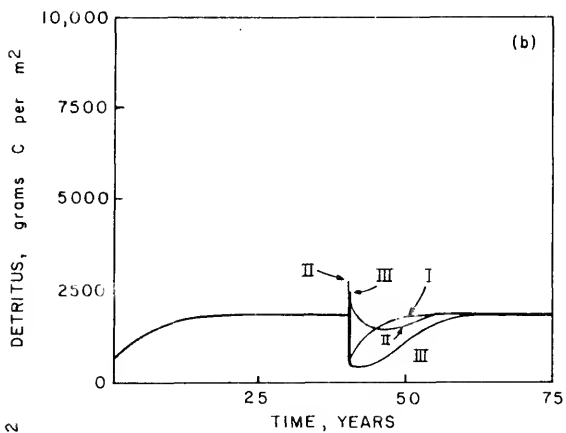
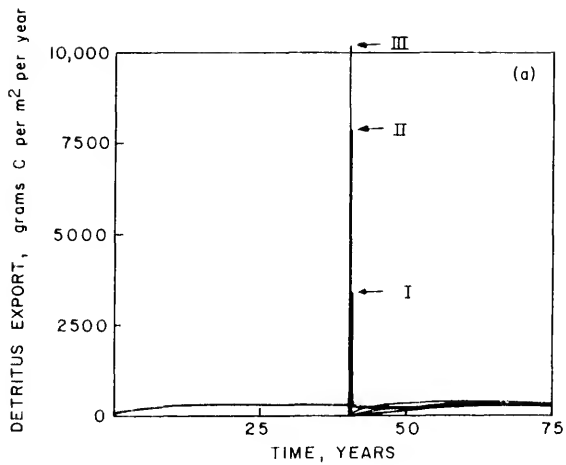

Figure 23. Simulation of effect of hurricane on the mangrove when nutrient storage was initially high. Hurricane frequency used in this simulation was to have a hurricane occur at five years into the simulation and at 32-year intervals after the first hurricane, three storms during the 75-year simulation; (a) rate of detritus export; (b) detritus standing crop; and (c) mangrove biomass.

Case I - Moderate hurricane with wind speeds up to 58 m/sec

Case II - Severe hurricane with wind speeds up to 90 m/sec and moderate tidal damage

Case III - Severe hurricane with wind speeds up to 90 m/sec and severe tidal damage

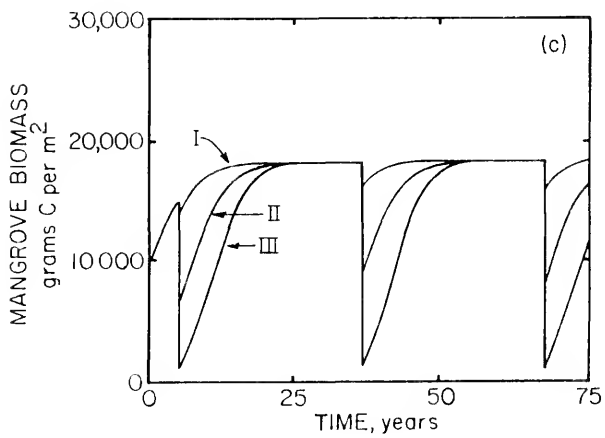
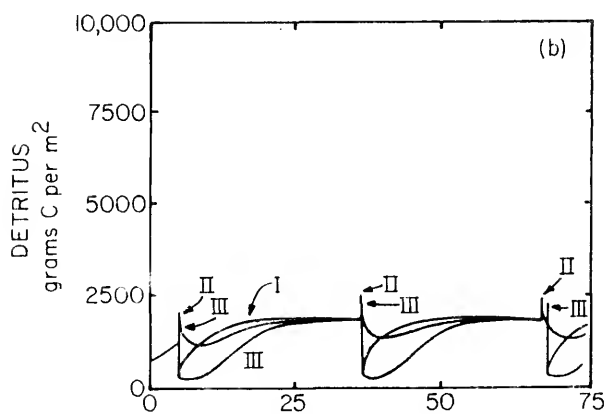
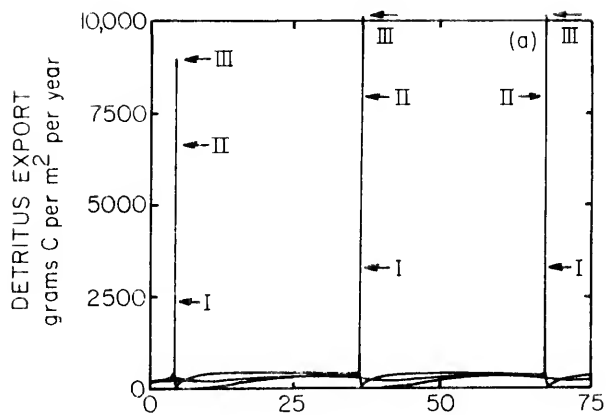
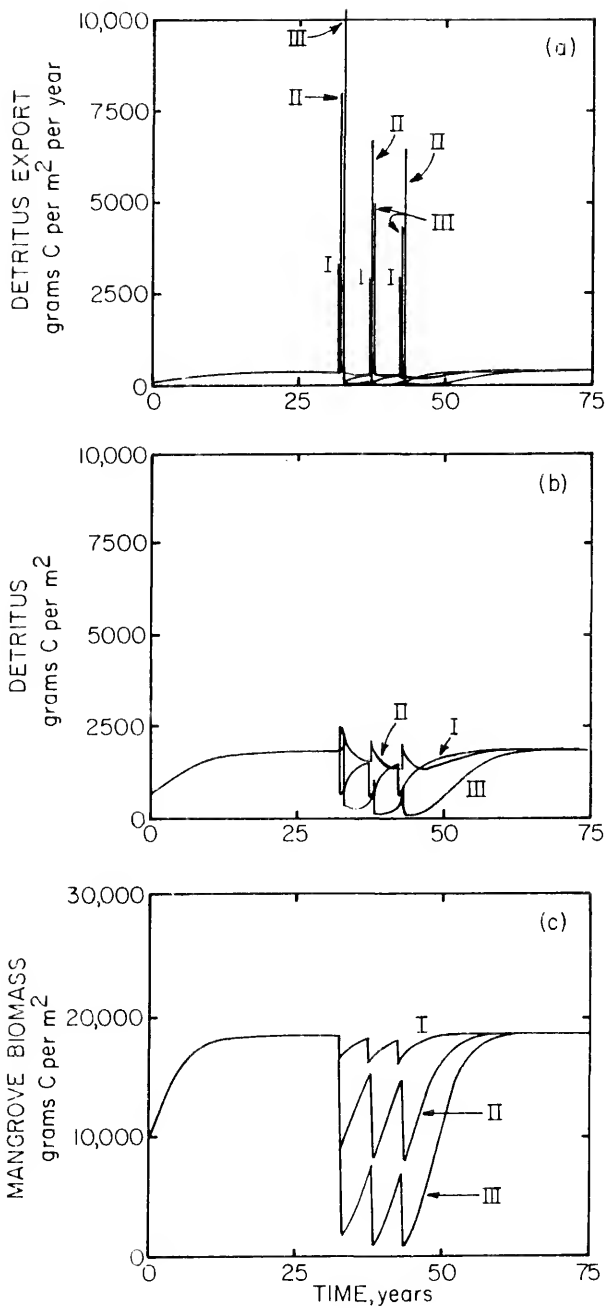

Figure 24. Simulation of the effect of hurricanes on the mangrove forest when nutrient storage was initially high. Hurricane frequency used in this simulation was to have no hurricane until 30 years into the simulation and then 3 hurricanes within 10 years, followed by no damaging hurricanes the rest of the simulation; (a) rate of detritus export; (b) detritus and standing crop; (c) mangrove biomass.

- Case I - Moderate hurricane with wind speeds up to 58 m/sec
- Case II - Severe hurricane with wind speeds up to 90 m/sec and moderate tidal damage
- Case III - Severe hurricane with wind speeds up to 90 m/sec and severe tidal damage





slightly more variable however. The degree of effect on mangrove biomass and detritus depended on the intensity of the hurricane. In Figure 22 only one hurricane occurred during the simulation. As the hurricane intensity was increased, the time required for the mangroves to recover also increased (Figure 22a). In Figure 22b, the nature of the storm affected the amount of detritus. A moderate storm lowered detritus; a moderately severe storm increased detritus abruptly with a slow decrease over time, and a severe storm increased detritus slightly, followed by a sharp instant decrease with slow recovery to steady state. The amount of detritus exported into the estuary during the hurricane increased with increasing severity of the hurricane. Detritus refers to that present on the forest floor when the hurricane occurred and leaves and small branches blown off by hurricane winds. The hurricane effect is shown as a spike about 40 years into the simulation. Export of detritus remained low for many years after the hurricane.

In Figure 23, a hurricane pulse occurred about five years into the simulation and then at 30-year intervals. The first hurricane pulse occurred before steady state was reached but mangrove biomass and detritus were already at steady state when the other simulated hurricanes occurred.

In Figure 24, no hurricane occurred until 30 years into the simulation run when three hurricanes occurred within 10 years. The effect was to keep mangrove biomass (Figure 24a) from reaching steady state but mangrove biomass did return to steady state when no more hurricanes

occurred the next 35 years of the simulation. Detritus (Figure 24b) followed a similar pattern. Detritus export (Figure 24c) was high during a hurricane but the amount decreased with the second and third hurricanes. In fact, the effect of a severe hurricane (Curve III) was to lessen the amount of detritus exported during the latter hurricanes.

Figures 25, 26, and 27 simulate the impact of the hurricane on the mangrove swamp for low nutrients. In Figure 25 one hurricane was initiated during the simulation. As hurricane intensity increased, mangrove biomass (Figure 25a) and detritus (Figure 25b) decreased, while detritus export increased during the hurricane pulse. For the most severe storm export of detritus was zero for some years after the hurricane. Figure 26 has the same hurricane frequencies as Figure 23. The effect of the first hurricane was greater than that of the later hurricane on mangrove biomass and detritus. Detritus export was lower during the first hurricane.

In Figure 27, the hurricane frequency is the same as in Figure 24. Note that for the most severe hurricane (Curve III), mangrove biomass was eliminated after the third hurricane. Mangroves were able to recover from the other less severe hurricane pulses although mangrove biomass, detritus and detritus export were lower during the 10-year period of hurricanes and for many years afterward.

Figure 25. Simulation of effect of hurricanes on the mangrove forest when nutrient storage was initially low. Hurricane frequency of one every 40 years was used in this simulation; (a) detritus export; (b) detritus and standing crop; (c) mangrove biomass.

Case I - Moderate hurricane with wind speeds up to 58 m/sec

Case II - Severe hurricane with wind speeds up to 90 m/sec but only average tidal damage

Case III - Severe hurricane with wind speeds up to 90 m/sec and severe tidal damage

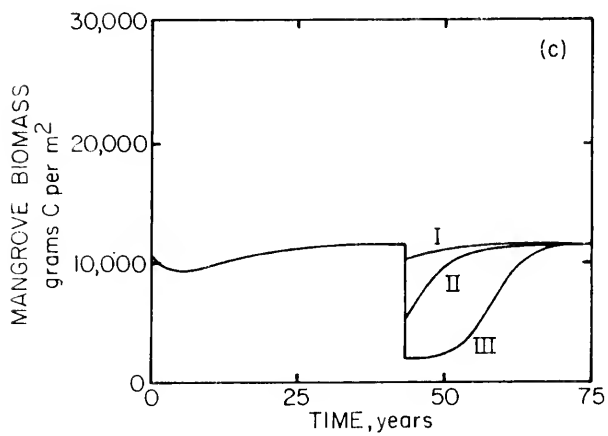
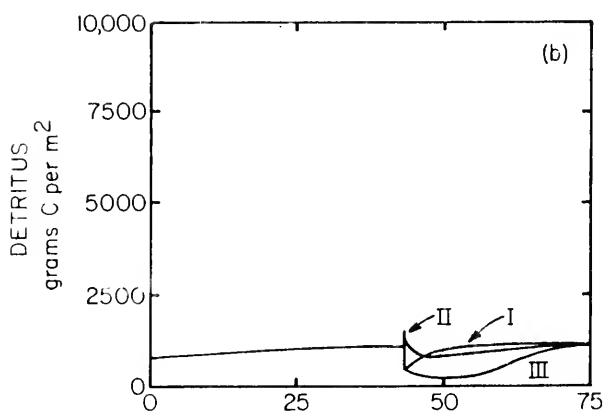
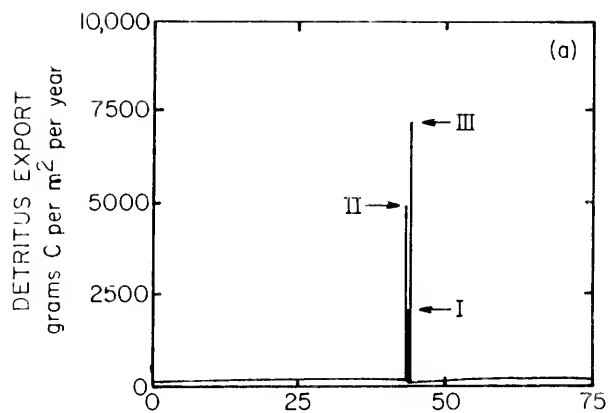

Figure 26. Simulation of effect of hurricane on the mangrove forest when nutrient storage was initially low. Hurricane frequency used in this simulation was to have a hurricane occur at 5 years into the simulation and at 32-year intervals after the first hurricane, three storms during the 75-year simulation; (a) detritus export; (b) detritus and standing crop; and (c) mangrove biomass.

- Case I - Moderate hurricane with wind speeds up to 58 m/sec
- Case II - Severe hurricane with wind speeds up to 90 m/sec but only average tidal damage
- Case III - Severe hurricane with wind speeds up to 90 m/sec and severe tidal damage

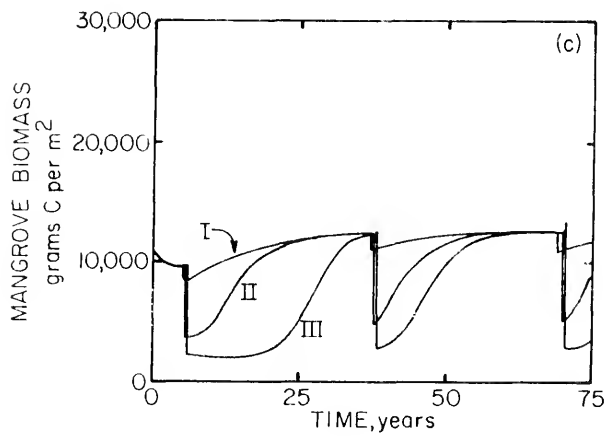
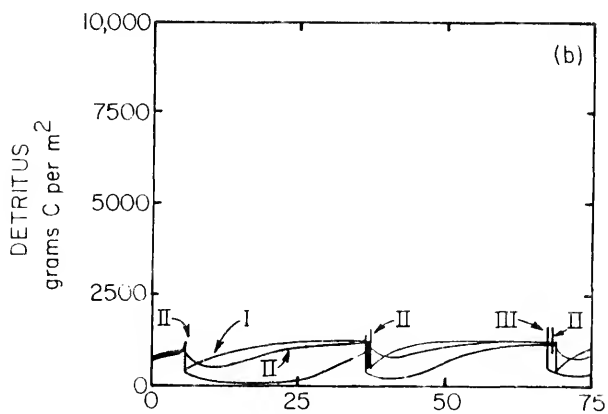
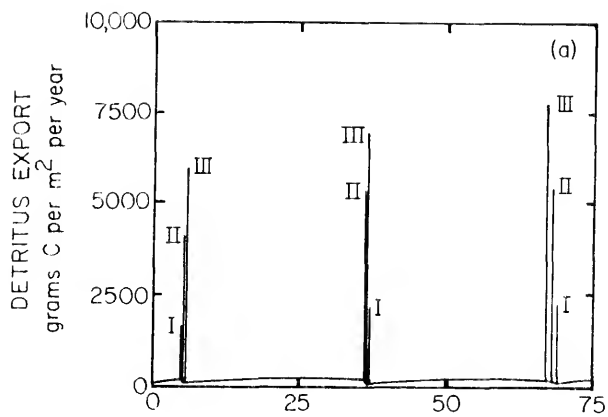

Figure 27. Simulation of the effect of hurricanes on the mangrove forest when nutrient storage was initially low. Hurricane frequency used in this simulation was to have no hurricane until 30 years into the simulation and then 3 hurricanes occur within 10 years, followed by no damaging hurricanes the rest of the simulation; (a) detritus export; (b) detritus and standing crop; (c) mangrove biomass.

Case I - Moderate hurricane with wind speeds up to 58 m/sec

Case II - Severe hurricane with wind speeds up to 90 m/sec but only average tidal damage

Case III - Severe hurricane with wind speeds up to 90 m/sec and severe tidal damage



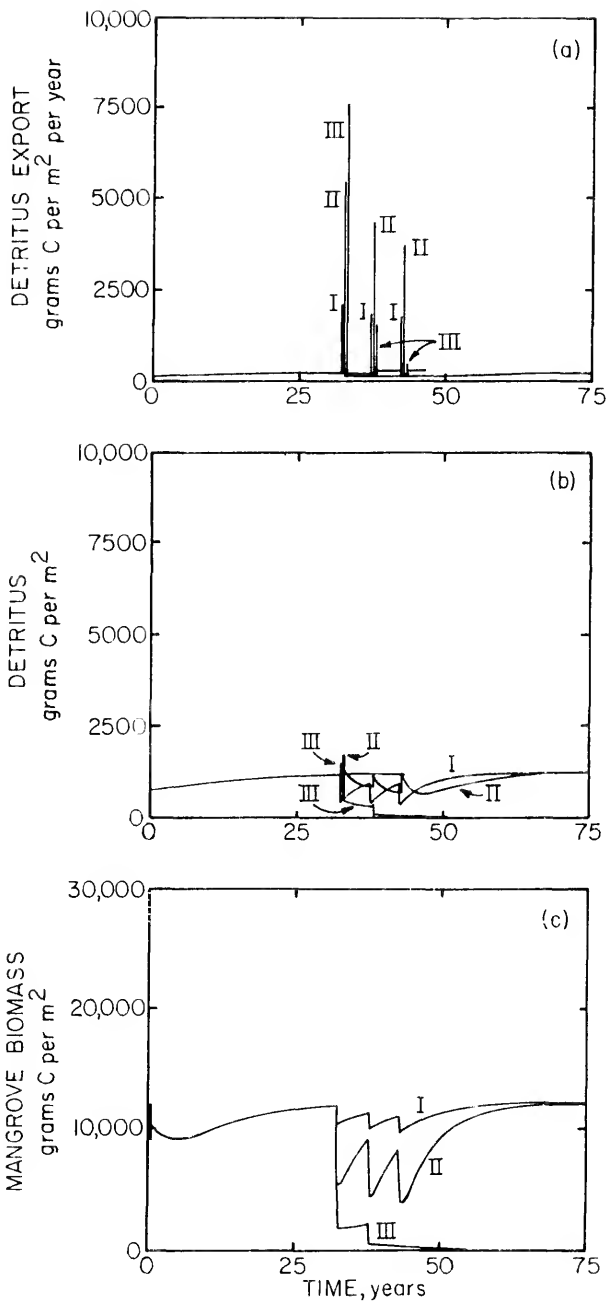

### Model of Mangroves and Economic Development

The model of Figure 28 was conceptualized to help understand the interactions that occur between the energy flows of economic development and the energy flows of the mangrove forest. In this model mangrove biomass was affected by both high and low levels of water. High water levels in the model acted as a stress on mangrove vegetation. Higher than normal levels of tidal flooding would cause the high water levels and this was programmed into the model to represent the storm surge resulting from a hurricane. Hurricane storm surges also stressed the economic structure at high levels of flooding. For the other extreme of low water levels soil salinities increased and reduced the productivity of the mangroves. A threshold of 60 ppt soil salinity was chosen as the value at which a mangrove forest cannot sustain itself. This threshold refers to prolonged exposure of the forest to this soil salinity concentration. Brief exposure to this concentration of salt can probably be tolerated by most mangrove trees. Soil salinities also seemed to play a significant role in mangrove productivity in studies by Carter et al. (1973). Therefore, salinity is shown interacting with solar radiation, mangrove land area, and mangrove biomass to produce a flow of organic matter to the compartment of mangrove biomass. A portion of this organic matter is used in the respiration process.

In addition to the stress of extremely high water levels, the development of economic structure also stresses mangrove biomass by

Figure 28. Model of the interactions between a mangrove forest and economic development within the forest. Differential equations describing the relationships are given below.

$$\dot{Q}_1 = R + W + H - k_1 E - k_2 Q_1$$

$$\dot{Q}_2 = k_3 I - Q_2 Q_3 (0.06 - \frac{S}{Q_1}) - k_5 Q_2^2 - k_6 Q_1 Q_2 - k_7 Q_1 H - k_8 Q_2 Q_5$$

$$\dot{Q}_3 = -k_9 Q_3$$

$$Q_4 = A_T - Q_3$$

$$\dot{Q}_5 = k_{10} Q_2 Q_5 Q_4 P_1 - k_{11} \frac{Q_5}{Q_4} - k_{12} Q_2 Q_5 - k_{13} Q_5^2 - k_{14} Q_1 Q_5 + k_{17} Q_4 L P$$

$$I_R = \frac{I}{1 + k_R Q_2 Q_3 (0.06 - \frac{S}{Q_1})}$$



decreasing the mangrove land area and also simply by the presence of the structure. The remaining mangrove forest may be stressed by a reduction in tidal flushing, increased erosion due to boat traffic, people walking in the mangroves, air pollution, and other stresses brought about by development in a previously undisturbed region.

In this model for a hypothetical coastal development in Florida the natural energy flows of the mangrove ecosystem are shown as providing an attraction that results in the investment of fossil fuel energies for economic development of the region. The attractions would be in the form of aesthetic appeal of the forest, good fishing, and other water related recreational activities. The structure that results from development is affected by depreciation, maintenance, a density-dependent relationship, and a price index. The density-dependent relationship was designed to increase as the amount of structure per unit area increased. This means that high-density development would be more affected by this relationship than low-density development. The price index can be thought of as an economic indicator that affects the flow of goods and services to economic structure. The range of the price index could be from 0 to 1. As this index increased, the flow of purchased goods and services also increased. An increase in the price index in this model meant that the economic system was receiving an increase in purchased goods and services per dollar spent. A decrease in price index meant that more money had to be spent to receive the same amount of goods and services. In addition to the attraction of purchased energies due to the presence of mangrove

vegetation, urban vegetation such as lawns, shrubs, etc. also provided an attractive image for the inflow of purchased energies. The ratio of mangrove productivity to lawn productivity determined the amount of fossil fuel drawn in by each system.

In this model a condominium development at a density of 44 units/ha and a residential finger canal development at a density of 10 units/ha were both considered as the types of development that might occur in a mangrove swamp. The data were taken from several sources because no one study contained all the needed information. The data for the development flows and structures came from calculations by Steller (1976) and Miller (1975). The data for the mangroves and water flows and depth came from Lugo and Snedaker (1974a) and Carter et al. (1973). Several values such as hurricane effects and stress of economic structure on mangroves were estimated.

The differential equations that describe this model are given in Figure 28. The values for the driving forces, compartments, and pathways are given in Figure 29. The calculations for the values in Figure 29 are given in Table G-1. Calculation of the rate equations is given in Table G-2 and the scaled differential equations are given in Table G-3. The model was simulated by connecting two Electronics Associates, Inc. Miniac analog computers. The analog computer circuit diagram for this model is shown in Figure G-1.

The impact was simulated for a period of 75 years. The effect of changing investment ratios and hurricane frequency and intensity was also simulated.

Figure 29. Model of the interactions between a mangrove forest and economic development. Values are given for the driving forces, storage compartments, and pathways. Storages are  $\text{g}/\text{m}^2$  for water and salt,  $\text{kcal}/\text{m}^2$  for developed structure and mangrove biomass, and hectares for land. Sunlight is in  $\text{kcal}/\text{m}^2\text{-yr}$ . Flows are per year and all values are times  $10^{10}$  except where noted on the model.

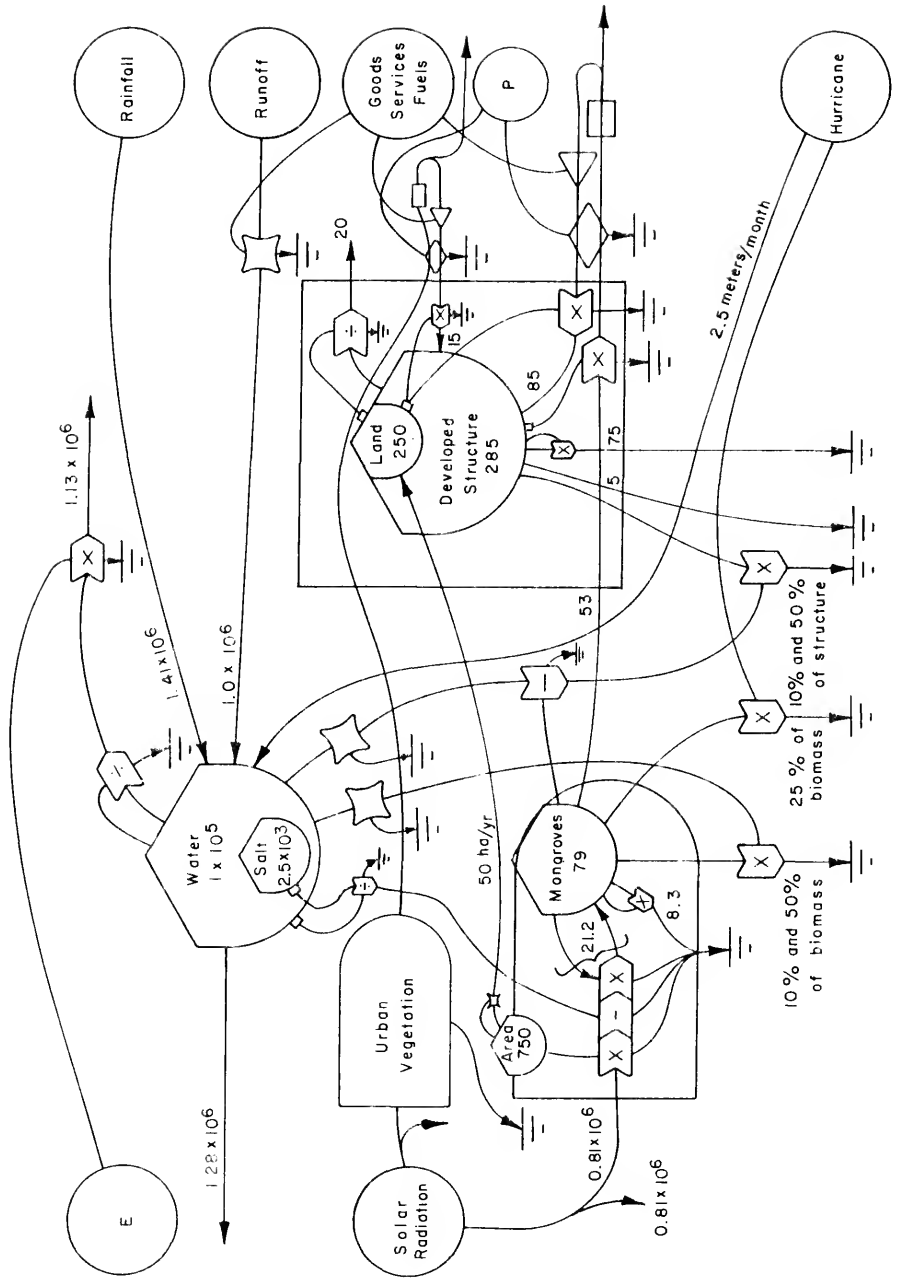



### Effect of land development

Figure 30 shows the relationship between mangrove biomass and economic structure as mangrove land is developed. In Figure 30a mangrove biomass became increasingly lower as more and more mangrove land was cleared for condominium development. Figure 30c shows a similar pattern for residential finger canal development. Figure 30b shows that the steady state value for condominium structure was highest if development stopped after 50% of the mangrove land was cleared. Higher percentages of land development resulted in a sharp initial increase in condominium structure followed by a decline to steady state values lower than the values reached if only 50% of the land were cleared. Figure 30d shows a similar pattern for residential finger canal development.

Figure 31 shows the relationship between mangrove productivity, lawn productivity and the fossil fuel energy flows. In Figure 31a, the fossil fuel energy flow due to the attraction of lawn productivity in a condominium increased as the amount of land developed was increased. Figure 31b shows that the fossil fuel energy flow due to the attraction of mangrove productivity reached its highest steady state value if only 50% of the mangrove land is cleared. The development of all the mangrove land eventually resulted in the elimination of those fossil fuel energy flows originally attracted by the mangrove forest. Similar patterns are shown in Figures 31d and e for residential finger canal development. For both types of development, the total mangrove productivity declined as more and more land was cleared.

Figure 30. Simulation of the impact of the amount of land development on mangrove forest biomass and economic structure; (a) mangrove biomass adjacent to condominium development; (b) economic structure in a condominium development; (c) mangrove biomass adjacent to residential finger canal development (d) economic structure in a residential finger canal development.

- Case I - 15% development
- Case II - 25% development
- Case III - 50% development
- Case IV - 75% development
- Case V - 100% development

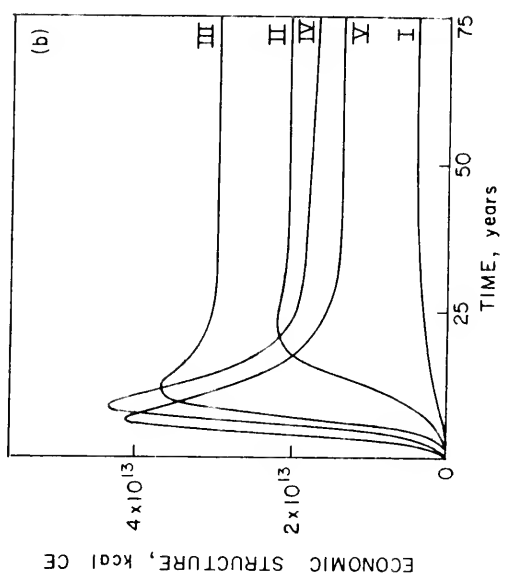
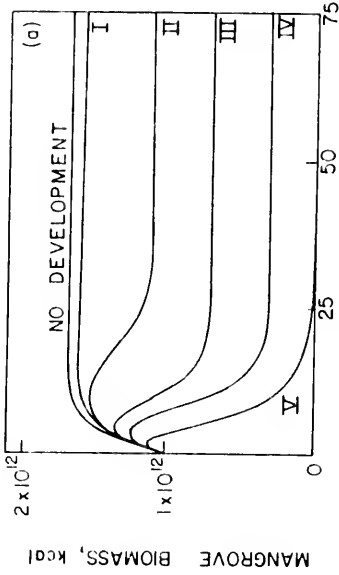
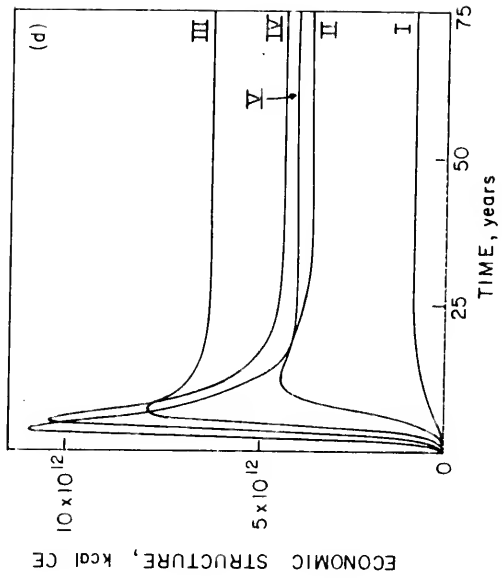
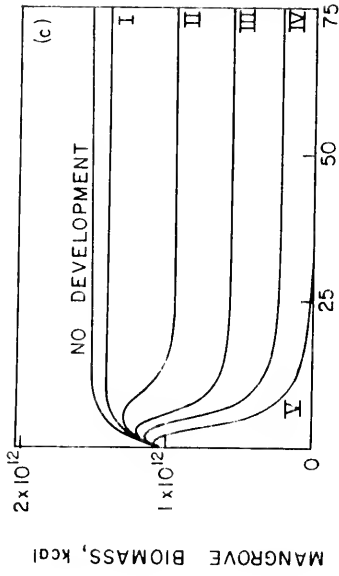
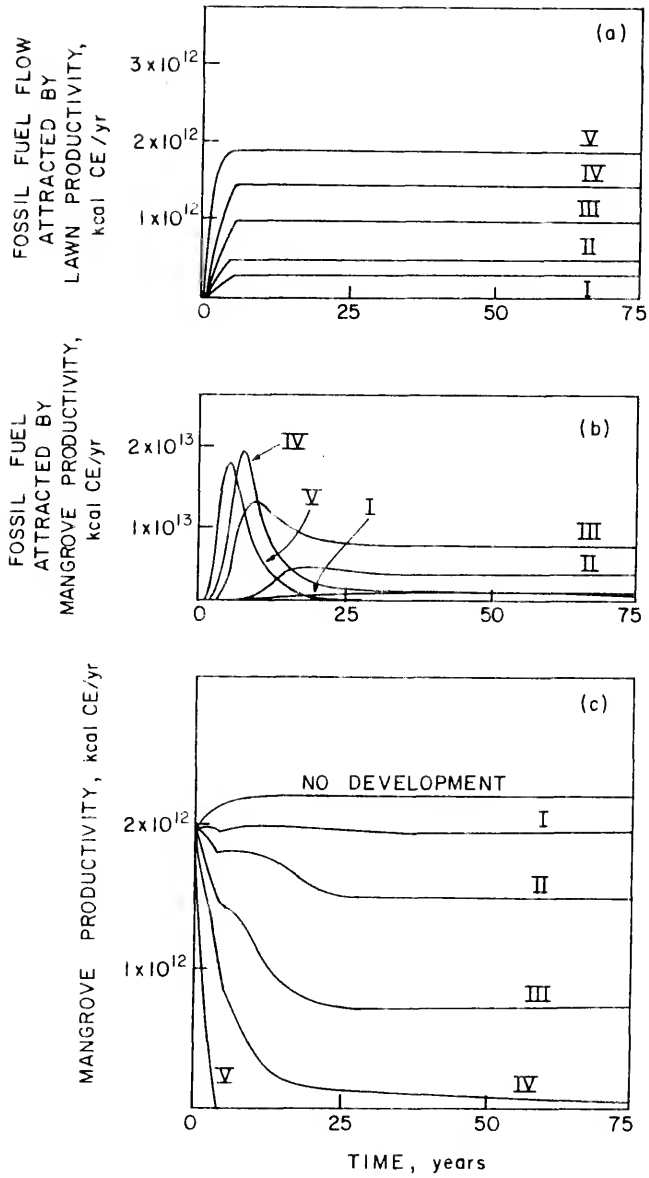

Figure 31. Simulation of the impact of economic development on mangrove productivity and flow of goods and services; (a) energy flow of goods and services attracted by open space vegetation in condominium development; (b) energy flow of goods and services attracted by mangrove productivity adjacent to condominium development; (c) mangrove productivity adjacent to condominium development; (d) same as (a) for residential finger canal development; (e) same as (b) for residential finger canal development; (f) same as (c) for residential finger canal development.

- Case I - 15% development
- Case II - 25% development
- Case III - 50% development
- Case IV - 75% development
- Case V - 100% development



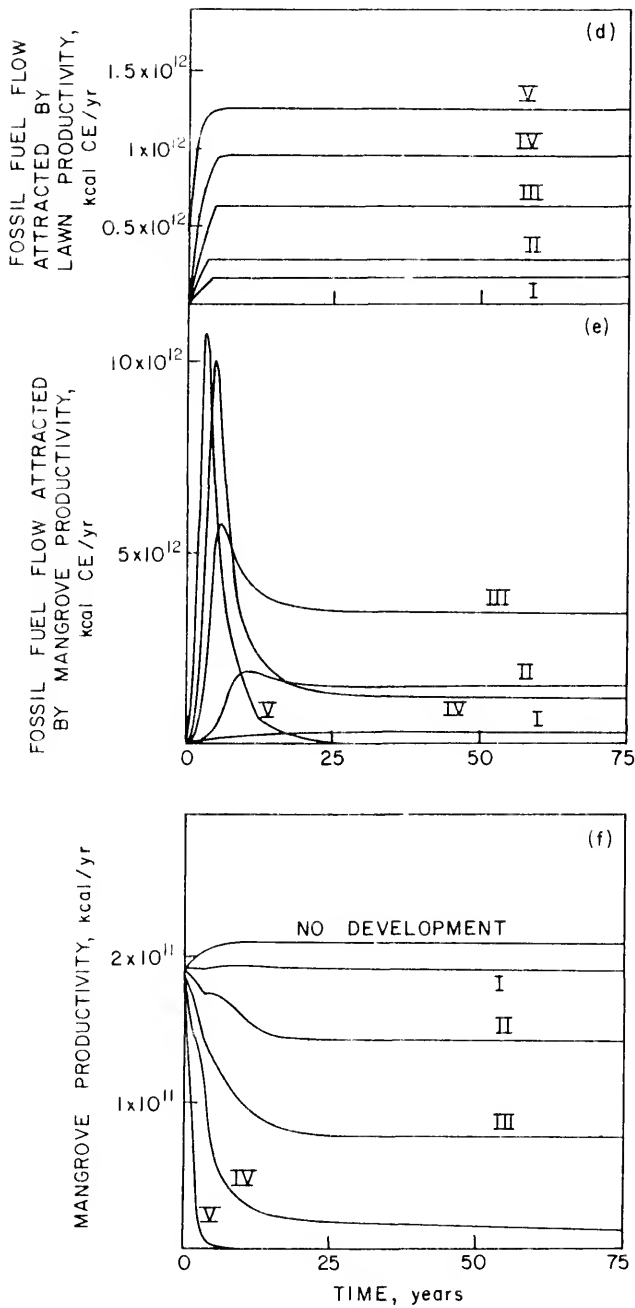

Figure 31 (continued)

### Effect of changing price index

Figure 32 shows the relationship between economic development and the price index. In the model a decreasing price index was represented by an exponential decline from an initial value of 0.5 down to 0.1 after 50 years and then remained constant. An increasing price index was represented by a charge-up curve that went from an initial value of 0.5 up to 1.0 after 50 years and then remained constant. For the third case the price index was held constant at 0.5. In Figure 32a, development was in the form of residential finger canal estates on 25% of the land. As the price index increased or decreased, the steady state value for economic structure also increased or decreased. A similar pattern was observed for condominium development on 25% of the land. When 50% of the land was developed either as condominiums or residential finger canal estates, increasing the price index caused only a slight increase in economic structure but a decreasing price index substantially reduced economic structure.

### Effect of hurricanes on development

Figures 33 and 34 show the impact of one hurricane on mangrove biomass and economic structure. In Figure 33, the curves illustrate possible results if the economic structure were situated behind the remaining mangrove forest. As the storm intensity increased, more mangrove forest was eliminated. The direct damage to economic structure was negligible for the moderate hurricane but about 40% of the

Figure 32. Simulation of the impact of changing the price index on economic structure; (a) 25% of land developed as condominiums; (b) 50% of land developed as condominiums; (c) 25% of land developed as finger canal estates; (d) 50% of land developed as residential finger canal estates.

Case I - price index remained constant

Case II - price index gradually increased to twice the initial value after 50 years and then remained constant

Case III - price index gradually decreased to 20% of the initial value after 50 years and then remained constant



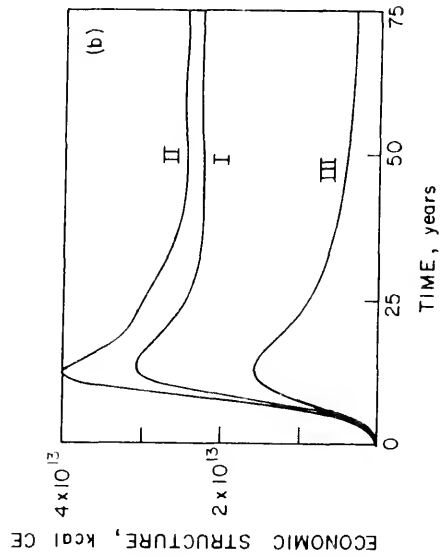
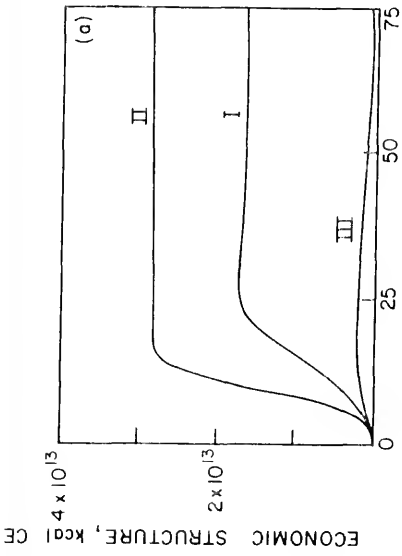
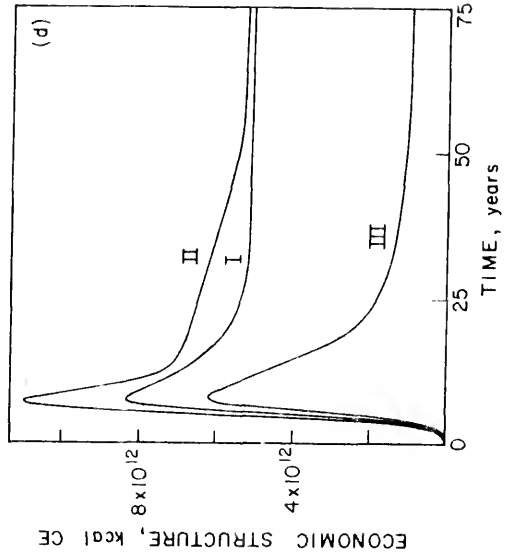
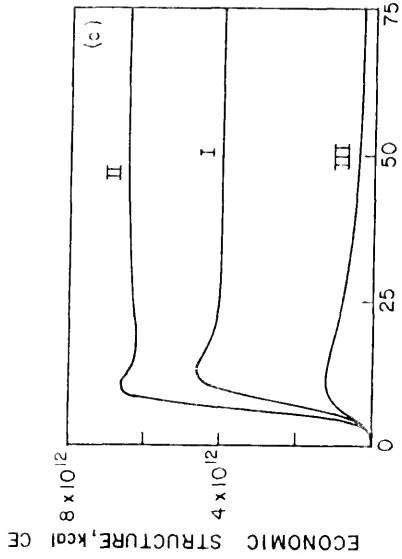

Figure 33. Simulation of the impact of one hurricane on mangrove biomass and economic structure; (a) mangrove biomass adjacent to condominium development; (b) economic structure of condominium development; (c) mangrove biomass adjacent to residential finger canal development; (d) economic structure of residential finger canal development.

Case - Mangrove swamp affected by hurricane winds and light damage due to storm surge. No damage to economic structure from hurricane.

Case II - Mangrove swamp severely affected by winds and storm surge with moderate damage to economic structure.

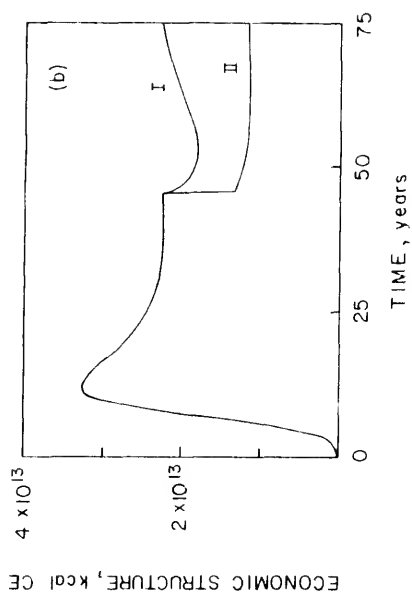
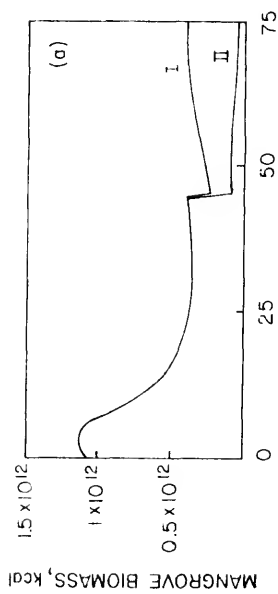
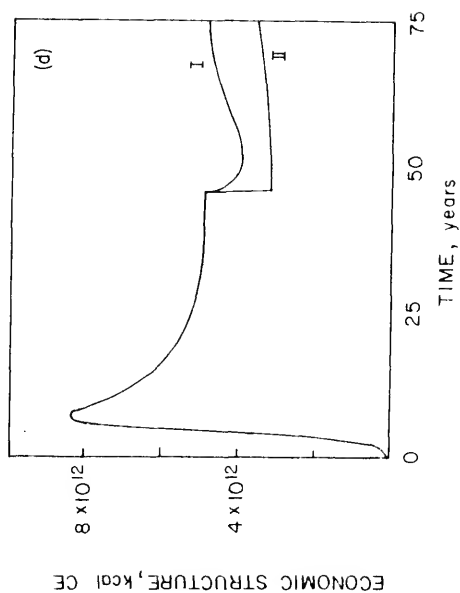
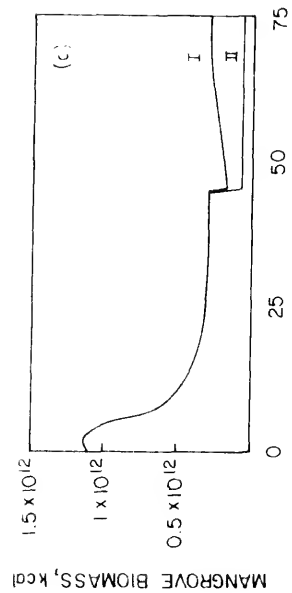
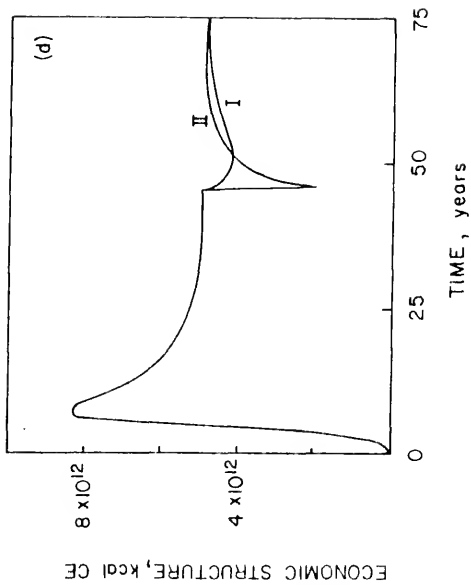
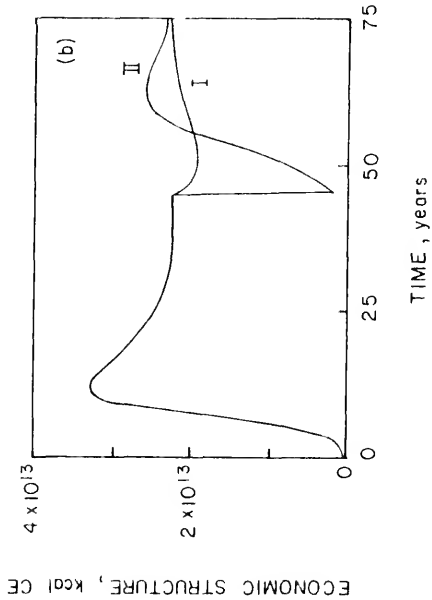
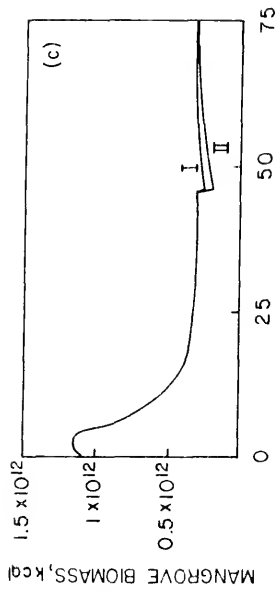
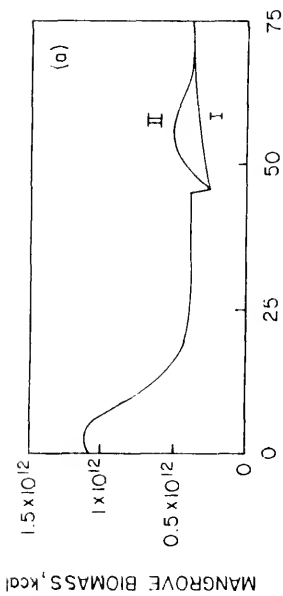

Figure 34. Simulation of the impact of one hurricane on mangrove biomass and economic structure; (a) mangrove biomass adjacent to condominium development; (b) economic structure of condominium development; (c) mangrove biomass adjacent to residential finger canal development; (d) economic structure of residential finger canal development.

Case I - Mangrove swamp affected only by hurricane winds, no effect of storm surge on economic structure.

Case II - Mangrove swamps affected only by hurricane winds and heavy damage to economic structure from storm surge.



structure was affected by the severe hurricane. For a moderate hurricane, recovery of mangrove biomass and economic structure to pre-hurricane steady state values required about 30 years. The severe hurricane reduced mangrove biomass to such a low value that recovery to pre-hurricane values was not occurring. Economic structure followed a similar pattern. In Figure 34, the curves illustrate possible results if the economic structure were situated in front of the remaining mangrove forest. A moderate hurricane caused some direct damage to the mangrove forest but no direct damage to economic structure. This caused a gradual decline in economic structure followed by a return to pre-hurricane values. A severe hurricane substantially reduced economic structure but recovery was rapid. Mangrove biomass was only slightly affected.

Figures 35 and 36 show the impact of two hurricanes on mangrove biomass and economic structure. Figure 35 shows the result of maintaining a mangrove forest in front of the economic structure. When two moderate hurricanes strike the region within 10 years of each other, the recovery of mangrove biomass and economic structure to pre-hurricane values is in excess of 40 years. Two severe hurricanes within 10 years decrease the recovery rate even further. When the economic structure is in front of the mangroves as in Figure 36, two hurricanes within 10 years result in a recovery time of about 40 years required to reach pre-hurricane values.

Figure 35. Simulation of the impact of two hurricanes within 10 years on mangrove biomass and economic structure; (a) mangrove biomass adjacent to condominium development; (b) economic structure of condominium development; (c) mangrove biomass adjacent to residential finger canal development; (d) economic structure of residential finger canal development.

Case I - Mangrove swamp affected by hurricane winds and light damage from storm surge. No damage to economic structure due to hurricane.

Case II - Mangrove swamp severely affected by winds and storm surge with moderate damage to economic structure.

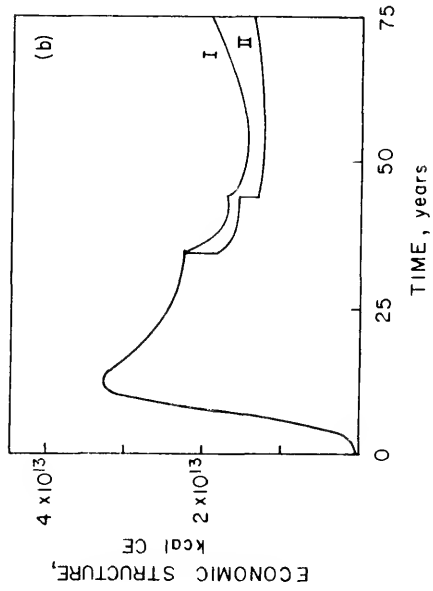
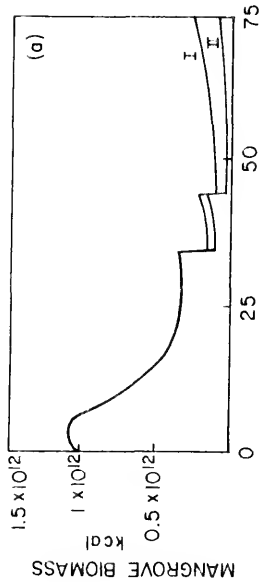
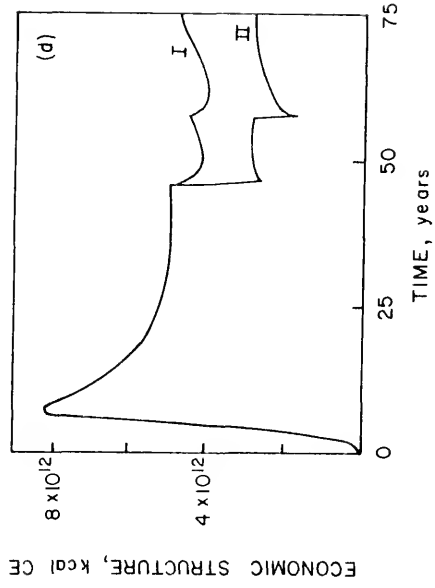
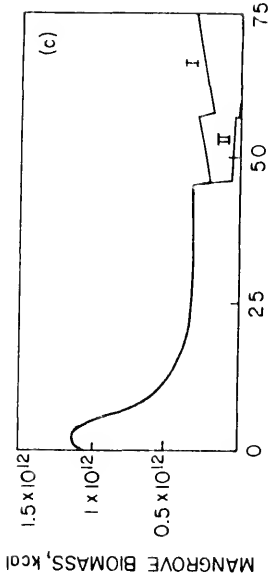

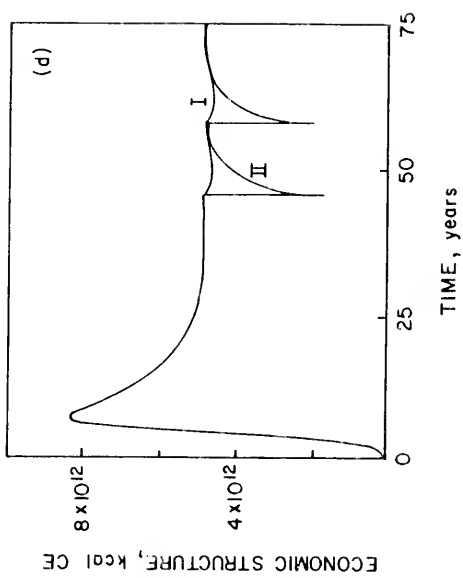
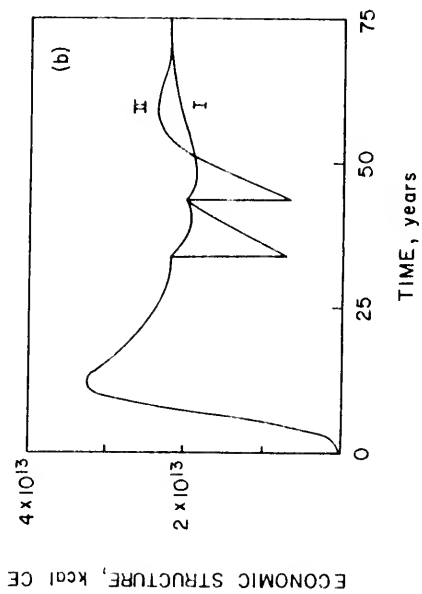
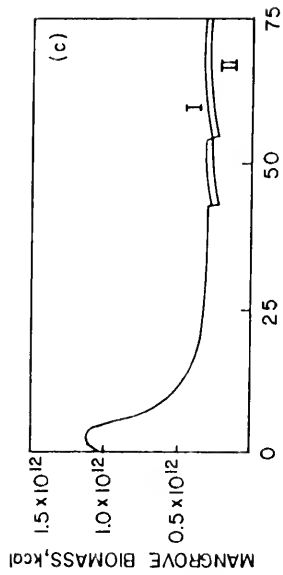
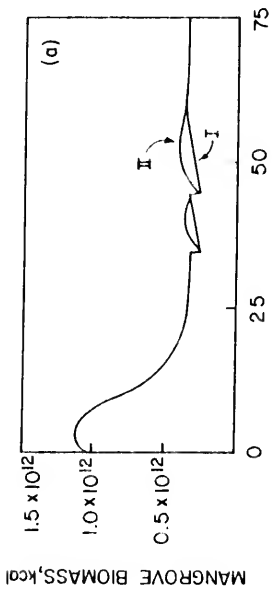

Figure 36.

Simulation of the impact of two hurricanes within 10 years on mangrove biomass and economic structure; (a) mangrove biomass adjacent to condominium development; (b) economic structure of condominium development; (c) mangrove biomass adjacent to residential finger canal development; (d) economic structure of residential finger canal development.

Case I - Mangrove swamp affected only by hurricane winds with no storm surge effect on economic structure.

Case II - Mangrove swamp affected only by hurricane winds and heavy damage to economic structure from storm surge.



### Energy Calculation Results

This section presents the results of calculating steady state natural and purchased energy flows for the hypothetical economic development within a 1000 ha mangrove forest (Figure 28). Investment ratios were also determined at steady state when 25% or 50% of the land was developed either as condominiums or residential finger canal estates. In addition, the theoretical carrying capacity in terms of attractable fossil fuel energies was computed using the U.S. national average of 2.5 kcal of fossil fuel energy per kcal of natural energy.

#### Calculation of Energy Flows

Table 3 presents the values of the energy flows through a 1000 ha mangrove forest for both undeveloped and developed conditions. Heat equivalent energy flow were converted to coal equivalent energy flows using the energy quality factors presented in Table 1. These values are presented in graphic form in Figure 37. The energy flows of the undeveloped mangrove forest are shown in Figure 27a. In the undeveloped state, the significant natural energy flows were sun, wind, rain, and tides and the total incoming natural energy flow was  $1.9 \times 10^{10}$  kcal CE/year. Mangrove productivity amounted to  $1.05 \times 10^{10}$  kcal CE/year.

When the mangrove area was 25% developed, the total invested energy flows at steady state were  $410 \times 10^{10}$  kcal CE/year for condominiums and  $180 \times 10^{10}$  kcal CE/year for finger canals, much higher

Table 3. Energy values for hypothetical cases of steady state residential development in a mangrove forest consisting of 1000 hectares.

	Energy in heat equivalents, kcal/yr	Quality factors	Energy in coal equivalents, kcal/yr
Natural Energies			
Sun (a)	$1.6 \times 10^{13}$	2000	$0.8 \times 10^{10}$
Wind (b)	$1.9 \times 10^{10}$	7.7	$0.24 \times 10^{10}$
Rain (c)	$8.5 \times 10^{10}$	10.0	$0.85 \times 10^{10}$
Tides (d)	$.01 \times 10^{10}$	<u>2.5</u>	<u><math>0.004 \times 10^{10}</math></u>
Total	---	---	$1.9 \times 10^{10}$
Natural Ecosystem			
Mangrove <sup>e</sup>			
No Development	$21 \times 10^{10}$	20	$1.05 \times 10^{10}$
25% developed	$15 \times 10^{10}$	20	$0.75 \times 10^{10}$
50% developed	$7.5 \times 10^{10}$	20	$0.38 \times 10^{10}$

Invested fossil fuel energy<sup>f</sup>

Condominium <sup>g</sup> 25% developed	410 x 10 <sup>10</sup>
50% developed	830 x 10 <sup>10</sup>
Residential finger canal <sup>h</sup> 25% developed	180 x 10 <sup>10</sup>
50% developed	410 x 10 <sup>10</sup>

<sup>a</sup>Solar energy flux was  $1.6 \times 10^6$  kcal/m<sup>2</sup>·year or  $1.6 \times 10^{13}$  kcal/year for 1000 ha.

<sup>b</sup>Costanza (1975) calculated wind energy as  $65 V^2$  kcal/ac·year where  $V$  is average wind speed in cm/sec. Average wind speed of 340 cm/sec was taken from National Oceanic and Atmospheric Administration (1973). This gave

$$65 \times (340)^2 \times \frac{1 \text{ acre}}{4047 \text{ m}^2} \text{ kcal/m}^2 \cdot \text{year} \text{ or } 1.9 \times 10^3 \text{ kcal/m}^2 \cdot \text{year}.$$

<sup>c</sup>Rainfall contribution to natural energy flow was as mixing energy with sea water. Free energy of mixing =

$$G_0 + n RT \ln \left( \frac{C_2}{C_1} \right)$$

Where  $C_2$  = concentration of dissolved solids in rainwater, 1 ppm

$C_1$  = concentration of dissolved solids in seawater, 35,000 ppm

$n$  = number of moles

$R$  = universal gas constant,  $1.987 \frac{\text{cal}}{\text{deg-mole}}$

$T$  = average temperature, °K

Table 3 (continued)

$$\text{Free energy of mixing} = 0 + \frac{1 \text{ mole}}{35 \text{ g}} \times 1.987 \times 293 \times \ln \frac{1}{35,000}$$

$$\text{Free energy of mixing} = -170 \text{ g cal/g salt} \times \frac{35,000 \text{ g salt}}{1 \text{ m}^2 \text{H}_2\text{O}} \times \frac{1}{1000} = 6.1 \times 10^5 \text{ kcal/m}^3 \text{H}_2\text{O}.$$

At 1.4 m/year of rainfall, free energy of mixing =  $6.1 \times 1.4 = 8.5 \times 10^3 \text{ kcal/m}^2 \text{year}$  or  $8.5 \times 10^{16} \text{ kcal/year}$  for 1000 ha.

<sup>d</sup>Tidal energy was calculated by Costanza (1975) as  $340 \text{ h}^2 \text{ kcal/ac}\cdot\text{year}$  where  $h$  is tidal amplitude, cm. In the mangroves  $h$  was estimated as 10 cm which would give  $3.4 \times 10^4 \text{ kcal/ac}\cdot\text{year}$  or  $0.01 \times 10^{16} \text{ kcal/year}$  for 1000 ha.

<sup>e</sup>The values for mangrove productivity were taken from Figure 31c for three amounts of development on 1000 ha.

<sup>f</sup>Invested fossil fuel energies represent purchased energies in the form of fuel, electricity, food and goods and services. This total invested energy flow was taken from Figures 31a and b for condominium development and from Figures 31d and e for finger canal development.

<sup>g</sup>Condominium development was 44 units/ha and supporting energies needed at steady state were equal to the sum of the proper curves in Figures 31a and b. Curve II was used for the 25% development and curve III was used for the 50% development.

<sup>h</sup>Residential finger canal development was 10 units/ha and supporting energies needed at steady state were equal to the sum of Figures 31d and e. Curve II was used for the 25% development and curve III was used for the 50% development.

Figure 37. Undeveloped and developed steady state energy flows for a hypothetical development of 1000 hectares of mangrove forest; (a) undeveloped case; (b) 25 percent of land developed; (c) 50 percent of land developed. All flows are given in units of  $10^{10}$  kcal coal equivalents/yr.

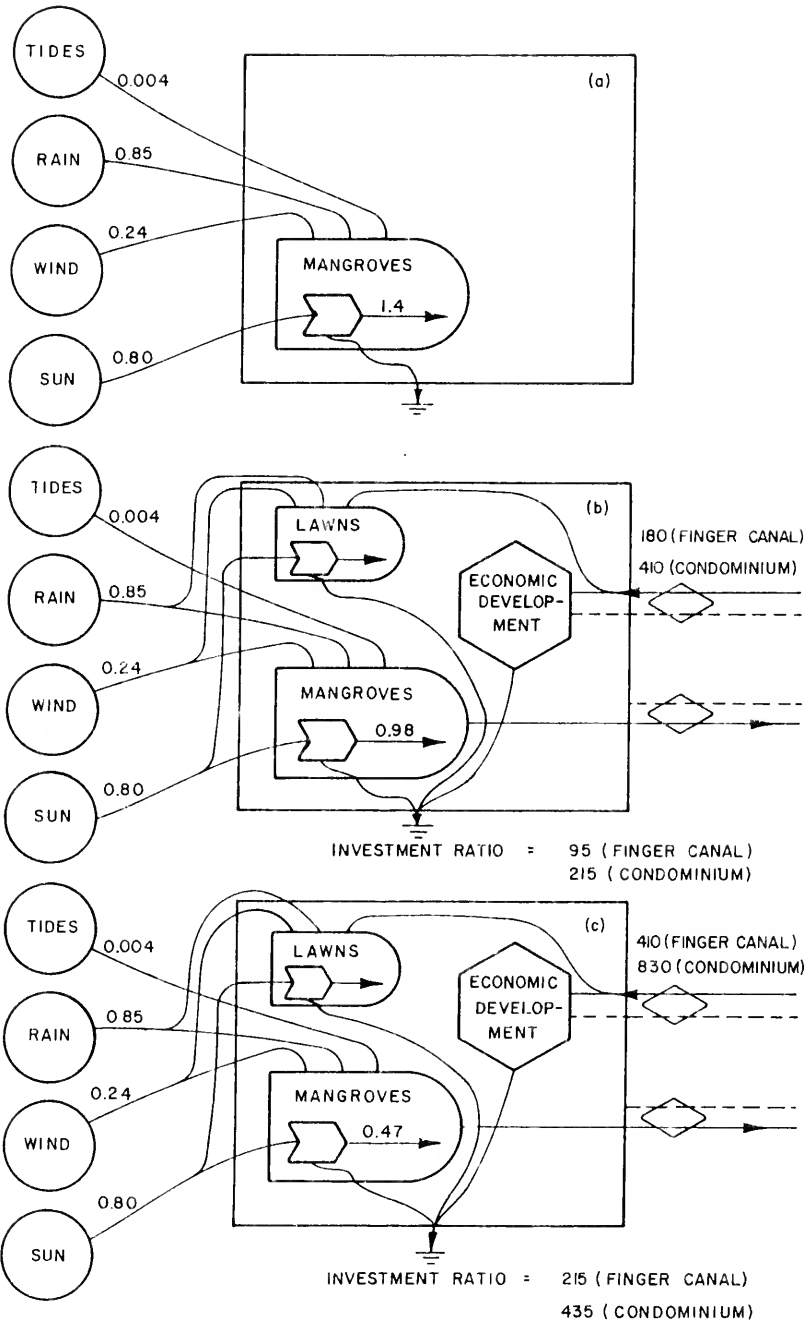



flows than the natural energy flows in the undeveloped state. Natural productivity of mangroves declined 30% to  $0.75 \times 10^{10}$  kcal CE/year for 25% development. At 50% development the total invested energy flows at steady state increased to  $830 \times 10^{10}$  kcal CE/year for condominiums and  $410 \times 10^{10}$  kcal CE/year for finger canals. Mangrove productivity declined by 64% to  $0.38 \times 10^{10}$  kcal CE/year.

#### Calculation of Investment Ratios

The steady state energy investment ratios for 25% of the land being developed were 95 for residential finger canal estates and 215 for condominiums. When development occurred on 50% of the land, the energy investment ratios were 215 for residential finger canal estates and 435 for condominiums. These are much higher than the national average of 2.5 and may indicate a potentially noncompetitive situation. Using the national average of 2.5, the purchased energy inflow was calculated to be  $4.75 \times 10^{10}$  kcal/CE/year. If the purchased energy inflow did not exceed this value, the maximum development might be only 12 ha of residential finger canal estates at a density of 10 units/ha or only 5.2 ha of condominiums at a density of 44 units/ha.

#### Field Study Results

Field study results are presented here for the data collected at the Marco Island sites that were sprayed with herbicide and also at the nutrient enriched sites at Naples and Everglades City. These

measured results showed the observed response of a mangrove forest to herbicide spraying and nutrient enrichment and might show that some aspects of the modeling responses have validity.

#### Sites Treated with Herbicide

Results are given in this section for the sites sprayed with herbicide at Marco Island. The data include results on the composition of the forest, tree growth rates, numbers of fallen leaves, snails, and crabholes, and also numbers of live seedlings and dead seedlings.

#### Composition of study sites

The composition of the mangrove forest in the sprayed sites was determined one month after the spraying with herbicide. A. germinans was by far the dominant tree in the control site. The few R. mangle found there were saplings of less than 2 centimeters in diameter. Dead mangroves were quite noticeable in the control site and comprised 32% of the total number of trees. A. germinans made up 72% of the dead trees in the control with R. mangle accounting for the rest. In the site sprayed with an estimated 14 liters of Tordon 101/ha (site 3) live mangrove population was composed of 76% A. germinans and 24% R. mangle. At this site the dead mangrove population represented 43% of the total population with A. germinans making up 78% of these dead trees. In the site sprayed with an estimated 28 liters of Tordon 101/ha (site 4), live mangrove population was

composed of 60% A. germinans, 39% R. mangle, and 1% L. racemosa. At this site the dead mangrove population represented 36% of the total population and consisted of 73% A. germinans, 22% R. mangle, and 5% L. racemosa. In the site sprayed with a measured 20.5 liters of Tordon 101/ha (site 5) the live mangrove population was composed of 22% A. germinans, 70% R. mangle, and 8% L. racemosa. At this site the dead mangrove population represented 20% of the total number of trees and consisted of 19% A. germinans, 56% R. mangle and 25% L. racemosa. Live and dead mangrove populations were not determined for the cleared site. The densities (number/100 m<sup>2</sup>) of the live and dead mangrove populations for each site are given in Table 4.

#### Growth of mangroves

The growth of mangroves was determined by measuring the increase in tree diameter over a 13-month period. This was done for the control site and three sprayed sites but not for the cleared site. The results of these measurements are summarized in Table 5. The average diameter increase for A. germinans was 0.13 cm in the control site and ranged from 0 to 0.17 cm in the sprayed sites. Mature R. mangle were not found in the control site and there was no stem diameter increase in the sprayed sites. Stem diameter showed a slight decrease in each of the treated sites but this decrease was not significant. L. racemosa occurred only in very small numbers and there was essentially no change in the stem diameter of this mangrove species. When all the trees in one site were combined, only the control trees showed any stem diameter increase.

Table 4. Density ( $n/100 \text{ m}^2$ ) of live and dead trees in the herbicide study sites on Marco Island, Florida, at the time of spraying and 2 years after spraying. Only trees with diameter at breast height  $>2.5$  cm were measured.

	Rhizophora mangle		Avicennia germinans		Laguncularia racemosa		Total	
	Initial	2 yrs	Initial	2 yrs	Initial	2 yrs	Initial	2 yrs
Control								
Live trees	0	0	38	38	0	0	38	38
Dead trees	5	5	12	12	0	0	17	17
Spray site 3 <sup>b</sup>								
Live trees	7	4	20	20	0	0	27	24
Dead trees	4	7	16	16	0	0	20	23
Spray site 4 <sup>c</sup>								
Live trees	20	9	32	32	1	0	53	41
Dead trees	6	17	22	22	2	3	30	42
Spray site 5 <sup>d</sup>								
Live trees	23	4	7	7	2	0	32	12
Dead trees	4	22	2	2	2	4	8	28

<sup>a</sup>Two year data on percent of trees still living was supplied by Dr. Howard Teas, Department of Biology, University of Miami.

<sup>b</sup>Sprayed with estimated 14 liters/ha.

<sup>c</sup>Sprayed with estimated 28 liters/ha.

<sup>d</sup>Sprayed with measured 20.5 liters/ha.

Table 5. Mean tree diameter at breast height (SE) of each species of mangrove in the herbicide study sites at Marco Island, Florida. Measurements were made in January 1973 and February 1974.

	Diameter, cm			All trees
	<u>Rhizophora</u> <u>mangrove</u>	<u>Laguncularia</u> <u>racemosa</u>	<u>Avicennia</u> <u>germinans</u>	
Control site				
January 1973	---	---	8.15 (0.41)	8.15 (0.41)
February 1974	---	---	8.24 (0.41)	8.24 (0.41)
Percent change	---	---	1.1	1.1
Site 1 (Sprayed with estimated dosage of 14 liters of herbicide/ha)				
January 1973	8.9 (0.79)	---	9.97 (0.87)	9.63 (0.64)
February 1974	8.8 (0.79)	---	10.0 (0.87)	9.62 (0.64)
Percent change	-1.1	---	0.30	-0.10

Site 2 (Sprayed with estimated dosage of 28 liters of herbicide/ha)

January 1973	7.33 (0.34)	---	7.12 (0.48)	7.20 (0.33)
February 1974	7.32 (0.34)	---	7.08 (0.48)	7.17 (0.33)
Percent change	-0.1	---	-0.6	-0.4

Site 3 (Sprayed with measured dosage of 20.5 liters of herbicide/ha)

January 1973	8.72 (0.56)	12.34 (2.1)	10.01 (2.3)	9.27 (0.64)
February 1974	8.65 (0.56)	12.36 (2.1)	10.18 (2.3)	9.26 (0.64)
Percent change	-0.8	0.2	1.7	-0.1

---

The average basal areas per tree were also computed for each site and the results are summarized in Table 6. When all the trees in each site are considered, only those in the control site showed an increase in basal area per tree.

#### Density of fallen green leaves

Data from the studies of Teas and Kelly (1974) at the herbicide treated sites indicated that leaf fall began about three weeks after aerial application of the herbicide. Figure 38a is a comparison of the number of fallen green leaves/m<sup>2</sup> for the control, cleared, and average of the three sprayed sites. The vertical lines indicate the deviation of one standard error from the mean. The control site had a low number of fallen green leaves whenever sampled. No green leaves were found at any time in the cleared site. Each sprayed site had significant numbers of green leaves on the ground one month after spraying and the overall average was 50 leaves/m<sup>2</sup>. At later samplings the average number of leaves was usually < 1/m<sup>2</sup> with no statistical significance between the control site and the sprayed sites. The data are summarized in Table E-1, Appendix E. Figure E-1, Appendix E compares each of the three sprayed sites with the control site and cleared site.

Table 6. Mean basal area per tree (SE) of each species of mangrove in the herbicide study sites at Marco Island, Florida.

	Rhizophora mangie	Basal area, cm <sup>2</sup>		All trees
		Laguncularia racemosa	Avicennia germinans	
Site 1 Marco Island control site				
January 1973	---	---	69.2 (7.7)	69.2 (7.7)
February 1974	---	---	70.7 (7.7)	70.7 (7.7)
Percent change	---	---	2.2	2.2
Site 3 (Sprayed with estimated dosage of 14 liters of herbicide/ha)				
January 1973	69.7 (11.5)	---	97.8 (15.4)	88.8 (11.1)
February 1974	68.1 (11.1)	---	98.3 (15.5)	88.7 (11.1)
Percent change	-2.3	---	0.5	-0.1



## Site 4 (Sprayed with estimated dosage of 28 liters of herbicide/ha)

January 1973	45.6 (4.2)	---	51.6 (7.1)	49.4 (4.8)
February 1974	45.4 (4.2)	---	51.2 (7.2)	49.1 (4.8)
Percent change	-0.4	---	-0.8	-0.6

## Site 5 (Sprayed with measured dosage of 20.5 liters of herbicide/ha)

January 1973	70.9 (8.9)	133.7 (43.5)	133.3 (55.1)	89.2 (13.5)
February 1974	69.8 (8.8)	133.3 (42.2)	134.8 (54.8)	88.7 (13.4)
Percent change	-1.6	-0.3	1.1	-0.6

Figure 38. Variation with time in (a) number of fallen green leaves; (b) number of fallen yellow leaves; (c) number of dead seedlings; (d) number of live seedlings; (e) number of snails and (f) number of crabholes for the control site, the cleared site and the average of the three sprayed sites located in a mangrove forest on Marco Island, Florida. Vertical bars represent  $\pm 1$  SE.

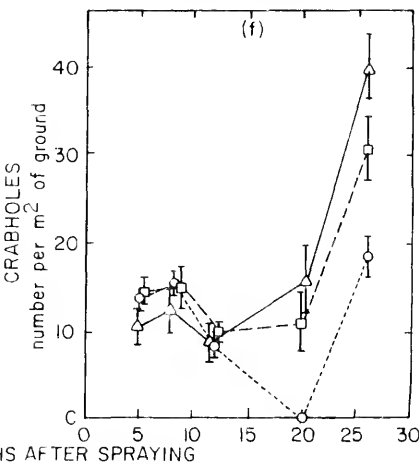
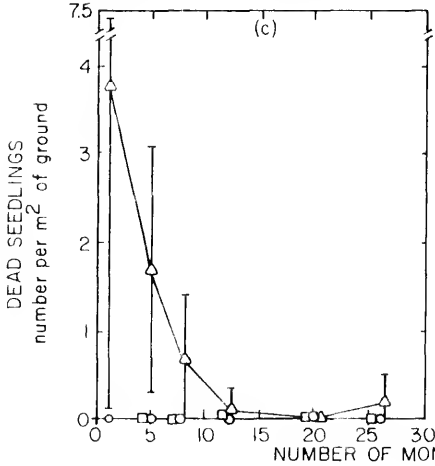
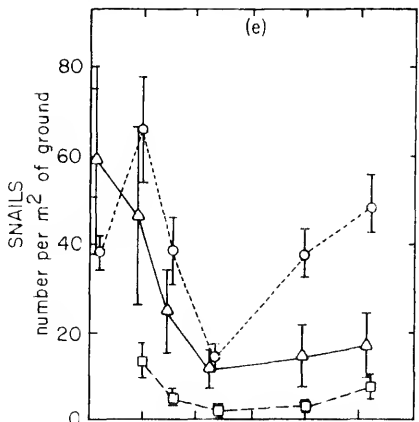
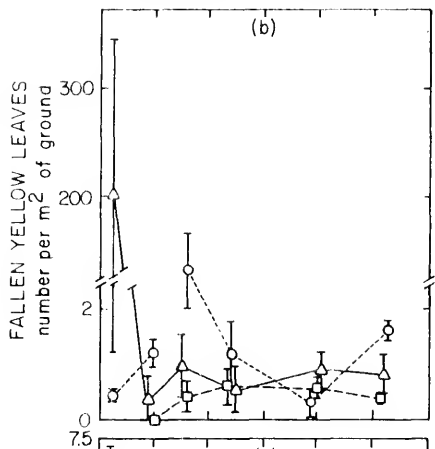
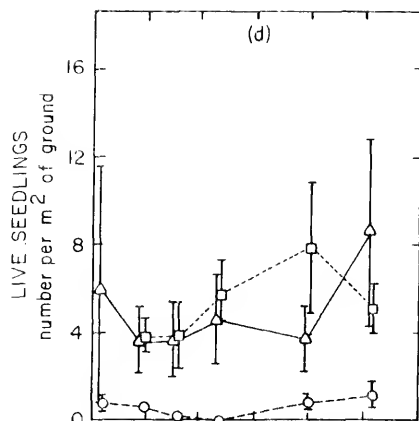
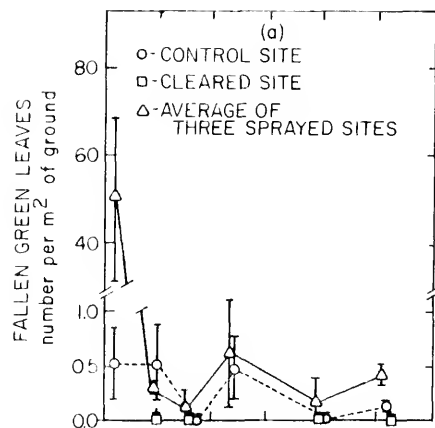

### Density of fallen yellow leaves

Figure 38b is a comparison of the number of fallen yellow leaves/ $m^2$  for the control, cleared, and average of the three sprayed sites. The control site had a high number of yellow leaves one month after spraying, but the numbers dropped to about  $1/m^2$  for the remaining sampling periods. The sprayed sites had a large number of yellow leaves on the ground one month after spraying with the overall average of 200 leaves/ $m^2$ . At later samplings, the numbers were much lower. The cleared site had no observed yellow leaves on the ground until eight months after the sites were sprayed. The number was  $< 1/m^2$  for each sampling period. Except for the one month sampling period, the differences were not statistically significant. The data are summarized in Table E-2. Figure E-2 compares each of the three sprayed sites with the control and cleared sites.

### Density of dead seedlings

Figure 38c is a comparison of the number of dead seedlings (all species) per  $m^2$  for the control, cleared, and average of the three sprayed sites. The control site had no observed dead seedlings during the study and only one dead seedling was observed in the cleared site. In the sprayed sites the greatest number of dead seedlings occurred at the one month sampling period. The number of dead seedlings gradually decreased to zero at 20 months, but then increased slightly at 26 months. The differences between the numbers of dead mangrove

seedlings in each site were not statistically significant. The data are summarized in Table E-3. Figure E-3 compares each of the three sprayed sites with the control and cleared sites.

#### Density of live seedlings

Figure 38d is a comparison of the number of live seedlings (all species) for the control, cleared, and the average of the three sprayed sites. The control site maintained a low number of live seedlings throughout the study, but the cleared site had a gradual increase in live seedlings up to the 20-month sampling period followed by a decrease at 26 months. The average number of live seedlings of the three sprayed sites was high initially, then decreased to a nearly uniform value and increased again at 26 months. The numbers in the cleared and sprayed sites were not statistically different, but each was statistically different from the control site. The data are summarized in Table E-4. Figure E-4 compares each of the three sprayed sites with the control and cleared sites.

#### Population density of coffee shell snail

The coffee shell snail, Melampus coffeus was initially found to be prevalent in the various study areas. Figure 38e is a comparison of the population of M. coffeus for the control, cleared, and the average of the three sprayed sites. In the control site the number of M. coffeus increased from January 1973 to May 1973 and then decreased

from May to January 1974. The numbers increased from January 1974 to February 1975. In the cleared site the number of snails remained low throughout the study except for a slight increase at 26 months after spraying. For the sprayed sites the snail population gradually decreased from January 1973 to January 1974 and then remained almost constant the remainder of the study. The control site and the averaged spray sites were not statistically different except at 20 and 26 months after spraying. The snail population in the cleared site was always statistically lower than the spray site average. The data are summarized in Table E-5. Figure E-5 compares the snail populations in each of the sprayed sites with the control and cleared sites.

#### Density of crabholes

In addition to the snails crab populations consisting of Uca spp. (fiddler crabs) and Sesarma spp. (tree crabs) were found in the control, cleared, and sprayed sites. Figure 38f is a comparison of the number of crabholes for the control, cleared, and the average of the three sprayed sites. The control site showed very little change in the number of crabholes except at 20 months when no crabholes were observed. This may have been due to the wet conditions observed at that time, but the actual reason has not been ascertained. The number of crabholes in the cleared and sprayed sites also showed very little change with time except at 26 months when many tiny crabholes were observed. The sites had statistically different numbers of

crabholes at 20 and 26 months. The number of crabholes in the control site was statistically lower than the number in the cleared and sprayed sites average at 20 and 26 months. The cleared site had a statistically lower number of crabholes than the sprayed sites at the 26 month measurements. The data are summarized in Table E-5 and Figure E-6 compares the number of crabholes in each of the sprayed sites with the control and cleared sites.

#### Sites Enriched with Sewage Effluent

At the two sites occasionally enriched with nutrients by tidal flooding, the parameters measured included composition of forest, growth of trees, litter fall, and concentration of total phosphorus in the water column and in the mangrove leaves and wood. All of these parameters except litter fall were also measured in two control areas located in the same vicinity as the areas receiving nutrient enriched waters but apparently not influenced by the higher nutrient levels.

#### Composition of mangrove forest

Table 7 gives the species and population of the mangrove trees in the four study sites. At the Naples research sites, two species of mangroves, R. mangle and L. racemosa, were present and the control site had a higher population in terms of numbers/m<sup>2</sup>. At the Everglades research sites, three species, R. mangle, L. racemosa, and A. germinans were present and the higher population was in the forest receiving

Table 7. Density ( $n/100\text{ m}^2$ ) of trees in the sites receiving sewage effluent and at the control sites. Measurements were made in August 1974.

Seedling density	Site 1 <sup>a</sup> (Sewage)	Site 2 <sup>b</sup> (Control)	Site 3 <sup>c</sup> (Sewage)	Site 4 <sup>d</sup> (Control)
<u>Rhizophora mangle</u>	10	33	42	45
<u>Laguncularia racemosa</u>	37	50	57	12
<u>Avicennia germinans</u>	0	0	12	6
Total	47	83	111	63

<sup>a</sup>Site 1 is a mangrove island located in the Gordon River 100 m from the Naples, Florida, sewage outfall.

<sup>b</sup>Site 2 is the Naples control site located 1 mile upstream from outfall along the Gordon River.

<sup>c</sup>Site 3 is a mangrove forest located upstream and downstream of the Everglades City, Florida, sewage outfall.

<sup>d</sup>Site 4 is a mangrove forest located along a small tidal creek about 1 mile upstream from outfall.

Table 8. Density ( $n/m^2$ ) of Rhizophora mangle seedlings on parent trees at the sites receiving sewage effluent and at the control sites. Measurements were made in August 1974.

Seedling density	Site 1 <sup>a</sup> (Sewage)	Site 2 <sup>b</sup> (Control)	Site 3 <sup>c</sup> (Sewage)	Site 4 <sup>d</sup> (Control)
	7.4 (1.7)	5.4 (0.8)	1.5 (0.65)	2.3 (1.2)

<sup>a</sup>Site 1 is a mangrove island located in the Gordon River 100 m from the Naples, Florida, sewage outfall.

<sup>b</sup>Site 2 is the Naples control site located 1 mile upstream from outfall along the Gordon River

<sup>c</sup>Site 3 is a mangrove forest located upstream and downstream of the Everglades City, Florida, sewage outfall.

<sup>d</sup>Site 4 is a mangrove forest located along a small tidal creek about 1 mile upstream from outfall.



sewage effluent. The measurements used to obtain the values in Table 7 are given in Table F-1.

#### Population of *R. mangle* seedlings

Table 8 shows the population in numbers/m<sup>2</sup> of *R. mangle* seedlings attached to parent trees at the study sites in August 1974. As noted in the table the differences in seedling numbers between a site receiving sewage effluent and its corresponding control site were not statistically significant. The data used to compute the seedling averages are given in Table F-2.

#### Growth of trees

Table 9 summarizes the data on average tree diameters for September of 1973 and 1974 at the sewage-enriched and control sites in Naples and Everglades City. The trees in the sewage-enriched mangrove forest at Naples had a higher average diameter increase than the trees in the control forest. Standard error calculations suggest that this difference in growth rates was significant for each species, and for all species combined. Standard error of the mean tree diameters also suggested that these two forests were not statistically different in size. All species of trees in the mangrove forest receiving effluent from the Everglades City sewage treatment plant also had a higher tree diameter increase than the control forest.

Table 9. Mean tree diameter at breast height (SE) of each species of mangrove in the sites receiving sewage effluent and in the control sites. Measurements were made in September of 1973 and 1974.

	Tree diameters, cm			Change cm	Percent
	Sept. 1973	Sept. 1974			
Naples site receiving sewage effluent					
<u>Rhizophora mangle</u> <sup>a</sup>	5.39 (0.30)	5.77 (0.29)	0.39 (0.03)	6.6	
<u>Laguncularia racemosa</u>	8.20 (0.51)	8.85 (0.50)	0.65 (0.06)	8.3	
All trees	6.67 (0.30)	7.18 (0.30)	0.51 (0.03)	7.5	
Naples control site					
<u>Rhizophora mangle</u>	4.88 (0.30)	5.02 (0.31)	0.14 (0.02)	3.4	
<u>Laguncularia racemosa</u>	7.86 (0.52)	8.13 (0.54)	0.27 (0.04)	3.4	
All trees	6.49 (0.38)	6.70 (0.39)	0.21 (0.03)	3.7	

## Everglades City site receiving sewage effluent

<u>Rhizophora mangle</u>	3.72 (0.30)	3.96 (0.30)	0.24 (0.03)	6.9
<u>Avicennia germinans</u>	6.52 (1.12)	6.64 (1.13)	0.12 (0.04)	1.8
<u>Laguncularia racemosa</u>	6.35 (0.53)	6.57 (0.53)	0.23 (0.03)	3.7
All trees	5.00 (0.30)	5.23 (0.30)	0.23 (0.02)	4.5

## Everglades City control site

<u>Rhizophora mangle</u>	5.96 (0.46)	6.05 (0.47)	0.09 (0.03)	1.4
<u>Avicennia germinans</u>	11.00 (1.81)	11.09 (1.82)	0.09 (0.06)	0.9
<u>Laguncularia racemosa</u>	9.89 (0.54)	10.03 (0.54)	0.14 (0.03)	1.4
All trees	7.84 (0.45)	7.95 (0.45)	0.11 (0.02)	1.3

<sup>a</sup>Diameters of Rhizophora mangle were measured 6-8 inches above the highest prop root rather than at breast height.

Table 10 shows the average tree diameters for September 1973, 1974, and 1976 at the sewage-enriched and control sites in Naples and Everglades City. Fewer trees were measured in 1976 and so this table was separated from Table 9. At the Naples sites the 3-year tree diameter increase averaged 1.34 cm with sewage enrichment and 0.59 cm in the control site. The tree diameter increase in the sewage enriched site was statistically greater than the increase in the control site. At the Everglades City sites the 3-year tree diameter increase averaged 0.49 cm with sewage enrichment and 0.29 cm in the control site and the difference was significant.

Table 11 summarizes the calculations of the average tree basal area of all trees for September 1973 and 1974 at the sewage-enriched and control sites in Naples and Everglades City. The trees in the Naples sewage-enriched mangrove forest had a higher average basal area increase per tree than the trees in the control forest. At Everglades City the trees in the sewage-enriched mangrove forest had a higher average basal area increase than the trees in the control forest.

Table 12 contains average tree basal areas for September 1973, 1974, and 1976. At the Naples sites tree basal area increase was higher in the sewage-enriched site than in the control site and the difference was significant. At Everglades City the average tree basal area was higher in the sewage-enriched site than in the control site but the difference was not very great.

Tables 13 to 16 give the average tree diameters for September 1973 and 1974 according to four size classes. At the Naples sewage-enriched

Table 10. Mean tree diameter at breast height (SE) of each species of mangrove in the sites receiving sewage effluent and in the control sites. Measurements were made in September of 1973, 1974, and 1976.

	Tree diameter, cm			1-year change		3-year change	
	Sept. 1973	Sept. 1974	Sept. 1976	cm	percent	cm	percent
Naples site receiving sewage effluent							
<u>Rhizophora mangle</u> <sup>a</sup>	7.14 (0.32)	7.47 (0.32)	8.07 (0.35)	0.33 (0.04)	4.5	0.93 (0.09)	12.6
<u>Laguncularia racemosa</u>	9.60 (0.70)	10.2 (0.68)	11.4 (0.70)	0.62 (0.07)	6.5	1.8 (0.18)	18.8
All trees	8.28 (0.39)	8.75 (0.39)	9.61 (0.41)	0.47 (0.04)	5.7	1.34 (0.10)	16.2
Naples control site							
<u>Rhizophora mangle</u>	5.06 (0.33)	5.22 (0.34)	5.40 (0.39)	0.16 (0.02)	3.2	0.34 (0.11)	6.7
<u>Laguncularia racemosa</u>	7.82 (0.53)	8.10 (0.55)	8.59 (0.67)	0.28 (0.04)	3.6	0.77 (0.17)	9.8
All trees	6.69 (0.40)	6.92 (0.41)	7.28 (0.49)	0.23 (0.03)	3.4	0.59 (0.11)	8.8

## Everglades City site receiving sewage effluent

<u>Avicennia germinans</u>	9.93 (0.61)	10.07 (0.66)	10.73 (0.68)	0.14 (0.09)	1.4	0.80 (0.36)	8.1
<u>Rhizophora mangle</u>	4.01 (0.47)	4.27 (0.50)	4.64 (0.53)	0.26 (0.05)	6.5	0.63 (0.09)	15.7
<u>Laguncularia racemosa</u>	7.47 (0.84)	7.69 (0.84)	7.96 (0.84)	0.22 (0.05)	2.9	0.59 (0.12)	7.9
All trees	5.90 (0.53)	6.14 (0.53)	6.49 (0.54)	0.24 (0.03)	4.1	0.49 (0.07)	8.3

## Everglades City control site

<u>Avicennia germinans</u>	12.97 (0.91)	13.09 (0.87)	13.31 (0.92)	0.11 (0.08)	0.8	0.34 (0.09)	2.6
<u>Rhizophora mangle</u>	6.51 (0.53)	6.59 (0.54)	6.81 (0.55)	0.07 (0.04)	1.1	0.30 (0.04)	4.6
<u>Laguncularia racemosa</u>	9.97 (0.58)	10.12 (0.58)	10.25 (0.60)	0.15 (0.04)	1.5	0.28 (0.06)	2.8
All trees	8.48 (0.46)	8.58 (0.47)	8.77 (0.47)	0.11 (0.03)	1.3	0.29 (0.03)	3.4

<sup>a</sup>Diameters of Rhizophora mangle were measured 6-8 inches above the highest prop root rather than at breast height.

Table 11. Mean basal area per tree (SE) of each species of mangrove in the sites receiving sewage effluent and in the control sites. Measurements were made in September 1973 and 1974.

	Basal area, cm <sup>2</sup>		Change cm <sup>2</sup>	percent
	Sept. 1973	Sept. 1974		
Naples site receiving sewage effluent				
<u>Rhizophora mangle</u>	30.2 (2.8)	33.3 (2.9)	3.1 (0.3)	10.9
<u>Laguncularia racemosa</u>	64.6 (6.1)	72.4 (6.6)	7.9 (0.8)	12.2
All trees	45.8 (3.4)	51.1 (3.7)	5.3 (0.4)	11.6
Naples control site				
<u>Rhizophora mangle</u>	18.3 (2.2)	19.4 (2.3)	1.1 (0.3)	6.0
<u>Laguncularia racemosa</u>	53.8 (7.2)	57.7 (7.8)	3.9 (0.8)	7.2
All trees	37.9 (4.8)	40.6 (5.2)	2.7 (0.5)	7.1

## Everglades City site receiving sewage effluent

<u>Rhizophora mangle</u>	14.7 (2.3)	16.4 (2.5)	1.7 (0.3)	11.6
<u>Laguncularia racemosa</u>	41.2 (5.7)	43.5 (6.0)	2.3 (0.4)	5.6
<u>Avicennia germinans</u>	42.2 (12.0)	43.6 (12.4)	1.4 (0.5)	3.3
All trees	27.5 (3.0)	29.4 (3.1)	1.9 (0.2)	6.9

## Everglades City control site

<u>Rhizophora mangle</u>	35.1 (5.1)	36.1 (5.2)	1.1 (0.4)	3.1
<u>Laguncularia racemosa</u>	82.2 (8.6)	84.5 (8.8)	2.3 (0.5)	2.8
<u>Avicennia germinans</u>	118.1 (24.7)	120.1 (24.8)	1.9 (1.2)	1.6
All trees	60.5 (6.0)	62.1 (6.1)	1.5 (0.3)	2.6



Table 12. Mean basal area per tree (SE) of each species of mangrove in the sites receiving sewage effluent and in the control sites. Measurements were made in September 1973, 1974, and 1976.

	Tree basal area, cm <sup>2</sup>		1-year change		3-year change		
	Sept. 1973	Sept. 1974	Sept. 1976	cm	percent	cm	percent
Naples site receiving sewage effluent							
<u>Rhizophora mangle</u>	44.9 (3.8)	48.8 (4.1)	56.7 (4.8)	3.9 (0.5)	8.7	11.8 (1.3)	26.3
<u>Laguncularia racemosa</u>	91.7 (10.7)	100.4 (11.3)	121.2 (13.2)	8.7 (1.1)	9.5	29.5 (3.5)	32.2
All trees	66.8 (5.8)	73.0 (6.2)	86.9 (7.3)	6.2 (0.6)	9.3	20.1 (2.0)	30.1
Naples control site							
<u>Rhizophora mangle</u>	21.6 (3.2)	23.0 (3.4)	25.0 (4.1)	1.4 (0.3)	6.5	3.4 (1.4)	15.7
<u>Laguncularia racemosa</u>	53.5 (7.3)	57.4 (7.8)	66.8 (10.5)	3.9 (0.8)	7.3	13.3 (3.6)	24.9
All trees	40.5 (5.1)	43.3 (5.4)	49.7 (7.1)	2.8 (0.5)	6.9	9.2 (2.3)	22.7

## Everglades site receiving sewage effluent

<u>Avicennia germinans</u>	78.1 (1.4)	80.2 (10.1)	91.2 (11.1)	2.2 (1.4)	2.8	13.1 (6.3)	16.8
<u>Rhizophora mangle</u>	16.3 (3.6)	18.5 (4.1)	21.5 (4.6)	2.2 (0.6)	13.5	5.1 (1.1)	31.3
<u>Laguncularia racemosa</u>	55.3 (9.6)	57.8 (10.0)	61.1 (10.2)	2.5 (0.85)	4.5	5.8 (1.7)	10.5
All trees	37.4 (5.6)	39.7 (5.8)	43.3 (5.1)	2.3 (0.5)	6.1	6.0 (1.0)	16.0

## Everglades control site

<u>Avicennia germinans</u>	136.1 (17.7)	138.1 (17.1)	143.0 (18.6)	2.0 (1.6)	1.5	6.9 (2.1)	5.1
<u>Rhizophora mangle</u>	40.0 (6.4)	41.1 (6.5)	43.6 (6.9)	1.0 (0.5)	2.5	3.6 (0.7)	9.0
<u>Laguncularia racemosa</u>	83.2 (9.3)	85.7 (9.5)	88.1 (9.8)	2.5 (0.6)	3.0	4.8 (1.0)	5.8
All trees	66.4 (6.6)	68.0 (6.7)	70.8 (6.9)	1.6 (0.4)	2.4	4.4 (0.6)	6.6

Table 13. Mean tree diameter at breast height (SE), growth (SE), and percent growth for September 1973 and 1974 in the mangrove forest receiving sewage effluent at Naples, Florida. Trees are grouped according to size class for each species and for all species combined.

	Diameter, cm		Growth, cm	Percent growth
	Sept. 1973	Sept. 1974		
<u>Rhizophora mangle</u> <sup>a</sup>				
DBH $\leq$ 4 cm	1.79 (0.08)	2.35 (0.10)	0.56 (0.06)	31.3
4 < DBH $\leq$ 8 cm	6.26 (0.16)	6.50 (0.17)	0.24 (0.04)	3.8
8 < DBH $\leq$ 12 cm	9.16 (0.25)	9.56 (0.23)	0.40 (0.07)	4.4
DBH > 12 cm	13.4 (0.6)	13.7 (0.7)	0.30 (0.10)	2.2
Combined average				
<u>Laguncularia racemosa</u>				
DBH $\leq$ 4 cm	1.45 (0.27)	2.41 (0.23)	0.96 (0.15)	66.2
4 < DBH $\leq$ 8 cm	5.93 (0.24)	6.51 (0.23)	0.58 (0.12)	9.8

8 < DBH ≤ 12 cm	9.87 (0.25)	10.38 (0.27)	0.51 (0.07)	5.2
DBH > 12 cm	14.55 (0.50)	15.22 (0.50)	0.67 (0.08)	4.6
Combined average	8.20 (0.51)	8.85 (0.50)	0.65 (0.06)	7.9
<u>All species combined</u>				
DBH ≤ 4 cm	1.68 (0.12)	2.37 (0.10)	0.69 (0.07)	41.1
4 < DBH ≤ 8 cm	6.14 (0.13)	6.50 (0.14)	0.36 (0.05)	5.9
8 < DBH ≤ 12 cm	9.54 (0.17)	10.00 (0.19)	0.46 (0.05)	4.8
DBH > 12 cm	14.46 (0.46)	15.09 (0.47)	0.63 (0.07)	4.4
Combined average	6.67 (0.30)	7.18 (0.30)	0.51 (0.03)	7.6

<sup>a</sup>The diameters of Rhizophora mangie trees were measured 6-8 inches above the highest prop root.

Table 14. Mean tree diameter at breast height (SE), growth (SE), and percent growth for September 1973 and 1974 in the control forest at Naples, Florida. Trees are grouped according to size class for each species and for all species combined.

	Diameter, cm		Growth, cm	Percent growth
	Sept. 1973	Sept. 1974		
<u>Rhizophora mangle</u> <sup>a</sup>				
DBH $\leq$ 4 cm	3.61 (0.12)	3.76 (0.13)	0.15 (0.02)	4.2
4 < DBH $\leq$ 8 cm	5.13 (0.28)	5.27 (0.29)	0.14 (0.05)	2.7
8 < DBH $\leq$ 12 cm	8.7 (0)	8.8 (0)	0.1 (0)	1.1
DBH > 12 cm	---	---	---	---
Combined average	4.88 (0.30)	5.02 (0.31)	0.14 (0.02)	2.9
<u>Laguncularia racemosa</u>				
DBH $\leq$ 4 cm	---	---	---	---
4 < DBH $\leq$ 8 cm	5.93 (0.19)	6.14 (0.21)	0.21 (0.03)	3.5
8 < DBH $\leq$ 12 cm	9.71 (0.54)	10.01 (0.54)	0.30 (0.09)	3.1

DBH > 12 cm	12.57 (0.42)	13.10 (0.53)	0.53 (0.17)	4.2
Combined average	7.86 (0.52)	8.13 (0.52)	0.27 (0.04)	3.4
<u>All species combined</u>				
DBH $\leq$ 4 cm	3.61 (0.12)	3.76 (0.13)	0.15 (0.02)	4.2
4 < DBH $\leq$ 8 cm	5.53 (0.18)	5.70 (0.19)	0.17 (0.02)	3.1
8 < DBH $\leq$ 12 cm	9.60 (0.49)	9.87 (0.50)	0.27 (0.08)	2.8
DBH > 12 cm	12.57 (0.42)	13.10 (0.53)	0.53 (0.17)	4.2
Combined average	6.49 (0.38)	6.70 (0.39)	0.21 (0.03)	3.2

<sup>a</sup>The diameters of Rhizophora mangle trees were measured six inches above the highest prop root.

Table 15. Mean tree diameters at breast height (SE), growth (SE), and percent growth for September 1973 and 1974 in the mangrove forest receiving sewage effluent at Everglades City, Florida. Trees are grouped according to size class for each species and for all species combined.

	Diameter, cm		Growth, cm	Percent growth
	Sept. 1973	Sept. 1974		
<u>Rhizophora mangle</u> <sup>a</sup>				
DBH $\leq$ 4 cm	2.41 (0.13)	2.62 (0.14)	0.21 (0.03)	8.7
4 < DBH $\leq$ 8 cm	5.79 (0.33)	6.11 (0.34)	0.32 (0.05)	5.5
8 < DBH $\leq$ 12 cm	9.08 (0.32)	9.35 (0.44)	0.27 (0.19)	3.0
DBH > 12 cm	---	---	---	---
Combined average	3.72 (0.30)	3.96 (0.30)	0.24 (0.03)	6.5
<u>Laguncularia racemosa</u>				
DBH $\leq$ 4 cm	1.97 (0.38)	2.23 (0.35)	0.26 (0.06)	13.2
4 < DBH $\leq$ 8 cm	6.29 (0.24)	6.50 (0.26)	0.21 (0.05)	3.3
8 < DBH $\leq$ 12 cm	9.99 (0.38)	10.19 (0.37)	0.20 (0.06)	2.0
DBH > 12 cm	13.3 (0.15)	13.6 (0.36)	0.30 (0.21)	2.3
Combined average	6.35 (0.53)	6.57 (0.53)	0.22 (0.03)	3.5

Avicennia germinans

DBH $\leq$ 4 cm	2.91 (0.34)	2.99 (0.34)	0.08 (0.07)	2.7
4 < DBH $\leq$ 8 cm	6.55 (0.35)	6.65 (0.45)	0.10 (0.10)	1.5
8 < DBH $\leq$ 12 cm	10.13 (0.73)	10.28 (0.77)	0.15 (0.06)	1.5
DBH > 12 cm	---	---	---	---
Combined average	6.52 (1.12)	6.64 (1.13)	0.12 (0.04)	1.8

All species combined

DBH $\leq$ 4 cm	2.35 (0.13)	2.56 (0.13)	0.21 (0.02)	8.9
4 < DBH $\leq$ 8 cm	6.11 (0.19)	6.36 (0.20)	0.25 (0.03)	4.1
8 < DBH $\leq$ 12 cm	9.81 (0.28)	10.01 (0.28)	0.20 (0.05)	2.0
DBH > 12 cm	13.3 (0.15)	13.6 (0.36)	0.30 (0.21)	2.3
Combined average	5.00 (0.30)	5.23 (0.30)	0.23 (0.02)	4.6

<sup>a</sup>The diameters of Rhizophora mangle trees were measured six inches above the highest prop root.



Table 16. Mean tree diameter at breast height (SE), growth (SE), and percent growth for September 1973 and 1974 in the control forest at Everglades City, Florida. Trees are grouped according to size class for each species and for all species combined.

	Sept. 1973	Sept. 1974	Growth, cm	Percent growth
<u>Rhizophora mangle</u> <sup>a</sup>				
DBH $\leq$ 4 cm	2.68 (0.30)	2.69 (0.28)	0.01 (0.04)	0.4
4 < DBH $\leq$ 8 cm	5.93 (0.27)	6.04 (0.29)	0.11 (0.04)	1.9
8 < DBH $\leq$ 12 cm	9.80 (0.31)	9.96 (0.36)	0.16 (0.10)	1.6
DBH > 12 cm	14.7 (0)	14.7 (0)	0 (0)	0
Combined average	5.96 (0.46)	6.05 (0.47)	0.09 (0.03)	1.5
<u>Laguncularia racemosa</u>				
DBH $\leq$ 4 cm	---	---	---	---
4 < DBH $\leq$ 8 cm	6.88 (0.34)	6.92 (0.33)	0.04 (0.04)	0.6
8 < DBH $\leq$ 12 cm	9.96 (0.34)	10.20 (0.33)	0.24 (0.05)	2.4
DBH > 12 cm	13.22 (0.40)	13.34 (0.43)	0.12 (0.04)	0.9
Combined average	9.89 (0.54)	10.03 (0.54)	0.14 (0.03)	1.4

Avicennia germinans

DBH $\leq$ 4 cm	1.08 (0.06)	1.07 (0.06)	-0.01 (0.01)	-0.9
4 < DBH $\leq$ 8 cm	---	---	---	---
8 < DBH $\leq$ 12 cm	9.80 (1.00)	10.05 (0.85)	0.25 (0.15)	2.6
DBH > 12 cm	14.7 (0.61)	14.78 (0.62)	0.08 (0.08)	0.5
Combined average	11.00 (1.81)	11.09 (1.82)	0.09 (0.06)	0.8

All species combined

DBH $\leq$ 4 cm	2.46 (0.29)	2.47 (0.28)	0.01 (0.04)	0.4
4 < DBH $\leq$ 8 cm	6.19 (0.23)	6.28 (0.24)	0.09 (0.03)	1.5
8 < DBH $\leq$ 12 cm	9.88 (.21)	10.08 (0.22)	0.20 (0.05)	2.0
DBH > 12 cm	13.96 (0.38)	14.06 (0.38)	0.10 (0.04)	0.7
Combined average	7.84 (0.45)	7.95 (0.45)	0.11 (0.02)	1.4

<sup>a</sup>The diameters of Rhizophora mangle trees were measured six inches above the highest prop root.

mangrove forest the tree diameter increases were highest for trees < 4 cm while trees from 4 to 8 cm showed the lowest increase. At the Naples control forest the highest diameter increases occurred among the larger trees with the small trees showing the lowest increase in diameter. At the Everglades City sewage-enriched forest, tree diameter increases were about the same for all size classes. The Everglades City control forest had the highest tree diameter increase in the 8 to 12 cm DBH size class and the lowest increase for trees of lower than 4 cm DBH.

Tables 17 to 20 show the average tree basal areas in September 1973 and in September 1974 for four diameter size classes. At the sewage-enriched forest and the control forest in Naples, the basal area increase was the highest for trees with DBH > 12 cm and lowest for trees of lower than 4 cm DBH. At Everglades City the forest receiving sewage effluent had the highest basal area increase for trees with DBH > 12 cm and the lowest for trees of lower than 4 cm DBH. Trees in the 8 to 12 cm DBH size class in the control forest had the highest basal area increase while trees of lower than 4 cm DBH had the lowest increase in basal area.

#### Litter fall

Figures 39 and 40 show the variation with time in the rate of leaf, wood, seed, and total litter fall for the Naples and Everglades City sewage-enriched sites. Figure 39a shows that for the Naples sewage-enriched forest, the rate of leaf fall for site 1A decreased

Table 17. Mean tree basal area (SE), growth (SE), and percent growth for September 1973 and 1974 in the mangrove forest receiving sewage effluent at Naples, Florida. Trees are grouped according to size class for each species and for all species combined.

	Basal area, cm <sup>2</sup>		Percent growth
	Sept. 1973	Sept. 1974	
<u>Rhizophora manglie</u>			
DBH $\leq$ 4 cm	2.7 (0.2)	4.6 (0.4)	70.4
4 < DBH $\leq$ 8 cm	31.7 (1.6)	34.3 (1.8)	8.2
8 < DBH $\leq$ 12 cm	66.4 (3.0)	72.5 (2.3)	9.2
DBH > 12 cm	141.3 (12.6)	147.8 (15.1)	4.6
Combined average	30.2 (2.8)	33.3 (2.9)	10.9
<u>Laguncularia racemosa</u>			
DBH $\leq$ 4 cm	2.6 (0.8)	5.3 (1.0)	103.8
4 < DBH $\leq$ 8 cm	29.2 (3.8)	35.1 (4.1)	20.2

8 < DBH ≤ 12 cm	77.5 (3.9)	85.8 (4.5)	8.3 (1.2)	10.7
DBH > 12 cm	153.5 (7.3)	168.2 (8.2)	14.7 (2.0)	9.6
Combined average	64.6 (6.1)	72.4 (6.6)	7.9 (0.8)	12.2
<u>All species combined</u>				
DBH ≤ 4 cm	2.7 (0.3)	4.8 (0.4)	2.2 (0.3)	81.5
4 < DBH ≤ 8 cm	30.7 (1.3)	34.6 (0.4)	3.8 (0.5)	12.4
8 < DBH ≤ 12 cm	72.4 (2.6)	79.6 (2.8)	7.3 (0.9)	10.1
DBH > 12 cm	152.4 (6.7)	166.3 (7.6)	13.9 (1.9)	9.1
Combined average	45.8 (3.4)	51.1 (3.7)	5.3 (0.4)	11.6

Table 18. Mean tree basal area (SE), growth (SE), and percent growth for September 1973 and 1974 in the control forest at Naples, Florida. Trees are grouped according to size class for each species and for all species combined.

	Basal area, cm <sup>2</sup>		growth, cm <sup>2</sup>	Percent growth
	Sept. 1973	Sept. 1974		
<u>Rhizophora mangle</u>				
DBH $\leq$ 4 cm	10.3 (0.6)	11.2 (0.8)	0.9 (0.2)	8.7
4 < DBH $\leq$ 8 cm	21.5 (2.6)	22.7 (2.9)	1.2 (0.4)	5.6
8 < DBH $\leq$ 12 cm	---	---	---	---
DBH > 12 cm	---	---	---	---
Combined average	18.3 (2.2)	19.4 (2.3)	1.1 (0.3)	6.0
<u>Laguncularia racemosa</u>				
DBH $\leq$ 4 cm	---	---	---	---
4 < DBH $\leq$ 8 cm	28.0 (1.8)	30.1 (2.0)	2.1 (0.4)	7.5

8 < DBH $\leq$ 12 cm	75.7 (8.5)	80.3 (8.8)	4.6 (1.3)	6.1
DBH > 12 cm	124.3 (8.4)	135.2 (11.0)	10.9 (3.6)	8.8
Combined average	53.8 (7.2)	57.7 (7.8)	3.9 (0.8)	7.2

All species combined

DBH $\leq$ 4 cm	10.3 (0.6)	11.2 (0.8)	0.9 (0.2)	8.7
4 < DBH $\leq$ 8 cm	24.7 (1.6)	26.4 (1.9)	1.7 (0.3)	6.9
8 < DBH $\leq$ 12 cm	75.7 (8.5)	80.3 (8.8)	4.6 (1.3)	6.1
DBH > 12 cm	124.3 (8.4)	135.2 (11.0)	10.9 (3.6)	8.8
Combined average	37.9 (4.8)	40.6 (5.2)	2.7 (0.5)	7.1

Table 19. Mean tree basal area (SE), growth (SE), and percent growth for September 1973 and 1974 in the mangrove forest receiving sewage effluent at Everglades City, Florida. Trees are grouped according to size class for each species and for all species combined.

	Basal area, cm <sup>2</sup>		Growth, cm <sup>2</sup>	Percent growth
	Sept. 1973	Sept. 1974		
<u>Rhizophora mangle</u>				
DBH $\leq$ 4 cm	5.1 (0.5)	6.0 (0.6)	0.9 (0.1)	17.6
4 < DBH $\leq$ 8 cm	27.5 (3.0)	30.5 (3.3)	3.1 (0.5)	11.3
8 < DBH $\leq$ 12 cm	64.9 (4.7)	69.1 (6.5)	4.2 (2.8)	6.5
DBH > 12 cm	---	---	---	---
Combined average	14.7 (2.3)	16.4 (2.5)	1.7 (0.3)	11.6
<u>Laguncularia racemosa</u>				
DBH $\leq$ 4 cm	4.3 (1.4)	5.0 (1.4)	0.7 (0.2)	16.3
4 < DBH $\leq$ 8 cm	32.0 (2.3)	34.3 (2.7)	2.3 (0.5)	7.2
8 < DBH $\leq$ 12 cm	79.3 (5.9)	82.4 (5.9)	3.0 (0.9)	3.8
DBH > 12 cm	138.9 (3.2)	145.5 (7.6)	6.5 (4.5)	4.7
Combined average	41.2 (5.7)	43.5 (6.0)	2.3 (0.4)	5.6



Avicennia germinans

DBH $\leq$ 4 cm	6.9 (1.7)	7.3 (1.8)	0.4 (0.3)	5.8
4 < DBH $\leq$ 8 cm	33.8 (3.6)	34.9 (4.7)	1.1 (1.1)	3.3
8 < DBH $\leq$ 12 cm	81.8 (11.1)	84.3 (11.7)	2.5 (1.1)	3.1
DBH > 12 cm	---	---	---	---
Combined average	42.2 (12.0)	43.6 (12.4)	1.4 (0.5)	3.3

All species combined

DBH $\leq$ 4 cm	5.1 (0.5)	5.9 (0.5)	0.8 (0.1)	15.7
4 < DBH $\leq$ 8 cm	30.3 (1.8)	32.9 (2.0)	2.6 (0.4)	8.6
8 < DBH $\leq$ 12 cm	76.5 (4.3)	79.7 (4.4)	3.2 (0.8)	4.2
DBH > 12 cm	138.9 (3.2)	145.5 (7.6)	6.5 (4.5)	4.7
Combined average	27.5 (3.0)	29.4 (3.1)	1.9 (0.2)	6.9

Table 20. Mean tree basal area (SE), growth (SE), and percent growth for September 1973 and 1974 in the control forest at Everglades City, Florida. Trees are grouped according to size class for each species and for all species combined.

	Basal area, cm <sup>2</sup>		Growth, cm <sup>2</sup>	Percent growth
	Sept. 1973	Sept. 1974		
<u>Rhizophora mangle</u>				
DBH $\leq$ 4 cm	6.5 (1.3)	6.4 (1.2)	0.0 (0.2)	0
4 < DBH $\leq$ 8 cm	28.8 (2.5)	30.0 (2.8)	1.2 (0.4)	4.2
8 < DBH $\leq$ 12 cm	76.0 (4.8)	78.7 (5.5)	2.6 (1.5)	3.4
DBH > 12 cm	---	---	---	---
Combined average	35.1 (5.1)	36.1 (5.2)	1.1 (0.4)	3.1
<u>Laguncularia racemosa</u>				
DBH $\leq$ 4 cm	---	---	---	---
4 < DBH $\leq$ 8 cm	37.7 (3.6)	38.2 (3.6)	0.5 (0.4)	1.3
8 < DBH $\leq$ 12 cm	78.7 (5.3)	82.3 (5.2)	3.0 (0.8)	3.8
DBH > 12 cm	138.0 (8.6)	140.7 (9.4)	2.7 (0.9)	2.0
Combined average	82.2 (8.6)	84.5 (8.8)	2.3 (0.5)	2.8

Avicennia germinans

DBH $\leq$ 4 cm	0.9 (0.1)	0.9 (0.1)	0	0
4 < DBH $\leq$ 8 cm	---	---	---	---
8 < DBH $\leq$ 12 cm	76.2 (15.4)	79.9 (13.4)	3.7 (2.0)	4.9
DBH > 12 cm	171.2 (14.5)	173.2 (14.8)	2.0 (1.8)	1.2
Combined average	118.1 (24.7)	120.1 (24.8)	1.9 (1.2)	1.6

All species combined

DBH $\leq$ 4 cm	5.7 (1.2)	5.7 (1.1)	0.0 (0.2)	0
4 < DBH $\leq$ 8 cm	31.3 (2.2)	32.2 (2.3)	1.0 (0.3)	3.2
8 < DBH $\leq$ 12 cm	77.3 (3.4)	80.5 (3.5)	3.2 (0.7)	4.1
DBH > 12 cm	154.5 (8.5)	156.7 (8.7)	2.2 (0.9)	1.4
Combined average	60.5 (6.0)	62.1 (6.1)	1.6 (0.3)	2.6

Figure 39. Litter fall from September 1973 to September 1974 in a mangrove forest receiving sewage effluent from the sewage treatment plant in Naples, Florida; (a) leaf fall; (b) seed fall; (c) wood fall; (d) total litter fall.

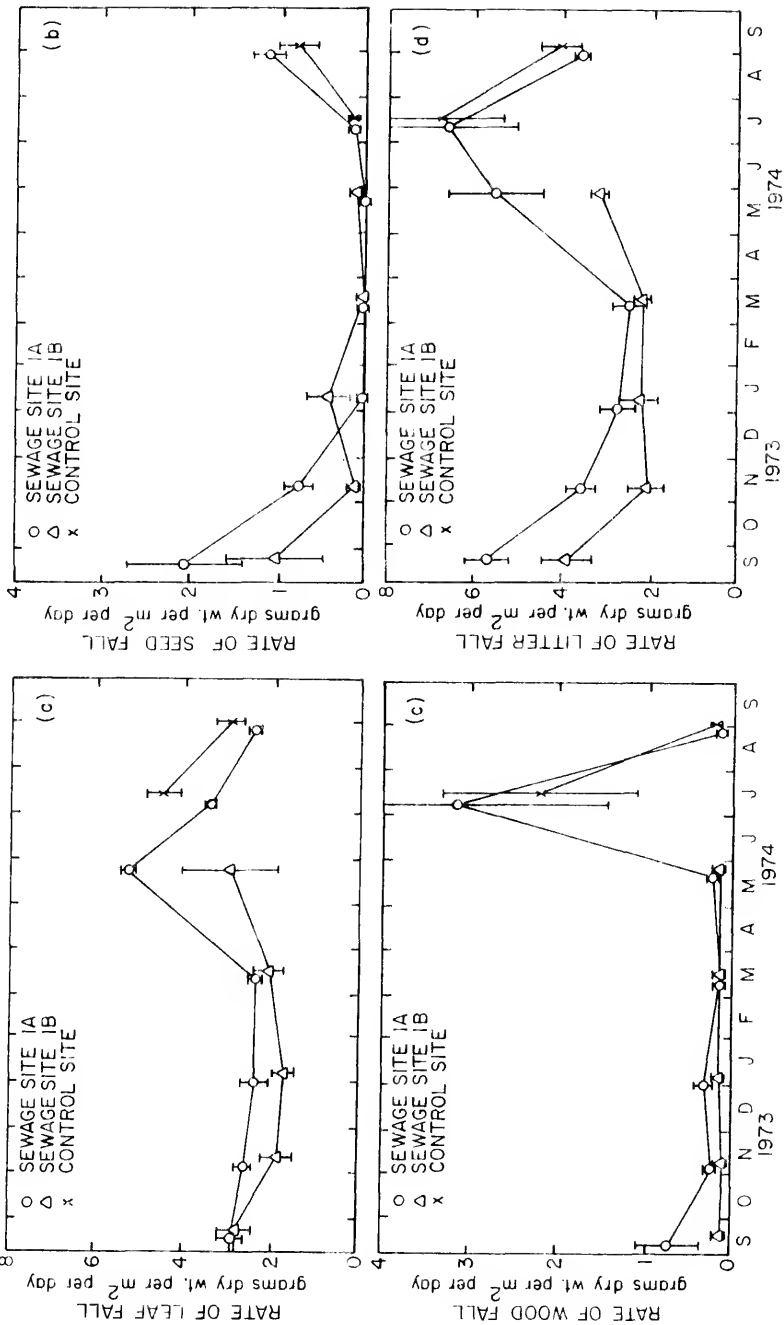
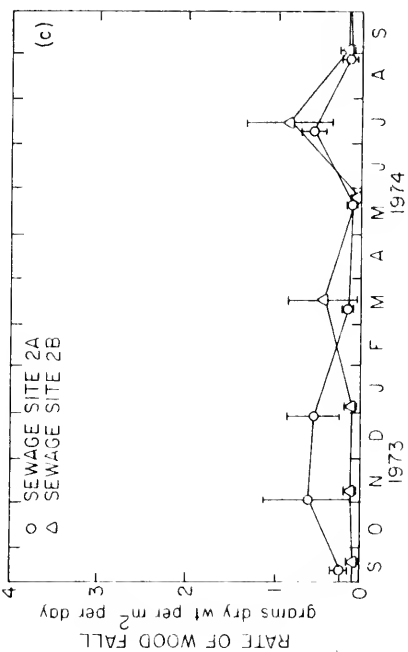
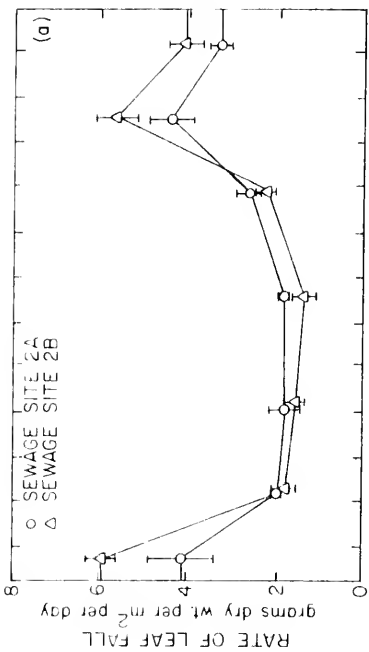
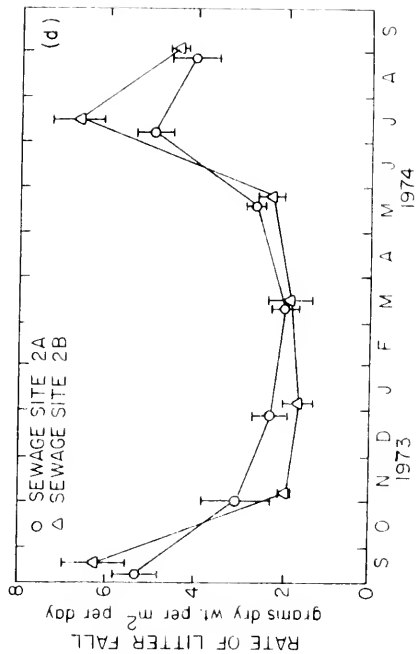
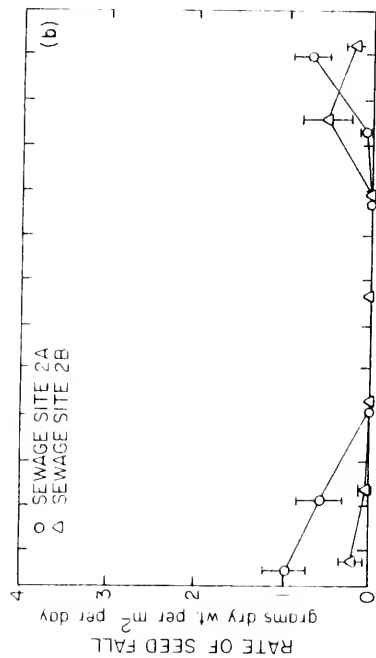

Figure 40. Litter fall from September 1973 to September 1974 in a mangrove forest receiving sewage effluent from the sewage treatment plant in Everglades City, Florida; (a) leaf fall; (b) seed fall; (c) wood fall; (d) total litter fall.



slightly from September to March and then increased to its highest rate at the beginning of June. The rate of fall then decreased again during the summer months to a rate in September 1974 that was nearly the same as the rate in September 1973. For site 1B in the sewage-enriched forest the rates of fall were generally lower than in site 1A but followed a similar pattern with time. In June the collection baskets at site 1B were moved to the Naples control site. During the three months of litter collection, the rate of leaf fall in the control site paralleled the rate in site 1A but at slightly higher values. Figure 40a shows that at Everglades City the rates of leaf fall were similar for both of the collection sites. Both Everglades City sites had high rates of leaf fall in September, followed by a sharp decrease during October and November. The rates then remained fairly steady until late March when the rate of fall began to increase until the highest value was reached in July. A decrease in the rate of fall was observed during the remaining summer months. The rates of leaf fall in September 1974 were slightly lower than the rates in September 1973 for each site. The annual leaf fall ranged from 957 to 1032 g/m<sup>2</sup> for Everglades City and from 744 to 1053 g/m<sup>2</sup> for Naples.

Figures 39b and 40b show the rates of seed fall observed during the study. Figure 39 shows that Naples site 1A had a high rate of seed fall during September 1973 and that seed fall gradually decreased to zero by January. The rate of seed fall remained at zero until July when there was a small amount of seed fall. The rate was high again in September 1974. Site 1B followed a similar pattern



except that there was a rise in seed fall in January. The control site was very similar to site 1A for its three-month sampling period. Figure 40b shows that at Everglades City site 2A also had a high rate of seed fall during September and October of 1973 but by January no seeds were dropping and the pattern remained this way until September 1974. Site 2B exhibited lower rates of seed fall than site 2A except for the July collection period. The annual amount of seed fall ranged from 76 to 161 g/m<sup>2</sup> for Naples and from 43 to 96 g/m<sup>2</sup> for Everglades City.

The rates of wood fall are shown in Figures 39c and 40c. In Figure 39c Naples site 1A had low rates of observed wood fall during the study except for a large fall in July. The control site also exhibited a high rate of fall in July followed by a sharp decrease in September. Site 1B had its highest rate of wood fall in September 1973. Everglades City sewage sites also exhibited low rates of wood fall as shown in Figure 40c. Site 2A did show a slight increase in wood fall during November and December and again in July while site 2B showed a slight increase in March and a larger increase in July. The annual amount of wood fall ranged from 109 to 122 g/m<sup>2</sup> for Everglades City and from 59 to 229 g/m<sup>2</sup> for Naples.

The combined rates of leaf, wood, and seed fall are shown in Figures 39d and 40d. Figure 39d shows that Naples sites 1A and 1B followed a similar pattern but that site 1B was always lower than site 1A. The control site rate of total litter fall during the three-month collection period was very similar to that of site 1A. Figure

40d shows that at Everglades City, the two sites were very similar except for the July period. When all the litter was combined, the maximum rate of fall occurred during July at both Naples and Everglades City. Also both places had about the same rate of fall during most of the year. The annual amount of total litter fall ranged from 908 to 1443 g/m<sup>2</sup> for Naples and from 1175 to 1183 g/m<sup>2</sup> for Everglades City. The actual rates and amounts are given in Tables G-7, G-8, G-9, and G-10.

#### Total phosphorus in water column

The concentration of total phosphorus in the Gordon River waters were measured as it flowed by the Naples sewage treatment plant. Samples were taken at infrequent intervals between September 1973 and February 1975. Figure 41 shows the average values for total phosphorus at various points in the Gordon River. At the point where the sewage effluent is discharged into the river, the phosphorus concentration averaged 1.81 mg/l with a range from 0.92 mg/l to 4.00 mg/l. The concentration dropped sharply as the sewage effluent was diluted by the river water. The concentrations were higher on the downstream side than on the upstream side of the sewage outfall. Along the river bank the average concentration a short distance upstream from the outfall was 0.09 mg/l while the average downstream concentration was 0.23 mg/l. The mangrove island was about 50 meters from the sewage outfall and the phosphorus concentrations in the waters around the island ranged from 0.21 to 0.34 mg/l. The upstream

Figure 41. Map of the study sites at Naples showing the average total phosphorus concentration in the waters of the Gordon River at the point of discharge of sewage effluent and other selected locations along the river. Samples were taken between September 1973 and February 1975.

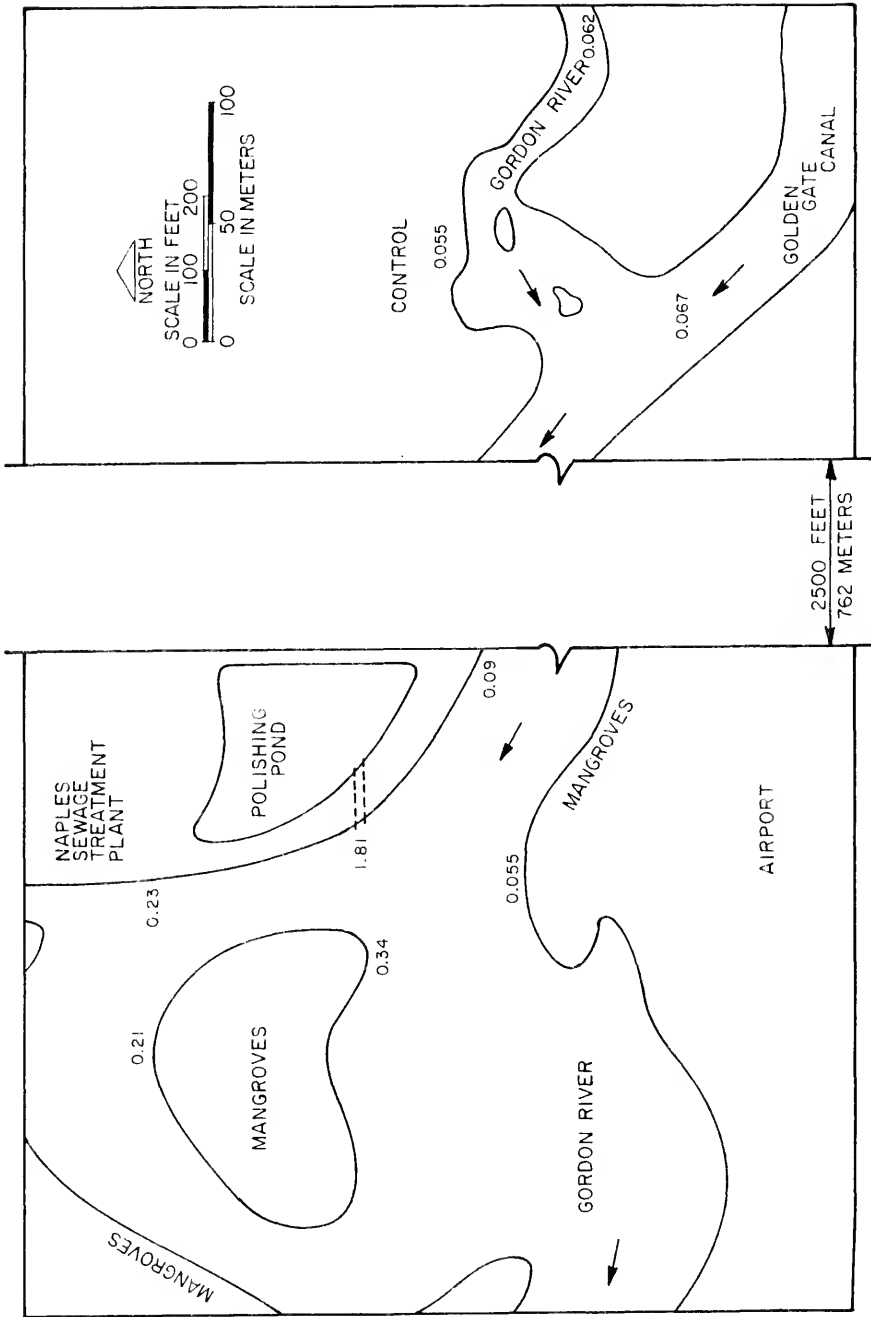

control site had an average phosphorus concentration of 0.055 mg/l. The control site was located near the junction of the Gordon River and the Golden Gate canal. The average concentration for the Gordon River was 0.062 mg/l while the average concentration for Golden Gate canal was 0.067 mg/l. On the other side of the Gordon River across from the sewage outfall (about 200 m) the phosphorus concentration was 0.055 mg/l or about the same as the control site.

A tidal canal flows past the Everglades City sewage treatment plant on its way to Chokoloskee Bay and the concentration of total phosphorus was measured at several points at and near the sewage outfall.

Figure 42 shows the average values for total phosphorus in the canal waters. At the sewage outfall the average phosphorus concentration was 0.48 mg/l with a range from 0.106 to 0.83 mg/l. At the control site the phosphorus concentration averaged 0.071 mg/l. The phosphorus concentrations dropped quickly as distance from the sewage outfall increased. A short distance upstream from the outfall the concentration of phosphorus decreased to 0.081 mg/l and downstream from the effluent discharge it was 0.049 mg/l. The low volume of sewage effluent discharged from the treatment plant probably accounted for the rapid decrease in phosphorus concentration. A large dilution factor appeared to lower the effect of the sewage effluent on the total phosphorus concentration in the tidal canal. The data used to generate the averages presented in Figures 40 and 41 are summarized in Table G-11.

Figure 42. Map of the study sites at Everglades City showing the average total phosphorus concentration in the waters of a tidal canal at the point of discharge of sewage effluent and other selected locations along the canal. The control area phosphorus concentration was in a natural tidal creek. Samples were taken between September 1973 and February 1975.

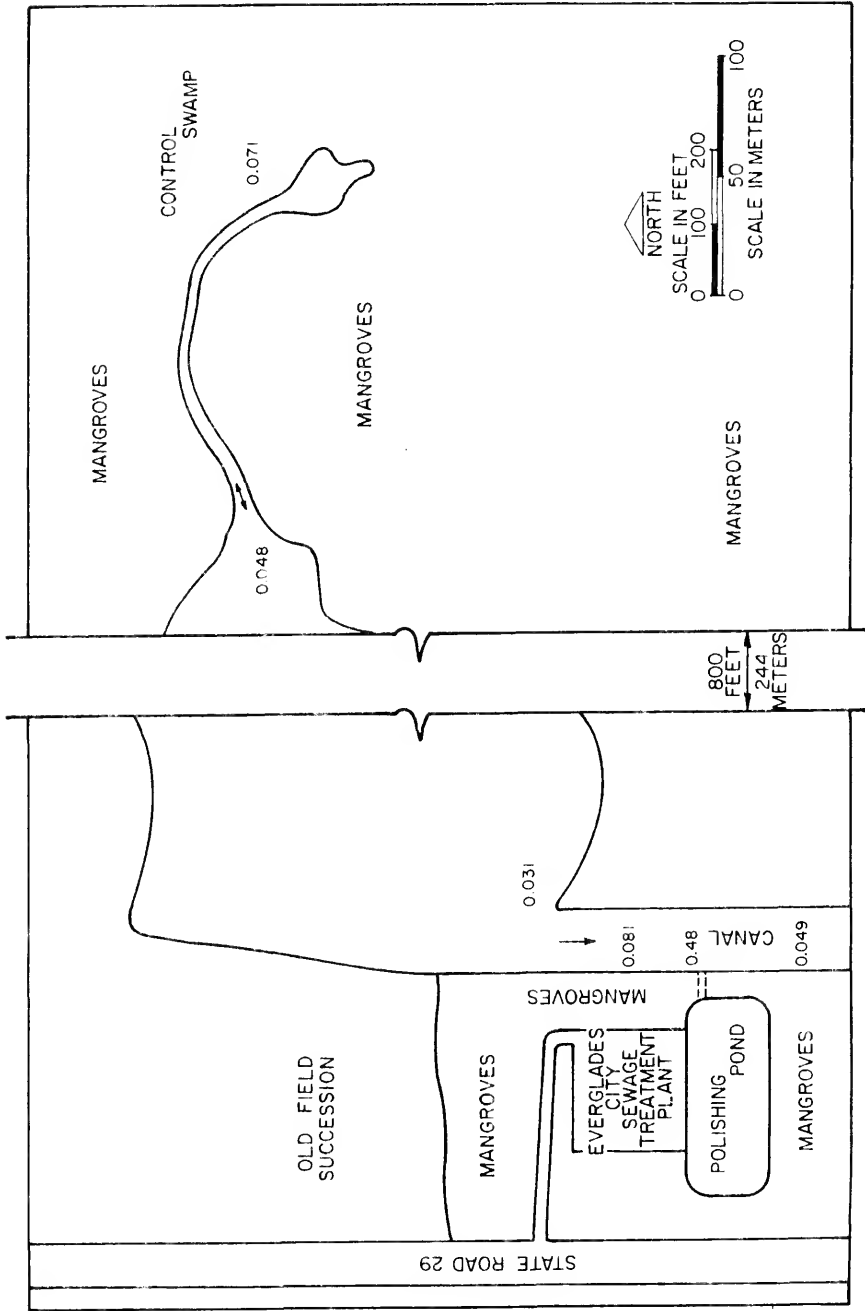

Phosphorus in mangrove wood and leaves

Table 21 contained the concentrations of phosphorus found in the leaves and wood of the mangrove trees at the Naples and Everglades City study sites. Except for the Everglades City site that received sewage effluent the leaves had higher amounts of phosphorus than the wood. Phosphorus concentration in the wood of the trees receiving sewage was generally higher than in the control trees, but the small number of samples taken make it difficult to judge whether this difference could be significant.



Table 21. Concentration of phosphorus (ppm) in mangrove wood and leaves at the Naples and Everglades City study sites. Standard error of mean is shown in parentheses.

	Leaves	Wood
Naples control	1550 1750 1120 <u>1120</u>	900 1250 1260 <u>1190</u>
Mean (SE)	1380 (160)	1150 (65)
Naples sewage	1400 1900 1120 <u>1110</u>	1250 1400 1200 <u>1150</u>
Mean (SE)	1380 (185)	1250 (55)
Everglades City control	990 <u>1010</u>	920 <u>920</u>
Mean (SE)	1000 (10)	920 (0)
Everglades City sewage	1400 1500 1230 <u>1250</u>	1750 1900 1250 <u>1260</u>
Mean (SE)	1340 (65)	1540 (165)

## DISCUSSION

Field measurements and simulation of models showed effects of stress, recovery, and management alternatives.

### Herbicide and Recolonization of Mangroves in South Vietnam

In the Rung-Sat district of South Vietnam, nutrient availability was originally considered as a factor that may be affecting mangrove recovery. In Figure 7 four rates of gross primary productivity were used to represent various amounts of nutrient availability. The curves in this figure suggested that when nutrients were plentiful the biomass of a mangrove forest may be larger than when nutrients are scarce. Although the model of herbicide effects implied that higher nutrient availability means higher biomass this hypothesis need not be necessarily true for all mangrove forests. Hurricanes, high salinity, poor tidal flushing, low-temperatures, or management for cutting may prevent a mangrove forest from reaching its full potential. Total structure is a balance between productive processes and those which consume and eliminate structure. Simulated biomass values at steady state ranged from 2000 g/m<sup>2</sup> at low primary productivity to 9800 g/m<sup>2</sup> at high primary productivity. In Thailand, Banijbatana (1957) reported a yield

for mangrove forests of  $10,000 \text{ g/m}^2$ , and Cruz and Banaag (1967) measured a biomass of  $4600 \text{ g/m}^2$  for mangroves in the Philippines. Lugo and Snedaker (1974b) reported mangrove biomass values ranging from 800 to  $17,400 \text{ g/m}^2$  for mangrove forests in Florida. Golley (1974) reported a standing crop of  $28,000 \text{ g/m}^2$  for Panamanian mangroves. In Puerto Rico, Golley, Odum, and Wilson (1962) measured a standing crop of  $5000 \text{ g/m}^2$  for a mangrove swamp. The simulated biomass ranges for the Rung-Sat mangroves approximated much of the range in biomass found elsewhere in the world. The exception appeared to be where tropical storms did not occur. The time required to reach steady state ranged from 8-13 years when initial biomass was  $5000 \text{ g/m}^2$ .

In the Rung-Sat, low biomass values were characteristic of areas with species of Cerriops, a bush-type mangrove that can colonize disturbed areas. Higher biomass values represent areas colonized by species of Rhizophora.

Woodcutters have been an important factor in sculpturing the landscape of the mangrove forests of Southeast Asia for some time. In Figure 8 the normal cutting cycle of about 30 years causes only a slight reduction in mangrove biomass. At a cutting cycle of 3 years, the mangrove biomass was reduced to  $5000 \text{ g/m}^2$  at a gross primary productivity of  $14 \text{ g/m}^2 \cdot \text{day}$  and  $3000 \text{ g/m}^2$  at a gross primary productivity of  $7 \text{ g/m}^2 \cdot \text{day}$ . The coefficient for the cutting pathway (C) is dependent on other factors such as market, population pressure, and management plans. Very high cutting rates were observed by refugees in 1973.

The high cutting rates may delay or even prevent the full recovery of the sprayed mangrove areas by removing mangrove trees before maturity. The recovery rate would then remain dependent on outside seed sources.

An interesting outcome of high rates of cutting is that the resulting mangrove trees would probably be undesirable for use as charcoal. The trees highly prized for charcoal such as Rhizophora sp. would be continually selected against by the woodcutters and the poorer quality trees such as Cerriops sp. would proliferate.

The extensive spraying of the mangrove forests in the Rung-Sat was best approximated by curve A in Figure 6. The total amount of herbicide sprayed during the simulation was 3.5 million liters which was reasonably close to the actual amount of 3.9 million liters of herbicide. In the simulation, the effect of increasing the spraying was to produce more bare land. By decreasing the primary productivity and holding the amount of herbicide constant, more bare land could be produced.

Figures 9a, 10a, and 11a indicated that for the lowest intensity of herbicide application the recovery of the mangrove forest seemed to be independent of gross primary productivity. At other spraying intensities, however, the rate of recovery was dependent on gross primary productivity. For example, in Figure 9a, the effect of high intensity spraying and low productivity combined to give curve F which indicated a mangrove recovery time in excess of 100 years. In Figure 12a,

the effect of a high level of spraying and a high productivity combined to reduce the recovery time to about 55 years. Steady state biomass values were generally attained slightly before the land had fully recovered. The reasons for this are not fully understood. A summary of the effect of spraying and primary productivity on recovery times required for recolonization of the land and mangrove biomass at steady state is given in Table 22.

In a model by Zieman et al. (1972) on mangrove succession in southeast Asia, the maximum biomass of about  $24,000 \text{ g/m}^2$  for Rhizophora mucronata was reached in about 30 years using a net productivity of  $9.6 \text{ g/m}^2 \cdot \text{day}$ . This biomass value was much higher than that obtained from the simulations in this study apparently because they used net primary productivity where this model used gross primary productivity. In the model simulated in this dissertation (Figure 5) net primary productivity was about 50% of gross primary productivity. With wood-cutting the model in this dissertation indicated that at a gross primary productivity of  $14 \text{ g/m}^2 \cdot \text{day}$ , a mangrove biomass of  $7200 \text{ g/m}^2$  was reached in 40 years following heavy spraying. In the model by Zieman et al. (1972) a biomass of  $7200 \text{ g/m}^2$  was reached in about 15 years. This difference was probably due largely to the differences in the estimated net growth rate chosen by each author. In this dissertation an increase in productivity generally reduced recovery time. This may be explained by a more productive forest producing more seedlings that would then colonize more land. In the model by Zieman et al. (1972) increasing

Table 22. Time in years required for recolonization of land at five rates of spraying and three rates of mangrove primary productivity. The time required for mangrove biomass to return to steady state is also given.

Amount of herbicide sprayed liters (liters/ha)	Primary productivity					
	3.5 g/m <sup>2</sup> ·day		7 g/m <sup>2</sup> ·day		14 g/m <sup>2</sup> ·day	
	Land	Mangrove biomass	Land	Mangrove biomass	Land	Mangrove biomass
0.16 × 10 <sup>6</sup> (2.1)	45	10	25	10	10	10
0.45 × 10 <sup>6</sup> (6.0)	70	35	40	20	20	13
0.89 × 10 <sup>6</sup> (11.9)	90	55	50	34	30	22
1.7 × 10 <sup>6</sup> (22.7)	>100	75	60	50	40	28
3.5 × 10 <sup>6</sup> (46.7)	>100	>100	90	75	55	40

net primary productivity reduced the time required for *R. mucronata* to reach maximum standing crop. This occurred in the model because the increase in growth rate was not accompanied by an increase in the maximum biomass value. Therefore, less time was required to reach this value.

Miller, Ehleringer, Hynum, and Stoner (1974) also used net productivity in their model of the recolonization problem in South Vietnam and found biomass values of  $2000 \text{ g/m}^2$  after 20 years where no factors were limiting growth and starting biomass was zero. The model in this dissertation developed a biomass of  $2000 \text{ g/m}^2$  after 20 years at a gross primary productivity somewhere between 7 and  $14 \text{ g/m}^2 \cdot \text{day}$ . An increase in soil temperature of  $1^\circ\text{C}$  reduced mangrove biomass to  $1000 \text{ g/m}^2$  after 20 years in the model of Miller, Ehleringer, Hynum, and Stoner (1974). At a primary productivity of  $7 \text{ g/m}^2 \cdot \text{day}$  in Figure 10b, mangrove biomass reached  $1000 \text{ g/m}^2$  after 13 years, but also began with an initial biomass of  $500 \text{ g/m}^2$ . Low primary productivity in this model could be used to approximate comparisons with the increased temperature for the model of Miller, Ehleringer, Hynum, and Stoner (1974).

Another variable that could very easily be the single most important factor limiting mangrove recolonization is the availability of seedlings to colonize the bare areas. Photographs of the sprayed areas in 1973 support the hypothesis that lack of seedlings was limiting recovery. In these photographs, seedling density was estimated by Odum et al. (1974) as one seedling/ $62 \text{ m}^2$ . Figure 13 indicated that

the rate of recolonization was slowed substantially as seedling availability was reduced. If seedling scarcity is the primary reason for the slow rate of recolonization, then why not plant seedlings?

Figure 14 suggests that planting mangrove seedlings will speed the rate of recolonization. However, artificial revegetation of these sprayed areas would be a formidable task. To achieve a successful planting rate of 37 seedlings/ha·year a total of approximately 22 million seedlings would eventually have to be planted on the 60,000 ha of bare land in the Rung-Sat. Based on an average mangrove forest having 7 seedlings/m<sup>2</sup> hanging from trees, this would require about 300 ha of mangrove forest to supply the seeds.

In South Vietnam the mangroves of the Camau peninsula also were heavily defoliated by herbicide spraying. According to the National Academy of Sciences (1974) 1.3 million liters of herbicide were sprayed on the Camau mangroves. This represents an area of 46,000 ha at the recommended dosage of 28 liters/ha. Many mangrove areas were treated more than once and the area sprayed was rounded off to 40,000 ha. Simulation curves were generated for the Rung-Sat district and the Camau peninsula at two rates of gross primary productivity and two densities of seedling availability.

The number of seedlings available at steady state varied depending on the biomass. The output of the model indicated that a normal value for seedlings ranged from 0.3-1.0 seedlings/m<sup>2</sup>·year. Using these seedling densities, the simulations of Figure 43 indicated that



Figure 43. Simulation of effect of seedling availability on the recovery of sprayed mangroves in the Rung-Sat district and in the Camau peninsula of South Vietnam; (a) normal seedling availability; (b) seedling availability reduced by 50 percent.

Curve 1 - Gross primary productivity of  $7 \text{ g/m}^2 \cdot \text{day}$  for Rung-Sat.

Curve 2 - Primary productivity of  $7 \text{ g/m}^2 \cdot \text{day}$  for Camau.

Curve 3 - Primary productivity of  $7 \text{ g/m}^2 \cdot \text{day}$  for Rung-Sat.

Curve 4 - Primary productivity of  $14 \text{ g/m}^2 \cdot \text{day}$  for Camau.

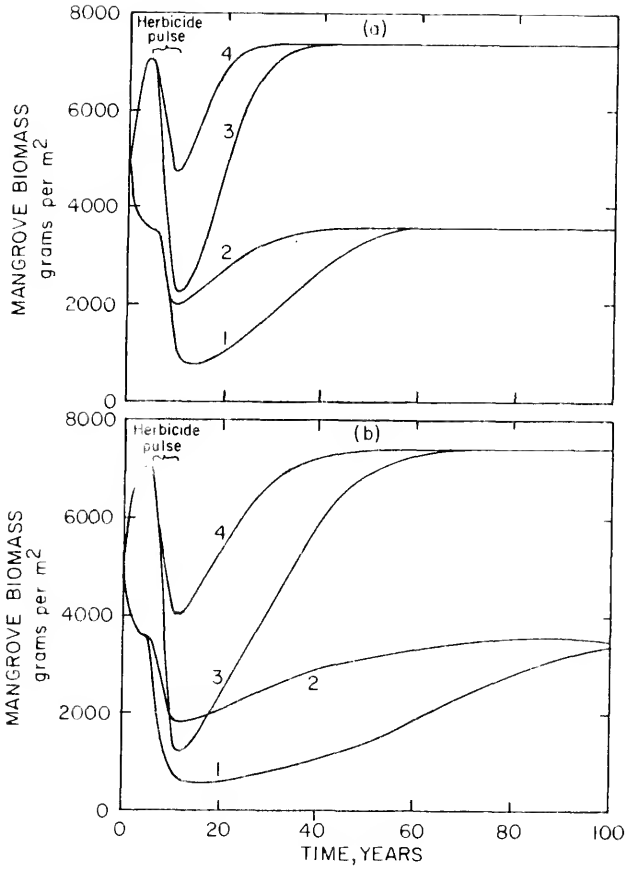

seedling availability is important to recovery as is nutrient availability. Under conditions of normal seedling availability, and a gross primary productivity of  $7 \text{ g/m}^2 \cdot \text{day}$ , Rung-Sat mangroves take 50 years to recover but at 50% of normal seedling availability and a gross primary productivity of  $14 \text{ g/m}^2 \cdot \text{day}$  recovery was slowed to 70 years. Even though the primary productivity was doubled, the recovery time was longer because the seedling availability was reduced by 50%. Camau mangroves took 30 years and 55 years, respectively. Camau forests are shown to recover faster than Rung-Sat forests primarily because the spraying was not as intensive and local seedling sources were available.

In the model of Miller, Ehleringer, Hynum, and Stoner (1974) a 40% reduction in seedling availability only reduced the 20-year biomass value about 9% but in the model presented here the reduction was about 50%. These authors found high temperature as a highly important factor in the rate of reforestation, while this study indicated availability of seedlings and primary productivity as affecting the rate. Golley (1971) measured a density of only 1 seedling/50  $\text{m}^2$  floating in the waterways of the Rung-Sat which supports the lack of seedlings hypothesis.

Soil temperatures in frequently flooded areas of the Rung-Sat were reported by Ross (1974) to be in the normal range for seedling growth. However, higher soil temperatures may occur where flooding is infrequent and thus create conditions unfavorable for mangrove

seedling growth. Evidence for slow mangrove seedling establishment where tidal flushing is poor was observed at Marco Island, Florida. Here, an area was cleared of mangroves by cutting. Recolonization was very rapid for the area except for a small strip that was infrequently flooded by the tides. This strip had changed very little even at 3 years after cutting, even though the uncut mangrove forest forms one of the edges. A few small seedlings were established and growing in the strip which suggested that soil temperature and even soil salinity were not excessively high. The observations suggest that very few seedlings are making it back to this strip. The temperature may be high enough during the summer months to hinder germination but this does not coincide with the maximum rate of seedfall in October and November. Planting experiments by those making the study for the National Academy of Sciences (1974) showed low seedling survival in sprayed areas was not a result of herbicide persistence, but rather the size of the sprayed area and the time of year seedlings were planted. The typhoons that frequently occur in southeast Asia may eventually play a significant role in mangrove recolonization by scattering mangrove seeds to the infrequently flooded areas that would be flooded during a storm surge.

### Herbicide and Mangrove Succession in Florida

The herbicide spraying of mangroves in Florida was performed on a much smaller scale than in South Vietnam. Here the area was in terms of hundreds of square meters rather than hundreds of square kilometers. Also, the sprayed sites were surrounded by healthy mangroves and the local source of seedlings was dominant when compared to the outside seed source. These species were similar to related species in Vietnam with respect to sensitivity to herbicide, but recolonization seemed to be more rapid. R. mangle in general was completely defoliated by spraying and after a year showed no growth. Later site inspections indicated that no new leaves were being grown and that these trees were dead. L. racemosa was also completely defoliated but coppiced from the base of the tree. The new growth eventually died and the trees showed no diameter increases after 1 year. A. germinans was never completely defoliated and in one of the sprayed sites, growth increase was equivalent to the control. Growth of A. germinans was negligible in the other sprayed areas.

The most noticeable effects of the herbicide application occurred two to three weeks after initial spraying. At this time large numbers of green and yellow leaves began to fall to the ground. This can be observed in Figures 38a and 38b. In these sprayed areas, Teas and Kelly (1974) measured leaf fall ranging from 350 to 560 g/m<sup>2</sup> in the spray plots and at 160 g/m<sup>2</sup> in the control. By May (about 5 months after spraying) the leaf counts in the sprayed sites were similar to those at the control site.

At the end of a year the number of dead seedlings/m<sup>2</sup> in the sprayed sites had declined to control site numbers. The high initial number may have been caused by a combination of (1) the herbicide spray and/or (2) the trampling of heavy feet in the study areas. The most obvious change was the exponential decay in the number of dead seedlings during the first year after spraying.

The high number of live seedlings initially may have been a result of counting seedlings that looked healthy right after spraying but later succumbed to the initial spraying. Between 5 months and 20 months the number of live seedlings suddenly increased to about 9/m<sup>2</sup>. Herbicide application apparently caused a 2-year lag in recolonization in seedlings. An area that was cleared of mature mangroves seemed to have about an 8-month time lag in recolonization that was probably due largely to the seasonality of the fall of black and white mangrove seedlings from the trees. Most of the increase in seedling density in the sprayed areas resulted from an influx of black mangrove seedlings. This reflects the presence of mature black mangroves in the sprayed sites.

The snail population gradually declined during the first year after spraying which may have been due to a drop in detritus as a result of the herbicide spraying. The snail population of the control area also showed a decline from May 1973 to January 1974 but recovered during the next year. Snail population seemed to be maintained at about 25% of the prespraying population. The population of snails in the cleared area remained very low during the study. The initially

Figure 44. Model of the interaction between herbicide and the mangrove forest on Marco, Island, Florida.

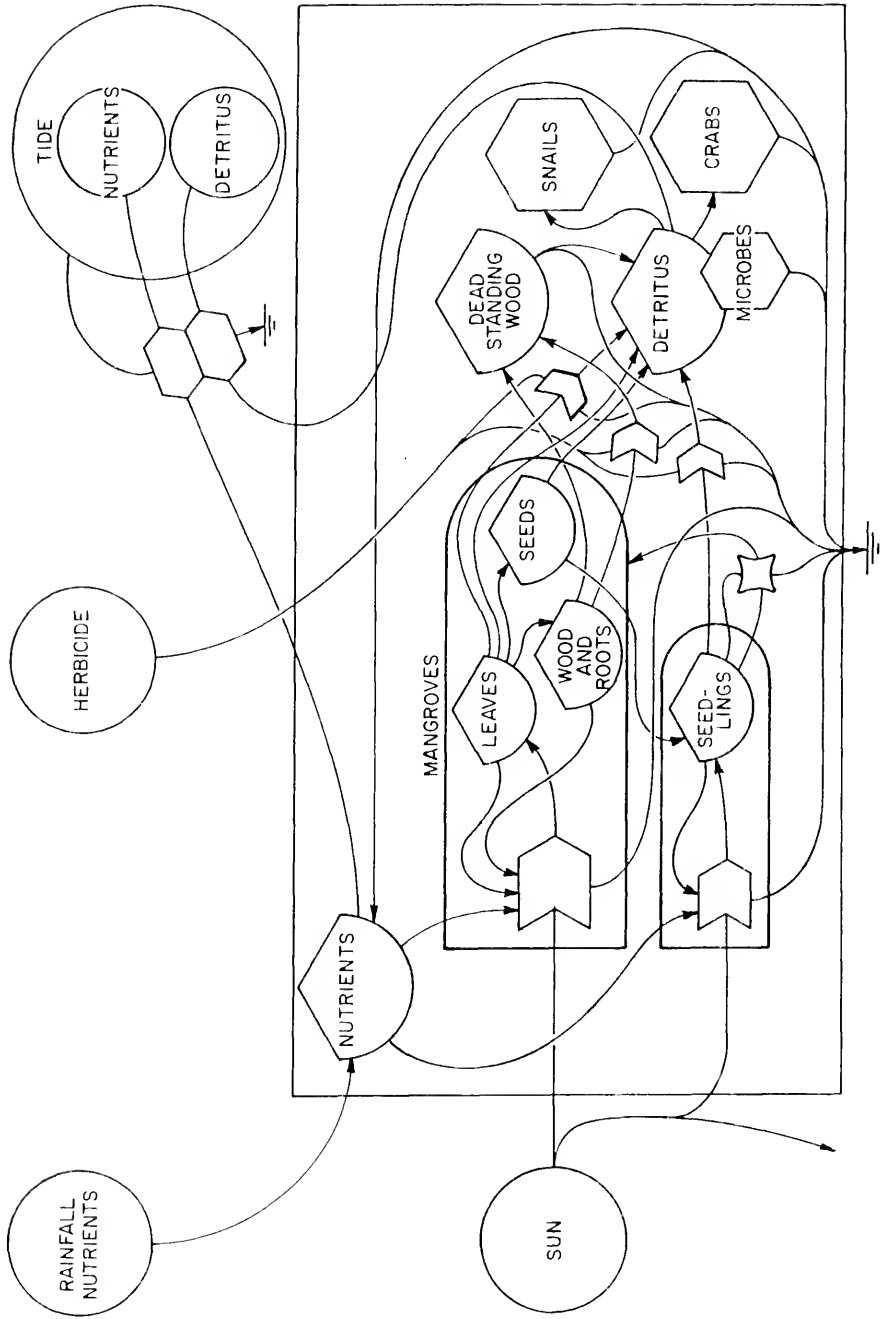



low values may have been due to the effect of several people working in the area to harvest the trees and remove them from the plot. The low population could be maintained after that due to lack of detritus. After 26 months, a slight recovery was suggested by an increase in snail population. This might be occurring because the cleared area has begun to have higher detritus levels.

The number of crabholes did not seem to be adversely affected by the spraying. The amount of decomposing organic matter remained high during the study and may have sustained the crab population. Crabs were always observed in the sites but counts of live crabs were not made. Crabs have also been observed in the Rung-Sat where the bare areas are much larger than in the Marco Island sites. The question also arises here as to the persistence of a crabhole. If the burrow is unused, how long does it last?

Figure 44 is a model that summarizes relationships in the mangrove ecosystem that was sprayed near Marco Island. The model includes compartments for mature mangroves and mangrove seedlings and summarizes components, treatments, and observed processes at the sprayed sites. Herbicide effects are shown for three compartments of leaves, wood, and roots of mature trees and seedlings. The overall effect of herbicide was to add to the compartments of detritus and standing dead wood. Snails and crabs are dependent on detritus for food although the crabs may have other food sources. Outside seed sources refer to sources from beyond the sprayed areas. In the case of small scale spraying, the outside seed supply was relatively large because each

area was surrounded by unsprayed forest. Reseeding of the land would occur quickly but the return of biomass to prespraying values would be slow. This was observed in the study.

### Hurricanes and Mangrove Structure

In many areas where mangrove forests occur, hurricanes may be important to the structure and function of the ecosystem. Two of the simulated models included the impact of hurricanes on the biomass, detritus and detritus export and also economic structure when present.

### Undeveloped Area of Mangroves

Simulations of the effects of hurricanes on the mangrove ecosystem in an undeveloped area showed different responses depending upon the soil nutrient concentration. When soil nutrient concentration was low, the recovery of the mangrove forest took longer, especially for the more severe hurricane. One hurricane (Figure 22 and 25) caused a reduction in biomass and detritus, but the mangroves did recover eventually. The extent of destruction and the recovery time depended upon hurricane intensity. In this study a frequency of one major hurricane every 18 years was calculated. For the most intense hurricane, mangroves at high soil nutrient concentration recovered within 10 years while at low soil nutrient concentrations the recovery to pre-hurricane biomass took 25 years. During the hurricane, there was a

sharp increase in the export of detritus into the estuary. What was the impact of this on estuarine life? During the recovery detritus export was less than before the hurricane pulse. Are the estuarine organisms able to adapt to less food?

When a hurricane struck before the mangroves reached steady state (Figures 23 and 26), the effect was much more noticeable for low soil nutrient concentration than for the high soil nutrient concentration. When the concentration of soil nutrients was low (Figure 26), mangrove recovery was longer for a hurricane stress prior to steady state than for a hurricane stress at steady state even though the amount of destruction during the hurricane seemed to be about the same. For the most severe hurricanes the recovery time was 32 years when the storm occurred prior to steady state and 25 years if the hurricane occurred at steady state.

The effects of a hurricane frequency of three within a 10-year period was simulated for high soil nutrient concentration (Figure 24). The only noticeable change seemed to be that the mangroves march to steady state was halted by the second and third hurricane. When hurricanes no longer occurred, the recovery time was about the same as that for other hurricane frequency patterns. For low nutrient concentration, the mangroves were eliminated by three severe hurricanes in 10 years. At lesser severities damage and recovery time were approximately equivalent to that for other hurricane patterns.

These simulations suggested that a mangrove forest growing on nutrient-poor soils was more susceptible to a major hurricane during

succession than during steady state. Indeed, if hurricanes are too frequent and too severe, the mangroves in the model were eliminated. The probability of this extreme case occurring would most likely be very low. In most situations an outside seed source would undoubtedly be available for recolonizing the impacted area. This permanent loss due to frequent hurricanes would be quite similar to the loss due to widespread development of a mangrove forest. The impact on man's activities of eliminating mangrove forests has yet to be determined, but the impact on the activities of the surrounding estuaries would be significant because the base of the estuarine food web would be destroyed.

#### Developed Area

The simulated impact of hurricanes on the economy of developed coastal areas was shown in Figures 33 to 36. The ranges of damage by hurricanes might represent the following situations. If mangroves were allowed to remain along the coast, then they would act as a buffer and absorb a good portion of the hurricane energies (Figures 33 and 35). If development occurred along the coast and mangroves were inland, then the developed structure would absorb the hurricane energies (Figures 34 and 36). When mangroves were in front (Figure 33), condominium and residential finger canal developments had about the same response to a moderate hurricane. Even though development was not directly damaged by the hurricane, the model responded with structural

decline as a result of the reduced mangrove productivity. A severe hurricane that eliminated the mangroves in the condominium development also decreased economic structure. For the residential finger canal development, recovery occurred very slowly after a severe hurricane.

When, as in Figure 34, the developments sustained more damage than the mangroves, a different picture emerged. The condominium development suffered heavy damage from a severe hurricane but recovered within 20 years with a slight amount of overdevelopment. The lower amount of condominium structure enabled mangrove biomass to temporarily reach values higher than those prior to the severe hurricane. This occurred because the stress of development was temporarily reduced by the loss of structure. Residential finger canal development did not have as much damage as condominiums and recovered quickly.

When two hurricanes occurred within 10 years (Figure 35), both mangrove and economic recovery were slow for condominium development. The more severe the hurricanes, the slower the recovery. In the condominium development the mangroves did show signs of recovery after the severe hurricanes but mangroves in the residential development did not recover from the second severe hurricane but the economic structure of residential development reached a new steady state very quickly based on the energy flow that the open space lawn vegetation attracted. In Figure 36 when economic structure sustained more damage than the mangroves, recovery was rapid as in Figure 34.

The results suggest that as long as the mangrove vegetation remained largely intact following a hurricane, fossil fuel would continue to be attracted to the coastal area. This was true even when most of the development was destroyed. The residential finger canal developments seemed to recover more quickly than condominium developments. However, when most of the mangrove vegetation was eliminated, a reduction occurred in the flow of fossil fuel. This resulted in a decrease in the amount of economic structure. In the model, the contribution of both lawn vegetation and mangrove vegetation as attractants for fossil fuel energies was based solely on gross primary productivity values. Since total lawn productivity was small, the model suggests that purchased energy flow due to the presence of lawn vegetation is small. In reality, other factors of development may also attract fossil fuel and this ratio of natural to developed images acting as attractants may be high.

#### Economic Development and Mangroves

The results of a model of development in mangroves were presented in Figure 30 for a condominium development and a residential development. A development of condominiums was able to support more structure than the single-family development given the same area of land developed. The impact on mangrove biomass was about the same for each type development. This was not unexpected because the reduction in primary productivity due to development was estimated to be the same in

each case. With either type of development the steady state economic structure showed evidence of passing through an optimum. Figure 45 shows the variation in economic structure at steady state as land developed was increased from no development to full development. The data points were obtained by setting a value on the analog computer for the fraction of land developed and letting the economic structure reach steady state. This was done for selected fractions of land development ranging from no development up to full development. The flow of goods and services is also presented in Figure 45 and was obtained in the same manner. For both condominium and residential development the economic structure passed through a maximum steady state value at about 50% development. This was also true for the flow of goods and services into the community. A maximum value for development was also found by Odum and Odum (1972) in a model of land management. They found that optimum development ranged from 35 to 65% and emphasized that the optimum ratio of natural and developed lands might vary from region to region. In Figure 30 land developments of 50% or greater produced an early period of overdevelopment of economic structure that was followed by a gradual decrease to the steady state values. Evidence of this overdevelopment pattern was reported in Tucker (1974) for Dade County, Florida, where condominiums were built in large numbers but many remain unoccupied.

Economic structure was not completely eliminated when mangroves disappeared because a portion of the purchased energy flow was

Figure 45. Variation in steady state economic structure and flow of purchased energies as the percent of land development is increased from 0 to 100 percent. The data points were obtained from simulation runs of the model in Figure 28; (a) condominium development; (b) residential finger canal development.

—●— steady state economic structure

—○— flow of purchased energies



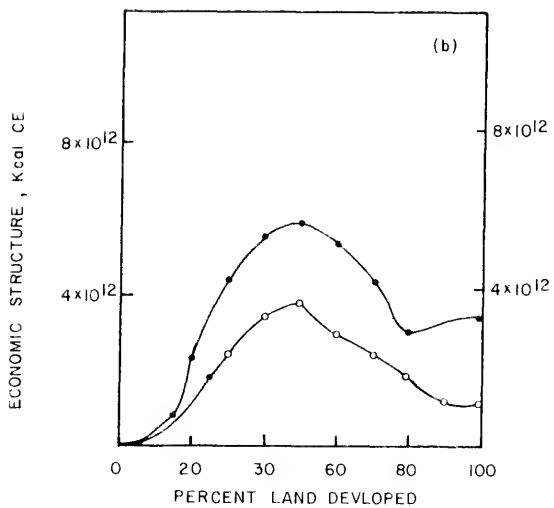
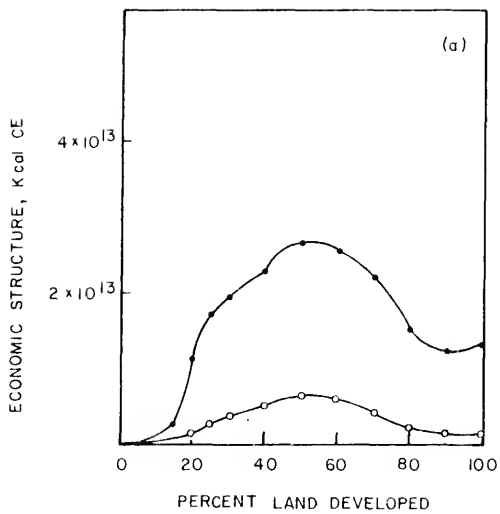

attracted by the presence of open space vegetation in the development as shown by Figures 31a and d.

In Figure 46 the price index was varied from 0 to 1 on the computer to observe the effect on economic structure at 25% and 50% development as condominiums or residential. When the price index exceeded 0.4, very little further increase in structure was noted for 50% development of land for condominiums or residential units. However, for 25% land development, the level of economic structure continued to increase with increasing price index. For both condominium and residential developments at the high investment ratios, more structure could be supported at 25% development than at 50% development. This suggests the value of the mangrove swamps or equivalent natural areas. If the interaction features of the model are correct, more mangroves occur at a land development of 25% and more fossil fuel energy might thus be attracted to the region.

The results of the energy calculations presented in Table 3 suggested that for this hypothetical development, energy investment ratios at steady state were high for both condominium and residential finger canal developments in a mangrove forest. If the national average for the investment is indeed 2.5, then in a nongrowing economy these areas might not be competitive with surrounding areas where the investment ratio was lower. Odum et al. (1976) calculated an energy investment ratio of 145 for a typical house in the United States if only that area of the lot was used to calculate the natural energy flow contribution to life support of the house.

Figure 46. Variation in steady state economic structure as the price index is varied from 0 to 1. The data points were obtained from simulation runs of the model in Figure 28; (a) condominiums developed on 25 percent of the land; (b) condominiums developed on 50 percent of the land; (c) residential finger canal estates developed on 25 percent of the land; (d) residential finger canal estates developed on 50 percent of the land.

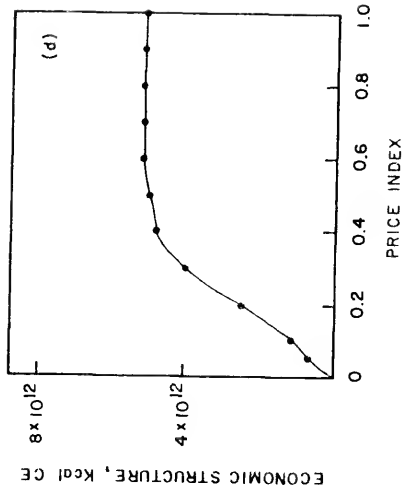
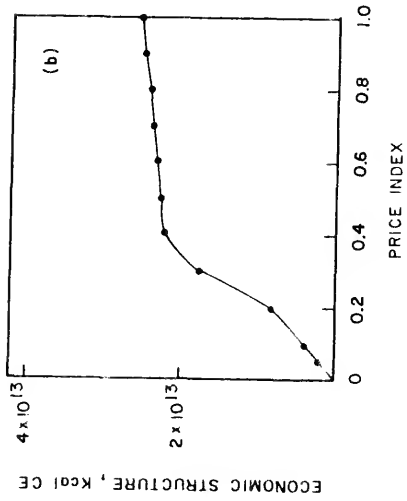
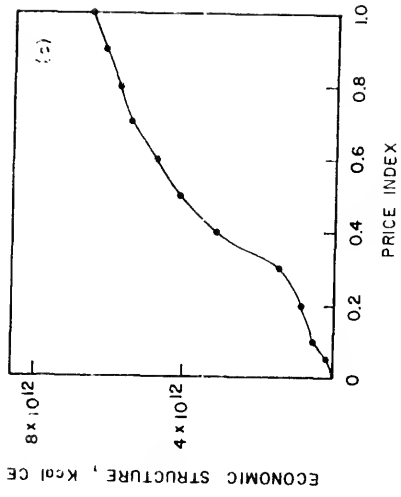
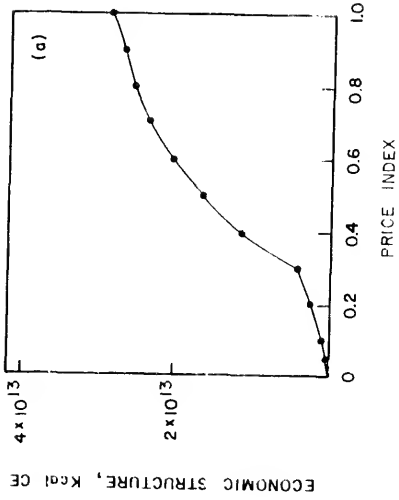

### Role of Nutrients in Mangroves

The results in Figure 18 showed that when the nutrient concentration was initially high, the mangrove forest was not greatly influenced by a doubling of the nutrient flux. The nutrient curve in Figure 18a suggested that nutrients were not limiting growth but that in this instance sunlight was the limiting factor on growth. If so, mangrove biomass should not be expected to go above about  $20,000 \text{ g C/m}^2$  for the mangrove overwash forest. As nutrient flux was reduced, nutrients did become a limiting factor and detritus and biomass were reduced. Since the major sources of nutrients in this simulation were tidal exchange and freshwater runoff, this indicated the importance of these parameters to the growth and survival of mangroves. When only rainfall and decomposition contributed to nutrient inflow, the mangroves were eliminated after 75 years. Bacon (1974) found that mangrove trees in Trinidad were not able to survive when tidal flushing and freshwater runoff were eliminated, while other trees survived where tidal movement was not impaired but freshwater runoff into the mangroves was eliminated. Macnae (1963) noted that along the northern coast of South Africa mangrove swamps did not occur naturally in estuaries which were closed to tidal flushing. Breen and Hill (1969) concluded that a mass mortality of mangroves in the Kosi estuary of South Africa was caused by the natural closing of the mouth of the estuary.

When nutrient concentration was initially low as in Figure 19, an increase in the nutrient flux greatly increased mangrove biomass. These responses to high and low nutrient concentrations have significance when considering a mangrove swamp for application of sewage effluent. If a mangrove forest were not nutrient-limited, then further additions of nutrients are not efficiently utilized and the excess nutrients would be flushed into the estuary. A nutrient-limited mangrove forest might make more efficient use of the additional nutrient source. Tidal flushing seems to have a role of bringing available nutrients to the mangrove trees on the incoming tide and in return for this service the forest exports detritus to the estuary on the outgoing tide. Simulations (Figures 18 and 19) suggested that mangrove trees were not able to survive if only nutrients from recycling and rainfall were available. Marshall (1970) found that in North Carolina, a salt marsh bathed frequently by the tides showed less response to nutrient enrichment than a salt marsh bathed infrequently by the tides. Valiela and Teal (1974) obtained similar results for salt marshes in Massachusetts.

Results of field data summarized in Tables 9, 10, 11, and 12 indicated that mangroves grew faster when bathed by tidal waters higher in nutrients due to the addition of sewage effluent. The species that showed the greatest response was the white mangrove (*L. racemosa*) which is usually subjected to infrequent tidal flushing and supports the hypothesis concerning tidal flushing. An estimate of biomass

increase was made from data on diameter increases. Basal area of a tree was multiplied times one-half of the tree height to give an approximate volume for each tree. The results are given in Tables G-3 to G-6. Data on the specific gravity of the mangrove trees was taken from a Florida Department of Agriculture report (1904). The average volume/tree was computed for each species in each site. The volume of each species/100 m<sup>2</sup> was then determined by multiplying volume/tree times number of trees/100 m<sup>2</sup>. This value was multiplied by the specific gravity and divided by 100 to give the biomass in g/m<sup>2</sup> for each species in each site. The total biomass was obtained by combining the individual species biomass values. These results are summarized in Table 23. Detailed calculations are given in Table G-12.

At the Naples study area, the increase in biomass at the sewage site was at the rate of 4.6 g/m<sup>2</sup>·day during the three-year study. The increase in biomass at the control site was 2.7 g/m<sup>2</sup>·day. These figures suggested that even though the sewage effluent had not been directly applied to the mangrove forest and only occasionally reached the forest during high tide, the response in terms of biomass was quite noticeable. At Everglades City, the biomass increase was 2.7 g/m<sup>2</sup>·day at the sewage site and 1.3 g/m<sup>2</sup>·day at the control site. Using the simulated results of the model in Figure 15 biomass increases were calculated during a three-year growth phase. For high initial nutrients and an average nutrient flux (Figure 18, Curve II) the increase in biomass was 4.8 g/m<sup>2</sup>·day. For low initial nutrients and a

Table 23. Estimated biomass and growth of trees in the mangrove forests at the Naples and Everglades City study sites for September 1973, September 1974, and September 1976. The 1- and 3-year biomass increases are also given.

	Mangrove biomass levels, g/m <sup>2</sup>				1-year change		3-year change	
	Sept. 1973	Sept. 1974	Sept. 1976	g/m <sup>2</sup>	percent	g/m <sup>2</sup>	percent	
Naples sewage site								
<u>Rhizophora mangle</u>	2,350	2,600	3,000	250	10.6	650	27.7	
<u>Laguncularia racemosa</u>	13,750	15,000	18,100	1250	9.1	4350	31.6	
All trees	16,100	17,600	21,100	1500	9.3	5000	31.1	
Naples control site								
<u>Rhizophora mangle</u>	2,750	3,000	3,200	250	9.1	450	16.4	
<u>Laguncularia racemosa</u>	9,650	10,400	12,200	750	7.8	2550	26.4	
All trees	12,400	13,400	15,400	1000	8.1	3000	24.2	



## Everglades sewage site

<u>Rhizophora mangle</u>	3,350	3,800	4,300	450	13.4	950	25.4
<u>Laguncularia racemosa</u>	11,350	11,900	12,600	550	4.8	1250	11.0
<u>Avicennia germinans</u>	4,800	4,900	5,600	100	2.1	800	16.7
All trees	19,500	20,600	22,500	1100	5.6	3000	15.4

## Everglades control site

<u>Rhizophora mangle</u>	10,850	11,200	11,800	350	3.2	950	8.8
<u>Laguncularia racemosa</u>	4,750	4,900	5,000	150	3.2	250	5.3
<u>Avicennia germinans</u>	4,850	4,900	5,050	50	1.0	200	4.1
All trees	20,450	21,000	21,850	550	2.7	1400	6.8

high nutrient flux (Figure 19, Curve III) the increase in biomass was  $5.7 \text{ g/m}^2\cdot\text{day}$ . For low initial nutrients and an average nutrient flux the growth rate was  $0.64 \text{ g/m}^2\cdot\text{day}$ . Table 24 compares the biomass values and growth rates calculated from field studies and model predictions with those discussed in the literature. Predicted growth rates and biomass under high soil nutrients were higher than any measured values found in the literature. The predicted growth rate for high soil nutrients and an average nutrient flux was similar in magnitude to the growth rate estimated from field studies in this dissertation. The growth rate under low soil nutrients, average nutrient flux was lower than any measured values in the literature or estimated from field studies in this dissertation.

The annual amounts of sewage treated by the Naples sewage treatment plant during the three-year study were 3.14 million cubic meters the first year, 3.85 million cubic meters the second year, and 4.53 million cubic meters the third year. Using an average concentration of  $1.81 \text{ g P/m}^3$  in the sewage effluent, the Naples plant might therefore discharge annually from 5.7 to 8.2 metric tons of phosphorus into the Gordon River. The annual discharge of the Golden Gate canal was 364 million cubic meters in 1973. At an average concentration of  $0.067 \text{ g P/m}^3$  the annual contribution was about 25 metric tons of phosphorus from the Golden Gate canal. The annual flow of the Gordon River upstream from its confluence with Golden Gate canal was estimated as 20% of the canal flow or 65 million cubic meters. At an average concentration of  $0.062 \text{ g P/m}^3$  the annual contribution was about 4

Table 24. Comparison of estimated wood growth rates and biomass with those predicted by the model of Figure 15 and those found in the literature.

Location	Growth rate, g/m <sup>2</sup> day	Biomass, g/m <sup>2</sup>	Reference
Naples, Florida			
sewage control	4.6	21,100 <sup>a</sup>	Se11 (this study)
	2.8	15,400	Se11 (this study)
Everglades, Florida			
sewage control	2.8	22,500 <sup>a</sup>	Se11 (this study)
	1.2	21,850	
Model prediction			
High soil nutrients Average nutrient flux	4.8	31,600 <sup>b</sup>	Se11 (this study)
Low soil nutrients High nutrient flux	5.7	31,200 <sup>b</sup>	Se11 (this study)
Low soil nutrients Average nutrient flux	0.64	20,000 <sup>b</sup>	Se11 (this study)

Rookery Bay, Florida	1.7		Lugo and Snedaker (1974a)
Malaya	2.9	23,000	Noakes (1955)
Puerto Rico	1.7	6,000	Golley, Odum, and Wilson (1962)
South Vietnam (Model)		32,000	Zieman (1972)
Ten Thousand Islands			
Riverine		20,800	Lugo and Snedaker (1974a)
Panama		28,000	Golley (1974)
Thailand		5,500- 6,600	Banijbatana (1957)

<sup>a</sup>Biomass after 3 years of measured growth.

<sup>b</sup>Biomass after 3 years of simulated growth.

metric tons of phosphorus from the Gordon River. Therefore, near the Naples sewage treatment plant the mangrove forests had 26 metric tons of phosphorus flowing by annually due to natural water runoff and 5.7 to 8.2 metric tons of phosphorus from sewage effluent. Carter et al. (1973) found annual runoff figures of 7.3 metric tons of phosphorus for Fakahia Union canal and 3.7 metric tons for the Barron River.

At Naples the mangrove forest was estimated to be flooded to an average depth of 10 cm at high tide. At a phosphorus concentration of  $0.34 \text{ g P/m}^3$  and 706 tidal cycles/year, the phosphorus made available to the mangroves was  $24 \text{ g P/m}^2 \cdot \text{year}$ . At a level of 0.125% phosphorus in branches, the uptake of phosphorus might amount to  $2.1 \text{ g P/m}^2 \cdot \text{year}$  at the sewage site, about 9% of the total phosphorus coming in with the tide. At the control site, phosphorus available through tidal flooding was  $0.044 \text{ g P/m}^3 \times 10 \text{ cm} \times 706 \text{ cycles}$  or  $3.9 \text{ g P/m}^2 \cdot \text{year}$ . Phosphorus uptake may be as high as  $1.1 \text{ g P/m}^2 \cdot \text{year}$  at the Naples control site. Table 25 summarizes uptake rates of phosphorus for the Naples and Everglades sites.

The Naples sewage treatment plant raised the phosphorus level about  $0.28 \text{ g/m}^3$  above ambient levels. This would make the phosphorus available to the forest amount to about  $20 \text{ g P/m}^2 \cdot \text{year}$ , a small portion of the 5.7 to 8.7 metric tons of phosphorus discharged by the treatment plant annually. For an uptake rate of  $2.1 \text{ g P/m}^2 \cdot \text{year}$ , from 270 to 410 ha of mangrove forest would be required for tertiary treatment of the sewage.

Table 25. Rate of uptake of phosphorus in wood for the Naples and Everglades City study sites. Uptake rate was obtained by multiplying the 3-year biomass change (Table 23) times the concentration of phosphorus in the wood.

Study area	Phosphorus uptake, $\text{g/m}^2\text{-year}$
Naples sewage site	2.1
Naples control site	1.1
Everglades sewage site	1.5
Everglades control site	0.4

At Everglades City the data on the amount of sewage treated was not available until December 1974, the second year of the study. In 1975 the annual amount of water treatment was 69,000 m<sup>3</sup> and in 1976 the amount was 145,000 m<sup>3</sup>. The high 1976 level was due largely to infiltration of salt water into the system. Therefore, for the study the rate of sewage treatment for 1975 was used as a more reasonable value for a town the size of Everglades City. At a concentration of 0.48 g P/m<sup>3</sup> the Everglades City treatment plant annually discharged about 0.033 metric tons of phosphorus into the tidal canal. Data for the tidal canal flow were not available but since this canal was approximately 50% as large as the Golden Gate canal, the phosphorus contribution would be in the vicinity of 10 metric tons/year.

At Everglades City the mangrove forest was also estimated to be flooded to an average depth of 10 cm at high tide. At a phosphorus concentration of 0.065 g P/m<sup>3</sup>, the phosphorus available to the mangroves amounted to 4.6 g/m<sup>2</sup>.year and the uptake was estimated as 2.7 x 0.00154 x 365 or 1.5 g P/m<sup>2</sup>.year.

The Everglades City control site received about 5.0 g P/m<sup>2</sup>.year from tidal flooding but only utilized 0.4 g P/m<sup>2</sup>.year because of the lower productivity and lower concentration of phosphorus in the wood.

The Everglades City sewage treatment discharged about 0.033 metric tons of phosphorus/year into the tidal canal. For an uptake of 1.5 g P/m<sup>2</sup>.year, about 2.2 ha of mangrove forest would be required to treat the sewage effluent from the treatment plant.

### Role of Mangrove Litter Fall

The results given in Figures 39 and 40 of the litterfall measurements indicated that during the dry season, the rate was reasonably constant at about  $3 \text{ g/m}^2 \cdot \text{day}$  but during the rainy season the rate rose to as much as  $6 \text{ g/m}^2 \cdot \text{day}$ . Pool, Lugo, and Snedaker (1974) and Heald (1971) also noted this pulse in several types of mangrove forests in Florida. Comparisons of litter fall data in this study with that in the literature are given in Table 26 and revealed that other riverine communities in Florida and Puerto Rico had comparable levels of litter fall. Fringe, basin, and overwash mangrove communities were generally lower in total litter fall. The high levels would suggest the importance of the riverine mangrove forest in providing sources of food for estuarine organisms. Even though the growth rate was higher in the sewage-enriched forests, litter fall was not greater. This seems counter-intuitive and further studies need to be undertaken to study this irregularity.

### Role of Mangrove Detritus

Figures 20 and 21 simulated the relationship between detritus and tidal flushing. Simulation results were compared with measured values found in the literature and are presented in Table 27. Low detritus was indicative of a situation in which litter fall moves quickly into the surrounding estuarine waters. Riverine communities and a simulated flooding depth of less than 0.2 m gave similar



Table 26. Comparison of measured annual litter fall ( $\text{g}/\text{m}^2\cdot\text{year}$ ) at the Naples and Everglades City study sites with rates found in the literature.

Location	Leaves	Seeds	Wood	Total	Reference
Florida					
Naples	770-1050	75-160	60-230	910-1440	Sell (this study)
Everglades	960-1030	40-95	110-120	1180	Sell (this study)
Whitewater Bay	730			880	Heald (1971)
Rookery Bay	570	115	55	740	Lugo and Snedaker (1974a)
Overwash community	790	170	55	1010	Pool, Lugo and Snedaker (1974)
Fringe	750	180	55	980	Pool, Lugo and Snedaker (1974)
Riverine	815-915	175-235	60-100	1100-1220	Pool, Lugo and Snedaker (1974)

Puerto Rico

Rivertine	880	210	190	1280	Pool, Lugo and Snedaker (1974)
Basin	600	180	55	830	Pool, Lugo and Snedaker (1974)
Fringe	565	130	85	680	Pool, Lugo and Snedaker (1974)
Panama	710				Golley (1974)

---

Table 27. Comparison of detritus amounts simulated by the model in Figure 15 with amounts reported in the literature.

Simulated results	Detritus, g C/m <sup>2</sup>	
	High nutrients	Low nutrients
No flooding	4400	3100
Flooding depth of 0.1 m	1560	1200
Flooding depth of 0.2 m	940	780
Flooding depth of 0.5 m	230	510
Literature results		
Overwash		700-865
Fringe (Lugo and Snedaker, 1974b)		3000-4900
Riverine		1100-2150
Panama (Golley, 1974)		5100

results. Overwash mangrove communities were similar to flooding depth of 0.2 m. Fringe mangrove communities were similar to no flooding.

Energy Quality, Herbicide, Hurricane, and  
Nutrient Enrichment

Odum and Odum (1976) have postulated that each process that transforms one energy form into another has an energy cost that is involved in the transformation. This energy cost of upgrading energy is a measure of the energy quality of the upgraded energy. A huge energy cost is involved in the photosynthetic process of converting dilute solar energy into sugars. In the mangrove forest, energy costs are involved in making leaves, stems, roots, seedlings on trees and flowers. If these energy costs were determined, then the energy quality of these variables could be calculated. The nectar from the flowers of the black mangrove (A. germinans) is used by bees to manufacture honey. By calculating this energy cost the energy quality of honey could be determined.

The above discussion of energy cost was primarily concerned with positive effects on the system. Suppose this same concept of energy cost and energy quality were used for processes that have a negative amplifying effect. A small amount of herbicide had a very destructive effect on the mangrove forests of South Vietnam and of Florida. Could this be used as a measure of the energy quality of the herbicide? Are the negative and positive energy qualities of a substance the same?

A hurricane can be a powerful package of energy that is formed by taking the dilute energy of the general circulation and the warm waters of the tropics and concentrating that energy. Hurricanes of moderate severity may have a positive amplifying effect on mangroves and thus a certain energy quality associated with this positive impact. Severe hurricanes may have a stressful effect on mangroves and also an energy quality associated with this negative effect. Are the energy qualities related? Is the severe hurricane of higher quality?

Enrichment of nutrients had a noticeably positive effect on mangrove productivity. An increase of 0.28 g of phosphorus/m<sup>3</sup> in the water nearly doubled the rate of biomass increase. This small amplifying effect resulted in an increased ability to do work for the system. The energy quality of sewage effluent may be rather high.

#### Mangroves and the Balance of Productive Potentials and Stresses

Lugo, in Wharton et al. (1976), felt that mangrove wetlands should be maintained in their natural state because of their location in an already stressed system. In this dissertation models were simulated to illustrate the impact of herbicide, hurricanes and economic development on the mangrove ecosystem. Herbicide impact was substantial in reducing mangrove biomass. Prior to spraying in Vietnam, mangrove wood was used for making charcoal but that use has either been sharply reduced or eliminated. Hurricane impact varied from essentially no

effect to elimination of mangroves growing in nutrient-poor soils. How does this effect the marine life? Odum (1971) showed that mangrove detritus was the base of the food web in estuaries lined with mangroves. Reduction of the size of a mangrove swamp could reduce this source of detritus and thus reduce the biomass of organisms relying directly and indirectly on this food source. Economic development could have this impact also. Hurricanes might be beneficial or damaging by virtue of their storm waves and huge amounts of rainfall. Mangroves that appear to be isolated from tidal exchange may depend on the occasional hurricane to flush out the detritus and high salt levels. In Vietnam the typhoon may be beneficial in spreading mangrove seeds to infrequently flushed areas.

Economic development stressed the mangroves in the simulation of the model in Figure 28. In terms of the total energy value of the region, the inflow of purchased energies may temporarily increase the value. Simulations suggest that this increase will not persist over a long time period of 100 or 200 years and that total natural productivity of the region will decline due to economic development activities.

#### Summarizing Guidelines for Management of Mangroves

Measurement of the growth of mangroves suggested that the use of mangrove forests to assimilate the nutrients of treated sewage effluent may be possible. For cities of 15,000 population, such as Naples,

Florida, the amount of mangrove land required for adequate treatment might be in excess of 400 ha. Simulation of the model in Figure 15 indicated that adequate tidal exchange between the mangrove and open estuary can be crucial to the survival of the swamp. The application of sewage effluent needs to be regulated very closely so as not to significantly alter the hydrologic scheme of the mangrove forest. The impervious nature of the mangrove soils could result in permanent flooding of the forest floor. Oxygen concentrations in the water would fall to zero and tidal exchange would be necessary to periodically supply fresh oxygenated waters to the mangrove ecosystem. How would the detritus-feeding snails and crabs and other organisms fare when the forest floor is more frequently covered with water?

Lugo, in Wharton et al. (1976), listed the types of mangrove forests as overwash, fringe, scrub, riverine, and basin mangroves. He recommended that overwash and scrub mangrove systems not be managed by man because of their location and slow tree growth. Fringe mangroves were discussed as being capable of handling intensive use providing that normal tidal exchange was not interrupted. Fringe mangroves were not recommended for treatment of sewage wastes because of their close proximity to the open estuary. Riverine mangroves can probably maintain their structure and function under intensive management. The riverine mangroves studied in this dissertation were infrequently bathed by the tides which may explain the significant response to nutrient enrichment from sewage wastes. Basin mangroves are also often infrequently flushed and could be useful for application

of sewage effluent provided the water level was not greater than the height of the pneumatophores.

The adaptability of mangrove forests to regrow between years with hurricanes or severe cold front suggests a cycle of management for timber production as is already done in many areas of the world where mangroves grow. Further studies are called for to ascertain the mangrove types that exhibit a growth rate compatible with harvesting. Riverine mangroves appear to be suitable. This was noted by Lugo, in Wharton et al. (1976) who also recommended fringe and basin mangroves for management with respect to timber production.

Simulation of the model of environmental attraction and economic development in Figure 28 indicated that some housing and high rise construction in mangrove forests could be too energy intensive for the best economic viability. Development within a mangrove forest would be very light if the investment ratio were maintained near the national average of 2.5. If the mangrove forest were preserved as much as possible around the housing developments, free services provided include hurricane protection, control of water quality, an aesthetically pleasing panorama, and a nursery area and food source for fish and crabs that are part of the attraction of these areas to tourists and retirees.



## APPENDICES

## APPENDIX A

### ENERGY LANGUAGE SYMBOLS USED IN DEVELOPMENT OF MODELS

The symbols of the energy circuit language developed by Odum (1971) and used to diagram the models in this dissertation are discussed.

Source - energy or material input that influences the structure and function of a system and is not influenced by the system. Examples include sun, fossil fuel, tides. Description of source behavior is necessary since it may be a constant value or time varying.

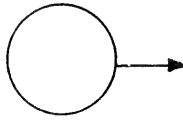

Storage - state variable within a system. The level of the state variable varies with time as determined by the difference between inflow and outflow forces of the state variable, i.e.,  $\frac{dQ}{dt} = J - k_1Q - k_2Q$ . Storage costs energy as indicated by the heat sink.

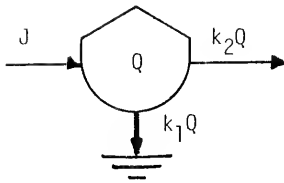

Energy circuit - a pathway that flows in proportion to the amount of upstream storage or source upstream. Without a barb the flow would also be influenced by downstream storage.



## APPENDIX A (continued)

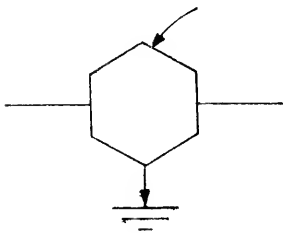
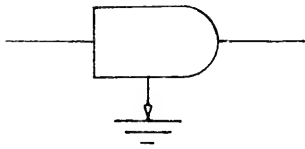
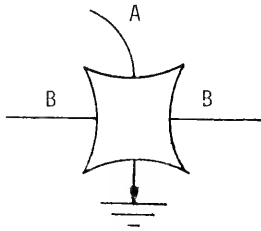
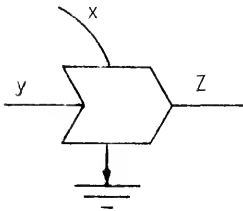

Heat sink - potential energy degrades to heat energy and can no longer perform any useful work for the system.

Work gate - shows the interactions between upstream flows to produce an outflow that is a function of both. Interaction can be multiplicative ( $Z = kxy$ ), a ratio, ( $Z = \frac{ky}{x}$ ) or any other function. Output follows limiting factor behavior.

Logic switching - denotes the on-off switching action of flow B as controlled by flow A or level A. As A exceeds a threshold value, flow B may either begin or cease flowing or the reverse if A is below the threshold value.

Producer unit - a self-maintaining unit that uses low quality energies, e.g., solar radiation to produce higher quality energies, e.g., organic matter.

Consumer unit - a self-maintaining unit that uses the amplifying feedback action of high quality energy to maintain a continuing input of lower quality energy for growth, reproduction and maintenance.

## APPENDIX A (continued)

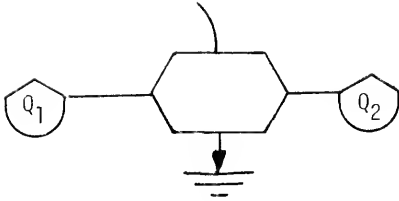

Two way work gate - a two-directional flow is operated on by another flow in proportion to the difference between  $Q_1$  and  $Q_2$ . Direction depends on levels of  $Q_1$  and  $Q_2$ .

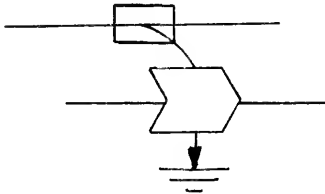

Flow controlled work gate - transport of material through the work gate is controlled by a carrier, e.g., water carrying nutrients.

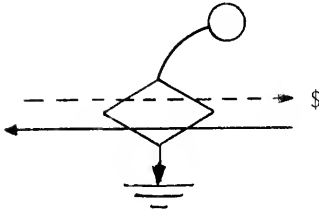

Transaction - used to relate the flow of money with the flow of materials or energy. Note that the money flows in a direction opposite to the material or energy flows. Price may be any function. Energy cost of the transaction is shown by heat sink.

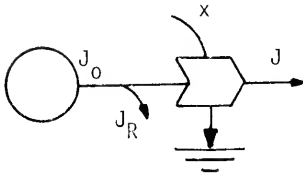

Flow-limited source - an energy or material source that is limited because as more of  $J_0$  is used, less of  $J_R$  is available and  $J$  depends on  $J_R$

$$J_R = J_0 - k_R J_R x; J = \frac{k_1 J_0 x}{1 + k_R x}$$

## APPENDIX A (continued)

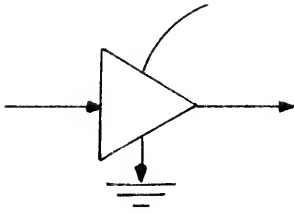

Constant gain amplifier - input force acts as a means to tap an infinite energy supply. The output is expressed in proportion to the input force as shown by the "gain."

## APPENDIX B

### PROCEDURE TO ANALYZE FOR CONCENTRATION OF TOTAL PHOSPHORUS IN WATER SAMPLES\*

1. Add 25 ml of sample (less if P concentration is high) to a 125 ml Erlenmeyer flask. Prepare blanks using 25 ml double distilled water.
2. Add 5.0 ml of 5% potassium persulfate (5 grams) in 5% sulfuric acid (5 ml conc. sulfuric acid diluted to 100 ml) and mix thoroughly.
3. Cover flasks with 50 ml beakers; autoclave at 15 psi for 1 hour.
4. Allow the autoclave to come to atmospheric pressure slowly to insure the solution will not blow out of the flask.
5. Cool flasks to room temperature; let stand overnight. This step is important.
6. Make up to 42 ml with distilled water.
7. Add 42 ml of sample to a 125 ml Erlenmeyer flask (use smaller sample and dilute to 42 ml if phosphorus concentration is unusually high).
8. Add 8 ml of mixed reagent and mix thoroughly.
9. After at least 20 minutes, measure the optical density of the solution. A 690 m $\mu$  filter is used with the Klett-Summerson photoelectric colorimeter and 4 cm cell. Or use 900 m $\mu$  and either 1 or 10 cm cell with a Beckman DU Spectrophotometer. A model 2400 Beckman DB-6 grating spectrophotometer was used for the high concentrations.

---

\*Menzel, D.W. and N. Corwin (1965)

## APPENDIX B (continued)

10. Determine three reagent blanks by using distilled water in the place of the sample.
11. The calibration curve needs only occasional checking as it remains constant and appears to be independent of changes in the batches of reagents.

## Reagents:

Sulfuric Acid (5N)

Dilute 70 ml of concentrated sulfuric acid to 500 ml.

Ammonium molybdate

Dissolve 20 grams of AR ammonium molybdate in water and dilute to 500 ml. Store solution in a polyethylene bottle in refrigerator.

Ascorbic acid (0.1 M)

Dissolve 1.06 grams of ascorbic acid in 60 ml of water (1.76 grams--100 ml). This solution should be prepared on the day that it is required.

Potassium antimonyl tartrate

Dissolve 0.274 (0.685) grams of potassium antimonyl tartrate in distilled water and dilute to 100 ml (250 ml). Keep in refrigerator.

## APPENDIX B (continued)

Mixed reagent	Mix thoroughly 100 ml of 5N sulfuric acid and 30 ml of ammonium molybdate. Add 60 ml of ascorbic acid solution and 10 ml of potassium antimonyl tartrate solution. This reagent is only good for 24 hours.
Stock phosphate solution	Prepare a solution containing 0.2197 grams of potassium dihydrogen phosphate per liter. This solution contains 50 mg P (as phosphate) per liter (50 ppm). Prepare dilutions over the desired range.

## Calculation of Results:

1. Subtract blank from optical density readings.
2. Multiply by dilution factor if a sample of less than 42 ml or 25 ml was used for phosphate or total phosphorus analyses, respectively.
3. Multiply by the "f" value from the Standard Curves. This value is about 5.13 for phosphate and 9.13 for total phosphorus. This gives an answer in  $\mu\text{g-at/l}$ .



## APPENDIX C

### SUPPLEMENTARY DATA FOR SIMULATION OF MODEL OF HERBICIDES AND MANGROVES SHOWN IN FIGURE 4

Table C-1. Monthly averages of solar radiation data for Saigon from January 1964 to October 1967.

Table C-2. Descriptions and values for the outside driving forces, state variables, and pathways of the herbicide and mangrove model.

Table C-3. Data on density and weight of Rhizophora mangle seedlings at Rookery Bay, Florida.

Table C-4. Calculations of rate coefficients for the model (Figure 4) simulating the effect of herbicide on the Rung-Sat mangroves in South Vietnam.

Table C-5. Scaled differential equations for the model (Figure 4) simulating the effect of herbicide on the Rung-Sat mangroves in South Vietnam.

Figure C-1. Annual variation in solar radiation ( $\text{kcal/m}^2 \cdot \text{day}$ ) for Saigon, South Vietnam.

Figure C-2. Analog circuit diagram for the model in Figure 4 simulating the effect of herbicides on mangroves of the Rung-Sat district in South Vietnam.

Table C-1. Monthly averages of solar radiation data for Saigon from January 1964 to October 1967\*

---

Month	Average Solar Radiation (kcal/m <sup>2</sup> ·day)
January	3500
February	4220
March	4560
April	4380
May	3680
June	3910
July	3860
August	3690
September	3560
October	3350
November	3160
December	3160

---

\*Directorate of Meteorology, Republic of Vietnam.

Table C-2. Descriptions and values for the outside driving forces, state variables, and pathways of the herbicide and mangrove model (see Figure 5).

Outside driving force	Description	Value	Reference
I	Solar radiation	See Table 1 and Figure 1, Appendix C	Directorate of Meteorology Republic of Vietnam
H	Annual amounts of herbicide applied to the mangroves of the Rung-Sat for 1966-1970	1966 - 91,525 gallons (346,000 liters) 1967 - 361,435 gallons (1,370,000 liters) 1968 - 407,175 gallons (1,540,000 liters) 1969 - 127,500 gallons (483,000 liters) 1970 - 21,400 gallons (81,000 liters) Total 1,009,035 gallons (3,820,000 liters)	National Academy of Sciences (1974)
S	Seedlings from other areas	Estimated to be zero	Golley (1971)
N	Planting rate <sup>2</sup>	Maximum value of $21 \times 10^6$ seedlings/day	Moquillon (1944)
C	Cutting rate by South Vietnamese woodcutters <sup>b</sup>	$.12 \times 10^9$ kgs/year	No reference for Rung-Sat

Table C-2 (continued)

State variable	Description	Value	Reference
Q <sub>1</sub>	Mangrove land that has been sprayed each year from 1965-1970 <sup>c</sup>	1965 - 0 hectares 1966 - 6500 " 1967 - 42,400 " 1968 - 44,500 " 1969 - 18,000 " 1970 - 2000 "	Estimated values using planimeter on maps of spray runs supplied by National Academy of Sciences (1974)
		Total- 52,400 hectares <sup>d</sup>	
Q <sub>2</sub>	Land covered by mangroves <sup>e</sup>	1965 - 71,000 hectares Maximum value of 75,000 hectares if all land colonized by mangroves	Ibid.
Q <sub>4</sub>	Seedlings present <sup>f</sup> in the water	Average value $0.8 \times 10^8$ Maximum value $3.2 \times 10^8$	No reference for Rung-Sat
Q <sub>5</sub>	Mangrove biomass <sup>g</sup>	Average value $3.55 \times 10^9$ kgs Maximum value $5.1 \times 10^9$ kgs	No reference for Rung-Sat Golley et al. (1962)
Q <sub>6</sub>	Seedlings on trees <sup>h</sup>	Average value $1.85 \times 10^{10}$ Maximum value $7.4 \times 10^{10}$	No reference for Rung-Sat

Table C-2 (continued)

Pathways	Description	Value	Reference
$J_0$	Flux of solar energy	Sinusoidal with maximum of 4560 kcal/m <sup>2</sup> /day and minimum of 3160 kcal/m <sup>2</sup> ·day	Directorate of Meteorology Republic of Vietnam
$k_2 Q_2^3 R$	Shortwave radiation	50 percent of pathway #1	No reference
$k_3 Q_2^4 R$	Primary production of mangroves <sup>1</sup>	$4.1 \times 10^9$ kgs/year	Golley et al. (1962)
$CQ_5$	Harvest rate of mangroves by woodcutters	$0.12 \times 10^9$ kgs/year	No reference
$k_6 Q_5$	Respiration and other losses (litterfall, grazing) in mangroves <sup>1</sup>	$2.05 \times 10^9$ kgs/year	Golley et al. (1962)
$k_7 Q_5$	Rate of seedling production in terms of biomass <sup>1</sup>	$0.47 \times 10^9$ kgs/year	No reference for Rung-Sat
$k_8 Q_5$	Rate of seedling production in terms of numbers <sup>m</sup>	$18.5 \times 10^9$ seedlings/year	No reference for Rung-Sat

Table C-2 (continued)

Pathways	Description	Value	Reference
$k_{9Q_6}$	Loss rate of seedlings to disease, meteorological conditions, predators <sup>n</sup>	$1.85 \times 10^9$ seedlings/year	No reference for Rung-Sat
$k_{10Q_6}$	Rate at which seedlings fall from trees <sup>o</sup>	$16.6 \times 10^9$ seedlings/year	No reference for Rung-Sat
$k_{11Q_6}$	Rate at which seedlings in trees become seedlings in water <sup>p</sup>	$7.5 \times 10^7$ seedlings/year	No reference
$k_{12Q_4}$	Loss rate of seedlings in the water <sup>q</sup>	$3.75 \times 10^7$ seedlings/year	No reference
$k_{13Q_4Q_4}$	Rate at which seedlings colonize bare land <sup>r</sup>	$3.75 \times 10^7$ seedlings/year	No reference
$k_{14Q_2H}$	Herbicide application rate from 1966-1970	Same as herbicide driving force values	National Academy of Sciences (1974)

Table C-2 (continued)

Pathways	Description	Value	Reference
$k_{15}Q_2H$	Rate at which mangrove land becomes bare due to spraying <sup>S</sup>	1965 0 1966 6500 1967 35,900 1968 10,000 1969 0 1970 0	Estimated by planimetry maps of spray area supplied by National Academy of Sciences (1974)
$k_{16}Q_1Q_4$	Natural recolonization rate <sup>t</sup>	2620 hectares/year	No reference
$k_{17}N$	Planting rate <sup>u</sup>	Case I - 0 Case II - 37 seedlings/hectare Case III -185 seedlings/hectare	No reference
$k_{18}S$	Seedlings from other areas floating into Rung-Satv	Estimated as zero	Golley (1971)

<sup>a</sup>Value based on Moquillon's (1944) recommendation of 50 days to plant seedlings at a density of 20,000 per hectare or

$$20,000 \frac{\text{seedlings}}{\text{hectare}} \times 52,400 \text{ hectares spray area} \times \frac{1}{50 \text{ days}} = 21 \times 10^6$$

Table C-2 (continued)

<sup>b</sup> Cutting rate estimated as 3 percent of primary production or  $0.03 \times 4.1 \times 10^9$  kg/year =  $.12 \times 10^6$  kg/year.

<sup>c</sup> Sprayed areas were calculated by planimetering maps that showed the actual spray runs for each of the years 1965-1970.

<sup>d</sup> The total area sprayed is less than the sum of the areas for all of the years because many areas were sprayed two or more times.

<sup>e</sup> Mangrove land area was determined by planimetering a map of the Rung-Sat.

<sup>f</sup> Average value was obtained by using 26 seedlings/m<sup>2</sup> (seedling density in Florida) x 3.2 meters of tree hanging over the water (Florida data) x 10<sup>6</sup> meters of waterway in the Rung-Sat to give  $0.8 \times 10^8$  seedlings. The maximum value was taken as 4 times the average value or  $3.2 \times 10^8$  seedlings.

<sup>g</sup> Biomass values were not available for mangrove forests in South Vietnam so a value was chosen from the literature for mangrove forests of similar stature. Golley et al. (1962) measured the biomass of mangroves in Puerto Rico to be 5000 grams/m<sup>2</sup>. Using this biomass figure the total biomass for the mangroves in the Rung-Sat was

$$5000 \text{ grams/m}^2 \times \frac{1 \text{ kg}}{1000 \text{ gm}} \times 7.1 \times 10^8 \text{ m}^2 = 3.55 \times 10^9 \text{ kgs.}$$

Maximum value estimated

as  $7.1 \times 10^9$  kgs.

<sup>h</sup> The average number of seedlings in the trees was obtained by multiplying  $26 \frac{\text{seedlings}}{\text{m}^2} \times 7.1 \times 10^8 \text{ m}^2 = 1.85 \times 10^{10}$  seedlings that may be in the mangrove trees of the Rung-Sat. The maximum level was chosen as 4 times the average value.



Table C-2 (continued)

- <sup>i</sup>Primary production of mangroves was not available for the Rung-Sat. Therefore a rate of 16 grams organic matter/m<sup>2</sup>/day was taken from Golley et al. (1962). For the Rung-Sat, the total mangrove primary production is  $\frac{16 \text{ grams}}{\text{m}^2 \cdot \text{day}} \times \frac{365 \text{ days}}{1 \text{ year}} \times 7.1 \times 10^8 \text{ m}^2 \times \frac{1 \text{ kg}}{1000 \text{ grams}} = 4.1 \times 10^9 \text{ kgs/year}$ .
- <sup>j</sup>Woodcutters were estimated to harvest 3 percent of primary production or  $.03 \times 4.1 \times 10^9 \text{ kgs/year} = 0.12 \times 10^9 \text{ kgs/year}$ .
- <sup>k</sup>Golley et al. (1962) estimated respiration to be approximately equal to primary production. However, in this model 50 percent of primary production was used.
- <sup>l</sup>Sampling of Rhizophora mangle seedlings in Florida yielded an average weight of 12.6 grams dry weight/seedling. If these seedlings were ready to drop, the annual rate of seedling production would be 12.6 grams dry weight/year. An efficiency of 50 percent was estimated for conversion of mangrove primary production into seedling biomass to give 25.2 grams dry weight/year. For the Rung-Sat the total amount of primary production used for seedlings was estimated as
- $$25.2 \frac{\text{grams}}{\text{year}} \times \frac{26 \text{ seedlings}}{\text{m}^2} \times 7.1 \times 10^8 \text{ m}^2 \times \frac{1 \text{ kg}}{1000 \text{ gms}} = 0.47 \times 10^9 \text{ kgs/year}$$
- <sup>m</sup>Total number of seedlings produced in the Rung-Sat was estimated as  $\frac{26 \text{ seedlings}}{\text{m}^2} \times 7.1 \times 10^8 \text{ m}^2 = 18.5 \times 10^9 \text{ seedlings}$ .
- <sup>n</sup>Estimated as 10 percent of the total number of seedlings produced on the trees.
- <sup>o</sup>Estimated as total number of seedlings produced minus those lost to disease, meteorological conditions and predators or  $18.5 \times 10^9 - 1.9 \times 10^9 = 16.6 \times 10^9 \text{ seedlings}$ .

Table C-2 (continued)

<sup>p</sup>Estimated by taking the ratio of mangrove land area ( $7.1 \times 10^6 \text{ m}^2$ ) to the total area of tree overhanging the water ( $3.2 \times 10^9$ ) and multiplying times the number of seedlings that fall from the trees or

$$\frac{3.2 \times 10^6 \text{ m}^2}{7.1 \times 10^9 \text{ m}^2} \times 16.6 \times 10^9 \text{ seedlings} = 7.5 \times 10^7 \text{ seedlings.}$$

LaRue and Muzik (1951) estimated that 95 percent of mangrove seedlings remain beneath the parent tree.

<sup>q</sup>Estimated that 50 percent or  $3.75 \times 10^7$  seedlings are lost while in the water.

<sup>r</sup>Number of seedlings falling from trees into water minus seedlings lost in the water or  $7.5 \times 10^7$  seedlings -  $3.75 \times 10^7$  seedlings =  $3.75 \times 10^7$  seedlings.

<sup>s</sup>These values represent new areas sprayed each year beginning with 1965 and ending in 1970.

<sup>t</sup>In two years from 1970-1972 only about 10 percent of the Rung-Sat sprayed area has been estimated as recolonized by mangroves or 5240 hectares. The annual rate would thus be 2620 hectares.

<sup>u</sup>A variable rate starting with no planting as the first case. Second case was a successful planting rate of 37 seedlings/hectare, and third case was a successful rate of 185 seedlings/hectare. (Only 10 percent of those planted survived the first year after planting.)

<sup>v</sup>Based on observations by Golley (1971).

Table C-3. Data on density ( $n/m^2$ ) and weight of Rhizophora mangle seedlings at Rookery Bay, Florida (July 13, 1972).

Seedlings lengths, centimeters	Dry weight of Seedlings, grams	
#1	27.6	9.1
#2	31.7	12.6
#3	24.4	7.0
#4	21.3	4.8
#5	25.6	7.7
#6	26.1	11.6

Seedlings counts of Rhizophora mangle along the perimeter of Rookery Bay

<u>Number of Seedlings/m<sup>2</sup></u>		<u>Overhang, feet</u>	
$y_i$	$y_i^2$	$y_i$	$y_i^2$
102	10,404	6	36
74	5,476	7	49
90	8,100	8	64
98	9,604	8	64
80	6,400	7	49
50	2,500	10	100
6	36	10	100
3	9	5	25
52	2,704	2.5	6.25
4	16	8	64
0	0	10	100
0	0	7	49
32	1,024	7	49
14	196	12	144
38	1,444	15	225
12	144	8	64
4	16	9	81
4	16	8	64
8	64	20	400
0	0	20	400
0	0	15	225
0	0	20	400
22	484	12	144
18	324	20	400
14	196	$y_i = 252.5$	$y_i^2 = 3,302$
0	0		
12	144	$\bar{y} = 10.52$ feet = 3.2 meters	
34	1,156	$(y_i)^2 = 63,756$	
$y_i = 783$	$y_i^2 = 50,601$	STD DEV = 6.4	
$\bar{y} = 26.1/m^2$			
STD DEV = 32.25/m <sup>2</sup>			

Table C-4. Calculations of rate coefficients for the model (Figure 4) simulating the effect of herbicide on the Rung-Sat mangroves in South Vietnam.

Flow 2 - Incoming flux of sunlight,  $k_2 Q_2 J_R$

$$k_2 Q_2 J_R = 0.83 \times 10^{12} \text{ kcal/m}^2 \cdot \text{year}$$

$$k_2 = \frac{0.83 \times 10^{12}}{(Q_2)(J_R)} = \frac{0.83 \times 10^{12}}{(71,000)(.83 \times 10^{12})} \frac{\text{kcal/m}^2 \cdot \text{year}}{\text{ha} - \text{kcal/m}^2 \cdot \text{year}}$$

$$k_2 = 1.41 \times 10^{-5} / \text{ha}$$

Flow 3 - Primary production of mangroves,  $k_3 Q_2 Q_3$

$$k_3 Q_2 J_R = 4.1 \times 10^9 \text{ kg/year}$$

$$k_3 = \frac{4.1 \times 10^9}{Q_2 J_R} = \frac{4.1 \times 10^9}{(71,000)(.83 \times 10^{12})} \frac{\text{kg/year}}{\text{ha} - \text{kcal/m}^2 \cdot \text{year}}$$

$$k_3 = 6.96 \times 10^{-8} \text{ kg m}^2 / \text{ha} \cdot \text{kcal}$$

Flow 5 - Woodcutting rate,  $C Q_5$

$$C Q_5 = .12 \times 10^9 \text{ kg/year}$$

$$C = \frac{.12 \times 10^9}{Q_5} = \frac{.12 \times 10^9}{3.55 \times 10^9} \frac{\text{kg/year}}{\text{kg}}$$

$$C = 3.38 \times 10^{-2} / \text{year}$$

Table C-4 (continued)

---

Flow 6 - Mangrove respiration,  $k_6 Q_5$

$$k_6 Q_5 = 2.05 \times 10^9 \text{ kg/year}$$

$$k_6 = \frac{2.05 \times 10^9}{Q_5} = \frac{2.05 \times 10^9}{3.55 \times 10^9} \frac{\text{kg/year}}{\text{kg}}$$

$$k_6 = 0.577 \times 10^{-1} / \text{year}$$

---

Flow 7 - Translocation of organic matter to seedlings,  $k_7 Q_5$

$$k_7 Q_5 = 0.491 \times 10^9 \text{ kg/year}$$

$$k_7 = \frac{0.491 \times 10^9}{Q_5} = \frac{0.491 \times 10^9}{3.55 \times 10^9} \frac{\text{kg/year}}{\text{kg}}$$

$$k_7 = 1.38 \times 10^{-1} / \text{year}$$

---

Flow 8 - Seedling production in terms of number,  $k_8 Q_5$

$$k_8 Q_5 = 18.5 \times 10^9 \text{ seedlings/year}$$

$$k_8 = \frac{18.5 \times 10^9}{Q_5} = \frac{18.5 \times 10^9}{3.55 \times 10^9} \frac{\text{seedlings/year}}{\text{kg}}$$

$$k_8 = 5.21 \text{ seedlings/year} \cdot \text{kg}$$

---

Flow 9 - Seedling losses while on tree,  $k_9 Q_6$

$$k_9 Q_6 = 1.85 \times 10^9 \text{ seedlings/year}$$

$$k_9 = \frac{1.85 \times 10^9}{Q_6} = \frac{1.85 \times 10^9}{1.85 \times 10^{10}} \frac{\text{seedlings/year}}{\text{seedlings}}$$

$$k_9 = 0.1 / \text{year}$$

Table C-4 (continued)

---

Flow 10 - Seedlings falling from trees,  $k_{10}Q_6$

---

$$k_{10}Q_6 = 16.6 \times 10^9 \text{ seedlings/year}$$

$$k_{10} = \frac{16.6 \times 10^9}{Q_6} = \frac{16.6 \times 10^9}{1.85 \times 10^{10}} \frac{\text{seedlings/year}}{\text{seedlings}}$$

$$k_{10} = 0.9/\text{year}$$

Flow 11 - Seedlings available in the water,  $k_{11}Q_6$

---

$$k_{11}Q_6 = 7.5 \times 10^7 \text{ seedlings/year}$$

$$k_{11} = \frac{7.5 \times 10^7}{Q_6} = \frac{7.5 \times 10^7}{1.85 \times 10^{10}} \frac{\text{seedlings/year}}{\text{seedlings}}$$

$$k_{11} = 4.05 \times 10^{-3}/\text{year}$$

Flow 12 - Loss of seedlings in water,  $k_{12}Q_4$

---

$$k_{12}Q_4 = 3.75 \times 10^7 \text{ seedlings/year}$$

$$k_{12} = \frac{3.75 \times 10^7}{Q_4} = \frac{3.75 \times 10^7}{8 \times 10^7} \frac{\text{seedlings/year}}{\text{seedlings}}$$

$$k_{12} = 4.69 \times 10^{-1}/\text{year}$$

Flow 13 - Seedlings colonizing bare land,  $k_{13}Q_1Q_4$

---

$$k_{13}Q_1Q_4 = 3.75 \times 10^7 \text{ seedlings/year}$$

Table C-4 (continued)

$$k_{13} = \frac{3.75 \times 10^7}{Q_1 Q_4} = \frac{3.75 \times 10^7}{(4000)(8 \times 10^7)} \frac{\text{seedlings/year}}{\text{ha} \cdot \text{seedlings}}$$

$$k_{13} = 1.17 \times 10^{-4} / \text{year} \cdot \text{ha}$$

Flow 15 - Conversion of mangrove covered land to bare land,  $k_{15}^{Q_2 H}$

$$k_{15}^{Q_2 H} = 36,500 \text{ ha/year (maximum rate)}$$

$$k_{15} = \frac{36,500}{Q_2 H} = \frac{3,6500}{(71,000)(1.095 \times 10^6)} \frac{\text{ha/year}}{\text{ha} \cdot \text{liters}}$$

$$k_{15} = 4.63 \times 10^{-7} / \text{liters} \cdot \text{year}$$

Flow 16 - Natural recolonization by mangroves,  $k_{16}^{Q_1 Q_4}$

$$k_{16}^{Q_1 Q_4} = 2620 \text{ ha/year}$$

$$k_{16} = \frac{2620}{Q_1 Q_4} = \frac{2620}{(4000)(8 \times 10^7)} \frac{\text{ha/year}}{\text{ha seedlings}}$$

$$k_{16} = 8.19 \times 10^{-9} / \text{seedlings} \cdot \text{year}$$

Flow 17 - Hand planting of mangroves, N

$$\text{Case I } N = 0$$

$$\text{Case II } N = 37 \text{ seedlings/ha} \cdot \text{year}$$

$$\text{Case III } N = 185 \text{ seedlings/ha} \cdot \text{year}$$

Table C-5. Scaled differential equations for the model (Figure 4) simulating the effect of herbicide on the Rung-Sat mangroves in South Vietnam.

Bare Land,  $Q_1$

$$\frac{\dot{Q}_1}{75,000} = 0.509 \left[ \frac{Q_2}{75,000} \right] \left[ \frac{H}{1.1 \times 10^6} \right] - 2.62 \left[ \frac{Q_1}{75,000} \right] \left[ \frac{Q_4}{3.2 \times 10^8} \right]$$

Land Covered by Mangroves,  $Q_2$

$$\frac{Q_2}{75,000} = 1 - \left[ \frac{Q_1}{75,000} \right]$$

Seedlings in Water,  $Q_4$

$$\frac{\dot{Q}_4}{3.2 \times 10^8} = 0.937 \left[ \frac{Q_6}{7.4 \times 10^{10}} \right] - 0.469 \left[ \frac{Q_4}{3.2 \times 10^8} \right] - 8.78 \left[ \frac{Q_1}{75,000} \right] \left[ \frac{Q_4}{3.2 \times 10^8} \right]$$

Mangrove Biomass,  $Q_5$

$$\begin{aligned} \frac{\dot{Q}_5}{7.5 \times 10^9} = & 2.27 \left[ \frac{J_R}{3.26 \times 10^{12}} \right] \left[ \frac{Q_2}{75,000} \right] - 0.577 \left[ \frac{Q_5}{7.5 \times 10^9} \right] \\ & - 0.138 \left[ \frac{Q_5}{7.1 \times 10^9} \right] - 0.034 \left[ \frac{Q_5}{7.1 \times 10^9} \right] \end{aligned}$$



Table C-5 (continued)

---

Seedlings on Trees,  $Q_6$

---

$$\frac{\dot{Q}_6}{7.4 \times 10^{10}} = 0.528 \left[ \frac{Q_5}{7.5 \times 10^9} \right] - 0.9 \left[ \frac{Q_6}{7.4 \times 10^{10}} \right] - 0.1 \left[ \frac{Q_6}{7.4 \times 10^{10}} \right]$$

Available Light,  $J_R$

---

$$\frac{J_R}{3.2 \times 10^{12}} = \left[ \frac{J}{3.26 \times 10^{12}} \right] - 1.057 \left[ \frac{Q_2}{75,000} \right] \left[ \frac{J_R}{3.26 \times 10^{12}} \right]$$

---

Figure C-1. Annual variation in solar radiation ( $\text{kcal}/\text{m}^2 \cdot \text{day}$ ) for Saigon, South Vietnam.\*  
Monthly values are averages from January 1964 to October 1967.

\*Directorate of Meteorology, Republic of Vietnam.

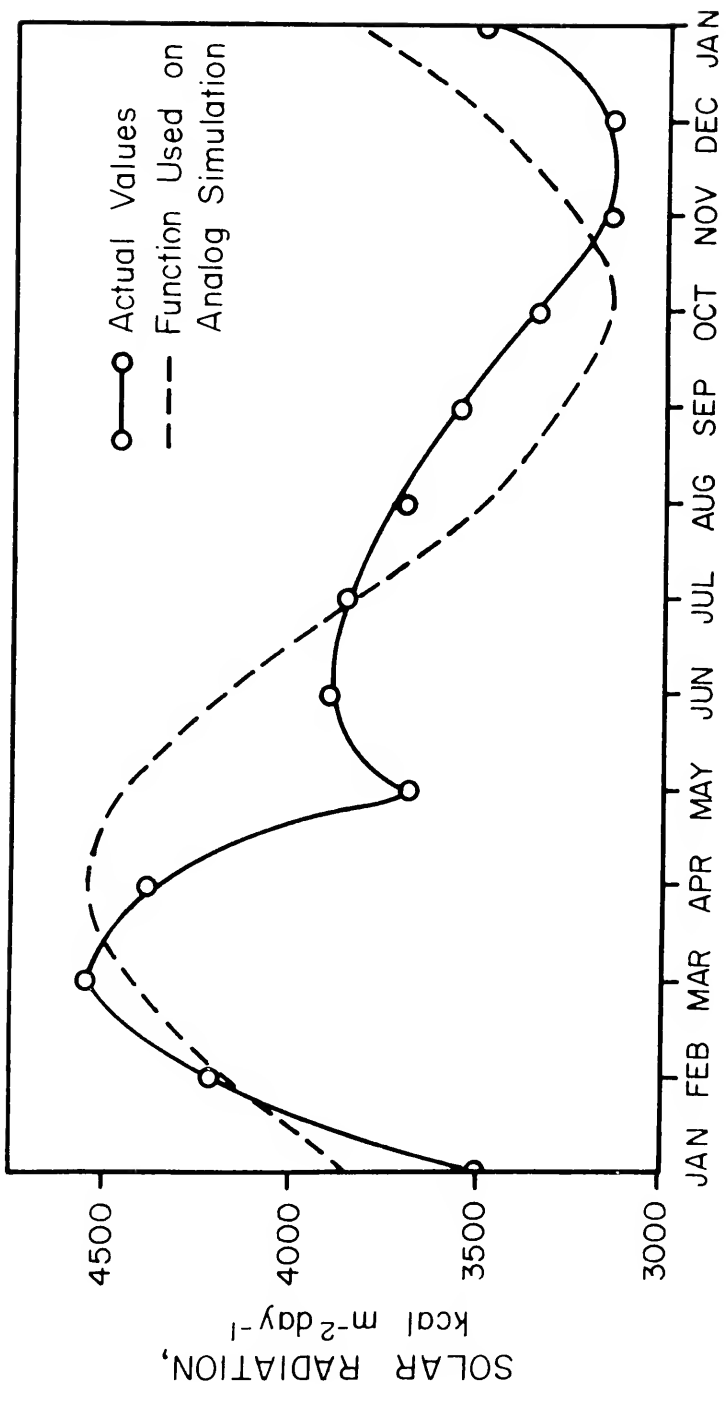
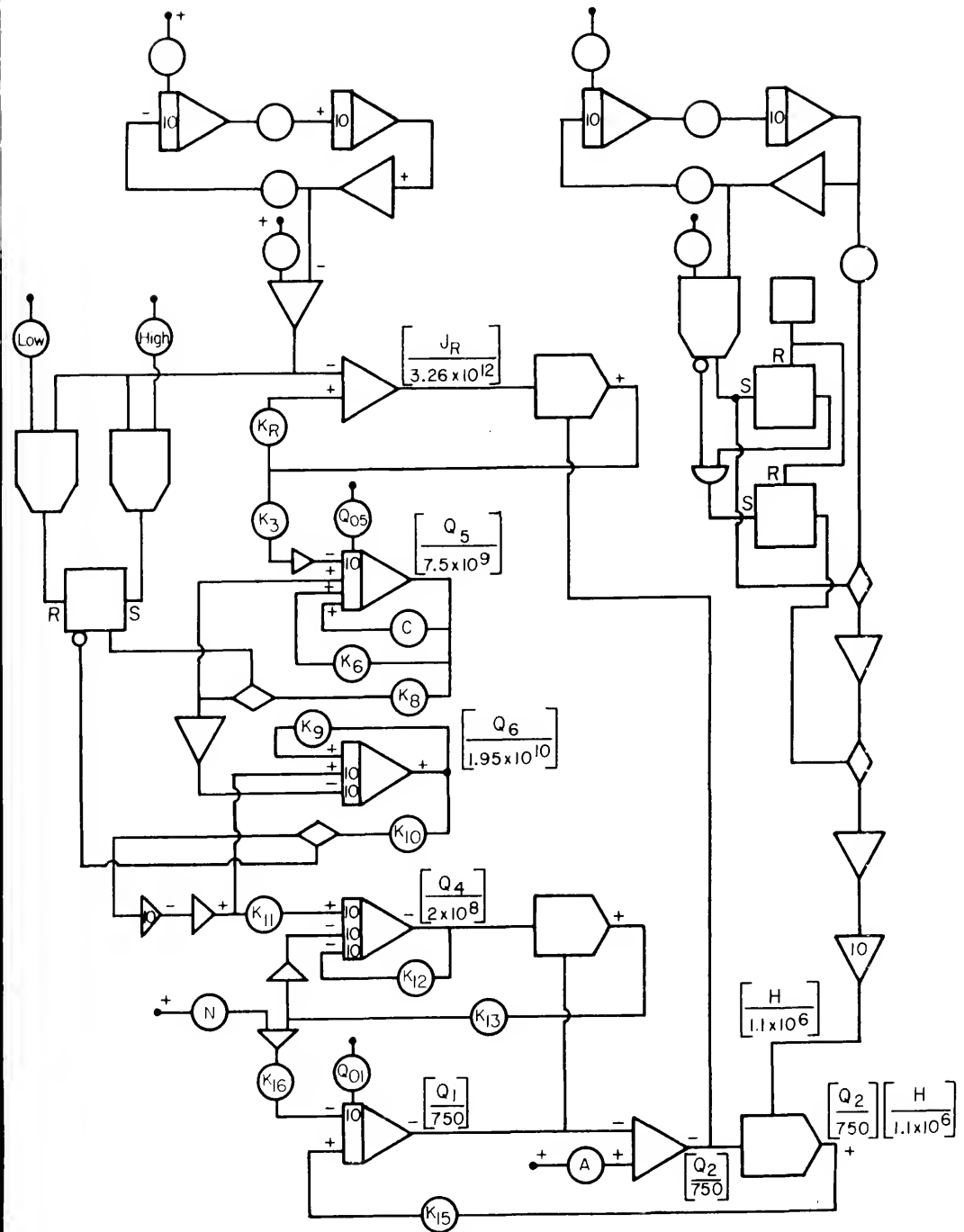

Figure C-2. Analog circuit diagram for the model simulating the effect of herbicides on the mangroves of the Rung-Sat district in South Vietnam.



APPENDIX D

SUPPLEMENTARY DATA FOR SIMULATION OF MODEL OF HURRICANES  
AND MANGROVES SHOWN IN FIGURE 15

Table D-1. Descriptions and values for the driving forces, state variables, and pathways of the model simulating the relationship among hurricanes, nutrients, and mangroves.

Table D-2. Calculation of rate coefficients for the model simulating the relationship among hurricanes, nutrients, and mangroves.

Table D-3. Scaled differential equations for the model simulating the relationship among hurricanes, nutrients, and mangroves.

Figure D-1. Analog circuit diagram for simulated model of nutrients, hurricanes and mangroves.

Table D-1. Descriptions and values for the driving forces, state variables, and pathways of the model (Figure 15) simulating the relationship among hurricanes, nutrients, and mangroves.

Outside driving force	Description	Value	Reference
I	Incoming solar radiation <sup>a</sup>	$1.60 \times 10^6$ kcal/m <sup>2</sup> ·year	Climatological data U.S. Weather Bureau Dept. of Commerce
T	Tidal amplitude that floods mangroves <sup>b</sup>	Average value of 0.10 m Maximum value of 2.0 m	Lugo and Snedaker (1974a)
N	Nutrients (nitrogen and phosphorus) available to mangroves from rainfall <sup>c</sup> , tidal exchange and freshwater runoff <sup>e</sup>	Rainfall P - 0.17 g/m <sup>2</sup> ·year N - 1.03 g/m <sup>2</sup> ·year Tidal Exchange P - 2.5 g/m <sup>2</sup> ·year N - 29 g/m <sup>2</sup> ·year Runoff P - 3.9 g/m <sup>2</sup> ·year N - 51 g/m <sup>2</sup> ·year Total P - 6.6 g/m <sup>2</sup> ·year N - 81.0 g/m <sup>2</sup> ·year	Joyner (1971) Carter et al. (1973)

Table D-1 (continued)

State variable	Description	Value	Reference
$Q_1$	Mangrove biomass (leaves and wood)	Initial value - 10,500 g C/m <sup>2</sup> Maximum value - 30,000 g C/m <sup>2</sup>	Lugo and Snedaker (1974a)
$Q_2$	Detritus on the forest floor	Initial value - 780 g C/m <sup>2</sup> Maximum value - 10,000 g C/m <sup>2</sup>	Lugo and Snedaker (1974a)
$Q_3$	Nutrients available to the mangroves	Initial value - 1600 g/m <sup>2</sup> Maximum value - 10,000 g/m <sup>2</sup>	No reference
$I_R$	Longwave radiation not used for photosynthesis <sup>g</sup>	$8.0 \times 10^5$ kcal/m <sup>2</sup> ·year	No reference
$k_{O_1 Q_3 I_R}$	Shortwave radiation used for photosynthesis <sup>h</sup>	$8.0 \times 10^5$ kcal/m <sup>2</sup> ·year	No reference
$k_{I_1 Q_1 I_R}$	Gross primary production rates for the mangrove forest	Fringe forest $\frac{2820 \text{ g C/m}^2 \cdot \text{year}}{\text{Basin forest}}$ 3130 g C/m <sup>2</sup> ·year	Lugo and Snedaker (1974a)
$k_{S_1 Q_1^2}$	Respiration rate for the mangrove forest	Fringe forest $\frac{1110 \text{ g C/m}^2 \cdot \text{year}}{\text{Basin forest}}$ 1010 g C/m <sup>2</sup> ·year	Lugo and Snedaker (1974a)



Table D-1 (continued)

State variable	Description	Value	Reference
$k_2 Q_1$	Rate at which mangrove biomass flows to detritus as litterfall	Fringe forest $347 \text{ g C/m}^2 \cdot \text{year}$	Lugo and Snedaker (1974a)
$k_5 Q_2^T$	Export of detritus into the estuaries as determined by tidal action	$197 \text{ g C/m}^2 \cdot \text{year}$	Carter et al. (1973)
$k_6 Q_2$	Decomposition rate of detritus <sup>i</sup>	$122 \text{ g C/m}^2 \cdot \text{year}$	Lugo and Snedaker (1974a) Stanford (1976)
$k_6^1 Q_2$	Rate of nutrient flux due to detrital decomposition <sup>j</sup>	$6.1 \text{ g/m}^2 \cdot \text{year}$	
$k_8 Q_2$	Loss of detritus to peat formation <sup>k</sup>	Negligible	No reference
$k_9 Q_3$	Loss of nutrients to sediments and to the sea <sup>l</sup>	$17 \text{ g/m}^2 \cdot \text{year}$	No reference
$k_{10} Q_1 Q_2^1 R$	Uptake of nutrients by photosynthesis <sup>m</sup>	$70.5 \text{ g/m}^2 \cdot \text{year}$	No reference

Table D-1 (continued)

State variable	Description	Value	Reference
$k_{11}Q_{1H}$	Loss of mangrove biomass due to high winds and tides from hurricanes <sup>n</sup>	Case I - 50% of leaves plus 10% of wood destroyed. Case II - 100% of leaves plus 50% of wood destroyed. Case III - 100% of leaves plus 90% of wood destroyed.	No reference
$k_{12}Q_{2H}$	Export of detritus due to tides from hurricanes <sup>o</sup>	Case I - 50% of standing stock plus leaves and wood blown down by hurricane. Case II - 50% of standing stock plus leaves plus 20% of wood blown down. Case III - 100% of standing stock plus leaves plus 20% of wood blown down.	No reference

<sup>a</sup>Value used was for Miami, Florida, where the 10-year average (1961-1970) was 4400 kcal/m<sup>2</sup>day or 1.60 x 10<sup>6</sup> kcal/m<sup>2</sup>year.

<sup>b</sup>Tidal amplitude was determined as the depth to which the mangroves were flooded at high tide. Average depth was estimated as 10 cm with a maximum depth of 2 m.

Table D-1 (continued)

<sup>c</sup>The average concentration of phosphorus in rainwater was taken as  $0.12 \text{ g/m}^3$  and of nitrogen as  $0.73 \text{ g/m}^3$ . Average annual rainfall in the Ten Thousand Islands area is 141 cm. Therefore, the average inputs of phosphorus and nitrogen due to rainfall were calculated to be  $0.17 \text{ g of phosphorus/m}^2 \cdot \text{year}$  and  $1.03 \text{ g of nitrogen/m}^2 \cdot \text{year}$ .

<sup>d</sup>The average concentration of total phosphorus in estuarine waters was  $0.035 \text{ g/m}^3$  and for nitrogen the value was  $0.40 \text{ g/m}^3$ . Based on two high tides per day flooding the area of mangroves to an average depth of 0.1 m the average yearly inputs of phosphorus and nitrogen due to tides were calculated as 2.5 and  $29 \text{ g/m}^2$ , respectively.

<sup>e</sup>Nutrient flow from Fakahia-Union canal to Fakahia-Union Bay was measured to be 7300 kgs of phosphorus/year and 94,900 kgs of nitrogen/year. The area of Fakahia-Union Bay is 186 ha and nutrient fluxes were calculated as  $3.9 \text{ g of phosphorus/m}^2 \cdot \text{year}$  and  $51 \text{ g of nitrogen/m}^2 \cdot \text{year}$ .

<sup>f</sup>Nutrient level was estimated.

<sup>g</sup>Longwave radiation energy is about 50% of the incoming solar energy.

<sup>h</sup>Shortwave radiation energy is about 50% of the incoming solar energy.

<sup>i</sup>Stanford (1976) has measured decomposition rates of red mangrove leaves in a dwarf mangrove community and found that 50% of the leaves decomposed in about five months. This gives a decay constant of  $0.139/\text{month}$  if

$$N = N_0 e^{-kt}$$

is used as the decay equation. From Lugo and Snedaker (1974a), the rate of litterfall was  $347 \text{ g C/m}^2 \cdot \text{year}$ . Export to the bay was  $197 \text{ g C/m}^2 \cdot \text{year}$  from Carter et al. (1973). This leaves  $150 \text{ g C/m}^2 \cdot \text{year}$  available for in situ decomposition. The amount decomposed after one year was  $122 \text{ g C}$ .

Table D-1 (continued)

$N = N_0 e^{-kt} = 150 e^{-.139 (12)} = 28 \text{ g C/m}^2$  remaining out of the original  $150 \text{ C/m}^2$  available for decomposition.

<sup>j</sup>Level of nitrogen and phosphorus equals 5% of the detritus on a g carbon basis. Therefore, the nutrient recycle rate equals  $0.05 \times 122 \text{ g C/m year}$  or  $6.1 \text{ g nutrients/m}^2 \cdot \text{year}$ .

<sup>k</sup>Peat formation is a slow process and detritus going to peat was considered negligible.

<sup>l</sup>Nutrient loss to sea was estimated as the difference between input from tides, runoff and rainfall and the uptake rate ( $87.6 \text{ g/m}^2 \cdot \text{year} - 70.5 \text{ g/m}^2 \cdot \text{year}$ ).

<sup>m</sup>Using a nitrogen and phosphorus level of 2.5% of photosynthesis gives  $.025 (2820 \text{ g C/m}^2 \cdot \text{year})$  or  $70.5 \text{ g C/m}^2 \cdot \text{year}$ .

<sup>n</sup>In Case I, the estimate was that 50% of the leaves and 10% of the wood were lost. Based on initial leaf biomass of  $700 \text{ g/m}^2$  and initial wood biomass of  $9800 \text{ g/m}^2$ , the total mangrove biomass lost was  $0.50 (700) + 0.10 (9800)$  or  $1330 \text{ g/m}^2$ . In Case II, the estimate of 100% of leaves and 50% of wood destroyed would give  $1.00 (700) + (0.5 (9800))$  or  $5600 \text{ g/m}^2$  as the amount of mangrove biomass destroyed. In Case III, the estimate of 100% of leaves and 90% of wood destroyed would give  $1.00 (700) + 0.9 (9800)$  or  $9520 \text{ g/m}^2$  destroyed.

<sup>o</sup>In Case I the amount of detritus exported due to the hurricane was 50% of the standing stock plus the leaves and wood knocked down by the hurricane or  $0.50 (780) + 1.00 (1330)$  which equals  $1720 \text{ g/m}^2$ . In Case II, the amount of detritus exported due to the hurricane was 50% of the standing stock plus the leaves and 20% of the wood knocked down. This would give  $0.50 (780) + 1.0 (700) + 0.20 (4900)$  or  $2070 \text{ g/m}^2$ . In Case III, the amount of detritus exported due to the hurricane was 100% of the standing stock, 100% of the leaves and 20% of the wood. This gives  $1.00 (780) + 1.00 (700) + 0.2 (8820)$  or  $3240 \text{ g/m}^2$ .

Table D-2. Calculation of rate coefficients for the model (Figure 15) simulating the relationship among hurricanes, nutrients, and mangroves.

Rate of gross primary production,  $k_1 Q_1 Q_3 I_R$

$$k_1 = \frac{2820}{Q_1 Q_3 I_R} = \frac{2820}{(10,500)(1600)(8.0 \times 10^5)} \frac{\text{g C/m}^2 \cdot \text{year}}{(\text{g C/m}^2)(\text{g/m}^2)(\text{kcal/m}^2 \cdot \text{year})}$$

$$k_1 = 2.1 \times 10^{-10} \text{ m}^4/\text{kcal} \cdot \text{g}$$

Respiration,  $k_3 Q_1^2$

$$k_3 Q_1^2 = 1110 \text{ g C/m}^2 \cdot \text{year}$$

$$k_3 = \frac{1110}{Q_1^2} = \frac{1110}{(10,500)^2} \frac{\text{g C/m}^2 \cdot \text{year}}{(\text{g C})^2/\text{m}^4}$$

$$k_3 = 1.007 \times 10^{-5} \text{ m}^2/\text{g C} \cdot \text{year}$$

Rate of litterfall,  $k_2 Q_1$

$$k_2 Q_1 = 347 \text{ g C/m}^2 \cdot \text{year}$$

$$k_2 = \frac{347}{Q_1} = \frac{347}{10,500} \frac{\text{g C/m}^2 \cdot \text{year}}{\text{g C/m}^2}$$

$$k_2 = .033/\text{year}$$

Tidal export of detritus into estuary,  $k_5 Q_2 T$

$$k_5 Q_2 T = 197 \text{ g C/m}^2 \cdot \text{year}$$

$$k_5 = \frac{197}{Q_2 T} = \frac{197}{(780)(.1)} \frac{\text{g C/m}^2 \cdot \text{year}}{\text{m} \cdot \text{g C/m}^2}$$

$$k_5 = 2.53/\text{m} \cdot \text{year}$$

Table D-2 (continued)

---

Rate of detrital decomposition,  $k_6 Q_2$

$$k_6 Q_2 = 122 \text{ g C/m}^2 \cdot \text{year}$$

$$k_6 = \frac{122}{Q_2} = \frac{122}{780} \frac{\text{g C/m}^2 \cdot \text{year}}{\text{g C/m}^2}$$

$$k_6 = 0.156/\text{year}$$

Loss of detritus to peat formation,  $k_8 Q_2$

---

$$k_8 Q_2 = 0$$

$$k_8 = 0$$

Rate of nutrient flux due to detrital decomposition,  $k_6' Q_2$

---

$$k_6' Q_2 = 6.1 \text{ g nutrients/m}^2 \cdot \text{year}$$

$$k_6' = \frac{6.1}{Q_2} = \frac{6.1}{780} \frac{\text{g nutr/m}^2 \cdot \text{year}}{\text{g C/m}^2}$$

$$k_6' = .008 \text{ g nutr/g C} \cdot \text{year}$$

Loss of nutrients to the sea,  $k_9 Q_3$

---

$$k_9 Q_3 = 17 \text{ g nutrients/m}^2 \cdot \text{year}$$

$$k_9 = \frac{17}{Q_3} = \frac{17}{(1600)} \frac{\text{g nutr/m}^2 \cdot \text{year}}{\text{g nutr/m}^2}$$

$$k_9 = 0.0106/\text{year}$$

Table D-2 (continued)

Uptake of nutrients by mangrove vegetation,  $k_{10}Q_1Q_3I_R$

$$k_{10}Q_1Q_3I_R = 70.5 \text{ g nutrients/m}^2 \cdot \text{year}$$

$$k_{10} = \frac{70.5}{Q_1Q_3I_R} = \frac{70.5}{10,500(1600)8.0 \times 10^5} \frac{\text{g nutr/m}^2 \cdot \text{year}}{(\text{g C/m}^2)(\text{g nutr/m}^2)(\text{kcal/m}^2 \cdot \text{year})}$$

$$k_{10} = 5.24 \times 10^{-12} \text{ m}^4 \text{ g/C} \cdot \text{kcal}$$

Incoming shortwave radiation,  $k_RQ_1Q_3I_R$

$$k_RQ_1Q_3I_R = 8.0 \times 10^5 \text{ kcal/m}^2 \cdot \text{year}$$

$$k_R = \frac{8.0 \times 10^5}{Q_1Q_3I_R} = \frac{(8.0) \times 10^5}{(10,500)(1600)(8.0 \times 10^5)} \frac{\text{kcal/m}^2 \cdot \text{year}}{(\text{g C/m}^2)(\text{g nutr/m}^2)(\text{kcal/m}^2 \cdot \text{year})}$$

$$k_R = 5.95 \times 10^{-8} \text{ g/C g nutr} \cdot \text{m}^4$$

Loss of mangrove biomass due to hurricane,  $k_{11}HQ_1$

Case I - Moderate storm with winds up to 58 m/sec

50% of leaves + 10% of wood biomass

$$k_{11}Q_1H = 350 + 980 \text{ g C/m}^2 \cdot 30 \text{ days}$$

$$k_{11} = \frac{1330}{Q_1H} = \frac{1330 (365) \text{ g C/m}^2 \cdot \text{year}}{(10,500)(9)30 (\text{g C/m}^2)(\text{newtons/m}^2)}$$

$$k_{11} = 0.171 \text{ m}^2/\text{newtons} \cdot \text{year}$$

Table D-2 (continued)

Case II - Severe storm with winds up to 90 m/sec

100% of leaves + 50% of wood biomass

$$k_{11}Q_1H = 700 + 4900 \text{ g C/m}^2 \cdot 30 \text{ days}$$

$$k_{11} = \frac{5600}{Q_1H} = \frac{5600 (365) \text{ g C/m}^2 \cdot \text{year}}{(10,500)(13)(30)(\text{g C/m}^2)(\text{newtons/m}^2)}$$

$$k_{11} = 0.500 \text{ m}^2/\text{newtons} \cdot \text{year}$$

Case III - Severe storm with winds up to 90 m/sec

100% of leaves and 90% of wood biomass

$$k_{11}Q_1H = 9520 \text{ g C/m}^2 \cdot 30 \text{ days}$$

$$k_{11} = \frac{9520}{Q_1H} = \frac{9520 (365) \text{ g C/m}^2 \cdot \text{year}}{(10,500)(13)(30)(\text{g C/m}^2)(\text{newtons/m}^2)}$$

$$k_{11} = 0.849 \text{ m}^2/\text{newtons} \cdot \text{year}$$

Export of detritus due to hurricane,  $k_{12}Q_2H$

Case I - Moderate storm with winds up to 58 m/sec

50% of standing stock + leaves and wood blown down

$$k_{12}Q_2H = 390 + 1330 \text{ g C/m}^2 \cdot 30 \text{ days}$$

$$k_{12} = \frac{1720}{Q_2H} = \frac{1720 (365) \text{ g C/m}^2 \cdot \text{year}}{(780)(9)(30)(\text{g C/m}^2)(\text{newtons/m}^2)}$$

$$k_{12} = 2.98 \text{ m}^2/\text{newtons} \cdot \text{year}$$



Table D-2 (continued)

Case II - Severe storm with winds up to 90 m/sec

50% of standing stock + leaves + 20% of wood blown down

$$k_{12}Q_2H = 390 + 700 + 980 \text{ g C/m}^2 \cdot 30 \text{ days}$$

$$k_{12} = \frac{2070}{Q_2H} = \frac{2070 (365) \text{ g C/m}^2 \cdot \text{year}}{(780)(13)(30)(\text{g C/m}^2)(\text{newtons/m}^2)}$$

$$k_{12} = 2.48 \text{ m}^2/\text{newtons} \cdot \text{year}$$

Case III - Severe storm with winds up to 90 m sec

100% of standing stock + 100% of leaves and 20% of wood  
killed

$$k_{12}Q_{12}H = 780 + 700 + 1760 \text{ g C/m}^2 \cdot 30 \text{ days}$$

$$k_{12} = \frac{3240}{Q_{12}H} = \frac{3240 (365) \text{ g C/m}^2 \cdot \text{year}}{(780)(13)(30)(\text{g C/m}^2)(\text{newtons/m}^2)}$$

$$k_{12} = 3.89 \text{ m}^2/\text{newtons} \cdot \text{year}$$

Table D-3. Scaled differential equations for the model (Figure 15) simulating the relationship among hurricanes, nutrients, and mangroves.

Mangrove biomass,  $Q_1$

No hurricane

$$\frac{\dot{Q}_1}{3 \times 10^4} = 5.10 \left[ \frac{Q_1}{3 \times 10^4} \right] \left[ \frac{Q_3}{10^4} \right] \left[ \frac{I_R}{2.43 \times 10^6} \right] - 0.302 \left[ \frac{Q_1}{3 \times 10^4} \right] - 0.033 \left[ \frac{Q_1}{3 \times 10^4} \right] - 0$$

Case I - Moderate hurricane (winds up to 58 m/sec)

$$\begin{aligned} \frac{\dot{Q}_1}{3 \times 10^4} = & 5.10 \left[ \frac{Q_1}{3 \times 10^4} \right] \left[ \frac{Q_3}{10^4} \right] \left[ \frac{I_R}{2.43 \times 10^6} \right] - 0.302 \left[ \frac{Q_1}{3 \times 10^4} \right] - 0.033 \left[ \frac{Q_1}{3 \times 10^4} \right] \\ & - 2.22 \left[ \frac{Q_1}{3 \times 10^4} \right] \left[ \frac{H}{13} \right] \end{aligned}$$

Case II - Severe hurricane (winds up to 90 m/sec)

$$\begin{aligned} \frac{\dot{Q}_1}{3 \times 10^4} = & 5.10 \left[ \frac{Q_1}{3 \times 10^4} \right] \left[ \frac{Q_3}{10^4} \right] \left[ \frac{I_R}{2.34 \times 10^6} \right] - 0.302 \left[ \frac{Q_1}{3 \times 10^4} \right] - 0.033 \left[ \frac{Q_1}{3 \times 10^4} \right] \\ & - 6.49 \left[ \frac{Q_1}{3 \times 10^4} \right] \left[ \frac{H}{13} \right] \end{aligned}$$

Case III - Severe hurricane (winds up to 90 m/sec)

$$\begin{aligned} \frac{\dot{Q}_1}{3 \times 10^4} = & 5.10 \left[ \frac{Q_1}{3 \times 10^4} \right] \left[ \frac{Q_3}{10^4} \right] \left[ \frac{I_R}{2.43 \times 10^6} \right] - 0.302 \left[ \frac{Q_1}{3 \times 10^4} \right] - 0.033 \left[ \frac{Q_1}{3 \times 10^4} \right] \\ & - 11.0 \left[ \frac{Q_1}{3 \times 10^4} \right] \left[ \frac{H}{13} \right] \end{aligned}$$

Table D-3 (continued)

Mangrove detritus,  $Q_2$ 

No hurricane

$$\frac{\dot{Q}_2}{10^4} = 0.099 \left[ \frac{Q_1}{3 \times 10^4} \right] - 5.06 \left[ \frac{Q_2}{10^4} \right] \left[ \frac{T}{2} \right] - 0.156 \left[ \frac{Q_2}{10^4} \right]$$

Case I - Moderate hurricane (winds up to 58 m/sec)

$$\begin{aligned} \frac{\dot{Q}_2}{10^4} = & 0.099 \left[ \frac{Q_1}{3 \times 10^4} \right] - 5.06 \left[ \frac{Q_2}{10^4} \right] \left[ \frac{T}{2} \right] - 0.156 \left[ \frac{Q_2}{10^4} \right] + 6.66 \left[ \frac{Q_1}{3 \times 10^4} \right] \left[ \frac{H}{13} \right] \\ & - 38.74 \left[ \frac{Q_2}{10^4} \right] \left[ \frac{H}{13} \right] \end{aligned}$$

Case II - Severe hurricane (winds up to 90 m/sec)

$$\begin{aligned} \frac{\dot{Q}_2}{10^4} = & 0.099 \left[ \frac{Q_1}{3 \times 10^4} \right] - 5.06 \left[ \frac{Q_2}{10^4} \right] \left[ \frac{T}{2} \right] - 0.156 \left[ \frac{Q_2}{10^4} \right] + 19.47 \left[ \frac{Q_1}{3 \times 10^4} \right] \left[ \frac{H}{13} \right] \\ & - 32.2 \left[ \frac{Q_2}{10^4} \right] \left[ \frac{H}{13} \right] \end{aligned}$$

Case III - Severe hurricane (winds up to 90 m/sec)

$$\begin{aligned} \frac{\dot{Q}_2}{10^4} = & 0.099 \left[ \frac{Q_1}{3 \times 10^4} \right] - 5.06 \left[ \frac{Q_2}{10^4} \right] \left[ \frac{T}{2} \right] - 0.156 \left[ \frac{Q_2}{10^4} \right] + 33.0 \left[ \frac{Q_1}{3 \times 10^4} \right] \left[ \frac{H}{13} \right] \\ & - 50.6 \left[ \frac{Q_2}{10^4} \right] \left[ \frac{H}{13} \right] \end{aligned}$$

Table D-3 (continued)

---

 Nutrients,  $Q_3$ 

No hurricane

$$\dot{Q}_3 = 0.009 + 0.008 \left[ \frac{Q_2}{10^4} \right] - 0.382 \left[ \frac{Q_1}{3 \times 10^4} \right] \left[ \frac{Q_3}{10^4} \right] \left[ \frac{I_R}{2.43 \times 10^6} \right] - 0.011 \left[ \frac{Q_3}{10^4} \right]$$

Nutrient equations remain the same for hurricanes.

---

 Light-limiting equation,  $I_R$ 

$$\frac{I_R}{2.43 \times 10^6} = \frac{0.053 \left[ \frac{I_0}{2.43 \times 10^6} \right]}{0.053 + 0.947 \left[ \frac{Q_1}{3 \times 10^4} \right] \left[ \frac{Q_3}{3 \times 10^4} \right]}$$

---

Figure D-1. Analog circuit diagram for simulated model of nutrients, hurricanes and mangroves.

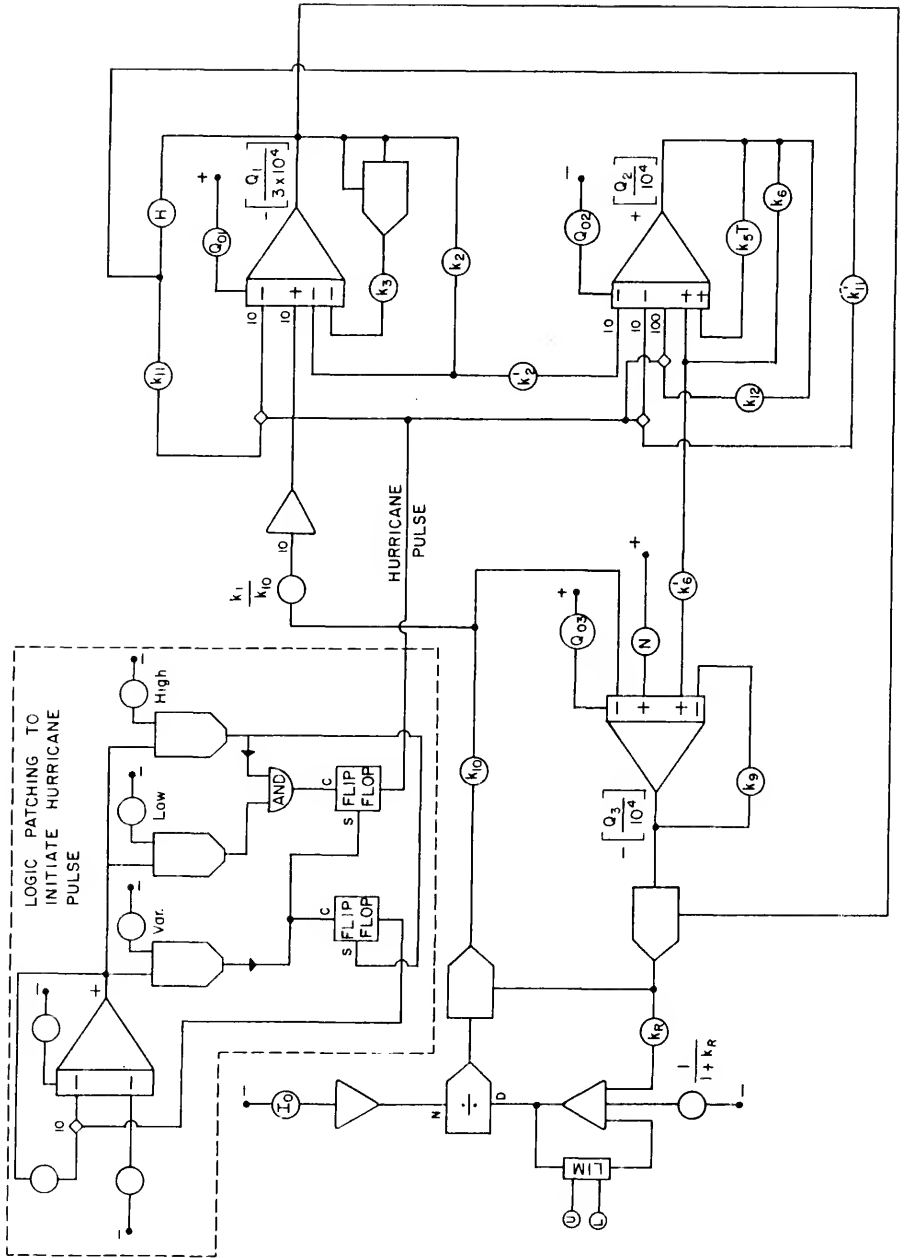

## APPENDIX E

### SUPPLEMENTARY DATA USED IN SIMULATION OF THE MODEL OF ECONOMIC DEVELOPMENT AND MANGROVES SHOWN IN FIGURE 28

Table E-1. Descriptions and values for the driving forces, state variables, and pathways of the model simulating the relationship between economic development and mangroves.

Table E-2. Calculation of rate coefficients for the model simulating the relationship between economic development and mangroves.

Table E-3. Scaled differential equations for the model simulating the relationship between economic development and mangroves.

Figure E-1. Analog circuit diagram of mangrove swamp and economic development system model.

Table E-1. Descriptions and values for the driving forces, state variables, and pathways of the model (Figure 28) simulating the relationship between economic development and mangroves.

Outside driving force	Description	Value	Reference
$I_0$	Incoming Solar Radiation <sup>2</sup>	$1.6 \times 10^6$ kcal/m <sup>2</sup> ·year	Climatological data U.S. Weather Bureau Dept. of Commerce
R	Rainfall <sup>b</sup>	$1.41 \times 10^6$ g/m <sup>2</sup> ·year	Carter et al. (1973)
$W_0$	Upland Runoff <sup>c</sup>	$1.0 \times 10^6$ g/m <sup>2</sup> ·year	Carter et al. (1973)
State Variable			
$Q_1$	Water on mangroves <sup>d</sup>	$0.1 \times 10^6$ g/m <sup>2</sup> Maximum value of $2.5 \times 10^6$ g/m <sup>2</sup>	Estimated
S	Salt in water <sup>e</sup>	2500 g/m <sup>2</sup> Maximum value of $2.5 \times 10^5$ g/m <sup>2</sup>	Estimated
$Q_2$	Mangrove biomass <sup>f</sup>	$79 \times 10^{10}$ kcal Maximum value of $3 \times 10^{12}$ kcal	Lugo and Snedaker (1974a)
$Q_3$	Estuarine area	750 ha Maximum value of 1000 ha	Estimated



Table E-1 (continued)

State variable	Description	Value	Reference
Q <sub>4</sub>	Developed land Residential <sup>g</sup>	250 ha total 112 ha of home 138 ha of lawn	Steller (1976)
	Condominium <sup>h</sup>	62 ha of buildings 188 ha of lawn	Steller (1976)
Q <sub>5</sub>	Developed structure Residential <sup>i</sup>	2.85 x 10 <sup>12</sup> kcal Maximum value of 11.4 x 10 <sup>12</sup> kcal	Miller (1975)
	Condominium <sup>j</sup>	13.8 x 10 <sup>12</sup> kcal Maximum value of 55.2 x 10 <sup>12</sup> kcal	Miller (1975)
Pathway			
k <sub>1E</sub>	Evaporation <sup>k</sup>	1.13 x 10 <sup>6</sup> g/m <sup>2</sup> ·year	Carter et al. (1973)
k <sub>2Q<sub>1</sub></sub>	Outflow of water into bay <sup>l</sup>	1.28 x 10 <sup>6</sup> g/m <sup>2</sup> ·year	Estimated by difference
k <sub>3I-R</sub> Q <sub>3</sub> (k <sub>1</sub> Q <sub>1</sub> <sup>5</sup> )	Primary production of mangrove swamp <sup>m</sup>	2.12 x 10 <sup>11</sup> kcal/year	Lugo and Snedaker (1974a)

Table E-1 (continued)

Pathway	Description	Value	Reference
$k_{50}^2$	Respiration of mangrove swamp <sup>n</sup>	$8.3 \times 10^{10}$ kcal/year	Lugo and Snedaker (1974a)
$k_{80}^2$	Effect of economic development on mangrove swamp <sup>o</sup>	$5.3 \times 10^{10}$ kcal/year	Estimate
$k_{90}^3$	Conversion of mangrove land to developed land <sup>p</sup>	50 ha/year if 250 ha 100 ha/year if 500 ha 150 ha/year if 750 ha 200 ha/year if full development	Estimate
$k_{1020}^4$	Flow of goods and fuels into developed structure because of mangrove-attracting energy flow. <sup>q</sup>		
	Residential	$8.5 \times 10^{10}$ kcal/year	
	Condominium	$18.4 \times 10^{11}$ kcal/year	
$k_{1516}^4$	Lawn primary production	$3.8 \times 10^{10}$ kcal/year	
	Residential <sup>r</sup>	$5.2 \times 10^{10}$ kcal/year	
	Condominium		

Table E-1 (continued)

Pathway	Description	Value	Reference
$Q_5$ $k_{11}Q_4$	Effect of density on developed structure <sup>t</sup> Residential Condominium	$2 \times 10^{10}$ kcal/year $4.6 \times 10^{11}$ kcal/year	Estimate Estimate
$k_{17}Q_4LP$	Flow of goods and services and fuels into structure due to law attractiveness <sup>q</sup> Residential Condominium	$1.5 \times 10^{11}$ kcal/year $4.6 \times 10^{11}$ kcal/year	Estimate Estimate
$k_{12}Q_5$	Depreciation of structure <sup>u</sup> Residential Condominium	$11.5 \times 10^{10}$ kcal/year $11.5 \times 10^{10}$ kcal/year	Estimate
$k_{13}Q_5^2$	Maintenance of existing structure <sup>v</sup> Residential Condominium	$7.5 \times 10^{11}$ kcal/year $17.3 \times 10^{11}$ kcal/year	Estimate Estimate
H	Flow of water onto mangroves due to storm surge of hurricanes. <sup>w</sup>	$2.5 \times 10^6$ m in one month	Estimate

Table E-1 (continued)

Pathway	Description	Value	Reference
k <sub>6</sub> Q <sub>1</sub> Q <sub>2</sub>	Stress of storm surge on mangrove swamp <sup>x</sup>	Case I - 10% of mangrove swamp affected Case II - 50% of mangrove swamp affected	Estimate
k <sub>7</sub> Q <sub>2</sub> H	Stress of hurricane winds on the mangrove swamp <sup>y</sup>	All cases - 25% of mangrove swamp affected.	Estimate
k <sub>14</sub> Q <sub>1</sub> Q <sub>5</sub>	Stress of storm surge on economic structure <sup>z</sup>	Case I - 10% destruction Case II - 50% destruction	Estimate

<sup>a</sup>Incoming solar radiation is based on a 10-year average of 4400 kcal/m<sup>2</sup>·day for Miami, Florida, or 365 x 440 = 1.5 x 10<sup>6</sup> kcal/m<sup>2</sup>·day.

<sup>b</sup>Rainfall average for Everglades City weather station was 141 cm/year or 141 cm/year x  $\frac{1\text{m}}{100\text{cm}} \times \frac{10^6\text{gm}}{\text{m}^3} = 1.41 \times 10^6 \text{ gm/m}^2 \cdot \text{year}$ .

<sup>c</sup>From Carter et al. (1973) the average annual flow of freshwater into Fakah Union Bay was 177 x 10<sup>6</sup>m<sup>3</sup> in 1972. The flow was then estimated to affect an area of 24 km<sup>2</sup> of mangroves. The flow in gms/m<sup>2</sup>·year would then be equal to

$$177 \times 10^6 \frac{\text{m}^3}{\text{year}} \times \frac{10^6 \text{ gms}}{1\text{m}} \times \frac{1}{24 \times 10^6 \text{m}^2} \quad \text{or}$$

$$7.4 \times 10^6 \text{ gms/m}^2 \cdot \text{year}.$$

Table E-1 (continued)

This value was thought to be higher than might be expected for an undrained upland system. Therefore, a value of  $1 \times 10^6$  gms/m<sup>2</sup>·year was used in the model.

<sup>d</sup>Mangrove swamps were estimated to have an average water depth of 0.1 meter or  $0.1 \times 10^6$  gms/m<sup>2</sup>.

<sup>e</sup>Salinity of the water flooding the mangrove swamps was estimated as 25 parts per thousand. Total amount of salt would then be equal to

$$0.1 \times 10^6 \text{ gms/m}^2 \times \frac{25 \text{ gms}}{1000 \text{ gms}} = 2500 \text{ gms/m}^2$$

<sup>f</sup>Mangrove biomass equals  $10,500 \text{ gm C/m}^2 \times \frac{10 \text{ kcal}}{1 \text{ gm C}} \times 7.5 \times 10^6 \text{ m}^2$  or  $79 \times 10^{10}$  kcal on 750 ha.

<sup>g</sup>A density of 10 units/ha was chosen for light residential and economic structure occupies 45% of developed land while lawns occupy the remaining 55%. By using 250 ha of development this leads to  
 .45 ha of building x 250 ha = 112 ha of buildings  
 .55 ha of lawn x 250 ha = 137 ha lawn.

<sup>h</sup>A density of 44 units/ha was chosen for condominium development and the buildings occupy 25% of the land and lawns account for 75%  
 .25 ha of buildings x 250 ha = 62 ha of buildings  
 .75 ha of lawn x 250 ha = 188 ha of lawn.

<sup>i</sup>Developed structure of light residential was taken from Miller (1975) as  $1.14 \times 10^5$  kcal/m<sup>2</sup>·unit. For 10 units/ha on 250 ha this gives

$$1.14 \times 10^5 \frac{\text{kcal}}{\text{m}^2 \cdot \text{unit}} \times 10 \text{ units} \times 2.5 \times 10^6 \text{ m}^2 = 2.85 \times 10^{12} \text{ kcal.}$$

Table E-1 (continued)

<sup>j</sup>Developed structure of condominium was taken from Miller (1975) as  $1.25 \times 10^5$  kcal/m<sup>2</sup>·unit. At 44 units/ha on 250 ha this gives

$$1.25 \times 10^5 \frac{\text{kcal}}{\text{m}^2 \cdot \text{unit}} \times 44 \text{ units} \times 2.5 \times 10^5 \text{m}^2 = 13.8 \times 10^{12} \text{kcal}$$

<sup>k</sup>Evaporation was estimated as 80% of rainfall or .080 x 1.41 x 10<sup>6</sup> equals 1.13 x 10<sup>6</sup> g/m<sup>2</sup>·year.

<sup>l</sup>The outflow of water into the bay was evaluated by the difference between rainfall plus runoff minus evaporation or (1.41 + 1.0 - 1.13) x 10<sup>6</sup> equals 1.28 x 10<sup>6</sup> g/mi<sup>2</sup>·year.

<sup>m</sup>Mangrove swamp primary production equals

$$2820 \frac{\text{g C}}{\text{m}^2 \cdot \text{year}} \times \frac{10 \text{ kcal}}{1 \text{ g C}} \times \frac{7.5 \times 10^6 \text{m}^2}{1} = 21.2 \times 10^{10} \text{ kcal.}$$

<sup>n</sup>Mangrove swamp respiration equals

$$\frac{1110 \text{ g C}}{\text{m}^2 \cdot \text{year}} \times \frac{10 \text{ kcal}}{1 \text{ g C}} \times 7.5 \times 10^6 \text{m}^2 = 8.3 \times 10^{10} \text{ kcal.}$$

<sup>o</sup>The effects of light residential and condominium development on the mangrove swamp was estimated as 25% of primary production or  $0.25 \times 21.2 \times 10^{10}$  kcal gives  $5.3 \times 10^{10}$  kcal.

<sup>p</sup>Clearing of mangrove land was estimated to take 5 years for all development ratios.

<sup>q</sup>The flow of goods and services and fuels into developed structure was taken from values given by Miller (1975). For light residential the total flow was equal to  $4 \times 10^5$  kcal/m<sup>2</sup>·year and for condominiums the flow was equal to  $9.2 \times 10^5$  kcal/m<sup>2</sup>. The attraction of the mangroves was estimated to be responsible for 85% of this flow for residential and 80% for condominium. Lawn vegetation was the other attraction that drew in the remaining 15 and 20%, respectively.

Table E-1 (continued)

<sup>r</sup>Lawn primary production for residential was equal to

$$\frac{7.55 \text{ g C}}{\text{m}^2 \cdot \text{day}} \times \frac{365 \text{ days}}{1 \text{ year}} \times \frac{10 \text{ kcal}}{1 \text{ g C}} \times 1.38 \times 10^6 \text{ m}^2 = 3.8 \times 10^{10} \text{ kcal}$$

<sup>s</sup>Lawn primary production for condominium was equal to

$$\frac{7.55 \text{ g C}}{\text{m}^2 \cdot \text{day}} \times \frac{365 \text{ days}}{1 \text{ year}} \times \frac{10 \text{ kcal}}{1 \text{ g C}} \times 1.88 \times 10^6 = 5.2 \times 10^{10} \text{ kcal}.$$

<sup>t</sup>The effect of density on developed structure was estimated as 20% of the flow of goods and services and fuel.

<sup>u</sup>The depreciation of structure was estimated as 5% of the flow of goods and services and fuels.

<sup>v</sup>The maintenance of existing structure was estimated as 75% of the flow of goods and services and fuels.

<sup>w</sup>The flow of water onto the mangrove swamp due to a hurricane storm surge was estimated to flood the mangroves to a depth of 2.5 m. The actual time is probably several tidal cycles but the shortest time obtained on the analog corresponded to about 1 month.

<sup>x</sup>The actual impact of a storm surge is difficult to measure and two estimates were used. The first estimate was that 10% of the mangrove swamp was destroyed and the second was that 50% was destroyed. The water level that affected the mangroves was anything above 2 m.

<sup>y</sup>Wind damage to the mangrove swamp due to a hurricane was estimated to effect 25% of the swamp.

<sup>z</sup>Storm surge damage to economic structure was estimated at 10% and 50%.

Table E-2. Calculation of rate coefficients for the model (Figure 28) simulating the relationship between economic development and mangroves.

---

Water outflow into bay,  $k_2 Q_1$

$$k_2 Q_1 = 1.28 \times 10^6 \text{ g/m}^2 \cdot \text{year}$$

$$k_2 = \frac{1.28 \times 10^6}{Q_1} = \frac{1.28 \times 10^6}{10^5} \frac{\text{g/m}^2 \cdot \text{year}}{\text{g/m}^2}$$

$$k_2 = 12.8/\text{year}$$

Primary production of mangrove swamp,  $k_3 I_R Q_2 Q_3 (k_4 - \frac{S}{Q_1})$

---

$$k_3 I_R Q_2 Q_3 (k_4 - \frac{S}{Q_1}) = 2.12 \times 10^{11} \text{ kcal/year}$$

$$k_3 = \frac{2.12 \times 10^{11}}{I_R Q_2 Q_3 (k_4 - \frac{S}{Q_1})} = \frac{2.12 \times 10^{11}}{(8 \times 10^5)(79 \times 10^{10})(750)(.06 - .025)}$$

$$\frac{\text{kcal/year}}{(\text{kcal/m}^2 \cdot \text{year})(\text{kcal} \cdot \text{ha} \cdot \text{ppt})}$$

$$k_3 = 1.28 \times 10^{-8} \text{ m}^2/\text{kcal} \cdot \text{ha} \cdot \text{ppt}$$

Respiration of mangrove swamp,  $k_5 Q_2^2$

---

$$k_5 Q_2^2 = 8.3 \times 10^{10} \text{ kcal/year}$$

$$k_5 = \frac{8.3 \times 10^{10}}{Q_2^2} = \frac{8.3 \times 10^{10}}{(79 \times 10^{10})^2} \frac{\text{kcal/year}}{\text{kcal}^2}$$

$$k_5 = 1.33 \times 10^{-13} / \text{kcal/year}$$



Table E-2 (continued)

---

 Effect of development on mangroves,  $k_8 Q_2 Q_5$ 

---

Residential

$$k_8 Q_2 Q_5 = 5.3 \times 10^{10} \text{ kcal/year}$$

$$k_8 = \frac{5.3 \times 10^{10}}{Q_2 Q_5} = \frac{5.3 \times 10^{10}}{(79 \times 10^{10})(2.85 \times 10^{12})} \frac{\text{kcal/year}}{\text{kcal} \cdot \text{kcal}}$$

$$k_8 = 2.35 \times 10^{-14} / \text{kcal} \cdot \text{year}$$

Condominiums

$$k_8 = \frac{5.3 \times 10^{10}}{(79 \times 10^{10})(12.8 \times 10^{10})}$$

$$k_8 = 4.86 \times 10^{-15} / \text{kcal} \cdot \text{year}$$

---

 Conversion of mangrove land to developed land,  $k_9 Q_3$ 

---

$$25\% \text{ developed/5 years } k_9 = 0.070/\text{year}$$

$$50\% \text{ developed/5 years } k_9 = 0.140/\text{year}$$

$$75\% \text{ developed/5 years } k_9 = 0.280/\text{year}$$

$$99\% \text{ developed/5 years } k_9 = 0.96/\text{year}$$

Table E-2 (continued)

---

Flow of goods and services and fuels due to mangrove energies,

$$k_{10} Q_2 Q_4 Q_5^P$$

Residential

$$k_{10} Q_2 Q_4 Q_5^P = 8.5 \times 10^{11} \text{ kcal/year}$$

$$k_{10} = \frac{8.5 \times 10^{11}}{Q_2 Q_4 Q_5^P} = \frac{8.5 \times 10^{11}}{(79 \times 10^{10})(250)(2.85 \times 10^{12})(.5)} \frac{\text{kcal/year}}{\text{kcal} \cdot \text{ha} \cdot \text{kcal}}$$

$$k_{10} = 3.02 \times 10^{-15} / \text{kcal/ha} \cdot \text{year}$$

---

Effect of density on development,  $k_{11} \frac{Q_5}{Q_4}$

Residential

$$k_{11} \frac{Q_5}{Q_4} = 2 \times 10^{11} \text{ kcal/year}$$

$$k_{11} = \frac{2 \times 10^{11} (Q_4)}{Q_5} = \frac{2 \times 10^{11} (250)}{2.85 \times 10^{12}} \frac{(\text{kcal/year}) \cdot \text{ha}}{\text{kcal}}$$

$$k_{11} = 17.5 \text{ ha/year}$$

Condominium

$$k_{11} = \frac{4.6 \times 10^{11} (250)}{13.8 \times 10^{12}}$$

$$k_{11} = 8.33 \text{ ha/year}$$

Table E-2 (continued)

---

 Depreciation of structure,  $k_{12}Q_5$ 

---

Residential

$$k_{12}Q_5 = 5 \times 10^{10} \text{ kcal/year}$$

$$k_{12} = \frac{5 \times 10^{10}}{Q_5} = \frac{5 \times 10^{10}}{2.85 \times 10^{12}} \frac{\text{kcal/year}}{\text{kcal}}$$

$$k_{12} = 0.018/\text{year}$$

Condominium

$$k_{12} = \frac{11.5 \times 10^{10}}{13.8 \times 10^{12}}$$

$$k_{12} = 0.008/\text{year}$$

---

 Maintenance of structure,  $k_{13}Q_5^2$ 

---

Residential

$$k_{13}Q_5^2 = 7.5 \times 10^{11} \text{ kcal/year}$$

$$k_{13} = \frac{7.5 \times 10^{11}}{Q_5^2} = \frac{7.5 \times 10^{11}}{(2.85 \times 10^{12})^2} \frac{\text{kcal/year}}{\text{kcal}^2}$$

$$k_{13} = 9.23 \times 10^{-14}/\text{kcal}\cdot\text{year}$$

Table E-2 (continued)

---

Condominium

$$k_{13} = \frac{17.3 \times 10^{11}}{(13.8 \times 10^{12})^2}$$

$$k_{13} = 9.08 \times 10^{-15} \text{ kcal/year}$$

Flow of goods and services attracted by lush urban vegetation,  $k_{17}Q_4^{LP}$

---

Residential

$$k_{17}Q_4^{LP} = 1.5 \times 10^{11} \text{ kcal/year}$$

$$k_{17} = \frac{1.5 \times 10^{11}}{Q_4^{LP}} = \frac{1.5 \times 10^{11}}{(250)(3.8 \times 10^{10})(.5)} \frac{\text{kcal/year}}{\text{ha} \cdot \text{kcal/year}}$$

$$k_{17} = 3.16 \times 10^{-2}/\text{ha}$$

Condominium

$$k_{17}Q_4^{LP} = 4.6 \times 10^{11}$$

$$k_{17} = \frac{4.6 \times 10^{11}}{(250)(5.2 \times 10^{10})(.5)}$$

$$k_{17} = 7.08 \times 10^{-2}/\text{ha}$$

Table E-2 (continued)

---

Light-limiting term,  $k_R I_R Q_2 Q_3 (k_4 - \frac{S}{Q_1})$

---

$$k_R I_R Q_2 Q_3 (k_4 - \frac{S}{Q_1}) = 8 \times 10^5 \text{ kcal/m}^2 \text{ year}$$

$$k_R = \frac{8 \times 10^5}{1.0 \cdot 0.000 (k_4 - \frac{S}{Q_1})} = \frac{8 \times 10^5}{(8 \times 10^5)(79 \times 10^{10})(750)(.035)}$$

$$\frac{\text{kcal/m}^2 \cdot \text{year}}{(\text{kcal/m}^2 \cdot \text{year})(\text{kcal} \cdot \text{ha} \cdot \text{ppt})}$$

$$k_R = 4.82 \times 10^{-14} / \text{kcal} \cdot \text{ha} \cdot \text{ppt}$$

---

Table E-3. Scaled differential equations for the model (Figure 28) simulating the relationship between economic development and mangroves.

Water compartment,  $Q_1$

$$\dot{Q}_1 = R + W_0 - k_1 E - k_2 Q_1 + H^*$$

$$\frac{\dot{Q}_1}{2.5 \times 10^6} = 0.564 + 0.400 - 0.452 - 12.8 \left[ \frac{Q_1}{2.5 \times 10^6} \right] + 12$$

\*H occurs only during hurricane

Mangrove biomass compartment,  $Q_2$

$$\dot{Q}_2 = k_3 I_R Q_2 Q_3 \left( 0.06 - \frac{S}{Q_1} \right) - k_5 Q_2^2 - k_8 Q_2 Q_5 - k_6 Q_1 Q_2 - k_7 H Q_2$$

Residential development

$$\begin{aligned} \frac{\dot{Q}_2}{3 \times 10^{12}} = & 3.07 \left[ \frac{I_R}{2.4 \times 10^6} \right] \left[ \frac{Q_2}{3 \times 10^{12}} \right] \left[ \frac{Q_3}{10^3} \right] \left( 0.6 - \left[ \frac{S}{Q_1} \right] \right) - 0.400 \left[ \frac{Q_2}{3 \times 10^{12}} \right]^2 \\ & - 0.268 \left[ \frac{Q_2}{3 \times 10^{12}} \right] \left[ \frac{Q_5}{11.4 \times 10^{12}} \right] \\ & - 0.2^* \left[ \frac{Q_1}{2.5 \times 10^6} \right] \left[ \frac{Q_2}{3 \times 10^{12}} \right] - 0.65 \left[ \frac{Q_2}{3 \times 10^{12}} \right] \end{aligned}$$

\*above value is for 10% destruction. For 50% the value increases to 2.

Table E-3 (continued)

Condominium

$$\begin{aligned} \frac{\dot{Q}_5}{55.2 \times 10^{12}} &= 4.05 \left[ \frac{Q_2}{3 \times 10^{12}} \right] \left[ \frac{Q_3}{10^3} \right] \left[ \frac{Q_5}{55.2 \times 10^{12}} \right] \left[ \frac{P}{1} \right] \\ &+ 0.067 \left[ \frac{Q_4}{10^3} \right] \left[ \frac{L}{5.2 \times 10^{10}} \right] \left[ \frac{P}{1} \right] - 0.008 \frac{\left[ \frac{Q_5}{55.2 \times 10^{12}} \right]}{\left[ \frac{Q_4}{10^3} \right]} \\ &- 0.008 \left[ \frac{Q_5}{55.2 \times 10^{12}} \right] - 0.501 \left[ \frac{Q_5}{55.2 \times 10^{12}} \right] - 1.0^* \left[ \frac{Q_1}{2.5 \times 10^6} \right] \left[ \frac{Q_5}{55.2 \times 10^{12}} \right] \end{aligned}$$

\*Above value of 1.0 is for 10% destruction. for 50% destruction, a value of 5.5 was used.

Mangrove land compartment, Q<sub>3</sub>

$$\begin{aligned} \dot{Q}_3 &= -k_9 Q_3 \\ \dot{Q}_3 &= -0.072 \left[ \frac{Q_3}{10^3} \right] \end{aligned}$$

Light-limiting factor, I<sub>R</sub>

$$\frac{I_R}{2.4 \times 10^6} = \frac{0.065 \left[ \frac{I_0}{2.4 \times 10^6} \right]}{0.065 + 0.935 \left[ \frac{Q_2}{3 \times 10^{12}} \right] \left[ \frac{Q_3}{10^3} \right] 0.6 - \left[ \frac{S}{Q_1} \right]}$$

Table E-3 (continued)

Condominiums

$$\dot{Q}_2 \text{ remains the same except } \left[ \frac{Q_5}{11.4 \times 10^{12}} \right] \text{ becomes } \left[ \frac{Q_5}{55.2 \times 10^{12}} \right]$$

Economic structure compartment,  $Q_5$ 

$$\dot{Q}_5 = k_{10} Q_2 Q_4 Q_5 P + k_{17} Q_4 L P - k_{11} \frac{Q_5}{Q_4} - k_{12} Q_5 - k_{13} Q_5^2 - k_{14} Q_1 Q_5$$

Residential development

$$\begin{aligned} \frac{\dot{Q}_5}{11.4 \times 10^{12}} &= 9.06 \left[ \frac{Q_2}{3 \times 10^{12}} \right] \left[ \frac{Q_4}{10^3} \right] \left[ \frac{Q_5}{11.4 \times 10^{12}} \right] \left[ \frac{P}{1} \right] \\ &+ 0.236 \left[ \frac{Q_4}{10^3} \right] \left[ \frac{L}{3.8 \times 10^{10}} \right] \left[ \frac{P}{1} \right] - 0.018 \frac{\left[ \frac{Q_5}{11.4 \times 10^{12}} \right]}{\left[ \frac{Q_4}{10^3} \right]} \\ &- 0.018 \left[ \frac{Q_5}{11.4 \times 10^{12}} \right] - 1.05 \left[ \frac{Q_5}{11.4 \times 10^{12}} \right]^2 - 1.0 \star \left[ \frac{Q_1}{2.5 \times 10^6} \right] \left[ \frac{Q_5}{11.4 \times 10^{12}} \right] \end{aligned}$$



Figure E-1. Analog circuit diagram of mangrove swamp and economic development system model.

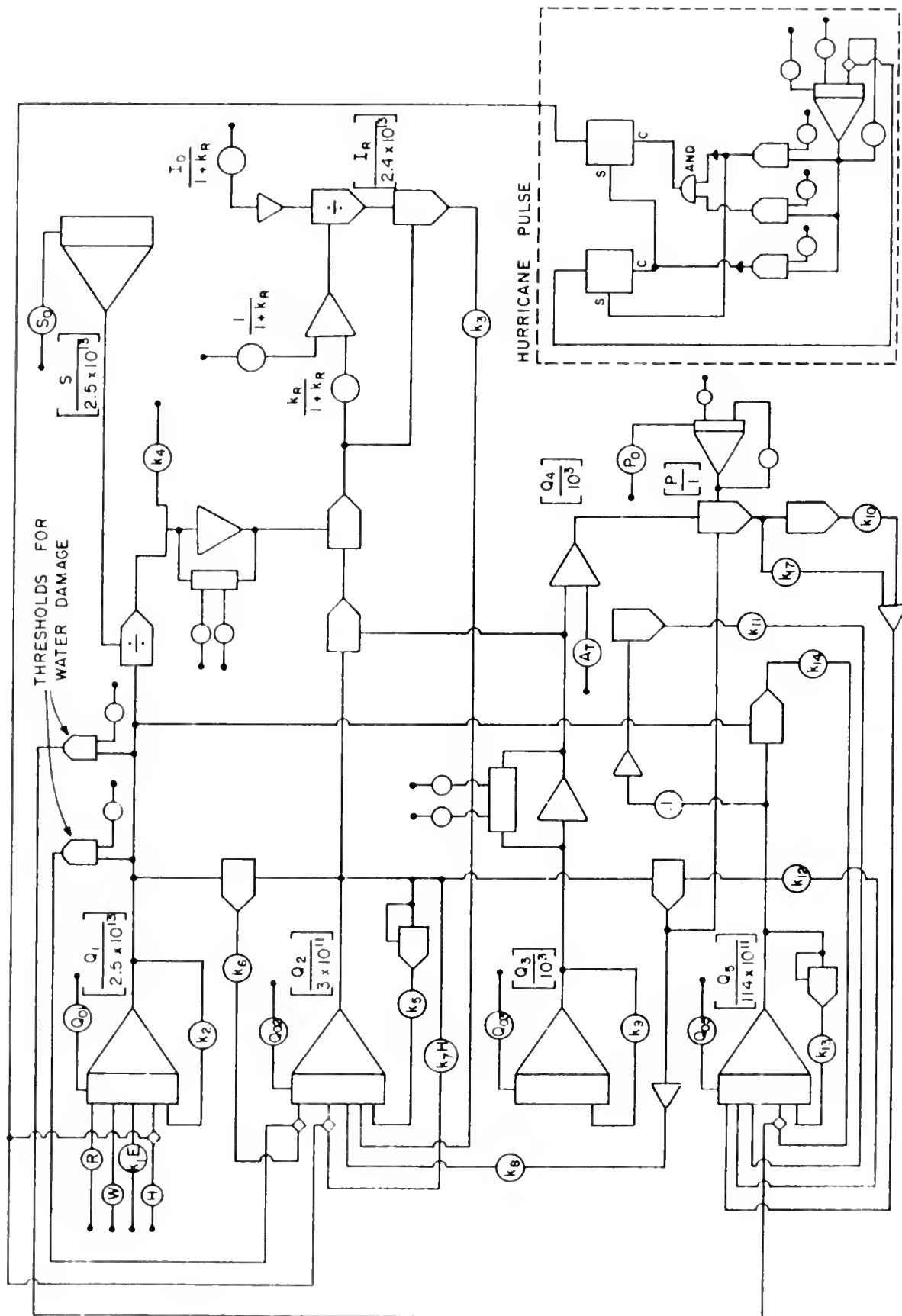

## APPENDIX F

### DETAILED DATA COLLECTED AT THE SPRAYED PLOTS ON MARCO ISLAND, FLORIDA

Table F-1. Number of fallen green leaves per  $m^2$  occurring in the control, cleared and sprayed areas near Marco Island, Florida, over a period of 26 months after aerial application of herbicide in December 1972.

Table F-2. Number of fallen yellow leaves per  $m^2$  occurring in the control, cleared and sprayed areas near Marco Island, Florida, over a period of 26 months after aerial application of herbicide in December 1972.

Table F-3. Number of dead seedlings per  $m^2$  occurring in the control, cleared and sprayed areas near Marco Island, Florida, over a period of 26 months after aerial application of herbicide in December 1972.

Table F-4. Number of live seedlings per  $m^2$  occurring in the herbicide study sites near Marco Island, Florida, over a period of 26 months after aerial application of herbicide in December 1972.

Table F-5. Number of Melampus coffeus per  $m^2$  occurring in the herbicide study sites near Marco Island, Florida, over a period of 26 months after aerial application of herbicide in December 1972.

Table F-6. Number of crabholes per  $m^2$  occurring in the herbicide study sites near Marco Island, Florida, over a period of 26 months after aerial application of herbicide in December 1972.

## APPENDIX F (continued)

Figure F-1. Number of fallen green leaves per  $m^2$  of study area in the Marco Island herbicide spraying experiment.

Figure F-2. Number of fallen yellow leaves per  $m^2$  of study area in the Marco Island herbicide spraying experiment.

Figure F-3. Number of dead seedlings per  $m^2$  of study area in the Marco Island herbicide spraying experiment.

Figure F-4. Number of live seedlings per  $m^2$  of study area in the March Island herbicide spraying experiment.

Figure F-5. Number of snails per  $m^2$  in the Marco Island herbicide spraying experiment.

Figure F-6. Number of crabholes per  $m^2$  in the Marco Island herbicide spraying experiment.

Table F-1. Number of fallen green leaves per m<sup>2</sup> occurring in the control, cleared, and sprayed areas near Marco Island, Florida, over a period of 26 months after aerial application of herbicide in December 1972.

Months after spraying	Number of fallen green leaves per m <sup>2</sup> (standard error)					
	1	5	8	12	20	26
Control area	0.5 (0.3)	0.5 (0.4)	0.0 (0.0)	0.5 (0.3)	0.0 (0.0)	0.1 (0.1)
Cleared area	0.0 (0.0)	0.0 (0.0)	0.0 (0.0)	0.0 (0.0)	0.0 (0.0)	0.0 (0.0)
Spray area 3 <sup>a</sup>	34.4 (6.3)	0.1 (0.1)	0.1 (0.1)	0.6 (0.3)	0.0 (0.0)	0.0 (0.0)
Spray area 4 <sup>b</sup>	38.9 (8.4)	0.8 (0.3)	0.1 (0.1)	1.0 (0.4)	0.5 (0.3)	0.4 (0.1)
Spray area 5 <sup>c</sup>	75.8 (16.7)	0.0 (0.0)	0.0 (0.0)	0.3 (0.2)	0.0 (0.0)	0.0 (0.0)
Average of 3 spray areas	49.7 (19.7)	0.3 (0.3)	0.1 (0.1)	0.6 (0.5)	0.2 (0.3)	0.1 (0.1)

<sup>a</sup>Amount of herbicide applied estimated as 14 liters of Tordon 101 per hectare.

<sup>b</sup>Amount of herbicide applied estimated as 28 liters of Tordon 101 per hectare.

<sup>c</sup>Amount of herbicide applied measured as 20.5 liters of Tordon 101 per hectare.

Table F-2. Number of fallen yellow leaves per m<sup>2</sup> occurring in the control, cleared, and sprayed areas near Marco Island, Florida, over a period of 26 months after aerial application of herbicide in December 1972.

Months after spraying	Number of fallen yellow leaves per m <sup>2</sup> (standard error)					
	1	5	8	12	20	26
Control area	20.2 (4.6)	1.2 (0.3)	2.7 (0.7)	1.2 (0.7)	0.6 (0.2)	1.6 (0.6)
Cleared area	--	0.0	0.4 (0.3)	0.6 (0.4)	0.3 (0.3)	0.4 (0.3)
Spray area 3 <sup>a</sup>	110.0 (20.2)	0.3 (0.2)	1.8 (0.4)	0.6 (0.3)	0.5 (0.3)	0.8 (0.4)
Spray area 4 <sup>b</sup>	193.0 (75.5)	0.5 (0.2)	0.1 (0.1)	0.5 (0.2)	1.4 (1.1)	0.8 (0.4)
Spray area 5 <sup>c</sup>	304.0 (122.3)	0.4 (0.3)	1.0 (0.4)	0.6 (0.3)	0.9 (0.5)	0.8 (0.4)
Average of 3 spray areas	203 (145.1)	0.4 (0.4)	1.0 (0.6)	0.6 (0.5)	0.9 (1.2)	0.8 (0.7)

<sup>a</sup>Amount of herbicide applied estimated as 14 liters of Tordon 101 per hectare.

<sup>b</sup>Amount of herbicide applied estimated as 28 liters of Tordon 101 per hectare.

<sup>c</sup>Amount of herbicide applied measured as 20.5 liters of Tordon 101 per hectare.

Table F-3. Number of dead seedlings per m<sup>2</sup> occurring in the control, cleared, and sprayed areas near Marco Island, Florida, over a period of 26 months after aerial application of herbicide in December 1972.

Months after spraying	Number of dead seedlings per m <sup>2</sup> (standard error)				
	1	5	8	12	26
<u>Control area</u>					
<u>Avicennia germinans</u>	0	0	0	0	0
<u>Rhizophora mangle</u>	0	0	0	0	0
<u>Cleared area</u>					
<u>Avicennia germinans</u>	0	0	0	0.1 (0.1)	0
<u>Spray area 3<sup>a</sup></u>					
<u>Avicennia germinans</u>	2.3 (0.5)	0.5 (0.3)	0.5 (0.3)	0	0
<u>Rhizophora mangle</u>	0	0.1 (0.1)	0.4 (0.3)	0	0
<u>Spray area 4<sup>b</sup></u>					
<u>Avicennia germinans</u>	4.0 (1.9)	1.7 (0.7)	0	0	0
<u>Rhizophora mangle</u>	0.2 (0.4)	1.0 (0.4)	0.3 (0.2)	0.1 (0.1)	0

Spray area 5<sup>C</sup>

<u>Avicennia germinans</u>	4.8 (3.0)	0	0.4 (0.3)	0.1 (0.1)	0	0.4 (0.2)
<u>Rhizophora mangle</u>	0	1.6 (0.8)	0.5 (0.3)	0	0	0.1 (0.1)
Average of 3 spray areas						
<u>Avicennia germinans</u>	3.7 (3.6)	0.7 (0.8)	0.3 (0.4)	0	0	0.1 (0.2)
<u>Rhizophora mangle</u>	0.1 (0.4)	0.9 (0.9)	0.4 (0.5)	0	0	0

<sup>a</sup>Amount of herbicide applied estimated as 14 liters of Tordon 101 per hectare.

<sup>b</sup>Amount of herbicide applied estimated as 28 liters of Tordon 101 per hectare.

<sup>c</sup>Amount of herbicide applied measured as 20.5 liters of Tordon 101 per hectare.



Table F-4. Number of live seedlings per m<sup>2</sup> occurring in the herbicide study sites near Marco Island, Florida, over a period of 26 months after aerial application of herbicide in December 1972.

Months after spraying	Number of live seedlings per m <sup>2</sup> (standard error)					
	1	5	8	12	20	26
<b>Control area</b>						
<u>Avicennia germinans</u>	0.8 (0.4)	0.6 (0.2)	0.3 (0.2)	0	0.5 (0.2)	1.2 (0.7)
<u>Rhizophora mangle</u>	0	0.1 (0.1)	0	0	0.3 (0.3)	0
<b>Cleared area</b>						
<u>Avicennia germinans</u>	--	3.2 (0.8)	2.3 (0.8)	1.9 (0.7)	3.8 (2.2)	2.2 (0.9)
<u>Rhizophora mangle</u>	--	0.7 (0.4)	0.7 (0.8)	1.3 (0.5)	1.7 (1.1)	0.4 (0.1)
<u>Laguncularia racemosa</u>	--	0	0.7 (0.5)	2.5 (0.8)	2.2 (0.9)	2.5 (1.1)
<b>Spray area 3<sup>a</sup></b>						
<u>Avicennia germinans</u>	2.3 (1.2)	2.1 (0.7)	2.2 (0.5)	1.8 (0.7)	1.4 (0.6)	10.1 (2.7)
<u>Rhizophora mangle</u>	1.5 (0.6)	0.1 (0.1)	0.5 (0.4)	0.6 (0.3)	0.8 (0.3)	1.6 (0.4)
<u>Laguncularia racemosa</u>	0	0	0	0.1 (0.1)	0	0.4 (0.3)

Spray area 4<sup>b</sup>

<u>Avicennia germinans</u>	5.8 (3.7)	4.3 (1.0)	3.2 (1.1)	3.5 (1.2)	4.9 (1.3)	6.4 (2.3)
<u>Rhizophora mangle</u>	1.5 (1.2)	0.4 (0.2)	0.5 (0.2)	0.5 (0.3)	0.5 (0.2)	0.4 (0.3)
<u>Laguncularia racemosa</u>	0	0.1 (0.1)	0	0.5 (0.3)	0.8 (0.3)	0.3 (0.3)

Spray area 5<sup>c</sup>

<u>Avicennia germinans</u>	4.5 (3.8)	1.8 (0.8)	2.7 (1.2)	4.3 (1.1)	0.9 (0.3)	3.2 (2.3)
<u>Rhizophora mangle</u>	2.8 (1.2)	2.3 (0.8)	1.7 (1.0)	0.8 (0.5)	0.6 (0.2)	1.9 (0.3)
<u>Laguncularia racemosa</u>	0	0	0	1.3 (0.5)	1.0 (0.3)	1.7 (0.5)

Average of 3  
spray areas

<u>Avicennia germinans</u>	4.2 (5.4)	2.7 (1.5)	2.7 (1.7)	3.2 (1.8)	2.4 (1.5)	6.6 (4.2)
<u>Rhizophora mangle</u>	1.9 (1.8)	0.9 (0.8)	0.9 (1.1)	0.6 (0.7)	0.6 (0.4)	1.3 (0.6)
<u>Laguncularia racemosa</u>	0	.1 (0.1)	0	0.6 (0.6)	0.6 (0.4)	0.8 (0.7)

<sup>a</sup>Herbicide applied at an estimated 14 liters Tordon 101 per hectare.

<sup>b</sup>Herbicide applied at an estimated 28 liters Tordon 101 per hectare.

<sup>c</sup>Herbicide applied at a measured 20.5 liters Tordon 101 per hectare.

Table F-5. Number of Melampus coffeae per m<sup>2</sup> occurring in the herbicide study sites near Marco Island, Florida, over a period of 26 months after aerial application of herbicide in December 1972.

Months after spraying	Number of <u>M. coffeae</u> per m <sup>2</sup> (standard error)					
	1	5	8	12	20	26
Control area	38.1 (4.1)	66.0 (12.2)	38.4 (7.7)	14.0 (2.8)	37.7 (5.4)	48.2 (6.3)
Cleared area	--	13.8 (3.6)	5.1 (0.9)	2.1 (1.0)	3.1 (1.1)	6.9 (2.3)
Spray area 3 <sup>a</sup>	65.2 (11.0)	68.2 (10.7)	54.8 (7.8)	22.4 (4.0)	20.0 (3.2)	37.1 (6.3)
Spray area 4 <sup>b</sup>	35.4 (12.0)	56.5 (13.1)	3.2 (1.1)	3.8 (1.1)	18.8 (6.1)	7.4 (3.1)
Spray area 5 <sup>c</sup>	77.7 (18.8)	15.7 (7.2)	15.5 (5.6)	9.0 (2.2)	4.0 (1.3)	4.0 (2.3)
Average of 3 spray areas	59.4 (24.9)	46.8 (18.4)	24.5 (9.7)	11.7 (4.7)	14.3 (7.0)	16.2 (7.4)

<sup>a</sup>Herbicide applied at an estimated 14 liters Tordon 101 per hectare.

<sup>b</sup>Herbicide applied at an estimated 28 liters Tordon 101 per hectare.

<sup>c</sup>Herbicide applied at a measured 20.5 liters Tordon 101 per hectare.

Table F-6. Number of crabholes per m<sup>2</sup> occurring in the herbicide study sites near Marco Island, Florida, over a period of 26 months after aerial application of herbicide in December 1972.

Months after spraying	Number of crabholes per m <sup>2</sup> (standard error)					
	1	5	8	12	20	26
Control area	--	14.2 (0.9)	15.5 (1.4)	8.3 (1.4)	0	18.4 (2.3)
Cleared area	--	14.9 (1.4)	14.9 (2.5)	10.0 (1.2)	10.9 (3.4)	30.6 (3.7)
Spray area 3 <sup>a</sup>	--	6.8 (0.9)	13.1 (1.4)	8.3 (1.3)	10.0 (1.8)	38.2 (2.2)
Spray area 4 <sup>b</sup>	--	13.2 (1.1)	10.7 (1.1)	7.5 (1.1)	18.1 (2.5)	35.3 (1.8)
Spray area 5 <sup>c</sup>	--	12.5 (1.3)	14.0 (2.2)	10.5 (1.6)	19.1 (2.2)	48.1 (2.1)
Average of 3 spray areas	--	10.8 (1.9)	12.6 (2.8)	8.8 (2.3)	15.7 (3.8)	40.5 (3.5)

<sup>a</sup>Herbicide applied at an estimated 14 liters Tordon 101 per hectare.

<sup>b</sup>Herbicide applied at an estimated 28 liters Tordon 101 per hectare.

<sup>c</sup>Herbicide applied at a measured 20.5 liters Tordon 101 per hectare.

Figure F-1. Number of fallen green leaves per m<sup>2</sup> of study area in the Marco Island herbicide spraying experiment.

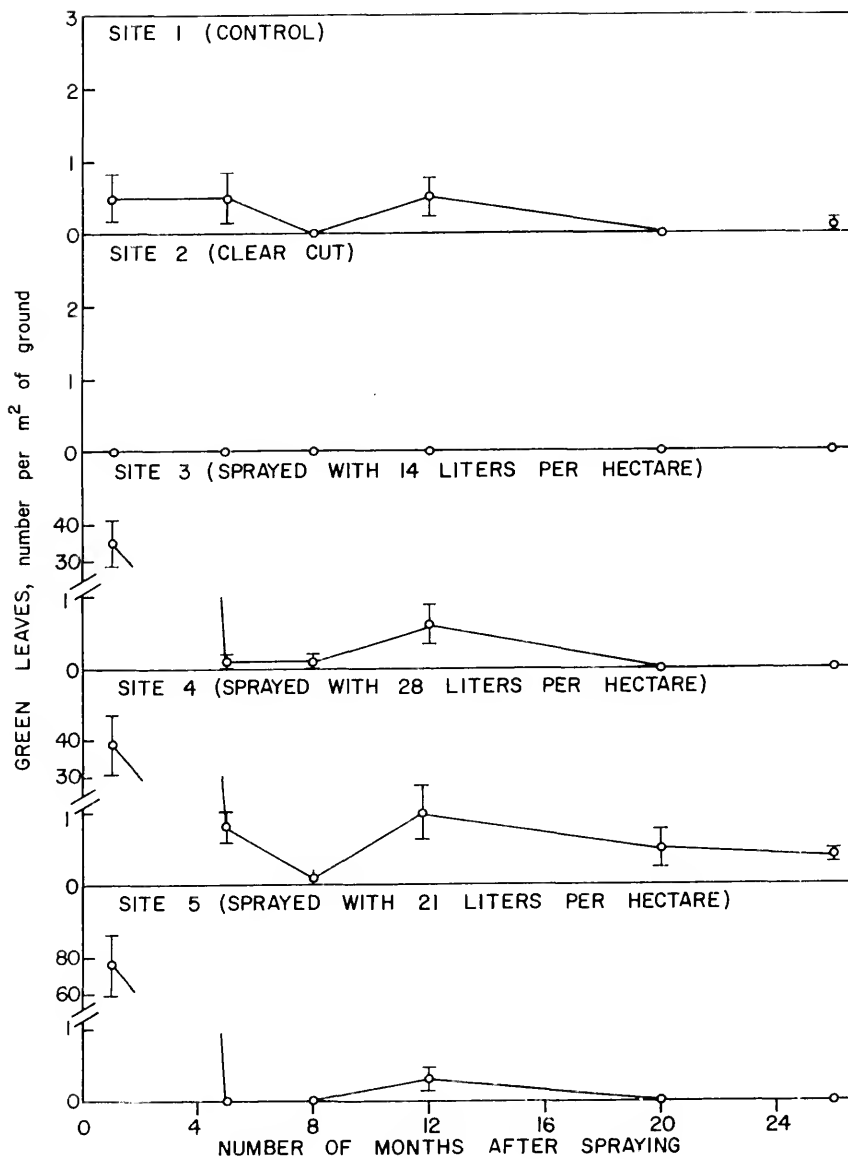

Figure F-2. Number of fallen yellow leaves per m<sup>2</sup> of study area in the Marco Island herbicide spraying experiment.

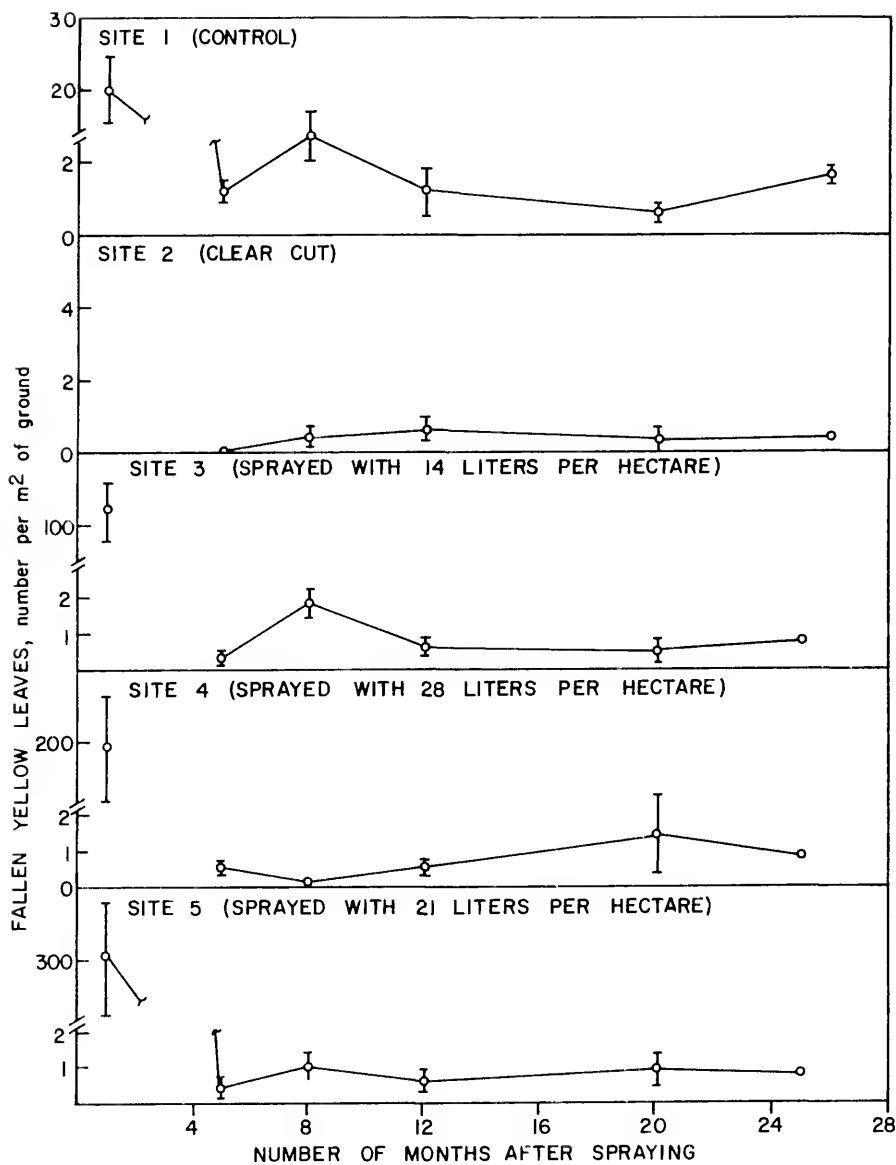



Figure F-3. Number of dead seedlings per m<sup>2</sup> of study area in the Marco Island herbicide spraying experiment.

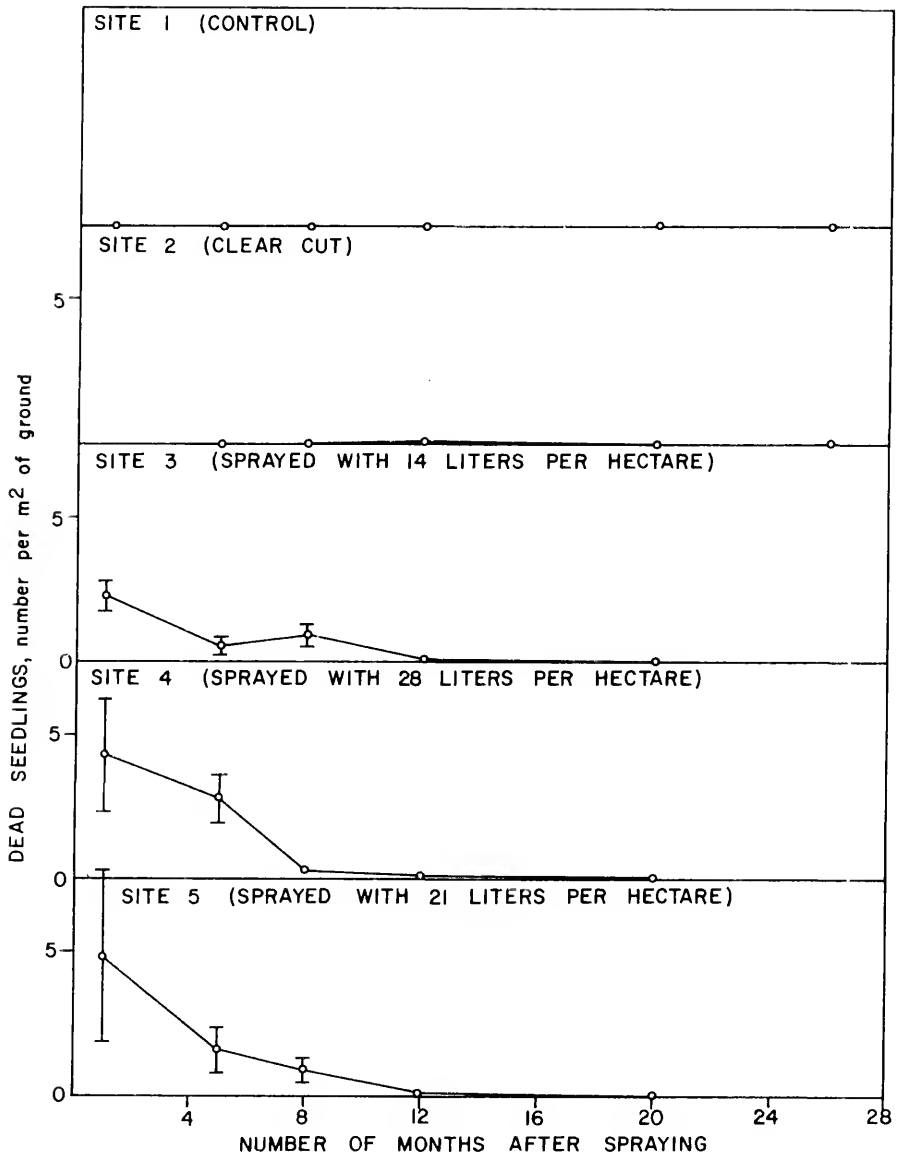

Figure F-4. Number of live seedlings per m<sup>2</sup> of study area in the Marco Island herbicide spraying experiment.

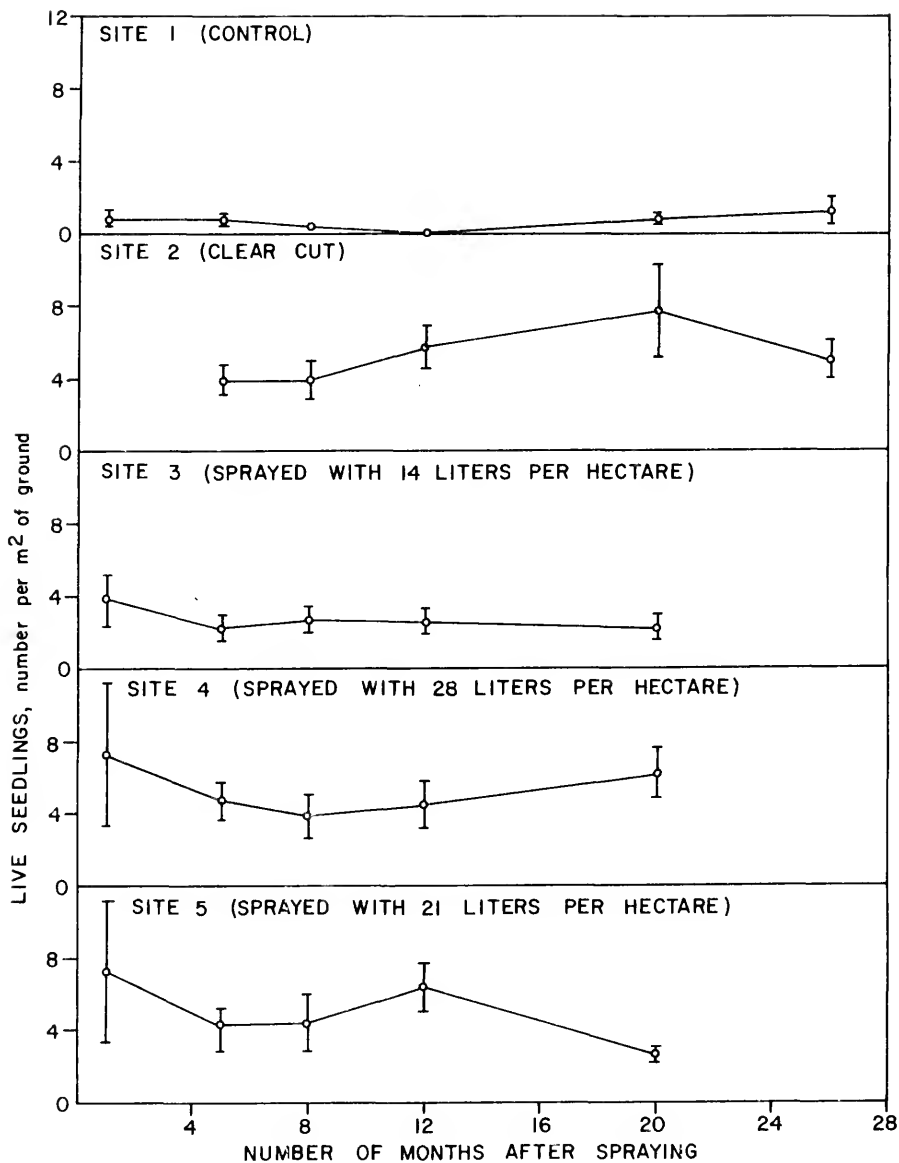

Figure F-5. Number of snails per m<sup>2</sup> of study area in the Marco Island herbicide spraying experiment.

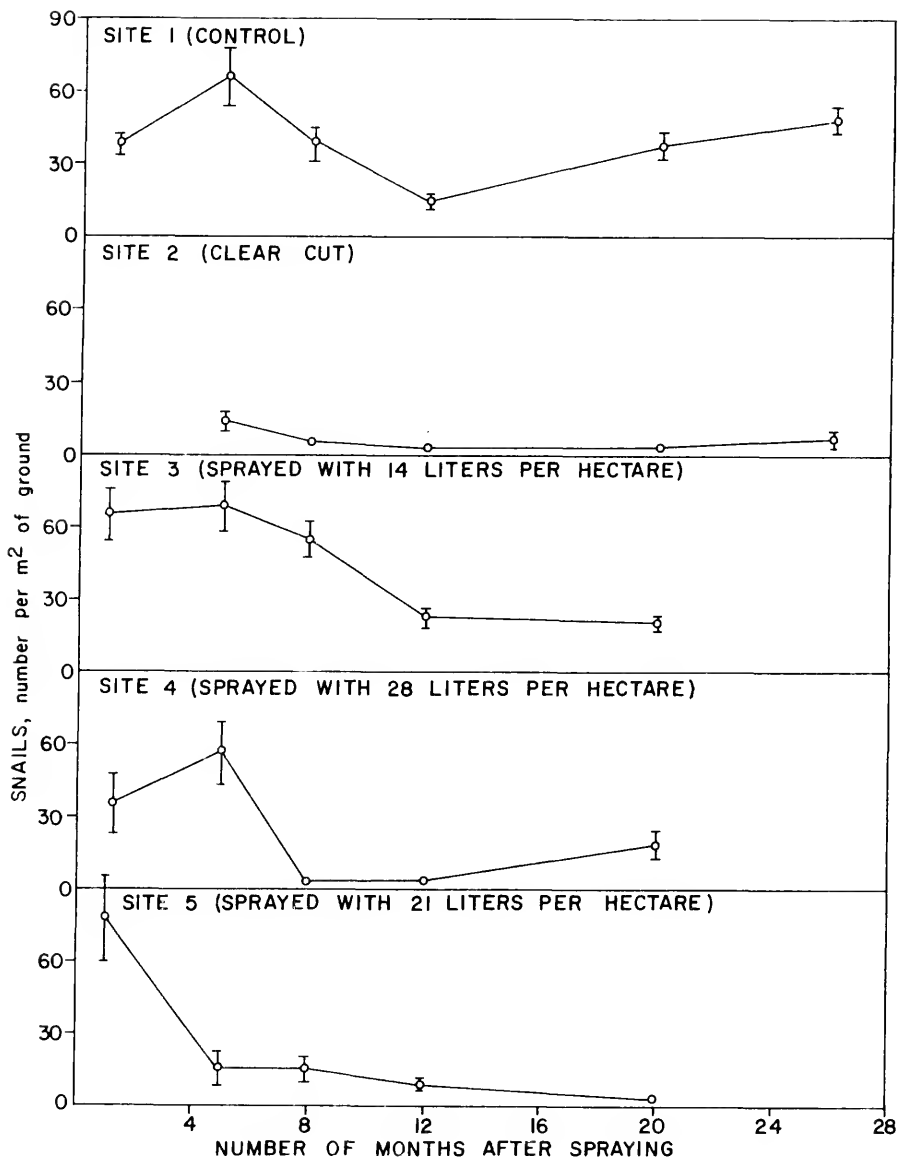
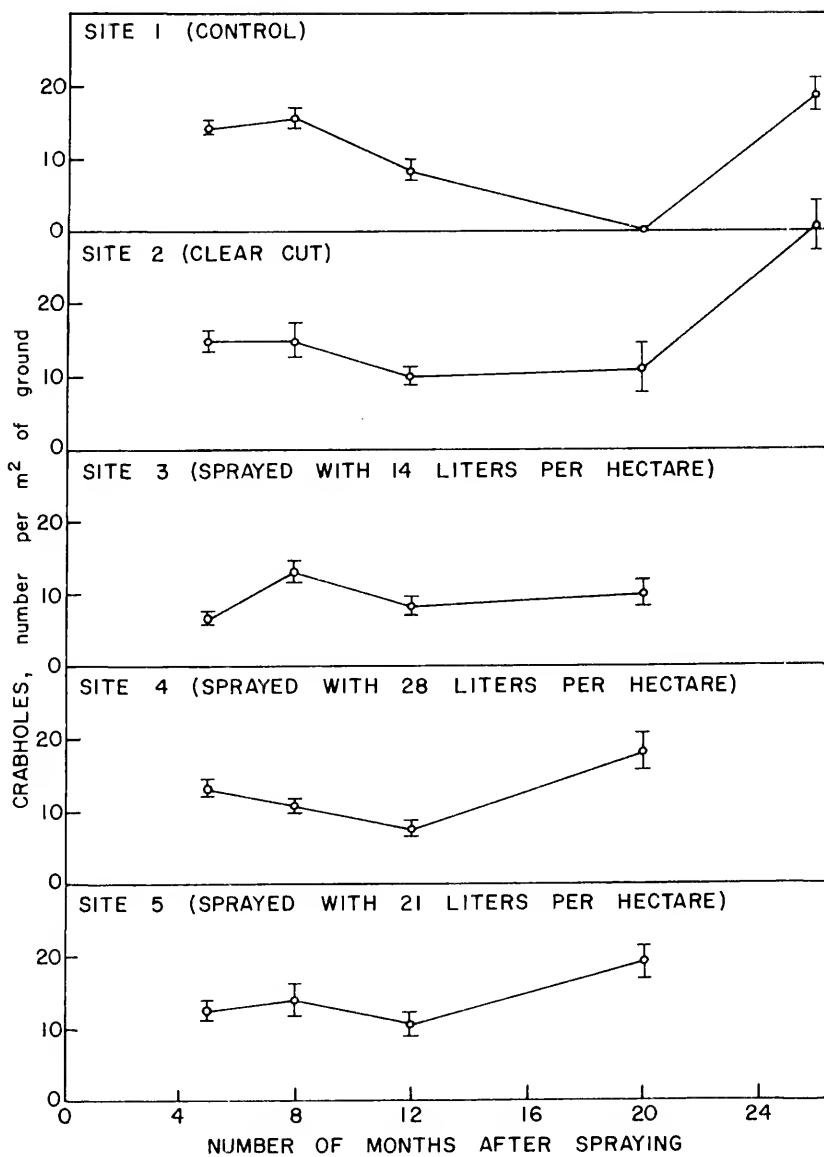

Figure F-6. Number of crabholes per m<sup>2</sup> of study area in the Marco Island herbicide spraying experiment.





## APPENDIX G

### DETAILED DATA COLLECTED ON RESPONSE OF MANGROVE FOREST TO NUTRIENT ENRICHMENT

- Table G-1. Evaluation of species and populations of mangroves in two sites receiving sewage effluent and also two sites not receiving sewage effluent.
- Table G-2. Population density of Rhizophora mangle seedlings on the parent tree at the two sites receiving sewage effluent and the two control sites.
- Table G-3. Diameter, height, basal area, and volume of individual trees in the mangrove forest receiving sewage effluent from the Naples, Florida, sewage treatment plant.
- Table G-4. Diameter, height, basal area, and volume of individual trees in the control mangrove forest at Naples, Florida.
- Table G-5. Diameter, height, basal area, and volume of individual trees in the mangrove forest receiving sewage effluent from the Everglades City, Florida, sewage treatment plant.
- Table G-6. Diameter, height, basal area, and volume of individual trees in the control mangrove forest at Everglades City, Florida.
- Table G-7. Leaf, wood, and seed fall during a 55-week period from September 6, 1973, to September 27, 1974, in the mangrove forest that occasionally received sewage effluent from the Naples, Florida, sewage treatment plant; and from June 21 to September 26, 1974, in the control mangrove forest.

## APPENDIX G (continued)

Table G-8. Leaf, wood, and seed fall during a 55-week period from September 4, 1973, to September 27, 1974, in the mangrove forest that occasionally received sewage effluent from the Everglades City, Florida, sewage treatment plant.

Table G-9. Rate of leaf, wood, seed, and total litter fall during a 55-week period from September 6, 1973, to September 27, 1974, in the mangrove forest that occasionally received sewage effluent from the Naples, Florida, sewage treatment plant; and from June 21 to September 27 in the control mangrove forest.

Table G-10. Rate of leaf, wood, seed, and total litter fall during a 55-week period from September 4, 1973, to September 27, 1974, in the mangrove forest that occasionally received sewage effluent from the Everglades City, Florida, sewage treatment plant.

Table G-11. Concentrations of total phosphorus found in the Gordon River at Naples, Florida, at various sampling times from September 1973 to February 1975.

Table G-12. Concentration of total phosphorus in the tidal canal at Everglades City, Florida, at various sampling times from September 1973 to February 1975.

## APPENDIX G (continued)

Table G-13. Calculation of mangrove forest biomass for the Naples and Everglades City, Florida, study sites.

Table G-1. Evaluation of species and populations of mangroves in two sites receiving sewage effluent and also two sites not receiving sewage effluent.

Area sampled, m <sup>2</sup>	Species and number of trees		
	Rhizophora mangle	Laguncularia racemosa	All trees
Naples sewage site			
36	4	3	7
45	22	3	25
42	17	3	20
30	23	1	24
38	24	1	25
59	33	0	33
46	24	1	25
49	29	1	30
33	0	11	11
42	1	12	13
48	3	10	13
67	18	5	23
Total 535	197	52	249
Number per 100 m <sup>2</sup>	37	10	47
Naples control site			
35	28	17	45
44	19	14	33
33	20	8	28
46	12	13	25
Total 158	79	52	131
Number per 100 m <sup>2</sup>	50	33	83

Table 6-1 (continued)

Area sampled, m <sup>2</sup>	Species and number of trees			All trees
	<u>Avicennia germinans</u>	<u>Rhizophora mangle</u>	<u>Laguncularia racemosa</u>	
Everglades sewage site				
56	9	22	5	36
42	9	21	5	35
36	1	3	51	55
33	11	6	10	27
36	4	8	28	40
30	0	20	27	47
24	1	22	19	42
25	1	11	21	33
15	1	9	9	19
<u>39</u>	<u>5</u>	<u>19</u>	<u>16</u>	<u>40</u>
Total 336	42	141	191	374
Number per 100 m <sup>2</sup>	12	42	57	111
Everglades control site				
28	1	15	3	19
28	3	10	2	15
33	4	12	4	20
33	1	23	3	27
<u>39</u>	<u>0</u>	<u>12</u>	<u>8</u>	<u>20</u>
Total 161	9	72	20	101
Number per 100 m <sup>2</sup>	6	45	12	63

Table G-2. Population density of Rhizophora mangle seedlings on the parent tree at the two sites receiving sewage effluent and the two control sites.

Sample number	<u>Naples sewage</u> <u>Number of</u> <u>seedlings</u>	<u>Naples control</u> <u>Number of</u> <u>seedlings</u>	<u>Everglades sewage</u> <u>Number of</u> <u>seedlings</u>	<u>Everglades control</u> <u>Number of</u> <u>seedlings</u>
1	10	5	6	0
2	0	1	8	0
3	1	4	0	14
4	12	3	0	0
5	0	6	0	0
6	7	6	0	7
7	7	0	0	0
8	0	5	0	0
9	26	3	2	0
10	0	2	0	0
11	9	6	2	0
12	0	1	2	0
13	1	8	0	0
14	8	0	1	0
15	1	7	0	12
16	6	5	0	1

17	6	4	12	1
18	0	1	1	0
19	1	10	0	0
20	1	6	0	0
21	8	-	0	-
22	23	-	0	-
23	11	-	0	-
24	20	-	0	-
25	0	-	0	-
26	6	-	0	-
27	2	-	0	-
28	14	-	0	-
29	14	-	0	-
30	<u>0</u>	<u>-</u>	<u>0</u>	<u>-</u>
Total	171	83	34	35
Area sampled =	23.1 m <sup>2</sup>	15.4 m <sup>2</sup>	23.1	15.4
Number of seedlings per m <sup>2</sup>	7.4	5.4	1.5	2.3
Std error	1.7	0.8	0.65	1.2





Table G-3 (continued)

Tree number	Diameter, cm		Basal area, cm <sup>2</sup>		Height, meters	Volume, m <sup>3</sup>	
	Initial	1-year	3-year	Initial		1-year	3-year
27R	2.06			3.3			
28R	1.99			3.1			
29R	8.45		8.8	56.1		60.8	
30R	6.55			33.7			
31W	4.9			18.8			
32R	1.42			1.6			
33W	3.05			7.3			
34W	1.97			3.0			
35R	2.25			4.0			
36R	1.36		3.56	1.5		9.9	0.0002
37R	2.3		2.67	4.2		5.6	0.0006
38R	1.64		3.18	2.1		7.9	0.0002
39R	1.57			1.9			
40R	2.47	3.28		4.8	8.4		0.0007
41R	1.92	2.42		2.9	4.6		0.0007
42R	1.66	2.43		2.2	4.6		0.0008
43R	1.75	2.92		2.4	4.3		
	1.67	2.54		2.2			
	2.09	3.35		3.4			
44R	1.57			1.9			
45R	1.73	3.01		2.4			
46R	0.89	1.22		0.6			
47R	0.96	1.68		0.7			
48R	1.2	1.5		1.1			
49R	1.23			1.2			
50R	2.04			3.3			

Table 6-3 (continued)

Tree number	Diameter, cm		Basal area, cm <sup>2</sup>		Height, meters	Volume, m <sup>3</sup>	
	Initial	3-year	Initial	3-year		Initial	3-year
51R	5.4	5.7	22.9	25.5	7	0.008	0.009
52R	9.9	10.4	77.0	84.9	10	0.038	0.042
53R	1.82	1.99	2.6	3.1			
54R	1.14	1.96	1.0	3.0			
55R	1.58	2.84	2.0	6.3	4	0.0004	0.001
56R	1.45		1.7				0.003
57R	6.5	6.6	33.2	34.2	7	0.012	0.012
58R	8.45	8.6	56.1	58.1	9	0.025	0.030
59W	15.0	15.6	176.1	191.1	10	0.088	0.096
60R	6.7	6.9	35.3	37.4	10	0.018	0.018
61R	4.3	4.5	14.5	15.9	4	0.003	0.003
62R	8.2	8.7	52.8	59.4	8	0.021	0.024
63W	6.1	6.1	29.2	31.2	7	0.009	0.010
64W	3.58		10.1				
65R	1.59		2.0				
66W	4.2		13.8				
67B	11.4	12.1	102.1	115.0	10	0.051	0.058
68W	3.74		11.0				
69R	7.1	7.5	39.6	41.9	9	0.018	0.019
70R	5.3	5.5	22.1	21.2	6	0.007	0.007
71W	7.9	8.3	49.0	54.1	10	0.024	0.027
72W	15.05	15.7	177.9	193.6	11	0.098	0.106
73R	7.15	7.3	40.2	41.9	5	0.010	0.010
74W	8.55	9.0	57.4	63.6	12	0.034	0.038
75R	4.8	4.8	18.1	18.1	6	0.006	0.006
76W	11.9	12.2	111.2	116.9	12	0.066	0.070
77W	14.1	14.1	156.1	156.1	12	0.094	0.094

Table G-3 (continued)

Tree number	Diameter, cm		Basal area, cm <sup>2</sup>		Height, meters	Volume, m <sup>3</sup>	
	Initial	3-year	Initial	3-year		Initial	3-year
78R	9.0	9.35	63.6	68.7	10	0.032	0.034
79R	12.8	13.0	128.7	132.7	12	0.077	0.080
80W	16.6	17.4	216.4	237.8	10	0.108	0.119
81W	4.3	4.3	14.5	14.5	6	0.004	0.004
82W	4.6	5.3	16.6	22.1	5	0.004	0.009
83R	8.2	8.3	52.8	54.1	7	0.018	0.020
84R	8.7	9.0	59.4	63.6	8	0.024	0.029
85R	6.0	6.6	28.3	34.2			
86W	9.05	9.2	64.3	66.5			
87W	17.3	18.3	235.1	263.0			
88W	5.8	5.9	26.4	27.3			
89R	6.25	6.35	30.7	31.7			
90R	8.0	8.1	50.3	51.5			
91W	6.35	6.45	31.7	32.7	10	0.016	0.016
92W	22.5	22.8	397.6	408.1	15	0.298	0.345
93W	12.1	12.6	115.0	124.7	12	0.069	0.077
94W	11.0	11.6	95.0	105.7			
95W	8.3	9.1	54.1	65.0			
96R	5.7	6.0	25.5	28.3	6	0.008	0.009
97R	5.6	5.9	24.6	27.3	6	0.008	0.010
98R	9.1	10.0	65.0	78.5	6	0.020	0.025
99W	10.5	10.6	86.6	88.2	10	0.044	0.063
100W	5.35	5.4	22.5	22.9			
101W	6.3	6.6	31.2	34.2	6	0.010	0.011
102W	2.79	2.88	6.1	6.5			
103R	8.0	8.6	50.3	58.1	8	0.020	0.023
		10.2	81.7				

Table G-3 (continued)

Tree number	Diameter, cm		Basal area, cm <sup>2</sup>		Height, meters	Volume, m <sup>3</sup>		
	Initial	1-year	Initial	1-year		Initial	1-year	3-year
104R	4.5	4.6	15.9	16.6	7	0.006	0.006	0.006
105W	6.5	6.7d	33.2	35.2d				
106W	10.3	10.8	83.3	91.6	11	0.046	0.050	0.056
107W	8.25	8.3	53.5	54.1	11	0.030	0.030	0.042
108R	9.65	10.4	73.1	84.9	12	0.044	0.051	0.061
109W	7.3	7.3	41.9	41.9				
110R	6.1	6.2	29.2	30.2	6	0.009	0.009	0.010
111R	8.8	9.0	60.8	63.6	10	0.030	0.032	0.032
112R	6.8	7.0	36.3	38.5				
113R	14.0	14.4	153.9	162.9	12	0.092	0.098	0.104
114W	11.6	12.2	105.7	116.9	12	0.064	0.070	0.084
115W	10.3	11.0	83.3	95.0	11	0.046	0.052	0.066
116R	8.2	8.9	52.8	62.2	10	0.026	0.031	0.036
117R	6.6	6.6	34.2	34.2				
118W	4.9	4.9	18.9	18.9	5	0.005	0.005	0.005
119R	4.8	4.8	18.1	18.1	5	0.005	0.005	0.005
120R	5.6	5.6	24.6	24.6	9	0.011	0.012	0.015
121R	5.6	5.8	24.6	26.4	5	0.010	0.010	0.010
122W	7.3	7.3	41.9	41.9	10	0.028	0.032	0.038
123W	8.4	9.1	55.4	65.0	13	0.068	0.077	0.090
124W	11.6	12.3	105.7	118.8	13	0.037	0.049	0.076
125W	8.5	9.8	56.7	75.4	8	0.014	0.015	0.016
126R	6.6	6.9	34.2	37.4	14	0.110	0.116	0.157
127W	14.1	14.5	156.1	165.1	5	0.005	0.005	0.006
128R	5.0	5.0	19.6	19.6	10	0.046	0.050	0.064
129W	10.9	11.3	92.3	100.3	9	0.054	0.055	0.062
130W	12.3	12.5	118.8	122.7				

Table G-3 (continued)

Tree number	Diameter, cm		Basal area, cm <sup>2</sup>		Height, meters	Volume, m <sup>3</sup>		
	Initial	1-year	3-year	Initial		1-year	3-year	Initial
131W	13.7	13.7	14.6	147.4	9	0.066	0.066	0.076
132R	3.58	3.9	4.7	10.1	3	0.002	0.002	0.002
133W	7.8	7.9	8.25	47.8	9	0.022	0.022	0.024
134R	9.0	9.6	10.5	63.6	10	0.032	0.036	0.043
135R	7.7	8.4	9.65	46.6	8	0.018	0.022	0.029
136R	7.0		7.4	38.5				
137R	8.3	9.1	10.2	54.1	11	0.030	0.036	0.045
138R	5.5	5.8	7.1	23.8	10	0.012	0.013	0.020
139R	7.4	8.2	7.2d	43.0				
140R	5.2	6.0		21.2				
141R	8.8	9.1	9.3	60.8	11	0.034	0.036	0.038
142R	6.6	7.0	7.6	34.2	10	0.017	0.019	0.022
143R	7.2	7.5	8.1	40.7	10	0.020	0.022	0.026
144R	4.6	4.6		16.6				
145R	5.2	5.8		21.2				
146W	14.9	15.8	17.8	174.4	14	0.122	0.138	0.174
147W	9.4	9.8	11.3	69.4	12	0.042	0.045	0.060
148W	8.6	8.7		58.1				
149W	15.8	17.1	19.9	196.1	15	0.147	0.172	0.233
150W	4.4	4.4	4.8	15.2	5	0.004	0.004	0.004
151W	12.9	13.4	15.6	130.7	13	0.085	0.092	0.124
152W	12.4	13.5	15.0	120.8	13	0.078	0.093	0.115
153W	4.7	4.7		17.3				
154R	4.45	4.5		15.6				
155W	7.8	8.0		47.8				
156W	9.3	10.1		67.9				



Table 6-3 (continued)

Tree number	Diameter, cm		Basal area, cm <sup>2</sup>		Height, meters	Volume, m <sup>3</sup>		
	Initial	3-year	Initial	3-year		Initial	1-year	3-year
183R	8.0	8.2	50.3	52.8	7	0.018	0.019	0.018
184R	7.2	7.3	40.7	41.9	7	0.014	0.014	0.016
185W	15.4	16.1	186.3	203.6	12	0.112	0.122	0.134
186R	11.1	11.8	96.8	109.4	9	0.044	0.049	0.057
187R	6.6	7.2	34.2	40.7				
188R	4.9	5.5	18.9	23.8	8	0.008	0.010	0.014
189W	12.2	13.2	116.9	136.8				
190W	16.8	17.5	221.7	240.5	10	0.111	0.120	0.144
191R	7.4	7.7	43.0	46.6	9	0.020	0.020	0.022
192R	dead							
193W	9.8	10.2	75.4	81.7	12	0.045	0.049	0.060
194W	7.6	7.8	45.4	47.8				
195W	10.3	10.75	83.3	90.8				
196R	8.3	8.4	54.1	55.4				
197W	13.6	14.5	145.3	165.1				
198W	7.8	7.8	47.8					
199W	11.6	47.8	105.6					
200W		12.5		122.7	13			
201W	4.5	5.8	15.9	26.4				
202R	3.4		9.1					
203R	1.81		2.6					
204R	1.46		1.7					
205R	1.73	2.04	2.4	3.3				
206R	1.75	2.55	2.4	5.1				
95W	0.43		0.10					
115W	0.66	1.62	0.3	2.1	3	0.000	0.001	0.001
			2.54	6.1				

Table G-3 (continued)

Tree number	Diameter, cm		Basal area, cm <sup>2</sup>		Height, meters	Volume, m <sup>3</sup>	
	Initial	1-year	Initial	1-year		Initial	1-year
12SW	0.52	1.11	0.2	1.0	2	0.000	0.000
13SW	0.57	1.64	0.3	2.1			
14SW	1.95	3.77	3.0	11.2	5	0.001	0.008
23SW	0.49	1.82	0.2	2.6			
28SW	1.99	4.03	3.1	12.8	5	0.001	0.003
29SW	0.47	1.69	0.2	2.2	4	0.000	0.001
30SW	0.52	2.13	0.2	3.6	5	0.000	0.001
31SW	0.84	2.06	0.6	3.3	4	0.000	0.001
32SW	0.69	3.68	0.4	10.6	4		
33SW	0.44	0.2	0.2				
34SW	1.24	4.95	1.2		6		
35SW	1.11		1.0				
36SW		2.03			2		
10SW		2.16			3		
57SR	1.78	2.37	2.5	4.4			
62SR	1.36	1.58	1.5	2.0			
63SR	1.6	1.82	2.0	2.6			
65SW	4.5	5.9	15.9	27.3			
66SW	4.5	6.0	15.9	28.3			
	6.1	7.4	29.2	43.0			
	6.7	8.6	35.3	58.1			
67SW	7.3	8.4	41.9	55.4			
69SR	1.08		0.9				
71SR	1.42	1.47	1.6	1.7			
73SR	2.27		4.0				



Table G-3 (continued)

Tree number	Diameter, cm		Basal area, cm <sup>2</sup>		Height, meters	Volume, m <sup>3</sup>	
	Initial	1-year	Initial	1-year		Initial	1-year
74SR	1.16		1.1				
75SR	1.58	1.81	2.0	2.6			
76SR	1.22	1.63	1.2	2.1			
77SR	1.92		2.9				
78SR	1.72	1.74	2.3	2.4			
79SR	1.47	2.10	1.7	3.5			
80SR	1.46	2.53	1.7	5.0			
81SR	1.63		2.1				
82SR	1.82		2.6				
83SR	1.79	1.79	2.5	2.5			
84SW	0.53		0.2				
85SW	0.66	1.3	0.3	1.3			
86SW	0.57	1.38	0.3	1.5			
88SW	0.65	2.39	0.3	4.5			
89SR	2.28		4.1				
90SR	1.11		1.0				
91SR	1.42		1.6				
92SR	1.88		2.8				
93SR	1.81		2.6				

Table G-4. Diameter, height, basal area, and volume of individual trees in the control mangrove forest at Naples, Florida.

Tree number	Diameter, cm		Basal area, cm <sup>2</sup>		Height, meters	Volume, m <sup>3</sup>			
	Initial	1-year	Initial	1-year		Initial	1-year	3-year	
1CR	4.29	4.5	4.8	14.5	15.9	18.1	0.004	0.005	0.006
2CR	8.7	8.8	8.8	59.4	60.8	60.8	0.030	0.030	0.030
3CR	4.4	4.5	4.45	15.2	15.9	15.5	0.004	0.004	0.004
4CR	3.8	4.0	3.96	11.3	12.6	12.3	0.002	0.002	0.002
5CR	7.9	8.4	9.2	49.0	55.4	75.4	0.022	0.025	0.034
6CW	12.1	12.3	13.1	115.0	118.8	134.7	0.058	0.060	0.068
7CW	6.1	6.3	6.2	29.2	31.2	30.2	0.009	0.010	0.009
8CW	4.8	4.8	4.6	18.1	18.1	16.6	0.005	0.005	0.004
9CW	4.7	4.7	dead	17.3	17.3	dead	--	--	--
10CW	7.3	7.65	8.3	41.9	46.0	54.1	0.023	0.026	0.030
11CW	8.1	8.35	8.9	51.5	54.8	62.2	0.026	0.028	0.031
12CR	4.4	4.5	4.6	15.2	15.9	16.6	0.003	0.003	0.003
13CW	5.5	5.8	6.1	23.8	26.4	29.2	0.013	0.014	0.016
14CR	3.13	3.22	3.05d	7.7	8.1	7.3d			
15CR	3.36	3.51	3.35d	8.9	9.7	8.8d			
16CR	4.6	4.6	4.65	16.6	16.6	17.0	0.004	0.004	0.004
17CR	3.78	3.94	3.81	11.2	12.2	11.4	0.002	0.002	0.002
18CW	5.9	6.0	5.95	27.3	28.3	27.8	0.011	0.012	0.011
19CW	8.1	8.9	9.8	51.5	62.2	75.4	0.028	0.034	0.042
20CW	6.4	6.6	6.85	32.2	34.2	36.8	0.014	0.016	0.016
21CW	6.6	6.9	6.8	34.2	37.4	36.3	0.017	0.018	0.018
22CW	6.8	7.1	7.2	36.3	39.6	40.7	0.018	0.020	0.020
23CR	4.8	5.0	4.95	18.1	19.6	19.2	0.006	0.007	0.006
24CR	4.8	4.9	4.8	18.1	18.9	18.1	0.004	0.004	0.004
25CR	5.8	5.7	5.6d	26.4	25.5	24.6d	--	--	--

Table 6-4 (continued)

Tree number	Diameter, cm		Basal area, cm <sup>2</sup>		Height, meters	Volume, m <sup>3</sup>		
	Initial	1-year	Initial	1-year		Initial	1-year	
26CW	5.0	5.1	4.95	19.6	20.4	19.2	0.007	0.006
27CW	12.2	12.9	14.6	116.9	130.7	167.3	0.076	0.108
28CW	8.7	8.7	8.8	59.4	59.4	60.8	0.024	0.024
29CW	6.3	6.5	6.5	31.2	33.2	33.2	0.012	0.014
30CR	7.0	7.1	7.05	38.5	39.6	39.0	0.016	0.016
31CR	dead							
32CR	4.3	4.45	4.6	14.5	15.6	16.6	0.005	0.006
33CW	5.8	6.3	6.85	26.4	31.2	36.8	0.013	0.018
34CW	13.4	14.1	16.05	141.0	156.1	202.2	0.092	0.132
35CW	8.9	8.9	8.8	62.2	62.2	60.8	0.040	0.040
	11.9	12.3	13.5	111.2	118.8	143.1	0.072	0.093
36CW	11.3	11.5	13.0	100.3	103.9	132.7	0.025	0.026
37CR	4.2	4.4	4.25	13.9	15.2	14.2	0.003	0.003
38CW	6.1	6.3	6.1	29.2	31.2	29.2	0.012	0.012
39CR	3.8	4.0	4.0	11.3	12.6	12.6	0.002	0.002
40CR	5.2	5.7	5.7	21.2	22.1	25.5	0.006	0.008
41CW	5.6	5.8	5.9	24.6	26.4	27.3	0.008	0.008
42CW	11.2	11.5	13.9	98.5	103.9	151.7	0.059	0.062
43CR	5.0	5.1	5.75	19.6	20.4	26.0	0.006	0.008
44CR	4.5	4.7	4.8	15.9	17.3	18.1	0.003	0.003
45CR	5.7	5.85	6.5	25.5	26.9	33.2	0.009	0.010
46CW	9.5	9.9	10.5	70.9	77.0	86.5	0.036	0.038
47CW	6.0	6.2	6.2	28.3	30.2	30.2	0.012	0.012
48CW	3.8	3.9	3.8	11.3	11.9	11.3	0.002	0.002

Table G-5. Diameter, height, basal area, and volume of individual trees in the mangrove forest receiving sewage effluent from the Everglades City, Florida, sewage treatment plant.

Tree number	Diameter, cm		Basal area, cm <sup>2</sup>		Height, meters	Volume, m <sup>3</sup>			
	Initial	1-year	3-year	Initial		1-year	3-year		
1W	13.5	14.1	14.4	143.1	156.1	162.8	0.086	0.094	0.098
2W	5.4	5.5	5.5	22.9	23.8	23.8	0.008	0.008	0.008
3W	5.3	5.3	5.1d	22.1	22.1	20.4d			
4W	6.9	6.9	7.4	37.4	37.4	43.0	0.018	0.018	0.022
5R	7.5			44.2					
6R	5.1	5.2	5.6	20.4	21.2	24.6	0.007	0.008	0.008
7R	2.02	2.21	2.41	3.2	3.8	4.6	0.001	0.001	0.001
8R	1.79	1.79	1.91	2.5	2.9				
9R	1.28	1.68		1.3	2.2				
10R	1.14	1.55		1.6	1.9				
11R	1.51	1.63		1.8	2.1				
12R	2.72	2.86	3.18	5.8	6.4	7.9	0.001	0.001	0.001
13R	7.1	7.4		39.6	43.0				
14W	7.2	7.5	7.5	40.7	44.2	44.2	0.016	0.018	0.018
15W	10.4	10.6		84.9	88.2				
16B	6.9	7.1		37.4	39.6				
17R	8.7	8.9		59.4	62.2				
18R	2.25		2.67	4.0		5.6			
19B	5.4			22.9					
20R	4.4	4.6	4.75	15.2	16.6	17.7	0.004	0.004	0.004
21R	2.2	2.58	2.67	3.8	5.2	5.6	0.001	0.001	0.001
22R	8.6	8.4		58.1	55.4				
23W	13.4	13.8		141.0	149.6				
24R	2.71	2.96		5.8	6.9				
25R	2.95	3.04		6.8	7.3				

Table G-5 (continued)

Tree number	Diameter, cm		Basal area, cm <sup>2</sup>		Height, meters	Volume, m <sup>3</sup>	
	Initial	1-year	3-year	Initial		1-year	3-year
26R	3.13	3.46		7.7		9.4	
27W	7.3	7.7		41.9		46.6	
28W	7.1	7.3		39.6		41.9	
29R	3.04	3.19		7.3		8.0	
30R	1.37	1.51		1.5		1.8	
31R	1.58	1.80		2.0		2.5	
32W	5.2	5.4		21.2		22.9	
33W	4.7	4.8		17.3		18.1	
34W	4.0	4.2		12.6		13.9	
35B	11.4	11.6		102.1		105.7	
36B	6.2	6.2		30.2		30.2	
37R	10.0	10.4		78.5		84.9	
38R	6.3	6.3		31.2		31.2	
39W	11.7	11.9	11.4	107.5	9	111.2	0.046
40R	6.6	6.8	7.25	34.2	7	36.3	0.014
41W	8.5			56.7			
42R	4.3	4.7	4.8	14.5	5	17.3	0.004
43R	4.57			16.4			
44R	3.08			7.4			
45R	2.71			5.8			
46R	3.85			11.6			
47R	1.61			2.0			
48R	2.27			4.0			
49R	2.85			6.4			
50W	14.8			171.9			
51R	7.2	7.8	8.5	40.7	11	47.8	0.031
52W	3.95	3.9	3.94	12.3	5	11.9	0.003

Table G-5 (continued)

Tree number	Diameter, cm		Basal area, cm <sup>2</sup>		Height, meters	Volume, m <sup>3</sup>	
	Initial	1-year	1-year	3-year		Initial	1-year
53B	8.8	8.8	60.8	69.4	9	0.028	0.031
54R	2.2	2.21	3.8				
55N	5.9	5.7	27.3	25.5	5	0.007	0.006
56R	2.74	2.74	5.9				
57R	2.23	2.38	3.9	4.5	4	0.001	0.001
58B	1.15		1.0	0.5	1		
60R	1.9	2.03	2.8	3.2			
61R	1.4	1.52	1.5	1.8			
62B	10.9	11.0	93.3	98.5	11	0.052	0.054
63B	2.64	2.6	5.5	5.3			
64B	8.1	8.1	51.5	51.5			
65R	3.34		8.8				
66W	8.4		55.4				
67B	3.91	4.0	12.0	12.6			
68W	4.17		13.7				
69R	2.35	2.52	4.3	5.0			
70R	4.6	5.1	16.6	20.4			
71R	4.8		18.1				
72R	4.33	4.8	14.7	18.1			
73W	7.6	8.0	45.4	50.3			
74W	7.1	7.5	39.6	44.2			
75W	6.0		28.3				
76B	1.54		1.9				
77R	3.47		9.5				
78R	3.48		9.5				
79R	4.4		15.2				

Table G-5 (continued)

Tree number	Diameter, cm		Basal area, cm <sup>2</sup>		Height, meters	Volume, m <sup>3</sup>	
	Initial	3-year	Initial	3-year		Initial	3-year
80W	9.2		66.4				
81R	3.67		10.6				
82B	6.0		28.3				
83R	4.3		14.5				
84R	4.7		17.3				
85W	1.58		2.0				
86R	2.73		5.9	7.0			
87R	2.35		4.3				
88R	1.99	3.56	3.1	3.4	9.9		
89R	5.55		24.2				
90R	5.3		22.1				
91R	2.77	2.97	6.0	6.9			
92F	6.3		31.2				
93W	9.0		63.6	72.4			
94R	8.5		56.7				
95R	2.47		4.8				
96W	12.5		122.7				
97R	3.86		11.7				
98R	3.85		11.6				
99R	3.47		9.5				
100R	2.61	2.79	5.3		6.1	3	
101R	6.5		33.2				
102R	3.64		10.4	11.9			
103B	4.36	3.9	14.9				
104W	10.9	11.05	93.3	95.0	95.6	12	0.056
105W	9.6		72.3				0.057

0.058

Table G-5 (continued)

Tree number	Diameter, cm		Basal area, cm <sup>2</sup>		Height, meters	Volume, m <sup>3</sup>	
	Initial	1-year	Initial	1-year		Initial	1-year
106R	4.8		18.1				
107R	2.93		6.7				
108R	3.22		8.1				
109R	10.1		80.1		13	0.052	0.068
110R	2.92	10.4	6.7	84.9			
111R	6.1		29.2				
112W	4.23		14.1				
113R	2.58	4.5	5.2	15.9			
114W	7.5		44.2				
115R	3.08		7.4				
116W	3.37		8.9		5	0.002	0.002
117R	2.62	3.52	5.4	9.7	5	0.002	0.002
118B	3.22		8.1				
119R	3.24		8.2		3		
120R	2.98		7.0				
121R	2.45		4.7				
123R	3.87		11.8				
124R	2.96		6.9				
125W	1.98		3.1				
126W	5.05	5.2	20.0	21.2			
127R	2.64	2.53	5.5	5.0			
128B	3.98		12.4				
129R	4.46		15.6				
130R	3.85	4.1	11.6	13.2			
131R	3.98		12.4				
132R	1.91		2.9				
133B	6.3		31.2				



Table 6-5 (continued)

Tree number	Diameter, cm		Basal area, cm <sup>2</sup>		Height, meters	Volume, m <sup>3</sup>	
	Initial	3-year	Initial	3-year		Initial	3-year
134W	10.55	11.05	87.4	91.6	10	0.044	0.046
135R	3.48		9.5				
136R	5.0	5.3	19.6	22.1			
137R	3.72		10.9				
138R	2.01		3.2				
139R	3.92	4.3	12.1	14.5			
140R	5.9		27.3				
141W	2.09	2.11	3.4	3.5			
142W	5.7	5.85	25.5	25.5	10	0.013	0.013
143W	7.8	8.4	47.8	55.4	11	0.026	0.030
144R	3.89		11.9				
145R	4.26		14.2				
146R	5.9		27.3				
147R	3.37		8.9				
148Q	10.7	4.06	89.9		4		
149R	3.15		7.8				
150R	4.7		17.3				
151W	3.56		9.9				
152R	3.47	3.63	9.5	10.3			
153R	2.44	2.89	4.7	6.6	4	0.001	0.002
154R	2.56	2.44	5.1	4.7	4	0.001	0.001
155R	5.17	6.2	21.0		7		
156W	5.48	5.7	23.6	25.5	6	0.007	0.008
157R	3.55	4.7	9.9	11.3	5	0.002	0.003
158W	11.5		103.8				
159W	2.83		6.3				
160W	6.3	6.4	31.2	32.2			



Table G-5 (continued)

Tree number	Diameter, cm		Basal area, cm <sup>2</sup>		Height, meters	Volume, m <sup>3</sup>	
	Initial	3-year	Initial	3-year		Initial	3-year
187W	11.65		106.5				
188R	1.94		3.0				
189W	13.0	13.2	132.7	136.8	12	0.080	0.079
190R	3.77	4.2	11.2	13.8			
191W	5.9	6.1	27.3	29.2			
192R	6.1	7.0	29.2	35.3	7	0.010	0.012
193W	3.8		11.3				
194W	7.2	8.55	40.7	49.0	10	0.020	0.024
195R	1.66		2.2				
196W	7.6		45.3				
197R	12.4		120.7				
198R	3.77		11.2	40.7			
199W	7.1	7.2	39.6				
200R	2.37		4.4				
201W	8.6	8.9	58.1	59.4	10	0.029	0.030
1SR	1.18		1.1				0.031
5SW	0.69	0.98	0.4	0.8			
6SW	0.73	1.23	0.4	1.2			
8SW	1.32	1.85	1.4	2.7	2	0.000	0.001
9SW	0.70	0.07	0.4	0.7	2	0.000	0.000
10SW	0.48		0.2				
11SW	0.53	1.11	0.2	1.0			
19SR	1.51	1.52	1.8	1.8			
20SR	1.15	1.27	1.0	1.3			
63SW	0.96		0.7				
64SW	0.84		0.6				

Table G-5 (continued)

Tree number	Diameter, cm		Basal area, cm <sup>2</sup>		Height, meters	Volume, m <sup>3</sup>	
	Initial	1-year	Initial	1-year		Initial	1-year
66SW	0.95		0.7				
69SW	0.69		0.4				
71SR	3.24		8.2				
72SR	3.31		8.6				
73SR	1.74	1.95	2.4	3.0			
74SW	3.06		7.4				
75SW	1.0		0.8				
76SW	0.93		0.7				
77SR	3.27		8.4				
78SB	4.82		18.2				
79SB	2.34		4.3				
80SR	1.7	2.62	2.3	5.4			
81SW	1.02	2.12	0.8	3.5	0.8	2	
82SW	3.05	3.5	7.3	9.6			
83SW	1.59	1.74	2.0	2.4			
84SW	1.56	1.62	1.9	2.1			
85SW	4.79		18.0				
86SR	3.82		11.5				
87SR	3.06		7.4				
88SR	2.34		4.3				
89SB	2.06		3.3				
90SR	7.08		39.3				
91SR	1.86	1.96	2.7	3.0	3.7	2	0.001
92SR	4.91		18.9				0.001
96SR	2.86	3.20	6.4	8.0			
99SR	3.72	4.1	10.9	13.2			

Table 6-6. Diameter, height, basal area, and volume of individual trees in the control mangrove forest at Everglades City, Florida.

Tree number	Diameter, cm		Basal area, cm <sup>2</sup>		Height, meters	Volume, m <sup>3</sup>			
	Initial	1-year	1-year	3-year		Initial	1-year	3-year	
214CW	14.35	14.5	14.6	165.1	167.3	16	0.130	0.132	0.134
215CW	9.8	10.1	9.85	65.4	76.2	16	0.060	0.063	0.061
216CW	7.8	7.8		47.8		13	0.031	0.031	
217CR	1.52			1.8					
218CR	11.1	11.2	11.3	96.8	100.2	12	0.058	0.059	0.060
219CR	9.15	9.2	9.65	65.8	73.1	11	0.036	0.036	0.040
220CR	3.99	3.88	4.05	11.8	12.9	4	0.002	0.002	0.002
224CR	6.75	7.0	7.25	35.8	41.3	10	0.018	0.020	0.020
225CR	6.2	6.4		30.2	32.2	10	0.015	0.016	
226CR	5.8	5.8	6.1	26.4	29.2	8	0.010	0.010	0.012
227CR	2.51			4.9					
228CW	12.7	12.7	12.8	126.7	128.6	15	0.095	0.095	0.096
229CB	dead								
230CB	14.0	14.2	14.4	153.9	162.8	15	0.116	0.119	0.122
231CB	17.0	17.2		227.0	232.4	15	0.170	0.174	
232CR	4.7		4.85	17.3	18.5				
233CR	7.7	8.0		46.6	50.3	12	0.028	0.030	
234CW	12.5	12.6	12.8	122.7	128.6	17	0.104	0.106	0.110
235CR	9.85	10.6	10.8	76.2	88.2	10	0.038	0.044	0.046
236CW	dead								
237CW	10.5	10.7	11.2	86.6	98.5	16	0.070	0.072	0.079
238CR	6.9	6.9	7.2	37.4	40.7	8	0.015	0.015	0.016
239CR	10.1	10.2	10.7	80.1	89.9	11	0.044	0.045	0.050
240CR	3.3			8.5					
241CR	2.8	3.01	3.05	6.2	7.1	5	0.002	0.002	0.002
242CR	3.9	3.59	4.15	11.9	13.5	6	0.004	0.003	0.004

Table G-6 (continued)

Tree number	Diameter, cm		Basal area, cm <sup>2</sup>		Height, meters	Volume, m <sup>3</sup>		
	Initial	1-year	Initial	1-year		Initial	1-year	3-year
243CW	11.8	11.9	11.7	109.4	15	0.082	0.084	0.080
244CW	11.4		11.6	102.0				
245CW	13.3	13.4		138.9	14			
246CR	11.7			107.5				
247CR	2.94		3.3	6.8			8.5	
248CW	5.7	5.9		25.5	11			
249CW	7.2	7.25	7.25	40.7	10	0.020	0.020	0.020
250CR	1.26			1.3				
251CR	6.8	7.1		36.3				
252CR	1.6	1.76	1.78	2.0	10	0.018	0.020	0.001
253CR	2.41		2.62	4.6	2.5	0.001	0.001	0.001
254CR	2.26			4.0			2.5	
255CR	2.47			4.8			5.4	
256CR	2.03			3.2				
257CR	4.8			18.1				
258CW	9.6	10.0	10.3	72.4	13	0.047	0.051	0.054
259CW	7.9	7.8	7.9	49.0	12	0.030	0.028	0.030
260CW	6.6	6.6	6.6	34.2	10	0.017	0.017	0.017
261CR	8.9			62.2				
262CR	7.2	7.2	7.35	40.7	11	0.022	0.022	0.024
263CR	1.76			2.4				
264CR	5.4	5.5		22.9				
265CR	6.1	6.15	6.4	29.2	10	0.014	0.015	0.016
266CW	8.6	8.7	8.8	58.1	13	0.038	0.038	0.040
267CB	2.51			4.9				

Table G-6 (continued)

Tree number	Diameter, cm		Basal area, cm <sup>2</sup>		Height, meters	Volume, m <sup>3</sup>	
	Initial	3-year	Initial	3-year		Initial	3-year
2680B	13.6		145.2				
2690R	11.1	11.5	96.8	100.3	10	0.048	0.052
2700W	11.6	11.8	105.6	109.3			
2710B	13.6	13.75	145.3	147.4	11	0.080	0.082
2720B	15.9	16.6	198.6	201.1	11	0.109	0.119
2730R	10.1	10.3	80.1	83.3	12	0.048	0.050
2740R	4.3	4.45	14.5				
2750R	4.05	4.3	12.9	13.9	7	0.004	0.005
2760R	14.7	15.4	169.7	169.7	14	0.119	0.130
2770R	5.5	5.9	23.8	24.6	8	0.010	0.011
2780W	7.9	8.25	49.0	50.9	12	0.030	0.032
2790R	3.9	3.7	11.9	10.8	7	0.004	0.004
2800B	14.7	14.9	169.7	162.9	15	0.123	0.130
2810R	3.7	3.94	10.8	11.5	6	0.003	0.004
2820R	4.5	4.7	15.9	17.3	8	0.006	0.007
2830R	2.5	2.44	4.9	4.7	4	0.001	0.001
2840R	4.7	4.8	17.3	18.1	8	0.007	0.007
2850W	15.0	15.5	176.7	183.9	13	0.115	0.120
2860R	8.0		50.3				
2870R	5.5		23.7				
2880R	4.05		12.9		7	0.004	0.005
2890R	2.53		5.0				
2900B	10.8	11.0	91.6	93.3	12	0.055	0.056
2910B	8.8	9.2	60.8	66.5	11	0.034	0.036
2920B	8.6	8.75	58.1	60.1			

Table G-6 (continued)

Tree number	Diameter, cm		Basal area, cm <sup>2</sup>		Height, meters	Volume, m <sup>3</sup>	
	Initial	3-year	Initial	3-year		Initial	3-year
293CR	9.0	9.3	63.6	67.9	10	0.032	0.034
294CR	5.1	5.2	20.4	19.6	7	0.007	0.008
295CW	8.4	8.55	55.4	57.4	13	0.036	0.038
296CR	6.5	6.6	33.2	34.2	9	0.015	0.016
297CR	5.8		26.4				
298CR	4.4	4.35	15.2	14.9	10	0.008	0.008
299CR	5.8		26.4				
300CW	9.6	10.3	72.4	83.3	11	0.040	0.046
301CW	dead						
302CW	12.2	12.5	116.9	122.7	13	0.076	0.080
303CW	9.5	9.95	70.9	78.5	12	0.042	0.046
304CR	8.0	8.3	50.3	56.7	10	0.025	0.027
305CR	7.8	8.0	47.8	47.8	10	0.024	0.025
306CW	10.8	11.2	91.6	98.5	11	0.050	0.054
307CW	12.5	13.1	122.7	134.7	13	0.080	0.088
308CR	4.8	4.95	18.1	17.0	8	0.007	0.008
309CR	3.7	3.8	10.8	11.3	8	0.004	0.004
310CR	2.6		5.3				
311CR	9.5	9.9	70.9	76.9	14	0.050	0.054
312CB	13.0	13.1	132.7	134.7	15	0.100	0.101
313CW	6.2	6.4	30.2	32.2	8	0.012	0.013
314CR	2.7	2.65	5.7	5.5			
315CR	8.3	8.2	54.1	49.0	10	0.027	0.026



Table G-6 (continued)

Tree number	Diameter, cm		Basal area, cm <sup>2</sup>		Height, meters	Volume, m <sup>3</sup>	
	Initial	1-year	3-year	Initial		1-year	3-year
316CW	11.0	11.1	95.0	96.8	15	0.071	0.072
317CW	5.7	5.7	25.5	25.5	7	0.009	0.009
318CR	2.79	2.93	6.1	6.7	5	0.002	0.002
319CR	6.3	6.55	31.2	33.7	8	0.012	0.014
337CSR	1.12		1.0				
339CSR	1.62	1.59	2.1	2.0			
340CSR	1.52	1.65	1.8	2.1			
347CSR	1.35	1.41	1.4	1.6			
350CSR	1.29		1.3				
359CSB	1.14	1.13	1.0	1.0			
361CSB	1.02	1.0	0.8	0.8			

Table G-7. Leaf, wood, and seed fall during a 55-week period from September 6, 1973, to September 27, 1974, in the mangrove forest that occasionally received sewage effluent from the Naples, Florida, sewage treatment plant; and from June 21 to September 26, 1974, in the control mangrove forest.

Collection interval	Amount of litter fall, grams per m <sup>2</sup>			Total
	Leaves	Wood	Seeds	
September 6 - October 5				
Site 1A	93.8	21.8	60.8	166.4
Site 1B	81.7	4.1	29.1	114.9
October 6 - December 12				
Site 1A	173.6	14.6	49.8	238.0
Site 1B	123.2	9.8	6.8	139.8
December 13 - February 1				
Site 1A	117.4	17.8	0.0	135.2
Site 1B	84.2	8.8	19.6	112.6
February 2 - April 29				
Site 1A	196.3	12.3	0.0	208.6
Site 1B	173.4	14.1	0.0	187.5

April 30 - June 20						
Site 1A	269.9	13.5	1.2	284.6		
Site 1B	148.3	9.4	4.7	162.4		
June 21 - August 8						
Site 1A	160.8	153.8	4.8	319.4		
Control	213.7	107.8	5.3	326.7		
August 9 - September 26						
Site 1A	111.4	7.9	54.1	173.4		
Control	139.9	18.5	37.7	196.1		
Annual rate						
Site 1A	1052.6	228.6	161.4	1442.6		
Site 1B	774.1	58.6	76.3	909.0		
Control	--	--	--	--		

Table G-8. Leaf, wood, and seed fall during a 55-week period from September 4, 1973, to September 27, 1974, in the mangrove forest that occasionally received sewage effluent from the Everglades City, Florida, sewage treatment plant.

Collection interval	Amount of litter fall, grams per m <sup>2</sup>			Total
	Leaves	Wood	Seeds	
September 4 - October Site 2A	130.7	8.4	30.6	169.7
Site 2B	189.0	3.6	6.5	199.1
October 7 - December 10 Site 2A	123.1	39.5	35.1	197.7
Site 2B	113.3	9.1	4.9	126.6
December 11 - February 2 Site 2A	95.1	28.4	0.0	123.5
Site 2B	81.6	7.0	0.0	88.6

February 3 - April 30					
Site 2A	156.6	14.0	0.0	170.6	
Site 2B	117.4	39.8	0.0	157.2	
May 1 - June 20					
Site 2A	132.2	4.1	0.0	136.3	
Site 2B	113.0	3.5	0.0	116.5	
June 21 - August 9					
Site 2A	219.5	26.6	2.5	250.6	
Site 2B	282.3	43.0	24.9	334.8	
August 10 - September 27					
Site 2A	162.6	7.0	33.7	203.3	
Site 2B	202.9	10.1	9.2	222.2	
Annual rate					
Site 2A	956.9	122.0	95.6	1174.5	
Site 2B	1031.7	108.9	42.7	1183.3	

Table G-9. Rate of leaf, wood, seed, and total litter fall during a 55-week period from September 6, 1973, to September 27, 1974, in the mangrove forest that occasionally received sewage effluent from the Naples, Florida, sewage treatment plant; and from June 21 to September 27 in the control mangrove forest. Standard error about the mean is in parentheses.

Collection interval	Rate of litter fall, grams/m <sup>2</sup> ·day (standard error)			Total
	Leaves	Wood	Seeds	
September 6 - October 5 Site 1A	2.79 (0.29)	0.73 (0.37)	2.03 (0.65)	5.55 (0.50)
Site 1B	2.72 (0.40)	0.14 (0.06)	0.97 (0.52)	3.83 (0.53)
October 6 - December 12 Site 1A	2.55 (0.16)	0.21 (0.05)	0.73 (0.16)	3.49 (0.33)
Site 1B	1.81 (0.35)	0.14 (0.06)	0.10 (0.06)	2.05 (0.40)
December 13 - February 1 Site 1A	2.30 (0.32)	0.35 (0.12)	0.0	2.65 (0.40)
Site 1B	1.65 (0.25)	0.17 (0.06)	0.39 (0.26)	2.21 (0.44)

February 2 - April 29						
Site 1A	2.26 (0.11)	0.14 (0.05)	0.0	2.40 (0.12)		
Site 1B	1.99 (0.32)	0.16 (0.09)	0.0	2.15 (0.33)		
April 30 - June 20						
Site 1A	5.19 (0.18)	0.26 (0.05)	0.02 (0.02)	5.47 (0.20)		
Site 1B	2.85 (1.06)	0.18 (0.06)	0.09 (0.06)	3.12 (1.04)		
June 21 - August 8						
Site 1A	3.22 (0.09)	3.08 (1.67)	0.10 (0.06)	6.39 (1.67)		
Control	4.27 (0.38)	2.16 (1.11)	0.11 (0.04)	6.53 (1.42)		
August 9 - September 26						
Site 1A	2.27 (0.15)	0.16 (0.05)	1.10 (0.19)	3.54 (0.16)		
Control	2.85 (0.33)	0.37 (0.08)	0.77 (0.25)	4.00 (0.43)		
Average rate						
Site 1A	2.88	0.63	0.44	3.95		
Site 1B	2.12	0.16	0.21	2.49		
Control	---	---	---	---		

Table G-10. Rate of leaf, wood, seed, and total litter fall during a 55-week period from September 4, 1973, to September 27, 1974, in the mangrove forest that occasionally received sewage effluent from the Everglades City, Florida, sewage treatment plant. Standard error about the mean is in parentheses.

Collection interval	Rate of litter fall, grams/m <sup>2</sup> ·day (standard error)			
	Leaves	Wood	Seeds	Total
September 4 - October 6 Site 2A	4.09 (0.35)	0.26 (0.10)	0.97 (0.25)	5.30 (0.53)
Site 2B	5.93 (0.76)	0.11 (0.05)	0.20 (0.13)	6.24 (0.75)
October 7 - December 10 Site 2A	1.89 (0.25)	0.61 (0.51)	0.54 (0.26)	3.04 (0.80)
Site 2B	1.74 (0.09)	0.14 (0.03)	0.08 (0.02)	1.96 (0.11)
December 11 - February 2 Site 2A	1.76 (0.18)	0.53 (0.30)	0.0 (0.0)	2.29 (0.42)
Site 2B	1.51 (0.29)	0.13 (0.07)	0.0 (0.0)	1.64 (0.33)



February 3 - April 30						
Site 2A	1.80 (0.26)	0.16 (0.04)	0.0 (0.0)	1.96 (0.30)		
Site 2B	1.35 (0.10)	0.46 (0.41)	0.0 (0.0)	1.81 (0.51)		
May 1 - June 20						
Site 2A	2.59 (0.20)	0.08 (0.04)	0.0 (0.0)	2.67 (0.21)		
Site 2B	2.22 (0.29)	0.07 (0.02)	0.0 (0.0)	2.29 (0.30)		
June 21 - August 9						
Site 2A	4.39 (0.48)	0.57 (0.15)	0.05 (0.04)	5.01 (0.45)		
Site 2B	5.65 (0.50)	0.86 (0.45)	0.50 (0.29)	7.01 (0.60)		
August 10 - September 27						
Site 2A	3.32 (0.39)	0.14 (0.05)	0.69 (0.21)	4.15 (0.56)		
Site 2B	4.14 (0.25)	0.21 (0.07)	0.19 (0.11)	4.53 (0.22)		
Average rate						
Site 2A	2.62	0.33	0.26	3.22		
Site 2B	2.83	0.30	0.12	3.24		

Table G-11. Concentrations of total phosphorus found in the Gordon River at Naples, Florida, at various sampling times from September 1973 to February 1975. Standard error of mean in parentheses.

Location	Phosphorus, mg/l (SE)
Naples sewage treatment plant outfall into Gordon River	
9-6-73	0.92
10-7-73	2.05
8-8-74	1.00 evening
	4.00 morning
2-15-75	1.09
Average	1.81 (0.58)
Gordon River near outfall	
9-6-73	0.265
12-13-73	0.848
8-8-74	0.124, 0.126, 0.190
2-15-75	0.32, 0.50
Average	0.34 (0.10)

Gordon River on side of  
island farthest from outfall

9-6-73  
10-7-73  
12-13-73  
Average

0.22, 0.225, 0.23  
0.088  
0.219, 0.251  
0.21 (0.02)

## Control area

10-7-73  
8-8-74  
2-15-75  
Average

0.038, 0.130  
0.068, 0.063  
0.012, 0.018  
0.055 (0.018)

Gordon River upstream  
from control area

10-7-73  
8-8-74  
Average

0.013  
0.111  
0.062 (0.049)

Golden Gate Canal upstream  
from control area

10-7-73  
8-8-74  
Average

0.012  
0.121  
0.067 (0.054)

---

Table G-12. Concentration of total phosphorus in the tidal canal at Everglades City, Florida, at various sampling times from September 1973 to February 1975. Standard error of the mean is given in parentheses.

Location	Phosphorus concentration, mg/l
Everglades City sewage treatment plant outfall into tidal canal	
9-4-73	0.57, 0.57
10-7-73	0.106, 0.135
12-11-73	0.45
2-15-75	0.83, 0.72
Average	0.48 (0.10)
Tidal canal at edge of mangrove forest on upstream side of outfall	
9-4-73	0.05, 0.07, 0.05, 0.05, 0.05, 0.20, 0.145

10-7-73  
Average  
0.055, 0.084, 0.054,  
0.048  
0.081 (0.016)

Tidal canal at edge of mangrove  
forest on downstream side of  
outfall

9-4-73  
10-7-73  
2-15-75  
Average  
0.045, 0.04, 0.036  
0.100, 0.069  
0.024, 0.028  
0.049 (90.010)

Control area  
10-7-73  
12-11-73  
8-8-74  
2-15-75  
Average  
0.151  
0.025  
0.142  
0.021, 0.014  
0.071 (0.031)

---

Table G-13. Calculation of mangrove forest biomass for the Naples and Everglades City, Florida, study sites.

	Naples		Everglades City	
	Control	Sewage	Control	Sewage
<u>Average volume per tree, m<sup>3</sup></u>				
<u>Laguncularia racemosa</u>				
September 1973	0.0274	0.0528	0.0564	0.0284
September 1974	0.0295	0.0578	0.0580	0.0296
September 1976	0.0347	0.0695	0.0595	0.0314
<u>Rhizophora mangle</u>				
September 1973	0.0073	0.0206	0.0210	0.0068
September 1974	0.0079	0.0224	0.0216	0.0078
September 1976	0.0086	0.0260	0.0228	0.0089
<u>Avicennia germinans</u>				
September 1973	--	--	0.0886	0.0436
September 1974	--	--	0.0896	0.0512
September 1976	--	--	--	--

Table G-13 (continued)

	Naples		Everglades City	
	Control	Sewage	Control	Sewage
<u>Volume per m<sup>2</sup></u>				
<u>Laguncularia racemosa</u>				
September 1973	0.0137	0.0196	0.0068	0.0162
September 1974	0.0148	0.0214	0.0070	0.0169
September 1976	0.0174	0.0257	0.0072	0.0179
<u>Rhizophora mangle</u>				
September 1973	0.0024	0.0020	0.0094	0.0029
September 1973	0.0026	0.0022	0.0097	0.0033
September 1976	0.0028	0.0026	0.0102	0.0038
<u>Avicennia germinans</u>				
September 1973	--	--	0.0053	0.0052
September 1974	--	--	0.0054	0.0054
September 1976	--	--	0.0056	0.0062

Table 6-13 (continued)

Biomass, grams/m <sup>2</sup>	Naples		Everglades City	
	Control	Sewage	Control	Sewage
<u>Laguncularia racemosa</u> (Density equals $0.704 \times 10^6$ grams/m <sup>3</sup> )				
September 1973	9,650	13,750	4,750	11,350
September 1974	10,400	15,000	4,900	11,900
September 1976	12,200	18,100	5,000	12,600
<u>Rhizophora mangle</u> (Density equals $1.15 \times 10^6$ grams/m <sup>3</sup> )				
September 1973	2,750	2,350	10,850	3,350
September 1974	3,000	2,600	11,200	3,800
September 1976	3,200	3,000	11,800	4,300
<u>Avicennia germinans</u> (Density equals $0.912 \times 10^6$ grams/m <sup>3</sup> )				
September 1973	--	--	4,850	4,800
September 1974	--	--	4,900	4,900
September 1976	--	--	5,050	5,600



Table G-13 (continued)

	Naples		Everglades City	
	Control	Sewage	Control	Sewage
<u>Total biomass, grams/m<sup>2</sup></u>				
September 1973	12,400	16,100	20,450	19,500
September 1974	13,400	17,600	21,000	20,600
September 1976	15,400	21,100	21,850	22,500

## BIBLIOGRAPHY

- Australian Conservation Foundation. 1972. Mangroves and man. Viewpoint No. 7.
- Bacon, P.R. 1974. Recovery of a Trinidadian mangrove swamp from attempted reclamation. *In* Proceedings of the International Symposium on Biology and Management of Mangroves. Edited by G. Walsh, S. Snedaker, and H. Teas.
- Baines, G.B.K. 1974. Patterns of exploitation of mangrove ecosystems. *In* Proceedings of the International Symposium on Biology and Management of Mangroves. Edited by G. Walsh, S. Snedaker, and H. Teas.
- Banijbatana, D. 1957. Mangrove forest in Thailand. Proceedings of 9th Pacific Science Congress. Bangkok.
- Boyt, F.L. 1976. A mixed hardwood swamp as an alternative to tertiary waste treatment. Master's thesis. University of Florida. Gainesville.
- Breen, C.M. and B.J. Hill. 1969. A mass mortality of mangroves in the Kosi estuary. *Trans. R. Soc. S. Africa* 38:285-303.
- Burgess, R.L. and L.H. Kern. 1973. Eastern deciduous forest biome, U.S.-IBP Progress Report 1971-1972. Oak Ridge National Laboratory.
- Candeub, Fleissig, and Associates. 1973. Technical report-Comprehensive planning program for the Naples urban area. Prepared for the city of Naples, Florida.
- Carter, M.R., L.A. Burns, T.R. Cavinder, K.R. Dugger, P.L. Fore, D.B. Hicks, H.L. Revells, and T.W. Schmidt. 1973. Ecosystems analysis of the Big Cypress Swamp and estuaries. U.S. Environmental Protection Agency.
- Chapman, V.J. 1974. Mangrove biogeography. *In* Proceedings of the International Symposium on Biology and Management of Mangroves. Edited by G. Walsh, S. Snedaker, and H. Teas.
- Clough, B.F. and P.M. Attiwell. 1974. Nutrient cycling in a community of *Avicennia marina* in a temperate region of Australia. *In* Proceedings of International Symposium on Biology and Management of Mangroves. Edited by G. Walsh, S. Snedaker, and H. Teas.

- Costanza, R. 1975. Distribution of incoming energy flows and energy use. In Carrying Capacity for Man and Nature in South Florida. Edited by H.T. Odum and M. Brown. Final Report on Contract #CX 000130057 to National Park Service, U.S. Dept. of Interior, and State of Florida Division of State Planning.
- Craighead, F.C. 1971. The trees of south Florida Volume I. The natural environments and their succession. University of Miami Press. Miami, Florida.
- Craighead, F.C. and V.C. Gilbert. 1962. The effects of hurricane Donna on the vegetation of southern Florida. The Quart. J. of Florida Acad. Sci. 25:1-28.
- Cruz, A.A. de la and J.F. Banaag. 1967. The ecology of a small mangrove patch in Matabung Kay Beach, Batangas Province. Univ. Phillipp. Nat. Appl. Sci. Bull. 20:486-494.
- Department of Commerce. 1961-1970. Annual Summaries of U.S. Climatological Data.
- Directorate of Meteorology. 1973. Republic of Vietnam.
- Dixon, R.G. 1959. A working plan for the Matang Forest Reserve Perak.
- Florida Department of Agriculture. 1904.
- Fosberg, F.R. 1971. Mangroves versus tidal waves. Biological Conservation 4. No. 1.
- Fowler, W.J. 1952. Hurricanes of August 17-18, 1951 in Jamaica. The Meteorological Magazine 81:197-202.
- Glynn, P.W., L.R. Almodovar, and J.G. Gonzalez. 1964. Effects of hurricane Edith on marine life in La Parguera, Puerto Rico. Caribbean Journal of Science 4:335-345.
- Golley, F.B. 1971. Effect of defoliation on mangroves. Report to National Academy of Sciences Committee on The Effects of Herbicides in South Vietnam.
- Golley, F.B. 1974. Mineral cycling in a tropical moist forest ecosystem. University of Georgia Press. Athens, Georgia.
- Golley, F.B., H.T. Odum, and R.F. Wilson. 1962. The structure and metabolism of a Puerto Rican red mangrove forest in May. Ecology 43:9-19.

- Heald, E.J. 1971. The production of organic detritus in a south Florida estuary. Sea Grant Technical Bulletin Number 6. University of Miami. Miami, Florida.
- Ivens, G.W. 1957. Arboricides for killing mangroves. W. Afr. Rice Res. Stat. Per. Sci. Rep. No. 8.
- Joyner, B.F. 1971. Appraisal of chemical and biological conditions of Lake Okeechobee, Florida 1969-1970. Open-file Report 71006 United States Department of Interior. U.S. Geological Survey. Tallahassee, Florida. 112 p.
- Krishnamurthy, K. 1974. Socio-economic aspects of Indian Mangroves. *In* Proceedings of the International Symposium on Biology and Management of Mangroves. Edited by G. Walsh, S. Snedaker, and H. Teas.
- LaRue, C.D. and T.J. Musik. 1951. Does the mangrove really plant its seedlings? *Science* 114:661-662.
- Levins, R. 1966. The strategy of model building in population biology. *Am. Scientist* 54:421-431.
- Ludlum, D.M. 1963. Early American hurricanes, 1492-1870. American Meteorological Society. Boston, Mass.
- Lugo, A.E., M.G. Sell, and S.C. Snedaker. 1976. Mangrove ecosystem analysis. *In* Systems Analysis and Simulation in Ecology Volume IV. Edited by B.C. Patten. Academic Press. New York.
- Lugo, A.E. and S.C. Snedaker. 1974a. Properties of a mangrove forest in southern Florida. *In* Proceedings of International Symposium on Biology and Management of Mangroves. Edited by G. Walsh, S. Snedaker, and H. Teas.
- Lugo, A.E. and S.C. Snedaker. 1974b. The ecology of mangroves. *Annual Review of Ecology and Systematics*. Volume 5.
- Macnae, W. 1963. Mangrove swamps in South Africa. *J. of Ecology* 51:1-25.
- Macnae, W. 1968. A general account of the fauna and flora of mangrove swamps and forests in the Indo-West-Pacific region. *Advances in Marine Biology* 6:73-270.
- Malkus, J.S. and H. Riehl. 1960. On the dynamics and energy transformations in steady-state hurricanes. *Tellus* 12:1-20.

- Marshall, D.E. 1970. Characteristics of *Spartina* marsh receiving treated municipal sewage wastes. Master's thesis. University of North Carolina. Chapel Hill, N.C.
- Menzel, D.W. and N. Corwin. 1965. The measurement of total phosphorus in sea water based on the liberation of organically bound fractions by persulfate oxidation. *Limnology and Oceanography* 10:280-282.
- Meselson, M.S., A.H. Westing, J.D. Constable, and R.E. Cook. 1970. Preliminary report of the Herbicide Assessment Commission for the American Association for the Advancement of Science.
- Miller, M.A. 1975. Energy basis for housing systems in Collier County. Master's thesis. University of Florida. Gainesville. 157 p.
- Miller, P.C. 1972. Bioclimate, leaf temperature, and primary production in red mangrove canopies in south Florida. *Ecology* 53:22-45.
- Miller, P.C., J.R. Ehleringer, B. Hynum, and W. Stoner. 1974. Digital simulation of potential reforestation studies in the Rung-Sat delta, Vietnam. *In* Effects of Herbicides in South Vietnam. Part B: Working Papers. National Academy of Sciences.
- Minarik, C.E. and A.L. Bertram. 1962. Evaluation of Camau peninsula defoliation targets. U.S. Army Biological Laboratories.
- Mitsch, W.J. 1975. Systems analysis of nutrient disposal in cypress wetlands and lake ecosystems in Florida. Ph.D. dissertation. Univ. of Florida. Gainesville.
- Moquillon, C. 1944. La foret de paletuviers de la Pointe de Camau. Rapport, Inspecteur Principal de la Classe des Eaux et Forêts de l'Indochine, Saigon.
- National Academy of Sciences. 1974. The effects of herbicides in South Vietnam. Part A: Summary and conclusions.
- National Oceanographic and Atmospheric Administration. 1973. Climates of the states. Vol. 1.
- Nedwell, D.B. 1974. Sewage treatment and discharge into tropical coastal waters. *Search* 5:187-190.
- Nielands, J.B., G.H. Orians, E.W. Pfeiffer, A. Vennema, and A.H. Westing. 1972. Harvest of death. Free Press. San Francisco, Calif.

- Noakes, D.S.P. 1955. Methods of increasing growth and obtaining natural regeneration of the mangrove type in Malaya. *Malayan Forester* 18:23-30.
- Odum, E.P. and H.T. Odum. 1972. Natural areas as necessary components of man's total environment. In *Transactions of the 37th North American Wildlife and Natural Resources Conference*.
- Odum, H.T. 1971. *Environment, power and society*. John Wiley and Sons. New York.
- Odum, H.T. and M.T. Brown. 1975. Carrying capacity for man and nature in south Florida. Final Report on Contract #CX 000130057 to National Park Service, U.S. Dept. of Interior and State of Florida Division of State Planning.
- Odum, H.T., D.C. Ewel, W.J. Mitsch, and J.W. Ordway. 1975. Recycling treated sewage through cypress wetlands in Florida. Occasional Publication No. 1. Center for Wetlands. University of Florida. Gainesville.
- Odum, H.T., C. Kylstra, J. Alexander, and N. Sipe. 1976. Net energy analysis of alternatives for the United States. pp. 254-304 in *U.S. Energy Policy: Trends and Goals. Part V-Middle and Long-term Energy Policies and Alternatives*. 94th Congress 2d Session Committee Print. Prepared for the Subcommittee on Energy and Power of the Committee on Interstate and Foreign Commerce of the U.S. House of Representatives. 66-273. U.S. Government Printing Office. Washington, D.C.
- Odum, H.T. and E.C. Odum. 1976. *Energy basis for man and nature*. McGraw-Hill. New York.
- Odum, H.T., M. Sell, M. Brown, J. Zucchetto, C. Swallows, J. Browder, T. Ahlstrom, and L. Peterson. 1974. Models of herbicide, mangroves and war in Vietnam. In *The Effects of Herbicides in South Vietnam Part B: Working Papers*. National Academy of Sciences.
- Odum, W.E. 1971. Pathways of energy flow in a south Florida estuary. Sea Grant Technical Bulletin Number 7. University of Miami. Miami, Florida.
- O'Neill, R.V. 1971. Error analysis of ecological models. Deciduous Forest Biome Memo Report #71-15.
- Orians, G.H. and E.W. Pfeiffer. 1970. Ecological effects of the war in Vietnam. *Science* 168:544-554.

- Pool, D.J., A.E. Lugo, and S.C. Snedaker. 1974. Litter production in mangrove forests of southern Florida and Puerto Rico. *In* Proceedings of International Symposium on Biology and Management of Mangroves. Edited by G. Walsh, S. Snedaker, and H. Teas.
- Ramage, C.S. 1971. Monsoon meteorology. International Geophysics Series Volume 15. Academic Press. New York.
- Riehl, H. 1972. Introduction to the atmosphere. McGraw-Hill. New York.
- Ross, P. 1974. The effects of herbicides on the mangrove of South Vietnam. *In* The Effects of Herbicides in South Vietnam Part B: Working Papers. National Academy of Sciences.
- Sauer, J.D. 1962. Effects of recent tropical cyclones on the coastal vegetation of Mauritius. *Journal of Ecology* 50:275-290.
- Shellard, H.C. 1971. Extreme wind speeds in the Commonwealth Caribbean. *Meteorological Magazine* 100:144-149.
- Spangler, F.L., W.E. Sloey, and C.W. Fetter. 1976. Wastewater treatment by natural and artificial marshes. National Technical Information Service. Springfield, Va.
- Stanford, R.L. 1976. Nutrient cycling in a south Florida mangrove ecosystem. Master's thesis. University of Florida. Gainesville. 165 p.
- Steller, D.L. 1976. An energy evaluation of residential development alternatives in mangroves. Master's thesis. University of Florida. Gainesville. 124 p.
- Tabb, D.C. and E.J. Heald. 1973. The coastal interceptor waterway. University of Miami Sea Grant Program Bulletin. University of Miami. Miami, Florida. 19 p.
- Tannehill, I.R. 1938. Hurricanes. Princeton University Press. Princeton, New Jersey.
- Tanner, W.F. 1961. Mainland beach changes due to Hurricane Donna. *J. Geophys. Res.* 66:2265-2266.
- Tanner, W.F., R.G. Evans, and C.W. Holmes. 1963. Low-energy coast near Cape Romano, Florida. *Journal of Sedimentary Petrology* 33:713-722.

- Teas, H.J. and J. Kelly. 1974. Effects of herbicides on mangroves of South Vietnam and Florida. In Proceedings of the International Symposium on Biology and Management of Mangroves. Edited by G. Walsh, S. Snedaker, and H. Teas.
- Truman, R. 1961. The eradication of mangroves. Australian Journal of Science. 24(4):199-200.
- Tschirley, F.H. 1969. Defoliation in Vietnam. Science 163: 779-786.
- Tucker, J. 1974. Florida economy - Down but not out. Florida Trend 17(8):20-45.
- Valiela, I. and J.M. Teal. 1974. Nutrient limitation in salt marsh vegetation. In Ecology of Halophytes. Edited by R.J. Reimold and W.H. Queen. Academic Press. New York.
- Veri, A.R., A.R. Marshal, S.V. Wilson, J.H. Hartwell, P. Rosendahl, and T. Mumford. 1973. The resource buffer plan: a conceptual land use study. Study No. 2. Rookery Bay Land Use Studies. The Conservation Foundation. Washington, D.C. 41 p.
- Vu Van Cuong, H. 1964. Flore et vegetation de la mangrove de la region de Saigon - Cap Saint-Jacques, Sud Viet-nam. Ph.D. dissertation. University of Paris. Paris, France. 202 p.
- Wadsworth, F.H. 1959. Growth and regeneration of white mangroves in Puerto Rico. Caribbean Forester 21:59-71.
- Walsh, G.E., R. Barrett, G.H. Cook, and T.A. Hollister. 1973. Effects of herbicides on seedlings of the red mangrove Rhizophora mangle L. Bioscience 23(6):361-364.
- Wentz, W.A. 1975. The effects of simulated sewage effluents on the growth and productivity of peatland plants. Ph.D. dissertation. The University of Michigan. Ann Arbor.
- Westing, A.H. 1971. Ecological effects of military defoliation on the forests of South Vietnam. Bioscience 21:893-898.
- Wharten, C.H., H.T. Odum, K. Ewel, M. Duever, A. Lugo, R. Boyt, J. Bartholomew, E. DeBelleuve, S. Brown, M. Brown, and L. Duever. 1976. Forested wetlands of Florida - Their management and use. Final report to Division of State Planning, State of Florida on a contract for a Forested Wetlands Manual.
- Woodley, K. 1962. Surface winds over Ireland on Saturday, 16 September 1961. Meteorological Magazine 91:191-197.



Zieman, J.C., W.C. Keene, T.C. Lederman, J.T. Morris, and W.E. Odum. 1972. An ecological model for the study of mangrove succession in southeast Asia. Unpublished report.

## BIOGRAPHICAL SKETCH

Maurice George Sell, Jr. was born October 20, 1941, in Pottstown, Pennsylvania. He received his B.S. in chemical engineering from The Pennsylvania State University, University Park, Pennsylvania, in 1963 and his M.S. in chemical engineering from the University of Illinois in 1965. The title of his master's thesis was "The Effect of Conduction on Forced Convective Heat Transfer." He was employed for nearly six years as a research engineer for Mobil Research and Development Corporation in Paulsboro, New Jersey. In January 1971 he enrolled at the University of Florida to begin graduate studies leading to a Ph.D. in environmental engineering sciences. In December 1976 he was awarded a 3-year research fellowship by the Ministry of Science and Technology for the government of New Zealand and will begin his research studies in July 1977.

I certify that I have read this study and that in my opinion it conforms to acceptable standards of scholarly presentation and is fully adequate, in scope and quality, as a dissertation for the degree of Doctor of Philosophy.



Howard T. Odum, Chairman  
Graduate Research Professor of  
Environmental Engineering Sciences

I certify that I have read this study and that in my opinion it conforms to acceptable standards of scholarly presentation and is fully adequate, in scope and quality, as a dissertation for the degree of Doctor of Philosophy.

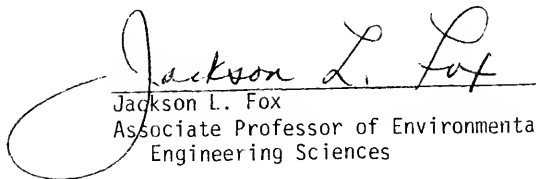

Jackson L. Fox  
Associate Professor of Environmental  
Engineering Sciences

I certify that I have read this study and that in my opinion it conforms to acceptable standards of scholarly presentation and is fully adequate, in scope and quality, as a dissertation for the degree of Doctor of Philosophy.

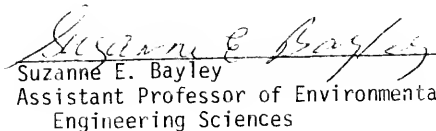

Suzanne E. Bayley  
Assistant Professor of Environmental  
Engineering Sciences

I certify that I have read this study and that in my opinion it conforms to acceptable standards of scholarly presentation and is fully adequate, in scope and quality, as a dissertation for the degree of Doctor of Philosophy.

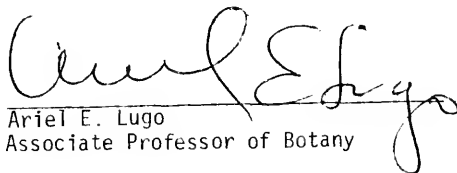

Ariel E. Lugo  
Associate Professor of Botany

I certify that I have read this study and that in my opinion it conforms to acceptable standards of scholarly presentation and is fully adequate, in scope and quality, as a dissertation for the degree of Doctor of Philosophy.

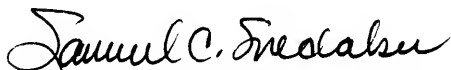

---

Samuel C. Snedaker  
Associate Professor of Biology and  
Living Resources, Rosenstiel  
School of Marine and Atmospheric  
Sciences, University of Miami  
(Florida)

This dissertation was submitted to the Graduate Faculty of the College of Engineering and to the Graduate Council, and was accepted as partial fulfillment of the requirements for the degree of Doctor of Philosophy.

June 1977

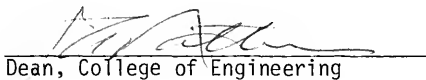

---

Dean, College of Engineering

---

Dean, Graduate School

UNIVERSITY OF FLORIDA



3 1262 08666 274 8