

UNIVERSITY OF
ILLINOIS LIBRARY
AT URBANA-CHAMPAIGN
BIOLOGY

JUL 21 1957

12 oct.

57

FIELDIANA Zoology

Published by Field Museum of Natural History

VOLUME 57

THE MORPHOLOGY, SYSTEMATICS, AND EVOLUTION OF THE OLD WORLD TREEFROGS (Rhacophoridae and Hyperoliidae)

SIOE SING LIEM

SEPTEMBER 30, 1970

UNIVERSITY OF ILLINOIS
AT URBANA-CHAMPAIGN

OCT 25 1972

THE LIBRARY OF THE

FIELD MUSEUM OF NATURAL HISTORY
101 SOUTH MICHIGAN

OCT 30 1972

FIELDIANA: ZOOLOGY

A Continuation of the

ZOOLOGICAL SERIES

of

FIELD MUSEUM OF NATURAL HISTORY

VOLUME 57



FIELD MUSEUM OF NATURAL HISTORY
CHICAGO, U. S. A.

THE MORPHOLOGY, SYSTEMATICS, AND
EVOLUTION OF THE
OLD WORLD TREEFROGS
(*Rhacophoridae* and *Hyperoliidae*)

FIELDIANA Zoology

Published by Field Museum of Natural History

VOLUME 57

THE MORPHOLOGY, SYSTEMATICS, AND EVOLUTION OF THE OLD WORLD TREEFROGS (Rhacophoridae and Hyperoliidae)

SIOE SING LIEM

Department of Zoology, University of Illinois

SEPTEMBER 30, 1970

PATRICIA M. WILLIAMS
Editor

Library of Congress Catalog Card Number: 72-129463

PRINTED IN THE UNITED STATES OF AMERICA
BY FIELD MUSEUM PRESS

ABSTRACT

Based on a study of the myology, skeleton, and external morphology of 420 species of Old World treefrogs, two families were recognized: Rhacophoridae and Hyperoliidae. New characters discovered in the forearm, foot, and throat musculature and in the hyoid skeleton established a basis for a new classification and a means for deducing phylogenetic relationships. Two computer methods were used to handle the mass of data assembled and to provide objectivity in the analysis. The Rhacophoridae as revised here includes 14 (10 examined) genera in the Orient, Madagascar, and the African tropics; the limits of these genera were redefined. Undue emphasis on vomerine teeth as a generic character had resulted in the lumping of four Oriental genera under *Rhacophorus auct.* and four under *Philautus auct.* The Hyperoliidae includes 14 genera (eight examined) in Africa, Madagascar, and the Seychelles Islands; their generic limits are in accord with those in previous studies. The Rhacophoridae probably evolved from a ranid stock in the Orient, but four primitive genera reached Madagascar, where they still occur, and one advanced genus appears to have recently reached Africa. The Hyperoliidae evolved from a ranid stock in Africa but have also dispersed to Madagascar and the Seychelles Islands, where the family is represented by one endemic genus each.

CONTENTS

	PAGE
INTRODUCTION	1
MATERIALS AND METHODS	6
DEFINITIONS AND ANALYSES OF CHARACTERS	8
1. M. Humero-dorsalis (HU)	10
2. Palmaris Complex	12
3. Extensor Radialis Accessorius Lateralis (ERAL)	18
4. M. Adductor Longus (ADL)	19
5. M. Extensor Digitorum Communis Longus of the Tarsus	20
6. Throat Musculature	21
7. Most Anterior Slip of the M. Petrohyoideus Posterior	23
8. M. Petrohyoideus	23
9. M. Geniohyoideus	24
10. Thyrohyal (TH)	26
11. Presence or Absence of the Alary Process	28
12. Shape of the Alary Process (AL)	28
13. Presence or Absence of the Anterior Horn (ANP)	29
14. Form of the Anterior Horn	29
15. Posterior Lateral Process (PLP)	30
16. Vertebral Column	30
17. Shape of the Eighth Vertebra	31
18. Dimensions of the Vertebral Column	32
19. Frontoparietal (FP)	33
20. Shape of the Nasal and Exposure of the Sphenethmoid	36
21. Vento-posterior Portion of the Sphenethmoid (SA)	36
22. Presence or Absence of Vomerine Teeth (VT)	37
23. Vomerine Odontophore (VO)	37
24. Omosternum (O)	37
25. Metasternum (M)	38
26. Metacarpal of the Third Finger	39
27. Terminal Phalanx (TP)	40
28. Carpal Bones (C)	41
29. Tarsal Bones (T)	42
30. Wolffian Duct (WD)	44
31. Vesicula Seminalis (VS)	44
32. Presence or Absence of Web Between the Two Outer Metatarsals	45
33. Digital Disc	46
34. Orientation of the Pupil	47
35. Nuptial Pad	47
36. Vocal Pouch	49
RESULTS	51

	PAGE
DISTRIBUTION, CENTERS OF EVOLUTION, AND DISPERSAL	80
SYSTEMATIC ACCOUNTS	84
REFERENCES	114
APPENDIX	127

ACKNOWLEDGEMENTS

I wish to express my sincere gratitude to Dr. Robert F. Inger for his aid and encouragement through all phases of this research, to Dr. Philip W. Smith for much help with the writing of the thesis, and to Dr. Hobart M. Smith for guidance and supervision of the preliminary stages of the research. I am indebted to Mr. Glen Sharrock and Dr. David C. Eades for assistance and counsel with the computer analyses and to Miss Martha Jill Merritt for her patience in typing copy from handwritten manuscript.

I wish to acknowledge the courtesy of the Center for Graduate Studies in Systematics and Paleontology at Field Museum of Natural History for providing laboratory and library facilities and for subsidizing computer expense.

I also wish to acknowledge the courtesy of Field Museum of Natural History (FMNH), University of Illinois Museum of Natural History (UIMNH), University of Michigan Museum of Zoology (UMMZ), Stanford University Zoological Collections (SU), the Museum Zoologicum Bogoriense at Bogor (MZB), and the following officials at these museums for lending specimens in their care: Dr. Inger, Dr. Donald F. Hoffmeister, Dr. Charles F. Walker, Dr. Walter C. Brown, and Dr. Sampurno Kadarsan. I thank Hymen Marx and Tom Olechowski for making my stay at Field Museum a pleasant and memorable one.

I am grateful to Dr. Kadarsan and Dr. Sarwono Prawirodihardjo, who were instrumental in my receiving a fellowship in the Agency for International Development to come to the United States, and to Charles W. McIntosh, Howard H. Hanson, Miss Carol Littlejohn, and Miss Janice M. Johnson in the Washington office for looking after my needs during my stay in the United States.

Finally, I am grateful to my wife, Francisca Eugenie Liem, for her encouragement and understanding during the course of this study.

The Morphology, Systematics, and Evolution of the
Old World Treefrogs¹
(Rhacophoridae and Hyperoliidae)

INTRODUCTION

A complete taxonomic revision of the Old World treefrogs² was done by Ahl (1931b), who treated 12 genera and 527 species; eight of the 12 genera were reported to be distributed in Africa and the adjacent Seychelles Islands, one in Asia, and two in Madagascar. He defined the Old World treefrogs as having a firmisternous pectoral girdle, not or only slightly dilated sacral diapophysis, and, most important of all, an intercalary cartilage between the two distal phalanges of the fingers and toes. Generally, these frogs (except *Mantidactylus* and most species of *Kassina*) are arboreal, and most of them show the specialized breeding habit of building aerial nests for their eggs. The Old World treefrogs differ morphologically from the Ranidae only in the presence of the intercalary cartilage.

One year after Ahl's monumental work appeared, Hoffman (1932), who studied primarily the African treefrogs, questioned the validity of the African group as an autonomous family. Hoffman examined the arterial system, vertebral column, sacral vertebra, and shoulder girdle.

After years of extensive osteological studies on African and some Asiatic treefrogs and ranids, Laurent (1940b, 1941a,b, 1942b, 1943a,b, 1944, 1946b, and 1950a) erected a new subfamily, the Hyperoliinae, to include all of the African treefrog genera (except *Chiromantis*), *Heterixalus* from Madagascar, and *Megalixalus* from the Seychelles Islands. He recognized 11 genera in that subfamily: *Hyperolius*,

¹ Submitted in partial fulfillment of the requirements for the degree of Doctor of Philosophy in Zoology in the Graduate College of the University of Illinois, 1969.

² All members of Rhacophoridae (i.e., all Asiatic genera plus *Boophis*, *Mantidactylus*, *Mantella*, *Gephyromantis*, and *Trachymantis* from Madagascar, and *Chiromantis* from Africa) and all members of the Hyperoliidae (*Heterixalus* from Madagascar, *Megalixalus* from the Seychelles, and all African hyperoliid genera).

Afrixalus, *Megalixalus*, *Heterixalus*, *Acanthixalus*, *Phlyctimantis*, *Cryptothylax*, *Hylambates*, *Kassina*, *Mocquardia*, and *Leptopelis*.

The following year Laurent (1951b) proposed radical changes in the classification of firmisternous anurans by dividing them into two families: the Ranidae and Hyperoliidae. In the latter family they included, besides the Hyperoliinae (Laurent, 1951b), some African groups that are generally considered as ranids, i.e., *Astylosterninae*, *Hemisinae*, and *Scaphiophryinae*. All Asiatic rhacophorids, *Boophis* from Madagascar, and *Chiromantis* from Africa were placed in the Rhacophorinae of the Ranidae, whereas *Mantidactylus*, *Mantella*, *Pseudophilautus*, *Gephyromantis*, and *Trachymantis* were placed in a separate subfamily, the Mantellinae. Besides these two subfamilies Laurent (1951b) placed the subfamilies Raninae, Cornuferinae, Petropedetinae, and Cacosterninae in the Ranidae.

Other than the classifications proposed by Ahl (1931b) and Laurent (1951b), part or all of the Old World treefrogs were either classified in the following subfamilies or families: *Hylae* (Tschudi, 1838; Schlegel, 1837-1844), *Hylaeformes* (Duméril and Bibron, 1841; Duméril et al., 1854; A. Duméril, 1853), *Hylina* (Hoffmann, 1873-1878), *Cystignathidae* (Günther, 1858), *Hylodidae* (Hoffmann, 1873-1878), *Discophidae* (Ahl, 1924), *Ranae phaneroglossa* (Wagler, 1830), *Ranae* (Wiegmann, 1832), *Raniformes* (Duméril and Bibron, 1841; Duméril et al., 1854; Cope, 1864), *Ranidae* or *Raninae* (Cope, 1864, 1865; Peters, 1882; Boulenger, 1882, 1912; Thurston, 1888; Gadow, 1901; Stejneger, 1907, 1910; Nicholls, 1916; Taylor, 1921; Noble, 1922, 1924; van Kampen, 1923; Ahl, 1924; Smith, 1930), *Polypodidae* (Günther, 1858; Mivart, 1869; Hoffmann, 1873-1878; Boettger, 1881b; Peters, 1882; Noble, 1931; Parker, 1932), and finally in the *Rhacophoridae* or *Rhacophorinae* (Hoffmann, 1932; Parker, 1934; Witte, 1941; Inger, 1954a, 1966, 1967; Kirtisinghe, 1957; Schmidt and Inger, 1959; Taylor, 1962; Schiøtz, 1967).

The various classifications proposed above tend to reflect the characters utilized. In short, the evolution of the classification of the Old World treefrogs can be divided into several eras: in the first half of the 19th century anuran classifications were based primarily on easily accessible, external characters, e.g., tongue, dentition, webbing, and degree of dilation of the distal segment of the digit. It is therefore not surprising that Old World treefrogs with dilated distal tips of digits were placed in the hylids (Schlegel, 1837-1844; Tschudi, 1838; and Duméril and Bibron, 1841; Duméril et al., 1854), whereas treefrogs with simple toe tips were placed in the *Ranae* (Wiegmann,

1832; Wagler, 1830) or Raniformes (Duméril and Bibron, 1841; Duméril et al., 1854).

After the two types of pectoral girdle, arciferous and firmisternous, were discovered by Cope (1864, 1865), all Old World treefrogs were considered more closely related to ranids because they were found to share the firmisternous pectoral girdle. Dilated distal tips of digits and extensive toe webbing were no longer considered as important characters at higher levels in the classification of anurans. As a result, Boulenger (1882), Gadow (1901), and others classified Old World treefrogs in the Ranidae. The presence of an intercalary cartilage between the two distal phalanges was discovered for the first time by Leydig (1876) in *Hyla arborea*. Although the presence of an intercalary cartilage between the two distal phalanges of the fingers and toes was discovered in Old World treefrogs as early as 1882 by Peters, and was mentioned by Boulenger (1888) and by Howes and Davies (1888), this structure was not recognized as a distinguishing character for separating Old World treefrogs from ranids by many prominent herpetologists of the late 19th century.

As early as 1858 Günther erected the new family Polypedatidae for all known genera of Old World treefrogs (except *Kassina*), and included in it some arciferous genera; this family was characterized by extensive webbing of the toes, cylindrical sacral diapophysis, and the absence of parotoid glands. Mivart (1869) accepted Günther's Polypedatidae but considered that genera in this family may be either arciferous or firmisternous.

With the exception of Peters (1882), none of the 19th century workers recognized the subfamily Polypedatinae exclusively for Old World treefrogs. Peters did recognize it as a separate subfamily based on the presence of an intercalary cartilage between the two distal digits of fingers and toes, a character which distinguishes it from the Raninae.

Noble (1931) redefined the Polypedatidae and considered that all Old World treefrogs belonged to this family, which differs from the closely related Ranidae by the intercalary cartilage.

Placement in a separate family for Old World treefrogs is widely accepted by modern workers (Ahl, 1931b; Parker, 1932, 1934; Laurent, 1941b, 1943b, 1944; Inger, 1967; and Schiøtz, 1967). Laurent (1951b) and Perret (1966) are exceptions.

At the start of this study I accepted majority opinion and assumed that Old World treefrogs were one evolutionary unit as defined, for instance, by Ahl (1931b) and Noble (1931).

Currently 24 genera are recognized, 12 of which occur on the African continent, six in Madagascar, one in the Seychelles, and five in the Orient.

In size Old World treefrogs range from two cm. to a little more than 10 cm. in snout-vent length; and the body is generally slender at the waist; some robust forms are known, viz., *Kassina*, some *Leptopelis*, and *Philautus*. A few forms have extensive skin folds or fringes along the forearm and sometimes also have anal and tarsal dermal flaps. Generally the skin is smooth but in some genera the body is warty and may even have calcium deposits (*Theloderma*). In some species the skin of the head is co-ossified with the skull (*Polypedates otilophus*, *Hazelia picta*, and others).

In almost all Old World treefrogs the distal segments of the fingers and toes are dilated into distinct discs, apparently an adaptation for arboreal life (Noble, 1931; Ahl, 1931b). In addition, the skin of the abdomen and the ventral surfaces of the thighs are granular and may serve as an adhesive apparatus, when pressed on a substrate (Siedlecki, 1909). The fingers and toes of some species are extensively webbed, and the ratio of the total web area to snout-vent length may reach as high as 12.0 in *Rhacophorus pardalis* (Inger, 1956).

The extensive webbing of the hands and feet and elaborate dermal flaps on the forearm and tarsus may serve as a parachute in breaking the fall when the frog is in the air (Wallace, 1869; Siedlecki, 1908, 1909; Inger, 1956; Davis, 1965).

The snout may be acute, obtuse, or rounded; usually it is short with large eyes facing the front. The pupil is horizontal or vertical.

Most Old World treefrogs are arboreal, and live in tropical rainforests in trees as high as 10 m. (*Rhacophorus reinwardti*), in tree holes (*Theloderma*, Taylor, 1962), or they may live in shrubs or in savannas among the grass and reeds near water (some *Afrivalus* and *Hyperolius*, Schiøtz, 1967). A few are ground dwellers as in some *Kassina* and *Hylambates maculatus* (Laurent, 1950a; Schiøtz, 1967).

The reproductive behavior of some rhacophorids is unusual. A foam nest is built by beating a gelatinous secretion with the hind limbs while the pair is in amplexus. The foam nest produced is usually deposited on leaves overhanging water and after a few days young larvae hatch and fall into the water to continue the usual aquatic tadpole development. Such a reproductive pattern is known, for example, in *Rhacophorus reinwardti* (Siedlecki, 1908, 1909), *R. pardalis* (Inger, 1956), *Polypedates leucomystax* (Pope, 1931; Liu, 1950;

Inger, 1966; Taylor, 1962), *P. otitophus* and *P. macrotis* (Inger, 1956), and *P. dennysi* (Liu, 1950). Foam nests may also be deposited on water plants, under stones in water (*Polypedates omeimontis* and *P. dugritei*, Liu, 1950), in underground burrows (*Rhacophorus schlegeli*, Ikeda, 1897; Okada, 1928), or in water holes in tree trunks (*Theloderma gordonii*, Taylor, 1962). In some cases a foam nest is not produced, but instead the gelatinous mass that surrounds the eggs is deposited on reeds or leaves of low shrubs above water (Perret, 1961; Schiøtz, 1967). In other instances a gelatinous nest is not formed, and the eggs are deposited directly on leaves as in *Philautus hosei* (Inger, 1966), are buried in moist soil (*Leptopelis viridis*), or are deposited in water as *Kassina senegalensis* (Schiøtz, 1967). Specialized reproductive behavior in which the eggs are deposited in the soil and guarded by the female and followed by direct development without an aquatic larval stage is found in *Rhacophorus microtympanum* (Kirtisinghe, 1946).

The primary objective of this study is to define the major evolutionary lines within Old World treefrogs and to ascertain whether the genera recognized at present are true natural assemblages. Based on data that follow, a new classification is constructed.

MATERIALS AND METHODS

This study was based on 420 specimens belonging to 112 species of Old World treefrogs and 85 specimens belonging to 64 species and 20 genera of the Ranidae. The forearm musculature of 37 species of other families was also examined (Appendix 1).

Dry skeletons were prepared for most of the species studied; small specimens were cleared and stained using either Davis and Gore's (1936) or Taylor's (1967) method. Radiographs of several species were made to obtain additional osteological information and to determine the variation in some structures.

All observations and dissections were carried out under a low-power stereoscopic microscope. A caliper and reticles were used for measurements. The illustrations were drawn with the aid of a stereoscopic microscope.

Myological terminologies were adopted from various sources: the forearm muscles from Haines (1939), the throat and hyoid muscles from Gaupp (1896) and Trewavas (1933), the foot and thigh muscles from Dunlap (1960, 1966) and Noble (1922). Most of the osteological terminologies were adopted from Laurent (1940b, 1941a,b, 1943b, 1944).

It was not possible within the limits of this study to determine the validity of species examined, and I have had to follow recent published works on the group: Inger (1954a, 1966), Taylor (1962), Liu (1950), and Pope (1931) for Asiatic treefrogs; and Laurent (1941b, 1943c, 1944, 1946a, 1950a, 1951a), Schiøtz (1967), and Perret (1966) for African treefrogs.

Since phylogenetic relationships are a consequence of genetic continuity, the best method to reveal the phylogenetic relationships is to study directly the genotypes. Since this is outside our powers now, only phenotypic characters were sampled in the hope that they truly reflect the genotypes. In order to obtain an idea of the genotypes, a number of phenotypic characters from various parts of the organisms were sampled, and only those characters deemed not necessary correlates (Cain and Harrison, 1960) were used for this analysis.

The various characters used in this study fall into three major groups:

Osteology.—The osteology of the skull, vertebrae, pectoral girdle, hyoid skeleton, carpals, tarsals, metacarpals, and the terminal phalanges.

Musculature.—The musculature of the forearm, the thigh, the foot, and the hyoid.

Miscellaneous structures.—Characters such as the Wolffian ducts, vesicula seminales, vocal pouches, digital discs, dermal ornamentation, and the shape of the pupil.

A large number of specimens were examined for several species to determine the degree of intra-specific variation.

Two computer programs were used for analyzing the data. The program of the "Combinatorial Method," developed by Glen Sharrock and Joseph Felsenstein (1969) was used to obtain alternative phylogenies of groups under study. The program of the "Mean Character Difference" by Dr. David C. Eades (1969) was used to show the phenetic similarities between species. The procedures of the above methods will be discussed in the *Results* (p. 51).

IBM 7094 at the University of Chicago was used for the "Combinatorial Method," and IBM 360-75 of the University of Illinois at Urbana was used for the "Mean Character Difference" runs.

DEFINITIONS AND ANALYSES OF CHARACTERS

A character is defined here as a "feature which varies from one kind of organism to another" (Michener and Sokal, 1957) or "anything that can be considered as a variable independent of any other thing considered at the same time" (Cain and Harrison, 1958). A character state (or states) implies a qualitative and quantitative expression of a character. For example, the elliptical pupil is a character, whereas its orientation, i.e., vertical or horizontal, is considered a state of that character.

Character states were recorded in a numerical order from zero to eight; nine was assigned for missing data (see *Appendix 3*).

It is widely accepted that organisms that are closely related phylogenetically are more similar morphologically than more distantly related ones.

For the Combinatorial Method, the primitive state and the direction of change of states of each character has to be determined; then they are recoded in binary form on IBM cards.

In order to determine the primitive state of a character in a given group, one has to consider character states of taxa of the presumed ancestral group from which the group under study has evolved. The presumed ancestral stock of Old World treefrogs is probably the Ranidae, because of many morphological similarities (see p. 60). This assumption is widely accepted by many workers, e.g., Noble (1922, 1931), Parker (1932, 1934), Laurent (1951b), and Inger (1967).

Since in tracing the phylogeny of a group of organisms one cannot avoid studying and comparing the presumed ancestral stock and closely related groups, many representative genera of the Ranidae and other families were examined (*Appendix 1*).

Primitive character states of Old World treefrogs were inferred from the following criteria and are listed in the presumed order of significance:

1. Character states widely distributed in the presumed ancestral stock (the Ranidae) are considered primitive. The more widely a

character state is distributed within a well-defined taxon, the less likely that its several occurrences are independent evolution.

2. If two or more character states are equally distributed in the ancestral stock, the character state that occurs widely in the most generalized group is considered primitive. In the Ranidae, the genus *Rana* is considered as generalized as contrasted to *Platymantis*.

3. Character states distributed in a restricted small group of ranids can be considered primitive, if this assumption leads to the shortest and most logical evolutionary route (Rule of Parsimony). For example, the free third carpale, even though it is restricted in *Trichobatrachus*, *Cardioglossa*, *Astylosternus*, and most species of *Arthroleptis* (Laurent, 1940b, 1941a, 1942a) among the ranids, is probably primitive for the following reasons. Apparently this condition is retained from the presumed ancestral stock of the ranids, inasmuch as the third carpale is free in the Pelobatidae and in other primitive families, such as the Discoglossidae, Pipidae, and Ascaphidae (Howes and Ridewood, 1888; Ritland, 1955). Furthermore, if one assumes the fusion of the third carpale in ranids is primitive, then the presence of the free third carpale in the hyperoliids and *Mantidactylus* would require assuming a sequence of free to fused to free, a more complex evolutionary step than assuming that the free third carpale is the primitive state.

If a character has only two states, the sequence of change is simply from the primitive to the derived state. If more than two derived states are involved, the sequence of change is determined as follows:

a. The direction of the degree of specialization is followed, and it involves inferring the functional adaptive significance of a structure by relating that structure to the habits of the organisms. For example, the splitting of the *M. humerodorsalis*, and the shift of insertion (see character 1-3) are undoubtedly arboreal adaptations since they are not only restricted to the Old World treefrogs but similar patterns also occur in unrelated treefrogs, the Hylidae.

b. If the adaptive significance of a structure is obscure, then the least complex evolutionary sequence to produce its state is assumed. For example, relationships among patterns of the palmaris complex (character 2-2, 2-3, and 2-4, figs. 4-6) are obscure because their adaptive significance is unknown. Apparently character 2-2 gave rise to both characters 2-3 and 2-4, which is the shortest evolutionary route.

1. M. HUMERODORSALIS (HU)

The M. humerodorsalis muscle is the most superficial muscle of the forearm extensors and lies over the M. extensor radialis superficialis and the M. supinator manus. Distally, it splits into several slips inserting on the digits. A distal slip of the M. humerodorsalis and its associated tendon, which runs distally over a given digit, inserts along the phalanges and ends up on the dorsal tip of the terminal phalanx and is called a phalangeal slip. On the other hand, a slip of muscle and associated tendon that inserts either on the disto-medial or on the lateral side of the metacarpal is called a metacarpal slip. A number denotes the digit to which a slip runs. Based on the number of distal slips and their insertion, four states are recognizable in the Old World treefrogs.

State 0. The M. humerodorsalis splits into three main, short slips at the level of the carpometacarpal joint: the second, third, and fourth phalangeal slips; the short tendinous fourth metacarpal slip is also present.

State 1. At the distal half of the radio-ulna, the M. humerodorsalis splits into two main halves. The medial half consists of two distal slips, i.e., the second and the third phalangeal slips while the lateral half consists of the fourth phalangeal and the short fourth metacarpal slips.

State 2. This state is identical to state 1, except for the absence of the second phalangeal slip.

State 3. The M. humerodorsalis is completely divided, inserting on the third and on the fourth metacarpals (fig. 9). The third metacarpal slip inserts on the disto-medial bony knob of the third metacarpal, whereas the fourth metacarpal slip inserts somewhere along the proximo-lateral half of the fourth metacarpal; in most cases the latter insertion can be easily located by the presence of a small bony knob.

Direction of change. State 0 was found in all ranids examined and is thus considered primitive for the Old World treefrogs (criteria 1, p. 8). Since in the anurans, splitting of the M. humerodorsalis and the shift of insertion of these separated slips from the phalangeal tip to the metacarpals are found only in treefrogs (most rhacophorids, hyperoliids, and hylids) these states are undoubtedly the derived conditions. Apparently the splitting of the M. humerodorsalis, reduction of the number of the distal slips and the shift of their insertion are correlated with an arboreal specialization. These changes apparently have a functional adaptive value and will be dis-

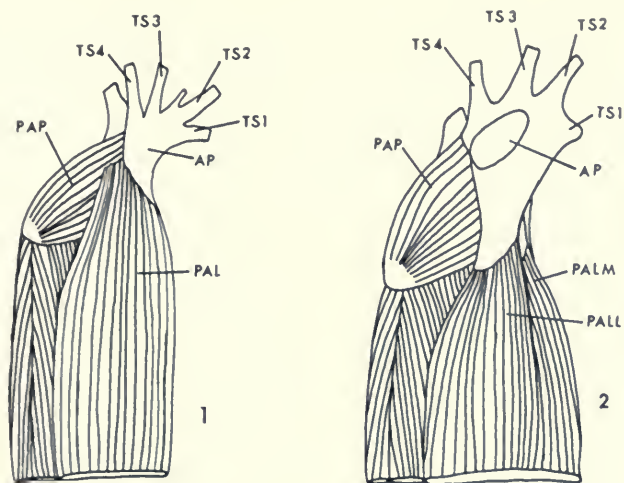

FIGS. 1, 2. Ventral aspect of the palmaris complex of: 1. *Rana latouchi* Boulenger (FMNH 16918); 2. *Mantidactylus ulcerosus* (Boettger), (UMMZ 1823). AP, Aponeurosis palmaris; PAL, Musculus palmaris longus; PALL, Musculus palmaris longus lateralis; PALM, Musculus palmaris longus medialis; PAP, Musculus palmaris profundus; TS1, Tendo superficialis of the 1st finger; TS2, Tendo superficialis of the 2nd finger; TS3, Tendo superficialis of the 3rd finger; TS4, Tendo superficialis of the 4th finger.

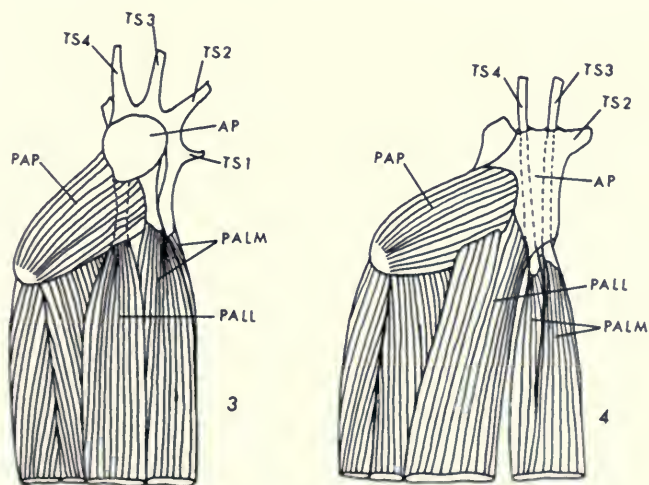

FIGS. 3, 4. Ventral aspect of the palmaris complex of: 3. *Kassina senegalensis* (Duméril & Bibron), (FMNH 81570); 4. *Boophis tephraeomystax* (A. Duméril), (FMNH 56377). All abbreviations as in Figures 1 and 2.

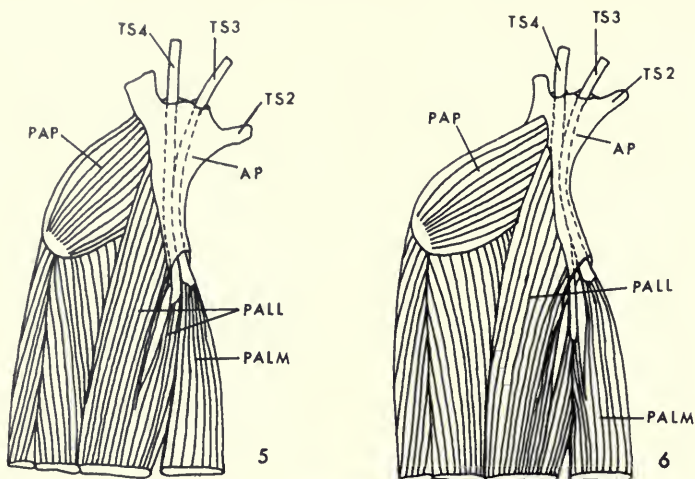

FIGS. 5, 6. Ventral aspect of the palmaris complex of: 5. *Philautus hosei* (Boulenger), (FMNH 145595); 6. *Polypedates cruciger* (Blyth), (UIMNH 37557). All abbreviations as in Figures 1 and 2 (p. 11).

cussed further under the Palmaris Complex (see below). According to the degree of specialization (criteria 1, p. 8), the direction can be arranged as follows:

0 —————> 1 —————> 2 —————> 3

2. PALMARIS COMPLEX

The superficial muscles and tendons of the ventral surface of the forearm and the hand are treated here as one character since they form one functional unit. This complex of muscles and their tendons function as a flexor of the hand and fingers. Four structures are included in the palmaris complex: M. palmaris longus, M. palmaris profundus, Aponeurosis palmaris, and the Tendo superficiales.

a. M. Palmaris Longus (PAL)

The M. palmaris longus (Gaupp, 1896) originates from the epicondylus humeri and inserts on the proximal rim of the Aponeurosis palmaris. In the majority of the Old World treefrogs, the distal half or third of the M. palmaris longus is divided into three heads, and only one head inserts on the Aponeurosis palmaris, i.e., either the lateralmost or the medianmost one, whereas the two other heads join the Tendo superficiales.

b. *M. Palmaris Profundus* (PAP)

The *M. palmaris profundus* (Gaupp, 1896) originates from the distal third of the ulna and runs obliquely and medially and inserts on the dorsal surface of the Aponeurosis palmaris (see figs. 1-7). If the tendinous Aponeurosis palmaris is absent the *M. palmaris profundus* inserts directly on the proximal portion of the Tendo superficialis (see fig. 8).

c. Aponeurosis Palmaris (AP)

The Aponeurosis palmaris is a tendinous tissue that is located ventral to the carpals and distal to the *M. palmaris longus*. In all species of anurans examined (except some *Leptopelis*), it serves as the insertion of the whole or part of the *M. palmaris longus* and also as the insertion of the *M. palmaris profundus*. It may either serve as the origin of the Tendo superficiales (see figs. 1-3) or as tubing for the third and fourth tendons (see figs. 4-7). The distal rim of the Aponeurosis palmaris serves as the origin of the *M. lumbricales*, which is not included in this discussion.

d. Tendo Superficialis (TS)

The Tendo superficiales (Gaupp, 1896) are the superficial tendons ventral to each finger that usually originate from the Aponeurosis

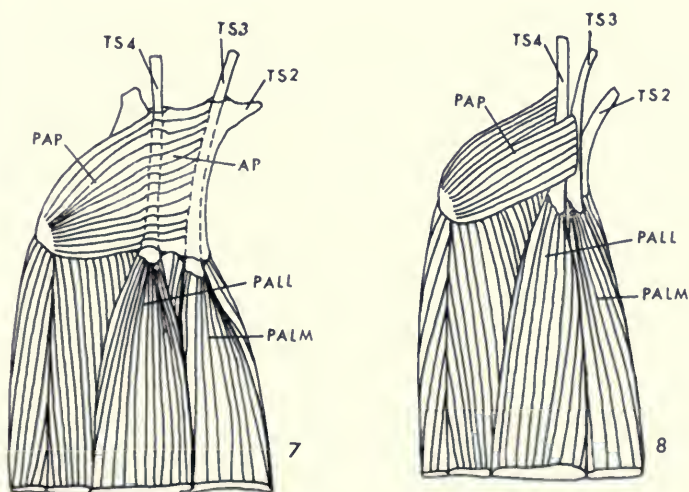

FIGS. 7, 8. Ventral aspect of the palmaris complex of: 7. *Phlyctimantis verrucosus* (Boulenger), (FMNH 154766); 8. *Leptopelis aubryi* (Duméril), (FMNH 59110). All abbreviations as in Figures 1 and 2 (p. 11).

palmaris, inserting on the terminal phalanx of each digit (state 0 in all ranids examined). In all other states, the third and the fourth Tendo superficiales each joins one of the distal heads of the fragmented *M. palmaris longus*. In all species examined (except some *Leptopelis*), the second Tendo superficialis (TS2) originates from the lateral portion of the Aponeurosis palmaris. The first Tendo superficialis (TS1) may either originate on the Aponeurosis palmaris or the carpal. This tendon will not be included in our discussion further.

Seven palmaris complex states are recognizable:

State 0. The distal third of the palmaris longus muscle splits into two, both inserting on the proximal rim of the Aponeurosis palmaris. All four Tendo superficiales originate from the distal rim of the Aponeurosis palmaris, whereas the *M. palmaris profundus* inserts on the dorsolateral portion (fig. 2).

State 1. The distal half of the *M. palmaris longus* is divided into two main halves. Distally, the medial half splits again into two and the medianmost one inserts on the proximo-medial rim of the Aponeurosis palmaris, whereas the medial portion joins the third Tendo superficialis. The lateralmost half of *M. palmaris longus* joins the fourth Tendo superficialis. The proximal portions of both the third and the fourth Tendo superficiales are present in the thick tendinous Aponeurosis palmaris, but they are not able to slide through (fig. 3).

State 2. The distal two-thirds of the *M. palmaris longus* divides into two halves. Smaller slips branch off the medial and the lateral halves, and they fuse before joining the fourth Tendo superficialis. The lateralmost slip of the lateral half (PALL) inserts on the proximo-lateral rim of the Aponeurosis palmaris, whereas the medianmost slip of the medial half (PALM) joins the third Tendo superficialis. The proximal portion of the third and fourth Tendo superficiales can slide through the Aponeurosis palmaris. The second Tendo superficialis originates from the disto-lateral portion of the Aponeurosis palmaris, whereas the first originates from the carpal (fig. 6).

State 3. The small medial slip of the lateral half of the *M. palmaris longus* is absent; all other structures are similar to state 2 (fig. 6).

State 4. The small lateral slip of the medial half of the *M. palmaris longus* is absent; all other structures are similar to state 2 (fig. 5).

State 5. The distal two-thirds of the *M. palmaris longus* divides into two. The distal third of the medial half divides again with the medianmost slip inserting on the proximo-medial rim of the Aponeurosis palmaris, whereas the lateral slip joins the third Tendo superficialis. The lateral half of the *M. palmaris longus* joins the fourth Tendo superficialis. The proximal portions of the third and fourth Tendo superficiales can slide through the Aponeurosis palmaris. The *M. palmaris profundus* inserts on the dorsal side of the Aponeurosis palmaris. The origin of the second Tendo superficialis is on the Aponeurosis palmaris (fig. 7).

State 6. The general pattern of this state is similar to state 5. The tendinous Aponeurosis palmaris is absent; as a consequence the *M. palmaris profundus* inserts directly on the dorsal sides of the proximal portion of the third and fourth Tendo superficiales, whereas the second Tendo superficialis joins the medianmost slip of the medial half of the *M. palmaris longus* (fig. 8).

Direction of change. Since in the majority of the ranids the *M. palmaris longus* is undivided, and in all of them the Tendo superficiales are not able to slide through the Aponeurosis palmaris (see fig. 1), this pattern is considered primitive (criteria 1, p. 8). Because the divided *M. palmaris longus* and the ability of the third and fourth Tendo superficiales to slide through the Aponeurosis palmaris are found in almost all treefrogs: rhacophorids (except *Mantidactylus*), hyperoliids (except some *Kassina*), and hylids, this is probably the derived condition. Apparently these modifications have an adaptive significance and are correlated with an arboreal life habit. Based on these observations, state 0 appears to be intermediate between the palmaris complex pattern of the typical ranids (fig. 1) and that of treefrogs (figs. 3-8). Since state 0 is also found in some ranids, e.g., *Platymantis*, *Astylosternus*, and *Arthroleptis*, it can be regarded as primitive among the Old World treefrogs (criterion 3, p. 9). Although the general patterns of all states (except state 0) of the palmaris complex of the Old World treefrogs are similar (figs. 3-8), they can easily be separated into two categories based on which portion of the *M. palmaris longus* inserts on the Aponeurosis palmaris. States 2, 3, and 4 fall into one category with the outermost lateral slip of the *M. palmaris longus* inserting on the proximo-lateral rim of the Aponeurosis palmaris, whereas states 1, 5, and 6 fall into another category with the medianmost portion of the *M. palmaris longus* inserting on the proximo-medial portion of the Aponeurosis palmaris. State 6 falls in the second category because of the

great over-all similarity to other states in that group; because of the loss of the tendinous Aponeurosis palmaris, probably the median-most slip of the *M. palmaris longus* joins directly on the second Tendo superficialis.

Apparently two diverging lineages are involved; the first consists of states 2, 3, and 4 and the second consists of states 1, 5, and 6. Among the latter lineage apparently state 1 is the immediate derivative of state 0 because this state was intermediate between the primitive (state 0) and the derived condition (state 5) of that group; state 1 in turn gives rise to state 5, which finally gives rise to state 6. Among states of the first category, state 2 is considered as the immediate derivative of state 0 and this in turn gives rise to both states 3 and 4. State 2 is considered as the intermediate state between state 0, on the one hand, and states 3 and 4, on the other hand, because state 2 bridges the shortest evolutionary step toward states 3 and 4 (criterion 3, p. 9).

Direction of change of the states is as follows:

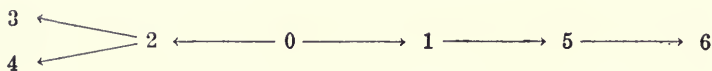

Arboreal adaptation involves, besides development of adhesive organs on the external surfaces (such as the rough surfaces of the skin of the abdomen, ventral portion of the thighs, and the throat and the dilation of the digital tips) some changes in internal structures. For example, since the division of the distal portion of the *M. palmaris longus* and modification of the third and fourth Tendo superficiales, which enable them to slide through the Aponeurosis palmaris, are found in all rhacophorids, hyperoliids, and hylids (except *Mantidactylus* and some species of *Kassina*), it is almost certain that these modifications are adaptations for arboreal life. Similar modifications are also true for the splitting, the reduction of the number of slips, and the shift of the insertions of the *M. humerodorsalis* (Char. 1, p. 10) and *M. extensor digitorum communis longus* (Char. 5, p. 20).

As far as the fingers are concerned, apparently modifications of muscles are centered in the third and fourth fingers. Division of the distal *M. palmaris longus* into several separated heads, and fusion of the third or the fourth Tendo superficialis to one of these slips enable it not only to flex the third and the fourth digits independently

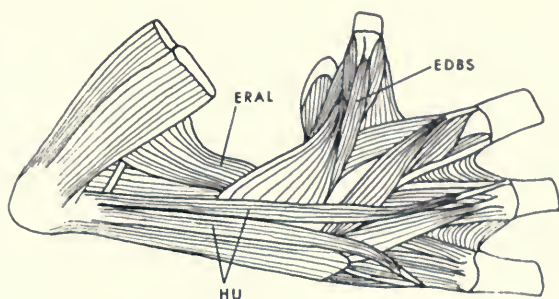

9

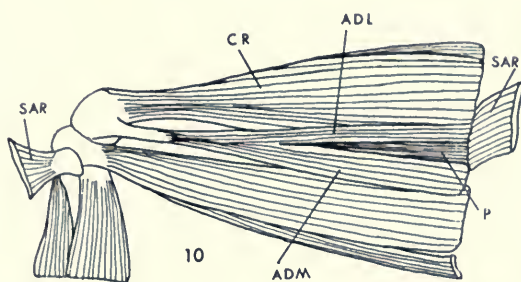

10

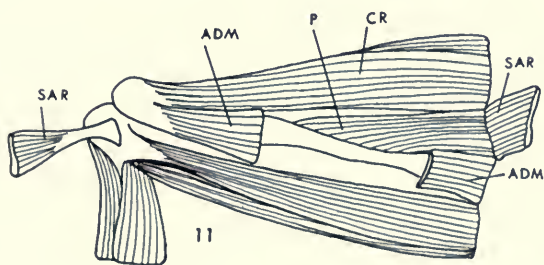

11

FIGS. 9-11. 9. Dorsal aspect of the forearm musculature of *Polypedates dugri- lei* David (FMNH 49513). EDBS, Extensor digitorum brevis superficialis; ERAL, Extensor radialis accessorius lateralis; HU, Musculus humerodorsalis. 10. Ventral aspect of the thigh musculature of *Boophis bicalcaratus* (Boettger), (UMMZ 86047). Musculus sartorius (SAR) was dissected out. 11. Ventral aspect of the thigh musculature of *Chiromantis petersi* Boulenger (UMMZ 70299). Musculus sartorius (SAR) and Musculus adductor magnus (ADM) were dissected out. ADL, Musculus adductor longus; ADM, Musculus adductor magnus; CR, Musculus cruralis; P, Musculus pectineus; SAR, Musculus sartorius.

but also to press these digits more firmly on the substrate when the *M. palmaris longus* contracts (see figs. 4-8). The division of the *M. humerodorsalis*, reduction of the number of the distal slips, and shift of the insertion of these slips from the distal phalanges to the distal or proximal portion of the metacarpals of the third and the fourth digits increases the efficiency of the extension of these digits and enables them to extend independently when individual slips of the *M. humerodorsalis* contract (see fig. 9).

If the *M. palmaris longus* slips joining the third and the fourth *Tendo superficiales* contract and, at the same time, slips of the *M. humerodorsalis* inserting on the metacarpals of the third and the fourth digit contract, these two digits are bent into a curve. Flexion and extension of the third and the fourth digits can occur independently, contingent upon which slips contract. Modifications of these muscles not only strengthen and increase the grasping ability of these digits but also press the dilated digital discs more firmly even on a large flat surface. Apparently these modifications are an efficient adaptation for arboreal life in these treefrogs.

3. EXTENSOR RADIALIS ACCESSORIUS LATERALIS (ERAL)

The *M. extensor radialis accessorius lateralis* is the lateral slip of the *M. extensor radialis accessorius* of Haines (1939). It is dorsal to the *M. brachio-radialis* and dorso-medial to the *M. extensor radialis superficialis*. Usually it originates on the epicondylus lateralis humeri, and it runs distally along the forearm either inserting directly on the distal portion of the radio-ulna or on the distal third of the *M. extensor radialis superficialis*. The distal tendon of the latter is very strong and forms a ligamentous arch around the radio-ulna head before splitting into two distal tendons, one inserting on the centrale and the other on the disto-medial end of the radio-ulna. Sexual dimorphism of the *M. extensor radialis accessorius* was reported in *Rana*, *Bufo*, and *Hyla* (Kändler, 1924). In ranids examined only *Rana sauteri* and *R. latouchi* showed this sexual dimorphism. Only *Buergeria robustus* among the Old World treefrogs shows slight sexual dimorphism but generally no observable differences between the sexes were recorded.

Character states of the *M. extensor radialis accessorius lateralis* utilized below are not or only very slightly affected by sexual dimorphism. Four states of the *M. extensor radialis accessorius lateralis* are recognized, based on the insertion, the origin, and the relative mass.

State 0. The M. extensor radialis accessorius lateralis is moderately large and the width at the origin is .75 to 1.5 that of the M. extensor radialis superficialis. It originates along the lateral side of the humerus between the crista ventralis and the epicondylus humeri and inserts on the distal tendon of the M. extensor radialis superficialis.

State 1. As in state 0, except that the insertion is on the disto-dorsal end of the radio-ulna.

State 2. The M. extensor radialis accessorius lateralis is very narrow, less than half the width of the M. extensor radialis superficialis at its origin. It originates from the lateral side of the crista ventralis and runs diagonally across the plane between the fore and upper arm and inserts on the distal tendon of the M. extensor radialis superficialis.

State 3. As in state 2, except that its insertion is on the disto-dorsal end of the radio-ulna.

Direction of change. State 0 is widely distributed in the ranids examined, and this condition is considered primitive (criterion 1, p. 8). Since the shift of the insertion of the M. extensor radialis accessorius lateralis from the distal portion of the M. extensor radialis superficialis to the radio-ulna involves more complex evolutionary change than the reduction in size of the muscle, states 1 and 2 are considered as a separate lineage, and both are derived from state 0; state 3 is derived from state 1 rather than from state 2 because reduction in size is the least complex evolutionary change (criterion 3, p. 9).

The direction of change is as follows:

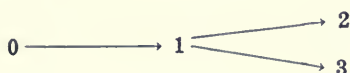

4. M. ADDUCTOR LONGUS (ADL)

The M. adductor longus lies between the M. cruralis (CR) and M. adductor magnus (ADM) and partially covers the M. pectineus (P). Usually the M. adductor longus and M. pectineus are visible only after the M. sartorius is removed.

The M. adductor longus originates on the iliac portion of the ventral pelvic rim and fuses with various segments of the M. adductor magnus. The common distal tendon finally inserts on the disto-ventral end of the femur. The absence of the M. adductor

longus as defined here requires that no slip is present between the M. pectineus and M. cruralis.

Two states are recognizable here:

State 0. The M. adductor longus is present, inserting along the distal half or third of the M. adductor magnus.

State 1. The adductor longus is absent.

Direction of change. Dunlap (1966) has shown that the M. adductor longus and M. pectineus developed from one anlage in *Rana pipiens* tadpoles and are distinct by larval stage IX. The absence of the M. adductor longus may be interpreted either that this muscle undergoes reduction in the muscle mass or has never differentiated. The absence of the M. adductor longus is considered when no distinct slip is present between the M. pectineus and M. cruralis. Since the M. adductor longus is present in all the ranids examined and in many modern anurans (Dunlap, 1960), this condition is considered as the primitive state. The direction of change is from state 0 to state 1.

5. M. EXTENSOR DIGITORUM COMMUNIS LONGUS OF THE TARSUS

Dunlap's (1960) definition of the M. extensor digitorum longus is adopted here. This muscle originates by a common tendon with the M. tarsalis anticus from the disto-lateral end of the tibia, stretches distally on the dorsal surface of the toes and has a varying number of slips inserting on either the distal or the proximal portion of the metacarpal.

Based on the number of slips and the sites of their insertion, five states are recognized:

State 0. Three distal slips of the M. extensor communis longus are present, inserting on the distal portion of the metatarsals of the third, fourth, and fifth toes.

State 1. Two distal slips of the M. extensor digitorum communis longus are present, inserting on the distal portion of the metatarsals of the third and fourth toes.

State 2. One slip of the M. extensor digitorum communis longus is present, inserting on the distal portion of the metatarsal of the fourth toe.

State 3. Two distal slips of the M. extensor digitorum communis longus are present. The lateral one inserts on the distal portion of the metatarsal of the fourth toe, whereas the medial one inserts on the proximal portion of the metatarsal of the third toe.

State 4. One distal slip of the *M. extensor digitorum communis longus* is present, inserting on the proximal portion of the metatarsal of the third toe.

Direction of change. Although the majority of the ranids examined had only one or two slips of the *M. extensor digitorum communis longus* inserting on the distal portion of the metatarsals, this condition is not considered as the most primitive. The largest number of slips with insertions on the distal portion of the metatarsals is found in some ranids; apparently this condition is primitive because it is found in the presumed ranid ancestral stock (criterion 3, p. 9). This view was also held by Dunlap (1960).

Insertion of the *M. extensor digitorum longus* on the proximal portion of the metatarsal is found only in the hyperoliids and undoubtedly is the derived condition (criterion 1, p. 8); probably the shift of insertion increases the efficiency in extending the metatarsal. Based on the above conclusions, state 4 appears to be the most specialized condition in Old World treefrogs.

Apparently state 0 gave rise to state 1 by the loss of the fifth slip, and from this point on it diverged into two lineages, i.e., state 2 by the loss of the third slip, and state 3, with the shift of the insertion of the third slip from the distal to the proximal portion of the metatarsal; the latter gave rise to state 4 with the loss of the fourth slip (criterion b, p. 9).

The direction of change is as follows:

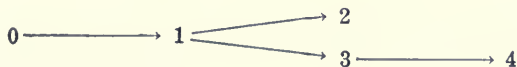

6. THROAT MUSCULATURE

Generally, only three distinct muscles form the throat musculature, i.e., *M. submentalis*, *M. submaxillaris*, and the *M. subhyoideus* (Gaupp, 1896). Trewavas (1933) reported that in some species of frogs a distinct narrow superficial muscle is present along the inner sides of the mandible, and she considered this muscle as part of the *M. intermandibularis posterior*.

With careful dissection of the anterior portion of the throat, I was able to recognize two distinct fan-shaped slips. The outermost slip lies in front of the *M. submaxillaris* (SM), and it is here called *M. submaxillaris ventralis* (SMV). It originates midway on the lower jaw and inserts on the median tendon with its fibers running parallel to the adjacent *M. submaxillaris*. An elongated fan-shaped slip lies

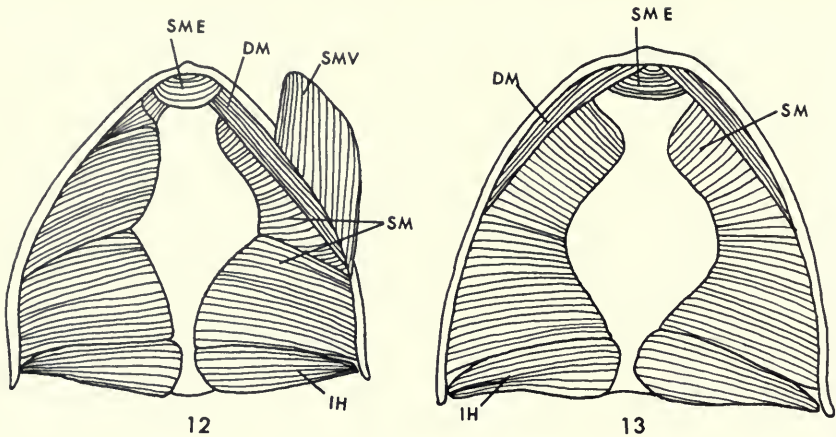

FIGS. 12, 13. Ventral aspect of the throat musculature of: 12. *Philautus acutirostris* (Peters), (FMNH 96061); 13. *Hyperolius concolor* (Hallowell), (FMNH 57764). DM, Musculus dentomentalis; IH, Musculus interhyoideus; SM, Musculus submaxillaris; SME, Musculus submentalis; SMV, Musculus submaxillaris ventralis.

between the ventral slip and the anterior portion of the M. submaxillaris and is called M. dentomentalis (DM). This muscle originates about midway on the inner side of the lower jaw with fibers running forward and mediad and inserts along the inner side of the mento-Meckelian bone (figs. 12, 13). In some species the M. dentomentalis is superficial and very narrow, lying parallel to the lower jaw (fig. 13).

Three states of the throat musculature pattern are recognizable:

State 0. The M. dentomentalis is fan-shaped; the M. submaxillaris ventralis and the M. submaxillaris are distinct (fig. 12).

State 1. The M. dentomentalis is fan-shaped and distinct; the M. submaxillaris ventralis is not distinct from the M. submaxillaris, and they form a continuous muscle layer.

State 2. The M. dentomentalis is narrow and runs parallel to the lower jaw. The M. submaxillaris ventralis is absent, and as a result the M. dentomentalis is superficial, lying directly under the skin. The M. submaxillaris is present, with the anterior portion lying dorsal to the M. dentomentalis (fig. 13).

Direction of change. Since state 1 is widely distributed in the generalized ranids, it is considered primitive (criterion 2, p. 9). The loss of the M. submaxillaris ventralis (state 2) and the distinctiveness of the M. submaxillaris ventralis are apparently derived conditions (state 0). These two states are probably derived from

state 1 (criterion 2, p. 9). Because state 2 is constant throughout the hyperoliids, apparently it has evolved only once. The direction of change can be visualized as follows:



7. MOST ANTERIOR SLIP OF THE M. PETROHYOIDEUS POSTERIOR

In general, the M. petrohyoideus posterior (PP) consists of three slips. They originate from the parotic crest; the two anterior slips usually insert along the proximal portion of the thyrohyal, whereas the posterior one inserts on the distal end of the thyrohyal (TH).

Based on the insertion of the most anterior slip of the M. petrohyoideus posterior, two states are recognizable:

State 0. The most anterior slip of the M. petrohyoideus posterior inserts on the thyrohyal or on the cartilaginous stalk of this process (CST).

State 1. The most anterior slip of the M. petrohyoideus posterior inserts on the membrana thyroideus.

Direction of change. Since in the majority of ranids and other anurans, the most anterior slip of the M. petrohyoideus posterior inserts on the thyrohyal, this condition is considered primitive (criterion 1, p. 8). Shift of the insertion of the most anterior slip of the M. petrohyoideus posterior from the thyrohyal to the membrana thyroideus is regarded as derived. Therefore the direction of change is from state 0 to state 1.

8. M. PETROHYOIDEUS

This muscle consists of two portions: the M. petrohyoideus anterior (PA) and the M. petrohyoideus posterior (PP). The former originates on the otic region of the skull and inserts on the lateral edge of the hyoid plate, whereas the latter may consist of two or three slips that originate from the crista parotica and usually insert on the thyrohyal.

Four states of the M. petrohyoideus are recognized:

State 0. The M. petrohyoideus anterior is separate from the M. petrohyoideus posterior; the latter consists of three equal-sized slips.

State 1. As in state 0, except that the two posterior slips of the M. petrohyoideus posterior overlap.

State 2. The M. petrohyoideus anterior is separated from the M. petrohyoideus posterior. The latter consists of two distinct slips, the anterior slip being 1 to 1.5 times the width of the posterior one (fig. 14). (The width was measured at their insertions.)

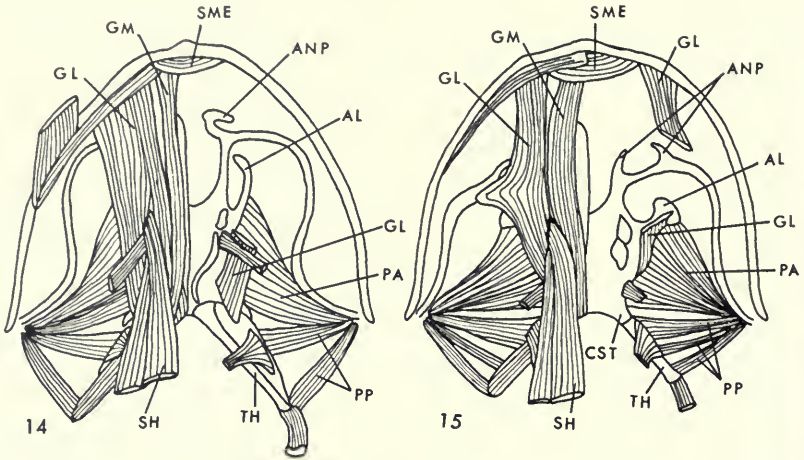

FIGS. 14, 15. Ventral aspect of the hyoid musculature of: 14. *Philautus woodi* Stejneger (FMNH 50689). 15. *Kassina senegalensis* (Duméril & Bibron), (FMNH 81578). AL, Alary process; ANP, Anterior process; CST, Cartilaginous stalk of the thyrohyal; GL, Musculus geniohyoideus lateralis; GM, Musculus geniohyoideus medialis; PA, Musculus petrohyoideus anterior; PP, Musculus petrohyoideus posterior; SH, Musculus sternohyoideus; SME, Musculus submentalis; TH, Thyrohyal.

State 3. As in state 2 except that the anterior slip of the M. petrohyoideus posterior is two or three times the width of the posterior one.

Direction of change. Since state 0 is widely distributed in the ranids examined and also in other frogs (Trewavas, 1933), it is regarded here as primitive (criterion 1, p. 8). Apparently the presence of two M. petrohyoideus posterior slips is the derived condition (states 2 and 3), state 1 being intermediate between the primitive (state 0), on the one hand, and states 2 and 3, on the other (criterion b, p. 9). Since our present data do not show whether the two posterior or the two anterior slips of the M. petrohyoideus posterior fused, or whether one of them was lost, states 2 and 3 are regarded as derived from state 1.

The direction of change is as follows:

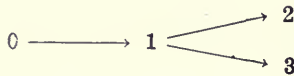

9. M. GENIOHYOIDEUS

Trewavas' (1933) terminology of the M. geniohyoideus is adopted here.

Usually the *M. geniohyoideus lateralis* (GL) divides into two slips posteriorly; the external slip runs lateral to the *M. sternohyoideus* (SH) and usually inserts on the posterior lateral process (PLP), whereas the internal slip runs medial to the *M. sternohyoideus* and inserts on the posterior portion of the hyoid plate, sometimes extending down on the thyrohyal. The *M. geniohyoideus medialis* (GM), which lies ventral to the internal slip of the *M. geniohyoideus lateralis*, inserts partially on the posterior part of the hyoid plate adjacent to the internal slip of the *M. geniohyoideus lateralis* and partially on the medial edge of the thyrohyal. The origins of both the medialis and the lateralis are on the anterior part of the lower jaw.

Based on various conditions of the *M. geniohyoideus lateralis*, five states are recognized:

State 0. The *M. geniohyoideus lateralis* straddles the *M. sternohyoideus* and is separated from the *M. geniohyoideus medialis*. The external slip of the *M. geniohyoideus lateralis* inserts on the posterior lateral process.

State 1. As in state 0 except that the external slip of the *M. geniohyoideus lateralis* inserts on the membrana thyroidea (fig. 14).

State 2. The *M. geniohyoideus lateralis* and medialis are fused; the external slip of the *M. geniohyoideus lateralis* inserts on the posterior lateral process.

State 3. The internal slip of the *M. geniohyoideus lateralis* is absent; the *M. geniohyoideus lateralis* is separated from the medialis. The *M. geniohyoideus lateralis* inserts on the posterior rim of the alary process; anteriorly, some fibers insert on the hyalia on the base of the anterior horn (fig. 15).

State 4. The internal slip of the *M. geniohyoideus lateralis* is absent; the external slip however inserts on the proximal portion of the thyrohyal.

State 5. The *M. geniohyoideus medialis* and lateralis are separated; the latter straddles the *M. sternohyoideus*, whereas the external slip of the *M. geniohyoideus lateralis* inserts on the thyrohyal.

Direction of change. State 0 is widely distributed in the ranids examined as well as in other frogs (Trewavas, 1933) and is regarded as primitive (criterion 1, p. 8). Therefore the presence of both the internal and external slips of the *M. geniohyoideus lateralis*, the insertion of the external slip of the *M. geniohyoideus* on the posterior lateral process, the absence of an additional slip of the *M. geniohyoideus lateralis* inserting on the hyale, and the separated *M. genio-*

hyoideus medialis from the lateralis are regarded as primitive conditions.

Apparently states 1, 5, and 4 belong in one lineage, in which the insertion of the external slip of the *M. geniohyoideus* shifted from the primitive site, on the posterior lateral process (state 0), to the membrana thyroideus (state 1, fig. 14) and finally to the proximal portion of the thyrohyal (state 5). State 4, which lost the internal slip of the *M. geniohyoideus* lateralis, is probably derived from state 5 (criterion a, p. 9).

State 2 is probably derived directly from state 0, which represents the shortest evolutionary route (criterion b, p. 9). Although the absence of the internal slip of the *M. geniohyoideus* lateralis in state 3 is similar to that in state 4, state 3 is probably not derived from state 4; if one assumes state 3 is derived from state 4 the shift of insertion of the *M. geniohyoideus* lateralis calls for a drastic change in insertion from the thyrohyal to the posterior rim of the alary process. Such a shift is unlikely because an unnecessary evolutionary step is required. Therefore state 3 is regarded as derived directly from state 0 (criterion b, p. 9).

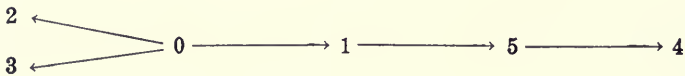

10. THYROHYAL (TH)

The thyrohyal consists of a slender bony shaft, which is slightly dilated caudally and ends in a short cartilaginous epiphysis. In some groups the bony thyrohyal abuts on a cartilaginous stalk (CST) that extends caudally from the hyoid plate (figs. 16, 18).

Three states are recognized:

State 0. The bony thyrohyal abuts on the postero-medial side of the hyoid plate. Usually both ends of this bony shaft are slightly dilated, and the free end has a short cartilaginous epiphysis. The space between the proximal ends of the thyrohyals is narrow and is more or less equal to the width of the proximal end of the thyrohyal (figs. 15, 17).

State 1. The bony thyrohyal abuts on a cartilaginous stalk; neither end of the bony shaft is dilated. The distance between the proximal ends of the bony thyrohyal is larger than the width of that end (figs. 16, 18).

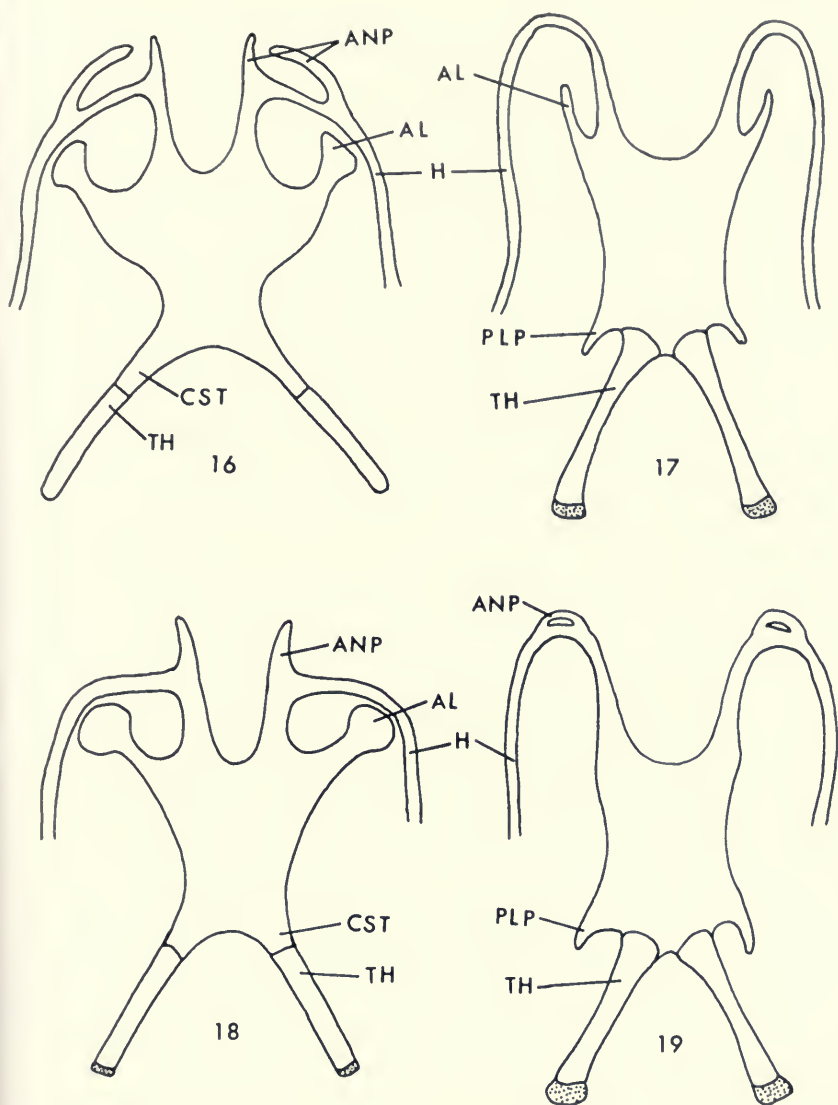

FIGS. 16-19. Ventral aspect of the hyoid skeleton of: 16. *Heterizalus madagascariensis* (Duméril & Bibron), (After Trewavas, 1933); 17. *Polypedates leucomystax* (Boes), (MZB 374); 18. *Leptopelis bocagei* (Günther), (FMNH 80892); 19. *Chirizalus doriae* Boulenger (FMNH 173982). AL, Alary process; ANP, Anterior horn; CST, Cartilaginous stalk of thyrohyal; H, Hyalia; PLP, Posterior lateral process; TH, Thyrohyal.

State 2. As in state 1, except the bony thyrohyal abuts directly on the postero-medial rim of the hyoid plate, and the cartilaginous stalk of the thyrohyal is absent.

Direction of change. Because state 0 is widely distributed in the ranids examined and also occurs in many other frogs (Trewavas, 1933), it is regarded as primitive (criterion 1, p. 8). States 1 and 2 are restricted to the hyperoliids and apparently they are derived from state 0. State 2 is regarded as intermediate between state 0 and state 1, since this pattern represents the shortest evolutionary route (criterion b, p. 9). It is obscure what functional significance, if any, the cartilaginous stalk of the thyrohyal has. Since this structure is found in almost all hyperoliids, apparently it has evolved only once in this group.

The direction of change is as follows:



11. PRESENCE OR ABSENCE OF THE ALARY PROCESS

The alary process (AL) lies on the antero-lateral side of the hyoid plate (figs. 16-18). This structure is treated as two separate characters based on presence or absence and, in the following section, on its shape.

Based on the presence or absence of the alary process, two states are recognizable:

State 0. The alary process is present (figs. 16-18).

State 1. The alary process is absent (fig. 19).

Direction of change. Since the presence of the alary process is widely distributed in the ranids examined and other frogs (Trewavas, 1933), this state is regarded as primitive (criterion 1, p. 8); therefore its absence is derived in Old World treefrogs. Because the absence of the alary process is known in some species in other families (Trewavas, 1933), apparently its loss has occurred many times.

The direction of change is from state 0 to state 1.

12. SHAPE OF THE ALARY PROCESS (AL).

If the alary process was absent (Char. 11-1), this state was coded here with a "nine" in the IBM card.

At present four states are recognized:

State 0. The alary process is dilated distally and the length of the stalk is less than the width of the distal dilation.

State 1. The alary process is club-shaped (fig. 18).

State 2. The alary process is blade-shaped without or with slight dilation at the distal end (fig. 17).

State 3. The base of the alary process is extremely broad, two or three times the width of the distal dilation. The shape of the distal dilation varies (fig. 16).

Direction of change. Since state 0 is widely distributed in the ranids examined and in other frogs (Trewavas, 1933), it is regarded as primitive (criterion 1, p. 8). Apparently two lineages are involved here, one in the direction of reduction of the alary process (states 1 and 2) and the other toward enlargement of its base (state 3). The club-shaped alary process (state 2) is probably intermediate between state 0 and state 2. State 3 was derived directly from state 0. This reasoning represents the shortest evolutionary routes (criterion b, p. 9).

The direction of change can be visualized as follows:



13. PRESENCE OR ABSENCE OF THE ANTERIOR HORN (ANP)

The anterior horn of the hyoid, like the alary process, is treated as two characters based on presence or absence and, in the following section, on its shape.

Two states are recognized:

State 0. Anterior horn present (figs. 16, 18, 19).

State 1. Anterior horn absent (fig. 17).

Direction of change. Since in the majority of ranids examined and in other frogs (Trewavas, 1933), the anterior horn is present, state 0 is regarded as primitive (criterion 1, p. 8). Absence of the anterior horn is the derived state. Since the anterior horn is also absent in some species of other families, apparently its loss has occurred many times in frogs.

The direction of change is from state 0 to state 1.

14. FORM OF THE ANTERIOR HORN

If the anterior horn was absent (Char. 13-1), it was coded with a "nine" on the IBM card. If present, three states are recognized.

State 0. The anterior horn consists of a complete arch along the anterior portion of the hyalia (fig. 19).

State 1. The anterior horn consists of two processes: a median and a lateral branch (fig. 16).

State 2. Only the median branch of the anterior horn is present (fig. 18).

Direction of change. State 0 is found in some species of ranids examined and in other frogs (Trewavas, 1933), including some of the presumed ancestors of the ranids; it seems that this state may have been retained in some ranids and thus represents the primitive condition (criterion 3, p. 9). The direction of change is assumed to be toward the loss of various parts of the anterior horn. The first step was probably the interruption of the complete arch of state 0 and subsequently loss of part, and eventually all, of the anterior horn (criterion b, p. 9).

The direction of change is as follows:



15. POSTERIOR LATERAL PROCESS (PLP)

The posterior lateral process is a cartilaginous process on the proximo-lateral corner of the hyoid plate; usually it is parallel to the thyrohyal. A tendinous sheet which stretches between these processes is called the Membrana thyroideus.

Three states are recognizable:

State 0. The posterior lateral process is long, at least one-third the length of the thyrohyal (figs. 17, 19).

State 1. The posterior lateral process is very short, a mere stump on the postero-lateral corner of the hyoid plate.

State 2. The posterior lateral process is completely absent (figs. 16, 18).

Direction of change. Since all ranids examined and most other frogs (Trewavas, 1933) have the long posterior lateral process, state 0 is regarded as primitive (criterion 1, p. 8), and states 1 and 2 are derived. The direction of change is probably toward the loss of this structure; therefore state 1 is regarded as intermediate between state 0 and state 2 (criterion b, p. 9).

The direction of change is as follows:

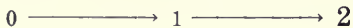

16. VERTEBRAL COLUMN

Although the nature of the vertebral centra, i.e., procoelous or opisthocoelous, is of questionable value for some categories (Gadow, 1901; Mahendra, 1936, 1937; Griffith, 1963), I have utilized it because of the surprisingly high percentage of procoelous vertebral col-

umns in rhacophorids. Nicholls (1916) reported procoelous vertebral columns in four species of rhacophorids (*Rhacophorus maximus*, *R. schlegelii*, *R. reinwardti*, and *Boophis madagascariensis*), a group referred to as the Diplasiocoela. Laurent (1940b, 1941a) reported procoelous vertebrae in the ranids, *Arthroleptis* and *Schoutedenella*. Procoelous vertebral columns in rhacophorids were also reported in *Mantidactylus cowani*, *Buergeria buergeri*, *Philautus variabilis*, *P. glandulosus*, *Boophis gaudoti*, and in *B. rhodoscelis* by Laurent (1943a, b).

Hitherto the rhacophorids have been considered to be diplasiocoelous, but, surprisingly, our sample shows that 37 of the 54 species examined were procoelous (state 40, in *Appendix 3*). It then becomes necessary to reassess the significance of the vertebral centra; furthermore, procoelous or diplasiocoelous vertebrae, in general, are constant within groupings based on other structural characters and on geographical grounds. Consequently, this character appears to be quite useful. Procoelous vertebrae appear to be constant at the generic level in the Microhylidae (Parker, 1934).

Two states are recognized:

State 0. The vertebrae are diplasiocoelous.

State 1. The vertebrae are procoelous.

Direction of change. Since the diplasiocoelous vertebrae are widely distributed in ranids, this condition is considered primitive (criterion 1, p. 8). Procoelous vertebrae are found only in the following genera, *Arthroleptis*, *Schoutedenella*, and *Trichobatrachus* (Laurent, 1940b, 1942a). Since the procoelous condition occurs in unrelated diplasiocoelous frogs, apparently it has evolved several times in the anurans. The direction of change is from state 0 to state 1.

17. SHAPE OF THE EIGHTH VERTEBRA

Based on the shape of the neuropophysis (NP) and its relationships to the centrum, three states of the eighth vertebra are recognizable:

State 0. The segment of the neuropophysis connecting the centrum and the transverse process attaches on the dorsolateral portion of the centrum. The contour of the centrum viewed ventrally is distinctly cylindrical (figs. 20, 24).

State 1. The segment of the neuropophysis connecting the centrum and the transverse process attaches on the lateral portion of the centrum; the neuropophysis is moderately broad and usually it is

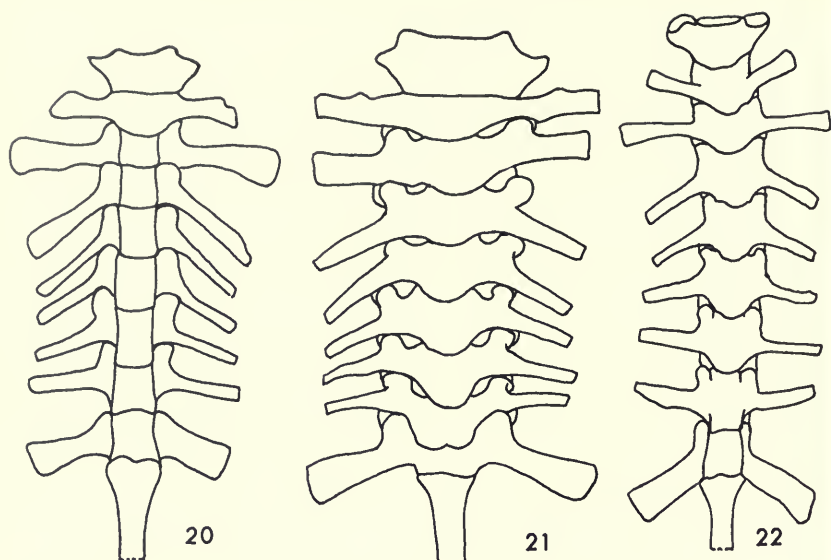

FIGS. 20, 22. Ventral aspect of the vertebral column of: 20. *Philautus hosei* (Boulenger), (FMNH 145595); 21. *P. acutirostris* (Peters), (FMNH 96061); 22. *Hyperolius sansibaricus* (Pfeffer), (FMNH 119456).

slightly convex. The contour of the centrum viewed ventrally is only slightly cylindrical (fig. 22).

State 2. The segment of the neuropophysis connecting the centrum and the transverse process attaches on the ventro-lateral portion of the centrum. As a result, the contour of the centrum is not cylindrical when viewed from the ventral side (figs. 21, 23).

Direction of change. Since state 0 is widely distributed in the ranids it is considered primitive (criterion 1, p. 8). Apparently, state 2 is a paedomorphic condition as it is found in some juvenile specimens of species in which the adult's eighth vertebra is identical to state 0. It appears that state 1 is intermediate between state 0 and state 2, inasmuch as this pattern is the shortest evolutionary route (criterion b, p. 9).

The direction of change is probably as follows:

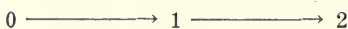

18. DIMENSIONS OF THE VERTEBRAL COLUMN

The relative length of the vertebral column was expressed as the ratio of vertebral column length / greatest width of transverse proc-

ess of the eighth vertebra. These values gave an indication of the relative length of the vertebral column. These values were plotted in a frequency table and each cluster was defined as one state. The three states recognizable are:

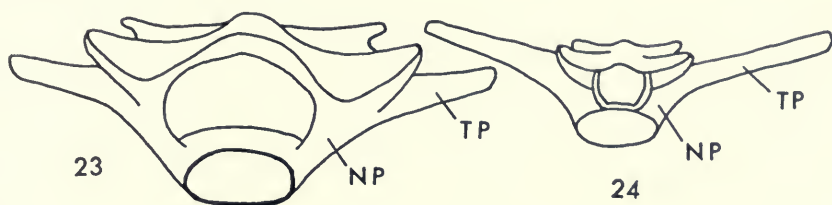

FIGS. 23, 24. Frontal aspect of the eighth vertebra of: 23. *Philautus acuti-rostris* (Peters), (FMNH 96061); 24. *Polypedates leucomystax* (Boie), (MZB 374). NP, Neuropophysis; TP, Transverse process.

State 0. Relative length of the vertebral column was from 1.6 to 2.4 (fig. 20).

State 1. Relative length of the vertebral column was from 1.0 to 1.5 (fig. 21).

State 2. Relative length of the vertebral column was more than 2.8 (fig. 22).

Direction of change. Since state 0 is widely distributed in ranids, it is regarded primitive, so far as Old World treefrogs are concerned (criterion 1, p. 8). Apparently, both states 1 and 2 are derived from state 0 (criterion b, p. 9).

The direction of change is as follows:

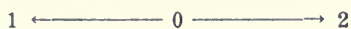

19. FRONTOPARIETAL (FP)

Six states are based on the shape of the frontoparietal and the presence or absence of bony processes. The bony arch which extends posteriorly from the postero-lateral corner of the frontoparietal is called the parieto-squamosal arch (PSA); the parieto-squamosal plate (PSP) is the bony plate which covers the posterior portion of the fronto-parietal and extends over the exoccipital, prootic, and the squamosal (fig. 32).

State 0. The frontoparietal is rectangular; the parieto-squamosal arch is absent (fig. 29).

State 1. The anterior portion of the fronto-parietal is wider than the posterior portion; the parieto-squamosal arch is absent (fig. 25).

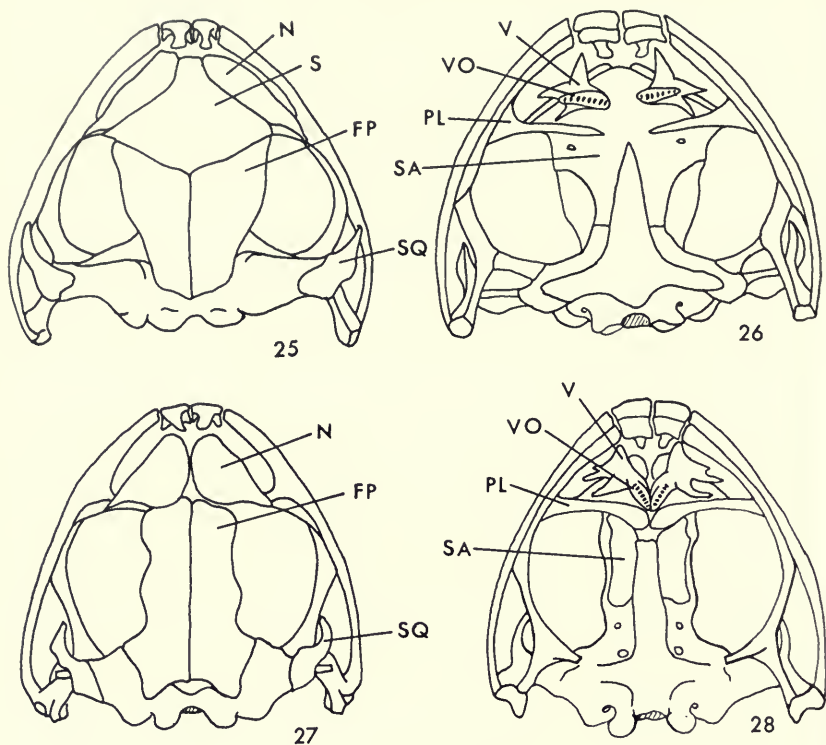

FIGS. 25-28. 25. Dorsal aspect of the skull of *Polypedates dennysi* (Blanford), (FMNH 24691); 26. Ventral aspect of the skull of *P. dennysi* (Blanford), (FMNH 24691); 27. Dorsal aspect of the skull of *Cryptothylax gresshoffi* (Schilthuis), (FMNH 120147); 28. Ventral aspect of the skull of *C. gresshoffi* (Schilthuis), (FMNH 120147). FP, Frontoparietal; N, Nasal bone; PL, Palatine bone; S, Sphenethmoid; SA, Ventro-posterior portion of the sphenethmoid; SQ, Squamosal bone; V, Vomerine bone; VO, Vomerine odontophore.

State 2. The anterior end of the fronto-parietal is wider than the posterior one. The parieto-squamosal arch is short, reaching only to the occipito-prootic ridge (fig. 30).

State 3. As in state 2 except that the parieto-squamosal arch is long, behind the skull, almost reaching to the dorsal prootic plate of the squamosal (fig. 31).

State 4. The entire fronto-parietal bone is covered by a bony plate; it continues posteriorly by forming a wide parieto-squamosal plate reaching to the outermost edge of the squamosal (fig. 32).

State 5. The frontoparietal is trapezoidal; the parieto-squamosal arch and plate are absent.

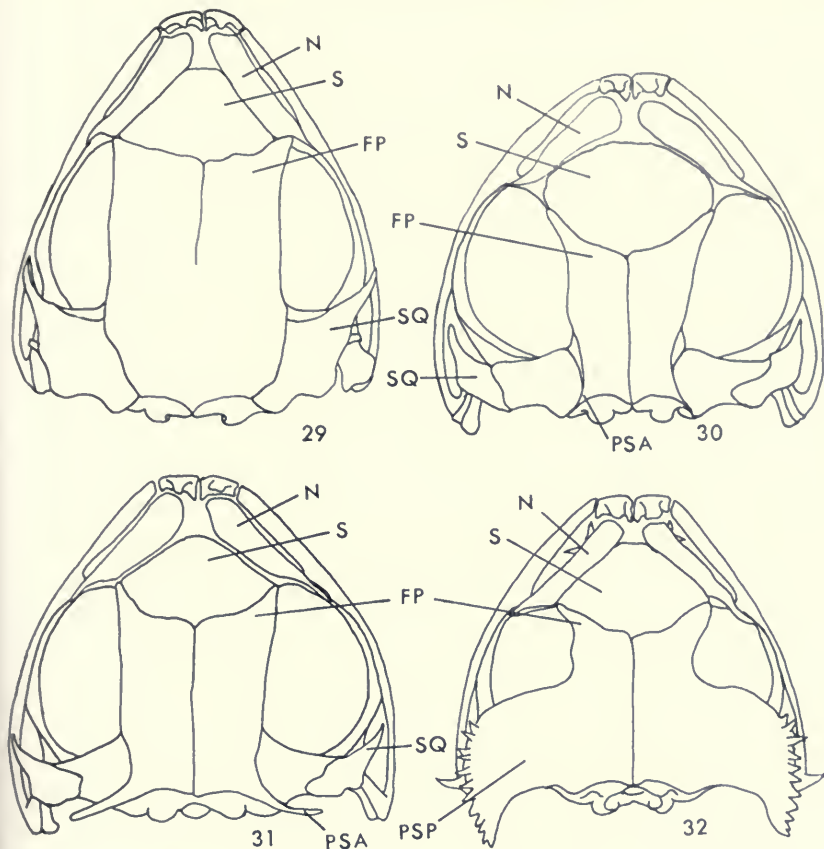

FIGS. 29-32. Dorsal aspect of the skull of: 29. *Hazelia picta* (Peters), (FMNH 157297); 30. *Polypedates macrotis* (Boulenger), (FMNH 14282); 31. *P. otilophus* (Boulenger), (FMNH 63746); 32. *P. cruciger* (Blyth), (FMNH 37657). PSA, Parieto-squamosal arch; PSP, Parieto-squamosal plate. All other abbreviations as in Figs. 25-28 (p. 34).

Direction of change. In the majority of the ranids, the frontoparietal is rectangular but somewhat narrower than in state 0 and the parieto-squamosal arch is absent. This condition is regarded as primitive (criterion 1, p. 8) and all others derived. Apparently, two lineages are involved: first, enlargement of the anterior portion of the fronto-parietal and development of the parieto-squamosal arch and plate; second, narrowing of the anterior portion of the fronto-parietal.

The direction of change can be visualized as follows:

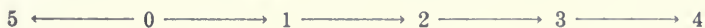

20. SHAPE OF THE NASAL AND EXPOSURE OF THE SPHENETHMOID

Because the nasal (N) and sphenethmoid bones (S) are close together and may act as one functional unit to reinforce the snout, they are treated here as one character. Based on the shape and the position of the nasal, and the extent of the exposure of the sphenethmoid, five states are recognizable:

State 0. The nasals are spindle-shaped and are not in contact with each other or the sphenethmoid. The sphenethmoid is barely visible from the dorsal view.

State 1. The nasals are triangular, touching along their medial edge and are in contact with the sphenethmoid. The latter is barely visible in dorsal view, and its exposure is 0.1 to 0.2 of the length of the fronto-parietal (fig. 27).

State 2. Nasals triangular, touching each other along the medial edge. Usually, they barely touch the sphenethmoid. The sphenethmoid is moderately large and its exposure is 0.3 to 0.5 the length of the fronto-parietal.

State 3. Nasals squash-shaped and not in contact with each other, but usually they are in contact with the sphenethmoid. The latter is large, and its exposure is 0.6 to 1.0 of the length of the fronto-parietal (figs. 25, 29-32).

State 4. As in state 3, except that the nasals are club-shaped.

Direction of change. Since state 1 is widely distributed in the ranids, it is regarded primitive (criterion 1, p. 8). Apparently, two lineages are involved, one with reduction in size of the nasals (state 0), and the other with an increase in exposure of the sphenethmoid bone as well as a reduction in size of the nasal bones (states 2, 3, and 4).

The direction of change can therefore be visualized as follows:



21. VENTRO-POSTERIOR PORTION OF THE SPHENETHMOID (SA)

The ventro-posterior portion of the sphenethmoid bone may consist of two separate bones or only one. Two states are recognized:

State 0. The ventro-posterior portion of the sphenethmoid forms a fused bony plate in the region of the palatine bone (fig. 26).

State 1. The ventro-posterior portion of the sphenethmoid consists of two separate bones and usually does not extend anteriorly beyond the palatine bone (fig. 28).

Direction of change. Since state 0 is found in all ranids examined, it is regarded primitive (criterion 1, p. 8); consequently state 1 is

the derived condition. The direction of change is from state 0 to state 1.

22. PRESENCE OR ABSENCE OF VOMERINE TEETH (VT)

Three states are recognized:

State 0. Vomerine teeth are always present.

State 1. Vomerine teeth are always absent.

State 2. In at least 25 per cent of the sample examined, vomerine teeth are either present or absent.

Direction of change. Since state 0 is widely distributed in the ranids, it is considered primitive (criterion 1, p. 8). Apparently, state 1 is the most specialized condition and state 2, intermediate. Evidently the loss of vomerine teeth has occurred several times in many groups of anurans (Parker, 1932).

The direction of change is as follows:



23. VOMERINE ODONTOPHORE (VO)

This structure is part of the vomerine bone which bears the vomerine teeth; two states are recognized:

State 0. Vomerine odontophore is present (figs. 26, 28).

State 1. Vomerine odontophore is absent.

Direction of change. If present, the vomerine odontophore may or may not have vomerine teeth; in *Philautus*, for example, the odontophore is present but vomerine teeth are absent. Since the presence of the vomerine odontophore is widely distributed in the ranids, it is regarded primitive (criterion 1, p. 8) and its absence derived.

The direction of change is from state 0 to state 1.

24. OMOSTERNUM (O)

The omosternum of all species examined was bony and four states were recognized based on the extent of forking:

State 0. The base of the omosternum is not forked.

State 1. The base of the omosternum is slightly forked. The greatest space between the arms is less than half the width of one arm.

State 2. The base of the omosternum is moderately forked. The greatest space between the arms is once to twice the width of one arm (fig. 33).

State 3. The base of the omosternum is broadly forked. The greatest space between the arms is two to four times the width of one arm (fig. 34).

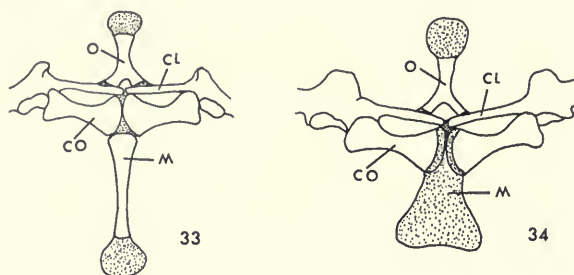

FIGS. 33, 34. Ventral aspect of the pectoral girdle of: **33.** *Chiromantis xerampelina* Peters (FMNH 58246); **34.** *Cryptothylax gresshoffs* (Schilthuis), (FMNH 120147). CL, Clavicle; CO, coracoid; M, Metasternum; O, Omosternum.

Direction of change. States 0, 1, and 2 are almost equally distributed in ranids, i.e., in nine, ten, and seven genera, respectively (Deckert, 1938), whereas state 3 occurs in the Astylosterninae and the Arthroleptinae (Noble, 1924; Laurent, 1941a). Deckert (1938) believed that the unforked gave rise to the forked omosternum. Since state 0 is found in the majority of *Rana* (Boulenger, 1920; Deckert, 1938), it is regarded primitive (criterion 2, p. 9). In frogs it appears that state 3 is the specialized, and probably the direction of change is toward the broadly forked condition.

The direction of change can therefore be visualized as follows:

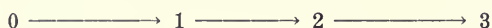

25. METASTERNUM (M)

The metasternum is either a narrow bony stylus or forms a flattened, broad cartilaginous plate. Laurent (1941b, 1944) and Hoffman (1932, 1942) have shown that in some *Hyperolius* the cartilaginous metasternum may be partially ossified. It is assigned here to state 1 because of its great over-all similarity to the typical cartilaginous metasternum.

Two states were recognizable:

State 0. Metasternum is a narrow bony stylus (fig. 33).

State 1. Metasternum is broad and cartilaginous, sometimes partially ossified (fig. 34).

Direction of change. Although the cartilaginous metasternum is found in relatively few ranids, *Scotobleps*, *Astylosternus*, *Gampsosteo-*

nyx, *Arthroleptis*, *Cardioglossa*, *Schoutedenella*, *Leptodactylodon*, and *Phrynopsis* (Noble, 1931; Deckert, 1938; and Laurent, 1941a), it appears to be primitive (criterion 3, p. 9). Apparently, the cartilaginous condition was retained from the presumed ancestral stock, because cartilaginous metasterna are found in "primitive" frogs, e.g., Pipidae, Discoglossidae, Microhylidae, Pelobatidae, and *Soo-glossus* (Parker, 1934; Griffith, 1960, 1963). Therefore, if one assumes the bony metasternum (state 1) in ranids is primitive, the cartilaginous condition in the hyperoliids and in some ranids would require assuming a sequence of cartilaginous to bony to cartilaginous, a more complex evolutionary step than assuming the cartilaginous condition is primitive (criterion 2, p. 9).

The direction of change is from state 1 to state 0.

26. METACARPAL OF THE THIRD FINGER

Two states of the third metacarpal bone are recognizable:

State 0. The distal end of the third metacarpal is not or only slightly dilated distally and no bony knob is present (figs. 36, 38).

State 1. The distal end of the third metacarpal is distinctly dilated distally and a prominent disto-medial bony knob is present. This bony knob is the insertion of the third metacarpal slip of the *M. humerodorsalis* (figs. 35, 37).

Direction of change. State 0 is found in all ranids and in other anurans and it is considered primitive (criterion 1, p. 8). The direction of change is from state 0 to state 1.

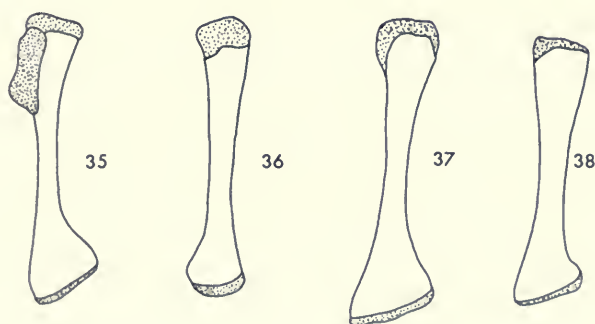

FIGS. 35-38. Dorsal aspect of the metacarpal of the third finger of: 35. *Polypedates macrotis* (Boulenger), (FMNH 14282); 36. *Mantidactylus albofrenatus* (Fr. Müller), (UMMZ 86040); 37. *Buergeria robustus* (Boulenger), (FMNH 96729); 38. *Boophis tephraeomystax* (A. Duméril), (FMNH 50377).

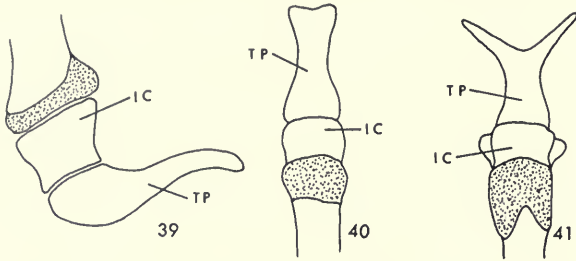

FIGS. 39-41. 39. Lateral aspect of the distal phalanges of the third finger of *Hyperolius sansibaricus* (Pfeffer), (FMNH 119456); 40. Dorsal aspect of the distal phalanges of the third finger of *Philautus acutirostris* (Peters), (FMNH 96061); 41. Dorsal aspect of the distal phalanges of the third finger of *Polypedates colletti* (Boulenger), (FMNH 147716). IC, Intercalary cartilage; TP, Terminal phalanx.

27. TERMINAL PHALANX (TP)

Four states of the terminal phalanx are recognizable:

State 0. Obtuse terminal phalanx; the distal end is simple or a rounded knob.

State 1. Claw-shaped terminal phalanx; it is pointed and curved downward (fig. 39).

State 2. Bifurcate terminal phalanx; the distal end is slightly bifurcate but not pointed, and the length of each branch is less than the width of the phalanx (fig. 40).

State 3. Y-shaped terminal phalanx; the distal ends are pointed and the length of each branch is longer than the width of the phalanx (fig. 41).

Direction of change. Some authors do not distinguish T-shaped, Y-shaped, or bifurcate terminal phalanges. The Y-shaped terminal phalanx, as defined here, requires that the free branches form an angle of about 120° or less (see fig. 41), whereas in the T-shaped terminal phalanx, the free branches form almost a straight line and are at right angles with the main shaft of the phalanx.

Although states 0, 1, and 2 are found in the ranids, it appears that state 0 is primitive because it is found in the majority of the generalized ranids, such as *Rana* (criterion 2, p. 9). Because modifications of the terminal phalanx, states 2 and 3, appear to be found in most frogs adapted for arboreal life, they are probably derived conditions. Therefore, if one follows the degree of specialization (criterion a, p. 9) state 0 gave rise to state 2 and it, in turn, gave rise to state 3.

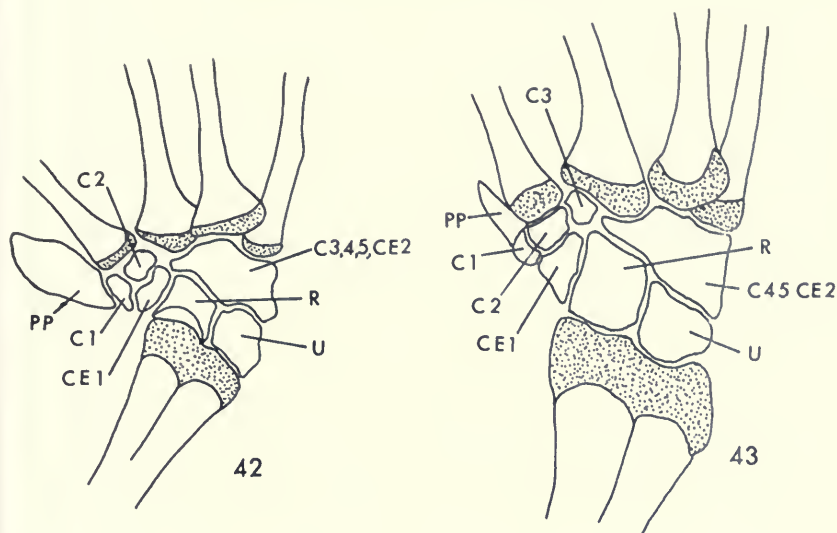

FIGS. 42, 43. Dorsal aspect of the right carpals of: **42.** *Rhacophorus harrissoni* Inger & Haile (FMNH 137945); **43.** *Cryptothylax gresshoffi* (Schilthuis), (FMNH 120147). C1, 1st carpale; C2, 2nd carpale; C3, 3rd carpale; C4, 4th carpale; C5, 5th carpale; CE1, 1st centrale; CE2, 2nd centrale; PP, Prepollex; R, Radiale; U, Ulnare.

In addition to the hyperoliids, the claw-shaped terminal phalanges are found in some ranids, e.g., *Ptychadena*, *Astylosternus*, *Schoutedenella*, and *Arthroleptis* (Laurent, 1940b; Perret, 1966), and also in the Hylidae. This structure appears to be specialized and is derived from state 0.

The direction of change can be visualized as follows:



28. CARPAL BONES (C)

I follow Laurent's (1940b, 1941a,b, 1943a, 1944) terminology for the carpal bones. He considered the carpal bone at the base of the prepollex as the first carpale. Since the ulnare (U) and the radiale (R) are present in all anurans, they will not be discussed further. Only the carpale (C) and centrale (CE) are utilized in recognizing states.

State 0. The first, second, and third carpals and the first centrale are free; the fourth and fifth carpals, and the second centrale are fused (fig. 43).

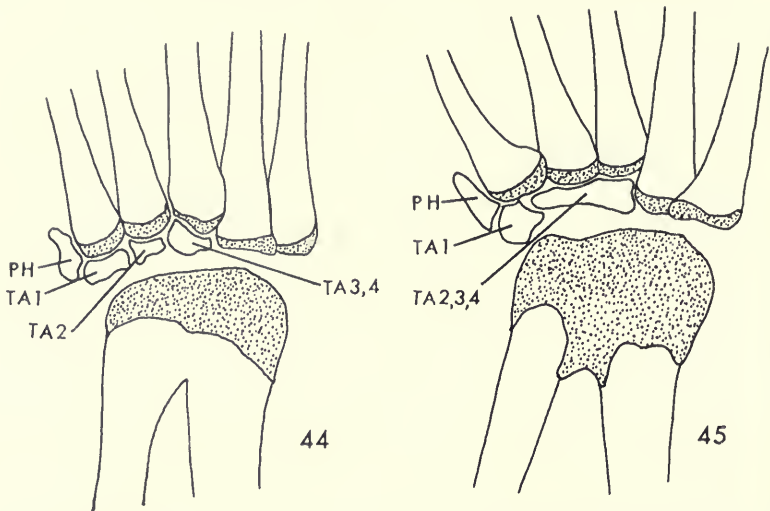

FIGS. 44, 45. Dorsal aspect of the right tarsals of: 44. *Cryptothylax gresshoffi* (Schilthuis), (FMNH 120147); 45. *Polypedates dennysi* (Blanford), (FMNH 24691). PH, Prehallux; TA1, 1st tarsale; TA2, 2nd tarsale; TA3, 3rd tarsale; TA4, 4th tarsale.

State 1. The first and second carpals and the first centrale are free; the third, fourth, and fifth carpals, and the second centrale are fused (fig. 42).

Direction of change. State 0 is regarded as the primitive and state 1 as the derived state (criterion 3, p. 9).

The direction of change is from state 0 to state 1.

29. TARSAL BONES (T)

Laurent's (1940b, 1941a,b, 1943a, 1944) terminology is adopted here. In the group studied only two states are recognized.

State 0. The first and second tarsal bones are free; the third and fourth are fused (fig. 44).

State 1. Only the first tarsal is free; the second, third, and fourth tarsals are fused (fig. 45).

Direction of change. Because state 0 is widely distributed in the ranids examined and reported in other groups by several authors (Howes and Ridewood, 1888; Laurent, 1940b, 1941a, 1942a, 1943a), it is regarded as primitive (criterion 1, p. 8). In general, free tarsals are found in "primitive" frogs, i.e., Discoglossidae, Ascaphidae, *Pelodytes* (Howe and Ridewood, 1888; Ritland, 1955), and fused tarsals in advanced frogs. Therefore, it appears that the evolution-

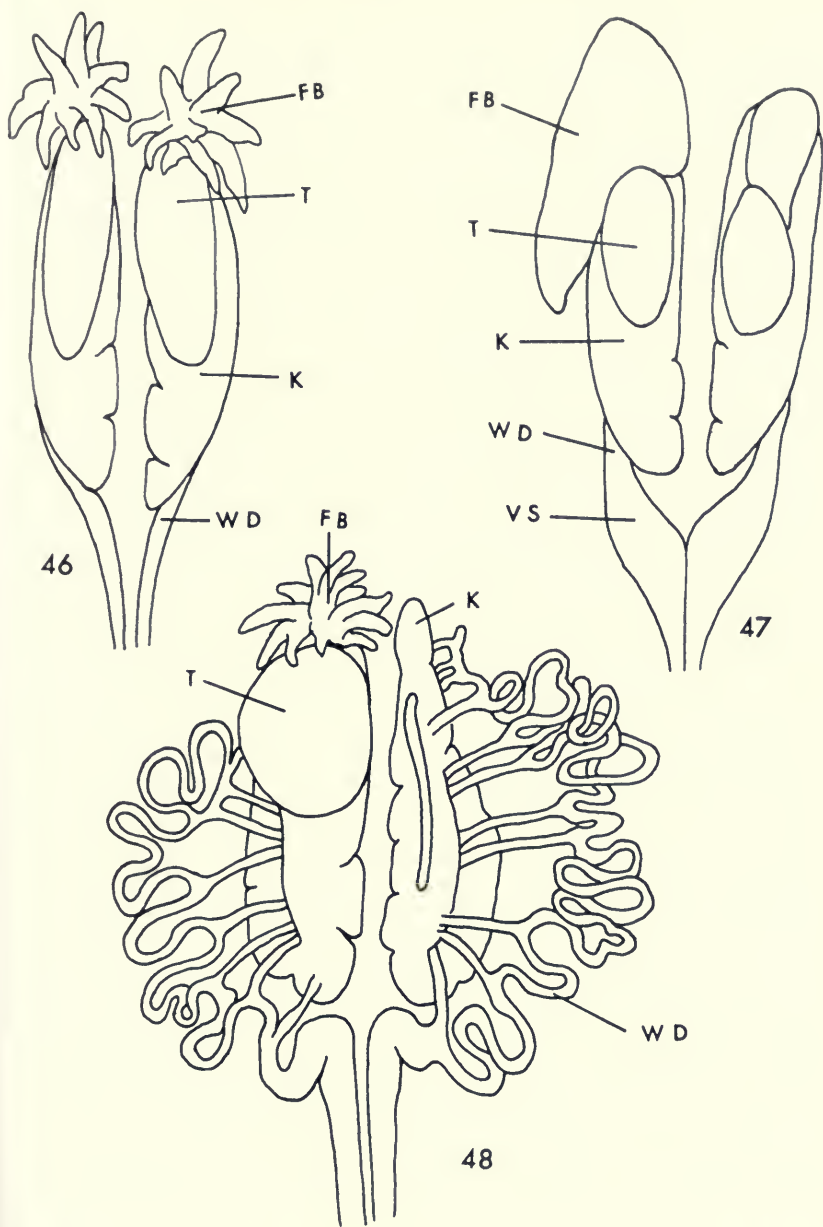

FIGS. 46-48. Ventral aspect of the male reproductive organ of: 46. *Manti-dactylus ulcerosus* (Boettger), (FMNH 8230); 47. *Philautus aurifasciatus* (Schlegel), (FMNH 172440); 48. *Polypedates dugritei* David (FMNH 49513). FB, Fat body; K, Kidney; T, Testis; VS, Vesicula seminalis; WD, Wolffian duct.

ary trend is toward the fusion of tarsals and thus state 1 is derived from state 0.

30. WOLFFIAN DUCT (WD)

Bhaduri (1953), Bhaduri & Basu (1957), Hoffman (1943), and Bhaduri and Mondal (1965) have shown that in some species of rhabdophorids the males have an elaborate, convoluted Wolffian duct; Bhaduri (1932, 1953) and Bhaduri and Mondal (1965) reported that the walls of these convoluted Wolffian ducts have specialized glandular cells. He implied that these elaborate convolutions and the presence of these glandular cells are correlated with the foam-nesting habit, i.e., production of a secretion to form foamy nests for the eggs. The proximal portion of the Wolffian duct of males, which lies along the lateral side of the kidneys, was treated here as one character, and portions posterior to the kidney were treated as another character (Character 31). Based on the gross morphology of the anterior portion of the Wolffian duct, two states are recognized:

State 0. The Wolffian duct along the kidney is a simple tube (figs. 46, 47).

State 1. The Wolffian duct along the lateral side of the kidney is convoluted with short branches extending to the kidney (fig. 48).

Direction of change. It is not known if the Wolffian duct hypertrophies during the breeding season. It is known that the development of nuptial pads is directly controlled by the amount of androgen production in various frogs (Aron, 1926; Cei, 1944; Glass and Rugh, 1944); therefore the presence of nuptial pads is an indicator of the breeding status. In order to avoid the effects of seasonal variation on Wolffian ducts, males with well-developed nuptial pads were dissected. If males lacked nuptial pads then adult males which were collected at the same period and locality along with gravid females were dissected.

Because state 0 is found in almost all ranids examined, it is considered primitive (criterion 1, p. 8). Apparently, the convoluted Wolffian duct is a derived condition.

The direction of change is from state 0 to state 1.

31. VESICULA SEMINALIS (VS)

The vesicula seminalis as defined here is a distinct, bottle-shaped outpouching of the Wolffian duct which lies posterior to the kidney. Two states are recognized in material studied.

State 0. Bottle-shaped vesicula seminalis is absent (figs. 46, 48).

State 1. Bottle-shaped vesicula seminalis is present (fig. 47).

Direction of change. Spengel (1876) reported bottle-shaped vesicula seminalis in *Rana esculenta*, *R. pipiens*, and *Philautus* spp. and noted that the size of this structure decreases during the non-breeding period. The bottle-shaped vesicula seminalis was reported also in the following species: *Ptychadena mascarenensis*, *Phrynobatrachus natalensis*, *P. kinangopensis*, *Stauroides natator*, and *Philautus aurifasciatus* (Bhaduri, 1953; Bhaduri and Basu, 1957; Bhaduri and Mondal 1965). To minimize differences in the vesicula seminalis due to seasons I used the same procedures for selecting males as described in Character 30 (p. 44). In addition to the above species, the bottle-shaped vesicula seminalis was also observed in five species of ranids examined: *Rana latouchi*, *R. sauteri*, *R. longicrus*, *Platymantis corrugatus*, and *P. guentheri*. Apparently, the presence of the bottle-shaped vesicula seminalis is a specialized condition; therefore it is regarded the derived state (criterion 2, p. 9).

The direction of change is from state 0 to state 1.

32. PRESENCE OR ABSENCE OF WEB BETWEEN THE TWO OUTER METATARSALS

Two states are recognizable based on the presence or absence of web between the two outer metatarsals.

State 0. The two outer metatarsals are distinctly separated with webbing in between.

State 1. The two outer metatarsals are united or are separated only by a groove.

Direction of change. Extensive webbing of the feet is commonly associated in frogs with aquatic habits, e.g., some *Rana*, *Pseudobufo*, and *Xenopus*, an opinion also held by Noble (1931). Some treefrogs also show the extensive webbing, e.g., *Rhacophorus*; it seems that at least in some treefrogs the extensive webbing of the hands and toes acts as a parachute when the frog soars through the air (Siedlecki, 1908, 1909; Ayyanger, 1915; Inger, 1956; Davis, 1965).

It is not known if there is adaptive significance in the separated, webbed (state 0) or in the united (state 1) conditions of the two outer metatarsals. In the ranids state 0 is found in *Ooeidozyga*, most *Arthroleptis*, and most *Rana*, whereas state 1 occurs in *Platymantis*, *Phrynobatrachus*, *Micrixalus*, and *Astylosternus* (Boulenger, 1882; Ahl, 1931b; Laurent, 1940b, 1941a; Inger, 1954a, 1966). Apparently, state 1 has evolved several times in various genera because of its sporadic appearance.

In the Old World treefrogs probably state 1 is the specialized condition and therefore derived. State 0 appears to be primitive because it is found in the majority of the ranids (criterion 1, p. 8).

The direction of change is from state 0 to state 1.

33. DIGITAL DISC

The digital disc as defined here is the dilated tip of the digit of the finger or toe, whereas the digital pad (DP) is a fleshy pad resembling a cushion on the ventral surface of the digital tip. This pad is usually surrounded by a ventro-marginal groove (VMG). In some cases a transverse groove bounds the proximal portion of the digital pad.

Five states of this character are recognizable:

State 0. Terminal segment of the digit is not dilated; a distinct digital pad is not present and consequently no transverse or ventro-marginal groove is present (fig. 49).

State 1. Terminal segment of the digit is slightly dilated. Digital pad is elongated and is surrounded distally by a horseshoe-shaped ventro-marginal groove; the transverse groove is absent.

State 2. Terminal segment of the digit is extensively dilated. The roundish digital pad is surrounded distally and laterally by a ventro-marginal groove; the transverse groove is absent (fig. 50).

State 3. Terminal segment of the digit is extensively dilated. Digital pad is pear-shaped and is surrounded distally and laterally by a ventro-marginal groove. A distinct transverse groove runs across the proximal portion of the digital pad.

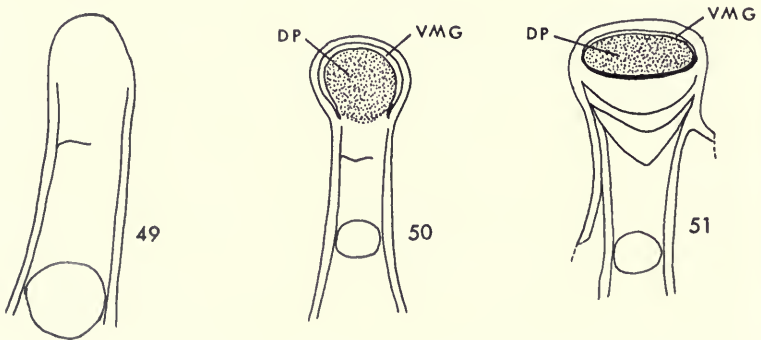

FIGS. 49-51. Ventral aspect of the distal portion of the third finger of: **49.** *Kassina senegalensis* (Duméril & Bibron), (FMNH 81578); **50.** *Hyperolius marmoratus* Rapp (FMNH 119220); **51.** *Rhacophorus reinwardti* Kuhl & van Hasselt (MZB 1691). DP, Digital pad; VMG, Ventro-marginal groove.

State 4. Terminal segment of the digit is extensively dilated. The digital pad is oval and oriented transversely across the digital disc. This digital pad is completely surrounded by a deep groove; apparently the posterior portion is the transverse groove, whereas the remaining portion is the ventro-marginal groove (fig. 51).

Direction of change. The presence of dilated toe tips has been widely accepted as an arboreal adaptation in frogs (Siedlecki, 1910; Noble and Jaeckle, 1928; Noble, 1931). Dilated digital tips of fingers and toes are also found in some ranids, e.g., *Platymantis*, *Staurois*, *Amolops*, and *Hylarana* (Noble, 1931; Inger, 1954a, 1966; Taylor, 1962). Dilation of digital tips probably has evolved several times in several groups of frogs, because a similar condition is found in unrelated frogs, the hylids. So far as the Old World treefrogs are concerned, probably the direction of change parallels the degree of specialization of the digital pads for an arboreal existence. Therefore, the direction of change can be visualized as follows:



34. ORIENTATION OF THE PUPIL

In frogs the shape of the pupil may vary from round, oval, or rhomboid (Ahl, 1931b; Noble, 1931; Laurent, 1940b, 1941a, 1944; Perret, 1966; Schiøtz, 1967). The shape of the pupil in preserved specimens sometimes is not like that in live animals, as demonstrated by Walls (1932) and Kluge (1967) in geckos. Variation in the shape of the pupil occurs in Old World treefrogs. When the shape and orientation of the pupil in a preserved specimen were doubtful, I have relied on the literature to ascertain the form of the pupil.

Two states of the pupil are recognizable:

State 0. Pupil is horizontal and oval-shaped or almost round.

State 1. Pupil is vertical and oval-shaped or rhomboidal.

Direction of change. Because state 0 is widely distributed in the majority of the ranids, it is considered primitive (criterion 1, p. 8). Probably the vertical pupil has evolved several times, because it occurs in various unrelated groups of frogs; for example, it is found in *Scaphiopus*, *Astylosternus*, *Scotobleps*, and *Gamsosteonyx* (Noble, 1931; Deckert, 1938; Laurent, 1941b; Perret, 1966).

The direction of change is probably from state 0 to state 1.

35. NUPTIAL PAD

A nuptial pad is generally present on the dorsal surface of the metacarpals of the first or second and rarely on the third digit. This

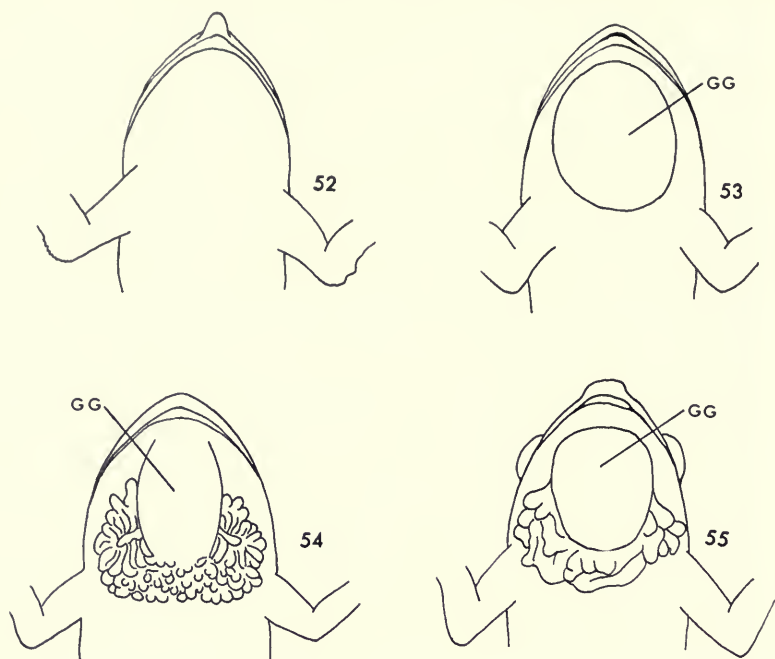

FIGS. 52-55. Ventral aspect of the throat region of: **52.** *Rhacophorus appendiculatus* (Günther), (FMNH 147527); **53.** *Cryptothylax gresshoffi* (Schilthuis), (FMNH 120147); **54.** *Kassina senegalensis* (Duméril & Bibron), (FMNH 81578); **55.** *Hyperolius horstocki* (Schlegel), (FMNH 130956). GG, Gular gland.

nuptial pad usually consists of a spinulated pad on the surface of the skin and the acinous glands underneath it. The nuptial pad is regarded here as absent if the superficial spinules on the skin are not present, as seen under a low-power stereo-microscope; a cluster of subcutaneous acinous glands may or may not be present.

Two states of this character are recognized:

State 0. Nuptial pad is present; the nuptial pad may be only on the dorsal surface of the first digit or it may also be present on the proximal metacarpal of the second digit.

State 1. Nuptial pad is absent. A cluster of subcutaneous glands may or may not be present; if present the glands lie at the disto-medial portion of the forearm.

Direction of change. In order to minimize differences due to season, a procedure for selecting males was similar to that mentioned in character 30 (p. 44) was employed. Since nuptial pads are widely distributed in the ranids, their presence is considered primitive (cri-

terion 1, p. 8). It appears that the absence of nuptial pads is the derived condition, because of its sporadic occurrence in various groups.

Therefore, the direction of change is from state 0 to state 1.

36. VOCAL POUCH

The vocal pouch is defined here as an outpouching of the skin of the throat of the male frog to allow distension when the vocal sac is inflated. The presence or absence of the subcutaneous gular gland is also considered in the states since it is closely associated with the vocal pouch.

Based on the two structures above, five states are recognized:

State 0. The skin of the throat is plain; no vocal pouch is present. The gular gland is absent.

State 1. The vocal pouch is formed by a loose skin of the throat. The gular gland is absent (fig. 52).

State 2. The skin of the throat is plain; an oval subcutaneous gular gland (GG) is present and not bounded by a skin fold (fig. 53).

State 3. An oval gular gland is present, bounded by distinct folds laterally. The skin of the vocal pouch on both sides of and behind the gular gland is wrinkled (fig. 54).

State 4. An oval gular gland is present and bounded posteriorly by a horseshoe-shaped fold, followed by wrinkled skin of the vocal pouch (fig. 55).

Direction of change. In ranids vocal pouches are present in some species in various genera, e.g., *Rana nigromaculata*, *R. areolata*, *Amolops jerboa*, and *Ptychadena* (Liu, 1935; Laurent, 1954; Taylor, 1962; Inger, 1966). It appears that the degree of development of gular pouches is a specialization to increase the distension of the vocal sac and consequently the effectiveness of the mating call; therefore, it is the derived condition, an opinion also held by Liu (1935).

Since in the majority of ranids examined, the vocal pouches and gular glands were absent, state 0 was regarded as primitive (criterion 1, p. 8).

Apparently vocal pouches have evolved several times in various groups of frogs, as has also been suggested by Liu (1935).

Probably two lineages are involved: one the development of vocal pouch when the gular gland is present (states 2, 3, and 4) and the other, the development of the vocal pouch when the gland is absent

(state 1). Probably state 1 has evolved directly from state 0, rather than from states 2, 3, or 4. If one assumes the latter, a considerably more complex evolutionary sequence must be envisioned. The direction of change of the other lineage seems to be toward specialization. Apparently, the gular gland evolved first and was followed by the development of a vocal pouch. The horseshoe-shaped skin fold almost surrounding the gular gland (state 4) probably was derived from the condition of the lateral skin folds of state 3 (criterion a, p. 9).

The direction of change can be visualized as follows:



RESULTS

METHODS OF ANALYZING RELATIONSHIPS

The Combinatorial Method (Sharrock and Felsenstein, 1969; Inger, 1969), one approach in constructing alternative phylogenies, was used to derive phylogenetic relationships of taxa in this study. The results were analyzed and interpreted further by scrutinizing the several alternative phylogenies in the light of additional morphological characters and data provided by ecology, behavior, and geographical distribution.

The Mean Character Difference was used to show the degree of phenetic similarities among species.

Combinatorial Method

For each character the states were defined; their nature, i.e., whether primitive or derived, determined, and their sequence of change deduced as outlined under *Definitions and Analyses of Characters* (pp. 8-50). In the first step of the program the computer eliminated all primitive character states. Then the derived states were recoded in binary form.

The primitive states were eliminated because they do not give information concerning branching sequences of groups under study (Hennig, 1965; Throckmorton, 1968; Inger, 1969); therefore, only derived states were used in determining the phylogenetic relationships of species.

The computer program finds and lists in the print out all non-redundant combinations of those species sharing derived states. (A non-redundant combination is the largest combination of species sharing a particular set of character states.)

From the list of combinations one is able to construct alternative phylogenetic trees by tracing the lineages of the different, possible combinations of species (Sharrock and Felsenstein, 1969; Inger, 1969).

The trees are constructed as follows: the stem of a tree consists of all species utilized in the run, and the states shared by all are put along that stem (figs. 56, 70). After this main lineage (stem) is illus-

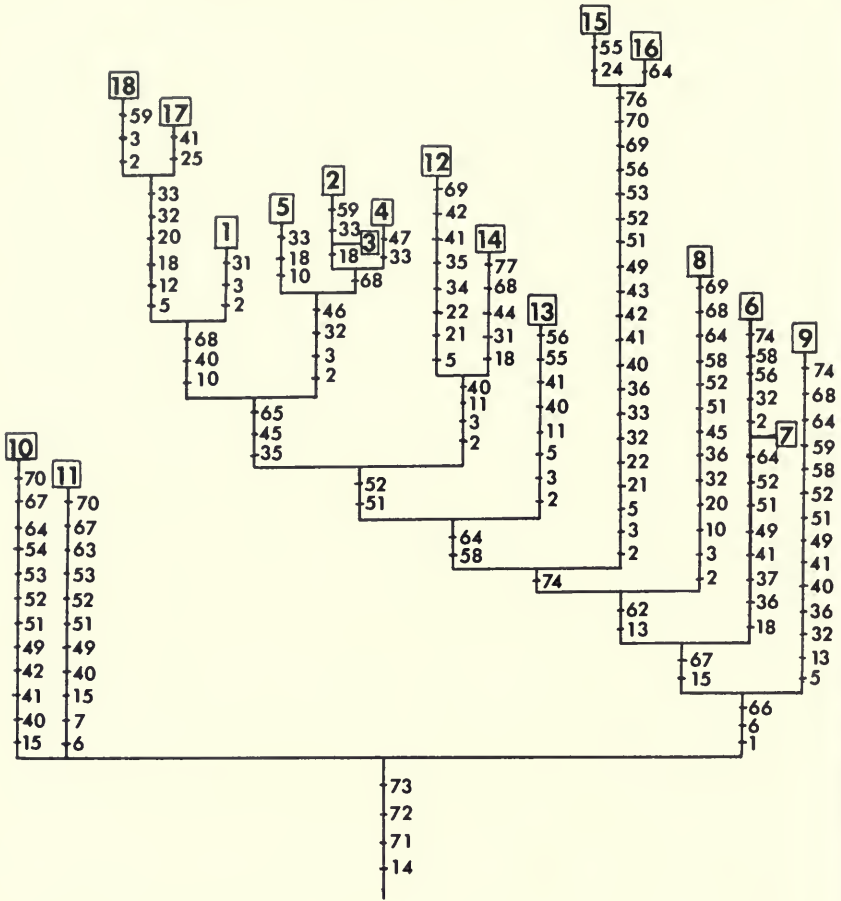

FIG. 56. One of the alternative trees showing phylogenetic relationships of 18 species of representative genera of Rhacophoridae as indicated by the Combinatorial Method. Numbers within squares or rectangles represent species tabulated below. Numbers along the lineages designate character states (see Appendix 4). Genera in the right column below indicate current generic recognition.

- | | | |
|------------------------------------|---|--------------------------------------|
| 1, <i>Rhacophorus omeimontis</i> | } | <i>Polypedates</i> |
| 2, <i>R. leucomystax</i> | | |
| 3, <i>R. macrotis</i> | | |
| 4, <i>R. maculatus</i> | | |
| 5, <i>R. colletti</i> | | |
| 6, <i>R. japonicus</i> | } | <i>Buergeria</i> |
| 7, <i>R. robustus</i> | | |
| 8, <i>Chiromantis xerampelina</i> | } | <i>Chiromantis</i>
<i>Boophis</i> |
| 9, <i>Boophis tephraeomystax</i> | | |
| 10, <i>Mantidactylus ulcerosus</i> | } | <i>Mantidactylus</i> |
| 11, <i>M. madagascariensis</i> | | |

Continued, p. 53.

trated, sublineages can be traced by selecting combinations of species from the computer print out and putting character states shared by the species in the combination along the appropriate branch. A lineage with more than one species can be subdivided further until it ends in a species. Closely-related species sharing a large number of states usually diverge at the terminal end of a lineage. A character state which appears at the base of a major lineage will not be represented again in its sublineages.

A character state can appear along several but not all of a set of sublineages, if it has not appeared in the stem or in stalks preceding the divergence of these sublineages; state 33, for example, appears three times, in sublineages leading to species 2, 4, and 5 (fig. 56).

Appearance of a character state along a lineage represents one evolutionary "mutation" to that state. The total number of mutations present in a given tree is obtained by adding the number of all states along all lineages in a tree. (These values are listed in tabular form in *Appendix 4.*) When the total number of mutations in a given tree exceeds the total number of character states utilized, this means that at least one state appears more than once. In other words, the excess number of mutations is the total number of convergences of character states. The total number of convergences in a given tree is obtained by subtracting the total number of character states present in the species treated from the total number of mutations present in all lineages. The relative length of a lineage in a tree is determined by the total number of mutations in it.

If many character states appear along a lineage leading to a species, this is interpreted to mean that this species has undergone more changes than those with fewer states. This assumption is valid if one assumes that all mutations of character states are equal and involve the same amount of genetic change. Since character states probably differ in the number of genes controlling them and in the number involved in producing an observable phenotypic change, all character state changes are probably not equal. Therefore, the relative number of occurrences of states along a lineage is actually not a

FIG. 56. *Continued.*

12, <i>Philautus picta</i>	<i>Hazelia</i>
13, <i>Theloderma stellatum</i>	<i>Theloderma</i>
14, <i>Philautus doriae</i>	<i>Chirixalus</i>
15, <i>P. aurifasciatus</i>	} <i>Philautus</i>
16, <i>Rhacophorus lissobrachiis</i>	
17, <i>R. moltrechti</i>	} <i>Rhacophorus</i>
18, <i>R. pardalis</i>	

good index to measure the amount of genetic change, but number of occurrences does provide an approximation of the degree of change in the species.

Criteria for a good tree, i.e., the tree that represents most accurately the probable phylogeny, are as follows:

1. A tree with the least number of convergences. Since evolution is usually a gradual process and involves an accumulation of slight changes in the genome, duplication of exactly the same result is highly improbable, except in very closely-related taxa. Therefore, if the number of convergences in a given tree is small, the tree probably approaches the actual phylogeny of the group under consideration.

2. Least number of convergences of conservative character states. These involve states which are unlikely to have evolved many times during the course of evolution of a given group. Actually, it is difficult to determine such states, because in most cases one is not completely sure what has happened in the past. Usually complex structures which are very widely distributed in a well-defined group fall in this category; the vertebrate eye, for example, has almost certainly evolved once in the evolutionary history of the vertebrates. Non-adaptive structures that appear in a single state in a well-defined group also fall in this category. The position of the anal opening probably has no adaptive significance, because of its relative constancy (median in the Bufonidae and dextral in the Ranidae and Rhacophoridae), and it suggests that these states are conservative and have evolved once (Inger, 1958, 1967).

3. Correspondence between terminal branches and over-all phenetic similarity. Species that are closely clustered in a phylogenetic tree and therefore considered closely related should be similar morphologically. Closely-related species have very similar genotypes and consequently similar phenotypes. Phenotypic similarity and difference among species were measured by means of the Mean Character Difference (fig. 57). Evidence from ecology, behavior, and geographical distribution of species was used to substantiate the validity of clusters of species in the phylogenetic trees (figs. 56, 58-70) and in the phenogram (fig. 57).

Eighty states for 36 different characters were used in the computer analysis.

Since the program of the Combinatorial Method using the IBM 7094 cannot handle much more than 1,000 non-redundant combina-

tions of species, only 39 species were attempted in the first run (19 species of representative genera of hyperoliids and 20 of rhacophorids). Because the problem exceeded the core capacity of the machine, this run terminated while operating on species Number 29. Even though only 29 of the 39 species were analyzed by the computer, the incomplete results gave us some indication of the existence of two major groups, i.e., rhacophorids and hyperoliids. Species of rhacophorids did not combine with species of the hyperoliids at the stage of 18 or more character states shared. The complete separation between species of the rhacophorids and species of the hyperoliids was also clearly shown by the results of the Mean Character Difference (fig. 57).

In order to stay within the limit of the core capacity of the machine, the above groups were analyzed separately by the Combinatorial Method. Eighteen representative species of recognized genera of rhacophorids and 19 of hyperoliid genera were used. These runs were completed with 398 and 308 non-redundant species combinations. These combinations were used as the bases for constructing alternative phylogenies of rhacophorids and hyperoliids.

Mean Character Difference

This computer method utilized both the primitive and the derived states. It then calculated the coefficients of differences of species entered in the run (Eades, 1969). Phenetic similarities among species were presented in the form of a phenogram (fig. 57). These results showed only the phenetic similarities among species and therefore phylogenetic relationships are not implied. In this analysis 66 species of Old World treefrogs were utilized and 80 states for 36 different characters were used, a quantity of data similar to that used in the Combinatorial Method.

PHYLOGENETIC RELATIONSHIPS OF THE GROUP UNDER STUDY

By whatever method used, the hyperoliids were separable completely from the rhacophorids. Species of the hyperoliids were separable from rhacophorids at 18 or more character states shared and, when analyzed by the Mean Character Difference, separable at a coefficient of difference value of 0.525 (fig. 57).

Laurent (1943b), using only osteological characters, arrived at the same conclusion and treated them as separate subfamilies, the Hyperoliinae and the Rhacophorinae. He based the separation on



whether the third carpale was free or fused to the fourth and fifth and whether the metasternum was bony or cartilaginous.

The hyperoliids differ from the rhacophorids in many character states. For example, morphological character states which are found in the hyperoliids but not in the rhacophorids are as follows: cartilaginous metasternum (Char. 25-1), postero-ventral portion of the sphenethmoid separated (Char. 21-1), third carpale free (Char. 28-0), second tarsale free (Char. 29-0), cartilaginous stalk of the thyrohyal present (Char. 10-2), posterior lateral process of the hyoid absent (Char. 15-2), some states of the palmaris complex present (Char. 2-1, 7, 8), *M. dento-mentalis* narrow (Char. 6-2), and the *M. extensor digitorum communis longus* slip short (Char. 5-3, 4).

The geographical distribution of these groups supports this separation; the hyperoliids are primarily distributed in Africa south of the Sahara, with one genus in the Seychelles Islands and another in Madagascar, whereas the rhacophorids are primarily distributed in the Orient with one genus in Africa and five genera in Madagascar.

There are two schools of thought concerning the rank of these groups. Many herpetologists today place them in a single family

FIG. 57. Phenogram of Mean Character Difference of 66 rhacophorid-hyperoliid species. Numbers in the right margin indicate the species and capital letters are the current generic assignment. Numbers along base line indicate the coefficient of difference.

1, *Hyperolius marmoratus*; 2, *H. sansibaricus*; 3, *H. picturatus*; 4, *Afrrixalus fulvovittatus*; 5, *A. dorsalis*; 6, *Cryptothylax gresshoffi*; 7, *Phlyctimantis verrucosus*; 8, *Hylambates maculatus*; 9, *Kassina senegalensis*; 10, *K. deserticola*; 11, *K. weali*; 12, *K. fusca*; 13, *K. wittei*; 14, *Mocquardia obscura*; 15, *Leptopelis aubryi*; 16, *L. oryi*; 17, *L. millsoni*; 18, *L. bocagei*; 19, *Philautus leucorhinus*; 20, *Chiromantis petersi*; 21, *C. rufescens*; 22, *C. xerampelina*; 23, *Rhacophorus everetti*; 24, *R. appendiculatus*; 25, *R. microtypanum*; 26, *R. dugritei*; 27, *R. omeimontis*; 28, *R. eques*; 29, *R. denysyi*; 30, *R. leucomystax*; 31, *R. macrotis*; 32, *R. maculatus*; 33, *R. otlophus*; 34, *R. colletti*; 35, *R. moltrechti*; 36, *Philautus bimaculatus*; 37, *P. gauri*; 38, *Rhacophorus bimaculatus*; 39, *R. pardalis*; 40, *R. javanus*; 41, *R. nigropalmatus*; 42, *R. harrissoni*; 43, *Philautus doriae*; 44, *P. hansenae*; 45, *P. vittatus*; 46, *Rhacophorus eiffingeri*; 47, *Philautus nongkhorensis*; 48, *P. picta*; 49, *Rhacophorus robustus*; 50, *R. japonicus*; 51, *R. pollicaris*; 52, *Boophis tephraeomystax*; 53, *B. bicalcaratus*; 54, *Mantidactylus ulcerosus*; 55, *M. albofrenatus*; 56, *M. luteus*; 57, *Aglyptodactylus madagascariensis*; 58, *Rhacophorus hosei*; 59, *Philautus aurifasciatus*; 60, *P. acutirostris*; 61, *P. woodi*; 62, *P. nasutus*; 63, *Rhacophorus surdus*; 64, *R. lissobranchius*; 65, *R. emembranatus*; 66, *Philautus parvulus*. A, *Hyperolius*; B, *Afrrixalus*; C, *Cryptothylax*; D, *Phlyctimantis*; E, *Hylambates*; F, *Kassina*; G, *Leptopelis*; H, *Chiromantis*; I, *Rhacophorus*; J, *Polypedates*; K, *Rhacophorus*; L, *Chirixalus*; M, *Hazelia*; N, *Buergeria*; O, *Boophis*; P, *Mantidactylus*; Q, *Philautus*.

TABLE 1.—Distribution of some characters in the Ranidae, Rhacophoridae, and Hyperoliidae.

Character	Ranidae	Rhacophoridae	Hyperoliidae
Intercalary cartilage	absent	present	present
Metasternum	usually a bony style	bony style	cartilaginous
Omosternum	usually not forked	usually forked	forked
Nasal	variable	usually squash-shaped	usually triangular
Sphenethmoid	one, usually not or only slightly exposed dorsally	one, almost always largely exposed dorsally	a pair, usually not or only slightly exposed dorsally
Frontoparietal	narrow, elongated	broad, usually anterior portion is broader	broad, usually rectangular
Vomerine odontophore	usually present	usually present	usually absent
Carpal bones	3rd carapale usually fused to the 4th and 5th	3rd carapale fused to 4th and 5th (except <i>Mantidactylus</i>)	3rd carapale free
Tarsal bones	2nd tarsale usually free	2nd tarsale fused to the 3rd and 4th (except <i>Mantidactylus</i>)	2nd tarsale free
Terminal phalanx	usually obtuse, sometimes claw- or T-shaped	Y-shaped or bifurcate	claw-shaped
Distal bony knob on the metacarpal of the 3rd digit	absent	present	present
Cartilaginous stalk of the thyrohyal	absent	absent	present
Posterior lateral process	present	present	usually absent
M. humero-dorsalis	one, which splits into three distally	almost always completely separated slips	two completely separated slips

TABLE 1.—Distribution of some characters in the Ranidae, Rhacophoridae, and Hyperoliidae—*Continued*.

Character	Ranidae	Rhacophoridae	Hyperoliidae
<i>M. palmaris longus</i>	usually distal end not separated	distal portion splits into three heads	distal portion splits into three heads
3rd and 4th tendo-superficiales	originate on Aponeurosis palmaris	usually originate on distal head of <i>M. palmaris longus</i> and able to slide through	originate on distal head of <i>M. palmaris longus</i> and usually able to slide through Aponeurosis palmaris
<i>M. adductor longus</i>	present	usually absent	present
<i>M. extensor communis longus</i>	number of slips present variable	usually only one slip inserting on distal metacarpal of 4th toe	usually one short slip inserting on proximal metacarpal of 3rd toe
Life habit	aquatic, semi-aquatic	arboreal	arboreal (except <i>Kassina</i>)
Deposition of eggs	usually in water	in foamy nest on vegetation over water	in gelatinous mass on vegetation over water
Labial teeth of tadpoles	variable, usually 3-4 rows on lower lip	generally 3 rows on lower lip	usually less than 3 rows on lower lip

(Ahl, 1931b; Noble, 1931; Hoffman, 1932; Parker, 1932, 1934; Inger, 1967; Schiøtz, 1967). Laurent (1943b) at first considered them as separate subfamilies of Rhacophoridae; later he (1946b) placed some genera of rhacophorids (*Mantidactylus*, *Mantella*, *Gephyromantis*, and *Trachymantis*) in a separate subfamily Mantellinae and considered it as part of the family Ranidae. Laurent (1951b) suppressed the family Rhacophoridae and placed the Rhacophorinae and the Mantellinae along with four other subfamilies (the Raninae, Cornuferinae, Petropedetinae, and Cacosterninae) in the family Ranidae; at the same time he assigned the Hyperoliinae and the subfamilies Astylosterninae, Arthroleptinae, Hemisinae, and Scaphiophryinae in a new family Hyperoliidae. Higher categories are ranked in a

subjective manner and there is no definite rule which sets their limits (Mayr et al., 1953); whether the rhacophorids and the hyperoliids are to be ranked as separate families or subfamilies depends not only on the distinctiveness of these groups but also on their phylogenetic relationship, particularly with closely-related groups and with other families as well.

There is no doubt that the hyperoliids and rhacophorids are closely related to the Ranidae, a view accepted by many workers (Noble, 1931; Parker, 1932, 1934; Laurent, 1951b; Inger, 1967). Inger (1967) used 13 characters to assess phylogenetic relations of anuran families and has shown that the Ranidae are closely related to the Rhacophoridae (including the hyperoliids) in all alternative phylogenies presented.

Laurent (1951b) erected two families for the ranid-rhacophorid-hyperoliid group, based on the carpal and the metasternum. If one uses more characters, then the ranid-rhacophorid-hyperoliid group gives a completely different picture, inasmuch as some characters are unique to each of these groups (Table 1). The rhacophorid-hyperoliid group, for example, differs from the ranids by the presence of the intercalary cartilage, broad frontoparietal bone, the presence of the bony knob on the distal metacarpal of the third digit, two completely separated slips of the *M. humerodorsalis*, division of the distal portion of the *M. palmaris longus*, by the ability of the third and fourth *Tendo superficialis* of the fingers to slide through the *Aponeurosis palmaris*, and almost always by the dilated distal segment of the fingers and toes.

In spite of these differences, however, some characters are shared between some hyperoliids and some African ranids. For example, the vertical pupil is shared by *Leptopelis*, *Kassina*, *Hylambates*, *Cryptothylax*, and *Afrixalus* of the hyperoliids and the *Astylosterninae* and *Trichobatrachus* of the ranids; the cartilaginous metasternum of the hyperoliids is shared with *Arthroleptis*, and the free third carpal of the hyperoliids is shared with *Arthroleptis*, *Cardioglossa*, and *Trichobatrachus* of the ranids (Laurent, 1940b, 1941b, 1943b,c, 1944). Because of the similarities of these characters it appears that the hyperoliids evolved from this ranid group. The similar geographical distribution of both groups, i.e., in Africa, supports also the above assumption.

Some characters of the rhacophorids are shared with some ranids: bony metasternum (with most ranids), united postero-ventral portion of the sphenethmoid (with most ranids), fusion of the third

carpale to the fourth and fifth (in *Rana*, *Hylarana*, *Amolops*, and *Platymantis*), and the presence of the posterior lateral process (with all ranids).

Because of the similarities of some characters between hyperoliids and the African ranids and between the rhacophorids and some ranids (primarily Asiatic genera), apparently the rhacophorids and the hyperoliids are diphyletic, and have evolved independently from two different ranid groups. Probably the hyperoliids evolved from the African ranid stock, whereas the rhacophorids evolved from Asiatic stock. According to Laurent (1951b), the hyperoliids were derived from the Astylosterninae, whereas the rhacophorids were derived from Mantellinae and/or Cornuferinae.

Apparently, the hyperoliids and the rhacophorids have passed the threshold of the ranid adaptive zone and have entered a new adaptive (arboreal) zone. Because the ranids, rhacophorids, and the hyperoliids are separated from each other by equally distinct morphological gaps they probably warrant equal taxonomic rank. I regard these three groups as separate families, i.e., Ranidae, Rhacophoridae, and Hyperoliidae.

This classification disagrees substantially with that of Laurent (1951b). His subfamily Hyperoliinae is here elevated to family rank, the Hyperoliidae, and his Mantellinae and Rhacophorinae are considered another distinct family, the Rhacophoridae. All other subfamilies mentioned by Laurent (1951b) are here placed in the family Ranidae.

PHYLOGENETIC RELATIONSHIPS WITHIN THE FAMILY RHACOPHORIDAE

Six alternative rhacophorid trees were constructed from the combinations provided by the Combinatorial Method. The total number of occurrences for each derived character state in each tree is listed in *Appendix 4*. A blank in the columns of *Appendix 4* means that character state does not appear in species of that tree. If a character state (e.g., state 48) does not appear in the column of either the rhacophorid or the hyperoliid, it means that this state is found in only a few species which were not used in the computer runs.

The first (fig. 58), fourth (fig. 61), and sixth trees (fig. 63) have relatively large numbers of convergences (124, 117, and 113, respectively, *Appendix 4*). Therefore, they can be eliminated from further

considerations because they do not meet the criteria established for a good phylogenetic tree on p. 54, specifically criterion 1. In addition, the close relationships implied by clustered species in those trees could not be confirmed by their over-all similarity (criterion 3, p. 54).

In the first tree (fig. 58), for example, species 10 (*Mantidactylus ulcerosus*) and species 11 (*Mantidactylus madagascariensis*) are indicated as not closely related, but their relationship is clearly indicated by their over-all similarity as shown by the phenogram of the Mean Character Difference (fig. 57). Furthermore, separation of species 1 from species 2, 3, 4, and 5 in the first tree cannot be confirmed because these species share a relatively large number of states (Table 2); their close similarity was shown by the phenogram (fig. 57).

However, if species 10 and 11, on the one hand, and species 1, 2, 3, 4, and 5, on the other hand, were placed close together in a tree by selecting their appropriate combinations from the print out, for example, the fourth tree (fig. 61) or the sixth tree (fig. 63), they still have relatively large numbers of convergences (117 and 113, respectively, *Appendix 4*). These values are relatively high compared with the second, third, or the fifth tree (*Appendix 4*), and therefore do not meet criterion 1 (p. 54).

The three other alternative trees left have about equal numbers of convergences, the second and the fifth trees (figs. 59, 62) with 107 and the third tree (fig. 60) with 104 convergences (*Appendix 4*). The third and the fifth trees differ in the pattern of lineages leading to species 6 through 11 and 15 and 16, whereas the second tree differs from the third and fifth in almost all lineages. Placing species 10 and 11 close to species 15 and 16 in the fifth tree forces species 6, 7, and 8 to shift to new positions, and at the same time calls for an increase in the number of convergences of relatively conservative states; for example, states 1, 13, 62, and 66 occur less frequently in the second and third trees than in the fifth (*Appendix 4*). Because of the relatively large number of convergences of conservative character states, the fifth tree is probably not as good as the second or third (criterion 2, p. 54).

FIGS. 58-63. Six of the alternative phylogenetic trees constructed from the data provided by the Combinatorial Method for 18 species of rhacophorid frogs. Numbers in the trees represent species as in Figure 56 (p. 52). In the text Figure 58 is referred to as the first tree, Figure 59 as the second, etc.

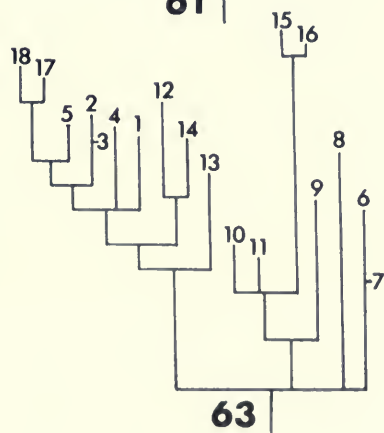
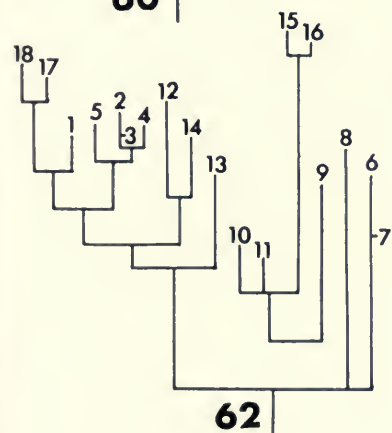
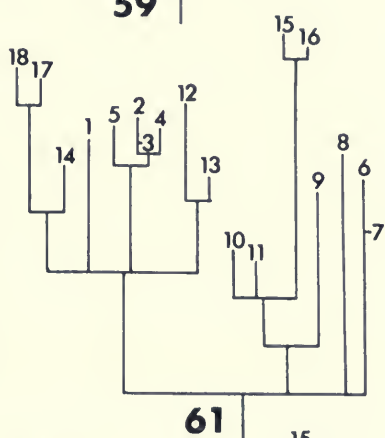
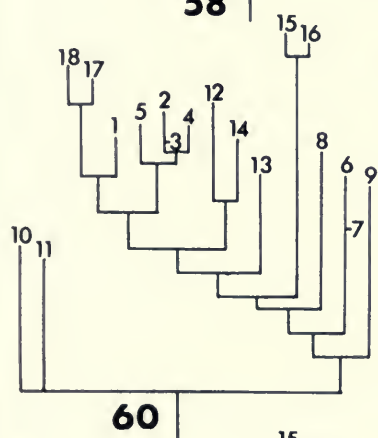
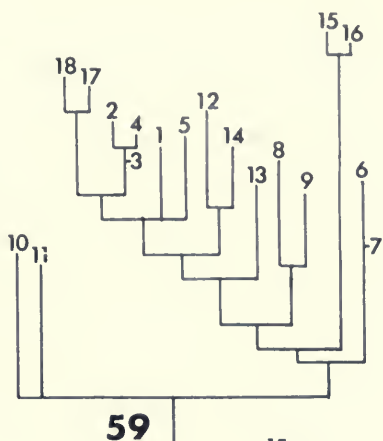
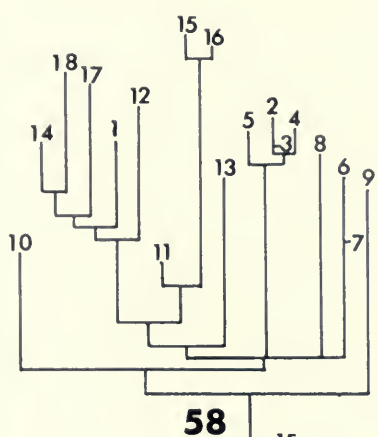

Lineages in the second and third trees are similar, differing only in the relationships between species 8 and 9, on the one hand, and among species 1 through 5, on the other hand. Even though joining species 8 and 9 in the second tree decreases the number of convergences between these species to zero (Table 3),—whereas their separation, in the third tree, calls for eight convergences (Table 2, fig. 56)—the total number of convergences is less in the third than in the second tree. Furthermore, no matter what one does with the tree, the best relationship (i.e., least number of convergences) between species 1 through 5 and 17 and 18 is the pattern shown in the third tree; this relationship was also shown by the phenogram (fig. 57). The number of occurrences of “mutations” of almost all states did not differ much in the second and third trees except for the following: States 6, 11, 44, and 55 appeared less frequently in the second tree, whereas states 10, 15, 40, 41, 49, and 68 appeared less frequently in the third. Since convergence of state 68 (convoluted Wolffian duct) seems to be rather unlikely because it is a complex structure and since convergence of this state is less frequent in the third tree, this tree appears to be more acceptable in accordance with criterion 2 (p. 54).

Of the six alternatives, the third tree meets all criteria set for a good phylogenetic tree. It portrays the phylogenetic relationships of taxa within the Rhacophoridae.

TABLE 2.—Matrix of shared derived character states of 18 rhacophorid species used in constructing the phylogenetic trees. The last line gives the total number of derived character states present in a given species. The numbers along the top and side margins represent species (see p. 52).

	1	2	3	4	5	6	7	8	9	10	11	12	13	14	15	16	17	18
1																		
2	22																	
3	22	25																
4	22	25	24															
5	22	25	24	24														
6	15	17	17	16	18													
7	12	13	13	12	13	17												
8	20	19	20	20	20	16	13											
9	11	16	15	15	14	15	12	15										
10	10	9	9	9	9	11	11	9	11									
11	10	9	9	9	9	10	10	9	11									
12	19	19	19	19	19	16	13	18	16	12	10							
13	17	17	16	16	16	15	11	15	14	9	8	20						
14	20	20	20	19	19	16	13	18	15	10	10	20	18					
15	17	18	17	18	18	19	14	18	17	14	12	23	19	13				
16	20	19	18	19	19	19	15	19	18	15	12	24	19	18	32			
17	22	23	22	22	22	17	14	21	18	11	10	19	17	19	19	20		
18	24	25	24	24	24	17	13	22	18	10	10	20	18	21	20	21	28	
	25	27	25	26	26	22	17	24	21	16	15	28	22	25	34	33	30	31

TABLE 3.—Matrix of numbers of convergences of derived states for pairs of 18 rhacophorid species in the second phylogenetic tree (upper right) and the third tree (lower left) as illustrated in Figures 59 and 60. The numbers along the top and side margins represent species (see p. 52).

	1	2	3	4	5	6	7	8	9	10	11	12	13	14	15	16	17	18
1			3	3	3	3	9	5	10	5	6	3	3	4	8	9	3	5
2	3		0	0	6	10	6	10	0	5	5	2	2	3	9	10	2	4
3	3	3	0	0	3	9	5	10	0	5	5	2	2	3	8	9	0	2
4	3	1	0		5	9	5	10	0	5	5	2	2	3	9	10	1	3
5	3	2	1	1		11	6	10	4	5	5	2	2	4	9	10	3	5
6	6	8	8	7	9		0	9	9	7	6	10	8	9	10	11	10	10
7	3	4	2	3	4	0		5	6	7	6	6	4	6	8	8	7	6
8	9	8	9	9	9	7	4		0	5	5	6	5	7	5	10	10	12
9	8	9	8	8	7	8	5	8		6	5	6	4	5	4	9	6	5
10	6	5	5	5	5	7	7	5	6		8	8	5	6	9	10	7	6
11	6	5	5	5	5	6	6	5	5	8		6	4	6	8	8	6	6
12	4	3	3	3	3	7	4	7	9	8	6		6	0	13	14	3	4
13	3	2	2	2	2	6	2	4	7	5	4	6		4	9	10	2	3
14	5	4	4	3	3	7	4	7	8	6	6	0	4		8	9	3	4
15	5	6	5	6	6	7	5	7	10	10	8	11	7	5		0	10	11
16	6	7	6	7	7	7	6	8	11	11	8	12	7	6	0		11	12
17	0	4	3	3	4	8	5	10	11	7	6	4	3	3	7	8		0
18	2	7	5	5	6	8	4	11	11	6	6	5	4	5	8	9	0	

Generic limits are sometimes difficult to define. It is widely accepted that genera are defined by monophyly and by rather distinct gaps among taxa and that the size of these gaps should often be an inverse ratio to the sizes of the taxa (Mayr et al., 1953). Furthermore, a genus should more or less occupy a well-defined ecological zone (Inger, 1958).

There is no rule for determining the size of the genera in a phylogenetic tree. Generic limits are set subjectively by considering the following postulates: first, there must be well-defined morphological gaps; second, there should be unique structures or combination of structures that will diagnose the groups; third, whenever possible these structures should relate to changes in behavior and ecology that accompanied the evolutionary shift into a new adaptive zone; fourth, the geographical distribution of included species should support the other postulates.

In the rhacophorid tree selected (fig. 60), ten major lineages are recognized for the 18 species treated. Other species, which were not used in the Combinatorial Method, were assigned to the above lineages on the basis of the Mean Character Difference analysis. The species studied were assigned to the following genera: *Mantidactylus*, *Boophis*, *Buergeria*, *Chiromantis*, *Philautus*, *Theloderma*, *Chirixalus*, *Hazelia*, *Polypedates*, and *Rhacophorus*.

TABLE 4.—Matrix of derived states shared among pairs of genera of Rhacophoridae. The last line gives the total number of derived character states present in a given genus. The numbers along the top and side margins represent the following genera: 1—*Mantidactylus*, 2—*Boophis*, 3—*Buergeria*, 4—*Chiromantis*, 5—*Philautus*, 6—*Theلودerma*, 7—*Chirixalus*, 8—*Hazelia*, 9—*Polypedates*, and 10—*Rhacophorus*.

	1	2	3	4	5	6	7	8	9	10
1										
2	13									
3	13	19								
4	10	19	16							
5	16	22	22	20						
6	11	16	15	14	21					
7	12	21	16	17	21	18				
8	14	19	17	16	25	20	20			
9	16	23	22	21	23	19	21	23		
10	12	25	20	23	27	19	22	22	30	
	20	28	27	25	38	22	26	28	42	38

Mantidactylus Boulenger

This taxon was represented in the third tree by species 10 (*Mantidactylus ulcerosus*) and species 11 (*M. madagascariensis*). These species remained separate lineages in all trees attempted (figs. 58–63), but their great similarity was indicated by the phenogram of the Mean Character Difference (fig. 57). Species 10 and 11 shared from 10 to 16 states with other genera (Table 4).

This genus is characterized by the following combination of states, some of which are unique among the rhacophorids: a ranid type *M. humerodorsalis* (Char. 1-0), incompletely divided *M. palmaris longus* (Char. 2-1, fig. 2), vomerine odontophore usually in contact with palatine bone, and femoral gland present in many species (the last three are unique). Because these species are morphologically similar, characterized by a combination of structures that separates them from other species, and have a cohesive geographical range (Madagascar), they warrant generic rank (criteria 1, 2, 4, p. 65).

The ranid type *M. humerodorsalis* and the pattern of the palmaris complex indicate that this genus is probably intermediate between the ranids and rhacophorids.

Boophis Tschudi

In the third tree this taxon was represented by species 9 (*Boophis tephraeomystax*). Other species studied but not included in the Combinatorial Method runs shared also a combination of distinctive features of *Boophis tephraeomystax*, i.e., a ranid type *M. humerodorsalis*

(Char. 1-0) in some species, presence of *M. adductor longus*, reduced nasal bone, and the presence of two *M. extensor digitorum communis longus* slips (Char. 5-1). The great similarity among the species was also indicated by the phenogram (fig. 57).

Because these species as a group are morphologically more similar to each other than to any other group and have a cohesive geographical range, they warrant generic recognition (criteria 1, 2, and 4, p. 65). This genus, restricted to Madagascar, probably evolved from *Mantidactylus*.

Buergeria Tschudi

In the third tree this taxon was represented by species 6 (*Buergeria japonicus*) and species 7 (*Buergeria robustus*). In every combination attempted these two species were linked, and they are undoubtedly closely related; their similarity was also shown by the phenogram (fig. 57). This group is regarded as a separate genus because of its cohesive geographical range and the following combination of character states: the pattern of the *M. humerodorsalis* (Char. 1-1), the presence of *M. adductor longus* (Char. 13-0), and the shape of the anterior horn of the hyoid (Char. 14-1). It shared from 13 to 22 states with other genera (Table 4).

Buergeria seems to be primitive among Asiatic rhacophorids since it has several states that are primitive and unique in the Asiatic stock: presence of *M. adductor longus* (Char. 4-0), arch-shaped anterior horn of the hyoid (Char. 14-0), and the presence of second and fourth phalangeal slips of the *M. humerodorsalis* (Char. 1-1).

This genus consists of Asiatic rhacophorid species generally placed in the genus *Rhacophorus auct.* Its species are restricted to Formosa and the Riu Kiu Archipelago.

Chiromantis Peters

In the third tree this taxon was represented by species 8 (*Chiromantis xerampelina*). Other species studied but not included in the Combinatorial Method runs were very similar morphologically to *Chiromantis xerampelina* (fig. 57). As a group *Chiromantis* shares a relatively large number of states with other genera (from 10 to 23 of 25 states of *Chiromantis*, Table 4). *Chiromantis* has the following combination of distinguishing states: arch-shaped anterior horn of the hyoid (Char. 14-0), reduced squamosal plate, and opposable fingers. Because of these distinctive states and the cohesive geographical range of *Chiromantis*, it warrants generic recognition.

Chiromantis is distributed in Africa south of the Sahara. Because *Chiromantis* shares so many character states with Asiatic rhacophorid genera, it appears to have evolved from an Asiatic rhacophorid stock and to have recently reached Africa, contrary to the view of Laurent (1941b, 1943b), who regarded *Chiromantis* as the ancestral stock of the Asiatic and Madagascan rhacophorids.

Philautus Gistel

In all phylogenetic trees examined, species 15 (*Philautus aurifasciatus*) and 16 (*P. lissobranchius*) were linked and separate from other lineages. Had other species of this group been analyzed in the Combinatorial Method (note similarities in fig. 57), they would have exhibited a similar pattern. These species shared from 16 to 27 derived states, relatively small proportions, with other genera (Table 4). The following combination, which includes some unique states, appears to substantiate their recognition as a distinct genus (criteria 1, 2, and 3, p. 65): trapezoidal frontoparietal (Char. 19-5), unique broad neuropophyses of the eighth vertebra (Char. 17-2), two *M. petrohyoideus* posterior slips (Char. 8-2), simple Wolffian duct (Char. 30-0), and the distinct vesicula seminalis (Char. 31-1). The extremely large eggs in gravid females are unique and differ from those of most other rhacophorids. Probably the large eggs are associated with a shortening of the tadpole stage as reported for *Philautus hosei* (Inger, 1966) and some *Platymantis* (Alcala, 1962).

This genus has been traditionally defined as a small Oriental rhacophorid group lacking vomerine teeth (Ahl, 1931b; Noble, 1931; Inger, 1954a, 1966; Taylor, 1962). The validity of absence of vomerine teeth as a generic character was questioned by Taylor (1962) and Inger (1966). Apparently, in Asiatic rhacophorids vomerine teeth cannot be used as generic character, because their presence or absence is not constant even within the same species, e.g., *Philautus lissobranchius*, *P. emembranatus*, and *Chirixalus eiffingeri*. Parker (1932) and Noble (1924) have shown that vomerine teeth are not reliable generic characters in various other frogs.

Several species generally placed in *Rhacophorus auct.* are here transferred to *Philautus*, e.g., *lissobranchius*, *surdus*, *emembranatus*, and *hosei*. Species of this genus are distributed from Ceylon to Indochina and down to the Greater Sunda Islands and the Philippines.

Theloderma Tschudi

This taxon was represented by species 13 (*Theloderma stellatum*) in the third tree. Another species (*T. gordonii*) studied, but not in-

cluded in the Combinatorial Method analyses, shared the distinctive features of *T. stellatum*. These species shared from 11 to 21 states with other genera and shared from three to seven states that were convergent. I agree with Taylor (1962) in recognizing the above species group as a separate genus, characterized by a combination of the following states: two M. extensor digitorum communis longus slips (Char. 5-1) and numerous calcified warts on the dorsum. Small clutches of large eggs are deposited above water-filled holes in tree trunks. This peculiar breeding behavior is similar to that of *Hazelia picta* (Inger, 1966), probably a closely-related genus. Species of *Theloderma* are distributed in the Indochinese region and in Sumatra.

Chirixalus Boulenger

In the third tree this taxon was represented by species 14 (*Chirixalus doriae*). Other species studied, but not included in the Combinatorial Method runs, shared many distinctive features of *C. doriae* and showed greater similarity to each other than to other genera (fig. 57). As a group *Chirixalus* shared from 12 to 22 states with other genera (Table 4).

The above group warrants generic recognition because of the following combination of states, the first of which is unique (criterion 2, p. 65): vertebral column elongated (Char. 18-2), vomerine teeth usually absent (Char. 22-1), and fingers opposable. *Chirixalus* is resurrected for a group of small Asiatic rhacophorids usually placed in *Philautus* or *Rhacophorus auct.* and found in the Indochinese region and Formosa.

Hazelia Taylor

In the third tree this taxon was represented by species 12 (*Hazelia picta*). Another species *H. spinosa* studied, but not included in the Combinatorial Method analyses, shared many features of *H. picta*.

These species shared from 14 to 25 states with other genera (Table 4). Even though *Hazelia picta* was closely linked with *Chirixalus doriae* in the third tree (fig. 60), they warrant separate generic recognition, because species of *Hazelia* showed greater similarity to each other than to other genera and are characterized by the following combination of states, which include some unique structures (criteria 1 and 2, p. 65): warty dorsum, head skin co-ossified to the skull, the presence of bony ridges along the frontoparietals, lack of vomerine teeth, and the median anal opening in tadpoles (the third and the fifth are unique). *Hazelia* and *Theloderma* show similar breeding

habits, depositing the egg masses above water-filled holes in tree trunks. *Hazelia* is distributed in Thailand, Malay Peninsula, Sumatra, Borneo, and the Philippine Islands.

Polypedates Tschudi

This taxon was represented by species 1 to 5 in the third tree (*Polypedates omeimontis*, *P. leucomystax*, *P. macrotis*, *P. maculatus*, and *P. colletti*). The close relationship between these species was indicated by the accepted tree (fig. 60), and they appeared to be much more closely related to each other than to any other species (Table 2); their similarity was also indicated by the phenogram (fig. 57). This group of similar species warrants generic rank because of the morphological gap separating it from other groups (criterion 1, p. 65). It shared from 16 to 30 states with other genera (Table 4). *Polypedates* is resurrected for some Oriental rhacophorids generally placed in *Rhacophorus auct.* *Polypedates* is distinct from *Rhacophorus sensu stricto* by the combination of characters listed in Table 5.

Apparently *Polypedates* was derived from an early rhacophorid stock. This genus ranges from Ceylon to southern China and down to the Greater Sunda Islands and the Philippines.

Rhacophorus Kuhl and van Hasselt

This taxon was represented in the third tree by species 17 (*Rhacophorus moltrechti*) and species 18 (*R. pardalis*). Although no convergences were present between them (fig. 56, Table 3), the great number of states shared indicates their close relationship (Table 2). Several other species of rhacophorids clustered with them (fig. 57).

This group warrants generic rank because of the great similarity of species within it and the gap separating it from all other genera of rhacophorids (criterion 1, p. 65). Although *Rhacophorus everetti*, *R. appendiculatus*, and *R. microtympanum* appeared quite similar to each other in the phenogram (fig. 57), they differed markedly from other *Rhacophorus* species. They are provisionally assigned to *Rhacophorus*, pending further study of their relationships.

Rhacophorus shared from 12 to 30 states with other genera (Table 4). It is closely related to *Polypedates* but can be distinguished by characters listed in Table 5. The presence of vomerine teeth is not a trenchant character in the genus *Rhacophorus* despite its use by previous workers (see discussion on p. 65). The genus *Rhacophorus* as defined here includes some *Rhacophorus auct.* and some of

TABLE 5.—Some differences between the genera
Rhacophorus and *Polypedates*.

Characters	<i>Rhacophorus</i>	<i>Polypedates</i>
Parieto-squamosal arch of the frontoparietal	absent	present in most species; usually short
Vomerine teeth	usually present	always present
Vertebral column	procoelous	diplosiocoelous
M. extensor brevis superficialis of the 1st digit	absent in most species	present in most species
M. extensor radialis accessorius lateralis	usually narrow, originates near crista ventralis of the humerus	moderately large, originates along lateral side of humerus, distal to the crista ventralis
M. cutaneous pectoris	thin, with only a few layers of muscle fibres	thick and muscular
Dermal tarsal or anal fold	present in many species	absent, except in <i>Polypedates eques</i>
Dermal fold along the forearm and tarsus	extensive in many species	absent or forming only a dermal fringe
Color	usually bright, green or brownish	usually dull, grayish with various dark markings

Philautus auct. Species of this genus are distributed from India to Japan and south to the Greater Sunda Islands and the Philippines.

PHYLOGENETIC RELATIONSHIPS WITHIN THE FAMILY HYPEROLIIDAE

The procedures used for constructing and analyzing alternative hyperoliid phylogenetic trees were similar to those employed for the rhacophorids (p. 54). Six alternative trees were constructed from data for 19 species of hyperoliids analyzed by the Combinatorial Method (figs. 64–69); the number of occurrences of each derived state in every tree is presented in tabular form in *Appendix 4*.

In accordance with the first criterion (p. 54), relatively large numbers of convergences present, the second (fig. 65), the fourth

(fig. 67), the fifth (fig. 68), and the sixth trees (fig. 69) could be eliminated from further consideration. In addition, the placing of species 17 (*Kassina senegalensis*), 18 (*K. weali*), and 19 (*K. obscura*) in separate lineages in the second (fig. 65), the fourth (fig. 67), and the

TABLE 6.—Matrix of shared derived character states of 19 hyperoliid species used in constructing phylogenetic trees. The last line gives the total number of derived states present in a given species. Numbers along the top and side margins represent species (see fig. 70).

	1	2	3	4	5	6	7	8	9	10	11	12	13	14	15	16	17	18	19	
1																				
2	34																			
3	34	34																		
4	35	36	34																	
5	35	35	34	35																
6	34	35	33	35	34															
7	34	35	33	35	34	40														
8	34	35	33	35	34	40	40													
9	34	35	33	35	34	40	40	40												
10	35	36	34	36	35	35	35	35	35											
11	29	30	28	30	29	30	30	30	30	30										
12	31	31	30	31	31	31	31	31	31	31	30									
13	20	21	20	21	20	24	24	24	24	21	21	20								
14	18	19	18	19	18	22	22	22	22	19	19	18	18							
15	18	19	18	19	18	22	22	22	22	19	19	18	17	29						
16	28	28	28	28	28	28	28	28	28	28	26	28	21	19	19					
17	25	26	24	26	25	31	31	31	31	26	24	24	18	17	17	22				
18	20	21	19	21	20	23	23	23	23	21	19	20	17	16	15	19	23			
19	20	20	19	20	20	20	20	20	20	20	16	18	16	15	14	18	18	20		
	35	36	34	36	35	40	40	40	41	36	31	33	30	30	29	29	33	28	24	

fifth trees (fig. 68), not only increases the number of convergences of some conservative states (e.g., thyrohyal, Char. 10-1), but it is also contrary to the close similarities indicated by the phenogram of the Mean Character Difference (fig. 57); therefore, the above trees did not meet criteria 2 and 3 (p. 54), and consequently they do not represent the most likely phylogenetic tree.

The two alternatives left (the first, fig. 64, and the third, fig. 66, trees) were similar with 65 and 63 convergences, respectively (Appendix 4). Relationships among species 1 through 12 and 16 were similar in both trees; they differed only in the relationships of species 17 through 19.

FIGS. 64-69. Six of the alternative phylogenetic trees constructed from the data provided by the Combinatorial Method for 19 hyperoliid frogs. Numbers in the trees represent species as in Figure 70 (p. 76). In the text Figure 64 is referred to as the first tree, Figure 65 as the second, etc.

Species 1 through 12 and 16 each shared more derived states with species 17, 18, or 19 than with species 13, 14, or 15 (Table 6); therefore, species 17, 18, or 19 should be more closely linked with species 1 through 12 and 16 than with species 13, 14, or 15. For this reason and the fact that a smaller total number of convergences was present in the third tree, it was regarded as the most acceptable phylogenetic tree (criteria 1 and 3, p. 54). A similar pattern for these species was also indicated by the phenogram of the Mean Character Difference (fig. 57).

In the hyperoliid tree selected (fig. 70, redrawn from fig. 66), seven major lineages are recognized for the 19 species treated. Other species, which were not analyzed by the Combinatorial Method, were assigned to the above lineages on the basis of the Mean Character Difference analysis. The species studied were assigned to the following genera: *Hyperolius*, *Afrixalus*, *Cryptothylax*, *Phlyctimantis*, *Hylambates*, *Kassina*, and *Leptopelis*.

Hyperolius Rapp

In the accepted tree (fig. 70) this taxon was represented by species 1 (*Hyperolius marmoratus*), 2 (*H. sansibaricus*), 3 (*H. pictoratus*), 4 (*H. guttulatus*), 5 (*H. cinnemameoventris*), and 10 (*H. concolor*). These species remained linked in all alternative trees attempted (figs. 64-70). The Mean Character Difference analysis clearly indicated that the first three species had greater similarity to each other than to any other species of other genera. As a group the species of *Hyperolius* shared from 25 to 35 states with other genera (Table 7).

Because these species are morphologically very similar and separate from other species, they warrant generic rank (criterion 1, p. 65). This generic assignment agrees with that of recent workers (Laurent, 1941b, 1944, 1950a; Laurent and Combaz, 1950; Schiøtz, 1967). The present data indicate a very close relationship of *Hyperolius* to *Afrixalus* (figs. 57, 70). *Hyperolius* is distinguishable from *Afrixalus* by its horizontal pupil in the adult and by the tooth formula in the tadpole of I/1,II (one uninterrupted row on upper lip, one interrupted row, and two uninterrupted rows in lower lip) or I/III (Schiøtz, 1963, 1967; Inger, 1968). Species of this genus are distributed in Africa south of the Sahara.

Afrixalus Laurent

In the accepted tree this taxon was represented by species 6 (*Afrixalus fornasinii*), 7 (*A. fulvovittatus*), 8 (*A. wittei*), and 9 (*A.*

TABLE 7.—Matrix of derived states shared among pairs of genera of Hyperoliidae. The last line gives the total number of derived character states present in a given genus. The numbers along the top and the side margins represent the following genera: 1—*Hyperolius*, 2—*Afrixalus*, 3—*Cryptothylax*, 4—*Phlyctimantis*, 5—*Hylambates*, 6—*Kassina*, and 7—*Leptopelis*.

	1	2	3	4	5	6	7
1							
2	35						
3	30	30					
4	31	31	30				
5	28	28	27	28			
6	35	30	26	26	25		
7	25	22	22	21	22	23	
	36	41	31	33	29	40	32

dorsalis). In all alternative trees attempted these species were linked (figs. 64–70). The two species analyzed by the Mean Character Difference also exhibited close similarity (fig. 57). As a group the species of *Afrixalus* shared from 22 to 35 states with other genera (Table 7). *Afrixalus* is very similar to *Hyperolius* with 35 states shared (Table 7), but despite the large number of shared states the former is distinguishable from *Hyperolius* by its vertical, rhomboid pupil. The tooth formula of known tadpoles, in *Afrixalus*, is usually 0/I (Lamotte and Vogeli, 1956; Schiøtz, 1967; Inger, 1968) and is unique among the hyperoliids.

Because of the great similarity among species of *Afrixalus* and their distinctiveness from other genera, particularly from the closely related *Hyperolius*, *Afrixalus* warrants generic rank (criteria 1 and 2, p. 65). *Afrixalus* occurs in the African tropics.

Cryptothylax Laurent and Combaz

In the accepted tree this taxon was represented by species 11 (*Cryptothylax gresshoffi*). As seen from the phylogenetic trees (figs. 64–70), species 11 linked closely with species 12. Their great similarity was also shown by the phenogram (fig. 57), and these two species appear to be closely related. *Cryptothylax* shared from 22 to 30 states with other genera (Table 7). *Cryptothylax* is distinct from other hyperoliids by the following combination of structures: vomerine teeth present, gular gland present but vocal pouches absent, and nuptial pads present. It differs from the closely-related *Phlyctimantis* as shown in Table 8. In view of the above statements, *Cryptothylax* warrants generic assignment (criteria 1 and 2, p. 65); this assignment agrees with that of Laurent and Combaz (1950). This monotypic genus occurs in the Congo and in the Cameroons.

TABLE 8.—Some differences between the genera *Cryptothylax* and *Phlyctimantis*.

	<i>Cryptothylax</i>	<i>Phlyctimantis</i>
Nasal bone	triangular	squash-shaped
Frontoparietal	rectangular	trapezoidal
Vomerine odontophore	robust	narrow
Palatine bone	dilated at its medial end	obtuse at its medial end
Anterior horn	the lateral and medial branches are present	arch-shaped anterior horn
Omosternum	broadly forked	moderately forked
Vocal pouch	absent	present
Life habit	arboreal	probably arboreal

Phlyctimantis Laurent and Combaz

This taxon was represented in the accepted tree by species 12 (*Phlyctimantis verrucosus*). Results from the Combinatorial Method analysis showed that this species is very closely related to *Cryptothylax* (fig. 70), and their great similarity was also indicated in the phenogram (fig. 57). This taxon warrants generic recognition be-

FIG. 70. The tree showing the most probable phylogenetic relationships of 19 species of representative genera of the Hyperoliidae as indicated by the Combinatorial Method. Numbers within the squares or rectangles represent species tabulated below. Numbers along the lineages designate character states (see Appendix 4). Genera in the right column tabulated below indicate current generic assignment.

1, <i>Hyperolius marmoratus</i>	}	<i>Hyperolius</i>
2, <i>H. sansibaricus</i>		
3, <i>H. picturatus</i>		
4, <i>H. guttulatus</i>		
5, <i>H. cinnemameoventris</i>		
6, <i>Africalus fornasinii</i>	}	<i>Africalus</i>
7, <i>A. fulvovittatus</i>		
8, <i>A. wittei</i>		
9, <i>A. dorsalis</i>		
10, <i>Hyperolius concolor</i>		<i>Hyperolius</i>
11, <i>Cryptothylax gresshoffi</i>		<i>Cryptothylax</i>
12, <i>Phlyctimantis verrucosus</i>		<i>Phlyctimantis</i>
13, <i>Leptopelis aubryi</i>	}	<i>Leptopelis</i>
14, <i>L. oryi</i>		
15, <i>L. bocagei</i>		
16, <i>Hylambates maculatus</i>		<i>Hylambates</i>
17, <i>Kassina senegalensis</i>	}	<i>Kassina</i>
18, <i>K. weali</i>		
19, <i>Mocquardia obscura</i>		

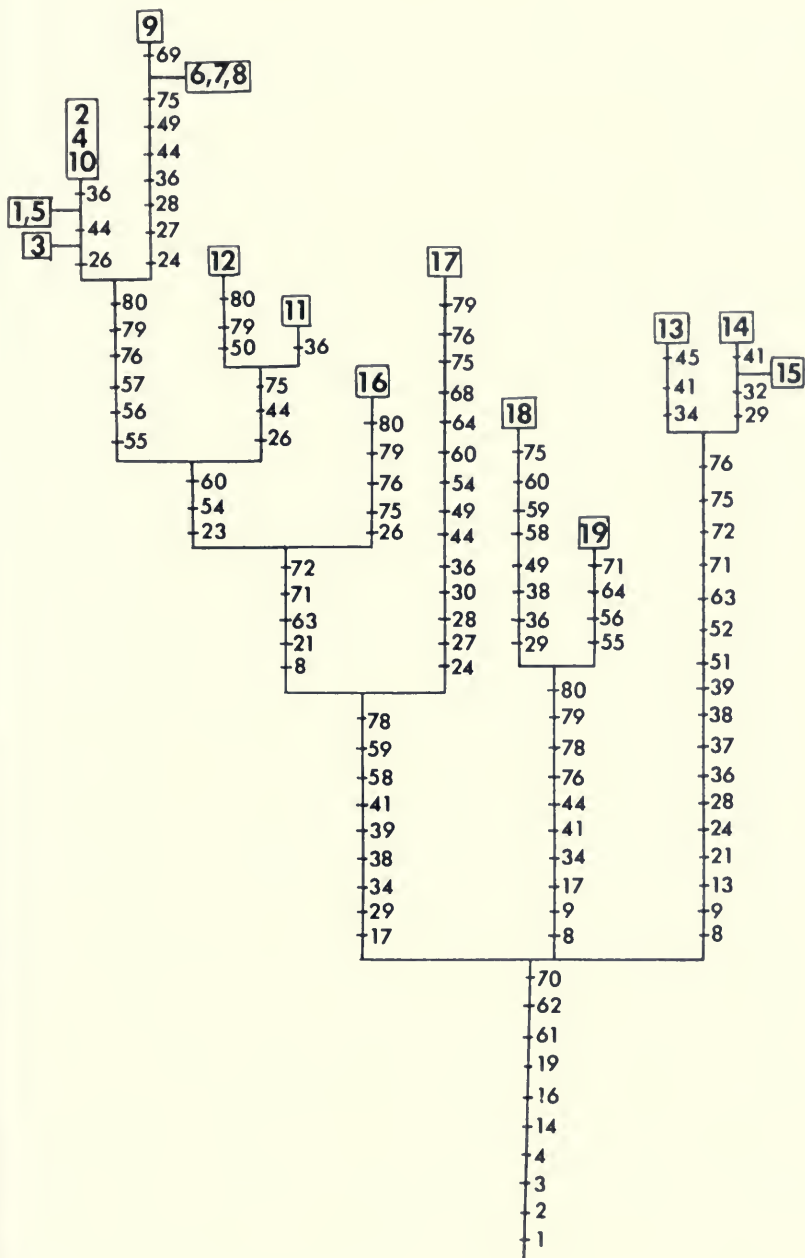

cause the following combination of characters distinguishes it from all other hyperoliids: presence of nuptial pads, vomerine teeth, and a vertical pupil. It can be distinguished from the closely-related *Cryptothylax* by characters listed in Table 8. Only two species are assigned to *Phlyctimantis*: *leonardi* and *verrucosus* (Laurent and Combaz, 1950; Perret, 1966; Schiøtz, 1967). This genus occurs in West Africa.

Hylambates Duméril

This monotypic genus was represented in the accepted tree by species 16 (*Hylambates maculatus*). As indicated in Table 7, it is similar to the preceding genera and shared from 22 to 28 of 29 states present. I agree with Laurent and Combaz (1950) in placing *Hylambates maculatus* in a separate genus because its terrestrial life habit represents an ecological shift (criterion 3, p. 65), which appears to be secondary, inasmuch as arboreal adaptive structures are still retained, e.g., two metacarpal slips of *M. humerodorsalis* (Char. 1-3), the type of palmaris complex (Char. 2-5, fig. 7), and moderately large-sized digital discs. Although ground-dwelling hyperoliids are known in the genus *Kassina*, the latter does not appear closely related to *Hylambates* since the two shared relatively few states (Table 7). Their distinctiveness is also indicated in the phenogram (fig. 57). *Hylambates* is distributed in East Africa.

Kassina Girard

This taxon was represented in the phylogenetic tree by species 17 (*Kassina senegalensis*), 18 (*K. weali*), and 19 (*Mocguardia obscura*). Although species 17 appeared to be separated from species 18 and 19 (fig. 70), their close similarity is indicated in the phenogram (fig. 57). Since these species are similar and distinct from other hyperoliid species and are ground dwellers (except *Kassina maculata*, Schiøtz, 1967), they warrant generic recognition (criteria 1 and 3, p. 65).

Ahl (1931b) assigned *Mocguardia obscura* (species 19) to a different genus because it allegedly differed from *Kassina* by having a cartilaginous omosternum and a horizontal pupil. The specimen examined in the present study did not show these characters and, since both analyses utilized indicated its great similarity to other species of *Kassina*, it is assigned to the latter genus.

Species of *Kassina* are known to lay their eggs in water, a habit differing from that of typical hyperoliids which deposit egg masses above water (Wager, 1926; Perret, 1961; Schiøtz, 1967). In addi-

tion, the robust, broad-finned tadpoles are unique among the hyperoliids (Wager, 1926; Hoffman, 1942; Schiøtz, 1967). Their tooth formula in known species is almost always I/1,I (Lamotte and Vogeli, 1956; Schiøtz, 1963, 1967).

Leptopelis Günther

In the accepted tree this taxon was represented by species 13 (*Leptopelis aubryi*), 14 (*L. oryi*), and 15 (*L. bocagei*). These species were linked in all trees attempted (figs. 64-69, 70). Their greater similarity to each other than to any other species is indicated in the phenogram (fig. 57). Therefore, their close relationships are obvious. They shared from 21 to 25 states with other genera (Table 7).

Leptopelis is distinct from other genera of hyperoliids and characterized by the following combination of states, the third of which is unique: pattern of the palmaris complex (Char. 2-6), absence of *M. adductor longus* (Char. 4-1), type of *M. extensor digitorum communis longus* (Char. 5-3), club-shaped alary process (Char. 12-1), and the absence of both vocal pouch and the gular gland (Char. 36-0).

The eggs are usually deposited in moist soil near water or in water (Perret, 1961; Schiøtz, 1967). Tadpoles usually have the following tooth formula: I,3/III or I,2/III (Lamotte and Perret, 1961; Schiøtz, 1963, 1967; Inger, 1968).

For reasons outlined above this group warrants generic recognition (criteria 1, 2, and 3, p. 65). It appears that *Leptopelis* diverged very early from the ancestral stock of the hyperoliids. Species of this genus are usually arboreal, except *L. bocagei* and *L. bufonides* (Schiøtz, 1967). *Leptopelis* is found in the African tropics.

DISTRIBUTION, CENTERS OF EVOLUTION, AND DISPERSAL

Although fossils of the Rhacophoridae and Hyperoliidae are unknown, the diversity and the present distribution of the included species and of the presumed ancestral group (Ranidae), enable one to speculate on the dispersal history of these groups.

The center of origin of the Ranidae is unknown; Darlington (1957) suggested the Old World tropics, without mentioning any specific region. Laurent (1951b) believed that the ranids (*sensu* Laurent) originated in the Asiatic tropics. Whatever the origin may be, there is clear indication of two different centers of ranid differentiation, one on the African continent (about 16 genera, Laurent, 1940b, 1941a; Perret, 1966) and another in the Oriental region (about 14 genera, Boulenger, 1920; Kirtsinghe, 1957; Inger, 1954a, 1966; Taylor, 1921, 1962). (The number of genera present is less important than the distinctiveness between those two groups.) A similar disjunct distribution is found in the Microhylidae (Parker, 1934). Only a few species of two genera of Asiatic ranids are found in Africa (*Rana* and *Hylarana*), and they undoubtedly originated from Asiatic stocks (Laurent, 1951b).

As has been discussed earlier, the Hyperoliidae is distinct from the Rhacophoridae on morphological grounds (p. 55). Furthermore, some unique African ranid characters are shared with hyperoliids (p. 60) but not with rhacophorids, and numerous Asiatic ranid characters (p. 60) are shared with rhacophorids.

It thus appears that the hyperoliids evolved from African ranids and the rhacophorids evolved from the Asiatic ranids independently. This hypothesis is similar to that of Laurent (1951b) but disagrees completely with that of Noble (1931) and Darlington (1957). The latter regarded Asiatic rhacophorids as derived from African treefrogs. If one accepts his hypothesis, then one must assume *Chiromantis* as the ancestral stock of the Oriental rhacophorids because of its close relationship and great similarities with other rhacophorids (fig. 57). However, *Chiromantis* certainly could not be the ancestor

of Oriental rhacophorids because it appears to be a specialized rhacophorid (see similarities with *Rhacophorus* in Table 4, p. 66); in addition, one would have difficulty explaining the presence of primitive rhacophorids in the Orient (*Buergeria*) and in Madagascar (*Boophis*, *Mantidactylus*, and other genera of Mantellinae *sensu* Laurent).

Noble (1931) made some contradictory statements concerning the relationships and distributional patterns among African (Hyperoliidae *sensu stricto*), Asiatic, and Madagascar treefrogs. He (Noble, 1931, p. 525) stated that Madagascar treefrogs (Mantellinae *sensu* Laurent, 1951b, including *Mantidactylus*) arose from the same "polypedatid" ancestors as the African genera, whereas on page 526, he suggested that *Polypedates* gave rise to *Mantidactylus*. The latter statement is probably not tenable because the present study indicates that *Mantidactylus* has many primitive characters so far as rhacophorids are concerned; furthermore, some characters of *Mantidactylus* indicate it to be intermediate between the Ranidae and the Rhacophoridae (p. 66).

This hypothesis disagrees in part with that of Laurent (1951b), who regarded the "Cornuferinae" as the ancestral stock of the rhacophorids. Although most species of the "Cornuferinae" are arboreal like rhacophorids, some specialized structures (e.g., the T-shaped terminal phalanges) and other characters indicate that it is not the immediate ancestor of the rhacophorids, and is more likely a distinct, specialized ranid lineage.

Since the greatest diversity of the rhacophorids is in the Oriental region and a relatively primitive genus, *Buergeria*, is at its periphery (Formosa and Riu Kiu Archipelago), the Orient is probably the center of origin for the Rhacophoridae, and the ancestral form was probably similar to *Mantidactylus*.

Consequently, *Mantidactylus* is a relict of a rhacophorid ancestral stock isolated in Madagascar. It is not certain, however, whether the ancestor of *Mantidactylus* reached Madagascar directly from the Orient or through Africa, but it is likely that *Mantidactylus* took the first route, because of the absence of closely-related groups in Africa, whereas a closely-related genus (*Pseudophilautus*) is known from India (Laurent, 1943b). This latter hypothesis is paralleled by the Dycophinae of the Microhylidae, which has one endemic genus (*Dycophus*) in Madagascar but is otherwise confined to the Orient (Parker, 1934). It is doubtful if Madagascar has ever had a land bridge with Asia (Darlington, 1957). Although there probably was

TABLE 9.—Distribution of the genera of the Rhacophoridae and Hyperoliidae. The numbers in the column headings refer to the following geographical areas: 1—Africa, 2—Seychelles Islands, 3—Madagascar, 4—Ceylon, 5—India, 6—Indochinese region (Burma to Indo-China), 7—South-west and south China, 8—Formosa, 9—Riu Kiu Islands and southern Japan, 10—Malay Peninsula, 11—Sumatra, 12—Borneo, 13—Philippine Islands, 14—Java, 15—Celebes, 16—Lesser Sunda Islands.

	1	2	3	4	5	6	7	8	9	10	11	12	13	14	15	16
Mantidactylus			+													
Mantella			+													
Gephyromantis			+													
Trachymantis			+													
Pseudophilautus				+												
Boophis			+													
Chiromantis	+															
Buergeria								+	+							
Philautus				+	+	+				+	+	+	+	+		
Theloderma										+	+					+
Hazelia										+	+	+	+			
Chirixalus																
Polypedates				+	+	+	+	+		+	+	+	+	+	+	+
Rhacophorus					+	+	+	+	+	+	+	+	+	+	+	+
Leptopelis	+															
Kassina	+															
Hylambates	+															
Cryptothylax	+															
Phlyetimantis	+															
Afrixalus	+															
Hyperolius	+															
Heterixalus			+													
Megalixalus		+														
Opisthothylox	+															
Acanthixalus	+															

no land connection these frogs might have reached Madagascar from Asia by other means, for example, waiving across the ocean.

Chiromantis apparently reached Africa from the Orient very recently, because of its great similarities to the specialized Oriental rhacophorid genus, *Rhacophorus* (fig. 57). This recent arrival is paralleled by the dispersal from Asia of some species of *Hylarana* to Africa (*H. albolabris*, *H. lemairei*, and *H. lepus*), probably during the Pliocene (Laurent, 1951b).

Boophis, which is sympatric and shares some primitive characters with *Mantidactylus*, probably evolved from the latter.

The distribution of contemporary Oriental rhacophorid genera indicates (Table 9) that the center of radiation is the Indochinese region.

The more advanced genera *Rhacophorus*, *Polypedates*, and *Philautus*, probably pushed the primitive genus, *Buergeria*, to the periphery of the rhacophorid range. Because of the large number of species

of advanced genera present in Borneo (Inger, 1966), it apparently was a secondary center of speciation.

Because some characters shared between the Astylosterninae and the Hyperoliidae, it appears that the Hyperoliidae were derived from Astylosterninae (Laurent, 1951b).

As for the Hyperoliidae, the dispersal pattern seems to be less complex (Table 9). Since this family evolved from African ranids, and the greatest diversity occurs in Africa, this continent is undoubtedly the center of origin of the Hyperoliidae. *Megalixalus* from the Seychelles and *Heterixalus* from Madagascar almost certainly have evolved from the African hyperoliids (Laurent, 1951b).

SYSTEMATIC ACCOUNTS

The following systematic accounts include synonymies, diagnoses and definitions, type-designations, distribution, and contents of taxa for families and genera treated.

RHACOPHORIDAE Hoffman

Ranae: Wagler, 1830: 199; Wiegmann, 1832: 200.

Hylae: Tschudi, 1838: 25, 27, 70 (part.).

Hylaeformes: Duméril and Bibron, 1841: 49 (part.); A. Duméril, 1853: 137 (part.); Duméril et al., 1854: 400 (part.).

Hylidae: Cantor, 1847: 1062 (part.).

Polypedatidae: Günther, 1858: 10 (part.); Mivart, 1869: 292 (part.); Hoffmann, 1873-1878: 646 (part.); Boettger, 1879: 41 (part.); 1881b: 540 (part.); Noble, 1931: 524 (part.); Ahl, 1931b: 1; Laevit, 1932: 78 (part.).

Ranidae: Cope, 1864: 189 (part.); 1865: 114 (part.); 1867: 198 (part.); Boulenger, 1882: 3 (part.); 1888a: 204 (part.); Thurston, 1888: 19 (part.); Boulenger, 1890: 435 (part.); Gadow, 1901: 237 (part.); Roux, 1905: 777 (part.); Stejneger, 1907: 92 (part.); 1910: 95 (part.); Boulenger, 1912: 226; Annandale, 1912: 7 (part.); Nicholls, 1916: 87; Taylor, 1921: 28 (part.); Noble, 1922: 22 (part.); 1924: 183 (part.); Ahl, 1923: 1 (part.); Smith, 1930: 92 (part.); Malendra, 1936: 746; Laurent, 1951b: 116, 119 (part.); Perret, 1966: 327 (part.).

Hylina: Hoffmann, 1873-1878: 646 (part.); Boettiger, 1881b: 497 (part.).

Bombinatorina: Hoffmann, 1873-1878: 633 (part.).

Raninae: Gadow, 1901: 238 (part.).

Dendrobatidae: Methuen and Hewitt, 1913: 57 (part.).

Rhacophoridae: Hoffmann, 1932: 562 (part.); Parker, 1934: 9 (part.); Bourret, 1937: 42; Laurent, 1941b: 86 (part.); Bourret, 1942: 407; Inger, 1954a: 370; Kirtisinghe, 1957: 53; Koba, 1958: 148; Taylor, 1962: 480; Loveridge, 1957: 314 (part.); Inger, 1966: 380, 381 (part.).

Rhacophorinae: Laurent, 1950a: 269; Laurent, 1951b: 119; Perret, 1966: 352.

Diagnosis and definitions.—The size of adult varies from two to a little over 10 cm. in snout-vent length; skin of body and limbs shagreen or warty as in *Theloderma*; in some genera skin of head co-ossified with skull; in many species of *Rhacophorus*, elaborate dermal ornamentations present, e.g., flap on forearm, heel, or dorsal to anal opening; digital tips distinctly dilated into discs, with digital pads usually completely surrounded by ventro-marginal groove; two outer metatarsals usually separated by web, except in *Philautus* and *Man-*

tidactylus; webbing of fingers variable but generally extensive; vocal pouches usually absent; gular gland always absent; vocal sacs present, except in *Philautus* and a few other rhacophorid species; nuptial pads present in males, except in *Philautus*; the pupil is always horizontal.

This family is characterized by pectoral girdle firmisternous; metasternum consisting of a bony style; base of omosternum generally forked; intercalary cartilage between two distal phalanges of fingers and toes always present; metacarpals usually dilated distally; a distinct bony knob usually present on disto-medial portion of metacarpal of third finger; a tiny bony knob generally present on proximo-lateral third of metacarpal of fourth finger; terminal phalanges either bifurcate or Y-shaped; first and second carpals and first centrale free, third, fourth, and fifth carpals and second centrale fused (*Mantidactylus* is an exception with the free third carpal bone); only first tarsal free, second, third, and fourth fused; sacral diapophysis cylindrical; vertebral column diplasiocoelous or procoelous; ratio of length of vertebral column to length of transverse process of eighth vertebra measured from tip to tip 1.0 to 2.4; ventro-posterior portion of sphenethmoid consisting of a continuous bone; dorsal exposure of sphenethmoid, which is anterior to frontoparietal, large; shape of nasal bones variable, being squash-shaped, club-shaped, or elongated; vomerine teeth present or absent; shape of frontoparietal bone variable, sometimes covered by a bony plate; alary process almost always present; anterior horn present or absent; posterior lateral process of hyoid skeleton always present; posterior lateral process of thyrohyal always present; cartilaginous stalk of thyrohyal always absent.

Usually M. petrohyoideus posterior consisting of three slips but only two in *Philautus*; insertion of external portion of geniohyoideus lateralis usually on posterior-lateral process; M. humerodorsalis consisting of two completely separated slips except in *Buergeria*, *Mantidactylus*, and some species of *Boophis*; third and fourth Tendo superficialis can slide through Aponeurosis palmaris; distal portion of M. palmaris longus splitting into three heads, two joining third and fourth Tendo superficialis; except in *Mantidactylus*, only most lateral head of M. palmaris longus inserting on Aponeurosis palmaris; M. adductor longus absent, except in *Buergeria*, *Mantidactylus*, and *Boophis*; M. extensor digitorum communis longus of foot usually consisting of one slip which inserts on disto-dorsal site of metatarsal of fourth toe.

Usually Wolffian duct convoluted; bottle-shaped vesicula seminalis present only in *Philautus*.

Tadpoles have sinistral spiracle and usually a dextral anal opening (the median anal opening in *Hazelia* Taylor and *Theلودerma moloch* Annandale are exceptions); the number of labial tooth rows is variable, but three uninterrupted rows on the lower lip are generally present.

Remarks.—The number of eggs in a clutch varies from six to 12 in *Philautus* and to 200 in *Polypedates*. In *Polypedates* and *Rhacophorus* the eggs are deposited in a foamy nest and attached to vegetation over water.

Distribution.—In the Oriental region: Ceylon, India, Burma, Thailand, Indo-China, Southeast and south China, Hainan, Formosa, Riu Kiu Archipelago, Kiu Shiu, Hondo, Malay Peninsula, Sumatra, Borneo, Java, Bali, Celebes, the Lesser Sunda Islands as far as Timor and the Philippine Islands. In the Ethiopian region: African tropics and Madagascar.

Type genus.—*Rhacophorus* Kuhl and van Hasselt, by subsequent designation of Wolf, 1936.

Contents.—*Mantidactylus* Boulenger, **Gephyromantis* Methuen, **Trachymantis* Methuen, *Mantella* Boulenger, **Pseudophilautus* Laurent, *Boophis* Tschudi, *Buergeria* Tschudi, *Chirromantis* Peters, *Philautus* Gistel, *Theلودerma* Tschudi, *Hazelia* Taylor, *Chirixalus* Boulenger, *Polypedates* Tschudi, and *Rhacophorus* Kuhl and van Hasselt.

Mantidactylus Boulenger

Limnodytes: A. Duméril, 1853: 154; Duméril et al., 1854: 401; Boettger, 1880: 282; 1881b: 497.

Hylarana: Günther, 1858: 71 (part.).

Rana: Boulenger, 1881: 360; 1882: 6.

Rhacophorus: Boulenger, 1882: 73.

Mantidactylus: Boulenger, 1895: 450; Roux, 1905: 780; Methuen and Hewitt, 1913: 50; Boulenger, 1919: 353; Ahl, 1927: 471; 1931b: 10; Laurent, 1943a: 1; Guibé, 1948: 235.

Diagnosis and definition.—Small to large-sized rhacophorids (snout-vent length 3–10 cm.); skin of body and limbs smooth or shagreen; skin of head never co-ossified to skull; dermal ornamentation usually absent; distal segment of the digits slightly dilated;

* The asterisk means genera not examined.

digital pad surrounded by ventro-marginal groove; fingers free; toes webbed.

Omosternum forked at the base; metasternum a short, narrow, bony style; neuropophysis of eighth vertebra moderately broad, attaching on the lateral portion of centrum; ventral column diplasio-coelous and moderately long; nasal bones club-shaped; dorsal exposure of sphenethmoid narrow; frontoparietal rectangular; vomerine teeth present, forming a small cluster; vomerine odontophore touching palatine bone; metacarpals not dilated distally; bony knob on the disto-medial portion of third finger absent; terminal phalanges bifurcated; third carpal free; usually second tarsale free.

M. humerodorsalis consists of one main slip which splits distally into three smaller slips, i.e., second, third, and fourth phalangeal and short fourth metacarpal slip; third and fourth Tendo superficialis not able to slide through Aponeurosis palmaris, originating from it; distal third of the *M. palmaris longus* divided into two; *M. extensor radialis accessorius lateralis* moderately large; *M. extensor digitorum communis longus* consisting of one slip inserting on distal portion of metatarsal of fourth toe or if two slips are present, they insert on metacarpal of third and fourth toe; *M. petrohyoideus posterior* consisting of three slips; anterior horn present; alary process present.

Wolffian ducts not convoluted; vesicula seminalis absent.

Vocal pouches absent; nuptial pads present in males; femoral glands present in many species of this genus.

The tadpoles with sinistral spiracle and dextral opening. Of the known tadpoles the upper labial teeth rows vary, but the teeth on the lower labial always consists of three rows: I,4/III (*Mantidactylus betsileanus*), I,2/III (*M. curtus*), and I/III (*M. alutus*) (Arnoult and Razarihelisoa, 1967).

Remarks.—The reproductive behavior is unknown. This genus apparently is the most primitive among the rhacophorids because of the presence of the following primitive character states, i.e., the presence of the second, third, and fourth phalangeal slips of the *M. humerodorsalis*, the third and fourth Tendo superficialis are unable to slide through the aponeurosis palmaris, the presence of the *M. adductor longus*, and the free second tarsale.

Distribution.—Madagascar and surrounding islands.

Type species.—*Mantidactylus guttulatus* Boulenger, by subsequent designation of Ahl (1931b).

Content.—*Mantidactylus aeruminalis* (Peracca), *M. albofrenatus* (F. Müller), *M. asper* (Boulenger), *M. betsileanus* (Boulenger), *M. biporus* (Boulenger), *M. frenatus* (Boettger), *M. guttulatus* (Boulenger), *M. lugubris* (A. Duméril), *M. luteus* Methuen and Hewitt, *M. madagascariensis* (A. Duméril), and *M. ulcerosus* (Boettger).

Boophis Tschudi

Boophis: Tschudi, 1838: 36, 76; Laurent, 1943b: 438; Guibé, 1947: 438.

Elophila: Duméril and Bibron, 1841: 515.

Polypedates: Duméril and Bibron, 1841: 517 (part.); A. Duméril, 1853: 156 (part.); Duméril et al., 1854: 401 (part.); Günther, 1858: 77; Peters, 1871b: 644; Hoffmann, 1873–1878: 647; Boettger, 1879: 41 (part.); 1881a: 47; 1881b: 505.

Rhacophorus: Hoffmann, 1873–1878: 648; Peters, 1874: 618; Boulenger, 1882: 73 (part.); Boettger, 1893: 14 (part.); Gadow, 1901: 245 (part.); Methuen and Hewitt, 1913: 53; Ahl, 1927a: 478 (part.); 1928: 311; 1931b: 51 (part.).

Hylambates: Boettger, 1881a: 47; 1881b: 514 (part.).

Diagnosis and definition.—Small to moderate size rhacophorids (snout-vent length between 2.5 and 7.5 cm.); skin of body and limbs smooth or shagreen; skin of head never co-ossified to skull; usually no dermal ornamentations; digital discs moderately large; digital pad completely surrounded by ventro-marginal groove; fingers between one-third and three-fourths webbed; toes half to fully webbed.

Omosternum forked at base; neuropophysis of eighth vertebra broad; vertebral column procoelous and moderately long; nasal bones variable, spindle-shaped, squash-shaped, or triangular; dorsal exposure of the sphenethmoid narrow; frontoparietal rectangular; vomerine teeth forming a small cluster; vomerine odontophore usually touching palatine bones; metacarpals not dilated distally; bony knob on disto-medial portion of metacarpal of third finger absent; terminal phalanges bifurcate.

M. humerodorsalis consists of two completely separated slips, inserting on metacarpal of third and fourth finger; sometimes it consists of four slips, i.e., second, third, and fourth phalangeal and short fourth metacarpal slip; M. extensor radialis accessorius lateralis moderately large; M. adductor longus present or absent; M. extensor digitorum communis longus consisting of either one slip inserting on the distal portion of metatarsal of fourth toe or two slips inserting on metatarsal of third and fourth toe; M. petrohyoideus posterior consisting of three slips; anterior horn absent; alary process present or absent.

Wolffian duct in males convoluted; bottle-shaped vesicula seminalis absent.

Vocal pouches absent; nuptial pads present in males. The reproductive behavior is unknown; tadpoles are unknown.

Remarks.—The presence of convoluted Wolffian ducts in the males indicates that foam nests similar to those of *Polypedates* and *Rhacophorus* may be produced.

Distribution.—Madagascar and surrounding islands.

Type species.—*Boophis goudoti* Tschudi, by monotypy.

Content.—*Boophis bicalcaratus* (Boettger), **B. goudoti* Tschudi, **B. madagascariensis* (Peters), **B. rhodoscelis* (Boulenger), and *B. tephraeomystax* (A. Duméril).

Buergeria Tschudi

Hyla: Siebold, 1838: 113 (part.); Schlegel, 1837–1844: 13 (part.); Leydig, 1876: 168 (part.).

Bürgeria: Tschudi, 1838: 34, 75 (part.).

Polypedates: Duméril and Bibron, 1841: 517 (part.); A. Duméril, 1853: 156 (part.); Duméril et al., 1854: 401 (part.); Günther, 1858: 77 (part.); Hallowell, 1860: 501; Hoffmann, 1873–1878: 647 (part.); Stejneger, 1907: 143 (part.); Okada, 1931: 202 (part.).

Dendricus: Gistel, 1848: 8 (part.).

Rana: Boulenger, 1882: 6; Okada, 1891: 6 (part.); Boulenger, 1892: 302.

Rhacophorus: Boulenger, 1882: 72 (part.); Boettger, 1893: 14 (part.); Gadow, 1901: 245 (part.); Ahl, 1931b: 51 (part.); Wolf, 1936: 147 (part.); Bourret, 1942: 408 (part.); Inger, 1947: 337.

Ixalus: Hallowell, 1860: 50 (part.); Okada, 1891: 66.

Diagnosis and definition.—Species of this genus are moderately large to small, with a range of 4–8 cm. in snout-vent length; form of body like *Rana*; skin of body and limbs smooth; no dorsal ornamentations; digital tips moderately dilated and transverse groove sometimes distinct; feet fully webbed; fingers up to half webbed.

Omosternum not or only slightly forked at base; neuropophysis of eighth vertebra moderately broad, attaching on lateral portion of centrum; vertebral column diplasiocoelous and moderately long; nasal squash-shaped or slightly triangular; dorsal exposure of sphenethmoid moderately large; fronto-parietal trapezoidal; vomerine teeth present; distal end of metacarpal only slightly dilated; bony knob on distomedial portion of metacarpal of third finger small; terminal phalanges bifurcate.

* The asterisk denotes species not examined.

Distal slips of *M. humerodorsalis* consisting of second, third, and fourth metacarpal and fourth phalangeal slip; third and fourth Tendo superficialis able to slide through Aponeurosis palmaris; *M. extensor radialis accessorius lateralis* moderately large and usually slightly larger in males; *M. adductor longus* always present; metacarpal slip of *M. extensor digitorum communis longus*, which inserts on fourth toe present; *M. petrohyoideus posterior* consisting of three slips; only medial branch of anterior horn present; alary process present.

Wolffian duct simple; bottle-shaped vesicula seminalis absent. Vocal pouches absent; nuptial pads present in males.

The tadpole with sinistral spiracle and dextral anal opening. The labial teeth formula is I,3/III in *Buergeria robustus* and II,4/1,III in *B. buergeri* (Okada, 1931).

The life habits and breeding behavior are unknown.

Remarks.—The habitus of the species resembles *Rana*. At one time *Buergeria buergeri* was placed in the genus *Rana* (Boulenger, 1882). Probably *Rhacophorus oxycephalus* Boulenger and *Rhacophorus tonkinensis* Ahl should also be assigned to *Buergeria*.

Distribution.—Formosa, Riu Kiu Archipelago, and Kiu Shiu Island.

Type species.—*Bürgeria subversicolor* Tschudi (= *Hyla bürgeri* Schlegel). (Recommendation 69B/2/ of the International Code of Zoological Nomenclature.)

Content.—*Buergeria japonica* (Hallowell), *B. pollicaris* (Werner), *B. robustus* (Boulenger), and *B. buergeri* (Schlegel).

Chiromantis Peters

Chiromantis: Peters, 1855: 56; Günther, 1858: 84; Cope, 1865: 116; Hoffmann, 1873–1878: 648; Buchholz and Peters *in* Peters, 1875: 203; Boulenger, 1882: 92; 1888a: 204; Boettger, 1893: 16; Gadow, 1901: 244; Roux, 1905: 784; Nieden, 1910: 52; Werner, 1922: 62; Ahl, 1923: 7; Noble, 1924: 228; Ahl, 1929b: 127; 1930b: 219; 1931a: 211; 1931b: 38; Laurent, 1941b: 88; Loveridge, 1957: 314; Perret, 1966: 352; Schiøtz, 1967: 21.

Polypedates: Günther, 1868: 485 (part.).

Leptopelis (nec Boulenger): Romer, 1953: 123.

Diagnosis and definition.—A moderately large rhacophorid, with a snout-vent length of 3.5–8 cm.; skin of body and limbs shagreen to smooth; skin of head never co-ossified to skull; dermal ornamentation absent; distal segment of fingers and toes dilated into a disc; digital pad surrounded by ventromarginal groove anteriorly; a transverse

groove across digital pad posteriorly; two inner fingers usually one-third webbed, two outer ones between one-half and two-thirds webbed; webbing giving an impression that two inner are opposable to two outer fingers; toes fully webbed.

Omosternum forked at base; neuropophysis of eighth vertebra moderately large; vertebral column diplasiocoelous; nasal bone squash-shaped; dorsal exposure of sphenethmoid extensive; frontoparietal rectangular, or slightly wider at anterior end; vomerine teeth always present; metacarpal dilated distally; bony knob on disto-medial portion of metacarpal of third finger moderately large; terminal phalanges bifurcate.

M. humerodorsalis consisting of two completely separated slips, inserting on metacarpal of third and fourth finger; M. extensor radialis accessorius lateralis moderately large; M. extensor digitorum superficialis of first finger absent; M. adductor longus absent; usually only one slip of M. extensor digitorum communis longus present, inserting on distal end of metacarpal of fourth toe; M. petrohyoideus posterior consisting of three slips; M. cutaneous pectoris moderately thick; anterior horn usually arch-shaped; alary process present.

Wolffian ducts in males always convoluted; bottle-shaped vesicula seminalis absent.

Vocal pouches absent; nuptial pads present in males. The tadpoles have sinistral spiracle and dextral anal opening. The labial teeth formula in *Chiromantis rufescens* is as follows: I,1/III or I,4/1,II (Lamotte and Perret, 1963a).

Remarks.—Species in which the reproductive behavior is known make foam nests for the eggs; these nests are formed by beating the gelatinous secretion with the hind legs while the pair is in amplexus; foam nests are deposited on vegetation over water bodies.

Distribution.—In the African tropics.

Type species.—*Chiromantis xerampelina* Peters, by monotypy.

Content.—*Chiromantis kelleri* Boettger, *C. petersi* Boulenger, *C. rufescens* (Günther), and *C. xerampelina* Peters.

Philautus Gistel

Hyla: Kuhl and van Hasselt, 1822: 104 (part.); Schlegel, 1837–1844: 13 (part.).

Orchestes: Tschudi, 1838: 76.

Ixalus: Duméril and Bibron, 1841: 523; Duméril, 1853: 153; Duméril et al., 1854: 402; Günther, 1864: 432; Cope, 1865: 116; 1868: 484; Hoffmann, 1873–1878: 646 (part.); Boulenger, 1882: 93 (part.); 1890: 481 (part.); Thurston,

1888: 33 (part.); Boettger, 1893: 17 (part.); Gadow, 1901: 241 (part.); Boulenger, 1912: 252 (part.); Annandale, 1917: 109.

Philautus: Gistel, 1848: 10; Taylor, 1922: 96 (part.); Van Kampen, 1923: 268 (part.); Smith, 1930: 115 (part.); Ahl, 1931b: 63 (part.); Bourret, 1942: 450 (part.); Inger, 1954a: 393 (part.); Smith, 1953: 477; Kirtisinghe, 1957: 68 (part.); Taylor, 1962: 522 (part.); Inger, 1966: 340 (part.).

Rhacophorus: Boulenger, 1882: 73 (part.); Ahl, 1931b: 52 (part.); Wolf, 1936: 147 (part.); Inger, 1954a: 370 (part.).

Nyctixalus: Roux, 1905: 782; Annandale, 1917: 110.

Polypedates: Taylor, 1921: 80 (part.).

Diagnosis and definition.—Small robust rhacophorids, which are usually 2–3 cm. in snout-vent length; skin of body and limbs shagreened; pupil horizontal; digital discs distinct; digital pads completely surrounded by an oval groove; fingers free or with rudimentary web at base; toes up to half-webbed; two outer metatarsals not separated by web.

Usually omosternum not forked at base; metasternum a short bony stylus, 0.8–1.0 the length of coracoid; vertebral column procoelous; vertebral column very short; neuropophysis of vertebra very broad, attaching on ventro-lateral portion of centrum. Nasal usually club-shaped and sometimes squash-shaped; sphenethmoid exposure large; frontoparietal trapezoidal; vomerine teeth usually absent, present in some species groups; vomerine odontophore always present; terminal phalanges simple or bifurcate, never Y-shaped.

M. humerodorsalis consisting of two completely separated slips; muscular slip which joins fourth Tendo superficialis consisting of one slip arising from medial half of *M. palmaris longus* or two slips joining together which arise from both medial and lateral halves of *M. palmaris longus*; *M. extensor radialis accessorius lateralis* moderately large; *M. adductor longus* always absent; one slip of *M. extensor digitorum communis longus* present, inserting on distal portion of metatarsal of fourth toe; *M. submaxillaris ventralis* distinct from *M. dentomentalis* and from remaining *M. submaxillaris*; external slip of *M. geniohyoideus lateralis* inserting either on posterior lateral process or on membrana thyroideus; *M. petrohyoideus posterior* usually consisting of two slips, rarely of three slips; anterior horn usually consisting of medial and lateral branches which sometimes form a complete arch; alary process always blade-shaped; vocal pouches absent; nuptial pads usually absent; Wolffian duct always simple; bottle-shaped vesicula seminalis usually present.

In the tadpole of *Philautus hosei*, the larval oral apparatus, the gills, and operculum are lacking (Inger, 1966).

Remarks.—Species of this genus live in shrubs and low vegetation in tropical rainforest, sometimes quite far from water. The reproductive habits are unknown. Since species of this genus have very large eggs and only small clutches (from six to 12 eggs in a clutch), probably they are deposited directly on vegetation as in *Philautus hosei* (Inger, 1966).

Species are usually gray with dark markings on body and limbs; a dark X-shaped pattern usually present on the dorsum.

Distribution.—India, Ceylon, Burma, Thailand, Indo-China, Malay Peninsula, Sumatra, Borneo, Java, Bali, and in smaller islands adjacent to the Greater Sunda Islands, Mindanao, Sulu archipelago, Leyte, Palawan, Mindanao, Luzon, Pollilo, and in some adjacent smaller islands.

Type species.—*Philautus aurifasciatus* (Kuhl and van Hasselt), by monotypy.

Content.—*Philautus acutirostris* (Peters), *P. aurifasciatus* (Kuhl and van Hasselt), *P. emembranatus* (Inger), *P. glandulosus* (Jerdon), *P. hosei* (Boulenger), *P. leucorhinus* (Lichtenstein and Mertens), *P. lissobrachiatus* (Inger), *P. nasutus* (Günther), *P. parvulus* (Boulenger), *P. schmackeri* (Boettger), *P. surdus* (Peters), and *P. woodi* Stejneger.

Theloderma Tschudi

Hyla: Schlegel, 1837–1844: 13 (part.); 1857: 55 (part.).

Theloderma: Tschudi, 1838: 32, 73; Taylor, 1962: 509.

Rana: Boulenger, 1882: 6 (part.).

Polypedates: Günther, 1887: 315; Stejneger, 1907: 143 (part.).

Ixalus: Boulenger, 1890: 481 (part.); Boettger, 1893: 17 (part.); Boulenger, 1912: 252 (part.).

Phrynoderma: Boulenger, 1893: 341; Gadow, 1901: 241; Roux, 1905: 780; Ahl, 1931b: 60.

Rhacophorus: Boulenger, 1912: 247 (part.); Van Kampen, 1923: 242 (part.); Ahl, 1927b: 35 (part.); Smith, 1930: 111 (part.); Ahl, 1931a: 107 (part.); 1931b: 51 (part.); Wolf, 1936: 147 (part.); Bourret, 1942: 408 (part.).

Philautus: Smith, 1930: 115 (part.); Ahl, 1931b: 63 (part.); Bourret, 1942: 450 (part.); Kirtisinghe, 1957: 68 (part.).

Diagnosis and definition.—Medium to large oriental rhacophorids (3–6 cm. in snout-vent length), with numerous large or small, and sometimes calcified, warts on body and limbs; fingers webbed at base or up to half webbed.

Omosternum moderately forked at base; vertebral column procoelous and moderately long; vomerine teeth present or absent; terminal phalanges Y-shaped.

M. humerodorsalis consisting of two completely separated slips; M. extensor radialis accessorius lateralis slender and originating from crista ventralis humeri; M. adductor longus absent; usually two slips of M. extensor digitorum communis longus present, inserting on distal metacarpal of third and fourth toe; sometimes a slip to fourth toe present.

The labial teeth formula in tadpoles is 3/III in *Theلودerma horridum* (Bourret, 1942).

Remarks.—Apparently this genus is closely related to *Hazelia*. Taylor (1962) reported that some species of this genus have similar reproductive behavior; small numbers of eggs (4–8) are placed above water-filled cavities or holes in tree trunks; and the tadpoles develop in these water pockets. The warty skin of the body and limbs and the skin of the head which is co-ossified to the skull are similar to *Hazelia*.

Distribution.—Burma, Thailand, Indochina, Malay Peninsula, and Sumatra.

Type species.—*Theلودerma leporosa* (S. Müller), by monotypy.

Content.—**Theلودerma asperum* (Boulenger), **T. bicolor* Bourret, **T. corticalis* Boulenger, *T. gordonii* Taylor, **T. horridum* (Boulenger), **T. leporosa* (S. Müller), **T. schmardanus* (Kelaart), and *T. stellatum* Taylor.

Chirixalus Boulenger

Ixalus: Boulenger, 1890: 481 (part.).

Chirixalus: Boulenger, 1893: 340; Roux, 1905: 780; Annandale, 1915: 345; Ahl, 1931b: 103 (part.); Bourret, 1942: 472.

Rana: Boettger, 1895: 267.

Philautus: Bourret, 1942: 450 (part.); Taylor, 1962: 522 (part.).

Rhacophorus: Ahl, 1931b: 51 (part.).

Polypedates: Okada, 1931: 202 (part.).

Diagnosis and definition.—Medium-sized, slender oriental rhacophorids (from 3–4 cm. in snout-vent length); skin of body and limbs smooth; pupil horizontal; two inner fingers free; two outer ones two-thirds to three-fourths webbed; consequently two outer fingers appearing to be opposable to the two inner ones; toes extensively webbed.

Omosternum moderately forked at base; metasternum a long bony stylus; vertebral column procoelous and relatively elongate;

* The asterisk denotes species not examined.

nasal squash-shaped; frontoparietal rectangular or dilated anteriorly; vomerine teeth absent; sacral diapophysis cylindrical; terminal phalanges bifurcate.

M. humerodorsalis consisting of two completely separated slips; muscular slip which joins the fourth Tendo superficialis branching off medial half of *M. palmaris longus* or from two slips, fused into one, branching off from the medial or lateral half of *M. palmaris longus*; *M. extensor radialis accessorius lateralis* very slender, originating from crista-ventralis humeri, inserting either on distal portion of *M. external radialis superficialis* or on radio-ulna; *M. adductor longus* absent; only metatarsal slip of *M. extensor digitorum communis longus* inserting on fourth toe; *M. dento-mentalis* fan-shaped; *M. geniohyoideus lateralis* inserting on posterior lateral process; anterior horn forming an arch or consisting of medial and lateral branches; alary process absent; vocal pouch forming a loose wrinkle of skin on throat; Wolffian duct convoluted; vesicula seminalis absent.

Labial tooth formula of tadpoles is I,4/III (*Chirixalus doriae* Boulenger) or II,3/III (*Chirixalus vittatus*) (Bourret, 1942).

Remarks.—Species of this genus are arboreal, living in trees or shrubs. Only *Chirixalus vittatus* is known to build the characteristic *Rhacophorus* foamy nest.

Distribution.—Assam, Burma, Thailand, Indochina, Hainan, and Formosa.

Type species.—*Chirixalus doriae* Boulenger, by original designation.

Content.—*Chirixalus doriae* Boulenger, *C. eiffingeri* (Boettger), *C. hansenae* (Cochran), **C. laevis* (Smith), *C. nongkhorensis* (Cochran), **C. simus* Annandale, and *C. vittatus* (Boulenger).

Hazelia Taylor

Ixalus: Peters, 1871a: 580 (part.); Boulenger, 1882: 93 (part.); 1912: 252 (part.).

Hazelia: Taylor, 1920: 292; 1921: 93; 1962: 503.

Rhacophorus: Smith, 1927: 213 (part.); Ahl, 1931b: 251 (part.); Wolf, 1936: 147 (part.).

Philautus: Ahl, 1931b: 63 (part.); Bourret, 1942: 450 (part.); Inger, 1954a: 393 (part.); 1966: 340 (part.).

Diagnosis and definition.—Medium-sized Asiatic rhacophorids (3–4 cm. in snout-vent length); body and limbs with numerous spiny tubercles; skin of head co-ossified to skull; canthus rostralis sharp; two well-defined bony ridges from canthus rostralis to occiput,

* Names preceded by asterisk represent species not examined in this study.

these ridges lateral edges of frontoparietal which are slightly elevated; fingers free or webbed at base; vocal sacs always absent.

Omosternum only slightly forked at base; vertebral column procoelous and moderately long; nasal squash-shaped; frontoparietal rectangular covered by a bony plate down to squamosal, consequently sutures not distinct (fig. 29); vomerine teeth absent; terminal phalanges Y-shaped.

M. humerodorsalis consisting of two completely separated slips; M. extensor radialis accessorius lateralis very slender and originating from crista ventralis of humerus; M. adductor longus absent; only two slips of M. petrohyoideus posterior present; anterior horn absent.

Anal opening in tadpoles median. The labial teeth formula in tadpoles is II,3/III in *Hazelia picta* (Inger, 1966).

Remarks.—*Hazelia picta* has a unique reproductive behavior; eggs are covered by gelatinous substance and deposited on the walls of water-filled tree holes (Taylor, 1962; Inger, 1966); apparently tadpoles develop in these water pockets. Foam nests are not formed in this species, as suggested by the absence of convoluted Wolffian ducts in males. Probably *Phrynoderma moloch* Annandale should also be placed in the genus *Hazelia* because of the median anal opening of the tadpoles (Annandale, 1912; Ahl, 1931b), but this needs further study.

Distribution.—Thailand, Malay Peninsula, Sumatra, Mentawai Islands, Borneo, Mindanao, and Basilan.

Type species.—*Hazelia spinosa* Taylor, by original designation.

Content.—*Hazelia anodon* (van Kampen), **H. flavosignatus* (Boettger), *H. picta* (Peters), and *H. spinosa* Taylor.

Polypedates Tschudi

Hyla: Boie in Gravenhorst, 1829: 26 (part.); Schlegel, 1837–1844: 13 (part.); Wiegmann, 1832: 260 (part.); Daudin, 1840: 18 (part.); Barbour, 1912: 127 (part.); Barbour, 1920: 98.

Bürgeria: Tschudi, 1838: 34 (part.).

Polypedotes (sic): Tschudi, 1838: 34 (part.).

Polypedates: Tschudi, 1838: 75; Duméril and Bibron, 1841: 519 (part.); Cantor, 1847: 1063; A. Duméril, 1853: 156 (part.); Duméril et al., 1854: 401 (part.); Günther, 1858: 77 (part.); 1864: 427 (part.); 1868: 485 (part.); Hoffmann, 1873–1878: 647 (part.); Boettger, 1879: 41 (part.); Stejneger, 1907: 143 (part.); Taylor, 1921: 80 (part.); Noble, 1931: 525 (part.); Okada, 1931: 202 (part.).

* The asterisk denotes species not examined.

Trachyhyas: Fitzinger, 1843: 31 (part.).

Rhacophorus: Duméril and Bibron, 1841: 530; Boulenger, 1882: 73 (part.); Thurston, 1888: 29 (part.); Boulenger, 1890: 470 (part.); Boettger, 1893: 14 (part.); Gadow, 1901: 245 (part.); Boulenger, 1912: 247 (part.); Van Kampen, 1923: 242 (part.); Ahl, 1927b: 35 (part.); Smith, 1927: 123 (part.); 1930: 111 (part.); Okada, 1931: 178 (part.); Ahl, 1931b: 51 (part.); Wolf, 1936: 147 (part.); Bourret, 1942: 408 (part.); Liu, 1950: 359; Inger, 1954a: 370 (part.); Kirtsinghe, 1957: 54 (part.); Taylor, 1962: 522 (part.); Inger, 1966: 279 (part.).

Diagnosis and definition.—Species of this genus are moderately to very large, ranging from 5.0 to 10.0 cm. in snout-vent length. Skin of body and limbs smooth or shagreen; in many species skin of skull co-ossified to either frontoparietal, nasal and/or squamosal bones; except for pointed tarsal flap in *Polypedates eques*, elaborate dermal ornamentations absent; digital discs large; usually fingers only webbed at base but sometimes two-thirds webbed; nuptial pads always present in males.

Omosternum slightly forked at base; neuropophysis of the eighth vertebra moderately broad, attaching on dorsolateral portion of centrum; anterior portion of frontoparietals broader than posterior portion; in many species secondary dermal plates present; these plates may cover only the frontoparietal or extend to lateral edges of squamosal bone (*Polypedates ottilophus*); in some species a parieto-squamosal arch behind the skull present (*Polypedates cruciger*); vomerine teeth always present; distal end of metacarpal distinctly dilated; bony knob on distal metacarpal of third digit large; terminal phalanges of fingers and toes Y-shaped.

The M. adductor longus is absent. M. humerodorsalis consists of two completely separated slips; M. extensor radialis accessorius lateralis moderately large; M. adductor longus absent; M. extensor digitorum superficialis present; only one slip of M. extensor digitorum communis longus present, inserting on distal portion of metacarpal of fourth toe; M. petrohyoideus posterior consisting of three slips; M. cutaneous pectoris muscular; anterior horn usually absent; alary process blade-shaped.

Wolffian duct always convoluted; bottle-shaped vesicula seminalis absent.

The tadpoles have a sinistral spiracle and dextral anal opening. Teeth on upper lip vary from four to six rows, on lower lip almost always three uninterrupted rows. The labial teeth formula in tadpoles is I,4/III in *Polypedates cruciger* (Kirtsinghe, 1957), I,3/III in *P. ottilophus* (Inger, 1966).

Remarks.—All species in which the breeding habit is known deposit a large number of small eggs (up to 200 eggs) in foam nests attached to vegetation over water.

Color of adult of many species is gray, usually with dark hour-glass marking on the dorsum; a dark transverse bar across the head is usually present.

Polypedates leucomystax (Boie) is the most common species in the Orient. Almost all species of this genus are arboreal.

Distribution.—Ceylon, India, Burma, Thailand, Indochina, Formosa, Southwest and South China, Hainan, Malay Peninsula, Sumatra, Borneo, Celebes, Java, Lesser Sunda Islands as far as Timor and the Philippine Islands.

Type species.—*Polypedates leucomystax* Tschudi, by subsequent designation of Stejneger, 1907.

Content.—*Polypedates bambusicola* (Barbour), *P. colletti* Boulenger, *P. cruciger* (Blyth), *P. dennysi* (Blanford), *P. dugritei* David, *P. eques* Günther, *P. feae* (Boulenger), *P. leucomystax* (Boie), *P. macrotis* (Boulenger), *P. maculatus* (Gray), *P. omeimontis* Stejneger, and *P. otitophus* (Boulenger).

Rhacophorus Kuhl and van Hasselt

Rhacophorus: Kuhl and van Hasselt, 1822: 104; Tschudi, 1838: 23, 73; Duméril and Bibron, 1841: 503; Duméril, 1853: 153; Duméril et al., 1854: 403; Günther, 1858: 82; Günther, 1864: 435; Hoffmann, 1873–1878: 648 (part.); Boulenger, 1882: 73 (part.); Thurston, 1888: 29 (part.); Boulenger, 1890: 470 (part.); Boettger, 1893: 14 (part.); Gadow, 1901: 245 (part.); Boulenger, 1912: 247 (part.); Van Kampen, 1923: 242 (part.); Ahl, 1927b: 35 (part.); Smith, 1927: 213 (part.); 1930: 111 (part.); Ahl, 1931b: 51 (part.); Okada, 1931: 178 (part.); Wolf, 1936: 147 (part.); Bourret, 1942: 408 (part.); Brongersma, 1942: 341; Laurent, 1943b: 7 (part.); Inger, 1947: 337 (part.); 1954a: 370 (part.); 1954b: 250; Taylor, 1962: 480 (part.); Inger, 1966: 279 (part.).

Hypsiboas: Wagler, 1830: 200 (part.).

Hyla: Wiegmann, 1832: 201 (part.); Schlegel, 1837–1844: 13 (part.).

Leptomantis: Peters, 1867: 32; Hoffmann, 1873–1878: 649.

Ixalus: Boulenger, 1882: 93 (part.).

Hylambates: Boulenger, 1882: 132 (part.).

Polypedates: Stejneger, 1907: 143 (part.); Taylor, 1921: 80 (part.); Noble, 1931: 525 (part.).

Philautus: Taylor, 1922: 96 (part.); Van Kampen, 1923: 268 (part.); Smith, 1930: 115 (part.); Ahl, 1931b: 63 (part.); Bourret, 1942: 450 (part.); Inger, 1954: 393 (part.); Taylor, 1962: 522 (part.); Inger, 1966: 340 (part.).

Chirixalus: Ahl, 1931b: 103 (part.); Bourret, 1942: 412 (part.).

Diagnosis and definition.—Moderately small to very large rhacophorid frogs (3–10 cm. in snout-vent length); snout usually rounded;

body usually slender with narrow waist; skin of head never co-ossified to skull; dermal ornamentations such as flaps on forearm, tarsus, heel, or above anus usually present in most species; digital discs large; digital pad completely surrounded by ventro-marginal groove; in most species fingers fully webbed; toes fully webbed.

Omosternum forked at base; neuropophysis of eighth vertebra moderately broad attaching on lateral portion of centrum; vertebral column procoelous and moderately long; nasal bones squash-shaped; dorsal exposure of sphenethmoid extensive; fronto-parietal broader at its anterior end; vomerine teeth usually present; metacarpals dilated distally, bony knob on disto-medial portion of metacarpal of third finger large, and the one on the proximo-lateral third of metacarpal of fourth digit usually very distinct; terminal phalanges Y-shaped.

M. humerodorsalis consisting of two completely separated slips, inserting on metacarpal of third and fourth finger; M. extensor radialis accessorius lateralis very narrow, originating from crista ventralis humeri and running diagonally across the plane between lower and upper arm and inserting on distal end of either radio-ulna or M. extensor radialis superficialis. M. adductor longus absent; M. extensor digitorum superficialis of first finger absent; one slip of M. extensor digitorum communis longus present, inserting on distal metacarpal of fourth toe; M. petrohyoideus posterior consisting of three slips; M. cutaneous pectoris a thin muscular layer; usually anterior horn absent; alary process present, usually blade-shaped.

Wolffian ducts in males always convoluted; bottle-shaped vesicula seminalis absent.

Vocal pouches absent; nuptial pads present in males.

Tadpoles of species of this genus have a sinistral spiracle and dextral anal opening; the upper labial teeth vary from three to seven rows, whereas the lower labial teeth usually consist of three uninterrupted rows. For example, I,5/III in *Rhacophorus reinwardti* (Van Kampen, 1910), II,4/1,II in *R. pardalis* (Inger, 1966).

Remarks.—Species of this genus in which the reproductive behavior is known build foamy nests for the eggs; these foam nests are formed by beating the gelatinous secretion with the hindlegs while the pair is in amplexus; usually foam nests are attached to vegetation over water.

Although *Rhacophorus everetti* Boulenger, *Rhacophorus microtympanum* (Günther), and *Rhacophorus appendiculatus* (Günther) differ

from members of *Rhacophorus* in many characters, I temporarily place them in this genus, until further studies reveal their affinity; I suspect these species are related to members of *Theلودerma*.

Generally, species of *Rhacophorus* are either greenish or brownish, sometimes with dark markings.

Distribution.—India, Burma, Thailand, Indochina, Formosa, Riu Kiu Archipelago, Japan, Malay Peninsula, Sumatra, Borneo, Philippine Islands, Java, and Celebes.

Type species.—*Rhacophorus reinwardti* Kuhl and van Hasselt, by subsequent designation of Wolf, 1936.

Content.—*Rhacophorus baluensis* Inger, *R. bimaculatus* Boulenger, *R. bipunctatus* Ahl, *R. dulitensis* Boulenger, *R. fasciatus* Boulenger, *R. gauni* (Inger), *R. harrissoni* Inger and Haile, *R. javanus* Boettger, *R. moltrechti* Boulenger, *R. malabaricus* Jerdon, *R. maximus* Günther, *R. nigropalmatus* Boulenger, *R. pardalis* Günther, *R. reinwardti* Kuhl and van Hasselt, *R. robinsoni* Boulenger, *R. rufipes* Inger, **R. schlegelii* (Günther), and *R. zamboangensis* Taylor.

Pseudophilautus Laurent

Pseudophilautus: Laurent, 1943b: 2.

Remarks.—No specimens examined.

Distribution.—India.

Type species.—*Philautus temporalis* (Günther), by original designation.

Mantella Boulenger

Mantella: Boulenger, 1882: 141; Methuen and Hewitt, 1913: 57.

Remarks.—No specimens examined.

Distribution.—Madagascar.

Type species.—*Mantella betsileo* Boulenger, by present designation.

Trachymantis Methuen

Hemimantis: Boettger, 1880: 282.

Arthroleptis: Boulenger, 1882: 116.

Microphryne: Methuen and Hewitt, 1913: 55.

Trachymantis: Methuen, 1919: 352; Ahl, 1931b: 203.

* The asterisk denotes the species was not examined.

Remarks.—No specimens examined.

Distribution.—Madagascar.

Type species.—*Microphryne malagasia* Methuen and Hewitt, by original designation.

Gephyromantis Methuen

Gephyromantis: Methuen, 1919: 351; Guibé, 1945: 383.

Rhacophorus: Ahl, 1927a: 478 (part.).

Remarks.—No specimens examined.

Distribution.—Madagascar.

Type species.—*Gephyromantis boulengeri* Methuen, by original designation.

Hyperoliidae Laurent

Hylae: Tschudi, 1838: 25, 27, 70 (part.).

Hylina: Hoffmann, 1873–1878: 646 (part.).

Hylaeformes: Duméril and Bibron, 1841: 491 (part.); A. Duméril, 1853: 137 (part.); Duméril et al., 1854: 400 (part.).

Hylodidae: Hoffmann, 1873–1878: 650 (part.).

Cystignathidae: Günther, 1858: 26 (part.).

Raniformes: Duméril and Bibron, 1841: 317 (part.); Duméril et al., 1854: 392 (part.); Cope, 1864: 181 (part.).

Ranidae: Cope, 1864: 189 (part.); Cope, 1865: 114 (part.); 1867: 198 (part.); Boulenger, 1882: 3 (part.); 1888a: 204 (part.); Gadow, 1901: 237 (part.); Roux, 1905: 777 (part.); Nicholls, 1916: 87 (part.); Noble, 1922: 22 (part.) Ahl, 1923: 1 (part.); Noble, 1924: 183 (part.).

Raninae: Peters, 1882: 142 (part.); Gadow, 1901: 238 (part.).

Polypedatidae: Günther, 1858: 70 (part.); Mivart, 1869: 292 (part.); Hoffmann, 1873–1878: 646 (part.); Boettger, 1881b: 540 (part.); Peters, 1882: 21 (part.); Ahl, 1931b: 1 (part.); Noble, 1931: 515 (part.); Laevit, 1932: 178 (part.); Monard, 1937: 31.

Discophidae: Ahl, 1924: 10 (part.).

Rhacophoridae: Hoffmann, 1932: 562 (part.); Parker, 1934: 9 (part.); deWitte, 1941: 94; Laurent, 1941b: 86 (part.); 1944: 110 (part.); Loveridge, 1957: 314 (part.); Schmidt and Inger, 1959: 176 (part.); Inger, 1967: 380–381 (part.).

Hyperoliidae: Laurent, 1951b: 117 (part.); Perret, 1966: 376 (part.).

Hyperoliinae: Laurent and Combaz, 1950a: 269; Laurent, 1951b: 119; Perret, 1966: 399.

Diagnosis and definition.—Moderate-sized to small treefrogs, with snout-vent length between 2.5 and 8 cm.; skin of body and limbs usually smooth, warty in *Acanthixalus*; dermal ornamentation absent; digital tips usually dilated, simple in some species of *Kassina*; transverse groove on the digital pad absent; fingers moderately

webbed, usually between one-half and one-third webbed; gular gland always present except *Leptopelis*; vocal pouches present, except *Leptopelis*, *Cryptothylax*, and *Acanthixalus*; vocal sacs usually present; nuptial pads absent in males except in *Cryptothylax* and *Phlyctimantis*; pupil horizontal or vertical.

Pectoral girdle firmisternous; metasternum a broad cartilaginous plate; omosternum broadly forked at base; intercalary cartilage between two distal phalanges of fingers and toes always present; usually metacarpal slightly dilated distally; a small bony knob on disto-medial portion of metacarpal of third finger present; bony knob on proximo-lateral portion of metacarpal of fourth finger usually not distinct; terminal phalanges claw-shaped except *Kassina*; first, second, and third carpal and first centrale free; fourth and fifth carpal and second centrale fused together; first and second tarsal free; third and fourth tarsal fused; sacral diapophysis cylindrical or slightly dilated; vertebral column always diplasiocoelous; vertebral column elongated, with a ratio of 2.8 or more of length of vertebral column to distance between tips of diapophyses of eighth vertebra; ventro-posterior portion of sphenethmoid consisting of two separated bones; usually dorsal exposure of sphenethmoid narrow, except *Leptopelis*; generally nasals triangular, rarely squash-shaped; vomerine teeth present or absent, if absent usually vomerine odontophore also absent; posterior lateral process of hyoid almost always absent; cartilaginous stalk of thyrohyal present; external slip of the M. geniohyoideus lateralis either inserting on thyrohyal or on posterior edge of alary process; usually only two slips of the M. petrohyoideus posterior present, three in *Kassina* and *Leptopelis*; except for some species of *Kassina* and *Leptopelis*, third and fourth Tendo superficialis can slide through Aponeurosis palmaris; distal half of the M. palmaris longus splitting into three heads, only medianmost one inserting on Aponeurosis palmaris, except some species of *Kassina* and *Leptopelis*; M. humerodorsalis consisting of two completely separated slips; M. adductor longus present except in *Leptopelis*; M. extensor digitorum communis longus of foot usually consisting of one short slip inserting on proximal portion of metatarsal of third toe.

The tadpoles have a sinistral spiracle and a dextral anal opening; the labial teeth rows in tadpoles vary, usually consisting of one uninterrupted row on the upper lip and generally not more than two rows and on the lower lip rows vary from none to three.

Remarks.—The eggs are laid singly or deposited in gelatinous masses of 30–50 eggs. Usually the egg masses are attached to low

vegetation over water. These frogs live in savannas or in the forest and they are arboreal or terrestrial.

Distribution.—Africa south of the Sahara, Madagascar, and the Seychelles Islands.

Type genus.—*Hyperolius* Rapp.

Content.—*Leptopelis* Günther, *Kassina* Girard, *Hylambates* A. Duméril, *Cryptothylax* Laurent and Combaz, *Phlyctimantis* Laurent and Combaz, *Afrizalus* Laurent, *Hyperolius* Rapp, *Heterizalus* Laurent, *Megalizalus* Tschudi, **Opisthohylax* Perret, **Acanthixalus* Laurent, **Chrysobatrachus* Laurent, **Dendrobatorana* Ahl, and **Calizalus* Laurent.

Leptopelis Günther

Polypedates: Smith, 1850: 25.

Hyla: Hallowell, 1844: 193.

Hylambates: Günther, 1858: 89; Cope, 1865: 115 (part.); Günther, 1868: 487 (part.); Boulenger, 1882: 132 (part.); 1888a: 205 (part.); Nieden, 1909: 361 (part.); 1910: 53 (part.); Noble, 1924: 247 (part.); Ahl, 1931b: 450 (part.).

Leptopelis: Günther, 1858: 89; Cope, 1865: 115; Hoffmann, 1873-1878: 649; Ahl, 1924: 270; Noble, 1924: 234; Ahl, 1929a: 185; 1931b: 206; deWitte, 1941: 94; Laurent, 1941b: 91; Loveridge, 1957: 316 (part.); Schmidt and Inger, 1959: 176; Perret, 1958: 259; 1962: 235; 1966: 421; Schiøtz, 1967: 25.

Cystignathus: Günther, 1864: 481 (part.).

Pseudocassina: Ahl, 1923: 8.

Diagnosis and definition.—Moderate to large-sized hyperoliids (snout-vent length 2-7 cm.); body usually robust but occasionally slender; skin smooth or shagreen; distal segment of digits usually dilated; digital pad surrounded anteriorly and laterally by a ventromarginal groove; transverse groove absent; fingers one-third to two-third webbed; toes two-thirds to three-fourths webbed; pupil vertical.

Omosternum not forked at base; metasternum cartilaginous. Vertebral column diplasiocoelous, moderately long; sacral diapophysis slightly dilated distally; nasal squash-shaped; dorsal exposure of the sphenethmoid moderately extensive; ventro-posterior portion of sphenethmoid fused; frontoparietal rectangular or slightly wider at its anterior end; vomerine teeth present. Terminal phalanges bifurcate. Only the medial branch of the anterior horn present; alary process club-shaped.

Aponeurosis palmaris usually absent; M. adductor longus present; M. extensor digitorum communis longus consisting of two slips,

* The asterisk denotes species of the genus were not examined.

one inserting on proximal portion of metatarsal of third toe, whereas the other inserting on distal portion of metatarsal of fourth toe; *M. geniohyoideus* lateralis inserting on thyrohyal; *M. petrohyoideus* posterior consisting of three slips, the two posterior ones overlapping; *M. adductor longus* absent.

Wolffian duct not convoluted; vesicula seminalis absent.

Vocal pouches absent; gular glands absent; nuptial pads absent; usually pectoral glands present in males.

Tadpoles have sinistral spiracles and dextral anal openings. Usually the tadpoles have the following labial teeth formula: I,3/III or I,2/III (Lamotte and Perret, 1961; Schiøtz, 1967).

Remarks.—Species of this genus are arboreal, except *Leptopelis bocagei* and *L. bufonides* which are ground dwellers. Species of *Leptopelis*, in which the reproductive behavior is known, usually bury their large eggs in moist soil near water; probably after the tadpoles hatch they migrate to a pool for further development (Schiøtz, 1967).

Distribution.—Equatorial Africa.

Type species.—*Leptopelis aubryi* (A. Duméril), by monotypy.

Content.—*Leptopelis aubryi* (A. Duméril), *L. bocagei* (Günther), *L. flavomaculatus*, *L. johnstoni* (Boulenger), *L. karrisimbiensis*, Ahl, *L. millsoni* (Boulenger), *L. natalensis* (A. Smith); *L. notatus* (Buchholz and Peters), *L. ocellatus* (Mocquard), *L. oryi* Inger, and *L. viridis* (Günther).

Kassina Girard

Cystignathus: Duméril and Bibron, 1841: 418 (part.); Duméril et al., 1854: 395 (part.); Günther, 1858: 26.

Kassina: Girard, 1853: 421; Cope, 1865: 115; Roux, 1905: 785; Noble, 1924: 231; Ahl, 1924: 8; 1930d: 277; 1931b: 447; deWitte, 1941: 103; Laurent, 1941b: 105; 1950a: 1; Laurent and Combaz, 1951: 273; Loveridge, 1957: 320; Schmidt and Inger, 1959: 183; Laurent, 1963: 137; Perret, 1966: 418; Schiøtz, 1967: 67.

Cassina: Cope, 1864: 182; Boulenger, 1882b: 31; 1888a: 205; Ahl, 1923: 8.

Rotschildia (nec de Grote, 1896): Mocquard, 1905: 287.

Paracassina: Peracca, 1907: 3.

Tornierella: Ahl, 1924: 10; 1931b: 459.

Hylambates: Ahl, 1931: 452 (part.).

Mocquardia: Ahl, 1931b: 330; deWitte, 1941: 106.

Cassiniopsis: Monard, 1937: 41.

Semnodactylus: Hoffmann, 1939: 90.

Kassinula: Laurent, 1940a: 314, 1941b: 106.

Diagnosis and definition.—Medium-sized hyperoliid frogs (snout-vent length 2.5–5 cm.); body robust; skin of dorsum and limbs shagreened; anal lobes sometimes present; distal segment of digit not or only slightly dilated; fingers free; toes up to half webbed; gular gland oval, bounded by a distinct fold laterally, followed by wrinkled gular pouches; nuptial pads absent. Pupil vertical.

Nasals triangular, touching each other; dorsal exposure of sphenethmoid narrow; ventro-posterior portion of the sphenethmoid separated; frontoparietal trapezoidal; vomerine teeth present, and form two small clusters behind the choanae.

Vertebral column diplasiocoelous and elongated; neuropophysis of eighth vertebra moderately large; sacral diapophysis slightly dilated; omosternum broadly forked at base. Terminal phalanges bifurcate or simple.

Medial and lateral branches of anterior horn present; posterior lateral process usually absent, sometimes reduced; cartilaginous stalk of thyrohyal usually present, sometimes absent.

M. geniohyoideus lateralis inserting on posterior edge of alary process with an additional slip inserting on hyale; the two posterior slips of the M. petrohyoideus posterior overlapping; third and fourth Tendo superficiales may or may not be able to slide through Aponeurosis palmaris; M. adductor longus present; one slip of M. extensor digitorum communis longus present, inserting on proximal portion of metatarsal of third digit; Wolfian duct simple; vesicula seminalis absent.

The tadpole is characterized by its high tail fin and strong beak; spiracle sinistral, anal opening dextral; labial teeth formula for known species is I/1:1 (Schlötter, 1967). A pair of horny accessory plates is present below the lower mandible of tadpoles (Noble, 1926).

Remarks.—All members of this genus are ground dwellers, except *Kassina maculata* Parker which is arboreal. Most species of *Kassina* are cursorial (Laurent, 1963).

The eggs are laid singly or in clusters in water (Schlötter, 1967).

The call of West African species of *Kassina* is so similar and characteristic that it can be used as a generic character (Schlötter, 1967).

The chromosome number is known only in *Kassina senegalensis* (Duméril and Bibron): $2n=24$ (Morescalchi, 1968).

Distribution.—Africa, south of the Sahara.

Type species.—*Cystignathus senegalensis* Duméril and Bibron by monotypy.

Content.—*Kassina deserticola* Ahl, *K. fusca* Schiøtz, *K. maculosa* A. Duméril, *K. modesta* Ahl, *K. obscura*, *K. senegalensis* (Duméril and Bibron), *K. weali* Boulenger, and *K. wittei* (Laurent).

Hylambates A. Duméril

Hylambates: A. Duméril, 1853: 161 (part.); Peters, 1855: 561; Hoffmann, 1873–1878: 651; Boulenger, 1882: 132 (part.); 1888a: 205 (part.); Ahl, 1924: 269; Noble, 1924: 247 (part.); Ahl, 1931b: 452; Laurent, 1941b: 103 (part.); 1950a: 1; Laurent and Combaz, 1950: 271; Loveridge, 1957: 320 (part.).

Diagnosis and definition.—Large-sized hyperoliid frogs (snout-vent length 6–7 cm.); body slightly robust; skin on dorsum and limbs smooth; digital discs distinct; digital pads roundish, surrounded by horseshoe-shaped, ventro-marginal groove on the anterior portion; fingers free; toes half webbed.

Gular gland oval, bounded by horseshoe-shaped skin fold posteriorly, followed by wrinkled gular pouches; nuptial pads absent. Pupil vertical. Nasals triangular, in contact with each other; frontoparietal trapezoidal; vomerine teeth present. Vertebral column diplaciocoelous, moderately long; omosternum forked at base. Terminal phalanges claw-shaped.

M. geniohyoideus lateralis inserting on thyrohyal; M. petrohyoideus posterior consisting of two slips; palmaris complex as in *Hyperolius*; M. adductor longus present; M. extensor digitorum communis longus consisting of one short slip inserting the proximal portion of third toe.

Wolffian duct simple; vesicula seminalis absent.

Labial teeth formula in tadpole is I/3 (Ahl, 1931b). Tadpoles of *Hylambates maculatus* have horny accessory plates below the lower mandible (Noble, 1926).

Remarks.—Frogs of this monotypic genus are ground dwellers. Reproductive behavior is unknown. Apparently this genus is related to *Kassina*.

Distribution.—East Africa from Mozambique to Zanzibar.

Type species.—*Hylambates maculatus* A. Duméril, by monotypy.

Cryptothylax Laurent and Combaz

Hylambates: Schilthuis, 1889: 286; Noble, 1924: 247 (part.); Ahl, 1931b: 452 (part.); Laurent, 1941b: 103 (part.); 1946a: 15.

Cryptothylax: Laurent and Combaz, 1950: 276; Laurent, 1950a: 1; Perret, 1966: 448.

Leptopelis: Loveridge, 1957: 316 (part.).

Diagnosis and definition.—Large-sized hyperoliid frogs (snout-vent length 4–6 cm.); body slender; skin shagreen with small warts on dorsum; distal segment of digits dilated into discs; roundish digital pads surrounded by ventro-marginal groove anteriorly; transverse groove absent; finger free to slightly webbed at base; toes three-fourths webbed.

Gular gland present, oval shaped; vocal pouches or skin fold on skin of throat absent; nuptial pad present. Pupil vertical.

Nasals triangular, in contact with each other along medial end; dorsal exposure of sphenethmoid narrow; ventro-posterior portion of sphenethmoid separated; frontoparietal rectangular; palatine bones dilated at medial ends; vomerine teeth present. Terminal phalanges claw-shaped.

M. geniohyoideus lateralis inserting on the posterior edge of the alary process; a pair of M. petrohyoideus posterior slips present; Palmaris complex similar to *Hyperolius*; M. adductor longus present; one short slip of M. extensor digitorum communis longus present, inserting on proximal portion of metatarsal of third toe.

Wolfian duct simple; vesicula seminalis absent.

The tadpole has the following labial teeth formulae: I/III, rarely 1/III (Lamotte et al., 1959).

Remarks.—Frogs of this monotypic genus live on floating vegetation in small streams or on shrubs near water. Probably the eggs are deposited in water or on floating plants (Perret, 1961). Apparently this genus is very closely related to *Phlyctimantis* Laurent and Combaz.

Distribution.—Congo and Cameroon.

Type species.—*Hylambates gresshoeffi* Schilthuis, by original designation.

Phlyctimantis Laurent and Combaz

Hylambates: Nieden, 1909: 361 (part.); 1910: 53 (part.); Noble, 1924: 247 (part.); Ahl, 1931b: 452, 457 (part.); Loveridge, 1941: 128 (part.); deWitte, 1941: 103; Laurent, 1941b: 103 (part.); Loveridge, 1957: 320 (part.).

Phlyctimantis: Laurent and Combaz, 1950: 271; Laurent, 1950a: 1; Perret, 1966: 448; Schiøtz, 1967: 95.

Diagnosis and definition.—Large hyperoliid frogs (snout-vent length 4–5 cm.); body slender; skin shagreen; dorsum with small warts; distal segment of digits dilated into discs, roundish digital pad surrounded anteriorly by ventro-marginal groove; transverse groove absent; fingers free; toes half webbed; gular gland oval, bounded by a horseshoe-shaped skin fold posteriorly and followed by wrinkled vocal pouches posteriorly; nuptial pads present in males. Pupil vertical.

Nasals spindle-shaped, not in contact with each other; dorsal exposure of sphenethmoid narrow; ventro-posterior portion of sphenethmoid separated; frontoparietal rectangular or slightly trapezoidal; vomerine teeth present, forming two close clusters behind choanae; vertebral column diplasiocoelous, elongated sacral diapophysis slightly dilated; omosternum broadly forked at base; terminal phalanges claw-shaped; anterior horn forms a complete arch; alary process present; posterior lateral process absent.

M. geniohyoideus lateralis inserting on posterior edge of the alary process; two slips of the petrohyoideus posterior present; M. adductor longus present; one slip of M. extensor digitorum communis longus inserting on proximal portion of metatarsal of third toe.

Wolffian duct simple; vesicula seminalis absent.

Tadpoles unknown.

Remarks.—Species of this genus are arboreal. The eggs are deposited in a gelatinous mass on vegetation above water bodies (Lamotte and Perret, 1959). Apparently, this genus is closely related to *Cryptothylax* Laurent and Combaz.

Distribution.—Liberia, Cameroon, Nigeria, Gold Coast, and Uganda.

Type species.—*Hylambates leonardi* Boulenger, by original designation.

Content.—*Phlyctimantis leonardi* (Boulenger) and *P. verrucosus* (Boulenger).

Afrixalus Laurent

Euchnemis (sic): Bianconi, 1850: 23.

Hyperolius: Peters, 1855: 56 (part.); Günther, 1858: 85; Noble, 1924: 250 (part.).

Rappia: Günther, 1868: 479 (part.); Boulenger, 1882: 119 (part.).

Megalixalus: Günther, 1868: 485; Boulenger, 1882: 128 (part.); Boulenger, 1888a: 205 (part.); Nieden, 1910: 57 (part.); Noble, 1924: 270 (part.); Ahl, 1930b: 89 (part.); 1931b: 422 (part.); Laurent, 1941b: 119 (part.); 1944: 110 (part.).

Afrizalus: Laurent, 1944: 113; 1950b: 14; Laurent and Combaz, 1950: 277; Laurent, 1951a: 23; Perret, 1960: 366; 1966: 439; Schiøtz, 1967: 98.

Diagnosis and definition.—Small hyperoliid frogs (snout-vent length 2.0–3.5 cm.); body elongated; skin of body and limbs smooth; distal segment of digit and its digital pad similar to *Hyperolius*; fingers webbed only at base to one-third webbed; toes half-webbed. Gular gland roundish or oval, bounded by a horseshoe-shaped skin fold and followed by wrinkled gular pouches; nuptial pad absent; pupil vertical.

Nasals triangular, in contact at their medial end; dorsal exposure of the sphenethmoid not extensive; ventro-posterior portion of the sphenethmoid separated; frontoparietal rectangular, both halves separated by a narrow fontanelle; palatine bone not dilated at its medial end; vomerine teeth absent; vomerine odontophore absent; terminal phalanges claw-shaped; anterior horn consisting of medial and lateral branches; alary process present with broad base.

M. geniohyoideus lateralis inserting on thyrohyal; some fibres sometimes inserting on hyale; M. petrohyoideus posterior consisting of two slips; Palmaris complex similar to *Hyperolius*; M. adductor longus present; M. extensor digitorum communis longus short, inserting on the proximal portion of metatarsal of third toe.

Wolffian duct simple; sometimes a bottle-shaped vesicula seminalis present.

Tadpoles almost always have the following labial tooth formulae: 0/I or 0/0 (Lamotte and Zuber Vogeli, 1956; Schiøtz, 1967).

Remarks.—All species of this genus are arboreal. The eggs are placed on leaves above water; the leaves are folded and glued together by a gelatinous substance. This genus is very closely related to *Hyperolius* and *Heterixalus*.

Distribution.—African tropics: Liberia, Gold Coast, Dahomey, Nigeria, Ivory Coast, Sierra Leone, Guinea, Ghana, Mali, Hant Volta, and Cameroon.

Type species.—*Megalixalus fornasinii* Bianconi, by original designation.

Content.—*Afrizalus brachynemis* (Boulenger), *A. congicus* Perret, *A. dorsalis* (Peters), *A. fornasinii* (Bianconi), *A. fulvovittatus* (Cope), *A. weidzholzi* (Mertens), and *A. wittei* (Laurent).

Hyperolius Rapp

Eucnemis: Tschudi, 1838: 35, 75 (part.); Duméril and Bibron, 1841: 529 (part.); A. Duméril, 1853: 161 (part.); Duméril et al., 1854: 402 (part.).

Hyperolius: Rapp, 1842: 289; Peters, 1855: 56, 57 (part.); Günther, 1858: 85; Cope, 1862: 342; Hoffmann, 1873-1878: 649 (part.); Boettger, 1881a: 46, 47; Noble, 1924: 250 (part.); Ahl, 1931b: 254 (part.); Laurent, 1944: 115; 1950b: 26; 1951a: 28; Loveridge, 1957: 324; Perret, 1962: 235; 1966: 399; Schiøtz, 1967: 25.

Ixalus: Hallowell, 1844: 60 (part.).

Crumenifera: Cope, 1862: 343.

Rappia: Günther, 1864: 130; 1868: 487; Boulenger, 1882: 119 (part.); 1888a: 205 (part.); Nieden, 1910: 59.

Hylambates: Günther, 1868: 479 (part.).

Megalixalus: Boulenger, 1882: 28 (part.).

Diagnosis and definition.—Small to medium-sized hyperoliid frogs (snout-vent length 2-4.5 cm.); body elongated; skin of body and limbs smooth; distal segment of digits distinctly dilated; digital pad roundish surrounded anteriorly by a horseshoe-shaped ventro-marginal groove; transverse groove absent; fingers webbed at base or up to one-third webbed; toes usually half webbed; gular gland round or oval, bounded by a horseshoe-shaped skin fold and followed by wrinkled gular pouches; nuptial pads absent; pupil horizontal.

Nasal triangular or squash-shaped, sometimes a distinct pointed ventro-posterior process running to septo-maxilla present; dorsal exposure of sphenethmoid narrow; ventro-posterior portion of sphenethmoid separated; frontoparietal rectangular; sometimes separated by a hair-like space between them; sometimes the palatine bone dilated at its medial end; vomerine teeth absent; vomerine odontophore absent.

Vertebral column elongated; sacral diapophyses very slightly dilated; omosternum broadly forked at base; terminal phalanges claw-shaped; anterior horn arch-shaped or consists of medial and lateral branches; alary process present, with a broad base; posterior lateral process absent; cartilaginous stalk of the thyrohyal present.

M. geniohyoideus lateralis inserting on posterior edge of alary process, sometimes additional muscle fibres inserting on hyale; M. petrohyoideus posterior consisting of two slips; third and fourth Tendo superficialis able to slide through Aponeurosis palmaris; the latter tendon joining the lateral half of M. palmaris longus, third Tendo superficialis joining lateral slip of medial half of M. palmaris longus; M. adductor longus present, usually inserting on distal third of M. adductor magnus; a short slip of M. extensor digitorum com-

munis longus inserting on the proximal portion of metatarsal of third toe.

Wolffian duct simple; vesicula seminalis absent.

Tadpoles generally have the following labial teeth formulae: I/1:II or I/III (Lamotte and Perret, 1963b; Schiøtz, 1967).

Remarks.—Members of this genus are arboreal. The eggs are deposited in a gelatinous mass and attached on leaves, reeds or grass at varying heights above water. *Hyperolius* is very closely related to *Afrizalus*. The chromosome number is known only in *Hyperolius argentivittis*: $2n=26$ (Morescalchi, 1968).

Distribution.—Africa, south of the Sahara.

Type species.—*Hyperolius marmoratus* Rapp, by monotypy.

Content.—*Hyperolius bocagei* Steindachner, *H. castaneus* Ahl, *H. cinnemameoventris* Bocage, *H. concolor* (Hallowell), *H. guttulatus* Günther, *H. granulatus* (Boulenger), *H. horstocki* (Schlegel); *H. marmoratus* Rapp, *H. multicolor* Ahl, *H. multifasciatus* Ahl, *H. nasutus* Günther, *H. phantasticus* (Boulenger), *H. picturatus* Peters, *H. sibiricus* (Pfeff.), and *H. schoutedeni* Laurent.

Heterixalus Laurent

Eucnemis: Duméril and Bibron, 1841: 528 (part.); A. Duméril, 1853: 161 (part.); Duméril et al., 1854: 402 (part.).

Hyperolius: Günther, 1858: 85 (part.); Boettger, 1881b: 508; Ahl, 1931e: 65.

Megalixalus: Boettger, 1881c: 650; Boulenger, 1882: 128 (part.); Methuen and Hewitt, 1913: 56; Ahl, 1930a: 524 (part.); 1931b: 422 (part.); Laurent, 1944: 110 (part.).

Rappia: Boulenger, 1882: 119 (part.).

Heterixalus: Laurent, 1944: 111; Laurent and Combaz, 1950: 277.

Distribution.—Madagascar.

Type species.—*Megalixalus madagascariensis* (Duméril and Bibron), by designation of Laurent, 1944.

Content.—*Heterixalus betsileo* (Grandidier) and *H. madagascariensis* (Duméril and Bibron).

Megalixalus Günther

Eucnemis: Tschudi, 1838: 35, 76; Duméril and Bibron, 1841: 527 (part.); A. Duméril, 1853: 161 (part.); Duméril et al., 1854: 402 (part.).

Megalixalus: Günther, 1868: 485; 1870: 150; Hoffmann, 1873–1878: 650; Boulenger, 1882: 128 (part.); 1888a: 205 (part.); Ahl, 1930a: 524 (part.); 1931b: 422 (part.); Guibé, 1948: 500.

Hyperolius: Günther, 1858: 85 (part.); Hoffmann, 1873–1878: 649.

Remarks.—No specimens examined.

Distribution.—This monotypic genus is restricted in the Seychelles Islands.

Type species.—*Megalixalus infrarufus* Günther, by original designation.

Acanthixalus Laurent

Hyperolius: Buchholz and Peters in Peters, 1875: 208 (part.); Boulenger, 1882: 130 (part.); Ahl, 1931b: 422 (part.); Laurent, 1941b: 119 (part.).

Megalixalus: Boulenger, 1882: 128 (part.); Nieden, 1910: 57 (part.); Noble, 1924: 270 (part.); Ahl, 1930b: 89 (part.); 1931b: 422 (part.).

Acanthixalus: Laurent, 1944: 111; Laurent and Combaz, 1950: 277; Perret, 1962: 90; 1966: 446; Schiøtz, 1967: 134.

Remarks.—No specimens examined.

Distribution.—This monotypic genus occurs in Cameroon and Nigeria.

Type species.—*Megalixalus spinosus* (Buchholz and Peters), by designation of Laurent, 1944.

Opisthothylax Perret

Megalixalus: Noble, 1924: 270 (part.); Ahl, 1930b: 89; 1931b: 422 (part.).

Heterixalus (nec Laurent): Perret, 1960: 373.

Opisthothylax: Perret, 1962: 92; 1966: 445; Schiøtz, 1967: 132.

Remarks.—No specimens examined.

Distribution.—This monotypic genus occurs in Guinea, Cameroon, and Nigeria.

Type species.—*Opisthothylax immaculatus* (Boulenger), by monotypy.

Dendrobatorana Ahl

Hylambates: Peters, 1875: 209 (part.); Boulenger, 1882: 137 (part.).

Cardioglossa: Nieden, 1908: 661 (part.).

Dendrobatorana: Ahl, 1926: 112; 1931b: 204.

Remarks.—No specimens examined.

Distribution.—Yoruba in Lagos.

Type species.—*Hylambates dorsalis* Peters, by monotypy.

Chrysobatrachus Laurent

Cardioglossa: Nieden, 1908: 661.

Chrysobatrachus: Laurent, 1951c: 376.

Remarks.—No specimens examined.

Distribution.—Eastern Congo.

Type species.—*Chrysobatrachus cupreonitens* Laurent, by original designation.

Callixalus Laurent

Callixalus: Laurent, 1950c: 5.

Remarks.—No specimens examined.

Distribution.—Kisenyi, Ruanda.

Type species.—*Callixalus pictus* Laurent, by original designation.

REFERENCES

AHL, ERNST

1923. Über eine Froschsammlung aus Nordost-Afrika und Arabien. Mitt. Zoolog. Museum Berlin, **11**(1), pp. 1-12.
1924. Über einige afrikanische Frösche. Zool. Anz., **40**, pp. 269-273.
1926. Ueber neue oder seltene Froschlurchen aus dem Zoologischen Museum Berlin. Sitz. Ges. naturf. Freunde, Berlin, **1926**, pp. 111-117.
- 1927a. Beschreibung neuer Frösche aus Madagascar. Mitt. Zoolog. Museum Berlin, **14**(3/4), pp. 471-484.
- 1927b. Zur Systematik der asiatischen Arten der Froschgattung *Rhacophorus*. Sitz. Ges. naturf. Freunde, Berlin, **1927**, pp. 35-47.
1928. Neue Frösche der Gattung *Rhacophorus* aus Madagaskar. Zool. Anz., **75**, pp. 311-318.
- 1929a. Zur Kenntnis der afrikanischen Baumfrosch-Gattung *Leptopelis*. Sitz. Ges. naturf. Freunde, **1929**, pp. 185-222.
- 1929b. Zur Kenntnis der Baumfrosch-Gattung *Chiromantis* Peters. Zool. Anz., **80**(1/2), pp. 27-37.
- 1930a. Zur Kenntnis der *Megalixalus*-Arten Madagascars und der umliegenden Inseln (Amphibia, Anura). Mitt. Zoolog. Museum Berlin, **16**(4), pp. 523-529.
- 1930b. Ueber die afrikanischen Arten der Baumfroschgattung *Megalixalus*. Sitz. Ges. naturf. Freunde, Berlin, **1930**, pp. 89-102.
- 1930c. Beschreibung einer neuen Baumfroschart der Gattung *Chiromantis*. Zool. Anz., **88**, pp. 219-221.
- 1930d. Zur Kenntnis der afrikanischen Froschgattung *Kassina* Girard. Zool. Anz., **88**, pp. 277-283.
- 1930e. Zur Kenntnis der madagassischen Arten der Baumfroschgattung *Hyperolius*. Zool. Anz., **90**, pp. 65-68.
- 1931a. Beschreibungen zweier neuer Baumfrösche der Gattung *Chiromantis*. Sitz. Ges. naturf. Freunde, Berlin, **1931**, pp. 211-216.
- 1931b. Anura III, Polypedatidae. In Das Tierreich. De Gruyter, Berlin and Leipzig. xvi+477 pp.

ALCALA, A. C.

1962. Breeding behavior and early development of frogs of Negros, Philippine Islands. Copeia, **1962**, pp. 679-726.

ANNANDALE, NELSON

1912. Zoological results of the Abor Expedition, 1911-1912. I. Batrachia. Rec. Indian Mus., **8**, pp. 7-36.
1915. Herpetological notes and descriptions. Rec. Indian Mus., **11**, pp. 341-347, 1 pl.
1917. Report on a collection of Reptiles and Batracians from Java. Jour. Fed. Malay. Mus., **7**, pp. 107-111.

ARON, M. M.

1926. Recherches morphologique et expérimentales sur le déterminisme des caractères sexuels secondaires mâles chez les anoures. Arch. Biol., 30, pp. 1-97.

ARNOULT, J. and M. RAZARIELISOA

1967. Contribution à l'étude des batraciens de Madagascar de genre *Mantidactylus* adultes et formes larvaires de *M. betsileanus* (Blgr.), *M. curtos* (Blgr.) et *M. alutus* (Peracca). Bull. Mus. Hist. Nat. (Paris), 39(3), pp. 471-487.

AYYANGER, M. O. P.

1915. A South Indian flying frog, *Rhacophorus malabaricus* (Jerdon). Rec. Indian Mus., 11, pp. 140-142.

BARBOUR, THOMAS

1912. Some Chinese vertebrates. Amphibia and Reptiles. Mem. Mus. Comp. Zool., 40, pp. 125-136, 2 pls.
1920. A preoccupied name in *Hyla*. Copeia, 88, p. 98.

BHADURI, J. L.

1932. Observation on the urino-genital system of the treefrogs of the genus *Rhacophorus* Kuhl with remarks on their breeding habits. Anat. Anz., 74, pp. 336-343.
1953. A study of the urogenital system of Salientia. Proc. Zool. Soc. Bengal, 6, pp. 1-111.

BHADURI, J. L. and S. L. BASU

1957. A study of the urinogenital system of Salientia. Part I. Ranidae and Hyperoliidae of Africa. Ann. Mus. Roy. Congo Belg., 55, pp. 1-67.

BHADURI, J. L. and A. MONDAL

1965. A study of the urogenital system of Philippine Salientia, together with notes on *Cornufer novaebritannae* from New Guinea and a North Bornean *Rhacophorus otitophus*. Phil. Jour. Sci., 94, pp. 469-517.

BIANCONI, G. G.

1850. Specimina Zoologica Mossambicana quibus vel novae vel minus notae animalium species illustrantur. Bononiae, 1847-1869.

BOETTGER, OSKAR

1879. Die Reptilien und Amphibien von Madagascar. Abh. Senck. Nat. Ges., 1879, pp. 1-56.
1880. Diagnoses reptilium et batrachiorum novorum a Carola in insula Nossi-Bé Madagacariensi lectorum. Zool. Anz., 3, p. 279-283.
- 1881a. Diagnoses reptilium et batrachiorum novorum ab ill. Dr. Christ Rutenberg in insula Madagascar collectorum. Zool. Anz., 4, pp. 46-48.
- 1881b. Studien über Reptilien und Amphibien von Madagascar. Abh. Senck. naturf. Ges., 12, pp. 435-558.
- 1881c. Diagnoses reptilium et batrachiorum novorum in insula Nossi-bé Madagascariensis. Zool. Anz., 4, pp. 650-665.
1893. Katalog der Batrachier-Sammlung. Ber. Senck. naturf. Ges., 6, pp. 1-50.
1895. Neue Frösche und Schlangen von den Liukiu-Inseln. Zool. Anz., 28, pp. 266-270.

BOIE, H.

1829. In Gravenhorst, J. L. Ch. Deliciae musei Zoologici Vratislaviensis. Fasciculi Primus. Chelonias et Batrachia. Lipsiae: Sumptibus Leopoldi Vossii. xiv + 106 pp., 17 pls.

BOULENGER, G. A.

1881. Description of a new species of frog from Madagascar. *Ann. Mag. Nat. Hist.*, 7(5), pp. 360-361.
1882. Catalogue of the Batrachia Salientia S. Ecaudata in the collection of the British Museum. *Brit. Mus.*, London, xvi+503 pp.
1888. Note on the classification of the Ranidae. *Proc. Zool. Soc. London*, 1888, pp. 204-206, 8 figs.
1890. The Fauna of British India including Ceylon and Burma. Reptilia and Batrachia. Taylor and Francis. London. xvi+541 pp.
1892. Description of new reptiles and batrachians from the Loo Choo Islands. *Ann. Mag. Nat. Hist.*, 10(6), pp. 302-304.
1893. Concluding report on the reptiles and batrachians obtained in Burma by Signor L. Fea, dealing with the collection made in Pegu and the Karin Hills in 1887-88. *Ann. Mus. Genova*, 13(2), pp. 305-347, pls. VII-XII.
1895. On a genus of frogs peculiar to Madagascar. *Ann. Mag. Nat. Hist.*, 15(6), p. 450.
1912. A vertebrate fauna of the Malay Peninsula. Reptilia and Batrachia. Taylor and Francis. London. xiii+286 pp., 79 figs.
1919. On the Madagascar Frogs of the genus *Mantidactylus* Blgr. *Proc. Zool. Soc. London*, 1918, pp. 257-261.
1920. A monograph of the South Asian, Papuan, Melanesian, and Australian frogs of the genus *Rana*. *Rec. Indian Mus.*, 20, pp. 1-226.

BOURRET, R.

1937. Notes herpetologique sur l'Indochine francaise. *Bull. Gen. Instruction publique*, (4), pp. 1-80.
1942. Les batraciens de l'Indochine. *Institut Oceanographique de l'Indochine*, x+517 pp., 196 figs., 4 pls.

BRONGERSMA, L. D.

1942. On two *Rhacophorus* species mentioned by Kuhl and van Hasselt. *Arch. Neerl. Zool.*, 6(4), pp. 341-346.

CAIN, A. J. and G. A. HARRISON

1958. An analysis of the taxonomist's judgment of affinity. *Proc. Zool. Soc. London*, 131, pp. 85-98.
1960. The phyletic weighting. *Proc. Zool. Soc. London*, 135, pp. 1-31.

CANTOR, T. E.

1847. Catalogue of reptiles inhabiting the Malayan Peninsula and Islands. *Journ. Asiatic Soc. Bengal*, 26(7), pp. 607-1078.

CEI, G.

1944. Analisi biografica e ricerche biologiche e sperimentale sul ciclo sessuale annuo delle Rane rosse d'Europa. *Monit. Zool. Italiano*, 54, pp. 1-117, 18 figs.

COCHRAN, D. M.

- The herpetological collections made by Dr. Hugh M. Smith in Siam from 1923 to 1929. *Proc. U. S. Nat. Mus.*, 77, pp. 1-39.

COPE, E. D.

1862. Notes upon some reptiles of the Old World. *Proc. Acad. Nat. Sci. Philadelphia*, 1862, pp. 337-344.
1864. On the limits and relations of the Raniformes. *Proc. Acad. Nat. Sci. Philadelphia*, 1864, pp. 181-183.
1865. Sketch of the primary groups of Batrachia salientia. *Nat. His. Rev.*, 1865, pp. 97-120.

1867. On the families of Raniformes Anura. Journ. Acad. Nat. Sci. Philadelphia, **6**, pp. 189-206.

DARLINGTON, P. J.

1957. Zoogeography: The geographical distribution of animals. John Wiley and Sons, New York. xi+675 pp., 80 figs.

DAUDIN, F. M.

1840. Histoire naturelle des rainettes, des grenouilles et des crapauds. Levrault, Paris. 108 pp., 36 pls.

DAVIS, D. D.

1965. Wallace's flying frog. Malay Nat. Journ., **19**, pp. 149-151.

DAVIS, D. D. and U. R. GORE

1936. Clearing and staining skeletons of small vertebrates. Fieldiana: Technique, **4**, pp. 1-16, 3 figs.

DECKERT, K.

1938. Beiträge zur Osteologie und Systematik ranider Froschlurche. Inaugural-Dissertation, Math-Naturwissenschaftlichen Fakultät, Friedrich-Wilhelm-Universität zu Berlin. Gustav Kunze, Bernburg, pp. 127-184, 48 figs.

DE WITTE, G. F.

1932. Exploration du Parc National Albert. Mission G. F. de Witte (1933-1935). Bruxelles. Fasc. 33. v+261 pp.

DUMÉRIL, A. M.

1853. Mémoire sur les Batraciens Anoures, de la Famille des Hylaformes ou Rainettes comprenant la description d'un genre nouveau. Ann. Sci. Nat. Zool., **19**, pp. 135-179.

DUMÉRIL, A. M. and G. BIBRON

1841. Erpetologie générale ou histoire naturelle complète des reptiles. Librairie Encyclopedique de Roret, Paris. Tome 8. iii+792 pp.

DUMÉRIL, A. M. C., G. BIBRON, and A. DUMÉRIL

1854. Erpetologie générale ou histoire naturelle complète des reptiles. Librairie Encyclopedique de Roret, Paris. Tome 9, vii+440 pp.

DUNLAP, D. G.

1960. Comparative myology of the pelvic appendage in the Salientia. Jour. Morph., **106**, pp. 1-76, 37 figs.

1966. The development of the musculature of the hindlimb in the frog, *Rana pipiens*. Jour. Morph., **119**, pp. 241-258.

EADES, D. C.

1970. Discussion and procedure for numerical phyletics. Syst. Zool. **19**, pp. 142-171.

FITZINGER, L.

1843. Systema Reptilium. Fasciculu Primus Amblyglossae. Vindobonae. ix+106 pp.

GADOW, H.

1901. Amphibia and Reptiles. MacMillan and Co., Ltd. London. xiii+668 pp.

GAUPP, E.

1896. Anatomie des Frosches. Erste Abteilung. Friedrich Vieweg und Sohn Braunschweig. xiii+229 pp.

GIRARD, C.

1853. Description of new species of reptiles, collected by the U. S. Exploring Expedition, under the command of Capt. Charles Wilkes, U.S.N. Part II. Including the species of Batrachians, exotic to North America. Proc. Acad. Nat. Sci., Philadelphia, 6, pp. 420-424.

GISTEL, J. VON N. F. X.

1848. Naturgeschichte des Thierreichs für höhere Schulen. Stuttgart. xvi + 216, 32 pls.

GLASS, F. M. and R. RUGH

1944. Seasonal study of the normal and pituitary stimulated frog (*Rana pipiens*). Jour. Morph., 74, pp. 409-427.

GRIFFITH, I.

1960. The phylogenetic status of the Sooglossinae. Ann. Mag. Nat. Hist., 2(13), pp. 626-640.
1963. The phylogeny of the Salientia. Biol. Rev., 38, pp. 241-292.

GUIBE, J.

1945. A propos du genre *Gephyromantis* (Batraciens). Bull. Mus. Nat. Hist. nat. Paris, 27(5), pp. 283-284.
1947. Description d'un batracien nouveau de Madagascar (*Boophis Laurenti* n. sp.) et synonymie de plusieurs espèces du genre *Boophis*. Bull. Mus. Hist. nat., Paris, 19(6), pp. 438-439.
1948. Contribution à l'étude ostéologique de *Megalixalus seychellensis* (Tschudi) (Batraciens). Bull. Mus. Hist. nat. Paris, 20(6), pp. 500-501.

GÜNTHER, A.

1858. Catalogue of the Batrachia Salientia in the collection of the British Museum. Brit. Mus., London, xvi + 160 pp., 12 pls.
1864. The Reptiles of British India. Taylor and Francis. London. xxvii + 452 pp.
1868. First account of species of Tailless Batrachians added to the collection of the British Museum. Proc. Zool. Soc. London, 1868, pp. 478-490.
1870. Notes on the locality of *Megalixalus infrarufus*. Proc. Zool. Soc. London, 1870, p. 150.
1887. Notes on batrachians from Perak. Ann. Mag. Nat. Hist., 20(5), pp. 312-316.

HAINES, R. WHEELER

1939. A revision of the extensor muscles of the forearm in tetrapods. Jour. Anat., 73, pp. 211-233.

HALLOWELL, E.

1844. Description of new species of African reptiles. Proc. Acad. Nat. Sci. Philadelphia, 2(3), pp. 58-62.
1860. Report upon the Reptilia of the North Pacific Exploring Expedition under command of Capt. John Rogers, U.S.N. Proc. Acad. Nat. Sci. Philadelphia, 1860, pp. 480-510.

HENNIG, W.

1965. Phylogenetic systematics. Ann. Rev. Ent., 10, pp. 97-116.

HOFFMAN, A. C.

1932. Researches relating to the validity of the south African Polypedatidae (Rhacophoridae) as an autonomous family of the Anura. South Afr. Jour. Sci., 29, pp. 562-583, 13 figs.

1939. A new frog from Thaba 'Nchu. Soölogiese Navorsing Nasionale Museum, 8, pp. 89-95.
1942. Investigations on the anatomical characters of the genus *Kassina* together with descriptions of the different species and of two subspecies. Soölogiese Navorsing Nasionale Museum, 1, pp. 113-166, 38 figs.
1943. Die urino-genitaalbuise van *Chiromantis xerampelina*. Tijds. Wetens. Kuns, 3, pp. 121-128, 6 figs.
- HOFFMANN, C. K.
1873-1878. Dr. Bronn's Klassen und Ordnungen der Amphibien. Leipzig und Heidelberg. 726 pp., 50 pls.
- HOWES, G. B. and A. M. DAVIES
1888. Observation and genesis of supernumerary phalanges with special reference to those of the Amphibia. Proc. Zool. Soc. London, 1888, pp. 495-511, pls. XXIV and XXV.
- HOWES, G. B. and W. RIDWOOD
1888. On the carpus and tarsus of the Anura. Proc. Zool. Soc. London, 1888, pp. 141-182, pls. VIII and IX.
- IKEDA, SAKUJIRO
1897. Notes on the breeding habit and development of *Rhacophorus schlegelii* Günther. Annotations Zool. Japonenses, 1, pp. 113-122, 2 figs.
- INGER, R. F.
1947. Preliminary survey of the amphibians of the Riu Kiu Islands. Fieldiana: Zool., 32, pp. 297-352.
1954a. Systematics and zoogeography of Philippine Amphibia. Fieldiana: Zool., 33, pp. 181-531, 71 figs.
1954b. On a collection of amphibians from Mount Kina Balu, North Borneo. Jour. Wash. Acad. Sci., 44, pp. 250-251.
1956. Some amphibians from the lowlands of North Borneo. Fieldiana: Zool., 34, pp. 389-424.
1958. Comments on the definition of genera. Evolution, 12, pp. 370-384.
1966. The systematics and zoogeography of the Amphibia of Borneo. Fieldiana: Zool., 52, pp. 1-402, 71 figs.
1967. The development of a phylogeny of frogs. Evolution, 21, pp. 369-384.
1968. Amphibia. Exploration du Parc National de la Garamba. Mission H. de Saeger. Fasc. 52, pp. 1-190.
In press. Numerical taxonomy. Results of a symposium on modern methods in the study of evolutionary biology of amphibians. Bogota.
- INGER, R. F. and B. GREENBERG
1956. Morphology and seasonal development of sex characters in two sympatric African toads. Jour. Morph., 99, pp. 549-574, 11 figs.
1963. The annual reproductive pattern of the frog *Rana erythraea* in Sarawak. Phys. Zool., 36, pp. 21-33, 5 figs.
- INGER, R. F. and N. S. HAILE
1959. Two new frogs from Sarawak. Sarawak Mus. Jour., 9, pp. 270-276, 4 figs.
- KÄNDLER, R.
1924. Die sexuelle Ausgestaltung der Vorderextremität der anuren Amphibien. Jena. Zeits. Natur., 60, pp. 176-240.

KIRTISINGHE, P.

1946. The presence in Ceylon of a frog with direct development on land. Ceylon Jour. Sci., **23**, pp. 109-112.
 1957. The Amphibia of Ceylon. Published by the Author. Colombo, Ceylon. 112 pp., 74 figs.

KLUGE, A. G.

1967. Higher taxonomic categories of gekkonid lizards and their evolution. Bull. Am. Mus. Nat. Hist., **135**, pp. 1-60.

KOKA, KAZUO

1958. Herpetofauna of the Amami group of the Loo Choo Islands. II. Memoirs of the Faculty of Education Kumamoto University, **6**, pp. 173-185.

KUHLE, H. and J. C. VAN HASSELT

1822. Uittreksel uit de brieven van de Heeren Kuhl en van Hasselt, aan de Heeren C. J. Temminck, Th. van Swinderen en W. de Haan. Algemene Konst- en Letter-Bode voor het jaar 1822, no. 7, pp. 99-104.

LAMOTTE, M. and J.-L. PERRET

1961. Contribution à l'étude des batraciens de l'Ouest africain XIII. Les formes larvaires de quelques espèces de *Leptopelis*, *L. aubryi*, *L. viridis*, *L. anchietae*, *L. ocellatus* et *L. calcaratus*. Bull. Inst. française Afrique noire, **23a**, pp. 855-885, 30 figs.
 1963a. Contribution à l'étude des batraciens de l'Ouest africain XIV. Le développement larvaire de *Chiromantis rufescens* Günther. Bull. Inst. française Afrique noire, **25**, pp. 265-276.
 1963b. Contribution à l'étude des batraciens de l'Ouest africain XVI. Les formes larvaires de cinq espèces de *Hyperolius* du Cameroun: *H. hieroglyphycus*, *H. steindachneri*, *H. pardalis*, *H. acutirostris*, *H. viridiflavus*, *H. tuberculatus*. Bull. Inst. française Afrique noire, **25a**, pp. 544-558, 20 figs.

LAMOTTE, M., J.-L. PERRET, and S. DZIEDUSZYCKA

1959. Contribution à l'étude des batraciens de l'Ouest africain X. Les formes larvaires de *Cryptothylax gresshoffi*, *Leptopelis notatus* et *Ptychadena taenio-celis*. Bull. Inst. française Afrique noire, **21**, pp. 1336-1350.

LAMOTTE, M. and M. ZUBER VOGELI

1956. Les formes larvaires de *Chiromantis rufescens*, *Afraxalus leptosomas fulvovittatus*, et *Kassina senegalensis*. Bull. Inst. française Afrique noire, **18**, pp. 863-876.

LAURENT, R.

- 1940a. Description d'un Rhacophoride nouveau du Congo Belge (Batraciens). Rev. Zool. Bot. africaines, **33**, pp. 314-316.
 1940b. Contribution à l'osteologie et à la systematique des Ranides africain. Première Note. Rev. Zool. Bot. africaines, **34**, pp. 74-97, 3 pls.
 1941a. Contribution à l'osteologie des Ranides africains. Deuxième Note. Rev. Zool. Bot. africaines, **34**, pp. 192-235, 7 figs., pls. 6-7.
 1941b. Contribution à l'osteologie et à la systematique des Rhacophorides africains. Rev. Zool. Bot. africaines, **35**, pp. 85-111, 24 figs., pls. 10-11.
 1942a. Notes sur l'osteologie de *Trichobatrachus robustus*. Rev. Zool. Bot. africaines, **36**, pp. 56-60.
 1942b. Note sur les procoelous Firmisternes (Batrachia, Anura). Bull. Mus. Roy. hist. nat. Belgique, **18**, no. 43, pp. 1-20.
 1943a. Sur la position systematique et l'osteologie du genre *Mantidactylus* Blgr. Bull. Mus. Roy. Hist. nat. Belgique, **19**, no. 5, pp. 1-8, 20 figs.

- 1943b. Contribution à l'osteologie et à la systematique des Rhacophoridae non africains. Bull. Mus. Roy. Hist. nat. Belgique, 19(28), pp. 1-16.
- 1943c. Contribution à l'étude des genres *Megalixalus* et *Hyperolius*. Bull. Mus. Roy. Hist. Nat. Belgique, 39, no. 30, pp. 1-20.
1944. Contribution à l'osteologie et à la systematique des Rhacophoridae africains. Deuxieme Note. Rev. Zool. Botanique africains, 38, pp. 110-138, 41 figs.
- 1946a. Note sur une petite collection de *Megalixalus* et sur *Hylambates gresshoffi*. Bull. Mus. Roy. Hist. nat. Belgique, 22, pp. 1-16, 3 figs.
- 1946b. Mises au point dans la taxonomie des Ranides. Rev. Zool. Bot. africaines, 39, pp. 336-338.
- 1950a. Sur l'attribution generique de certains batraciens appartenant a la sous-famille des Hyperoliinae. Troisieme Rapport Ann. l'I.R.S.A.C., 1950, pp. 225-226.
- 1950b. Genres *Afrixalus* et *Hyperolius*. Exploration du Parc national Albert. Mission Witte, Fasc. 64, pp. 1-120.
- 1950c. Diagnoses preliminaires de treize batraciens nouveau d'Afrique centrale. Rev. Zool. Bot. africains, 44, pp. 1-18.
- 1951a. Catalogue des rainettes africaines (genres *Afrixalus* et *Hyperolius*) de la collection du Museum National d'Histoire nat. de Paris. Ann. Soc. Roy. Zool. Belgique, 82, pp. 23-50.
- 1951b. Sur la necessite de supprimer la famille des Rhacophoridae mais de creer celle des Hyperoliidae. Rev. Zool. Bot. africaines, 45, pp. 116-122.
- 1951c. Deux reptiles et onze batraciens nouveau d'Afrique centrale. Rev. Zool. Bot. africaines, 44, pp. 360-381.
1954. Étude de quelques especes meconnues du genre *Ptychadena*. Ann. Mus. Roy. Congo Belge, Sci. Zool., 34, pp. 7-34.
1963. A new frog of the genus *Kassina* from Northern Rhodesia. Fieldiana: Zool., 44, pp. 137-140, 1 fig.
1964. Adaptive modifications in frogs of an isolated highland fauna in Central Africa. Evolution, 18, pp. 458-467, 7 figs.

LAURENT, R. and J. COMBAZ

1950. Sur l'attribution generique de certains batraciens appartenant a la sous-famille des Hyperoliinae. Rev. Zool. Bot. africaines, 43, pp. 269-280.

LAURENT, R. and H. M. SMITH

1966. *Kassina* Girard, 1853 (Amphibia: Anura); proposed grant priority over *Hylambates* Duméril, 1853. Z.N.(S.) 1718. Bull. Zool. Nomencl., 22(5/6), pp. 317-318.

LAEVIT, B. B.

1932. Comments on Polypedatidae. Copeia, 1932, pp. 178-179.

LEYDIG, F.

1876. Ueber den Bau der Sehnen bei Batrachiern und die Bedeutung des Fersenhockers. Morph. Jahrb., 2, pp. 165-196.

LIU, C. C.

1935. Types of vocal sac in the Salientia. Proc. Boston Soc. Nat. Hist., 41, pp. 19-40, pls. 4-8.
1936. Secondary sex characters of Chinese frogs and toads. Field Mus. Nat. Hist.: Zool., 22, pp. 115-156, 12 pls.
1950. Amphibians of Western China. Fieldiana: Zool. Mem., 2, pp. 1-400 100 figs., 10 pls.

LOVERIDGE, A.

1941. Report on the Smithsonian-Firestone Expedition's collection of Reptiles and Amphibians from Liberia. Proc. U. S. Nat. Mus., 91, pp. 113-140.

1957. Check list of the reptiles and amphibians of East Africa (Uganda; Kenya, Tangayika; Zanzibar). *Bull. Mus. Comp. Zool.*, **117**, pp. 153-362.
- MAHENDRA, B. C.
 1936. The vertebral column of the Anura. *Current Science*, **4**, pp. 744-747.
 1937. The vertebral column of the Anura: Its bearing on the classification. *Current Science*, **6**, pp. 13-16.
- MAYR, E., E. G. LINSLEY, and R. L. USINGER
 1953. *Methods and Principles of Systematic Zoology*. McGraw Hill Book Co., Inc. New York. ix + 328 pp.
- METHUEN, P. A.
 1919. New diagnosis and key of the genus *Xenocalamus* and some Batrachia from Madagascar. *Proc. Zool. Soc. London*, **1919**, pp. 349-355.
- METHUEN, P. A. and J. HEWITT
 1913. On the collection of Batrachia from Madagascar made during the year 1911. *Ann. Trans. Mus. Pretoria*, **4**, pp. 49-64, 2 pls.
- MICHENER, C. D. and R. S. SOKAL
 1957. A quantitative approach to a problem in classification. *Evolution*, **11**, pp. 130-162.
- MIVART, ST. GEORGE
 1869. On the classification of the anurous Batrachians. *Proc. Zool. Soc. London*, **1869**, pp. 280-295.
- MOCQUARD, M. F.
 1905. Note preliminaire sur une collection de reptiles et de batrachiens offerte au Museum par M. Maurice de Rothschild. *Bull. Mus. Hist. nat.*, **11**, pp. 285-289.
- MONARD, A.
 1937. Contribution á la batrachologie d'Angola. *Bull. Soc. Neuchat. Sci. Nat.*, **62**, pp. 1-59.
- MORESCALCHI, A.
 1968. Initial cytotaxonomic data on certain families of amphibious Anura (*Diplasiocoela*, after Noble). *Experientia*, **24**, pp. 280-283.
- NICHOLLS, G. E.
 1916. The structure of the vertebral column in the Anura *Phaneroglossa* and its importance as a basis of classification. *Proc. Linn. Soc. London*, **128**, pp. 80-92.
- NIEDEN, FRITZ
 1908. Über einige westafrikanische Frösche. *Zool. Anz.*, **32**, pp. 651-662.
 1909. Über westafrikanische *Hylambates*-Arten nebst Beschreibung einer neuen Art. *Archiv Natur.*, **75**, pp. 361-366.
 1910. Die Fauna der deutschen Kolonien. Reihe I: Kamerun. Heft 2: Die Reptilien (auser den Schlangen) und Amphibien. Berlin. iv + 75 pp., 155 figs.
- NOBLE, G. K.
 1922. The phylogeny of the Salientia: I. The osteology and the thigh musculature; their bearing on classification and phylogeny. *Bull. Am. Mus. Nat. Hist.*, **46**, pp. 1-87, pls. 1-23.
 1924. Contribution to the herpetology of the Belgian Congo based on the collection of the American Museum Congo Expedition 1909-1915. *Bull. Am. Mus. Nat. Hist.*, **44**, pp. 147-347.

1926. The importance of larval character in the classification of South African Salientia. *Am. Mus. Novit.*, no. 237, pp. 1-10, 6 figs.

1931. *The Biology of the Amphibia*. McGraw Hill Co., Inc., New York. xiii+577 pp., 174 figs.

NOBLE, G. K. and M. E. JAECKLE

1928. The digital pads of the treefrogs. A study of the phylogenies of an adaptive structure. *Jour. Morph. Physiol.*, **45**, pp. 259-292, 18 figs.

OKADA, YAICHIRO

1891. *Catalogue of Vertebrated Animals of Japan*. Tokyo, Japan, Kinkodo. xxii+128 pp.

1928. Notes on the breeding habits of *Rhacophorus* in Japan. *Annot. Zool. Japonenses*, **11**, pp. 279-285, 1 pl.

1931. *The Tailless Batrachians of the Japanese Empire*. Tokyo Imperial Experimental Station, iv+215 pp., 29 pls., 97 figs.

PARKER, H. W.

1932. Parallel modification in the skeleton of the Amphibia Salientia. *Arch. Zool. Italiano*, **16**, pp. 1239-1240, 11 figs.

1934. *A monograph of the frogs of the family Microhylidae*. Jerrold & Sons, Ltd. London. viii+208 pp., 67 figs.

PERACCA, M. G.

1907. Spedizione al Ruivenzori di S.A.R. Luigi Amedeo di Savia Duca degli Abruzzi. Nuovi Retilli ed Anfibi; diagnosi preventive. *Boll. Musei Zool. Anat.*, Torino, **22**, pp. 1-3.

PERRET, JEAN-LUC.

1958. Observations sur des rainettes africaines du genre *Leptopelis* Günther. *Rev. Suisse Zool.*, **65**, pp. 259-275.

1960. Batraciens du genre *Afraxalus* du Cameroun. *Rev. Zool. Bot. africaines*, **61**, pp. 366-373.

1961. La biologie d'*Acanthixalus spinosus* (Amphibia Salientia). *Recherches Études Camerounaises*, 1962, pp. 90-101, 4 figs., 3 pls.

1962. Revision des types de *Leptopelis* et note sur quelques *Hyperolius* (Amphibia Salientia) de la region camerounaise, conservé du museum de Berlin. *Rev. Zool. Bot. africaines*, **65**, pp. 235-246.

1966. Les amphibiens du Cameroun. *Zool. Jahr., Systematik*, **8**, pp. 289-464.

PETERS, WILHELM

1855. Übersicht der auf einer Reise (in Madagascar und Mossambique) gesammelten Amphibien. *Archiv. Nat.*, **21**, pp. 43-58.

1867. Herpetologische Notizen. *Monatsber. Akad. Wissens. Berlin*. 1867, pp. 13-37.

1871a. Über neue Reptilien aus Ostafrika und Serawak (Borneo) vorzüglich aus der Sammlung des Herrn Marquis J. Doria zu Genua. *Monatber. Akad. Wissens. Berlin*, 1871, pp. 566-581.

1871b. Über einige Arten der Herpetologischen Sammlung des Berliner Zoologischen Museums. *Monatsber. Akad. Wissens. Berlin*. 1871, pp. 644-652.

1874. Über neue Amphibien. *Monatsber. Akad. Wissens. Berlin*. 1874, pp. 616-624.

1875. Über die von Herrn Prof. Buchholz gesammelten Amphibien. *Monatsber. Akad. Wissens. Berlin*. 1875, pp. 196-212.

1882. *Naturwissenschaftliche Reise nach Mosambique*. Pt. 3. Amphibien. Berlin. 191 pp.

POPE, C. H.

1931. Notes on amphibians from Fukien, Hainan, and other parts of China. Bull. Am. Mus. Nat. Hist., **61**, pp. 397-611, pls. 13-22, 39 text figs.

RAPP, W. VON

1842. Neue Batrachia. Arch. Nat., **8**, pp. 289-291, pl. 6.

RITLAND, R. M.

1955. Studies on the postcranial morphology of *Ascaphus truei*. I. Skeleton and spinal nerves. Jour. Morph., **97**, pp. 119-178.

ROMER, J. D.

1953. Reptiles and amphibians collected in the Port Harcourt area of Nigeria. Copeia, **2**, pp. 121-123.

ROUX, M. J.

1905. La famille des Ranidae. Zool. Anz., **28**, pp. 777-785.

SCHILTHUIS, L.

1889. On small collection of Amphibia from the Congo with description of a new species. Tijds. Nederl. Dierk. Ver., **2**, pp. 285-286. Not seen.

SCHIØTZ, A.

1963. The amphibians of Nigeria. Vidensk. Medd. dansk. naturh. Foren. Kobenhaven, **125**, pp. 1-92.

1966. On the collection of amphibians from Nigeria. Vidensk. Medd. dansk. naturh. Foren. Kobenhaven, **129**, pp. 43-48.

1967. The treefrogs (Rhacophoridae) of West Africa. Spolia Zoologica Musei Hauniensis, Copenhagen, **25**, pp. 1-346, 226 figs., 1 map.

SCHLEGEL, H.

- 1837-1844. Abbildungen neuer oder unvollständig bekannter Amphibien, nach der Natur oder dem leben entworfen herausgegeben und mit erläuternden Texta begleitet von Dr. H. Schlegel, conservator des Niederländischen Reichs-Museums. Düsseldorf, Verlag von Arnz & Comp. xiv+141 pp., 50 pls.

1838. In Ph. Fr. de Siebold. Fauna Japonica. Reptilia elaborantibus. Lugduni Batavorum **10**. xxi+144 pp., 8 pls.

1857. Handleiding der Dierkunde. Breda. Vol. 2, 58 pp.

SCHMIDT, K. P. and R. F. INGER

1959. Amphibians exclusive of the genera *Afrivalus* and *Hyperolius*. Parc Nat. Upemba, Mission de Witte, Fasc., **56**, pp. 1-264.

SHARROCK, G. and J. FELSENSTEIN

1969. Manuscript in preparation.

SIEDLECKI, M.

1908. Über Bau, Lebensweise und Entwicklung des javanischen Flugfrosches (*Rhacophorus reinwardtii* Boie). Bull. Acad. Sci. Cracovie, **1908**, pp. 682-689.

1909. Zur Kenntnis des javanischen Flugfrosches. Biol. Cent., **29**, pp. 704-737, 19 figs.

1910. Die Haftballen des javanischen Flugfrosches (*Polypedates reinwardtii*). Bull. Acad. Sci. Cracovie, series B, **10**, pp. 593-606, 9 figs.

SMITH, A.

1850. Illustrated Zoology of South Africa, Reptilia. London. 78 pls.

SMITH, M. A.

1927. Contribution to the herpetology of the Indo-Australian Region. Proc. Zool. Soc. London, **1927**, pp. 199-225, 4 figs., 2 pls.

1930. The Reptilia and Amphibia of the Malay Peninsula. Bull. Raffles Mus. no. 3, pp. 1-149, 13 figs.
1953. Description of a new species of frog of the genus *Philautus*. Ann. Mag. Nat. Hist., 6(66), pp. 477-478.
- SPENGLER, S. W.
1876. Das Urogenitalsystem der Amphibien. Arbeiten von Zoologischen Institut. Wurzburg, 3, pp. 77-114.
- STEJNEGER, L.
1907. Herpetology of Japan and adjacent territory. Bull. U. S. Nat. Mus., 58, xx+577, 409 figs., 35 pls.
1910. The batrachians and reptiles of Formosa. Proc. U. S. Nat. Mus., 38, pp. 91-114.
- TAYLOR, E. H.
1920. Philippine Amphibia. Phil. Jour. Sci., 16, pp. 213-259, 9 figs., 10 pls.
1921. Amphibians and Turtles of the Philippine Islands. Manila Bureau of Printing. Publ. no. 15, 193 pp., 17 pls.
1922. Additions to the herpetological fauna of the Philippine Islands. I and II. Phil. Jour. Sci., 22, pp. 161-206, 257-303.
1962. The amphibian fauna of Thailand. Univ. Kansas Sci. Bull., 43, pp. 265-599, 107 figs.
- TAYLOR, W. R.
1967. An enzyme method of clearing and staining small vertebrates. Proc. U. S. Nat. Mus., 122, pp. 1-17.
- THROCKMORTON, L. H.
1968. Concordance and discordance of taxonomic characters in *Drosophila* classification. Syst. Zool., 17, pp. 355-387.
- THURSTON, E.
1888. Catalogue of the Batrachia Salientia and Apoda (Frogs, Toads and Caeilians) of Southern India. Madras Government Press. 54 pp., 13 pls.
- TREWAVAS, E.
1933. The hyoid and larynx of the Anura. Phil. Trans. Roy. Soc. London (B), 222, pp. 401-527, 82 figs.
- TSCHUDI, J. J.
1838. Classification der Batrachier, mit Berücksichtigung der fossilen Thiere. Mem. Soc. Sci. Nat. Neuchatel. 2, vi+99 pp., 6 pls.
- VAN KAMPEN, P. N.
1910. Beitrag zur Kenntnis der Amphibienlarven des indischen Archipels. Nat. Tijd. Nederl. Indie, 69, pp. 25-48, 1 pl.
1923. The Amphibia of the Indo-Australian Archipelago. Leiden. xii+304 pp., 29 figs.
- WAGER, V. A.
1926. Breeding habits and life-histories of some of the Transvaal Amphibia. Trans. Roy. Soc. S. Afr., 13, pp. 163-174.
- WAGLER, J. G.
1830. Naturliche System der Amphibien mit vorangehender Classification der Saugethiere und Vogel. Munchen, Stuttgart und Tubingen. vi+354 pp., 12 figs.
- WALLACE, A. R.
1869. The Malay Archipelago. 2 vols. London.

WALLS, GORDON L.

1932. Pupil shapes in reptilian eyes. Bull. Antivenin Inst. Amer., 5, pp. 68-70.

WERNER, F.

1922. Zur Systematik der Amphibiengattung *Chiromantis* Peters. Verhandl. Zool. Ges. Wien, 1922, pp. 62-66.

WIEGMANN, A. F. A.

1832. Handbuch der Zoologie. C. G. Luderitz. Berlin. vi+622 pp.

WITTE, G. F. DE

1941. Batraciens et reptiles. Exploration du Parc National Albert. Mission G. F. de Witte. Fasc. 33. xvii+261 pp.

WOLF, S.

1936. Revision der Untergattung *Rhacophorus*. Bull. Raffles Mus., no. 12, pp. 137-217, 8 figs.

APPENDIX

APPENDIX 1.—List of anuran families studied. The asterisk denotes that only the external characters, forearm, and hindlimb musculature, and part of the skeleton were examined.

Family	Number of genera	Number of species	Number of specimens
Ascaphidae*	1	1	1
Discoglossidae*	2	2	2
Pelobatidae*	3	4	4
Pipidae*	1	1	1
Leptodactylidae*	2	4	6
Rhinophrynidae*	1	1	1
Bufoidea*	3	8	10
Dendrobatidae*	2	2	4
Hylidae*	6	9	12
Microhylidae*	5	5	7
Ranidae	20	64	85
Rhacophoridae	11	69	216
Hyperoliidae	9	43	65

APPENDIX 2.—List of species of Rhacophoridae, Hyperoliidae, and Ranidae examined.

Species	Number of specimens examined		
	Skeleton	Musculature	External Characters
Hyperoliidae			
<i>Hyperolius sansibaricus</i>	1	4	6
<i>guttulatus</i>	1	2	4
<i>marmoratus</i>	2	5	7
<i>multicolor</i>	1	2	4
<i>picturatus</i>	1	1	2
<i>concolor</i>	2	2	4
<i>bocagei</i>	1	2	3
<i>cinnemameoventris</i>	1	3	4
<i>granulatus</i>	1	2	3
<i>phantasticus</i>	—	1	1
<i>castaneus</i>	—	1	1
<i>nasutus</i>	—	1	1
<i>schoutedeni</i>	—	1	1
<i>multifasciatus</i>	—	1	1
<i>Afrizalus dorsalis</i>	2	5	8
<i>fulvovittatus</i>	1	3	4
<i>wittei</i>	1	2	2
<i>fornasini</i>	1	1	1
<i>orophilus</i>	—	1	1
<i>weidholzi</i>	—	1	1
<i>Cryptothylax gresshoffi</i>	1	1	1
spp.	—	1	1
<i>Phlyctimantis verrucosus</i>	—	1	1
<i>Heterizalus</i>			
<i>madagascariensis</i>	1	1	1
<i>Hylambates maculatus</i>	—	1	1
<i>Leptopelis aubryi</i>			
<i>oryi</i>	1	2	4
<i>bocagei</i>	1	3	4
<i>karrisimbiensis</i>	1	2	3
<i>ocellatus</i>	—	1	2
<i>ocellatus</i>	—	1	1
<i>millsoni</i>	—	1	1
<i>viridis</i>	—	1	1
<i>notatus</i>	—	1	1
<i>johnstoni</i>	—	1	1
<i>natalensis</i>	—	1	1
<i>flavomaculatus</i>	—	1	2
<i>Kassina senegalensis</i>			
<i>maculosa</i>	2	4	7
<i>maculosa</i>	—	1	1
<i>deserticola</i>	1	1	1
<i>weali</i>	—	1	1
<i>fusca</i>	—	1	1
<i>wittei</i>	—	1	1
<i>obscura</i>	—	1	1
Rhacophoridae			
<i>Buergeria robustus</i>	2	4	8
<i>pollicaris</i>	2	3	8
<i>japonicus</i>	2	2	10
<i>pleurostictus</i>	—	1	1

APPENDIX 2.—List of species of Rhacophoridae, Hyperoliidae, and Ranidae examined.—*Continued.*

Species	Number of specimens examined		
	Skeleton	Musculature	External Characters
<i>Polypedates leucomystax</i>	28	30	30
<i>macrotis</i>	5	10	15
<i>cruciger</i>	3	6	10
<i>eques</i>	1	1	2
<i>maculatus</i>	5	8	10
<i>otilophus</i>	1	3	8
<i>dennysi</i>	1	2	4
<i>omeimontis</i>	1	2	5
<i>dugritei</i>	1	1	2
<i>bambusicola</i>	—	1	2
<i>colletti</i>	2	3	6
<i>feae</i>	—	1	1
<i>dennysi</i>	1	2	4
<i>omeimontis</i>	1	2	5
<i>dugritei</i>	1	1	2
<i>bambusicola</i>	—	1	2
<i>Rhacophorus pardalis</i>	5	8	10
<i>jananicus</i>	3	5	8
<i>nigropalmatus</i>	1	1	5
<i>reinwardti</i>	3	4	8
<i>moltrechti</i>	2	4	9
<i>everetti</i>	1	3	4
<i>dulitensis</i>	1	3	5
<i>harrissoni</i>	1	2	6
<i>bimaculatus</i>	1	2	2
<i>bipunctatus</i>	—	1	2
<i>malabaricus</i>	—	1	2
<i>acutirostris</i>	—	1	1
<i>baluensis</i>	—	1	1
<i>rufipes</i>	1	1	5
<i>zamboangensis</i>	2	4	8
<i>gauni</i>	1	1	5
<i>microtympnum</i>	1	1	2
<i>appendiculatus</i>	13	20	15
<i>Philautus nasutus</i>	1	1	1
<i>aurifasciatus</i>	2	4	5
<i>acutirostris</i>	1	1	5
<i>woodi</i>	2	3	4
<i>surdus</i>	2	2	8
<i>emembranatus</i>	1	1	5
<i>lissobranchius</i>	1	1	5
<i>schmackeri</i>	1	1	4
<i>leucorhinus</i>	1	2	5
<i>parvulus</i>	1	2	3
<i>variabilis</i>	—	1	1
<i>hosei</i>	2	4	9
<i>Boophis tephraomystax</i>	1	1	1
<i>bicalcaratus</i>	1	1	1
<i>Chirixalus doriae</i>	1	1	2
<i>vittatus</i>	1	2	3
<i>nongkhorensis</i>	1	3	3
<i>hansena</i>	—	1	1
<i>eiffingeri</i>	2	4	4

APPENDIX 2.—List of species of Rhacophoridae, Hyperoliidae, and Ranidae examined.—*Continued.*

Species	Number of specimens examined		
	Skeleton	Musculature	External Characters
<i>Hazelia picta</i>	2	4	8
<i>spinosa</i>	—	1	1
<i>Theloderma stellatum</i>	—	1	1
<i>gordoni</i>	—	1	1
<i>Chiromantis xerampelina</i>	2	3	5
<i>rufescens</i>	1	2	2
<i>petersi</i>	1	1	1
<i>kelleri</i>	—	1	1
<i>Mantidactylus ulcerosus</i>	1	1	3
<i>albofrenatus</i>	1	2	2
<i>luteus</i>	—	1	1
<i>boulengeri</i>	—	2	2
<i>frenatus</i>	—	1	1
<i>aeruminalis</i>	—	1	1
<i>lugubris</i>	—	1	1
<i>madagascariensis</i>	—	1	1
Ranidae			
<i>Platymantis corrugatus</i>	1	1	2
<i>guppyi</i>	1	1	2
<i>solomonis</i>	—	1	1
<i>papuensis</i>	—	2	2
<i>meyeri</i>	—	1	1
<i>myersi</i>	—	1	1
<i>pelewensis</i>	—	1	1
<i>hazelae</i>	—	1	1
<i>guentheri</i>	—	1	1
<i>vitianus</i>	1	1	1
<i>neckeri</i>	1	1	1
<i>Palmatorappia solomonis</i>	—	1	1
<i>Stauroides natator</i>	2	4	6
<i>Amolops jerboa</i>	1	1	2
<i>chunganensis</i>	1	1	2
<i>larutensis</i>	—	1	1
<i>microtympaanum</i>	—	1	1
<i>Nanorana pleskei</i>	—	1	1
<i>Micrixalus baluensis</i>	1	1	2
<i>Ooeidozyga laevis</i>	1	1	2
<i>Aubria subsigillata</i>	—	1	1
<i>Astylosternus occidentalis</i>	1	1	2
<i>diadematus</i>	—	1	1
<i>Arthroleptis stenodactylus</i>	—	1	1
<i>Tomopterna delalandi</i>	—	1	1
<i>Phrynobatrachus krefftii</i>	—	1	1
<i>petropedetoides</i>	—	1	1
<i>Ptychadena mascareniensis</i>	—	1	1
<i>Nyctibates corrugatus</i>	—	1	1
<i>Cardioglossa leucomystax</i>	—	1	1
<i>Petropedetes johnstoni</i>	—	1	1
<i>natator</i>	—	1	1
<i>Dimorphognathodon africanus</i>	—	1	1
<i>Hemisis marmoratus</i>	—	1	1

APPENDIX 2.—List of species of Rhacophoridae, Hyperoliidae, and Ranidae examined.—*Continued.*

Species	Number of specimens examined		
	Skeleton	Musculature	External Characters
<i>Hylarana erythraea</i>	1	2	3
<i>chalconota</i>	1	4	5
<i>hosei</i>	1	2	3
<i>graminea</i>	—	1	1
<i>lateralis</i>	—	1	1
<i>albolabris</i>	—	1	1
<i>Rana latouchi</i>	—	1	1
<i>sauteri</i>	—	1	1
<i>longicrus</i>	—	1	1
<i>papua</i>	—	1	1
<i>baramica</i>	1	2	3
<i>asiatica</i>	—	1	1
<i>nigromaculata</i>	—	1	1
<i>plancyi</i>	—	1	1
<i>macrodon</i>	1	2	3
<i>paramacrodon</i>	—	2	2
<i>blythi</i>	—	2	2
<i>ibanorum</i>	—	2	2
<i>cancrivora</i>	1	2	3
<i>limnocharis</i>	2	2	4
<i>nicobariensis</i>	—	1	1
<i>acanthi</i>	1	—	1
<i>occipitalis</i>	1	—	1
<i>breviceps</i>	1	—	1
<i>clamitans</i>	1	2	3
<i>calesbeiana</i>	3	2	5
<i>pipiens</i>	4	2	6
<i>fuscigula</i>	—	1	1

APPENDIX 3.—Characters and character states of species of Old World tree-frogs as used in the computer analysis. Italicized numbers represent character states obtained from published studies (see Appendix 5).

	Characters											
	1	2	3	4	5	6	7	8	9	10	11	12
	States											
1. <i>Hyperolius</i>												
<i>marmoratus</i>	3	5	0	0	4	2	0	3	3	1	0	3
<i>multicolor</i>	3	5	0	0	4	2	0	3	3	1	0	3
2. <i>sansibaricus</i>	3	5	0	0	4	2	0	3	3	1	0	3
3. <i>picturatus</i>	3	5	0	0	4	2	0	3	3	1	0	3
4. <i>guttulatus</i>	3	5	0	0	4	2	0	3	3	1	0	3
5. <i>cinnemameoventris</i>	3	5	0	0	4	2	0	3	3	1	0	3
6. <i>bocagei</i>	3	5	0	0	4	2	0	3	3	1	0	3
7. <i>Afrivalus fornasinii</i>	3	5	0	0	4	2	0	3	4	1	0	3
8. <i>fulvovittatus</i>	3	5	0	0	4	2	0	3	4	1	0	3
9. <i>wittei</i>	3	5	0	0	4	2	0	3	4	1	0	3
10. <i>dorsalis</i>	3	5	0	0	4	2	0	3	4	1	0	3
11. <i>Heterixalus</i>												
<i>madagascariensis</i>	3	5	0	0	4	2	0	3	3	1	0	3
12. <i>Cryptothylax</i>												
<i>gresshoffi</i>	3	5	0	0	4	2	0	3	3	1	0	3
13. <i>Phlyctimantis</i>												
<i>verrucosus</i>	3	5	0	0	4	2	0	3	3	1	0	3
14. <i>Leptopelis aubryi</i>	3	6	0	1	3	2	0	1	5	0	0	3
15. <i>oryi</i>	3	6	0	1	3	2	0	1	5	1	0	1
16. <i>bocagei</i>	3	6	0	1	3	2	0	1	5	1	0	1
17. <i>millsoni</i>	3	5	0	1	3	2	0	1	5	1	0	1
18. <i>viridis</i>	3	6	0	1	3	2	0	1	5	1	0	1
19. <i>Hylambates</i>												
<i>maculatus</i>	3	5	0	0	4	2	0	1	3	1	0	3
20. <i>Kassina senegalensis</i>	3	1	0	0	4	2	0	0	4	2	0	3
21. <i>deserticola</i>	3	1	0	0	4	2	0	1	4	2	0	3
22. <i>wittei</i>	3	6	0	0	4	2	0	1	4	1	0	3
23. <i>weali</i>	3	6	0	0	4	2	0	9	9	1	0	3
24. <i>fusca</i>	3	6	0	0	4	2	0	1	4	1	0	3
25. <i>obscura</i>	3	6	0	0	4	2	0	9	9	9	0	3
26. <i>Rhacophorus</i>												
<i>microtyimpanum</i>	3	2	0	1	2	0	0	0	0	0	0	2
27. <i>Polypedates dugritei</i>	3	3	1	1	2	0	0	0	0	0	0	2
28. <i>omeimontis</i>	3	3	1	1	2	0	0	0	0	0	1	9
29. <i>dennysi</i>	3	3	1	1	2	0	0	0	0	0	0	0
30. <i>Buergeria robustus</i>	1	3	0	0	2	1	0	0	0	0	0	0
31. <i>japonicus</i>	2	3	0	0	2	1	0	0	0	0	0	1
32. <i>pollicaris</i>	1	3	0	0	2	1	0	0	0	0	0	1
33. <i>Polypedates</i>												
<i>leucomystax</i>	3	3	0	1	2	1	0	0	0	0	0	2
34. <i>macrotis</i>	3	3	0	1	2	1	0	0	0	0	0	1
35. <i>maculatus</i>	3	3	0	1	2	0	0	0	0	0	0	2
36. <i>eques</i>	3	3	0	1	2	0	0	0	0	0	0	2
37. <i>cruciger</i>	3	3	0	1	2	0	0	0	0	0	0	2
38. <i>colletti</i>	3	3	1	1	2	1	0	0	0	0	0	2
39. <i>otilophus</i>	3	2	0	1	2	0	0	0	2	0	0	2

APPENDIX 3.—Characters and character states of species of Old World tree-frogs as used in the computer analysis. Italicized numbers represent character states obtained from published studies (see Appendix 5).—*Continued.*

Species	Characters											
	13	14	15	16	17	18	19	20	21	22	23	24
1. <i>Hyperolius</i>												
<i>marmoratus</i>	0	0	2	0	1	2	0	1	1	1	1	3
<i>multicolor</i>	0	1	2	0	1	2	0	1	1	1	1	3
3. <i>sansibaricus</i>	0	1	2	0	1	2	0	1	1	1	1	3
4. <i>picturatus</i>	0	0	2	0	1	0	0	1	1	1	1	3
5. <i>guttulatus</i>	0	1	2	0	1	2	0	1	1	1	1	3
6. <i>cinnemameoventris</i>	0	0	2	0	1	2	0	1	1	1	1	3
7. <i>bocagei</i>	0	0	2	0	1	2	0	1	1	1	1	3
8. <i>Afrizalus fornasinii</i>	0	1	2	0	1	2	5	1	1	1	1	3
9. <i>fulvorittatus</i>	0	1	2	0	1	2	5	1	1	1	1	3
10. <i>wittei</i>	0	1	2	0	1	2	5	1	1	1	1	3
11. <i>dorsalis</i>	0	1	2	0	1	2	5	1	1	1	1	3
12. <i>Heterixalus</i>												
<i>madagascariensis</i>	0	1	2	0	1	2	0	1	1	1	1	3
13. <i>Cryptothylax</i>												
<i>gresshoffi</i>	0	1	2	0	1	2	0	1	1	0	0	3
14. <i>Phlyctimantis</i>												
<i>verrucosus</i>	0	0	2	0	1	2	0	0	1	0	0	3
15. <i>Leptopelis aubryi</i>	0	2	2	0	1	0	1	3	0	0	0	0
16. <i>oryi</i>	0	2	2	0	1	0	0	3	0	0	0	0
17. <i>bocagei</i>	0	2	2	0	0	0	0	3	0	0	0	0
18. <i>millsoni</i>	0	2	2	0	1	0	9	3	0	0	0	0
19. <i>viridis</i>	0	2	2	0	0	0	9	3	0	0	0	0
20. <i>Hylambates</i>												
<i>maculatus</i>	0	0	2	0	1	0	9	9	9	0	0	2
21. <i>Kassina senegalensis</i>	0	1	2	0	1	2	5	1	1	0	0	3
22. <i>deserticola</i>	0	1	2	0	1	2	9	1	0	0	0	9
23. <i>wittei</i>	0	1	2	0	1	2	5	1	0	1	9	2
24. <i>weali</i>	0	1	1	0	1	2	5	9	9	0	0	3
25. <i>fusca</i>	0	1	2	0	1	2	9	1	1	0	0	3
26. <i>obscura</i>	0	9	9	0	1	2	9	9	9	1	0	9
27. <i>Rhacophorus</i>												
<i>microtypanum</i>	0	2	0	1	0	0	0	3	0	0	0	1
28. <i>Polypedates dugritei</i>	1	9	0	1	1	0	0	3	0	2	0	1
29. <i>omeimontis</i>	1	9	0	1	0	0	1	3	0	0	0	1
30. <i>dennysi</i>	1	9	0	0	0	0	1	3	0	0	0	1
31. <i>Buergeria robustus</i>	0	2	0	0	1	0	5	3	0	0	0	0
32. <i>japonicus</i>	0	2	0	0	1	0	5	3	0	2	0	1
33. <i>pollicaris</i>	0	2	0	0	1	0	5	3	0	2	0	1
34. <i>Polypedates</i>												
<i>leucomystax</i>	1	9	0	0	0	0	2	3	0	0	0	2
35. <i>macrootis</i>	1	9	0	0	0	0	2	3	0	0	0	1
36. <i>maculatus</i>	1	9	0	0	0	0	3	3	0	0	0	1
37. <i>eques</i>	1	9	0	1	0	0	2	3	0	0	0	1
38. <i>cruciger</i>	1	9	0	0	0	0	3	3	0	0	0	1
39. <i>colletti</i>	1	9	0	0	0	0	2	3	0	0	0	1
40. <i>otilophus</i>	1	9	0	0	0	0	4	3	0	0	0	1

APPENDIX 3.—Characters and character states of species of Old World tree-frogs as used in the computer analysis. Italicized numbers represent character states obtained from published studies (see Appendix 5).—*Continued.*

Species	Characters											
	25	26	27	28	29	30	31	32	33	34	35	36
1. <i>Hyperolius</i>												
<i>marmoratus</i>	1	1	1	0	0	0	0	1	2	0	1	4
2. <i>multicolor</i>	1	1	1	0	0	0	0	1	2	0	1	4
3. <i>sansibaricus</i>	1	1	1	0	0	0	0	1	2	0	1	4
4. <i>picturatus</i>	1	1	1	0	0	0	0	1	2	0	1	4
5. <i>guttulatus</i>	1	1	1	0	0	0	0	1	2	0	1	4
6. <i>cinnemameoventris</i>	1	1	1	0	0	0	0	1	2	0	1	4
7. <i>bocagei</i>	1	1	1	0	0	0	0	1	2	0	1	4
8. <i>Africalus fornasinii</i>	1	1	1	0	0	0	0	1	2	1	1	4
9. <i>fulvovittatus</i>	1	1	1	0	0	0	0	1	2	1	1	4
10. <i>wittei</i>	1	1	1	0	0	0	0	1	2	1	1	4
11. <i>dorsalis</i>	1	1	1	0	0	0	1	1	2	1	1	4
12. <i>Heterixalus</i>												
<i>madagascariensis</i>	1	1	1	0	0	0	0	1	2	0	1	4
13. <i>Cryptothylax</i>												
<i>gresshoffi</i>	1	1	1	0	0	0	0	1	2	1	0	2
14. <i>Phlyctimantis</i>												
<i>verrucosus</i>	1	1	1	0	0	0	0	1	2	1	0	4
15. <i>Leptopelis aubryi</i>	1	1	1	0	0	0	0	1	2	1	1	0
16. <i>oryi</i>	1	1	1	0	0	0	0	1	2	1	1	0
17. <i>bocagei</i>	1	1	1	0	0	0	0	1	2	1	1	0
18. <i>millsoni</i>	1	1	1	0	0	0	0	1	2	1	1	0
19. <i>viridis</i>	1	1	1	0	0	0	0	1	2	1	1	0
20. <i>Hylambates</i>												
<i>maculatus</i>	1	1	1	0	0	0	0	1	2	1	1	4
21. <i>Kassina senegalensis</i>	1	1	2	0	0	1	0	1	0	1	1	3
22. <i>deserticola</i>	1	1	2	0	0	0	0	1	0	1	1	4
23. <i>wittei</i>	1	1	2	0	0	0	0	1	1	1	1	4
24. <i>weali</i>	1	1	0	0	0	0	0	1	0	1	1	4
25. <i>fusca</i>	1	1	2	0	0	0	0	1	0	1	1	4
26. <i>obscura</i>	1	1	2	0	0	0	0	1	1	0	1	4
27. <i>Rhacophorus</i>												
<i>microtympalum</i>	0	1	3	1	1	0	1	0	4	0	0	0
28. <i>Polypedates dugritei</i>	0	1	3	1	1	1	0	0	4	0	0	0
29. <i>omeimontis</i>	0	1	3	1	1	1	0	0	4	0	0	0
30. <i>dennysi</i>	0	1	3	1	1	1	0	0	4	0	0	0
31. <i>Buergeria robustus</i>	0	0	2	1	1	0	0	0	3	0	0	0
32. <i>japonicus</i>	0	0	2	1	1	0	0	0	4	0	0	0
33. <i>pollicaris</i>	0	0	2	1	1	0	0	0	3	0	0	0
34. <i>Polypedates</i>												
<i>leucomystax</i>	0	1	3	1	1	1	0	0	4	0	0	0
35. <i>macrotis</i>	0	1	3	1	1	1	0	0	4	0	0	0
36. <i>maculatus</i>	0	1	3	1	1	1	0	0	4	0	0	0
37. <i>eques</i>	0	1	3	1	1	1	0	0	4	0	0	0
38. <i>cruciger</i>	0	1	3	1	1	1	0	0	4	0	0	0
39. <i>colletti</i>	0	1	3	1	1	0	0	0	4	0	0	0
40. <i>otilophus</i>	0	1	3	1	1	1	0	0	4	0	0	0

APPENDIX 3.—Characters and character states of species of Old World tree-frogs as used in the computer analysis. *Italicized numbers represent character states obtained from published studies (see Appendix 5).—Continued.*

Species	Characters											
	1	2	3	4	5	6	7	8	9	10	11	12
41. <i>Rhacophorus appendiculatus</i>	3	3	2	1	2	0	1	0	0	0	0	2
42. <i>Philautus hosei</i>	3	4	1	1	2	1	0	0	2	0	0	2
43. <i>Chiromantis xerampelina</i>	3	3	1	1	2	0	1	0	0	0	0	1
44. <i>rufescens</i>	3	3	1	1	0	0	1	0	0	0	0	1
45. <i>petersi</i>	3	3	1	1	0	1	1	0	0	0	0	1
46. <i>Boophis lephraeomystax</i>	1	2	0	1	1	0	0	0	0	0	0	1
47. <i>bicalcaratus</i>	3	2	0	0	2	0	0	0	0	0	1	1
48. <i>Mantidactylus ulcerosus</i>	0	0	0	0	2	0	0	0	0	0	0	0
49. <i>albofrenatus</i>	0	2	0	0	2	0	0	0	0	0	0	0
50. <i>luteus</i>	0	2	0	0	1	0	0	0	0	0	0	0
51. <i>madagascariensis</i>	0	4	0	0	2	0	0	0	0	0	0	0
52. <i>Hazelia picta</i>	3	2	2	1	2	0	0	2	0	0	0	3
53. <i>Theloderma stellatum</i>	3	2	2	1	2	0	0	0	9	0	9	9
54. <i>gordoni</i>	3	2	2	1	1	0	0	0	9	0	9	9
55. <i>Chirixalus doriae</i>	3	3	2	1	2	1	0	0	0	0	1	9
56. <i>vittatus</i>	3	2	3	1	2	0	0	0	0	0	1	9
57. <i>hansenae</i>	3	3	2	1	2	1	0	0	0	0	1	9
58. <i>Philautus aurifasciatus</i>	3	2	0	1	2	0	0	2	1	0	0	2
59. <i>woodi</i>	3	3	0	1	2	0	0	2	1	0	0	2
60. <i>acutirostris</i>	3	3	0	1	2	0	0	2	1	0	0	2
61. <i>schmackeri</i>	3	2	0	1	2	0	0	2	1	0	0	2
62. <i>nasutus</i>	3	3	0	1	2	0	0	0	0	0	0	2
63. <i>parvulus</i>	3	2	0	1	2	0	0	2	1	0	0	2
64. <i>leucorhinus</i>	3	3	0	1	2	0	0	0	0	0	0	2
65. <i>surdus</i>	3	2	0	1	2	0	0	2	0	0	0	2
66. <i>lissobranchius</i>	3	2	0	1	2	0	0	2	0	0	0	2
67. <i>emembranatus</i>	3	2	0	1	2	0	0	2	0	0	0	2
68. <i>Rhacophorus moltrechti</i>	1	2	3	1	2	1	1	0	2	0	0	2
69. <i>Chirixalus eiffingeri</i>	2	2	0	1	2	0	1	0	2	0	0	2
70. <i>Rhacophorus dulitensis</i>	3	2	3	1	2	1	1	0	0	0	0	2
71. <i>everetti</i>	3	2	0	1	2	1	1	0	2	0	0	2
72. <i>Chirixalus nongkhorensis</i>	3	2	3	1	2	0	1	0	0	0	1	2
73. <i>Rhacophorus zamboangensis</i>	3	2	2	1	2	1	1	0	0	0	0	2
74. <i>gauni</i>	3	2	0	1	2	1	1	0	0	0	0	2
75. <i>bimaculatus</i>	3	2	3	1	2	1	1	0	0	0	0	2
76. <i>rufipes</i>	3	2	3	1	2	1	1	0	0	0	0	2
77. <i>harrissoni</i>	3	2	1	1	2	0	1	0	0	0	0	2
78. <i>pardalis</i>	3	2	3	1	2	1	1	0	0	0	0	2
79. <i>javanus</i>	3	3	1	1	2	1	1	0	0	0	0	2
80. <i>reinwardti</i>	3	2	3	1	2	1	1	0	0	0	0	2
81. <i>nigropalmatus</i>	3	2	3	1	2	1	1	0	0	0	0	2

APPENDIX 3.—Characters and character states of species of Old World tree-frogs as used in the computer analysis. Italicized numbers represent character states obtained from published studies (see Appendix 5).—*Continued.*

Species	Characters											
	13	14	15	16	17	18	19	20	21	22	23	24
41. <i>Rhacophorus</i> <i>appendiculatus</i>	0	2	0	0	0	0	1	3	0	0	0	1
42. <i>Philautus hosei</i>	0	1	0	0	0	0	1	3	0	0	0	0
43. <i>Chiromantis</i> <i>xerampelina</i>	0	1	0	0	0	0	1	3	0	0	0	1
44. <i>rufescens</i>	0	1	0	0	0	0	1	3	0	0	0	0
45. <i>petersi</i>	0	1	0	0	0	0	1	3	0	0	0	2
46. <i>Boophis</i> <i>tephraeomystax</i>	1	1	0	1	1	0	5	3	0	0	0	2
47. <i>bicalcaratus</i>	0	1	0	1	2	0	5	2	0	0	0	3
48. <i>Mantidactylus</i> <i>ulcerosus</i>	0	0	0	1	2	0	5	4	1	0	0	1
49. <i>albofrenatus</i>	0	0	0	1	2	0	5	4	0	0	0	1
50. <i>luteus</i>	0	0	0	1	2	0	5	4	0	0	0	0
51. <i>madagascariensis</i>	0	0	0	1	9	9	5	4	0	0	0	0
52. <i>Hazelia picta</i>	1	9	0	1	2	0	0	3	0	0	0	1
53. <i>Theloderma stellatum</i>	9	9	0	1	1	0	9	9	0	1	0	1
54. <i>gordoni</i>	9	9	0	1	1	0	9	9	0	0	0	1
55. <i>Chirixalus doriae</i>	0	0	0	1	0	2	0	3	0	0	0	1
56. <i>vittatus</i>	0	0	0	1	1	2	5	3	0	0	0	1
57. <i>hansena</i>	0	0	0	1	0	2	0	3	0	0	0	1
58. <i>Philautus</i> <i>aurifasciatus</i>	0	1	0	1	2	1	5	4	0	1	0	0
59. <i>woodi</i>	0	2	0	1	2	1	5	3	0	1	0	0
60. <i>acutirostris</i>	0	1	0	1	2	1	5	3	0	1	0	0
61. <i>schmackeri</i>	0	1	0	1	2	1	5	4	0	1	0	0
62. <i>nasutus</i>	0	1	0	1	2	1	5	4	0	1	0	0
63. <i>parvulus</i>	0	1	0	1	2	1	5	4	0	1	0	1
64. <i>leucorhinus</i>	0	1	0	0	2	1	5	3	0	2	0	0
65. <i>surdus</i>	0	1	0	1	2	1	5	3	0	2	0	0
66. <i>lissobranchius</i>	0	1	0	1	2	1	5	4	0	2	0	0
67. <i>emembranatus</i>	0	1	0	1	2	1	5	3	0	2	0	0
68. <i>Rhacophorus</i> <i>moltrechti</i>	1	9	0	1	1	0	1	3	0	0	0	1
69. <i>Chirixalus eiffingeri</i>	0	1	0	1	1	0	5	3	0	0	0	1
70. <i>Rhacophorus</i> <i>dulitensis</i>	1	9	0	1	0	0	1	3	0	0	0	2
71. <i>everetti</i>	0	2	0	1	0	0	1	3	0	0	0	0
72. <i>Chirixalus</i> <i>nongkhorensis</i>	0	1	0	1	1	0	1	3	0	1	0	1
73. <i>Rhacophorus</i> <i>zamboangensis</i>	1	9	0	1	0	0	1	3	0	1	0	1
74. <i>gauni</i>	1	9	0	1	0	0	1	3	0	1	0	1
75. <i>bimaculatus</i>	1	9	0	1	0	0	0	3	0	0	0	1
76. <i>rufipes</i>	1	9	0	1	0	0	1	3	0	0	0	2
77. <i>harrissoni</i>	1	9	0	0	0	0	1	3	0	0	0	1
78. <i>pardalis</i>	1	9	0	1	0	0	1	3	0	0	0	2
79. <i>javanus</i>	1	9	0	1	0	0	1	3	0	0	0	2
80. <i>reinwardti</i>	1	9	0	1	0	0	1	3	0	0	0	2
81. <i>nigropalmatus</i>	1	9	0	0	0	0	1	3	0	0	0	2

APPENDIX 3.—Characters and character states of species of Old World treefrogs as used in the computer analysis. Italicized numbers represent character states obtained from published studies (see Appendix 5).—*Continued.*

Species	Characters											
	25	26	27	28	29	30	31	32	33	34	35	36
41. <i>Rhacophorus</i> <i>appendiculatus</i>	0	1	2	1	1	0	0	0	4	0	0	0
42. <i>Philautus hosei</i>	0	1	2	1	0	0	1	1	4	0	1	0
43. <i>Chiromantis</i> <i>xerampelina</i>	0	1	2	1	1	1	1	0	3	0	0	0
44. <i>rufescens</i>	0	1	2	1	1	1	0	0	3	0	0	0
45. <i>petersi</i>	0	1	2	1	1	1	0	0	3	0	0	0
46. <i>Boophis</i> <i>tephraeomystax</i>	0	0	2	1	0	1	0	0	4	0	0	0
47. <i>bicalcaratus</i>	0	0	2	1	1	1	0	0	4	0	0	0
48. <i>Mantidactylus</i> <i>ulcerosus</i>	0	0	2	0	1	0	0	1	3	0	0	0
49. <i>albofrenatus</i>	0	0	2	0	1	0	0	1	3	0	0	0
50. <i>luteus</i>	0	0	2	0	1	0	0	1	3	0	9	0
51. <i>madagascariensis</i>	0	0	1	0	1	0	0	1	3	0	0	0
52. <i>Hazelia picta</i>	0	1	2	1	1	0	1	0	4	0	0	0
53. <i>Theloderma stellatum</i>	0	1	2	1	1	9	9	0	4	0	0	0
54. <i>gordoni</i>	0	1	2	1	1	9	9	0	4	0	0	0
55. <i>Chirixalus doriae</i>	0	1	2	1	1	1	0	0	4	0	0	1
56. <i>vittatus</i>	0	1	2	1	1	1	0	0	4	0	0	1
57. <i>hansena</i>	0	1	2	1	1	1	0	0	4	0	0	0
58. <i>Philautus</i> <i>aurifasciatus</i>	0	1	0	1	1	0	1	1	4	0	1	0
59. <i>woodi</i>	0	1	0	1	1	0	1	1	4	0	1	0
60. <i>acutirostris</i>	0	1	0	1	1	0	1	1	4	0	1	0
61. <i>schmackeri</i>	0	1	0	1	1	0	1	1	4	0	1	0
62. <i>nasutus</i>	0	1	2	1	1	0	1	1	4	0	1	0
63. <i>parvulus</i>	0	1	0	1	1	0	1	1	4	0	0	1
64. <i>leucorhinus</i>	0	1	2	1	1	0	1	1	4	0	0	0
65. <i>surdus</i>	0	1	2	1	1	0	1	1	4	0	0	0
66. <i>lissobranchius</i>	0	1	2	1	1	0	1	1	4	0	1	0
67. <i>emembranatus</i>	0	1	2	1	1	0	1	1	4	0	1	0
68. <i>Rhacophorus</i> <i>moltrechti</i>	0	1	3	1	1	1	0	0	4	0	0	0
69. <i>Chirixalus eiffingeri</i>	0	1	2	1	1	1	0	0	4	0	0	0
70. <i>Rhacophorus</i> <i>dulitensis</i>	0	1	3	1	1	1	0	0	4	0	0	0
71. <i>everetti</i>	0	1	2	1	1	0	0	0	4	0	0	0
72. <i>Chirixalus</i> <i>nongkhorensis</i>	0	1	2	1	1	1	0	0	4	0	0	1
73. <i>Rhacophorus</i> <i>zamboangensis</i>	0	1	2	1	1	1	0	0	4	0	0	0
74. <i>gauni</i>	0	1	2	1	1	1	0	0	4	0	0	0
75. <i>bimaculatus</i>	0	1	3	1	1	1	0	0	4	0	0	0
76. <i>rufipes</i>	0	1	3	1	1	1	0	0	4	0	0	0
77. <i>harrissoni</i>	0	1	3	1	1	1	0	0	4	0	0	0
78. <i>pardalis</i>	0	1	3	1	1	1	0	0	4	0	0	0
79. <i>javanus</i>	0	1	3	1	1	1	0	0	4	0	0	0
80. <i>reinwardti</i>	0	1	3	1	1	1	0	0	4	0	0	0
81. <i>nigropalmatus</i>	0	1	3	1	1	1	0	0	4	0	0	0

APPENDIX 4.—Characters, newly assigned character state numbers, state numbers referred to in text, and total number of occurrences of each derived character state in alternative phylogenetic trees constructed for the Rhacophoridae and for the Hyperoliidae.

Character	New character state numbers	Old character and state numbers	Number of occurrences of each derived character state in alternative trees.											
			Rhacophoridae trees						Hyperoliidae trees					
			1	2	3	4	5	6	1	2	3	4	5	6
<i>M. humerodorsalis</i>	1	1-1	6	1	1	5	5	5	1	1	1	1	1	1
	2	1-2	8	8	7	8	10	1	1	1	1	1	1	
	3	1-3	7	7	7	6	7	9	1	1	1	1	1	1
Palmaris complex	4	2-1	—	—	—	—	—	—	1	1	1	1	1	1
	5	2-3	6	5	5	4	5	5	—	—	—	—	—	—
	6	2-2	2	1	2	6	6	6	—	—	—	—	—	—
	7	2-4	1	1	1	1	1	1	—	—	—	—	—	—
	8	2-5	—	—	—	—	—	—	2	3	3	3	5	1
	9	2-6	—	—	—	—	—	—	2	3	2	3	3	1
<i>M. extensor radialis</i> <i>accessorius lateralis</i>	10	3-1	5	4	3	4	3	3	—	—	—	—	—	—
	11	3-2	4	2	2	2	2	2	—	—	—	—	—	—
	12	3-3	2	1	1	1	1	1	—	—	—	—	—	—
<i>M. adductor longus</i>	13	4-1	6	2	2	4	4	4	1	1	1	1	1	1
	14	5-1	1	1	1	1	1	1	1	1	1	1	1	1
<i>M. extensor digitorum</i> <i>communis longus</i>	15	5-2	1	3	3	4	4	4	—	—	—	—	—	—
	16	5-3	—	—	—	—	—	—	1	1	1	1	1	1
	17	5-4	—	—	—	—	—	—	3	4	2	3	1	2
Throat musculature	18	6-1	4	5	5	4	5	3	—	—	—	—	—	—
	19	6-2	—	—	—	—	—	—	1	1	1	1	1	1
Insertion of the most anterior slip of <i>M. petrohyoideus</i> posterior	20	7-1	3	2	2	2	2	2	—	—	—	—	—	—

APPENDIX 4.—Characters, newly assigned character state numbers, state numbers referred to in text, and total number of occurrences of each derived character state in alternative phylogenetic trees constructed for the Rhacophoridae and for the Hyperoliidae.—*Continued*

Character	New character state numbers	Old character and state numbers	Number of occurrences of each derived character state in alternative trees.																	
			Rhacophoridae trees						Hyperoliidae trees											
			1	2	3	4	5	6	1	2	3	4	5	6	1	2	3	4	5	6
M. petrohyoideus	21 22 23	8-1 8-2 8-3	— 2 2	— 2 2	— 2 2	— 2 2	— 2 2	— 2 2	— 2 2	— 2 2	— 2 2	— 2 2	— 2 2	— 2 2	— 2 2	— 2 2	— 2 2	— 2 2	— 2 2	
M. geniohyoideus	24 25 26 27 28	9-1 9-2 9-3 9-4 9-5	1 1 — — —	1 1 — — —	1 1 — — —	1 1 — — —	1 1 — — —	1 1 — — —	1 1 — — —	1 1 — — —	1 1 — — —	1 1 — — —	1 1 — — —	1 1 — — —	1 1 — — —	3 3 — — —	3 3 — — —	3 3 — — —	3 3 — — —	
Thyrohyal	29 30	10-1 10-2	— —	— —	— —	— —	— —	— —	— —	— —	— —	— —	— —	— —	— —	4 1	4 1	2 1	5 1	3 1
Presence or absence of the alary process	31	11-1	2	2	2	2	2	2	2	2	2	2	2	2	2	—	—	—	—	—
Shape of the alary process	32 33 34	12-1 12-2 12-3	7 6 1	6 5 1	6 5 1	6 5 1	6 5 1	6 5 1	6 5 1	6 5 1	6 5 1	6 5 1	6 5 1	6 5 1	6 5 1	1 — 4	1 — 5	1 — 3	1 — 4	1 — 2
Presence or absence of the anterior horn	35	13-1	5	2	2	4	2	2	2	2	2	2	2	2	2	—	—	—	—	—
Form of the anterior horn	36 37	14-1 14-2	4 1	4 1	4 1	4 1	4 1	4 1	4 1	4 1	4 1	4 1	4 1	4 1	4 1	6 1	6 1	6 1	6 1	6 1
Posterior lateral process	38 39	15-1 15-2	— —	— —	— —	— —	— —	— —	— —	— —	— —	— —	— —	— —	— —	3 2	1 1	3 2	5 1	3 2

APPENDIX 4—Characters, newly assigned character state numbers, state numbers referred to in text, and total number of occurrences of each derived character state in alternative phylogenetic trees constructed for the Rhacophoridae and for the Hyperoliidae.—*Continued*

Character	New character state numbers	Old character and state numbers	Number of occurrences of each derived character state in alternative trees.											
			Rhacophoridae trees						Hyperoliidae trees					
			1	2	3	4	5	6	1	2	3	4	5	6
Concavity of the centrum	40	16-1	3	8	7	4	4	5	—	—	—	—	—	—
Shape of the eighth vertebra	41	17-1	7	7	5	6	7	7	5	6	4	5	3	5
	42	17-2	3	3	3	3	3	3	—	—	—	—	—	—
Dimension of the vertebral column	43	18-1	1	1	1	1	1	1	—	—	—	—	—	—
	44	18-2	1	1	2	1	1	2	5	6	5	6	6	5
Shape of the fronto-parietal bone	45	19-1	3	2	2	4	2	1	1	1	1	1	1	1
	46	19-2	1	1	1	1	1	3	—	—	—	—	—	—
	47	19-3	1	1	1	1	1	1	—	—	—	—	—	—
	48	19-4	—	—	—	—	—	—	—	—	—	—	—	—
	49	19-5	4	5	4	2	2	2	3	3	3	3	3	3
Shape of the nasal and the exposure of the sphenethmoid	50	20-0	—	—	—	—	—	—	1	1	1	1	1	1
	51	20-2	6	7	7	7	4	4	1	1	1	1	1	1
	52	20-3	6	7	7	7	4	4	1	1	1	1	1	1
	53	20-4	2	3	3	1	1	1	—	—	—	—	—	—
Ventro-posterior portion of the sphenethmoid	54	21-1	1	1	1	2	1	1	2	2	2	2	3	2
Presence or absence of the vomerine teeth	55	22-1	2	2	2	1	2	2	2	2	2	2	2	2
	56	22-2	3	3	2	3	3	3	2	2	2	2	2	2

APPENDIX 4.—Characters, newly assigned character state numbers, state numbers referred to in text, and total number of occurrences of each derived character state in alternative phylogenetic trees constructed for the Rhacophoridae and for the Hyperoliidae.

Character	New character state numbers	Old character and state numbers	Number of occurrences of each derived character state in alternative trees.											
			Rhacophoridae trees						Hyperoliidae trees					
			1	2	3	4	5	6	1	2	3	4	5	6
	74	33-4	6	3	3	4	4	4	—	—	—	—	—	—
Shape of the pupil	75	34-1	—	—	—	—	—	—	6	6	6	6	5	6
Nuptial pad	76	35-1	1	1	1	1	1	1	5	6	5	6	4	4
Vocal pouch	77	36-1	1	1	1	1	1	1	—	—	—	—	—	—
	78	36-2	—	—	—	—	—	—	3	4	2	3	1	3
	79	36-3	—	—	—	—	—	—	5	6	5	6	4	5
	80	36-4	—	—	—	—	—	—	4	5	4	5	5	4
Total number of occurrences of derived character states in each tree			180	163	160	173	163	169	117	124	115	136	119	120
Total number of derived character states utilized in deriving each tree			56	56	56	56	56	56	52	52	52	52	52	52
Total number of convergences in each tree			124	107	104	117	107	113	65	72	63	84	67	68

APPENDIX 5.—Sources of information for characters of species that were not examined in the present study. States for these characters are italicized in Appendix 3.

Species	Character number	Source
<i>Heterixalus</i> <i>madagascariensis</i>	10-15 19-21, 23, 28	Trewavas, 1933 Laurent, 1944
<i>Phlyctimantis</i> <i>verrucosus</i>	19-21, 23, 28	Laurent & Combaz, 1950
<i>Hylambates maculatus</i>	19-21, 23, 28	Laurent & Combaz, 1950
<i>Kassina wittei</i>	19, 24	Hoffman, 1942
<i>Kassina weali</i>	15, 20	Hoffman, 1942
<i>Kassina obscura</i>	20, 23, 28	Laurent & Combaz, 1950
<i>Mantidactylus</i> <i>madagascariensis</i>	19-21, 24, 28, 29	Laurent, 1943a

Publication 1107



UNIVERSITY OF ILLINOIS-URBANA

590.5FI C001
FIELDIANA, ZOOLOGY\$CHGO
55-58,61 1968-72



3 0112 009379840