

8 TT56500 TOEN 0

PRESENTED

BY

The Trustees

OF

THE BRITISH MUSEUM.

*In exchange for the
Biological Journal*

NATIONAL ANTARCTIC EXPEDITION
1901-1904

115
N2
500

NATURAL HISTORY

VOL. IV.

ZOOLOGY

(VARIOUS INVERTEBRATA)



LONDON

PRINTED BY ORDER OF THE TRUSTEES OF
THE BRITISH MUSEUM

1908

(All Rights Reserved)

SOLD BY LONGMANS AND CO., 39 PATERNOSTER ROW, E.C. ; BERNARD QUARITCH, 15 PICCADILLY, W. ;
DULAU AND CO., 37 SOHO SQUARE, W. ;
AND AT
THE BRITISH MUSEUM (NATURAL HISTORY), CROMWELL ROAD, LONDON, S.W.

PREFACE.

WHEN, in 1901, the Expedition of the S.S. 'Discovery,' under Captain Scott, R.N., was sent to the Antarctic Regions, the Trustees of the British Museum gave their assistance to this national enterprise by allowing the cases containing the natural history specimens which might be obtained by the Expedition to be sent to the Natural History Museum for unpacking and sorting. They further undertook to publish a detailed report on the collections so obtained, under the superintendence of the Director of the Natural History Departments.

Some of the most important collections have been dealt with by naturalists who were members of the Expedition. Thus, the Mammals* and Birds* are described by Dr. Edward A. Wilson, the Isopoda and Pycnogonida* by Mr. T. V. Hodgson, and the Rocks* (in relation to Field Geology) by Mr. H. T. Ferrar. Other groups have been dealt with by members of the staff of the Natural History Departments of the British Museum: Mr. Boulenger describes the Fishes*: Mr. E. A. Smith, the Gastropoda,* Lamellibranchia,* and Brachiopoda*; Mr. Jeffrey Bell, the Echinoderma*; Dr. Calman, the Crustacea Decapoda,* and the Cumacea*; Mr. Kirkpatrick, the non-calcareous Sponges*; whilst Dr. G. T. Prior has prepared a petrographical description of the Rock-specimens.*

It has been necessary to obtain the assistance of other specialists in order to deal with the rest of the collections. So far as the latter group of contributors is concerned, the following is a list of the subject-matters, together with the name of the naturalist who has undertaken the work in each case:—

EMBRYOS OF SEALS	DR. MARRETT TIMS.
*ANATOMY OF EMPEROR PENGUIN	MR. W. P. PYCRAFT.
TUNICATA	PROF. HERDMAN.
*CEPHALODISCUS	DR. RIDWOOD.
*CEPHALOPODA	DR. HOYLE.
*NUDIBRANCHS AND PTEROPODS	SIR CHARLES ELIOT, K.C.M.G.
POLYZOA	MR. H. W. BURROWS.
*EGGS AND YOUNG OF ASTERIAS	PROF. MACBRIDE.
*AMPHIPODA	MR. A. O. WALKER.
*SCHIZOPODA	MR. HOLT.
*NEBALLE	DR. J. THIELE.
*OSTRACODA	PROF. BRADY.
*COPEPODA	DR. WOLFENDEN.

*CIRRIPEDIA	PROF. GRUVEL.
*MYZOSTOMA	PROF. V. GRAFF.
*ACARI	DR. TROUËSSART.
*COLLEMBOLA	PROF. CARPENTER.
POLYCHÆTA	PROF. EILERS.
*GEPHYRIA	MR. A. E. SHIPLEY.
*CHÆTOGNATHA	DR. FOWLER.
NEMERTINES	PROF. HUBRECHT.
FREE PLATYHELMINTHES	MR. F. F. LAIDLAW.
*CESTODA	MR. A. E. SHIPLEY.
*NEMATODA	DR. V. LINSTOW.
*ZOANTHARIA	MR. CLUBB.
*ALCYONARIA AND PENNATULIDA	PROF. HICKSON.
HYDROMEDUSÆ	MR. E. T. BROWNE.
*CALCAREOUS SPONGES	MR. FREWEN JENKIN.
RADIOLARIA	MR. LEWIS H. GOUGH.
*MOSESSES	M. JULES CARDOT.
LICHENS	MR. DARBISHIRE.
*ALGÆ (MARINE)	MRS. GEPP.
ALGÆ (FRESH-WATER)	DR. FRITSCH.
*ALGÆ (CALCAREOUS)	DR. FOSLIE.
PHYTOPLANKTON	DR. LEWIS H. GOUGH.

The work of securing the assistance of these specialists and of distributing the collections has been performed by Mr. Jeffrey Bell, of the Zoological Department, who has also acted as sub-editor of the Zoological and Botanical portions of the reports. The Keeper of Minerals, Mr. Fletcher, has superintended the reports in the subjects belonging to his department.

The Director desires to acknowledge the ability and energy which have been brought to bear on the preparation of the Zoological reports by Mr. Jeffrey Bell. Owing to his care, the reports have been got ready by the various contributors and published within a reasonable time after the return of the 'Discovery' from the Antarctic Regions. Neither trouble nor expense has been spared in order to render the illustration and presentation of the Natural History of the Expedition worthy of the generous efforts both of Captain Scott and his fellow-explorers and of those who provided the funds for that enterprise.

E. RAY LANKESTER.

October, 1906.

* Have been or are now published.—1/3/1908.

CONTENTS OF VOL. IV.

MOLLUSCA.

- VII.—SOLENOGASTRES. By DR. H. F. NIERSTRASZ (13 pp., 2 Pls.)

ARTHROPODA.

(A) INSECTA.

- APTERA. By G. H. CARPENTER, B.Sc., M.R.I.A. (5 pp., 1 Pl.)

(B) CRUSTACEA.

- VII.—SCHIZOPODA. By W. M. TATTERSALL, M.Sc. (42 pp., 8 Pls.)
VIII.—COPEPODA. By R. NORRIS WOLFENDEN, M.D. (44 pp., 7 Pls.)

ECHINODERMA.

- I.—ECHINODERMA. By F. JEFFREY BELL, M.A. (16 pp., 5 Pls.)
II.—ECHINODERM LARVÆ. By E. W. MACBRIDE, M.A., F.R.S.,
and J. C. SIMPSON, B.Sc. (9 pp., 1 Pl.)

MYZOSTOMIDÆ.

- By DR. RUDOLF RITTER v. STUMMER-TRAUNFELS (26 pp., 1 Pl.)

SIPUNCULOIDEA.

- By W. F. LANCHESTER, M.A. (6 pp.)

COELENTERA.

- IV.—ACTINIA. By J. A. CLUBB, M.Sc. (12 pp., 3 Pls.)

PORIFERA.

- II.—TETRAXONIDA. By R. KIRKPATRICK (56 pp., 19 Pls.)
III.—CALCAREA. By C. F. JENKIN, B.A. (50 pp., 12 Pls.)

21166

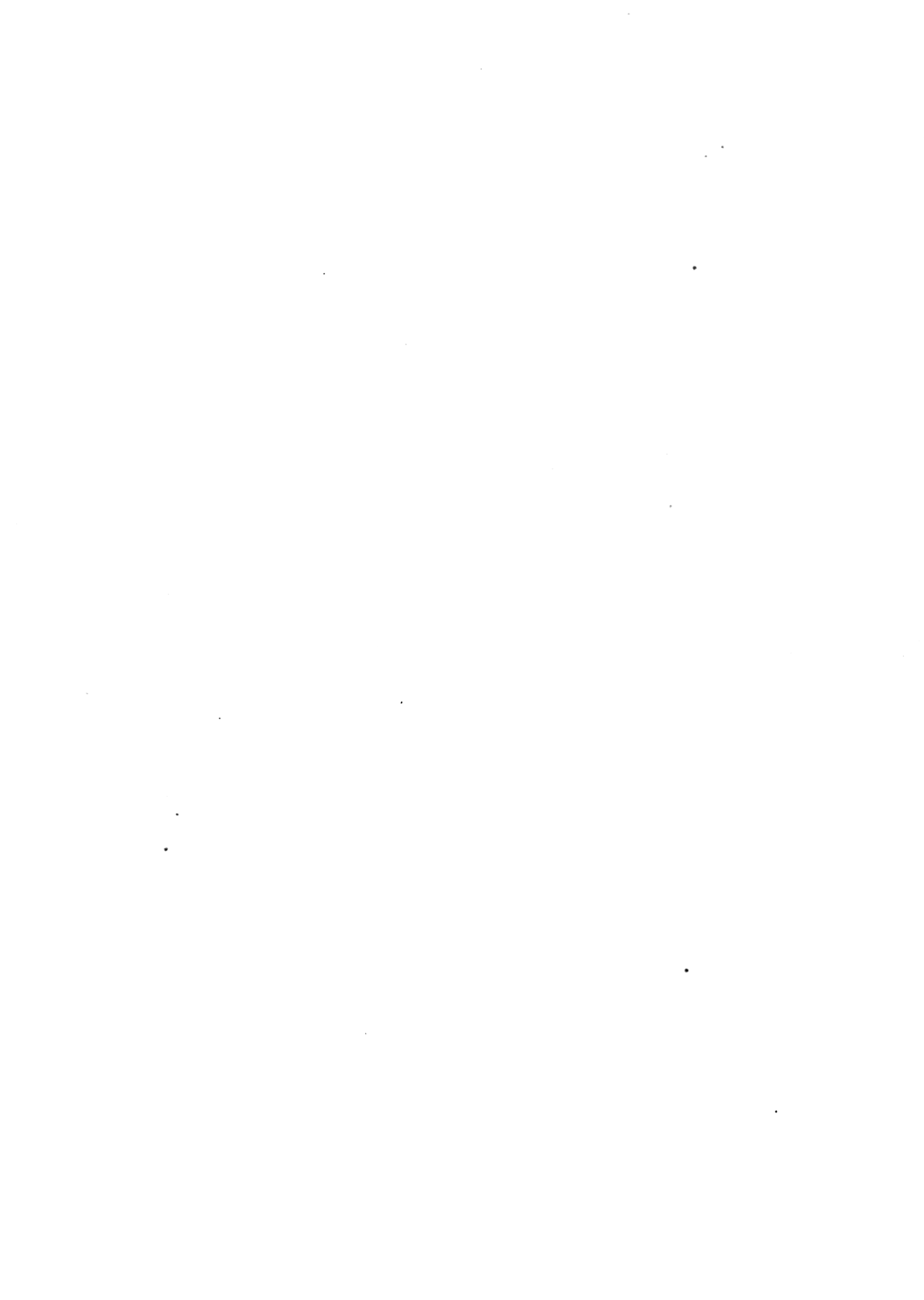

MOLLUSCA.

VII. SOLENOGASTRES.

By Dr. H. F. NIERSTRASZ.

(2 Plates.)

THE 'Discovery' expedition brought back one specimen of Solenogastres from $77^{\circ} 50' 30''$ S., $165^{\circ} 40' 5''$ E., 100 fathoms, of which Fig. 1, A gives a representation. The length is 23 mm., the diameter 2.25 mm., the index therefore about 10. Proximally the animal is blunt, slightly broadened, with a slit-like mouth (Fig. 1, B). The distal part terminates in a dorsal prolongation. On the ventral side the rhomboid opening of the cloaca is distinctly visible, as also the ventral groove, which runs as far as that opening (Fig. 1, C). The opening of the ciliated groove ("Flimmerhöhle" of Wirén) is also visible. The animal has no lustre. When slightly enlarged, spicules are seen crossing each other at obtuse angles. The colour of the animal in alcohol is a yellowish brown.

After being decalcified in nitric acid (1 per cent. in alcohol 90 per cent.) and being stained in iron carmalum for twenty-four hours, transverse sections were made of the proximal and distal portions for the study of the internal organs. The spicules of the different parts of the body were isolated in Eau de Javelle. They are small, but strictly uniform. They belong to the true *Proneomenia* type: hollow, straight, or more or less curved or S-shaped calcareous tubes, which end either sharply or bluntly (Fig. 2). In some cases the base is slightly broadened. I have not succeeded in finding spicules of different shapes along the ventral groove, nor at the proximal and distal portions. At the proximal end, however, they are somewhat more curved.

The spicules are arranged in different layers upon each other. The whole of the strong cuticle is pierced by numerous papillae. The greater part of these are oval, pear- or club-shaped, sometimes round, and they show some transparent cells (Fig. 4). They are placed on strong multinuclear stalks, the cells of which are more or less fibrous. Amongst the transparent cells granular supporting cells are found. It is worthy of note that these papillae are often branched. The side-branch never reaches the length of the stalk, though ending also in a papilla. In most cases these epidermal papillae do not open on to the exterior, but remain closed. Thiele believes the papillae to be sensitive, an opinion which I share (13, p. 280). In the stalk a thin thread may occur, arising from the circular muscular layer. Whether this thread is of a nervous character or not remains undecided. There is, however, no penetration into the circular

muscular layer by nervous threads. I am also inclined to ascribe to the epidermal papillae, and more especially to the granular cells amongst the transparent ones, a secretory function, if not an excretory function as well. The purpose of such a secretion is doubtful. Perhaps it prevents the cuticle from damage by causing small particles to adhere to its surface. In any case, it is remarkable that the cuticle of the *Solenogastres* is nearly always covered with a thin layer of mud firmly sticking to it.

The spicules are formed in small cellular accumulations in the epidermis. Such accumulations frequently occur, and consist of a few transparent cells (Fig. 3, A). In one of the cells the spicule is formed. This cell often has two nuclei, a fact which may give rise to the supposition that there are two cells that form the spicule. The spicules are pushed to the periphery of the cuticle, and are connected with the epidermis by short stalks. The older spicules lose their connection with these stalks, but preserve the mother-cells, which surround their base like a cap (Fig. 3, B). In the case of the oldest spicules, however, this cap has also disappeared. Nowhere did I meet with a formation of the spicules such as Thiele described in *Amphimonia neapolitana*, Thiele (13, p. 246). Thiele is also of the opinion that it is one cell only that produces a spicule.

The ventral groove is distinct and deep. In it three folds of the epidermis are found, a large and broad median fold and two small lateral ones. All three run as far as the opening of the cloaca. Close before the latter the groove and the median fold broaden considerably. The folds are formed of a single layer of epithelial cells. All along the median fold the ventral glands open between its cells. These glands ("hintere Bauchdrüse," of Wirén) are strongly developed, especially at the proximal end of the body, where they entirely surround the digestive tract (Figs. 6-11, *vg*). They are conspicuous by their more or less distinct vesicular structure and granular contents, which stain intensely. At the proximal part of the body, amongst the strongly developed ventral glands, voluminous anterior glands ("vordere Bauchdrüse," of Wirén) are also found. They are of a more delicate structure, and stain much less intensely (Fig. 6, *ag*). They open out between the epithelial cells which invest the ciliated cavity ("Flimmerhöhle," Fig. 6, *f*). The latter is large, and divided by a median dorsal fold. The wall carries strong cilia.

There are two dorso-terminal sense organs situated on the distal lip behind the cloaca. Fig. 5 shows three sections through the more proximal of these organs. The epithelium (*ep*) shows an evagination (Fig. 5, C) into which the muscular layers and the connective tissue continue (*m*). This evagination separates ventrally from the epidermis and pierces the thick cuticle (*cut.* Fig. 5, B). It forms a pedicle (*ped.*), upon which a round knob is resting, the sense organ visible at the surface of the cuticle (Fig. 5, A, *dto*). The external layer of this knob consists of high epithelial cells, amongst which slender, fine, easily staining cells are found, which I believe to be sense-organs.

The mouth-slit is terminal and vertical. It leads into a spacious mouth-cavity, provided with numerous ramified cirri, as is the case in other forms. A horseshoe-

shaped sense-organ is wanting, though usually present in other species. The digestive tract opens to the exterior at the same place as the mouth-cavity, with which it has, however, no communication (*cf. Dinomenia*, 6, p. 12, Pl. 2, Fig. 43). I share Thiele's opinion, who does not regard the so-called mouth-cavity as a part of the digestive tract, but considers it an independent ectodermal sense-cavity (17, pp. 308 and 314). A proper mouth-cavity occurs in the proximal part of the digestive tract, which is slightly dilated, and the wall of which presents numerous folds. The epithelial cells of which the wall of this part is composed are very transparent and have large oval nuclei. The wall is surrounded by a thin circular muscular layer. The folds, as it appears to me, allow this portion of the digestive tract to extend considerably after the taking of food. I do not believe them to be sensitive (Figs. 6 and 7, *ph*). Gradually this portion passes into the following part of the alimentary canal. The latter is much wider, and likewise provided with a strongly folded wall (Fig. 8, *res*). Its cells are taller than those of the first portion, and have elongated nuclei; they are covered with a cuticle. Consequently these two parts of the digestive tract are easily distinguished from one another. More distally, however, between these slender cells there occur broader ones with more oval nuclei, the cuticle no longer being easily discerned throughout. Finally the spacious intestine unites with the proximal caecum (Fig. 8, *e*).

In the second portion of the digestive tract the radula, which is of a very peculiar structure, is found. In the digestive tract a proximally directed cone appears with a strong ventral fold (Fig. 8, *cu*). This cone is beset throughout with radula-teeth (Fig. 12, *e*). For its further structure compare figures 12-14 and 8-11. An epithelial layer appears (*a*), which covers the radula. The ventral wall of the digestive tract (*b*) unites with the ventral wall of the cone (*c*); the epithelial layer *a* with the side-walls of the cone. The two lateral walls of the proximal part of the alimentary canal unite dorsal from the cone. By this complicated process the cone, which on the outside is beset with small teeth, is divided into two closed pouches; the latter are on the inner side closely beset with teeth and are situated outside the alimentary canal. The dorsal pouch is the radula-sac, the ventral contains adult radula-teeth and, distally, ends blindly. Consequently the ventral pouch is but a ventral caecum of the proximal part of the digestive tract, directed distally; teeth on the ventral wall are wanting, in the distal part teeth only occur on the dorsal wall. The radular teeth are well developed (Fig. 16). They are triangular, with a broad base, and more or less strongly curved, often recurved at the point (Fig. 17, B). Frequently forms occur as represented in Fig. 17, A; often other forms are met with, which, however, I consider fragments of whole teeth. Fig. 17, C shows a tooth as seen from the ventral side: the base appears to be broader than the curved part. The teeth are placed in irregular rows, and rest in crypts of the epithelium (Fig. 16). A basal membrane is present. This is remarkable; Thiele lays stress on the absence of such a membrane

in different forms and doubts its existence (17, pp. 268 and 315). As has been indicated by me elsewhere, the existence of a basal membrane has to be accepted for several forms (9). The membrane is stained red with carmalum, consequently its structure differs from that of the chitinous teeth. Probably it must be considered as a cuticle, and so its origin is entirely different from that of the radula-teeth, which are formed in the distal portion of the radula-sac by large odontoblasts. In this respect *Proneomenia discoveryi* resembles those forms, already described by me elsewhere (9). So we have to do here with a multiserial radula with basal membrane. Of any double character of the radula, *viz.*, of the existence of a right and a left half, no trace is to be found. The distal portion of the radula-sac, however, is divided into two parts, a right and a left one (Figs. 10, 20); in both parts radula-teeth are formed by a thick cushion of odontoblasts. Here also the radula originates from the coalescence of a right and a left portion.

The wall of the cone and the dorsal wall of the ventral pouch consist of epithelial cells with round nuclei, between which numerous extremely slender supporting cells occur with elongated nuclei (Fig. 16). On the ventral wall of the ventral pouch and on the dorsal wall of its distal end supporting cells are absent; this ventral wall is formed by cylindrical epithelium with oval nuclei, whilst the constituent cells of the dorsal wall of the distal portion are higher and more cylindrical. One part of this dorsal wall more especially deserves notice; the distal and median part is invaginated and of an entirely different structure. Here very long and slender cells are found, with pointed nuclei and granular contents. It leaves the impression that these cells have pushed themselves wedgewise between the epithelial cells; yet no sharp line can be drawn between these two elements (Fig. 18). Upon this wedge-shaped part the proximal rows of the radula-teeth are resting; the basal membrane, however, fails here. As to the significance of this wedge I am at a loss. There seems to be a connection between the wedge and the layer of muscular and connective tissue surrounding the radula-sac, numerous fibrils pushing themselves between the cells of the wedge. I am bound to mention its existence, having found in a similar ventral pouch containing the proximal portion of the radula in *Proneomenia weberi*, a regeneration either of the cuticle or of the radula (6, p. 4). But in this new form I do not believe we have to do with a regeneration; its significance remains undecided.

Still, in another respect the ventral pouch is of great importance, as the salivary glands open into it (Figs. 11 and 15 *sq*). These are tube-shaped, and extend a long way distally; they merge separately into the ventral wall of the ventral pouch.

The connective tissue and the muscles, which are in connection with the radular apparatus, are strongly developed. Ventrally and laterally from the radula-sac numerous crystal-clear cells occur; usually these are small, sometimes, however, of large size (Fig. 10 *cc*). They serve as a support for the surrounding connective

tissue and muscles. The course of these muscles is difficult to trace; they surround the radula-sac and the distal portion of the ventral pouch; a very broad transverse muscle takes its course between the radula-sac and the ventral pouch (Fig. 10, *m*). Around the salivary glands a thin muscular layer likewise occurs. I do not know how to explain the mechanism of the radular movement. No doubt, the diverse muscles allow of movement in various directions.

A subradular organ, as found by Heath (1) in *Pronomenia* and *Rhopalomenia*, is wanting.

The spacious intestine is formed by the coalescence of the already described portion of the digestive tract with the dorsal caecum (Fig. 8). I have avoided making use of the names pharynx and œsophagus, as there cannot be question here of any sharp separation between the two, even though the proximal part is of a different structure from the following portion. Thiele mentions a strong fold in which the salivary glands open out, and which separates pharynx from œsophagus (13, p. 288). A similar condition does not exist here. An œsophagus, in the sense Thiele ascribes to it, fails entirely.

The spacious intestine shows strongly folded walls, with the exception of the dorsal wall, which remains smooth, except in the median line, where a small fold occurs. The dorsal wall carries cilia; the ventral and lateral walls show glandular epithelium. Lateral caeca are met with as usual; the transverse sections do not teach much in regard to their relative situation. The rectum has strong cilia (Fig. 21, *r*).

The cloaca with its strongly folded wall opens to the exterior through a wide longitudinal slit. Gills are entirely wanting. The wall of the cloaca is very thick and consists of several layers of small transparent cells with small nuclei, between which slender ciliated supporting cells occur with narrow long nuclei, which stain well (Fig. 19). As it seems to me, the wall of the cloaca does not perform any respiratory function, it being too thick. A secretory function must not be excluded. Oftentimes in the cloaca and against its wall little feebly staining globules are found, which I believe to be formed by the wall-cells of the cloaca. Yet we must take into consideration that the cloaca is surrounded by extremely loose connective tissue with large spaces, filled with blood-corpuscles. This arrangement more especially obtains in that part of the cloaca which is contiguous with the dorsal lip; this part is entirely surrounded by blood-corpuscles, and, as it is only clothed by a single layer of epithelial cells, a respiratory function may be ascribed to it. The lateral walls of the ventral slit, by which the cloaca communicates with the exterior, are coated with ciliated cylindrical epithelial cells (Fig. 19).

Properly speaking, the praecloacal organ does not open into the cloaca, but into the ventral slit, as well as both cloacal spicules (Figs. 19, 20). The latter (Kloaken-spicula of Thiele) are well developed, and consist of small bars of about .75 mm. length. These bars are probably calcareous. Around the bars a strong envelope is found, which is not dissolved in nitric acid, but stains easily with carmalum. Probably

this envelope is of chitinous character (Fig. 24). The two extremities of the envelope are tube-shaped (Fig. 24, B); it is open in the middle portion (Fig. 24, A), which may have been caused by damage. Around the proper spicule a cellular envelope is found, consisting of transparent epithelial cells with round nuclei, between which there are long supporting cells with oblong nuclei (Fig. 24). Between the cellular envelope and the spicule an almost homogeneous mass occurs, staining pale-red with carmalum, which I believe to be a secretion of the cells of the envelope, though perfect certainty cannot be obtained. In this case the envelope might perform the duty of a poison gland, the spicule having consequently the power of attack and defence. At the proximal end of the spicules numerous small muscles are attached, which enable the animal to move the spicules in various directions.

The nervous system does not furnish much worthy of note. The cerebral ganglion is large (Fig. 6, *cg*); the latero-ventral ganglia are large also (Fig. 7, *gr*), whereas the latero-dorsal ones are very small (Fig. 6, *gd*). As in other *Proneomeniidae*, the cerebro-ventral and the cerebro-lateral connectives take their origin from the cerebral ganglion separately. The buccal ganglia are distinct, as well as the buccal commissure (sub-lingual commissure of Simroth), which takes its course dorsally from the radula-sac (Fig. 10, *be*). The posterior superior ganglia are large (Fig. 21, *gps*), the commissure between them strong. The posterior inferior ganglia are much smaller; the connectives between the posterior superior and inferior ganglia are strong. From the posterior superior ganglia some strong nerves take their course distally toward the lip, situated behind the cloaca (Fig. 19, *n*).

The heart shows some very interesting peculiarities. As far as can be observed, the structure generally corresponds with that of the other forms, of which I have already given a detailed account (8). Fig. 21 represents the proximal offsets of the cloaca, which gradually disappear (*cl*). Ventrally from these the distal offsets of the pericardium are found (*p*), into one of which—the left—the left cloacal duct opens (*cd*). The medial walls of these pericardial offsets invaginate; these invaginations together form the atria. There exists also a median distal offset of the pericardium (Fig. 21, *p*). By the union of these three offsets the spacious pericardial cavity is formed; at the dorsal wall the two atrial invaginations still exist, separated (Fig. 22, *a*); more proximally, however, they unite and form together the atrium. The double character of the atrium remains here plainly visible. The atrium is consequently open on the distal side; on the dorsal side it is more or less closed by connective tissue. The ventricle originates similarly to the atrium by the coalescence of two invaginations, *viz.*, the median walls of the pericardial ducts. The unpaired portion of the ventricle unites with the dorsally situated atrium (Fig. 23, *a, v*). Concerning this we must notice the following differences: in other forms the ventricle is situated dorsally from the atrium; it also arises from the union of two parts, but is continued as a dorsal unpaired invagination at the dorsal pericardial wall, and communicates at its ventral side with the atrium (8). In this form, however, the ventricle remains small and is not

continued along the dorsal wall of the pericardium ; consequently it is situated ventrally from the atrium. The blood of the atrium is driven into the ventricle through one large opening, there being no question of two atrio-ventricular openings. The wall of both parts of the heart here also remains thin ; it is strengthened by muscular fibres belonging to the surrounding tissue. The ciliated bands ("bourrelets ciliés" of Pruvot) do not fail, at least not in the distal part of the pericardium (Fig. 22, *cb*). The relatively very large blood-corpuseles are of a peculiar shape, oblong, more or less pointed corpuseles of various forms. They stain pale-red with carmalum and usually have a small round nucleus, which may occur at different points, and often obviously protrudes (Fig. 26, A). Further, there occur in the blood large round cells with round granular nucleus (Fig. 26, B).

The animal is mature ; the gonads extend to close behind the radula. The eggs are formed on the median walls, the spermatozoa on the dorsal, ventral, and lateral walls. Both the gonads are densely filled with products, more especially the distal part, which is entirely filled with eggs, or rather with generative epithelium. The latter seems to become free in the gonads ; in the pericardium, compact masses of small round cells occur (Fig. 25, A), which are also found on the median walls of the gonads, and which probably belong to the generative epithelium. Amongst these large cells mature eggs are observed, with granular contents and of various sizes (Fig. 25, B) ; even very large eggs are found, though they are of rare occurrence. Such eggs are often surrounded by the small cells of the generative epithelium, enveloping them like a follicle. Further, numerous spindle-shaped cells occur, the extremities of which are more transparent and stain less obviously (Fig. 25, C). Whether there exists any connection between the round eggs and the spindle-shaped cells cannot be decided, any more than we can follow the further development of the eggs. Full-grown eggs occur sporadically ; they are large and round, finely granular, with round nucleus. Amongst the ripening eggs there are always found numerous extremely small globules, the significance of which is perfectly unknown to me. Besides the female genital products, numerous spermatozooids occur in the pericardium (Fig. 25, D).

The cloacal ducts are not in any way remarkable (Figs. 21-23, *cd*). They leave the pericardium as wide tubes with ciliated epithelium of irregular height, the inner surface being consequently undulating. First they take a proximal course ; afterwards they bend and run distally, becoming gradually broader and having a more glandular epithelium, which produces a granular secretion. The state of preservation is not such as to enable us to decide whether the structure is similar to that of other forms, *viz.*, glandular cells, alternating with supporting ones. The two ducts unite into a broad prae-cloacal organ (Fig. 22, *po*). Each cloacal duct bears, at the point where it bends proximally, a spacious pouch, placed on a short stalk, which I believe to be a receptaculum seminis ; in both of them numerous spermatozooids occur.

Now it remains to be decided to what form this new species, for which I propose

the name *Proneomenia discoveryi*,* is related. In the first place we must mention the different forms, which are now considered as belonging to the genus *Proneomenia*. The thick cuticle with the needle-shaped spicules, the polystichous radula, the two tube-shaped salivary glands, and the absence of gills point towards a relation to that genus. The genus *Proneomenia* includes at present no less than fourteen species, viz., *sluiteri* Hubr., *acuminata* Wir., *vagans* Kow. a. Mar., *desiderata* Kow. a. Mar., *gorgonophila* Kow. a. Mar., *weberi* Nierstr., *longa* Nierstr., *thulensis* Thiele, *valdiviae* Thiele, *australis* Thiele, *amboinensis* Thiele, *gerlachei* Pels., *hawaiiensis* Heath, and *neapolitana* Thiele. As already mentioned by me (8), the expression "polystichous" radula has to be taken in a wide sense, as very different types belong to it, which must be kept sharply separated. The salivary glands likewise show remarkable differences.

All the above-named forms have a thick cuticle beset with numerous needle-shaped spicules. This characteristic, however, is not typical of *Proneomenia*, but also holds good for other genera, e.g., *Rhopalomenia*. The length-index varies considerably, from 6 (*P. desiderata*) to 50 (*P. longa*).

Epithelial papillae are of general occurrence; however, they are said to be wanting in *Proneomenia sluiteri*, though represented and described by Heuscher for *P. langi*. On studying Hubrecht's sections of *sluiteri* more closely, I came to the conclusion that epidermal papillae really are present in this form. In the outer part of the cuticle many of these papillae are found, just as Heuscher observed them in *langi* (3, p. 3). Owing to this fact another point of difference between the two forms disappears, and we have the more reason to share Thiele's opinion, and to consider both forms as belonging to one species (17, pp. 261).

All the forms of *Proneomenia* have one or more dorso-terminal sense-organs.

The structure of the coelomoducts (cloacal ducts) and their appendages varies considerably. The latter always occur at the point where the proximal directed part of the coelomoducts bends to take a distal direction. *Proneomenia sluiteri* shows glandular, ramified tubes; *langi*, winding coeca; *weberi*, *longa*, *acuminata* and *gerlachei*, one vesicular appendage; *thulensis*, twenty, often lobate vesicles; *valdiviae*, a tube; *australis*, thirteen stalked vesicles.

The abdominal and cloacal spicules (abdominale Hakenbündel und Kloakenspicula, Thiele (13, p. 291)) show also important points of difference: *sluiteri*, *langi*, *desiderata*, *gorgonophila*, *weberi* and *longa* have the so-called abdominal spicules in great numbers. Thiele found their homologon in *vagans* and *australis* (13, p. 261; 17, p. 256). In *longa* they even are numerous, though of smaller size. In *discoveryi* two complicated copulation-spicules likewise are present, which show affinity to those of *vagans* and to the penis-spicules of *Neomenia*.

Regarding the cloaca, we must observe that gills are always wanting, the gills of the Solenogastres being merely folds of the cloacal epithelium. It is a very remarkable fact that they are absent from all species of *Proneomenia*.

* *Sit venia verbo*; we have a precedent in *Challengeri*.—Ed.

As a consequence of these facts, to which might be added many others concerning the structure of the digestive tract, nervous system, etc., we must acknowledge that there exist great differences between the various species of *Proncomenia*, and consequently it would be rational not to class them in one genus. The difference between *weberi* and *australis*, for instance, is greater than that between *weberi* and *Rhopalomenia indica* or *Dinomenia*. The same holds good for *Rhopalomenia* itself. This genus was created by Simroth on account of the presence of club-shaped epidermal papillae (12, p. 229). It is with good reason that Thiele observes, that the absence of a radula is more typical of *Rhopalomenia* than the presence of the said papillae (13, p. 272). In this sense the genus *Rhopalomenia* was enlarged by me, some years ago, to contain new species (6, p. 22).

As to the geographical distribution, nothing confirmative is given. Arctic are *sluiteri* and *thulensis*; both forms are most certainly not closely related (14, p. 115).

Antarctic forms: *gerlachei* and *discoveryi*. Between these two forms there exist great differences (dimensions, radula, dorsal spicules, buccal gland of *gerlachei*, structure of the proximal portion of the digestive tract). In dimensions, *gerlachei* resembles *sluiteri*; for the rest, according to Pelseneer (10, p. 34), these two forms do not correspond in many respects.

Mediterranean forms: *neapolitana*, *gorgonophila*, *desiderata*, *vagens*. No doubt *neapolitana* is a distinct form (*Amphimonia* of Thiele, 13, p. 244). *Vagens*, *desiderata* and *gorgonophila* agree in the structure of the pharynx and salivary glands (5, pp. 59, 76); the index, however, varies from 6 to 25. Yet I am inclined to consider these forms related to each other. *Vagens* differs importantly from *sluiteri*, *gerlachei* and *discoveryi*, by the structure of the radula; on the other hand, a relation with *thulensis* is very well possible (radula, salivary glands, abdominal spicules), though in the latter form cloacal spicules are wanting.

Indo-pacific forms: *weberi*, *longa*, *amboinensis*, *australis*, *valdiviae* and *hawaiiensis*. Of these forms *hawaiiensis* is insufficiently known; only the nervous system has been accurately studied by Heath (1). *Weberi* and *longa*, no doubt, are related; *amboinensis*, however, must be considered an isolated form, on account of the structure of the radula and the coelomoducts. *Australis* has a biserial radula, *valdiviae* a multiseriate one (9, pp. 681, 672).

Atlantic forms: *acuminata* shows a multiseriate radula and two salivary glands, which open out separately. Abdominal and cloacal spicules are wanting.

Recapitulating these facts, we come to the following conclusion. The known species of *Proncomenia* present great differences; all of them, however, have a radula, a thick cuticle with many layers of pointed, hollow spicules, numerous epidermal sense-organs, and one or more dorso-terminal sense-organs; gills are wanting. If no other characteristics were considered, we might keep the genus *Proncomenia*. In my opinion, however, we have good reason to divide the genus into a number of smaller

ones, considering in the first place the exact structure of the radula and salivary glands. I propose the following division :—

FAMILY PRONEOMENIDAE.

Index—at least—6. Cuticle thick, with many layers of spicules, by far the greater part of which is pointed and hollow. Epidermal papillae present. One or more dorso-terminal sense-organs. Radula and salivary glands present. Gills are wanting.

A. Radula multiserial. Salivary glands tube- or bag-shaped.

Proneomenia Hubrecht.

- a. Radula with basal membrane. Salivary glands tube-shaped, uniting before opening out into the digestive tract. Receptacula seminis strongly folded, glandular. The spicules remain connected with the epidermis by multinuclear stems. Abdominal spicules present. Index 9–14.

Proneomenia sluiteri Hubr. (4.)

(= *langi* Heuscher),

Barent's Sea, Spitzbergen.

70–160 fathoms.

- b. Radula with basal membrane. Salivary glands tube-shaped, opening out separately. Receptacula seminis vesicular or tube-shaped.

- a. With abdominal and cloacal spicules. Receptacula seminis vesicular. One dorso-terminal sense-organ. Index 22–50.

Proneomenia weberi Nierstr. (6, p. 2.)

East-Indian Archipelago, 22–1633 M.

Proneomenia longa Nierstr. (6, p. 7.)

Saley, East Indian Archipelago, 1158 M.

- β. Without abdominal, with cloacal spicules. Receptacula seminis vesicular. Two dorso-terminal sense-organs. Index 10.

Proneomenia discoveryi Nierstr.

77° 50' 30" S., 165° 40' 5" E. 100 fathoms.

- γ. Without abdominal or cloacal spicules. One dorso-terminal sense-organ. Receptacula seminis vesicular or tube-shaped. Index 9–18·5.

Proneomenia valdiviae Thiele (16.)

3° 7' S., 40° 45' 8" E. 748 M.

Proneomenia acuminata Wirén (18, p. 68.)

West India. 300 fathoms.

Proneomenia hawaiiensis Heath (1.)

(? insufficiently known.)

Hawaiian Islands.

Proneomenia gerlachei Pels. (10, p. 16.)

70° S., 80° 48' W. 500 M.

- c. Radula without basal membrane. Salivary glands tube- or bag-shaped, opening out separately. Receptacula seminis vesicular.

- a. With abdominal and cloacal spicules. Salivary glands tube-shaped. 1–3 dorso-terminal sense-organs. Index 6.

Proneomenia vityans Kow. a. Mar. (5, p. 29.)

Mediterranean.

- β. With abdominal, without cloacal spicules. Salivary glands bag-shaped. Receptacula seminis numerous, often lobate. One dorso-terminal sense-organ. Index 11.

Proneomenia thulensis Thiele (14.)

80° 8' N., 16° 55' E. 480 M.

- γ. With abdominal, without cloacal spicules. Salivary glands tube-shaped.
Index 6-25.
- Proneomenia gorgonophila* Kow. a. Mar. (5, p. 75.)
Mediterranean.
- Proneomenia desiderata* Kow. a. Mar. (5, p. 59.)
Mediterranean.
- B. Radula biserial. Salivary glands tube-shaped and opening out separately. With abdominal spicules. Receptacula seminis numerous. One dorso-terminal sense-organ.
Index 18.
- Epimenia* Nierstrasz.
Epimenia australis (Thiele) (17, p. 255.)
N.W. coast of Australia. 60 fathoms.
- C. Radula bi-pectinid. Salivary glands consisting of more or less developed accumulations of glandular cells, opening out through salivary ducts, which remain separated. Abdominal spicules present. Receptacula seminis numerous. The coelomoducts remain separated. Index 24.
- Anamenia* Nierstrasz.
Anamenia amboinensis (Thiele) (15.)
Ambon.
- D. Radula bi-pectinid (?). Salivary glands lobed, consisting of accumulations of glandular cells, and opening out through salivary ducts, which remain separated. Without abdominal and cloacal spicules. Index 20.
- Amphimenia* Thiele.
Amphimenia neapolitana Thiele (13, p. 244.)
Naples.

The same holds good for *Rhopalomenia*. Up to now, of this genus five species are known, viz., *aglaopheniae* Kow. a. Mar.; *eisigi* Thiele; *indica* Nierstr.; *debilis* Nierstr.; and *scandens* Heath. All these forms resemble the Proneomeniidae; they differ, however, in the absence of a radula. Traces of the latter are found in the radula-sac. The structure of the salivary glands presents important points of difference. *R. aglaopheniae* has two pairs of salivary glands, one pair vesicular and the other lobate, just as they occur in *Amphimenia*. Undoubtedly, *R. eisigi* is related to *aglaopheniae*. *R. indica* shows numerous receptacula seminis; cloacal spicules, however, fail. True abdominal spicules are absent, though around the cloacal opening spicules occur of special form. Moreover, there only occur two tube-shaped salivary glands; relation with *Proneomenia thulensis* and *Epimenia australis* should, therefore, not be excluded. *Rhopalomenia debilis*, thoroughly known to us, probably is closely related to *Rhopalomenia indica*. Our knowledge of the structure of the internal organs of *Rhopalomenia scandens*, with the exception of the nervous system, is insufficient. It appears to me that these forms are connected with different genera of the Proneomeniidae, and, therefore, the genus *Rhopalomenia* may be a heterogeneous one. A division into smaller genera is for the present not to be recommended; in still stronger degree the same holds good for *Chaetoderma* (7, p. 368).

MEMOIRS REFERRED TO.

- | | | | |
|----|---------|------------------------|-----------------------------------------------------------------------------------------------------------------------------------------------------|
| 1 | 1904 | HEATH, HAROLD . . . | The nervous system and subradular organ in two genera of Solenogastres. Zool. Jahrb., Vol. 20, Anat. |
| 2 | 1905 | „ „ . . . | The Morphology of a Solenogastre. Zool. Jahrb., Vol. 21, Anat. |
| 3 | 1892 | HEUSCHER, J. . . . | Zur Anatomie und Histologie der <i>Proneomenia sluiteri</i> Hubrecht. Jen. Zeitschr. Naturw., Vol. 27. |
| 4 | 1881 | HUBRECHT, A. A. W. . . | <i>Proneomenia sluiteri</i> , gen. et sp. n. Niederl. Arch. Zool. Suppl. |
| 5 | 1887 | KOWALEVSKY, A. O. . . | Kowalevsky, A. O., et Marion, A. F. Contributions à l'histoire des Solenogastres ou Aplacophores. Ann. Mus. Hist. Nat. Marseille. Zoologie. Vol. 3. |
| 6 | 1902 | NIERSTRASZ, H. F. . . | The Solenogastres of the Siboga Expedition, in Sib. Exp., Monogr. 47. |
| 7 | 1903 | „ „ . . . | Nene Solenogastren. Zool. Jahrb., Vol. 18, Anat. |
| 8 | 1903 | „ „ . . . | Das Herz der Solenogastren. Verhand. Kon. Akad. Wet. Amsterdam. Sect. 2, Vol. 10, No. 2. |
| 9 | 1905 | „ „ . . . | <i>Kruppomenia minima</i> und die Radula der Solenogastren. Zool. Jahrb., Vol. 21, Anat. |
| 10 | 1903 | PELSENEER, P. . . . | Mollusques (Amphineures, Gastropodes et Lamellibranches). Result. Voyage Belgica, 1897-1899, Zoologie. |
| 11 | 1891 | PRUVOT, G. | Sur l'organisation de quelques Néoméniens des côtes de France. Arch. Zool. Expér. Ser. 2, Vol. 9. |
| 12 | 1892-94 | SIMROTH, H. | Aplacophora. Bronn's Klassen u. Ordnungen des Thierreichs. Mollusca, pp. 128-226. |
| 13 | 1894 | THIELE, J. | Beiträge zur vergleichenden Anatomie der Amphineuren. Zeitschr. f. Wiss. Zool., Vol. 58. |
| 14 | 1900 | „ „ | <i>Proneomenia thulensis</i> , nov. spec. Fauna arctica (Römer u. Schaudinn). Vol. 1, Lief. 1, pt. iii. |
| 15 | 1902 | „ „ | <i>Proneomenia amboinensis</i> , n. sp. Semon, Zool. Forschungsreisen in Austr. u. d. Mal. Arch., pp. 735-737. |
| 16 | 1902 | „ „ | <i>Proneomenia valdiviae</i> , n. sp. Wiss. Ergebn. deutsch. Tiefs. Exp. Valdivia., Vol. 3, pp. 169-174. |
| 17 | 1902 | „ „ | Die systematische Stellung der Solenogastren und die Phylogenie der Mollusken. Zeitschr. f. Wiss. Zool., Vol. 72. |
| 18 | 1892 | WIRÉN, A. | Studien über die Solenogastren. II. Königl. Svenska. Vet. Ak. Handl., Vol. 25. |

PLATES I. AND II.

FIG. 1.—A. *Proneomenia discoveryi*. The animal ($\times 5$), drawn from spirit specimen.

B. Anterior extremity. ($\times 5$.)

C. Posterior extremity. ($\times 5$.)

FIG. 2.—Spicula. ($\times 330$.)

FIG. 3.—Spiculum with mother-cells. ($\times 730$.)

FIG. 4.—Epidermal papilla. ($\times 330$.)

FIG. 5.—A. Dorso-terminal sense-organ at the surface of the cuticle.

B. *id.* in the cuticle.

C. *id.* as evagination of the epidermis. ($\times 124$.) *cut.* cuticle; *dto.* dorso-terminal sense-organ; *ep.* epidermis; *m.* circular muscular layer; *ped.* pedicle.

FIGS. 6-11.—Transverse sections through the anterior extremity. ($\times 53$.)

ag. anterior mucous gland.

bc. buccal commissure.

bg. buccal nerve.

c. proximal caecum of the intestine.

cc. cartilaginous cells.

cg. cerebral ganglion.

cn. cone with radula-teeth. (*See text.*)

f. ciliated cavity.

i. intestine.

gv. latero-ventral ganglion.

gd. latero-dorsal ganglion.

ln. lateral nerve.

m. muscle.

oes. oesophagus.

ph. pharynx.

rs. radula sac.

sg. salivary gland.

vg. ventral gland.

vn. ventral nerve.

vs. ventral sac of the radula.

FIGS. 12-14.—Schematic transverse sections through radula, ventral sac of the radula, and pharyngeal wall.

FIG. 15.—Salivary glands (*sg.*), opening into the ventral sac of the radula. ($\times 124$.)

FIG. 16.—Radula-teeth, basal membrane and pharyngeal wall. ($\times 330$.)

FIG. 17.—Radula-teeth. ($\times 780$.)

FIG. 18.—Distal portion of the ventral sac of the radula. ($\times 330$.) (*See text.*)

FIGS. 19-23.—Transverse sections through the distal extremity. ($\times 29$.)

a. atrium.

cb. ciliated bands. (*See text.*)

cd. cloacal duct.

cl. cloaca.

cs. cloacal-spicule.

ggs. ganglion posterius superius with commissure.

i. intestine.

ln. lateral nerve.

n. distal nerves.

p. pericardium.

po. praecloacal organ.

r. rectum.

v. ventricle.

vn. ventral nerve.

FIG. 24.—Transverse section through a cloacal-spicule. ($\times 330$.)

FIG. 25.—Genital products in the pericardium. (*See text.*) ($\times 480$.)

FIG. 26.—Blood-corpuses. (*See text.*) ($\times 780$.)

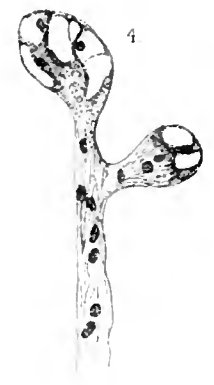
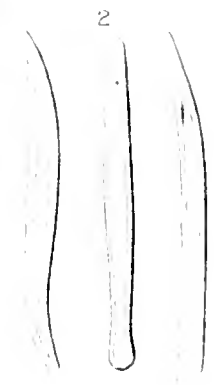
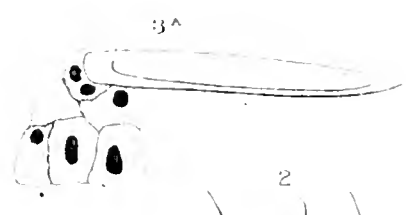
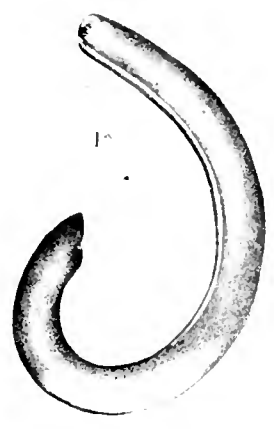

6

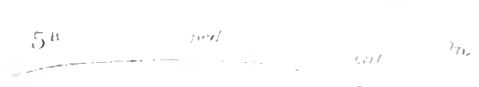
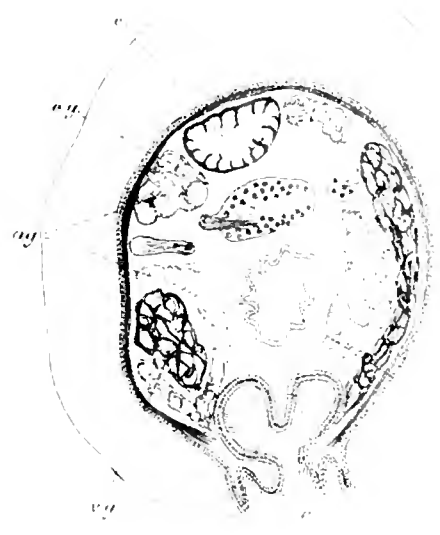

7

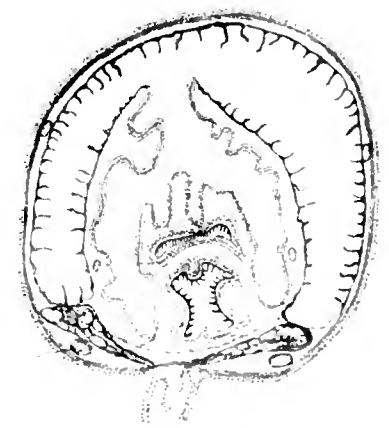
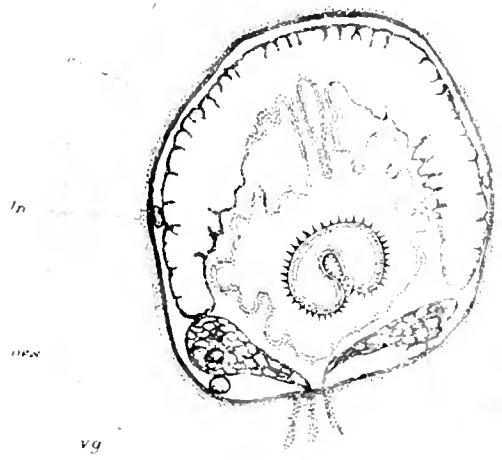
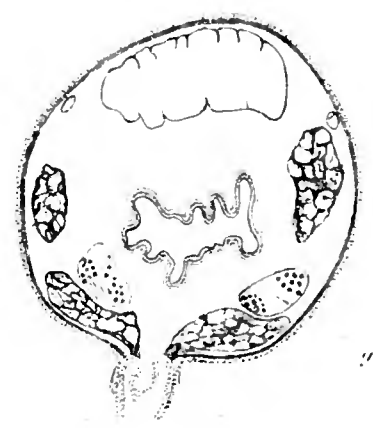

9

INSECTA APTERA.

By GEORGE H. CARPENTER, B.Sc. (LOND.), M.R.I.A.,

Professor of Zoology in the Royal College of Science, Dublin.

(1 Plate.)

THE explorations of the National Antarctic Expedition have established the presence of a wingless insect of exceptional interest, far south in the Continent of Victoria Land. From Granite Harbour, 77° S. lat. and 162° E. long., on the south-trending continental coast-line, almost opposite Ross Island, on which stand Mounts Erebus and Terror, and about 100 miles N.W. of the Winter Quarters of the 'Discovery,' a jar-full of moss believed to contain Collembola was secured. Examination of this material has resulted in the detection of half-a-dozen very imperfect specimens of a small dark-blue springtail. Unfortunately, these insects are in a poor state of preservation; either the spirit in which the moss was placed was too strong, or the insects had died and shrivelled before the moss was collected. The result, however, is that no really good example of the species can be obtained, and the following descriptions with the accompanying figures have been made from various fragments. Under these circumstances the descriptions are necessarily imperfect. It is hoped that the account will not require correction by the discovery of further and more satisfactory specimens by some future expedition, but it will assuredly need supplementing. The remoteness of the locality, and the difficulty with which the insects must have been obtained, render it a duty to make the best possible use even of such unpromising material.

At first I spent many hours pulling the leaves of the moss plants asunder with the help of a dissecting microscope, and this labour was rewarded by the discovery of one or two shrivelled specimens, almost useless for study. Afterwards it was found that the bases of the shoots afforded a better hunting-ground, and several more days' work resulted in the unearthing of a few specimens in a less shrivelled state. From these, when cleared in potash and mounted in glycerine jelly, it was possible to make out various details of structure, and the systematic position of the insect has been gradually traced. All the specimens seen are referable to the same species. Unfortunately, the general shape of the body can only be surmised, and the segmentation of thorax and abdomen cannot be clearly distinguished in any specimen. On the other hand, the delicate sense-organs on the feelers and head, and some details of the jaws, can be plainly seen in one or two examples. A large quantity of the moss still remains unexamined, so that further light may yet be thrown on the species

by the collection already in hand; but I think it unlikely that any specimens more satisfactory than those here described and figured will be found in it.

This is the second species of Collembola known from the Antarctic Continent of South Victoria Land. The first, described five years ago (Carpenter, 1902) was brought home by the 'Southern Cross' Expedition from Geikie Land, on the shores of Robertson Bay near Cape Adare, some 380 miles north of Granite Harbour. That species was an *Isotoma*, a member of the family Entomobryidae. The present insect belongs to the family Poduridae, so that the two largest families of Collembola are both represented on the Antarctic Continent. A summary of the distribution of the known species of Antarctic and sub-Antarctic Collembola will be found in Wahlgren's recent paper (1906) on the insects of this order collected by the Swedish Expedition. To the species that he enumerates have now to be added the insect here described and the two new species brought from the South Orkney Islands by the 'Scotia' Expedition (Carpenter, 1906). The last-named paper contains arguments, from the distribution of Antarctic springtails, in favour of a former wide extension of the Antarctic Continent. The present species, having no near allies, does not throw any additional light on such geographical problems.

COLLEMBOLA.

FAMILY PODURIDAE.

GOMPHIOCEPHALUS, gen. nov.*

Cuticle very finely granulate. Abdomen with two anal spines. Spring and catch vestigial. Empodium of foot without appendix ("inferior claw"). Feeler four-segmented; sensory setae on the third segment; a sub-apical, depressed sense-organ, and a protrusible apical sense-organ on the fourth. On each side of head a simple post-antennal organ surrounded by a single ovate or cordiform rim; and a stout sensory tooth-like spine behind the post-antennal organ. Mandible with molar surface close to base. Maxillula with apical teeth and a feeble but distinct molar area.

This genus will probably require a new sub-family (Gomphiocephalinae) to express its peculiar affinities. On the whole it comes nearest to the Hypogastrurinae in the recent classification of Börner (1906). But the dentiform sense-organ on the head, the shortened mandibles, and the mandibuliform maxillulae appear to be absolutely distinctive characters; while the feeble granulation of the cuticle, and especially the simple post-antennal organ, show an approach to the Anurophorini, a tribe of the Isotominae which belong to the Entomobryidae. Indeed the genus *Gomphiocephalus*

* From *γομφίος*, a back-tooth, and *κεφαλή*. I have to thank the Editor, Prof. F. J. Bell, for kindly proposing this name to replace my suggestion *Odontoccephalus*, which is pre-occupied. The allusion is to the peculiar dentiform sense-organ on the head (fig. 1, *f*).

seems a Podurid, with affinities to the Entomobryidae, just as the Anurophorinae—which include that remarkable Antarctic genus *Cryptopygus* (Willem, 1902)—are Entomobryids, with affinities to the Poduridae. The presence of such ancient connecting links on the Antarctic Continent and islands might reasonably have been expected.

I have pleasure in naming the type-species of *Gomphiocephalus* after Mr. T. V. Hodgson, of the 'Discovery.'

GOMPHIOCEPHALUS HODGSONI.

Length, 1 mm. Colour dark blue-violet. Feelers rather shorter than head; proportional length of segments 8 : 11 : 12 : 15. Foot with three long, slender tenent hairs; claw simple without teeth; empodium vestigial. Anal spines nearly as long as foot-claw, on short contiguous papillae.

Habitat. In moss (*Bryum algens*, Cardot*), Granite Harbour, South Victoria Land. (Types in British Museum.)

The whole insect is of a very deep blue-violet colour. The cuticle is finely rugose, and bears numerous bristles, many of which, especially on the terminal abdominal segments, are elongate, but none are feathered. The general aspect of the species and the form of the foot are suggestive of a *Xenylla*.

Feelers. The feelers (figs. 1, 2) have characteristic sense-organs both on the third and fourth segments. On the dorsal aspect of the extremity of the third segment is a group of four short, sharp spines arising from large circular depressions in the cuticle, and surrounded by a sinuous ridge (fig. 1, *d*). The two outer spines of this organ are stronger than the two central. At the tip of the fourth segment is a long tapering sensory bristle (fig. 1, *b*), and near it is a sub-apical sense-organ (fig. 1, *a*) consisting of an oval depression within which is placed a slender bristle. Close to this are two small rounded papillae with a bristle at the tip of each. At the apex of the fourth segment and directed ventralwards, a bladder-like protrusible organ (fig. 2, *c*) can be seen in two specimens.

Cephalic sense-organs. The most careful search has failed to discover any trace of ocelli, and I believe that they are absent. In every specimen, however, the post-antennal organ (fig. 1, *e*) is prominent—a simple chitinous ridge of oval or heart-shaped form, varying in the details of its outline in different specimens (*e'* *e''*). Behind this is a structure, which appears to be a sense-organ, hitherto undescribed, as I believe, in any springtail. It is a stout curved tooth-like outgrowth (fig. 1, *f*), probably performing a tactile function in connection with the shelters beneath which these insects live.

Jaws. The front region of the head is distinctly produced towards the mouth, producing the "prognathous" aspect which characterises this group of Collembola.

* See these Reports, vol. iii.: Musci, p. 5.

The *labrum* (fig. 8) is narrow and rounded in front, and bears a proximal row of four and a distal row of three long bristles.

The jaws are in many respects highly remarkable. The *mandibles* (figs. 3, 4) have four strong teeth at the apex, and a very well-developed molar area, the teeth at its distal region being especially strong. At the proximal end of the molar area are two prominent recurved hooks directed dorsalwards. On the outer edge of the mandible is a strong "shoulder," and just proximal to this a rounded "boss." The large basal extension of the mandible so characteristic of the Collembola generally is entirely wanting in the present genus. At first I could not believe this to be so, supposing that the basal region had somehow got destroyed in the specimens that I was examining. But on finding the mandibles in all the specimens in exactly the same condition, I can only conclude that this insect shows a modification of the jaws unique in the Collembola. As the muscles are usually attached to this missing basal part of the mandible, fresh specimens of the present genus would be especially welcome subjects for anatomical research.

The *maxillulae* (fig. 5) are also very remarkable on account of their likeness to the mandibles. I have not succeeded in isolating these appendages, but one of the heads is so transparent that their shape can be easily seen. At its apex the maxillula has three delicate pointed teeth, while the inner edge of the base carries, not, as is usual, one row of spines, but four rows of short denticles, forming a molar area analogous to that of the mandible. I have not succeeded in seeing the tongue (hypopharynx) so that I cannot state whether the relation of the maxillulae to that structure is of the usual nature or not. In this genus they are more unmistakably a pair of jaws than in any Collembolan that I have examined.

Each *maxilla* (fig. 6) has a "head" of the usual Collembolan form with a two-toothed galea (*g*) and three internal lamellae (*l*); on account of their delicate texture these latter structures are somewhat shrivelled, and the shape given to them in the figure may be inaccurate. The base of the maxilla (fig. 6, *st*) can only be traced a short distance into the head capsule, but I cannot satisfy myself that the cardo, with its usual associated sclerites, is absent. There is a blunt palp (fig. 6, *p*) carrying three or four bristles at its tip.

The *second maxillae* combine, as is usual in the Collembola, to form a transverse *labium* (fig. 7) with alternating narrower and broader lobes, carrying long bristles.

Legs. The legs (fig. 9) are of the usual Collembolan form. The tibio-tarsus carries a simple pointed claw without trace of tunica, and a small rounded empodium without appendix. There are three elongate tenent hairs, without terminal club, springing from large circular depressions of the cuticle.

Ventral Tube. The ventral tube (fig. 10) on the first abdominal segment is abrupt on its front and rounded on its hinder face, beset with numerous bristles like those of the cuticle generally. It appears to be in the undeveloped state characteristic of the section to which this genus belongs.

Spring and Catch. Most of the specimens examined show no trace of these structures, but in two the appearance drawn in fig. 11 can be plainly seen. The spring (fig. 11, *s*) is clearly in a vestigial condition, its manubrium being merged in the ventral region of the fourth abdominal segment, while the combined dens and mucro terminate in a blunt, rounded knob.

The catch (retinaculum) is represented by a pair of small rugose prominences (fig. 11 *r*) on the third abdominal segment.

Anal Spines. The anal spines are nearly as long as the foot-claw, slightly and evenly curved (figs. 11, 12). They are situated on short, contiguous papillae. In all the specimens examined the spines are slightly asymmetrical (fig. 12), but this is probably due to the position of one having been slightly shifted.

REFERENCES.

1906. C. BÖRNER. Das System der Collembolen nebst Beschreibung neuer Collembolen des Hamburger naturhistorischen Museums. 2 Beiheft zum *Jahrb. der Hamburg. wissensch. Anstalten*, xxiii., 1906, pp. 147-188.
1902. G. H. CARPENTER. "Insecta Aptera," in *Report on Collections, Voyage of Southern Cross*, pp. 221-3, pl. xlvii. London (British Museum), 1902.
1906. ———— Scottish National Antarctic Expedition. 'Scotia' Collections. Collembola from the South Orkney Islands. *Proc. Royal Soc. Edinb.*, xxvi., 1906, pp. 173-183, pls. 1-2.
1906. E. WAHLGREN. Antarktische und subantarktische Collembollen gesammelt von der schwedischen Südpolarexpedition. *Wissensch. Ergebn. der Schwed. Südpolarexpedition*, 1901-3, vol. v., 1906, pp. 1-22, pls. 1-2.
1902. V. WILLEM. Collemboles: *Résultats du Voyage de S. Y. 'Belgica' en 1897, 1898, 1899. Rapports Scientifiques.* Anvers, 1902.

EXPLANATION OF PLATE.

Gomphiocephalus hodgei.

- FIG. 1.—Left feeler with part of head, dorsal aspect; *a*, sub-apical, depressed sense-organ; *b*, sensory bristle; *d*, sensory spines on third antennal segment; *e*, post-antennal organ; *f*, dentiform cephalic sense-organ; *e'*, *e''*, variations in form of post-antennal organ from other specimens.
- FIG. 2.—Right feeler, lateral aspect of extremity; *a* and *d* as in fig. 1; *c*, apical, protrusible sense-organ.
- FIG. 3.—Left mandible, seen from inner aspect.
- FIG. 4.—Left mandible, dorsal aspect.
- FIG. 5.—Right maxillula, showing teeth and molar area.
- FIG. 6.—Left maxilla; *s*, stipes; *g*, galea; *l*, lamellae; *p*, palp.
- FIG. 7.—Second pair of maxillae forming labium.
- FIG. 8.—Labrum.
- FIG. 9.—Right hind leg, showing claw, vestigial empodium, and tenent hairs on foot.
- FIG. 10.—Ventral tube on first abdominal segment, seen from right side.
- FIG. 11.—Part of hind abdominal segments, showing anal spines, and vestigial spring (*s*) and catch (*r*): lateral view.
- FIG. 12.—Tip of abdomen, with papillae and anal spines; postero-ventral view.

All figures are magnified 600 diameters.

AMU

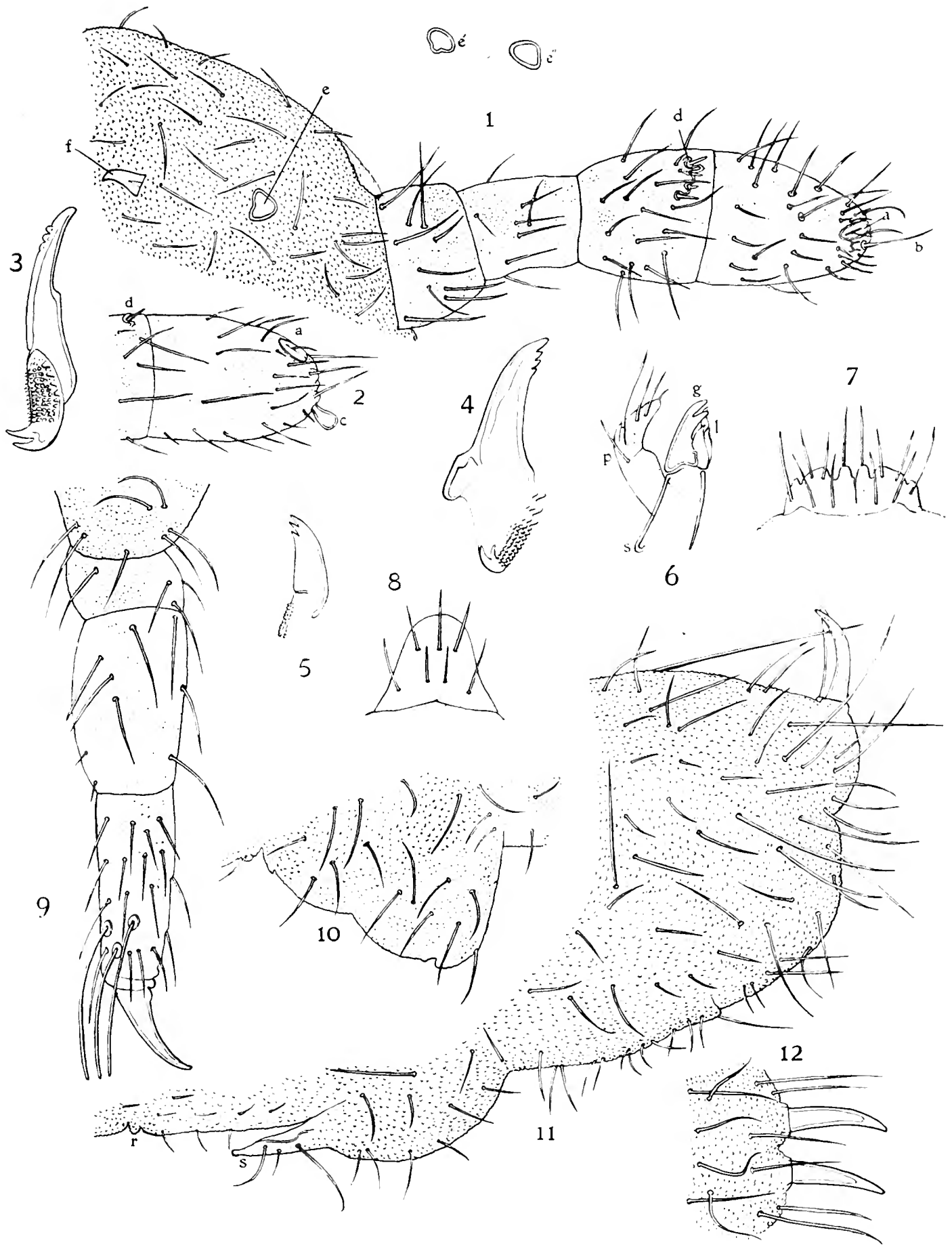

Antarctic (Discovery) Exp.

G.H.C. del Butterworth sc.

Gomphiocephalus hodgsoni.

C R U S T A C E A .

VII.—SCHIZOPODA.

By W. M. TATTERSALL, M.Sc.

(8 Plates.)

THE collection of 'Discovery' Schizopoda is a large one from the point of view of the number of specimens it contains, considerably over ten thousand, including larvæ, having been collected. By far the majority of these specimens, nearly ten thousand, however, belong to one species, and the total number of species reaches thirteen. The collection is in a generally excellent state of preservation, though many specimens have undoubtedly suffered from being frozen after coming out of the water and from the subsequent thawing before preservation.

In the preliminary notice of this collection (Holt and Tattersall, 1906 (1)*) ten species were noted, of which five were absolutely new, two were only known under manuscript names given to them by Dr. Hansen from the collections of the 'Belgica' Antarctic Expedition, while the remaining three were already described forms.

Since the publication of that notice further material has come to hand, collected on the homeward journey of the 'Discovery.' It contained two species of *Euphausia* not included in the earlier material, one, an immature form which was too young to be specifically identified; the second, a species very close to *E. lucens*, Hansen (= *E. splendens*, G. O. Sars), but which Dr. Hansen has kindly informed me is distinct, and will be described by him in a forthcoming paper. A re-examination of the two specimens which in the preliminary note were referred to *Mysis marima*, Hansen (MS.), has shown that they represent in reality two very closely allied species, the second of which will also be described by Dr. Hansen in a future work.

Previous to the recent activity in South Polar exploration only three expeditions to the Antarctic had brought back zoological material from which Schizopoda were recorded. Dana (1852) in his great work on Crustacea records two species from Antarctic waters (*i.e.*, south of lat. 60° S.) viz., *Euphausia superba* and *Eucopia australis*.

H.M.S. 'Challenger' in 1874 collected, in the same region, *Euphausia superba*, *E. murrayi*, *E. antarctica*, *Thysanoëssa macrura* and a species of *Pseudomma*, doubtfully referred to *P. sarsi* by Prof. Sars, who described the Schizopoda of that expedition. The second and third species in this list are, however, only synonymous with the first, so that the real total of 'Challenger' Antarctic species is three.

* These dates refer to the list of Memoirs on p. 38.

Mr. Hodgson (1902) described two species as new, *Euphausia glacialis* and *E. australis*, collected by the 'Southern Cross' South Polar Expedition. Both species are synonymous with *E. superba*, Dana, so that previous to 1903 only four Antarctic species of Schizopoda were known, viz., *Eucopia australis*, Dana, *Euphausia superba*, Dana, *Thysanoëssa macrura*, G. O. Sars, and *Pseudomma sarsi*, Will.-Suhm.

Of the recent expeditions to the South Pole, which number seven, the results of the Schizopoda of the French Antarctic Expedition have been published in full, and of the 'Valdivia' Expedition in part only. M. Coutière (1906) notes from the French Antarctic collections, *Euphausia superba*, Dana, *E. similis*, G. O. Sars, *Thysanoëssa macrura*, G. O. Sars, and *Antaretomysis maxima* (Hansen, MS.), a species also recorded in the preliminary note on the present collection.

Preliminary descriptions have been published of two Antarctic *Mysidæ* collected by the 'Valdivia' (Illig, 1906), *Dactylerythrops arcuata* and *Echinomysis chuni*. The first of these is synonymous with a species *Dactylamblyops hodgsoni*, described below.

This completes the bibliography as regards purely Antarctic Schizopoda, though a number of sub-Antarctic species are known.

Ten of the thirteen species collected by the 'Discovery' were taken in Antarctic waters, and when, as we have seen above, the total previously recorded species number seven, it will be recognised that the present collection has added considerably to our knowledge of South Polar species of this group.

The most abundant species in the collection is a small *Euphausia*, *E. crystallophiæ*, H. and T., which evidently has its head-quarters under the ice, since all the specimens were collected from ice-holes at Winter Quarters, and none were met with in the open sea. On the other hand, the dominant species of the collections from open Antarctic waters are *Euphausia superba*, Dana, and *Thysanoëssa macrura*, G. O. Sars.

The abundant material of the first-named species has afforded opportunity for some observations on the sexual characters and life history of the species, with the result that four other species, hitherto regarded as distinct from *E. superba*, must now be allocated to its synonymy, having been founded either on characters which are sexual and not specific, or else from immature specimens.

The scarcity of fully grown males of *E. superba* seems worthy of note. This fact seems to be established by the results of the various collections of which we have knowledge, since, so far as I am aware, the only one recorded is Sars' 'Challenger' specimen. M. Coutière (1906), it is true, notes that male specimens were more numerous than females in the collection he examined, but it is equally clear that none were fully grown, since the largest measured only 45 mm., and was in the stage previous to the last moult into completely grown specimens. There are no fully-grown males in the 'Discovery' collections, but to judge from the development of the copulatory apparatus on the first pleopods, many of them must be sexually mature at any rate.

Thysanoëssa macrura, G. O. Sars, too, seems never to have been previously met with in full-grown condition, and but very few of the 'Discovery' specimens can be

said to have reached that state. Still, they afford material for a re-description and figures of the species in the adult state, with some notes on the growth changes.

The Mysidacea consist of eleven specimens, referable to six species. The most interesting of these species is *Hansenomysis antarctica*, an Antarctic representative of a genus hitherto known from but three specimens from Arctic and boreal waters.

The chief interest of the collection lies in the evidence which it may afford as to the similarity or dissimilarity of the fauna at the two poles. There are no species common to the fauna of both polar regions in the collection; but, on the other hand, all the genera save one, *Antaretomysis*, are represented in northern waters by species which are quite distinct from their southern allies.

Exploration of the bottom fauna of the deep waters of the globe, especially in tropical and sub-tropical regions, is as yet only in its infancy, and it is therefore extremely probable that what are now known to be bipolar genera and species will in future be found to be cosmopolitan in their distribution. The Schizopoda were long thought to have in *Lophogaster typicus* a stock instance of a bipolar form, but the gaps in its distribution have been almost completely filled up as a result of recent deep-sea work, and, with the exception of the tropical Atlantic, its range is known to be complete from Norway to the Cape.

Two bipolar species of Mysidæ are known, however—*Boreomysis scyphops*, G. O. Sars, from Arctic waters, and Lat. 50° S., near the Crozet Islands, and *Amblyops crozetti*, from the seas of Greenland and Ian Mayen in the north and the Crozet Islands in the south. They are not known from the intermediate waters.

Of the genera of Antarctic Schizopoda, *Euphausia*, *Thysanoëssa*, and *Eucopia* are world-wide in range, but the northern and southern species are quite distinct, even the hitherto supposedly cosmopolitan *Eucopia australis*, Hansen having shown to contain at least two species, probably three.

Pseudomma, *Hansenomysis*, *Dactylamblyops*, and *Mysidetes* are, as at present known, bipolar genera, but *Pseudomma*, at least, ranges far from both poles, and further exploration will probably extend the known range of the other genera also.

The most interesting case is presented by the genus *Antaretomysis*. It is closely related in structure to the northern species *Michtheimysis miata* (Lilljeborg), a species inhabiting chiefly the colder waters of the northern hemisphere. The two genera are separated only in the characters of the male pleopods, which are more primitive in the Antarctic form, and neither genus is likely to be found to have a distribution which extends very far from the poles they frequent.

In the preparation of this report I have received much valuable help from many sources. The authorities of the British Museum kindly allowed me to examine and dissect two specimens from the 'Challenger' collections in their charge. To Dr. Calman, of the British Museum, I have been much indebted for information on many points connected with the 'Challenger' material, and he has, also, at my request, furnished me with drawings of various species. Mr. E. W. L. Holt kindly examined

the British Museum material, and provided me with valuable notes as a result, which I have freely used in this report. The Rev. T. R. R. Stebbing, F.R.S., placed two of the type specimens of *Euphausia vallentini* at my disposal, with full permission to dissect them if found to be necessary, while Prof. D'Arcy W. Thompson, C.B., allowed me to examine and retain for some time a small collection of Antarctic Schizopoda from the collections of the Museum at University College, Dundee. I am specially indebted to Dr. Hansen, of Copenhagen, for the most generous and valuable assistance. Not only did he kindly confirm or modify my determinations of the more subtle species of *Euphausia*, but he placed at my disposal his notes and drawings of the male copulatory apparatus of the species of this genus, of which he has made a special study. Without his help I should have failed to recognise that the two specimens of *Antarctomysis* belonged to two distinct species, while I should have recorded as *E. lucens* the new Antarctic species which Dr. Hansen will himself describe. For all this assistance I wish to express my best thanks.

ORDER EUPHAUSIACEA.

FAMILY EUPHAUSIIDÆ.

SUB-FAMILY EUPHAUSINÆ, Holt and Tattersall.

GENUS EUPHAUSIA, Dana.

EUPHAUSIA SUPERBA.

(Plate I., Figs. 1-12.)

Euphausia superba, Dana, 1852.

Euphausia superba, G. O. Sars, 1883 and 1885.

Euphausia murrayi, G. O. Sars, 1883 and 1885.

Euphausia antarctica, G. O. Sars, 1883 and 1885.

Euphausia glacialis, Hodgson, 1902.

Euphausia australis, Hodgson, 1902.

Euphausia superba, Holt and Tattersall, 1906 (1).

Euphausia superba, Couzière, 1906.

Localities of captures :—

Lat. $61^{\circ} 46'$ S., long. $141^{\circ} 12'$ E., 16. 11. 01, five specimens, 14-20 mm.

Off Scott Island, 26. 12. 01, two specimens, 15-19 mm.

Lat. $66^{\circ} 52' 9''$ S., long. $178^{\circ} 8' 15''$ E., 3. 1. 02, eight specimens, 12-16 mm.

From stomach of *Lobodon carcinophaga*, 3. 1. 02, eleven specimens, 43-47 mm.

Lat. $72^{\circ} 5'$ S., long. $172^{\circ} 23'$ E., 10. 1. 02, eleven specimens, 15-47 mm.

Lat. $72^{\circ} 10' 33''$ S., long. $172^{\circ} 26' 2''$ E., 11. 1. 02, ninety specimens, 35-48 mm.

From River Koettlitz, 2. 1. 03, sixty-nine specimens, 13-27 mm.

Lat. $70^{\circ} 29' 27''$ S., long. $168^{\circ} 51' 46''$ E., 26. 2. 04, five specimens, 45-47 mm.

None were taken at Winter Quarters from the holes dug in the ice.

The synonymy given here, whereby five supposed distinct species of *Euphausia* are merged into *E. superba*, Dana, is the result of a careful examination of the abundant and valuable 'Discovery' material, aided by a comparison with the 'Challenger' and 'Southern Cross' types (for which I am greatly indebted to Mr. E. W. L. Holt), and the small collection from the zoological museum of University College, Dundee.

Reasons for these views were briefly stated in the preliminary notice of this collection, and the opinions as to the synonymy of this species, as far as they concern *Euphausia antarctica* and *E. murrayi*, have recently been confirmed and adopted by Couzière (1906) as a result of his examination of the collection of the French Antarctic Expedition. A fuller justification for these opinions is given below, together with some notes on the growth changes, and sexual differences.

Female.—This sex has been very well described under the names *E. murrayi* by G. O. Sars (1885), and *E. australis* by Hodgson (1902).

The 'Discovery' specimens present some slight differences from Sars' description, but the examination of his type specimens proves them to be due to errors on Sars' part. They may be noted under their separate heads as follows:—

(1) *Preal anal spine*.—Sars states that this spine is wanting in *E. murrayi*, but the type specimen shows it to be distinct, well-developed and simple, but not visible from the side from which Sars took his drawing. All the 'Discovery' specimens show a well-developed simple preanal spine.

(2) *Small blunt spine on the outer distal corner of the first joint of the antennular peduncle*.—This spine is not shown in Sars' figures nor mentioned in his description. It is, however, clearly visible in the type in lateral view, but in dorsal view is quite obscured by the numerous setæ arming the basal joint of the peduncle, which are well preserved and very opaque. The 'Discovery' material conforms to the type in possessing this spine well-developed.

(3) *Terminal spine on the outer margin of the antennal scale*.—Sars mentions this spine in his description as very small, but does not figure it. It is, in fact, not visible in his type from the dorsal aspect, owing to its being slightly ventrally deflexed, and the specimen is so well preserved and rigid, that the pressure necessary to place its dorsal surface uppermost for drawing is not sufficient to straighten out the spine and render it visible in dorsal view.

(4) *Shape of the epimeral plate of the penultimate segment of the pleon*.—Sars both describes and figures the penultimate epimeral plate as acute and triangular, but in the type and the 'Discovery' material, whereas these plates have substantially the same shape as depicted by Sars, the apex in all is bluntly rounded instead of acutely pointed.

(5) *Spinules on the dorsal surface of the telson*. Sars figures and describes three pairs in *E. murrayi*, but, as a matter of fact, the number is subject to variation, an additional pair anterior to the three shown by Sars being frequently noticed. In all

other respects the 'Discovery' material and the 'Challenger' types are in perfect agreement, and the facts noted above establish the identity of the females here referred to *E. superba*, with the species described by Sars as *E. murrayi*. It now remains to show that the differences between *E. murrayi* and *E. superba* are only sexual.

Male.—Under the name *E. superba* Sars has described and figured this sex adequately. The only point in which his description is deficient is the structure and armature of the telson. He figures no dorsal spinules on the telson, and both describes and figures the apex as slightly produced and obtusely pointed. Examination of Sars' type shows that the apex of the telson is clearly broken, so that Sars' figure is in this respect entirely imaginary. In the present material the apex of the telson is much produced and acutely pointed, and the number of dorsal spinules is usually three pairs, but may be four or two, placed as in Sars' figure of the telson of *E. murrayi*. One pair of spinules still remains in Sars' type of *E. superba*, but the others had probably been broken off (or obsolete?).

The most conspicuous difference between *E. superba* and *E. murrayi*, as described by Sars, is the presence in the latter and absence in the former of a lateral denticle on the carapace. But both Sars' *E. murrayi* were females, and his single specimen of *E. superba* a male. In all the females in the present collection, the largest of which is 47 mm. in length, the spine on the lateral margin is large and prominent, and even in a female, 50 mm. in length, in the collection from University College, Dundee, the spine is equally well-developed. I have figured the spine of the latter specimen on Pl. I., Fig. 10. In male specimens, on the other hand, only those which are less than 42 mm. in length have the spine well-developed (*cf.* Pl. I., Fig. 12, taken from a male, 39 mm. in length). In males above 42 mm. up to 47 mm. in length the lateral spine on the carapace is nearly obsolete and persists only as a blunt protuberance (*cf.* Pl. I., Fig. 11, taken from a specimen 45 mm. long, and also Coutière (1906), Pl. II., Fig. 22, taken from a male of the same size). The 'Discovery' collection contains no male specimens exceeding 47 mm. in length, but the 'Challenger' type measures 48 mm. It is well preserved and shows no trace of the lateral spine at all. Obviously, then, the absence of a spine is a sexual character confined to absolutely full-grown males only. The remaining differences between *E. superba* and *E. murrayi* given by Sars are as follows:—

(1) *E. superba* has the antennules considerably more robust than in *E. murrayi* and the lobe from the second joint almost obsolete. This difference is, I think, a purely sexual one, affording a parallel instance to that seen in the northern species, *Nyctiplanes couchi*. Pl. I., Figs. 1 and 2 are taken respectively from male and female specimens of the same size, viz., 45 mm., and from the same bottle. They indicate, clearly, the difference in relative stoutness in the two sexes, and that of the male shows the lobe from the second antennular joint in an intermediate stage of reduction between that of the female and that shown by Sars in his figure of the male *E. superba*, 48 mm. in length.

(2) In *E. superba* the rostrum is shorter and blunter than in *E. murrayi*, and has the margins less deeply concave. This, again, is clearly shown to be a sexual difference in Pl. I., Figs. 1 and 2. The rostrum of the male figured (Fig. 2) is shorter than that of the female, but is still rather more acute than in Sars' figure of *E. superba*. Reduction is probably not complete till a size of at least 48 mm. is attained.

A further difference between the two sexes is brought out by the figures here given, namely, the reduction in the male of the spine on the outer distal corner of the basal joint of the antennular peduncle. It is not visible in dorsal view, being hidden by the slightly projecting anterior margin of the joint, but it still persists as a small blunt protuberance. In the female, on the contrary, it is well-developed, distinctly visible in dorsal view, and acutely pointed throughout life.

A fourth distinction shown in the figures, the absence in the female of the curved setae on the dorsal surface of the basal joint of the antennules, is due to the accident that in the female from which the figure was taken, these setae had become broken off. They are, in reality, present, and equally developed in both sexes.

The above detailed description proves, I think, clearly, that *E. superba* and *E. murrayi* are the adult male and female, respectively, of one species which must bear the name *E. superba* Dana.

I also give (Plate I., Figs. 5-9), figures of the mouth organs and endopods of the first two thoracic limbs, to show two characters in which *E. superba* differs from all other *Euphausia* yet described. The first of these points is the narrow and elongate form of the terminal joint of the mandibular palp, with its peculiar armature of four or five terminal strong plumose setae. In all the other species of the genus (with the exception of *E. antarctica*, Sars, and *E. glacialis*, Hodgson), the terminal joint of the mandibular palp is much shorter and stouter. In the two exceptions just mentioned the mandibular palp is figured by Sars and Hodgson respectively, almost exactly as here given for *E. superba*. This fact first suggested to me that these two species were only developmental stages of *E. superba*, a suggestion fully borne out by the evidence derived from a study of the present collection. The second distinctive character of the appendages is found in the great length of the setae arming the joints of the thoracic limbs. They are very much longer than in any other species of the genus, and with the character of the mandibular palp serve for recognition of *E. superba* at any stage in its development.

Euphausia superba is the giant of the genus, and the only one of Dana's original four species which is now retained by Hansen (1905 (2)), the other three having been cancelled by that author as unrecognisable.

Some Notes on the development of E. superba.

These notes were made chiefly with a view to confirming the suspicion, aroused by the similarity in mouth organs, that *Euphausia antarctica* and *E. glacialis* were merely developmental stages of *E. superba*. The changes which accompany growth to

maturity concern chiefly the rostrum and the antennules, and these notes refer to these organs more particularly.

The smallest recognisable specimen of *E. superba* measured 12·5 mm. in length. The anterior end is represented in Plate I, Fig. 4. The rostrum is a bluntly rounded triangular plate. The spine on the outer distal corner of the basal joint of the antennule is still larval in character, being much longer than in larger specimens. There is no trace of the lobe from the basal joint of the antennule, but the one from the second joint already shows as a slight membranous projection of the anterior margin. The antennal scale also shows larval characters in that the outer margin is shorter than the inner. Finally, the telson has assumed adult form, but the dorsal spinules immediately anterior to the sub-apical spines are still long and plumose. The lateral spine of the carapace is present, but small. Between 12·5 mm. and 15 mm. the spine on the basal joint of the antennule gradually shortens up and assumes the characters seen throughout adult life. The antennal scale also assumes adult form, and the spinules immediately anterior to the sub-apical spines on the telson lose their plumose character and shorten to adult size. The rostrum, however, still remains obtusely rounded.

The next stage is that described by Sars as *E. antarctica*, and measures 17 mm. The rostrum has now become a broad, acutely pointed triangular plate, while the lobe from the basal joint of the antennules first becomes evident as a slight inflation of the anterior margin. This is shown by Sars in his 'Challenger' Report (Plate XV., Fig. 2). He has, however, overlooked the lobe on the second joint of the antennules, which is now considerably forward in development. The spine on the lateral edge of the carapace is now quite conspicuous.

Sars describes *E. antarctica* as being without lateral denticles. Examination of his type specimen, however, shows that, while the side from which he took his figure is rather damaged and the spine not visible, on the other side the spine is quite conspicuous and perfect. This removes the only serious difference which existed between the young *E. superba* here noted and Sars' description of *E. antarctica*.

The transition from *E. antarctica* at 17 mm. to *E. glaciialis*, Hodgson, is simple and obvious. I figure (Plate I, Fig. 3) the anterior end of a typical *glaciialis* stage from a specimen 26 mm. in length. The only differences to be noted from the *antarctica* stage are the better development of the antennular lobes and the shortening and broadening of the rostrum, which is still, however, pointed at the apex. The stage figured agrees well with Hodgson's figures and description of *E. glaciialis*.

After a length of about 27 mm. the sides of the rostrum gradually become more and more concave till at about 30 mm. the completely adult form is reached. Very little change takes place in either the form of the rostrum or the antennular lobes after a length of 35 mm. has been attained, except, of course, in the changes accompanying the last two or three moults in the male, already noted above. Examination of the

mouth organs at various stages confirms the identification of the specimens with *E. superba*.

This brief *résumé* of the development, I think, justifies the view that *E. antarctica* and *E. glacialis* represent stages in the development of *E. superba*, and must therefore be regarded as synonymous with that species.

It should be mentioned that Hodgson's types of *E. australis* differ in no way from *E. superba* (females), except in being considerably damaged.

EUPHAUSIA CRYSTALLOROPHIUS.

(Plate II., Figs. 1-10 ; Plate IV., Fig. 10.)

Euphausia crystallorophius, Holt and Tattersall, 1906 (1).

Localities of Captures :—

Winter Quarters.

26. 1. 02-8. 3. 02, 1 specimen, 24 mm.
 „ „ 216 specimens, larval.
 No. 3 Hole, 52 specimens, larval to 25 mm.
 No. 4 Hole, 4572 specimens, larval to 32 mm.
 No. 6 Hole, 13 specimens, larval to 25 mm.
 No. 8 Hole, 4642 specimens, larval to 32 mm.
 No. 13 Hole, 50 specimens, larval.

No specimens were captured either on the outward or homeward journey.

Form, moderately robust.

Carapace (Plate II., Figs. 1 and 2), with a prominent, rather long and acute spine on its lateral margins, a little anterior to the middle, and just above the insertion of the second thoracic limb; antero-lateral angles terminating in an acute spine; anterior margins inflated above the eyestalks and produced into a long acute rostrum extending to the visual part of the eye and about half-way along the basal joint of the antennular peduncle; there is a faint gastro-hepatic groove and a distinct keel runs forward medio-dorsally from the latter into the rostrum.

Pleon (Plate II., Fig. 1) without ridges or dorsal spines; none of the epimeral plates much produced; sixth segment about one and a half times as long as the fifth; preanal spine well developed and usually simple, but in large examples bifid.

Eyes (Plate II., Fig. 1) globose and rather large; greatest diameter of the cornea exceeding half the length of the last pleon segment; pigment black.

Antennular peduncle (Plate II., Fig. 2), with the basal joint as long as the second and third joints combined and much wider; no lobe or lappet; a row of about twelve long curved plumose setae set on a ridge on the distal part of its length; a short stout spine on the outer distal corner, which is more or less concealed by the numerous setae which arm the outer half of the anterior margin and the distal

half of the exterior margin; a bunch of coupling setæ on the inner distal corner; second joint slightly longer than the third and without a lobe, its anterior margin a little oblique.

Antennal peduncle about equal in length to the basal two joints of the antennular peduncle, the third joint only very slightly shorter than the second.

Antennal scale reaching the centre of the third joint of the antennular peduncle, about three times as long as broad, outer margin entire and terminating in a spine, apex broadly rounded; spine on the outer corner of the basal joint long and slender, extending one-third of the way along the scale, plumose at least on the proximal part.

The mouth parts (Plate II., Figs. 3, 4, 5) are figured for comparison with those of other species. They do not appear to present any striking peculiarities.

First thoracic limb (Plate II., Fig. 6), has the penultimate joint of the endopod longer than either the preceding or ultimate joints; the latter has the lower margin armed with a row of short fine setæ in addition to the longer ones at the apex.

Second thoracic limb (Plate II., Fig. 7), with the terminal joint armed with a row of three (sometimes four) short, rather stout and curved spines on the inner face.

The remaining thoracic limbs have the penultimate joint in all cases longer than the ultimate and slightly longer than the antepenultimate. The following table gives the lengths of the joints of the first six thoracic limbs in millimetres and the total length of the limbs from a specimen 27 mm. long.

Thoracic limb.	Lengths of the joints in mm.						Total length of limb in mm.
	1	2	3	4	5	6	
1	·50	1·11	1·50	·77	1·00	·66	5·54
2	·50	1·22	1·77	1·11	1·22	·50	6·32
3	·66	1·50	1·88	1·22	1·28	·72	7·26
4	·66	1·83	2·05	1·28	1·33	·83	7·98
5	·61	2·00	2·11	1·00	1·05	·66	7·43
6	·55	2·00	2·00	·72	·83	·44	6·54

First pleopod of the male (Plate IV., Fig. 10) with both movable processes on the inner plate of the endopod shorter than the plate itself; distal process feebly curved, bifid at the tip; proximal process expanded at the tip into two lobes not in the same plane, the outer lobe the larger, and wider than long, the inner lobe but little expanded; uncinus of the inner plate of the endopod without secondary spinule.

Telson about one and a half times as long as the last segment of the pleon; apex acutely pointed; sub-apical spines extending for half their length beyond the

apex of the telson and bearing a few minute spinules on their inner margins; dorsal denticles usually in two pairs, the first about half-way towards, the second at the base of, the sub-apical spines.

Uropods reaching to the level of the insertion of the sub-apical spines, the outer very slightly longer than the inner, with a prominent denticle at its outer extremity.

Length of the largest adult specimens of both sexes, 32 mm.

Euphausia crystallorophias approaches most nearly among the species of the genus to *E. similis*, G. O. Sars, but differs (1) in the different shape of the rostral projection, (2) in the shape of the epimeral plates of the fourth and fifth segments of the pleon, (3) in the absence of antennular lobes and lappets.

From *E. splendens*, G. O. Sars (*E. lucens*, Hansen) the present species is distinguished by the greater length of the rostrum and by the absence of antennular lobes and leaflets, the types of *E. splendens*, G. O. Sars, being possessed of a small but distinct antennular lobe. *E. crystallorophias* is an enormously abundant species under the ice, some ten thousand specimens having been taken. None, however, were met with in any other locality except Winter Quarters.

Larvæ of *E. CRYSTALLOROPHIAS*.

The collection contains individuals in all stages of development from the *Metanauplius* to the adult condition.

The *Calyptopsis* larvæ (Plate II., Fig. 8) first appear at the beginning of January and continue in the tow-nettings till nearly the end of February. The hood of the carapace is very obtusely pointed in front and has the margins quite smooth. There is no posterior median spine on the carapace, while the telson has the apical margin lightly emarginate. I can see the beginning of the lateral spine of the carapace at this stage. The largest *Calyptopsis* larva measures 3.9 mm.

The *Furcilia* stages (Plate II., Fig. 9) first appear during the last week of February and are abundant all through March. They cease after the first week in April. The emargination of the apex of the telson is most marked during this stage and serves readily to connect it with the early *Calyptopsis* larvæ. The spine on the lateral margin of the carapace is now well developed. The size of the *Furcilia* larvæ is from 4.5 mm. to 8 mm.

The *Cyrtopia* larvæ (Plate II., Fig. 10) first occur about the last week in March, and late post-larval stages are still to be had at the beginning of August. The size of this stage is from 8 to 11 mm. The rostral projection is now an acutely pointed triangular plate, but the sides are still but little concave. The final shape of the rostrum is not assumed till the animal is in all other respects like the adult.

At a size of 11 mm. the telson assumes its adult shape, but the pair of spines immediately anterior to the sub-apical spines are still long and plumose. They finally become reduced to adult size when a length of 13 mm. is reached. At this

latter size the species has all the adult characters, except perhaps the rostrum, which has the margins hardly as concave as fully adult specimens. Examples of 13 mm. in length are to be met with in January, and so were presumedly larvæ of the preceding season, from which it would appear that the species takes at least one year, and very probably longer, to reach the final adult size of 32 mm.

EUPHAUSIA TRIACANTHA.

(Plate IV., Figs. 1-3.)

Euphausia triacantha, Holt and Tattersall, 1906 (1).

Locality of capture:—Lat. $66^{\circ} 52' 09''$ S., long. $178^{\circ} 08' 15''$ E., 2030 fathoms; one specimen, immature male, 23 mm.

Carapace (Plate IV., Fig. 1), with a single lateral denticle posterior to the centre of the lower margin of the carapace; antero-lateral margins somewhat inflated over the eyestalks, and then produced into a long and very acute rostrum, which extends beyond the eyes and almost to the distal end of the basal joint of the antennular peduncle; a faint keel is present on the carapace behind the rostrum.

Pleon (Plate IV., Fig. 1) with the posterior dorsal margin of the terga of the third, fourth, and fifth segments produced into rather long, slender, very acute and slightly curved median spines; sixth segment rather long, nearly twice as long as the fifth segment without the spine.

Eyes somewhat damaged in the single specimen, but apparently rather small, pyriform in shape.

Antennular peduncle (Plate IV., Fig. 2) bearing on the inner distal corner of the basal joint a well-developed bifid leaflet, the lappets of the leaflet of about equal size; outer corner of the basal joint rounded and adorned with numerous rather long plumose setæ; a row of six curved plumose setæ on the dorsal surface of the basal joint; second joint with a simple acutely spiniform lappet arising from the median anterior margin; third joint slightly narrower and shorter than the second.

Antennal peduncle shorter than the scale, the third joint a little shorter than the second.

Antennal scale reaching very slightly beyond the distal extremity of the second joint of antennular peduncle, broadly oval in shape, about three times as long as broad, apex broadly and obtusely rounded, spine at the distal end of the outer margin small but distinct; spine on the outer distal corner of the basal joint long, slender and smooth.

First pleopods of the male (Plate IV., Fig. 3) obviously not fully metamorphosed, since both the proximal and distal movable processes on the endopod are small and simple, and the uncinus on the middle lobe is without a secondary spinule.

Telson with the portion between and posterior to the sub-apical spines acutely produced and smooth; sub-apical spines extending beyond the apex of the telson,

smooth; dorsal denticles in two pairs, the first situated at about two-thirds of the distance from the base of the telson to the insertion of the sub-apical spines, second pair just above the spines.

Uropods sub-equal in length, rather slender, extending to the level of the insertion of the sub-apical spines of the telson.

Precanal spine small and simple.

A fuller description of this species is not possible, since the single specimen is in bad condition and dissection was not desirable.

The species belongs to that group of the genus with a posterior median dorsal spine on the third segment of the pleon, and is distinguished from the other members of the group by having an equally developed spine on the fourth and fifth segments of the pleon in addition. It presents no very near kinship with any described species of the genus, and from the depth at which it was captured is probably a deep-water form.

EUPHAUSIA VALLENTINI.

(Plate IV., Figs. 4-6.)

Euphausia splendens (*pars*), G. O. Sars, 1885.

Euphausia vallentini, Stebbing, 1900.

Euphausia vallentini, Holt and Tattersall, 1906 (1).

Localities of captures:—Lat. $56^{\circ} 54'$ S., long. $170^{\circ} 28'$ E., two specimens, male and female, 19 mm.

I have carefully compared these two specimens with two of the types from the Falkland Islands which the Rev. T. Stebbing kindly sent me, giving me at the same time full permission to dissect them if necessary. The 'Discovery' specimens are in perfect agreement with the types, and I have nothing to add to Stebbing's description except a note on the copulatory organs on the first pleopod of the male.

In the course of working out this collection the authorities of the British Museum kindly allowed me to examine and dissect two of the 'Challenger' specimens labelled *Euphausia splendens* by Sars. They were from the second of the localities given by Sars on p. 82 of his "'Challenger' Report," viz., "October 21, 1875, South Pacific." It became at once apparent on examination that one of these specimens did not agree with Sars' description, since the antennule was furnished with a large evenly rounded lappet on the basal joint, very conspicuous in lateral view.* Further examination showed that it probably, indeed almost certainly, belongs to the present species. It is true that I could not see the spine on the third pleon segment, but the specimen is in very poor condition, and if, as I suspect to be the case, the spine has been broken off, the scar would be difficult to detect.

I give (Plate IV., Fig. 5) an outline sketch of the rostrum and the basal joint

* Examination of the 'Challenger' types of *E. splendens* shows that this species possesses a small antennular lobe, but it is nothing like so well developed and conspicuous as in *E. vallentini* (*see* Hansen (1905 (2)), Holt and Tattersall (1906 (1), and below, p. 14.)

of the antennule of the 'Challenger' specimen and (Plate IV., Fig. 4) a sketch of the antennule of one of the 'Discovery' examples for comparison with those given by Stebbing (1900). This shows clearly, in my opinion, that all three specimens belong to one species, and that the absence of the spine on the third pleon segment of the 'Challenger' example is the result of accident or possibly an abnormality. The peculiar shape of the antennular lobe is practically the same in the 'Discovery' and 'Challenger' individuals, and only differs from Stebbing's types in degree, a result of more complete growth.

The rostrum of *E. vallentini* is very like that of *E. splendens*, G. O. Sars, but is slightly longer, and the angle formed by its margins a little more acute. Sars may have been misled by the resemblance between the rostra of the two species, which caused him to overlook the marked differences which exist in the antennulæ. Dr. Hansen has seen the 'Challenger' specimen referred to, and agrees with my interpretation of its specific identity.

One of the 'Discovery' *E. vallentini* is a male, but unfortunately the copulatory apparatus on the first pleopods is considerably damaged, so that I am obliged to refer to the 'Challenger' example, which is likewise an adult male, for a description and figure of this apparatus (Plate IV., Fig. 6). The figure represents the inner lobe of the endopodite of the first pleopod of the male. This inner lobe bears internally two movable processes, the inner and more distal of which is feebly curved, slightly over-reaching the inner lobe and bifid at the tip. The external and more proximal of the two processes has the distal extremity greatly expanded, the expansion very much broader than long, oblique, and divided into two lobes, the more distal of which is the larger. On the under side of the expansion of the proximal process as viewed in the figure there is a small spine-like process. The inner lobe of the endopodite itself bears a strongly curved uncinus with a small secondary spine near the tip.

Distribution.—Southern Pacific, between New Zealand and Chili ('Challenger'); Falkland Islands (*Stebbing*).

EUPHAUSIA, sp.

Locality of capture.—Lat. 57° 25' 30" S., long. 151° 43' E., nineteen specimens, 10–18 mm.

On first looking over these specimens I identified them with *Euphausia splendens*, G. O. Sars (1885), a species which Hansen (1905 (2)) considers to be different from *E. splendens*, Dana, and which he has re-named *E. lucens*. Hansen, in the same paper, notes that *E. splendens*, G. O. Sars, has the first joint of the antennular peduncle without a leaflet, but distally produced above. Holt and Tattersall (1906 (1)) have confirmed this statement by an examination of Sars' type specimens of *E. splendens*, in which they found that in the female type the lobe is quite conspicuous both in lateral and dorsal view; while in the male type, which is considerably smaller than the female, the lobe is less developed, but still easily seen in lateral view. Sars

was therefore in error when he described the antennular peduncle of his *E. splendens* as "more particularly distinguished by the total absence of any dorsal leaflet or lobe." Moreover, it is apparent from what has already been written above in dealing with *Euphausia vallentini* that Sars confused at least two distinct species under the name *E. splendens*. It was subsequent to the publication of the preliminary notice of the 'Discovery' collection that the present specimens came to hand. I therefore appealed to Dr. Calman for further information with regard to the 'Challenger' species, and he very kindly sent me a sketch of the dorsal aspect of the anterior end of both types. From these sketches and Sars' description in the 'Challenger' report I identified the 'Discovery' specimens as *Euphausia splendens*, G. O. Sars = *E. lucens*, H. J. Hansen. Wishing, however, to have confirmation of my identification, I submitted the specimens to Dr. Hansen, who at first was inclined to agree with me that they belonged to *E. splendens*, G. O. Sars. I may, perhaps, be allowed to quote Dr. Hansen's remarks. They read as follows: "*E. lucens (splendens)*.—I have specimens from the southern Atlantic and the southern Pacific, and in all these the leaflet from first antennular joint is easily seen, triangular, but not acuminate, with the end often a little obtuse. In the material from the Swedish Antarctic expedition I have a large number of specimens which differ only from the Copenhagen specimens in the feature that the antennular leaflet is extremely small (visible as a very small triangular distally obtuse plate when seen from in front . . .) or rudimentary, but I find it necessary to consider this difference only as a variation" (Hansen, *in litt.*). Then, after some remarks in which he noted that my specimens agree with the latter condition, he concludes by saying that he considers them to belong to the more Antarctic variety of *E. lucens*. In a later communication Dr. Hansen kindly informed me that, after an elaborate study of the copulatory organs on the first pleopods of the males of the genus *Euphausia*, he had found that these two varieties were readily distinguishable in the characters of the male pleopods, and that he proposed to consider them as two species. At the same time he was good enough to send me sketches of the first pleopods of both species for comparison with my own specimens.

The largest 'Discovery' specimen is a male 18 mm. in length, and as far as I can judge, it appears to be quite adult. The copulatory apparatus on the first pleopods agrees exactly with the sketch which Dr. Hansen sent me of the same apparatus in his Antarctic form. It would therefore appear that these specimens belong to Hansen's new Antarctic species. I have not attempted to give a detailed description with figures of this form, since it is quite evident that an accurate diagnosis can only be drawn up from a close study of this species and the true *E. lucens* side by side, and a careful comparison, character by character. There are no specimens of the true *E. lucens* in the 'Discovery' collection, so I leave the descriptions of the two species to Dr. Hansen, who has abundant material for the purpose.

I may mention here that some specimens of an *Euphausia* (labelled *E. splendens*, G. O. Sars) in the small collection of Antarctic Schizopods kindly lent me by Prof.

D'Arcy W. Thompson, from the collections of the University College, Dundee, appear to belong to this species. They were collected in the Antarctic Ocean, the exact locality being uncertain, but it is believed to be in the neighbourhood of the South Shetland Islands.

EUPHAUSIA, sp. ?, juv.

(Pl. IV., Figs. 7-9.)

Localities of captures:—Lat. 49° 40' S., long. 172° 18' 30" W., five specimens, immature, 8-9 mm.

Lat. 58° 49' 45" S., long. 154° 48' W., three specimens, immature, 10 mm.

The specimens from the above two localities all belong to the same species. They were submitted to Dr. H. J. Hansen of Copenhagen, who agreed with my suggestion that they were too young for absolute specific determination. I give here only a brief description, pointing out a few of the characteristic features.

Carapace with a prominent slender denticle on lateral margins just over the base of the third thoracic limbs; antero-lateral margins slightly undulate, only partially concealing the eyestalks and produced into a long, narrowly acute rostrum (Fig. 7) extending almost to the anterior end of the eye and about half-way along the basal joint of the antennules.

Pleon having the third segment provided dorsally on the median posterior margin of the tergum with a slender spine (Fig. 9); sixth segment long and slender, about twice as long as the fifth.

Antennular peduncle (Figs. 7 and 8), with a minute bluntly pointed simple lobe on the inner distal corner of the basal joint; a thin oblique lamella-like ridge running across the third joint from the inner proximal to the outer distal corner and partly continued down the inner side of the second joint.

Antennal scale reaching to about half-way along the terminal joint of the antennular peduncle.

Telson having the portion beyond the sub-apical spines produced into an acute apex with smooth margins; two pairs of spinules present.

Uropods reaching to the level of the insertion of the sub-apical spines.

This species belongs to that section of the genus provided with a spine on the dorsal surface of the third segment of the pleon. Among members of this section it approaches most nearly to *E. gibboides*, Ortmann (1893), but Dr. Hansen has kindly pointed out to me that it differs from that species in the much greater length of the rostrum and its different shape.

The smallest of the specimens, *i.e.* all under 9 mm. in length, have the spine on the third pleon segment still undeveloped, only the two largest ones, 9.5 mm. and 10 mm. in length, showing it fully formed. We have here slight evidence as to the stage in development at which this spine appears. None of the specimens present any larval characters in the form of the telson or antennules. It would appear, then, that

the spine, at any rate in this species, develops late in life, only after the final adult form is reached.

The species was taken on the homeward voyage of the 'Discovery,' in the extreme southern part of the Pacific Ocean between New Zealand and Cape Horn.

SUB-FAMILY NEMATOSCELINÆ, Holt and Tattersall.

GENUS THYSANOËSSA, Brandt.

THYSANOËSSA MACRURA.

(Pl. III., Figs. 1-12).

Thysanoëssa macrura, G. O. Sars, 1883; *id.* (1885); Ortmann, 1893; Stebbing, 1900; Holt and Tattersall, 1906 (1); Couzière, 1906.

Localities of captures:—

Winter Quarters.

No. 4 Hole,	47 specimens,	7-18 mm.
No. 8 Hole,	40 ,,	8-21 mm.
No. 12 Hole,	2 ,,	7 and 20 mm.

From River Koettlitz, 2. 1. 03, 6 specimens, 9-14 mm.

Outward or Homeward Journey.

Lat. 61° 46' S., long. 141° 12' E., 16. 11. 01, 18 specimens, 14-20 mm.

Lat. 57° 25' 30" S., long. 151° 43' E., 20. 11. 01, 35 specimens, 12-22 mm.

Lat. 54° 1' 15" S., long. 170° 49' E., 27. 12. 01, 1 specimen, 6 mm.

Lat. 61° 13' 30" S., long. 173° 33' E., 31. 12. 01, 30 specimens, 12-19 mm.

Lat. 66° 52' 9" S., long. 178° 8' 15" E., 3. 1. 02, 3 specimens, 8-9 mm.

Lat. 70° 29' 27" S., long. 168° 51' 46" E., 26. 2. 04, 1 specimen, 28 mm.

Lat. 49° 40' S., long. 172° 18' 30" W., 12. 6. 04, 2 specimens, 8-12 mm.

Lat. 58° 49' 45" S., long. 154° 48' W., 24. 6. 04, 4 specimens, 10 mm.

Lat. 59° 34' 30" S., long. 106° 28' 12" W., 28. 6. 04, 3 specimens, 7 mm.

Lat. 55° 44' S., long. 95° 43' 30" W., 1. 7. 04, 3 specimens, 6-8 mm.

Form (Fig. 1) of the body rather slender.

Carapace (Fig. 1) with a single rather long slender spine on the lower lateral margin posterior to the middle, just above the origin of the sixth thoracic limb; antero-lateral corners acute and somewhat produced; anterior margins very concave and produced forwards into a long, slender, acute rostrum which reaches beyond the eyes and far beyond the middle of the basal joint of the antennules; there is a low keel on the anterior part of the carapace behind the rostrum, and a very faint gastro-hepatic groove.

Pleon (Fig. 1) rather elongate, narrow and attenuate; segments unarmed; sixth segment equal to or slightly less than the combined lengths of the preceding two;

preanal spine well developed, provided with an external strong tooth and a comb-like row of finer teeth up to twelve in number.

Antennular peduncle (Fig. 2) rather long and slender, considerably longer than half the carapace; basal joint rather flattened, considerably wider than the remaining two joints, bearing on its outer distal corner a rather long and slender spine, its anterior margin somewhat overlapping the basal part of the second joint, fringed with numerous setæ and exhibiting near the inner side a shallow fissure: terminal two joints very long and slender, subequal in length, their combined lengths slightly exceeding that of the basal joint.

Antennal peduncle (Fig. 3) very long and slender, nearly as long as the scale, third joint less than half as long as the second.

Antennal scale (Fig. 3) extending to about midway along the terminal joint of the antennular peduncle, almost five times as long as broad, outer margin terminating in a well-marked spine, inner margin sloping away obliquely towards the apex; spine on the basal joint moderately long, slender and smooth.

Mouth parts (Figs. 4-6) do not offer any marked differences from those of *Thysanoëssa gregaria* as figured by Sars (1885, Pl. XXII).

Second thoracic limbs (Fig. 8), with the endopod remarkably long and well developed, in full-grown specimens equalling nearly three-quarters of the total length of the body from the eyes to the telson; meral joint the longest, extending beyond the tip of the antennular peduncle; carpal joint a little shorter than the meral and more slender, nearly four times the length of the propodal joint, armed with four slender spiniform setæ on the outer margin at the distal extremity, and five similar setæ on the inner distal margin; propodal joint with five long spiniform setæ on the outer and six on the inner margin; terminal joint small, tipped with six spiniform setæ.

The remaining thoracic limbs (figs. 7, 9, 10) not differing greatly from the same limbs in *T. gregaria*.

Copulatory apparatus (Fig. 11) on the first pleopod of the male exhibits a structure very similar to that figured by Sars for *T. gregaria*, except that the distal extremities of the two movable processes on the inner lobe do not seem to be serrate.

Telson slender, apex acutely produced and smooth; sub-apical spines smooth; dorsal denticles two pairs, the first pair just anterior to the centre of the telson, the second pair a little anterior to the insertion of the sub-apical spines.

Uropods exceedingly slender, inner one reaching the apex of the telson, outer slightly shorter.

Length of the largest specimen, 28 mm.

I have thought it well to describe and re-figure this species, since Sars' original description was taken from admittedly young forms, and I cannot find that mature specimens have ever been described and figured. The changes that take place during growth affect principally the rostrum, the second thoracic (or elongate) limb and the preanal spine.

The rostrum is figured correctly by Sars from a specimen, 13 mm. in length. At that stage in development the rostrum is an acutely triangular projection, the sides of the triangle very nearly straight and but little concave. As growth proceeds, however, the sides of the triangular plate become deeply concave and the rostrum assumes the form of a long narrow acutely spiniform projection, as shown in Fig. 2. This gives it something of the form as seen in *T. gregaria*, but it is much longer and more slender than in that species.

Sars describes and figures the preanal spine in his 13 mm. specimen as armed with only two teeth. This is correctly stated for a specimen that size, but increase in size is also accompanied by an increase in the number of teeth in the preanal spine, till in a specimen 28 mm. in length I found the teeth to number twelve in addition to the strong external one. The teeth are, moreover, fine and comb-like, and the whole spine closely resembles that figured by Sars for *T. gregaria*. I have noticed all intermediate stages in the present material. This clearly undermines the value of the preanal spine as a specific character, since the number of teeth is dependent first of all upon age, while individual variation must also be taken considerably into account.

The most considerable changes due to growth are, however, exhibited by the second thoracic limbs. Sars describes them as much smaller than in *T. gregaria*, with the meral joint scarcely reaching beyond the middle of the antennal scale. But the above description and accompanying figures show that the limb is quite as well developed as in *T. gregaria*, and that the meral joint in full-grown individuals actually extends beyond the antennular peduncle. Stebbing (1900) has already called attention to the fact that in specimens of this species from the Falkland Islands the elongate limbs were proportionately longer than in Sars' drawing, but he gives no figures. I find that this statement applies generally to the material in the present collection, even in specimens of the same size as Sars'. Only two exceptions were noted, and in these two specimens the elongate limbs were proportionally as in Sars' figures. I will deal with these two exceptions and Sars' specimen below, but will proceed first to briefly note the changes which take place in these limbs during growth. In two specimens, 8 and 9 mm. in length, the second thoracic limbs are developed about as fully as in Sars' figures. They are considerably less than one-half of the total body-length of the specimens, the meral joint extends very little beyond the centre of the antennal scale, and is about equal to the terminal three joints combined, while the carpal joint is only about twice as long as the propodal.

In specimens from 13 mm. to 18 mm. in length, these limbs are about equal in length to the half of the length of the body, the meral joint extends to the tip of the antennular peduncle, and is a little shorter than the terminal three joints combined, while the carpal joint is now three times as long as the propodal. This is the condition noted by Stebbing in his Falkland Islands specimens. In the full-grown specimen, 28 mm., the elongate limbs measure 21 mm. in length, or three-quarters of

the total body-length. The meral joint extends beyond the tip of the antennular peduncle, and is about one-tenth shorter than the combined lengths of the terminal three joints, while the carpal joint is four times as long as the propodal. It will be seen, therefore, that these changes during growth are quite considerable, and most evident in the elongation of the carpus.

It was noted above that Sars' specimen, 13 mm. in length, had the elongate limbs only as well developed as in a specimen 8 mm. long. I have found in the present collection two specimens, 16 and 17 mm. long, in which these limbs were at the same stage of development. They were accompanied by specimens with more fully developed elongate limbs, and I would suggest that the comparative shortness of these legs in the above-mentioned two specimens and in Sars' type is due to their having at some earlier period been broken off and grown again. This is a common occurrence in Decapods, and I should think is by no means rare in Euphausians, especially those with elongate second legs, which must be specially liable to be detached. The re-developed limb is usually shorter than the one it replaces. I believe this explanation to be the correct one in the present instance, though it may be that we have here a case of retarded development. Further slight changes during growth are seen in the proportional length of the last pleon segment, which in very young specimens is slightly longer than the combined length of the preceding two, while in full-grown specimens the reverse is seen, though the differences either way are not great.

The antennular peduncle is a little longer proportionally in full-grown specimens, while the outer uropod likewise approaches more nearly to the length of the inner ones, though even in full-grown specimens it remains slightly shorter than the latter. This account of the growth changes in *T. macrura* reduces considerably the points of distinction formerly supposed to exist between it and *T. gregaria*. The most conspicuous difference is in the proportional length of the last pleon segment, and this distinction would seem to hold throughout life. *T. macrura* is, besides, a much more slender and graceful form than *T. gregaria*, with its parts proportionally attenuated.

Distribution.—*T. macrura* was recorded from several localities in the Southern Ocean, South Atlantic, and Antarctic Ocean by the 'Challenger.' It has since been noted by Stebbing from the neighbourhood of the Falkland Islands, and by Couzière from the collections of the French Antarctic Expedition. These records, together with the list of localities for specimens in the present collection, indicate that the species has a wide range in the waters of the southern temperate and Antarctic regions, but its northern limit would seem to be the 40th parallel of south latitude.

EUPHAUSIAN LARVÆ.

The larvæ listed below could not be referred to any species, and are merely noted here for completeness.

Lat. $57^{\circ} 25' 30''$ S., long. $151^{\circ} 45'$ E., 21. 11. 01, numerous Euphausian *Metanauplii* and *Calyptopsis* larvæ, and two *Furcilia*s.

The *Metanauplii* and *Calyptopsis* larvæ are characterised by the presence of a short blunt posterior median spine on the carapace. The front part of the latter, which forms the hood over the eyes, appears to have its margin quite smooth. In the majority of the *Calyptopsis* larvæ a small spine on the lateral margins of the carapace is clearly present. The apex of the telson is very slightly emarginate. The largest *Calyptopsis* larva measures 4 mm. in length.

Lat. $56^{\circ} 31'$ S., long. $156^{\circ} 19' 30''$ E., 22. 11. 01, seventeen *Calyptopsis* and fifty *Furcilia* larvæ.

The *Calyptopsis* larvæ belong to the same species as in the preceding lot.

The *Furcilia* larvæ measure from 2.5 to 4 mm. They present no features of note, but from their size they probably belong to a smaller species of adult than the *Calyptopsis* larvæ which accompany them. All present a lateral spine on the carapace, and the rostrum is in the form of an acutely produced triangular plate.

Lat. $54^{\circ} 1'$ S., long. $170^{\circ} 49'$ E., 27. 12. 01, numerous *Metanauplii*, *Calyptopsis*, and *Furcilia* larvæ.

All these are apparently stages of one species. The largest *Calyptopsis* larva measures 3 mm. and is without a posterior median spine on the carapace. The anterior margin of the hood is smooth; there is a lateral spine on the carapace, and the apex of the telson is very lightly convex. The largest *Furcilia* measures 4.5 mm.

Lat. $61^{\circ} 13' 30''$ S., long. $173^{\circ} 33'$ E., 31. 12. 01, one *Furcilia* larva, 5 mm., apparently the same species as the following larvæ.

Lat. $63^{\circ} 4' 24''$ S., long. $175^{\circ} 47' 57''$ E., 1. 1. 02; numerous *Furcilia* larvæ from 4 mm. to 5.25 mm. in length, and apparently the same species as the preceding larva.

Wood Bay, 22. 2. 04, numerous small *Metanauplii* and *Calyptopsis* larvæ, the largest of which measured 2 mm.

Lat. $70^{\circ} 29' 27''$ S., long. $168^{\circ} 51' 46''$ E., 26. 2. 04, one late *Cyrtoplia* larva, 9 mm. in length, which, from its size, is probably *Euphausia superba*.

Lat. $49^{\circ} 40'$ S., long. $112^{\circ} 18' 30''$ W., 12. 6. 04; forty-eight larvæ, from *Calyptopsis* stage to post-larval form, measuring 5 mm., and probably the larvæ of *Thysanoëssa macrura*.

ORDER MYSIDACEA.

FAMILY PETALOPHTHALMIDÆ, Czerniavsky.

Petalophthalmidæ, Czerniavsky, 1882.

Petalophthalmidæ, Holt and Tattersall, 1906 (2).

When defining this family Holt and Tattersall, 1906 (2), overlooked the fact that it had been established and defined, albeit rather incompletely, by Czerniavsky (1882) a quarter of a century previously. Czerniavsky, however, had no specimens of any of

the genera of the family before him, but drew up his definition from the descriptions and figures of Willemoes-Suhm (1875). He includes in the family the single type genus, *Petalophthalmus*, Will.-Suhm, with two species—*P. armiger*, Will.-Suhm, and *P. willemoesii*, a new species which he founds for the reception of the female ascribed by Suhm to *P. armiger*.

Faxon and Hansen, however, have since pointed out that the female specimen described by Will.-Suhm is in reality a *Boreomysis*, probably *B. scyphops*, G. O. Sars, so that if this latter view of its identity be adopted, *P. willemoesii* becomes a synonym of *B. scyphops*.

Czerniavsky's definition of the family is inadequate, inasmuch as no reference is made therein to the remarkable characters of the carapace, and the first and second thoracic limbs, while the importance which is given to the supposed characters of the exopods of the thoracic limbs is exaggerated, the difference in development as compared with those of the *Mysidæ* being very slight.

The definition given by Holt and Tattersall, 1906 (2), may, therefore, be adopted with some slight alteration in the characters ascribed to the eyes, rendered necessary by recent discoveries.

Examination of British specimens of *Hansenomysis fyllæ* (Hansen, 1887) has revealed the fact that eyes are, in reality, present in this species. They resemble those described below for the Antarctic species, except that the lappets are much reduced and almost obsolete.

Further, in a new species of *Petalophthalmus*, *P. oculus*, recently defined by Illig (1906), the eyes are described as well developed, with the cornea bright brown in colour and distinctly faceted.

In the amended definition of the family, therefore, the description of the eyes would read:—*Eyes* (first cephalic appendages) small, either imperfectly developed as lamellar or spiniform organs, without visual elements, or furnished with a distinct cornea in which visual elements are clearly defined and functional.

GENUS HANSENOMYSIS, Stebbing.

Arctomysis, Hansen, 1887 (*non* Czerniavsky, 1883).

Hansenomysis, Stebbing, 1893.

Hansenomysis, Holt and Tattersall, 1906 (1 and 2); Tattersall, 1907.

The name *Arctomysis*, given to this genus by Hansen (1887), having been already used by Czerniavsky (1883) for an entirely different form, was changed to *Hansenomysis* by Stebbing (1893). *Arctomysis* Czerniavsky is itself a synonym of *Boreomysis* G. O. Sars.

Of the other three genera belonging to the *Petalophthalmidæ*—*Petalophthalmus*, *Ceratomysis* and *Scolophthalmus*, *Hansenomysis* comes nearest to the last. Both agree in having the first thoracic limbs devoid of exopods and lacking the internal lamelliform meral lobe, and in the presence of well-developed exopods to the second

thoracic limbs. Whereas, however, in *Scolophthalmus* the rostrum is prominent and the eyes are modified into sharp spiniform organs, *Hansenomysis* has the rostrum obsolete and the eyes more or less leaflike.

Males of this genus have not yet been noted, but specimens of that sex of the northern species, *H. fyllæ* (Hansen, 1887), have come into my hands. Detailed examination and description are reserved for a future occasion, but it may be mentioned here that, besides having the pleopods biramous, males also have the basal portion of the inner flagellum of the antennule considerably thickened and adorned with rings of setæ.

HANSENOMYSIS ANTARCTICA.

(Pl. V., Figs. 1-19.)

Hansenomysis antarctica, Holt and Tattersall, 1906 (1).

Locality of capture.—Off Coulman Island, 100 fathoms, two specimens, females, 20 mm.

Form (Fig. 1) compact, rather slender, tapering considerably towards the posterior end.

Carapace (Figs. 1 and 3) short, sub-membranous, leaving the last two thoracic segments completely exposed, and part of a third visible behind its posterior emargination; anterior border produced, but very slightly, into a broadly and evenly-rounded but somewhat strongly upturned rostrum; antero-lateral angles evenly rounded and extending forwards as much as the rostrum; cervical sulcus well marked and rather deep, the posterior margin bounded by a conspicuous and rather sharp ridge formed by the carapace. Behind the cervical sulcus is a shield-shaped dorsal area, indicating the attachment of the carapace to the thorax, behind, and on either side of which the wings of the carapace are free. A slight ridge runs from the antero-lateral angles, first downwards and then posteriorly, to meet the cervical sulcus, while a shallow groove runs forward on each side from the dorsal shield-shaped area, thus marking off a hepatic area, on which is a prominent forwardly-directed spine with a broad base. A shallow depression follows the base of the rostrum, and merges on either side into the groove formed by the ridge from the antero-lateral angles. A small blunt and rounded spine is present on the gastric area.

Pleon (Fig. 1) 9 mm. in length, a little longer than the thorax, which measures 8 mm. from the eyes to the posterior margin of the last free segment; segments cylindrical, postero-lateral inferior margins not at all produced as epimera; first segment arcuate in dorsal contour, its anterior margin slightly raised above the level of that of the last thoracic segment, its posterior margin broadly produced, so as to partly cover the second segment, the whole forming a sort of "cap" over the junction of the thorax and pleon; second to fifth segments sub-equal in length and succeedingly narrower; sixth segment narrower than any of the preceding ones, and nearly twice as long.

Eyes (Figs. 1, 2 and 3) small, united at their base into a thick flattened pad, from the anterior part of which proceed two thin, short, sub-triangular, slightly-diverging lappets, which do not reach the middle of the basal joint of the antennular peduncle; visual elements entirely absent.

Antennular peduncle (Fig. 2) short and stout, its three joints sub-equal in length and quadrangular in outline; basal joint, with a single long seta on its internal distal corner, and a more or less continuous submarginal row of setæ across the anterior dorsal region; second joint with about seven long stout plumose setæ on its inner margin and two or three long setæ on the outer distal corner; third joint with about eleven long stout plumose setæ on the inner margin. On the dorsal surface of the basal joint, partly concealed by the eye in dorsal view, is an organ of rather problematical function (Figs. 2, 4 and 5). It appears to consist of a shallow depression bounded by a raised ridge marked with pigment, and overhung by a membranous flap, which apparently rises from its posterior border. The flap only imperfectly covers the depression. In the preliminary notice of this collection it was suggested that this organ might prove to be auditory in function, but under moderately high powers of the microscope no otoliths or even sensory hairs could be distinguished in the shallow pit.

Antennal peduncle longer than the antennular, and considerably more slender; distal joint shorter than the preceding.

Antennal scale (Fig. 2) lanceolate in shape, about three-and-a-half times as long as broad, apex evenly rounded, the whole of the inner margin and distal third of the outer margin setose; proximal two-thirds of the outer margin devoid of setæ, but armed with eleven strong spines, the proximal one of which is the shortest, and is situated at the end of the proximal quarter of the outer margin, the spines increasing in size distally; spine on the outer distal corner of the basal joint short, but prominent.

Mandibles (Fig. 6) with the cutting edge prominent and molar process well-developed and rather long; between the cutting edge and the molar process is a single spine-like seta, and in the left mandible a *lacinia mobilis* in addition; palp (Fig. 7) rather long and powerfully developed, terminal joint shorter than the penultimate, both joints armed on both outer and inner margin with numerous long and rather stout setæ.

First maxilla (Fig. 8) having the outer lobe much larger than the inner, and armed at its apex with about thirteen spines, behind which is a row of five plumose setæ; inner lobe armed at its tip with four long plumose setæ.

Second maxilla (Fig. 9) consisting of the usual three lobes, a two-jointed palp and outer setiferous plate, the setæ arming the appendage being numerous and rather strong.

First thoracic limb (Fig. 10) short and stout, devoid of exopod, but with well-developed epipod; third joint small; fourth joint with numerous setæ and a row of

six short stout spines on its inner margin; fifth joint with three, sixth joint two, and seventh joint four rather long, strong plumose spines on their inner margins as well as numerous setæ.

Second thoracic limbs (Fig. 11) with the endopods longer and rather more slender than the first, exopods well developed; fourth or meral joint produced internally into a large setiferous lamelliform lobe nearly as long as the fifth joint; the latter, the longest joint of the limb, longer than the combined length of the sixth and seventh joints, its outer margin armed with a single seta, the distal half of the inner margin slightly excavate with a row of eight short, closely-set plumose spines and a single long plumose seta on the emarginate portion, and a few long simple setæ, set widely apart, on the proximal portion of the inner margin; sixth joint longer than the seventh, its outer margin armed with a few long setæ, the proximal portion of the inner margin bearing a row of about nine short closely-set plumose spines and a single long plumose seta, the distal portion of the inner margin with a few long simple setæ; seventh joint small, armed with numerous long and rather stout simple setæ.

Third to fifth thoracic limbs (Fig. 12) with the endopods feeble, long and slender; sixth joint slightly longer and more slender than the fifth; seventh joint very small, forming with two strong spines a very minute chela, densely clothed with short fine setæ; the rest of the endopod armed with a few short scattered setæ.

Sixth to eighth thoracic limbs (Fig. 13) with the endopods slightly longer and stouter than those of the three preceding pairs; sixth joint shorter than the fifth; seventh joint small and bearing a long slightly-curved nail, the junction between the nail and seventh joint being indicated by a seta on the inner margin; rest of the endopod feebly armed with short setæ.

Exopods of the second to eighth thoracic limbs well-developed; basal joint long and rather narrow, the outer distal corner rounded; flagelliform part composed of from ten to thirteen joints.

Incubatory lamellæ, seven pairs, situated on the second to eighth thoracic limbs.

Pleopods (Figs. 14 to 18) in the female uniramous, the first pair small, succeeding pairs increasing in size to the fifth pair, which are slightly longer than the sixth segment of the pleon; first four pairs one-jointed; fifth pair two-jointed, the second joint longer than the first; all the pleopods bearing long setæ at the apex.

Telson (Fig. 19) rather massive, longer and a little wider than the last segment of the pleon, dorsally grooved, oblong in shape, slightly wider at the apex than at the base, its margins lightly arcuate; apex truncate or very lightly emarginate, bearing a single median spine with six or seven long spines on either side; lateral margins armed with from twenty-five to thirty fairly long spines arranged more or less in series.

Inner uropods broken in both specimens.

Outer uropods (Fig. 19) nearly twice as long as the sixth segment of the pleon, two-jointed, the terminal joint about one-seventh as long as the basal; outer margin

of the basal joint without setæ, but armed with twenty-one stout spines increasing in size posteriorly.

Length of adult and ovigerous female, 20 mm. from the eyes to the tip of the telson.

Colour of preserved specimens light brown, with a broad band of dark brown pigment across the dorsal surface of the first segment of the pleon and scattered patches of dark pigment on the lateral parts of the carapace, basal joints of the antennules and antennæ and the basal membranous pad of the eyes.

One of the specimens has young, considerably advanced in development, in the incubatory lamellæ.

In both specimens the telson is considerably damaged, and the description and figures have been drawn up from both specimens and fragments of the telsons found along with them. This fact must be borne in mind in dealing with specimens of this species which may be found by future expeditions. It was a matter of considerable surprise and no little interest to find in this collection two specimens belonging to a genus hitherto known only from a single specimen from Greenland and two taken off the coast of Ireland.

There can be no doubt that *H. antarctica* is co-generic with *H. fyllæ* (Hansen, 1887). All the distinctive characters of generic importance in the mouth parts and thoracic limbs of the latter are reproduced in *H. antarctica* down to the minutest detail. The points of difference between the two species are, however, sufficiently well-marked and numerous enough to justify specific separation. They may be pointed out as follows:—

H. antarctica is in general build a more robust and less fragile species than *H. fyllæ*.

Antennæ.—In *H. fyllæ* the terminal joint of the peduncle is longer than the penultimate, whereas in *H. antarctica* the reverse obtains.

Antennal scale.—In *H. fyllæ* the outer margin bears only five spines, between which are numerous setæ. In *H. antarctica*, on the other hand, there are eleven spines on the outer margin and no setæ between them.

Telson.—The telson in Hansen's type-specimen was broken, but so much of it as remained showed that the armature consisted of both spines and setæ. In *H. antarctica* the telson is armed with spines only, which are probably more numerous than in *H. fyllæ*. The shape of the telson in both species is also somewhat divergent. That of *H. antarctica* recalls rather markedly the telson of *Petalophthalmus armiger* as figured by Sars in the 'Challenger' Report.

Outer uropods.—*H. fyllæ* has the outer uropods armed with both spines and setæ, whereas in *H. antarctica* there are spines only present. The spines in *H. fyllæ* number six, while in *H. antarctica* there are twenty-one.

Pleopods.—The type specimen of *H. fyllæ* had only one pleopod remaining. This was one of the third pair, and is described by Hansen as biarticulate. Presumably,

therefore, the fourth and fifth pleopods will likewise be found to be biarticulate when perfect specimens are examined. In *H. antarctica* only the fifth pleopods are biarticulate, the remaining pairs consisting of a single joint only.

The eyes in the genus are described for the first time. They are remarkable chiefly for their small size and degenerate structure, for the complete absence of visual elements, and the subservience, either entirely or in great part, of ophthalmic functions to those of probably a tactile nature.

The cap-like form of the tergum of the first segment of the pleon recalls the somewhat similar form of the third pleon segment in many Carida, and suggests that the posterior part of the body is capable of great ventral flexure. The 'Discovery' expedition is to be congratulated on the finding of this species, by far the most interesting Schizopod in the collection.

FAMILY MYSIDÆ.

SUB-FAMILY LEPTOMYSINÆ, Norman.

GENUS PSEUDOMMA, G. O. Sars.

PSEUDOMMA BELGICÆ.

(Plate VI., Figs. 1-8.)

Pseudomma belgicæ, Holt and Tattersall, 1906 (1).

Locality of capture.—Lat. $78^{\circ} 25' 40''$ S., long. $185^{\circ} 39' 6''$ E., 300 fathoms, one specimen, immature female, 23 mm.

Form (Fig. 1) compact and moderately stoutly built.

Carapace (Fig. 1) large, less than half the total length of the body, covering laterally all the segments of the thorax, but dorsally exposing the last one behind its posterior emargination; its anterior margin very slightly produced into a blunt, very broadly rounded rostrum; antero-lateral angles rounded; cervical sulcus well marked.

Pleon (Fig. 1), excluding the telson, about half the total length of the body from the eye to the tip of the telson; first four segments subequal in length and slightly longer than the fifth; sixth segment twice as long as the fifth.

Eye plates (Fig. 1) contiguous, exhibiting only a very slight anterior median cleft; each plate subquadrangular or rhomboidal in shape, nearly twice as broad as long, antero-lateral angles rounded, anterior margin nearly straight, no serrations or armature of any kind; no pigment present in preserved specimens; corneal lenses absent, but the ramifications of the optic nerve are clearly visible in dorsal view.

Antennular peduncle (Fig. 1) short and stout, not extending beyond half the length of the antennal scale; basal joint almost entirely covered by the ocular laminae, a few plumose setae on each anterior corner; second joint very short, more than twice as broad as long, a few short setae on the outer distal corner, inner margin with a few longer plumose setae; third joint longer than either of the other two and slightly

narrower, rectangular in shape, outer margin unarmed, inner margin beset with a few plumose setæ.

Antennal peduncle (Fig. 1) equal in length to the antennular, but more slender; last two joints subequal in length.

Antennal scale (Fig. 1) slightly longer than the last segment of the pleon and twice as long as the antennular peduncle, about three and a half times as long as broad, outer margin entire and terminating in a very strong spine, beyond which the apex of the scale is but slightly produced; spine on the basal joint short and acute.

Mouth parts (Figs. 2, 3, 4, and 5) exhibit no salient points of difference from those of the type species of the genus *P. roseum*, G. O. Sars.

First and second thoracic limbs (Figs. 6 and 7) agreeing in the main with those figured by Sars for *P. roseum*, but a dactylus is distinctly visible among the dense mass of plumose setæ arming the terminal joints, though it is smaller and shorter than the terminal joint; exopods having the outer distal corner of the basal joint round, though produced, and the flagelliform part composed of ten to twelve joints.

Telson (Fig. 8) slightly shorter than the last segment of the pleon, tapering to an evenly rounded apex which is one-third as wide as the base; apex armed with a median pair of plumose setæ and four pairs of strong smooth spines, the innermost and largest of which equals one-sixth of the telson in length; distal half of the lateral margins armed with five shorter spines.

Inner uropods half as long again as the telson, armed with a single long spine in the region of the inner posterior corner of the otoecyst.

Outer uropods about twice as long as the telson.

Length of an immature female, 23 mm. By an error the specimen was described in the preliminary report as adult. This is scarcely correct, since the incubatory lamellæ are still only about half developed, so that the adult female probably reaches to nearly 30 mm. The specimen is badly mutilated, the third to the eighth thoracic limbs being entirely absent.

P. belgica is far and away the largest species of the genus yet described, none of the other ten known species exceeding 15 mm., whereas adult specimens of this species must reach to nearly 30 mm. It is most nearly related to *P. sarsi* Will.-Suhm, described by Sars (1885) from the 'Challenger' collections for specimens taken at Kerguelen Island. Besides the great difference in size (*P. sarsi* measures only 14 mm., adult specimens), the only other conspicuous difference is in the ocular laminae. In *P. sarsi* the antero-lateral angles of the eye-plates are serrate, whereas in *P. belgica* they are quite smooth. Minor differences in the shape of the antennal scale and telson may also be noted. The antennal scale in *P. sarsi* has the spine terminating the outer margin less strong than in *P. belgica*, while the apex of the scale is more produced. The telson in *P. sarsi* has the apex more truncate than *P. belgica* and the lateral margins, according to Sars, bear eight short spines. Mr. Holt, however, who has kindly examined the types of *P. sarsi* in the British

Museum, informs me that only five spines are present on the lateral margins, so that the armature of the telson of *P. sarsi* approximates closely to that of *P. belgica*.

The only other species of *Pseudomma* having smooth ocular laminae is *P. australe*, G. O. Sars (1885), from Bass Straits, Australia. The vastly different form of the antennal scale in the latter, however, abundantly distinguishes it from *P. belgica*.

Besides the single 'Discovery' specimen, this species is also known from the 'Belgica' collections, and has been described by Hansen in MS. under the name which is here used. It is possible that the mutilated specimen noted by Sars (1885, p. 191) from 1675 fathoms in the Antarctic Ocean may have belonged to this species rather than to *P. sarsi*. Sars notes that it was much larger than the latter.

Genus DACTYLAMBLYOPS, Holt and Tattersall.

Dactylamblyops, Holt and Tattersall, 1906 (1).

Dactylerythroops, Illig, 1906, *non* Holt and Tattersall, 1905.

? *Amblyops* (*pars*), Ohlin, 1901.

Dactylamblyops, Tattersall, 1907.

This genus was established for the reception of the single rather mutilated specimen of *D. hodysoni* in the present collection. Since the publication of the preliminary notice of the 'Discovery' Schizopoda, however, two closely allied species have been discovered off the west coast of Ireland (Tattersall, 1907). A clearer idea of the exact relationships of the genus has thus been gained, and while the species referred thereto appear, in the present state of our knowledge, to form a natural group, it is undeniably very nearly allied to *Dactylerythroops*, Holt and Tattersall (1905), to which genus, indeed, the present species was referred by Illig (1906).

The definition of the genus given by Holt and Tattersall, 1906 (1), may therefore be amended as follows:—

DACTYLAMBLYOPS, Holt and Tattersall.

Characters generally as in *Amblyops*, G. O. Sars, except:—

Eyes placed close together, but not contiguous, more or less pyriform in shape, furnished with distinct and definite peduncles; visual elements imperfectly developed, numerous, reaching to the surface of the eye, and probably directly functional as organs of sight: outer distal corner rounded, and not produced into a digitiform process; a short blunt process always present on the inner and upper surface.

Second thoracic limbs with the endopods not noticeably short, but well developed, and considerably longer than the endopods of the first thoracic limbs.

Telson not very long, triangular in shape, the distal parts of its margins armed with more or fewer spines: median setæ absent.

Type species, *D. hodysoni*, Holt and Tattersall.

The absence of median setæ from the apex of the telson is not necessarily of generic importance, since the genera *Pseudomma* and *Dactylerythrops* both contain species in some of which these setæ are present, and others in which they are wanting. As, however, all three species at present referred to this genus are without median apical setæ, it is convenient to retain this character in the generic definition.

DACTYLAMBLYOPS HODGSONI.

(Pl. VI., Figs. 9-16.)

Dactylamblyops hodysoni. Holt and Tattersall, 1906 (1).

Dactylerythrops arcuata, Illig, 1906.

Locality of capture:—Lat. $66^{\circ} 52' 09''$ S., long. $178^{\circ} 08' 15''$ E., 2030 fathoms, one specimen, male, 13 mm.

The single specimen in the collection is considerably damaged, the antennules, antennal scales, and the third to the eighth thoracic limbs being missing. A complete description is therefore not possible, but it is hoped that as many of the characters as can be made out with certainty will suffice for future recognition of the species in collections.

Carapace submembranaceous, covering all the thoracic segments except the last one, anterior margin produced into a blunt, broadly but evenly rounded rostrum projecting between the eyes; cervical sulcus well marked; antero-lateral angles rounded.

Pleon slightly longer than the carapace; first five segments subequal in length; sixth nearly twice as long as the fifth.

Eyes (Fig. 9) small, placed on definite peduncles, not in any way contiguous, pyriform in shape, external angle evenly rounded, a short digitate process arising from the inner dorsal face; visual elements imperfectly developed, apparently represented by numerous minute granular bodies with a refractive centre; a large opaque ganglionic mass, probably the optic nerve, visible in the peduncle, from which a nerve fibre proceeds to the cornea.

Antennal peduncle short, composed of three subequal quadrangular joints.

Antennal scale broken on both sides, but there does not appear to be a spine on the outer corner of the basal joint.

Mouth parts (Figs. 10-13) not differing markedly from those figured by Sars for *Amblyops abbreviata* (1870-79).

First thoracic limbs (Fig. 14) with the endopod substantially of the same form as in *A. abbreviata*.

Second thoracic limbs (Fig. 15) of essentially the same structure as in *A. abbreviata*, but with the endopod apparently much longer, being nearly twice as long as the endopod of the first thoracic limbs.

Genital appendix to the last thoracic limbs of the male terminating in two lobes, the larger of which bears six long setæ, the smaller one being devoid of setæ, but apparently having a covering of very fine hairs.

Pleopods in the male agreeing in all points with those of males of the genus *Amblyops*.

Telson (Fig. 16) not quite as long as the last segment of the pleon, triangular in shape, tapering evenly to a narrowly rounded apex, nearly twice as long as broad at its base; distal half of each lateral margin armed with nineteen spines, increasing in length towards the apex, the terminal ones about one-tenth of the total length of the telson; median setæ absent.

Uropods broken on both sides, but the inner one possesses a single strong spine on the ventral surface at the inner posterior angle of the otocyst.

Length of the single specimen, an apparently adult male, 13 mm.

There can be little doubt, I think, that *Dactylerythrops arcuata*, Illig (1906), is the same species as the present one. Minor differences, it is true, are to be noticed. For instance, the visual elements of the eye in Illig's species are represented as larger and less numerous than in *D. hodgsoni*. It may be that in the former preservation has caused the visual elements to mass in groups of more or fewer lenses, since in the 'Discovery' specimen, as the figure (Fig. 9) shows, the visual elements are not regularly arranged, but more numerous in some places than others, an effect probably due to the mode of preservation.

Moreover, in *D. arcuata*, the telson is not quite so long compared with the breadth at its base as in *D. hodgsoni*, and is furnished with only eighteen spines on each lateral margin. But these differences are insignificant when compared with the general agreement between the two species in most points. One or two characters may be added to the above diagnosis from Illig's description and figures.

Antennular peduncle long and rather stout, last joint the largest and nearly equal to the combined length of the other two.

Antennal scale slightly over-reaching the antennular peduncle, about four times as long as broad, outer margin entire, and terminating in a short spine beyond which the apex of the scale is only slightly produced.

Four species of this genus are now known, *D. sarsi* (Ohlin, 1901), *D. thaumatops* and *D. goniops*, Tattersall (1907), and the present species.

From the other three species, *D. hodgsoni* is at once distinguished by the shape of the eye. In *D. sarsi* the eye is acutely pointed in front; in *D. thaumatops* it is of quite peculiar form, with an outer equatorial membranous ridge, while in *D. goniops* the eye is quadrangular rather than pyriform in shape. Otherwise the four species are rather closely allied and form quite a distinct generic group to themselves.

D. hodgsoni is at present only known from very deep water in the Antarctic Ocean. Illig's specimens were collected over a depth of 4000-5000 metres, while the present specimen was dredged in 2030 fathoms (*ca.* 3700 metres).

SUB-FAMILY MYSIDETINÆ, Holt and Tattersall.

GENUS MYSIDETES, Holt and Tattersall.

? *Mysidopsis*, G. O. Sars, 1883 and 1885, *non* G. O. Sars, 1864.

Mysideis (pars), Holt and Tattersall, 1905, *non* G. O. Sars, 1869.

Mysidetes, Holt and Tattersall, 1906 (1) and (2).

Metamysidella, Illig, 1906.

A full diagnosis of this genus and a statement of its possible affinities have already appeared, Holt and Tattersall (1906 (2)). While agreeing in most characters with the normal genera of the *Leptomysinae*, the rudimentary nature of the pleopods of the male offers a feature of sharp distinction from members of that sub-family and has necessitated the establishment of a new sub-family for its reception. In the form of the telson and armature of the inner uropods it approaches rather closely to the genera *Heteromysis* and *Mysidella*, but whereas in the former the third, and in the latter the first, thoracic limbs are peculiarly modified and strongly armed, in *Mysidetes* both these limbs are of normal structure. The external resemblance of females of the present genus to those of *Mysidopsis* and *Mysideis* has already been noted, and a comparative table of their respective characters was given (Holt and Tattersall 1906 (2)). It will suffice here to mention that *Mysidetes* differs from *Mysidopsis*, (1) in having a well-developed molar tubercle to the mandible; (2) in the presence of a setiferous expansion of the inner margin of the basal part of the second maxilla, and (3) in having the endopods of the first thoracic limbs seven-jointed instead of six.

From *Mysideis* it is distinguished by having the endopods of the first and second thoracic limbs of normal stoutness and usual armature, instead of being unusually massive and strongly armed; while from both genera it differs, (1) in having the cleft of the telson armed with spines; (2) in the uropods having a row of spines in their inner edges extending well over half-way down their length, and finally, (3) in having the pleopods of the male rudimentary.

Mysidopsis incisa, G. O. Sars (1885), probably belongs to this genus. It was described in the 'Challenger' Report from a specimen taken off Australia. This specimen is a female much mutilated, and dissection was neither practicable nor desirable. The telson and inner uropods, however, conform to the type found in *Mysidetes*.

The genus *Metamysidella* (Illig, 1906) is undoubtedly synonymous with this genus, though no mention is made in the diagnosis of the character of the pleopods of the male. In all other features the two genera agree absolutely.

MYSIDETES POSTHON.

(Pl. VII., Figs. 1-13.)

Mysidetes posthon, Holt and Tattersall, 1906 (1).

Localities of captures:—Off Coulman Island, 100 fathoms, one specimen, male, 25 mm.

Winter Quarters, 5. 6. 02. 56 fathoms, one specimen, female, 23 mm.

Winter Quarters, 29. 8. 03. No. 12 Hole, 25-30 fathoms, three specimens, two females and one male, 21 mm.

General form (Fig. 1) compact and moderately robust.

Carapace (Fig. 1) leaving the last segment of the thorax exposed posteriorly; antero-lateral margins produced into a short obtuse rostrum not extending beyond the eyestalks; antero-lateral corners rounded, cervical sulcus well marked.

Pleon (Fig. 1) longer than the carapace; first five segments sub-equal in length; sixth segment about once and a half to twice as long as the fifth.

Eyes (Fig. 1), large, globose; pigment brown.

Antennular peduncle (Fig. 2) much shorter than the antennal scale; basal joint longer than the terminal joint, and having its outer corner produced beyond the distal extremity of the second joint, the produced part tipped with four or five long setae; second joint small; third joint almost square in shape; antennular brush in the male rather small and feebly hirsute.

Antennal peduncle (Fig. 3) slightly shorter and more slender than the antennular, and little more than half as long as the scale; third joint shorter than the second.

Antennal scale (Fig. 3), lanceolate in shape; between four and five times as long as broad; setose all round; a minute second joint at the apex; a spine on the outer distal corner of the basal joint.

Mandibles (Fig. 4) with a well-developed molar process and cutting edge; palp (Fig. 5) with the second joint somewhat expanded and armed with long setae on both margins; third joint not much expanded, a row of strong plumose setae on the lower edge, and two very strong simple spine-like setae at the tip.

Second maxillae (Fig. 7) with the setiferous expansion of the basal joint well developed.

Endopods of the first thoracic limbs (Fig. 8) of about the same build as in the genus *Mysidopsis*, but seven-jointed; masticatory lobe well developed; inner margins of the proximal four joints armed with numerous plumose setae; sixth joint bearing a well-developed nail and beset with numerous plumose setae.

Endopods of the second thoracic limbs (Fig. 9) very similar to those of *Mysidopsis*; longer than the first; sixth joint armed with numerous plumose setae, but in the specimen dissected I was unable to detect a nail, though it may have been broken off.

Endopods of the third thoracic limbs (Fig. 10) with the merus longer than the tarsus; latter composed of six joints; nail well developed and longer than the last joint of the tarsus.

Endopods of the remaining thoracic limbs become successively longer and more slender from the fourth to the eighth; the increase in length takes place chiefly in the ischial joint; the number of joints in the tarsus of the endopods also increases in the more posterior limbs; in one specimen there were six joints in the tarsus of the third limb, six in the tarsus of the fourth, ten in the tarsus of the seventh, and twelve in the tarsus of the last limb.

Genital appendix (Fig. 11) on the last thoracic limb of the male exceedingly long and slender, equal in length to the first three joints of the limb to which it is attached.

Pleopods (Fig. 12) similar in both sexes, consisting of a single ramus bearing proximally and externally a rather large process tipped with setæ.

Telson (Fig. 13) a little longer than the last segment of the pleon, and more than twice as long as broad at its base; cleft at the apex for nearly a quarter of its length, cleft rather wide, its margins armed with about eighteen teeth on each side; the apex of each lobe of the cleft armed with a pair of spines, the inner one the shorter; lateral margins armed throughout their whole length with about seventy spines, which become arranged in series towards the apex.

Inner uropods slightly longer than the telson, with a row of moderately slender and long spines on its inner ventral margin, varying in number from twenty-six to twenty-eight, and extending from the otocyst to near the apex; spines not arranged in series, but increasing in size distally. In some specimens the spines extend further down the uropod than in others.

Outer uropods about half as long again as the inner.

Length of an adult female with embryos in the brood pouch, 21 mm.; of an apparently adult male, 25 mm. A second female with embryos in the brood pouch measured 23 mm.

It is not a little interesting that this genus should have been discovered almost simultaneously in the northern and southern hemispheres, *M. farrani*, Holt and Tattersall (1906 (2)) having just been described when the 'Discovery' collections came to hand.

M. posthon is a more stoutly built form than *M. farrani*, and is further distinguished from the latter in the following characters:—

Antennules.—*M. farrani* has not the outer corner of the basal joint of the peduncle produced nearly as much as in *M. posthon*.

Thoracic limbs.—The tarsus of the endopods in *M. posthon* is composed of six to twelve joints, while in *M. farrani* there are only four.

Genital appendix to the last thoracic limb of the male is much longer and more slender in *M. posthon* than in *M. farrani*.

Pleopods.—The lateral lobe is less developed in *M. farrani* than in *M. posthon*.

Telson.—In *M. farrani* the cleft is armed with only about thirteen spines, whereas in *M. posthon* there are about thirty-six. In the former, moreover, the lateral margins of the telson are armed with not more than twenty-six spines, not arranged in series, and situated only on the distal two-thirds of the margin. In *M. posthon* the lateral margins are armed throughout the entire length with about seventy spines, arranged, at any rate, distally in series. The whole telson in *M. farrani* is more slender than in *M. posthon*.

The spines on the inner uropods of *M. posthon* appear to be somewhat longer than in *M. farrani*. I have already expressed the opinion that the genus *Metamysidella* of Illig is synonymous with *Mysidetes*. The type species of the former, *M. kerguelensis*, Illig (1906), is, however, a much smaller species than *M. posthon*, measuring only 10 mm. in length. It is otherwise closely allied to the latter, but differs in having the antennular peduncle almost equal in length to the antennal scale and in the details of the armature of the telson.

If *Mysidopsis incisa*, G. O. Sars (1885), should in future be found referable to the genus *Mysidetes*, as seems probable, it differs from the present species in size, in having fewer joints in the tarsus of the thoracic limbs, and in the details of the armature of the telson.

I should mention here that I do not attach too great an importance to the difference in size between *M. kerguelensis* and *Mysidopsis incisa* as compared with *M. posthon* as a specific character, for I have found both males and females of *M. farrani* quite sexually mature at 15 mm. (judging from the characters of the antennular brush in the male and the incubatory lamellæ in the female), while the species, fully grown, reaches to 28 mm. in total length.

SUB-FAMILY MYSINÆ.

GENUS ANTARCTOMYSIS, Coutière.

Mysis, Holt and Tattersall, 1906 (1).

Antarctomysis, Coutière, 1906.

This genus has been recently established by Coutière for the reception of the species briefly noted as *Mysis maxima*, Hansen (MS.), in the preliminary notice of this collection.

There can be little doubt as to the correctness of the reasons which have led to its formation, since the biramous character of the fifth pair of pleopods in the male offers a character of undoubted generic value, as distinguishing *Mysis maxima* from the genus *Mysis* (*sens. stricto*). The genus *Hemimysis* has the fifth pair of pleopods in the male biramous and natatory, but the third pair are only imperfectly biramous, the outer ramus being very minute and single-jointed, whereas in *Antarctomysis* the third pair resemble the fifth in having both rami multiarticulate and setose.

I became aware, only after the plates illustrating this report had been printed, that the two specimens of *Antarctomysis* in the 'Discovery' collections, referred in the preliminary note to one species *A. maxima*, in reality belong to two distinct but very closely allied species. On my appealing to Dr. Hansen, he very kindly sent me some notes and sketches of *A. maxima*, and a second species of the genus discovered by him in a collection which he is engaged in working out. These notes and drawings placed the matter beyond doubt, the larger of my two specimens clearly belonging to Hansen's second species. I note the species here, and give the points of distinction, but leave a full description and name to Dr. Hansen. The drawing on Pl. VIII., Fig. 1, was taken from the real *A. maxima*, but the remaining figures on the plate represent the appendages of the second species, which, at the time, I took to be *A. maxima* also. They will probably be of use, however, in illustrating how closely allied the two species are when they are compared with the figures given by Coutière (1906) of the true *A. maxima*.

ANTARCTOMYSIS MAXIMA.

(Pl. VIII., Fig. 1.)

Mysis maxima (*pars*), Holt and Tattersall, 1906 (1).

Antarctomysis maxima, Coutière, 1906.

Locality of capture.—Winter quarters, 5. 6. 02, D-net hole, 56 fathoms, one specimen, immature male, 33 mm.

Coutière (1906) has recently described this species in great detail from mature examples collected by the French Antarctic Expedition. I have practically nothing to add to his description, but since no figure of the entire animal was given by him, my drawing on Pl. VIII., Fig. 1 may be useful.

Coutière does not mention the spines arming the inner ventral edge of the inner uropod. They extend from the posterior inner corner of the otocyst to the extreme tip of the uropod, and posteriorly, at least, are arranged in series of twos, threes and occasionally fours. The species would appear to be circumpolar in distribution, since, besides the single specimen in the 'Discovery' collection, it has been taken by the French, Swedish and Belgian Antarctic expeditions; by the two former, in considerable numbers.

ANTARCTOMYSIS sp.

(Pl. VIII., Figs. 2-12.)

Mysis maxima (*pars*), Holt and Tattersall, 1906 (1).

Locality of capture:—Lat. $78^{\circ} 25' 40''$ S., long. $185^{\circ} 39' 6''$ E., 300 fathoms, one specimen, immature male, 40 mm.

This species is so closely allied to *A. maxima* that I only became aware that it was distinct when too late to properly illustrate it. The figures 2-12 on Plate VIII. were taken from the appendages of this specimen.

The species will be fully described and named by Dr. Hansen, so here I will merely note the points of distinction between it and *A. maxima*.

(1) *Eye*.—In *A. maxima* (Pl. VIII., fig. 1) the eye is large and the visual elements occupy a large part of the outer side of the eye-stalk, so that in dorsal view the inner eye-stalk proper is much longer than the outer, and in external lateral view very little of the latter is visible. In the present form the eye is smaller and narrower than in *A. maxima*, the visual elements occupy the terminal part of the eye-stalk only, so that the inner and outer margins of the latter are subequal in length, and in external lateral view practically the whole of the eye-stalk is visible.

(2) *Rostrum*.—In *A. maxima* the angle contained by the antero-lateral margins of the carapace which form the rostrum is equal to or slightly greater than a right angle, so that in lateral view the antero-lateral margins are not very oblique. The tip of the rostrum is produced into a very small spine.

In the new species the angle of the rostrum is considerably less than a right angle, so that the antero-lateral margins of the carapace in lateral view are very oblique. The apex of the rostrum is bluntly rounded.

(3) *Antenna*.—In *A. maxima* the basal joint of the antenna, from which the antennal scale and peduncle arise, bears two spines ventrally, one at each of the outer and inner distal corners. In the new form, only the one on the outer distal corner is present, the inner corner being rounded.

(4) In *A. maxima* the tarsus of the third to the eighth thoracic limbs is seven to eight-jointed (excluding the nail); in the present species the tarsus is six to seven-jointed, so that the two distal joints before the nail are proportionately longer than in *A. maxima* (*cf.* Pl. VIII., Fig. 8, with Coutière (1906), Pl. I., Fig. 11).

In other characters the two species are practically identical.

LIST OF AUTHORITIES QUOTED.

- COUTIÈRE, H., 1906.—Expédition Chareot. Crustacés Schizopodes et Décapodes, Paris.
- CZERNIAVSKY, W., 1882-3.—*Monographia Mysidarum imprimis Imperii Rossici*, fasc. i.-iii., St. Petersburg.
- DANA, J. D., 1852.—United States Exploring Expedition, Crustacea.
- HANSEN, H. J., 1887.—“Malacostraca marina Groenlandiae occidentalis.” Vid. Medd. naturh. Foren. Kjöbenhavn.
- HANSEN, H. J., 1905 (1).—“Prelim. Report Schizopoda ‘Princess Alice,’ 1904.” Bull. Mus. Océan. Monaco, no. 30.
- HANSEN, H. J., 1905 (2).—“Further notes on the Schizopoda.” Bull. Mus. Océan. Monaco, no. 42.
- HODGSON, T. V., 1902.—Schizopoda in “Report collections Natural History ‘Southern Cross.’” London.
- HOLT, E. W. L., and TATTERSALL, W. M., 1905.—“Schizopod. Crust. N. E. Atlantic Slope.” Report Sea and Inland Fisheries, Ireland, 1902-3, Pt. ii., Scientific Investigations, Appendix no. iv.
- HOLT, E. W. L., and TATTERSALL, W. M., 1906 (1).—“Prelim. notice Schizopoda ‘Discovery.’” Ann. and Mag. Nat. Hist. ser. 7, vol. xvii.
- HOLT, E. W. L., and TATTERSALL, W. M., 1906 (2).—“Schizopod. Crust. N. E. Atlantic Slope. Supplement.” Fisheries, Ireland, Sci. Invest., 1904, v.
- ILLIG, G., 1906.—“Bericht ü. die neuen Schizopoden-Gattung und Arten der Deutschen Tiefsee-Expedition, 1898-1899.” Zoologischer Anzeiger, Bd. xxx., no. 7.
- NORMAN, A. M., 1902.—“Notes on the Natural History of East Finmark.” Ann. and Mag. Nat. Hist., ser. 7, vol. x.
- OHLIN, A., 1901.—“Arctic Crustacea.” Bihang Kongl. Sven. Vet.-Akad. Handl., Bd. 27, Afd. iv.
- ORTMANN, A. E., 1893.—Decapoden und Schizopoden der Plankton-Expedition. Ergeb. Plankton Erf. der Humboldt-Stiftung, Bd. ii. G, b.
- SARS, G. O., 1864.—Beretning om en i Sommeren 1863 foretagen Zoologisk Reise i Christiania Stift.
- SARS, G. O., 1869.—Undersøgelser over Christianiafjordens Dybvandsfauna. Christiania.
- SARS, G. O., 1870-79.—Carcin. Bidrag til Norges Fauna. I. Monog. Norges Mysider.
- SARS, G. O., 1883.—“Prelim. notices Schizopoda ‘Challenger.’” Forhandl. Vidensk. Selsk. Christiania, no. 7.
- SARS, G. O., 1885.—Report on the Schizopoda collected by H.M.S. ‘Challenger.’ Zool. ‘Challenger’ Exped., Pt. xxxvii., vol. xiii.
- STEBBING, T. R. R., 1893.—History of Crustacea. London.
- STEBBING, T. R. R., 1900.—“On some Crustaceans from the Falkland Islands.” Proc. Zool. Soc., London.
- TATTERSALL, W. M., 1907.—“Prelim. diagnoses of six new Mysidae from the West Coast of Ireland.” Ann. and Mag. Nat. Hist., ser. 7, vol. xix.
- WILLEMÖES-SUHM, R., 1875.—“Some Atlantic Crustacea from the ‘Challenger’ expedition.” Trans. Linn. Soc., London, ser. ii., vol. i.
- ZIMMER, C., 1904.—Arktische Schizopoden. Fauna Arctica, ii.
- ZIMMER, C., 1905.—“Biologische Notizen über Schizopoden.” Verhandl. d. Deutsch. Zool. Gesellschaft.

EXPLANATION OF THE PLATES.

PLATE I.

Euphausia superba.

- FIG. 1.—Male, 45 mm., dorsal view of anterior end $\times 10$.
 FIG. 2.—Female, 45 mm., dorsal view of anterior end $\times 10$.
 FIG. 3.—“*Glacialis*” stage, dorsal view of anterior end $\times 15$.
 FIG. 4.—Late Cyrtopia stage, dorsal view of anterior end $\times 30$.
 FIG. 5.—Mandibular palp $\times 13$.
 FIG. 6.—Second maxilla $\times 13$.
 FIG. 7.—First maxilla $\times 13$.
 FIG. 8.—First thoracic limb, endopod $\times 9$.
 FIG. 9.—Second thoracic limb, endopod $\times 9$.
 FIG. 10.—Lateral spine on carapace of female, 50 mm. $\times 30$.
 FIG. 11.—Lateral spine on carapace of male, 45 mm. $\times 30$.
 FIG. 12.—Lateral spine on carapace of male, 39 mm. $\times 30$.

PLATE II.

Euphausia crystallorophias.

- FIG. 1.—Male, lateral view of entire animal $\times 6$.
 FIG. 2.—Female, dorsal view of anterior end $\times 15$.
 FIG. 3.—Mandibular palp $\times 30$.
 FIG. 4.—First maxilla $\times 30$.
 FIG. 5.—Second maxilla $\times 30$.
 FIG. 6.—First thoracic limb $\times 20$.
 FIG. 7.—Second thoracic limb, endopod $\times 20$.
 FIG. 8.—Calyptopis larva $\times 40$.
 FIG. 9.—Purcellia larva $\times 20$.
 FIG. 10.—Cyrtopia larva $\times 20$.

PLATE III.

Thysanöessa macrura.

- FIG. 1.—Female, 28 mm., lateral view $\times 6$.
 FIG. 2.—Female, dorsal view of anterior end $\times 10$.
 FIG. 3.—Antennal scale and peduncle $\times 15$.
 FIG. 4.—Mandibular palp $\times 30$.
 FIG. 5.—First maxilla $\times 30$.
 FIG. 6.—Second maxilla $\times 30$.
 FIG. 7.—First thoracic limb, endopod $\times 30$.
 FIG. 8.—Second thoracic limb, endopod $\times 15$.
 FIG. 9.—Seventh thoracic limb, endopod $\times 30$.
 FIG. 10.—Rudimentary eighth thoracic limb $\times 60$.
 FIG. 11.—Endopod of the first pleopod of the male $\times 60$.
 FIG. 12.—Endopod of the second pleopod of the male $\times 60$.

PLATE IV.

Euphausia triacantha.

FIG. 1.—Male, lateral view $\times 6$.

FIG. 2.—Male, dorsal view of anterior end $\times 20$.

FIG. 3.—Inner lobe of the endopod of the first pleopods of the male to show copulatory apparatus $\times 80$.

Euphausia vallentini.

FIG. 4.—Outline of antennular peduncle of 'Discovery' specimen $\times 20$.

FIG. 5.—Outline of rostrum and basal joint of antennular peduncle of 'Challenger' specimen $\times 30$.

FIG. 6.—Inner lobe of the endopod of the first pleopods of the male in 'Challenger' specimen, to show copulatory apparatus $\times 80$.

Euphausia sp., juv.

FIG. 7.—Dorsal view of anterior end of specimen, 10 mm. $\times 60$.

FIG. 8.—Lateral view of antennular peduncle of the same specimen $\times 60$.

FIG. 9.—Spine on the third segment of the pleon of the same specimen $\times 20$.

Euphausia crystallorophias.

FIG. 10.—Inner lobe of the endopod of the first pleopods of the male, to show copulatory apparatus $\times 80$.

PLATE V.

Hansenomysis antarctica.

FIG. 1.—Female, dorsal view $\times 10$.

FIG. 2.—Enlarged view of anterior end $\times 23$.

FIG. 3.—Side view of anterior end $\times 23$.

FIG. 4.—Dorsal view of peculiar antennular organ $\times 70$.

FIG. 5.—Side view of same $\times 70$.

FIG. 6.—Mandible $\times 20$.

FIG. 7.—Mandibular palp $\times 20$.

FIG. 8.—First maxilla $\times 20$.

FIG. 9.—Second maxilla $\times 20$.

FIG. 10.—First thoracic limb $\times 20$.

FIG. 11.—Second thoracic limb, endopod $\times 10$.

FIG. 12.—Third thoracic limb, endopod $\times 10$.

FIG. 13.—Sixth thoracic limb, endopod $\times 10$.

FIG. 14.—First pleopod $\times 20$.

FIG. 15.—Second pleopod $\times 20$.

FIG. 16.—Third pleopod $\times 20$.

FIG. 17.—Fourth pleopod $\times 20$.

FIG. 18.—Fifth pleopod $\times 20$.

FIG. 19.—Telson and uropods $\times 20$.

PLATE VI.

Pseudomma belgicae.

FIG. 1.—Female, dorsal view $\times 10$.

FIG. 2.—Mandible $\times 30$.

FIG. 3.—Mandibular palp $\times 30$.

FIG. 4.—First maxilla $\times 30$.

FIG. 5.—Second maxilla $\times 30$.

FIG. 6.—First thoracic limb, endopod $\times 13$.

FIG. 7.—Second thoracic limb, endopod $\times 13$.

FIG. 8.—Telson $\times 20$.

Dactylamblyops hodgsoni.

- FIG. 9.—Eye, external lateral view $\times 20$.
 FIG. 10.—Mandible $\times 40$.
 FIG. 11.—Mandibular palp $\times 40$.
 FIG. 12.—First maxilla $\times 40$.
 FIG. 13.—Second maxilla $\times 40$.
 FIG. 14.—First thoracic limb, endopod $\times 27$.
 FIG. 15.—Second thoracic limb, endopod $\times 27$.
 FIG. 16.—Telson $\times 20$.

PLATE VII.

Mysidetes posthon.

- FIG. 1.—Female, dorsal view $\times 13$.
 FIG. 2.—Antennular peduncle $\times 18$.
 FIG. 3.—Antennal peduncle with antennal scale $\times 18$.
 FIG. 4.—Mandible $\times 18$.
 FIG. 5.—Mandibular palp $\times 18$.
 FIG. 6.—First maxilla $\times 18$.
 FIG. 7.—Second maxilla $\times 18$.
 FIG. 8.—First thoracic limb, endopod $\times 18$.
 FIG. 9.—Second thoracic limb, endopod $\times 18$.
 FIG. 10.—Third thoracic limb, endopod $\times 18$.
 FIG. 11.—Genital appendix of male $\times 18$.
 FIG. 12.—First pleopod $\times 24$.
 FIG. 13.—Telson $\times 18$.

PLATE VIII.

Antarctomysis maxima.

- FIG. 1.—Immature male, dorsal view $\times 6$.

Antarctomysis sp.

- FIG. 2.—Mandible $\times 20$.
 FIG. 3.—Mandibular palp $\times 20$.
 FIG. 4.—First maxilla $\times 20$.
 FIG. 5.—Second maxilla $\times 20$.
 FIG. 6.—First thoracic limb, endopod $\times 8$.
 FIG. 7.—Second thoracic limb, endopod $\times 8$.
 FIG. 8.—Third thoracic limb $\times 8$.
 FIG. 9.—Second pleopod of the male (immature) $\times 15$.
 FIG. 10.—Third pleopod of the male (immature) $\times 15$.
 FIG. 11.—Fourth pleopod of the male (immature) $\times 15$.
 FIG. 12.—Fifth pleopod of the male (immature) $\times 15$.

INDEX OF GENERA AND SPECIES.

- Amblyops*, 29.
Amblyops abbreviata, 30.
Amblyops crozetti, 3.
Antarctomysis, 3, 35.
Antarctomysis marina, 2, 36.
Arctomysis, 22.
Boreomysis, 22.
Boreomysis scyphops, 3, 22.
Ceratomysis, 22.
Dactylamblyops, 3, 29.
Dactylamblyops gonatops, 31.
Dactylamblyops hodgsoni, 2, 30.
Dactylamblyops sarsi, 31.
Dactylamblyops thaumatops, 31.
Dactylerythrops, 29.
Dactylerythrops arcuata, 2, 30.
Echinomysis chuni, 2.
Eucopia, 3.
Eucopia australis, 1, 2, 3.
Euphausia, 4.
Euphausia sp., 14, 16.
Euphausia antarctica, 1, 4.
Euphausia australis, 1, 4, 5.
Euphausia crystallophias, 2, 9.
Euphausia gibboides, 16.
Euphausia glacialis, 1, 4, 8.
Euphausia lucens, 1, 11, 14.
Euphausia murrayi, 1, 4, 6.
Euphausia similis, 2, 11.
Euphausia splendens, 1, 11, 13, 14.
Euphausia superba, 1, 2, 4.
Euphausia triacantha, 12.
Euphausia vullentini, 13, 14.
Hansenomysis, 3, 22.
Hansenomysis antarctica, 3, 23.
Hansenomysis fyllæ, 22, 26.
Hemimysis, 35.
Heteromysis, 32.
Lophogaster typicus, 3.
Metamysidella, 32.
Metamysidella kerguelensis, 35.
Michtheimysis mirta, 3.
Mysideis, 32.
Mysidella, 32.
Mysidetes, 3, 32.
Mysidetes farrani, 34.
Mysidetes posthon, 33.
Mysidopsis, 32.
Mysidopsis incisa, 32, 35.
Mysis, 35, 2.
Mysis marina, 1, 35, 36.
Nyctiphanes cowhi, 6.
Petalophthalmus, 22.
Petalophthalmus armiger, 22.
Petalophthalmus ocellatus, 22.
Petalophthalmus willemoesii, 22.
Pseudomma, 3, 27, 30.
Pseudomma australe, 29.
Pseudomma belgicæ, 27.
Pseudomma roseum, 28.
Pseudomma sarsi, 1, 2, 28.
Scotophthalmus, 22.
Thysanoëssa, 3, 17.
Thysanoëssa gregaria, 18.
Thysanoëssa macrura, 1, 2, 17.

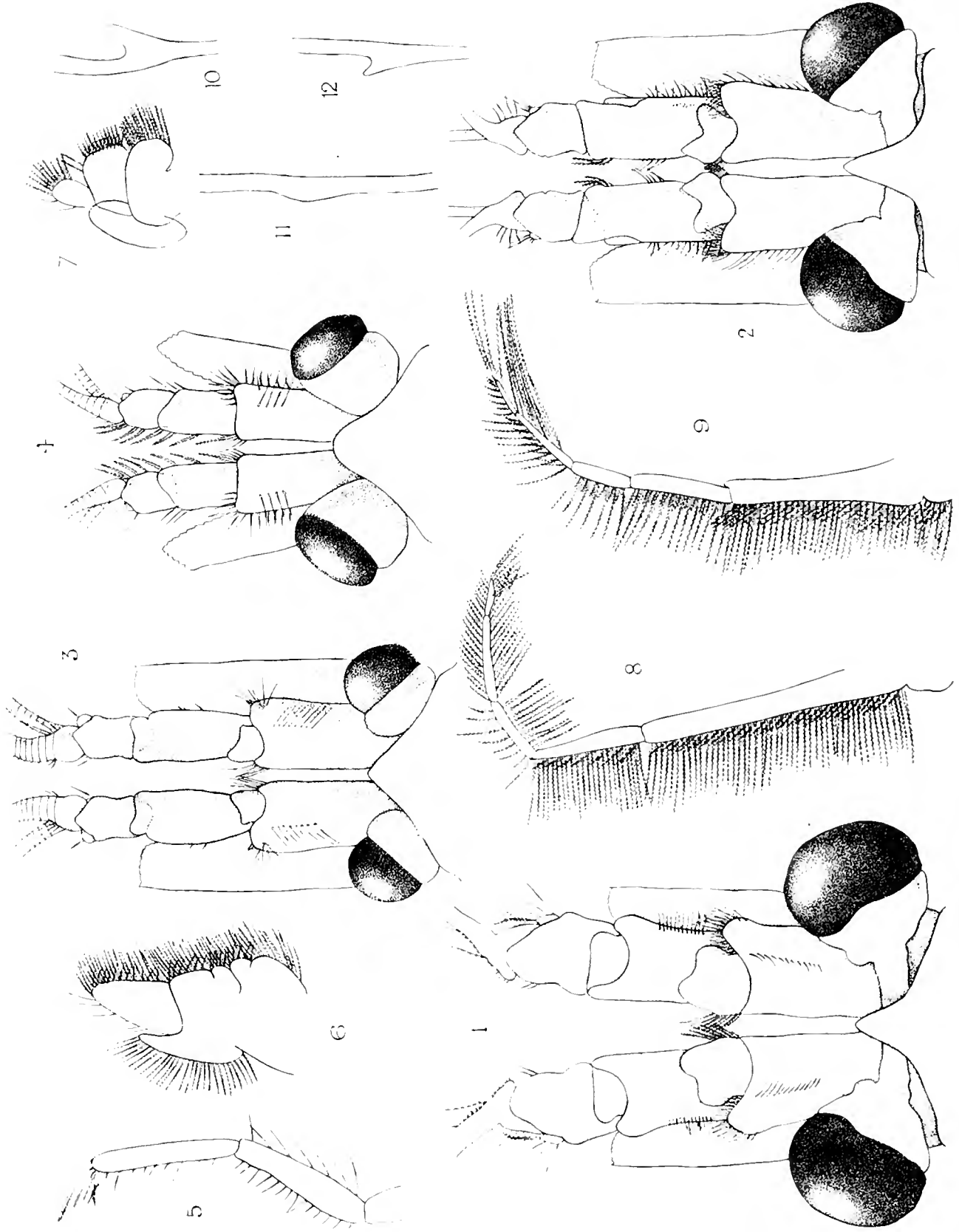

W.M.F. } del.
G.M.V. }

Edwards with rev.

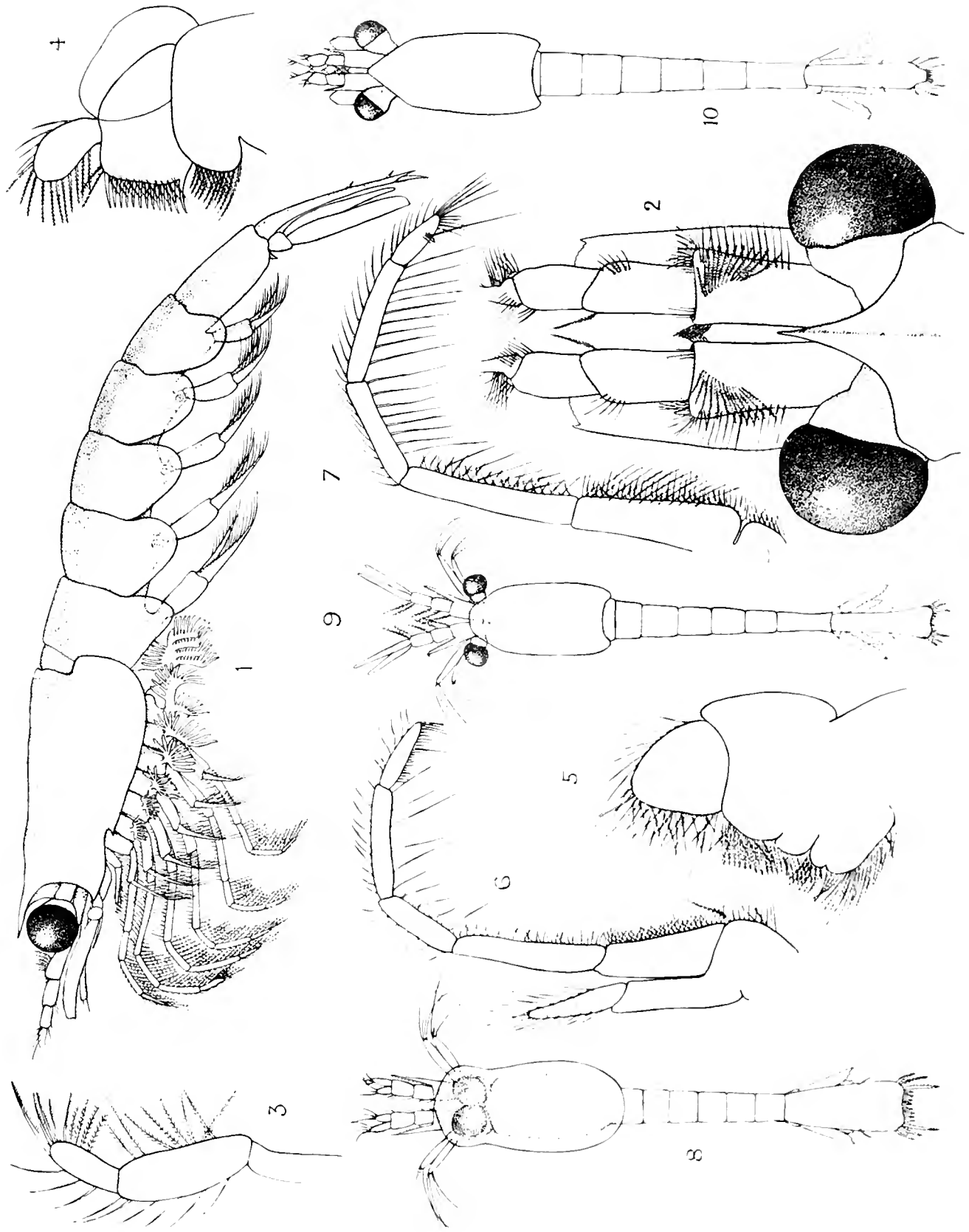

W. N. S. } 6.1
H. W. S. }

Butterworth, Inc.

Euphausia crystallorophias.

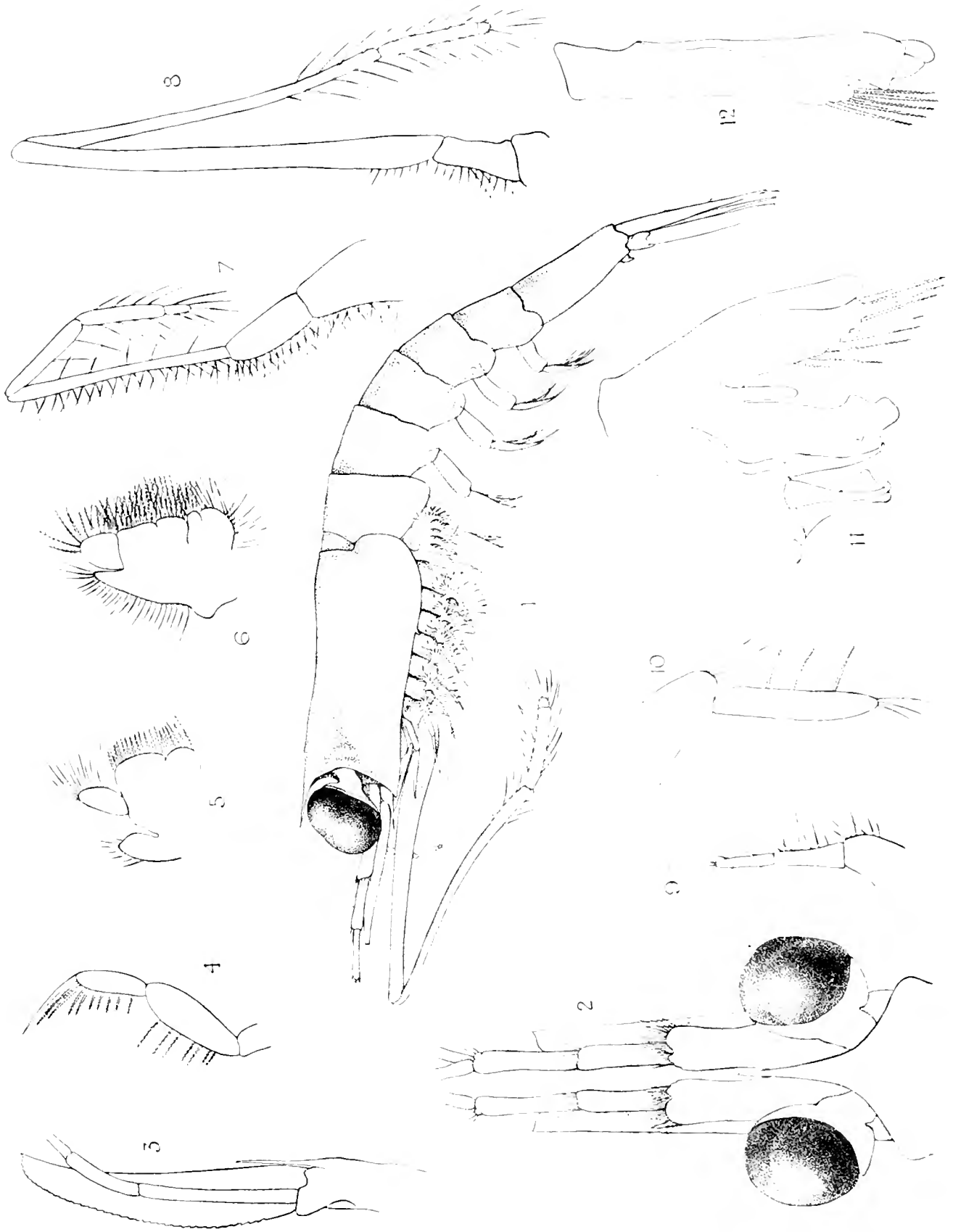

N. M. C. } det
W. A. W. }

Thysanoessa macrura

Hutterworth, sc.

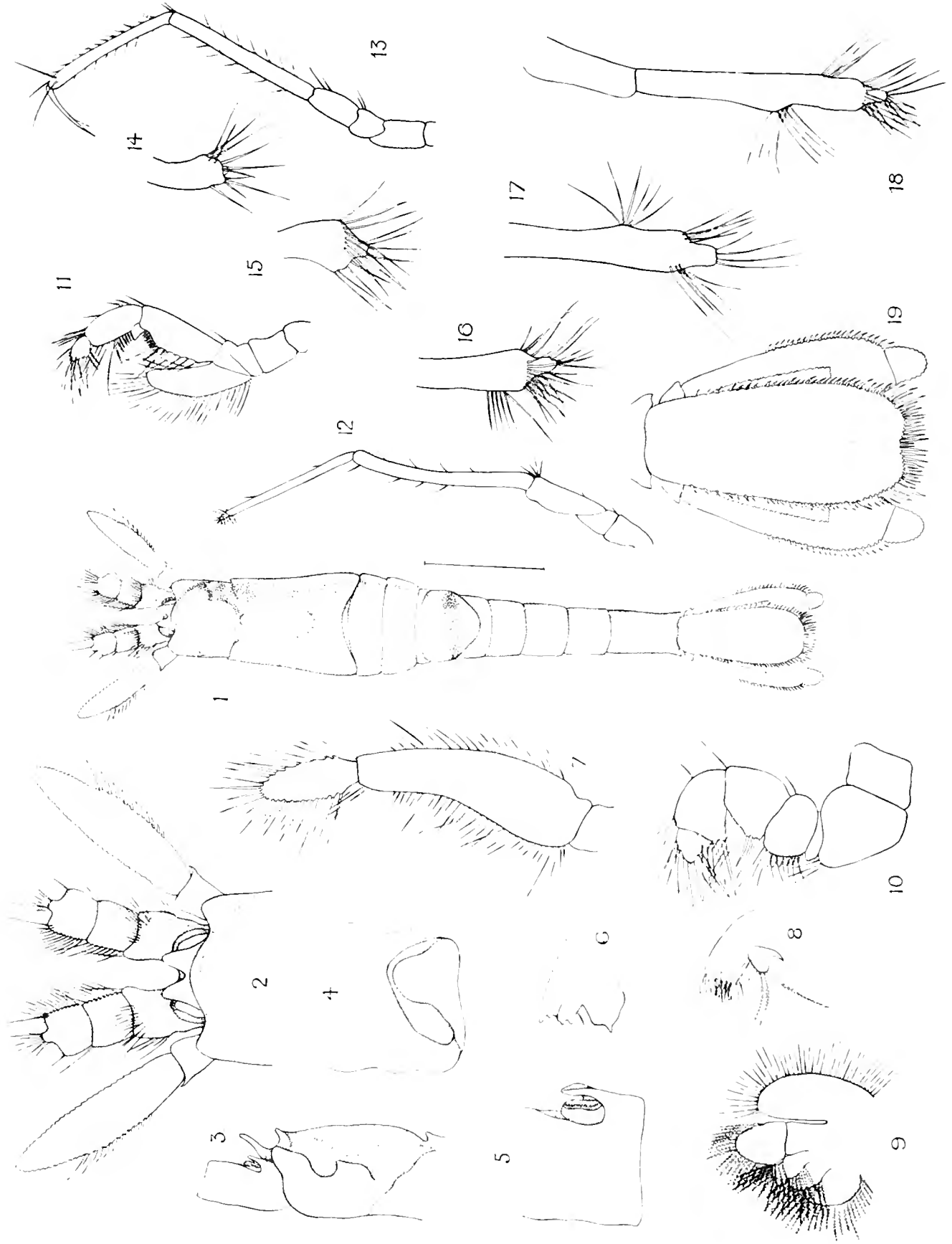

W. M. J. } det
G. B. W. }

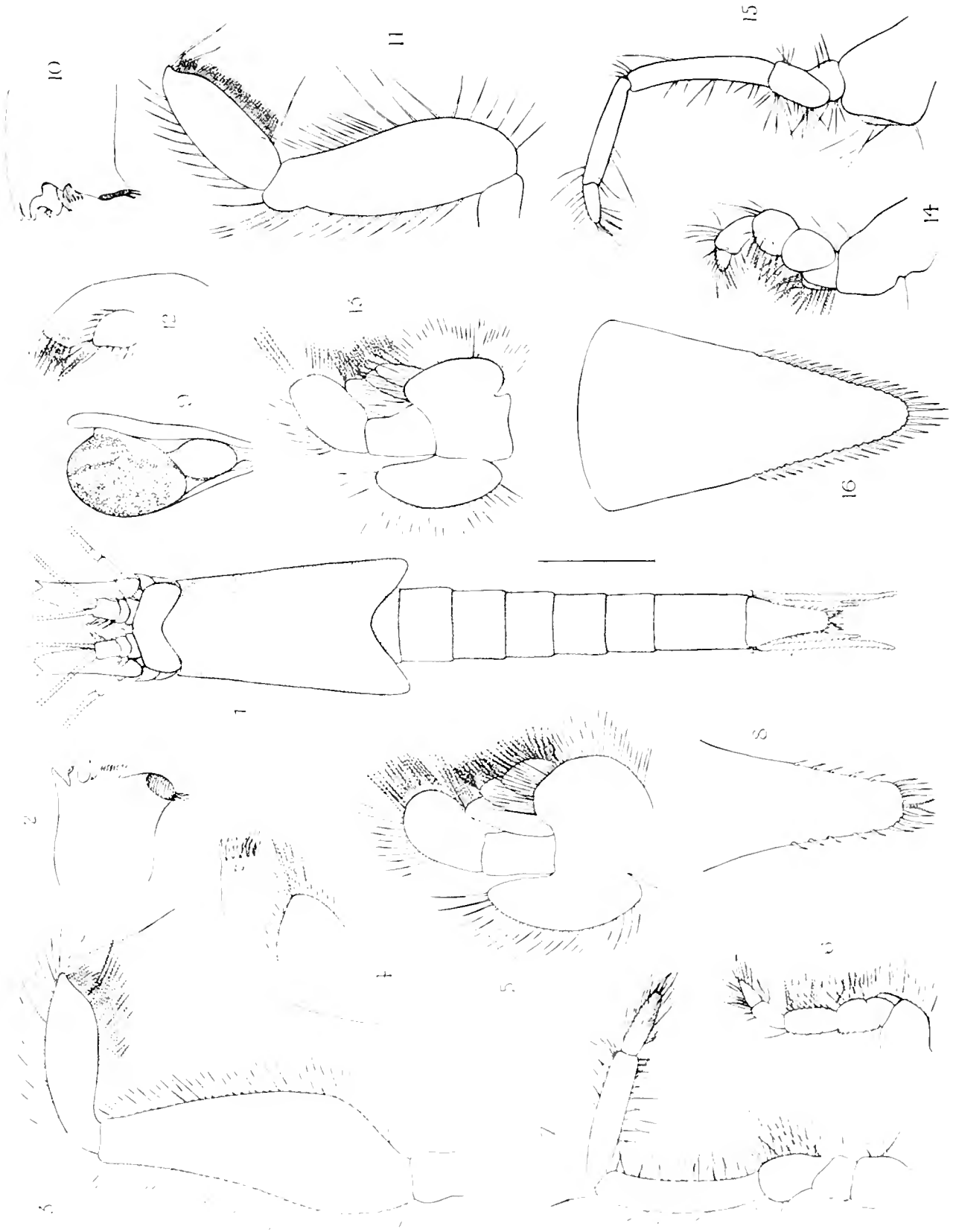

Figs. 1-8. *Pseudomma belgicae*.

Figs. 9-16. *Dactylamblyops hodgsoni*.

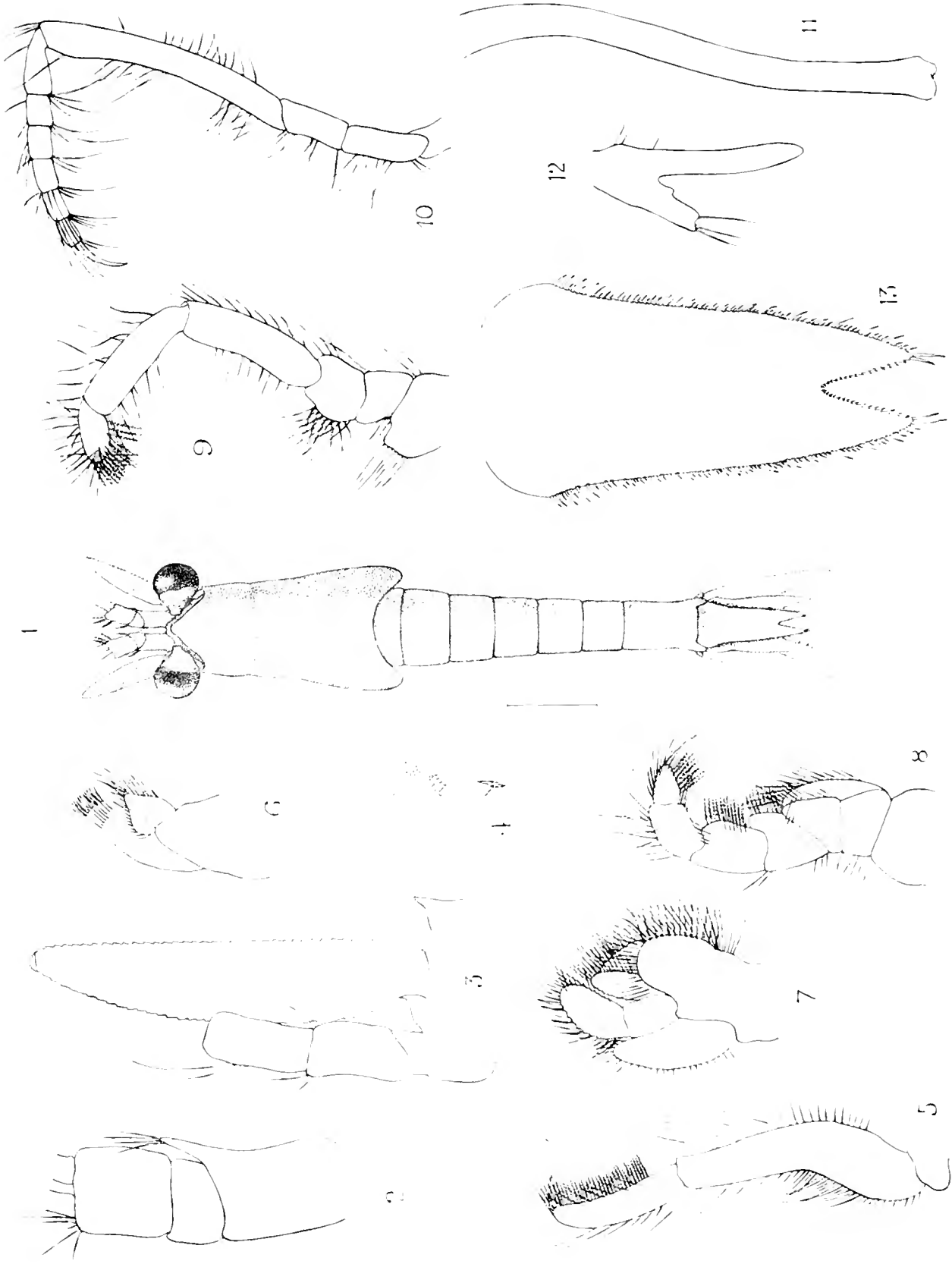

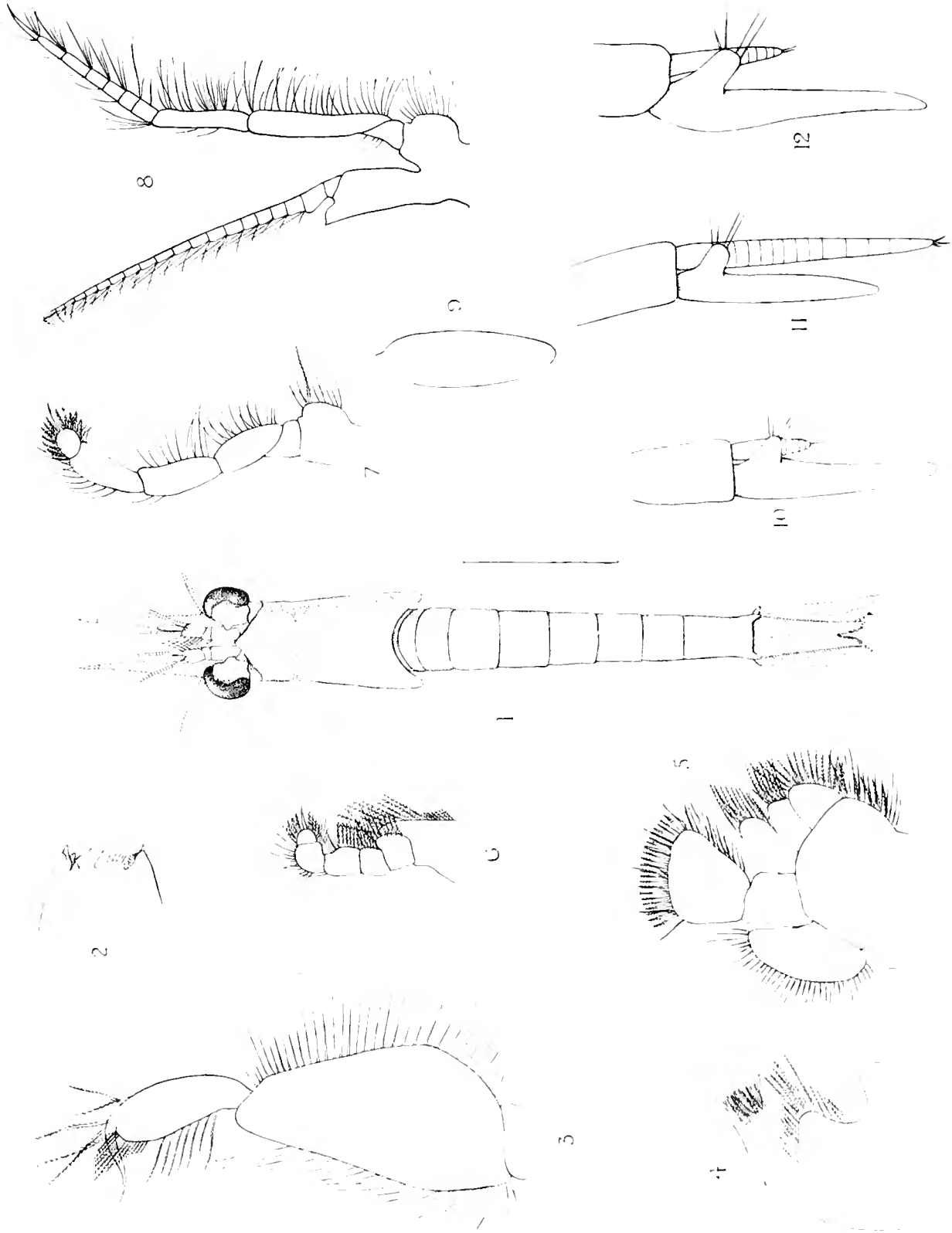

W.M.T. } del.
C.M.W. }

Putterworth sc.

Fig. 1. *Antarctomysis maxima*.

Figs. 2-12. *Antarctomysis* sp.

CRUSTACEA.

VIII.—COPEPODA.*

BY R. NORRIS WOLFENDEN, M.D. (Cantab.), F.L.S., F.Z.S.

(7 Plates.)

PREFATORY NOTE.

THE collection handed to me for examination and report thereon was contained in 163 bottles, the contents of a few of which were in such bad preservation that they were practically worthless for the purpose of identification. The collection of individual species is not a large one, though there were great quantities of the more common species. But few absolutely new forms were found; these comprised a new genus (*Paralabidocera*) and seven new species (*Euchaeta similis*, *Stephus antarcticum*, *Xanthocalanus antarcticus* and *X. magnus*, *Haloptilus ocellatus*, *Faroella antarctica*, and *Gaetanus antarcticus*). As such of these copepods as may be considered Antarctic were collected within a small area, I have not deemed it necessary to occupy space by the repetition of individual captures, which would be monotonous and of no particular interest. The drawings have been made by Miss Marion Lees.

The signs used in the following pages are *B* 1 and *B* 2 for first and second basals; *Ri* and *Re* for endopodite and exopodite; *Si* for inner marginal and *Se* for outer marginal spine (or bristle); *Li* for inner and *Lo* for outer lobe; *Th* for thoracic somite. As they were first used in Giesbrecht's great work, and have been subsequently often employed by others as abbreviations, the author has thought no excuse necessary for their use here, in order to avoid the constant repetition of the words "exopodite" and "endopodite," etc.

I.

UNTIL the expedition of the 'Belgica' there existed no records of the collection of Copepoda south of Kerguelen, except those of Dr. Brady, which referred to the 'Challenger' collections made from the south of Kerguelen to the pack-ice at 66° 29' S.

The collections made by the 'Discovery,' the 'Belgica,' and the 'Gauss' form a most important contribution to the planktonology of this southern region, and the

* Owing to the author's absence from England he was unable to see the "revise" of this Report.—Ed.

results of any one expedition cannot properly be appreciated without reference to the others.

The 'Belgica' collections were made S. and S.E. of Peter I. Island, between $69^{\circ} 48'$ and $71^{\circ} 18' S.$, and $81^{\circ} 19'$ and $92^{\circ} 22' W.$, between April 21st and December 6th, 1898, by means of nets lowered through holes in the pack-ice to a depth of 0-500 mètres.

The 'Discovery' collections were made by lowering and raising a vertically actuated net through holes cut in the ice, while the ship was in Winter Quarters.*

The 'Gauss' collections were made from the South of Kerguelen to the winter station in Gauss Bay, Kaiser Wilhelm II. Land, and were of very extensive character, and as the collections were further made throughout the Atlantic traverse of the ship, they afford an opportunity for the comparison of the purely Antarctic fauna with that of the Southern Ocean.

In considering the question of the distribution of the Copepoda of the southernmost area of the Atlantic (the Antarctic region) it is convenient to consider the results of these expeditions together, since any conclusions drawn from the results of the 'Discovery' alone would be incomplete and even misleading. The 'Belgica' collections have been reported upon by Dr. Giesbrecht ("Résultats du Voyage du S.Y. 'Belgica' en 1897-1898-1899"; Rapports Scientifiques, 1902), and the 'Gauss' collections are still under examination, and I only now refer to the results of my examination of that collection in so far as they assist the elucidation of the 'Discovery' results.

From the results of the three expeditions ('North American,' 'Challenger' and 'Vettor Pisani') which, previously to the 'Belgica,' had collected in the Southern Ocean as far south as the pack-ice. Giesbrecht accepts seventeen species as correct, after rejecting a number of species as "ungenügend beschriebenen und nicht zuverlässig genug bestimmten", † viz., *Actilius armatus* ($50^{\circ} S.$), *Calanus finmarchicus* (52°), *Calanus patagoniensis* (47°), *C. propinquus* ($64^{\circ} 37'$), *simillimus* (52°), *Centropages brachiatus* (52°), *Clausocalanus arcuicornis* (53°), *Clytemnestra scutellata* (46°), *Drepanopus forcipatus* (53°), *D. pectinatus* ($49^{\circ} 16'$), *Metridia boeckii* (45°),

* Mr. Hodgson has supplied me with the following.—ED.

•• TOW-NETTING IN WINTER QUARTERS.

"After the surface of the sea was frozen over there was no means of dragging a tow-net through the water, and as the current seemed sufficiently strong to hold the net out, it was attached to a line about a fathom above a heavy sinker, 28 lbs., and lowered to a depth of ten fathoms, except in special instances or during the summer. This depth was decided on, it having been found that the formation of ice crystals on the nets could be avoided. These crystals formed on the lines down to 5-8 fathoms, according to the season. The nets remained down for twenty-four hours, sometimes longer if the holes could not be visited on account of the weather, or opened on account of some difficulty with the ice. The mouth of the net was always in an approximately vertical position, this was secured by the attachment of the line direct to the ring of the net and the sinker to the other side of the ring."

† The rejected species are, *Acartia denticornis* (52°), *Candacia curta* (50°) and *truncata* ($64^{\circ} 37'$), *Eucalanus attenuatus* ($47^{\circ} 25'$), *Euchota marina* ($47^{\circ} 25'$), *Haloptilus aculeatus* ($46^{\circ} 46'$), *Heterorhabdus spinifrons* (50°), *Lucicutia flavicornis* ($47^{\circ} 25'$), *Pleuromamma abdominale* ($65^{\circ} 42'$), *Copilia stylifera* ($66^{\circ} 29'$).—Giesbrecht, 'Belgica' report, p. 5.

Monstrilla grandis (49°), *Oithona similis* (52°), *Paracalanus parvus* (52°), *Rhincalanus nasutus* (52°), *R. gigas* (65° 42'), *Scopelithrix minor* (46° 46').

This list contains a striking number of forms which are usually associated with more temperate regions, and, as Dr. Giesbrecht remarks, the failure in agreement with the pelagic species of the 'Belgica' is very striking, for only two species are common to all collections. Comparing it with the results of the 'Discovery' the same extraordinary differences are manifest, only four species (*C. propinquus*, *C. simillimus*, *Clausocalanus arcuicornis*, *Oithona similis*) being common to both collections.

In the 'Gauss' collections, in the area between Kerguelen and the Winter Station, appear a great number of species in excess of those either of the 'Belgica' or 'Discovery.' Whereas in the 'Belgica' collection occur thirty species, of which nineteen only are pelagic, in the 'Discovery' collection are twenty-four species of pelagic Copepoda; but in the 'Gauss' collection this number is more than doubled, and a number of species occur even in the collections made round about the Winter Station which are not entirely Antarctic, but extend a long way northwards through the deeper waters of the Atlantic Ocean, and have been brought there probably by southern currents. The species determined, however, show but little agreement with the list enumerated above.

The very extensive number of species captured by the 'Gauss' naturalists is probably due to the fact that the tow-nets were used at much greater depths than in the case of either the 'Belgica' or 'Discovery.' In the former, 500 mètres appears to have been the limit, whereas in the latter the collections may be considered to be practically surface collections. If the tow-net had been used at the depths it was employed on the 'Gauss,' viz., to 3,000 mètres, the agreement between the respective captures might certainly have been greater, and the number of species taken greatly increased.

In the 'Gauss' collections appear only six species which agree with any of the species referred to above (viz., *Aetideus armatus*, *Calanus propinquus* and *C. simillimus*, *Clausocalanus arcuicornis*, *Oithona similis*, *Lucicutia flavicornis*), and when it is remembered that in the 'Belgica' collection there are only two species, and in the 'Discovery' only four species, of the twenty-seven species enumerated by Giesbrecht which are in agreement, the conclusion is inevitable either that the captures made by the expeditions mentioned were unusual, or that the identification of species has in some instances been erroneous. That unusual species do appear in these areas, even close to the ice, is shown by the occurrence in the 'Gauss' Antarctic collections of *Corycaeus speciosus*, *Sapphirina metallina*, *Aetideus armatus*, *Labidocera acutifrons*, *Undulacheta major*, *Arietellus setosus*, and others; and in the 'Discovery' collection in Lat. 56° 31' S., Long. 156° 19' 30" occurred *Eucalanus subtennis*, and in Lat. 49° 40' S., and Long. 172° 18' 30" W., *Pleuromamma gracilis*, several young *Candace*, *Eucharta murina*, and *Centropages violaceus*, which belong undoubtedly to a subtropical or warm temperate area, and are to be regarded as accidental.

While the number of species captured was in each case comparatively small, the number of individuals in any one haul in the case of the 'Discovery' was very great. The rule which appears to hold good for tow-netting in the north part of the North Atlantic, *viz.*, that the further north we go the smaller the number of species, but the immensely increased preponderance of individuals of certain species, certainly holds good as regards the South Polar regions. Immense numbers of the small copepod *Ctenocalanus vanus* appear in some of the hauls, to the almost entire exclusion of any other species, and in other cases the larger copepod *Euchaeta antarctica* appears in great preponderance. *Calanus acutus* and, to a lesser extent, *Calanus propinquus* also preponderate largely. Similarly, *Metridia gerlachei* appears in most of the captures.

The collections of the 'Gauss' provide information which is not given by those of the 'Discovery' or of the 'Belgica,' namely, that several species which appear in the Southern Polar Sea also occur in the deeper water of the Atlantic Ocean to the northwards of the Antarctic area. But as this properly belongs to the report of the 'Gauss' collections which I have in hand, I forbear its discussion in this place.

Two questions are suggested by Dr. Giesbrecht in his 'Belgica' report, *viz.*, (1) Does the Antarctic area possess a peculiar fauna? (2) Is the small agreement of the Antarctic copepod fauna with that of the nearest seas due to defective research, or is it that the area of the pack-ice has its own peculiar fauna? and the further questions as to whether the admixture of Polar and Antarctic fauna occurs in the deep ocean, or whether there are physical and biogenetic conditions in the Polar regions which differ from those in the warm seas and prevent such exchange of species, receive some elucidation from the collections of the 'Gauss.'

With regard to the first question, *viz.*, Does the Antarctic area possess its own peculiar fauna? it must be remarked that from the results of the three collections named the typical copepod fauna (pelagic) of this region consists in the following:—

<i>Calanus acutus</i>	<i>Oncea curvata, similis, frigida, notopus,</i>
„ <i>simillimus</i>	<i>conifera</i>
„ <i>propinquus</i>	<i>Scolecithrix glacialis</i>
<i>Rhincalanus grandis</i>	<i>Oithona similis</i>
<i>Euchaeta antarctica</i>	„ <i>frigida</i>
„ <i>austrina</i>	<i>Gaetanus antarcticus</i>
„ <i>similis</i>	<i>Haloptilus ocellatus</i>
<i>Ctenocalanus vanus</i>	<i>Paralabidocera hodgsoni</i>
<i>Heterorhabdus austrinus</i>	<i>Stephus longipes</i>
<i>Euchirella magna</i>	„ <i>antarcticum</i>
<i>Spinocalanus antarcticus</i>	<i>Ectinosoma antarcticum</i>
<i>Metridia gerlachei</i>	<i>Microcalanus pusillus</i>

1. Of the Antarctic Copepoda the following are new species and genera :—

<i>Paralabidocera hodysoni</i>	<i>Euchirella magna</i>
<i>Haloetilus ocellatus</i>	<i>Faroella antarctica</i>
<i>Stephus antarcticus</i>	<i>Gaetanus antarcticus</i>
<i>Euchæta similis</i>	<i>Xanthocalanus antarcticus</i>
<i>Calanus simillimus</i> (mentioned briefly by Giesbrecht, <i>loc. cit.</i>).	

2. The following are species newly described by Dr. Giesbrecht ('Belgica' report), occurring also in the 'Discovery' collection :—

<i>Euchæta antarctica</i>	
<i>Stephus longipes</i>	
<i>Metridia gerlachei</i> (nearly related to <i>M. boeckii</i> and <i>M. lucens</i>).	
<i>Oncea curvata</i> " "	<i>O. subtilis</i> , Giesb.
<i>Rhincalanus grandis</i> " "	<i>R. gigas</i> , Brady.
<i>Harpacticus furcifer</i> " "	<i>H. flexus</i> , Brady.

3. Of species which occur in the North Polar regions there are only the following 'Discovery' species, which bear such slight modification as to be practically identical : *Microcalanus pusillus* (= *Pseudocalanus pygmaeus*); *Oithona similis*.

4. The 'Discovery' collection would therefore lead us to suppose that, so far as copepod fauna is concerned, there is little resemblance between the characteristic fauna of both Polar regions. In the 'Belgica' collection, *Oncea conifera* and *notopus*; and in the 'Gauss' collection, *Oncea conifera*, *Gaidius tenuispinus* and *brevispinus*, and *Amalophora magna*, that is, seven species of a total of 55-60 species occurring in the South Polar seas, are all that are identical with the species described by Prof. Sars as collected by Nansen's Norwegian North Polar Expedition. It would not, however, be safe to take this list of Prof. Sars' as the ultimate result of copepod research of the North Polar seas, and other species may yet be found to be identical.

The following table shows the comparative relationship of species of the more frequently occurring genera :—

N. Polar.		S. Polar.
<i>Calanus finmarchicus</i>	replaced by	<i>C. propinquus</i>
.. <i>hyperboreus</i>		.. <i>tonsus</i>
		.. <i>simillimus</i>
		.. <i>acutus</i>
<i>Metridia longa</i>	replaced by	<i>M. gerlachei</i>
		.. <i>princeps</i>
<i>Amalophora magna</i> (= <i>Scapho-</i> <i>calanus acrocephalus</i> , Sars)		<i>A. magna</i>
<i>Scolecithrix brevicornis</i>	replaced by	<i>S. glacialis</i>
<i>Xanthocalanus borealis</i>	replaced by	<i>X. magnus</i>
		.. <i>antarcticus</i>

N. Polar.		S. Polar.
<i>Gaidius tenuispinus</i> }	replaced by	<i>G. tenuispinus</i>
„ <i>brevispinus</i> }		„ <i>major</i>
		„ <i>antarcticus</i>
<i>Microcalanus pusillus</i> (= <i>Pseudo-</i> <i>calanus pygmaeus</i>)		<i>M. pusillus</i>
<i>Heterorhabdus norvegicus</i>	replaced by	<i>H. austrinus</i>
„ <i>compactus</i>		„ <i>longicornis</i>
<i>Eucheta norvegica</i>	replaced by	<i>E. antarctica</i>
„ <i>glacialis</i>		„ <i>austrina</i>
„ <i> barbata</i>		„ <i> similis</i>
<i>Haloptilus spinifrons</i>	replaced by	<i>H. ocellatus</i>
		„ <i> spiniceps</i>
<i>Spinocalanus longicornis</i>	replaced by	<i>S. antarcticus</i>
<i>Undeucheta spectabilis</i>	replaced by	<i>U. major</i>
<i>Oithona similis</i>	replaced by	<i>O. similis</i>
„ <i> helgolandica</i>		„ <i> curvata</i>
„ <i> conifera</i>		„ <i> conifera</i>
„ <i> notopus</i>		„ <i> notopus</i>
		„ <i> frigida</i>

In the North Polar Sea, as Prof. Sars remarks, besides the few distinctly Arctic species are many which extend southwards to the warmer seas, and the North Polar basin copepod fauna has a pronounced resemblance to that of the North Atlantic basin, the greater number of species being common to both, and some deep-water forms of the Norwegian Sea are often surface forms in the North Polar basin. A few forms regarded as quite southern also occur in the North Polar Sea.

So far as the distribution can be followed from the 'Gauss' collections, it may be said that, of the typical Antarctic fauna its representatives diminish gradually to latitude 40° S. (*i.e.* about the latitude of St. Paul and New Amsterdam) north of which they do not appear, but extend westwards to those stations situated directly south and westward to 10° E. as a limit of the Cape of Good Hope, north of which no typically Antarctic species appears.

North of Kerguelen, *i.e.* 50° S. lat., no Antarctic species appear to extend, while the typically subtropical species of the Indian Ocean extend as far south as latitude 30° S., where their southern extension appears to be arrested. There is thus a barrier between lat. 40° and 50° S. and between long. 10° and 80° E. as indicated by the 'Gauss' collections, at which extension northwards of Antarctic species and southwards of Indian Ocean subtropical species is prevented, or at any rate, does not occur. While the same collections indicate that the Antarctic species extend northwards into the Atlantic Ocean in gradually diminishing numbers, only as far as lat. 40° S., north of which they do not occur, a few typically Atlantic deep-water species find their way into the Antarctic Sea (such are *Heterorhabdus profundus*, *Labidocera acutifrons*, *Metridia princeps*, *Lucicutia grandis*, *Gaidius major*, *Arietellus setosus*).

Until the 'Gauss' collections are fully examined it is of course rash to say that no

typically Antarctic species ever find their way northwards by way of the deep Atlantic trough, but there is little evidence of it in the many collections made by the 'Gauss' throughout its Atlantic traverse. A certain number of species which are ubiquitous, such as *Oithona similis*, some species of *Onca*, *Haloptilus longicornis*, *Gaidius tenuispinus* and *major*, and *Gastanus* (*armiger*, and possibly *caudini*), extend from the Faroe Channel to the southern ocean; but so far as the evidence at present goes, the Antarctic Copepod fauna is distinct from that of the Arctic seas, and the species which are typical of this region, and most numerous, do not extend far into the Southern Atlantic. As no observations have been made of the Copepod fauna of the deep water of the Indian Ocean, it is quite possible that Antarctic species may bear a considerable extension northwards in this direction.

It is curious that no great number of *Harpacticidæ* appear in the collections of the 'Discovery,' only three examples all told of *Harpacticus furcifer*, which is somewhat different from any *Harpacticus* of the northern hemisphere; and only five are described from the 'Belgica' collection by Dr. Giesbrecht, two of which (*H. brevicornis*, *H. chelifer*), are identical with northern species. A fair number of species occur in the 'Gauss' collection, but these have not yet been examined.

The paucity in numbers of the *Harpacticidæ* in the 'Discovery' captures is no doubt due to the mode of collection.

II.

LIST OF COPEPODS IN THE 'DISCOVERY' COLLECTION.

<i>Euchata antarctica.</i>	<i>Microcalanus pusillus.</i>
.. <i>similis.</i>	<i>Stephus longipes.</i>
<i>Metridia gerlachei.</i>	.. <i>antarcticum.</i>
.. <i>princeps.</i>	<i>Xanthocalanus antarcticus.</i>
<i>Calanus acutus.</i>	.. <i>magnus.</i>
.. <i>propinquus.</i>	<i>Paralabidocera hodysoni.</i>
.. <i>tonsus.</i>	<i>Rhincalanus grandis</i>
.. <i>simillimus.</i>	<i>Clausocalanus arcuicornis.</i>
<i>Ctenocalanus vanus.</i>	<i>Haloptilus ocellatus.</i>
<i>Oithona similis.</i>	<i>Faroella antarctica.</i>
.. <i>frigida.</i>	<i>Gastanus antarcticus.</i>
<i>Onca curvata.</i>	<i>Heterorhabdus longicornis.</i>
	<i>Harpacticus furcifer.</i>

CALANUS (LEACH).

The species first described by Brady as *Calanus propinquus* has been subsequently described by Giesbrecht, who now concludes ('Belgica' report, p. 16) that the copepod described by himself in 1892 as *C. propinquus* from the S.W. Atlantic, between 37° and 52° S., is not this species, but one closely resembling it, to which he gives the name

C. simillimus. Giesbrecht also suggests that the similarity between the two species leads to the doubt whether *C. propinquus* has such a wide distribution as Brady imagined. This author gave it a distribution throughout all oceans—in the southern Indian, north in the Pacific (to 35° N.), and in the Atlantic to 30° N.*

I have made a careful examination of dissected specimens from the following localities :

- Lat. 56° 31' S. Long. 156° 19' 30" E.
 Lat. 59° 19' S. Long. 124° 24' 30" W. (28. vi. 04).
 Lat. 84° 01' S. Long. 170° 49' E.
 Lat. 58° 49' 45" S. Long. 154° 48' W. (24. vi. 04).
 Lat. 50° 48' S. Long. 170° 2' E.

and in these hauls occur many examples of a *Calanus* which answers in all particulars to Giesbrecht's *C. simillimus*. As these have well-developed genital segments, in some cases with spermatophores attached, and differ from *C. propinquus* not only in size, being very much smaller than this species, but also in the proportions of the third and fourth pairs of feet, and the serration and proportions of the fifth pair, there is no doubt that this entirely agrees with the animal briefly described by Giesbrecht; and I think he is correct in regarding it as a species different from *C. propinquus*, and that the distribution of the latter is not so extensive as was imagined by Brady. I therefore describe *C. simillimus* (Giesbrecht) as a different species.

A third species of *Calanus* which does not agree with either of these, being altogether less robust than *C. propinquus*, and constantly much smaller, but at the same time larger than *simillimus*, but with the basals of the fifth pair without any marginal teeth, and the distal margins of the basals of the second to fourth pairs with a row of spines, may probably be *C. tonsus* (Brady), but the description given by this author is of the briefest character, and he gives only two figures, which do not assist in the identification. However, I attach to it Brady's name, as it is probably the animal meant by Brady.

Four species of *Calanus* are found in the 'Discovery' collection :—

1. *Cal. propinquus* (Brady).
2. *Cal. acutus* (Giesbrecht).
3. *Cal. simillimus* (Giesbrecht).
4. *Cal. tonsus* (Brady).

* Lat. 46° 46' S. Long. 45° 31' E.
 Lat. 64° 37' S. Long. 85° 49' E.
 Lat. 47° 25' S. Long. 130° 12' E.
 Lat. 35° 41' N. Long. 157° 42' E.
 Lat. 40° 3' S. Long. 132° 58' W.
 Lat. 9° 43' S. Long. 13° 51' W.
 Lat. 3° 10' N. Long. 14° 51' W.
 Lat. 37° 17' S. Long. 53° 52' W.
 Off Kerguelen Island. Brady, *loc. cit.*

I. CALANUS PROPINQUUS.

(Plate I., figs. 1, 2, 3, 3^a, 4.)

- Calanus propinquus*, Brady, Rep. 'Challenger' XIX., Copepoda (1883), p. 34.
 .. Giesbrecht, Fauna u. Fl. Neap. XIX. (1892), p. 91.
 .. Giesbrecht und Schmeil, Das Tierreich, Copepoda (1898), p. 15.
 .. Giesbrecht, 'Belgica' Report, p. 16.
 .. T. Scott, Trans. Linn. Soc. VI. (1893), p. 25.

The length of this copepod given by Brady is 5·5 mm., by Giesbrecht 4·9–5·3 mm. The majority of the 'Discovery' and 'Gauss' specimens measure under 5 mm. The cephalothorax is rather over three times as long as the abdomen, furcal segments twice as long as broad. Head evenly rounded, without any trace of crest. Head separate from first thoracic segment. Last thoracic segment laterally produced a little, and ending in short points. Anterior antennæ not reaching beyond the furca (thus shorter than described by Giesbrecht, in these specimens). Relative proportions of 24th to 25th segments as 18 : 21.

Second feet	<i>Re</i> 3	divided into proximal portion	24 ;	distal	25.
Third	"	"	"	20 ;	" 23.
Fourth	"	"	"	36 :	" 20.

Ri 3 with seven bristles, end saw two-thirds the length of *Re* 3. Fifth feet, *B* 1 with inner margin convex below, concave distally, with thirteen or fourteen teeth, and distally with three teeth, larger than the others. *Ri* 3 with five bristles, two outer, two apical, one inner. This animal is much more robust than the next species (*simillimus*).

The ♂ is about the same size as the ♀, and the chief differences consist in the structure of the fifth feet and shape of the head and thorax. The latter is very like *C. jimmarchicus*, the head oval, rounded, and produced, the first thoracic segment with deep indentation between it and the second, and its posterior margin protruded. The anterior antennæ with the basal joints much coalesced. Posterior footjaw with a long, stout, densely-feathered dorsal bristle. Fifth left foot much prolonged, *Re* 1 and 2 elongated, *Re* 3 very short and pyriform shape, with short distal bristle. *Ri* only half the length of *Re*, with respectively 1 : 1 : 6 short weak bristles. Right foot *Ri* nearly as long as *Re*, with 1 : 1 : 6 bristles. *Re* not much more than half as long as *Re* of opposite side. First basal with inner margin armed with seventeen to twenty large teeth ; in its upper part slightly concave, in its lower part slightly convex, the teeth all of pretty much the same size.

2. CALANUS ACUTUS.

(Plate I., figs. 9, 10.)

Calanus acutus, Giesbrecht, 'Belgica' Report,* p. 17.

This copepod was first described by Giesbrecht from the Belgian South Polar Expedition, and in the 'Discovery' collection it forms the chief constituent of the South Polar copepod plankton, along with *Euchaeta antarctica*.

The majority of the animals I have met with both in the 'Gauss' and 'Discovery' collections are smaller than the size given by Giesbrecht, *viz.*, 4.7–5.3 mm. But few of our specimens reach 5 mm. length, the majority being from 4.5–4.7 mm. The cephalothorax is not quite four times as long as the abdomen, the head divided from the first thoracic segment, the last segment of the latter produced laterally, but with evenly rounded margins and no points. In lateral aspect the head is slightly produced forwards, and more inclined to be oval than rounded. In the dorsal aspect it has a distinct triangular appearance, with slight crest in the mid-line. In its broadest part the thorax is 1.15 mm. broad, that is, three times as long as broad.

The furcal segments are a very little longer than the anal, and nearly twice as long as broad. The anterior antennae vary in length in different animals, in some being only as long as the furca, in others one or two joints longer, and are distinguished by the comparative length of the last joint, which is about twice as long as the one before it.

In the second feet the *Re* is divided into two portions, proximal = 24; distal = 13.

„ third „ „ „ „ „ = 29; „ = 15.
 „ fourth „ „ „ „ „ = 15; „ = 15.

The *Ri* 3 has in the second and third feet eight bristles, in the fourth only seven, and in the fifth only four (with no outer marginal bristle). The end saw of the *Re* 3 of the second feet is shorter than the *Re* 3; in the third and fourth pair longer.

The fifth feet are distinguished by the absence of the outer marginal bristle of the *Ri* 3, and the total absence of teeth or hairs on the inner margin of the first basal. All males appeared to be immature.

3. CALANUS SIMILLIMUS.

(Plate I., figs. 5, 6.)

Calanus simillimus, Giesbrecht, 'Belgica' Report, p. 17.

♂ 2.5–2.9 mm.; cephalothorax, 1.9 mm.; abdomen, .6 mm. long.

Head separate from first thoracic segment, evenly rounded, without any trace of crest. Head not quite as long as the rest of the thorax (as 18:21). Last thoracic

* "Belgica Report" is throughout this monograph used to indicate "Résultats du Voyage du S. Y. 'Belgica' en 1897–1898–1899." Rapports Scientifiques. 1902.

segment laterally produced somewhat and ending in short points. Anterior antennæ about as long as the furca, or about one joint longer.

Genital segment as long as the next two. Furca three times as long as broad, and longer than the anal segment.

Second feet, *Re* 3 divided by the marginal spine into two about equal parts.

Third feet, *Ri* 3 with eight bristles (four outer, two apical, two inner), *Re* 3 divided into two parts, of which proximal : distal = 17 : 13.

Fourth feet, *Re* 3 divided by the marginal spine, proximal : distal = 20 : 11.

Ri 3 with seven *Si* (two outer, two apical, three inner), terminal saw of *Re* 3 only three-quarters as long as *Re* 3.

Fifth feet *B* 1 toothed, with fourteen teeth on the rather convex margin, and at the distal end a slight break in the continuity, with three rather larger teeth somewhat hidden, in front view, by the upper teeth of the marginal surface. *Ri* 3 with five bristles (two inner, thin and short, two apical, and three outer). In the second pair the *Ri* reaches about the end of the *Re* 2, in the third pair to the first inner marginal bristle of the exopodite, and in the fourth pair as far as the second inner marginal bristle, in the fifth pair beyond the origin of the first inner marginal bristle. The endopodites are therefore proportionately larger than in *C. tonsus*, and the third segment of the exopodite is not four times as long as broad.

While this species agrees with *C. propinquus* in many particulars, the proportions of the third and fourth feet differ, also the toothing and convex margins of the basals of the fifth feet, and the size. Many of the examples were quite adult females with spermatophore attached, so there can be no question of their being merely undeveloped examples of *C. propinquus*, and, as before mentioned, this species has a considerable area of distribution in the southern oceans.

4. CALANUS TONSUS.

(Plate I., figs. 7, 8.)

- Calanus tonsus*, Brady, Rep. XIX., 'Chall.' Report, p. 34.
 " " Scott, Tr. Linn. Soc. VI. (1893), p. 25.
 " " Giesbrecht, Fauna u. Flora Neap. XIX., p. 92.
 " " Dahl, Verh. Deutsches Zool. Gesells. IV. (1894), p. 77.

Brady's original description of this species is very incomplete, and he merely states that it is "like *C. jimarchicus* and *propinquus*, except that the anterior antennæ are almost devoid of setæ, except on the three apical joints; the posterior antennæ are like those in *C. propinquus*, the fifth pair without basal teeth, and the first abdominal segment large and tumid. The anterior antennæ are as long as the body . . . ♀ Size 3·6 mm." He gives only two figures—*viz.*, of the anterior antennæ and the abdomen.

Giesbrecht includes it under the "Unbestimmbare species," remarking that the

first character probably results from the bad preservation of the animals; the second is a character of other members of this genus; and the third point is characteristic of *gracilis* and *robustior*.

Scott merely mentions that "the large and tumid first abdominal segment seems to be a fairly good character" (*loc. cit.*). However, this is not a characteristic of this species any more than of *C. robustior*, and the existence of this species up to the present time therefore must be regarded as extremely doubtful. However, the 'Discovery' collections contain several examples of a copepod, which, if it is not Brady's species, answers fairly well to it so far as his description goes.

♀ 3·5–3·6 mm. long (cephalothorax, 2·75; abdomen, ·75. Body broadest at the end of the first thoracic segment (1·1 mm. broad). Abdomen short, genital segment broad, and one-third broader than the following segment. Furcal segments not quite twice as long as broad, and nearly twice as long as the anal segment. Head evenly rounded, without trace of crest, separate from the first thoracic segment, last thoracic segment only slightly produced, and with rounded margins. Anterior antennæ only reaching the end of the third abdominal segment, the only long bristles on the twenty-third, twenty-fourth, and twenty-fifth segments, the twenty-fourth joint twice as long as the twenty-fifth. Mouth parts resembling *C. jinmarchicus*.

Second feet—second basal with four large spines on the distal margin at the inner side. *Re* 3 divided by the external outer spine into proximal and distal portions respectively as 23 : 16. *Ri* 3 with eight bristles. The whole endopodite does not reach beyond the distal margin of *Re* 2. *Re* 3 as large as *Re* 1 + *Re* 2.

Third feet—four large spines on *B* 2 distal inner margin, endopodite reaching a little beyond the distal margin of *Re* 2. *Re* 3 divided into proximal part = 32, distal portion = 16. *Ri* 3 with eight bristles.

Fourth feet—*Re* 3 divided into proximal part = 37, distal = 15; apical saw only seven-ninths as long as *Re* 3. *Ri* with seven bristles only (three inner, two outer, two apical). *B* 2 with one or two spines on distal inner margin.

On the second, third, fourth and fifth feet the outer margin of the second basal is distally armed with a spine; in second—fourth, the *Re* 3 = *Re* 1 + 2, and is about three times as long as broad.

Fifth feet—first basal with straight inner margin without teeth or hairs, *B* 2 with five spines on the distal inner surface. *Ri* 3 with six bristles (two inner, two outer, two apical).

The only *Calanus* with which this shows agreement is, possibly, Brady's *C. tonsus*; but Brady's description is so fragmentary that it may well be another species. It occurred in some numbers at Station, 22·11·01, Lat. 56° 31' S., Long. 156° 19' 30". Such males as were observed were all immature.

RHINCALANUS (DANA).

(Plate II., fig. 6.)

Rhinc. grandis, Giesbrecht, 'Belgica' Rep., p. 18.? *Rh. gigas*, Brady, 'Challenger' Rep. XIX., p. 42.

,, Scott, 19th Rep. Scotch Fishery Board (1901), p. 237.

,, Giesbrecht, Fauna u. Fl. Neap. XIX. (1892), p. 153.

Rh. gigas was described by Brady as distributed over a very wide area between long. $53^{\circ} 32'$ W.— $130^{\circ} 52'$ E. and lat. $36^{\circ} 44'$ S— $65^{\circ} 42'$ S. Much doubt has been expressed by Giesbrecht as to the validity of this species, and the figures given by Brady of abdomen and of the whole animal are those, in Giesbrecht's opinion, of immature animals, and this author thinks that Brady's figure of the first feet is really of one of the other pairs of feet.

Scott's specimens (Fair Isle and Firth of Forth) are regarded by Giesbrecht as *Rh. nasutus* (*Th.* 3 and 4 with dorsal or with a lateral spine, as in *nasutus*, and a pair of small dorsal points on the genital segment). Möbius's specimen from the north of Scotland is also identical with *nasutus*. *Rh. nasutus* is very common in the Faroe Channel and seas off the north of Scotland, and occurs abundantly in my collections made in these regions and along the Atlantic trough, west of Ireland, and also appears in the 'Gauss' collections as far south as lat. 20° N., while in the same collections *Rh. grandis* (Giesbrecht) appeared. From the remarks of Sars in "Crustacea of Norway," Vol. IV., p. 15, it might be inferred that *Rh. nasutus* is of rare occurrence in the Northern Ocean ("two specimens were taken east of Iceland, one specimen by Hjort between Scotland and Norway, and it has not yet been found in the immediate vicinity of the Norwegian coast.") However I have taken it in abundance on many occasions throughout the Faroe Channel. It is rather important to establish the identity of Brady's *Rh. gigas*, and of two preserved specimens at the British Museum, which I have examined, one measured 5.8 mm. and another 6.0 mm. Both were immature females with four-jointed abdomen, lateral spines on *Th.* 3 (small), and on *Th.* 4 (large), with none on the fifth segment, resembling *Rh. grandis*, one dorsal spine on the first abdominal segment (no dorsal spines on the thoracic segments), and so far as could be seen without dissection, the first feet had an exopodite of two segments only, and the fifth pair consisted each of only one ramus of three segments. These two animals were, of course, very much smaller than described by Brady (8.5–10 mm.) and were undoubtedly immature, and the species may well be identical with young *Rh. grandis* (Giesbrecht).

RHINCALANUS GRANDIS.

Rhincalanus grandis, Giesbrecht, 'Belgica' Rep., p. 18.

♀ 7·2–8·0 mm. Head produced in front, dorsally roughly triangular in shape, with large lateral swellings at the base, rostrum not visible from behind. The cephalothorax is over six times as long as the abdomen, which is composed of three segments. A pair of short spines on the anterior margin of the third thoracic segment, and a pair of strong and longer spines on the fourth segment, differentiate this species from *nasutus*, also the absence of any spines on the abdominal segments. The first pair of feet have the *Ri* and *Re* of only two segments, *Re* three with two marginal spines; other feet (except the fifth) have three-jointed rami.

The fifth pair, of one branch only on each side, with three segments, have on the second segment a long inner marginal bristle, and on the last segment three bristles of nearly equal length, two apical, of which the outer is the thickest and the middle one a little the longest, and one on the inner distal margin. A short spine is present on the outer margin in its upper third. The anterior antennæ are about six joints longer than the furca. Adult males were absent.

These examples are absolutely identical with Giesbrecht's species.

METRIDIA (BOECK).

One of the most remarkable things about Brady's 'Challenger' Copepoda is the omission of mention of any example of this genus from his report. Distributed throughout the Atlantic from the North to the South Pole, and in the Pacific, and throughout the track followed in the Atlantic and Southern Ocean by the 'Challenger,' the absence of mention of any species of this genus is certainly extraordinary. In the northernmost regions *Metridia longa* occurs (Sars, Norwegian North Polar Expedition) throughout the Faroe Channel and the Atlantic trough as far south as Valentia in Ireland; and south of the Wyville Thompson ridge, *M. lucens*, *normani* and *curticauda* (Wolfenden); while south of Lat. 40° and throughout the Atlantic occur *M. curticauda*, *brevicauda*, *princeps* and *venusta*; but south of Kerguelen appears a new and characteristic species, *M. gerlachei*, which replaces all others. This is the representative species of the South Polar seas, and it appears abundantly in the 'Gauss,' 'Discovery,' and 'Belgica' collections, and it is as characteristic of this area as *M. longa* and *lucens* are of the northern cold area. *M. princeps* occurs seldom, and *M. brevicauca* as a straggler, outside its proper area of distribution.

METRIDIA GERLACHEI.

Metridia gerlachei, Giesbrecht, 'Belgica' Report, p. 27.

♀ 3·5–3·8 mm., very variable in size, occasionally a little larger and often smaller, but the average of size of examples in the 'Discovery' and 'Gauss' collections is rather less than that given by Giesbrecht for the 'Belgica' specimens. The cephalothorax is one and a half times as long as the abdomen, head separate from first thoracic segment, last segment with rounded margins. The abdomen has the proportional length of its three segments as 9 (genital) : 6 : 4 (anal), and the furca is one-fifth longer than the anal, and three times as long as broad. It is divided into two portions by the outer marginal bristle, of which the proximal is twice the length of the distal.

The shape of the head and thorax is in this species characteristic, the back being extremely gibbous, and the head with very bold curve, which makes it easily recognisable at sight from any other species of this genus. The anterior antennae are comparatively short and do not reach beyond the genital openings. The first and second segments are coalesced; the eighth, ninth, tenth, eleventh, have only faint indications of separation; the thirteenth and fourteenth joints are not so clearly divided as the others. There are strong teeth on one, two, three, five, seven (one each), those of the third, fifth, seventh joints the strongest, and directed straight forwards. The aesthetascs are numerous.

The endopodites of the second pair of feet have the usual excavation and hook process on the first segment, but in this species the inner hook is exceedingly strong. In the fourth pair the end saw is only two-fifths of the whole length of the *Re* 3 (shorter than in Giesbrecht's examples).

The fifth pair consists on each side of three segments, but the distal segment is more or less completely divided into two, the division however is not complete. The two basal joints are of about the same length and breadth, each as broad as a little over half the length. The third joint, however, is not more than four-fifths as long as the basals, and only half the breadth. The second joint bears one short distal bristle, the last joint one outer marginal bristle in the proximal half, and three distal bristles, of which the innermost is the longest and thickest, the outermost the shortest.

METRIDIA PRINCEPS.

(Plate III., figs. 3, 4, 5.)

Metridia princeps, Giesbrecht, Atti Line. Rend., Ser. 4, v. 5, p. 24.

" " " Fauna u. Fl. Neap. XIX., p. 340.

" " " Farran, Ann. Rep. Fish. Ireland 1902–03, Pl. H. App. H. (1905).

? *Metridia macrura*, Sars, Bull. du Mus. Oceanog. Monaco, 1905, no. 10, p. 7.

Though only one example of this species occurred in the 'Discovery' collection, it was frequent in the 'Gauss' collection, not only at several Atlantic stations, but also

at the southernmost stations. Northwards it ranges to the west coast of Ireland, and, as has been mentioned, has an extreme southern distribution. Giesbrecht's description was given from only one specimen, and compared with Sars', very briefly described, *M. macrura*.

<i>M. princeps</i> , Giesbrecht.	<i>M. macrura</i> , Sars.
Cephalothorax one and a half times as long as the abdomen	Tail about as long as the anterior division
Anterior antennæ extend beyond the furca	Longer than the body
Short teeth on 1, 2, 4, 5, and 6, the 2nd the longest	Only feeble traces of the strong teeth of <i>princeps</i>
Genital segment longer than both the following	?
Anal segment half as long as the preceding one	?
Furca twice as long as anal, and 5 times as long as broad	About as long as the two preceding segments
Size 8·5 mm.	5th feet like <i>princeps</i> , but less unequal Size 10·50 mm.

Of the many examples which have come under my notice I find that the relative sizes of the abdominal segments and furca are subject to some variation, thus :—

1. G.S. 30. Ab. 2, 16. Anal 6. Furca 28 long, 3 broad. Size 8·15 mm.
2. „ 28. „ 16. „ 8. „ 25 „ 3 „ „ 8 mm.
3. „ 27. „ 16. „ 7. „ 23 „ 3 „ „ 8 mm.
4. „ 22. „ 11. „ 4. „ 12 „ 2 „ „ 6 mm.

The genital segment is thus always twice as long as the two succeeding segments, the anal is not more than half the preceding segment, the furca is generally longer than the two preceding segments, and usually from seven to nine times longer than broad. The teeth on the antennæ are weak, and entirely resemble the figure given by Giesbrecht in Plate 33, fig. 3 (*op. cit.*).

It is difficult to resist the conclusion that these are one and the same species, and not two different species. The male was not described by either Giesbrecht or Sars, but I have met with several examples.

♀. The largest adults were from 8–9 mm. in length.

The body is very transparent, the head evenly rounded, cephalothorax (4·15–4·5 mm. long, abdomen 4·0 mm. long), only slightly longer than the whole abdomen, and a little over one-third as long as broad.

The genital segment is larger than the next two, the anal not more than half as long as the preceding, often much more than the combined length of the two preceding segments and 6–9 times as long as broad, and divided into two portions by the marginal bristle, of which the proximal is to the distal as 8:5. The right furcal segment is sometimes a little longer than the left. Anterior antennæ at least three joints longer than the furca, the basal joints broad, with short teeth on the basal seven joints, of which those on the first two joints are the largest. The

distal joints taper and are very slender. Proportional length of joints of anterior antennæ:—

1 & 2	3	4	5	6	7	8 & 9	10	11	12	13	14	15	16	17	18	19	20	21	22	23	24	25
12	4	5	5	5	5	14	6	9	9	12	12	13	13	14	14	15	10	9	10	10	7	3

The eighth and ninth joints are quite coalesced, but in some there is a weak line of division.

The second pair of feet have each the characteristic hooks on *Ri* 1, and the outer one is the longest. The surface of the second basal is beset with short spines, but not the *Re* 1. The third feet are normal and with shortened end saw. The fifth pair each consist of four segments, of which the basal is greater than the second, this longer than the third, and third longer than the fourth and terminal segment. The first joint has on its surface a considerable bunch of long stiff hairs (as in *princeps*), the second joint has a long stiff feathered bristle on the outer distal margin, and the third joint has a short upright spine on the outer distal margin, in all specimens (not on the inner side as figured by Giesbrecht), and the end joint has three rather long fine bristles, of which the innermost is the longest. The spine on the third joint was in one example replaced by two very short spinules on the right foot, while none were present on the left side.

♂ 5.8–6 mm. long (cephalothorax 3.25 mm. Abdomen 2.3 mm. long).

Relative lengths of the abdominal segments = 14, 10, 10, 4, and the furcal segments 13. The left furcal segment is a little the largest and thickest, and six times as long as broad, and three times as long as the short anal segment.

The anterior antennæ extend for about three joints beyond the furca, as in the female, and the left one is a clasping organ with weak joint between the seventeenth and eighteenth segments. The segment beyond the elbow is very long and thin, and as long as the next two distal joints. There are four joints beyond the elbow. The conjoined first and second (basal) joints have two strong teeth, the distal one the largest and curved slightly forwards. The fourth joint has a smaller tooth. Fifth feet: The right foot with very long first joint, the second short, but with very strong, broad-based curved and long hook, the third joint nearly twice as long as the second, and the fourth and end joint a long simple spoon-process twice as long as the third. In the left foot the first joint is very small, the second nearly twice as long, the third a short joint, the fourth a very long simple curved spoon-shaped process. On the inner margin (proximal) of the fourth, of the third, and the distal foot of the second are fine hairs. Both feet are of nearly similar length.

EUCHAETA (PHILIPPI).

Two representatives of this genus appear in the 'Discovery' collections—*E. antarctica*, and another which appears to have constant differences, and to which I have attached the name *E. similis*. I do not in this collection find any example of

Giesbrecht's species *E. austrina*, though I have found it in the 'Gauss' collections. *E. antarctica* appears in many stages, extensive captures consisted wholly of immature specimens, but there are many adult examples. Many males appear amongst these, and while the females are very distinctively different, I am not able to discriminate between those males, as to which definitely belong to *antarctica*, and others which might belong to *similis*. Both species are very closely allied, and differ very considerably from the large species of the northern cold seas, viz., *norwegica*, *glacialis* and *barbata*.

EUCHAETA ANTARCTICA.

(Plate IV., figs. 5, 6.)

Euchaeta antarctica, Giesbrecht, 'Belgica' Report, p. 21.

This is one of the most abundant copepods in the 'Discovery' collection, appearing in all stages of growth, and in some samples almost to the exclusion of other species.

Size of adult examples 7.6 mm.—8 mm. Head evenly rounded, without frontal prominence and with short rostrum directed forwards. Last thoracic segment with rounded margins, produced forwards and with a bunch of hairs on each side. The abdominal segments have the postero-distal margins armed with rather strong bluntly conical and striated teeth, and the two middle segments have on the ventral side bunches of long hairs. The furca and bristles are the same as in *E. similis*. The genital protuberance occupies the lower half of the segment, its upper margin is not deeply concave like *similis*, but the whole swelling is directed downwards, and its upper margin is slightly convex. Above the genital swelling is a secondary prominence, which in the ventral aspect is seen to consist of two valve-like chitin thickenings. The lower part of the protuberance has two lateral lobes, the upper are small, and above this a prominent horn directed straight forwards and never absent in adult specimens of *E. antarctica*, making it quite characteristic of the species.

In the ventral aspect the appearance is quite different from that of *similis*. The genital opening is oval, almost round, with lateral cushions, and above the upper edge of the genital opening guarded by a chitin ridge, is the horn.

The whole swelling is quite symmetrical, rather conical, and occupies quite the lower part of the segment.

The first pair of feet have the outer margin very concave above and very convex below, with a bunch of hairs on the *Re* 1, and a long seta. The seta of *Re* 2 is also very long and thin. The *Re* 3 is only half the length of the coalesced *Re* 1 and 2.

In the second pair the *Re* 1 has a very short *Se*, that of *Re* 2 is very long and more than twice as long as the *Se* 1 of *Re* 3.

In *Re* 3, the *Se* 1 does not reach the origin of *Se* 2, the *Se* 2 does not quite reach the end of the segment, and is three times as long as *Se* 3 and twice as long as *Se* 1. The *Se* 1 and 2 are very greatly curved and almost sickle-shaped.

In the fourth pair the *Re* 3 is not three times as long as broad (16 : 6). The anterior antennæ are a little longer than the cephalothorax.

The ♂ is a little smaller than the ♀, and presents the same sexual differences as in other *Euchaetae*. The bunches of hairs on the last thoracic segment, so prominent in the ♀, are absent in the ♂.

The first feet have a three-jointed exopodite, the outer margin of which is not so concavo-convex as in the ♀, and its *Se* are short.

In the second pair, the *Se* of the exopodite are also smaller, the *Se* of *Re* 2 only reaching the origin of the *Se* 1 of *Re* 3; the *Se* 2 of *Re* 3 being little more than half the length of the distal part of the segment. The fifth feet are characteristic. The penultimate segment of the left foot is prolonged on the upper margin into a strongly toothed process, and has a setose conical unhaired process on the distal margin, the last segment into a long process, narrow and with a strong bunch of hairs at the distal extremity, and with a large conical and strongly haired process. (This process is sometimes nearly as long as the principal process of the penultimate joint.)

The first basal is short, the second basal long, and with very small and rudimentary endopodite.

The right foot has short first basal, very broad second basal, long first and second *Re* (which are coalesced), and with the last segment blunt and rounded.

EUCHAETA SIMILIS.

(Plate IV., figs. 1, 2, 3, 4.)

This species occurs plentifully in the same samples in which *E. antarctica* is present. For a long time I regarded them as merely different stages in the history of the same animal, but the careful examination of a great number of individuals from different tow-nettings proves the constancy of the points of difference between the two, and as many of the *E. antarctica* and *E. similis* have spermatophores or egg sacs attached, I have come to the conclusion that, though so very similar in most characters, the two species must be separated on account of the invariably different characters of the abdomen and genital segment.

E. similis is constantly rather larger than *E. antarctica*, 8·6 mm.—8·8 mm., and more robust, the head flat and rostrum small, but strong and directed forwards and rather upwards. The cephalothorax is two and a half times as long as the abdomen. The last thoracic segment is produced forwards, slightly triangular shaped, with evenly rounded margin, no spine, but a bunch of long hairs on each side. The abdominal segments, of which the genital is twice as long as the next, are covered with fine hairs, nowhere with large bunches, and the posterior distal margins have only very small teeth, not large, as in *antarctica*. Furca with, on each side, a very short dorsal bristle, the ventral accessory bristle not geniculated at the base, though bent outwards, its length not more than about half of the two long tail bristles (next to the innermost).

Genital segment with very prominent genital tubercle, occupying half the segment, (the lower half only), directed slightly upwards in lateral aspect, with apparently three lobes, an upper and lower, each large with small middle lobe, and without any eminence on the upper part (of the ventral surface) of the segment as in *antarctica*, and also invariably without the ventral horn which is so characteristic of *antarctica*. In the ventral aspect the genital tubercle appears to be obliquely placed, directed downwards towards the left, the vulva guarded by two prominent flaps of which the right one is below the left one. The whole tubercle occupies more of the left than the right side of the segment, which in the dorsal view is only slightly swollen at each side.

The first and second pairs of feet and the number of bristles on the maxilla are the same as in *antarctica*.

While the female is so distinctly different from that of *E. antarctica* I am unable to find similar distinction in the males. Both kinds appear frequently to occur together in the same sample, and all the males appear to be alike.

ONCEA (GIESBRECHT).

ONCEA CURVATA.

Oncea curvata, Giesbrecht, 'Belgica' Report, p. 42.

According to Giesbrecht, this species differs from *O. subtilis* in the following points: Length, 0.6–0.8 mm., the body lengthened, the three segments posterior to the genital are about as long as broad, and comparatively longer than in any other *Oncea* species except *subtilis* (in which they are longer than broad), all three segments together are shorter than the genital (in *subtilis*, the genital segment is only a little longer than the two succeeding segments), the furca is as long or a little longer than the anal segment (in *subtilis* shorter). The posterior antennæ in both kinds are similar, the maxillipedes, however, differ; the terminal hook which, in *subtilis*, is thin and unarmed, is strong and beset with pretty long teeth on the concave side, in *curvata*. The swimming feet are similar in both species, except that in *curvata* the proximal outer marginal bristle on *Ri* 3 occurs in all four pairs, while it is absent in *subtilis*, and the lancet-shaped apical bristle of the fourth foot is in *curvata* longer than in *subtilis*.

The few examples that occur in the 'Discovery' collections are smaller than Giesbrecht's examples, none being more than .56 mm. in total length (♀s with egg sacs attached).

The genital segment is a little longer than the next three segments, the furcal and anal segments of the same length, the second abdominal segment as long as broad, and rather larger than the third segment, the relative lengths of Ab. 2 : 3 : 4 and furca being as 4 : 3 : 4 : 4, the latter nearly three times as long as broad.

In the posterior antennæ, the first basal joint is the largest, and the inner margin of the second basal has a few fine teeth; the distal segment has three proximal bristles

of unequal length, the middle one very short, and distal to it, a comparatively long and slightly armed bristle, terminally four long and two shorter bristles.

The maxillipede is armed with a strong claw bristle, denticulated on the inner margin, and the second basal has two comparatively stout bristles, the proximal of which is armed with wide-apart bristles.

In the fourth pair of feet the apical bristle of the exopodite is longer than the third exopodite segment by one-third of its length.

The agreement, therefore, between this species and Giesbrecht's examples is very close, the only difference being one of size, and there is no doubt that the two species are identical.

STEPHUS.*

Möbianus, Giesbrecht, Fauna u. Fl. Neap. XIX. (1892), p. 205.

Stephos, Th. Scott, 10th Rep. Scotch Fishery Board, Vol. X. (1892), p. 245.

Stephus = *Stephos*, Giesbrecht, 'Belgica' Rep., p. 20.

Stephos, Sars, "Crustacea of Norway," Vol. IV. (1903), p. 61.

Since Giesbrecht described the genus *Möbianus*, which was subsequently identified with *Stephos* (Scott), several other examples of the same genus have been described. Scott himself recorded three specimens, viz., *S. minor*, *S. fultoni*, and *S. gyrans*, supposing the latter to be identical with Giesbrecht's *Möbianus gyrans*.

Sars has described two new species from Norway, viz., *S. lamellatus* and *S. scotti*, which latter is again identical with *Stephos gyrans* Scott (not Giesbrecht). Giesbrecht's species (*gyrans*) is said by Sars to differ in the asymmetrical last thoracic segment and genital segment, the latter with "a number of irregularly arranged spiniform processes not found in any of the northern species," the last feet of the male also differing from *S. scotti*.

The 'Belgica' report contains yet another species described by Giesbrecht as Antarctic, viz., *S. longipes*. This species recurs also in both the 'Gauss' and 'Discovery' collections, and in the latter I find a further and considerably larger example, to which I have given the name *antarcticum*.

As these descriptions are scattered over six different volumes, I think it may be of service to bring them together here.

I. S. GYRANS.

S. gyrans, Giesbrecht, Fauna u. Fl. Neap. XIX. (1892), p. 205; Giesbrecht, u. Schmeil, Das Tierreich, Copep., p. 29.

Furca longer than broad, anterior antennæ reaching to end of genital segment, genital segment with a curved hook on ventral side, shorter hook on dorsal, fifth feet

* The author, in agreement with Sars, prefers the name originally given to the genus by Scott, but it is perhaps better to observe the ordinary rule.—ED.

in female, end segment rather curved and broad basally ; in male, left foot with several long appendages, right foot, thin appendages at end and rest foliate ; size = 0·8–1 mm. (Naples.)

2. *S. SCOTTI*.

S. gyrans, Scott, Nineteenth Rep. Scotch Fishery Board (1901), p. 237.

S. scotti, Sars, "Crustacea of Norway," Vol. IV., p. 63.

Slender ; cephalothorax symmetrical ; genital segment without spines, furca longer than broad, anterior antennæ reach end of abdomen 2, *Re* of posterior antennæ twice as long as *Ri*. ♀, fifth, with denticles on last segment, which is elongated and pointed ; ♂, fifth, penultimate joint of left foot tumefied, last segment with about half a dozen short processes ; last joint of right foot with long, sickle-shaped process. Size = ·85–·95 mm. (Loch Fyne ; Norway.)

3. *S. MINUS*.

S. minor, Scott, Tenth Rep. Scotch Fishery Board, 1892, p. 245.

Robust, cephalothorax symmetrical ; genital segment without spines, anterior antennæ about as long as the thorax, furca as long as broad, fifth feet in ♀ with elongated last segment with two little lateral spinules ; in ♂, right foot a long foliate joint at end, left foot with two digitiform processes at end, penultimate joint only slightly tumefied. Size = 0·74 mm. (Firth of Forth.)

4. *S. LAMELLATUM*.

S. lamellatus, Sars, "Crustacea of Norway," Vol. IV., p. 62.

Short and robust, last segment asymmetrical ; right side longest, genital segment unsymmetrical and rounded prominence on right side, but no spines ; furca about as long as broad, anterior antennæ reach to furca, branches of posterior antennæ equal ; fifth foot in ♀, last joint elongated, with fine spine midway ; in ♂, left foot with much tumefied penultimate segment, with proximally a long spine, and last joint with a number (about nine) of leaf-like appendages ; right foot not foliate, but last joint with three or four short, rounded appendages. Size = 1 mm. (Norway.)

5. *S. FULTONI*.

S. fultoni, Scott, Ann. and Mag. Nat. Hist., 7th series, Vol. I. (1898), p. 185.

Cephalothorax symmetrical ; genital segment with spine and hook ventrally. Fifth feet in ♀ are larger and broader (knife-like) than the other, which is pointed ; in ♂ right foot with elongated penultimate segment and short, strong, foliate end segment ; left foot, penultimate segment tumefied, extremity with five or six leaf appendages, and bifid claw. Size = 1 mm. (Clyde.)

6. *S. LONGIPES.*

S. longipes, Giesbrecht, 'Belgica' Rep., p. 20.

Cephalothorax symmetrical; genital segment swollen laterally and roughly triangular-shaped, anterior antennæ not reaching end of thorax, no spines on genital segment; fifth feet in ♀ last segment elongated, curved (foliate), with external spine half as long as in ♂; right foot with two middle segments very elongated, ending distally in curved hook not articulating; left foot without tumefied segment, two middle elongated, last shorter with knob and spine, but no processes. Size ·8–·9 m. (Antarctic). ('Discovery' and 'Gauss' collections. Wolfenden.)

7. *S. ANTARCTICUM.*

Robust, cephalothorax a little unsymmetrical, right side prolonged; genital segment swollen laterally, with bunch of spine-like bristles each side; furca as broad as long; anterior antennæ reach to Ab. 2; *Re* of posterior antennæ longer than *Ri*. Fifth feet in ♀ right side longest, each with three end spines, innermost hook-like; in ♂, right with third joint elongated and club-shaped distally, with a large, roughly triangular plate, and last joint a strong, curved hook; left foot, no tumefied segment, and last joint with distally a short-stalked haired knob, no appendages. Size = 1·75–2 mm. ('Discovery' collection.)

STEPHIUS LONGIPES.

(Plate V., figs. 1, 2, 3.)

Stephus longipes, Giesbrecht. 'Belgica' Rep., p. 20.

♀ ·75–·80 mm. ♂ ·65–70 mm. Cephalothorax rather more than twice as long as the abdomen; head separated from first thoracic segment, but all segments very difficult to determine, owing to the indistinctness of the lines. Last thoracic segment with rounded margins and symmetrical. Abdomen in the female four, in the male five segments, furcal segments only as long as the anal, as broad as long, and with rounded margins, each with four tail bristles and a short fifth inner marginal bristle. Genital segment in the female as long as the next two, laterally with roughly triangular swellings, and in its greatest breadth, broader than long. Anterior antennæ not as long as the thorax, and of twenty-three joints, the first, second, eighth and ninth coalesced, with few bristles, the longest on the seventh and eighteenth joints, but well supplied with long æsthetascs.

Posterior antennæ with exopodite about one-third longer than the endopodite. Posterior foot-jaw with rather thick first basal and *B 1* : *B 2* : *Ri* as 8 : 7 : 6; mandibles with broad-ended masticatory plate, one pointed outer tooth, with considerable space between it and the middle stout comparatively broad teeth, and three pointed inner teeth.

First feet $Ri=1$, $Re=3$; no Se on Re 1, and very short Se on Re 2.

Second feet $Ri=2$, $Re=3$.

Third and fourth feet Ri and $Re=3$.

Fifth, each of three segments, two basal, each short and comparatively thick, terminal segment longer and thinner, prolonged, with a stout curved hook with short bristles on the upper margin and an external marginal thin and short bristle.

The male is rather smaller than the female, the abdomen has five segments, the mouth organs are as in the female, but the fifth feet are transformed into clasping organs, that of the right side of four segments, the left of five. The second and third segments of the left are elongated, the distal segment short and broadened out, the distal extremity ending in a spine, and at the opposite side a short knob process, apparently without marginal hairs.

The right foot with short broad second basal, and two distal very elongated and thin segments, with a long thin sickle-shaped process at the end, which appears to be a continuation only of the joint above it, and though forming an elbow, does not articulate.

In the general structure this small Copepod bears great resemblance to the species *Stephus antarcticum*, which, however, is twice as large; the fifth feet in the female as well as the male are different, and the two species are therefore quite distinct.

STEPHUS ANTARCTICUM.

(Plate V., figs. 4, 5, 6, 7, 8.)

♀ 1.85–2.0 mm. long, cephalothorax about three times as long as abdomen, and in its broadest part distal of the middle line one-third as broad as long. Head evenly rounded, a little produced in front, but without trace of rostrum, a weak line indicating its division from the first thoracic segment. Last two segments of the thorax imperfectly divided, and last segment a little unsymmetrical; on the right side a little longer than on the left, produced into a round-ended margin, on the left side more acutely pointed, which is most marked in lateral view. Abdomen of four segments respectively proportioned: genital segment, 2:3 and anal as 20:13:8:8; furcal segments as long as the anal, and as broad as long. Genital segment laterally swollen in the upper part (genital protuberances) and again slightly swollen laterally in its lower part, with on each side a bunch of rather long spines, none dorsally. Furca with four tail setae on each side, outer margins haired and with, on each side, a short lateral spine instead of the usual bristle, and on the ventral side a very short accessory bristle. Of the tail bristles, the two middle ones are much the longest and thickest, and those of the right side more so than those of the left.

Anterior antennae reach in both sexes to about the end of the second abdominal segment, having twenty-four segments, the eighth and ninth coalesced. In the posterior antennae the exopodite is longer than the endopodite. The mandibles with branches

nearly of same length, masticatory plate with strong teeth. The posterior foot jaws with first and second basal and *Ri* in proportion of 24 : 11 : 20 ; maxillæ, *B* 2 with 5 ; *Re* with 10 ; *Ri* 1 with 4, *Ri* 2 with 3, *Ri* 3 with six bristles, *Li* 2 and 3 present, and *Le* 1 with eight bristles.

The first feet have one jointed *Ri* and three jointed *Re*, without *Se* on *Re* 1.

The second feet have two jointed *Ri* and three jointed *Re*.

The third and fourth feet have both rami three-jointed.

Fifth feet comparatively large, that of the right side a little longer than the left. Each of three segments, of which the two basals are equal in size, but the last segment on the right foot is a little longer than in the opposite foot. Each has terminally three spiny processes, the innermost comparatively thick, curved, and hook-like, and with hairs only on the outer margin. The two outer spines are neither much more than half the length of the inner one, and only half as thick.

The ♂ is a little smaller, 1.75 mm., and of slenderer build ; the asymmetry of the last thoracic segment is only slight, and on neither side is it so prolonged as in the female. The abdomen consists of five segments, the first segment is more laterally swollen than in the female, and is broader than long ; the second and third segments about equal in length, and much longer than the anal, which is very short. The antennæ, oral organs and feet are the same as in the female, with the exception of the fifth pair, which are converted into two extraordinary appendages. Arising from a common basal, the right leg possesses four segments, the left five segments. In the right leg the first joint is short and rather broad, the second elongated, rather longer and thicker than the third, which is a long thin joint with club-shaped distal extremity, and having attached to the joint it makes with the last appendage a broad, rather triangular plate covered with fine hairs and a few rather strong spines. The last joint is represented by a comparatively strong and large curved appendage, armed along its inner margin with short stiff bristles, these two terminal appendages resembling an awkward-looking pair of shears.

The left foot, of five segments, has the first and second comparatively shorter but broader than the third and fourth. The fifth segment short and broad at the distal end, has externally a short curved tooth-like ending of the distal margin, and at the inner end an upright knob-shaped appendage, strongly armed all over, and especially at the base of the stalk, with short stiff bristles.

The fifth feet of the ♂ and ♀ possess no near resemblance to similar organs in any other species of *Stephus* ; the size of the animal, moreover, is comparatively large for any representative of this genus, and it must therefore be regarded as a new species. Several examples occurred in two or three of the 'Discovery' collections.

PARALABIDOCERA.

There is no mention of any example of the genus *Labidocera* in Giesbrecht's 'Belgica' report. In the 'Discovery' collection there are a great number of specimens of an animal superficially resembling *Labidocera*, but which does not agree with any known species of that genus, though bearing some relation to *L. wollastoni*. Between 60° and 70° S. *Labidocera acutifrons* appears in the 'Gauss' collection, but is absent from either the 'Discovery' or 'Belgica' collections, and this genus is thus very sparingly represented in the Antarctic area. The copepod referred to below differs distinctly from any known *Labidocera* in the character of the swimming feet of the female and the five-jointed abdomen of the male, and the fifth pair of feet, and I have thought it better to create a genus for it.

Characters of the genus.—Very similar in appearance to *Labidocera*, but a total absence of "ocelli," and of very unsymmetrical shape, the swimming feet without spines on the last segment of the exopodite, and the male abdomen of five segments.

PARALABIDOCERA HODGSONI.

(Plate VI., figs. 1-13.)

♀ 1.55-2 mm.; ♂ 1.6 mm. long. The head is evenly rounded, produced forwards a little, and in front are two delicate rostral filaments. There is no trace of eyes, either dorsal or ventral, but in some males there are two dark spots laterally on the head, and in a few females a dark pigmented spot on each side, which may possibly have been ocelli. But considering the mode of preservation, which included freezing and thawing, and a long sojourn in spirit, these organs may very well have been present at some time, and subsequently vanished. The head is quite without any trace of side hooks, and separated from the first thoracic segment; last two segments coalesced and produced on each side into lateral expansions, but bluntly ended. Abdomen of three segments, the genital with large lateral outgrowths, and also dorsally and ventrally swollen a little; spines entirely absent; next segment also laterally enlarged, and anal segment small; furcal segments a little unsymmetrical, the right a little longer and broader than the left; all tail bristles comparatively short, consisting of four apical and one lateral marginal (situated a little distal of the middle), all slightly thickened at the base. There is also a small accessory dorsal furcal bristle on each side. Anterior antennæ shorter than the cephalothorax and with only twenty-two distinct joints, very densely covered with long bristles.

PROPORTIONAL LENGTH OF ANTENNAL JOINTS.

1	2	3	4	5	6	7	8	9	10	11	12	13	14	15	16	17	18	19	20	21	22
10	10	2	4	1½	1	2	3	3	8	4	4	4	6	6	6	6	7	5	10	6	3½

Posterior antennæ with *Ri* much longer than *Re*, the former with six long bristles on the first segment, and seven and six bristles on the distal segment. *Re* very indistinctly segmented, the proximal joint very elongated.

Mandibles with *Ri* longer than *Re*, *B 2* with one marginal bristle, masticatory plate broad, with one rather large tooth and a good space between it and the next five conical short teeth.

Maxilla with *B 2* and *Ri* bent outwards; *B 2*, *Ri*, and *Re* coalesced and almost indistinguishable; *Li 1* with seven rather long and stout hooks and two shorter bristles; *Li 2* a large lobe with three bristles, *Li 2* with one bristle; *Ri* indistinctly segmented on the outer margin with five apical bristles; *Re* scarcely segmented, with only two bristles; *Le 1* with seven long and very thick bristles, and three shorter bristles.

Anterior foot jaws with lobes much compressed, and terminal five bristles longer than the proximal and also much thicker.

Posterior foot jaw very similar to that of *Anomalocera*. *B 2* is short, but rather thick, and with one short bristle; *Ri* short, unsegmented, with only three terminal and short bristles.

One to four pairs of feet, with *Ri* of only two, *Re* of three segments. In the first pair the external marginal setæ of *Re* are long and thin, in the others the external spines are short, and in all there is only one marginal spine (apical) on *Re 3*.

First pair of feet, *B 1* and *B 2* with only slightly convex inner margin and no *Si*. *Re 1* longer than *Re 2* + *Re 3*, outside margin haired and long marginal bristle. *Re 2* and *Re 3* with similarly long marginal bristles. *Se* = 1 : 1 : 2 and *Si* = 1 : 1 : 5. *Ri 2* nearly twice as long as *Ri 1* and with 5 *Si*.

In the second pair *B 2* is broader than long, the inner margin convex and without hairs or bristles; *B 1* is also without *Si*. *Ri 1* prolonged, *Ri 2* shorter (as 7 : 10). *Ri 1* with 2 *Si*, *Ri 2* with 7 *Si*.

Re 1 : 2 : 3 as 11 : 6 : 9, with respectively 1 : 1 : 1 *Se*, that of *Re 1* the largest and of *Re 3* the smallest; the end saw about two-thirds as long as the whole *Re*; a small curved spine distal margin of *Re 3* just external to the saw. 5 *Si* on *Re 3*.

3rd feet. *B 1* and *B 2* without bristles or hairs, *Ri* as in the preceding pair, *Re* as in the preceding pair and with 1 : 1 : 1 *Se* only.

4th feet. *B 1* and *B 2* as before. *Ri 1* with three *Si*, *Ri 2* with only six *Si*. The three joints of *Re* rather more equal in length, *Se* 1 : 1 : 1 as in the other feet. *Ri 1* is more elongated than in the other feet and twice as long as *Ri 2*.

In the second to fourth pairs the *Ri* is more than half as long as the *Re* and extends beyond the distal margin of *Re 2*. In all feet the number of external marginal spines is certainly peculiar, the usual rule being three marginal spines on the *Re 3*, so that the animal differs from any true *Labidocera*.

The 5th feet consist of a common basal and one ramus on each side of two segments *B 2* and *Re*. *Ri* represented only by a spine. The first and second basals are

nearly equal in length and each about as broad as long. The second basal segment has at its distal inner margin a very stout articulating spine, *Ri* four-fifths as broad as this joint is long. On its outer surface, near the distal and outer end, is a delicate bristle. The third segment is nearly twice as long as the second basal, tapers to a point, and just below the distal end is a delicate little bristle. Near the end of the joint and on the inner side is a very stout broad-based spine, not articulating, and nearly half as long as the whole segment. Frequently the foot of one side is a little longer than of the other.

The whole animal is very unsymmetrical, especially in the shape of the last thoracic segment and the genital segment of the abdomen. The characters of the swimming feet, as to proportions, *and especially as to the absence of spines on the last joint of the exopodite*, and the absence of anything like the usual ocelli of *Labidocera*, are points which appear to remove it from that genus. The abdomen of most females is more or less enveloped in a mass of colourless, structureless membrane. The ♂ is distinctly five-jointed in the abdomen, whereas in *Labidocera* this is four-jointed. The right anterior antenna especially also differs from other species. From the characters of the female feet and the abdomen of the males I have thought it justifiable to create a new genus for this animal. I name the species after Mr. Hodgson, the naturalist of the 'Discovery' Expedition.

♂ smaller than the ♀ (1.6 mm). Cephalothorax with head separate from next segment, two dark lateral spots, but not ocelli, in front of the head. Abdomen little more than half as long as the thorax. Head evenly rounded, without side hooks, last thoracic segment rounded and not produced. Abdomen of undoubtedly five segments, of which the second is about as long as the third and fourth together, the first is very short, the fourth is twice as long as the anal, which is a short segment: the furcal segments, of which the right is a little larger than the left, are twice as long as broad and three times the length of the anal segment.

Right anterior antenna a clasping organ, the middle joints swollen, the joint before the elbow with a marginal row of small teeth and with only two distinct segments beyond the elbow, of which the distal is very long and thin (over three times as long as broad), and in its distal part carrying on the inner margin a very long spine tapering to a fine whip-like extremity, but broad in its basal portion. This appendage is half as long again as the whole joint. The joint immediately distal to the elbow has on its margin proximally a short but thick spine. I find it very difficult in any of the specimens, of which there are several, to agree with any degree of accuracy upon the exact number of segments in this antenna owing to the fact of its being curled up in every case. First to fourth feet and mouth organs as in the female.

5th feet, powerful clasping organs, the right one of four segments, the left of three, with a common basal. The first segment of the right foot has on its inner margin a small knob projection, the second has two short, thick spines, the third a fine spine, and the last joint is curved into a strong hook, without any appendages.

The first joint of the left foot has a short spine on the external margin, and the last joint is broad proximally and foliaceous, and on its inner surface is a row of fine bristles, with three or four stiff and longer than the rest.

EUCALANUS (DANA).

That any species of *Eucalanus* should be found at extreme southern latitudes is certainly curious. *E. elongatus* certainly occurs south of lat. 40° , and about 40° W. long., 'Gauss' collection; and in the 'Discovery' collection I have found about half a dozen examples of a *Eucalanus* which I regard as a variety of *E. subtenuis* or *mucronatus*. This occurred at station marked 21. x. 01, lat. $57^{\circ} 25\frac{1}{2}'$ S., long. $151^{\circ} \frac{3}{4}'$ E., and station lat. $56^{\circ} 31'$ S., long. $156^{\circ} 19' 30''$, 22. xi. 01; in both cases a long distance outside the Antarctic Circle.

The ♀ (no males were found) is 4 mm. long. The head is very triangular, elongated, and produced in front into a blunt point slightly bent downwards; there are lateral swellings as in *attenuatus*, the part behind is not, however, indented. The last thoracic segment is rounded. The abdomen has three segments, and one tail bristle on the left side is a little thicker and longer than the rest. The genital segment is laterally swollen and broader than long. Posterior antennæ with first and second joints of the exopodite coalesced, the first joint of the endopodite about three times as long as broad, and about the same length as *Ri* 2. The mandibles with very short *Ri*, the proximal part about three times as long as the distal, the whole *Ri* very much shorter than the distal part of the basal, and with four bristles and two short marginal bristles. Maxilla, *B* 2 with five, *Ri* 1 with four, *Ri* 2 with four, *Ri* 3 with five bristles. With some resemblance to *E. subtenuis*, *pilatus*, and *mucronatus*, it is larger than any of them. The five bristles on the *B* 2 of the maxilla cause it to differ from either *mucronatus* or *subtenuis*, and it has considerable differences from *pilatus* in size, posterior antenna and mandible. The shape of the head is certainly not that of *subtenuis*, nor is it so triangular and pointed as *mucronatus*.

CTENOCALANUS (GIESBRECHT).

CTENOCALANUS VANUS.

Ctenocalanus vanus. Giesbrecht, Atti Acc. Lincei Rend., Ser. 4, 1888, p. 335.

" " " Fanna u. Fl. Neap. XIX. (1892), p. 194.

This is extremely abundant in the 'Discovery' collections, but does not differ in any material particular from the species well known in the Atlantic. Its range of distribution is very great, extending from the Faroe Channel (Wolfenden) throughout the Atlantic to the southernmost parts of the Antarctic area, *i.e.* to the ice region.

CLAUSOCALANUS (GIESBRECHT).

CLAUSOCALANUS ARCUICORNIS.

- Clausocalanus arcuicornis*. Giesbrecht, Atti. Acc. Lincei Rend., Ser. 4., vol. 4, p. 334.
 „ „ Giesbrecht, Fauna n. Fl. Neap. XIX. (1892), p. 50.
 „ „ Giesbrecht u. Schmeil, Das Tierreich, p. 27.

That this species should occur so far south is rather peculiar. It was found in the collections made at:—

Lat. 49° 40' S.	Long. 172° 18' 30" W.
Lat. 55° 44' S.	Long. 95° 43' 30" W.
Lat. 56° 12' 45" S.	Long. 136° 18' 30" W.
Lat. 57° 25½' S.	Long. 151° 43' E.
Lat. 58° 49' 45" S.	Long. 154° 48' W.
Lat. 59° 19' S.	Long. 120° 24' 30" E.
Lat. 63° 5' S.	Long. 175° 43' E.
Lat. 84° 01' S.	Long. 170° 49' E.

and does not differ essentially from the species common in the Atlantic. It has a considerably greater range than was thought, since I can record it from the Irish coast to nearly the Antarctic Circle.

GAETANUS (GIESBRECHT).

GAETANUS ANTARCTICUS.

(Plate III., fig. 6.)

Gaetanus antarcticus, Wolfenden, Plankton Studies, Part I. (1905), p. 7.

Size 8 mm. The body is very robust and dorsally very gibbous. The head and first thoracic segment are coalesced, and together much longer than all the rest. The last thoracic segment carries two short stout curved spines, directed backwards. The head is in its upper part quite square, and with short stout curved spine, directed a little forwards. The abdomen is not a quarter the length of the cephalothorax.

Anterior antennæ not as long as the body, of twenty-three segments, with the eighteenth, nineteenth and twenty-first segments longer than the twentieth, and all joints with very few setæ. *Ri* of the posterior antennæ more than half the length of *Re*. Posterior foot jaws with lamellar process on the first basal.

Maxillæ; *Li* 2 and *Li* 3, each with four bristles; *B* 2 with five, *Ri* small and two-jointed. *Re* small, and less than half the length of *B* 2.

First feet, *Re* of three segments with three marginal spines, the segmentation being complete; *Ri* of only one segment.

Second feet, *Ri* distinctly two-jointed.

Third and fourth feet, *Ri* and *Re* of three joints each. *B* 2 of the fourth feet with tubal bristles as in *Gaidius*.

The extraordinary size of this animal makes it the largest known species of *Gaetanus*. It occurred once only in the 'Discovery' collection, and also appeared in the 'Gauss' collection, and is probably Antarctic in its habitat. Several new species of *Gaetanus* have been described recently, and it may serve some useful purpose to recapitulate here the different species discovered since Giesbrecht and Schmeil's last work (Tierreich, 1898).

1. GAETANUS MAJOR.

G. major, Wolfenden, Proc. Zool. Soc., London, Feb. 3, 1903, in Dr. Fowler's paper.

.. Farran, Ann. Rep. Fish. Ireland, 1902-03, Part II., App. II., 1905.

Size 5 mm. and over. Anterior antennæ larger than the body by about one joint; lamellar appendage of posterior foot jaws absent; *Re* of first feet of three segments, and with three *Se*. Cephalic spine short, and as in *G. armiger*.

2. GAETANUS CAUDANI.

Gaetanus caudani, Canu, Ann. Univ. Lyon, V. 26, 1896.

.. " Wolfenden, Jour. Mar. Biol. Assoc., 1904, p. 24.

.. (?) *pilatus*, Farran, *ibid.*

Like *G. miles*, but anterior antennæ only one-and-half times as long as the body; lamella of posterior foot jaw like that of *G. miles*. *Re* of first feet, three segmented basals of fourth feet with tubal bristles, 5 mm. and over. Canu's original description was of one immature ♂. Farran's were also immature specimens.

3. GAETANUS HOLTI.

Gaetanus holti, Farran, *ibid.*

.. *latifrons*, Sars, Bull. Mns. Monaco, No. 26, March, 1905.

.. *longispinus*, Wolfenden, Plankton Studies, Part I. (1905), p. 7.

Cephalic spine strong and directed backwards with long interval between the frontal part and base of the horn. Anterior antennæ not as long as the body-spines of the last thoracic segment, strong, long, and directed backwards. Small lamella on posterior foot jaw. First feet with three segments and three *Se*. Fourth feet with basal tubal bristles. Size 4.74 mm.

4. GAETANUS ANTARCTICUS.

Gaetanus antarcticus, Wolfenden, Plankton Studies, Part I. (1905), p. 7.

Thorax gibbous, very stout short curved cephalic spine directed forwards, head square, not like *G. armiger*. Abdomen short and thick, not a quarter of whole length.

Anterior antennæ not as long as the body. Posterior foot jaw with lamella. *Re* of first feet with three segments and three *Se*. Fourth feet with tubal bristles. Size 8 mm.

5. GAETANUS MINOR.

Gaetanus minor, Farran, Ann. Rep. Fish. Ireland, 1902-03, P. II., App. II. (1905), p. 34.

Cephalic spine as in *G. armiger*, long slender spines of last thoracic segment. Anterior antennæ reaching only to genital segment. First feet with *Re* of two segments and only two *Se*. Second feet with one-jointed *Re*. Size 2.4 mm.

6. GAETANUS ROBUSTUS.

Gaetanus robustus, Sars, Bull. Mns. Océanographique Monaco, no. 26 (1905), p. 11.

Robust, cephalothorax a little swollen in middle. Cephalic spine small, curved, or sometimes absent. Spines of last thoracic segment very strong and divergent. Abdomen thick and about one-third of whole length. Anterior antennæ scarcely as long as the body. Size 8 mm. (? possibly the same as *G. antarcticus*, but the description of *G. robustus* is insufficient.)

7. GAETANUS INERMIS.

Gaetanus inermis, Sars, *op. cit.*, p. 12.

Body very thick, anterior division swollen. No trace of cephalic spine, last segment of thorax rounded and without spines. Abdomen very short, not a quarter of whole length. Anterior antennæ not longer than body. Structure of other parts not different from other species of this genus (?) Size 6.30 mm.

(In the absence of cephalic and thoracic spines, which are constant in this genus, this is probably not a *Gaetanus*.)

8. GAETANUS CURVICORNIS.

Gaetanus curvicornis, Sars, *op. cit.*, p. 11.

Body like *G. miles* (Giesbrecht), short curved cephalic spine. Spines of last thoracic segment moderately large and divergent. Very short abdomen only a quarter the whole length. Anterior antennæ scarcely longer than the body. Size 4.35 mm.

9. GAETANUS KRÜPPL.

Gaetanus krüppi, Giesbrecht, Mitt. Zool. St. zu Neapel, XVI. (1903), p. 202.

Like *G. armiger*, but larger, *viz.*, 3.6-4 mm. long, thorax shorter. Anterior antennæ reach three joints beyond furca, twenty-second segment longer than in *G. armiger*. Feet like *G. miles*. ♂ 3.7 mm. long, thoracic spines shorter than ♀ and antennæ shorter than body. *Se* of *Re* 2 of first foot rudimentary; fourth feet without tubal bristles. Fifth feet *Ri* of one segment, *Re* of right foot of two; of left, of three segments. Mediterranean.

XANTHOCALANUS (GIESBRECHT).

There are only two examples of this genus in the 'Discovery' collection. Since the publication of Giesbrecht and Schmeil's "Copepoda" (in "Tierreich") the genus has received many additional species. To the originally described species, *viz.*, *X. agilis* and *X. minor* (Giesbrecht), are now added *X. borealis* (Sars), *X. propinquus* (Sars), *X. muticus* (Sars), *X. cristatus* (Wolfenden), *X. suberistatus* (Wolfenden), *X. simplex* (Wolfenden), *X. magnus* (Wolfenden), *X. calaminus* (Wolfenden), *X. atlanticus* (Wolfenden), *X. greeni* (Farran), *X. pinguis* (Farran), and *X. obtusus* (Farran); and, as they are described in scattered publications, it may be well to recapitulate the characters here.

1. *X. AGILIS*.

X. agilis, Giesbrecht, Fauna u. Fl. Neap. XIX. (1892), p. 286.

Size 2.4; furcal segments broader than long, abdominal segments very hirsute; anterior antennæ reaching end of furca; fifth feet three segments, beset with spines and teeth, and with three apical teeth.

In the ♂ only one (the left) foot five-jointed. (Mediterranean.)

2. *X. SUBAGILIS*.

X. subagilis, Wolfenden, Jour. Mar. Biol. Assoc., VII. (1904), p. 118.

Size 2.6 mm., resembling *X. agilis*, but abdominal segments not hirsute.

Fifth feet with three segments, the basal with strong teeth, the middle with only hairs, the distal spinulose and with three long apical spines.

♂ with a pair of fifth feet nearly equal, the right of four, the left of five segments. (Mull of Galloway.)

3. *X. BOREALIS*.

X. borealis, Sars, Crustacea of Norway, Vol. IV., p. 46.

Size 3.50 mm.; furcal segments as broad as long, anterior antennæ reach end of genital segment; fifth feet of three segments, proximal two, with teeth on inner margin; last with two apical and two lateral spines.

♂ with a pair of fifth feet left of five segments, right very short and of only three segments. (Polar Seas. Norway.)

4. *X. PROPINQUUS*.

X. propinquus, Sars, *loc. cit.*

Size 1.75 mm.; furcal rami longer than broad; anterior antennæ slender and reaching only to second abdominal segment, posterior antennæ with *R₂* much longer

than *Ri*; fifth feet of three segments, last much smaller than proximal two, only basal with marginal teeth, end segment with three short outer and one long inner spine.

♂ a pair of fifth feet, the right very rudimentary and short, of three segments. (Polar Sea. Norway.)

5. X. CRISTATUS.

X. cristatus, Wolfenden, Jour. Mar. Biol. Assoc., 1904, p. 119.

Size 5.0 mm.; head triangular and with prominent crest, anterior antennæ reaching to end of furca; fifth feet of three segments, all densely spinulose, with two short apical spines. ♂ not known. (West of Ireland.)

6. X. SUBCRISTATUS.

X. subcristatus, Wolfenden, Plankton Studies, Part II. (1906), p. 31.

Size 7.0 mm.; head with crest, abdomen very hirsute, furcal segments very short, anterior antennæ reaching end of genital segment; fifth feet three segments, the distal long and tapering, with two short apical spines; all these segments densely spinulose. ♂ not known. (South Polar Sea.)

7. X. MAGNUS.

X. magnus, Wolfenden, *op. cit.*, p. 32.

Size 8.8 mm.; head rounded, not clearly separated from next segment; furcal segments very short, anterior antennæ reaching the genital segment; abdominal segments very hirsute; fifth feet of three segments, very small; all segments very spinulose, with two apical and two lateral spines on the last segment. ♂ not known. (South Polar Sea.)

8. X. SIMPLEX.

X. simplex, Wolfenden, *op. cit.*, p. 30.

Size 1.45 mm.; whole surface of thoracic segments covered with fine prickles, anterior antennæ very short, posterior antennæ with *Re* nearly twice as long as *Ri*; anterior foot jaws with only vermiform processes, posterior foot jaws with long, thin *B2* without bristles; fifth feet very small, of common basal and two segments, the distal one very small, with two apical spines on the left and only one on the right foot. ♂ unknown. (West of Ireland.)

9. X. CALAMINUS.

X. calaminus, Wolfenden, *op. cit.*, p. 34.

Size 5.5 mm.; furcal segments as broad as long, posterior antennæ with rami of equal length; anterior foot jaw with powerful toothed hook on fourth lobe, and two slenderer hooks on fifth lobe; brush and vermiform processes; posterior foot jaw short and stout, the bristles of the endopodite very peculiar and like quills, with broad chitin expansion with serrated edge; fifth feet very small, of three segments; distal segment with short apical and two short marginal spines. (Bay of Biscay.)

10. X. ATLANTICUS.

X. atlanticus, Wolfenden, Jour. Mar. Biol. Assoc., April, 1904.

Size 2·5 mm. ; anterior antennæ much shorter than thorax and very thick basally, abdominal segments prickly and hirsute, feet very spinulose ; fifth of three segments, distal the largest, with four large articulating spines, two apical, two lateral ; all segments very spinulose ; furcal rami as broad as long, and *Re* of posterior antennæ much longer than *Ri*. (West of Ireland.)

11. X. OBTUSUS.

X. obtusus, Farran, Ann. Rep. Fish., Ireland, 1902-03, pt. ii., App. II. (1905), p. 40.

Size 2·4 mm. Furcal rami little longer than broad, anterior antennæ reach genital segment, feet very spinulose. Fifth feet, three segmented, spinulose, and with two terminal and two lateral spines on last segment ; second joint longest, and spinulose on both margins. (Atlantic. Ireland.)

12. X. PINGUIS.

X. pinguis, Farran, Ann. Rep. Fish., Ireland, 1902-03, pt. ii., App. II. (1905), p. 40.

Size 4·5 mm. Head imperfectly separated from thorax ; lateral processes of last segment blunt ; furcal segments slightly longer than broad ; anterior antennæ short, not as long as thorax ; rami of posterior antennæ short and broad ; feet spinulose. Fifth feet of three segments, and two lateral and two apical end spines ; surface of third and margins of first (inner) and second (outer) spinulose. (Atlantic. Ireland.)

13. X. GREENI. X. MUTICUS.

X. greeni, Farran, Ann. Rep. Fish., Ireland, 1902-03, pt. ii., App. II. (1905), p. 40. *X. muticus*, Sars, Bull. Mus. Monaco.

Size 5·30-6 mm. ; last two segments of thorax united, last segment with obtusely triangular margins ; furcal segments short, broader than long ; anterior antennæ little longer than body. Fifth feet small, two-jointed (Sars), or three-jointed (Farran), without spines on inner margin ; last joint with three small apical spines. (Atlantic. Ireland.)

14. X. TYPICUS.

Amallophora typica, Scott, Tr. Linn. Soc. (2), VI. (1894), p. 54.

Only the ♂ known ; 2·7 mm. long ; anterior antennæ, twenty segments ; right fifth foot short and three segments, left like that of *X. agilis*.

XANTHOCALANUS ANTARCTICUS.

(Plate VII., figs. 10, 11.)

♀ 2.5 mm. long (cephalothorax 2.0 mm., abdomen 0.5 mm. long). Abdomen, therefore, only one-fourth as long as the thorax. Head rounded and rather oval in front, with bifid rostrum, composed of two chitinous plates each with a long and rather thick filament. Head separate from first thoracic segment, last two segments separate, and distal segment on each side produced into lappets ending in rather pointed but rounded margins. Furcal segments half as long again as broad. In the middle, the thorax is broad, about half as broad as long. Abdominal segments with row of pectinations laterally, and over whole dorsum at the margin of the very short anal segment. Anterior antennæ twenty-four segments, and short, only reaching to the end of the cephalothorax.

Posterior antennæ with *Re* a little longer than *Ri*.

Mandibles, *Ri* and *Re* about equal; *B 2* with three marginal bristles; *Re* elongated and narrow, with seven bristles. Maxilla, *B 2* and *Ri* elongated and narrow, imperfectly segmented; *B 2* with four, *Ri 1* with 1, *Ri 2* and 3 with six bristles, *Li 1* nearly twice as long as broad, with long, thin hook bristles. Anterior foot jaws with very convex *B 2*, the proximal margin of the basals much embayed. Strong toothed and curved hook on the last lobe; a number of brush processes, with small heads, and two vermiform processes distally.

Posterior foot jaws, having proportionately $B 1 : B 2 : Ri = 40 : 30 : 20$, the second basal about three and a half times as long as broad, and a brush process on the first basal.

1st feet *Ri* = 1 segment. *Re* = 3 segments with three long, thin marginal spines.

2nd feet *Ri* = 2 segments, *Re* = 3 segments. *Ri 2* with a strong corona of spines.

3rd feet with a few delicate spines on surface of *Re 2*.

4th feet *Ri* = 2 segments, *Re* = 3 segments. *Ri 2* with a few spines on the outer margin. The exopodites of the 3rd and 4th feet not spinulose.

5th feet small. A common basal and each three segments; the first segment rather longer and broader than the second, with convex inner margin, and several (about eight or nine) strong teeth on the margin; the second segment with two or three shorter spines on the proximal part of the convex inner margin; the third segment with two short apical, and one outer and one inner marginal spines—four in all—each articulating with the segment, and on the inner margin a bunch of small teeth. A cluster of five spines on the distal surface of the last segment, and two very small spines on the outer margin of the middle segment distally. No spines on the surface of the two proximal joints.

XANTHOCALANUS MAGNUS.

(Plate VII., figs. 1-9.)

Xanthocalanus magnus, Wolfenden, Plankton Studies, Part II. (1906), p. 32.

♀ 6.0 mm. long. Head dorsally with line of separation from the first segment, rounded and without any trace of crest; produced in front into a chitinous lamella with two pointed rami. Last thoracic segment on each side a little produced. Abdomen short, the cephalothorax being three and a half times its length. Genital segment protuberant ventrally and longer than the next two, anal segment very small, and furcal segments much longer than the anal.

Anterior antennæ, reaching about the end of the genital segment, of twenty-four segments, with thick basal joints, the eighth and ninth coalesced, the last segment very small. Posterior antennæ with *Ri* longer than *Re*, the first joint of the latter with strong rounded projection of the lower and inner margin. The masticatory plate of the mandibles with strong teeth, the two outer longer than the inner ones, which are short and all of the same size. Anterior foot jaws short, but strongly built, the outer margin very convex, the last lobe bearing a very strong thick basally and curved sickle-shaped hook, tapering distally; all the bristles of *Ri* represented by sensory brush and vermiform appendages. The posterior foot jaws somewhat extended, the first basal comparatively thick and with a brush appendage, the second basal elongated and thin, with very short marginal bristles; *Ri* also elongated, the first and second joints long, and its bristles comparatively short. Maxillæ very like the preceding species, but *B* 2 with five, *Ri* with ten bristles, *Re* elongated and narrow.

1st feet, *Re* with three distinct segments and three external spines; *Ri* only one segment.

2nd feet, *Re* of three broad segments very spinulose on the surface, and with short external marginal spines, *Ri* of two segments with prominent bunches of spines on the surface of *Ri* 2.

3rd and 4th feet, each ramus of three segments, the surfaces spinulose.

5th feet small, of three segments more or less covered, especially the last segment and margins, with comparatively long, spine-like bristles; the terminal segment with two short terminal and two very short marginal spines, not articulating.

This is an adult female, and resembles the animal I have described as *Xanthocalanus magnus* (Plankton Studies, Feb., 1906) so closely that I think they must be regarded as the same animal. The 'Gauss' animals are, however, very much larger (up to 8.8 mm.), but the only essential differences which I can detect are the much greater size of the latter, the rather more pointed dorsum of the head, and the more hirsute abdominal segments. In these collections I have found many examples which appear to differ only in size, and I am inclined to think that this 'Discovery' example is merely a smaller one of the same species. The 5th pair of feet are strikingly different from the northern species.

HETERORRHABDUS (GIESBRECHT).

Only one specimen of this genus occurs in the 'Discovery' collection, which is only what might be expected from the fact that the collection is practically only epiplanktonic, whereas *Heterorrhabdus* is without doubt one of the most confirmed deep-water genera of Copepoda. The species *H. austrina* (Giesbrecht), which occurs in the 'Belgica' and 'Gauss' collections, is absent from those of the 'Discovery,' and the only specimen of the genus occurring in the latter is, I think, referable to *H. longicornis*.

HETERORRHABDUS LONGICORNIS.

- Heterochacta longicornis*, Giesbrecht. Atti. Acc. Line. Rend., Ser. 4, v. (1889) p. 811.
 " " " Fauna u. Fl. Neap. XIX. (1892), p. 373.
 " " Wolfenden. Jour. Mar. Biol. Assoc., Vol. VII. (1904) p. 124.
 ? *Heterochacta major*, Dahl. Verh. d. Zool. Gesells., 1894, p. 79.
Heterorrhabdus major, Wolfenden. Plankton Studies, Part I. (1905), p. 11.

I first described the male of *H. longicornis*, hitherto unknown, in 1902. Since then I have found it frequently throughout the Atlantic, extending to the Antarctic area. Dahl's description of *H. major* is very scanty, and the only essential point of difference between it and *longicornis* appears to be one of size. The specimen in the 'Discovery' collection is a ♂ of 4.5 mm. length, but there is no essential difference between it and smaller males from the Faroe Channel. I suggest therefore that Dahl's *H. major* is really *H. longicornis*, and I now think that the species which I described in "Plankton Studies" as *H. major* may best be described as *H. longicornis* (Giesbrecht).

The diagnostic points of *H. major* (Dahl) are, according to this author, "anterior antennæ very long, the posterior foot-jaw with only weak median bristles; the penultimate lobe of the anterior foot-jaw a long 'tap' lobe, the mandible teeth but little differing in thickness, nearly the same distance apart; the exopodite of the third feet like those of the second and fourth, the size over 5 mm. long."

Except as to size, it will be observed that none of these points differ from those of *H. longicornis*, the largest examples of which are not, however, more than 3.5 mm. long in the North Atlantic.

The 'Discovery' specimen is a ♂ of 4.5 mm. length, the anterior antennæ several joints (about six) longer than the whole body; the geniculating antennæ with six joints beyond the elbow. The right furcal segment is much longer than the left. The fifth lobe of the anterior foot-jaw has a very thick-based stout curved hook, without teeth or bristles except for a few bristles at the proximal end; the lobe itself is very large. The two other bristles are long and thin. The sixth lobe has a long and thin hook, also uncombed. The bristles of *Ri* are extremely long. The posterior foot-jaw has a long thin second basal, three times as long as broad, and only two weak bristles in the middle. The mandible has a large simple conical tooth on the outside, and

these outer teeth are not in either mandible thickened. The third feet resemble the fourth. The right fifth foot has a long upright process on *B* 2, haired marginally; the *Re* 2 broad and with a marginal protuberance on which are two or three short teeth and a small bunch of hairs, flattened long spine distal to it. *Re* 3 a long curved spoon-shaped segment, with a stout-based apical spine, shorter spine on the inner aspect; the right *Ri* with the second segment elongated and narrow, the third segment comparatively broad and short, the inner marginal bristle of *Ri* 2 thickened.

The left foot has a haired marginal projection as *B* 2, *Re* 3 with a long stout apical spine, three-quarters as long as the segment, and with a short marginal spine on the inner side, *Ri* 2 broad, with thickened bristle. A specimen of *H. longicornis* from the Faroe Channel measured 3.5 mm. long; Esterly records it from Diego, California, 3 mm. long. The Southern Ocean species evidently reaches a much greater length (4.5 mm.).

FAROELLA (WOLFENDEN).

In the course of my cruising in the Faroe Channel in 1901 I captured a copepod which differed from any known species, to which I originally gave the name *Pseudotideus multiserrata*, in the paper read at the British Association, 1902. In 1903 appeared Sars' supplement, in which he described a new genus, *Ætidiopsis*, which appeared to be the same animal; and as I had already recognised that this copepod was distinctive from others closely allied (*Pseudotideus*, *Chiridius*, *Gaudius*), I had created for it a new genus, *Faroella*. My paper had been in the printers' hands for some time when Professor Sars' supplement appeared with the description of *Ætidiopsis*. Consequently I do not know to which name priority should be given, nor do I feel yet certain that the genus described briefly by Sars is identical with the *Faroella* described by me in the *J. M. B. Ass.* of 1904. Certainly the *Faroella* of the Antarctic Sea has some differences, and I therefore retain the name for the genus which I originally gave, more especially as Professor Sars, who has examined some Irish specimens, states, as I am informed, that they are not identical with his.

FAROELLA ANTARCTICA.

(Plate II., figs. 1, 2, 3, 4.)

♀ ♂ size 4.3 mm. (cephalothorax 3.3 mm., abdomen 1.0 mm.). The fore-body is therefore over three times as long as the abdomen. The head and first thoracic segment are united, the two last segments of the thorax separate, the anterior segment over twice as long as the four last segments; the most posterior of these is well defined from the one in front, small, and laterally prolonged into stout spines which are about three-quarters as long as the genital segment. In dorsal aspect the head is rather triangular-shaped, and on each side below the level of the posterior antennæ, laterally expanded. In the lateral aspect the head is evenly rounded, oval, and with stout two-pointed

rostrum directed forwards, with slight curve downwards, the rostral spines not at all divergent, as in Sars' picture of *Ætidiopsis*. The whole cephalothorax is studded with fine and closely-set prickles. Abdomen of four segments, slender, the genital only a little larger than the next, with strong ventral protuberance, $> Ab\ 2 > Ab\ 3 > Ab\ 4$. Furcal segments as long as the anal, and twice as long as broad. Tail bristles four on each side, with very short and delicate ventrally placed accessory bristles. Anterior antennæ reaching just beyond the end of the genital segment, the first two joints comparatively large and as long as the next five joints, the combined eighth and ninth joint as long as the two joints either proximal or distal to it, the eighteenth and nineteenth joints longer than those proximal or distal, and the twenty-fourth separate from the twenty-fifth. All joints only sparingly setiferous.

Posterior antennæ with exopodite a little longer only than the endopodite.

Anterior foot-jaws with the outer margin of the basal only a little convex, the fifth lobe longer than the four proximal and nearly equally-sized lobes, the *Ri* small but distinctly segmented. Each lobe with three bristles, two each on the first, second, third, and one on the fourth, being stout, long, and with wide apart stiff marginal bristles. Bristles of *Ri* long, not feathered, but slightly serrated marginally.

Posterior foot jaws having proportionately $B\ 1 : B\ 2 : Ri = 10 : 12 : 5$. *B\ 2* therefore a little longer than *B\ 1*, and over twice as long as *Ri*; *B\ 1* two and a half times as long as broad, with two small lobes with respectively two and three short bristles; *B\ 2* four times as long as broad, its marginal bristles very small and distal of the middle. *Ri* short and distinctly five-segmented.

Maxillæ, *Le\ 1* with nine bristles and its outer margin nearly straight; *B\ 2* with five, and not segmented from *Ri* with thirteen bristles; *Le\ 2* a small lobe, but without bristles; *Re* small, longer than broad, and with ten bristles; *Li\ 1* with nine large hooks and four bristles; *Li\ 2* and *3* well-formed lobes.

First feet. *Ri* one-jointed; *Re* three-jointed, with three long thin marginal spines.

Second feet. *Ri* two-jointed, *Ri\ 1* short, *Ri\ 2* very elongated, and nearly four times as long as *Ri\ 1*. The whole *Ri* only extends to the distal end of *Re\ 2*. On the distal part of the surface of *Ri\ 2* is a bunch of fine hairs; *Re\ 3* is as long as *Re\ 1 + 2*, and its end saw is longer than the *Re\ 3* and beset with a great number (exceeding fifty) of closely-set teeth, of which those in the middle are the largest.

Fourth feet. *Ri* and *Re* of three segments each. *Ri* proportionately longer than in the other feet, and the third segment as long as *Ri\ 1 + 2*, and a little over three times as long as broad, with fine hairs on the surface distally. *Re\ 3* much longer than *Re\ 1 + 2* and over three times as long as broad. Its end saw three-quarters as long as the *Re\ 3*, and with over fifty closely-set teeth. No fifth feet.

The chief points in which this Antarctic species differs from that of the northern seas are in its greater size, the greater strength of the rostrum, the rather different body proportions, and the more equal size of the rami of the posterior antennæ. The

chitin everywhere in the cephalothorax is almost covered with prickles, and the whole animal is more robust.

MICROCALANUS (SARS).

MICROCALANUS PUSILLUS.

(Plate II., fig. 5.)

Microcalanus pusillus, G. O. Sars, Crustac. of Norway, IV. (1903), p. 156.

Pseudocalanus pygmaeus, Sars, Norweg. N. Polar Expdn., Vol. V. Crustacea, 1900.

„ „ Giesbrecht, 'Belgica' Report, p. 20.

Sars originally described a small Calanoid, *Pseudocalanus pygmaeus*, from Nansen's Polar Expedition, which he subsequently re-named *Microcalanus*, and included in the new genus a second and still smaller form of *M. pusillus*. Giesbrecht described a small Calanoid from the Antarctic seas, which agreed generally with Sars' Polar species, except for very small differences, e.g. the length of the anterior antennæ, and the length of the outer marginal spines of the exopodites of the feet. The size varied, mostly from 0.7–0.75 mm.; some were even smaller. *P. pygmaeus*, Sars (= *M. pygmaeus*, Sars), is a little longer, viz. .86 mm. (Sars).

The 'Discovery' collection contains many examples of a very small Calanoid which agrees so closely with Sars' *M. pusillus*, that I regard them as identical; and Giesbrecht's *Pseudocalanus pygmaeus* must, I think, be also regarded as identical. This small Calanoid is one of the few examples of complete agreement in form and structure between the Polar and Antarctic forms, and on that ground is of interest.

The female is 0.60 mm. long. Cephalothorax two and a half times longer than the abdomen; the head and first segment united, the former evenly rounded and with short, delicate rostrum; the greatest breadth not quite half the length; the last thoracic segment with rounded and only slightly produced margins; abdomen of four segments. The genital segment is nearly twice as long as the next, which is rather larger than the distal segment, and the anal as long as the segment preceding it. Furcal segments as long as the anal and longer than broad, with four short terminal bristles. The genital segment is very swollen laterally, but symmetrical, and rather tumid ventrally.

Anterior antennæ reaching about the end of the genital segment, and of twenty-three joints.

Posterior antennæ with *Re* about one-third longer than the *Ri*.

Mandibles with *Ri* much longer than *Re*, both rami fully segmented. Masticatory plate with strong cutting teeth seven or eight in number, and distally nearly half as broad as long.

Anterior foot jaws with five well-formed lobes, of *Calanus* type, with well-segmented *Ri*.

Posterior foot jaws with segments proportionately *B* 1, *B* 2, *Ri* = 9, 8, 9. *Ri* elongated and thin, with five distinct segments.

First feet, *Ri* of one, *Re* of three segments, the first without *Se*; *Ri* with four *Si*.

Second feet, *Ri* of two, *Re* of three segments; no *Si* on *B* 1 or *B* 2.

Fourth feet, *Ri* and *Re* of three segments each. The end saw extremely long, and longer than the whole *Re*, broad and coarsely serrated marginally.

In the second to the fourth feet the *Re* 3 has three outer marginal spines. No fifth feet.

The few males present were apparently immature.

HALOPTILUS (GIESBRECHT).

One species of this genus appears to be characteristic of the Antarctic fauna, since it is present in very many of the 'Gauss' samples, but curiously enough, occurred only once in the 'Discovery' collection. It is large, and distinguished at a glance from any other examples of the genus by the prominent black ocellus dorsally placed, an organ not possessed by any other species of *Haloptilus*.

HALOPTILUS OCELLATUS.

(Plate III., figs. 1, 2.)

Haloptilus ocellatus, Wolfenden, Plankton Studies, Part I. (1905), p. 14.

♀, of length, from the end of the frontal spine to the end of the furca, 8.75 mm., with cephalothorax over five times as long as the abdomen; the conjoined head and first segment much longer than the remaining segments of the anterior body (about one-third); the last two segments of the cephalothorax united, and with rounded margins. On the second segment, in the centre of the dorsum, or a little to the right of the centre, is a prominent and very black rounded pigmented ocellus, standing out in clear contrast to the rest of the very transparent animal. The frontal spine is long, tapering, and usually a little curved downward, and often laterally, towards the tip. The distance from the tip of the spine to the base of the anterior antennæ is equal to the distance between the latter and nearly to the distal end of the second cephalic segment. Abdomen of four segments, with the anal as long as the two preceding, and the furcal segments over twice as long as broad.

Anterior antennæ a little longer than the whole animal, reaching beyond the furca by about three or four joints, and sparingly setiferous.

Posterior antennæ with endopodite very long and exopodite very short, the latter of six joints, with doubtful division of the last, which would be the seventh joint, the basal or first segment very long, and nearly as long as the joints distal to it. *Re* not

more than one quarter as long as *Ri* 1. *Re* 1 elongated and seven or eight times as long as broad.

Anterior foot jaws with a rather stout, but unarmed hook on the fifth lobe, not longer, however, than the other bristles.

Posterior foot jaws thick, with *Ri* of similar thickness to *B* 2, and of five segments; the five stout curved hook bristles of nearly equal length, the two terminal only a little the longest and thickest.

Mandibles with *Ri* very long and *Re* only as long as *Ri* 1; masticatory plate with outer stout, broad-based, conical and curved tooth; three pointed short teeth internal to it, rather like *II. mucronatus*.

Maxillæ.—First inner lobe with six bristles, of which only two of the distal ones are stout hooks; second inner lobe with one stout long bristle; third inner lobe with one stout elongated and two short thin bristles; *B* 2 about as broad as long, with four elongated and thick bristles and one thin, short proximal bristle, *Ri* longer than broad, and about three-quarters as long as *B* 2 and only half its width, and with five bristles; *Re* very long, twice as long as *Ri*+*B* 2, and nearly twice as long as broad, with eleven bristles, of which the three innermost are short and thin.

All feet with three jointed rami, *Re* of fifth pair only five-sevenths as long as *Re* of fourth pair; *Ri* of fifth pair only as long as *Re* 1+2; *Re* 3 longer than *Re* 1+2, twice as long as broad, with three inner bristles, two outer spines, and end spine nearly as long as the last segment. I have not yet seen the ♂ of this species.

OITHONA (BAIRD).

Two species of this genus occur in these collections, one of which, *viz.*, *Oithona similis*, is of world-wide distribution, and occurs with great frequency in Antarctic collections; the other, to which the name *Oithona frigida* has been given by Giesbrecht (and which has been fully described by him in the 'Belgica' report, *vide ante*), occurs very sparingly in the 'Discovery' collection.

HARPACTICUS (DANA).

HARPACTICUS FURCIFER.

Harpacticus furcifer, Giesbrecht, 'Belgica' Report, p. 37.

The ♀ of this species was first described by Giesbrecht in the 'Belgica' report; and in the 'Discovery' collection, marked 4. i. 02. W.Q., occurred three specimens of the male, though female examples were conspicuously absent.

The ♀, according to Giesbrecht, is 1.55 mm. long; the rostrum small, the series of points on the abdominal segments not numerous, the furca as long as both last abdominal segments, narrowing distally and about three times as long as broad; the

anterior antennæ nine-jointed, the exopodite of the posterior antennæ like *H. chelifera*, but smaller, the second basal of the mandible like *H. brevicornis* (= *H. fulvus*), and the exopodite scarcely half as long as the endopodite; both rami of the maxillæ are about equal; the first lobe of the anterior foot jaws has three bristles, the fourth lobe is long, and its hook short, the posterior foot jaw is much thinner and weaker than in *H. chelifera* and *H. brevicornis* and more like *H. flexus*. The first feet have thin and weak terminal claws, both rami of only two segments, and the endopodite is short, the joints of both branches being broader than in *flexus*; the endopodites of the second and fourth feet are larger in proportion to the exopodites than in *chelifera* and *brevicornis*, and in the fourth pair reach to the middle of the last joint of the exopodite; the bristles on the second endopodite joint are, however, two, instead of one as in *chelifera*; the last joint of the fifth feet is comparatively small, and is scarcely half so broad as this; its last joint has five, the process of the basal joint, four bristles.

The striking feature of *H. furcifer* is the length of the furcal segments, which are usually very short in this genus, and though related to *H. flexus*, it differs in the size, which, in the latter species, is only .64 mm. in length, compared with 1.5 in *H. furcifer*.

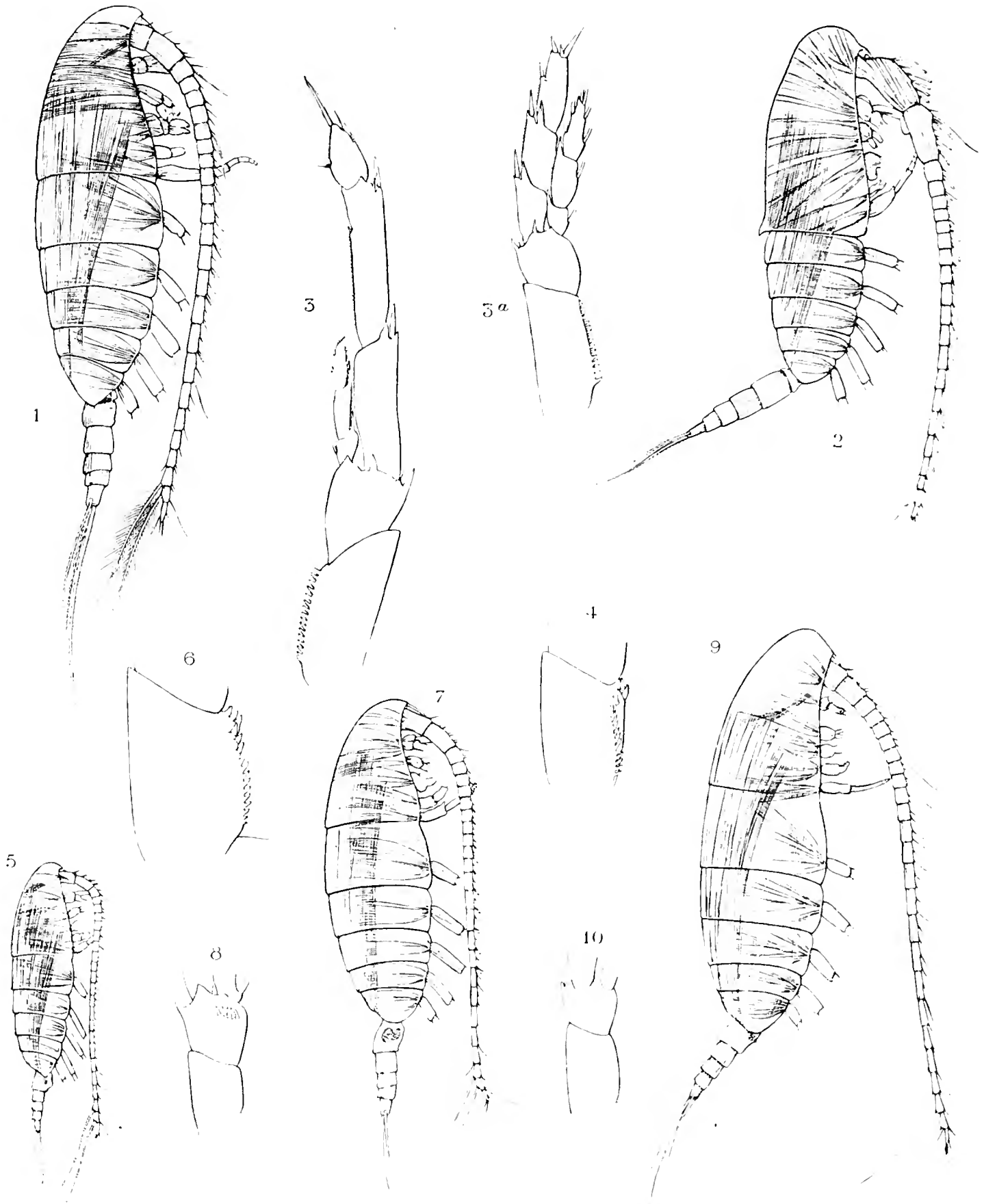

Antarctic (Discovery) Exp.

Marron Lees del. Bartoworth sc.

Copepoda pl. I.

- 1. *Calanus propinquus* (1, 4)
- 2. *simillimus* (2, 6)
- 3. *tonsus* (7, 8)
- 4. *acutus* (5, 10)

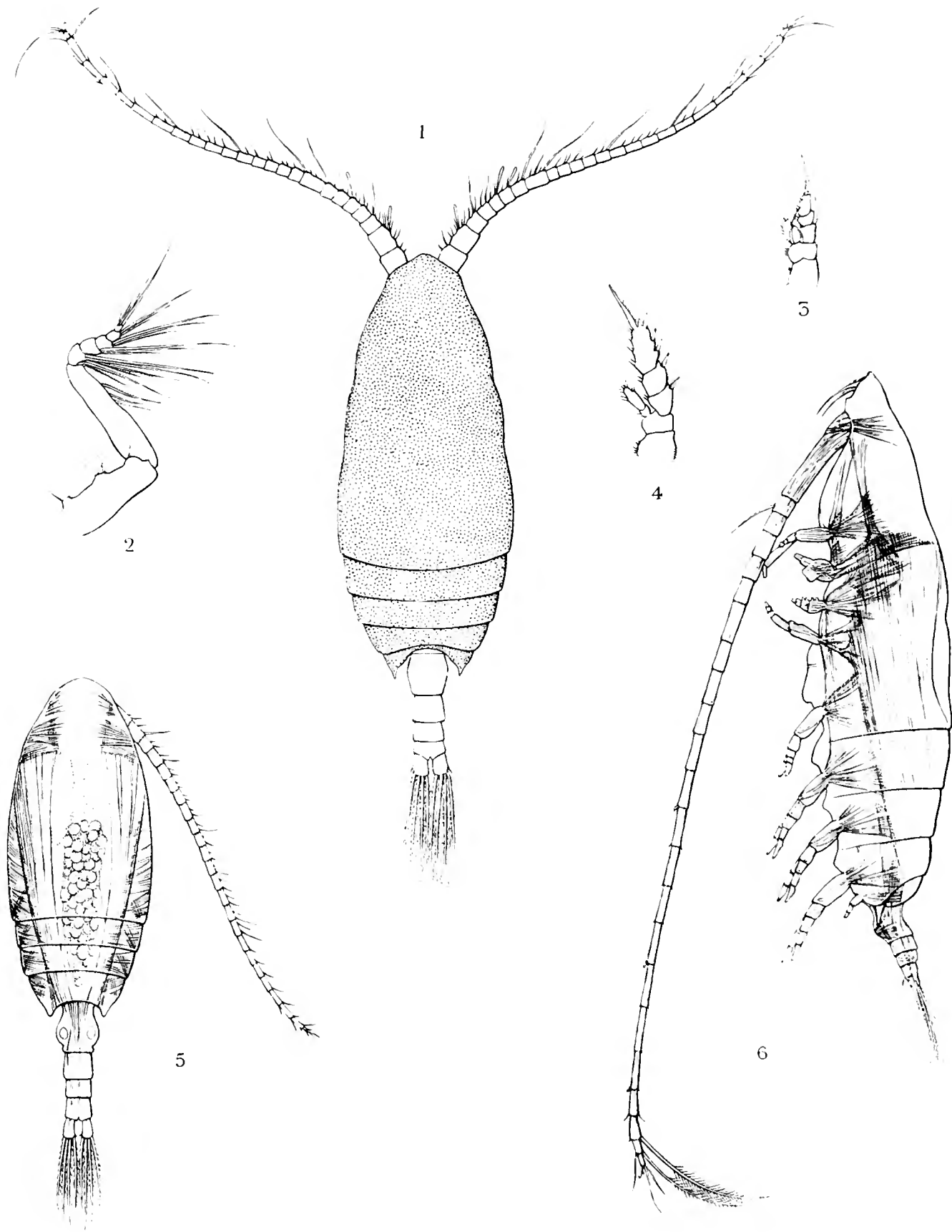

Antarctic (Discovery) Exp.

Marion Lees del. Walter Southw. sc.

Copepoda pl. II.

Faroella antarctica (1-4). *Microcalanus pusillus* (5)
Rhinocalanus grandis (6).

EXPLANATION OF THE PLATES.

PLATE I.

- Calanus propinquus*, fig. 1. Whole animal, ♀. Oc. 3, obj. 2 in.
 „ „ fig. 2. Whole animal, ♂. Oc. 3, obj. 2 in.
 „ „ fig. 3 and 3a, ♂. 5th pair of feet. Oc. 3, obj. $\frac{1}{2}$ in.
 „ „ fig. 4. ♀. Basal joint of 5th foot. Oc. 3, obj. $\frac{1}{2}$ in.
 „ *simillimus*, fig. 5. Whole animal, ♀. Oc. 3, obj. 2 in.
 „ „ fig. 6. Basal joint of 5th foot. Oc. 3, obj. $\frac{1}{4}$ in.
 „ *tonsus*, fig. 7. Whole animal. ♀. Oc. 3, obj. 1 in.
 „ „ fig. 8. Basal joints of 5th foot, ♀. Oc. 3, obj. $\frac{1}{4}$ in.
 „ *acutus*, fig. 9. Whole animal, ♀. Oc. 3, obj. 2 in.
 „ „ fig. 10. Basal joints of 5th foot, ♀. Oc. 3, obj. $\frac{1}{2}$ in.

PLATE II.

- Faroella antarctica*, fig. 1. ♀, whole animal. Oc. 3, obj. 2 in.
 „ „ fig. 2. ♀, Posterior foot-jaw. Oc. 3, obj. 1 in.
 „ „ fig. 3. ♀, 1st foot. Oc. 3, obj. 1 in.
 „ „ fig. 4. ♀, 2nd foot. Oc. 3, obj. 1 in.
Microcalanus pusillus, fig. 5. ♀, whole animal. Oc. 3, obj. $\frac{1}{2}$ in.
Rhincalanus grandis, fig. 6. ♀, whole animal. Oc. 3, obj. 2 in.

PLATE III.

- Haloptilus ocellatus*, fig. 1. ♀, whole animal. Oc. 3, obj. 2 in.
 „ „ fig. 2. 5th foot, ♀. Oc. 3, obj. 1 in.
Metrúlia princeps, fig. 3. Whole animal, ♀. Oc. 3, obj. 2 in.
 „ „ fig. 4. 5th pair of feet, ♀. Oc. 3, obj. $\frac{1}{2}$ in.
 „ „ fig. 5. 2nd pair of feet, ♀. Oc. 3, obj. 1 in.
Gaetanus antarcticus, fig. 6. ♀, whole animal. Oc. 3, obj. 2 in.

PLATE IV.

- Encheæta similis*, fig. 1. ♀, whole animal. Oc. 3, obj. 2 in.
 „ „ fig. 2. ♀, 1st foot. Oc. 3, obj. 1 in.
 „ „ fig. 3. ♀, 2nd foot. Oc. 3, obj. 1 in.
 „ „ fig. 4. ♀, abdomen and genital segment. Oc. 3, obj. 2 in.
 „ *antarctica*, fig. 5. ♀, abdomen and genital segment. Oc. 3, obj. 2 in.
 „ „ fig. 6. ♀, abdomen, lateral view. Oc. 3, obj. 2 in.

PLATE V.

<i>Stephus longipes</i> ,	fig. 1.	Whole animal, ♂.	Oc. 3, obj. $\frac{1}{2}$ in.
”	”	fig. 2. Whole animal, ♀.	Oc. 3, obj. $\frac{1}{2}$ in.
”	”	fig. 3. Whole animal, ♀.	Oc. 3, obj. $\frac{1}{2}$ in.
” <i>antarcticum</i> ,	fig. 4.	Whole animal, ♀.	Oc. 3, obj. 1 in.
”	”	fig. 5. Whole animal, ♀, dorsal.	Oc. 3, obj. 1 in.
”	”	fig. 6. 5th feet, ♀.	Oc. 3, obj. $\frac{1}{2}$ in.
”	”	figs. 7, 8. 5th feet, ♂.	Oc. 3, obj. $\frac{1}{2}$ in.

PLATE VI.

<i>Paralabidocera hodgsoni</i> ,	fig. 1.	♀, last thoracic segment and abdomen.	Oc. 3, obj. $\frac{1}{2}$ in.
”	”	fig. 2. Whole animal, ♀.	Oc. 3, obj. $\frac{1}{2}$ in.
”	”	fig. 3. 5th foot, ♀.	Oc. 3, obj. $\frac{1}{2}$ in.
”	”	fig. 4. 4th foot, ♀, exopodite.	Oc. 3, obj. $\frac{1}{2}$ in.
”	”	fig. 5. 1st foot, ♀.	Oc. 3, obj. $\frac{1}{2}$ in.
”	”	fig. 6. 2nd foot, ♀.	Oc. 3, obj. $\frac{1}{2}$ in.
”	”	fig. 7. Posterior antennæ, ♀.	Oc. 3, obj. $\frac{1}{4}$ in.
”	”	fig. 8. Maxilla, ♀.	Oc. 3, obj. $\frac{1}{4}$ in.
”	”	fig. 9. Mandible, ♀.	Oc. 3, obj. $\frac{1}{4}$ in.
”	”	fig. 10. Anterior foot-jaw, ♀.	Oc. 3, obj. $\frac{1}{4}$ in.
”	”	fig. 11. Terminal lobes of post-footjaw, ♀.	Oc. 3, obj. $\frac{1}{4}$ in.
”	”	fig. 12. Whole animal, ♂.	Oc. 3, obj. $\frac{1}{2}$ in.
”	”	fig. 13. 5th feet, ♀.	Oc. 3, obj. $\frac{1}{2}$ in.

PLATE VII.

<i>Xanthocalanus magnus</i> ,	fig. 1.	Whole animal.	Oc. 3, obj. 2 in.
”	”	fig. 2. Rostrum.	Oc. 3, obj. 1 in.
”	”	fig. 3. Posterior foot-jaw.	Oc. 3, obj. 1 in.
”	”	fig. 4. Anterior foot-jaw.	Oc. 3, obj. $\frac{1}{2}$ in.
”	”	fig. 5. Posterior antenna.	Oc. 3, obj. 1 in.
”	”	fig. 6. Maxilla.	Oc. 3, obj. $\frac{1}{2}$ in.
”	”	fig. 7. 1st foot.	Oc. 3, obj. 1 in.
”	”	fig. 8. 2nd foot.	Oc. 3, obj. 1 in.
”	”	fig. 9. 5th foot.	Oc. 3, obj. $\frac{1}{2}$ in.
” <i>antarcticus</i> ,	fig. 10.	5th foot.	Oc. 3, obj. $\frac{1}{4}$ in.
”	”	fig. 11. Posterior foot-jaw.	Oc. 3, obj. $\frac{1}{2}$ in.

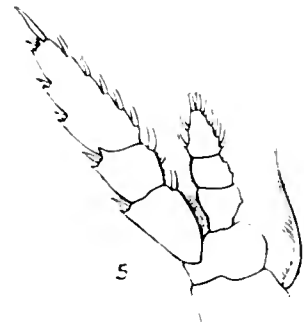
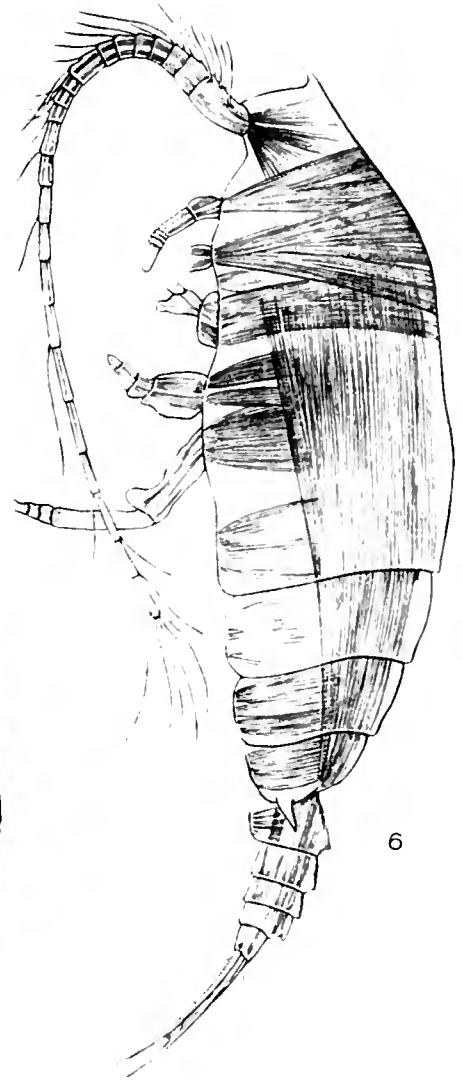
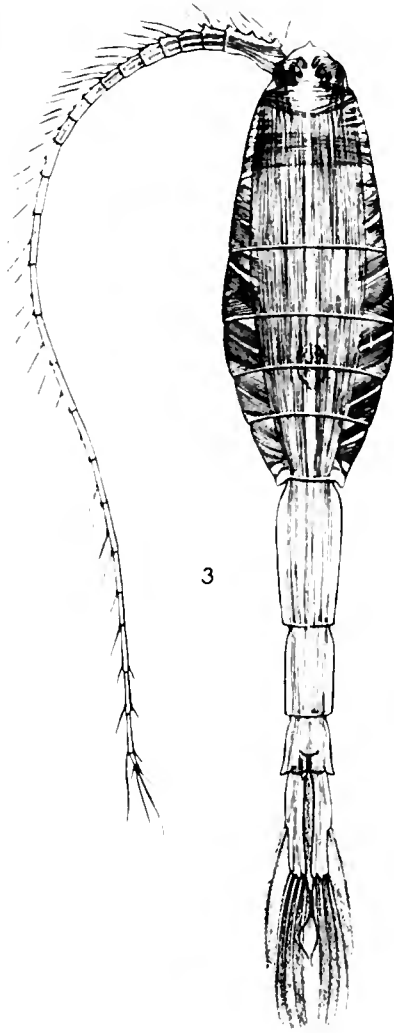
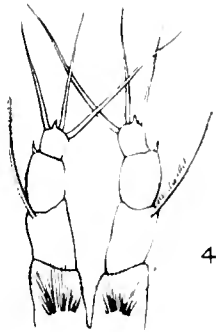
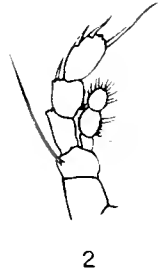
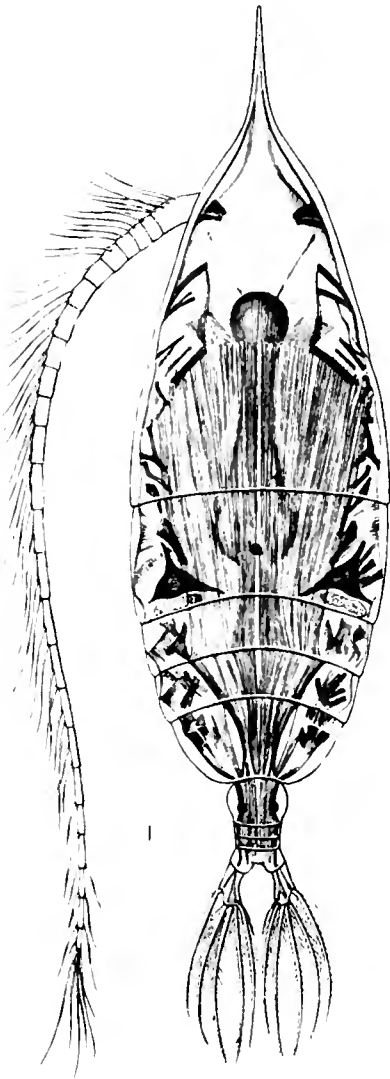

Antarctic (Discovery) Exp.

Marion Lees del. Butterworth sc.

Copepoda pl. III.

Haloptilus ocellatus (1, 2).
Metridia princeps (3-5).
Gaetanus antarcticus (6).

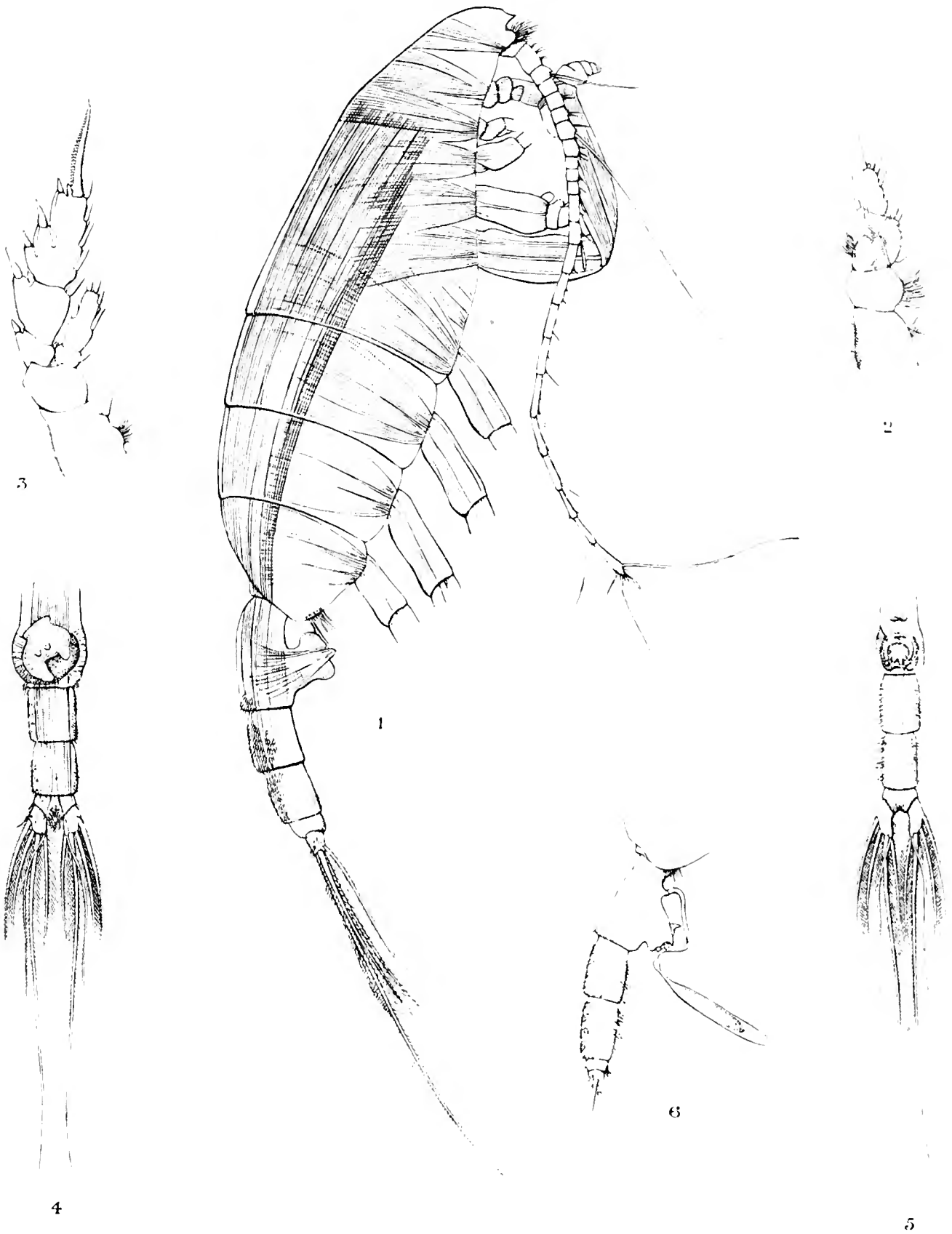

Antarctic (Discovery) Exp.

from U.S.S.R. - Butterworth's

Copepoda pl. IV.

Euchaeta similis (1-4)
 ,, *antarctica* (5, 6)

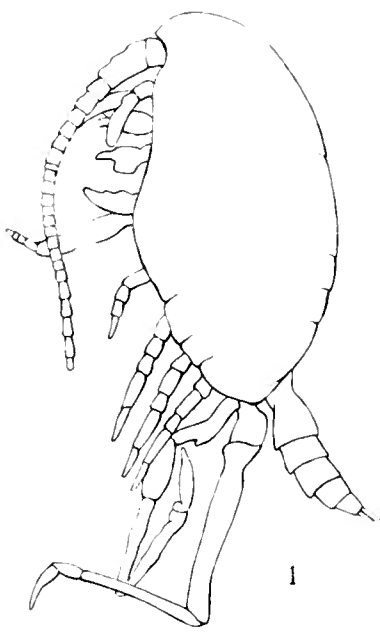

1

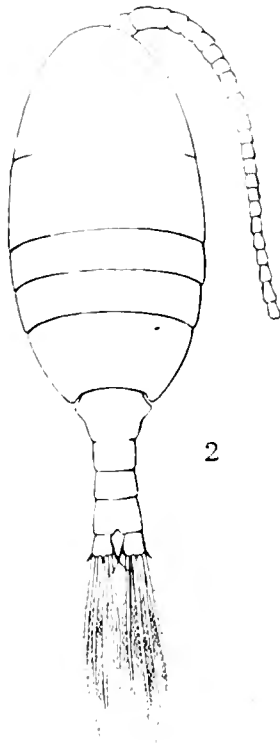

2

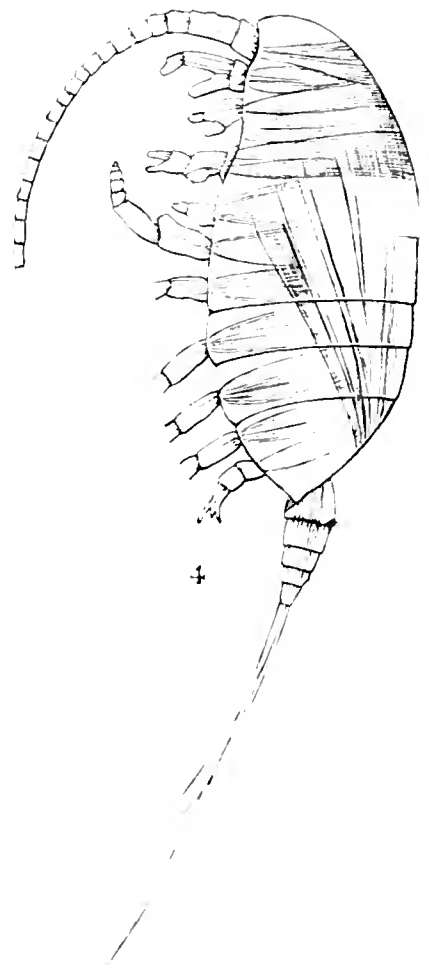

4

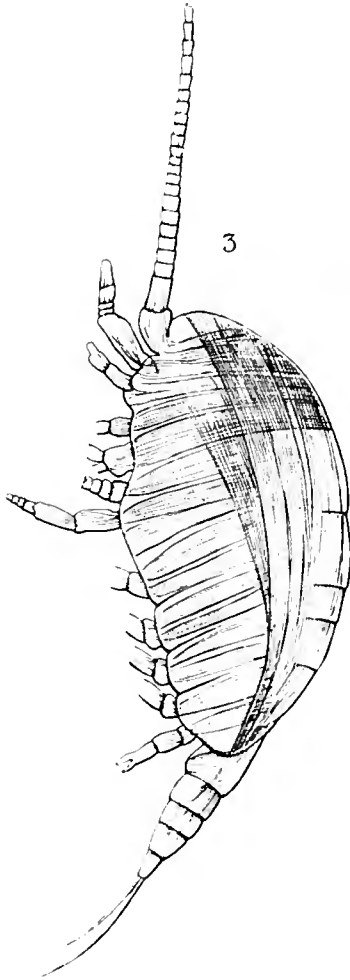

3



6

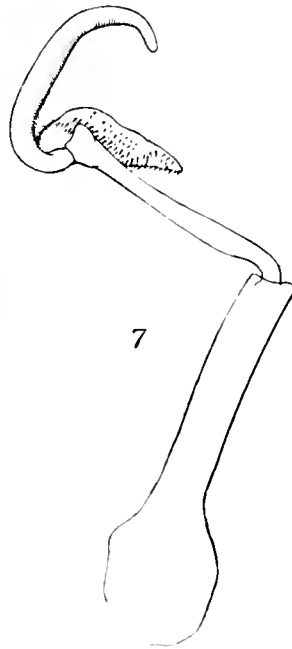

7

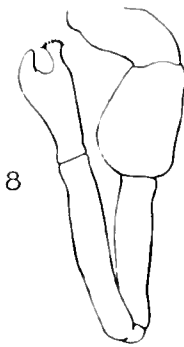

8

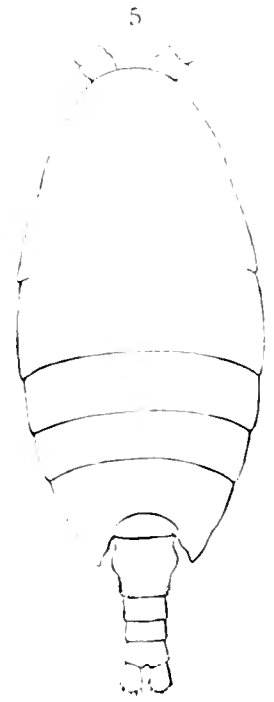

5

Antarctic (Discovery) Exp.

Marion Lees del. J. G. S. Entwistle sc.

Copepoda pl. V.
Stephus longipes (1-3).
 " *antarcticum* (4-8).

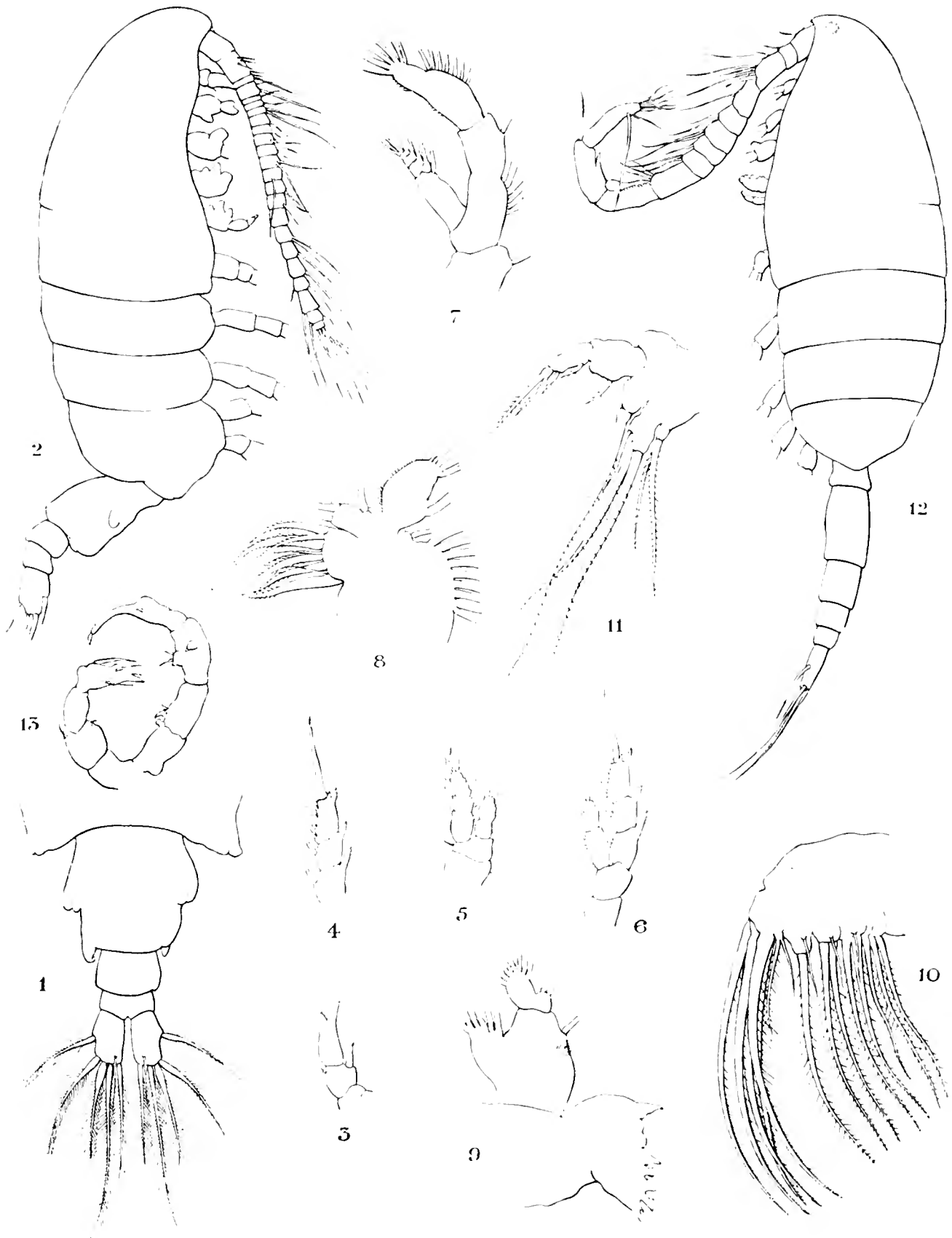

Antarctic (Discovery) Exp.

Marion Lees del. Lutterworth sc.

Copepoda pl. VI.
Paralabidocera.



Antarctic (Discovery) Exp.

Mission Log del ...

Copepoda pl. VII.

Xanthocalanus magnus (1-9)
 .. *antarcticus* (10, 11)

ECHINODERMA.

I.

By F. JEFFREY BELL, M.A.

Emeritus Professor and Fellow of King's College (University of London).

(5 Plates.)

HAD it not been for the earlier return of the 'Gauss,' this report would probably have had the distinction of signalling the re-discovery of the interesting Crinoid genus, *Promachocrinus*, which, as its name denotes, was one of the prizes of the voyage of the 'Challenger.'

As in the collection of the 'Southern Cross,' I am again able to call attention to some remarkable variations within what are obviously the limits of single species. The specimens which exhibit these variations could not have been obtained but by very careful collecting, and in the case of *Cyathra* it is of importance to note that they were all taken in a comparatively small area; the examples of this genus received by two naturalists, who made a number of species with them, were all taken from stations comparatively close to one another,* but it is to be hoped that such a course will never be taken again; evidence as to the variability of species of Echinoderms is now beyond question.

A.—ANACTINOGONIDIATA.

I. HOLOTHURIOIDEA.

The collection of Holothurians is small, and the points of greatest interest are revealed by Prof. MacBride and Mr. Simpson in their valuable report on the larvae, which follows this memoir.

CHIRIDOTA.

I submitted an example of a form taken at 100 fms., off Coulman Island, to Prof. Ludwig, who has made Antarctic Synaptids one of his special domains. Owing, apparently, to the unfortunate use of formol the spicules are so disintegrated that a definite judgment is impossible, but it seems probable that the species is *C. pisanii* or allied thereto.

* It is true that *C. simplex* was found at Trinidad Channel, and the 'Challenger' specimens on the eastern side of Patagonia; but he who will look at a map of South America will smile at a "Chorological Synopsis of the species" which gives three to the Atlantic and one to the Pacific.

CUCUMARIA CROCEA.

Holothuria (Cucumaria) crocea, Lesson, Cent. Zool. (1832), p. 153, pl. lii. fig. 1.

Cucumaria crocea,* Ludwig, Hamb. Magalh. Sammelreise, Holothurien (1898), p. 15 *ibique citata*.

In the succeeding memoir by Prof. MacBride and Mr. Simpson there will be found an interesting account of the brood-pouches and young of this form. It was taken at Coulman Island, 100 fms., and on various dates at Winter Quarters down to 41 fms.

CUCUMARIA LAEVIGATA.

Pentactella laevigata, Verrill, Bull. U.S. Nat. Mus. i. 3 (1876), p. 76.

Cucumaria laevigata, Ludwig, *op. cit.*, p. 32 *ibique citata*.

The characters of these two species have been fully discussed by Prof. Ludwig, and it is quite unnecessary for me to enter again on the subject.

Taken in Winter Quarters to 41 fms. and in McMurdo Bay.

Several distorted *Cucumariæ* and some young were taken at various dates while at Winter Quarters, and at 78° 25' 40" S., 185° 39' 06" E.

PSEUDOPSOLUS FERRARI.

(Plate V., fig. 3.)

It is unfortunate that this new species should be represented by a single specimen only, but there is no doubt that it is unlike any form that has as yet been described.

Tentacles ten, two much smaller than the rest; trivial pedicels in three complete longitudinal series; dorsal perisome devoid of large scales or grains, flexible and soft to the touch, and having only a few trellis-like spicules. There are some distinct pedicels scattered on the dorsal surface. 73 mm. long, 32.5 mm. greatest width.

The important differences between this species and the only form belonging to the genus which has yet been described are of varying value; the distinctness of the dorsal pedicels is of great significance, for their presence in *P. macquariensis* is so inconspicuous that Prof. Dendy denied their existence, on which Prof. Ludwig has remarked "Zu einer Entschuldigung will ich aber gleich hinzufügen, dass die dorsalen Füßchen sehr gering an Zahl und sehr retraktil sind, sodass sie sich der Beobachtung leicht entziehen können." †

The spicules are more delicate and trellis-like in the new species, and there is a

* In my 'Southern Cross' Report I cite Wyv. Thomson as the first author of the combination "*Cucumaria crocea*"; he wrote *Cladodactyla crocea* in 1876 (not 1878, and not on p. 55); as all my blunders were made by Dr. Lampert in his "Seewalzen." I stand convicted of neglecting the legendary advice of the venerable gentleman who was once President of my College at Oxford.

† Hamburger Magalh. Sammelreise Holothurien (1898). p. 49.

very considerable difference in size. As there is but a single specimen, I thought the question whether or no it is hermaphrodite might be left over for the present.

The only suggestion that I have to make is that Prof. Ludwig's definition of the genus (*op. cit.*, p. 50) should be altered by the omission of the words "Sehr wenigen," as applied to the dorsal "Füsschen."

As the type of the genus came from Macquarie Island, the two are not widely separated; no information is given as to the depth of the more northern species; the Antarctic form was taken at 20 fms., while at Winter Quarters.

THYONE sp.

A young specimen was taken off Cape Adare.

MESOTHURIA MAGELLANI.

Holothuria magellani, Ludwig, Ber. Oberhess. Ges. xxii. (1883), p. 175.

Mesothuria magellani, Oestergren, Festschrift für Lilljeborg (1896), p. 350; Ludwig, *Ergebn. Hamburg. Sammelreise Holothur.* (1898), p. 8.

Two much-injured specimens are assigned to this species; I was unable to find spicules, but I do not always expect to find specimens taken out of ice-cold water and from 100 fms. equal to the best products of the laboratories of Naples or Plymouth.

Coulman Island, 100 fms.

B.—ACTINOGONIDIATA.

II. CRINOIDEA.

COMATULIDAE.

PROMACHOCRINUS KERGUELENENSIS.

(Plate I.)

Promachocrinus kerguelensis, P. H. Carpenter, Proc. Roy. Soc. xxviii. (1879), p. 385.

This is certainly one of the most interesting finds of the 'Discovery,' for the genus was, till the German South Polar Expedition brought back specimens, only known from the collections of the 'Challenger,' which found two species in the Southern Seas, and one a few degrees north of the Equator. The only addition to our knowledge since Dr. Carpenter's report has been the note by Dr. Minekert of Greifswald,* while Dr. Bather has suggested that it may be a "permanent meristic variation."† I give a figure

* Zool. Anzeig. xxviii. (1905), p. 490.

† Treatise on Zoology iii. (1900), p. 195.

of a self-dissected specimen which is, I think, clearer and more illuminating than the originals of the 'Challenger' report. It would be of particular interest to discover fossil examples of this ten-rayed form; at present, all we can say as to the "permanency" of the form is that it has endured for thirty years; as to the polyphyletic origin of the genus which Dr. Bather suggests,* we can only say that we have only such data as are given by the distribution of the genus. Though Dr. Minckert had made two genera, he has not contributed to the elucidation of Dr. Bather's suggestion.

Taken at East end of Barrier, 100 fms.; off Coulman Island, 100 fms.; and at Winter Quarters.

ANTEDON ADRIANI.

(Plate II.)

This new species is represented by a number of specimens; as I have already named a member of the genus *A. wilsoni*, I take the specific name from the second Christian name of Mr. E. A. Wilson, M.B., surgeon and naturalist to the Expedition.

It was taken at various depths, down to 130 fms., at Winter Quarters, and at 500 fms. off Mts. Erebus and Terror.

At first sight this species does not recall the northern *A. eschrichti*, but it shows, on analysis, some striking points of resemblance—the shape of the centrodorsal, the length (but not the number of the cirri), and the shapes of their joints, as well as the form of the first brachial; but what distinguishes the creature from all *Antedons* known to me is the saw-like appearance of the arms when viewed from the side, and well shown in the figure; this is due to the presence of a well-marked square protuberance on the dorsal face of most of the arm-joints.

Arms ten, centrodorsal semicircular, with three rows of cirri; these are from 50–60 in number, may be 60 mm. long, and may have as many as 60 joints; the axillary has a prominent knob, and the outer edge of the first brachial is twice as long as the inner; the arm-joints are stout, laterally compressed, and nearly all have one or two dorsal spinous processes; syzygies are extraordinarily rare in the proximal part of the arm, where, too, the pinnules are rather short; further out they are better developed. No specimen is anything like perfect.

ANTEDON ANTARCTICA.

Antedon antarctica, P. H. Carpenter, Chall. Rep. Comatulæ (1888), p. 144.

I have compared a single specimen taken at Winter Quarters with those collected by the 'Challenger' at Heard Island, and have no doubt of their identity. Some young specimens, which appear to belong to this species, were also taken.

* Treatise on Zoology iii. (1900), p. 195.

III. ECHINOIDEA.

CIDARIDAE.

CIDARIS CANALICULATA.

Temnocidaris canaliculata, A. Agassiz, Bull. M.C.Z. i. (1863), p. 18.

Gonocidaris canaliculata, *id.* Rev. Echin. (1872), p. 131; Wyv. Thomson, Journ. Linn. Soc. xiii. (1876), p. 65; Loven, Bih. Svensk. Akad. Hdlg. xiii. iv., l. p. 5; Agass., Mem. M.C.Z. xxxi. (1904), p. 4.

Cidaris (Dorocidaris) canaliculata, Döderlein, Jap. Seeigel, i. (1887), p. 16.

Cidaris canaliculata, Meissner, Ergebn. Hamb. Magalh. Sammelreise, v. (1900), l., p. 3 *ibique citata*.

Stereocidaris canaliculata, Mortensen, Ingolf Echinoid. (1903), p. 29.

I have given the name of *C. canaliculata* to a number of specimens of an Echinoid, which were mainly collected at a depth of 100 fms., but I must own to grave doubts as to the correctness of the name. It seems to have escaped notice that this *consensu omnium* (with the exception of Dr. Mortensen*) circumpolar Antarctic form was first described from the "Caroline Islands," which Caroline Islands we surmise to be those in the Pacific, as in the Revision of the Echini we find "Caroline and Sandwich Islands"; elsewhere, Zanzibar and the Navigator Islands are given as habitats, "if the localities are to be trusted"; that is to say, the species was founded on specimens said to be found within the tropics.

I am not going to join those who claim that forms must differ specifically, either because they are found at different spots or different depths; but, as I showed many years ago, there is a distinct intertropical fauna in the Great Ocean,† and the fact, if fact it be, that a member of that fauna is also a circumpolar Antarctic form ought to rest on the firmest possible basis. Unfortunately, the National Collection has no examples from any station further north than Tasmania.

Again, the original diagnosis, based on the Caroline specimen or specimens, is too short for a form which every student who has examined it, except Dr. Mortensen, allows to be eminently variable; with the exception of Prof. Döderlein, none of these students has given a serious diagnosis of the species, and even his is not altogether what one wants.

Yet another difficulty remains to be mentioned; it is generally agreed that *C. nutrix*‡ and *C. vivipara* are synonyms of *C. canaliculata*; in other words, the form has a marsupial habit, but I cannot detect signs of it in the specimens before me; it may be, of course, as it curiously is in the case of *Hemiaster cavernosus*, that this collection consists of males only; but Mr. Hodgson tells me that he observed no signs of viviparous habit; our experience, in fact, is the same as that of the late Félix Bernard§: "Quoique *C. canaliculata* soit signalé comme vivipare, je n'ai pas constaté aucun jeune sur le corps des adultes."

* *Op. cit.*, p. 27.

† For some modification of this doctrine, see Prof. Koehler in "Die Fauna Sudwest-Australiens" I. iv. (1907), p. 242.

‡ Prof. Lyman Clark doubts this (see f.-n. next page); of *C. vivipara* of Studer he makes no mention.

§ Bull. Mus. Paris, i. (1895), p. 272.

Specimens were taken at Coulman Island, 100 fms. ; Winter Quarters, 100 fms. ; East end of Barrier, 100 fms.

This species is one that has lately been the subject of some dispute ; Prof. Agassiz,* who originally described it, suggests that it be placed in a new sub-genus *Centrocidaris*, while Dr. Mortensen † finds it to consist of several species, but he does not appear to be sure of the exact number. ‡

ECHINIDAE.

ECHINUS MARGARITACEUS.

Echinus margaritaceus. Lamk. An. s. V. iii. (1816), p. 47 ; Bell, Coll. 'Southern Cross' (1902), p. 219 *ibique citata* ; Mortensen, Ingolf Echinoid. (1903), p. 101.
Echinus diadema, Studer, MB. Akad. Berlin (1876), p. 456 ; Al. Ag. Chall. Rep. Echin. (1881), p. 117.
Echinus horridus. Al. Ag. *op. cit.* p. 117 ; Mortensen, *op. cit.* p. 102.
Sterechinus antarcticus, Koehler, Echin. Voy. 'Belgica' (1901), p. 8.

This appears to be a circumpolar species, as I remarked when I reported on the collections of the 'Southern Cross.' It was taken by the 'Discovery,' not only at several dates in Winter Quarters, but at the East end of the Barrier Reef, 100 fms. ; at Cape Wadsworth, 8-10 fms. ; off Coulman Island, 100 fms. ; and South of Antarctic Circle, 254 fms.

HEMIASTER CAVERNOSUS.

Spatangus (Tripylus) cavernosus, Philippi, Arch. f. Nat. xi. (1845), p. 345.
Hemiasler cavernosus, A. Ag. Rep. Ech. (1872), p. 132 ; Meissner, Ergebn. Hamburg Magalh. Sammelreise, v. (1900), p. 13 *ibique citata* ; Bell, Coll. 'South. Cross' (1902), p. 219.
Abatus cavernosus, Loven, Bih. Svenska Vet. Akad. Hdlgr. xviii. 4, no. 1, p. 3.

This species is not very well represented in this collection, and, curiously enough, all the examples are males.

If the late M. Bernard § was right in regarding *Tripylus excavatus* as a synonym, the name of the species ought to be *excavatus*, as that was the first of the three species described by Philippi ; for myself I am inclined to abide by Prof. Agassiz's view.

Taken at Coulman Island, 100 fms. ; Winter Quarters, 20 fms. ; and East end of Barrier Reef, 100 fms.

IV. ASTEROIDEA.

The collection of starfishes was rather large, and contained some very fine specimens ; but, as will be shown later, there is very great difficulty in coming to definite conclusions regarding them, and I have preferred to be vague rather than dogmatic in treating of them.

* Mem. Mus. Comp. Zool., xxxi. (1904), p. 32.

† Ingolf Echinoid. (1903), pp. 25-7.

‡ As the final proof was passing through the press I received Prof. Lyman Clark's latest memoir on the *Cidaridae* (Bull. Mus. C. Z. li. (1907), no. 7) ; he has instituted a new genus, *Austrocidaris*.

§ Bull. Mus. Paris, i. (1895), p. 247.

ASTERIAS BRANDTI.

Asterias brandti, Bell, Proc. Zool. Soc. (1881), p. 91.

Asterias neglecta, id. op. cit. pp. 94 and 506.

Dr. Meissner has suggested that *A. neglecta*, which I described at the same time as *A. brandti*, is the same species. I think he is right; *A. belli* of Prof. Studer and *A. glomerata* of Sladen appear to be also synonymous; with regard to the first three Prof. Perrier suggested the same view in 1891.

My species were described on pp. 91 and 94 of the Proc. Zool. Soc. for 1881; Dr. Meissner's synonymy will be found on p. 7 of the *Ergeb. Hamburg Magalhan. Sammelreise*, Lief. vii. (1904). I suggested in the report on the 'Southern Cross' collections (p. 215) that the species was circumpolar in its distribution, and so it certainly is.

A large number of specimens were collected; the largest, from 4–10 fms. McMurdo Bay, was the "mother of a number of young after capture" *; and some other large specimens were taken at No. 3 hole, and some smaller at No. 11. Flagon Point (10–20 fms.), Cape Wadsworth, and Hut Point also yielded examples; the large examples marked 48 and 49 are only said to be from Winter Quarters.

From 100 fms. (East end of Barrier) and 130 fms. (No. 2) specimens were collected which, but for the formidable synonymy of the species, I should be inclined to regard as distinct.

ASTERIAS LONGSTAFFI.

This fine species is represented by a single specimen, which presents well-marked features. I name it after the generous friend of science whose contribution to the funds of the Royal Geographical Society made the voyage of the 'Discovery' possible.

A large stout form with R about equal to $3r$; the whole of the dorsal surface is uniformly and densely covered with paxilliform spines of some size. The madreporite is of moderate size; the podia are enormous, the adambulacral spines are long, cylindrical, blunt at the tip, so irregularly set that it is difficult to say whether there are two or three rows; beyond them there are shorter and more delicate, but otherwise similar cylindrical spines very closely set; there are two quite well-marked sets of marginal plates; the inferomarginals are very narrow in the angle of the arm, while the superomarginals in the same region are very short; both sets are covered with coarse granules, among which no pedicellariæ are to be detected. The podia within the oral circle are of enormous size. $R = 210$; $r = 70$.

W.Q.; 10–20 fms.

As there is only a single specimen, no comparisons are possible; but it may be

* These have been made the subject of an interesting separate report by Prof. MacBride and Mr. A. C. Simpson.

pointed out that the closely packed arrangement of the podia, and the distinctness of the two rows of marginal plates are, on Mr. Sladen's basis of classification of Starfishes, mutually destructive; but the well-known observations of Prof. Ludwig on *Echinaster sepositus* justify us in supposing that we have here a case of retarded disappearance of the marginals; the crowding of the podia appears to be a much more important morphological character; but the union of these two strikes, I think, a final blow at the current classification, against which Prof. Ludwig has already raised his voice, and the adoption of which by MM. Delage and Hérouard in their "Zoologie Concrète" came as a great surprise to me.

HEURESASTER* HODGSONI.

(Plate III.)

Two specimens of a very fine starfish were taken at about 25 fathoms while in Winter Quarters; they appear to me to form the type of a new genus, as to the general position of which there can be little doubt; a still larger specimen was taken from McMurdo Bay at 2 fms.

It has somewhat the appearance of *Porania*, but has, in the larger examples, spines in the interambulacral actinal areas. Prof. Perrier defines the Poraniidae as follows: "Squelette masqué par les téguments; marginales apparentes, mais formant au corps un bord tranchant; squelette ventral formé de séries de plaques allant de chaque adambulacraire à une marginale, squelette dorsal reticulé."

I have invented for it a name which will remind the student both of the name of the ship, and of its indefatigable biologist.

The larger specimens may be thus described: Arms long, tapering to a rather fine point, R is about = 3. The upper surface is smooth and soft to the touch, and has papulae, in ill-defined areas, spread over the whole of it; the edge is quite sharp, forming almost a ledge, and made up by a large number of small supero- and infero-marginals. The lower interambulacra covered with some eight rows of small regularly set plates covered with rather coarse granules, and, in the angle, with short spines which give a hairy appearance to these areas. The ambulacral groove is bounded by rows of four or five spines, of which the outermost is small and the innermost spatulate and fluted at its free end. The podia are stout. At each oral angle there is a huge spine, the distal third of which is glossy. These specimens are flat, but the smallest example has the disc arched, and this is probably more natural--

$$R = 200 \quad r = 70.$$

$$R = 130 \quad r = 50.$$

$$R = 90 \quad r = 30.$$

Accepting Prof. Perrier's family diagnosis of the *Poraniidae*, we may make the generic diagnosis of *Heuresaster*: Abactinal surface only invested by integument,

* *Εύρηστος*, discovery.

margin very sharp, the inner actinal ambulacrals with spines, the oral angle provided with a large spine. While the specific characters would appear to be that the longer radius is more than twice as long as the shorter radius, the marginal plates are very numerous, and the innermost ambulacral spine is spatulate and fluted at its free end.

The smallest specimen has not quite acquired the generic characters of the larger; the abactinal integument is not so thick as to altogether hide the superficial granules, and the granules on the actinal interambulacra have not developed into spines, so that there is no marked difference between the outer and the inner parts of these areas.

PENTAGONASTER INCERTUS.

The single small specimen, is, I think, an ally of the Australian species of *Pentagonaster* (*sens. lat.*), but the arms are proportionately longer than they generally are in this genus; it is, possibly, an immature specimen in which R would gradually increase in proportion to r . If it should prove to be an adult, its proportions may be compared to those of *P. duebeni* and *P. gunni*; it is, however, to be distinguished by the fact that there are no large plates on the actinal inter-radial areas, the plates being of the character of, and a little larger than, the small squarish granular plates which bound the marginals; these last number about 12/14 for the side of each arm, and are completed by a large terminal; there are two rows of well-developed spines at the sides of the ambulacra; those of the inner row are nearly twice as long and as numerous as the outer. I propose to call this form *Pentagonaster incertus*; it was taken at 96-120 fms., in MacMurdo Bay.

LEPTOPTYCHASTER KERGUELENENSIS.

Leptoptychaster kerguelenensis, E. A. Smith, Phil. Trans. 168 (1879), p. 278, pl. xvii. 2; Sladen, Chall. Rep. Ast. (1889), p. 184; Bell, Mar. Invert. S. Africa iii. (1905) p. 242.
Leptoptychaster antarcticus, Sladen, *op. cit.* p. 190.

I must own to some temerity in associating a specimen in which $R = 212$ and $r = 58$ with a species whose type had $R = 38$ and $r = 12.5$, and a representative of which, hardly much larger, was found to be bearing young; but even the most recent writers on Echinoderms have not yet promulgated the doctrine that difference in size is a specific character, though I am not quite sure that in practice they do not sometimes act as though they had. However, one has only to get a clear idea of the essential characters of this genus to feel sure that one has it here; as to specific characters, it is first to be said that most of the *L. kerguelenensis* material is badly preserved, while the condition of *L. antarcticus* is particularly good. Though the differences between the two species appear, from Mr. Sladen's lengthy description, to be considerable, it will, I think, be found on examination of the specimens preserved in the Museum, that *L. antarcticus* is but the expression of some early stages of *L. kerguelenensis*. It will be remembered that both "species" come from closely adjacent localities. At any rate, we now know that the specimens of *L. antarcticus*

are small, and that the known adults of the genus are large; it is safe, therefore, to conclude that this specific name may be made a synonym.

Mr. Hodgson collected some quite young examples chiefly in W.Q., and, with the specimens sent by the Government Biologist at the Cape of Good Hope, we have now a very satisfactory series; it was also taken at McMurdo Bay, 96–100 fms.

CYCETHRA VERRUCOSA.

(Plate V., fig. 1.)

Goniodiscus verrucosus, Philippi, Arch. f. Nat. 1857, p. 132, *teste* Meissner, Zool. Anz. xxi. (1898), p. 394. *Cycethra simplex*, Bell, Proc. Zool. Soc. 1881, p. 96; *id.* Coll. 'Southern Cross,' 1902, p. 215 *ibique citata*.

I was much to blame for neglecting or forgetting, in 1902, Dr. Meissner's very useful note; the alteration of the name is not, of course, of the least importance to any sensible human being, but the knowledge that the species extends nearly as far north as Valparaiso is of great interest and significance, for it shows us that the distribution is far wider than we supposed; had Dr. Leipolt (Zeit. f. wiss. Zool. lix. (1895) p. 602) known of it, he would have spoken with less point than he did, when he doubted Prof. Studer's locality of 38° 10' S.

The variations of this species are truly bewildering; I have had an extreme form figured, and offer a slight account of it; it was long before I could convince myself that it is *C. verrucosa*, and I am doubtful as to convincing others.

The upper surface is uniformly covered by delicate spines which end in a few, not more than ten, paxilli; the space between these spines is soft and membranous; the lower surface is densely covered with spines of moderate length and sharp at the tip; the spines bordering the ambulacral grooves are somewhat irregularly arranged, but are longer and blunter than those that crowd the interambulacral spaces; there is a single glossy spine at each angle of the mouth. The two rows of marginal plates are well defined, and the paxilli are somewhat longer and more numerous than those on the upper surface of the body. The madreporite is very prominent and is not far from the centre; close to this last there is a small tuft of white spines which, I suppose, guard the anus. Colour, light creamy yellow; body flat; $R = 55$; $r = 20$.

Examples were taken on various dates at Winter Quarters; off Castle Rock, 14 fms.; Cape Wadsworth; Coulman Island; McMurdo Bay, 20 fms. It does not appear to inhabit deep water.

HENRICIA ORNATA.

Echinaster (Cribella) ornatus, Perrier, Ann. Sci. Nat. xii. (1869), p. 251. *Henricia ornata*, Bell, Mar. Invert. S. Africa, iii., (1905) p. 250.

H. ornata is recorded by Sladen from Campbell Island; his *H. simplex*, which is a synonym, was taken off the Crozets, Marion Island, etc.

One specimen was obtained off Coulman Island, 100 fms.; one from 4–10 fms. McMurdo Bay; and three from 96–120 fms., in the same bay.

SOLASTER OCTORADIATUS.

Solaster octoradiatus, Ludwig, Voy. 'Belgica,' Seesterne (1903), p. 25, pl. iii.

A single specimen of this species was taken at 100 fms., off Coulman Island. As the 'Belgica' took it at four stations between 80° and 88° West, it is, perhaps, a circumpolar species.

Two specimens of Starfish remain to be noticed, which I shall not name, as I feel confident that they have undergone some change either in formalin or otherwise, or are abnormal specimens which will not be again found; one English naturalist has so burdened the literature of Starfishes with generic names based on immature specimens that I may be pardoned for not following in his footsteps.

Both of these specimens are very soft to the touch, owing to the numerous large papulae and the apparent absence of any hard parts on the upper and lower surfaces of the Starfish, with the exception of a large and prominent madreporite, and of a few spicules round the vent; the ambulacral grooves are wide, and the podia of large size; there are two well-marked rows of spines, the more proximal of which are blunter and more flattened than the more distal; beyond the outer row there is some slight difference in the two specimens, for in one the integument rapidly becomes smooth, while in the other regular rows of spines may extend as far as the margin. I have not seen any pedicellariae.

The "register numbers" of these two specimens are: 1906. 1. 22; 2 & 3.

V. OPHIUROIDEA.

Though the collection of Brittlestars is large, there are not many species; the two new genera signalled by me in the report on the 'Southern Cross' collection are both well represented, and of *Ophiosteira* there is so remarkable a variety that I am constrained to add another figure to those that I have already published. There are many small immature forms which will be of much use in studying the evolution of species, but to which it would be most unwise to give definite systematic names; as it is, I am perhaps a sinner, though not so great as some, for I should be hard put to it to defend myself against the suggestion of MM. Delage and Hérouard,* that *Ophiocrone* is a young *Astrophyton*.

OPHIURA KOEHLERI.

Like *O. flagellata* of Lyman, in having the disc covered with smooth skin, in which, in neither of the two specimens, are small scales distinctly visible; the lower arm spines are deeply imbedded in the skin, and thick skin obscures the forms of the

* Zool. Concrète iii. (1903), p. 159.

oral plates. The diameter of disc is 27 or 20 mm. ; no arm complete ; width of arm at base about 4 mm., upper arm plates broader than long ; about 7 arm spines, the upper free and pointed at their free ends, the lower shorter, imbedded in thick skin, and blunted at the tip ; lower arm plates with narrow distal and proximal edges. Arm insertion of disc well marked and guarded by about 15 spines, of which the median are distinctly the larger.

Colour in spirit : disc sickly white, arms more the colour of human flesh.

Taken at $67^{\circ} 21' 46''$ S., $155^{\circ} 21' 10''$ E. 254 fms.

I am sorry that both the specimens of this interesting species are a good deal broken, as I should have liked to have had something better to offer to the honour of the distinguished French naturalist who has done so much for our knowledge of Ophiuroids.

OPHIOZONA INERMIS.

Ophiozona inermis, Bell, Rep. 'Southern Cross' (1902), p. 217.

This species, which was not well represented in the earlier collections, was found on numerous dates during the stay of the 'Discovery' at Winter Quarters.

It exhibits a very wide range of variation, so great indeed as to have been at first quite bewildering ; and it may be noted that Mr. Hodgson did not recognise any of them as belonging to an already known Antarctic form.

In the 'Southern Cross' report I figured some of the remarkable variations in the arrangement of the plates of the dorsal surface of the disc of *Ophiosteira antarctica* ; a similar, but less striking, variation obtains in this *Ophiozona*. In *O. antarctica* I described the serrated and keeled appearance of the upper surface of the arm ; this is to be seen also in some examples of *O. inermis*. The most striking differences are to be seen in the height of the disc, and the size of the so-called radial shields ; so that it is by no means always true that the shields are inconspicuous.

Winter Quarters, 10-178 fms. (various dates) ; MacMurdo Bay, 96-120 fms. ; East end of Barrier, 100 fms. ; off Barrier, 300 fms. ; Coulman Island, 100 fms.

In some specimens the dorsal plates of the disc are deeply incised ; this appears to be due to want of sufficient calcareous matter, but as others are infested by a sponge it is possible that it is the cause.

OPHIOSTEIRA ANTARCTICA.

(Plate V., fig. 2.)

Ophiosteira antarctica, Bell, Rep. 'Southern Cross' (1902), p. 218.

It appears that the 'Southern Cross' did not exhaust the variations in the disc plates of this wonderful species ; the upstanding plates shown in Plate V., fig. 2, are worthy of record, and it may be noted that the single arm left to this disc has the dorsal serration extremely well marked.

In the original diagnosis of the genus I spoke of "a large keel-like plate on the disc, which completely overshadows the radial shields," although I was aware of and figured (Plate XXVI., fig. 3) an angle of the disc in which there appeared to be two large radial shields; in this case, however, three of the angles of the disc conform exactly to the diagnosis.

I have now before me a specimen in which all five angles have a pair of plates. Were it not for the 'Southern Cross' specimens it would not be possible to put this specimen with the genus *Ophiosteira* at all.

When we are asked whether "specific characters are useful," we may retort that generic characters even are not always constant.

Winter Quarters, 13 fms. Coulman Island, 100 fms.

OPHIONOTUS VICTORIAE.

Ophionotus victoriae, Bell, Rep. 'Southern Cross' (1902) p. 219.

This species was not so abundant; it was taken off the Barrier at 300 fms., near Franklin Island, and from 254 fms. at an unrecorded locality.

OPHIACANTHA IMAGO.

Ophiacantha imago, Lyman, 'Chall.' Rep. Ophiur. (1882), p. 186 *ibique citatum*.

I hope I am right in referring to this species specimens from Winter Quarters, 30 fms.; Hut Point, 77° 12' 12" S., 167° 27' W., 77° 50' 30" S., 165° 40' E., 100 fms.; but, in sooth, some of the 'Challenger' types of Ophiuroids are hardly mature.

OPHIACANTHA VIVIPARA.

Ophiacantha vivipara, Ljungman, Öfv. Vet. Akad. Forh. 1870, p. 471; E. A. Smith, Phil. Trans. 168 (1879), p. 278, pl. xvii. fig. 3.

A number of authors have mentioned this species, but, since Dr. Lütken was cited by Mr. Edgar Smith, L.S.O. (Phil. Trans., vol. 168, p. 278), as doubtful of Ljungman's original locality ("Altatum urbem mexicanam"), none seems to have remarked on the apparent peculiarity of the distribution of this species.

Prof. Théel has been so good as to let me see Ljungman's Altatan specimen, and at the same time to inform me that the types of Ljungman's *Ophiacantha vivipara* were brought home from two quite different localities, Altata and Falkland Islands. Ljungman does not give (*op. cit.*) the latter locality, but Lütken (Zool. Record 1872, p. 448), threw grave doubts on the Mexican origin of the specimens, and suggested that Patagonia was the "true habitat of the typical specimen." What is really more interesting is the question whether the brood-pouch habit of a given species is found in the confines of the tropics as well as in the colder waters of the globe.*

* For a list of the viviparous Echinoderms of warmer waters, and for their preponderance in Arctic and Antarctic Seas. *cf.* Ludwig, Zool. JB. Suppl. Bd. vii. (1904), p. 684.

The single* six-armed specimen taken by the 'Discovery' at 8-15 fms. off Cape Wadsworth is a good deal stouter than Ljungman's types, but I can see no reason for making it a new species; the arms of the young may be seen projecting from some of the bursae.

OPHIACANTHA COSMICA.

Ophiacantha cosmica, Lyman, Chall. Rep. Ophiur. (1882), p. 194 *ibique citatum*.

This widely spread species was taken on various occasions, but many of the specimens have been marked by me "immature"; in connection with this I should like to quote some words of Mr. Lyman: "The specimen just described is unusually large for this division of the genus, which leads me to think that the bulk of those now known are immature, and therefore to be treated with all the more caution."

Winter Quarters. Off Coulman Island, 100 fms. Off Barrier, 300 fms.

OPHIOCONIS ANTARCTICA.

Ophioconis antarctica, Lyman, Chall. Rep. Ophiur. (1882), p. 107 *ibique citatum*.

If I have correctly determined some specimens from Winter Quarters, the types of Mr. Lyman's are very far from reaching the size to which this form attains.

AMPHIURA BELGICAE.

Amphiura belgicae, Koehler, Res. Voy. 'Belgica' (1901), p. 27.

The Antarctic area appears to be the home of large specimens of *Amphiura*; not only did the 'Discovery' bring home several examples of what appear to be the species obtained by the 'Belgica,' but there is a single specimen off the Barrier at 301 fms., which has a disc diameter of 18 mm.,† and which can hardly, I think, be the fully adult example of the somewhat smaller specimens; but, as it is solitary, I hesitate to regard it as an undescribed species.

Several specimens of *A. belgicae* were taken at Cape Wadsworth, 8 to 15 fms., and off the Barrier at 300 fms.; the latter is, as already said, the locality of the single larger form. Like *Solaster octoradiatus*, *A. belgicae* is probably a circumpolar species.

YOUNG OPHIURID.

(Plate IV.)

I give some figures of a remarkable Ophiuroid, to which it is very difficult to assign a systematic place; it appears to be a young form in which some of the arm-plates are still not consolidated. The exceedingly large size of the bursal slits is perhaps only due to the mode of preservation.

Two specimens, both broken, were taken in Winter Quarters on 2. 1. 04, and two off Barrier.

* As there is but a single specimen this collection throws no critical light on Prof. Koehler's just-made suggestion that this species exhibits sexual limorphism; *cf.* Bull. Sci. France xli. (1907), p. 322.

† That is exactly the same as the disk diameter of *A. magnifica*, of which Prof. Koehler has lately published a brief diagnosis. See Zool. Anz. xxxii., p. 146 (17 Sept. 1907), but the species is not the same.

ASTROTOMA AGASSIZI.

Astrotoma agassizii, Lyman, Ill. Catal. Mus. C. Z. No. viii. II. (1875), p. 24.

Mr. Lyman calls attention to the coarse granulation on his single specimen, which came from the Straits of Magellan; the series now collected shows that the granulation may be more or less obscured by thick skin. It is remarkable that the species was not collected by the 'Gauss.'

McMurdo Bay, 96-120 fms.

Specimens from off Coulman Island, and from $77^{\circ} 12' S.$, $167^{\circ} 27' E.$, 2 fms. seem to be sufficiently different to be regarded as varieties.

DESCRIPTION OF PLATES.

ECHINODERMA.

PLATE I.

Promacochrinus kerguelensis.

- FIG. 1.—Disc and base of arms from the side to show the insertion of the cirri, and the form of the cirrus pit, and the shape of the disc. $\times 2$.
- FIG. 2.—Disc and base of arms from below; the central boss is more distinctly seen than in fig. 1. $\times 2\frac{1}{2}$.
- FIG. 3.—An arm from the side, $\times 3$; the roughened edges of the joints are well seen in this figure; the proximal pinnules only are completely shown.

PLATE II.

Antedon adriani.

General view of this Crinoid. $\times 2$.

PLATE III.

Heuresaster hodysoni.

X not quite $\frac{3}{2}$, seen from below, to show the breadth of the ambulacral grooves, their size and arrangement.

PLATE IV.

The young Ophiurid (see p. 14).

- FIG. 1.—Aboral view of disc and arm. $\times \frac{3}{4}$.
- FIG. 2.—Oral view of same. $\times \frac{3}{4}$.
- FIG. 3.—View of mouth to show arrangement of the oral and adjacent plates. $\times 8$.
- FIG. 4.—1st, 2nd, and 3rd upper arm-plates. $\times 10$.
- FIG. 5.—View of arm from above, at about its middle. $\times 10$.
- FIG. 6.—1st, 2nd, and 3rd lower arm-plates. $\times 10$.
- FIG. 7.—View of arm from below at about its middle. $\times 10$.

PLATE V.

- FIG. 1a.—Variety of *Cyathra* (see p. 10) from above; fig. 1b from below; both slightly reduced.
- FIG. 2a.—Disc of an *Ophiosteira* (see p. 12), magnified to show keel-like plates; 2a, seen from above; 2b, seen from the side.
- FIG. 3.—*Pseudopsolus ferrari*. $\times \frac{3}{2}$.

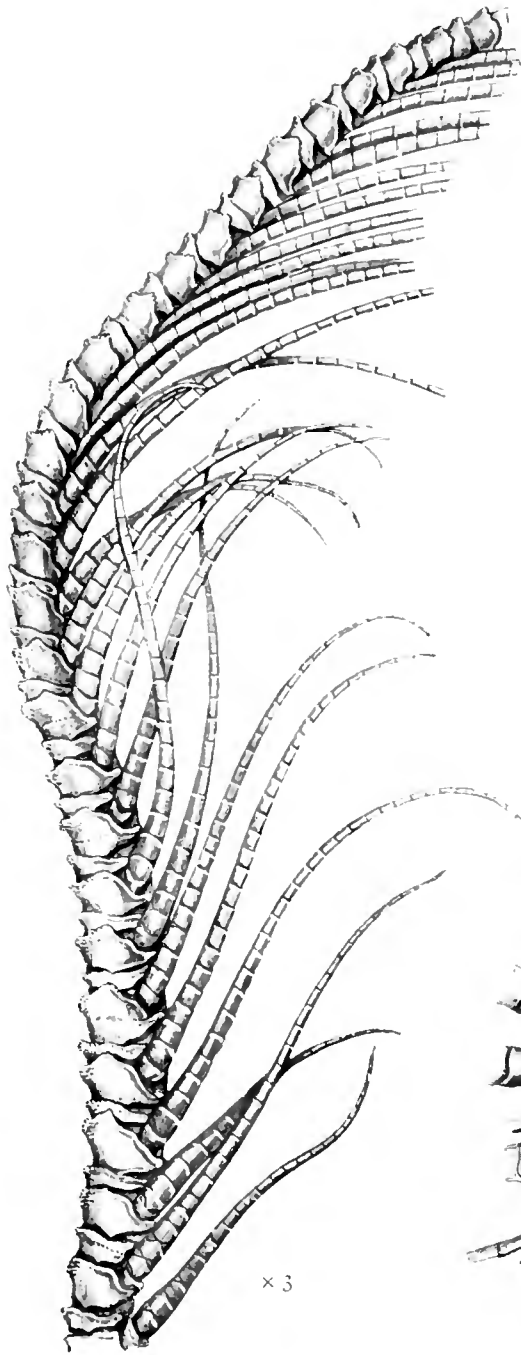

3

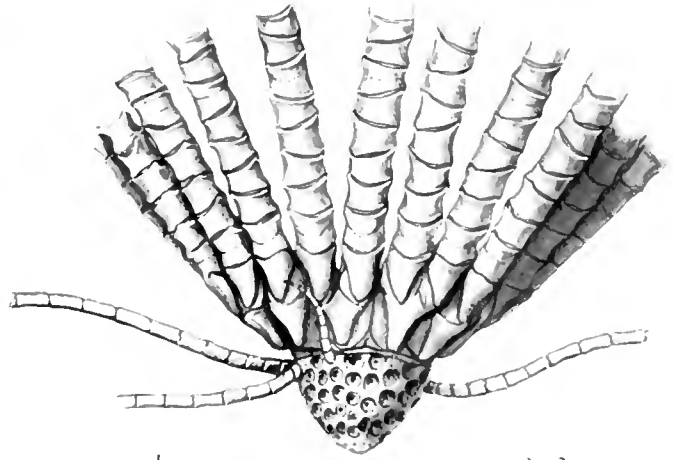

1

x 2

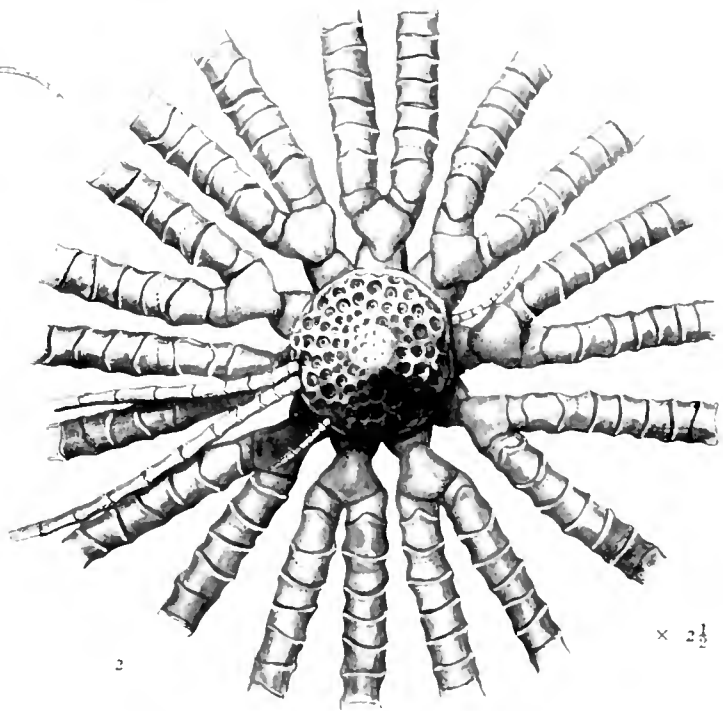

2

x 2 1/2

Antarctic (Discovery) Exp.

Echinoderma pl. I.

Berjeau del. Butterworth, sc.

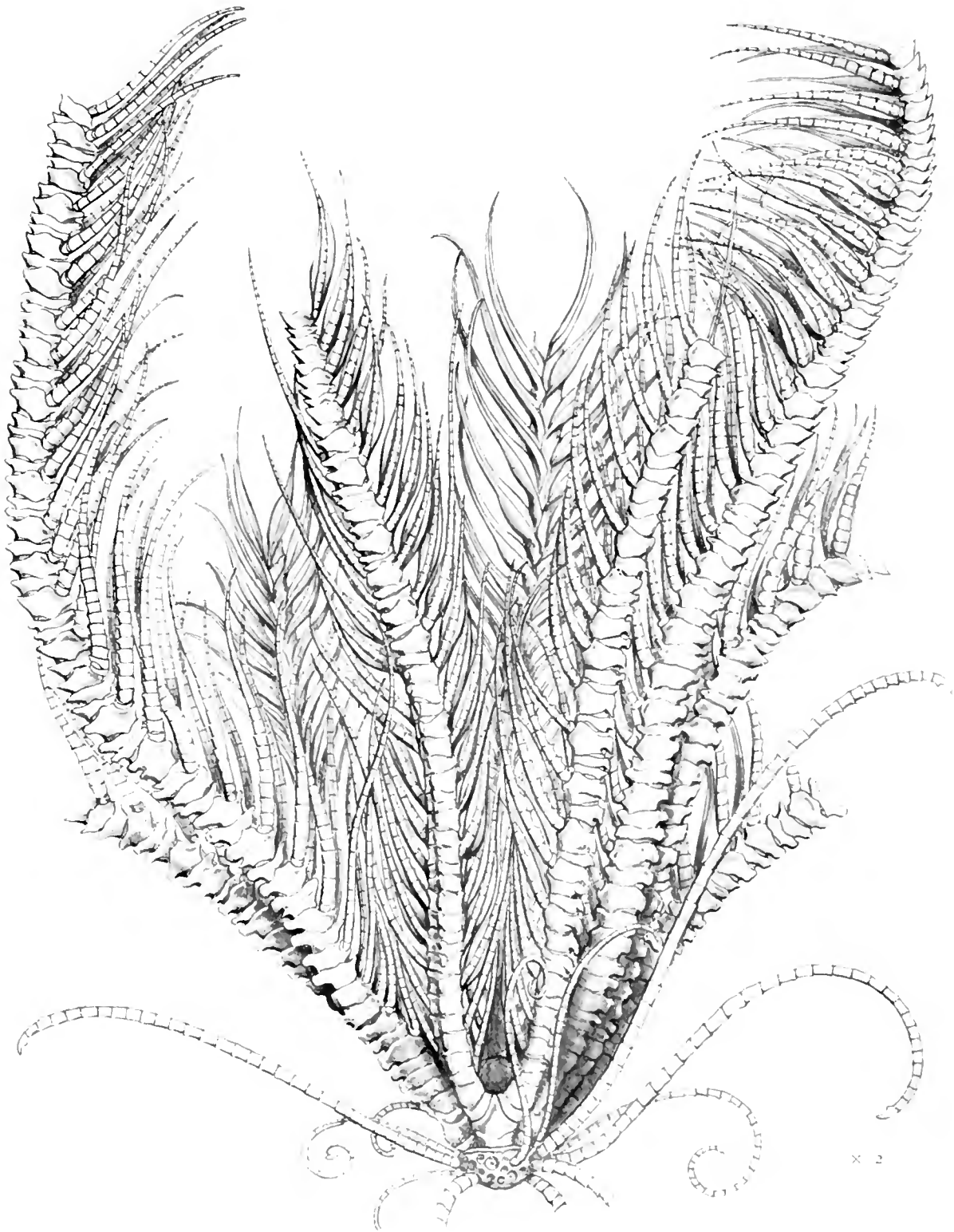

Antarctic (Discovery) Exp.

Echinoderma pl. II.

Berjeau del. Butterworth, sc.

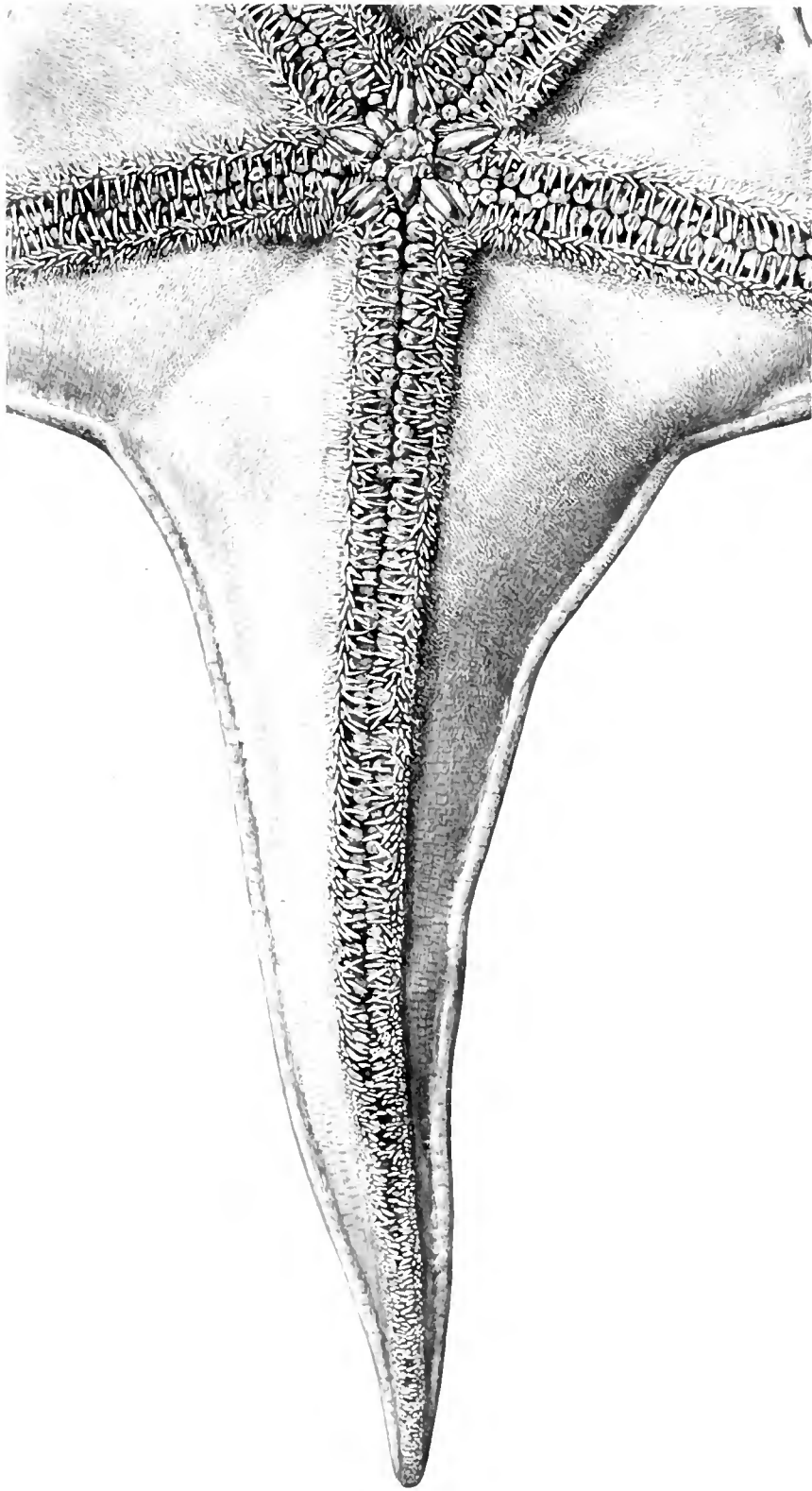

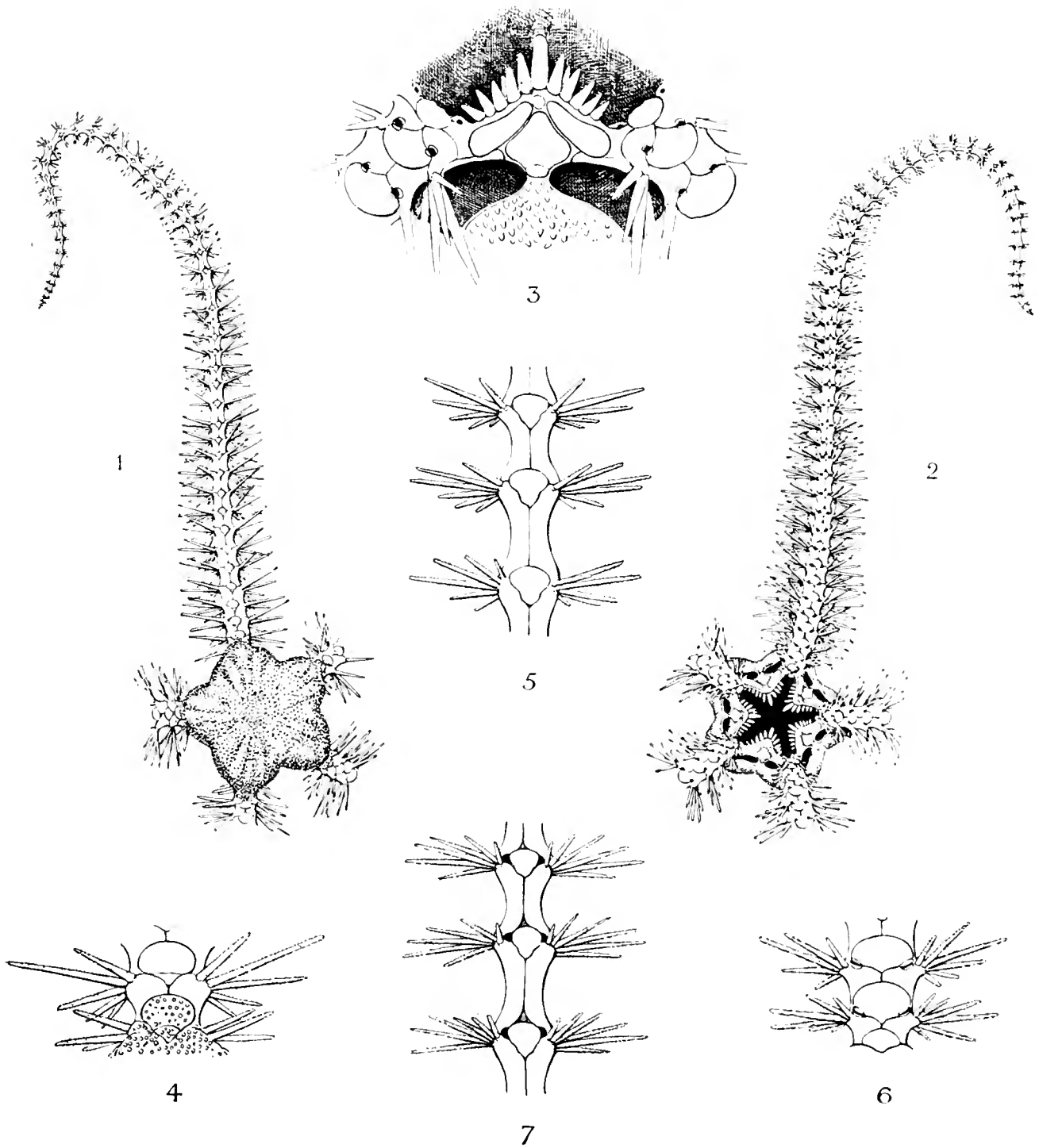

Antarctic (Discovery) Exp.

Eschscholtz del Butterworth sc

Echinoderma pl. IV.

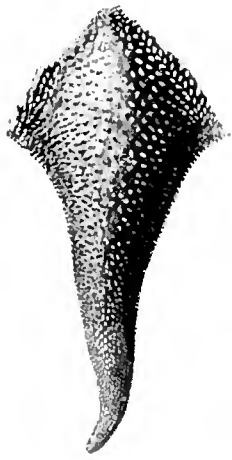

1a

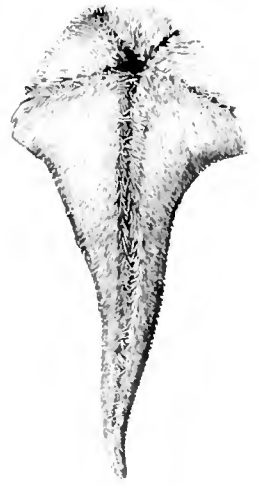

1b

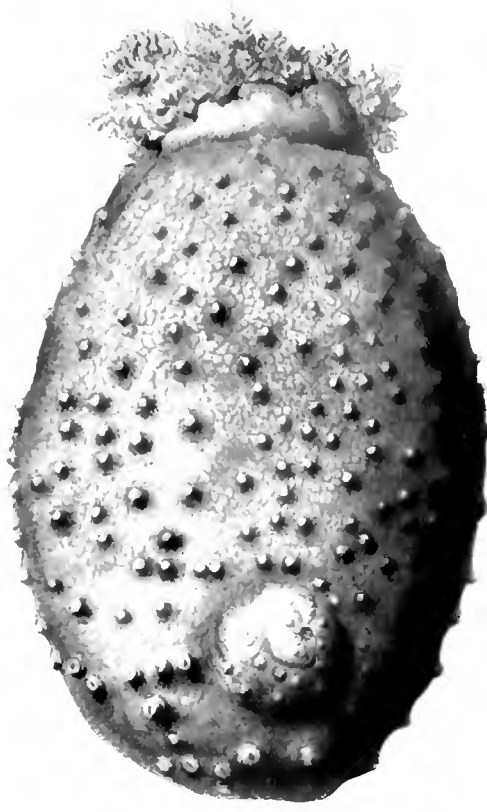

3



2a



2b

Antarctic (Discovery) Exp.

Terzi, del. Hath, del. Butterworth, sc.

Echinoderma pl. V.

ECHINODERMA.

II.—ECHINODERM LARVÆ.

By E. W. MACBRIDE, M.A., D.Sc., F.R.S., *Professor of Zoology, McGill University*; and
J. C. SIMPSON, B.Sc., *Demonstrator of Zoology, McGill University*.

(1 Plate.)

THE collection of larval Echinoderms brought back by the National Antarctic Expedition, when received by us from the authorities of the British Museum, was found to consist of forty tubes of material collected during the years 1902–1904. Of these forty tubes, however, by far the greater number contain nothing but early segmenting eggs showing no distinctive features; the present paper is, therefore, in reality based upon the contents of eight tubes only.

A preliminary examination showed that, though the collection contained but four species of Echinoderms, these differ widely from one another, there being one representative of each of the four great classes of the sub-phylum Eleutherozoa. These four species are: *Asterias brandti* Bell, *Cucumaria crocea* Lesson, a new *Echinopluteus*, and an *Ophiopluteus* which may also be new.

At first sight the *Asterias* seemed to promise much, for there were two tubes containing a couple of hundred specimens which had been born after the capture of the mother. More careful examination, however, disclosed the fact that they were all of approximately the same age, only two closely related developmental stages being represented. In the case of the *Cucumaria*, besides a number of new-born young, the collection contained an adult female which was the mother of some of them. To this specimen considerable interest attaches, from the fact that in it an unsuspected brood-pouch containing a great number of embryos was found. Of the two plutei it need only be said in this place that, since they are probably the first free-swimming Echinoderm larvæ found within the Antarctic Circle, they are not without considerable importance.

In the matter of preservation the material leaves much to be desired; but when one considers the difficulties of collecting under Antarctic conditions, it could hardly be expected that this could be otherwise. Of necessity the only preservatives used were formalin and spirit, and as neither of these is at all suitable to Echinoderm larvæ, the specimens show very little histological detail.

In examining the material it was found that the preservation of the plutei was such as to make sectioning useless, so they were studied *in toto*, first unstained, and then stained in eosin and mounted in balsam. This method was found to give very satisfactory results. The *Asterias* and *Cucumaria*, however, were treated quite differently. Selected specimens of these were first carefully drawn at a magnification

of $12\frac{1}{2}$ diameters by the aid of the camera lucida, and then, after double imbedding in celloidin and paraffin, were cut into serial sections and stained with Delafield's hæmatoxylin.

In the succeeding pages the four species will be taken up and described in detail.

I. ASTERIAS BRANDTI.

Asterias brandti, Bell, P.Z.S., 1881, pp. 94 and 506.

The young of this species contained in the collection consist in a brood "born after the capture of the mother," which was taken in McMurdo Bay, February 13th, 1902.

The parent was identified by Professor F. Jeffrey Bell as *A. brandti*, but as it was not sent with the embryos, nothing definite can be said as to its "brood-care," except that this species must now be added to the list of viviparous Asteroidea. It is probable, however, that according to the analogy of its family, the young are attached to the lips of the mother during the earlier stages of development.

All the embryos of this brood are of approximately the same stage; the difference between the youngest and oldest being simply a matter of size. The youngest is shown in Fig. 1, which gives a ventral view. It measures 2.4 mm. from the centre of the disc to the tip of the arms, while the radius of the disc is 1.5 mm. (R. = 2.4 mm., r. = 1.5 mm.). The only external trace of the embryonic condition is in the closed mouth and the small pre-oral lobe or larval organ. The oldest embryo is much larger than the preceding (R. = 3.2 mm., r. = 1.6 mm.), but apart from the smaller size of the pre-oral lobe there is little difference. Internally, too, there is little difference in the development of the organs, so that they may very well be described together.

As may be seen from the figure, metamorphosis is complete in these young starfish, and an examination of serial sections shows that the internal organs have nearly all attained the adult relations. As these relations are, moreover, practically the same as those in a young *Asterina gibbosa* of the same stage, it will only be necessary to mention here the few points which show peculiarity.

In the first place it will be noticed that the great size attained before the mouth and anus are formed must be looked upon as an expression of the favourable conditions under which development of this species proceeds. Another indication of the same thing may be seen in the amount of yolk which still remains in the closed gut, and which may even be seen outside the gut in the space between its dorsal wall and the inner wall of the coelom.

The pre-oral lobe (larval organ) in the oldest stage is little more than a vestige, but in the youngest its connection with the inner perihæmal ring can still be traced. The water-vascular system is well developed, and one can follow it quite easily in vertical sections. The madreporic pore, pore-canal, and stone-canal may be said to have assumed the adult relations. The axial sinus can be seen adjacent to the stone-

canal, and can be traced from its opening into the latter to its junction with the inner perihæmal ring. In none of the sections, however, can one be sure of the aboral sinus or of the madreporic vesicle, though this is doubtless due to the preservation.

Several points in the structure of these young Asterids suggest a relation to an embryonic starfish studied in this laboratory some time ago by Dr. E. H. Henderson (4). These were large yolky eggs of an unknown species, belonging, probably, to the genus *Anasterias*, collected off the Franklin Islands. In the remarkably close resemblance to the development of *Asterina gibbosa* of the same age, and in the similarity in the appearance and distribution of the yolk, we have indications of a near relationship between this species and *Asterias brandti*, but the great difference in age between the two lots of embryos makes it difficult to institute a closer comparison.

2. OPHIOPLUTEUS sp.n. (?).

(Fig. 2.)

Two specimens of this presumably new *Ophiopluteus* were taken at the Winter Quarters of the Expedition; the first on December 15th, 1903, from No. 12 hole, in 8 fms. of water; the other on January 4th, 1904, from No. 13 hole, in 6 fms. The first is in a comparatively good state of preservation: the second is badly disintegrated, and from it alone little could be made out. It is, however, of approximately the same stage of development, though a little larger, than the first. The following description is, therefore, based upon the better preserved specimen.

The body, exclusive of the arms, measures 2·3 mm. in length, and is marked by a strongly developed conical papilla at its posterior end.

Three pairs of arms are developed; of these the antero-laterals and post-orals are only slightly developed, but the postero-lateral pair are already equal to the body in length and are widely divergent. This development of the postero-lateral arms reminds us of the great size of the corresponding arms in the larva of *Ophiothrix fragilis*, which is such an early and marked characteristic of this species. In fact, the whole appearance of our specimen is strongly reminiscent of the larva of *Ophiothrix*. The ciliated band can be traced quite distinctly bordering all the arms.

In our better specimen the cœlom can just be made out. On the left side it has already divided into anterior and posterior cœloms, but on the right side it is still undivided.

The gut is well developed and shows the characteristic division into œsophagus, large spherical stomach, and intestine opening on the ventral surface.

No trace of the skeleton is preserved in these specimens, and this, together with their young stage, makes classification impossible. Judging from their habitat, however, and from their general appearance, they are quite possibly examples of a new species.

3. ECHINOPLUTEUS ANTARCTICUS.

(Fig. 3.)

The material contained only two specimens of this larva: one taken in lat. $78^{\circ} 29' 10''$ S., long. $103^{\circ} 38' 18''$ W., on January 25th, 1902, and labelled "30," the other marked "42," taken in the D-net at Hut Point, near the Winter Quarters of the Expedition, on February 19th of the same year. Both specimens are of approximately the same age.

In the stained and mounted condition the specimens measure 0.72 and 0.84 mm. in length, including the arms; but in each case the body, which is sub-spherical in form, is 0.43 mm. in diameter.

Four pairs of arms can be made out; of these, the post-oral pair are the longest, being a little more than two-thirds as long as the body. Of the others, the antero-laterals are about half and the postero-dorsals about one-quarter the body-length. The pre-oral arms are very rudimentary, appearing only as small outgrowths at the bases of the antero-laterals. All the arms are close together and are approximately parallel.

The ciliated band, which borders all the arms, extends back between the post-oral and postero-dorsal arms of either side, so as to form lateral bays running about half way along the body.

Three pairs of epaulettes are present, and are arranged so as to form two incomplete ciliated bands encircling the body. The anterior circle consists of a ventral pair situated at the bases of the post-oral arms, and a dorsal pair in a somewhat corresponding position on the dorsal surface of the body at the bases of the postero-dorsal arms. The posterior circle is made up of a single pair only, and these are smaller and much narrower than either of the other pairs, and are laterally placed near the posterior end of the body.

We find that three Echinoplutei have been described in which the presence of six ciliated epaulettes is noted. These are: *E. coronatus*, *E. theeli*, and the pluteus of *Echinus esculentus*. From each of these, however, the present larva differs considerably. In *Echinus esculentus* the presence of the posterior pair of epaulettes was first pointed out by MacBride (8), and a great deal of material of the larvæ of this species has been at our disposal for comparison with our new type. Selecting an individual which, judging by the development of the so-called "Echinus-rudiment," is of the same age as our specimens of *E. antarcticus*, we find that the size of the characteristic larval arms is quite different. The post-oral and postero-dorsal pairs are of about the same length, and are already about twice as long as the body, instead of two-thirds and one-quarter the body-length, as they are in *E. antarcticus*. The antero-laterals are also of great length, being more than twice as long in comparison as are the corresponding arms in our new species. The most marked difference, however, is

in the pre-oral pair; for while these are mere rudiments in *E. antarcticus*, they are almost equal to the length of the body in *E. esculentus*.

The other two larvæ, *E. coronatus* and *E. theeli*, were described by Mortensen (9). The first of these is a larva of about the same or a slightly older stage than our specimens. In it, however, the post-oral and postero-dorsal arms are about one and a half times as long as the body, while the antero-laterals and pre-orals are equal to it in length. Besides this great difference in the arms there is also a difference in the posterior pair of epaulettes; for Mortensen describes these as "very broad," while in *E. antarcticus* they are much the smallest of the six.

In *E. theeli* we are dealing with a larva which is much younger than the others just mentioned, but even here we see certain features in the arms by which to differentiate the two; for while three pairs of the arms are of about the same proportionate length as in our specimens of *E. antarcticus*, the fourth, the pre-orals, are long and well-developed, not at all resembling the mere rudiments by which they are represented in the latter species.

As in the case of the Ophiopluteus, so here nothing can be made out of the skeleton, the result, probably, of the method of preservation.

On the left side of the larva a well-developed "Echinus-rudiment" can be seen, but of this no details can be made out in either of the mounts.

4. CUCUMARIA CROCEA.

Holothuria (Cucumaria) crocea, Lesson, Cent. Zool. (1832), p. 153, pl. lii, fig. 1.
Cucumaria crocea, Lampert, Seewalzen (1885), p. 214.

Our collection contains some two hundred specimens of the young of this Holothurian, "born after the capture of the mothers," and one adult female, the parent of some of these young; all taken at Hut Point, near the Winter Quarters of the Expedition, on the 13th and 28th of February, 1904.

The young of this species were first dredged by the 'Challenger' at the Falklands in January, 1876. Since that time nothing, so far as we can learn, has been added to our knowledge of their development, and as the specimens then found were of a considerably older stage than those brought back by the 'Discovery,' it may be well to recall certain of the observations made by Sir Wyville Thomson at that time, which have a special bearing upon the developmental history.

In his "Voyage of the 'Challenger,'" Sir Wyville says: "In a very large proportion of the females which I examined, young were closely packed in two continuous fringes adhering to the water-vascular feet of the dorsal ambulacrum. The young were in all the later stages of growth, and of all sizes, from 5 mm. up to 40 mm. in length; but all the young attached to one female appeared to be of the same age and size. . . . All the young I examined were miniatures of their parents; the only marked difference was that in the young the ambulacra of the bivium were quite

rudimentary." They "attached themselves by the tentacular feet of the trivial ambulacra, which are early and fully developed." He says, however, that they "were too late at the Falklands (January 23rd) to see the process of attachment of the young in their nursery There can be little doubt that, according to the analogy of the class, the eggs are impregnated either in the ovarian tube or immediately after their extrusion, that the first developmental stages are run through rapidly, and the young are passed back from the ovarian opening, which is at the side of the mouth, along the dorsal ambulacra, and arranged in their places by the automatic action of the ambulacral tentacles themselves." (Vol. II., p. 215 *et seq.*)

Now the young brought back by the 'Discovery,' with two exceptions, all measured from $2\frac{1}{2}$ mm. to 3 mm. in length, and had been born in the interval between capture and preservation; it seems, therefore, that we had here a key to the solution of the manner in which the early developmental stages are passed over, and that we might thus get a more complete history of the "brood-care" of this species.

A careful examination of the adult female specimen, made with this object in view, showed two prominent openings, each about 3 mm. in diameter, situated in the dorsal interambulacrum, a short distance behind the peristome (Fig. 4). Looking into these openings, one could see a number of embryos of about the same size as the new-born specimens of the collection. At first sight these openings seemed to lead into the body-cavity, but a careful dissection revealed the fact that they were in reality the openings of two large brood-pouches situated in the dorsal body-wall (Fig. 5). Owing to the extreme contraction of the specimen, the extent of these pouches can be made out only approximately. The right, which is by far the larger of the two, extends from the mid-dorsal line downwards to the right ventral interambulacrum, and from a point just behind the peristome backwards for about one-third of the body length. The left sac, however, is only about half as large. Both pouches are divided up by a number of pillars representing the podia, which thus seem to traverse the sacs. In reality, however, the podia are probably only surrounded by the pouches as they develop. Some idea of the extent of these spaces may be gained from the figure, which is drawn of the natural size. No communication was found between the two sacs, nor was any opening into the body-cavity or genital ducts made out.

In these two pouches 140 embryos were found—110 in the right and 30 in the left. These, however, are all of the same size, and of a comparatively late stage of development, with the exception of two specimens which are much less developed than the rest.

Through the kindness of Professor F. Jeffrey Bell we have also been able to examine three other specimens of *C. crocea* belonging to the British Museum. It was hoped that they might show some trace of these brood-pouches, but the most careful search revealed nothing.

If we now try, from the facts before us, to get a connected idea of the "maternal care" of this species, we shall probably find that its course is somewhat as follows:—

The eggs, either before or after fertilization, are shed into the water and are attached to the mother's back, possibly by means of a mucoid secretion. They are soon, however, surrounded by the brood-pouches, which probably develop by a sinking-in of the dorsal ectoderm, and here they are retained until they have reached a condition where the tentacles are able to serve as organs of attachment to the mother. This we know must be when the little animals are between 3 mm. and 5 mm. in length. They then pass out of the brood-pouches and are arranged along the dorsal ambulacra of the mother as Thomson has described.

The presence in the sacs, among a large number of older embryos, of two which are comparatively young, naturally brings up the question of the number of broods in this species. Are all of the young brought forth in a single brood, or is there a succession of broods such as we find in *Synapta vivipara*, Clark (3)? If these two embryos represented the beginning of a second and younger brood, one would expect to find the gonad of the mother showing some sign of activity; but, as this is not the case, we must conclude that they are members of the same brood as the larger embryos, and that their development has been, for some reason or other, retarded. What evidence we have, therefore, seems to be in accord with Thomson's observation that all the young attached to one mother were of the same age and size.

Coming now to the embryos themselves, it is somewhat disappointing to find that among the large number brought back only two stages are represented. Turning our attention to the younger of these, we see that of the two specimens in the collection one was somewhat distorted through the pressure of the surrounding embryos in the brood-pouch; but this does not at all affect the disposition of the internal organs as seen in sections. The other specimen, apparently quite normal, is oval in form, and measured before sectioning 1.8 by 1.2 mm. No evidence of any external opening could be made out.

When sections of this stage are examined it is seen to be a typical pentactula, and the only points which need be specially mentioned are in connection with the water-vascular system. The ring canal is well developed, and the radial canals coming off from it can easily be followed as they arch back and run towards the aboral pole. As yet there is no sign of the development of podia, but the tentacular canals can be seen to originate one on either side of each radial canal, close to where it comes off from the ring canal, and to run out into the tentacles which do not reach the surface of the embryo, but still project into the "atrium." Even at this stage valves may be seen guarding the entrance to these tentacular canals. The stone-canal is well formed, and runs out in the dorsal inter-radius to open into a large, clearly-defined axial sinus. From the latter the pore-canal can be traced outwards for a short distance, but we were not able to follow it to its external opening in this stage, though in the older embryos it is very easily followed. No Polian vesicle has yet been developed.

Of the later stage there were a great number of specimens, for it was found that all the embryos in the brood-pouches (with the exception of the two already mentioned),

and a second brood dredged a fortnight later, are of approximately identical development. These embryos all measure from 2.5 to 3 mm. in length, and have assumed the typical ten-tentacled form. The tentacles are still simple, unbranched, peg-like outgrowths (Fig. 6), but there is some slight indication of a differentiation in size, the two ventral tentacles being just a shade smaller than the rest.

In sections the digestive tract is seen to be well developed, though the œsophagus is still solid, and the anus has not yet been formed. The stomach walls are thrown into heavy folds and the intestine shows the characteristic double twist.

The water-vascular system in this stage shows many advances. The pore-canal can be distinctly seen to open to the outside, and can be traced into the axial sinus, which runs for a short distance in the body-wall before it communicates with the stone-canal. The presence in Holothurians of an axial sinus opening, on the one hand, into the stone-canal, and on the other to the outside by means of the pore-canal, has been described in two cases only—once by Bury (2) and once by Ludwig (6). As Bury's observation, however, has been very generally questioned, and as Ludwig, though noting the presence of these structures, does not attach any very great weight to them, the present discovery becomes of extreme interest and importance, as a confirmation which places the matter beyond doubt. As has been noted above, in the younger embryos the pore-canal cannot be traced throughout its whole length, but this is in all probability due to bad preservation.

A large Polian vesicle is now seen in the left dorsal interradius, a position which Ludwig (5) says it occupies in some *Cucumariæ*, though he does not mention *C. crocea*. Tube feet have made their appearance, and we now find four arising from each radial canal, though they have not as yet reached the surface.

The state of the preservation prevents any very minute study of the nervous system, but one can readily see the well-developed nerve-ring and the five radial nerves, as well as the branches to the tentacles.

The epi-neural ring and canals are also clearly seen, and we find that the ring also gives off branches which accompany the tentacular nerves.

Of the condition of the mesenteries little can be made out. A bunch of cells in the dorsal mesentery close to the stone-canal may very possibly be the rudimentary gonad, but of these points it is impossible to be sure.

In conclusion, it may be said that the collection, though small, has yielded many interesting points. Chief among these may be mentioned the discovery of two pelagic Echinoderm larvæ within the Antarctic Circle, and of the brood-pouch in *Cucumaria crocea*. The first are important because they disprove the generally accepted theory that none of the Antarctic Echinoderms have free-swimming larvæ, the second because it fills a gap in our knowledge of the life-history of a well-known form. The well-marked axial sinus and pore-canal in the *Cucumaria* embryo is also

a point of importance, since it gives positive evidence of the existence of these structures among the Cucumariidæ, a fact which has been asserted, but never conclusively proven.

Zoological Laboratory, McGill University, April 1st, 1907.

LIST OF PAPERS QUOTED.

1. BELL, F. J.—“Echinoderms” in Report on the collections of the ‘Southern Cross,’ London, 1902, p. 214.
2. BURY, H.—“Studies in the Embryology of the Echinoderms.” Q.J. Micros. Sci., vol. 29 (1889), pp. 409-449.
3. CLARK, H. L.—“Synapta vivipara: a contribution to the morphology of Echinodermata,” Boston, Memoirs Soc. Nat. Hist., 5 (1898), pp. 53-88, 5 pls.
4. HENDERSON, E. H.—“Some observations on the development of an Asterid with large yolky eggs from the Franklin Islands,” Ann. Mag. Nat. Hist., vol. 16 (1905).
5. LUDWIG, H.—“Die Seewalzen” in Bronn’s Klassen u. Ordnungen d. Thier-Reichs, 2 Bd., 3 Abth., 1 Buch. (1889-92).
6. LUDWIG.—“Zur Entwicklungsgeschichte der Holothurien.” Sitzungsber. Preuss. Akad. d. Wiss. Berlin, 1891, p. 603.
7. MACBRIDE, E. W.—“Development of Asterina gibbosa.” Q.J. Micros. Sci., vol. 38 (1896), pp. 339-411.
8. MACBRIDE, E. W.—“The Development of Echinoids,” pt. 1. “The larvæ of Echinus miliaris and E. esculentus.” Q.J. Micros. Sci., vol. 42 (1899), pp. 335-339.
9. MORTENSEN, TH.—“Die Echinodermlarven der Plankton-Expedition d. Humboldt-Stiftung.” Bd. II. J., Kiel and Leipzig, 1898.
10. THOMSON, C. WYVILLE.—“The Voyage of the Challenger—the Atlantic,” London, 1877.

TABLE OF PLATES.

- FIG. 1. *Asterius brandti* Bell. $\times 12\frac{1}{2}$. Youngest embryo of brood.
- FIG. 2. *Ophiopluteus* sp. n. ? $\times 100$.
- FIG. 3. *Echinopluteus antarcticus* sp. n. $\times 100$.
- FIG. 4. *Cucumaria crocea* Lesson. $\times 1$. Adult female, showing openings of the two brood-pouches.
- FIG. 5. *Cucumaria crocea* Lesson. $\times 1$. Another view of the same specimen, with the body-wall cut through so as to expose the interior of the brood-pouches.
- FIG. 6. *Cucumaria crocea* Lesson. $\times 12\frac{1}{2}$. Young embryo, born after capture of the mother, which is shown in figs. 4 and 5.
- FIG. 7. *Cucumaria crocea* Lesson. Transverse section through the anterior region of embryo shown in fig. 6.

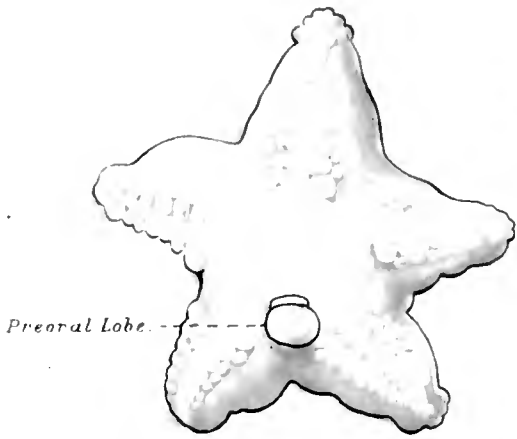

FIG. 1. ASTERIAS BRANDTI.
Youngest embryo of brood
x12½.

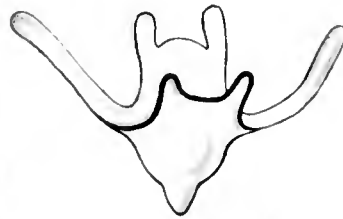

FIG. 2. OPHIOPLUTEUS N. SP.?
x100



FIG. 3. ECHINOPLUTEUS ANTARCTICUS
x100

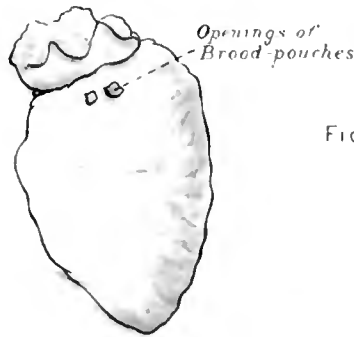

FIG. 4. CUCUMARIA CROCEA
Adult female — to show
openings of brood-pouches.
x7.

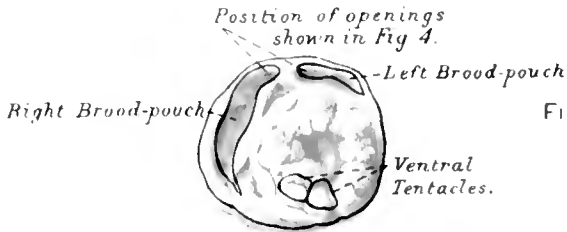

FIG. 5. CUCUMARIA CROCEA
Adult female — to show
interior of brood-pouches.
x1

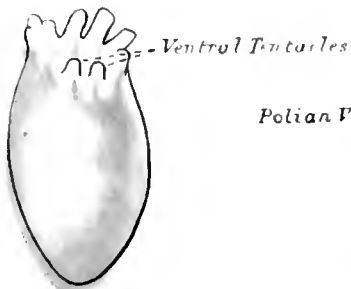

FIG. 6. CUCUMARIA CROCEA.
Young embryo born after
capture of mother
x12½.

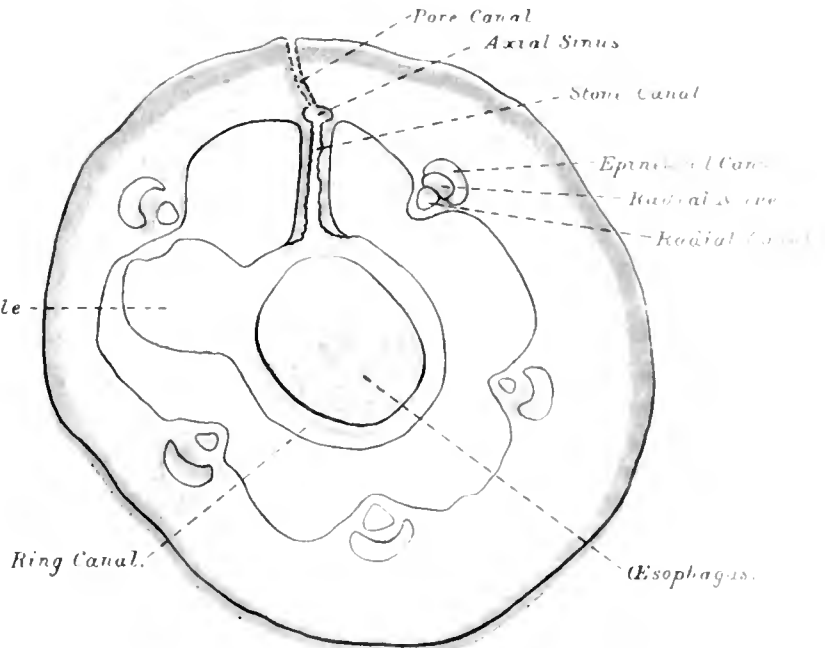
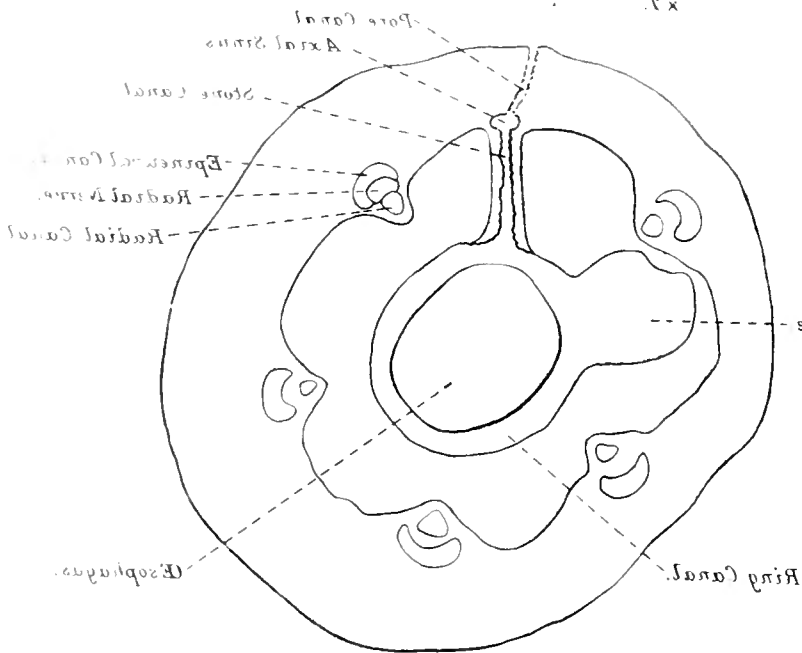
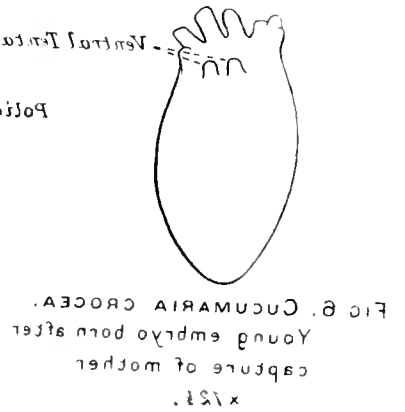
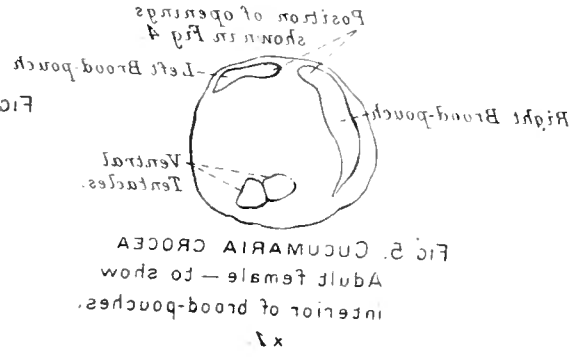
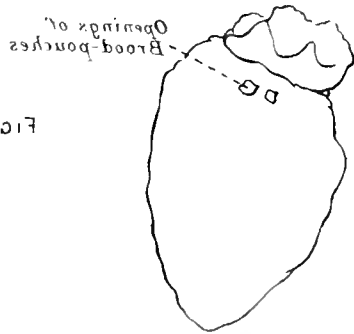
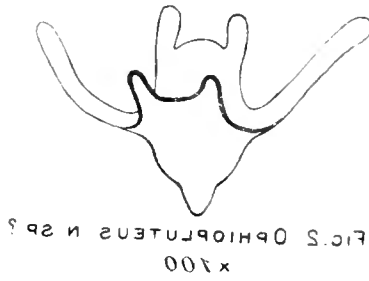
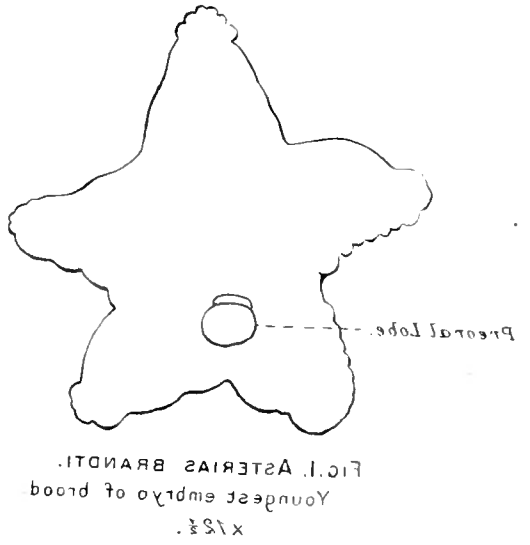
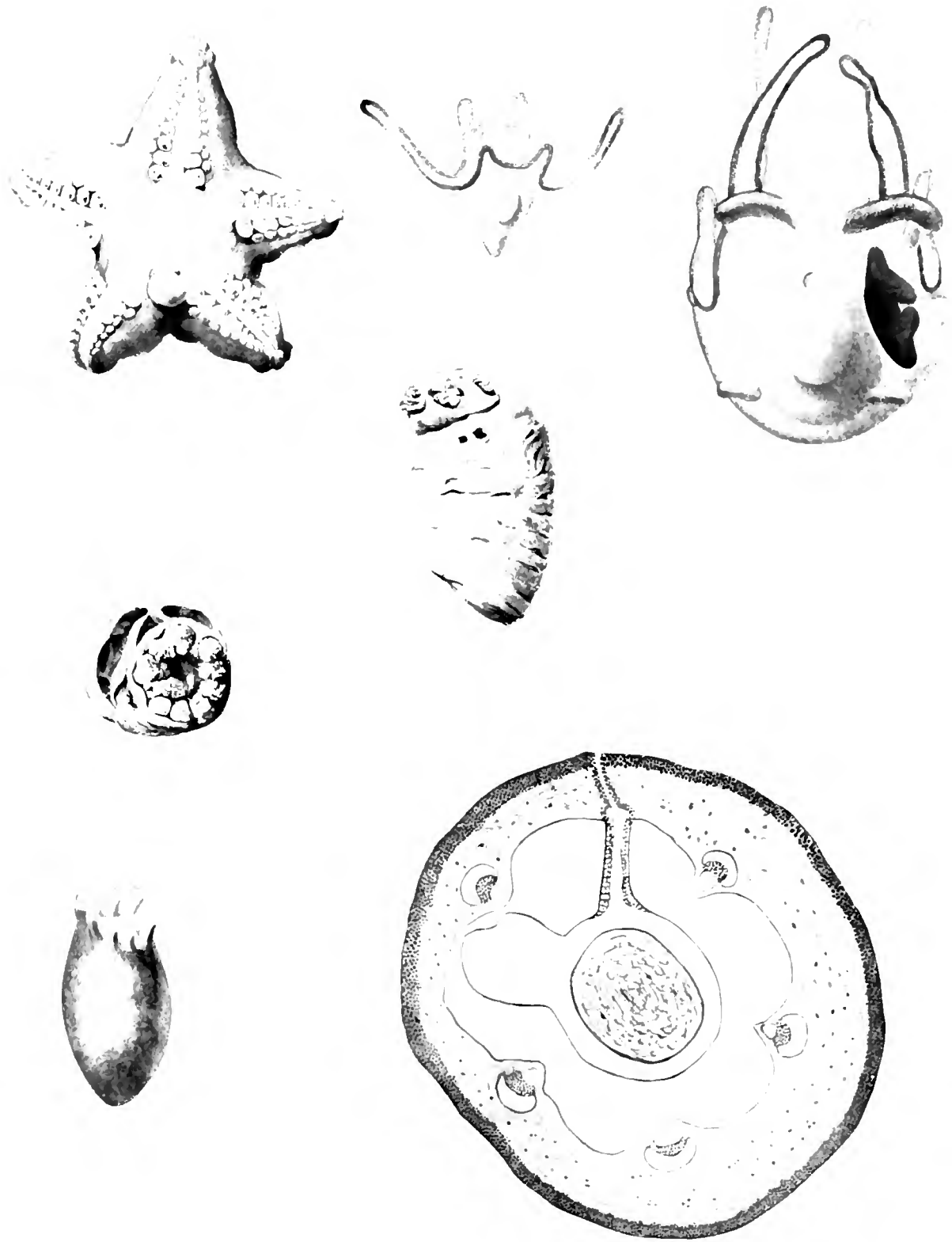

FIG. 7. CUCUMARIA CROCEA
Transverse section through
anterior region of embryo
shown in Fig 6



Polian Vessels



Antarctic (Discovery) Exp.

PLATE 100

Larval Echinoderms.

MYZOSTOMIDAE.

BY DR. RUDOLF RITTER V. STUMMER-TRAUNFELS (Graz, Austria).

(1 Plate.)

EINLEITUNG.

DAS von der 'Discovery' heimgebrachte und mir von Prof. F. Jeffrey Bell in liebenswürdigster Weise zur Bearbeitung übergebene *Myzostoma*-Material umfasst nur eine relativ geringe Anzahl von Exemplaren, die sich auf zwei Species, eine freilebende und eine encystirte, verteilen. Die erstere ist eine neue Art: *M. antarcticum*, die letztere halte ich für identisch mit dem schon von Prof. Graff beschriebenen *M. cysticolum*.

Wenngleich also die Ausbeute nur eine geringfügige Erweiterung unserer bezüglichen systematischen Kenntnisse zu bringen vermochte, so erscheint sie doch in tiergeographischer Beziehung recht bemerkenswert: einerseits, weil die beiden Arten aus dem südlichsten bekannten Gebiete des antarktischen Ozeans stammen, aus welch' letzterem bisher noch nie Myzostomen heimgebracht worden sind;* und andererseits, weil dadurch ein neuer Beweis für den Kosmopolitismus des *M. cysticolum* geliefert wird. Diese Art kennt man nun von drei geographisch ausserordentlich weit von einander entfernten Fundorten (tropischer West-Atlantic, Ostküste v. Japan, Ross-Meer in der Antaretis), ein Befund, welcher durch das hohe geologische Alter der Gruppe sowie durch die bekanntlich sehr uniformen Lebensbedingungen des Stillwassers und der Tiefsee seine Erklärung findet.

Da, wie schon gesagt, das mir zur Bearbeitung übergebene Material nur eine geringe systematische Ausbeutung zuließ, so beschränkt sich die vorliegende Arbeit hauptsächlich auf die anatomische Beschreibung der beiden Arten. In dieser Hinsicht vermochte ich insbesondere das *M. cysticolum* genauer zu untersuchen, als dies bisher

* Das südlichste Gebiet, aus welchem man bis jetzt Myzostomen kannte, nämlich die See um die Prince Edward- und die Crozets-Inseln, liegt noch in der Subantaretis u. zwar nur wenig südlich von der Nordgrenze der treibenden Eisberge und der Südgrenze des Weltverkehrs. Von hier wurden durch die 'Challenger'-Expedition folgende Arten gesammelt:—

<i>M. compressum</i> Graff	3, pag. 42.
<i>M. coronatum</i> Graff	3, .. 60.
<i>Stelechopus hyocerini</i> Graff	3, .. 76.

(Die fettgedruckten Zahlen zu Beginn jedes Literaturnachweises beziehen sich auf die entsprechenden Nummern des der vorliegenden Arbeit beigegebenen Literaturverzeichnisses.)

Die Angaben fremder Autoren erscheinen in folgendem durchwegs mit: pag., abs., taf., fig.; die Verweisungen auf Stellen der vorliegenden Abhandlung mit: Pag., Textfig., Fig., citiert, wobei unter der letzteren Bezeichnung die zu dieser Arbeit gehörenden Tafelfiguren zu verstehen sind.)

geschehen, und es gelang mir dadurch auch einen, allerdings noch nicht vollkommenen Einblick in die Sexualverhältnisse dieser Species zu gewinnen, der aber immerhin geeignet scheint, auch die Geschlechtsverhältnisse der von Graff für rein dioeisch gehaltenen Arten unter den cystenbewohnenden Myzostomen in eine neue Beleuchtung zu rücken.

GENUS MYZOSTOMA. F. S. LEUCKART.

1. MYZOSTOMA ANTARCTICUM.

(Textfig. ; Plate I., fig. 1.)

“ Winter Quarters, 8. iv. 1903, 124 fms.”

Von dieser ansehnlichen auf *Antedon adriani* Bell (diese Reports, vol. iv., Echinoderma, p. 4) freilebenden Form lagen mir 18 zumeist verschiedenalterige Exemplare vor. Die Länge des jüngsten betrug nur 0·7 mm., die des ältesten dagegen 6·0 mm. Zwischen diesen beiden extremen Gliedern der Reihe war noch eine ganze Anzahl von Zwischengrößen vertreten, von welchen die auf einander folgenden in Bezug auf ihre Länge zumeist nur durch Bruchteile von mm. differirten. Die nachstehende Tabelle giebt eine Übersicht über die Dimensionen der einzelnen Grössenklassen.

Classe.	Exemplare.	Länge in mm.	Breite in mm.	
<i>a</i>	2	0·7	} Breite gleich der Länge ; Körperumriss fast rein circular.	
<i>b</i>	1	1·0		
<i>c</i>	3	1·1		
<i>d</i>	3	1·2		
<i>e</i>	1	1·5	} Breite nur wenig grösser wie die Länge.	
<i>f</i>	1	1·75		2·0
<i>g</i>	1	2·5		2·75
<i>h</i>	1	2·75		3·0
<i>i</i>	2	3·25		3·75
<i>j</i>	1	4·0		5·0
<i>k</i>	1	4·5		5·5
<i>l</i>	1	6·0		7·5

Die Untersuchung erstreckte sich auf je ein in Xylol aufgehelltes Exemplar der Classe *a*, *d*, *e*, *g*, und *i*, ferner auf das in Längsschnitte zerlegte Exemplar der Classe *l*.

Wie schon Wheeler (8, pag. 228, abs. 3) hervorgehoben hat, sind die Jugendstadien der einzelnen *Myzostoma*-Arten von einander nur wenig verschieden, während die artlichen und generischen Merkmale erst bei den erwachsenen Individuen deutlich zum Ausdrucke kommen. Dieser Erfahrung zufolge stützt sich die nachstehende Beschreibung nur auf die bei dem grössten Exemplare (Classe *l*) gemachten Befunde.

ALLGEMEINE MORPHOLOGIE DES KÖRPERS.

Wie aus den in der obigen Tabelle angeführten Dimensionen hervorgeht besitzt derselbe bei den grösseren Exemplaren einen querovalen Umriss. An seiner Ventralseite fällt eine von der Leibesmitte bis zur Reihe der Parapodien reichende compacte und fast scheibenförmige centrale Partie auf ("Bauchscheibe," Graff, 2, pag. 41, abs. 3), welche sich von einer viel zarteren und durchscheinenderen Randzone (Fig. 1, *sr*) ziemlich scharf absetzt. Bei einer Länge von 6 mm. und einer Breite von 7·5 mm. beträgt die Dicke des Körpers in der Mitte circa 2 mm. Sie vermindert sich im Bereiche der Bauchscheibe bis zur Reihe der Parapodien hin relativ nur wenig, wird jedoch beim Übergange von dieser in die Randzone eine weitaus geringere. Die letztere läuft gegen den Körpertrand hin in einen allerdings nur schmalen jedoch ganz deutlich erkennbaren, schwach gewellten Randsaum aus, welcher in der Medianlinie sowohl am vorderen als auch am hinteren Körperende eine schwache Einbuchtung zeigt. Vom Randsaum entspringen jederseits 10 bilateral-symmetrisch angeordnete, relativ kurze (circa 0·75 mm. lange) Cirren (Textfig., *c*), welche mit ihrer Wurzel ein wenig auf die Dorsalfläche der Randzone hinaufgerückt sind (Fig. 1, *c*).

Die Rückenfläche des Körpers ist sanft gewölbt, die Bauchseite dagegen, dadurch dass sich die beiden lateralen Körperhälften ventralwärts etwas einbiegen, in geringem Masse concav gestaltet. Dorsalseitig zeigt das Integument eine eigentümliche, aus zahlreichen kleinen, dicht neben einander gelegenen Wärzchen bestehende Sculptur, (Fig. 1). Diese durch rinnenartige Vertiefungen von einander getrennten Erhabenheiten sind auf der Mitte des Rückens am bedeutendsten entwickelt und nehmen an Grösse von hier aus gegen die Randzone hin allmählig ab. Im Bereiche der letzteren sind sie nicht mehr wahrnehmbar. Die Ventralfläche des Körpers ist im Allgemeinen glatt, bis auf die Bauchscheibe, an welcher der Verlauf der sehr stark entwickelten Musculi centrales des Hackenapparates durch leistenförmige Vorsprünge des Integuments deutlich ausgeprägt erscheint.

Die 10 Parapodien (Textfig., *par*) sind kräftig dabei aber relativ schlank und wie ihre sehr entwickelte Musculatur vermuten lässt, recht beweglich. Sie können in eine Art von Scheide zurückgezogen werden, welche von einer grossen, stark vorspringenden Ringfalte des ventralen Integuments gebildet wird. An den beiden mittleren Fussstummeln jeder Seite öffnen sich die Ausführungswege des männlichen Geschlechtsapparates durch eine dem Parapodium von aussen her ansitzende konische Genitalpapille (Textfig., *p*).

Die 8 länglich ovalen, im eingezogenen Zustande nicht über die Ventralfläche vorspringenden Seitenorgane ("Saugnäpfe") liegen bilateral symmetrisch angeordnet im Gebiete der Randzone auswärts von der Reihe der Parapodien und in den Intervallen zwischen je 2 der letzteren (Textfig., *so*).

Wie schon früher erwähnt ist der Vorderrand des Körpers in der Medianlinie etwas eingezogen. Diese Einbuchtung schlägt als rinnenförmige Vertiefung auf die

Ventralseite über, um ungefähr in der Mitte der Randzone in die Mundöffnung zu führen (Textfig., *m*).

Die Kloake öffnet sich an der Spitze einer medianen flach-konischen Papille (Textfig., *clp*), welche ebenfalls ventralseitig und in einiger Entfernung vom hinteren Körperende gelegen ist. Auf derselben Papille liegt ausserdem unmittelbar dorsal über der Kloakenöffnung die weibliche Geschlechtsöffnung (Uterusausmündung).

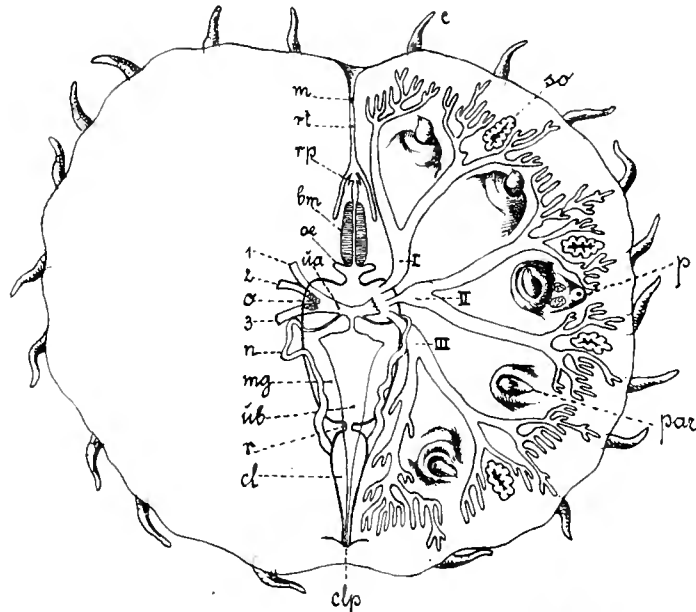

Halbschematisches Übersichtsbild der Organisation des *M. antarcticum*, nov. sp. Vergr.: 11-fach. Ansicht von der Ventralseite aus; die Organe sind in ihren Konturen sämtlich in die Bildebene projectirt.—*bm*, Bulbus musculosus; *c*, Cirren; *cl*, Kloake; *clp*, Kloakalpapille; *m*, Mundöffnung; *mg*, Magen; *n*, Nephridien; *o*, Ovarien; *oe*, Oesophagus; *p*, Penis; *par*, Parapodium; *r*, Rectum; *rp*, Rüsselpapillen; *rt*, Rüsseltasche; *so*, Seitenorgan; *ua*, vorderer Uterusabschnitt; *ub*, hinterer Uterusabschnitt; *I*, *II*, *III*, Hauptstämme der Darmverästelung; *1*, *2*, *3*, Hauptstämme der Uterus- (Leibeshöhlen-) Verästelung.

ERNÄHRUNGSAPPARAT.

Die Mundöffnung führt in eine, bei eingezogenem Pharynx vorne röhrenartig gestaltete Rüsseltasche (Textfig., *rt*), in deren glockenförmig erweiterte Caudalhälfte die Spitze des Pharynx hineinragt. Dieser trägt an seinem Vorderende einen Doppelkranz von kleinen Tastpapillen (Textfig., *rp*), und zeigt im übrigen, mit seinem relativ schwachen Bulbus musculosus (Textfig., *bm*), keine bemerkenswerte Ausbildung. Das Pharyngealrohr öffnet sich am Hinterende des Bulbus musculosus (bei eingezogenem Rüssel!) in einen dorsoventral compressen, beiderseits aber taschenartig ausgebuchteten Raum (Textfig. *oe*), der nach hinten durch eine (von Graff, **2**, pag. 49 letzter abs., pag. 50 abs. 1, als "Klappe" bezeichnete) Ringfalte vom Magen abgegrenzt wird. Es ist sehr wahrscheinlich, dass dieser Raum bei völlig protrahirtem Rüssel sich röhrenförmig streckt, also einen Oesophagus im Sinne Graff's darstellt.

Der grosse und weite Magen (Textfig., *mg*), ist tonnenförmig gestaltet und vom kurzen Rectum (Textfig., *r*) durch einen Sphinkter abgesetzt.

Ventralwärts entspringen von ihm beiderseits je drei Hauptstämme der Darmverzweigung (Textfig., I, II, III), von welchen sich ein jeder nach kurzem Verlaufe in zwei Hauptäste teilt. Von diesen sechs Hauptästen verlaufen in jeder Körperhälfte zwei nach vorne, zwei nach der Seite und zwei nach hinten und zwar ungeteilt bis zur Randzone des Körpers, wo sie sich dichotomisch in zahlreiche kleinere Verzweigungen auflösen.

Das sehr kurze und enge Rectum (Textfig., *r*) geht alsbald in die relativ langgestreckte kolbenförmige Kloake (Textfig., *cl*) über, in deren breitere Vorderhälfte sich von beiden Seiten her die Nephridien (Textfig., *n*) mit längsspaltigen Nephroporen öffnen. Nach hinten verschmälert sich die Kloake allmählig und mündet, wie schon gesagt, durch einen an der Spitze der Kloakalpapille gelegenen Porus nach aussen.

WEIBLICHER GESCHLECHTSAPPARAT.

Am sogenannten "Uterus" lassen sich zwei, durch ein enges und kurzes medianes Verbindungsrohr communicierende Abteilungen, eine vordere und eine hintere unterscheiden. Die erstere (Textfig., *ua*) ist kurz, dagegen bedeutend in die Quere entfaltet und liegt oberhalb des ersten Magendrittels. Sie teilt sich lateral jederseitig in drei Canäle, welche als Hauptstämme der Leibeshöhle (Textfig., 1, 2, 3) dorsal von den drei Hauptstämmen der Darmverzweigung verlaufen und nach entsprechender dichotomischer Teilung auch deren weitere Verästelungen begleiten. Der hintere Uterusabschnitt (Textfig., *ub*) ist gegenüber dem kurzen vorderen bedeutend in die Länge gestreckt, rostral zwar stark verbreitert, caudal jedoch röhrenartig verschmälert. Er mündet durch die knapp oberhalb des Kloakalporus noch auf der Kloakalpapille gelegene weibliche Geschlechtsöffnung aus und stellt das eigentliche Reservoir für die reifen Eier dar, welche man im vorderen Uterusabschnitte nur ganz vereinzelt antrifft.

Es sind jederseits zwei Ovarien (Textfig., *o*) vorhanden, von welchen je eines an der Wurzel des zweiten und des dritten Hauptstammes der Leibeshöhle gelegen ist. Diese beiden Ovarien sind einander jedoch sehr genähert, so dass ihre freien in den vorderen Uterusabschnitt hineinragende Spitzen fast zusammenzuströmen scheinen.

MÄNNLICHER GESCHLECHTSAPPARAT.

Die Hoden sind nach dem für die freilebenden Arten charakteristischen verzweigten Typus angeordnet.*

* Bei den verschiedenen *Myzostoma*-Arten kann der männliche Genitalapparat in dreierlei Modificationen auftreten, die anlässlich einer künftigen Zerteilung des Genus als Gattungscharaktere Verwendung finden könnten:—

(a) *Verzweigter Hoden* ("the typical ramified form": Graff, 3, pag. 11, abs. 1)—

Typen: *M. cirriferum* (Graff, 2, pag. 59-61).

M. asteriae (Stummer, 6, pag. 579-582).

EXCRETIONSAPPARAT.

Die beiden Nephridien beginnen mit je einem kleinen und engen Nephrostom, welches an der caudalen Wandseite des vorderen Uterusabschnittes unweit von dem die beiden Uterushälften verbindenden Rohre gelegen ist. Von diesen Nephrostomen aus verlaufen die anfangs sehr engen aber später weiteren Nephridialecanäle (Textfig., *n*) zuerst in lateraler Richtung an der Dorsalseite des Magens, um dann an dessen seitlicher Circumferenz ziemlich vertikal nach abwärts zu ziehen. Nach Umgreifung des hintersten Hauptstammes der Darmverzweigung schlängeln sie sich dann längs der Ventralseite des Magens zur Kloake hin, in welche sie schliesslich von beiden Seiten her mit je einem spaltförmigen Nephroporus ausmünden.

VERWANDTSCHAFTLICHE BEZIEHUNGEN ZU ANDEREN *MYZOSTOMA*-ARTEN.

Die Gründe, welche Graff seinerzeit (3, pag. 22, Abs. 2) veranlasst haben, von einer Untertheilung des provisorischen Sammel-Genus *Myzostoma* abzusehen, bestehen auch noch heute, da für die Hauptmasse der von ihm beschriebenen Arten noch immer eingehende anatomische Untersuchungen fehlen, ohne die eine systematische

Die einzelnen Hodenfollikel sind von einander relativ weit entfernt und durch mehr oder minder breite Bindegewebspforten oder durch andere Organteile getrennt. Die Spermiducte sind im Allgemeinen verlängert und in einzelne Abschnitte (Vasa efferentia und deferentia, Samenblase, Ductus ejaculatorius), differenziert. Der männliche Geschlechtsporus ist ventralseitig, zumeist ziemlich weit nach innen vom Körperende und fast regelmässig an der Spitze einer kegelförmigen von der Basis des mittleren Parapodiums nach aussen hin vorspringenden Genitalpapille (Penis) gelegen.

(b) *Compacter Hoden* ("compact roundish glands occupying definite areas in the lateral part of the body": Graff, 3, pag. 11, abs. 1)—

Typus: *M. cysticum* (vorliegende Arbeit, Pag. 13-14).

Die Hodenfollikel sind auf einem deutlich ungrenzten rundlichen Bezirk in den Seitenteilen des Körpers concentrirt. Sie liegen enge neben einander und werden nur durch dünne Bindegewebsbalkchen oder Lamellen, nie durch andere Organteile getrennt. In der Mitte des Hodens bildet sich durch Platzen der dortselbst gelegenen bindegewebigen Follikelwände ein centraler Sammelraum, in welchem sich die reifen Geschlechtsproducte anhäufen. Dieser steht entweder vermittelst eines ganz kurzen unbedeutenden Ductus ejaculatorius oder auch direct mit der männlichen Geschlechtsöffnung in Verbindung. Letztere ist am Seitenrande oder in unmittelbarer Nachbarschaft desselben gelegen. Eine Genitalpapille scheint nie ausgebildet zu werden.

(c) Den dritten von den zwei vorigen Modificationen principiell verschiedenen Typus der Hodenanordnung hat Wheeler (8, pag. 247, 248) bei dem *M. belli* u. bei dem *M. cryptopodium* beobachtet.

Bei diesen zwei Arten soll die Gesamtmasse der Hodenfollikel dorsal von den Darmästen in der mittleren Körperregion gelegen und durch zwei dorsoventrale Septa in drei Lappen (einen medianen u. zwei laterale) geteilt sein. Die Hodenfollikel springen in den dorsalen Theil der Leibeshöhle ("Uterus") vor, in welchen auch die fertiggebildeten Spermien entleert werden, die dann offenbar (Wheeler spricht sich darüber nicht aus) durch die weibliche Geschlechtsöffnung (oder Kloakalöffnung?) ihren Weg nach aussen finden.

Bei der Isoliertheit dieser Beobachtung und bei der Wichtigkeit, welche dieselbe hinsichtlich der Leibeshöhlenfrage sowie der Genese der männlichen Keimzellen bei den Myzostomen besitzt, erscheint eine Nachuntersuchung dieser beiden von Wheeler nur oberflächlich beschriebenen Arten dringend geboten.

Anhangsweise möchte ich hier noch die sogenannten *subectodermalen Hoden* erwähnen, welche Nansen (5, pag. 78 u. 79) bei *M. gigas*, *M. giganteum*, *M. graffi*, u. *M. carpenteri* beschrieben hat. Diese liegen als vollkommen von dem normalen verzweigten Hoden getrennte Follikel dicht unterhalb des Integumentes. Sie scheinen—dies lässt auch ihre eigentümliche Structur vermuten (Nansen, 5, pag. 79, zeile 3-5)—abgetrennte und in Rückbildung begriffene Terminalfollikel des normalen Hodens zu sein.

Bearbeitung der Myzostomiden undurchführbar ist. Dieser Mangel lässt daher im Allgemeinen vorderhand nur eine additionelle Einreihung einer neuen Species in diese Gattung geboten erscheinen. Im Speciellen wird man sich darauf beschränken müssen die neubeschriebene Form mit den wenigen Arten zu vergleichen, deren Organisation genauer bekannt ist und ihre Beziehungen zu ihnen festzustellen.

Von diesem Standpunkte aus betrachtet steht das *M. antarcticum* jener Gruppe von Arten am nächsten, zu welcher das *M. cirriferum* (Graff, **2**, div. pag., Nansen, **5**, div. pag., Wheeler, **8**, pag. 229–236; pag. 276, abs. 3), ferner das *M. gigas*, das *M. giganteum*, das *M. graffi* und das *M. carpenteri* gehören. (Die anatomische Beschreibung für die vier letztgenannten Arten hat Nansen **5**, pag. 69–70 u. ff. pag., geliefert.)

2. MYZOSTOMA CYSTICOLUM.

(Plate, fig. 2–10.)

Myzostoma cysticolum, Graff, Chall. Rep. (1884), p. 66.

“Mts. Erebus u. Terror; 22. i. 1902; 500 fms.”

Unter dem von der ‘Discovery’ heimgebrachten Crinoiden-Material fanden sich an den Armen eines Exemplares von *Antedon adriani* Bell zwei Cysten vor, welche eine *Myzostoma*-Art beherbergten, die ich für identisch mit dem *M. cysticolum* Graff (**3**, pag. 66–68) halte.

HISTORISCHES UND KRITISCHES.

Diese cystenbewohnende Species wurde von dem genannten Autor nach einer Serie von Exemplaren aufgestellt, die aus dem westlichen Gebiete des tropischen Atlantic's (“Cabo Frio,” Brasilien; “Insel Grenada,” kleine Antillen) stammten. Als Wirt derselben fungierte durchwegs *Actinometra meridionalis* var. *carinata* P.H.C. Graff hat aus Gründen, welche er in der Einleitung zu seinem ‘Challenger’-Report (**3**, pag. 22, abs. 2) auseinandersetzt, bei der Beschreibung der betreffenden Art fast ausschliesslich nur ihre äusserlich erkennbaren Merkmale sowie ihre biologischen Eigentümlichkeiten berücksichtigt. Seine Angaben über die innere Organisation dieser Form beschränken sich auf einige die Darmverzweigung sowie den Genitalapparat betreffende Befunde. Obwohl sich dieselben durchwegs als richtig beobachtet erwiesen haben, so hat sich inzwischen doch herausgestellt, dass jene unter ihnen, welche sich auf die Geschlechtsorgane des sogenannten “Weibchens” beziehen, von Graff in Übereinstimmung mit den damals noch herrschenden Ansichten über die Morphologie des weiblichen Sexualapparates missverständlich gedeutet worden sind. Dies gilt insbesondere von den angeblichen “Hodenrudimenten,” welche, wie später (Pag. 27) dargelegt werden wird, als die functionierenden Ovarien aufgefasst werden müssen.

Seit dem Erscheinen der ‘Challenger’-Publication ist das *M. cysticolum*, soweit mir bekannt, nur noch einmal und zwar an der pacifischen Küste von Japan in einer

Armeyste von *Antedon discoides* P.H.C. angetroffen worden. McClendon, welcher die beiden in der Cyste vorhandenen Individuen untersucht hatte, beschrieb dieselben als eine neue Varietät: *M. cysticolum* var. *orientale* (4, pag. 120–121), und zwar mit der Begründung, dass:

- (a) die Wirtsformen der Graff'schen und jene der japanischen Exemplare eine verschiedene systematische Stellung einnehmen;
- (b) die betreffenden Fundorte in tiergeographischer Hinsicht differierten, und
- (c) die japanischen Exemplare gegenüber den Graff'schen Typen einige unwesentliche morphologische Unterschiede zeigten.

Abgesehen davon, dass das McClendon vorgelegene Material (eine einzige Cyste!) an Zahl weitaus zu gering gewesen ist, um die Aufstellung einer besonderen Varietät zu rechtfertigen, so halte ich die hierfür angezogenen Argumente des genannten Autors nicht für einwandfrei.

(ad a) Bezüglich des ersten derselben erinnere ich an die durch Graff (3, pag. 21) bekannt gewordene Tatsache, dass ein und dieselbe *Myzostoma*-Art auf 1–4 Crinoidenspecies vorkommen kann (in einigen Fällen sogar auf Vertretern zweier Genera). Graff, gewiss der erfahrenste Kenner der *Myzostoma*-Systematik, hat sich jedoch nicht veranlasst gefühlt, auf Grund dieses Umstandes verschiedene Varietäten der betreffenden Species zu unterscheiden.

(ad b) Was die von McClendon hervorgehobene zoogeographische Differenz der Fundorte anbelangt, so dürfte dieses Argument gerade bei den Myzostomen nur mit grösster Vorsicht anzuwenden sein, da das Verbreitungsgebiet dieser Parasiten noch sehr wenig bekannt ist, aller Voraussicht nach aber mit jenem ihrer Wirte zusammenfällt, von welchen weitaus die meisten sich als charakteristische Vertreter der einen cosmopolitischen Charakter besitzenden "Stillwasserfauna" erwiesen haben (Doflein, 1, pag. 251 u. pag. 272–273). Im übrigen kann man der tiergeographischen Differenz der Fundorte als solcher allein keine Bedeutung für die Aufstellung von Varietäten beimessen, wenn sich nicht die verglichenen Localformen auch in morphologischer oder in biologischer Hinsicht als solche documentieren. Diese Bedingung erscheint meines Erachtens nach bei den Exemplaren McClendon's nicht erfüllt.

(ad c) Die Besonderheiten, durch welche sich die letzteren vor den Graff'schen Typen auszeichnen sollen, beschränken sich auf die bedeutendere Grösse sowie auf den etwas differenten Bau der Cyste, ferner auf die hervorragenderen Dimensionen der Parasiten selbst, schliesslich auf eine geringfügige formale Differenz der sogenannten "Männchen."

Die Grösse der durch das *M. cysticolum* hervorgerufenen Cyste hängt in erster Linie von der Grösse des ihr Lumen fast vollständig ausfüllenden "Weibchens" ab. Da dieses jedenfalls von kleineren Dimensionen zu grösseren heranwächst und auch sonst in dieser Beziehung individuelle Verschiedenheiten zeigen kann, so werden

demnach auch verschieden grosse Cysten vorkommen.* Da wir nun derzeit über die maximale Grösse, welche das *M. cysticum* erreichen kann, noch vollkommen im Unklaren sind, so erscheint es vorderhand untunlich eine über die bekannten Masse hinausreichende Cystengrösse als Kriterium zur Aufstellung einer neuen Varietät zu verwenden.

Ebensowenig geeignet sind zu diesem Zwecke auch kleinere, den formalen Typus der Cyste nicht beeinträchtigende Differenzen im Baue derselben. Den physiologischen Anlass zur Bildung einer Cyste gibt allerdings das *Myzostoma*, da es entweder durch seine Bisse oder wahrscheinlicher durch Absonderung toxischer Substanzen, wie es z. B. die Exeretstoffe sein können einen lokalen Reiz auf den Wirtskörper ausübt, auf welchen dieser dann durch Wucherung des geschädigten Gewebes reagiert. Da wir aber den hauptsächlichsten, das ist den formativen Anteil an der Cystenbildung der Wirtsform zuschreiben müssen, so werden wir kleine, unwesentliche Veränderungen in der Morphologie der Cyste in erster Linie als den Effect einer individuellen Verschiedenheit des Wirtes zu betrachten haben und erst in zweiter Linie, wenn sich eine solche ausschliessen lässt, an eine Veränderung des reizenden Substrates denken. Voraussetzung für diese Erwägung ist natürlich, dass sich die Cysten an verschiedenen Individuen ein und derselben Wirtspecies vorfinden.† In weit höherem Grade müssen wir jedoch die Wirtsform für etwaige Veränderungen im Bau der Cyste verantwortlich machen, wenn ein und dieselbe *Myzostoma*-Art verschiedene Wirtspecies befällt. Es kommt denn eben die *artliche* Differenz der letzteren auch im Baue der auf ihnen entstehenden Cysten zum Ausdruck. Von diesem Gesichtspunkte aus muss auch die von McClendon beschriebene Cyste beurteilt werden. Sie fällt hauptsächlich dadurch auf, dass sie im Gegensatze zu den mit einem einzigen Porus versehenen Exemplaren Graff's, zwei derartige Öffnungen und zwar eine an jedem ihrer Schmalenden besitzt.

Als morphologischen Unterschied zwischen den von Graff und den von McClendon untersuchten Parasiten erwähnt der letztgenannte Autor vor allem die bedeutendere Grösse seiner Individuen. Diese kann jedoch ebensogut durch individuelles Wachstum oder durch besondere Ernährungsverhältnisse bedingt sein. Weiters hebt derselbe Autor die Beobachtung hervor, dass bei dem männlich functionierenden ("small individual") seiner Exemplare die zwischen der Körperperipherie und der Reihe der

* Dies ist auch bei den von Graff untersuchten Cysten der Fall gewesen. Vergleicht man die auf die Cystenlänge bezüglichen Angaben des genannten Autors mit dem von McClendon gegebenem Masse, so ergibt sich, dass die Grössendifferenz zwischen dem kleinsten und dem grössten Exemplare Graff's genau dieselbe ist, wie zwischen dem letzteren und dem Exemplare McClendon's:—

Graff'scher Typ :	{	kleinstes Exemplar . . .	1 mm.	< Differenz = 2 mm.
		grösstes . . .	3 mm.	
		McClendon's Exemplar . . .	5 mm.	

† Die Cysten von *M. cysticum*, welche Graff untersucht hatte, fanden sich sämtlich an *Actinometra meridionalis* var. *carinata* P.H.C. Obgleich einige von ihnen kleine Verschiedenheiten in ihrer Gestalt und ihrer Lage am Crinoidenarme aufwiesen, so ist es dem genannten Autor doch nicht befallen, die Insassen derselben als differente Varietäten der typischen Form zu beschreiben.

Parapodien gelegene Randpartie ("edge of the disc") sich weiter gegen das Centrum der Bauchseite hin ausdehnte, als dies bei der von Graff gelieferten Abbildung (3, taf. XIII, fig. 5) der Fall wäre. Diesem Umstande vermag ich durchaus keine Bedeutung zuzumessen. Jeder Beobachter, welchem zahlreiche Exemplare einer *Myzostoma*-Species zu Gesicht gekommen sind, weiss wie modulationsfähig hinsichtlich seiner centripetalen Ausdehnung gerade dieser Körperabschnitt ist, dessen Areale durch stärkere Contractionen der "bauchständigen Muskelmasse" (Graff, 2, pag. 41-42) vergrössert, durch Entspannung derselben verkleinert werden kann.

Von den eben dargelegten Erwägungen ausgehend glaube ich also dass ein zureichender Grund zur Aufstellung einer neuen Varietät für die von McClendon beschriebenen Exemplare des *M. cysticolum* nicht vorliegt. Ich hoffe durch die Beschreibung der von der 'Discovery' heimgebrachten Individuen, für welche alle die von dem obgenannten Autor zu Gunsten seiner Auffassung ins Treffen geführten Argumente in gleicher Weise, ja vielleicht in noch höherem Ausmasse passen, wie für die von ihm untersuchten Exemplare, einen weiteren Beweis für meine Ansicht erbringen zu können.

Von der inneren Anatomie des *M. cysticolum* berücksichtigt McClendon im wesentlichen nur den Geschlechtsapparat. Er berichtet und ergänzt die bezüglichlichen Angaben Graff's und bestätigt auch für die genannte Species das Vorhandensein von weiblichen Gonaden bei einem jeden der beiden, früher als "Weibchen" und als "Zwergmännchen" unterschiedenen Individuen des die Cyste bewohnenden Parasiten-Pärchens.

BESCHREIBUNG DER 'DISCOVERY'-EXEMPLARE.

CYSTEN.

Die beiden mir zur Untersuchung übergebenen Cysten waren als eiförmige Auftreibungen des Wirtsintegumentes ihrer Länge nach dem Crinoidenarme etwas seitlich von dessen Ambulacralrinne angeschlossen (Fig. 3).

Sie massen 6·2 mm. bezüglich 5 mm. in der Länge und 3·2 mm. bezüglich 2·5 in der Breite. Die Wandungsdicke der grösseren Cyste betrug durchschnittlich 0·15 mm.; war also verhältnismässig viel geringer als bei den Cysten, welche Graff beschrieben hatte (3, pag. 67, zeile 9-10; pag. 68, abs. 2; taf. XIII, fig. 4).*

An jedem Cystenende zeigte sich in gleicher Weise wie bei den Exemplaren McClendon's eine ins Innere führende Öffnung, von welchen die von der Mundscheibe des Wirtes abgewendete in beiden Fällen viel grösser als die andersseitige war und sich vor dieser ausserdem noch durch eine schwache Aufwulstung ihres Randes

* Dies hängt mit der ansehnlichen Grösse der antarktischen *Myzostoma*-Individuen zusammen; denn eine Cyste, welche ein grösseres *Myzostoma* beherbergt, wird auch eine ausgedehntere, daher relativ dünnere Wandung besitzen als eine solche, welche einen kleineren Parasiten umschliesst. Auch unter den von Graff beschriebenen Cysten besass die kleinste (3, 'Blake'-Exemplar, pag. 68, abs. 2) eine derbere Wandung als die übrigen.

auszeichnete. Die kleinere der Cystenöffnungen wurde erst dann sichtbar, wenn man die in der Cyste enthaltenen Parasiten entfernt hatte, so dass Licht durch den punktförmigen Porus fallen konnte.*

ÄUSSERE MORPHOLOGIE DER PARASITEN.

Jede Cyste umschloss, wie bei den Exemplaren Graff's u. McClendon's, je ein grösseres weiblich- und ein kleineres männlich-functionierendes Individuum. In folgendem will ich nach dem Beispiele der früheren Autoren der bequemeren Ausdrucksweise halber das erste als "Weibchen," das letztere als "Männchen" bezeichnen, trotzdem beide, wie später nachgewiesen werden soll, als morphologische Hermaphroditen organisiert sind.

A. *Das Weibchen* ("female": Graff, **3**, pag. 67; "large individual": McClendon, **4**, pag. 121), (Fig. 2 u. 4), war der Länge nach in der Cyste gelagert, deren Innenraum es dabei so vollständig ausfüllte, dass sein Hinterende in ihm keinen Platz mehr fand und aus der grösseren der beiden Cystenöffnungen etwas herauszuragen gezwungen war. Auch der Breite nach entsprach das Cystenlumen nicht den Dimensionen des Tieres, weshalb dessen laterale Körperpartien, wie dies schon die beiden vorgenannten Autoren geschildert hatten, dorsalwärts aufgerollt waren, so dass die Seitenränder in der Medianebene nicht bloss zur Berührung sondern auch stellenweise (am Hinterende und in der Mitte des Körpers) zur Überlagerung gelangten (Fig. 7 u. 8).

Wie ein Blick auf das in Fig. 4 von der Ventralseite her abgebildete Weibchen zeigt, ist der (in der Fig. nach oben gerichtete) Hinterrand desselben medial ziemlich tief eingezogen. An dieser Stelle springen die benachbarten hintersten Abschnitte der aufgerollten Seitenränder nach rückwärts vor und legen sich zugleich, wie dies aus Fig. 6 zu erkennen ist, nach Art von zwei einander überdeckenden Flügelklappen von seitwärts und hinten her, über den trichterförmig erweiterten After ($\alpha\omega$), sowie über die unmittelbar oberhalb von diesem gelegene weibliche Geschlechtsöffnung ($\delta\ddot{o}$). Sie schliessen dadurch eine Art von Kloakalraum ab, der seinerseits nur vermittels eines sehr kleinen terminalen Porus nach aussen mündet. Zum Zwecke der Defaecation vermögen sich diese "Analklappen" zeitweise durch Contraction der entsprechenden Hautmuskelbezirke aufzuwulsten und so die im Rectum angesammelten Faeces ins Freie gelangen zu lassen; (dieses Verhalten ist aus Fig. 4 ersichtlich, während Fig. 6 eine der geschlossenen Analklappen im Längsschnitte zeigt). Wenngleich nun die Analklappen in geschlossenem Zustande—und dies scheint ihr normales Verhalten zu sein—die unmittelbare Verbindung des weiblichen Geschlechtsporus mit der Aussenwelt aufheben, so beeinträchtigen sie doch keineswegs die ständige Communication desselben mit dem von Graff als "broodpouch" (**3**, Erklärung zu taf. XIII., fig. 4) bezeichneten Behälter.

* Dieses Verhalten könnte möglicherweise die Angabe Graff's erklären, dass die von ihm untersuchten Cysten nur eine einzige Öffnung besessen hätten (**3**, pag. 66-67). Bei der Kleinheit des betreffenden Porus ist derselbe ausserordentlich leicht zu übersehen!

Dieser wird ja dadurch gebildet, dass einerseits von rechts und links her die aufgerollten lateralen Körperabschnitte, andererseits von unten her die mediale Rückenpartie des *Myzostoma* einen dorsal von der letzteren gelegenen, im Durchschnitte dreikantigen Raum umschliessen (Fig. 6, 7, 8, *br*), in welchen die reifen Eier abgelegt werden, und in dem die ausschlüpfenden Embryonen wahrscheinlich einen Teil ihrer Entwicklung durchmachen. Mir scheint nun die Einrichtung der Analklappen, abgesehen davon, dass sie der Afteröffnung einen ausgiebigen Schutz gewährt, auch für die Sicherung des Transportes der reifen Eier in die Bruttasche eine hervorragende Bedeutung zu besitzen. Denn nur dadurch dass der weibliche Genitalporus in der oben geschilderten Weise nach aussen hin abgeschlossen wird, vermögen die Eier in den Brutraum überzutreten, im gegenteiligen Falle müssten sie, da das Hinterende des Tieres aus der Cyste herausragt, im Momente des Austretens aus dem Uterus notwendiger Weise ins Freie gelangen.

Wie der Hinterrand des Weibchens so ist auch der Vorderrand desselben medial etwas eingebuchtet, jedoch bei weitem nicht so stark wie der erstere. Die Mundöffnung liegt frei, fast am vordersten Körperende, erscheint jedoch etwas nach der Ventralseite gerückt (Fig. 6, *m*).

Auf der Dorsalseite des Tieres, also noch innerhalb des Brutraumes öffnet sich ferner jederseits ein kleiner Porus (Fig. 7, $\delta\delta$), welcher unweit vom Körperende in der die mittleren Parapodien verbindenden Transversalebene gelegen ist. Diese zwei Öffnungen sind, wie später nachgewiesen werden soll (Pag. 17 und 18), den beiden männlichen Geschlechtsöffnungen des Männchens (Fig. 5, $\delta\delta$) homolog, wenn sie auch beim Weibchen als solche nicht mehr functionieren.

Schliesslich findet sich auf der Ventralseite des Körpers, direct unterhalb des Afters jedoch bereits ausser dem Bereiche der Analklappen, noch ein sehr kleiner medianer Excretionsporus (Nephroporus), (Fig. 6, *np*), der allerdings nur im Wege der Schnittmethode sichtbar gemacht werden kann.

Seitenorgane ("Saugnäpfe") fehlen vollständig.

Die Parapodien treten als äusserst kleine rudimentäre, mit freiem Auge nicht erkennbare Würzchen an der Ventralseite des Körpers auf (Fig. 2, 4; Fig. 7, *h*). Es sind ihrer jederseits fünf in einer genau zwischen dem aufgerollten Seitenrande und der ventralen Mittellinie verlaufenden Längsreihe gelegen. Sie bergen einen zwar deutlichen und vollständigen, jedoch infolge der Rückbildung der Bewegungsmusculatur kaum functionsfähigen Hackenapparat.

Die Aussenfläche (Ventralseite) des aus der Cyste herausgenommenen Weibchens erscheint makroskopisch im Allgemeinen glatt. Bei dem einen der zwei mir vorgelegenen Exemplare (Fig. 4) waren Andeutungen von Querfalten zu bemerken, die jedoch wahrscheinlich auf Contractionszustände zurückzuführen sind, welche durch die Conservierung hervorgerufen wurden. An jedem der beiden Exemplare fand sich weiters aussenseitig dort, wo zwischen ihnen und der Cystenwandung das kleinere Männchen gesessen hatte, eine durch den Gegendruck des letzteren hervorgerufene

flache Delle (Fig. 2, *d*; Fig. 4), welche förmlich ein Negativ von dessen Dorsalfläche darstellte. Dieser Eindruck wird sich am lebenden Tiere mit der zweifellos stattfindenden temporären Platzveränderung des Männchens entsprechend verschieben. Am conservierten Individuum erscheint er durch die vollzogene Härtung der Gewebe fixiert.

B. Das Männchen ("dwarf-male": Graff, **3**, pag. 67; "small individual": McClendon, **4**, pag. 121), (Fig. 5, 9, 10), sass in der von den beiden Autoren geschilderten Weise zwischen Cystenwand und dem Weibchen, wobei es diesem ungefähr in der Mitte von dessen Ventralseite mit der eigenen Rückenfläche enge angepresst war. Ein entsprechend durch die nicht entleerte Cyste geführter Querschnitt lieferte daher ganz ein ähnliches Bild wie die von Graff auf taf. XIII. seines 'Challenger'-Reportes dargestellte fig. 4.

Bezüglich der äusseren Configuration des Männchens kam ich mich in der Hauptsache (Gestalt, Umriss, Consistenz, Seitenrand, Cirren, Parapodien, Seitenorgane) auf die von den beiden obgenannten Autoren gelieferte und auch für die mir vorgelegenen Objecte vollkommen passende Beschreibung beziehen. Derselben wären nur noch hinsichtlich der Körperöffnungen folgende Ergänzungen beizufügen:

Wie schon McClendon beobachtet hat, erscheint der Vorder- und Hinterrand des Männchens in einem schmalen medianen Bezirke ziemlich weit nach der Körpermitte hin eingezogen. Diese Einbuchtungen setzen sich in ebenso schmale rinnenförmige Vertiefungen fort, von welchen die vordere und kürzere ventralseitig, die hintere etwas längere dorsalseitig verläuft. Am Hinterende der ersteren liegt der Mund (Fig. 9, *m*), am Vorderende der letzteren der After (Fig. 9, *ai*).

Oberhalb von diesem mündet der dem sogenannten Uterus des Weibchens entsprechende mediale Dorsalabschnitt des Coeloms durch eine kleine Öffnung aus, die wir demgemäss als ein Homologon der weiblichen Geschlechtsöffnung betrachten müssen (Fig. 9, *ö*). Die beiden männlichen Genitalporen (Fig. 5, *ö*), welche in der die mittleren Parapodien verbindenden Transversanebene gelegen sind, öffnen sich nicht, wie Graff und McClendon für ihre Exemplare angeben, marginal, sondern auf der Dorsalseite des Tieres, sind indess dem Körperande sehr nahe gerückt. Von diesem aus zieht zu einem jeden von ihnen eine kurze rinnenförmige Vertiefung des Integuments, welche möglicherweise von den beiden obgenannten Autoren als Ductus ejaculatorius aufgefasst worden ist, woraus sich ihre von meinem Befunde differierende Angaben erklären liessen.

Ein Excretionsporus ist auch beim Männchen nachzuweisen. Er liegt wie beim Weibchen median auf der Ventralseite dicht vor dem After (Fig. 10, *np*).*

* Wie aus dem Vorstehenden zu entnehmen ist, finden sich sämtliche am Körper des Weibchens tretende Öffnungen auch in gleicher Lage beim Männchen vor, ein Verhalten, welches mit dem Hinweis auf die später zu besprechenden morphologischen und biologischen Beziehungen der beiden Geschlechtsformen schon hier hervorgehoben sei.

INNERE ORGANISATION.

Wie in der Lage der Körperöffnungen so besteht auch hinsichtlich der inneren Organisation beim Männchen und beim Weibchen trotz deren äusserlichen Grössen- und Formdifferenz eine principielle Übereinstimmung. Diese äussert sich vor allem am Sexualsysteme, das bei jeder der zwei Geschlechtsformen durch zwei Apparate, einen männlichen und einen weiblichen, vertreten ist, von welchen aber beim Männchen nur der erstere, beim Weibchen nur der letztere reife Sexualproducte liefert. Die Differenzen zwischen den Geschlechtsorganen des Männchens und jenen des Weibchens sind also hauptsächlich functionelle und dies gilt im Grunde genommen auch für alle übrigen Organe. Diese erscheinen bei den zwei Geschlechtsformen nach demselben Plane angelegt und unterscheiden sich nur durch ihren Ausbildungsgrad, der seinerseits von ihrer Functionsintensität abhängt. Diese wird wieder durch die physiologische Sexualität des betreffenden Individuums bestimmt.*

Aus diesem Grunde halte ich es für zweckmässig in Nachfolgendem die einzelnen Organe gemeinsam für beide Geschlechtsformen zu beschreiben und zwar in folgender durch obigen Gedankengang begründeten Reihenfolge:—

- (1) *Weiblicher Geschlechtsapparat.*
- (2) *Männlicher Geschlechtsapparat.*
- (3) *Ernährungsapparat.*
- (4) *Excretionsapparat.*

Auf eine Schilderung des *Nervensystems* beabsichtige ich aus dem Grunde nicht einzugehen, weil sich dasselbe in seiner gröberen Morphologie nicht von jenem der anderen Myzostomen unterscheidet, und weil andererseits eine Untersuchung seines feineren Aufbaues, der bei dem Männchen und dem Weibchen möglicherweise interessante Differenzen vergeblich hätte, wegen der quantitativen und qualitativen Unzulänglichkeit des Materials aussichtslos schien.

WEIBLICHER GESCHLECHTSAPPARAT.

Derselbe wird bei den Myzostomen, wie bekannt, von einem Teile der Leibeshöhle (dem Uterus mit seinen Divertikeln), und weiters von bestimmt localisirten Wucherungen seiner peritonealen Auskleidung (den Ovarien) gebildet; (vergl. diesbezüglich: Stummer, 6, pag. 574 u. ff.).

Männchen: Bei diesem erscheint der zu den weiblichen Geschlechtswegen umgebildete Leibeshöhlenanteil,—im Gegensatze zu den ausschliesslich männlich

* Durch die physiologische Unisexualität werden abgesehen vom entsprechenden Geschlechtsapparate hauptsächlich die Stoffwechselorgane (Darm- u. Excretionssystem), in ihrem Ausbildungsgrade beeinflusst, und zwar in der Weise, dass die Functionsintensität dieser Organe beim Weibchen gegenüber jener beim Männchen erheblich gesteigert erscheint. Der mütterliche Körper, welchem die Ausbildung der grossen und dotterreichen Eier obliegt, besitzt eben ein weit grösseres Stoffwechselbedürfnis als der väterliche, der durch die Production der winzigen Spermien diesbezüglich nicht so sehr beansprucht wird (vergl. Pag. 20 und 21).

functionierenden Individuen anderer *Myzostoma*-Arten, bei welchen sich bisher nur spärliche Andeutungen dieser Coelompartie nachweisen liessen,—wohl entwickelt; er ist zwar räumlich nicht so ausgedehnt, wie beim Weibchen, zeigt aber dieselbe Untergliederung wie bei diesem. Er setzt sich aus einem dorsalen, zwei seitlichen und einem ventralen Abschnitte zusammen.

Der erste entspricht der bei anderen hermaphroditisch functionierenden *Myzostoma*-Arten gemeinlich als Uterus bezeichneten Leibeshöhlenpartie. Er stellt ein medianes, dorsoventral abgeplattetes Rohr dar, welches ungefähr oberhalb der Magenmitte beginnt und von hier aus unter allmählicher Verschmälerung nach rückwärts bis zur weiblichen Geschlechtsöffnung verläuft, durch welche es ausmündet (Fig. 9, *ua + ub*) Bald hinter seinem verbreiterten Vorderende erscheint seine Seitenwandung rechts und links in einen kurzen Zipfel ausgezogen, an dessen Lateralende sich je ein Nephrostom (Fig. 9, *ns*) öffnet.

Vorne steht der Uterus jederseits durch einen kurzen und breiten Querast mit den beiden Seitenabschnitten der Leibeshöhle in Verbindung. Diese verlaufen zunächst in dorsoventraler Richtung längs der rechten und linken Seitenwand der vorderen Magenhälfte nach abwärts, um sodann beiderseits nach Umfassung der Wurzeln des II. und III. Hauptdarmastes in den Ventralabschnitt der Leibeshöhle überzugehen.

Letzterer besteht aus zwei symmetrischen, durch eine schmale suboesophageale Quer-Commissur verbundene Hälften (Fig. 10, *vl*). Eine jede von diesen beginnt als ein länglicher, unter und seitwärts von den lateralen Magenpartien gelegener Hauptraum, von dem weiterhin drei Divertikel gegen die Hauptdarmäste ausgehen, welche die letzteren unter entsprechender Teilung längs ihrer ganzen Verzweigung ventralseitig begleiten (Fig. 10, *1, 2, 3*).

An der Wurzel des ersten und dritten dieser Divertikel liegt nun je ein aus einer localen Wucherung des Peritonealepithels hervorgehender Zellhaufen, welcher von seitwärts und von unten her in den Hauptraum einspringt. Im Ganzen sind daher vier derartige Gebilde vorhanden (Fig. 10, *o*). Ihrer Lage und ihrem histologischen Aufbaue nach müssen wir sie in Übereinstimmung mit McClendon (4, pag. 121, abs. 3) mit den von Nansen (5, pag. 78, abs. 4) bei anderen Myzostomen entdeckten "problematischen Organen" homologisieren, die später von Wheeler (7, pag. 178, abs. 2) als die echten Ovarien erkannt worden sind. Dass sie beim Männchen von *M. cysticum* tatsächlich als solche früher oder später functionieren lässt sich jedoch nicht nachweisen. Sie machen im Gegensatze zu den productiven Ovarien des Weibchens einen kümmerlichen Eindruck, so dass man sie entweder als noch unentwickelte oder als rückgebildete Organe auffassen kann.

Reife Eier oder auch nur solche in der ersten Entwicklung habe ich innerhalb der ganzen am Aufbaue des weiblichen Geschlechtsapparates beteiligten Leibeshöhle nicht beobachten können. Dieselbe erscheint,—abgesehen von den die Ovarien darstellenden Wucherungen,—in allen ihren Abschnitten von einem gleichmässigen Peritonealepithel ausgekleidet.

Beim *Weibchen* zeigt der weibliche Geschlechtsapparat gegenüber jenem des Männchens eine bedeutende durch sein Functionieren bedingte Ausgestaltung. Vor allem erscheint die Leibeshöhle viel stärker entwickelt. Dies gilt insbesondere von ihren Seitenabschnitten, welche sich lateralwärts ausserordentlich verbreitern, ventralwärts mit den Haupträumen des Ventralabschnittes sowie mit den von diesen ausgehenden Divertikeln verschmelzen und sich so als mächtige, die reichverzweigten Darmäste umhüllende Säcke in den seitlichen Partien des Körpers fast bis ans Integument hin erstrecken (Fig. 7, 8).

Infolge dessen bleibt das Körperparenchym, welches beim Männchen noch in relativ grossem Massstabe sämtliche Zwischenräume zwischen den einzelnen Organen ausfüllt, beim Weibchen hauptsächlich nur im Bereiche eines medialen, etwa ein Fünftel der Körperbreite einnehmenden Leibesabschnittes in Form grösserer zusammenhängender Bindegewebspartien erhalten. Diese umhüllen den Pharynx, den Magen, den Enddarm, den Uterus, die Nephridien und das Bauchmark (Fig. 8). In den Seitenabschnitten des Körpers hingegen erscheint das Parenchym auf dünne die primären und secundären Septen begleitende Schichten sowie auf einen relativ schmalen unterhalb des Integuments verlaufenden Streifen beschränkt der nur dort, wo die Parapodien zu liegen kommen, zu etwas bedeutenderen Complexen auswächst.

Von jenem beim Männchen als Ventralabschnitt der Leibeshöhle bezeichneten Raum bleibt beim Weibchen nur die suboesophageale Quercommissur der beiden Haupträume gesondert erhalten. Hinter dieser finden sich jedoch noch einige breitere, zwischen Magen und Bauchmark verlaufende Querdivertikel der lateralen Leibeshöhlsäcke, durch welche die letzteren mit einander in unregelmässiger Weise verbunden erscheinen (Fig. 6, 7, *vl*).

Auch der Uterus (Fig. 6, 7, 8 *ua*, *ub*) zeigt im Allgemeinen grössere Dimensionen wie jener des Männchens. Man kann an ihm einen kürzeren vorderen und einen längeren hinteren Abschnitt unterscheiden. Der erste (Fig. 6, 7, *ua*) ist der breitere und besitzt im Querschnitte die Form eines gleichschenkeligen Dreieckes, welches mit seiner Grundlinie der dorsalen Magenwand fast unmittelbar aufsitzt. Er liegt ober den Abzweigungsstellen der Hauptdarmäste und steht beiderseits fast seiner ganzen Länge nach in kontinuierlicher Verbindung mit den lateralen Leibeshöhlsäcken. An seinem hintersten Ende öffnet sich in ihm von jeder Seite her ein Nephrostom (Fig. 8, *ns*). An diesen beiden Stellen erscheint jedoch seine Wandung nicht in derartige trichterförmige Zipfel ausgezogen wie beim Männchen. Hinter der Einmündung der Nephrostome geht er in den schmäleren hinteren Uterusabschnitt über. Dieser (Fig. 6, *ub*) besitzt im Allgemeinen einen rundlichen Querschnitt mit radialen gegen seine Längsaxe einspringenden Epithellamellen und verläuft unter allmählicher Verringerung seines Kalibers ziemlich gestreckt oberhalb der hinteren Magenhälfte und oberhalb des Rectums bis zur weiblichen Geschlechtsöffnung. Ein die letztere abschliessender besonderer Sphinkter ist nicht ausgebildet.

Die Ovarien (Fig. 7, *o*) liegen beiderseits zu zwei an der ventralen Seite der Leibeshöhlsäcke unweit des Magens und zwar an genau denselben Körperstellen, wie beim Männchen, nämlich das vordere unter und hinter dem I., das rückwärtige hinter dem II. Hauptdarmaste; (in der Fig. 7 ist das rückwärtige Ovarium der linken Seite zu erkennen). Sie sind viel mächtiger entwickelt (ungefähr 15–20 mal so gross) wie jene des Männchens und bestehen auch aus einer viel grösseren Anzahl von Zellen. Unter diesen kann man bereits sehr deutlich die künftigen Eizellen mit ihren grossen bläschenförmigen Kernen von den kleine und dunkle Kerne besitzenden Nährzellen ("accessory cells": Wheeler, 7, pag. 178, abs. 2) unterscheiden.*

Die Innenwandung der Leibeshöhlsäcke und ihrer Divertikel wird teils von einem Peritoneal-, teils von einem Pseudoepithel (Stummer, 6, pag. 578) gebildet. Diese Auskleidung zeigt überall einen reichlichen Belag von sich daselbst entwickelnden Eiern, welche hier in allen Bildungsstadien von der eben vom Ovarium losgelösten Zelltriade (Wheeler, 8, pag. 233, abs. 2, "triplet-cells") an bis zum befruchtungsfähigen Ei vertreten sind.

MÄNNLICHER APPARAT.

Beim *Männchen* ist derselbe bereits von Graff und McClendon insoweit genau beschrieben worden, dass ich hierzu nur folgende unwesentliche Ergänzungen zu liefern vermag. In jedem der beiden der compacten Form (vergl. Pag. 6, Anmerk. 1, *b*) angehörenden Hoden liegt ein deutlicher centraler Sammelraum, der direct mit der Geschlechtsöffnung communiciert und sowohl Spermien als auch eine Menge von sich nicht weiter entwickelnden, vielleicht auch degenerierten Spermatoocyten (Stummer, 6, pag. 583) enthält.

Beim *Weibchen* fand ich die beiden Hoden genau in derselben Lage und in der formell gleichen Ausbildung, wie beim Männchen. Sie liegen jederseits in der Mitte des aufgerollten Seitenrandes, dicht neben dem männlichen Geschlechtsporus, und stellen eine deutlich vom übrigen Körperparenchym abgegrenzte Masse von reticulärem Bindegewebe dar, dessen Intercellularräume zu grösseren Blasen ausgedehnt sind (Fig. 7, *t*). Die letzteren fliessen in der Mitte dieses Complexes zu einem dicht an die männliche Geschlechtsöffnung anschliessenden centralen Sammelraum zusammen. Während aber die Intercellularräume beim Männchen dicht mit Keimzellen beziehungsweise mit deren Teilungsproducten erfüllt sind, enthalten sie beim Weibchen relativ nur wenige Zellen. Von diesen lassen sich zweierlei Formen unterscheiden: Die einen gleichen auffallend den von Graff (2, pag. 64, Abs. 1) als "Rundzellen"

* Bemerkenswert ist, dass schon Graff die Ovarien bei *M. cysticum* gesehen hat. Nur wurden sie von ihm zufolge der damals noch herrschenden Anschauung, dass die Verzweigungen des Uterus (Leibeshöhle und ihre Divertikel) das Ovarium bei den Myzostomen darstellten, als rudimentäre Hoden gedeutet (Graff, 3, pag. 67, abs. 2). Nach der Abbildung, welche der genannte Autor von diesen Gebilden geliefert hat (3, taf. XIII, fig. 4, *t*), erscheint es jedoch zweifellos—auch McClendon ist dieser Meinung (4, pag. 121, abs. 3)—dass sie mit den oben geschilderten echten Ovarien identifiziert werden müssen. Die Priorität, die wahren *Myzostoma*-Ovarien zuerst gesehen zu haben gebührt daher Graff, und nicht Nansen, dem sie bisher zugeschrieben worden ist.

beschriebenen freien Bindegewebelementen (Stummer, 6, pag. 589, letzt. Abs.). Die anderen machen jedoch vollständig den Eindruck von degenerierten Zellen. Sie besitzen einen relativ kleinen unregelmässig gestalteten Kern, der sich mit Haematoxylin intensiv färbt und dabei neben einem homogenen Aussehen auch ein eigentümliches Lichtbrechungsvermögen entwickelt. Ihr Cytoplasma ist nur in sehr geringer Menge vorhanden und im günstigsten Falle als ein kaum tingierbarer, schmaler, den Kern umhüllender Saum zu erkennen. Von Spermien fand sich innerhalb des ganzen Bindegewebscomplexes keine Spur. Der centrale Sammelraum desselben enthielt dagegen bei jedem der mir vorgelegenen Exemplare eine feinkörnige oft fädig angeordnete und auch aus der Geschlechtsöffnung dringende Masse, in welche zahlreiche der oberwähnten anscheinend degenerierten Zellen eingebettet waren.

Ich stehe nicht an, die eben geschilderten Organe auf Grund ihrer Lage und ihrer Ausbildung als functionslose Hoden zu betrachten, die jenen des Männchens vollständig homolog sind. Es ist infolge des ungenügenden Materials selbstverständlich sehr schwer zu entscheiden, ob sie als Rückbildungen von männlichen Gonaden aufzufassen sind, die in einem früheren Lebensalter des Individuums funktioniert haben, oder ob sie auf einem frühen Entwicklungsstadium stehengebliebene, niemals zur sexuellen Betätigung gelangte Apparate darstellen. Meiner Meinung nach dürfte die erstere Annahme die zutreffende sein, insbesondere deshalb, weil sich ähnliche Verhältnisse (Proterandrie mit späterer Rückbildung des Hodens) bei zahlreichen frei lebenden und auch bei einigen entoparasitischen *Myzostoma*-Arten, mit Sicherheit haben nachweisen lassen (Wheeler, 8, pag. 288–289). Schliesst man sich dieser Ansicht an, so könnte man von den oberwähnten, in den Interzellularräumen vorhandenen Zellen, die von mir als anscheinend degeneriert bezeichneten Elemente als rückgebildete Keimzellen, jene aber, welche den "Rundzellen" Graff's ähneln, als secundär in die Follikel eingewanderte freie Bindegewebszellen auffassen. Die feinkörnige, im Sammelraum enthaltene Masse würde dann auf Reste von abgestorbenen Spermien oder von zugrundegegangenen Spermatoocyten etc. zurückzuführen sein.

Derartige functionslose Hoden sind weder von Graff noch von McClendon bei den von ihnen untersuchten "Weibchen" beschrieben worden. Ich glaube aber, dass diesbezüglich ein Übersehen von Seiten der genannten Autoren vorliegt, da diese Gebilde bei dem vollständigen Fehlen von tätigen Keimzellen und von Spermien nicht sofort als Hoden zu erkennen sind. Graff dürfte ihnen schon deswegen keine weitere Beachtung geschenkt haben, weil er überzeugt war, in den von ihm beim Weibchen beschriebenen "collections of small cells closely resembling the immature testicular follicles . . ." (3, pag. 67, abs. 2) Hodenrudimente vor sich zu haben. Dass diese seine Auffassung eine irrthümliche war, und dass diese Gebilde die Ovarien darstellen, habe ich schon früher (Pag. 17) erwähnt.

ERNÄHRUNGS-APPARAT.

Derselbe ist nach dem schon von den übrigen Myzostomen her bekannten Typus gebaut.

Wegen der viel einfacheren Verhältnisse, welche er beim *Männchen* aufweist, sei er zuerst an diesem geschildert: Bezüglich von Mund und After verweise ich auf die schon früher (Pag. 13) gelieferten Angaben. Der lange, cylindrische, an seinem Vorderende nicht mit Tastpapillen ausgerüstete Pharynx (Fig. 9, *bm*), steht vermittels eines kurzen "Oesophagus" mit dem Magen in Verbindung. Dieser (Fig. 9, *mg*), zerfällt durch eine seichte, quere Einschnürung in einen vorderen weiten und einen hinteren engeren Abschnitt. Vom ersteren gehen ventral jederseits drei Hauptdarmäste (Fig. 9, I, II, III) ab, welche sich nach kurzem Verlaufe teilen und mit ihren wenig zahlreichen, stumpf endigenden Divertikeln bis zur Randzone des Körpers reichen. Von diesen drei Hauptdarmästen verzweigen sich jederseits die zwei ersten in der vor dem Hoden gelegenen, der dritte in der hinter diesem befindlichen Körperpartie. Der hintere Magenabschnitt ist kleiner als der vordere und geht vermittels eines nur am contrahierten Tiere (Fig. 5) sichtbaren Absatzes in das röhrenförmige dorsoventral compresse Rectum (Fig. 9, *r*) über. Die Afteröffnung kann durch einen sich aus dem Hautmuskelschlauche differenzierenden schwachen Sphinkter geschlossen werden.

Der gesamte Verdauungsapparat ist beim Männchen entsprechend dessen geringem Ernährungsbedürfnisse recht einfach gebaut. Seine einzelnen Abschnitte setzen sich aus einer weit geringeren Anzahl von Zellelementen zusammen wie jene des Weibchens. Auch seine Muscularis ist nur schwach entwickelt und an manchen Stellen überhaupt nicht nachzuweisen.

Beim *Weibchen* hingegen dessen Stoffwechselbedürfnis infolge der reichlichen Eierproduction ungemein gesteigert ist, zeigt der Ernährungsapparat eine viel mächtigere Ausgestaltung: vor allem ist der Magen (Fig. 6, 7, 8, *mg*) relativ bedeutend voluminöser wie beim Männchen. Er wird seiner ganzen Ausdehnung nach samt dem Oesophagus (Fig. 6, *o*) von einem sehr auffallenden Wimperepithel ausgekleidet, dessen zahlreiche und dicht stehende Cilien wegen ihrer ungewöhnlichen Länge bemerkenswert sind (Länge der Epithelzellen: 0.068 m., jene der Cilien: 0.1 m.). Die Hauptdarmäste sind distalwärts ausserordentlich reich verzweigt. Ihre Divertikel liegen vollkommen in die lateralen Leibeshöhlensäcke eingebettet (Fig. 7 u. 8, *da*), und verbreiten sich in grosser Zahl insbesondere innerhalb der aufgerollten Seitenpartien des Körpers, wo sie sich mit ihren Terminalenden bis knapp unter den Hautmuskelschlauch erstrecken. Das Hinterende des Magens erscheint scharf von Rectum (Fig. 6, *r*) abgesetzt. Das letztere verläuft in ziemlich gerader Richtung bis zum After. Es wird von einem Wimperepithel ausgekleidet, das in radiär in sein Lumen einspringende Längsfalten gelegt ist. Eine durch äussere Ring- und innere Längsfasern hergestellte Muscularis findet sich

sowohl am Magen als auch am Rectum. Sie erscheint insbesondere am ersteren kräftig ausgebildet; an letzterem ist sie jedoch schwach entwickelt, ihre beiden Schichten werden aber hier noch durch eine periphere dritte Lage vervollständigt, die aus locker verfilzten Fasern besteht. Ein besonders differenzierter Sphinkter findet sich weder an der Grenze zwischen Magen und Rectum, noch um die Afteröffnung. Für die letztere wird die Function eines solchen wohl von den benachbarten Partien des Hautmuskelschlauches übernommen. Ausserdem erscheint aber der After für gewöhnlich auch noch durch die früher (Pag. 11) beschriebenen Analklappen verschlossen.

NEPHRIDIEN.

Dieselben beginnen jederseits mit einem sich in dem vorderen Uterusabschnitt öffnenden cylindrischen Nephrostom (Wimpertrichter) (Fig. 8, 9, *ns*). Dieses setzt sich in einen engen, beim Männchen kürzeren, beim Weibchen, wegen dessen bedeutender Dicke, längeren Nephridialcanal fort, welcher in ziemlich geradem Verlaufe längs der Seitenwand der hinteren Magenhälfte nach abwärts zieht (Fig. 8), um sich etwa in halber Magenhöhe plötzlich (diese Stelle ist in Fig. 8 und 10 mit * bezeichnet) zu einer grossen, vielfache Windungen und Einschnürungen zeigenden Endblase zu erweitern. Die letztere (Fig. 6, 8, 10, *nb*) besitzt in ihrem proximalen an den Nephridialcanal anschliessenden Abschnitt eine bedeutende Ausdehnung, verschmälert sich aber distalwärts allmählig zu einem relativ langen, ziemlich gerade nach hinten verlaufenden Canal, welcher mit jenem der anderen Körperseite gegen die Medianebene convergiert und sich schliesslich mit ihm zu einem kurzen unpaaren Endstück (Fig. 6, 10, *nu*) vereinigt, das durch den median, knapp unter der Afteröffnung gelegenen Excretionsporus (Fig. 6, 10, *np*) ausmündet.

Während der Nephridialcanal von einem verhältnismässig niedrigen Wimperepithel ausgekleidet ist, findet sich in der Endblase bis zum Excretionsporus hin ein deutliches Drüsenepithel, dessen hohe keulenförmig gestaltete Elemente (aus Fig. 8 ist die Lagerung und die relative Höhe derselben ersichtlich) der Wimpern entbehren. Eine besondere Muscularis liess sich nur an der Endblase nachweisen, aber auch hier ist sie sehr schwach ausgebildet und besteht lediglich aus einer Ringfaser-schichte.

So wie der Ernährungsapparat, zeigen auch die Nephridien des Weibchens gegenüber jenen des Männchens eine viel mächtigere Entfaltung, die sich insbesondere in der relativen Länge des Nephridialcanals sowie in der Grösse der Endblase äussert.

SEXUALVERHÄLTNISSE UND DIMORPHISMUS DER GESCHLECHTSFORMEN.

Graff (3, pag. 11–12) unterscheidet unter den von ihm beschriebenen cysticoelen Myzostomen zweierlei in Bezug auf ihre Sexualverhältnisse divergente Formen und zwar rein dioecische und rein hermaphroditische.

Zur ersteren Gruppe gehören: *M. tenuispinum*, *M. willemoesi*, *M. inflator* und *M. murrayi*. Bei diesen Species finden sich in je einer Cyste zwei auffallend dimorphe Individuen vereinigt, ein kleines, nur männlich organisirtes "Männchen" und ein grosses, nur weibliche Charaktere besitzendes "Weibchen."*

Die zweite Gruppe wird durch *M. pentacrini* und *M. deformator* repraesentirt. Die Individuen dieser beiden Arten leben entweder einzeln in je einer Cyste, oder aber sie werden, falls sie zu mehreren (zwei bis drei) eine solche bewohnen, in dieser durch entsprechende Scheidewände von einander getrennt. Zur innigen Berührung zweier Exemplare, wie dies bei den rein dioecischen Species die Regel ist, kommt es daher bei ihnen nicht. Ebensowenig besteht hier ein Dimorphismus unter den Insassen einer und derselben Cyste. Jedes Individuum zeigt sowohl männliche als auch weibliche Charaktere und functioniert auch dementsprechend als Hermaphrodit.†

Das *M. cysticolum* betrachtete Graff als eine in sexueller Beziehung intermediäre Form zwischen den rein dioecischen und den rein hermaphroditischen Species (3, pag. 67, Abs. 2), da er vermutete, dass bei ihr das "Weibchen" Hodenrudimente besässe.

Auf Grund unserer heutigen Kenntnisse über die Anatomie dieser Art dürfen wir jedoch behaupten, dass ihre beiden dimorphen Geschlechtsindividuen morphologisch als Hermaphroditen organisirt sind, in physiologischer Beziehung jedoch nur eingeschlechtlich und zwar entweder nur als Männchen oder nur als Weibchen functionieren.‡ Von einem Sexualdimorphismus in der gebräuchlichen Bedeutung kann daher bei *M. cysticolum* nicht die Rede sein. Man wird vielmehr die bei dieser Species herrschenden Geschlechtsverhältnisse als das Endergebnis einer physiologischen Sexualdifferenzierung betrachten müssen, die sich im Laufe der Ontogenese auf (morphologisch-) hermaphroditischer Grundlage vollzieht und dabei mit einer Dimorphosierung der sich entwickelnden Geschlechtsindividuen verbunden ist.

Der typische *Myzostoma*-Habitus und die relativ geringe Grösse des Männchens, ferner die verhältnismässig sehr einfache Ausbildung seiner inneren Organe sowie der primitive Aufbau seiner Körpergewebe lassen dasselbe viel ursprünglicher und unveränderter erscheinen als das Weibchen, weshalb wir annehmen müssen, dass die Dimorphosierung hauptsächlich an dem letzteren während seiner Entwicklung vollzieht. Es wird hier die allmählig sich einstellende physiologische Praeponderanz der weiblichen Gonaden nicht nur den höheren Ausbildungsgrad des weiblichen Sexualapparates (Leibeshöhle), sondern auch die functionelle Ausgestaltung jener

* Nur einmal wurde von Graff (3a, pag. 8) in einer durch *M. willemoesi* hervorgerufenen Cyste bloss ein einziges und zwar männlich functionierendes Individuum vorgefunden.

† In diese Gruppe gehören noch: *M. beardi* und *M. platypus* (Graff 3a, pag. 13 u. 14; für *M. platypus* siehe auch: Wheeler 8, pag. 214), ferner *M. belli*, *M. cryptopodium* und *M. cremita* (Wheeler 8, pag. 246-251) sowie wahrscheinlich auch das *M. clarki* (McClendon 4, pag. 121-122), obwohl es dem letztgenannten Autor nicht gegückt ist, bei den von ihm untersuchten Individuen Hoden oder Reste von solchen aufzufinden.

‡ Ich vermute, dass ähnliche Verhältnisse auch bei den übrigen von Graff als "dioecisch" bezeichneten Arten herrschen. Eine diesbezügliche Entscheidung ist allerdings nur mit Hilfe der Schnittmethode zu erbringen, die der genannte Autor, wie aus dem betreffenden Texte und aus den von ihm gelieferten Abbildungen hervorgeht, bei diesen Species nicht angewandt hat.

Organe bedingen, welche für die Eierproduction eine nur indirecte Bedeutung haben : Darm und Excretionsapparat (Stoffwechsellorgane). In zweiter Linie wird der correlative Einfluss der auftretenden physiologischen Unisexualität bei dem sich zum Weibchen entwickelnden Individuum auch äusserlich und zwar an der relativen Dimensionierung, der Consistenz und der Form des Körpers, ferner am Bewegungsapparate zum Ausdruck kommen : Die reichliche Anzahl der producierten Eier, welche innerhalb der Leibeshöhle infolge der Aufnahme von Dotter zu einem Vielfachen ihrer ursprünglichen Grösse heranwachsen, bedingt einen verhältnismässig umfangreichen mütterlichen Körper mit derber dem bedeutenden Innendrucke gewachsener Wandung. So kommt es denn schliesslich dazu, dass die Dimensionen des Weibchens jene des Männchens weit übertreffen. Die Breitenausdehnung des ersteren wird sogar eine so grosse, dass ihr das Cystenwachstum nicht zu folgen vermag, weswegen die Seitenränder des Tieres gezwungen sind, sich medianwärts in der früher beschriebenen Weise einzurollen (Graff, **3**, pag. 12, abs. 1). Da ferner für das Weibchen die Bewegungsmöglichkeit innerhalb der dem Körper enge anliegenden Cyste verloren gegangen ist, so werden die Parapodien als für die Eiproduction überflüssig gewordene Körperteile eingeschmolzen. Es findet sich von ihnen nur mehr der Hackenapparat, während die häutigen Teile des Fussstummels fast vollständig in die Leibeshöhle aufgenommen erscheinen. Dementsprechend ist auch die Stummel- und Hackenmuskulatur rudimentiert.

Bei dem sich zum Männchen entwickelnden Individuum braucht sich die Sexualdifferenzierung fast nur auf die functionelle Ausgestaltung des männlichen Apparates zu beschränken ; denn der Darm und der Excretionsapparat werden hier jenen Ausbildungsgrad kaum überschreiten, welchen sie bereits bei dem der Geschlechtsform unmittelbar vorangehenden Jugendstadium besaßen. Beim Männchen erfährt eben das Stoffwechselbedürfnis durch die Erzeugung von Sperma keineswegs eine so wesentliche Steigerung, wie beim Weibchen durch die Versorgung der Eier mit Dotter. Die Production der kleinen, wegen ihrer Form in compendiösester Weise zusammenpackbaren Spermien benötigt nur relativ geringe Körperräume, wogegen für die Absatzmöglichkeit des Samens eine unbehinderte Bewegungsfähigkeit des Tieres vorteilhaft erscheint. So besitzt denn das Männchen einen kleinen, zarten und abgeflachten Körper mit wohlentwickeltem Parapodialapparate. Es spricht vieles dafür, dass sich dasselbe auch im Habitus nicht wesentlich von jener Jugendform unterscheidet, die ihm in der Ontogenese unmittelbar vorausgegangen ist.

Die Entwicklungsstadien, auf welchen sich die Sexualdifferenzierung bei den zwei Geschlechtsformen herausbildet, sind uns leider noch völlig unbekannt und daher bleibt die Frage noch offen : Gilt auch für das *M. cysticum* die Theorie Wheeler's von den *successiven Sexualphasen* (**8**, pag. 288–289), oder herrschen diesbezüglich bei dieser Art andere Verhältnisse ?

Nach den Beobachtungen des ebengenannten Autors ist die Sexualdifferenzierung

der Myzostomen eine successive, das heisst, es tritt im Leben eines jeden Individuums nach Ablauf eines geschlechtlich indifferenten Jugendstadiums zuerst eine männliche, später hingegen eine weibliche Geschlechtsperiode auf. Bei den meisten Arten fand Wheeler, dass diese beiden "Sexualphasen" durch einen intermediären functionell hermaphroditischen Zustand verbunden sind; er beobachtete jedoch auch Species (z. B. *M. pulvinar*, 8, pag. 289), bei welchen diese Zwischenperiode ausfällt, so dass die männliche und die weibliche Geschlechtsphase direct an einander anschliessen.

Ich halte es nun durchaus nicht für unwarscheinlich, dass diese Theorie Wheelers auch für das *M. cysticolum* Geltung besitzt. Das Vorhandensein von Ovarien beim Männchen und von Hodenresten beim Weibchen lassen diese Annahme zu, insbesondere, wenn man geneigt ist, die Ovarien des Männchens als sich erst entwickelnde, aber noch nicht functionsfähige Organe aufzufassen. Wenn wir demgemäss das Männchen als ein frühes Entwicklungsstadium des Weibchens betrachten, so wäre aber auch der auffallende Umstand zu erklären, dass in allen bisher beobachteten Fällen (16)* in jeder Cyste nur die beiden extremdimorphen Individuen, aber keine ontogenetischen Zwischen- oder Übergangsstadien, deren Vorkommen man ja in Consequenz der obigen Theorie voraussetzen muss, angetroffen wurden. Wheeler, welcher das Bedürfnis diesbezüglich zu einer plausiblen Vorstellung zu gelangen wohl gefühlt hatte, spricht sich darüber folgendermassen aus: "v. Graff's supposition that the young Myzostomes associate in pairs and together take part in forming a gall seems to me hardly plausible. Judging from my observations on *M. glabrum* and *pulvinar*, both of which show a distinct tendency to occur in pairs, each consisting of a senior and junior individual, I believe that in the case of the cysticolous species the gall must be formed by a single individual, and that later a young Myzostome, when it abandons its pelagic trochophore stage, must enter through the aperture of the gall and settle down to a quiet life with the senior individual. The latter probably dies at the end of its female stage, and, undergoing decomposition, may perhaps serve as food for its still vigorous junior partner. This one in turn may thereupon become the senior partner of another young Myzostome, and so on. According to this view, all the cysticolous Myzostomes of a given species would not be *cyst-producing*, but only those which, instead of entering the orifice of a pre-formed gall in their juvenile stage, happen to settle between the arm-joints or contrive to work their way into the calcareous skeleton of the Crinoid" (8, pag. 259 und 260, anmerkg. 1). Ich glaube dass es zur Erklärung des beredeten Umstandes einer derartigen etwas phantastisch anmutenden Annahme nicht bedarf. Ohne mich diesbezüglich auf Beobachtungen stützen zu können, halte ich es doch in höherem Grade für warscheinlich, dass das männliche Individuum eines encystirten Pärchens nach dem Absterben des durch die reichliche Eierproduction schliesslich erschöpften Weibchens die Cyste durchbricht, um dann einige Zeit, während welcher es eine functionell hermaphroditische oder vielleicht eine geschlechtlich

* 13 Cysten (12 von der 'Hassler'-Expedition, 1 von der 'Blake'-Expedition), beobachtete Graff (3, pag. 66 und 68); 1 Cyste lag McClendon vor; 2 Cysten wurden von der 'Discovery' heimggebracht.

unproductive Übergangsperiode vom männlichen zum weiblichen Zustand durchläuft, frei auf den Armen seines Wirtes weiter zu leben. Man kann sich nun leicht vorstellen, dass bei dieser Gelegenheit eine von den herumschwärmenden Larven derselben Art in ähnlicher Weise, wie es bei anderen Myzostomen der Fall ist, sich nach Abstreifung ihres Wimperkleides als künftiges Männchen auf den Rücken des betreffenden jetzt zum functionierenden Weibchen werdenden Individuums anzusiedeln vermag. Das letztere bohrt sich dann nach vollständiger Rückbildung seiner männlichen Keimzellen an einer passenden Stelle in das Integument des Wirtsarmes ein, von dem aus eine neue Cyste gebildet wird, welche das junge nun aus einem functionierenden Männchen und Weibchen bestehende Pärchen allmählig umgiebt.

Wenn wir uns also vorderhand bezüglich der Sexualverhältnisse des *M. cysticum* der eben besprochenen Theorie Wheelers als der bis heute noch die meiste Wahrscheinlichkeit besitzenden Erklärung anschliessen, so ist immerhin auch die Möglichkeit nicht von der Hand zu weisen, dass gerade bei der vorliegenden Species mit ihrem hochgradig ausgebildeten Sexualdimorphismus sich der ontogenetische Entwicklungsgang der Geschlechtsdifferenzierung anders abspielt, als bei den von dem genannten Autor untersuchten Formen. Es wäre ganz gut denkbar, dass von zwei frühzeitig associirten und ursprünglich als Hermaphroditen angelegten Individuen sich das eine unter Sistierung der weiblichen Fortbildung* zum Männchen, das andere unter Rückbildung der männlichen Keimzellen zum Weibchen entwickelt, so dass sich die Sexualphasen nicht successive an einem einzigen Individuum abspielen, sondern sich ziemlich gleichzeitig auf zwei zu einem Pärchen vereinigte und gleichalterige Exemplare aufteilen würden. Der Gegensatz, in welchem das *M. cysticum* unter dieser seinerzeit schon von Graff (3, pag. 11–12) ausgesprochenen Annahme zu den von Wheeler beobachteten Myzostomen zu stehen käme, hätte nichts Auffallendes an sich, da wir ja bei vielen anderen Parasiten die mannigfachsten Anpassungen hinsichtlich ihrer Sexualverhältnisse vorfinden, so zwar, dass die betreffenden Einrichtungen auch bei verschiedenen Arten einer und derselben Gattung differieren können.

Die Geschlechtsverhältnisse der Myzostomen scheinen überhaupt verwickelter zu sein als man bisher angenommen hat, und die Theorie Wheelers von den successiven sich an einem und demselben Individuum abspielenden Sexualphasen wird möglicherweise nicht für alle Arten aufrecht erhalten werden können. Leider ist bisher fast jeder diesbezüglichen Entscheidung der Mangel an ausreichendem insbesondere verschiedenalterigem Vergleichsmaterial hindernd in dem Wege gestanden. Die histologische Untersuchung der Gonaden bloss eines einzigen oder nur weniger Individuen vermag eben nur in den seltensten Fällen über diese Frage Aufschluss zu geben vor allem aber dann nicht, wenn — wie dies zumeist zutrifft — der Erhaltungszustand des Untersuchungsmaterials kein ganz einwandfreier ist.

* Man wird dann die Ovarien des Männchens als rudimentäre Organe aufzufassen haben.

LITERATURVERZEICHNIS.

1. F. DOFFLEIN. Ostasienfahrt. Leipzig und Berlin, 1906.
2. L. v. GRAFF. Das Genus Myzostoma (F. S. Leuckart). Leipzig, 1877.
3. L. v. GRAFF. Report on the Myzostomida collected during the Voyage of H.M.S. 'Challenger' during the years 1873-76. Rep. 'Challenger' Exped. vol. x. (1884), pag. 1-82, tab. I.-XVI.
- 3a. L. v. GRAFF. Supplement zu dem vorstehenden Report. Rep. 'Challenger' Exped. vol. xx. (1887), pag. 1-16, tab. I.-IV.
4. I. F. McCLENDON. The Myzostomes of the 'Albatross' Expedition to Japan. Bull. Amer. Museum of Natural History, vol. xxiii. (1906), pag. 119-130, tab. xv.-xvii.
5. F. NANSEN. Bidrag til Myzostomernes Anatomi og Histologi. Bergen, 1885.
6. R. RITTER v. STUMMER-TRAUNFELS. Beiträge zur Anatomie und Histologie der Myzostomen: I. Myzostoma asteriac Marenz. Zeitschr. f. wissensch. Zoolog. LXXV. (1903), pag. 495-595, taf. XXXIV.-XXXVIII.
7. W. M. WHEELER. Protandrie Hermaphroditism in Myzostoma. Zoolog. Anzeiger, xvii. (1894), pag. 177-182.
8. W. M. WHEELER. The Sexual Phases of Myzostoma. Mitth. Zoolog. St. Neapel. xii. (1896), pag. 227-302, tab. x.-xii.

ERKLÄRUNG DER ABBILDUNGEN.

FÜR ALLE FIGUREN GILTIGE BUCHSTABENERKLÄRUNG.

<i>aj</i> , After.	<i>o</i> , Ovarium.
<i>bm</i> , Bulbus musculosus.	<i>oe</i> , Oesophagus.
<i>br</i> , Bruttasche.	♂ <i>ö</i> , männliche Geschlechtsöffnung.
<i>c</i> , Cirrus.	♀ <i>ö</i> , weibliche Geschlechtsöffnung.
<i>cn</i> , Bauchmark.	<i>r</i> , Rectum.
<i>d</i> , dellenförmiger, durch das Männchen veranlasster Eindruck.	<i>rt</i> , Rüsseltasche.
<i>da</i> , Darmast.	<i>sr</i> , Randzone.
<i>h</i> , Hackenapparat.	<i>t</i> , Hoden.
<i>m</i> , Mund.	<i>ua</i> , vorderer Uterusabschnitt.
<i>mg</i> , Magen.	<i>ub</i> , hinterer Uterusabschnitt.
<i>ms</i> , Muskelseptum.	<i>vt</i> , Ventralabschnitt der Leibeshöhle.
<i>n</i> , Nephridium.	<i>æ</i> , aufgerollte Seitenpartie des Körpers.
<i>nb</i> , Endblase des Nephridiums.	I, II, III, Hauptstämme der Darmverzweigung.
<i>np</i> , Nephridialporus.	1, 2, 3, Hauptstämme der ventralen Leibeshöhlenverzweigung.
<i>ns</i> , Nephrostom.	*
<i>nu</i> , unpaares Endstück der Nephridien.	Übergangsstelle zwischen Nephridialcanal und Endblase.

In Fig. 5-10 ist mit *roter Farbe* angelegt: der Ernährungsapparat; mit *gelber Farbe* angelegt: der Excretionsapparat.

In Fig. 6-10 ist durch *weisse Farbe* gekennzeichnet: der weibliche Geschlechtsapparat.

In Fig. 6 erscheint ausserdem auch der Brutraum (*br*) in *weisser Farbe* gehalten.

FIGURENERKLÄRUNG (PLATE).

- FIG. 1.—*M. antarcticum*, n.sp. Von der Dorsalseite her abgebildeter Körpersector zur Demonstration seiner Oberflächensculptur und der Randzone. Vergr. 20-fach.
- FIG. 2–10.—*M. cysticolum* Graff.
- FIG. 2.—Weibchen (aus Cyste *a*); von der linken Seite gesehen. Das in der Abbildung obere Ende ist das Caudalende des Tieres. Vergr. 6-fach.
- FIG. 3.—Cyste (*a*) an einem Armstück von *Antedon adriani*; von der linken Seite gesehen. Vergr. 6-fach.
- FIG. 4.—Weibchen (aus Cyste *b*); von der Ventralseite gesehen. Man erkennt die dellenförmig eingebuchtete Stelle, an welcher das Männchen gesessen hatte. Vergr. 10-fach.
- FIG. 5.—Männchen (aus Cyste *a*); von der Ventralseite her abgebildet. Das Exemplar ist rostro-caudal etwas contrahiert. Vergr. $27\frac{1}{2}$ -fach.
- FIG. 6.—Weibchen (aus Cyste *a*). Medianer Längsschnitt. Vergr. 11-fach.
- FIG. 7.—Weibchen (aus Cyste *b*). Etwas schief zur Längsaxe ausgefallener Querschnitt in der die mittleren (dritten) Parapodien verbindenden Transversalebene. Von den beiden Ovarien der linken Körperseite ist nur das rückwärtige, von den beiden Hoden nur der linke getroffen. Vergr. 32-fach.
- FIG. 8.—Weibchen (aus Cyste *b*). Hinter dem vorigen, in der Gegend der Nephridialcanäle geführter Querschnitt. Nur der rechte Nephridialcanal ist in demselben getroffen. Vergr. 32-fach.
- FIG. 9 und 10.—Männchen (aus Cyste *b*). Aus Flächenschnitten combinirte und etwas schematisirte Teilbilder. In Fig. 9 sind die mehr dorsal gelegenen Organe, wie der Ernährungsapparat, der männliche Geschlechtsapparat und der Dorsalabschnitt des weiblichen Geschlechtsapparates, ferner die Nephrostomata dargestellt. Fig. 10 zeigt den Ventralabschnitt des weiblichen Geschlechtsapparates mit den Ovarien, ferner die Endblasen mit dem unpaaren Endabschnitte der Nephridien. Zwischen den Nephrostomatis (*ns* in Fig. 9), und den in Fig. 10 mit * bezeichneten Durchschnittsstellen durch die Nephridien verlaufen in dorsoventraler Richtung die kurzen Nephridialcanäle. Vergr. für beide Fig. 79-fach.

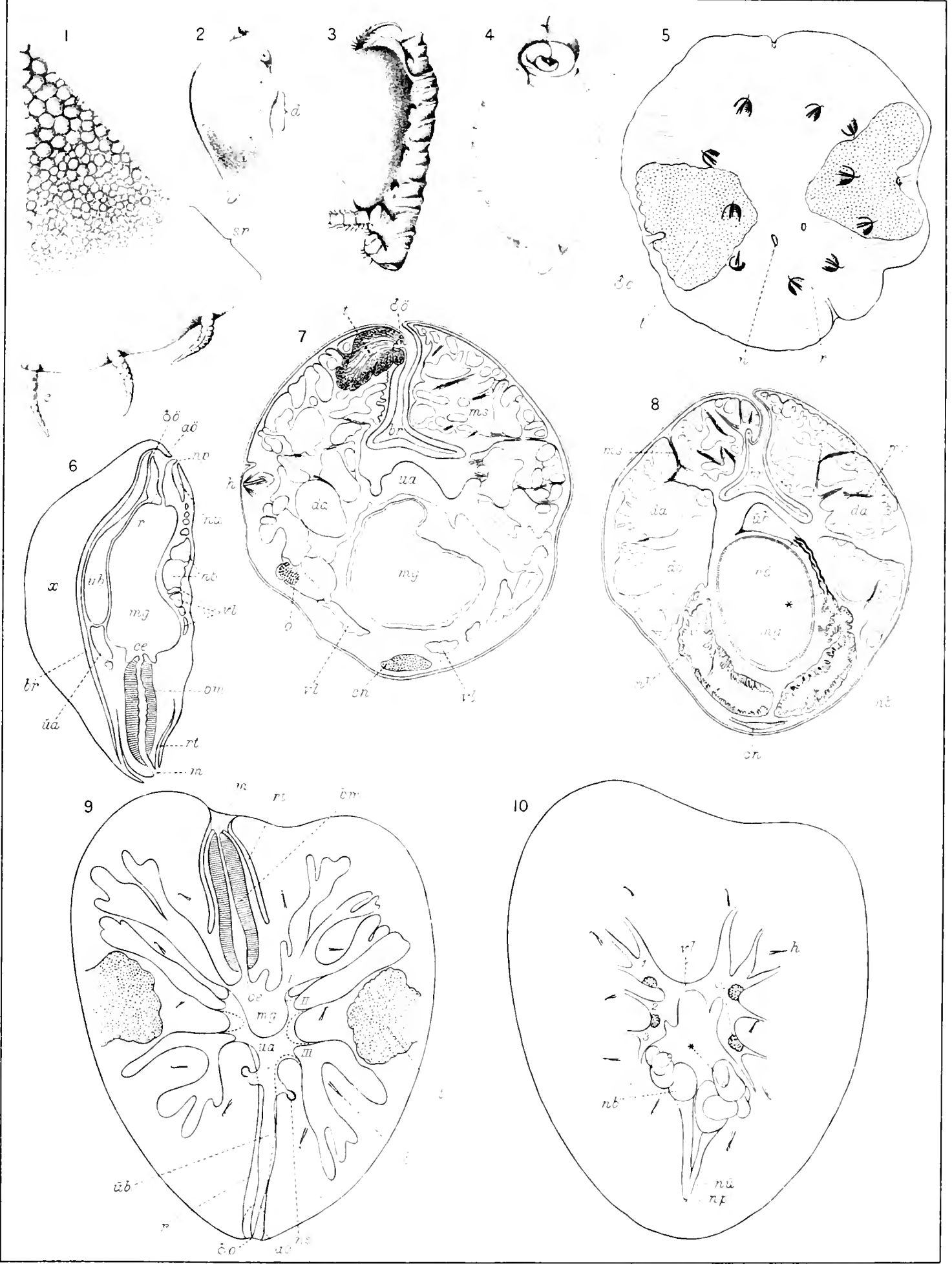

MYZOSTOMA

SIPUNCULOIDEA.

By W. F. LANCHESTER, M.A.,

King's College, Cambridge.

PHASCOLOSOMA SOCIUM.

THIS collection consists of some thirty specimens, all of small size, which were mostly taken by means of a net from holes in the ice, while the 'Discovery' was in Winter Quarters. One specimen, however, was captured with the dredge, the depth being given as 100 fathoms. That the bulk of them belong to a single species of *Phascolosoma* is quite certain, both from their general appearance and from a study of the relations of the various organs, though it is to be noted that these relations have been found to be far from invariable. Some half-a-dozen, however, have been the cause of considerable difficulty in the exact determination of their specific identity; yet it has seemed best to include them under the above species. In the first place, they agree in the main details of their structure with the typical forms; and I have not been able to place them without hesitation under any of the other closely allied species (sub-species or varieties) which centre round the Arctic *Ph. margaritaceum*, namely, *Ph. antarcticum*, *capsiforme*, *fusum*, *georgianum*, or *lagense*. In the second place, I find in some of them no structural differences from the typical form: while in others, such differences are hardly greater than those found within the limits of the typical form; while in regard to the most obvious distinction that separates them, namely, difference of general appearance, I have considered that, in so far as colour is concerned, the difference may be due to methods of preservation (in one case at least corrosive sublimate is given as the preservative), and that, in so far as the greater thickness and opacity of the body-wall is concerned, this is quite conceivably due to the greater contraction of the muscles that limit it interiorly. One has, of course, been influenced in forming an opinion on this matter by a variety of other considerations. A certain small acquaintance with the various types of Sipunculids enables one to estimate, by a method which is beyond description, except in so far as it may be called the method of past experience or the results of practice, how far one may venture to overlook those differences of detail which occur as between individual specimens. Again, one is able to recall that, while in many Sipunculids certain outstanding features appear, which enable one with little difficulty to place the individual considered, yet in others these same features are too indefinite or variable to be of much use. And the actual truth is that, speaking generally, the main features which we rely on as affording

differentiating specific characters in this group are ultimately of a very vague and unsatisfactory kind; while they appear clear enough in many cases, yet in others we at once realise how indefinite they are. We are dealing with very contractile animals, and yet use such points as the relative lengths of the body and the introvert; nay, the very limits between these two are generally indefinable, and even were they not, still, one portion may be relatively more contracted than the other. The length of the segmental organs relative to other structures has its value, yet I cannot help feeling that a certain amount of extensibility must be conceded to them; and the question of their colour surely affords an absolutely valueless criterion. So with the number of coils of the gut; extremes of number indicate a difference undoubtedly, but one is naturally suspicious of such distinctions as lie between 16, 18, 20, and so on. Thus the present specimens (out of those that are undoubtedly similar) give us a length of segmental organs varying from 1.5-4 mm., and number of gut-coils varying from 12-25. So that when Dr. Michaelsen tells us that two of the differences between *Ph. antarcticum* and *Ph. fuscum* are that the latter has "etwa 18" and the former "ungefähr 20 Doppelwindungen," and that in the latter the segmental organs are "weit länger als die von *Ph. antarcticum*," we feel that the first distinction is valueless, and that the value of the second must depend on the amount of the other distinctions, which are as a matter of fact admitted to be slight as between the two species. I trust I may not be taken to mean that the characters usually quoted as of specific worth have no value. My object is, in the main, to indicate the considerations that have induced me to join up in a particular instance what others might have been inclined to separate; though it is naturally obvious that I tend to consider that certain details that are universally quoted in specific descriptions of Sipunculids should be subjected to very careful consideration before they are accepted as having any absolute value. The absence of longitudinal muscles, and, in most species, of hooks within the genus *Phascolosoma* is doubtless one of the reasons why it is more unsatisfactory to deal with than the other genera of the family.

The present species then presents in the main the chief features of the *Ph. margaritaceum* group. From *Ph. margaritaceum* and *Ph. capsiforme* it seems to be distinguished by having the introvert not much shorter than, instead of being only half, or a little more than half, the length of the body; yet here I would like to point out that I have examined three specimens of *Ph. capsiforme* which were kindly sent to me, through Prof. F. J. Bell, by Dr. Michaelsen. Now in one of these, in which the introvert is fully extended, it appears from careful measurements that the introvert is "approximately" equal in length to the body. I say "approximately" only, because of two difficulties: (a) that the introvert is twisted round on itself; and (b) that, simple as it seems to distinguish the confines of introvert and body when regarding the object with the ordinary eye, yet the application of a measuring instrument at once reveals the difficulty of deciding on a real line of demarcation between the two.

However, it is clear that in this case, at any rate, the introvert is relatively much longer than in the cases originally described. I turn, however, to a second of the specimens lent me, which I have cut open, and find that the unextended introvert which lies inside the body is now markedly less than half the body length. Now it seems not at all unlikely, on *à priori* grounds (I have no actual observations to offer in this case), that the introvert, when pushed in amongst the organs of the body, should contract to a considerable extent, so as to occupy as little room as possible; and that, therefore, the normal length (if one can speak of any such thing) in this case may be considered as being about half the body length. But over and above this, we find that the number of gut-coils in this specimen is something between 30-40, while *capsiforme* is said to have only about 20. Since, however, I have been kindly permitted to examine these specimens pretty closely (I have not been able to open the other two), I am able to state that I see no reason to doubt the accuracy of their identification with *capsiforme*, despite these differences. That is to say that I, assuming a much more careful examination on the part of the original identifier, am not willing to controvert his decision, and that my own observations tend to support it. And so I provisionally assume that considerable differences of this nature may be expected to occur, at any rate within the *margaritaceum* group.

Ph. papillosum, *Ph. capense*, and *Ph. hansenii* appear to be sufficiently distinct from the *margaritaceum* group to render any detailed comparison with this species unnecessary. On the whole then, it seems reasonable enough to consider this form as a type differing from *Ph. margaritaceum* and *Ph. capsiforme*; and for much the same reasons that we can so separate *Ph. antarcticum* and *Ph. fuscum*. But the comparison with the two latter forms is a much more difficult matter. In the first place, much the most striking feature in the majority of these specimens, as viewed with the naked eye or the lens, is (a) the thinness and semi-transparency of the skin, and (b) its extreme smoothness, the papillae only being barely visible with the aid of the lens (they are all small specimens) on the hind end, or sometimes also at the base of the introvert.

In these features of their general appearance, in their light, somewhat straw-like colouration, coupled with the abruptly pointed termination of the body, and the localisation of the papillae, they recall the general facies of *Ph. vulgare* more than that of any other species with which I am familiar. And it is in just these features that they seem to differ so markedly from *Ph. antarcticum* and *Ph. fuscum*, in which the body-wall is relatively thick, the colour is dark, and a system of cross-striation is present at the hind and front ends of the body, which appears to be at best but weakly represented in this form. We may then proceed on the conceivable presumption that these are a single (*i.e.* from the specific point of view monovalent) group of points; in other words, that we are dealing with one specific point only, and that that point may be either variable according to size and age, or variable within the species. Passing on then to other points, we find a clear resemblance to *Ph. fuscum* in the close approximation of the openings of the segmental organs to the line of the anus.

Further, on opening up the body it is found that the ventral retractors arise from one-third to nearly one-half of the distance between the segmental openings and the end of the body, which again suggests *Ph. fuscum*; but that the segmental organs are very short and do not reach as far as the origin of the ventral retractors, which accords with the arrangement in *Ph. antarcticum*. The latter point is complicated by the fact that in three of the specimens the segmental organs do over-reach the ventral retractors by as far again, yet are not so much as half the length of the body in *Ph. fuscum*. And the number of coils of the gut points to neither the one nor the other, as they vary from about fifteen to about twenty-five (about eighteen in *Ph. fuscum*, about twenty in *Ph. antarcticum*). Turning lastly to the papillae, we find that the description of them in the other two species accords fully with their appearance in this, except that here they are variable in one point. Dr. Michaelsen tells us that in *Ph. antarcticum* they are .027 mm. wide and .08 mm. high (*i.e.* three times as high as wide); in *Ph. fuscum*, he only says that they are "bis .07 mm. lang, also nicht ganz so lang wie die entsprechenden von *Ph. antarcticum*," but the comparison of absolute lengths where the difference is so small is valueless, assuming the proportions to be the same; so that we can only conclude that they are practically identical in the two species of Michaelsen in regard to this point. Now in our species the papillae in some individuals show this ratio of 3 : 1, but in others the ratio of the height is less (2.5 : 1, 2.25 : 1, 2 : 1).

In *Ph. georgianum* the introvert is only half the length of the body, and the papillae are much longer than in the other species quoted; and these points, taken along with other smaller differences, seem to clearly separate our form from it. From *Ph. lagense* Fischer, these specimens are very little distinct; but this form is itself hardly to be distinguished from *Ph. antarcticum*. The thinness and clear colouration seem to be the main distinction in most of the specimens; and in all of them the relative unimportance of the system of striation on the hind end. In *Ph. lagense*, moreover, the segmental organs are as long as half the body.

I subjoin a list of measurements taken from a few of the specimens; the sign "S.O." is meant to indicate the "opening of the segmental organ," and the measurements are in millimetres and taken as accurately as the conditions would permit.

The letters A, B, etc., correspond to different localities, while the figures 1, 2, 3, etc., merely indicate different specimens. At the same time it may be pointed out that the A and B specimens are all obviously of one type, viz., thin-skinned and straw-coloured, while those marked E and F are those that I have already mentioned as differing from the rest in general facies, viz., dark in colour and apparently thicker-skinned.

The most remarkable difference is to be found in the specimen marked E2. Here the extended introvert is much longer than the body, 26.3 mm. and 8.5 mm. On the other hand, in the one marked E1, which presents all the general facies

	From and to S.O.		Distance of retractor origins from S.O.		Number of coils of alimentary canal.	Distance of anus from S.O.
	Body.	Length of— Introvert.	Dorsal.	Ventral.		
A 1	19	22	3.5	8	19	1
A 2	16.5	17.5	2	7	21	.25
A 3	18	15	2.25	7.75	20	1
A 4	11.5	13.5	2	4.75	17	.25
A 5	15.5	17.5	2.5	4.75	18	1
A 6	10	13	2	5	25	.25
A 7	10.5	8	1.25	4.25	17	.25
B 1	21	22	3	9.5	16	.5
B 2	12	15	2	5	20	.5
E 1	9	10	2	6.25	?	
E 2	8.5	26.5	1.75	3.5	21	
F 1	14	11.5	1.25	4	11-12	

and the same internal structure as in E2, together with closely similar papillae, the retracted introvert is shorter than the body, 14 mm. : 11.5 mm. In E1, moreover, the dorsal retractors originate from a point half-way between the opening of the segmental organ and the ventral retractor, while in E2 they originate at a position only one-third approximately (as in the other specimens) of the distance between these two points. It is a little difficult to see how to deal with those anomalies satisfactorily; and I have preferred to consider these two provisionally as within the limits of the present species. In two of the specimens I find the segmental organs reaching about as far again beyond the insertion of the retractors. A spindle muscle, not attached to the hind end, is generally present, though in one or two cases I have not been quite able to decide as to its presence or absence. In two cases I have found two distinct muscles attaching the front portion of the gut to the body-wall; in the other cases I have seen no muscles at all, though it seems quite possible that they may easily be torn, and so escape notice, in these small specimens.

The following list of localities and notes may be added:—

- A. 10 specimens Winter Quarters. 4. ix. 03. No. 12 Hole. D net.
S. of Hut Point. 25-30 fms. 100 yds.
- B. 2 specimens " " 28. ii. 02. Up to 10 fms.
- C. 3 specimens " " 11. xi. 02. D net. Hut Point.

D.	1 specimen	Winter Quarters.	17. i. 03.	Flagon Point.	102
								fms. Dredge.	
E.	4 specimens	" "	29. viii. 03.	Same as A.	
F.	4 specimens	" "	3. ii. 04.	D net. Hut Point.	
G.	1 specimen	" "	19. iii. 02.	D net. Hut Point.	
H.	3 specimens	" "	19. xi. 02.	D net. Hut Point.	
K.	1 specimen	" "	19. iii. 02.	Up to 10 fms.	

Finally, reference should be made to a very brief preliminary description of *Phascolosoma charcoti*, obtained by the Charcot Expedition, and described by M. Marcel Hérubel in the "Bulletin du Mus. d'Hist. Nat.," 1906, p. 127, together with *Ph. fuscum* and *Ph. antarcticum*. Since *Ph. charcoti* is there said to resemble *Ph. georgianum* closely, I do not think our species can be synonymous with it. On the other hand, we are told, in regard to the skin of *Ph. charcoti*, that it is "à peu près lisse," with "quelques papilles espacées et petites"; in which it both resembles our species and differs from *Ph. georgianum*, of which Michaelsen says, "Der ganze Körper ist mit grossen dunklen Papillen besetzt." This discrepancy in one point may not invalidate its general resemblance to *Ph. georgianum*, but, combined with the brevity of the diagnosis, it makes it impossible to assert similarity or the reverse as between our form and *Ph. Charcoti*.

COELENTERA.

IV.—ACTINIÆ.

BY JOSEPH A. CLUBB, M.Sc.

(3 Plates.)

THE Actinian collection of the 'Discovery' Expedition consisted of upwards of fifty specimens, which have been allocated to eight species, representing six genera and four families. With two exceptions, all were taken at or near to the Winter Quarters, McMurdo Bay. The two exceptions* are Port Harris, Falkland Islands, containing two species, and Enderby Island, Auckland Islands, containing one species, and from both places a considerable number of specimens, more than half the total, was obtained. The specimens were for the most part in a fair state of preservation, but I must express regret that no memoranda were made of the colours of the living animals. In the preserved condition absolutely no trace of colour remains, and while admitting that anatomical characters are the only sure guide in Actinological studies, the colours of living Actinians, when known, serve at least as a valuable clue to identification with the species of the older authorities, who give very little but external characters as their diagnoses.

The work has been carried on in the laboratories of the Liverpool Museums, and I have again to express my thanks to the Museums Committee for permission to use apparatus, etc., and to Dr. Forbes, the Director of Museums, for other facilities.

FAMILY ACTINIIDÆ, Gosse, 1858.

ACTINIARIA with an adherent base; column wall smooth or provided with verrucæ, but never with hollow vesicular outgrowths; sphincter muscle endodermal, generally diffuse and weak; tentacles simple; margin smooth or provided with simple acroragi; mesenteries in several cycles, of which usually more than one is perfect: longitudinal muscles of tentacles usually diffuse; no acontia.

GENUS PARANTHEOPSIS, McMurrich.

Actiniidæ without acroragi, but with conspicuous verrucæ on the distal portion of the column; no collar, but the margin a distinct parapet, within which is a well-marked fosse; tentacles of moderate length and rather slender, capable of being concealed in contraction; sphincter diffuse.

* These forms are so interesting that, after some consideration, I have allowed their entrance into this report.—ED.

PARANTHEOPSIS CRUENTATA.

Actinia cruentata Couthouy in Dana, U.S. Exploring Expedition, Zoophytes* (1846), p. 138, Pl. 3, Figs. 23 and 23A.

Cereus cruentatus Milne Edwards, Hist. Nat. Corall. (1857), 1, p. 268.

Bunodes cruentata Gosse, Actinologia Britannica (1860), p. 194. Verrill, Trans. Connect. Acad. (1869), 1, p. 467. Andres, Fauna und Flora des Golfes von Neapel (1884), p. 215.

Condylactis cruentata McMurrich, Scientific Results of Explorations U.S. Fish Commission Steamer 'Albatross' (1893) p. 150. Carlgren, Zoantharien, Hamb. Maghal. Sammel. (1898), p. 10, Figs. 13 and 14.

Parantheopsis cruentata McMurrich, Zoolog. Jahrb. Suppl. VI. (1905), p. 233.

I have adopted the course taken by McMurrich (10, p. 233), and place this species, previously known as *Condylactis cruentata*, under this genus.

Six specimens were taken by the 'Discovery' at Port Harris, Falkland Islands, along with a number of specimens of *Bunodes octoradiatus*. In my description of the latter species (p. 7) I refer to the extreme similarity in external appearance of these two species.

The largest specimen measures 2.5 cm. in height of column and 1.5 cm. in diameter. Proximally the body-wall is longitudinally grooved, corresponding to the insertion of the mesenteries; distally the corrugations are replaced by distinct rows of verrucæ. The papillæ or pseudoacroragi terminating the rows have no trace of nematocysts, and are simply outgrowths of the body-wall, being essentially identical in structure (Pl. 1, Fig. 3) with it. They vary considerably in size in different individuals, evidently depending on their state of contraction. In the specimen from which the section figured (Pl. 1, Fig. 1) is taken the pseudoacroragi are much inflated. Considerable variation exists in the number of tentacles. The largest specimen has 48 tentacles (6 + 6 + 12 + 24), the smallest has only 26, and an intermediate size 32. This certainly suggests that the adult condition is hexamerous, and that any octamerous condition is simply a stage in development and transitory, as Carlgren supposes. No sphincter muscle is developed, there being no indication in transverse sections through the parapet and adjoining body-wall of any modifications more than the ordinary muscle bands found generally (Pl. 1, Fig. 1). The circular muscles of the body-wall are moderately developed, and the mesogloal layer is relatively thick (Pl. 1, Fig. 1). The longitudinal muscles of the tentacles and oral disc are ectodermal, and the longitudinal and parieto-basilar muscles of the mesenteries are well marked.

FAMILY PARACTIDÆ, R. Hertwig, 1882.

ACTINIARIA with a mesodermal sphincter muscle; no acontia; mesenteries arranged in several cycles, of which usually more than one is perfect; longitudinal muscles of the mesenteries usually diffuse; column wall usually smooth, sometimes with sub-marginal plication and solid ridges; no acroragi.

* Dana (Amer. J. Sci. (2) i. (1846), p. 178) cites his Zoophyte work as of this year; the copy in the Zool. Dept. of the Museum bears date 1848.—E).

Genus PARACTIS.

Paractidae with thin and smooth column wall; tentacles of moderate length and of uniform thickness throughout; margin not lobed; individual mesenteries of each pair equally developed.

PARACTIS POLARIS.

One specimen labelled "Winter Quarters, 24. 8. 03," and taken in 25-30 fathoms (Pl. 1, Fig. 2).

Height of column 2.3 cm.; diameter of foot-disc 3.5 cm., diameter of oral disc 2.5 cm. Tentacles of uniform size, about 0.3 cm. long, in four cycles $12 + 12 + 24 + 48 = 96$. The base is adhesive and thin, the insertions of the mesenteries being visible through it. It is produced all round wider than the column, which narrows considerably. The body-wall is firm, and near the parapet somewhat thick, where it is slightly puckered by contraction. The mouth opening is visible in the centre of the tentacles, crowded together by contraction. The cesophagus is plicated and the two siphonoglyphs are well marked.

The sphincter is fairly strong, mesogloal, and produced to a fine termination. A transverse section (Pl. 1, Fig. 3) shows that it lies nearer to the endoderm, and is reticulate in appearance, giving indistinct traces of layering. Greater details of structure are given in Fig. 4.

The mesenteries are membranous, and the longitudinal muscles are somewhat diffuse, but well marked (Pl. 1, Fig. 5). The mesogloal layer is thin, except close to the body-wall, where the parieto-basilar muscle arises, but the lamellae of the muscles are conspicuous and branched. Two cycles of the mesenteries are complete, and these are fertile, including the directives. The specimen is female, ova in various stages of development being seen in sections.

The radial muscles of the oral disc and the longitudinal muscles of the tentacles are mesogloal (Pl. 1, Fig. 6). In regard to this character McMurrich (8, p. 161), in his comments on the genus *Paractis*, states that of two forms of the 'Albatross,' collections which, according to the generally accepted definition of the genus, must be assigned to *Paractis*, one had these muscles ectodermal and the other mesogloal, and while raising the question as to whether this character is worthy of generic distinction, he places both provisionally under *Paractis*. Of the 'Discovery' specimens, in both the one under consideration and the succeeding one the said muscles are mesogloal.

PARACTIS PAPAVER.

Actinia papaver Drayton in Dana, p. 143, Pl. 4, Fig. 29, *op. cit.*

Paractis papaver Milne Edwards, p. 249, *loc. cit.*

A single specimen labelled "McMurdo Bay, Winter Quarters, 20 fathoms," only slightly contracted, with tentacles, oral disc and cesophageal opening plainly visible, the last-named being 1.5 cm. in diameter.

The height of body-wall is 4.5 cm., diameter of column 5.5 cm., and of oral disc very slightly less. The body-wall is quite smooth and extremely membranous, giving the animal quite an inflated appearance. The upper margin is slightly crenulated by contraction of the sphincter; the pedal disc is adherent and a little firmer and thicker than the body-wall; the oral disc has slight radiating folds running outwards, up to and between the tentacles; the œsophagus is strongly corrugated, and the two siphonoglyphs are visible, but not markedly distinct. The tentacles are stout, in four cycles ($12+12+24+48=96$); in the innermost cycle about 1 cm. long in the contracted condition, and diminishing slightly in length in the outer cycles.

The sphincter is mesogloal, occupying almost the whole of the mesogloal layer, and projecting as a distinct collar, with the ectodermal epithelium, and forming a deep fosse between it and the tentacles. Fig. 7 on Pl. 2 shows a radial section through the sphincter. The muscles of the oral disc (Pl. 2, Fig. 7) and tentacles (Pl. 2, Fig. 8) are mesogloal. The longitudinal muscles of the mesenteries are in the form of slender strands, which may be seen running more or less parallel to each other over the extremely delicate and membranous mesenteries. In transverse section (Pl. 2, Fig. 11) it is seen that the mesogloea is extremely thin throughout, but is slightly thickened and bears short slightly branched lamellæ for the muscle strands. The parieto-basilar muscle is small and insignificant. Two cycles of mesenteries are complete, and the pairs of directive mesenteries bear the usual relation to the siphonoglyphs. All the complete mesenteries are fertile, including the directives, and ova in various stages are seen (Pl. 2, Fig. 9), and a figure is given of a section of the somewhat characteristic mesenterial filaments (Pl. 2, Fig. 10).

I have identified this specimen with *Paraetis papaver*, the *Actinia papaver* of Drayton, briefly described and figured by Dana (4, p. 143, Pl. 4).

Genus ACTINOSTOLA, Verrill.

Paraetidae usually of large size, with a firm leathery wall, which may be corrugated or folded, but with no verrucae. Margin tentaculate. Tentacles relatively thick, and not enlarged at the base. The pairs of mesenteries in certain cycles are unequally developed, having one of each pair smaller and narrower than the other.

ACTINOSTOLA CHILENSIS.

Actinostola chilensis McMurrich, Zoolog. Jahrb., Supp. VI. (Fauna Chilensis iii.), (1905), p. 247, Pls. 15 and 16, Figs. 30-33.

Five specimens of large size contained in one bottle labelled "4.3.04, 254 fathoms, mud and stones." The locality is not stated on the label, but I am informed that the position was $67^{\circ} 21' 46''$ S. and $155^{\circ} 21' 10''$ E. The specimens vary greatly in form and size. One specimen measures 5.5 cm. in height and 4 cm. in diameter of column; another is 4 cm. only in height, but 6 cm. in diameter.

The wall is firm and leathery, smooth to the touch, and no verrucae or tubercles

are present ; but irregular shallow furrows are formed by contraction in these preserved specimens. In all cases the tentacles are exposed, and they agree generally with the description given by McMurrich, in his account of the species (10, p. 247) from a specimen from Calbuco, both as regards number and arrangement and relative size.

The œsophagus is generally widely expanded, and in the majority of the specimens is almost indistinguishable from the portion of the oral disc inside the tentacles. But in one of the more contracted specimens the lip of the œsophagus is easily distinguished, but the corrugations are continued radially over the oral disc, running between and a short distance up the bases of the tentacles. The siphonoglyphs are in no case well marked. The foot-disc is well-marked and strongly adherent.

The more minute anatomy agrees generally with McMurrich's description. The mesogloea of the body-wall is variable in thickness, and in one specimen, just below the sphincter, is nearly 2 mm. thick, from which in an upward direction it thins rapidly to less than 1 mm. The mesogloecal sphincter exhibits no trace of layering, having a simple reticulate structure in transverse section. Transverse sections of the tentacles exhibit the same appearance of portions of the ectodermal epithelium being cut off and apparently enclosed in the mesogloea, as described by McMurrich, due to contraction and the unusual thickness of the mesogloecal layer.

The mesenteries in number and arrangement agree with McMurrich's description, but I cannot confirm the hermaphroditic condition described for the species. In the specimen selected for histological work no spermatozoa were found, and the ova were large and well-developed. Otherwise the 'Discovery' specimens agree well with McMurrich's description, and I have no hesitation in placing them under this species.

FAMILY ALICIIDÆ. DUERDEN (1895).

ACTINIARIA with a large, flat, contractile base. Tentacles simple, cylindrical and entamæous. Column wall with simple or compound hollow tubercles or vesicles, covering the greater part of the column, arranged mostly in vertical rows. Sphincter muscle endodermal and diffuse, variable in amount of development. No cinclides or acontia, margin with or without acroragi. Mesenteries arranged in several cycles of which usually more than one is perfect.

Genus CYSTIACTIS, M. Edw.

Aliciidæ having the column covered with simple vesicles. Tentacles of variable length, in one, two, or three cycles. Numerous perfect mesenteries ; sphincter muscle moderately well developed.

CYSTIACTIS ANTARCTICA.

A single specimen, bearing the label "McMurdo Bay, Winter Quarters, 28.2.02." Depth, 20 fathoms.

External characters—Height of body-wall 5·75 cm., diameter of column 4 cm., diameter of oral disc 3 cm., diameter of pedal disc (contracted condition) 2·75 cm.

There is no trace of distinctive coloration in the preserved specimen, and no record on the collector's label. The single specimen is poorly preserved, and owing to the thin and delicate body-wall is quite collapsed. The column is studded with thin-walled simple vesicles (Pl. 2, Fig. 12) communicating with the coelenteron and arranged in twenty-four vertical and parallel rows, corresponding to the mesenteric spaces. The attachment of the mesenteries may be seen in places, between the rows of vesicles. The vesicles of adjacent rows are arranged alternately, and they increase in size from the proximal to the distal portion of the column (Pl. 2, Fig. 12), where the largest are not much inferior in size to and do not differ much in appearance from the tentacles in the preserved and contracted specimen.

The tentacles are twenty-four in number, arranged in two cycles of equal size, short and somewhat club-shaped. The largest measures 0·5 cm. in length. The oral disc is slightly furrowed radially and the mouth is large and bears a well-marked hypostome. The œsophagus is short and strongly plicated, and two deep and well-marked siphonoglyphs are present, and are continued some distance below the rest of the œsophagus as distinct lappets.

The coelenteron is large, and twelve pairs of mesenteries, all complete, are present. Two pairs of directive mesenteries bear the usual relation with the siphonoglyphs. The single specimen taken is poorly preserved and much of the histological detail is lost. The sphincter is diffuse and endodermal in character, with slightly projecting mesogloal lamellæ shown in transverse section (Pl. 2, Fig. 13). The muscles of the tentacles are ectodermal. The muscles of the body-wall (Pl. 2, Fig. 14) are feeble, and sections through the vesicles show a similar structure. The ectoderm and endoderm layers consist of relatively high columnar cells (Pl. 2, Figs. 13 and 14); but the mesogloea is thin. The mesenteries are very thin and delicate, but transverse sections show a weak but well-marked longitudinal muscle (Pl. 2, Fig. 14), the mesogloea in relation with it being thickened and possessing short branching lamellae. The parieto-basilar muscle is small (Pl. 2, Fig. 14).

The specimen is female, and ovaries are found on all mesenteries, including directives, forming broad bands occupying in their widest portions about a third of the width of the mesenteries. Ova in all stages of development (Pl. 2, Figs. 14 and 15) are present.

FAMILY CRIBRINIDÆ, McMurrich, (1901.)

ACTINIARIA with a well-developed circumscribed endodermal sphincter; simple tentacles; without cinclides and acontia; verrucæ usually present; adherent base; no true acroragi, but frequently pseudoacroragi present.

Genus CRIBRINA.

Cribrinidæ with strong endodermal sphincter; frequently with pseudoacroragi; ectodermal musculature of discs and tentacles not imbedded in the mesogloea; column wall provided with verrucæ arranged more or less distinctly in vertical rows; tentacles simple.

CRIBRINA OCTORADIATA.

Bunodes octoradiatus Carlgren, Hamburg. Magalhaens. Sammelreise. Zoanth. (1898), p. 20. Figs. 11 and 12. 1898.

This species was formed by Carlgren (1, p. 20) for a number of specimens taken from the Straits of Magellan and other localities in the South Seas. In one of the 'Discovery' bottles, labelled "Falkland Islands, Port Harris," were fourteen specimens of very similar-looking Actinians. Upon dissection and microscopical examination, however, I find two distinct species—*Bunodes octoradiatus*, Carlgren, and *Parantheopsis eruentata*, Couthouy. Both Carlgren (1, pp. 12 and 21) and McMurrich (10, p. 233) comment on the similarity of appearance of this Cribrinid and this Actiniid, and it is interesting to note in this instance that they were apparently found in association in the same habitat. If this is commonly the case it is not surprising that confusion has occurred in previous descriptions of the Actiniid. Unfortunately I have no record as to the colours of the 'Discovery' specimens, but McMurrich (10, p. 234) describes the colour of the Actiniid as being very variable; it is possible that when in association the two species may also approximate in appearance when living, and if this be so it at once suggests mimetic resemblance.

In size the 'Discovery' specimens of *Cribrina octoradiata* agree with Carlgren's specimens (1, p. 20). The sixteen rows of verrucæ on the distal portion of the column and the sixteen pseudoacroragi are well seen in all the specimens. Usually gravel and broken shell are attached to the verrucæ. The number of the tentacles ($8 + 8 + 16 = 32$) appears quite constant. The two siphonoglyphs are well marked and quite regular. The sphincter muscle is strongly circumscribed, and may be described in McMurrich's terms (9, p. 20) as of the pedunculate palmate variety (Pl. 3, Fig. 16). The section figured is through the space between the pseudoacroragi, but sections passing through the latter show the sphincter projecting from the inner wall, near its base, so that the cavities of the pseudoacroragi project beyond and above the sphincter. The mesenteries number sixteen pairs ($8 + 8 = 16$), all complete and fertile, including the directives (Pl. 3, fig. 18). The longitudinal muscles of the tentacles are ectodermal and transverse sections (Pl. 3, Fig. 17) show strong mesogloal lamellæ. The longitudinal muscles of the mesenteries and the parieto-basilar muscles are exceedingly large and strong, and in the contracted specimens are closely packed into a solid mass, so that the various organs are quite dovetailed together (Pl. 3, Fig. 18). The mesogloal lamellæ of the muscles are long and branched. The circular muscles of the body-wall too are very strong. The strength of the musculature generally is quite a feature of the species.

But the most interesting character of these specimens from the Falkland Islands is the presence of "brood pouches." Immediately below the pseudoacroragi is a well-marked constriction of the body-wall, also present, it is interesting to note, in *Parantheopsis cruentata*. In this constriction, in the species under consideration, specimens were found possessing sixteen pores, one pore to each line of verrucæ, leading into distinct invaginations of the body-wall, forming characteristic "brood pouches" in the coelenteron. These "brood pouches" agree in all essential points with the arrangement shown to be present in the 'Southern Cross' specimens (3, p. 299). The drawing (Pl. 3, Fig. 16) shows a section of the body-wall, passing through one of these pores, and the "brood chamber" into which it opens. The three layers of the body-wall may be distinctly traced as shown, each of them much thinner—the mesogloea markedly so. Usually each "brood chamber" contains two embryos only, and in the section figured they are well advanced, showing several of the mesenteries complete and others well developed. Dissections were made so that, looked at from below, the sixteen "brood pouches" were seen like so many miniature grapes, lying quite regularly in the body cavity, between the mesenteries. In diameter they average about 3 mm.

In the short description of the species by Carlgren (1, p. 20) no mention of them is made. It is somewhat remarkable if none of Carlgren's specimens possess these "brood pouches," and possibly re-examination may show their presence in some.

CRIBRINA HERMAPHRODITICA.

Bunodes hermaphroditicus Carlgren, Hamburg. Magalhaens. Sammelreise, Zoanth. (1898), p. 23, Fig. 18, 1898.

About forty specimens from "Enderby Island, Auckland Islands, 19. 3. 04" of sizes ranging from 0.3 cm. to 2 cm. in height of column. In some cases the oral disc and tentacles are fully exposed, in others the animals are contracted so that the tentacles are entirely hidden, and there are many intermediate stages of contraction.

The foot-disc is well marked and strongly adherent. The rows of principal verrucæ, usually twenty-four in number, are well seen, especially on the distal portion of the column, where also secondary alternating series are visible. The pseudo-acroragi, terminating each principal row of verrucæ, are distinct, emphasizing greatly the parapet. The tentacles are in four ($6 + 6 + 12 + 24 = 48$), or five ($6 + 6 + 12 + 24 + 48 = 96$) cycles.

The sphincter is endodermal and circumscribed. The œsophagus is longitudinally folded, and two well-marked siphonoglyphs are present. The mesenteries in the specimens examined are all hexamerously arranged, and in the larger specimens in four cycles, of which three are complete. The longitudinal and parieto-basilar muscles (Pl. 3, Fig. 19) are well developed. Two pairs of directive mesenteries bear the usual relation with the siphonoglyphs. The longitudinal muscles of the oral disc and tentacles (Pl. 3, Fig. 21) are ectodermal. Zoanthellæ occur throughout the endoderm, being especially abundant in the tentacles (Pl. 3, Fig. 21). Reproductive elements

are present in relation with the mesenteries of the first cycle in small specimens, including directives, and in large specimens, with the mesenteries of two cycles; but I was not able to determine to my satisfaction if present in relation with the third complete cycle. Both ova and spermatozoa are present, often associated together in relation with the same mesentery (Pl. 3, Fig. 19). Occasionally fertile mesenteries are found showing ova or spermatozoa alone, but in all the specimens examined microscopically the hermaphroditic condition is constant. Embryos in various stages of development are present in the body-cavities of many.

Genus RHODACTINIA, Agassiz.

Cribrinidæ (Tealiidæ, Bunodidæ, Bunodactidæ), with well-developed foot disc; distinct verrucæ present on body-wall; radial muscles of oral disc and longitudinal muscles of the tentacles meso-ectodermal to mesogloal; tentacles simple; strongly circumscribed endodermal sphincter.

RHODACTINIA CRASSICORNIS.

Actinia crassicornis Müller, Prod. Zool. Dan. (1776), p. 231.

Actinia elegantissima Brandt, Prod. descriptionis animalium ab H. Mertensio observatorum (1835), p. 13.

Rhodactinia davisii Agassiz, L., Comptes Rendus, XXV. (1847), p. 677.

Rhodactinia davisii Verrill, A. E., Mem. Soc. Nat. Hist. Boston (1864), p. 18.

Urticina crassicornis Verrill, A. E., Proc. Essex Instit. VI. (1869), p. 469.

Leiotecalia spitzbergensis Kwietniewski, Zool. Jahrb. (Syst.) (1898), p. 1, p. 121.

Carlgren in 1902, in his report on "Die Actiniarien der Olga Expedition" (2, p. 39), thought it necessary to revive the old genus of Agassiz, *Rhodactinia*, and has taken for its type the well-known and widely distributed *Actinia crassicornis*, Müller. The principal distinguishing character given for the genus is that the radial muscles of the disc and the longitudinal muscles of the tentacles may be meso-ectodermal to mesogloal, and under *R. crassicornis* Carlgren places a number of synonyms, including *Actinia elegantissima*, Brandt, and *Leiotecalia spitzbergensis*, Kwietniewski. I have previously been struck with the variation in the degree in which the muscles of the tentacles are imbedded in the mesogloea, in specimens of *crassicornis* examined by me, from a well-known local habitat, Hilbre Island, at the mouth of the Dee. The text-figures (2, p. 41) given by Carlgren are most instructive, and from Hilbre Island specimens I can produce examples in which the longitudinal muscles are quite as much meso-ectodermal as Carlgren's figure 4, if not as much as his Fig. 3. In my examination of the 'Southern Cross' Antarctic Actinians (3, p. 294), I was convinced of the many close resemblances to the type species *crassicornis*, seen in the specimens then under observation; and notwithstanding that the longitudinal muscles of the tentacles were not imbedded in the mesogloea, I decided to include these species under the genus *Urticina*. I feel therefore some-

what justified in this course, although I agree that it will be better to adopt Carlgren's proposal, and include such forms under the genus *Rhodactinia*, and reserving the genus *Urticina* or *Tealia* for species where the radial muscles of the oral disc and the longitudinal muscles of the tentacles are always completely imbedded in the mesogloea.

In the 'Discovery' collection are six specimens, all taken at the Winter Quarters, McMurdo Bay, in from 10 to 20 fathoms, and bearing the following dates: 20. 2. 02; 17. 1. 03 and 17. 2. 04. They are all of large size, the largest being 6.5 cm. in height of column and 6 cm. in diameter of oral disc. The external appearance of these specimens varies considerably, according to the degree of contraction of the oral disc or body-wall. I have had under observation for some time a number of specimens of *crassicornis* from Hilbre Island, living in one of the tanks of the aquarium of the Liverpool Museum; they are all in a flourishing condition and feed voraciously. I have been surprised to note their extreme mobility. Tentacles, oral disc and body-wall exhibit remarkable degrees of inflation, sometimes all together, sometimes singly, and sometimes only sections of each of them. In extreme dilation of the body-wall all trace of verrucæ, as such, is lost, and as Teale (11) observes, it "renders the corium perfectly smooth, so that the small opaque spot alone indicates their former situation." Correspondingly, in extreme dilation of the oral disc, the tentacles may be so reduced as to be little more than papillæ. On Pl. 3, Fig. 22 is a reproduction from a photograph, of the oral disc of a living animal, which well illustrates this extreme contraction of the tentacles. On the other hand, I have recorded specimens where the tentacles have measured 4.5 cm. in length and 0.6 cm. in diameter near the base. There is always general expansion, especially of the tentacles after feeding. McMurrich (9, p. 28) discusses this great variation in external appearance brought about by this great mobility, and the internal anatomy, sphincter, muscles of the tentacles, mesenteries, and body-wall and other internal structures must correspondingly vary, according to the degree of contraction or expansion.

In all the 'Discovery' specimens under consideration the radial muscles of the oral disc and the longitudinal muscles of the tentacles are meso-ectodermal, and in contraction are identical in appearance with the figure given by Carlgren for his variety *spitzbergensis* (2, Fig. 3, p. 41). The sphincter is endodermal, and strongly circumscribed, and may be seen in all cases by the naked eye when the parapet is cut. Transverse sections show a little difference in detail in the arrangement of the mesogloecal processes, whereas in some the more typical bipinnate arrangement is seen, in others the plan is similar to the figure given by Kwietniewski (7, p. 14, Fig. 8), for his *Leiotelia spitzbergensis*, which Carlgren (2, p. 40) now regards as a synonym of *R. crassicornis*. I give a figure of this form of sphincter drawn from a section of a 'Discovery' specimen (Pl. III., Fig. 23).

As regards the verrucæ, tentacles, œsophagus, siphonoglyphs, directives and other mesenteries, and in other anatomical features, the specimens under consideration

agree generally with the typical *crassicornis*, so I have concluded to place them all under *Rhodactinia crassicornis*, probably more nearly approximating to the variety *spitzbergensis*.

MEMOIRS REFERRED TO IN TEXT.

1. CARLGRÉN, O.—Zoantharien ; Hamburg. Magalhaens. Sammelreise, Hamburg (1899).
2. CARLGRÉN, O.—Die Actiniarien der Olga-Expedition, Wissensch. Meeresunter. Neue Folge, v. Band. Abt. Helgoland (1902), Heft 1.
3. CLUBB, J. A.—Actiniæ. Report on the 'Southern Cross' Antarctic Expedition. London (1902).
4. DANA, J. D. Zoophytes. U.S. Exploring Expedition (1838-1842) ; Philadelphia (1846).
5. DUERDEN, J. E.—On the genus *Alicia* (Cladactis), with an anatomical description of *A. costa*. Panc. Ann. Mag. Nat. Hist. (6), Vol. xv. (1895).
6. GOSSE, P. H.—On the British Actiniæ. Ann. Mag. Nat. Hist. (3), Vol. i. (1858).
7. KWIECZKOWSKI, CASIMIR R.—'Actiniaria von Ost-Spitzbergen,' Zoologische Jahrbücher (Syst.) xi. (1898).
8. McMURRICH, J. PLAYFAIR.—Actiniæ of 'Albatross' Explorations. Proc. United States National Museum, Vol. xvi. (1893).
9. McMURRICH, J. PLAYFAIR.—Report on the Hexactiniæ of the Columbia University Expedition to the Puget Sound during the Summer of 1896 ; Annals New York Acad. Sci., Vol. xiv., No. 1 (1901.)
10. McMURRICH, J. PLAYFAIR.—Zoolog. Jahrb. Supp., vi. (Fauna Chiliensis iii.) ; The Actiniæ of the Plate Collection (1905).
11. TEALE, T. P.—On the Anatomy of *Actinia coriacea* ; Trans. Phil. Soc. Leeds, i. (1837).

EXPLANATION OF PLATES.

- b.c. brood chambers.
 c. coelenteron.
 d. directive mesenteries.
 ec. ectoderm.
 em. embryos.
 en. endoderm.
 in. ec. invaginated ectoderm.
 in. en. invaginated endoderm.
 in. mg. invaginated mesogloea.
 in. o. opening to brood chamber.
 l. m. longitudinal muscle.
 l. m. m. longitudinal muscle of mesentery.
 l. m. t. longitudinal muscles of tentacle.
 mes. mesenteries.

- m. f. mesenterial filaments.
- mg. mesogloea.
- m. l. muscle lamelke.
- oe. œsophagus.
- oe. in. œsophageal invagination of embryo.
- ov. ova.
- p. pseudoacroragus.
- p. b. m. parieto-basilar muscle.
- s. siphonoglyphe.
- sph. sphincter.
- t. tentacle.
- tes. testis.
- v. verrucae.
- x. zooanthellæ.

PLATE I.

- FIG. 1. *Parantheopsis cruentata* (Couthouy).—Radial section of the upper part of the body-wall, passing through a pseudoacroragus.
- FIG. 2. *Paractis polaris*, sp. n.—Drawing of the specimen (natural size).
- FIG. 3. *P. polaris*.—Radial section of upper part of body-wall and sphincter muscle.
- FIG. 4. *P. polaris*.—Portion of sphincter muscle more highly magnified.
- FIG. 5. *P. polaris*.—Horizontal section through the body-wall and mesenterics in connection with œsophagus.
- FIG. 6. *P. polaris*.—Transverse section of the wall of a tentacle.

PLATE II.

- FIG. 7. *Paractis papaver* (Drayton).—Radial section through the upper part of the body-wall and sphincter muscle.
- FIG. 8. *P. papaver*.—Transverse section of wall of a tentacle.
- FIG. 9. *P. papaver*.—Section through ovary.
- FIG. 10. *P. papaver*.—Section of mesenterial filament.
- FIG. 11. *P. papaver*.—Section through portion of a mesentery.
- FIG. 12. *Cystiactis antarctica*, sp. n.—Drawing of specimen (natural size).
- FIG. 13. *C. antarctica*.—Section of upper part of body-wall, passing through sphincter muscle.
- FIG. 14. *C. antarctica*.—Horizontal section through body-wall and mesentery, with ovary.
- FIG. 15. *C. antarctica*.—Section of ovary more highly magnified.

PLATE III.

- FIG. 16. *Cribrina octoradiata* (Carlgren).—Radial section through upper part of body-wall, sphincter and opening to 'brood' chamber.
- FIG. 17. *C. octoradiata*.—Section through wall of a tentacle.
- FIG. 18. *C. octoradiata*.—Horizontal section through body-wall and mesenterics, including the directive mesenterics.
- FIG. 19. *C. hermaphroditica* (Carlgren).—Horizontal section through body-wall and fertile mesenterics.
- FIG. 20. *C. hermaphroditica*.—Section, more highly magnified, of genital gland.
- FIG. 21. *C. hermaphroditica*.—Section through wall of tentacle.
- FIG. 22. *Rhodactinia crassicornis* (O. F. Müller).—Reproduction from a photograph of a living specimen, illustrating an extreme reduction of the size of the tentacles.
- FIG. 23. *R. crassicornis*.—Radial section through the sphincter of a 'Discovery' specimen.

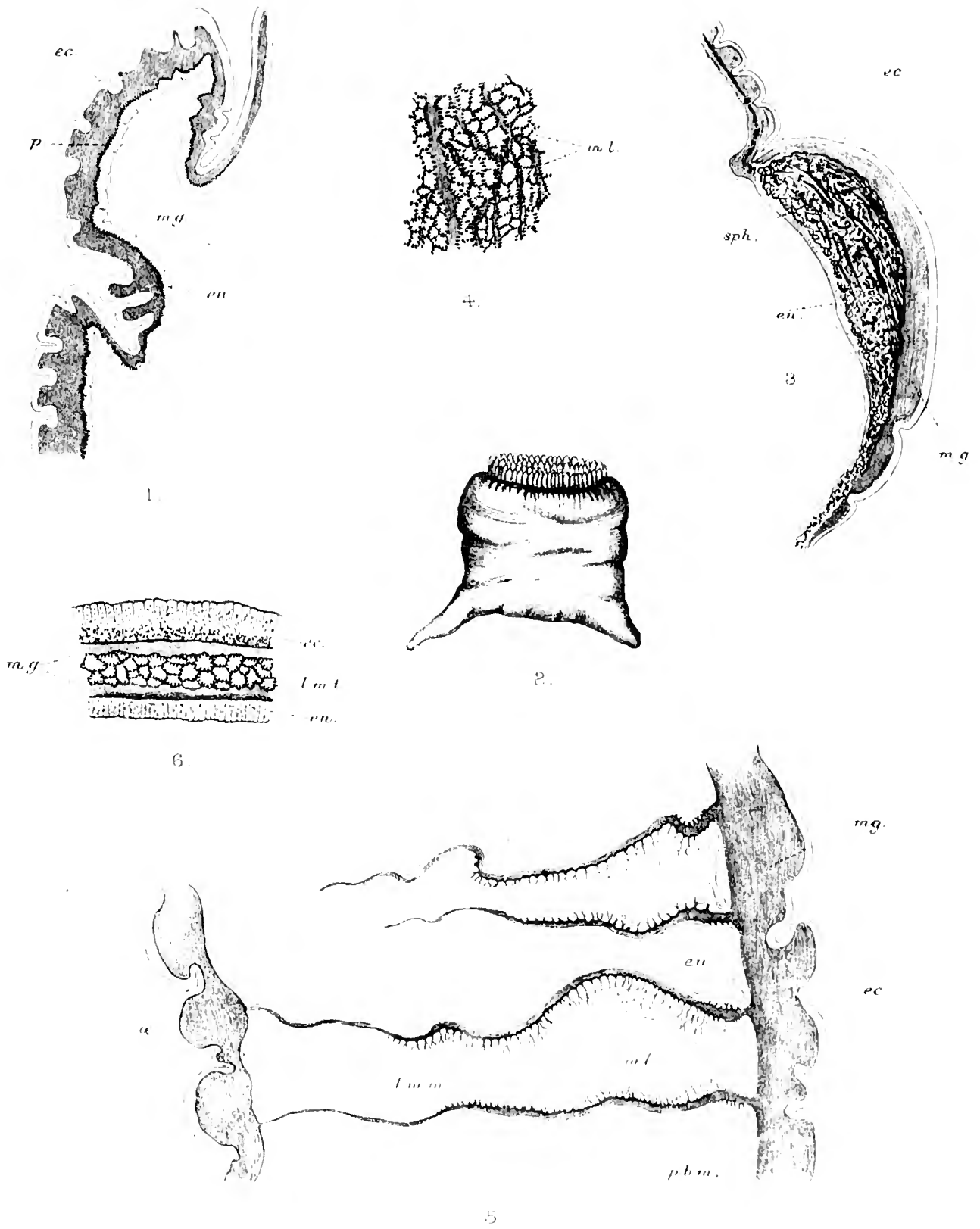

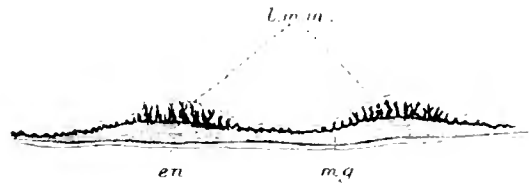
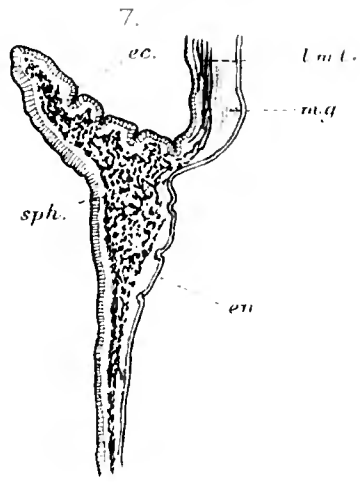

11.

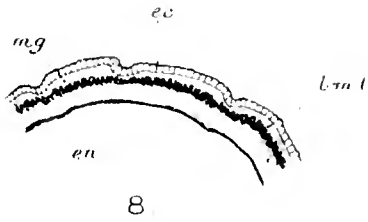

8.

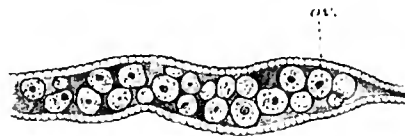

9.

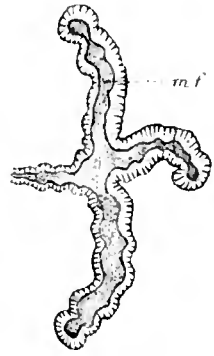

10.

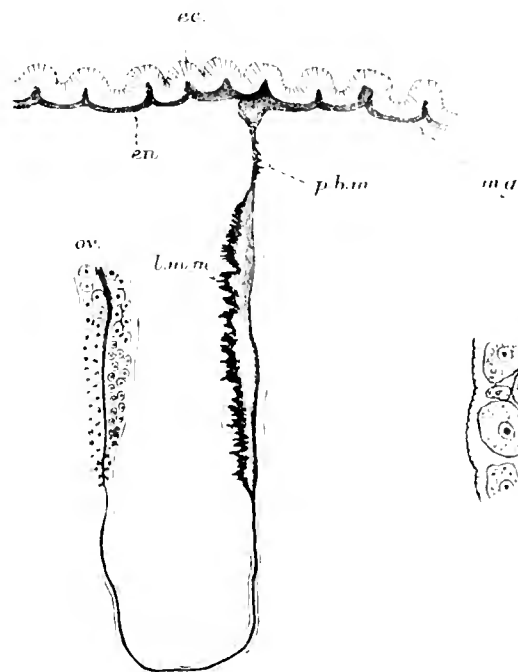

14.



15.

12.

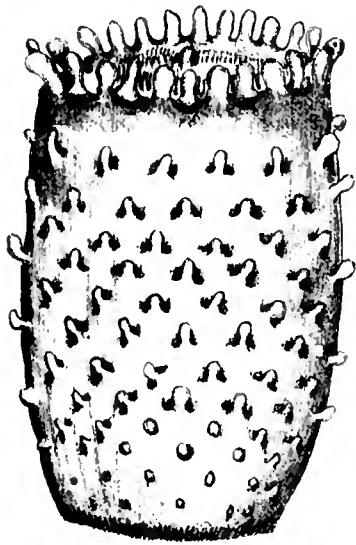

13.

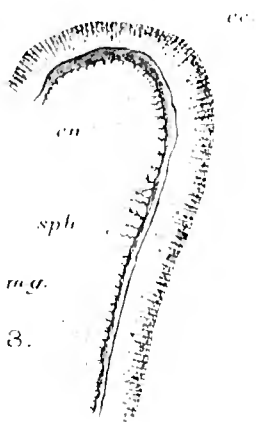

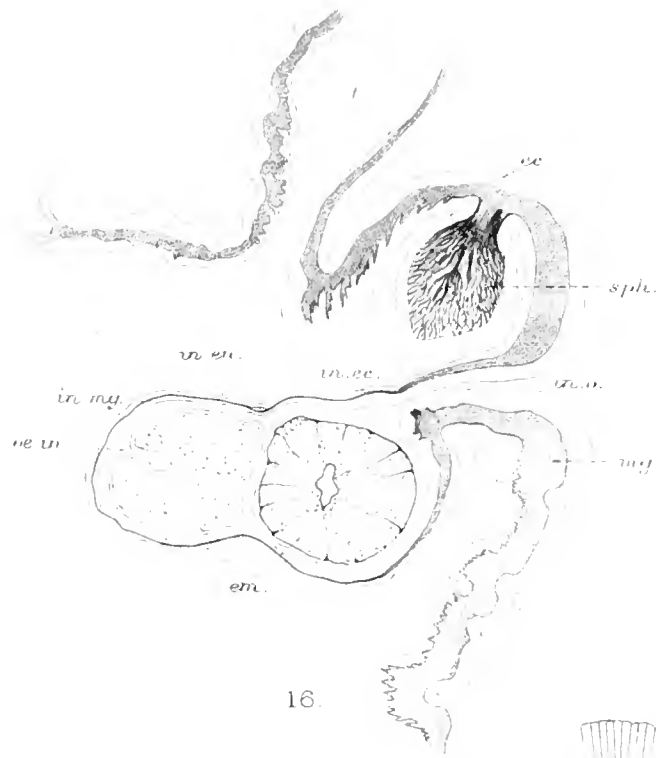

16.

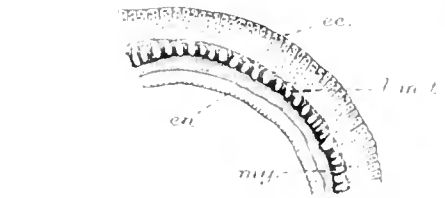

17.

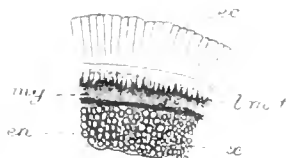

21.

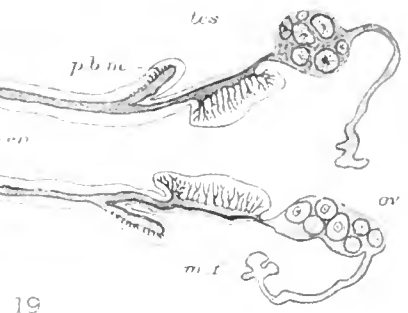

19.

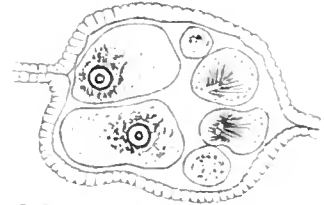

20.

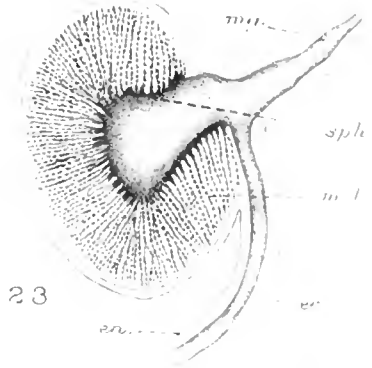

23.

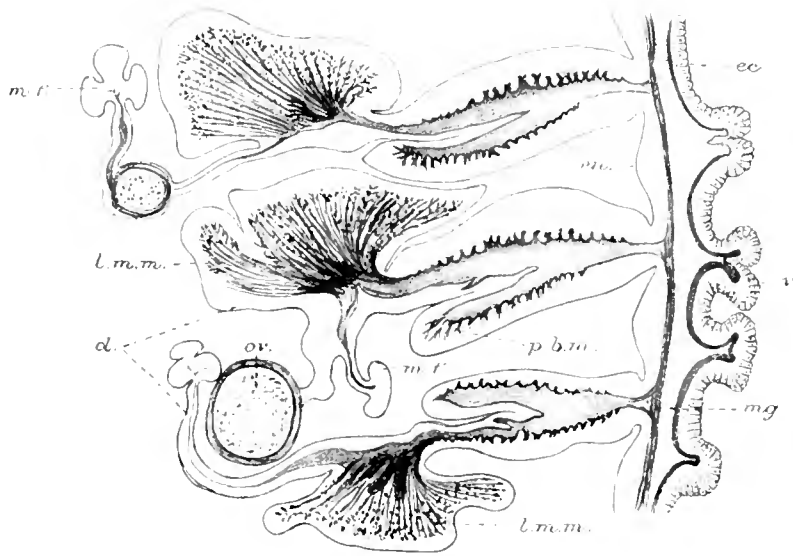

18.

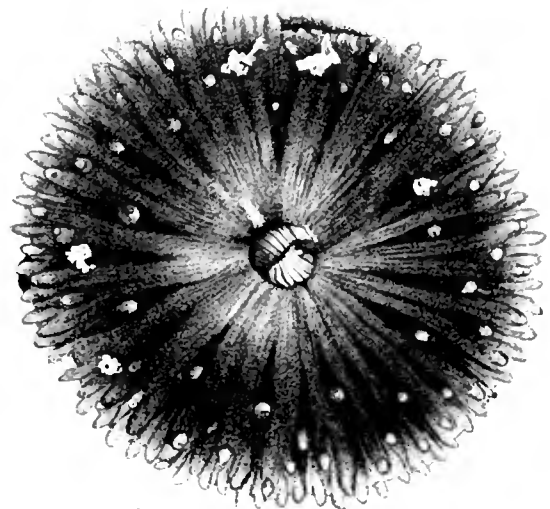

22.

PORIFERA (SPONGES).

II. TETRAxonIDA, DENDY (6. p. 63).

By R. KIRKPATRICK.

(Plates VIII.–XXVI.)

I. GRADE TETRACTINELLIDA, MARSHALL.

IN the collection made by the 'Discovery' there are fifty-nine specimens of Tetractinellida, belonging to four species of *Tetillidae*, all of which have been described before: and, further, there are new varieties of two of the species.

The bulk of the material consists of numerous and large specimens of *Cinachyra barbata* Sollas, a species which was originally obtained from Kerguelen by the 'Challenger.'

The following is a list of species:—

Craniella sagitta (Lendenfeld) var. *microsigma* var. n.

Craniella sagitta var. *pachyrrhabdus* var. n.

Craniella leptoderma (Sollas).

Cinachyra barbata Sollas.

Cinachyra vertex Lendenfeld.

Cinachyra vertex var. *monticularis* var. n.

SUB-ORDER SIGMATOPHORA, Sollas.

FAMILY TETILLIDAE, Sollas.

CRANIELLA, Sollas.

Tetillidae without porocalyces, and with a cortical skeleton of oxeas arranged more or less radially and vertically to the surface.

CRANIELLA SAGITTA var. *microsigma*.

(Plate VIII., figs. 1–13, and Plate IX., figs. 15, 16.)

1907. *Tethya sagitta* Lendenfeld (11a. p. 306).

Sponge large, pyriform or cocoanut-shaped, narrowed and truncate at lower end, with finely pilose surface and with root-tuft. With a few small circular oscules about 0.75 mm. in diameter in the contracted state. The body divided into three zones, an inferior root-tuft zone, a broad median or equatorial poral zone, and a superior oscular zone. Surface, where the pile has been denuded, showing obscurely-marked longitudinal anastomosing ridges, much more evident in the poral region. Pores in sieve-like

groups in grooves between the ridges. Flagellated chambers eurypylous. Cortical skeleton formed of palisade-like rows of oxeas and fan-like bundles of trichodal protriaenes, occurring only in the root-tuft zone and poral zone.

Spicules. Megascleres. 1. Somal Oxeas (VIII. 10)* from 5 to 13 mm. in length and 0.06 to 0.08 mm. in thickness, straight, fusiform, tapering gradually to very sharp ends.

2. Choanosomal oxeas lying scattered between the radial fibres, 1-3 mm. long and 0.04 to 0.06 mm. thick.

3. Cortical oxeas (VIII. 13) almost straight or slightly curved, 1.12×0.04 mm.

4. Anatriaenes of two kinds, each varying in length and tapering to a filiform extremity. 4a. (VIII. 5, 5a, 6) with pointed conical cladome, with slender sharp-pointed cladi each 225μ long, chorda 187μ long; rhabdome about 12 mm. long, and averaging about 20μ broad, thick below cladal origin, then with a slender neck followed by long thicker portion tapering finally to filiform extremity.

Anatriaenes, 4b (VIII. 7, 7a) common in root-tuft, with thick rounded conical cladome, with short thick cladi 118μ long, chorda 118μ long; rhabdome of nearly uniform diameter till it tapers off to filiform extremity, length varying from 10 to 40 mm.

5. Protriaenes. Cladome commonly with one cladus 0.135 mm., longer than the other two, though there may be two equal long ones, or they may all be equal; rhabdome fusiform, tapering to a filiform extremity, on an average about 9×0.054 mm. in length and thickness.

6. Trichodal protriaenes 218μ long, with one cladus 28μ in length, longer than the other two; cladal end of rhabdome slightly swollen.

Microscleres. Sigmata 12.3μ - 13μ long, 7.04μ broad (when seen in C-like aspect), and 1.5μ thick, surface micro-punctate.

There are five specimens of this sponge, four large and one very small. The largest (VIII. 1) is a fine example with a root-tuft; this appendage not being present in the other large specimens owing to having been torn away when the sponges were uprooted from the sea-bottom.

The body of the largest specimen is 10.5 cm. long and 11.5 cm. in broadest diameter, and of the smallest 10×8 mm. in length and breadth. The mass of root-tuft in the type specimen is about 4 cm. in thickness.

The surface pile of spicules varies considerably in its degree of development; in two examples the surface is almost bare; in two others the pile is soft, and about 3 to 4 mm. in height, with oscular fringes about 4.5 mm. in height. The pile is formed mainly of the projecting triaenes of the radiating fibres of the skeleton, each fibre spreading out fan-like in an oblique or vertical plane. In the specimens bare of the pile, the boundary between the poral and oscular zones (VIII. 2) is a fairly well marked circular line of demarcation situated at the junction of the upper fourth and lower

* Roman numerals followed by Arabic refer respectively to the Plate and figures; thus (VIII. 10) means Plate VIII., fig. 10.

three-fourths of the body. The surface of the oscular zone is smooth and glistening and with faintly marked longitudinal ridges: whereas that of the poral zone has more prominent ridges, and a punctate appearance due to the pores in the grooves between the ridges; this appearance is brought into relief by drying the sponge, for then the poral sieves contract and the points of the palisades of cortical oxeas prick up the dermal membrane; these palisades are not present in the oscular area, which, in fact, is devoid of a cortical skeleton of spicules, though it possesses a fibrous cortex.

The **oscules** are small circular orifices about 0.75 mm. in diameter, five or six in number, arranged in an irregular circle on the broad upper end of the sponge. In the complete state they each have an outer fringe of protriaenes about 4.5 mm. high, and an inner fringe of trichodal protriaenes, a little below which is a sphincter.

The **dermal pores** occur as sieve-like groups in the more or less longitudinal grooves (VIII. 2, 3) between the palisades of cortical oxeas, the meshes of the sieves being supported by fan-like tufts of trichodal protriaenes.

The **Ectosome**. The sponge cuts easily, and a vertical section shows the skeletal fibres radiating from a central nucleus. No well-defined boundary is visible to the naked eye between ectosome and choanosome. In the poral zone (VIII. 3 and IX. 15) the pores lead into sub-dermal spaces bounded by vertical rows of cortical oxeas; the rows of cortical oxeas are likewise present at the base of the sponge in the root-tuft zone. In the oscular zone (IX. 16) there is an ill-defined layer, about 1.5 mm. thick, composed of loose bundles of fibrous tissue crossing in various directions with rounded colleneytes scattered about; also there may be a few scattered oxeas.

The **Canal System**. The subdermal spaces beneath the sieve-groups of pores open into canals descending into the choanosome. The pyriform flagellated chambers, $47 \times 42 \mu$ (VIII. 4), are eurypylous: the figure shows several chambers opening direct into a terminal exhalant canal.

The chamber system of *Craniella simillima* Bk. and of other species of *Craniella*, described by Sollas in his 'Challenger' Report, is aphodal (21. p. 30, Pl. II., fig. 19).

The **Skeleton**. A tangential surface section in the poral region shows best the cortical oxeas, which are mostly arranged in double rows, each row bending outwards slightly towards a row of another double series, so as to form an incomplete arch over a sub-dermal space or channel.

A small "silica pearl" was found in one section.

Numerous large ova occur, with oval body and thick pseudopodia-like extensions, the body being $130 \times 65 \mu$, and the total diameter over 300μ . In some instances, the ova are more rounded and compact, with the cytoplasm more drawn together.

I had described the specimens as representatives of a new species, but I now find that they belong to *Craniella sagitta* (Lendenfeld).

Dr. v. Lendenfeld very kindly sent me the revised proofs of his Report "Tetraxonia der deutschen Südpolar-Expedition, 1901-1903," thus enabling me to make the necessary alterations before it was too late.

The 'Gauss' Expedition obtained six specimens, which are all young and small, being from 2–10 mm. in diameter.

The difference in the size of the megascleres of the 'Discovery' and 'Gauss' specimens may be attributed to differences in the age and size of the specimens: but the difference in the size of the sigmata of the two sets of specimens is more notable—those of the 'Gauss' being 14–20 μ , and of the 'Discovery' being only 12·3 μ to 13 μ in length as viewed in the C aspect. In my opinion difference in size of sigmata has not the importance that is sometimes attached to it.

All the specimens were dredged in the neighbourhood of Winter Quarters in depths of 10–130 fms. Also 'Gauss' Expedition, near its Winter Quarters, 350–385 m.

CRANIELLA SAGITTA *var.* pachyrhabdus.

(Pl. VIII., figs. 14, 15 : Pl. IX., figs. 17, 18, 19.)

1907. *Tethya sagitta* Lendenfeld (11a. p. 306).

This variety is represented by several oblong pieces about 6 cm. in length, deeply blackened by osmic acid, and forming part of a large sponge, which had been cut up for preservation in that reagent.

The fragments are sufficient to show that the surface of the sponge was covered with a spicular pile about 4 mm. in height.

Mr. Hodgson informs me that the bulk of the specimen was lost. He was under the impression that this sponge, which was obtained from the same locality as the var. *microsigma*, and which resembled the latter in general appearance, was identical with it in all its characters. An examination of a section, however, shows that the radiating fibres of the skeleton contain numerous large thick strongyles and styles, about $7 \times 0\cdot116$ mm. in dimensions (VIII. figs. 14, 15); the sigmata are 18–20 μ long, and slightly thicker and rougher than in the var. *microsigma*.

Plate IX. figs. 18, 19 show collar cells, stained in gentian violet. The cells are here seen to be separate, and the collars apparently not coalescent; but the tissues are not very well preserved; and, though much care was taken in the drawing, a renewed inspection of the preparation from which the illustrations were drawn has shown that the figures of the collars are not satisfactory. The flagellated chambers usually contain only a few collar cells in the normal position (IX. 17), the rest forming detached masses in the centre of the chambers. The flagellum originates from the end of the large oval nucleus, which is situated a little below the surface of the body of the cell.

Locality. Winter Quarters, Hut Point, 25 fms.

CRANIELLA LEPTODERMA.

(Plate XI., figs. 4–14.)

1888. *Tetilla leptoderma* Sollas (21. p. 3).

Sponge, club-shaped or pyriform; with verruculate surface; with one large oscule near the summit; with root-tuft. Surface pile of spicules absent in the adult state, and only slightly developed in early stages, large protriaenes being very rare or absent.

Spicules. Megascleres. 1. Large oxeas, 9.7×0.081 mm.

2. Smaller oxeas, scattered in the choanosome, 540 to 1350 μ in length.

3. Cortical oxeas (XI. 8), $770 \times 30 \mu$, straight, fusiform.

4. Anatriaenes of three kinds: *a.* (XI. 9) Cladi 170μ long \times 20μ thick at base, slender, sharp-pointed, chorda 110μ ; rhabdome, about 12 mm. long, thick at junction with cladome, then tapering, again thickening, and finally terminating in a filiform extremity.

b. (XI. 11) Cladome with thick conical cladi, $140 \times 35 \mu$, chorda 60μ ; rhabdome with a thick neck, and then nearly uniform till it tapers to a filiform extremity.

c. (XI. 10) Cladome with very long, straight, slender cladi, $150 \times 10 \mu$, nearly parallel with, or making an angle of, about 10° with the rhabdome, chorda only 31μ ; rhabdome slender (of uncertain length).

5. Protriaenes. Rare, usually with three slender equal cladi, 90μ long; rhabdome of nearly uniform diameter; but slightly diminishing near the cladome.

6. Trichodal protriaenes, usually (especially in the case of those forming the inner oscular fringe) with one ray greatly prolonged to 140μ or more, the other two having almost disappeared; rhabdome slightly thickened at cladal origin.

7. Sigmata, 14.25 to 15μ long, 0.75μ thick, and 12.3μ broad in the *c* aspect, with slightly and finely granulated surface.

There are three specimens of this sponge, the largest (XI. 4) being 12 cm. in total length and 5.2 cm. in breadth, with a root-tuft 3.5 cm. in length; the second specimen (XI. 5) is oval, 2.9 cm. long and 1.7 cm. broad, and the smallest is 13×12 mm.

The colour of the first two is dirty gray, and that of the last pale buff.

The scale-like, occasionally over-lapping, verrucae, attain a height of 2 mm., and a breadth at the base of 4 mm.

The oscule is oval-shaped, edged with a barely visible fringe of trichodal protriaenes; it measures, in the large specimen, 7.5×5 mm.

The **skeleton.** The radiating fibres only very rarely project beyond the surface; near the oscule are a few tufts of oxeas. Over the rest of the surface of the sponge, the dermal membrane covers over the summits of the verrucae, the distal points of oxeas and the cladomes of anatriaenes showing through; medium-sized in large protriaenes, so abundant in *Craniella sagitta*, are almost absent from the two large specimens of the present species, though in the smallest specimen there is one to each conule. Tufts of trichodal protriaenes are present in abundance.

The **ectosome.** On section, the ectosome is scarcely differentiated from the choanosome, excepting that sub-dermal spaces are visible just beneath the dermal membrane.

The cortical oxeas are more densely packed than in the preceding species.

A tangential section shows the pores in longitudinal areas between the densely serried rows of cortical oxeas, and fan-like tufts of trichodal protriaenes supporting the

sieve-like pore-areas; the pore-areas are distributed over the surface up to the neighbourhood of the oscule.

Canal System. The pores lead into sub-dermal channels whence canals descend into the choanosome. The flagellated chambers are eurypylous.

Small ova, $60 \times 30 \mu$, with pseudopodic-like processes, occur in the largest specimen.

A **young specimen** is pear-shaped with a granular surface, and without a root-tuft. Each "granule" is a sharp-pointed conule, with a protriaene projecting from it.

The young specimen of *Craniella sagitta* has a very different appearance, being quite fluffy on the surface owing to the numerous tufts of protriaenes.

Specimens were obtained from: (1) West of Balleney Island in 254 fms., Type specimen (XI. 4); (2) W.Q., Flagon Point, 10-20 fms.; (3) W.Q., Hut Point, 25 fms.

The 'Challenger' dredged specimens off Rio de la Plata, 600 fms.

CINACHYRA BARBATA.

(Plate IX., figs. 1-14.)

1888. *Cinachyra barbata* Sollas (21. p. 23. Pls. III., XXXIX.).

1906. *Cinachyra barbata* Kirkpatrick (10. p. 662. Pl. XIV.).

Twenty-seven specimens of this sponge, varying in diameter from a few millimetres up to 14 centimetres, were obtained. In addition to these, the collection includes a massive root-tuft no less than 32 cm. across and 12 cm. in thickness, belonging to what must have been a very large specimen, for the concavity into which the latter fitted occupies nearly the whole area of the upper surface of the root-tuft. The largest specimen obtained by the 'Challenger'—from Kerguelen—was 10 cm. in its longest diameter.

As in the case of the 'Challenger' specimens there is a considerable variation in the shape, which is usually spheroidal; some specimens are spherical, the nucleus of the radiating bundles of the skeleton being exactly central, others again resemble an inverted cone, and very young specimens are oval.

An interesting feature shown in adult specimens is the division of the sponge into three zones, viz., (1) a basal root-tuft zone; (2) an equatorial zone of porocalyces; and (3) a polar zone of oscules.

These zones are clearly perceptible in the fine series of well-preserved Antarctic specimens, but are not so well marked in those obtained by the 'Challenger.' The surface pile of spicules in the porocalycal zone is longer and looser than in the oscular zone, and directed obliquely downwards; but the pile in the oscular area is shorter, and more vertical and stubble-like.

The **root-tuft.** A remarkable feature about the root-tuft is its great size in some specimens, in which it may be much more bulky than the sponge body;

generally, however, it is of smaller size than the body, especially in large and old specimens.

The **porocalyces**. In adult specimens the porocalyces form a broad belt round the sides of the body. A few, in large specimens, were nearly 2.5 cm. (one inch) in depth. As I have already stated (10. p. 662) the porocalyces are, in all species of *Cinachyra*, inhalant areas perforated by true dermal pores, and are never exhalant or oscular.

The **oscles**. In *Cinachyra barbata* these structures are arranged in an obscurely spiral manner on the upper or "polar" surface of the sponge in adult specimens. In almost every instance, the oscles are tightly contracted, the spicular fringe being closed over them in form of a conical stack. It is this strong contractibility that has led to their being overlooked in most of the species of this genus, the porocalyces having been regarded as partly inhalant and partly exhalant.

The oscles are very rarely found open. Where this happens, the oscular orifice is at the summit of a slight crater-like elevation. Within the circle of long protriaenes forming the oscular fringe is a circle of fine protriaenes on the edge itself and also on the gentle slope leading inwards. At a short distance from the edge, the slope leads to a vertical barrel-shaped tube ending in a well-marked sphincter ring, which is about on a level with the innermost plane of the cortex; the oscular tube slightly expands below the sphincter into a sub-cortical cavity in the lateral walls of which are the orifices of exhalant canals proceeding from just beneath the cortex. At its lower end the sub-cortical space is continued on into a large main vertical canal, which passes up radially from the central region, receiving in its turn many affluents. The wall of the oscular tube is mainly composed of a thick sheath of concentrically arranged myocytes.

The vertical section of the oscular tube, when contracted, shows the almost closed lumen of the tube surrounded by a dark zone of sigmata, and with spiral bands of myocytes passing upwards around the lumen.

Two of the eight known *Cinachyra* species, viz., *C. voeltzkowi* Lendenfeld (11. p. 101) and *C. malaccensis* I. J. B. Sollas (19. p. 219), are described as having scattered pores in addition to the pores of the porocalyces. Some of these "pores" will certainly be found to be oscles situated, in young specimens, more or less antipodally to the porocalyces, others possibly belonging to developing porocalyces; for as W. J. Sollas observes (21. p. 29), "in their inception, the porocalyces are simply poriferous areas of the cortex."

Young specimens. Very young specimens (IX. 3) are oval, broader at the superior end, and without a root-tuft, though the surface spicules are longer at the narrow end of the sponge. At this stage the sponge lies with its long axis oblique or horizontal. The smallest specimen in this collection is 3 × 4 mm. in diameter. It has one porocalyx situated in the centre of one side, and one oscule a little to one side of the centre of the summit of the broad end. This nearly bilateral symmetry calls to

mind the species of *Fangophilina* Schmidt, viz. *F. submersa* O. Sch. (17. p. 73), and *F. gilchristi* Kirkp. (10. p. 667), in which the ovoidal body of the sponge has one large porocalyx and one large oscule situated on the upper aspect. As the sponge grows, the porocalyces increase in number and extend on each side of the original one till they form a complete equatorial belt; in the meantime, the main axis of the sponge gradually rotates from horizontal to vertical, so that the crown of oscules comes in many specimens to lie in a horizontal plane at right angles to the vertical axis.

The **cortex**. In young specimens the cortical oxeas are arranged tangentially in a single layer. In the largest examples, the cortex reaches a thickness of 3·25 mm., the densely packed oxeas being arranged vertically and obliquely to the surface.

The **skeleton**. The only additional observations to be made here are on certain bodies which Sollas (21. p. 24) refers to as "Globules; accessory or accidental forms, 0·0535 mm. in diameter." These bodies, which Schulze terms "silica pearls," are now known to be not uncommon in sponges (Schulze, 18. p. 6, and Weltner, 33. p. 190). Spheres may be normal spicules of the sponge, as in *Caminus sphaeroconia* Sollas. In many instances, however, spheres or globules result from malformation or incomplete development, as in cases where a tylote spicule is reduced to a knob, or a sphere may result from the reduction of an oxea, as in *Epallax callocyathus* Sollas. In some of the specimens of *C. barbata* there are a considerable number of pearls and some of them are double (IX. 6, 7). One example $114 \times 94 \mu$ is oval, with two nuclei and with concentric layers of deposition round each, up to the point where the spheres come in contact; later there is a single oval layer common to the two centres, but an annular depression or kink is always visible in the plane midway between the nuclei of the two original spheres. Sollas (21. p. 214, Pl. XXVII, figs. 8-9) figures composite spheres occurring in *Caminus sphaeroconia*, but here the composite sphere does not possess separate central points round which are deposited concentric laminae, but (apparently) one centre and an axial line or rod round the end of which the layers are deposited.

Whether these spheres or silica pearls are always spicules or the result of incomplete development of spicules, or whether they are sometimes due to deposition of layers of siliceous round some foreign organic or inorganic body, has not been determined. The nucleus is generally a refringent point, but is sometimes irregularly shaped and of a faint yellow colour; attempts to investigate it under high powers generally result in the pearl being crushed.

Several of the smallest pearls, only 6 or 7 μ in diameter, are associated with fan-shaped crystalline bodies (IX. 8-12); these latter proved to be simply crystals deposited from the sea-water. Sometimes the pearl is in the centre of a spheroidal mass of crystals. Under polarised light, the crystals are doubly refracting and are brilliantly defined on the dark field, while the pearls are isotropic, though usually very faintly visible; accordingly a spherical mass of crystals surrounding a pearl has a dark central space.

In a vertical section of the sponge stained in borax-carminum the spheroidal

conglomerations of crystals, 30–45 μ in diameter, are clearly defined owing to their being much more deeply stained than the surrounding tissues. The appearance of capsules in Pl. IX. figs. 13, 14, is due to an optical effect. The deep staining and the well-defined spheroidal shape might cause these bodies to be mistaken for organic structures; they are barely visible when unstained, and it is not easy to separate them from the dehydrated tissues in which they lie, in order to test the action of reagents; when separated they are found to be soluble in water.

Localities. The specimens come from six different localities in the neighbourhood of Winter Quarters, from depths ranging from 10 to 25 fms. Also Kerguelen Island, 25–60 fathoms, 'Voy. Challenger.'

CINACHYRA VERTEX.

(Plate X., figs. 1–14.)

1907. *Cinachyra vertex* Lendenfeld (11a. p. 310).

Sponge, generally oval, ovoidal, or conical, with long diameter horizontal. Surface with conules, usually oblique and more or less appressed to the surface, arranged in spiral rows, and terminating in tufts of spicules, the conules and tufts wrapping round the body. With well-developed root-tuft.

Porocalyces, varying greatly in size and appearance, being hemispherical pits with circular orifice, or obliquely directed pockets with slit-like opening; surface hispidated with trichodal protriaenes.

With several oscules situated in a more or less circumscribed area on the side opposite the area of greatest development of porocalyces, or at or near the summit of conico-ovate specimens. The oscules were open only in one instance; they were 3.25 \times 2 mm. in diameter, with a marginal fringe, and a platform-like spicule below the rim.

Ectosome, an outer layer of collencymæ, and an inner of fibrous tissue, with cortical spicules.

Flagellated chambers eurypylous.

Spicules. Megascleres. (1) Somal oxeas, 5.5 \times .057 mm., fusiform, tapering gradually to sharp points.

(2) Choanosomal oxeas 520 \times 18 μ , slightly curved.

(3) Anatriaenes; cladome, more or less hemispherical, often with apical umbo, cladi at first at right angles, then making a sharp bend; length 210 μ , thickness at base 70 μ , chorda 300 μ , sagetta 200 μ : rhabdome 6.5 μ broad at junction with cladome, then narrowing slightly, again thickening slightly, and terminating gradually in a fine sharp point.

(4) Protriaenes, cladome usually with one long cladus 170 μ twice the length of the other two; rhabdome 7.5 \times .019 mm. nearly uniform in thickness in distal half, tapering at proximal end to fine sharp termination.

(5) Trichodal protriaenes with rhabdome $550\ \mu$ in length, and with longest cladus $50\ \mu$.

Microscleres. (6) Sigmata, $18\cdot36\ \mu$ in length, $1\cdot8\ \mu$ in thickness, and $10\cdot5\ \mu$ in breadth in the C-aspect; surface finely granular.

There are twenty-five specimens of this sponge, the largest being $10\cdot5 \times 8$ cm. and the smallest 8×6 mm. The salient external features of the larger specimens are the spiral series of conules and tufts wrapping round the sponge, and the porocalyces obliquely displaced by the spiral growth of the sponge. The root-tuft is often much more bulky than the sponge body. The conules which form a fleshy basal sheath to the spicular tufts attain a height of 5 mm., and the tufts of an additional 10 mm. The porocalyces have an average diameter of about 4 mm., the oscules being about $\cdot5$ mm. in the contracted state; the latter have a fine marginal fringe of small protriaenes.

On section, the flesh is reddish in colour; the cortex indiscernible and can be peeled off in the form of a thin skin, its thickness being about 30 mm.; the outer third is formed of large rounded collencytes, $18\ \mu$ in diameter, full of granules, which stain deeply. Covering the outer surface of the sponge is a well-defined layer of sigmaspires; a layer of the same spicules also lines the surface of the canals.

Canal System. Currents pass through the pores in the porocalyces to large sub-dermal spaces leading to one large inhalant canal.

The flagellated chambers are eurypylous. Pl. X. fig. 5 shows numerous apopyles opening into a commencing exhalant canal.

The collar-cells (X. 6) here have their collars conerescent.

Numerous ova are present in some of the specimens, and in various stages—but not in the same specimen—some having pseudopodia-like processes, others being spheroidal and devoid of processes. In one unstained section in balsam the large spherical ova are $330\ \mu$ in diameter, with nucleus $50\ \mu$, and nucleolus $9\cdot75\ \mu$ in diameter; here the ova can be seen with the naked eye as deep yellow spots, and with a hand lens the clear nucleus can be distinctly made out.

Young specimens. In early stages there is no root-tuft, but in a series of small specimens, the conule tufts can be seen to lengthen at the narrow end of the specimen till they form a root-tuft. At first there is only one porocalyx situated on one side, and a single oscule, surrounded by a fringe of protriaenes, a little below and behind the broad end of the egg-shaped specimen. One small specimen (No. 264, 13, ii. 04) differs from the others in having long tufts each with a long fleshy base, the tufts all pointing downwards from the flat upper end; a few small contracted porocalyces are concealed in the axils of the fleshy conules.

Localities. Winter Quarters. Twenty-five specimens were obtained from ten localities, and from depths varying from 10–30 fathoms.

CINACHYRA VERTEX *var.* monticularis.

(Plate X., figs. 15, 16. Plate XI., figs. 1-3.)

1907. *Cinachyra vertex* Lendenfeld (11a. p. 310).

Two small specimens of this species, obtained from deep water (130 fms.), show a remarkable variation in the porocalyces and oscules. The porocalyces instead of being situated below the general surface are elevated above it in the form of rounded warts or monticules about 1 mm. in height; the oscules likewise form small cylindrical chimneys about 2 mm. in height.

The larger of the two specimens is 3.5 × 2.5 cm. in its diameters, not including the root-tuft, which is about 2 cm. in thickness. A large part of the surface is covered with the little porocalycal monticules, and at one end are several oscular chimneys. Situated at a varying height on each monticule is a semilunar slit which opens into a cæcal fold or pocket that has been formed by the upward growth and protrusion of the monticule; when the lip is near the summit of the monticule, it surrounds the latter like a kind of præpuce. The pore-perforated floor of the porocalyx itself is, in every instance, closely folded with longitudinal pleats which, however, can be unfolded. The summit of the monticule is formed by the tops of these folds, and bundles of the hispidating triehodal protriaenes can occasionally be seen projecting from the summit. The long slender bundles of protriaenes divide into two layers at the inferior proximal edge of the semilunar fold, one set being in the fold itself and extending to the edge of the same and sometimes a little beyond, the other set passing up in to the floor and walls of the porocalyx itself. The edge of the semilunar lip is provided with a band of myocytes. This curious variation appears to have taken place as an adaptation necessitated by the spiral mode of growth of the sponge; if such growth became excessive the porocalyces would be in danger of becoming elosed altogether from one lip of the orifice overlaying the other.

Locality. Winter Quarters. No. 10 Hole, 130 fms.

II.—GRADE MONAXONELLIDA, DENDY.

There are, in all, forty-three species belonging to this group. Of these, eight belong to the Astromonaxinellida, and thirty-five to the Sigmatomonaxinellida. Twenty-two species are new, and there are, in addition, seven new varieties of species already described. There are four new genera, of which one belongs to the *Axinellidae*, two to the *Mycalinae*, and a fourth, *Pygoderma* (Renierinae), has been established to receive *Halichondria latrunculioides* Ridley and Dendy.

New and interesting forms of spicules.—The new Mycaline genus *Cercidochela* is characterised by the possession of remarkable modified isochelae, which I have termed canochelae (*i.e.*, shuttle-shaped chelae). In them the single central teeth from each end have fused, so that a complete shuttle-shaped spicule results, recalling the melon-

like spicules of *Melonanchora*, in which, however, three opposite pairs of teeth have become united.

Hoplakithara dendyi is remarkable for its exotyles with very large spined heads; this species also has fimbriated placocheles.

The spathulate bipocilla occurring in two new species of *Iophon* are worthy of mention. A bipocillum of this kind occurs, also, outside the genus *Iophon*, viz., in a new species of *Myxilla*.

Geographical distribution.—As might have been anticipated, a large proportion of the known forms have already been recorded from the Southern Hemisphere.

Of the twenty known species, fourteen have been recorded from the South Atlantic or Indian Ocean, or from the southern portion of the east and west coasts of South America. Only two species have been previously recorded from the Antarctic region, viz., *Iophon radiatus* Topsent and *Gellius rudis* Topsent, both obtained by the 'Belgica' expedition from the opposite quadrant of the Antarctic circle.

Of four species which have been recorded from the Arctic region, one, viz., *Sphaerotylus capitatus* (Vosmaer), has never been obtained from any intermediate station. *Artemisina apollinis* (R. & D.), which was obtained by the 'Challenger' from Kerguelen Island, has been recorded by Lundbeck from off Greenland. *Stylocordyla borealis* (Lovén), recorded from the North Sea, and occurring also in the Antarctic, has been obtained from several intermediate localities. Of considerable interest is the occurrence of *Esperiopsis villosa* Carter, a form frequently recorded from high northern latitudes, but only from one intermediate station, viz., in deep water off the Azores.

Classification.—The classification of the main groups adopted here is that of Dendy (6. p. 60, 134). Dendy divides the Order Tetraxonida into two grades, Tetractinellida and Monaxonellida, and the latter grade into two sub-orders, Astromonaxonellida and Sigmatomonaxonellida. The use of the last two names implies the theory of the relationship of these sub-orders with the astrophorus and sigmatophorous Tetractinellida respectively.

The divisions Clavulida and Aciculida (Topsent) of the Astromonaxonellida (*Hadromerina pars* Topsent) are adopted; so likewise is Lundbeck's division of the Desmacidonidae (Pocilloscleridae Topsent) into two sub-families, *Mycalinae* and *Ectyoninae*, and of the *Mycalinae* into two groups, *Mycaleae* and *Myxilleae*.

A preliminary report giving descriptions of new genera and species has been published in the Ann. Mag. Nat. Hist. (7), vol. xx., pp. 271 *et seq.*, Sept. 1907.

Below is a list of species of Monaxonellida :—

GRADE MONAXONELLIDA DENDY.

I. Sub-order ASTROMONAXONELLIDA Dendy.

I. Tribe CLAVULIDA Vosmaer.

i. Family *Spirastrellidae* Ridley and Dendy.

Latrunculia apicalis Ridley and Dendy var. *biformis* var. n.

Latrunculia apicalis Ridley and Dendy var. *basalis* var. n.

ii. Family *Polymastidae* Vosmaer.

- Polymastia invaginata* Kirkp.
Sphaerotylus antarcticus Kirkp.
Sphaerotylus capitatus (Vosmaer).

iii. Family *Suberitidae* Schmidt.

- Suberites microstomus* Ridley and Dendy var. *stellatus* var. n.
Suberites caminatus Ridley and Dendy var. *papillatus* var. n.
Pseudosuberites hyalinus (Ridley and Dendy).

II. Tribe ACICULIDA.

i. Family *Stylocordylidae*.

- Stylocordyla borealis* (Lovén) var. *acuta* var. n.

II. Sub-order SIGMATOMONAXONELLIDA Dendy.

ii. Family *Axinellidae* Ridley and Dendy.

- Axinella supratumescens* Topsent.
Sigmariuyssa phakelloides Kirkp.

iii. Family *Desmacidonidae* Ridley and Dendy.I. Sub-family *Ectyoninae* Ridley and Dendy.

- Hymedesmia ureolata* Thiele.
Hymedesmia erigua Kirkp.
Hymerrhaphia rufa Kirkp.
Ophlitaspongia nidificata Kirkp.
Lissomyxilla hanitschi Kirkp.

II. Sub-family *Mycalinae* Thiele.I. Group *Myxillae* Lundbeck.

- Iophon radiatus* Topsent.
Iophon spatulatus Kirkp.
Iophon flabello-digitatus Kirkp.
Lissodendoryx spongiosa (Ridley and Dendy).
Myxilla decepta Kirkp.
Tedania variolosa Kirkp.
Tedania coulmani Kirkp.

II. Group *Mycalae* Lundbeck.

- Artemisina apollinis* (Ridley and Dendy).
Esperiopsis villosa (Carter).
Mycale magellanica (Ridley).
Mycale avorata Kirkp.
Mycale sp.
Desmacidon kerguelenensis Ridley and Dendy var. *antarctica* var. n.
Desmacidon kerguelenensis var. *cactoïdes* var. n.
Desmacidon spinigera Kirkp.
Desmacidon macedrina Kirkp.
Jayverzia belli Kirkp.
Cercidochela lankesteri Kirkp.
Hoplakithara dendyi Kirkp.

III. Family *Haploscleridae* Topsent.I. Sub-family *Gelliinae* Ridley and Dendy.

- Gellius rulis* Topsent.
Gellius fimbriatus Kirkp.

Gellius pilosus Kirkp.
Gellius cucurbitiformis Kirkp.
Gellius glacialis var. *nivea* Ridley and Dendy.
Oceanapia tantula Kirkp.

II. Sub-family *Renierinae* Ridley and Dendy.

Pylocleroma latrunculioides (Ridley and Dendy).
Petrosia fistulata Kirkp.
Reniera scotti Kirkp.
Reniera dancoi Topsent.

SUB-ORDER ASTROMONAXONELLIDA, Dendy.

TRIBE CLAVULIDA, Topsent.

FAMILY SPIRASTRELLIDAE, Ridley and Dendy.

LATRUNCULIA APICALIS var. *biformis*.

(Plate XV., figs. 1-7.)

Latrunculia apicalis Ridley and Dendy (15. p. 234).

There are three specimens of the new variety. The one selected as the type is massive and conical, 9 cm. high and 7.5 cm. broad at the base. The surface is covered with the little disk-like poral papillae, but in place of many conical oscules, such as are found in the typical form described by Ridley and Dendy, there is one large oscule (16 mm. in diameter and much contracted) at the summit of the specimen. The chief variation from the type is in the character of the discasters, of which there are two kinds, one with an apical spike resembling that found in the typical form, but stouter and shorter, and the other kind without the apical spike. Mr. Highley's figures show the characters of these two forms; the first kind is 362 μ long and 200 μ in greatest breadth; the second kind is 190 \times 150 μ . All the specimens have what appear to be reduced discasters, *i.e.*, spined styles in which the toothed disks of the discaster have become reduced to spines. The smooth styles are nearly straight, 325 \times 12.5 μ , and with tornote pointed ends.

Two of the specimens are chocolate brown in colour, but a third is paler and has more of the reduced discasters. One specimen is labelled "The green Sponge." The alcohol in which they have been preserved is dichroic, being amber-coloured by transmitted, and olive green by reflected, light.

The specimens were all dredged near Winter Quarters in 10-15 fms.

LATRUNCULIA APICALIS, var. *basalis*.

Latrunculia apicalis Ridley and Dendy (15. p. 234).

There is one small, thin cake-shaped specimen 30 \times 20 mm. in area and 6 mm. thick, of a light-brown mud colour.

There are several of the discoidal raised pore-areas, and one conical oscular papilla. The flagellated chambers are aphodal, 49 \times 19 μ , the aphodus being 32.5 μ long. The

discasters vary somewhat, the apparently typical form being 64μ long and 39μ broad, with a small spike at the base, and a still smaller one at the apex; sometimes neither the basal nor apical spines are present, and the spicule resembles more nearly the discaster of *Latrunculia brevis* Ridley and Dendy. There are two small basal whorls of spines; above them is a plano-convex whorl with denticulate edges and deeply cleft along 3-5 radii; then follow two smaller whorls pointing upwards.

The smooth styles are fusiform, with tornote point, 557μ long, 6.5μ in diameter at the head, and 10.5 in diameter at the centre.

The specimen was dredged West of Balleney Island in 254 fms.

FAMILY POLYMASTIDAE, Vosmaer.

POLYMASTIA INVAGINATA.

(Plate XII., fig. 1B, and Plate XIV., figs. 5-15a.)

Polymastia invaginata Kirkpatrick (10a. p. 271).

Sponge hemispherical, free or attached, covered with a thick pile of pointed spicules. With one large oscular papilla usually completely invaginated, so that the summit of the oscule is on a level with, or below the general surface. Under surface with a fleshy basal pad.

Pores in longitudinal meridional groups in the cortex.

Colour, in spirit pale yellow above, and often gray and semi-transparent on the under surface in free specimens.

Consistence dense and firm.

Flagellated chambers spherical, 30.5μ in diameter, diplodal (XIV. 7).

Skeleton. Choanosomal, formed of fibres curving upwards from the base to the periphery, penetrating the cortex and forming the thick surface pile; with stellate clusters of small tyles between the fibres.

Cortical skeleton formed of a dense layer of vertical tyles of various lengths embedded in a tough, fibrous layer from $.5$ to 1.25 mm. thick.

Basal skeleton consisting of spicules transversely arranged, and crossing each other in an irregular manner.

Spicules. Large, smooth, slightly curved styles, or occasionally strongyles, $2240 \times 40 \mu$.

Cortical tyles, with small spheroidal head, short neck, fusiform straight shaft, varying in length from 140 to 350μ , and in thickness from 12 to 19μ . A few very slender styles scattered in the choanosome, $70 \times 6 \mu$, with head and neck making an angle with the shaft. Some medium-sized cortical tyles in the oscular papilla with long, oval heads. Tyles of the stellate clusters, slender, with the head making an angle with the shaft, $200 \times 15 \mu$.

There are fourteen large specimens and five very small ones of this species. The largest is 8 cm. in diameter and 4.5 cm. high; and the smallest, which is triangular,

is 8 mm. high, 8 mm. in length at the base, and 4 mm. in thickness. In some the pile has been rubbed off, exposing the smooth, fleshy cortex. Some of the specimens are growing on large stones; others are free, but with numerous embedded pebbles in the fleshy basal pad.

In many specimens the oscule is invisible, being entirely retracted within a cavity below the summit, and with the opening of that cavity, contracted to a point and concealed by the surface pile of spicules; a vertical section reveals the oscular papilla in its cavity. One specimen has two oscular papillae. The general structure of the skeleton recalls *Trichostemma*, which likewise has a basal pad, with fibres radiating from base to periphery, and with a cortex of tytes. *T. sarsii* also has the stellate groups of tytes between the fibres of the choanosome. The basal pad is composed of stellate-celled collenchyma, the collencytes with their branched anastomosing processes being embedded in a clear, gelatinous matrix.

Most of the specimens were dredged in the neighbourhood of Winter Quarters in depths of 10–30 fms.; one came from near Mounts Erebus and Terror, 500 fms.

SPHAEROTYLUS, Topsent (26. p. 244).

Polymastidae, massive; provided with tylostyles, and with exotytes in the form of spherotytes or spherostyles.

This genus was established by Topsent to contain *Polymastia capitata*, Vosmaer (32. p. 16). I have slightly extended the original definition by the addition of the word "spherostyles," because one of the two species of *Sphaerotylus* in the present collection has exotytes in the form of spherostyles, i.e., exotytes with the proximal inner end simply rounded and not enlarged into a knob, a spherostyle being a style with the distal or outer end enlarged. The difference between a spherostyle and a spherotype is hardly of generic importance, consequently *Sphaerotylus* must include forms with spherostyles.

Hitherto only three Astromonaxonellid sponges with exotytes have been described, viz., *Tylexocludus joubinii* Topsent, *Proteleia sollasi* Ridley and Dendy, and *Sphaerotylus capitatus* (Vosmaer). The 'Discovery' collection contains two species of *Sphaerotylus*, a new one *S. antarcticus*, and one which appears to me to differ in no important respect from the Arctic species *S. capitatus* (Vosmaer).

SPHAEROTYLUS ANTARCTICUS.

(Plate XII., figs. 1A–16 and Plate XIII., figs. 1–7.)

Sphaerotylus antarcticus Kirkpatrick (10a. p. 272).

Sponge, dome-shaped or spheroidal, attached or free. Surface beset with a covering of long spherostyles, and with a dense short pile of cortical microtytes. With several usually elongated papillae with or without a large terminal orifice. Dermal pores distributed over the cortex, each pore opening into a single tubular

canal in the cortex; the mouth or pore of the pore canal guarded by a ring of radiating cortical tyles (XIII. 3). Flagellated chambers diplodal (XIII. 7).

Skeleton formed mainly of radiating fibres composed of styles, with diverging brushes of spherostyles near the surface. Cortex with a surface layer of densely packed tufts of small vertical tyles, and a sub-cortical layer of tangential styles and tyles.

Spicules. Spherostyles (XII. 8-12) 8 mm. in length by $30\ \mu$ in diameter in the middle, and $14\ \mu$ in the region below the distal knob; distal knob $28\ \mu$ in diameter, hemispherical, with granular surface and with a few square teeth or serrations on the edge.

Styles straight, fusiform, blunt-pointed, 2.8 mm. in length, $41\ \mu$ in diameter in the middle, $23\ \mu$ in diameter at the rounded end.

Cortical tyles (XII. 15, 15a), curved, $146\ \mu$ long, head, $3.25\ \mu$ in diameter; slender neck, $2.75\ \mu$ thick with broad oar-blade-like shaft, circular in section, $7\ \mu$ thick.

Styles of lower cortical tangential layer (XII. 7), also in choanosome, $900 \times 20\ \mu$. Tyles of the same layer, nearly straight, $270\ \mu$ long; with head $7\ \mu$ in diameter, and relatively thick neck $6.8\ \mu$ in diameter (XII. 16-16A).

Slender curved tyles, $460 \times 10\ \mu$, scattered in choanosome (XII. 13).

Young specimens are oval with one long closed papilla; the bundles of divergent exotyles are more or less separate and distinct, and the distal knobs retained and not broken off; the radial bundles of fibres radiate out from a point below the centre of the specimen.

There are five large specimens, of which three encrust rocks and two are free, and six very small ones, all of which are free. One of the large free ones (XII. 5) is a globular fluffy ball 6 cm. in diameter, with a few stumpy, much contracted papillae; another free specimen is dome-shaped, with a flat, fleshy base like a thin pad. The typical shape is that of a dome, with the skeletal fibres radiating upwards and outwards from the base to the surface. The spheroidal form results from the growing round of the edges till they meet; accordingly a section shows a central core with cortical microtyles still present, but displaced, and with main fibres radiating out all round the core.

The largest encrusting specimen (XII. 1), which is growing on a boulder of black volcanic rock, is 10 cm. in diameter and about 3 cm. in height, the papillae, about twenty in number, rising to an additional height of 3-4 cm. The papillae are coated with the thick pile of microtyles, but there are no exotyles. A few of the papillae have large terminal orifices with apparently cicatrised edges, as if the breach had arisen from a bursting away of the summit from pressure from within the papilla; these papillae, at any rate, are oscular; but so also, probably, are some of the closed papillae, which have irregular cribriform patches around the summit or along one side of the papilla. The same difficulty of deciding on the function of these organs occurs also in the case of species of *Polymastia*.

The radial bundles of styles proceed from base to periphery, and usually do not penetrate the surface; the exotyles form pyramidal tufts which originate just below the cortex, this arrangement being well seen in young specimens.

Specimens were obtained from Winter Quarters, Flagon Point, 10–20 fms.; from No. 12 hole, 25–30 fms.; and from McMurdo Bay up to 20 fms.

SPHAEROTYLUS CAPITATUS.

(Plate XII., fig. 1c, Plate XIII., figs. 8–13, and Plate XIV., figs. 1–4.)

1882. *Radiella schoenus* Sollas (20. p. 163), Nomen nudum.

1885. *Polymastia capitata* Vosmaer (32. p. 16).

1898. *Sphaerotylus capitatus* Topsent (26. p. 244).

The single specimen (XII. 1c) is attached to a block of volcanic rock on which specimens of *S. antarcticus* and *Polymastia invaginata* are growing. The sponge is in the form of a flattened dome 1.5 cm. in diameter and 5 mm. in height, with a small papilla 5 mm. in length, rising from near the centre of the upper surface. From one side of the specimen slender bud-bearing stalks arise to a height of 2–4 mm.; sometimes the buds are in linear series (XIV. 2), sometimes zigzag (XIV. 4).

The axes of the stalks are the prolongations of radial fibres, and consist of tyles. The buds, which vary from .5 mm. to 1.25 mm. in diameter, bristle with the sharp points of small and medium-sized tyles.

The largest bud (XIV. 3) has exotyles, and shows all the stages of their development. Firstly, there is a thickening of the distal end of an ordinary sharp-pointed tylostyle, which becomes cylindrical; then the end becomes roughened, and finally clavate.

Merejkowsky (14. p. 4, Pl. I., figs. 8, 12, and Pl. III., figs. 1–3) figures buds forming on stalks at the summits of the papillæ of *Polymastia mammillaris* (*Rinalda arctica*) from the White Sea. The stalks and buds strikingly resemble those of *Sphaerotylus capitatus*, excepting that the latter grow direct from the general surface of the body and not from the summits of the papillæ.

Merejkowsky gives an interesting account of the development of these buds, which drop off from their stalks, and become flattened and disk-like as they rest on the bottom. The surface becomes covered with *débris* which the spines help to retain. He supposed that the decaying organic *débris* served as nutriment, which was directly absorbed by the surface of the young sponge.

The flagellated chambers are diplodal. The colour of the specimen in spirit is pale yellow. The body presents a surface uniform to the naked eye, but under a strong lens the summits of the club-shaped exotyles are visible. These spicules arise in bundles of the shape of inverted cones, the apices of which are a short distance below the cortex.

The cortical skeleton is formed of slender tyles. There is no sub-cortical layer of tangential spicules.

The choanosomal skeleton is formed of fibres radiating upwards from the base to the periphery, and spreading out in the upper third of their course; they do not penetrate the cortex.

Spicules. Choanosomal tyles of the radiating fibres, $1120 \times 20 \mu$, straight, fusiform, attenuating gradually to a sharp point; head long, oval, 20μ long, 17μ broad.

Tyles scattered between the radial fibres, varying in length from 370 to 600μ , slightly curved.

Exotyles in form of spherotyles, 760μ long and 40μ in diameter at the broad distal end, which is clavate, and with a granulated surface; the heads at the proximal end (in the interior of the sponge) are 15μ in diameter.

The cortical tyles (XIII. 11), $218 \times 12.5 \mu$, are slender, tapering, curved, and with small oval heads and a thin neck; there is a shorter, straighter variety of cortical tyle (XIII. 12, 12a) with a relatively thicker neck, and abruptly pointed.

Although there is some uncertainty as to the actual size of the spicules in the specimen described by Vosmaer, yet the relative proportions and characters of these spicules are very similar in the Arctic and Antarctic specimens. The Arctic specimen was globular and 2 cm. in diameter.

Topsent mentions *Radiella schænus* Sollas, as a synonym of Vosmaer's species. Sollas gives the only names without generic or specific definition.

The specimen was obtained from Winter Quarters, off Flagon Point, 10–20 fms. It has also been found at Lat. $72^{\circ} 14' 8''$ N., Long. $22^{\circ} 30' 9''$ E., 165 fms., Vosmaer, Willem Barents Expedition.

FAMILY SUBERITIDAE, Schmidt.

SUBERITES MICROSTOMUS *var.* stellatus.

(Plate XV., figs. 8–13.)

Suberites microstomus Ridley and Dendy (15. p. 199).

There are four small specimens in the form of smooth, pale-coloured, whitish rounded masses, smooth to the eye but slightly rough to the touch, encrusting the stems of branching Polyzoa; the largest is about 4.5 cm. long and 2.5 cm. broad, and forms a nodulated mass on the branch of the Polyzoön.

There are two or three minute conical pointed oscular papillæ about 1 mm. high. The pores occur in stellate areas among the cortical tyles which occupy the rest of the surface. The skeleton is composed of radiating fibres and of a dense cortical layer of vertical or oblique tyles.

Spicules. Megascleres. Large straight fusiform tyles with an oval head, gradually attenuating to a sharp point, $1130 \times 24 \mu$. The head (XV. 9a) is usually sub-tylote or even tylote, and has a sub-terminal oval swelling 13μ in diameter. The cortical tyles vary considerably, the figures showing three kinds. The largest $500 \times 30 \mu$

(XV. 10) with a small spherical head $20\ \mu$ in diameter, with a slender neck, and a thick fusiform shaft, blade-like in optical section, and with tornote end; a few of these spicules are scattered in the choanosome between the radiating fibres. A second kind (XV. 12) $220 \times 20\ \mu$ is straight, with a short, thick neck and cylindrical shaft with blunt point. A third kind (XV. 11) $220 \times 7\ \mu$ is slender, slightly curved, and sharp-pointed.

The new variety differs from the typical form in having stouter cortical and choanosomal spicules. This is at once obvious on looking at the vertical sections of the two forms, the cortical spicules especially being much thicker and denser in the new variety. Again, the poral areas on the surface of the type are small and circular (XV. 14), whereas those of the new variety are stellate (XV. 13).

The specimens were dredged near Winter Quarters, at No. 10 hole, 130 fms.

The typical form was obtained from between Kerguelen and Heard Island from 150 fms. (Voy. 'Challenger').

SUBERITES CAMINATUS *var.* papillatus.

(Plate XV., fig. 16, and Plate XVI., figs. 11-14.)

Suberites caminatus Ridley and Dendy (15. p. 198).

There are two specimens, each firmly attached to a piece of rock; one has two oscular chimneys, the other only one. The body of the larger specimen is 2.5 cm. in diameter and 1.5 cm. in height, the oscules being 7 mm. in height.

The upper half or more of the surface is covered with small flattened papillæ, each about 1 to 1.25 mm. in diameter, and about .7 mm. high. These structures carry the pores in stellate grooves (XV. 16). At the base of the sponge is a chitinous lamella with tangential tyles scattered irregularly and intercrossing. At the base of the larger specimen the basal lamella is produced into a fringe of little processes formed of flattened bundles of tyles, the distal ends of which have become rounded. The skeleton is formed of radiating choanosomal fibres and of a dense cortical layer of dressed tyles.

Spicules. Straight fusiform tyles (XVI. 14), $1530 \times 20\ \mu$, with small oval head $15 \times 10\ \mu$. Cortical tyles mostly of two kinds; one (XVI. 12) with small spherical head, with relatively slender neck and thick cylindrical shaft, blade-like in optical section, with tornote pointed end; the other (XVI. 13) shorter and stouter and with thicker neck. A fourth kind of spicule, rather rare (not figured), is a sub-tylote, $1,530 \times 20\ \mu$ long, with a very slender curved distal end projecting beyond the surface, resembling the distal end of the heteroxea of *Stylocordyla*.

The chief variation from the type lies in the poral papillæ. In the typical form the pores are in stellate grooves. The papillæ of the new variety called to mind the same structures in *Trichostemma irregularis* R. & D. On examination, the papillæ in this species also proved to be poral, with the pores in radiating grooves.

The two specimens were dredged from a depth of 254 fms., due west of Balleney

Island. The typical form came from off the Rio de la Plata, 600 fms. (Voy. 'Challenger'). Topsent records it from near Fayal, 130 mètres, and 55 miles N.N.W. of Fayal, 1900 mètres.

PSEUDOSUBERITES HYALINUS.

(Plate XXVI., figs. 7a-b.)

1887. *Hymeniacion? hyalina* Ridley and Dendy (15. p. 168).

1898. *Pseudosuberites hyalinus* Topsent (27. p. 103).

1900. *Pseudosuberites hyalinus* Topsent (28. p. 170).

The single specimen is of a compressed cylindrical shape, 6 cm. long and 8 mm. in diameter. The colour is white. There does not appear to be any area of attachment, both ends being complete and rounded. Two thin walled oscules, each about 2 mm. in diameter occur along one edge of the specimen, the exhalant canals proceeding towards them being clearly visible. On one side of one of the oscules is a wall of spicules formed by a continuation and flattening out of some of the lateral or secondary skeletal bundles.

A longitudinal section shows clearly a central loose core of longitudinal fibres each about 100 μ thick, anastomosing slightly and giving off at right angles bundles of spicules which support the dermal membrane; in the thinner parts of the specimen these bundles are one spicule in length, but at the thickest part they may be two or three spicules in length and traversed by longitudinal bundles. The original specimens obtained from Kerguelen by the 'Challenger' are "massive and amorphous," and the skeleton is more of the "halichondrioid type," but here also the longitudinal bundles and those supporting the dermal membrane can be distinctly made out. In the Antarctic specimen the cylindrical shape has brought about the more regular arrangement. The Mediterranean sponge, identified by Topsent (27. p. 103) as *P. hyalinus*, is massive, amorphous, and encloses foreign bodies. The surface is mammillated and a little hispid, this condition resulting from the prolongation of the lateral bundles or fibres of the skeleton. The tyles of the Antarctic form are about $1000 \times 19 \mu$, those of the Kerguelen form $1100 \times 25 \mu$, and those of the Mediterranean form from $300 \times 10 \mu$ to $1200 \times 26 \mu$.

An interesting feature is that all the spicules point in a direction upwards or upwards and outwards.

Two other species of *Pseudosuberites* are *P. sulphureus* (Bowerbank), from the seas of N.W. Europe, and *P. andrewsi*, Kirkp. (9. p. 135), from Christmas Island; this last species forms a cake-like crust, and its spicules are much smaller than those of *P. hyalinus*, being only $350 \times 6 \mu$.

The specimen was dredged from W.Q. No. 10 hole, 130 fms.

The species has been found off S.W. Patagonia, Voy. 'Challenger,' St. 311, 175 fms., and off the Mediterranean coast of France in 500 to 600 mètres, Topsent.

TRIBE ACICULIDA, Topsent.

FAMILY STYLOCORDYLIDÆ, Topsent.

STYLOCORDYLA BOREALIS *var.* *acuata*.

(Plate XVI., figs. 6–10.)

1868. *Hyalonema boreale* Lovén (Öfvers. Vetensk Akad. Förhand., Årg. xxv, No. 2, p. 105, pl. ii.).1873. *Stylocordyla borealis* Wyville Thomson ('The Depths of the Sea,' p. 113, fig. 13).

The small specimen representing this variety has a slender stalk 6·2 cm. long with an oval head 7×5 mm. A second broken stem arises from the common base which has a few grains of gravel and a fragment of the horny tube of a Hydroid attached to it.

The following spicular elements occur:—

1. Large oxeas with a central swelling (XVI. 10), in the axis of the stem, $1450 \times 60 \mu$.

2. Smaller oxeas without central swelling (XVI. 8), in the radiating fibres of the head, $900 \times 20 \mu$.

3. Heteroxeas (XVI. 9) $1000 \times 10 \mu$ in the radiating fibres of the head.

4. Microstyles (XVI. 7, 7a) $110 \times 4 \mu$ vertically dressed at the surface of the stem, and not found in the head. In the typical form there are microxeas, which may be centrotylote. The variety is named "*acuata*" from the presence of the microstyles.

Topsent (25. p. 286) considered that *Stylocordyla stipitata* Carter, differs from *S. borealis* in not having microxeas, which the latter possesses; and he based his opinion on the absence of these spicules from certain preparations of *S. stipitata* lent to him by Canon Norman; but I have found the microxeas in abundance in Carter's type specimen. Accordingly there is probably only one known species of *Stylocordyla*, viz., the typical *S. borealis*, and two varieties, *var. globosa* R. & D., and *var. acuata* nov.

The figures of Lovén and Sars do not show any indication of the microxeas being centro-tylote, but this condition is found in specimens from the Bay of Biscay.

The Antarctic variety has no dermal tangential microscleres in the head, but microxeas occur in this position in the typical forms from the North Atlantic.

The 'Discovery' dredged the specimen from off Erebus and Terror in 500 fms. The species has been obtained from the following localities:—

North Sea (Lovén); between Scotland and Faroe (Carter, Schulze); Grenada (Schmidt); South of Nova Scotia, 85 fms. (Voy. 'Challenger'); Bay of Biscay, 1710 mètres (Topsent); Bahía 7–20 fms. (Voy. 'Challenger'); *var. globosa*—Southern Ocean 145 fms. (Voy. 'Challenger'); off Kerguelen 10–100 fms., Voy. 'Challenger.'

SUB-ORDER HALICHONDRINA, Vosmaer.

FAMILY AXINELLIDÆ, Ridley and Dendy.

AXINELLA SUPRATUMESCENS.

(Plate XXII., fig. 8, and Plate XXVI., figs. 6a-b.)

1907. *Axinella supratumescens* Topsent (31. p. 6).

The specimen, which is a small conico-cylindrical fragment 3.5 cm. long and 9 mm. in diameter, is the broken-off end of a branch. The surface is finely hispid, and the broken end shows the dense but flexible central axis.

The straight or slightly curved styles are mainly of two sizes, the larger (XXVI. 6a) being $594 \times 12.5 \mu$, and the smaller (XXVI. 6b), which forms the surface tufts, $306 \times 6.25 \mu$.

The specimen was dredged near Winter Quarters in 10 fms.

The 'Français' Antarctic Expedition obtained numerous specimens from Booth-Wandel Island and Wiencke Island, from low water up to 30 mètres (Topsent, 31. p. 74).

SIGMAXINYSSA Kirkpatrick.

1907. *Sigmaxinyssa* Kirkpatrick (10a. p. 272).

Cup-shaped Axinellidæ with longitudinal skeletal fibres joined by transverse ones on the inner aspect, and with tufts given off at right angles to these on the outer aspect. Megascleres, oxeas; microscleres, sigmata and toxa.

SIGMAXINYSSA PHAKELLIODES.

(Plate XVII., fig. 6, and Plate XXIV., figs. 4a-c.)

1907. *Sigmaxinyssa phakellioides* Kirkpatrick (10a. p. 272).

Sponge sessile, cornucopia- or cup-shaped. Inner surface smooth, outer surface coarsely pilose. Consistence rather hard, but flexible. Colour in spirit, grayish drab. Inner surface with numerous small oscules, each about 1 mm. in diameter; outer surface pilose, with dermal membrane perforated by round pores 95μ in diameter.

Skeleton. On inner surface formed of close set longitudinal lines joined by cross bars, and giving off tufts of fibres, which proceed outwards at right angles to the outer surface, pushing up the dermal membrane, but barely projecting beyond it.

Spicules. Oxeas, $835.5 \times 42.25 \mu$, curved at centre, sharp-pointed. Sigmata, 81.25μ long, 35.75μ broad, and 3.25μ thick, often with an angular bend at centre of shaft. Toxa, 130μ long, and 3.25μ thick at centre, with smooth surface.

This species bears in its outward aspect a very close resemblance to cup-shaped species of *Phakellia*; also the skeletal arrangement is like that of *Phakellia*; the oxeas, sigmata and toxa are those of a typical *Gellius*. The Axinellid genus *Sigmaxinella* Dendy, which has microscleres in the form of sigmata, has styles for megascleres.

The only specimen was dredged off Coulman Island in 100 fms.

FAMILY DESMACIDONIDÆ, Ridley and Dendy.

I. SUB-FAMILY ECTYONINÆ, Ridley and Dendy.

HYMEDESMIA AREOLATA.

(Plate XXII., fig. 3-3e.)

1905. *Hymedesmia areolata* Thiele (23. p. 452).

There are two specimens, one a fine large one, the other a small nodule; both have a broken surface, and on the label is the legend "Broken off a stone."

The larger specimen is an oval mass 12.5 cm. long, 6.5 cm. high, and 5.5 cm. thick.

The species is easily recognised from the areolated appearance of the surface. There are numerous oval or circular poral pits, 1.5 mm. across, with over-hanging edges; the concave floor is perforated with pores.

The densely packed ectosomal oxas are arranged radially round the pore pits.

The oscules are small inconspicuous cones contracted to a point.

The flagellated chambers are aphodal, $36 \times 23 \mu$ in diameter.

Thiele's specimens were in the form of incrustations on chitinous tubes.

The 'Discovery' specimens were dredged near Winter Quarters in $12\frac{3}{4}$ fms.

The species has also been recorded from Calbuco, Chile, 40 mètres (Thiele).

HYMEDESMIA EXIGUA.

(Plate XXII., fig. 4, and Plate XXVI., figs. 2a-f.)

1907. *Hymedesmia exigua* Kirkpatrick (10a. p. 273).

Description. The sponge forms a thin translucent grayish-white crust, about 5 mm. in diameter, on a stone. The surface is smooth, and the substance of a fleshy consistence.

The skeleton. The choanosome contains scattered short acanthostyles, and the dermal membrane tangential tyloles isolated or in bundles of a few.

Spicules. Megascleres. Acanthostyles, $94 \times 19 \mu$, short, thick, with spines pointing backwards slightly. Ectosomal tyloles, $157 \times 3.5 \mu$, straight, smooth, with oval heads, 5μ long, and 4.5μ broad.

Microscleres. Pluridentate isanecorae spatuliferae; with five foliate teeth, 5μ in length, at each end, sometimes with three or four; shaft deeply curved, 2.5μ thick, sometimes with central alate expansions.

Sigmata 9.6μ long, 5.6μ broad, $.5 \mu$ thick, scattered separately in the choanosome.

The new species resembles in several respects *H. zetlandica* Bowerbank, but the ancorae of the latter have only three teeth, the sigmata are much longer (51μ) and in sheaves; also the ectosomal tyloles are much larger, viz., $328 \times 3.25 \mu$, and the spines of the acanthostyles more verticillate. *Hymedesmia irritans* Thiele, from

Juan Fernandez, has nearly the same spicular elements, but of different dimensions, and has the labis among its microscleres.

The specimen was dredged from 254 fms. due west of Balleney Island.

HYMERRHAPHIA RUFA.*

(Plate XXII., fig. 5, and Plate XXVI., fig. 3a-e.)

Hymerrhaphia rufa Kirkpatrick (10a. p. 274).

Description. The sponge forms a thin mud-coloured brown crust on a branched Polyzoon. The surface is smooth, and no pores or oscules are visible. The consistence is rather tough. The **skeleton** of the choanosome is formed of longer and shorter acanthostyles dressed vertically, that of the ectosome being formed of tangentially arranged anisotornotes, either isolated or in bundles.

Spicules. Megascleres. Larger acanthostyles, $312 \times 25 \mu$, swollen at the head, spined all over, with larger curved spines at the head. Smaller acanthostyles, $131 \times 18.75 \mu$. Anisotornotes of ectosome, $344 \times 12 \mu$, straight, fusiform, attenuating gradually at one end but abruptly at the other. Microscleres.—Isanorae, 28.5μ long, with three or four teeth at each end; rarely, the teeth are not developed, the ends being in the form of hemispherical cups (XXVI. 3e).

Dredged near Winter Quarters, No. 10 hole, 130 fms.

OPLITASPONGIA NIDIFICATA.

(Plate XXII., figs. 6, 6a, and Plate XXVI., fig. 5a-d.)

Oplitaspongia nidificata Kirkpatrick (10a. p. 274).

Sponge massive, of an inverted pyramidal shape, sessile, narrow and contracted at its point of attachment. Surface uniformly coarsely spinous. Circular oscules ($.7$ mm. in diameter) on the upper surface, at the bases of the spines. Sub-dermal cavities flat and shallow. Flagellated chambers diplodal. Colour in spirit, dirty gray, the tips of the spines being yellowish. Consistence hard and tough.

Skeleton consisting of dense branching axes of styles cemented with spongin and cchinated by smooth styles passing at right angles from the axis to the surface. Ectosomal spicules in form of slender straight styles. (Considerable tracts of dermal membrane were devoid of these spicules.)

Spicules. Megascleres, large, straight, smooth styles, on an average about $1000 \times 50 \mu$. Also smooth curved kind 625μ long. Ectosomal styles, straight, smooth, tapering gradually to a point, $406 \times 9 \mu$. Microscleres, toxa smooth, 638μ long, 6.25μ thick at the centre. These spicules occur in nests or groups of 5-10.

The specimen is attached to a stone by a narrow base about 2 cm. in diameter. The height is 6.5 cm., and the greatest breadth on the upper surface 7.5 cm. The upper surface is triangular, each angle being slightly produced and provided with an oscule, there being also an oscule in the centre.

The spines, which are simply the ends of skeletal fibres, are about 1 cm. in height.

* Inadvertently the specific name has been badly chosen, the colour—in alcohol—being that of pale brown mud.

At the base of the spines is the thin dermal membrane, generally torn away, thus exposing the circular openings of inhalant channels.

The new species comes well within the genus *Ophlitaspongia* Bk., as amended by Dendy (5. p. 36). *O. seriata* Bk., *O. subhispida* Carter, and *O. membranacea* Thiele, all have toxa, but the first and third species are encrusting, and the second has long slender branches. The chief characters of the new species are the strongly spined surface, and the great development of the spicular core, the spongin not being so abundant as in other species, and not forming distinct fibres.

The single specimen was dredged off Coulman Island in 100 fms.

LISSOMYXILLA Hanitsch.

This genus was established by Hanitsch (8. p. 194), to include Ectyonine Sponges with fibres having a core of smooth styles echinated by acanthostyles and with special ectosomal megascleres; with or without microscleres. Unfortunately the species he selected as type of the genus (*Tethea spinosa*, Bowerbank) in no way fell in with the definition, since, as Topsent points out (28. p. 265), this species has neither echinating spicules nor special ectosomal spicules, and Topsent refers *Lissomyxilla* to the limbo of useless names. Among the 'Discovery' sponges, however, is a specimen which fits in with Hanitsch's definition of *Lissomyxilla*, which runs, "Skeleton fibres of the choanosome, formed of smooth monactinals echinated by spined styles. Megascleres of the ectosome smooth diactinals or monactinals. Microscleres (isochelae, &c.) may be present." Accordingly, I propose to revive the name.

LISSOMYXILLA HANITSCHI.

(Plate XXII., fig. 7, and Plate XXVI., fig. 4a-c¹.)

1907. *Lissomyxilla hanitschi* Kirkpatrick (10a. p. 275).

Description. There are two much-worn pieces of this sponge of a dark, dirty-gray colour, and a third young small specimen, whitish in colour, growing on a specimen of *Hornera*. The largest specimen is 4 cm. high and 5 cm. in diameter at the base; the dermal membrane is worn away, exposing several openings of exhalant canals, 4 mm. in diameter. The dermal membrane of the smallest specimen is transparent, smooth, and raised up at one place into a small conical oscule, with radial tangential spicules in its walls.

The **skeleton** of the choanosome is formed of branching fibres on an average about 150 μ thick, echinated by spined styles in an obscurely verticillate manner, the whole skeleton, as seen in sections, having a somewhat confused appearance. The ectosomal spicules partly proceed obliquely from the main fibres to the dermal membrane, and partly lie tangentially in that membrane.

Spicules. Megascleres. Smooth styles, 500 \times 19 μ , smooth, curved near the head, sharp-pointed.

Echinating acanthostyles, $219 \times 18.75 \mu$ (without including spines), larger spines situated on the head 9μ long.

Ectosomal amphityles, $356 \times .11 \mu$ straight, very slightly fusiform, subtylote, and with a small mucro at each end.

Microscleres, none.

Myxilla victoriana Dendy (*Halichondria pustulosa* Carter), (5. p. 30), would come under this genus, although, at the same time, it is in possession of isochelae, and the heads of the styli of the main fibres occasionally have a slight indication of spination.

Two fragments (No. 123) were dredged off Coulman Island in 100 fms. A third specimen (No. 38) on *Hornera* was obtained from east end of Barrier, 100 fms., bottom mud, stones, and rocks.

II. SUB-FAMILY MYCALINAE, THIELE.

I. GROUP MYXILLEAE, LUNDBECK.

MYXILLA DECEPTA.

(Plate XXII., figs. 1-2a, and Plate XXV., fig. 3a-f.)

1907. *Myxilla decepta* Kirkpatrick (10a. p. 278.)

Description. There are two very small specimens of this species. One is in the form of an extremely thin incrustation on a piece of rock; the surface is pilose owing to the projection of vertically dressed acanthostyles, each surrounded by tufts of ectosomal spicules. The other, which incrusts the branch of a Polyzoon, is thicker, and the surface here is partly smooth, partly provided with minute sharp-pointed conules supported by acanthostyles. The colour of both specimens is reddish brown.

The **skeleton** in the very thin incrustation, at first sight, resembles that of a *Hymenrhaphia*; each vertical acanthostyle is isolated, and with its head on the base and its pointed end projecting. In the thicker specimen it is possible to make out primary and secondary lines of skeletal fibres.

The ectosomal spicules are partly arranged in paniculate tufts, partly lying tangentially in the dermal membrane.

Spicules. Megascleres. Choanosomal acanthostyles, $468 \times 23.5 \mu$, curved, spined at the head only, with sub-tornote points. Ectosomal strongyles $238 \times 4.6 \mu$, straight, smooth, cylindrical, usually with a pointed mucro at one end.

Microscleres. Arcuate isochelae, 19.5μ long, 5.6μ broad, palmate tooth 8μ long ovoid, with rounded distal edge; with thick curved shaft; with tongue-shaped alae about 8μ long.

Isancoræ unguiferae, 15.3μ long, with slender, curved, sometimes wavy shaft, with three sharp claw-like teeth at each end.

Chelate bipocilla 8μ long, with deeply curved shaft with spatulate ends each with three triangular denticles; these spicules are fairly common and not accidental.

There are also several isochelæ arcuatæ in which the alæ and denticle are replaced at one end by a spoon-like lamella.

The presence in *Myxilla* of chelate bipocilla similar in many respects to those found in the new species *Iophon spatulatus* and *I. flabello-digitatus* is exceptional; somewhat similar structures occur, however, in *Myxilla iophonoides* Svartzevsky (Mem. Soc. Nat. Kieff, Tome XX., p. 340, Pl. XV., fig. 27g-l) from the White Sea, but there are no isochelæ arcuatæ. In other respects the spiculation of the new species is that of a typical *Myxilla*. The isochelæ arcuatæ, though only half the length, resemble in shape those of *Myxilla nobilis* R. and D., from off the Rio de la Plata, and *M. digitata* R. and D., from the Cape of Good Hope.

The specimen incrusting the rock was dredged from 254 fathoms, due west of Balleney Island; and the specimen incrusting the Polyzoon from Winter Quarters, No. 6 hole, 125 fathoms.

LISSODENDORYX SPONGIOSA.

1887. *Myxilla spongiosa* R. & D. (15, p. 134, Pl. XXVII., figs. 3-3f).

1901. *Lissodendoryx spongiosa*, Topsent (29, p. 18).

One small specimen and three minute fragments were obtained from three localities in the neighbourhood of Winter Quarters. The complete specimen is cylindrical, 2 cm. long, and 1.5 cm. in diameter, and is attached by part of its length to the branch of a Polyzoon. The specimen is well preserved. The colour is white, an opaque white axis showing through the transparent dermal layer.

The spicular elements are similar to those of the Challenger type, and sigmata occur in all, though in varying proportion. Topsent describes a variety of this species from the 'Belgica' collection, viz., *L. spongiosa*, var. *asigmata*, which is wholly without sigmata.

The specimens were dredged near Winter Quarters, (1) from near the ship, 20 fms.; (2) No. 12 hole, 25-30 fms.; (3) McMurdo Bay, 4-10 fms. The species has been found also off Rio de la Plata, 600 fms., Voy. 'Challenger.' The 'Belgica' collected the var. *asigmata* in Lat. 71° 14' S., Long. 89° 14' W. in 450 mètres.

IOPHON RADIATUS.

(Plate XXI., figs. 3, 4, 4a-c, and Plate XXV., fig. 4 a-c¹.)

1902. *Iophon radiatus*, Topsent (29, p. 21, Pl. III., fig. 13).

Specimens and fragments come from five different localities. They are mostly in the form of small cylinders about 4 mm. in diameter and varying in length up to 5 cm. The longest (XXI. 4) is 5 cm. long and 4 mm. broad, tapering to a point at one end. The colour is dark brown, a dark axial core of choanosome showing through the semi-transparent dermal membrane. One specimen, the largest (XXI., fig. 3), has broadened out into an oblong loose rather flabby mass, torn at each end, 4 cm. in length and 2.5 cm. in breadth, and with a branch given off on each side near one of the ends.

Several oscules about 9 mm. in diameter occur along the margin; they are slightly raised and with a thin plain rim with special spicular armature. The pores occupy irregular oval areas about 2 mm. in diameter. The spicules resemble those of specimen No. 421 described by Topsent, the dimensions being as follows:—The amphityles $266 \times 10 \mu$; acanthostyles spined at the head and near the point, $447 \times 16 \mu$; larger anisocheles 36μ long, a smaller kind 20μ long; bipocilla 9.75μ long, usually with one end pocillate and the other flattened and with three to five minute denticles.

An interesting feature is the presence of embryos .25 mm. in diameter with a solid cylindrical core of peculiar spined amphityles $105 \times 5 \mu$ reaching from surface to centre, and with anisocheles with a spine at the small end, 15.9μ long and arranged in rosettes, the latter being distributed around the summit of the spicular plug or cylinder.

Specimens were obtained from (1) Winter Quarters No. 12 hole, 25–30 fms.; (2) East end of Barrier, 100 fms.; (3) No. 5, Seal Hole, 178 fms.; (4) From near the ship, February 28, 1902; (5) Off Coulman Island, 100 fms.

The 'Belgica' collected specimens from Lat. $71^{\circ} 14' S.$, Long. $89^{\circ} 14' W.$, 450 mètres, and from Lat. $71^{\circ} 19' S.$, Long. $87^{\circ} 37' S.$, 450 mètres.

IOPHON SPATULATUS.

(Plate XXI, figs. 5, 5a–c, and Plate XXV., fig. 5a–d.)

1907. *Iophon spatulatus* Kirkpatrick (10a, p. 276).

Sponge slender, cylindrical, branched. Colour, pale brown in spirit. Oscules oval, about $1 \times .6$ mm. in diameter, slightly raised; surrounded by a radiating zone of tytes. Pores in sieve-like areas 2–3 mm. in length and about 2 mm. in breadth, on a level with the general surface.

Flagellated chambers $26 \times 23 \mu$.

Skeleton. Dermal; a closely packed layer of dermal amphityles.

Choanosomal, a loose network of 3–6 spicules thick, forming the core of the cylinder; multispicular fibres, giving off strands at right angles; the longitudinal fibres are joined obliquely or transversely by fibres one or two spicules thick, which support the dermal membrane.

Spicules. Megasccleres, smooth styles, $462 \times 25 \mu$, with a mucro at the basal end. Ectosomal sub-amphityles $225 \times 12.5 \mu$, fusiform with the swelled ends smooth laterally, and with the extremities only slightly convex, in fact almost truncate, and covered with spines.

Microsccleres. Palmate anisochele 18.7μ long, 6.2μ broad (front view).

Bipocilla, rare, 13.6μ long, 1.15μ thick, shaft deeply curved, slightly twisted, and with ends almost similar, spatulate, with crenulated edges; occasionally with five relatively large denticles in place of the finer crenulation. A second kind of bipocilla have a longer, less curved shaft with scoop-like rather than spatulate

ends, each scoop having four or five denticles. One example has three sharp prongs at one end and the spathulate prolongation at the other.

The species is represented by numerous small, for the most part fragmentary, slender cylindrical pieces. Many of the fragments came from the same locality as the specimens of *I. radiatus* and were mixed up with them. Generally it was easy to separate the two by the colour, that of *I. radiatus* usually being of a much darker brown; but in one or two instances the specimens of the new species were also dark coloured. Several of the fragments are branched. The specimen figured (XXI. 5) is 4 cm. long and 5 mm. in diameter. The oscules are provided with a ring of radiating amphityles, whereas *I. radiatus* is devoid of such structure. A glance at the spicules at once enables one to distinguish the two species. The ectosomal amphityles of *I. radiatus* have well-marked knobs spined all over, and not merely at the ends. The choanosomal spicules of *I. spatulatus* are apparently modified acanthostyles, smooth along the shaft, but with the spines at the rounded end gathered into one large spine situated on the summit, thus giving it a tornote aspect. In one instance, the single spine is represented by a little tuft of the spines. The axial canal terminates some distance below the base of the spine.

Several spherical embryos $268\ \mu$ in diameter were present in one fragment, but there were no special spicules in them.

Since writing the above description, accounts of two new species of *Iophon* from the Antarctic have been published by Topsent (31. pp. 4-6), viz. *I. unicornis* and *I. pluricornis*. The two new species described in the present Report and Topsent's two species all possess the curious modified acanthostyles. *I. unicornis* Topsent, has no bipocilla, and *I. pluricornis* has bipocilla apparently with pocillate ends; the 'Discovery' species have spathulate bipocilla with crenulated ends; and further, there are differences, viz., in the shape of the body, the arrangement of the skeleton, and the character of the ectosomal spicules, which lead me to regard the 'Discovery' specimens as belonging to distinct species. A differential diagnosis of the four Antarctic species with modified acanthostyles is given at the end of the description of the next species.

Fragments were dredged at No. 11 hole, 28 fms.; at No. 12 hole, 25-30 fms., and off Coulman Island, 100 fms.

IOPHON FLABELLO-DIGITATUS.

(Plate XXI., figs. 6, 6A-C, Plate XXV., fig. 6a-f, and Plate XXVI., fig. 1a-c¹.)

1907. *Iophon flabello-digitalus* Kirkpatrick (10a. p. 277).

Sponge forming a large palmato-digitate or digitate growth in one plane; branches compressed, usually with oscules along one edge. Surface finely verruculate; with elongated pore areas supported by fan-like wisps of ectosomal spicules.

Colour dark brown; consistence soft, the sponge being readily broken.

Skeleton typically formed of a network of spiculo-fibre, the primary lines of which proceed upwards and outwards from the inner surface of oscular tubes to the outer surface of the sponge, where their ends form the verrucae; the secondary fibres join the primary at right angles forming rectangular meshes about 1.25 mm. square. The thickness of the primary fibres is about .7 mm., that of the secondary about .5 mm.

The ectosomal skeleton consists of fan-like bundles and wisps of spicules, isolated or proceeding upwards and spreading out from the terminal main fibres.

Spicules. Megascleres. Smooth styles, $590 \times 25 \mu$, curved, with a mucro at the head end.

Ectosomal spicules, $344 \times 12.5 \mu$, sub-amphitylote, fusiform, with a marginal ring of vertical spines at both ends and a terminal central spike at one extremity.

Microscleres. Palmate anisochelae of two sizes, a large kind 35μ long and 10.7μ broad, with thick shaft; with triangular palmate tooth, 17.5μ long, at the large end, not quite as long nor as broad as the alae; lower margin of alae convex. Lower central tooth with a curved upper edge produced into a spine.

A small kind 17.5μ long, 6.2μ broad; upper palmate tooth triangular, rounded above, as broad and as long as the alae; lower border of alae concave; lower tooth with simple rounded upper edge.

Bipocilla varying in length from 5.5 to 11μ , according to the convexity of the shaft which is usually deeply curved; both ends spatulate, nearly similar, and with crenulate edges, or with 5-7 teeth.

The fine specimen (No. 184) which constitutes the type of the new species, is 24 cm. wide and 25.6 cm. high. Unfortunately, owing to the very soft nature of the tissues, the sponge has been broken into many fragments. A short stem expands into a palmate portion, from the edge of which arise several compressed digitate branches, usually with round sphinctrate oscules along one edge; the oscules lead into a pseudogastral cavity extending nearly to the opposite edge of the branch. The bipocilla of the new species somewhat resemble those of *I. spatulatus*, but the difference in the body form, skeletal arrangement and spiculation are too many to necessitate detailed enumeration.

A second specimen (No. 202) has two compressed branches rising from a flattened contracted base, the under surface of which is coated with pebbles. The oscules face each other along the edges of the entering angle. The branches are each about 10 cm. in length, the greatest breadth being 4.5 cm.

A third specimen (No. 287) of this species, which might, indeed, be regarded as a variety, forms a discoid crust on a small Ophiurid. There are embryos, 340μ in diameter, present, and some, but not all, of these have a plug of peculiar tylote spicules in them, with a ring of anisochelae round the outer end of the bundle. The tylote spicules of the embryo, $161 \times 7.8 \mu$, have a smooth rounded end surrounded by spines, the other end being cylindrical with marginal spines, and a single central spine.

The anisocheles of the embryos nearly resemble the smaller kind of these spicules found in the choanosome of the type specimen.

The type specimen (No. 184) was dredged near Winter Quarters, No. 11 hole, 28 fms.; specimens 202, 287, and 289 were dredged from No. 10 hole, 130 fms.

DIFFERENTIAL DIAGNOSIS OF THE FOUR SPECIES OF IOPHON WITH MODIFIED ACANTHOSTYLES.

	Shape.	Ectosomal Spicules.	Bipocilla.
<i>Iophon unicornis</i> . . .	Massive, of irregular configuration; fistular oscules rising from upper surface.	240 × 10 μ. Heads with a bouquet of spines at extremities.	Absent.
<i>Iophon pluricornis</i> . . .	Plate-like; oscules apparently level with surface.	280 × 10 μ. Heads elliptical, with spines at extremities, or over the whole surface of head.	Apparently with pocillate end or ends.
<i>Iophon spatulatus</i> . . .	Slender cylindrical: with oscules slightly raised.	225 × 12.5 μ. Ends truncate, with spines at extremities only.	Having spatulate ends with crenulated edges.
<i>Iophon flabello-digitatus</i>	Palmato - digitate, with oscules along the edges of branches.	344 × 12.5 μ. Ends truncate, with terminal marginal rim of spines at both ends and terminal central spike at one end.	Having spatulate ends with crenulated edges.

TEDANIA VARIOLOSA.

(Plate XXI., figs. 1, 1a, and Plate XXV., fig. 1a-b.)

1907. *Tedania variolosa* Kirkpatrick (10a. p. 279).

Sponge in form of a mass of thick flabellate or digitate fronds arising from a common base; with circular sphinctrate oscules, each about 1 cm. in diameter, situated at the summits, or along the upper edges of the branches, the canals into which they lead extending nearly to the base of the branches. General surface of the sponge covered with circular pore areas each about 4 mm. in diameter, the oval or circular pores being about 90 μ in diameter, and the strands of the poral reticulum about 30 μ in breadth. Colour in spirit, pale brown. Consistence, soft and fleshy, being easily torn.

Flagellated chambers, 42 × 35 μ, oval, aphodal, with aphodus (in a measured example), 13 μ long.

Skeleton. Choanosomal skeleton formed of loosely agglomerated compound, longitudinal or main bundles about 1 mm. in diameter, curving out to the surface as

they pass upwards; the separate fibres of the main bundles about 80μ thick. The main bundles joined at right-angles by secondary fibres, 1-3 spicules thick. Spongin not perceptible. Ectosomal skeleton formed of circles of strongyles, the spicules isolated or in fan-like wisps, arranged partly vertically, partly tangentially round the pore areas; the vertical spicules usually isolated, and the tangential ones in wisps. On drying the sponge, the edges of the pore areas stand up sharply, the areas themselves sinking in, giving a pock-marked aspect to the surface.

Spicules. Megascleres. Choanosomal styles, $402 \times 13\mu$, curved at about one-fourth of the length from the round end, smooth, but occasionally with a few spines about the head.

Ectosomal strongyles, $261 \times 6.5\mu$, smooth, occasionally slightly swollen at each end.

Microscleres. None.

The single specimen is in the form of a squarish mass of thick fleshy flabellate or digitate lobes; the height is 18 cm., and the breadth 13 cm. The flabellate fronds are obviously formed of fused tubular digitations, as can be seen from the oscules along the upper edge and from the faintly indicated longitudinal grooves down the sides. The walls of the oscular canals are smooth and lined with numerous orifices of exhalant canals, about 3 mm. in diameter. The arrangement of the pores in circular areas each surrounded by a zone of ectosomal spicules is not common in *Tedania*; it occurs in the second new species described below, and something of the kind is found in *Tedania tenuicapitata* Ridley (15a. p. 124), from the Straits of Magellan. In the present species this feature is so well marked as to give the surface a pock-marked appearance.

The rhabdides, usually so characteristic of *Tedania*, have entirely disappeared; but the loss of microscleres is of such frequent occurrence that it has not seemed necessary to create a new genus or subgenus to include such forms; though, perhaps, the more or less definite arrangement of the ectosomal spicules might, in the present instance, necessitate such a course.

The specimen was dredged near Winter Quarters, 10 fms.

TEDANIA COULMANI.

(Plate XXI., fig. 2. Plate XXV., fig. 2a-b¹.)

1907. *Tedania coulmani* Kirkpatrick (10a. p. 280).

Description. The single specimen is in the form of a finger-like fragment 5.5 cm. long and 1.7 cm. in its greatest thickness. The colour is dirty gray, and the consistence soft. The surface shows the same circular pore-sieve areas as in *T. variolosa*. Along one side of the sponge the surface has been torn away, exposing an exhalant canal running along the length of the specimen, but the terminal oscule has apparently been torn away.

Skeleton. Rings of spicules partly vertical, partly tangential, isolated or in tufts, surround the pore areas.

The choanosomal skeleton is formed of primary longitudinal fibres about $120\ \mu$ thick, joined by secondary fibres one spicule in length and 2-3 in thickness, joining the former at right angles.

Spicules. Megascleres. The choanosomal acanthostyles, $475 \times 18\ \mu$, curved, smooth, or with sparse spines, usually on the upper and lower thirds of the length.

Dermal ectosomal tornotes, $319 \times 12.5\ \mu$, smooth, straight, fusiform, larger at one end than the other. Under a high power each end shows a rounded shoulder prolonged into a mucronate spine. Microscleres absent.

The present species resembles *T. variolosa* in having the circular pore areas, and in the absence of raphides, but differs widely in the character of the dermal tornotes. Both species differ from all other species of *Tedania* in having no microscleres. The nearest species to the present one are *Tedania tenuicapitata* Ridley, from the Straits of Magellan, and *Trachytedania spinata* Ridley, from the same locality; both of these have raphides, and neither have the circular pore areas, though in *T. tenuicapitata* there is a tendency to a radial arrangement of bundles of dermal spicules. The spination of the acanthostyles recalls a similar character in *Trachytedania spinata*.

The specimen was dredged off Coulman Island in 100 fms.

II. GROUP MYCALEAE, LUNDBECK.

ARTEMISINA APOLLINIS.

(Plate XX., figs. 4, 4a-c.)

1887. *Amphilectus apollinis* Ridley and Dendy (15. p. 124).

1891. *Artemisina apollinis* Topsent (24. p. 13).

1905. *Artemisina apollinis* Lundbeck (13. p. 114).

1907. *Artemisina apollinis* Topsent (31. p. 70).

The single example is a massive cake-shaped specimen 8×8 cm. in area, and 4.5 cm. in its greatest thickness. The colour is dirty white in alcohol. One of the surfaces is smooth and opaque, and probably the sponge lay free on the bottom on this side. There is a large oval oscule ($1.5 \times .5$ cm.) on one of the edges, and several much smaller oscules on the upper surface. The sizes, in μ , of the spicules are:—curved styles 600×16 ; straight styles 400×6 ; chelae 13; toxa 300 (or less) $\times 3$. The flagellated chambers, $29 \times 23\ \mu$ in diameter, are eurypylous. An interesting feature, not occurring in the type specimen from Kerguelen Island, is the presence of small fusiform villous processes (XX. 4a) on the surface, especially round the margins of the oscules; similar villi, but larger, are found in the nearly related sponge named *Esperiopsis edwardii*, var. *americana* R. and D. The finding of this sponge in the Antarctic adds another to the list of bipolar species.

Topsent (**31**, p. 70) records a new species, *Artemisina dianae*, from Booth-Wandel Island, Antarctic, apparently very closely related to *A. apollinis*. The 'Discovery' specimen resembles *A. dianae* in having curved styles of the same length, but they are narrower; and the spined toxa are much smaller in the first species.

The specimen was dredged near Winter Quarters, off Hut Point, 25-30 fms.

The 'Challenger' obtained specimens from Kerguelen Island, 20-60 fms.; and the Danish Ingolf Exp. from East Greenland, depth?, Lundbeck.

ESPERIOPSIS VILLOSA.

(Plate XX., figs. 3, 3a-c, and Plate XXIV., figs. 9a-b².)

1874. *Esperiopsis villosa* Carter (**1**, p. 213).

1887. *Esperiopsis villosa* Fristedt (**7**, p. 451).

1904. *Esperiopsis villosa* Topsent (**30**, p. 211).

1905. *Esperiopsis villosa* Lundbeck (**13**, p. 9).

The single specimen, which has been broken off from its attachment, is massive below, but divides above into two cylindrical lobes. The colour is pale brown in spirit.

A few small oscules, evidently much contracted, occur at the summits of the lobes. The surface is finely villous, from the presence of the projecting points of fan-like lines of oxeas.

Here and there the flesh has become macerated away, leaving fluffy lines of fine skeleton fibres.

The only difference worthy of mention that I can find between the Northern and Antarctic specimens is the absence of the placocheles or isochelae palmatae with broad shafts. I can only discover two kinds of isochelae palmatae. The sigmata occur in many sizes. Some have bifurcated terminations, as figured by Fristedt, and Lundbeck.

Spicules. Megascleres. Styles $671 \times 18 \mu$, fusiform, straight, occasionally with head slightly bent.

The styles in Carter's type from Faroë are almost identical in character.

Microscleres. Larger palmate isochelae, 43μ long, 9.75μ broad, length of teeth, 16μ .

Smaller palmate isochelae, 18μ long, 4μ broad. Sigmata, numerous, varying from small up to very large sizes.

The distribution of this species is very interesting, occurring as it does in Arctic and sub-Arctic waters; then, as an intermediate link between Arctic and Antarctic, in deep water off the Azores.

The specimen was dredged near Winter Quarters, in McMurdo Bay, 20 fms.

This species has been found (1) Between Scotland and Faroë, 440 fms., Carter; E. Coast of Greenland, 254 m. (140 fms.), Fristedt; off Iceland, Denmark Strait and Davis Strait, 44-553 fms., Lundbeck; Azores 2,252 m. (1,196 fms.), Topsent.

MYCALE^{*} MAGELLANICA.

(Plate XX., fig. 2.)

1881. *Esperia magellanica* Ridley (15a. p. 117).1887. *Esperella magellanica* Ridley and Dendy (15. p. 67).1905. *Mycale magellanica* Thiele (23. p. 442).

The 'Discovery' collection contains one large piece, much damaged. The figure (XX. 2) shows the smooth surface in contrast to the hispid surface of the new species *M. acerata* described below.

The specimen was dredged near Winter Quarters, from No. 10 hole, 130 fms.

The species is also recorded from Sandy Point, 7-10 fms.; from Otter Island, Patagonia; and from east of Cape Virgins.

MYCALE ACERATA.

(Plate XX., figs. 1, 1a-b, and Plate XXIV., figs. 10a-e¹.)1907. *Myxilla acerata* Kirkpatrick (10a. p. 280).

Sponge large, massive, with numerous small rounded mammillae; surface finely reticulate and finely hispid. Colour, creamy-white in spirit. Consistence, soft, the tissues being easily torn. The flesh reddish (but soon decolorised), and showing the glistening white strands of the skeleton.

Oscules in form of wide thin-walled cylindrical chimneys with rather jagged upper edges, about 1 cm. in height, and 1-2 cm. in diameter.

Skeleton. Ectosomal:—A network of triangular meshes formed by bundles of oxeas, the strands being from .35 mm. thick and the meshes about .5 mm. across. Main skeleton formed of long thick anastomosing fibres which attenuate gradually from 1.5 mm. in thickness and break up a little below the surface into panicles of much finer fibres which support the dermal membrane and penetrate the strands and nodes of the dermal reticulum, giving rise to a finely hispid condition of the surface. Parallel groups of oxeas scattered in the choanosome.

Spicules. Megascleres. Oxeas $850 \times 16.25 \mu$, slightly curved, rather abruptly pointed at one end, and more tapering at the other. These oxeas form the fibres, and also are gathered into bundles, one spicule in length, of parallel oxeas, scattered in the choanosome.

Microscleres. Large anisochelae palmatae, $105 \times 50 \mu$, separate or in rosettes, usually with an angular bend in the shaft; with a triangular upper tooth 60μ long, about the same length as the upper alae, which latter are very wide. With the lower tooth oblong, 12.8μ high, with a slightly convex edge; in one of the specimens this edge is produced into a long denticle (XXIV. 10 c).

A smaller kind of anisochelae palmatae (fig. 10d, d¹), 47μ long and 17μ broad, at the upper end, with a long oval tooth 20μ long, extending below the alae.

Trichodragmata, $62 \times 12 \mu$, the trichites being very fine, sharply-pointed oxeas.

There are three fine specimens of this species, the largest forming a thick

massive flabellate body 17 cm. high, 11 cm. broad, and 7 cm. thick; a second specimen is massive and spheroidal, being about 15 cm. in diameter. The white mammillated surface covers a reddish flesh in which the glistening fibres of the skeleton are visible. The mammillae are on an average about .75 cm. in height, and 1 cm. in diameter at the base. The new species bears a very close resemblance to *Mycale magellanica* Ridley, which likewise has a mammillated, finely reticulate surface and glistening skeletal fibres, but in the latter the surface is smooth and not hispid (XX. 2), and the megascleres are styles, or sub-styles, such as are normally found in the genus *Mycale*. The microscleres also are different in the two species.

A second species of *Mycale* with oxoate megascleres is *Mycale intermedia* (O. Sch.), from East Greenland (16. p. 433) and Thiele (22. p. 381, fig. 12). The specimen consisted only of a fragment; the spicules, which are all considerably smaller than in the Antarctic species, have the following dimensions:—Oxeas, 450 μ long, 10–12 μ thick; large anisocheles, 50–60 μ long; small anisocheles, 18 μ long.

Specimens were dredged from three separate localities near Winter Quarters, viz.: (1) No. 6 hole, 125 fms.; (2) No. 12 hole, 25–30 fms.; No. 5 hole, seal hole, 178 fms.

MYCALE, sp.

Several pieces of glistening white skeletal framework were dredged from No. 12 hole. The largest is cylindrical, 7 cm. long and about 3 cm. in diameter. A very small quantity of the body substance still remains in some of the angles of the meshwork.

The spicules are:—Styles, fusiform, straight, abruptly pointed, 562 \times 17.5 μ ; large palmate anisochelae, separate or in rosettes, 100 μ long and 35 μ broad, with the larger tooth 47 μ long, nearly the same length as the alae, triangular, with straight lower border; with the central tooth at the smaller end squarish, with straight upper edge; small anisochelae, 14 \times 48 μ , with oval tooth 28 μ long, extending further than the alae; sigmata 224 μ long, 104 μ broad, and 6.5 μ thick.

This species resembles in many respects a form described by Thiele (23. p. 443, fig. 61, a–d) as *Mycale* sp., from Punta Arenas, Straits of Magellan; but the sigmata are much smaller in the South American form, being only 15 μ , and the small anisochelae are smaller and with a narrower and shorter upper central tooth. No specific name is given, owing to the incompleteness of the specimens.

Dredged near Winter Quarters, No. 12 hole, 25–30 fms.

DESMACIDON KERGUELENENSIS var. antarctica.

(Plate XIX., figs. 1, 1A, and Plate XXIII., figs. 1a–d!.)

Desmacidon kerguelensis Ridley and Dendy (15. p. 110).

Sponge ovoid or cylindrical, with hispid or finely conulated surface, the conules surmounted by fine tufts of spicules, conules and tufts rising to a height of 1 to 2 mm. Consistence, soft; colour in spirit, dirty white.

A single round oscule at the summit. Pores round or oval, scattered, $20\ \mu$ in diameter. Dermal layer not detachable; sub-dermal spaces $190\ \mu$ in depth. Flagellated chambers about $30\ \mu$ in diameter.

Skeleton composed of rather thick main fibres about 10 spicules broad viewed *en face*, about $190\ \mu$ or more in thickness, with a few loose spicules between the main fibres, scattered, but with a tendency to be parallel to the surface, and forming distinct horizontal bundles just below the surface. Spongin is present, but not easy to detect.

Spicules. Megascleres. Oxeas $676 \times 26\ \mu$, slightly curved at centre, terminating gradually in fine points.

Microscleres. Isocheles $19.5\ \mu$ long, $6.5\ \mu$ broad in lateral view, with slender convex shaft without perceptible alae; with broad saddle-shaped teeth with their distal edges not far from each other, but not touching or overlapping.

Four small specimens of this sponge were obtained. The largest is 4 cm. long and 1.4 cm. in diameter. The surface has a finely hispid aspect in two specimens, but is finely conulated in the third, and smooth and worn down in the fourth. The variety differs from the type (15. p. 110) in having much larger megascleres, those of the type being only $350 \times 18\ \mu$. The isocheles of the type, again, are longer, viz., $28\ \mu$. After a careful examination of the isocheles of the Kerguelen specimen in a good light and with the spicules slowly rotating in balsam, I found that the median sub-dental continuation of the shaft did not bend backwards from the tooth as in *Desmacidon* (*Homocodictya*) *palmata*; the appearance of bending back (see 15. Pl. xxiii., fig. 3*b*) being due to the lateral bend of the palmate tooth; accordingly, even if *Homocodictya* be a true genus or sub-genus, *D. kerguelenensis* would not belong to it.

Three specimens were dredged near Winter Quarters, from No. 12 Hole, 25-30 fms.; off Hut Point, 100 fms.; and off Coulman Island, 100 fms.

DESMACIDON KERGUELENENSIS *nov. cactoides*.

(Plate XIX., fig. 2, and Plate XXIII., fig. 2a-b¹.)

Sponge pyriform, laterally compressed; surface prickly, with an Acanthella-like aspect. Consistence rather firm. Colour in spirit, pale yellow.

Skeleton formed of rather stout main fibres proceeding to the surface, where they conspicuously push up the dermal membrane, with scattered spicules in between the main fibres.

Spicules. Megascleres. Slightly curved strongyles, but sometimes with rather blunt pointed ends (*i.e.* oxeas), $768 \times 31.25\ \mu$.

Microscleres. Isochelae palmatae $17\ \mu$ long and $6.25\ \mu$ broad with the wide saddle-shaped palmate teeth almost in contact or even overlapping.

The single specimen is attached to a worm tube by a contracted stalk-like base; the length is 5.5 cm., and the greatest breadth 3.5 cm. It was a matter of doubt whether to regard this form as a distinct species; but it will be obvious from the

figures of the spicules that the differences between the var. *antarctica* and var. *cactoides* are merely those of degree; the teeth of the isochelae, for instance, are more approximated in the latter than in the former; further, the rounding of the ends of the oxeas is not an important distinction; and lastly, the cactus-like surface would result from a branching of the ends of the skeletal fibres just below the surface, so that the dermal layer would stretch over the points of bifurcation.

If the new variety were devoid of cheles it would be placed under *Butzella*, thus justifying Thiele's observation (23. p. 438) that the latter genus might be regarded as a *Desmacidon* which had lost its chelae.

One specimen was dredged from Winter Quarters, No. 12 hole, 25-30 fms.

DESMACIDON SPINIGERA.

(Plate XIX., figs. 3, 3A, and Plate XXIII., figs. 3a-c¹.)

1907. *Desmacidon spinigera* Kirkpatrick (10a. p. 283).

Sponge digitiform, or knob-like; surface coarsely spinous. Consistence rather hard. Colour pale red. Several small oscules about 2 mm. in diameter.

Dermal membrane spread like a delicate net between the spines, and at some distance from the floors of the sub-dermal spaces. Flagellated chambers oval, $46 \times 32 \mu$.

Skeleton formed of coarse, longitudinal, main strands, about 180μ thick, radiating out to the surface, with loose scattered spicules between, united in horizontal bundles only beneath the surface.

Spicules. Megascleres. Oxeas $731 \times 26 \mu$, curved at centre, mostly sub-tornote, though some attenuate gradually, with sharp pointed ends.

Microscleres, of one kind, viz., isochelae palmatae, $24 \cdot 64 \mu$ long, and $5 \cdot 28 \mu$ broad on side view; pointed at each end; with straight axis; with palmate teeth $8 \cdot 8 \mu$ long, and with narrow alae $8 \cdot 8 \mu$ long.

Four specimens were obtained. The type specimen (XIX. 3) from 10 hole, 130 fms., is digitate, 7.5 cm. in length and 2 cm. in diameter. The spines are .2-.5 cm. long, those at the lower end pointing obliquely upwards, but above becoming vertical to the long axis. Another specimen forms a spheroidal knob encrusting the stem of a zoophyte.

A third specimen is in the form of cylindrical fragments.

A fourth specimen, much macerated, is massive and bifurcated, and about 12.5 cm. long; further there is a considerable amount of spongin present, sometimes appearing as distinct fibres, where the spicules have become lost or dissolved away. The spicules are in all respects identical with those of the foregoing forms.

This species bears much resemblance to *Desmacidon setifer*, Topsent, obtained by the 'Belgica' from the Antarctic. The isochelae are of much the same character, but those of *D. setifer* are very much larger, viz., $75-100 \mu$ by $18-20 \mu$. Further,

the consistence of *D. setifer* is soft, the colour yellowish in spirit, and the surface hispidation much finer.

The four specimens were dredged: (1) No. 48, from 10 hole, 130 fms.; (2) No. 124, near Winter Quarters, 20 fms.; (3) No. 124b, off Coulman Island, 100 fms.; (4) No. 126a, from 12 hole, 25–30 fms.

DESMACIDON MAEANDRINA.

(Plate XIX., figs. 4, 4a, and Plate XXIII., figs. 4a–b³.)

1907. *Desmacidon maeandrina* Kirkpatrick (10a. p. 282).

Description.—The material consists of three sub-cylindrical fragments tapering at the distal end.

The consistence is hard and dense. The colour in spirit is dirty brownish-gray.

The surface is fairly uniformly level, and presents flattened papillae or meandrine ridges, slightly roughened at the top by projecting oxeas (best seen on side view with a lens).

The dermal membrane roofs over the grooves and spaces between the papillae and ridges. The pores are mostly circular and about $95\ \mu$ in diameter.

The small circular oscules, numerous and scattered, are about 1 mm. in diameter. The skeleton is formed of a thick, main axis, consisting of rather loose, longitudinal strands; from this are given off at right angles cylindrical or lamellar bundles of loose strands, which proceed to the surface and form the papillae and ridges.

Spicules. Megascleres. Oxeas, $579 \times 39\ \mu$, curved (usually) or bent at the centre, with sharp, pointed ends. Microscleres. Isanocorae unguiferae, $26\ \mu$ long, and $15.8\ \mu$ broad, shaft strongly curved and $3.52\ \mu$ thick. With usually five teeth or claws, about $5.28\ \mu$ long, at each end, viz., a central, single, and two lateral bifurcated teeth.

The largest of the three pieces of this sponge is 6.2 cm. long and 16 mm. in diameter. The fragments appear to be broken off from some branched specimen, and I shall refer to them as branches. They are sub-cylindrical, being slightly compressed in one plane. The chamber system is aphodal, the flagellated chambers ($44 \times 29\ \mu$) being pyriform. There is a considerable amount of variation in the teeth of the isanocorae, the number varying from three to six, the most usual number being five.

In some respects the new species resembles *Desmacidon* (?) *ramosa* (R. and D.) (15. p. 107), obtained by the 'Challenger' from the Cape of Good Hope and Marion Island. In both species there is a central axis of longitudinal fibres, whence fibres proceed to the surface at right angles, but here the resemblance ends. In the 'Challenger' species the radiate bundles branch in a fan-like manner, finally forming an almost uniform surface layer of vertical oxeas. The microscleres in *D.* (?) *ramosa* are isochelae arcuatae. As in the case of *D.* (?) *ramosa*, it is doubtful whether the new species, with its *Raspailia*-like skeleton of axial and radial fibres, should be placed under *Desmacidon* or under a new genus.

The specimens were dredged off Coulman Island, 100 fms.

JOYEUXIA BELLI.*

(Plate XVI., Figs. 1-5a.)

1907. *Joyeuxia belli* Kirkpatrick (10a. p. 283).

Sponge attached, ovoid, with a thick firm rind enclosing a soft pulp. With short conical oscular, and long trumpet-shaped poral papillae. Surface finely pilose. Colour of surface yellow, of the rind whitish, and of the pith deep yellow.

Flagellated chambers $23 \times 20 \mu$; diplodal.

Skeleton. Cortical skeleton formed of layers of strongyles crossing each other at right angles. The walls of the oscular and poral papillae supported by a layer of longitudinal strongyles. The surface of the sponge hirsute with a fine pile of strongyles standing out at right angles or obliquely. Choanosome without spicules.

Spicules. Slightly flexuous smooth strongyles 850μ long, 10μ in diameter at the ends, and 13μ in diameter at the centre.

There is one adult specimen 5 cm. long, 3.5 cm. broad and 3 cm. thick, with a deep groove on the under aspect, by which it was probably attached to a worm tube or stem of a Hydroid. There is also a small conical specimen 6 mm. high, attached to a piece of rock.

I was at first disposed to regard this remarkable species as a member of a new genus, partly on account of its very thick rind, which is in places over a millimetre in thickness, and partly because of the highly specialised poral papillae; but apart from these characters, the new form evidently shows the closest affinities to *Joyeuxia*. The three hitherto described species all have a rind enclosing a soft pulp, the latter being without or almost without a skeleton; then too the pulp is highly coloured. *Joyeuxia tubulosa* Topsent and *J. ascidioides* (Fristedt) have fistulae, which, however, appear to be oscular. Two of the species, *J. viridis* and *J. tubulosa* have strongyles; *J. ascidioides* has tyles and also cheles. Accordingly Topsent places the genus near *Desmacidon*.

The poral papillae attain a height of 1 to 1.2 cm.; they are expanded at the end, the margin being sharp, usually a little jagged, and showing the ends of strongyles. The mouth is closed by a sieve-like funnel-shaped membranous pore-area, which is supported on its under surface by strands of tissue passing from the wall of the tube to the poral membrane.

The tube passes through the thick cortex into the choanosome, where it expands before branching into four or five inhalant canals.

Between certain parts of the inner surface of the cortex and the choanosome is what appears to be a space (see XVI. 2); but in other parts the choanosome abuts on to the cortex; probably these peripheral spaces do not result from contraction of the tissues, but form part of the exhalant canal system.

* Named in honour of Emeritus Professor F. J. Bell, of the Zoological Department of the Natural History Museum, and editor of the "Reports on the Natural History Collections" brought home by the 'Discovery' from the Antarctic.

The inconspicuous oscular papillae are only about 4 mm. high, and are tightly contracted.

The tissue of the cortex is crowded with branched collencytes immersed in a gelatinous matrix.

I am indebted to Professor Dendy for pointing out to me certain resemblances between the poral and oscular papillae of *Latrunculia* and the present species; in the case of both genera, too, the tissues are rich in pigment. Possibly we may have here a clue to the true position of *Latrunculia*, the discasters of which appear to be spined oxeas, or styles, the spines of which have become verticillate.

The specimens were dredged near Winter Quarters, Flagon Point, 10–20 fms.

Joyeuxia viridis Topsent was obtained from the Azores, 454–845 mètres; *J. tubulosa* Topsent, also from the Azores, from 200 mètres; and *J. ascidioides* (Fristedt) from Baffin Bay, 169 fms. (7. p. 445).

CERCIDOCHELA Kirkpatrick.*

1907. *Cercidochela* Kirkpatrick (10a. p. 284).

Mycalinae with peculiar shuttle-shaped chelæ or canochoelæ,† with the single central teeth from each end of the shaft joined together, and with a semi-circular vertical lamella extending inwards from the shaft and from the dental bridge, so as nearly to meet.

CERCIDOCHELA LANKESTERI.‡

(Plate XIX., figs. 5, 5A, and Plate XXIII., fig. 5a–l.)

1907. *Cercidochela lankesteri* Kirkpatrick (10a. p. 284).

Sponge elongated, slender, fusiform. Colour white; consistence soft. Surface smooth to the naked eye, but finely hispid under a lens. With several small scattered oscules about 1 mm. in diameter, level with the surface. Flagellated chambers aphodal, oval, $31 \times 21 \mu$.

Skeleton formed of long longitudinal lines of spicule fibres about 100μ thick, not forming a definite central axis, radiating out in plumose manner to the surface; with a few isolated spicules arranged in a scalariform manner at right angles to main fibres. Spongin not perceptible.

Spicules. Megascleres. Oxeas $452 \times 19.5 \mu$, curved at centre, attenuating gradually to sharp points slightly planed away on inner aspect. Microscleres. Canochoelæ, somewhat shuttle-shaped,§ 45.5μ long by 22.75μ broad, with the two teeth fused to form a bridge, and with a semi-circular lamella passing upwards from

* *κερκίς, ἴδος*, a shuttle.

† *κανών, ὄνος* a shuttle.

‡ Named in honour of Professor Sir E. Ray Lankester, K.C.B., F.R.S.

§ The canochoelæ are, in this species, shaped like an oval basin with a truncated bottom, but they look shuttle-like as commonly seen in balsam slides, viz., lying on one side with the lamellæ uppermost (see XIX. 5f).

the shaft and downwards from the dental bridge, both lamellae being nearly on the same plane and nearly meeting, the lamellae sometimes with basal tubercles. Developmental forms in shape of thin oval linear bodies, the oval at first not being complete.

The unique specimen representing the new genus and species is 12·5 cm. long and 1 cm. in breadth at the centre. The body attenuates to fine ends, and apparently has not been attached to anything.

The remarkable canochoelae recall to mind the spherancorae of *Melonanchora*, but the latter spicules have three pairs of fused teeth.

The canochoelae are scattered about in the choanosome in considerable numbers. The shape may be compared with an oval basin with the bottom cut out, and with two semi-circular lids or lamellae passing horizontally from the upper edge of the basin, so as to nearly meet; further it is necessary to imagine such a basin turned up on its side.

The earliest developmental forms have an elongated **C** shape; then the open **C** becomes a closed oval; by this time the falk at each end is perceptible, and the beginnings of the lamellae appear. A further change leads to a marked asymmetry, the thin oval ring becoming a broad band by widening in a direction away from the edges whence the lamellae arise. If the widening of the band were to continue the growing edges would meet and a sort of lateral dome would result, but growth does not go so far as this.

It is often difficult to make out the real form of a transparent body, with its lines, curves, lamellae, &c., crossing each other in various directions and altering their appearance with the slightest shifting of position. In the present instance the figures will show the remarkable variations in form corresponding to change in position, and it was only after a very prolonged examination that the real shape became apparent, a result finally due to Mr. Highley's ingenuity in devising a medium of suitable consistency in which the spicules could be made to slowly rotate on their long and short axes. Fig. 5 f is the position in which, in spicule preparations, the spicules commonly lie, viz., on the detruncated bottom of the basin and with the lamellar edges uppermost. Fig. 5 h, which resembles the Diatom *Amphora*, shows the aspect when the shaft portion or the dental portion of the band is uppermost and viewed in its breadth; the axial canal which traverses the shaft and part of the dental bridge is best seen in this aspect. When a spicule in this position continues to rotate a little more we see either the lamellae along one side or the free growing edges of the band on the other. Fig. 5 g shows the growing edge of the dental bridge nearly meeting the edge of the shaft. Fig. 5 k shows half of a spicule broken across, with the axial canal (which forms nearly a complete circuit) exposed at each lower corner of the figure. Lastly an end view is seen in fig. 5 l.

The specimen was dredged near Winter Quarters at No. 10 hole, 130 fms.

HOPLAKITHARA Kirkpatrick.*

1907. *Hoplakithara* Kirkpatrick (10a. p. 285).

Mycalinae possessing exotyles with large spherical spined heads, and with fimbriated placocheles.

HOPLAKITHARA DENDYL.

(Plate XIX., figs. 6, 6a, 6b, and Plate XXIII., fig. 6a-c².)

1907. *Hoplakithara dendyi* Kirkpatrick (10a. p. 286).

Sponge in form of a small cushion, attached by a narrow base. Surface smooth to the naked eye. Colour, pale brown in spirit. Consistence, hard externally, soft within. Flagellated chambers 32.5μ in diameter, spheroidal, eurypylous.

Skeleton with protective armour formed by gigantic spheroidal heads of exotyles, the exotyles being arranged as radiating bundles in form of inverted cones, with the apices a little below the cortex; with scattered strongyles.

Spicules. Megascleres. Exotyles † with the heads a little inclined to the long axis of the spicule, the proximal end (in the interior of the sponge) rounded, the distal end swollen into large spherical heads, with short cylindrical spines covering the distal three-fourths of the head. Total length 358μ , the shaft enlarging in diameter from 6.5μ at the proximal end to 16μ just below the head. Head, 55μ in diameter; cylindrical denticles, 1.76 to 3.52μ in height, with finely denticulate edge, and with cup-like depression at the summit.

Strongyles straight, fusiform, smooth, 467.5μ long, 9.75μ in diameter at centre, 6.5μ in diameter at ends.

Microscleres. Placocheles, fimbriated, 84.5μ long, 29.25μ broad; length of tooth, 37.75μ .

Sigmata very small, slender, C-shaped, 8.8μ long, 5.28μ broad, $.9 \mu$ thick.

The minute spheroidal or cushion-shaped specimen was 2.2 mm. in height and 3 mm. in horizontal diameter; it was growing on the side of an Alcyonarian, creeping over a branched *Cellepora*. No pores or oscules were discernible. The under surface, which was narrowed to the point of attachment, was paler in colour than the upper.

The new genus is closely related to the Mycaline genera *Rhaphidotheca* and *Guitarra*, to the former by its exotyles, and to the latter by its fimbriated placocheles.

The distal knobs of the exotyles of *R. marshall-hallii* Kent, 49μ in diameter, are smooth and spherical, and those of *R. rhopalophora* Schmidt (*R. affinis* Carter, see Thiele 22. p. 383) are 104μ long and 30μ broad and club-shaped. Lundbeck (13. p. 32) regards these two species as probably identical, and certainly the differences are slight.

In the centre of the heads of the exotyles of *H. dendyi* is an oval granular zone, which at first suggests a cavity filled with protoplasm, but that there is no cavity is

* ὄπλα (pl. of ὄπλον), armour; κιθάρα, a guitar.

† Professor Dendy, to whom I showed these remarkable exotyles with their large spined heads, regarded them as possible examples of spicules which might form a surface layer of pseudasters by reduction of the shafts.

evident from the fact that the axial canal can be seen traversing the granular zone. Some of the exotyles have one or more swellings in the length of the shaft.

The single example was dredged near Winter Quarters, at No. 6 hole, in 130 fms.

FAMILY HAPLOSCLERIDAE TOPSENT.

SUB-FAMILY GELLIINAE RIDLEY AND DENDY.

GELLIUS RUDIS.

(Plate XVII., figs. 1, 1A, and Plate XXIV., fig. 1 a-b.)

1902. *Gellius rudis*, Topsent (29. p. 14, Pl. I., fig. 9, and Pl. III., fig. 4).

The type of this species, described by Topsent, was a small globular specimen 27 mm. in diameter. The present collection contains six pieces of this sponge, some of them of large size; accordingly I am enabled to slightly supplement the original description. The largest fragment, $18 \times 5 \times 2.5$ cm. in dimensions, is massively lobate and closely resembles *Petrosia similis* var. *massa* R. and D. (15. plate III., fig. 6).^{*} The other specimens are in the form of thick sub-cylindrical unbranched or branched fragments, the largest (Pl. XVII., fig. 1) being 14 cm. in length and 2.5 cm. in diameter. Several of the pieces have oscules about 7 mm. in diameter with circular raised rims.

The surface, where the dermal membrane is intact, is to the naked eye quite smooth; though, where the dermis is rubbed off, the surface appears very finely hispid as Topsent describes, and feels rough to the touch.

A vertical section of a branch in the plane of the axis shows main longitudinal lines of fibres curving outwards from the axis to the surface as they pass upwards, and dividing in a more or less paniculate fashion near the surface; the secondary fibres, one or two spicules thick in the centre of the specimen, become much thicker a little below the dermal membrane.

The oxeas (XXIV. 1a), $403 \times 20 \mu$, are sub-tornote. The C-shaped sigmata have a uniform curve almost in one plane; they are 37μ long, 19.4μ broad, and $.8 \mu$ thick,

^{*} In this variety the skeletal arrangement is very similar to that found in *Gellius rudis*; the terminal branchlets of the main fibres are spread out beneath the dermal layer, and anastomose with branchlets from neighbouring main fibres; this sub-dermal reticulum, then, is due solely to the spreading out of the periphery of the paniculate ends of the main fibres (as in *G. rudis*), and is not as one might at first suppose a special dermal skeleton; the central tufts of the main fibres proceed vertically up to the surface; also, not a few scattered oxeas pass obliquely or vertically upwards from the subdermal network of spicule fibres; accordingly the dermal membrane is to a great extent supported on the tips of vertical oxeas. Though Ridley and Dendy clearly saw that the dermal reticulation was only the uppermost layer of the main skeleton (15. p. 11), it was not quite correct to state that the dermal membrane was not supported on tufts of spicules; a vertical section shows that it is supported in this manner, viz., by the central tufts of all the main fibres, as well as by oxeas from the subdermal reticulum. The spicules of *P. similis* var. *massa* resemble those of *G. rudis* in shape, but are smaller (viz. $239 \times 9.75 \mu$). Accordingly *P. similis* var. *massa* is closely similar to *G. rudis* in form, in skeletal arrangement, and in spiculation; in fact it very probably represents an example of a *Gellius* which has lost its sigmata. I have gone into this matter in some detail because it is always interesting to trace the probable line of descent of a Renierine sponge from some form with microscleres. Further, an instance of this kind furnishes some support to part of Dendy's recent scheme of classification, viz., that of making the Gelliinae the starting-point of the Halichondrina.

and frequently have a small central knob. (Figures are given for convenient comparison with the nearly related new species, *G. fimbriatus*, described below.)

The pores, abundant over the areas roofing over the spaces between the main fibres, are circular or oval and vary from 30–70 μ in diameter; the subdermal spaces are about a millimetre in depth; there are also smaller and shallower subdermal spaces between the more central terminal branches of the main fibres. The flagellated chambers, which are unusually small, viz., about 23 μ in diameter, are spheroidal and eurypylous; as seen in section they line labyrinthine folds and spaces.

The cellulæ sphéruleuses attain the large size of 35 μ in diameter, the sphérules also being of considerable size, viz., 8 μ .

Sections of the branches show nests containing 30–50 embryos, forming conspicuous red patches in the sections in balsam; each embryo is about 235 μ in diameter, and of yellowish colour, though red in masses. Some contain rhabdite-like oxeas. On the surface of the figured specimen are several little hemispherical pits from 2–5 mm. in diameter; these are probably the exposed surfaces of the embryo-containing cavities, and not due to parasites.

The specimens were dredged in McMurdo Bay, in depths up to 20 fms. The 'Belgica' obtained a specimen from Lat. 70° 23', Long. 82° 47' W., from 500 mètres.

GELLIUS FIMBRIATUS.

(Plate XVII., figs. 2, 2a, and Plate XXIV., fig. 2a–b.)

1907. *Gellius fimbriatus* Kirkpatrick (10a. p. 286).

Sponge in form of a thick triangular cake, or conico-cylindrical. Texture soft, easily broken. Colour in spirit, pale buff.

Surface level, or almost imperceptibly hispid; showing through the dermal membrane a somewhat areolated pattern, each areola being formed by the end of a main fibre giving off fimbriated twigs which roof over the subdermal spaces between the main fibres. A few circular oscules about 5 mm. in diameter and with slightly raised rims occur.

Skeleton formed of longitudinal lines of flat, loose, band-like main fibres, with an irregular and obscure reticulation of single spicules between. The main fibres spread out in a paniculate manner a little below the dermal membrane.

Spicules. Megascleres. Oxeas, 537 \times 16.25 μ , slightly bent or curved at centre, attenuating gradually to sharp points.

Sigmata varying in size, the largest being 40 μ long, 17.6 μ broad, and 1.76 μ thick, with one or more angular bends in the curve, usually one end of the shaft with an angular bend, the other end curved.

The specimen selected as the type of this species has a flattened angular pad-like body, 10 cm. long, 4.5 cm. broad, and 2.5 cm. thick; it apparently lay free on the bottom.

The upper surface alone shows the areolated appearance below the dermal membrane, the under surface being nearly opaque.

A second specimen is conico-cylindrical in shape, 11 cm. long and 3 cm. in diameter, the lower end being broken off. This specimen also apparently lay on the bottom along part of its length, as the pore surface extends all round only at the upper end of the specimen.

A third specimen from Coulman Island is fan-shaped, 7 cm. high, 3.5 cm. thick, 7 cm. broad at the upper edge, and 3 cm. broad at the base, where it is attached to two small stones. The surface is quite worn away, and the body of the sponge full of debris.

An "areola" with its central node (the end of the main fibre) and lateral branchlets occupies on an average an area of 6×4 mm.

The ends of the main fibres are arranged in linear series.

The dermal membrane is separated about 3 mm. from the floors of the large sub-dermal spaces, and the band-like supporting pillars are about 2 mm. broad. A vertical section gives the appearance of a miniature "hall of a thousand columns." The dermal membrane on the under surface of the sponge contains scattered oxeas arranged tangentially.

The pores vary a good deal in size and shape, being oval or round, and $45-120 \mu$ in diameter. The flagellated chambers are spheroidal, eurypylous, and about 25μ in diameter. The triangular cushion-like shape of the type recalls to mind *Gellius flagellifer* (R. and D.), but there are no flagellate sigmata in the new species. *G. rudis* (Topsent) has a much firmer and denser structure; the oxeas are shorter, thicker, and with tornote ends, and the sigmata are more slender and with uniform curve.

Dredged near Winter Quarters, off Hut Point in 12-20 fms.; also off Coulman Island in 100 fms.

GELLIUS PILOSUS.

(Plate XVII., figs. 3, 3a, and Plate XXIV., fig. 3a-c.)

1907. *Gellius pilosus* Kirkpatrick (10a, p. 287).

Sponge in form of an erect flattened triangular or elongate lamella divided or digitate at the upper edge.

Consistence soft, fleshy, compressible.

Colour in spirit, dirty white or very pale yellow.

Surface finely conulose and pilose owing to the projection of the ends of the main skeleton fibres about 1 mm., the conules being about .6 mm. apart from each other.

A few oscules about 1 mm. in diameter, on a level with the surface.

Skeleton formed of slender main axial fibres on an average about 2-5 spicules thick, curving out to the surface where they form the pile, and of secondary fibres, usually one, but sometimes two or three spicules thick, at right angles to the main ones, with which they form oblong scalariform meshes. Spongin well developed at the nodes of the network.

Spicules. Megascleres. Oxeas, $537 \times 22.75 \mu$, sharp pointed, sub-tornote, a few being distinctly tornote.

Microscleres. Sigmata, very abundant both in choanosome and ectosome, C-shaped, $39 \times 16.25 \mu$ in length and breadth, and 1.5μ thick.

There are two specimens. One of them is in the form of a triangular lamella dividing into two sub-terete branches, the total length being 10.5 cm., the breadth 3.5 cm., and the thickness 1 cm. The second specimen is 11 cm. long and 3 cm. broad, with little more than a notch at the upper edge, indicating a division into branches. The fleshy matter is nearly all macerated out, leaving a flexible skeletal framework. In the first specimen the surface shows the little conules penetrated by spikes 2-3 spicules thick, with squarish concave depressions about .5 mm. between any four conules. The dermal pores are imperceptible. There is a thin collenchymatous ectosome about .15 mm. thick, excavated by shallow sub-dermal cavities; the eurypylous flagellated chambers are ovoid, $26 \times 23 \mu$. The new species bears some resemblance to *Gellius flagellifer* (R. and D.), but differs from it in the absence of the peculiar flagellate sigmata. Further, *G. flagellifer* has an even surface, and a dermal skeleton network of spiculo-fibre; but in the new species the secondary fibres, usually not more than one spicule thick, are often not present at or just below the surface.

Dredged near Winter Quarters, off Hut Point, 25-30 fms.; and at No. 12 hole, 25-30 fms.

GELLIUS CUCURBITIFORMIS.

(Plate XVII., figs. 5, 5a-c, Plate XXIV., figs. 5a-b.)

1907. *Gellius cucurbitiformis* Kirkpatrick (10a, p. 288).

Sponge small, free, bulbous with fistular prolongations. Surface smooth, showing under a lens a fine white reticulum. Colour in spirit, pale brown. Consistence, rather soft.

Skeleton. With a distinct dermal layer of irregularly arranged tangential oxeas. Choanosomal skeleton a reticulum (with square or triangular meshes) of spiculo-fibre, the strands 2-3 spicules thick, with a faint indication of main fibres radiating to the surface.

Spicules. Megascleres. Oxeas, $342 \times 9.75 \mu$, slightly curved, sub-tornote.

Microscleres. Sigmata varying in size, the smallest being about 20μ long, C-shaped and with uniform curve, and the largest 39μ long, 19.8μ broad and 1.2μ thick.

There are two small specimens, both of which were found in a tangled mass of *débris* surrounding a worm-tube. The larger, the type specimen, consists of a basal bulbous portion, 13 mm. long, 7 mm. broad, and 8 mm. high, from one side of which arises a rather thick-walled fistula 13 mm. high and 5.5 mm. in diameter; at the opposite side is a broken circular area, from which, in all probability, a second fistula

arose; lastly, between these two, is a small raised knob with a rounded orifice on one side of it. The narrow oscular canal is not central, but along one side of the thick walled complete fistula.

The second specimen is tubular, with a slightly enlarged solid base, whence arises a fistula; the total length is 2·2 cm., and diameter '6 cm. No pores are discernible; the subdermal spaces are about '2 mm. in depth.

The eurypylous flagellated chambers are 23 μ in diameter. Cellules sphéruleuses, 8–9 μ in diameter, are common.

There is no bast-like subdermal layer as in *Oceanapia mollis* Dendy (4. p. 248), and the spicules of the latter are smaller, the oxeas being $200 \times 8 \mu$, and the sigmata only 16 μ . Lundbeck (12. pp. 64, 66) describes two species of *Gellius* with fistulae, and with a well-developed dermal bark, viz.: *G. luridus* and *G. microtoxa*, but both these species have toxa in addition to sigmata.

The two specimens were dredged off Hut Point (Winter Quarters) in 25–30 fms.

GELLIUS GLACIALIS, var. nivea.

(Plate XVII., fig. 4.)

1887. *Gellius glacialis* var. *nivea* Ridley and Dendy (15. p. 42, Pl. VIII., fig. 8, etc.).

The one example is in the form of a small spherical knob attached to a branched Polyzoon, resembling in these respects the 'Challenger' specimen from Prince Edward Island. The sponge, which is 17 mm. in diameter, is brittle, and has a well-marked ectosomal skeleton formed of tangential oxeas. The megascleres and sigmata are smaller than those of the 'Challenger' specimen, but are in other respects of the same character; accordingly I have not regarded the Antarctic specimen as a new variety.

The larger sigmata are often united in bundles of sigmadragmata.

The following table gives the dimensions in μ of the spicules of *G. glacialis*, and of the 'Challenger' and Antarctic specimens of var. *nivea*.

	<i>G. glacialis</i> .	var. <i>nivea</i> 'Challenger.'	var. <i>nivea</i> 'Discovery.'
Oxeas .	670 \times 40	704 \times 29·25	522 \times 19
Sigmata .	75 \times 45 \times 3·5	209 \times 71·5 \times 5·7	119 \times 67 \times 6·5

Dredged off Coulman Island, 100 fms.

The 'Challenger' obtained *G. glacialis* from Agulhas Bank, 150 fms., and var. *nivea* from Prince Edward Island, 140 fms.

OCEANAPIA TANTULA.*

(Plate XVIII., figs. 5, 5a, 5b, and Plate XXIV., fig. 8a-c¹.)1907. *Oceanapia tantula* Kirkpatrick (10a. p. 289).

Description.—The sponge consists of five small fragments of tubes, the longest of which is 8 mm. in length, by 4 mm. in diameter; three of the pieces are hollow, thin-walled and tubular; the other two are solid. One of the solid pieces seems to belong to the top of a fistula.

The colour is transparent white.

Skeleton. The dermal layer is composed of a chitinous-looking membrane with strongyles lying tangentially, usually in one layer and densely packed, but sometimes more or less scattered.

The white strands of the loose subdermal reticulum are visible through the surface. They are longitudinal, and only anastomose occasionally. The strands are less than .1 mm. in diameter. They vary in composition; in some parts being composed of strongyles smaller than those of the dermal layer, in other parts of smooth trichodragmata, or again of strongyles, amphityles and trichodragmata. The pale transparent choanosomal tissues are crowded with small spined raphides.

Spicules. Megascleres. Strongyles, $437 \times 19 \mu$, slightly fusiform, curved once or sometimes twice. Occasionally one end is pointed, the spicule becoming a style.

Amphityles, $395 \times 7.25 \mu$, slightly fusiform, heads 13μ long, 9.75μ broad.

Microscleres. Long, smooth raphides, separate or in bundles forming part of the subdermal reticulum, $650 \times 2.5 \mu$.

Short scattered spined raphides, usually stylote, 162μ long, and about 2.5μ broad.

H. V. Wilson describes (34. p. 128) a species of *Oceanapia*, viz. *O. bacillifera* with strongyles, but it has the usual sigmata.

Oceanapia (Phloeodictyon) singaporensis (Carter) has strongyles in the dermal layer, but oxeas as well as strongyles in the skeleton fibres, and there are no microscleres.

The species of the Gelline genus *Rhaphisia* have oxeas, trichodragmata, and, in one species, toxa; but there are no fistulae, and there is no subdermal reticulum of spicular fibres.

It is regrettable that there is so small an amount of material on which to base a new species, but the marked characters of that which is available seem to render such a proceeding justifiable.

Dredged near Winter Quarters, from No. 10 hole, 130 fms.

* *Tantulus*, ever so little.

SUB-FAMILY RENIERINAE, RIDLEY AND DENDY.

PYLODERMA.

Halichondria (pars) Ridley and Dendy (15, p. 6).

Renierinae with a parchment-like, easily-separated, dermal membrane in which are situated closely-packed tangential oxeads, and with distinct round or oval pore areas.

PYLODERMA LATRUNCULIOIDES.

1887. *Halichondria latrunculioides*, Ridley and Dendy (15, p. 6, Pl. I., fig. 5, &c.).

There is one flabellate specimen attached to a small stone. The height is 6 cm., the width at the upper rim 5.5 cm., and the thickness 1.8 cm. The oscules, generally contracted into little white conules, are scattered about among the pore areas, and not collected on the edges as in the 'Challenger' examples. Each oscular opening leads into a smooth funnel-like cavity with a sharp-edged circular sphincter-like opening at the base.

The strongly marked characters of this peculiar species seem to me to necessitate its removal from *Halichondria* and its inclusion under a new genus. In the 'Challenger' Report Ridley and Dendy state that they were at first doubtful whether the arrangement of the pores in definite areas would prove to be a character of generic importance, and finally decided that this feature was only one of adaptation. Prof. Dendy has since told me that he now thinks that this species should be placed in a distinct genus, and in this opinion I concur. There are no microscleres to help in tracing its affinities and the body skeleton is Renierine in character; accordingly it is for the present placed among the Renierinae.

Dredged off Coulman Island in 100 fms. The 'Challenger' obtained specimens from a depth of 600 fms. off the mouth of the Rio de la Plata.

PETROSIA FISTULATA.

(Plate XVIII., figs. 4, 4a-b, and Plate XXIV., fig. 7.)

1907. *Petrosia fistulata* Kirkpatrick (10a, p. 290).

Sponge tubular. Surface smooth, showing the round openings of the inhalant canals about .4 mm. in diameter and close together.

Inner surface of the tube of the sponge finely or rarely coarsely pilose, and showing the round openings of the exhalant canals about 1 mm. in diameter. Colour in spirit, pale yellow. Texture firm, but slightly compressible. Eurypylous flagellated chambers spheroidal, 24.5 μ in diameter.

Skeleton formed of main fibres proceeding from the inner to the outer surface, joined by secondary fibres one spicule thick, so as to form obscurely quadrangular or hexagonal tubes about .5 mm. in diameter; ends of spicules cemented with spongin.

Spicules. Oxeads, 492 \times 24.4 μ , bent usually, or curved at centre, sub-tornote.

There are four specimens, the two larger being uniformly cylindrical and the smaller ventricose. The largest is 6 cm. long, the diameter being 2·1 cm. and the thickness of the wall 5 mm.

The dermal membrane roofing over the inhalant orifices is usually supported there by two or three single spicules radiating to the centre. The pores are $\cdot 95 \mu$ in diameter.

Small embryos about $\cdot 76$ mm. in diameter occur. The new species comes nearest to the species from Kerguelen, which Carter (3. p. 287) identified as *Thalysias subtriangularis* Duch. and Mich., but which Ridley and Dendy (15. p. 9) regarded as synonymous with *Petrosia similis** (Ridley and Dendy).

The spicules of the Antarctic species are very much larger than those of Carter's, and partly in consequence of this the skeletal network of the latter is much denser from a closer approximation of the fibres.

The dimensions of the oxeas of four nearly related species of *Petrosia* are as follows:—

Petrosia similis (R. and D.), $225 \times 16 \mu$.

Thalysias subtriangularis (D. and M.), Carter, $190 \times 12 \mu$.

Petrosia (Schmidtia) aulopora, O. Sch., $175 \times 7 \mu$.

Petrosia fistulata, $493 \times 24\cdot 4 \mu$.

Dredged near Winter Quarters, No. 12 hole, 25–30 fms.; McMurdo Bay, 96–120 fms.

RENIERA SCOTTI.†

(Plate XVIII., figs. 1–2, and Plate XXIV., fig. 6.)

1907. *Reniera scotti* Kirkpatrick (10a. p. 291).

Sponge consisting of one or more fistulae. Texture very soft and easily lacerated. Colour in spirit, varying from yellow to pale reddish. Outer surface varying from being finely hispid to having large conules and meandrine ridges. Inner surface of fistulae very finely hispid in the spaces between the numerous orifices of exhalant canals. Flagellated chambers large hemispherical, $60 \times 40 \mu$.

Skeleton formed of parallel longitudinal lines of main fibres, about 2–6 spicules thick, curving outwards from the inner to the outer surface, where they pass into the conules and ridges; secondary fibres at right angles to the main ones, one or two spicules thick. The spicules are not closely united, and spongin is only present in very small amounts.

Spicules. Oxeas $343 \times 14\cdot 6 \mu$, curved or bent at centre, sub-tornote.

* The specimen from Kerguelen Island which Carter identifies as *Thalysias subtriangularis* Duch. & Mich. is, I believe, specifically distinct from *Petrosia similis* R. & D. The fine spicular network of the former, with its slender main fibres, and still more slender unispicular secondary fibres, contrasts strongly with the thick cable-like longitudinal and transverse strands of the latter. Carter's specimen appears to me to belong to a new species.

† This fine species is named in honour of Captain R. F. Scott, R.N., C.V.O., the leader of the Expedition.

There are six specimens and fragments. The outward appearance varies greatly according to age and size. In one small specimen the surface is finely hispid, in larger ones conulose, and in very large ones conulated and with high meandrine ridges. The largest specimen No. 118 (Pl. XVIII., fig. 1) is in the form of a wide thick-walled tube, 12 cm. high and 6 cm. in diameter, and with walls 1.5 cm. thick, but attenuating towards the rim of the tube. This specimen is incomplete below. The orifice is circular, and within the rim is a diaphragm contracted to a white line.

The surface is covered with large conules and meandrine ridges rising to a height of nearly 1 cm.

The dermal membrane, in the spaces between the conules and ridges, shows as a fine lace-like reticulum, with circular pores $133\ \mu$ in diameter, and beneath it the orifices (1–1.5 mm. in diameter) of the inhalant canals are visible. The exhalant orifices on the inner wall of the tube are much larger than the inhalant; they vary from 1 to 6 or 7 mm., their edges are smooth and rounded. In the second largest specimen, these orifices are arranged in longitudinal rows, and are oval with the long diameter vertical. This arrangement results from the way in which the contraction of the tubular sponge body is restricted by the main longitudinal skeletal fibres running beneath the inner surface.

In a third specimen (No. 132), the outer surface of the wall is almost smooth to the naked eye, though under a lens it is seen to be finely hispid, with the top of oxas projecting from minute conules.

In another specimen the basal part of the sponge divides into two tubes, one of which is nearly smooth, and the other with ridged surface.

The species closely resembles *R. spinosella*, Thiele (23. p. 459), from Punta Arenas. In Thiele's species the body is tubular, with conulated surface, and the texture is very soft; but the skeletal framework is irregular, and the oxas, though similar in form, are much shorter, smaller and more slender, being only 150–170 μ long and 7–8 μ thick.

Another species showing certain resemblances to *R. scotti*, viz. *R. aqueductus* Schmidt, var. *infundibularis* (R. and D.), has a unispicular skeletal network.

Specimens were dredged near Winter Quarters, in No. 12 hole, 25–30 fms.; S.E. of Cape Armitage, 100 fms.; off Flagon Point, 5–25 fms.; off E. end of Ice Barrier, 100 fms., mud and stones.

RENIERA DANCOI.

(Plate XVIII., fig. 3.)

1901. *Reniera dancoi*, Topsent (29. p. 12, Pl. II., fig. 1, and Pl. III., fig. 3.)

There are two specimens. One is of a compressed digitate form, 10 cm. long, 2.5 cm. wide, and 1 cm. thick. About the middle of one side is a projecting shoulder with an oscule. Near, but not quite at the summit, on the opposite edge, is a second oscule. The specimen is contracted at the centre; the alternate oscules

and contracted waist give the impression of a budding of the upper half of the specimen from the lower.

The colour is pale brown in spirit, and is due apparently to the abundance of masses of cellules sphéruleuses; the specimens described by Topsent are grayish or whitish.

The 'Discovery' specimens have, in parts, a hispid rather than a conulose surface, the spicules standing above the level dermal membrane like sticks out of water; but in other places the surface is finely conulose. The oxeas are $642 \times 18 \mu$, those of the 'Belgica' being $630 \times 18-20 \mu$. By deep staining of a portion of macerated skeletal network a small amount of spongin becomes discernible at the nodes. The flagellated chambers, $55 \times 40 \mu$, though rather large, are smaller than those of Topsent's specimens, in which they are of unusual size, viz. $70 \times 50 \mu$. The second specimen is merely a shapeless fragment.

Dredged near Winter Quarters, off Hut Point, 25 fms.; No. 12 hole, 25-30 fms. The 'Belgica' Expedition obtained several small specimens from 450 mètres, in Lat. $71^{\circ} 19' S.$, Long. $87^{\circ} 37' W.$

MEMOIRS REFERRED TO.

1. CARTER, H. J.—Descriptions and figures of Deep-sea Sponges . . . from the Atlantic Ocean, dredged . . . H.M.S. Porcupine. *Ann. Mag. Nat. Hist.* (4) xiv., 1874.
2. CARTER, H. J.—Some Sponges from the West Indies and Acapulco in the Liverpool Free Museum. *Ann. Mag. Nat. Hist.* (5) ix., 1882.
3. CARTER, H. J.—Spongiidae from Kerguelen Island. *Transit of Venus Expⁿ* *Phil. Trans.* vol. 138 (extra). London, 1879.
4. DENDY, A.—Catalogue of the Non-Calcareous Sponges . . . Port Phillip Heads. Part i. *Proc. Roy. Soc. Victoria*, vol. vii., n.s., 1895.
5. DENDY, A.—Catalogue of Non-Calcareous Sponges . . . Port Phillip Heads. Part ii. *Proc. Roy. Soc. Victoria*, vol. viii., n.s., 1896.
6. DENDY, A.—In HERDMAN, Ceylon Pearl Fisheries. Supplementary Report, xviii. London, 1905.
7. FRISTEDT, K.—Sponges from the Atlantic and Arctic Oceans and Behring Sea. *Vega-Expeditionens vetenskapliga jakttagelser Arbeten.* Bd. iv., 1887.
8. HANITSCH, R.—Revision of the Generic Nomenclature and Classification in Bowerbank's "British Spongiadae." *Trans. Liverpool Biol. Soc.*, vol. viii., 1894.
9. KIRKPATRICK, R.—On the Sponges of Christmas Island. *Proc. Zool. Soc. London*, 1900.
10. KIRKPATRICK, R.—On the Oscules of *Cinachyra*. *Annals and Mag. Nat. Hist.*, 1905 (7), vol. xvi.
- 10a. KIRKPATRICK, R.—Preliminary Report on the Monaxonellida of the National Antarctic Exhibition. *Ann. and Mag. Nat. Hist.* (7), vol. xx., September 1907.
11. LENDENFELD, R. VON.—Spongien von Sansibar. *Abhand. Senckenberg. Gesellsch.*, 1899, Bd. xxi.
- 11a. LENDENFELD, R. VON. *Deutsche Südpolar-Expedition, 1901–1903.* Bd. ix. *Zoologie I. Tetraxonia.* Berlin, 1907.
12. LUNDBECK, W.—Porifera (Part i.). Homorrhaphidae and Heterorrhaphidae. *The Danish Ingolf-Expedition*, vol. vi., Copenhagen, 1902.
13. LUNDBECK, W.—Porifera (Part ii.). Desmacidonidae. *The Danish Ingolf-Expedition*, vol. vi., Copenhagen, 1902.
14. MEREJSKOWSKY, C.—Études sur les Éponges de la mer Blanche. *Mém. Acad. Imp. Sci.* (7), xxvi., N^o 7, St. Pétersbourg, 1878.
15. RIDLEY, S. O., and DENDY, A.—Report on the Monaxonida collected by H.M.S. 'Challenger.' London, 1887.
- 15a. RIDLEY, S. O.—Account of the Zoological Collections made during the survey of H.M.S. 'Alert' in the Straits of Magellan. *Proc. Zool. Soc. London*, 1881.
16. SCHMIDT, O.—Die zweite deutsche Nordpolarfahrt, 1869–70. *Zweiter Band, Zoologie, Kiesel-spongien.* Leipzig, 1874.
17. SCHMIDT, O.—Die Spongien des Meerbusen von Mexico. *Jena*, 1879.
18. SCHULZE, F. E.—Über die Ableitung der Hexactinelliden-Nadeln vom regulären Hexactine. *Sitzungsb. Akad. Wiss., Berlin*, xlvi., 1893.
19. SOLLAS, I. B.—On the Sponges collected during the Skeat Expedition to the Malay Peninsula, 1897–1900. *Proc. Zool. Soc. London*, vol. ii., 1902.
20. SOLLAS, W. J.—The Sponge-fauna of Norway. *Annals and Mag. Nat. Hist.*, 1882, (5), vol. ix.
21. SOLLAS, W. J.—Report on the Tetractinellida collected by H.M.S. 'Challenger.' *Zoology*, vol. 25. London, 1888.
22. THIELE, J.—Beschreibung einiger unzureichend bekannten Monaxonen Spongien. *Archiv. Naturg.*, 1903. Band i. Berlin.
23. THIELE, J.—Die Kiesel- und Hornschwämme der Sammlung Plate. *Zool. Jahrb. Suppl.* vi., Dr. L. Plate, *Fauna Chilensis*: Bd. iii., Heft 3. *Jena*, 1905.

24. TOPSENT, E.—Une réforme dans la Classification des Halichondrina. Mém. Soc. Zool. France, tome vii. 1894.
25. TOPSENT, E.—Résultats scientifiques de la Campagne du 'Caudan' dans le Golfe de Gascogne, 1895. Éponges. Annales de l'Université de Lyon, xxvi., (4). Paris, 1896.
26. TOPSENT, E.—Éponges nouvelles des Açores (première série). Mém. Soc. Zool. France, vol. xi., p. 225-255. Paris, 1898.
27. TOPSENT, E.—Introduction à l'étude monographique des Monaxonides de France. Archiv. Zool. Exp. et Gén. (3) vi. 1898.
28. TOPSENT, E.—Étude Monographique des Monaxonides de France. Archiv. Zool. Exp. et Gén. (3). tome viii. 1900.
29. TOPSENT, E.—Expédition Antarctique Belge. Résultats du Voyage du S.Y. 'Belgica' en 1897-99. Zoologie. Spongiaires. Anvers, 1902.
30. TOPSENT, E.—Résultats des Campagnes Scientifiques du Prince de Monaco. Spongiaires des Açores. Monaco, 1904.
31. TOPSENT, E.—Pociloselérides nouvelles recueillies par le 'Français' dans l'Antarctique. Bulletin du Muséum d'histoire naturelle. Paris, 1907. No. 1.
32. VON MAER, G. C. J.—The Sponges of the Willem Barents Expedition, 1880-81. Bijdragen tot de Dierk. Af. 12. Amsterdam, 1885.
33. WELTNER, W.—Susswasserspongien von Celebes. Archiv. für Naturgeschichte, 1901. Beiheft.
34. WILSON, H. V.—Reports on an Exploration off the West Coasts of Mexico, Central and South America, and off the Galapagos Islands, by the 'Albatross' during 1891. The Sponges. Mem. Mus. Comp. Zool. Harvard, vol. xxx. No. 1. Cambridge, U.S.A., 1904.

PLATE VIII.

- FIG. 1.—*Craniella sagitta* (Lendenfeld) var. *microsigma*, n. var., $\frac{3}{4}$ nat. size, p. 1.
FIG. 2.—Surface at junction of poral and non-poral or oscular zones ($\times 2$).
FIG. 3.—Section showing poral areas and sub-dermal spaces ($\times 6$).
FIG. 4.—Eurypylous flagellated chambers opening into terminal exhalant canal ($\times 425$).
FIG. 5.—Anatriaene ($\times 50$). 5a, Cladome of same ($\times 160$).
FIG. 6.—Cladome of anatriaene with straighter cladi than 5a ($\times 160$).
FIG. 7.—Anatriaene with short, thick cladi ($\times 50$). Cladome of same ($\times 160$).
FIG. 8.—Protriaene ($\times 50$), 8a, cladome of same ($\times 160$).
FIG. 9.—Cladome of protriaene with equal cladi ($\times 160$).
FIG. 10.—Large oxea ($\times 50$).
FIG. 11.—Trichodal protriaene ($\times 160$).
FIG. 12.—Sigmata ($\times 700$); 12a, the same ($\times 1400$).
FIG. 13.—Cortical oxea ($\times 50$).
FIG. 14.—*Craniella sagitta* var. *pachyrrhabdus*, n. var. Style ($\times 50$).
FIG. 15.—Strongyle ($\times 50$).

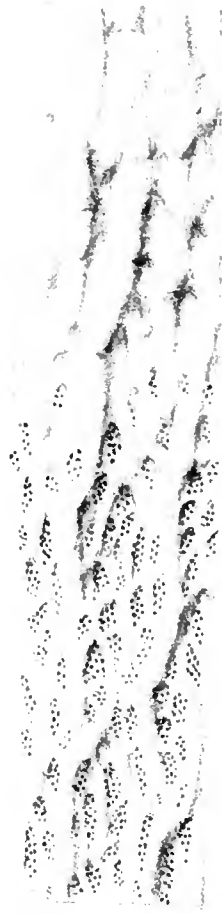
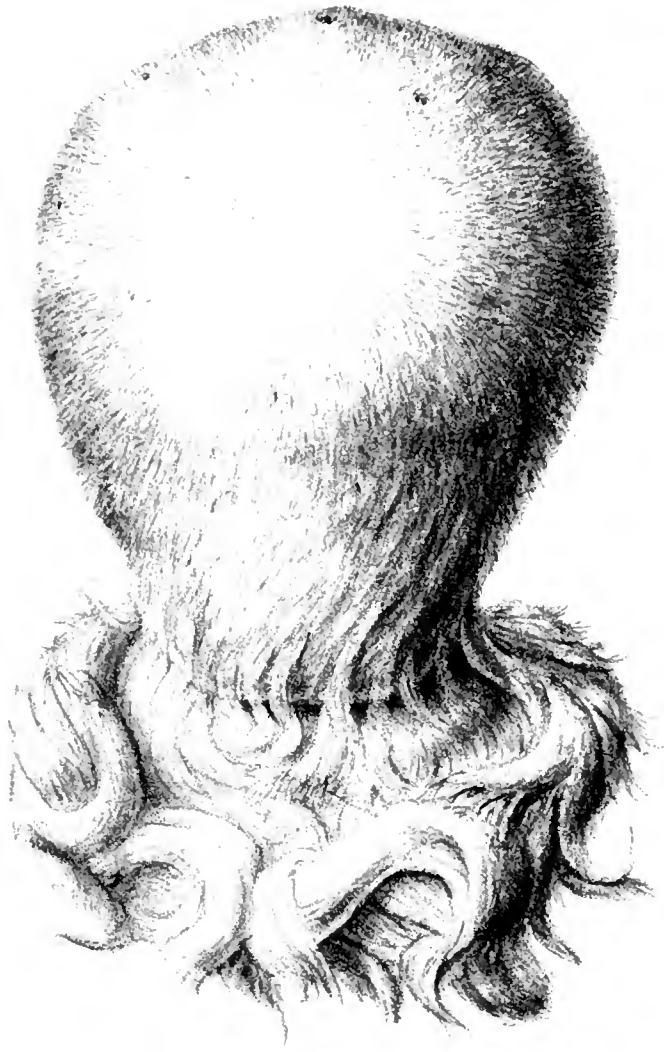
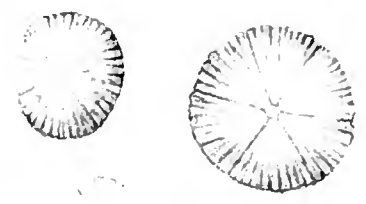
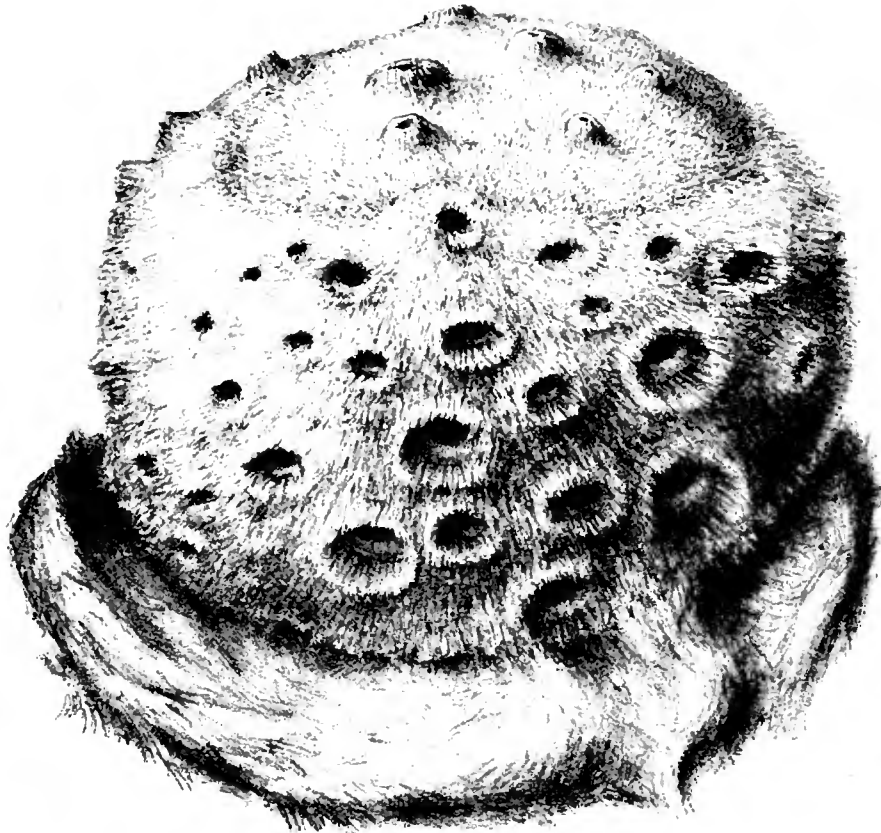

PLATE IX.

- FIG. 1.—*Cinorhyna barbata* Sollas, $\frac{3}{4}$ nat. size, p. 6.
FIG. 2.—Vertical section through an oscule ($\times 5$).
FIG. 3.—Young specimen with one porocalyx in front and one oscule at the upper end ($\times 3$).
FIG. 4.—Cortical oxea from a large specimen ($\times 100$).
FIGS. 5-7.—Single and double "silica pearls" ($\times 700$).
FIGS. 8-12.—"Silica pearls" around which crystals of sea-salts have become deposited ($\times 425$).
FIGS. 13, 14.—Spheroidal masses of sea-salt crystals (in optical section), which stain deeply in carmine ($\times 425$).
FIG. 15.—*Craniella sagitta* var. *microsigma*, vertical section of cortex in poral region, showing radial cortical oxeas arching over sub-dermal spaces ($\times 12$).
FIG. 16.—*Craniella sagitta* var. *microsigma*, vertical section of cortex in oscular region showing absence of radial cortical oxeas ($\times 12$).
FIG. 17.—*Craniella sagitta* var. *pachyrhabdus*, flagellated chambers ($\times 200$).
FIGS. 18, 19.—Collar cells of the same ($\times 1900$).

NOTE.—The flagellated chambers as seen in fig. 17 are nearly denuded of collar cells, which have probably become separated owing to the action of the osmic acid used in the case of this specimen: consequently the collar cells with their collars, as seen in the figures, have probably not become fixed in their normal position. See remarks on p. 4.





APPENDIX

The following table gives the results of the
 observations made on the 10th of June 1881
 at the observatory of Greenwich. The
 observations were made with the transit
 instrument, and the results are given in
 the following table. The observations were
 made at intervals of 10 minutes, and the
 results are given in the following table.

The following table gives the results of the
 observations made on the 10th of June 1881
 at the observatory of Greenwich. The
 observations were made with the transit
 instrument, and the results are given in
 the following table. The observations were
 made at intervals of 10 minutes, and the
 results are given in the following table.

PLATE X.

- FIG. 1.—*Cinachyra vertes* Lendenfeld, nat. size, p. 9.
FIG. 2.—Vertical section of a porocalyx ($\times 10$).
FIG. 3.—Vertical section of an oscule ($\times 10$).
FIG. 4.—Vertical section of cortex ($\times 25$).
FIG. 5.—Flagellated chambers, apopyles opening into beginning exhalant canal ($\times 160$).
FIG. 6.—Collar cells ($\times 1600$).—The section shows the cut edges of the concrescent collars of the collar cells; the diffused coloration beneath these cut edges apparently represents Sollas's membrane torn down in the course of section cutting. The material from which the section was cut was deep black from the effects of osmic acid, and was not good from a histological point of view.
FIG. 7.—Large somal oxea ($\times 100$).
FIG. 8.—Choanosomal oxea ($\times 100$).
FIG. 9.—Anatriaene with bend in cladi ($\times 100$).
FIG. 10.—Anatriaene with uniformly curved cladi ($\times 100$).
FIGS. 11, 12.—Protriaenes.
FIG. 13.—Trichodal protriaene ($\times 100$).
FIG. 14.—Sigmata ($\times 700$); 14a, the same ($\times 1400$).
FIG. 15.—*Cinachyra vertes* var. *monticularis*, n. var., nat. size, p. 11.
FIG. 16.—Oscular chimney of the same ($\times 10$).

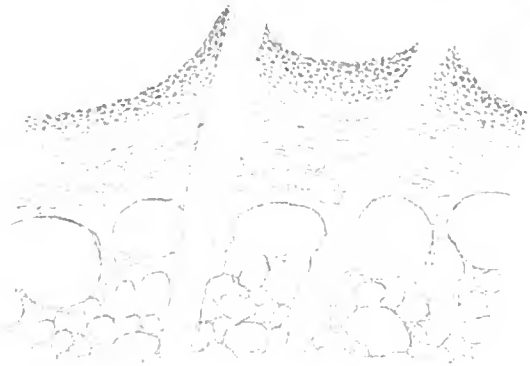
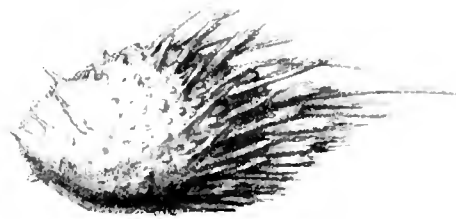
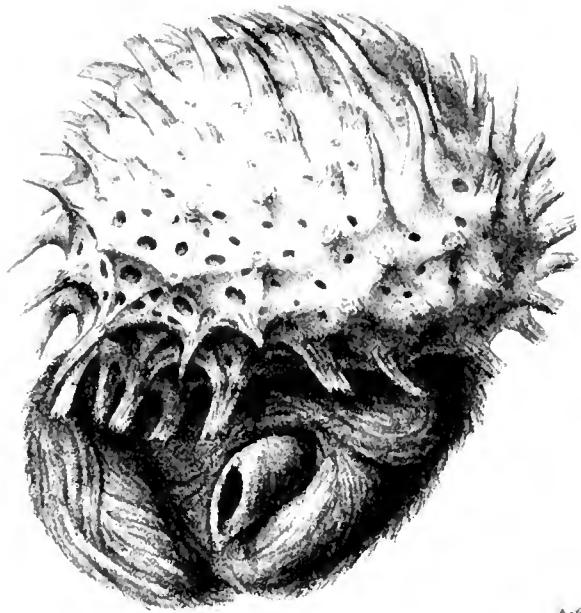
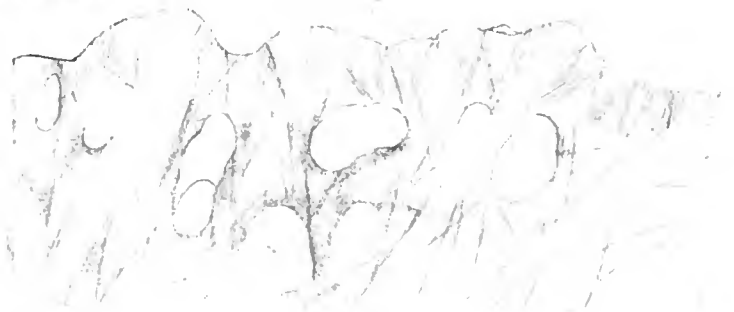
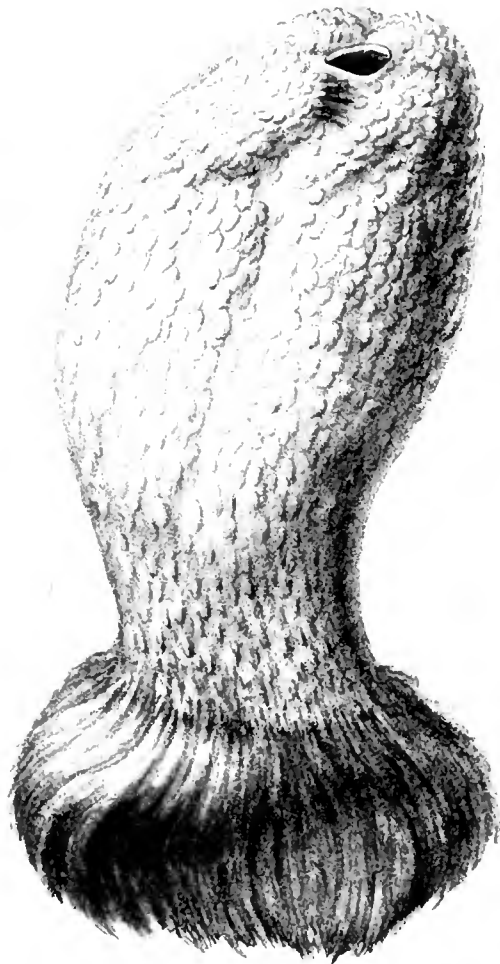
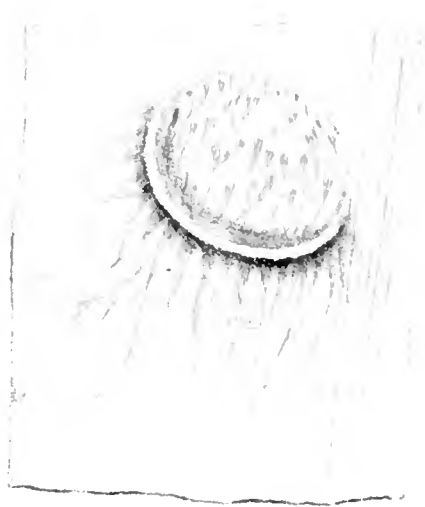

PLATE XI.

- FIG. 1.—*Cinachya vertex* var. *monticulbris*, two porocalycal monticules ($\times 10$).
FIG. 2.—One, ditto clarified and lightly stained ($\times 20$).
FIG. 3.—Vertical section of a monticule ($\times 20$).
FIG. 4.—*Craniella leptoderma* (Sollas), nat. size, p. 4.
FIG. 5.—A smaller specimen of the same, nat. size.
FIG. 6.—Tangential section of surface ($\times 100$).
FIG. 7.—Vertical section ($\times 15$).
FIG. 8.—Cortical oxea ($\times 100$).
FIG. 9.—Anatriaene ($\times 100$).
FIG. 10.—Another kind of anatriaene ($\times 100$).
FIG. 11.—A third kind of anatriaene ($\times 100$).
FIG. 12.—Distal end of protriaene from root-tuft ($\times 100$).
FIG. 13.—Trichodal protriaene ($\times 100$).
FIG. 14.—Signata ($\times 700$); 14a, the same ($\times 1400$).



11711 211
The following is a list of the names of the persons who have been appointed to the various offices of the County of Los Angeles, California, for the term ending on the 31st day of December, 1911.

County Clerk: J. H. ...
County Auditor: ...
County Assessor: ...
County Engineer: ...
County Surveyor: ...
County Treasurer: ...
County Jail: ...
County Sheriff: ...
County Coroner: ...
County Registrar: ...
County Recorder: ...
County Clerk of the Superior Court: ...
County Clerk of the District Court: ...
County Clerk of the Probate Court: ...
County Clerk of the Municipal Court: ...
County Clerk of the County Board of Supervisors: ...
County Clerk of the County Board of Education: ...
County Clerk of the County Board of Health: ...
County Clerk of the County Board of Public Works: ...
County Clerk of the County Board of Civil Service: ...
County Clerk of the County Board of Charities: ...
County Clerk of the County Board of Social Welfare: ...
County Clerk of the County Board of Public Safety: ...
County Clerk of the County Board of Public Health: ...
County Clerk of the County Board of Public Education: ...
County Clerk of the County Board of Public Welfare: ...
County Clerk of the County Board of Public Safety: ...
County Clerk of the County Board of Public Health: ...
County Clerk of the County Board of Public Education: ...
County Clerk of the County Board of Public Welfare: ...

PLATE XII

- FIG. 1.—A. *Sphaerotylus antarcticus* Kirkp. Nat. size ; p. 16. B. *Polymastia invaginata* Kirkp. ; p. 15.
(Note. The surface pile is, in the natural condition, more upright than in this specimen, where it has been crushed down.) C. The larger of the two small specimens above C is *Sphaerotylus capitatus* Vosmaer, nat. size ; p. 18 ; the smaller is *S. antarcticus*.
- FIGS. 2, 3.—*Sphaerotylus antarcticus*, young specimens. Nat. size.
- FIG. 4.—Portion of another young specimen ($\times 25$).
- FIG. 5.—*Sphaerotylus antarcticus*. A spheroidal specimen. Nat. size.
- FIG. 6.—Style from radiating main fibre ($\times 100$).
- FIG. 7.—Style from inner cortical tangential layer ($\times 100$).
- FIG. 8.—Spherostyle ($\times 100$) ; sa head of same ($\times 425$).
- FIGS. 9-12.—Heads of various spherostyles ($\times 425$).
- FIG. 13.—Slender curved choanosomal tyle ($\times 100$).
- FIG. 14.—Beaded tyle from radial fibres ($\times 425$).
- FIG. 15.—Curved cortical tyles of outermost layer of cortex ($\times 100$) ; 15a, the same ($\times 160$).
- FIG. 16.—Straight tangential tyle of lower cortical layer ($\times 100$) ; 16a, the same ($\times 425$).

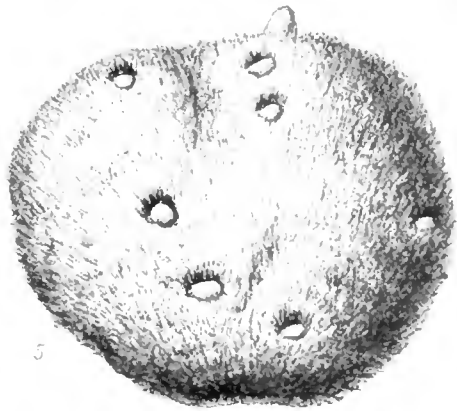

100



INDEX

1. Introduction 1

2. The first part of the book 2

3. The second part of the book 3

4. The third part of the book 4

5. The fourth part of the book 5

6. The fifth part of the book 6

7. The sixth part of the book 7

8. The seventh part of the book 8

9. The eighth part of the book 9

10. The ninth part of the book 10

11. The tenth part of the book 11

12. The eleventh part of the book 12

13. The twelfth part of the book 13

14. The thirteenth part of the book 14

15. The fourteenth part of the book 15

16. The fifteenth part of the book 16

17. The sixteenth part of the book 17

18. The seventeenth part of the book 18

19. The eighteenth part of the book 19

20. The nineteenth part of the book 20

21. The twentieth part of the book 21

22. The twenty-first part of the book 22

23. The twenty-second part of the book 23

24. The twenty-third part of the book 24

25. The twenty-fourth part of the book 25

26. The twenty-fifth part of the book 26

27. The twenty-sixth part of the book 27

28. The twenty-seventh part of the book 28

29. The twenty-eighth part of the book 29

30. The twenty-ninth part of the book 30

31. The thirtieth part of the book 31

32. The thirty-first part of the book 32

33. The thirty-second part of the book 33

34. The thirty-third part of the book 34

35. The thirty-fourth part of the book 35

36. The thirty-fifth part of the book 36

37. The thirty-sixth part of the book 37

38. The thirty-seventh part of the book 38

39. The thirty-eighth part of the book 39

40. The thirty-ninth part of the book 40

41. The fortieth part of the book 41

42. The forty-first part of the book 42

43. The forty-second part of the book 43

44. The forty-third part of the book 44

45. The forty-fourth part of the book 45

46. The forty-fifth part of the book 46

47. The forty-sixth part of the book 47

48. The forty-seventh part of the book 48

49. The forty-eighth part of the book 49

50. The forty-ninth part of the book 50

51. The fiftieth part of the book 51

PLATE XIII.

- FIG. 1.—*Sphaerotylus antarcticus*. Section of young specimen ($\times 3$).
FIG. 2.—Section of same ($\times 20$).
FIG. 3.—Dermal pores ($\times 100$).
FIG. 4.—Inner surface of cortex showing terminations of pore canals ($\times 100$).
FIG. 5.—Horizontal section of papilla ($\times 15$).
FIG. 6.—Vertical longitudinal section of papilla ($\times 15$).
FIG. 7.—Diplodal flagellated chambers ($\times 400$).
FIG. 8.—*Sphaerotylus capitatus* (Vosmaer) choanosomal tyle ($\times 100$); 8a, head of the same ($\times 160$).
FIGS. 9, 10.—Smaller tyle and sub-tyle from spread out ends of radiating fibres of skeleton ($\times 160$).
FIG. 11.—Cortical tyle, also found in choanosome between the main fibres ($\times 100$).
FIG. 12.—Smallest kind of cortical tyle ($\times 100$); 12a, the same ($\times 160$).
FIG. 13.—Exotyle ($\times 100$); 13a, clavate head of same ($\times 125$).

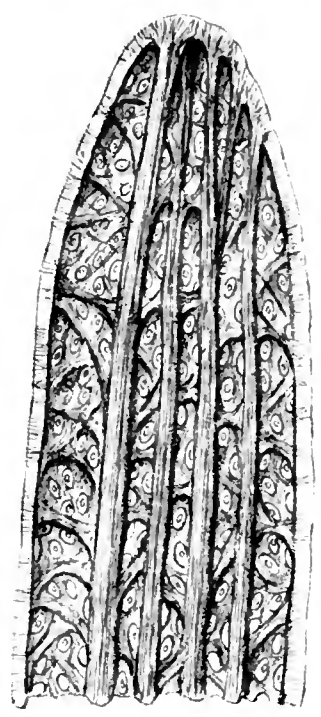
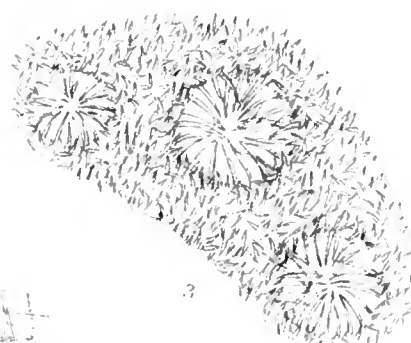
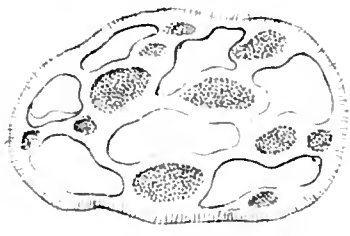
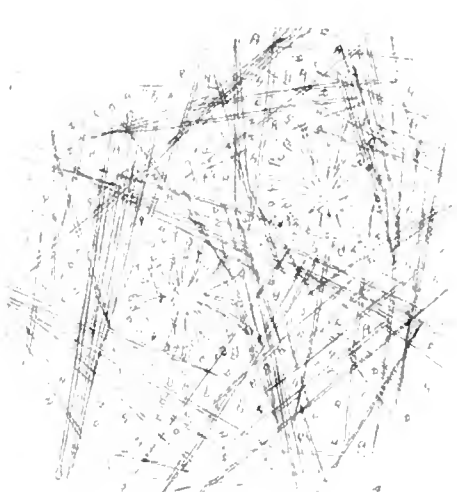
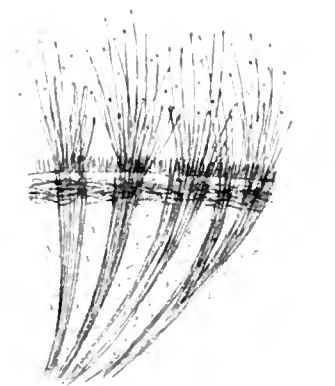
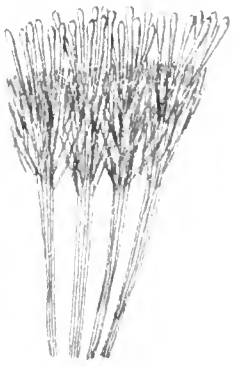

PLATE XIV.

- FIG. 1.—*Sphaerotylus capitatus*, vertical section ($\times 25$).
FIGS. 2-4.—Buds of the same ($\times 15$).
FIG. 5.—*Polymastia invagnata*, specimen cut in half; nat. size, p. 15.
FIG. 6.—Vertical section ($\times 25$).
FIG. 7.—Flagellated chambers (diplodal) ($\times 400$).
FIG. 8.—Stellate group of tyles in choanosome ($\times 100$); 8a, separate tyles of stellate groups ($\times 100$)
FIG. 9.—Straight style ($\times 100$).
FIG. 10.—Curved style ($\times 100$); 10a, narrower head of another spicule ($\times 100$).
FIG. 11.—Strongyle ($\times 100$).
FIG. 12.—Long slender tyle ($\times 100$).
FIGS. 13, 14.—Cortical tyles ($\times 100$).
FIG. 15.—Choanosomal tyles ($\times 100$); 15a, the same ($\times 160$).



1



2



3

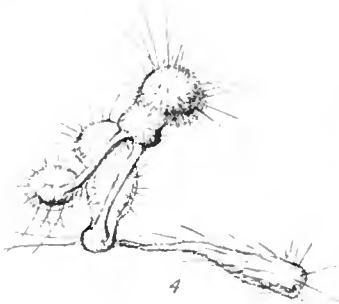

4

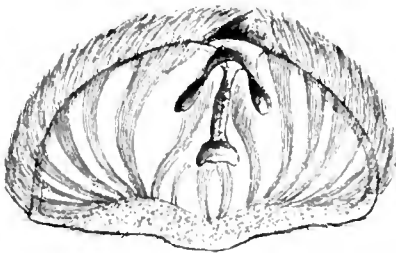

5



6



7



8



9



10

10''

10'



11



12



13



14



15

PLATE XV.

- FIG. 1.—*Latrunculia apicalis* R. & D. var. *biformis* var. n., $\frac{3}{4}$ nat. size, p. 14.
FIG. 2.—Style of same ($\times 100$).
FIG. 3.—Discaster with apical spine ($\times 700$).
FIG. 4.—Discaster without apical spine ($\times 100$); 4a ($\times 700$).
FIG. 5.—Reduced discaster ($\times 100$).
FIGS. 6, 7.—Reduced discasters from another specimen ($\times 160$).
FIG. 8.—*Suberites microstomus* R. & D. var. *stellatus*, var. n., nat. size, p. 19.
FIG. 9.—Sub-tyle of same ($\times 100$); 9a ($\times 400$).
FIGS. 10, 11, 12.—Cortical tytes ($\times 100$).
FIG. 13.—Surface of *S. microstomus* var. *stellatus*, showing stellate poral areas ($\times 25$).
FIG. 14.—Surface of typical *S. microstomus*, showing circular poral areas ($\times 25$).
FIG. 15.—Surface of typical *S. caminatus* R. & D., showing stellate poral areas ($\times 25$).
FIG. 16.—Surface of *S. caminatus* R. & D. var. *papillatus*, var. n., showing papillated stellate poral areas ($\times 25$), p. 20.

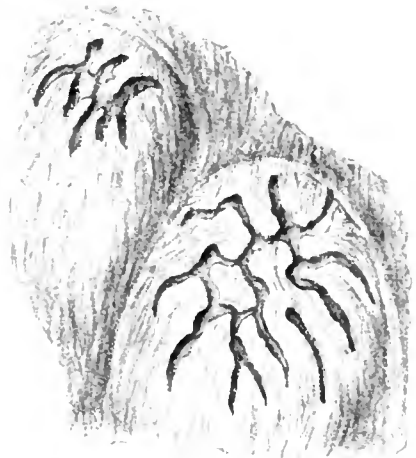
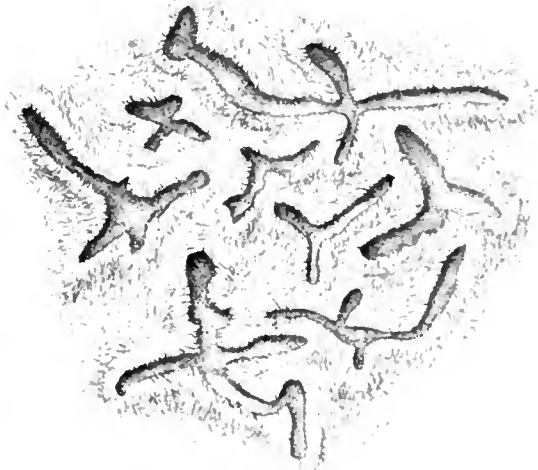
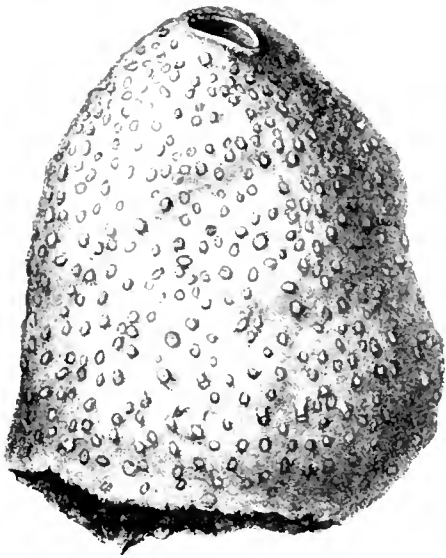

INDEX

1. Introduction	1
2. Theoretical background	10
3. Methodology	20
4. Results	30
5. Discussion	40
6. Conclusion	50
7. References	60
8. Appendix	70
9. Glossary	80
10. Index	90

PLATE XVI.

- FIG. 1. *Joguxia belli* Kirkp., nat. size, p. 41.
FIG. 2. Section of same through a poral tube, cortex and choanosome ($\times 10$).
FIG. 3. End of a larger poral tube, showing poral sieve ($\times 10$).
FIG. 4. Style (rare) ($\times 100$).
FIG. 5. Strongyle ($\times 100$); 5a, further enlarged.
FIG. 6. *Stylocordyla borealis* Lovén var. *acuta* var. n., nat. size, p. 22.
FIG. 7. Ectosomal micro-styles ($\times 100$); 7a ($\times 500$).
FIG. 8. Smaller oxea of the head of the sponge ($\times 100$).
FIG. 9. Heteroxea ($\times 100$).
FIG. 10. Large oxea of stem, with central swelling ($\times 100$).
FIGS. 11, 11a.—*Suberites caminatus* R. & D. var. *papillatus* n. var., nat. size, p. 20.
FIG. 12. Cortical tyle ($\times 100$).
FIG. 13. Ditto ($\times 100$).
FIG. 14. Tyle from radiating skeletal fibre ($\times 100$).

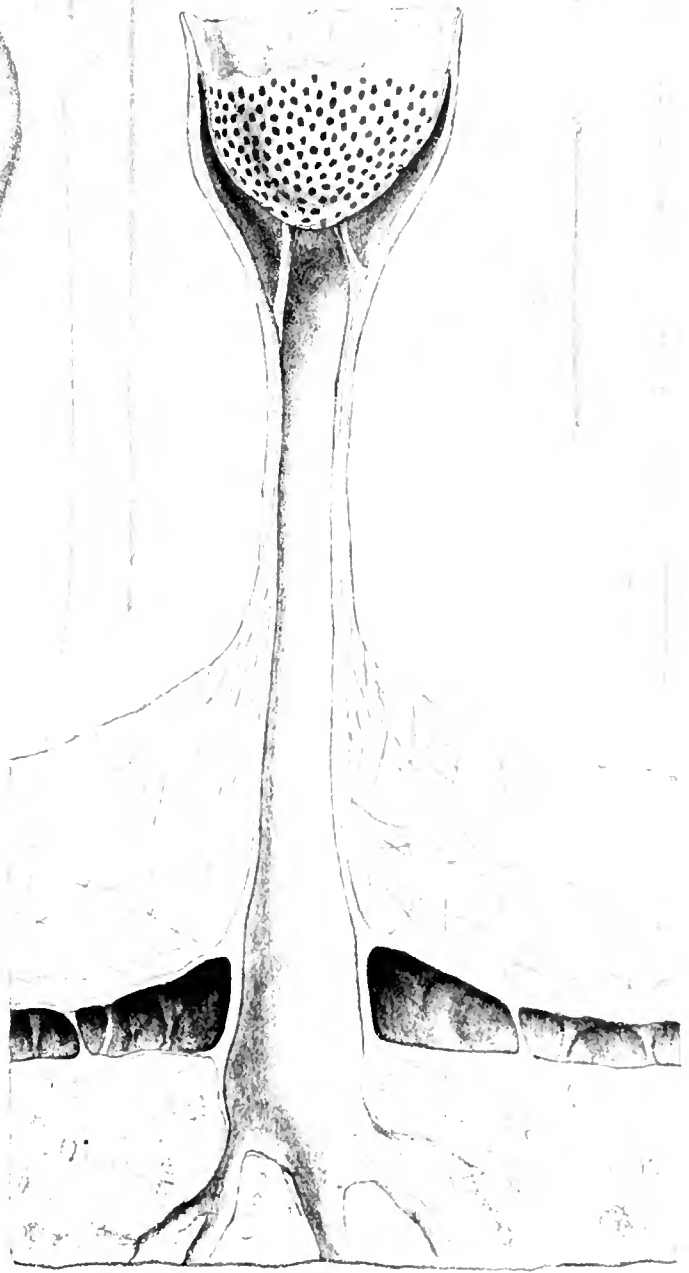
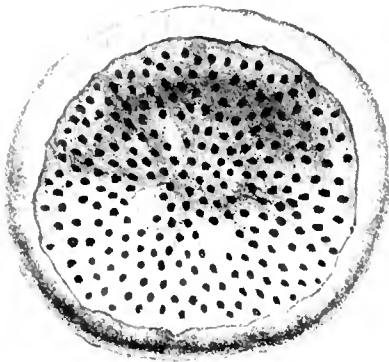
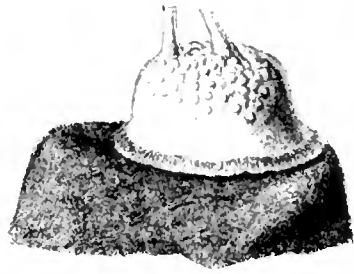

PLATE XVII.

- FIG. 1. — *Gellius rudis* Topsent, p. 45.
FIG. 1a. — Section of same ($\times 5$).
FIG. 2. — *Gellius fimbriatus* Kirkp., nat. size, p. 46.
FIG. 2a. — Section of same ($\times 5$).
FIG. 3. — *Gellius pilosus* Kirkp., nat. size, p. 47.
FIG. 3a. — Section ($\times 5$).
FIG. 4. — *Gellius glacialis* var. *nivea* Ridley and Dendy, nat. size, p. 49.
FIG. 5. — *Gellius cucurbitiformis* Kirkp., nat. size, p. 48.
FIG. 5a. — Another specimen of same, nat. size.
FIG. 5b. — Surface ($\times 65$).
FIG. 5c. — Section ($\times 65$).
FIG. 6. — *Sigmatinyssa phakellioides* Kirkp., nat. size, p. 23.

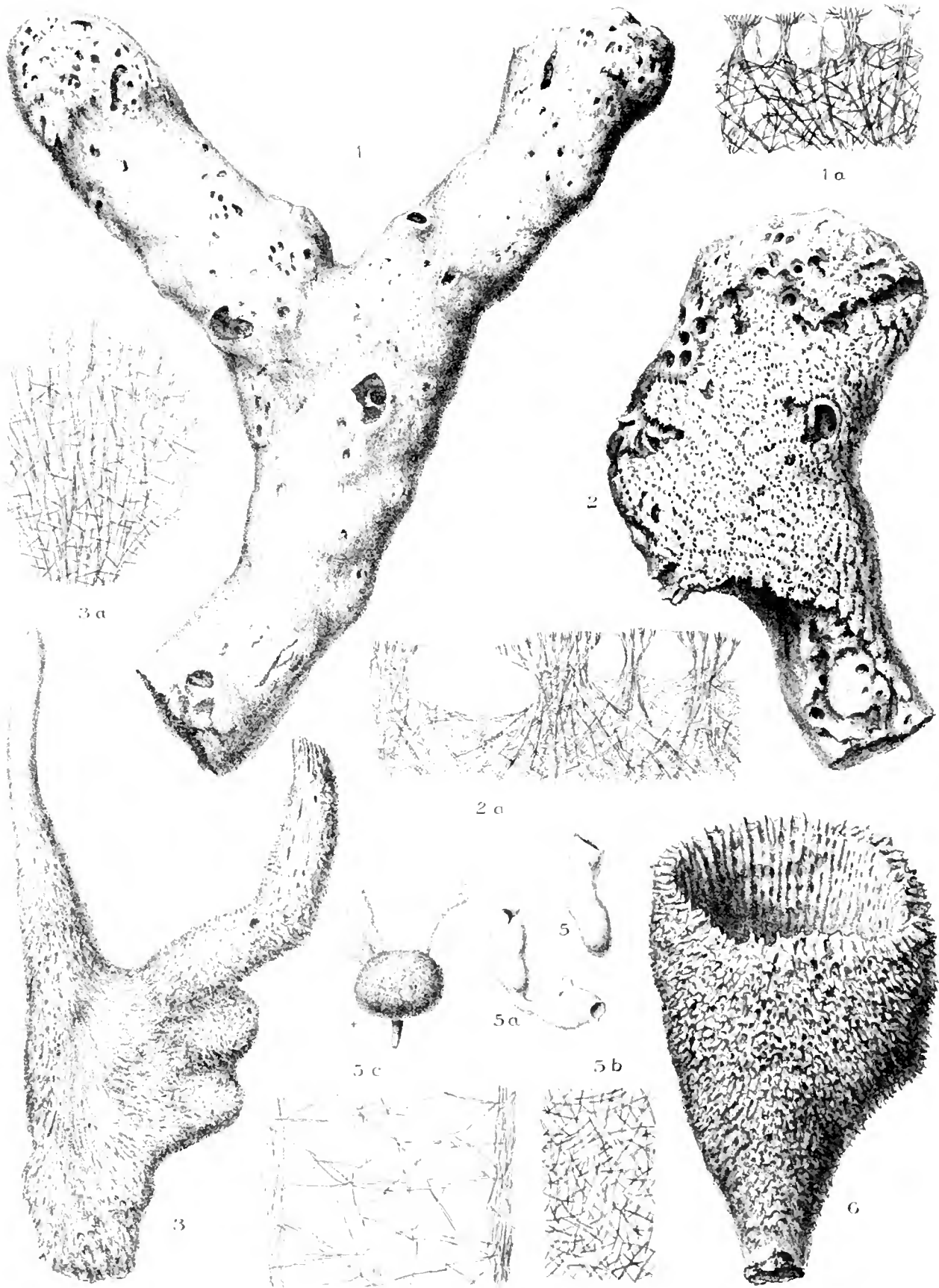
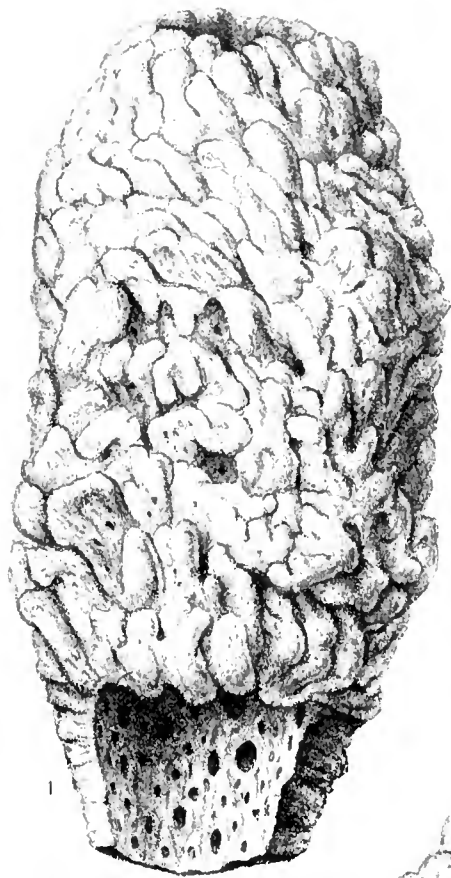
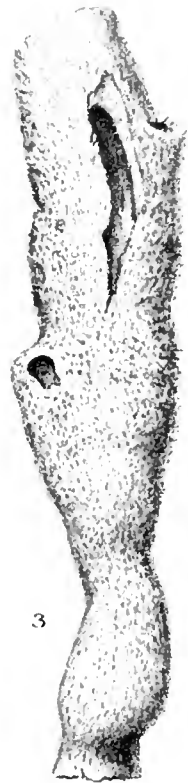

PLATE XVIII.

- FIG. 1.—*Reniera scotti* Kirkp., nat. size, p. 42.
FIG. 1a.—Surface, showing pores ($\times 2$).
FIG. 1b.—Vertical longitudinal section ($\times 8$).
FIG. 2.—*Reniera scotti*, another specimen.
FIG. 3.—*Reniera dancoi* Topsent, nat. size, p. 53.
FIG. 4.—*Petrosia fistulata* Kirkp., nat. size, p. 51.
FIG. 4a.—Surface of same ($\times 4$).
FIG. 4b.—Section ($\times 8$).
FIG. 5.—*Oceanapia tantula* Kirkp., fragments of fistulae, p. 52.
FIG. 5a.—Closed end of one of the fistulae ($\times 4$).
FIG. 5b.—Section ($\times 8$).



1 b



3

1 a



5 a



5 b



5



2



4 b

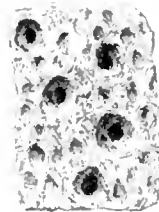

4 a



4

PLATE XIX.

- FIG. 1. *Desmacidon kerguelensis* R. & D. var. *australica* var. n. Nat. size, p. 37.
FIG. 1a. —Section of same ($\times 5$).
FIG. 2. *Desmacidon kerguelensis* R. & D. var. *cactoides* var. n. Nat. size, p. 38.
FIG. 3.—*Desmacidon spinigera* Kirkp. Nat. size, p. 39.
FIG. 3a. —Section of same ($\times 3$).
FIG. 4. *Desmacidon macandrina* Kirkp. Nat. size, p. 40.
FIG. 4a. —Section ($\times 2$).
FIG. 5. *Cercidochela lunkesteri* Kirkp. Nat. size, p. 42.
FIG. 5a. —Section of same ($\times 15$).
FIG. 6. *Hoplakithara denlyi* Kirkp. Nat. size, p. 44.
FIG. 6a. —The same ($\times 8$).
FIG. 6b. —Oblique section across the upper half of the specimen ($\times 25$).

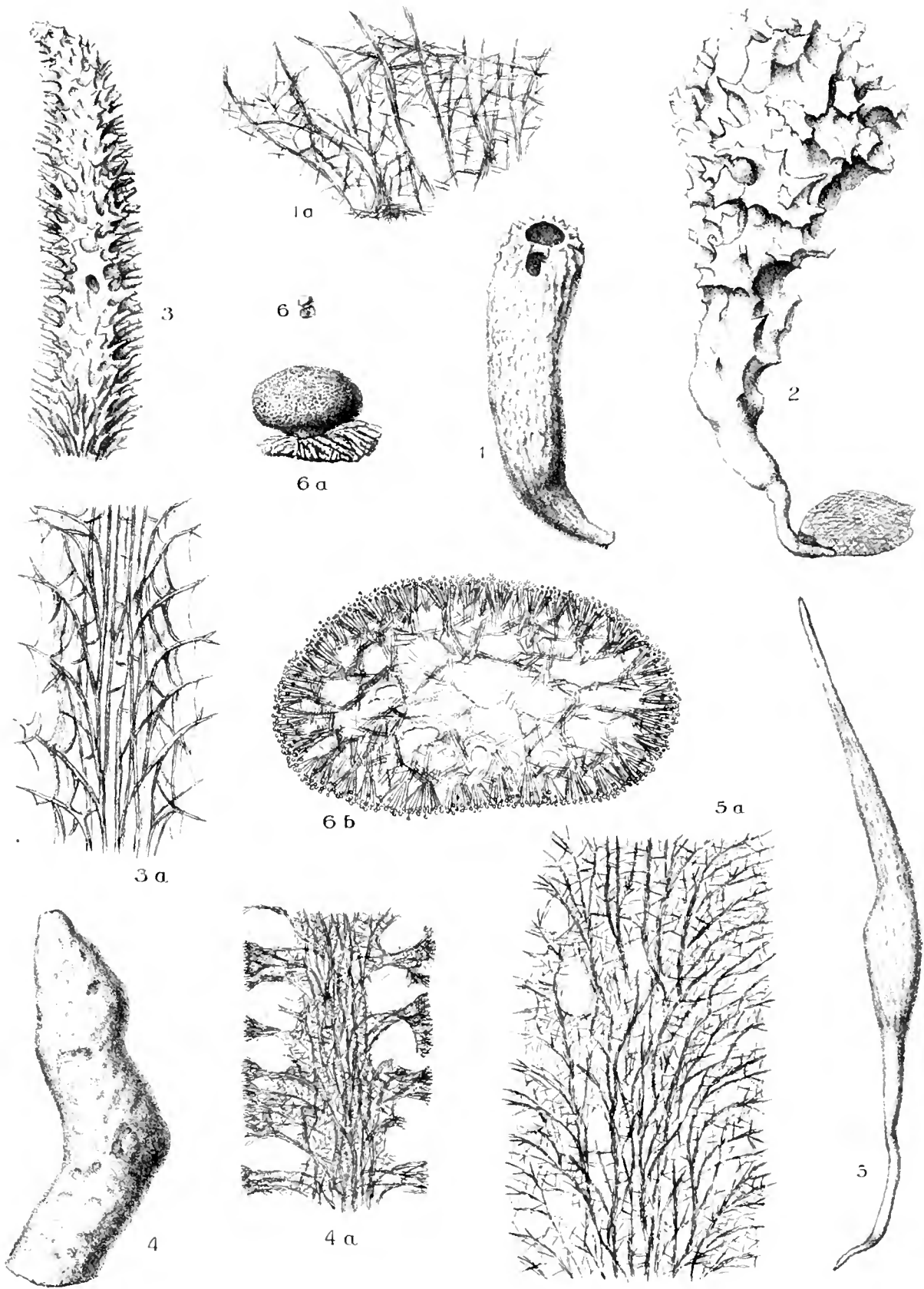



Z. 11. 11.

No. 1000

1911

1000

PLATE XX.

- FIG. 1. *Mycale acerata* Kirkp. $\frac{2}{3}$ nat. size, p. 36; *a*, surface ($\times 5$); *b*, vertical section, nat. size.
- FIG. 2. *Mycale magellanica* (Ridley). Dermal reticulum showing the uniformly level surface, p. 36.
- FIG. 3. *Esperiopsis villosa* (Carter). Nat. size, p. 35; *a*, *b*, villous and pilose surface ($\times 10$); *c*, vertical section ($\times 5$).
- FIG. 4.— *Artemisina apollinis* (R. & D.). $\frac{2}{3}$ nat. size, p. 34; *a*, villous process on the surface of the sponge ($\times 5$); *b*, surface ($\times 5$); *c*, vertical section ($\times 5$).

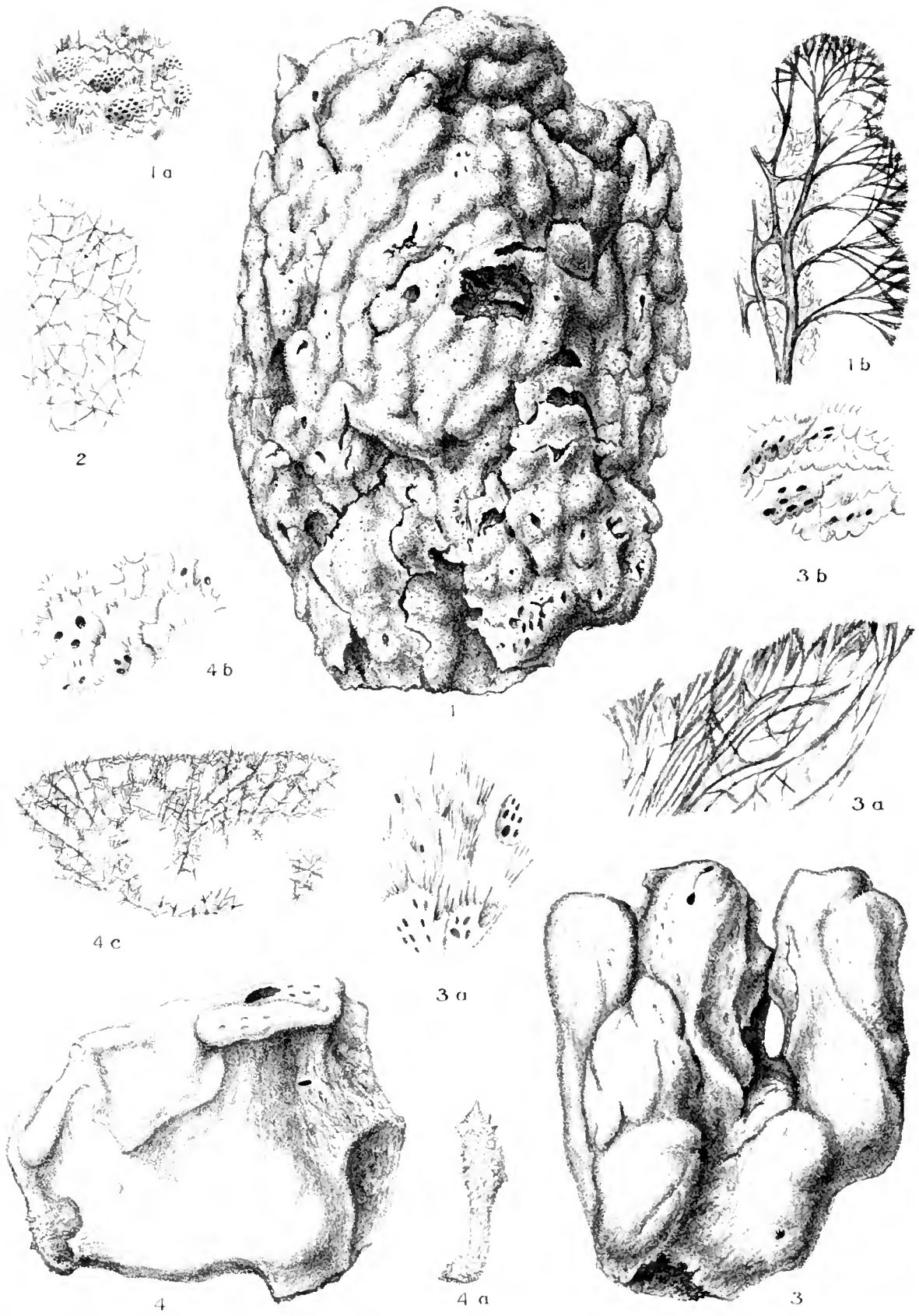
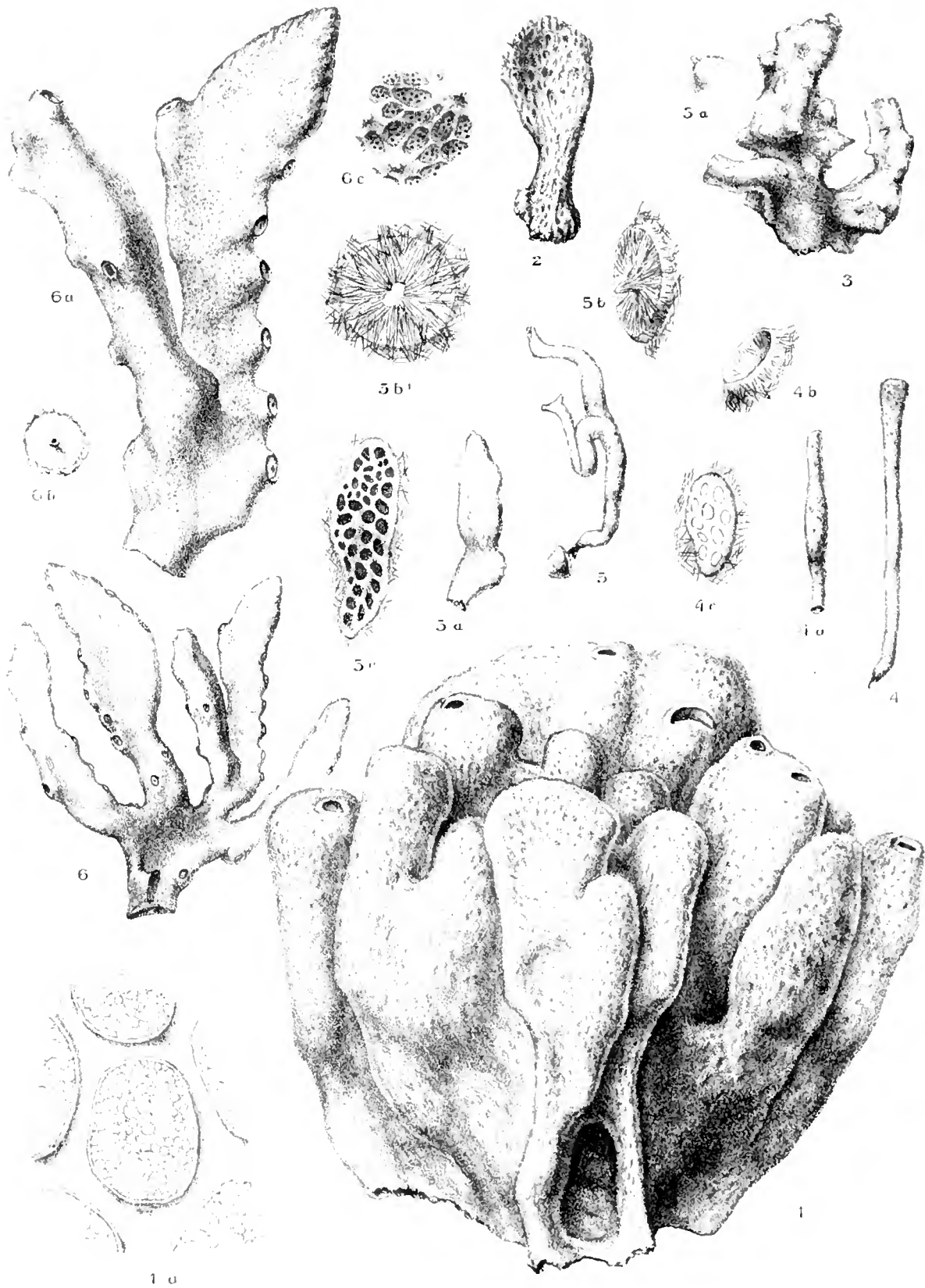

PLATE XXI.

- FIG. 1. — *Tedania variolosa* Kirkp., sp. n. $\frac{1}{2}$ nat. size, p. 32.
FIG. 1*a*. — Pore areas of same ($\times 10$).
FIG. 2. — *Tedania coulmani* Kirkp., p. 33.
FIGS. 3, 4, 4*a*. — *Iophon radiatus* Topsent. Nat. size, p. 28. 3*a*. closed oscule, $\times 2$.
FIG. 4*b*. — Open oscule of same ($\times 10$).
FIG. 4*c*. — Pore area of same ($\times 10$).
FIGS. 5. 5*a*. — *Iophon spatulatus* Kirkp., nat. size, p. 29.
FIG. 5*b*. — Oscule of same fully contracted, side view ($\times 10$).
FIG. 5*b*¹. — Oscule of same, front view ($\times 10$).
FIG. 5*c*. — Pore area of same ($\times 10$).
FIG. 6. — *Iophon flabello-digitatus* Kirkp. $\frac{1}{4}$ nat. size, p. 30.
FIG. 6*a*. — Branch of same, $\frac{1}{2}$ nat. size.
FIG. 6*b*. — Oscule of same, nat. size.
FIG. 6*c*. — Pore area of same ($\times 6$).



INDEX

Introduction	1
Chapter I. The History of the	10
Chapter II. The History of the	25
Chapter III. The History of the	40
Chapter IV. The History of the	55
Chapter V. The History of the	70
Chapter VI. The History of the	85
Chapter VII. The History of the	100
Chapter VIII. The History of the	115
Chapter IX. The History of the	130
Chapter X. The History of the	145
Chapter XI. The History of the	160
Chapter XII. The History of the	175
Chapter XIII. The History of the	190
Chapter XIV. The History of the	205
Chapter XV. The History of the	220
Chapter XVI. The History of the	235
Chapter XVII. The History of the	250
Chapter XVIII. The History of the	265
Chapter XIX. The History of the	280
Chapter XX. The History of the	295
Chapter XXI. The History of the	310
Chapter XXII. The History of the	325
Chapter XXIII. The History of the	340
Chapter XXIV. The History of the	355
Chapter XXV. The History of the	370
Chapter XXVI. The History of the	385
Chapter XXVII. The History of the	400
Chapter XXVIII. The History of the	415
Chapter XXIX. The History of the	430
Chapter XXX. The History of the	445
Chapter XXXI. The History of the	460
Chapter XXXII. The History of the	475
Chapter XXXIII. The History of the	490
Chapter XXXIV. The History of the	505
Chapter XXXV. The History of the	520
Chapter XXXVI. The History of the	535
Chapter XXXVII. The History of the	550
Chapter XXXVIII. The History of the	565
Chapter XXXIX. The History of the	580
Chapter XL. The History of the	595
Chapter XLI. The History of the	610
Chapter XLII. The History of the	625
Chapter XLIII. The History of the	640
Chapter XLIV. The History of the	655
Chapter XLV. The History of the	670
Chapter XLVI. The History of the	685
Chapter XLVII. The History of the	700
Chapter XLVIII. The History of the	715
Chapter XLIX. The History of the	730
Chapter L. The History of the	745
Chapter LI. The History of the	760
Chapter LII. The History of the	775
Chapter LIII. The History of the	790
Chapter LIV. The History of the	805
Chapter LV. The History of the	820
Chapter LVI. The History of the	835
Chapter LVII. The History of the	850
Chapter LVIII. The History of the	865
Chapter LIX. The History of the	880
Chapter LX. The History of the	895
Chapter LXI. The History of the	910
Chapter LXII. The History of the	925
Chapter LXIII. The History of the	940
Chapter LXIV. The History of the	955
Chapter LXV. The History of the	970
Chapter LXVI. The History of the	985
Chapter LXVII. The History of the	1000

PLATE XXII.

- FIG. 1. — *Myrilla decepta* Kirkp. on branch of Polyzoon, nat. size, p. 27.
FIG. 2. — The same encrusting a stone, nat. size.
FIG. 2*a*. — Surface of Fig. 2, enlarged.
FIG. 3. — *Hymedesmia areolata* Thiele, $\frac{2}{3}$ nat. size, p. 24.
FIG. 3*a*. — Oscule of same ($\times 2$); FIG. 3*b*. pore area ($\times 5$); 3*c*. vertical section ($\times 5$).
FIG. 4. — *Hymedesmia exigua* Kirkp., nat. size, p. 24.
FIG. 5. — *Hymerhaphia rufa* Kirkp., nat. size, p. 25.
FIG. 6. — *Ophidiaspongia nidificata* Kirkp., nat. size, p. 25.
FIG. 6*a*. — Section of half of echinated fibre ($\times 20$).
FIG. 7. — *Lissomyrilla hantschi* Kirkp., nat. size, p. 26.
FIG. 7*a*. — Vertical section of same ($\times 20$).
FIG. 8. — *Leivella supratumescens* Topsent, nat. size, p. 23.
FIG. 8*a*. — Longitudinal vertical section of same ($\times 20$).

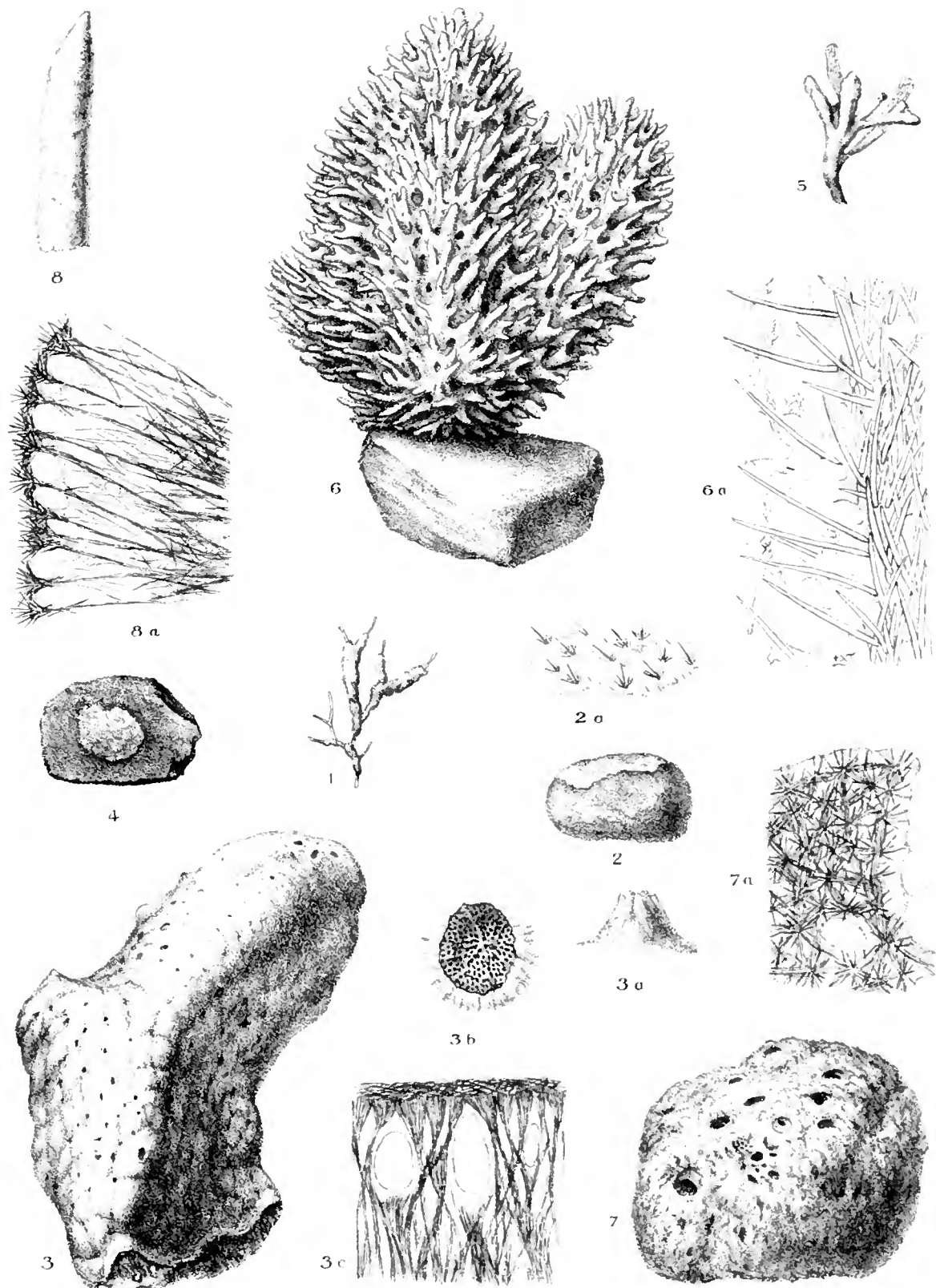

PLATE XXIII.

- FIG. 1.—*Desmacidon kerguelenensis* R. & D. var. *antarctica* var. n.; *a*, oxea ($\times 160$); *b*, side view; *b*¹, front view of isochela ($\times 1760$); *c*, a variety with smaller palmate tooth ($\times 1760$); *d*, *d*¹, side and front views of isochela from type of *D. kerguelenensis*, R. & D. ($\times 1760$); p. 37.
- FIG. 2.—*Desmacidon kerguelenensis* var. *ractoides* var. n.; *a*, stronglylate oxea ($\times 160$); *b*, *b*¹, front and side views of isochela ($\times 1760$); p. 38.
- FIG. 3.—*Desmacidon spinigera* Kirkp.; *a*, *b*, oxeas ($\times 160$); *c*, *c*¹, side and front views of palmate isochela ($\times 1760$), p. 39.
- FIG. 4.—*Desmacidon moranarini* Kirkp.; *a*, oxea ($\times 160$); *b*-*b*³, ancorae unguiferae ($\times 700$); p. 40.
- FIG. 5.—*Urcidochela lankesteri* Kirkp.; *a*, oxea ($\times 160$); *b*, *c*, *d*, *e*, canonocheles, developmental forms ($\times 700$); *f*, lateral view showing lamellae ($\times 700$); *g*, lateral view of side opposite to lamellae ($\times 700$); *h*, back view, *i.e.*, of the shaft, showing straight line of axial canal within the right edge ($\times 700$); *k*, half of a spicule broken across ($\times 700$); *l*, end view ($\times 700$), p. 42.
- FIG. 6.—*Hoplakithara doudyi* Kirkp.; *a*, oxea ($\times 160$); *b*, spherostyles ($\times 160$); *b*¹, spines on head of *b* ($\times 700$); *b*², end view of a spine; *c*, *c*¹, *c*², side, front, and back views of a fimbriated placochele, p. 44.

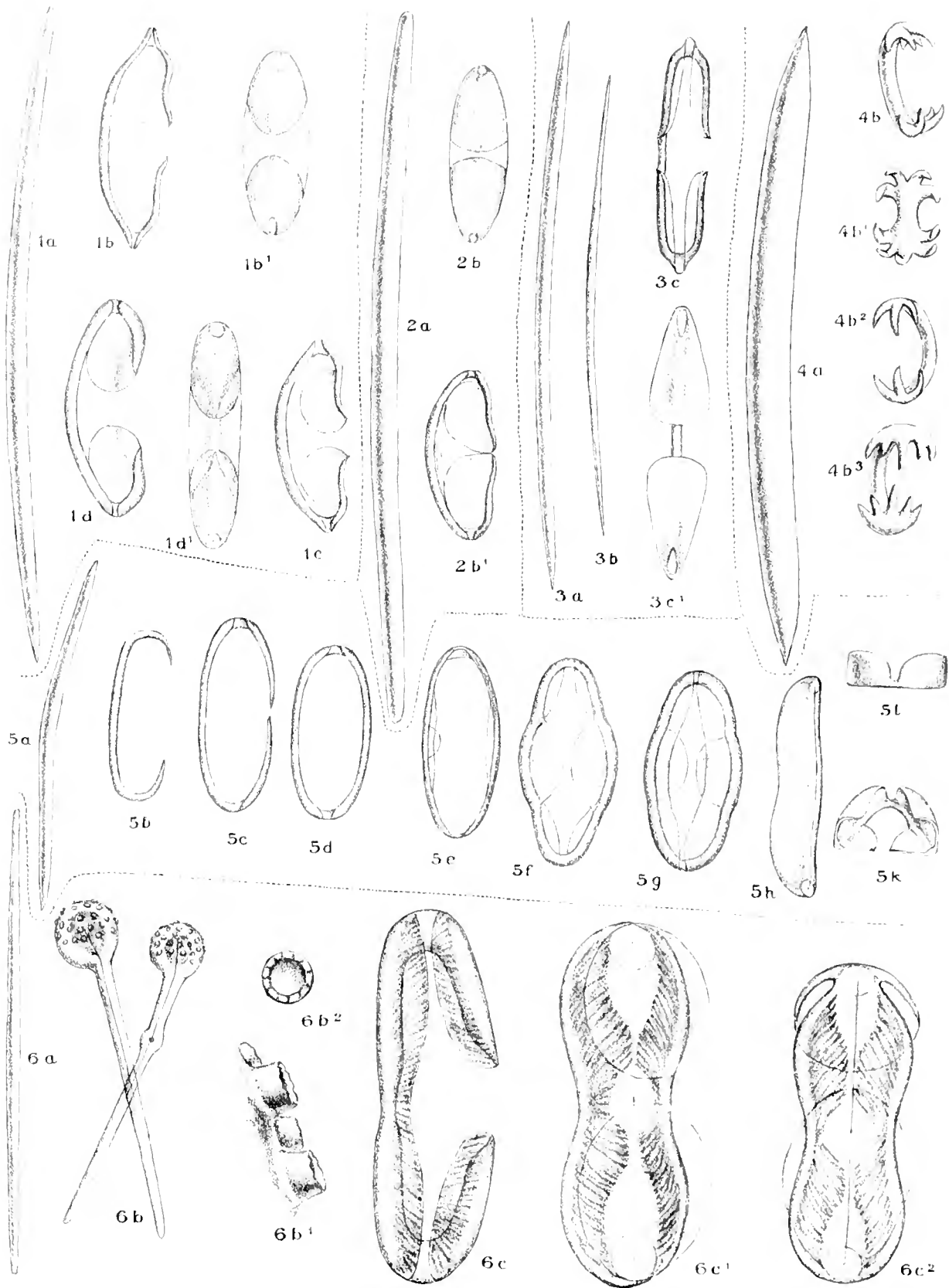

PLATE XXIV.

- FIG. 1.—*Gellius radis* Topsent : *a*, oxea ($\times 160$) ; *b*, sigma ($\times 700$), p. 45.
 FIG. 2.—*Gellius fimbriatus* Kirkp. : *a*, oxea ($\times 160$) ; *b*, sigma ($\times 700$), p. 46.
 FIG. 3.—*Gellius pilosus* Kirkp. : *a*, oxea ($\times 160$) ; *b*, *c*, sigmata ($\times 700$), p. 47.
 FIG. 4.—*Sigmarinyssa phakellioides* Kirkp. : *a*, oxea ($\times 160$) ; *b*, sigma ($\times 700$) ; *c*, toxon ($\times 160$), p. 23.
 FIG. 5.—*Gellius cucurbitiformis* Kirkp. : *a*, oxea ($\times 160$) ; *b*, sigma ($\times 700$), p. 48.
 FIG. 6.—*Reniera scotti* Kirkp. : oxea ($\times 160$), p. 52.
 FIG. 7.—*Petrosia fistulata* Kirkp. : oxea ($\times 160$), p. 51.
 FIG. 8.—*Oceanapia tantala* Kirkp., sp. n. : *a*, strongyle ($\times 160$) ; *b*, style ($\times 160$) ; *c*, amphityle ($\times 160$) ;
d, long smooth rhabdite ($\times 160$) ; *e*, shorter spined rhabdite ($\times 160$) ; *e*¹, the same ($\times 700$), p. 50.
 FIG. 9.—*Esperiopsis villosa* (Carter) : *a*, palmate isochele, larger kind ($\times 700$) ; *b*, smaller kind, side view
 ($\times 700$) ; *b*¹, front view ($\times 700$) ; *b*², front view ($\times 2900$), p. 35.
 FIG. 10.—*Mycale acerata* Kirkp. : *a*, oxea ($\times 160$), p. 36 ; *b*, palmate anisochele, side view ($\times 700$) ; *b*¹, the
 same, front view ($\times 700$) ; *c*, a variety with a spike on the margin of the central tooth of the
 smaller end ($\times 700$) ; *d*, smaller anisochele, side view ($\times 700$) ; *d*¹, front view of same ($\times 700$) ;
e, trichodragmata ($\times 160$) ; *e*¹, a rhabdite ($\times 700$).

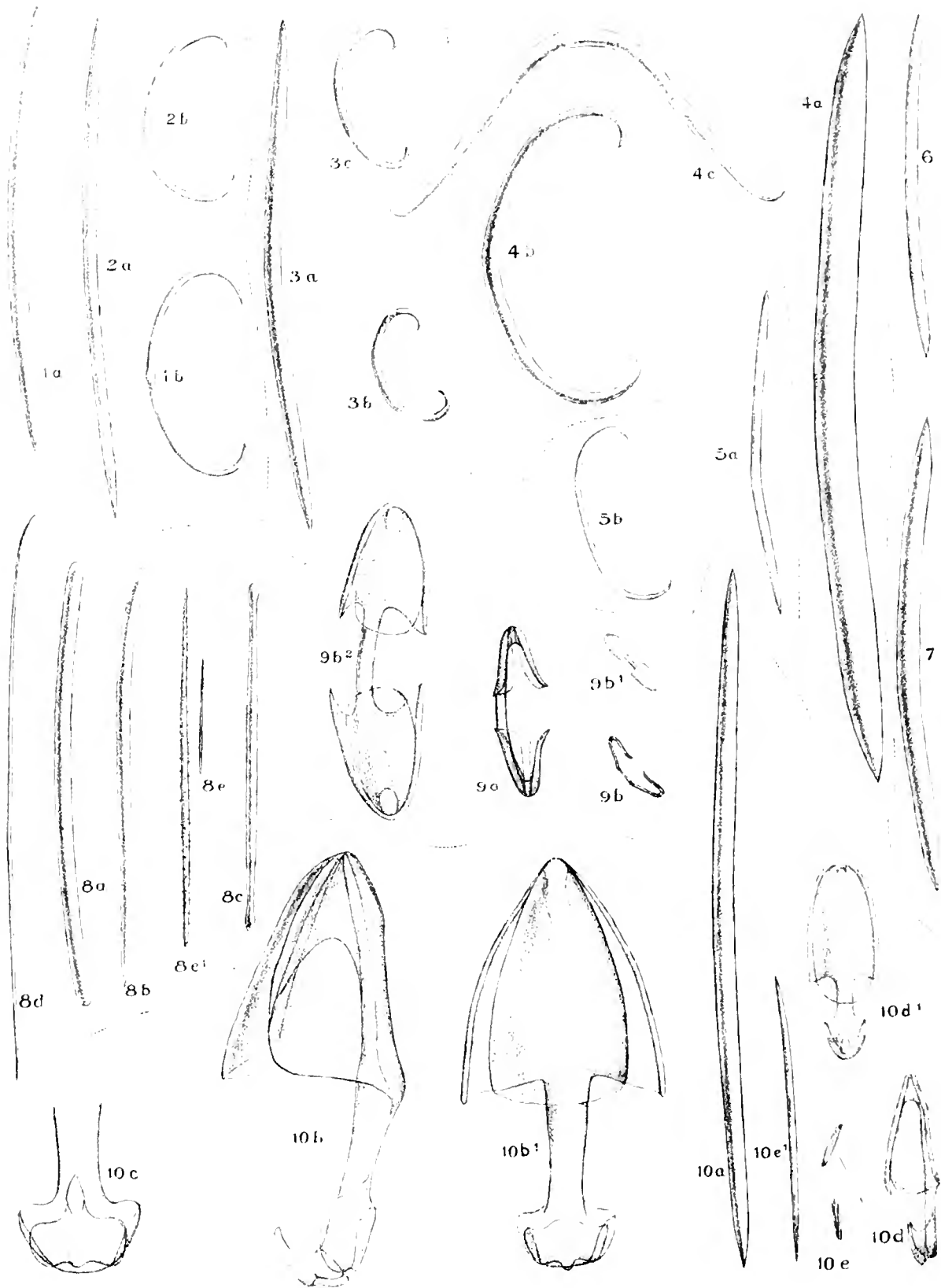
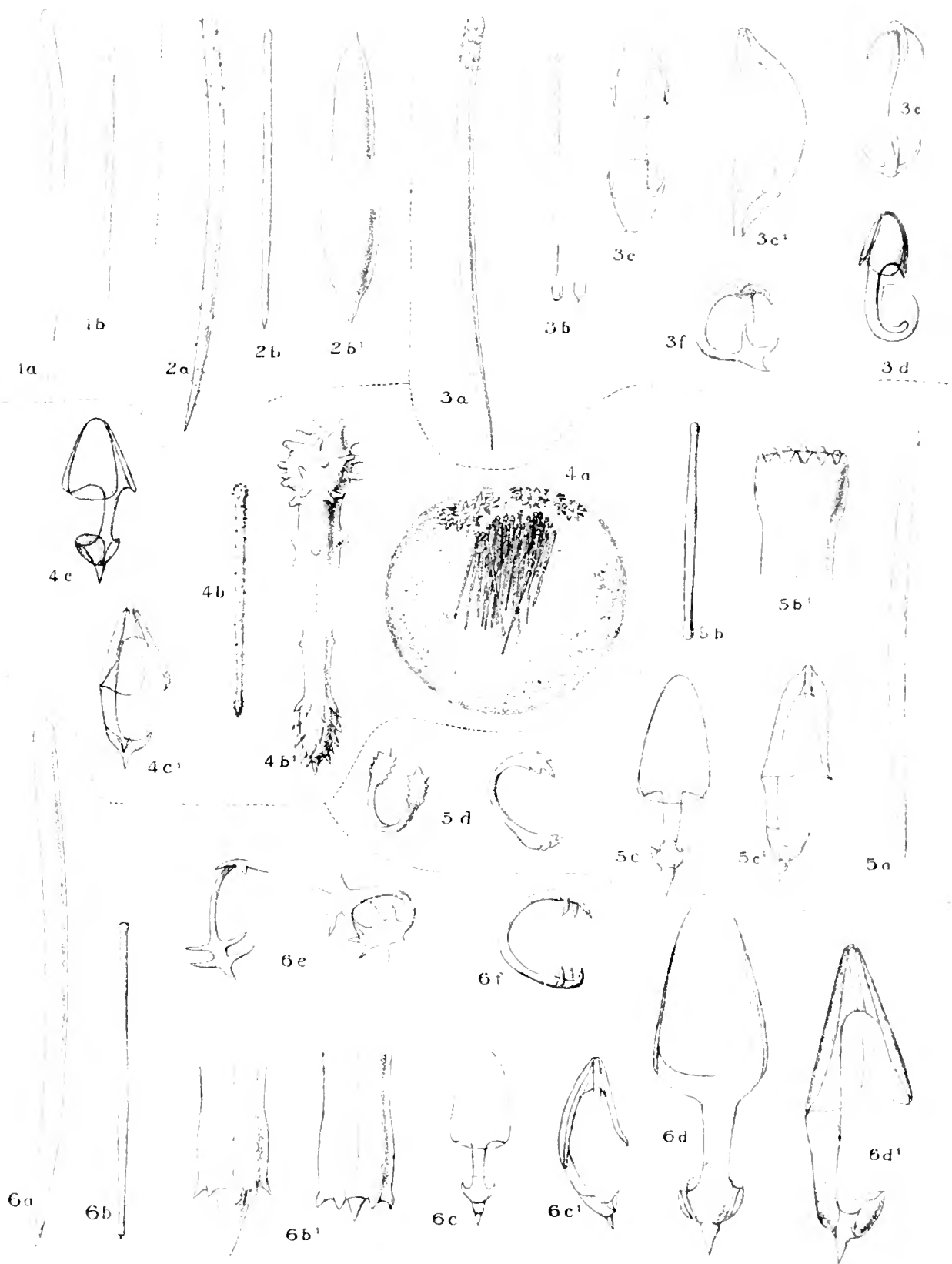

PLATE XXV.

- FIG. 1.—*Tedania variolosa* Kirkp. ; *a*, smooth style ($\times 160$) ; *b*, ectosomal strongyle ($\times 160$), p. 32.
- FIG. 2.—*Tedania coolmani* Kirkp. ; *a*, slightly spined style ($\times 160$) ; *b*, ectosomal tornote ($\times 160$) ; *b*¹, ends of same ($\times 700$), p. 33.
- FIG. 3.—*Myrilla decepta* Kirkp. ; *a*, acanthostyle ($\times 160$) ; *b*, ectosomal strongyle ; *c*, front view ; *c*¹, side view of arcuate isochele ($\times 1760$) ; *d*, the same, with one end spoon-shaped ($\times 1760$) ; *e*, isancora unguifera ($\times 1760$) ; *f*, chelate bipocillum ($\times 1760$), p. 27.
- FIG. 4.—*Iophon radiatus* Topsent ; *a*, part of embryo ($\times 160$) ; *b*, amphityle ($\times 380$) ; *c*, the same ($\times 1760$) ; *c*, front view ; *c*¹, side view of palmate anisochele ($\times 1760$), p. 28.
- FIG. 5.—*Iophon spatulatus* Kirkp. ; *a*, smooth, modified acanthostyle ($\times 160$) ; *b*, amphityle ($\times 160$) ; *b*¹, end of the same ($\times 1760$) ; *c*, front view ; *c*¹, side view of palmate anisochele ($\times 1760$) ; *d*, spatulate bipocilla ($\times 1760$), p. 29.
- FIG. 6.—*Iophon thabello-digitatus* Kirkp. ; *a*, smooth, modified acanthostyle ($\times 160$) ; *b*, sub-amphityle ($\times 160$) ; *b*¹, ends of same ($\times 1760$) ; *c*, *c*¹, front and side views of smaller palmate anisochele ; *d*, *d*¹, ditto of larger anisochele ($\times 1760$) ; *e*, spatulate bipocilla ($\times 1760$) ; *f*, (?) chelate bipocillum ($\times 1760$), p. 30.



PROBLEM 4

Let f be a function from \mathbb{R}^n to \mathbb{R}^n such that $f(0) = 0$ and $f(x) = Ax + o(\|x\|)$ as $\|x\| \rightarrow 0$. Suppose A is a symmetric matrix. Show that f is a local diffeomorphism at 0 if and only if A is invertible. (Hint: Use the Inverse Function Theorem.)

Let f be a function from \mathbb{R}^n to \mathbb{R}^n such that $f(0) = 0$ and $f(x) = Ax + o(\|x\|)$ as $\|x\| \rightarrow 0$. Suppose A is a symmetric matrix. Show that f is a local diffeomorphism at 0 if and only if A is invertible. (Hint: Use the Inverse Function Theorem.)

Let f be a function from \mathbb{R}^n to \mathbb{R}^n such that $f(0) = 0$ and $f(x) = Ax + o(\|x\|)$ as $\|x\| \rightarrow 0$. Suppose A is a symmetric matrix. Show that f is a local diffeomorphism at 0 if and only if A is invertible. (Hint: Use the Inverse Function Theorem.)

Let f be a function from \mathbb{R}^n to \mathbb{R}^n such that $f(0) = 0$ and $f(x) = Ax + o(\|x\|)$ as $\|x\| \rightarrow 0$. Suppose A is a symmetric matrix. Show that f is a local diffeomorphism at 0 if and only if A is invertible. (Hint: Use the Inverse Function Theorem.)

Let f be a function from \mathbb{R}^n to \mathbb{R}^n such that $f(0) = 0$ and $f(x) = Ax + o(\|x\|)$ as $\|x\| \rightarrow 0$. Suppose A is a symmetric matrix. Show that f is a local diffeomorphism at 0 if and only if A is invertible. (Hint: Use the Inverse Function Theorem.)

PLATE XXVI.

- FIG. 1.—*Ioplon stabella-digitatus* Kirkp. (specimen incrusting an Ophiurid): *a*, embryo with bundle of amphityles and ring of anisocheles ($\times 100$); *b*, tyle of embryo ($\times 380$); *b*¹, the same ($\times 1760$); *c*, *c*¹, anisochele of embryo, front and side view ($\times 1760$), p. 30.
- FIG. 2.—*Hymedesmia erigua* Kirkp.: *a*, tylote ($\times 160$); *a*¹, the same ($\times 380$); *b*, acanthostyle ($\times 160$); *c*, pluridentate isancora spatulifera ($\times 1760$); *c*¹, the same from above; *d*, *e*, the same, with central alae on shaft ($\times 1760$), *f*, sigma ($\times 1760$), p. 24.
- FIG. 3.—*Hynerchaphia rufa* Kirkp.: *a*, larger acanthostyle ($\times 160$); *b*, smaller acanthostyle ($\times 160$); *c*, ectosomal anisotornote ($\times 160$); *d*, isancora spatulifera ($\times 1700$); *e*, a variety of the same with cup-like ends ($\times 700$), p. 25.
- FIG. 4.—*Lissomyrilla hanitschi* Kirkp.: *a*, smooth style ($\times 160$); *b*, echinating acanthostyle ($\times 160$); *c*, ectosomal amphityle ($\times 160$); *c*¹, end of same ($\times 1760$), p. 26.
- FIG. 5.—*Ophlitaspongia nidificata* Kirkp.: *a*, smooth style ($\times 160$); *b*, a smaller curved style ($\times 160$); *c*, a still smaller straight (? ectosomal) style ($\times 160$); *d*, toxon ($\times 160$), p. 25.
- FIG. 6.—*Arinella supratumescens* Topsent: *a*, large style ($\times 160$); *b*, small ectosomal style ($\times 160$), p. 23.
- FIG. 7.—*Pseudosuberites hyalinus* (Ridley and Dendy): *a*, specimen, natural size; *b*, vertical longitudinal section ($\times 10$), p. 21.

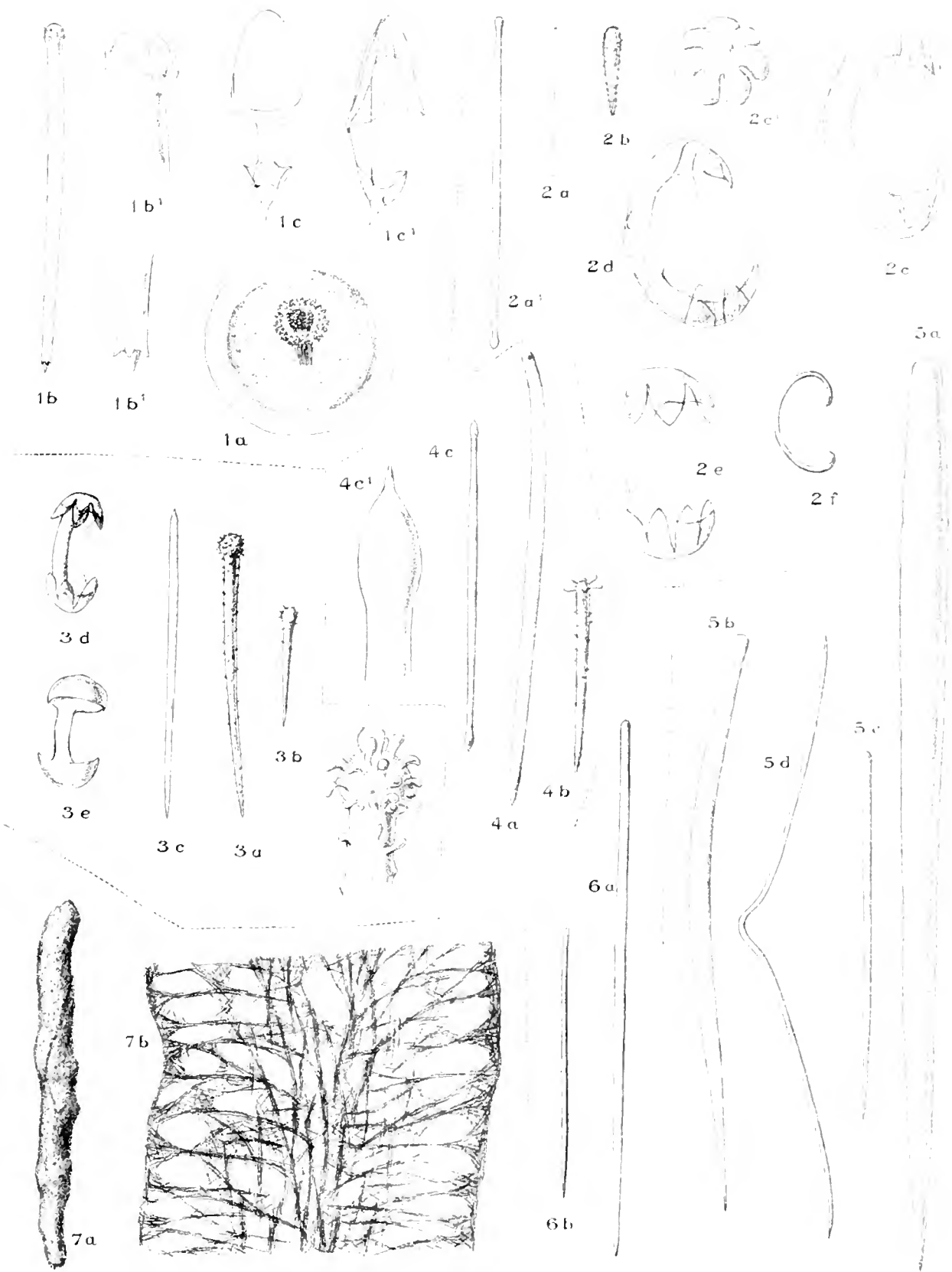

PORIFERA.

III.—CALCAREA.

By C. F. JENKIN, B.A.

(12 Plates.)

PART I.

INTRODUCTION AND CLASSIFICATION.

INTRODUCTION.

THE preparation of the Report on the 'Discovery' collection of calcareous sponges was, in the first instance, entrusted to Professor E. A. Minchin. He had partially examined the *Homocoela* and made some drawings of them, when he was unfortunately obliged to abandon the undertaking, owing to the pressure of other duties. The collection was then entrusted to the author, who has had the advantage of using Professor Minchin's notes on the *Homocoela* and his lifelike drawings (Figs. 12 and 14), showing the habit of growth of the two new species of *Leucosolenia*.

The author desires to record his indebtedness to Professor Minchin for much valuable advice, to Professor Dendy for valuable suggestions as to the classification of the new genera, and for specimens of *Grantiopsis cylindrica*, to Mr. R. Kirkpatrick for constant help and particularly for permission to examine the British Museum collection of calcareous sponges, to Professor R. von Lendenfeld for specimens of *Sycon tenellum*, and to Professor Jeffrey Bell, to whose kindness he owes the privilege of undertaking this most interesting investigation.

The collection consists of 109 specimens. Of these, 39 belong to the grade *Homocoela*, and are divided among five species, of which two are new to science. The remaining 70 belong to the grade *Heterocoela*, and are divided among 18 species and one variety of an existing species, all of which are new to science.*

Of the five species belonging to the grade *Homocoela*, two belong to the genus *Clathrina* and three to the genus *Leucosolenia*.

Of the 18 new species of *Heterocoela*, five belong to the genus *Leucandra* and the remaining 13 are distributed among six new genera.

CLASSIFICATION.

The classification here used, which is shown in the following table, is that proposed by Poléjaeff (4) for the *Homocoela* and by Dendy (2) for the *Heterocoela*

* With the possible exception of three of the species, which can only be considered as provisionally settled.

and adopted with slight modifications by Minchin (1); it has been considerably extended to include the new species. The last column in the table gives the number of species in each genus found in the 'Discovery' collection.

Families.	Genera.	Number of Species in 'Discovery' Collection.
GRADE A.—HOMOCOELA.		
1. Clathrinidæ	{ Clathrina Ascandra. Dendya.	2
2. Leucosoleniidæ	{ Ascyssa. Leucosolenia	3
		5 species.
GRADE B.—HETEROCOELA.		
1. Sycettidæ	{ Sycetta. Sycon.* <i>Teuthrenodes</i>	2
2. Grantiidæ	{ Grantia.† Ute. Sub-genus Symte. Utella. Anamaxilla. Sycissa. Leucandra Lelapia. Leucyssa. <i>Dermatreton</i>	5 and 1 variety.
3. Heteropidæ	{ Grantessa. Heteropia. <i>Vosmaropsis</i> .	2
4. Amphoriscidæ	{ Heteropegma. Amphoriscus. Syculmis. Leucilla.	
5. <i>Chiphorida</i>	{ <i>Streptoconus</i> <i>Hypodictyon</i>	1 1
6. <i>Staurorrhaphidæ</i>	{ <i>Achramorpha</i> Sub-genus Grantiopsis. <i>Megapogon</i>	3 4
		18 species and 1 variety.

In the above table the names of the new families and genera are printed in italics.

* The genus *Sycantha* is omitted for reasons stated on p. 4.

† *Grantiopsis* is transferred to the family *Staurorrhaphidæ*.

This classification is based primarily on the arrangement of the spicules, as is shown in the following diagram, where the families are arranged in four columns to show their dependence on the spiculation. The families on the same horizontal line correspond more or less in their canal systems.

NO SUBDERMAL SPICULES.		SUBDERMAL TRIRADIATES.		SUBDERMAL QUADRIRADIATES.		CHIACTINES.	
Family.	Genus.	Family.	Genus.	Family.	Genus.	Family.	Genus.
1. Sycettidæ	{ Sycetta	5. Chiphoridae . . .	{ Streptoconus.
	{ Sycon.						{ Hypodictyon.
2. Grantiidæ	{ Grantia.	3. Heteropidæ	{ Grantessa.	4. Amphoriscidæ	{ Heteropegma.	6. Staurorrhaphidæ	{ Achramorpha.
	{ Ute.						{ Heteropia.
	{ Synute.	Vosmæropsis	{ Syculmis.	{ Megapogon.
	{ Utella.						
	{ Anamaxilla.						
	{ Sycissa.						
	{ Leucandra . . .						
	{ Lelapia.						
	{ Leucyssa.						
	{ Dermatreton.						

NEW FAMILIES.—The two new families, *Chiphoridæ** and *Staurorrhaphidæ*,† are introduced to contain the 9 new species and 2 old ones which have chiactine spicules. The name *chiactine* ‡ is introduced to denote a special type of quadriradiate spicule which differs from the ordinary quadriradiates both in shape and in position in the sponge. The chiactine is a quadriradiate spicule lying with its basal ray directed radially outwards (centrifugally) and its apical ray, which is bent at its base so as to lie almost in line with the basal ray, directed radially inwards (centripetally) and projecting into the gastral cavity.§ This type of spicule has hitherto been found in only 2 species of sponge, each represented by a single specimen, viz., *Leuconia crucifera*, Poléjaeff (4) and *Grantiopsis cylindrica*, Dendy (7). The former is now included in the new genus *Megapogon*. The latter is transferred to the new family *Staurorrhaphidæ*, the generic name being retained. In order to make the present report a complete record of all species in the two new families, brief descriptions of *Megapogon crucifera* and *Grantiopsis cylindrica*, with drawings of the spicules, are included.

In some of the new species this type of spicule occurs in conjunction with the ordinary types, but in several it forms the whole gastral and body-wall skeleton, to the exclusion of the ordinary quadriradiates and triradiates; its importance, therefore, can hardly be over-rated, and fully justifies the formation of the new families. All the species containing chiactines might have been included in one family instead of two, but as they fall into two groups, which differ from each other in the same way that the *Sycettidæ* do from the *Grantiidæ*, it seemed better to divide them under two corresponding new families.

* χί, a cross; φορεῖν, to bear.

† σταυρός, a cross; ῥάφης, a needle or spicule.

‡ χί, a cross; ἀκρίς, a ray.

§ For a detailed description of the chiactines see Part III.

NEW GENERA.—The new genera, *Hypodictyon*,* *Dermatreton*,† and *Tenthrenodes*,‡ are introduced to contain the five new species which have “linked” flagellated chambers. The term “linked” is here used to describe the peculiar arrangement of the flagellated chambers in an open network or honeycomb pattern, so that a large number surround each of the very large incurrent canals (intercanals). In *Sycon* and *Grantia* the incurrent canals are usually smaller than the flagellated chambers, and are each surrounded by only three or four flagellated chambers.

Three of the new species have freely projecting distal cones; two of these are included in the new genus *Tenthrenodes*, in the family *Sycettidæ*, and the third, which contains chiaetines, is in the corresponding genus *Hypodictyon*, in the family *Chiphoridæ*. The two remaining species have distinct dermal cortices, and are, therefore, included in the new genus *Dermatreton*, in the family *Grantiidæ*. The dermal cortex is not continuous, but takes the form of a network covering the top of the flagellated chambers, and is pierced by large holes corresponding to the spaces (incurrent canals) between those chambers.

The “linked” arrangement of the flagellated chambers appeared to resemble closely the “grouped” arrangement described by von Lendenfeld (6) as occurring in *Sycantha tenella*. As doubts existed concerning the accuracy of some of the details of this description, it seemed advisable to re-examine the specimens. The author was enabled to make this examination by the great courtesy of Professor von Lendenfeld, who sent him all the remaining material he possessed. This material is considerably macerated (as is stated by von Lendenfeld in his original description), but is in quite good enough condition to allow the general structure to be ascertained with certainty. The results of the author’s examination show that all von Lendenfeld’s figures represent the structure correctly except Figs. 53, 54 and 56, which, though no doubt accurately drawn, are quite misleading. The interpretation placed on the figures by him appears, however, to be erroneous, and would seem to be due to the unfortunate cross-section shown in Fig. 56. The true structure is best shown in Fig. 57, representing a tangential section near the gastral cortex. This figure shows the regular rectangular network formed by the chamber walls. The rectangles are alternately flagellated chambers and canals, arranged like a chess board, exactly in the manner shown in Haeckel’s “Kalkschwämme,” Fig. 13, Plate 60, as typical of his sub-genus *Sycocubus* (sub-genus 3 of *Sycandra*). Haeckel’s figure shows (correctly) the arrangement of the flagellated chambers and inter-canals of *Sycon schmidtii*; this arrangement only differs from that of *Sycantha tenella* in the shape of the flagellated chambers, which in *Sycon schmidtii* are approximately square (in tangential section), whereas in *Sycantha tenella*, though still rectangular, they are much longer in one direction (parallel to the axis of the sponge) than in the other (circumferentially). *Sycantha tenella* is, therefore, a typical *Sycon*, remarkable for the size and regular arrangement

* ὑπο, under; δίκτυον, a net.

† δέρμα, skin; τρητός, holed.

‡ τενοθρευωδης, honeycombed.

of the flagellated chambers. The flagellated chambers touch each other only at the corners and have no intercommunication canals. Serial tangential sections show that each flagellated chamber opens independently into the gastral cavity. (See Plate XXXVIII, Fig. 137.) This may also be inferred by comparing the distances between the openings into the gastral cavity, shown in von Lendenfeld's Figs. 56 and 58, and the distances between the flagellated chambers shown in Fig. 57 (remembering that the rectangles are alternately flagellated chambers and canals). The cross-sections made by the author correspond exactly with the structure above described. It is, therefore, evident that there is no similarity between *Sycon tenellum*, as it should now be called, and the new genera with "linked" chambers.

The new genus *Streptoconus*,* in the family *Staurorrhaphidæ*, corresponds with *Sycon* in the *Sycettidæ*.

The new genera *Achromorpha*† and *Megapogon*‡ in the family *Staurorrhaphidæ* correspond with *Grantia* and *Leucandra* in the *Grantiidæ*.

Dendy's sub-genus *Grantiopsis* is transferred from the *Grantiidæ* to the *Staurorrhaphidæ*, because the only species (*Grantiopsis cylindrica*) contains chiacetine.

TERMINOLOGY.—The following terms are used to describe the different pores and passages by which the water passes through the sponge:—

Ostia.—The pores in the dermal membrane through which the water first enters the sponge.

Prosopyles.—The openings in the flagellated chambers by which the water enters them.

Apopyles.—The openings in the flagellated chambers by which the water leaves them.

Ports.—This is a new term used to describe the openings in the gastral membrane by which the water passes from the excurrent chambers into the gastral cavity.

Pore is only used in a general sense for any of the above.

Incurrent chambers.—The large spaces sometimes found under the dermal cortex. The water enters them by the ostia and leaves them by the incurrent canals.

Incurrent canals.—The passages by which the water reaches the outside of the flagellated chambers. They communicate with the outside water either through the ostia or directly.

Excurrent canals.—The passages by which the water, leaving the flagellated chambers through the apopyles, reaches the gastral cavity or oscule.

Excurrent chambers.—The spaces sometimes found outside the gastral membrane into which several excurrent canals or several apopyles open. The water flows out of them through ports into the gastral cavity.

Oscule.—The opening by which the water finally leaves the sponge. It may be at the end of one or more excurrent canals, or at the top of the gastral cavity.

Oscular collar.—A thin tubular extension of the body wall, without flagellated chambers, leading to the oscule.

The most interesting features of the collection are:—

(a) The large number of species (9) containing chiacetine spicules.

(b) The five new species with "linked" flagellated chambers.

(c) A remarkable sponge, *Megapogon villosus*, with larger spicules than any hitherto recorded for a calcareous sponge. The oxea are upwards of 15 mm. long.

* στρεπτός, twisted; κώνος, a cone.

† ἄχρα, a pear; μορφή, form.

‡ μέγας, great; πώγων, a beard.

(d) The development of the gelatinous mesoderm in *Leucandra gelatinosa*.

(e) The duplicate ovum, apparently a new type of egg cell, in *Megapogon raripilus*.

Locality.—All the specimens were taken, at various dates, in Winter Quarters and most of them from shallow waters.

PART II.

DESCRIPTION OF THE SPECIMENS WITH DEFINITIONS OF THE NEW GENERA AND SPECIES.

GRADE HOMOCOELA POL.

FAMILY CLATHRINIDÆ MINCHIN.

CLATHRINA PRIMORDIALIS.

Ascetta primordialis Haeckel (3), Vol. II., p. 16.

There is one small broken specimen of this species in the collection. In colour it is yellow as preserved in spirits. The spicules agree exactly with Haeckel's description.

CLATHRINA CORIACEA.

Ascetta coriacea Haeckel (3), Vol. II., p. 24.

There are two small broken specimens of this species in the collection. In colour they are yellow, as preserved in spirits. The spicules agree exactly with Haeckel's description.

FAMILY LEUCOSOLENIIDÆ MINCHIN.

LEUCOSOLENIA COMPLICATA.

Leucosolenia complicata Minchin (8), p. 360.

There are five pieces of sponges of this species in the collection. The spiculation agrees closely with the revised description given by Minchin.

LEUCOSOLENIA DISCOVERYI.

(Plate XXVIII., Figs. 12–13.)

There are about twenty-five specimens of this new species in the collection. Its appearance and habit of growth are admirably shown in Fig. 12, drawn by Professor Minchin. Its colour is white as preserved in spirits. The oscular tubes in some specimens attain a length of 9 mm. and a diameter (flattened) of 1 mm.

Spicules (Fig. 13).

The following description is due to Professor Minchin :—

Orea.—The monaxon spicules of this species are very constant and characteristic. They are divisible at the outset into (a) ordinary and (b) refringent monaxons :—

- (a) The ordinary monaxons are curved and vary greatly in dimensions, from about $100\ \mu$ to $450\ \mu$ or more in length, and from $3\ \mu$ to $16\ \mu$ in thickness. Every possible gradation is to be found between the greatest extremes in size, so that it is not possible to divide these spicules into different classes. The shaft is thickest near the proximal end, which is also nearly straight for rather more than half the length; from this point the shaft curves evenly, and tapers slightly, towards the distinct lance-head, which usually shows very plainly the form of a double bend, especially in the smaller examples of this type of spicule. Among the ordinary monaxons there are always a very few Γ type monaxons: these are very rare, and only one or two are usually found in a whole spicule slide.
- (b) The refringent monaxons are much scarcer than the ordinary type, but they are easily found, as their optical peculiarity makes it easy to distinguish them from the others, especially under a low power of the microscope. Like the ordinary monaxons, they show a wide range of variation in size, from small to very large. Their form is similar to that of the ordinary monaxons in a general way, but shows certain constant peculiarities; the shaft is very slightly curved, sometimes nearly perfectly straight; the proximal swelling of the shaft contrasts more sharply with the distal extremity, which is often very slender and tapers down rapidly about half-way from the proximal end; and the lance-head tends to be rudimentary or even quite absent. By these special features the spicules can easily be recognised as a distinct class, apart from their characteristic appearance under the microscope.

Triradiates.

- (c) The ordinary triradiates are of fairly large size, in form very similar to those of *Leucosolenia complicata*, with the unpaired rays markedly longer than the paired rays. The unpaired ray is straight and slender, varying in length from about $110\ \mu$ to as much as $185\ \mu$. The paired rays are generally slightly thicker than the unpaired, sometimes distinctly so; they curve symmetrically, first in a backward direction for the proximal two-thirds of their length, then forwards for the distal third; in length they vary from $100\ \mu$ to $145\ \mu$, the average length being about mid-way between these two extremes. The anterior angle is an open one, but the lateral angles are always greater than right angles, the spicules never being T-shaped as in

botryoides. In young specimens the triradiates are generally smaller and more slender than in the larger colonies.

Quadriradiates.

- (d) These spicules are generally much scarcer than the simple triradiates, but can always be found. Their facial rays are similar to the triradiates, with perhaps slightly less tendency to elongation of the unpaired rays. The gastral ray is short or of moderate length, laterally compressed, and set well back on the unpaired facial ray; its proximal end runs straight upwards for about two-thirds of its length, then the shaft curves forwards, the distal extremity, however, being again nearly straight.

Spiculation of the Ocular Rim.

The skeletal spicules of the ocular rim appear to be quadriradiates alone. They are of relatively small size and slender dimensions; the lateral angles are very nearly or even quite right angles, so that the spicule is more or less T-shaped; the unpaired rays are always distinctly longer than the paired, the latter being strongly curved, and the gastral rays are relatively long.

The monaxons of the ocular rim are, with rare exceptions, of the smallest size. Both ordinary and refringent monaxons are found; the former differ from those in other parts in the slenderness of the shaft, the proximal end of which is scarcely or not at all swollen. The refringent monaxons in this region are also very slender and sharp.

LEUCOSOLENIA MINCHINI.

(Plate XXVIII., Figs. 14-15.)

There are about eleven specimens of this new species in the collection, most of them being ocular tubes only, with very little root tube. Their appearance and habit of growth are well shown in Fig. 14, drawn by Professor Minchin. The ocular tubes, which are 3 mm. to 4 mm. long, are usually largest towards the middle of their length. Diameter, flattened, about 5 mm. The bulk of the skeleton spicules are triradiates, regularly arranged and often in rather open order, so that the walls have a transparent appearance. The oxea, which are small, usually about 90μ long and never exceeding 160μ , are usually scarce, and in some specimens almost, if not entirely, wanting. In the specimens with plentiful oxea there is a fringe round the oscule, see Fig. 15, but in the specimens with few oxea there is little or no fringe.

Spicules (Fig. 15).

Oxea.—There are two sorts of oxea, ordinary and refringent:—

- (a) Ordinary oxea, straight or slightly curved, with a lance head which is usually bent slightly to one side, 60μ to 160μ long \times 3μ to 6μ thick.

The commonest size is $90\ \mu$ long \times $4\ \mu$ to $5\ \mu$ thick. In some specimens the maximum size is $90\ \mu$ long.

Among the ordinary oxea there are a very few Γ type oxea. It is uncertain whether these are always present. It seems probable that in those specimens in which the oxea are very scarce there may be none of Γ type.

- (b) Refrigent oxea, similar to the smaller and thinner sizes of (a) and usually nearly straight.

The *Triradiates* are of one sort :—

- (c) Alate triradiates, with the basal ray longer than the paired rays. Basal ray straight, tapering, fairly sharply pointed, $90\ \mu$ to $140\ \mu$ long \times $5\ \mu$ to $10\ \mu$ thick. Paired rays equal, bent very slightly downwards, tapering slightly for about two-thirds of their length, then fairly sharply pointed, $50\ \mu$ to $90\ \mu$ long \times $5\ \mu$ to $7\ \mu$ thick ; oral angle 130° to 140° .

The *Quadriradiates* are of one sort :—

- (d) Alate quadriradiates, facial rays the same as the triradiates (c). Apical ray sharply pointed.

Oscular spicules :—

- (e) Oxea from the fringe, like (a) but shorter, with bluntly pointed lance heads, $55\ \mu$ to $65\ \mu$ long \times $5\ \mu$ to $6\ \mu$ thick.
- (f) Quadriradiates from the oscular edge like (d), but of the smallest size, the paired rays rather more bent. Oral angle 160° .

GRADE HETEROCOELA POL.

FAMILY SYCETTIDAE DENDY.

TENTHRENODES.

A Sycettid in which the radial chambers, with freely projecting distal cones, are "linked" so as to form a reticulated pattern round the large inter-canals.

This genus contains two species. In both these species the sponge is in the form of a tube, usually more or less bent, the cross-section being probably circular when alive, though it is considerably flattened in some of the preserved specimens. The diameter of the tube is greatest near the middle of its length. It tapers to the base, which is rounded off, and also to the top, which terminates in the oscule. The interior of the tube forms the gastral cavity. The inner or gastral layer is supported by a special skeleton of tri- and quadriradiates, the apical rays projecting into the gastral cavity. Outside the gastral layer stand the flagellated chambers, pointing more or

less radially, and "linked" into a meshwork pattern. They communicate with the gastral cavity either in groups through excurrent chambers (*T. scotti*) or independently (*T. antarcticus*).

TENTHRENODES SCOTTI.*

(Plate XXVII., Fig. 9; and Plates XXVIII. and XXIX., Figs. 16-27.)

There are two specimens of this new species in the collection, the larger one perfect, the smaller one a broken fragment. Both were fixed in osmic acid and preserved in alcohol. The larger and perfect specimen is referred to in the following description.

The sponge as preserved is flattened so that the opposite walls are in contact. Its shape in this flattened condition is shown in Fig. 16. The length is 115 mm. and the diameter (flattened) 32 mm. The colour is brown, owing to the osmic acid, and was probably white in life.

The whole surface is covered with a conspicuous honeycomb pattern due to the linking of the flagellated chambers. When slightly magnified the pattern is seen to consist of a principal network of larger and deeper meshes divided by a finer network of shallower meshes (see Fig. 9). To the naked eye the meshes appear to be smooth. The pattern extends up to the oscular edge, the size of the meshes diminishing gradually from the middle of the sponge to the oscule.

Canal System.—The flagellated chambers communicate through contractile apopyles with excurrent chambers, which open through irregular ports into the gastral cavity. The canal system is extremely difficult to make out in this species, owing to the very irregular shapes of the flagellated chambers near their bases and the erratic way in which they are crowded together. The presence of the excurrent chambers can be ascertained most easily by examining the gastral surface under a low power. The ports in the gastral wall are large enough to allow the interiors of the excurrent chambers to be inspected and two or three of the apopyles to be seen in each. Sections cut either perpendicular or parallel to the axis of the sponge are almost useless for demonstrating the structure, but serial tangential sections enable the actual connections to be followed satisfactorily and bring out the peculiar "linked" arrangement of the chambers admirably. Figs. 17-20 represent corresponding parts of four tangential sections chosen for illustration from a complete series; Fig. 17 shows the ports in the gastral layer; Fig. 18 the grouping of the chambers in the sub-gastral layer; Fig. 19 the grouping higher up, where both large and small meshes occur; Fig. 20 the grouping on the surface, where only large meshes occur, the smaller ones not reaching so high; the section includes the tops of most of the chambers, but a few project further and therefore appear cut through. Several groups of cells are numbered, and may be followed from one section to another.

In order to show the structure more clearly, the group of flagellated chambers com-

* This species, represented by the finest specimen in the collection, is named after the distinguished leader of the Expedition.

municating with the largest excurrent chamber in Fig. 18 is shown in Figs. 21–24 on a larger scale. Fig. 21 represents the subgastral structure, and shows the cells grouped round and partly over the excurrent chamber: the section includes the bottom diaphragms and apopyles of five of the flagellated chambers. The excurrent chamber extends below these apopyles, but exactly how far cannot be seen. The position of the port in the gastral layer, which is much smaller than the full extent of the excurrent chamber, is shown by the dotted line. Fig. 22 represents the next section higher, and includes the top of the excurrent chamber with one apopyle; the second apopyle belonging to flagellated chamber *K* cannot be clearly made out and has not been shown, though it must be present. Fig. 23 shows the same group of chambers higher up and Fig. 24 higher still.

Skeleton.—The gastral skeleton is a dense felt of large quadriradiates, with the basal rays pointing in all directions, though the majority point more or less towards the base of the sponge. The apical rays, which are very sharp, project into the gastral cavity. The arrangement of the spicules is shown in Fig. 26, which represents the same part that is shown in Fig. 21; in this drawing only a certain number of the spicules actually present are drawn. The large number of the distorted τ spicules is rather remarkable. The articulated tubar skeleton is formed of triradiates which are bent over the distal end of the chamber, forming a thick rounded end and not a cone. The tops of contiguous flagellated chambers are joined together by the fusion of their skeletons, which thus form a sort of dermal cortex, *cf.* Fig. 20, similar to that in genus *Dermatreton*. In the present species, however, the flagellated chambers are of different lengths, and consequently the dermal cortex is very irregular and not clearly defined, so that it seems advisable to include it in *Tenthrenodes* rather than *Dermatreton*. Round the distal ends of the chambers there are rings of oxea which project slightly.

The oscular skeleton differs very little from the normal gastral and dermal skeletons. The quadriradiates are rather smaller than the ordinary gastral quadriradiates. There is a thick fringe of hair oxea. The meshwork of flagellated chambers extends right up to the oscular edge, terminating in a scalloped edge. Fig. 25 represents a longitudinal section through the oscule at a point where the mesh reaches the edge.

Spicules (Fig. 27).

The *Oxea* are of one sort :

- (a) Projecting oxea, $160\ \mu$ to $240\ \mu$ long \times $10\ \mu$ to $15\ \mu$ thick, slightly and irregularly bent, thickest towards the outer end, which is bluntly pointed; the inner end is rather more sharply pointed.

The *Triradiates* are of one sort :

- (b) Alate triradiates from the body-wall and dermal cortex. Basal rays straight, tapering to a sharp point, $90\ \mu$ to $330\ \mu$ long \times $9\ \mu$ thick. Paired rays, unequal (appearing the more so owing to folding), bent slightly

upwards, $80\ \mu$ to $150\ \mu$ long \times 8 to $10\ \mu$ thick. Oral angle 110° to 125° . Occasionally a τ shaped variety is found.

The *Quadriradiates* are of one sort :

- (c) Large alate quadriradiates from the gastral layer. Basal ray straight, tapering uniformly to a very sharp point, $420\ \mu$ to $680\ \mu$ long \times $10\ \mu$ thick. Paired rays equal, bent slightly downwards near the centre, then straight, $330\ \mu$ to $380\ \mu$ long \times $10\ \mu$ to $11\ \mu$ thick. Oral angle 140° to 150° . The τ shaped variety is fairly common. Apical ray slightly bent orally, sharply pointed, $50\ \mu$ long \times $8\ \mu$ to $12\ \mu$ thick. Occasionally the apical ray appears to be wanting.

Oscular spicules.

- (d) The oscular fringe consists of hair spicules over $400\ \mu$ long.

The triradiates are the same as (b); the quadriradiates are similar to (c), only much smaller. The projecting oxea are the same as the smaller sizes of (a).

TENTHRENODES ANTARCTICUS.

(Plate XXIX., Figs. 28-32.)

There are three specimens of this new species in the collection; they are easily distinguished by the naked eye from *T. scotti*, owing to their having bare basal tubes and bare oscular collars, so that the sponge presents the appearance of an oval ball pierced by a tube. The dimensions of the three specimens are :—

11 mm. long \times 3 mm. diameter.

4 mm. „ \times 1.2 mm. „

10 mm. „ \times 1.6 mm. „

In colour they are white as preserved in spirits.

The flagellated chambers are branched near their proximal ends, and each opens directly into the gastral cavity through a contractile apopyle. They have articulated skeletons which terminate at the distal end in freely projecting cones of triradiates, amongst which are a few small oxea (see Fig. 28).

The gastral skeleton (see Fig. 29), consisting of large tri- and quadriradiates, extends the whole length of the tube.

The oscular edge has a very regular skeleton of small quadriradiates closely packed together, with a fringe of hair oxea (see Fig. 30). Unfortunately the specimens are not in a sufficiently good state of preservation to allow the exact structure of the basal tube to be made out. There are indications of a lining of flagellated cells in the basal tube, continuous with the lining of the lowest radial flagellated chambers. These chambers appear to arise as bulgings of the gastral layer.

It is unfortunate that this interesting structure cannot be made out with certainty. The origin of the flagellated chambers near the oscule can be seen clearly; an isolated group of flagellated cells forms outside the gastral layer, and over this a few triradiates and oxea grow (see Fig. 31*a*). As the flagellated chamber grows it tips up the triradiates and oxea, which thus begin to point outwards while they continue to grow (see Fig. 31*b*). At the oscular end of the sponge therefore the flagellated chambers do not grow as diverticula of the gastral layer, nor is there any lining of flagellated cells in this part of the gastral cavity.

Spicules (Fig. 32).

The *Oxea* are of one sort :

- (*a*) Small projecting oxea, slightly irregularly bent, faintly hastate at the thinner end, bluntly pointed at the thicker end. $70\ \mu$ to $210\ \mu$ long \times $6\ \mu$ to $10\ \mu$ thick.

Triradiates. The triradiates are of two sorts :—

- (*c*) Alate triradiates from the gastral layer. Basal ray straight, tapering slightly, then pointed; maximum size $480\ \mu$ long and $12\ \mu$ thick. Paired rays unequal, slightly irregularly bent, maximum size $160\ \mu$ long \times $12\ \mu$ thick. Oral angle 130° to 135° .
- (*d*) Alate triradiates from the tubar skeleton. Basal ray straight, tapering slightly, then pointed, $100\ \mu$ to $140\ \mu$ long \times $6\ \mu$ to $7\ \mu$ thick. Paired rays nearly equal, straight, $70\ \mu$ long \times $6\ \mu$ to $8\ \mu$ thick. Oral angle 120° to 130° .

The *Quadriradiates* are of one sort :—

- (*e*) Alate quadriradiates from the gastral layer. Basal ray straight, tapering slightly, then bluntly pointed, $320\ \mu$ to $480\ \mu$ long \times $10\ \mu$ to $12\ \mu$ thick. Paired rays unequal, nearly straight, $140\ \mu$ to $240\ \mu$ long \times $10\ \mu$ to $12\ \mu$ thick. Oral angle 130° to 140° . Apical ray bluntly pointed, slightly bent orally, $130\ \mu$ to $180\ \mu$ long, oval in section, $8\ \mu$ to $12\ \mu$ thick \times $12\ \mu$ to $16\ \mu$ deep. In side view the apical rays sometimes appear swollen near the point, the depth being greater than at the junction with the facial rays.

Oscular spicules :—

- (*f*) Quadriradiates from the oscular edge, basal ray straight or slightly bent backwards, $110\ \mu$ to $140\ \mu$ long \times $8\ \mu$ thick. Paired rays about equal, bending downwards, bluntly pointed, $80\ \mu$ to $110\ \mu$ long \times $10\ \mu$ thick. Oral angle 145° to 155° . Apical rays short and sharply pointed.

The triradiates in the oscular collar are similar to (c), but have longer paired rays.

The fringe consists of:—

(g) Minute oxea, $120\ \mu$ long \times $1\ \mu$ to $2\ \mu$ thick.

FAMILY GRANTIIDAE DENDY.

LEUCANDRA Dendy.

The collection contains five new species and one new variety belonging to this genus.

The genus *Leucandra*, as defined by Dendy, is too comprehensive and needs subdivision. The minute structure of the species belonging to the genus has not been sufficiently examined; the wide variations in the development of the mesoderm, and also the arrangement of the incurrent and excurrent canals, require investigation. Some notes on these points are contained in Part III.

Want of accurate knowledge about the structure makes the classification of the species in this genus difficult and uncertain. The species *Leucandra frigida*, *Leucandra brumalis*, and *Leucandra gelatinosa* can only be considered as provisional; *Leucandra cirrata* and *Leucandra hiberna* are more definitely differentiated.

LEUCANDRA PRIMIGENIA, H. var. *leptoraphis*.

(Plate XXIX., Figs. 33-34.)

Leucetta primigenia Haeckel (3), Vol. II., p. 118.

There are two specimens of this new variety in the collection. The larger consists of an irregular mass of anastomosing branches (Fig. 33), dirty white in colour as preserved in spirits. The surface is mostly smooth, but in places is more open or spongy in structure. The branches have a very small gastral cavity running down them, ending in inconspicuous closed oscules. It agrees with Haeckel's description of *Leucetta primigenia* (var. *isoraphis*), except that the spicules are very much slenderer. Haeckel gives the ratio of length of arm to thickness as 10 to 12. Poléjaeff, for the 'Challenger' specimens of *Leucetta primigenia*, which he calls *Leucetta fruticosa*, gives the ratio 12 to 15. The new variety has the ratio 25 to 40. The spicules are shown in Fig. 34, with one of the 'Challenger' specimens of *Leucetta primigenia* for comparison beside them. Haeckel does not describe the alate oscular spicules, which, in the new variety, differ widely from the normal spicules, as will be seen from the figure. These spicules lie with the basal rays circumferentially round the oscule, and not, as might have been expected, symmetrically.

Poléjaeff's species, *Leucetta dura*, cannot now remain, since it is only based on the existence of an oscule which was supposed not to be always present in *Leucetta microraphis*.

Spicules (Fig. 34).

The *Body spicules* are of one sort :—

- (a) Regular triradiates. Rays straight, very slender, parallel, bluntly pointed, $140\ \mu$ to $200\ \mu$ long \times $4\ \mu$ to $7\ \mu$ thick. Ratio of length to thickness, 25 to 40.

The *Oscular spicules* are of one sort :—

- (b) Alate triradiates, strongly folded. Basal ray straight, nearly parallel, bluntly pointed, $55\ \mu$ to $90\ \mu$ long \times $7\ \mu$ to $8\ \mu$ thick. Paired rays nearly straight in facial view, and twice bent when viewed parallel to the basal ray. Tapering, moderately sharply pointed, $90\ \mu$ to $140\ \mu$ long \times $8\ \mu$ to $10\ \mu$ thick. Oral angle 105° to 115° . Angle of fold 110° .

LEUCANDRA FRIGIDA.

(Plate XXVII., Fig. 6, and Plates XXIX. and XXX., Figs. 35-40.)

There are eleven specimens of this new species in the collection. They are all fig-shaped, with the oscule at the thick end (see Fig. 6). The surface is smooth, pure white and rather chalky in appearance. They vary in size from 10 mm. \times 3 mm. to 30 mm. \times 10 mm. (see Fig. 35). They are all solid to the touch, though they vary very much in texture when cut open. All but one of the specimens have the oscule completely closed, and its presence is only indicated externally by a slight protuberance. One specimen, 21 mm. long \times 7 mm. diameter, has the oscule open; it is 2 mm. in diameter, and is surrounded by a short spiculated membranous collar (see Fig. 39).

The canal system varies considerably in the different specimens; in some there is a wide gastral cavity with large branching canals opening into it, while in others there is no gastral cavity, the excurrent canals all converging to the oscule. In cross-section the specimens differ less than might be expected, for the gastral cavity appears to be divided by delicate septa, which give the whole section a meshwork appearance even when longitudinal sections show a large cavity.

The excurrent canals are usually surrounded with a fairly distinct skeleton of triradiates, among which are a few quadriradiates.

The incurrent canal system is made up of a series of very irregular spaces leading from the surface into the rather more regular longitudinal canals; these run parallel to the excurrent canals, from which they may be distinguished by their less pronounced skeleton, which never contains quadriradiates.

The bulk of the skeleton consists of regular triradiates; the quadriradiates round the gastral cavities and excurrent canals are very constant in size. In some specimens they are so rare that they can only be found with great difficulty. The apical rays, which are slender and crooked, project into the canals.

Spicules (Fig. 40).

The *Triradiates* are of one sort :—

- (a) Approximately regular triradiates. Rays straight, tapering, rather bluntly pointed, $130\ \mu$ to $310\ \mu$ long \times $10\ \mu$ to $20\ \mu$ thick. One of the rays is occasionally rather longer than the other two, the maximum ratio observed being $5/4$. Very rarely one of the rays is shorter than the other two, the maximum ratio observed being $3/2$. The angles in all cases are almost exactly equal ; τ forms are occasionally found.

The rare *Quadriradiates* are of two sorts :—

- (b) Approximately regular quadriradiates from the lining of the excurrent canals and gastral cavities. Facial rays straight, slender, slightly tapering, bluntly pointed, $160\ \mu$ to $200\ \mu$ long \times $9\ \mu$ to $12\ \mu$ thick. Angles equal, 120° . Apical rays slender, wavy, sharply pointed, $280\ \mu$ long \times $8\ \mu$ to $9\ \mu$ thick.
- (c) Abnormal quadriradiates apparently due to the growth of a very short apical ray on one of type (a) triradiates.

LEUCANDRA BRUMALIS.

(Plate XXX., Figs. 41–43.)

There are five specimens of this new species in the collection. They have no very definite shape (see Figs. 41 and 42), but all are considerably longer than they are broad, and each has a single small gastral cavity, surrounded at the upper end by a small membranous collar about 2.5 mm. long. They are smooth and white as preserved in alcohol. The consistency of the sponge is fairly solid.

Canal System.—There are small incurrent chambers under the dermis, communicating with irregular, more or less radial, incurrent canals. The excurrent canals are also more or less radial, opening into the gastral cavity.

The Skeleton consists of slender regular triradiates with a few regular quadriradiates round the gastral cavity. The apical rays, which project into the gastral cavity, are very slender and crooked, the point being usually bent rather sharply.

This species resembles *Leucaltis pumila*, var. *Bleckii* (H), but the triradiates are much smaller and slenderer, while the quadriradiates are regular instead of irregular.

Spicules (Fig. 43).

The *Triradiates* are of one sort :—

- (a) Regular triradiates, rays straight, tapering uniformly to a fairly sharp point, $170\ \mu$ to $180\ \mu$ long \times $6\ \mu$ to $10\ \mu$ thick.

The *Quadriradiates* are of one sort :—

- (b) Regular quadriradiates of varying size from the lining of the excurrent canals. Facial rays almost straight, tapering to a point 60μ to 180μ long \times 4μ to 8μ thick. Apical ray very slightly wavy, sharply pointed. The point usually bent a little to one side, 50μ to 120μ long \times 3μ to 4μ thick.

LEUCANDRA GELATINOSA.

(Plate XXX., Figs. 44–53.)

There are two specimens of this new species in the collection ; one fixed in osmic acid, which is therefore brown, and the other in spirits, which is quite white. The consistency is firm and the surface smooth. The general shape of the larger specimen shown in Fig. 44 is irregular and contorted, suggesting a tuberous root ; the oscule, which is entirely closed, is at the top of the dome-shaped end. The diameter of this part of the specimen is 11 mm. : the smaller specimen is in the form of a rod 24 mm. long, nearly straight, rounded off at the oscular end, which is 4 mm. diameter, and tapering gradually to the lower end, which is 2 mm. diameter.

The mass of the sponge is formed of the solid gelatinous mesoderm, which is remarkably developed in this species, and the incurrent and excurrent canals are reduced to definite pipes lined with epithelium in this jelly. There is no gastral cavity, the numerous excurrent canals converge to the oscule in the top of the domed end. These canals are regular circular pipes of small section lined with an extremely elastic epithelium, which has contracted to such an extent as to almost close the lumens of the canals (see Figs. 45 and 46).

The flagellated chambers are scattered throughout the body of the sponge and communicate with the excurrent canals by means of narrow outlet pipes. The outlet pipes from several flagellated chambers usually join together before they open into the main excurrent canals. These small outlet pipes are lined with elastic epithelium, which is continuous with the lining of the main excurrent canals, so that when the main canals close the small pipes are stretched out lengthwise in order to maintain their connection with the central lumen of the main canal (see Fig. 46).

There are a large number of small ostia (see Fig. 48), close together all over the dermal surface (see Fig. 47), which communicate through narrow passages (see Fig. 49) with irregular branching chambers under the dermal cortex : these in turn lead into the incurrent canals which run as irregular pipes radially inwards, and communicate with more regular circular canals running parallel to the axis of the sponge. These canals have not contracted. The flagellated chambers are often situated close against the incurrent canals, so that the communication is direct, presumably through a pore cell which, in the contracted condition of the sponge, is closed. When there is no incurrent canal near the chamber a narrow branch leads from the incurrent canal to the flagellated chamber (see Figs. 51, 52 and 53).

The Skeleton is built up almost entirely of regular triradiates, but among the triradiates lining the excurrent canals there are a very few regular quadriradiates with slender, wavy, apical rays projecting inwards.

The oscule is closed by the folding in of a thin oscular collar which, when open, probably stands erect as a short tube. The collar has a thin skeleton of triradiates.

Spicules (Fig. 50).

The *Triradiates* are of one sort :—

- (a) Regular triradiates of widely differing sizes. Rays almost perfectly straight, but not quite, tapering moderately to near their ends, then sharply pointed, 140 μ to 320 μ long \times 10 μ to 20 μ thick.

The rare *Quadriradiates* are of one sort :—

- (b) Regular quadriradiates from the lining of the excurrent canals. Facial rays equal, straight, tapering moderately to near their ends, then sharply pointed, 110 μ long \times 8 μ thick. Apical rays wavy, sharply pointed, 80 μ to 100 μ long \times 3 μ to 8 μ thick.

LEUCANDRA CIRRATA.

(Plate XXXI., Figs. 54–56.)

There are two specimens of this new species in the collection, one complete, the other much distorted, and possibly only a portion of a complete sponge. The following description applies to the complete specimen. The sponge is ovoid in shape, 8.5 mm. \times 3 mm., and is white as preserved in spirits. It is completely covered by long, angularly bent projecting oxea, which to the naked eye give the surface the appearance of being covered with curling hair.

The structure of the body wall which surrounds a large gastral cavity is shown in Fig. 54. The gastral skeleton consists of triradiates and quadriradiates lying tangentially with their basal ray downwards; the body skeleton consists of sub-gastral triradiates and the inner ends of the projecting oxea; the dermal skeleton is strong, consisting of about eight layers of triradiates, irregularly placed. The oxea and sub-gastral triradiates are arranged in groups up which the body substance (flagellated chambers) creeps to the dermis, forming as it were columns supporting the cortex. Between these columns under the cortex is a large space forming an incurrent chamber which is continuous over the whole sponge.

There are only two or three layers of the flagellated chambers, which are roughly spherical, between the gastral and dermal membranes. The excurrent canals are short and simple.

The oscule has a fringe of stumpy oxea (Fig. 56); there is no diaphragm.

Spicules (Figs. 55 and 56).

The *Oxea* are of one sort :—

- (a) Very large bent projecting oxea, of all sizes from $400\ \mu$ to $1,830\ \mu$ long, \times $20\ \mu$ to $33\ \mu$ thick, pointed at both ends, usually straight for about two-thirds of their length, then bent at two or three points angularly, the end being often bent through a total angle of 125° from the axis of the straighter portion of the spicule. The points where the angular bends occur are often marked on the convex side by flattened areas, as if the spicule had been deflected by contact with a plane surface.

The *Triradiates* are of one sort :—

- (b) Alate triradiates of very variable shape. There is no distinction between the gastral, body wall and dermal triradiates. Basal ray straight, tapering, sharply pointed, $190\ \mu$ to $360\ \mu$ long \times $10\ \mu$ to $14\ \mu$ thick. Paired rays straight or bent slightly up or down, $160\ \mu$ to $220\ \mu$ long \times $10\ \mu$ to $14\ \mu$ thick. Tapering slightly and rather bluntly pointed. Oral angle 110° to 145° .

Quadriradiates.—There is one sort of quadriradiate :—

- (c) Alate quadriradiates from the gastral cortex, basal ray straight, tapering to a sharp point, $280\ \mu$ long \times $12\ \mu$ thick. Paired rays equal, slightly bent upwards, 140 to $220\ \mu$ long \times 10 to $12\ \mu$ thick. Oral angle about 130° folded backwards, *i.e.* away from the face bearing the apical ray. Angle of fold about 170° . Apical ray $40\ \mu$ long \times 8 to $10\ \mu$ thick, sharply pointed, bent orally.

Oscular spicules.

- (f) The oscular fringe consists of short club-shaped oxea tapering to a point at the inner end and bent near the outer end, which is rounded, $150\ \mu$ to $230\ \mu$ long \times $12\ \mu$ to $45\ \mu$ thick. The thicker spicules are the commonest. The triradiates at the edge have an oral angle of nearly 180° .

LEUCANDRA HIBERNA.*

(Plate XXXI, Figs. 57-58.)

There are two specimens of this new species in the collection, one straight, vase-shaped, $7\ \text{mm.} \times 1\frac{1}{2}\ \text{mm.}$, the other bent through at right angle, $6\ \text{mm.} \times 1\ \text{mm.}$ In colour they are dull yellow as preserved in spirits, and appear minutely hispid to the naked eye.

The structure of the body wall, which surrounds a large gastral cavity, is shown in

* Most of the specimens were collected at the 'Discovery's' Winter Quarters.

Fig. 57. The gastral skeleton consists of quadriradiates with the basal ray pointing downwards: the body skeleton consists of sub-gastral triradiates and the inner ends of the projecting oxea. Among the sub-gastral triradiates there are a very few quadriradiates exactly like the triradiates, except for the development of the apical ray, which is roughly perpendicular to the plane of the other rays, and does not project into the gastral cavity.

The dermal skeleton consists of a thin layer of triradiates with the basal ray pointing downwards.

The space between gastral and dermal membranes is filled up with three or four layers of spherical flagellated chambers between which are small incurrent and excurrent canals. There are no large incurrent chambers as in *Leucandra cirrata*.

The oscular skeleton consists of quadriradiates with an oral angle of nearly 180° and oxea. The dermal triradiates do not reach quite up to the edge. The thin oxea which form the fringe are straight, with hastate ends. Just below the oscule there are a few very short stout projecting oxea, similar in form to the longer ones lower down.

Spicules (Fig. 58).

The *Oxea* are of one sort:—

- (a) Large projecting oxea, bluntly pointed at the inner end, hastate and sharply pointed at the outer end, nearly straight for about three-quarters of their length, then bent at the outer end, $260\ \mu$ to $670\ \mu$ long \times $12\ \mu$ to $24\ \mu$ thick at the thickest point. The thickness varies irregularly along the length.

Triradiates.—There are two sorts of triradiates:—

- (b) Sub-gastral alate triradiates. Basal ray straight, tapering uniformly to a sharp point, $160\ \mu$ to $200\ \mu$ long \times $6\ \mu$ thick. Paired rays equal, more or less bent downwards, $80\ \mu$ long \times $6\ \mu$ to $8\ \mu$ thick, nearly uniform in thickness all along, then bluntly pointed. Oral angle 135° to 150° .
- (c) Dermal alate triradiates. Basal ray straight, occasionally shorter than the paired rays, $60\ \mu$ to $200\ \mu$ long \times $8\ \mu$ to $11\ \mu$ thick, tapering slightly, then bluntly pointed. Paired rays usually differing slightly in shape and size; bent upwards in a wide sweep at the centre and then usually slightly downwards near the points. $100\ \mu$ to $140\ \mu$ long \times $9\ \mu$ to $12\ \mu$ thick. Oral angle 105° to 115° .

The *Quadriradiates* are of one sort:—

- (d) Gastral alate quadriradiates. Basal ray straight, tapering uniformly to a sharp point. $100\ \mu$ to $300\ \mu$ long \times $8\ \mu$ to $12\ \mu$ thick. Paired rays equal, bending upwards in a wide sweep at the centre, outer half straight, $80\ \mu$ to

180 μ long \times 9 μ to 13 μ thick. Oral angle 120°. Apical ray curved slightly orally, sharply pointed, 80 μ long \times 8 μ thick.

Oscular spicules.

- (e) Fringe oxea, slender, hastate, straight except for a slight bend at the junction of the spear-head. 160 μ to 240 μ long \times 7 μ to 9 μ thick. The maximum thickness is just below the spear-head.
- (f) Stumpy, stout, hastate oxea, from just below the edge, similar to (a) 140 μ to 160 μ long \times 14 μ to 16 μ thick.
- (g) Small quadriradiates from the oscular edge. Basal ray 180 μ or less \times 8 μ to 10 μ . Paired rays equal, sharply pointed, bending slightly downwards, 70 μ to 100 μ long \times 8 μ to 10 μ thick. Oral angle 155° to 160°. Apical ray short, sharply pointed, bent slightly orally.

DERMATRETON.

Grantiids in which the radial chambers are "linked" so as to form a reticulated pattern round the large inter-canals, and are covered with a continuous reticulated cortex.

The definition of this new genus in the family *Grantiidae* corresponds to that of *Tenthrenodes* in the family *Syctidae*.

The remarkable reticulated cortices of the two species in this genus are shown in Figs. 61 and 71. The importance of the "linking" of the flagellated chambers as a generic characteristic is emphasised by the fact that it produces a corresponding type of cortex. The cortical spicules have developed from the distal spicules of the tubar skeleton. In *Grantia* the inter-canals are small, and the skeleton bridges over them. In *Dermatretton* the inter-canals are too large to be bridged over, and a reticulated cortex results.

In both the species in this genus the sponge is in the form of a tube more or less bent, of circular cross-section, the maximum diameter being near the middle. The tube tapers gradually to the base, which is very small, and also to the upper end, which terminates in the oscule. The interior of the tube forms the gastral cavity. The inner or gastral layer is supported by a special skeleton of large quadriradiates regularly arranged, with the basal ray pointing downwards and the apical ray projecting into the gastral cavity. Outside the gastral layer stand the flagellated chambers, pointing radially outwards and linked into a meshwork pattern. They communicate with the gastral cavity either independently (*D. chartaceum*) or in groups through excurrent chambers (*D. hodgeyoni*). The distal ends of the flagellated chambers are covered by a reticulated cortex, which follows the "linked" pattern of the chambers. Many of the dermal triradiates lie in inclined positions, more or less embracing the rounded tops of the flagellated chambers. It thus happens not

infrequently that spicules may be found with one of the paired rays pointing almost radially inwards, and at first sight suggesting that sub-dermal triradiates are present (*cf.* Fig. 59). The peculiar shape of the dermal triradiates, however, makes it easy to prove that it is always a paired ray, and not the basal ray, which is centripetally directed.

DERMATRETON CHARTACEUM.

(Plate XXVII., Fig. 5, and Plates XXXI. and XXXII., Figs. 59-64.)

There is only one specimen of this new species in the collection. It was found at a depth of 180 fathoms. It is nearly straight, 23 mm. long \times 3 mm. maximum diameter, quite white as preserved in alcohol, and has the appearance of a delicate paper tube (see Fig. 5). The walls are only 0.32 mm. thick at their thickest point. The reticulated pattern on the surface is too small to be readily seen with the naked eye.

The structure of the body wall is shown in Fig. 59. The flagellated chambers open directly into the gastral cavity through contractile apopyles (see Fig. 60). The skeleton of the flagellated chambers consists normally of a single row of sub-gastral triradiates, but there is occasionally a smaller triradiate half-way between the gastral and dermal layers. There are also fine hair oxea, not shown in the figure, surrounding the flagellated chambers. The distal ends of the flagellated chamber skeletons are strengthened by oxea, which project a short distance beyond the dermis. The distal ends of the chambers are covered by a reticulated cortex with a skeleton formed of curved triradiates (see Fig. 63).

The gastral skeleton (Fig. 62) is formed of large quadriradiates, among which there are a very few which appear to have no apical ray.

The oscular skeleton is shown in Fig. 61. The edge, which is slightly everted, is formed of small quadriradiates. There is a very short fringe of hair oxea, amongst which are a few stout oxea similar to those in the body wall. The dermal triradiates extend up to the edge.

Spicules (Fig. 64).

Oxea.—There are two sorts of oxea :—

- (a) Projecting oxea, slightly crooked, slightly hastate, 130 μ to 270 μ long \times 11 μ to 16 μ thick.
- (b) Hair oxea about 1 μ thick.

Triradiates.—The triradiates are of two sorts :—

- (c) Alate sub-gastral triradiates forming the tubar skeleton. Basal ray straight, tapering to a moderately sharp point, 320 μ to 700 μ long \times 9 μ to 10 μ thick. Paired rays nearly equal, slightly crooked, 100 μ to 160 μ long \times 9 μ to 12 μ thick, bluntly pointed. Oral angle variable from 170° to 120°; strongly folded; angle of fold 120° to 130°.

- (*d*) Alate triradiates from the dermal cortex. Basal ray nearly straight, bluntly pointed, $80\ \mu$ to $140\ \mu$ long \times $9\ \mu$ to $10\ \mu$ thick. Paired rays unequal, slightly curved upwards, often longer than the basal ray, $65\ \mu$ to $150\ \mu$ long \times $8\ \mu$ to $10\ \mu$ thick. Oral angle 100° to 110° .

The *Quadriradiates* are of one sort:—

- (*e*) Alate quadriradiates from the gastral layer. Basal ray straight, tapering uniformly to a sharp point, $500\ \mu$ to $700\ \mu$ long \times $10\ \mu$ thick. Paired rays usually equal, slightly bent in either direction, $100\ \mu$ to $230\ \mu$ long \times $8\ \mu$ to $11\ \mu$ thick. Oral angle 130° . Apical ray nearly straight, sharply pointed, $70\ \mu$ to $100\ \mu$ long \times $6\ \mu$ thick.

Oscular spicules.—The fringe is formed of oxea of types (*a*) and (*b*).

The oscular edge is formed of small quadriradiates similar to (*e*), but smaller. Basal ray $100\ \mu$ long \times $8\ \mu$ thick. Paired rays about $100\ \mu$ long.

DERMATRETON HODGSONI.*

(Plate XXVII., Fig. 1, and Plate XXXII., Figs. 65-74).

There is only one specimen of this new species in the collection. It is bent and irregularly swollen (see Fig. 1), the length being 60 mm. and the maximum diameter 14 mm., tapering at both ends to about 3 mm. It is quite white as preserved in alcohol. To the naked eye the surface appears to be smooth and minutely reticulated. The walls are delicate, only 1 mm. thick at their thickest point.

The structure of the body wall is partly shown in Fig. 73. The flagellated chambers open through contractile apopyles into excurrent chambers, three or four into each, and these in turn communicate with the gastral cavity through large irregular ports. The excurrent chambers have no proper skeleton, but are merely spaces left between the proximal ends of the chambers and the gastral layer. Four of the flagellated chambers opening into an excurrent chamber are shown in Fig. 66. The skeletons are drawn and the interior linings indicated by dotted lines. A cross section of the same excurrent chamber is shown diagrammatically in Fig. 67. The form of the excurrent chambers varies widely, they are often much deeper than the one illustrated. The flagellated chambers have ordinary articulated skeletons of many joints, strengthened at the distal ends by oxea, which project a short distance beyond the dermis, and also by long hair oxea, which project with the thicker oxea and extend inwards nearly to the gastral layer. The "linked" arrangement of the flagellated chambers is shown in Figs. 68, 69 and 70. Fig. 68 shows the ports in the gastral layer, Fig. 69 the flagellated chambers just above the gastral layer, and Fig. 70 the same chambers higher up, arranged in a "linked" pattern. All three figures are drawn

* The author ventures to name this species after Mr. T. V. Hodgson, the biologist of the Expedition, to whose untiring industry and ingenuity the magnitude of the collection is due.

from corresponding portions of a series of tangential sections. Several of the chambers are numbered, and may be traced from one section to another. The distal ends of the flagellated chambers are covered by a reticulated cortex with a skeleton formed of curved triradiates (see Fig. 71).

The gastral skeleton, formed of large quadriradiates, is shown in Fig. 72.

The oscular skeleton is shown in Fig. 65. The quadriradiates at the edge are smaller than the gastral quadriradiates. There are a few stout oxea and hair oxea projecting. The dermal spicules extend to the edge.

Spicules (Fig. 74).

Oxea.—There are two sorts of oxea :—

- (a) Projecting hastate oxea, slightly crooked, 150 μ to 240 μ long \times 12 μ to 16 μ thick, bluntly pointed at each end.
- (b) Hair oxea of considerable length.

Triradiates.—The triradiates are of two sorts :—

- (c) Alate triradiates from the tubar skeleton, of very variable size. The largest are in the proximal joint of the skeleton, and they diminish towards the distal end, where they change into type (d). Basal ray straight, sharply pointed, 330 μ long \times 9 μ thick. Paired rays equal, straight, 120 μ long \times 10 μ thick. Oral angle of sub-gastral spicules 160°. Oral angle of spicules from the middle of the tubar skeleton 125°.
- (d) Alate triradiates from dermal cortex. Basal ray straight, bluntly pointed, 70 μ to 130 μ long \times 10 μ thick, often shorter than the paired rays. Paired rays equal, straight or slightly curved upwards, bluntly pointed, forming a short curve in the centre where they join the basal ray, 130 μ to 140 μ long \times 10 μ thick. Oral angle 105° to 110°, strongly folded; angle of fold 116° to 130°.

The *Quadriradiates* are of one sort :—

- (e) Alate quadriradiates from the gastral layer. Basal ray straight, tapering uniformly to a sharp point, 500 μ to 850 μ long \times 10 μ to 11 μ thick. Paired rays sometimes very unequal in length, straight, or slightly curved downwards, 150 μ to 400 μ long \times 9 μ to 12 μ thick, bluntly pointed. Oral angle, 135° to 145°. Apical ray sharply pointed, nearly perpendicular to the facial rays, slightly bent orally near the point, 7 μ or 8 μ thick.

FAMILY CHIPHORIDÆ. *nov.*

Definition.—Flagellated chambers elongated, arranged radially around a central gastral cavity, their ends projecting more or less on the dermal surface and not

covered over by a continuous dermal cortex. The tubar skeleton is articulate, *the first joint being formed of chiaetines.*

The above only differs from Dendy's definition of *Sycettidæ* by the addition of the words in italics.

STREPTOCONUS.

Chiphorids in which the radial chambers are usually more or less united at places where they come in contact with one another, and are always crowned at the distal extremity with tufts of oxeote spicules. The tubar skeleton is articulate, the first joint being formed of chiaetines.

The definition of this new genus in the *Chiphoridæ* corresponds to that of *Sycon* in the *Sycettidæ*.

STREPTOCONUS AUSTRALIS.

(Plate XXVII., Fig. 3, and Plates XXXII. and XXXIII., Figs. 75-80.)

There are three specimens of this new species in the collection; all are small, shaped like a Florence flask and covered with long projecting oxea, see Fig. 3. They are white as preserved in spirits.

Their dimensions are between 7 mm. \times 3 mm. and 10 mm. \times 4 mm.

The gastral cavity terminates in a long oscular collar 2 mm. to 3 mm. long, with slightly everted edge crowned with a fringe of slender hastate oxea.

The body wall is made up of the radial flagellated chambers (see Fig. 75), which touch each other for most of their length and have large projecting distal cones crowned by tufts of long slightly bent hastate oxea; these oxea converge in cones over the chambers, and then, crossing spirally, spread out and interlace. Each chamber opens separately into the gastral cavity. In tangential section the chambers appear more or less regularly arranged as hexagons with triangular intercanals.

The Skeleton.—The whole gastral cavity and oscular tube is lined with a sparse layer of large quadriradiates (see Figs. 77 and 79), regularly arranged with the basal ray pointing downwards and the apical ray projecting into the gastral cavity; the apical ray is slightly bent orally. A few of these large radiates appear to lack the apical ray.

The radial chambers have articulated skeletons (see Fig. 75), the proximal joint consisting of chiaetines, all of which have their apical rays turned towards the flagellated chamber, so that when looking at the gastral surface the apical rays appear to form a protection to the apopyle (see Fig. 79). The upper joints of the articulated skeleton of the flagellated chamber consist of triradiates of ordinary form. The unpaired rays of the outermost triradiates project, with the oxea, forming the bases of the large distal tufts.

The oscular collar has a very fragile skeleton consisting of large quadriradiates widely spaced (see Fig. 77). On the outside it is thinly covered with long oxea which project downwards and outwards at an angle of about 45° from the axis.

The rim of the tube is formed by a ring of small quadriradiates regularly and closely packed, with the unpaired ray downwards and apical ray inwards. The rim is crowned by a fringe of long nearly straight hastate oxea. (See Fig. 78.) The sharply defined line of the small quadriradiates forming the rim of the collar, standing above the widely spaced quadriradiates which form the lower part of the skeleton, produces the effect of a vacant space with no spicules between the two. The space is however no wider than between other rows of the collar skeleton, and occasionally one of the big quadriradiates is found in the rim itself. No diaphragm can be seen.

Fig. 80 represents a longitudinal section through the junction between the oscular collar and body. The gastral skeleton is continuous and the flagellated chambers grow outside it. The first is very minute, with no skeleton; the second is larger, with a primitive skeleton. The length of the chambers continues to increase down to the base of the sponge.

Spicules (Fig. 76).

Oxea. There are three sorts of oxea:—

- (a) Stout projecting hastate oxea, usually straight, but occasionally bent sharply through an angle of about 120° , varying irregularly in thickness; $300\ \mu$ to $1,250\ \mu$ long \times $9\ \mu$ to $15\ \mu$.
- (b) Thin projecting oxea, quite straight, faintly hastate, maximum size $1,020\ \mu \times 6\ \mu$.
- (c) Small hastate oxea $140\ \mu \times 8\ \mu$.

Triradiates. There are two sorts of triradiates:—

- (d) Large alate triradiates from the gastral layer. Basal rays straight, tapering uniformly to a sharp point from $190\ \mu$ to $300\ \mu$ long \times $6\ \mu$ to $8\ \mu$ thick. The paired rays are nearly equal, nearly straight, from $80\ \mu$ to $150\ \mu$ long \times $6\ \mu$ to $8\ \mu$ thick. Oral angle 130° to 140° .
- (f) Small alate triradiates from the tubar skeleton. Basal ray straight, $100\ \mu \times 6\ \mu$, tapering to a sharp point. Paired rays irregularly bent, $70\ \mu \times 6\ \mu$. Oral angle 120° to 135° . Considerably folded.

Quadriradiates. There are two sorts of quadriradiates:—

- (g) Large alate quadriradiates from the gastral layer. Basal ray straight, tapering uniformly to a sharp point, $230\ \mu$ to $430\ \mu$ long \times $6\ \mu$ to $12\ \mu$ thick; the larger sizes occur in the oscular collar. Paired rays bracket-shaped, nearly equal in length, $140\ \mu$ to $215\ \mu$ long \times $8\ \mu$ to $10\ \mu$ thick. Apical ray thin and sharply pointed, bent orally. Apparent size seen facially, $32\ \mu \times 4\ \mu$. Oral angle varying from 110° in body to 150° in oscular collar.
- (h) Small chiacines from the tubar skeleton. Basal ray, $140\ \mu$ to $220\ \mu$ long \times $4\ \mu$ to $6\ \mu$ thick, tapering uniformly to a sharp point, appearing

straight in facial view, but often slightly bent in side view at a point a short distance from the junction with the paired rays. This bend is connected with the close manner in which pairs of these spicules lie together. Paired rays bent slightly downwards, nearly equal in length, sharply pointed, $70\ \mu$ to $110\ \mu$ long \times $3\ \mu$ to $5\ \mu$ thick. Oral angle 140° to 150° . Folding considerable, angle of fold 115° to 125° . Apical ray thin, $50\ \mu$ to $65\ \mu$ \times $3\ \mu$, considerably set over out of line with the basal ray. Angle between apical and basal ray about 170° .

Oscular spicules. The fringe consists of:—

- (i) Hastate oxea, nearly straight, $240\ \mu$ to $700\ \mu$ long \times $5\ \mu$ to $8\ \mu$ thick.

The edge consists of:—

- (k) Small quadriradiates. Basal ray straight, uniformly tapering to a sharp point, $110\ \mu$ to $170\ \mu$ long \times $5\ \mu$ to $8\ \mu$ thick. Paired rays equal, considerably curved downwards, sharply pointed, $60\ \mu$ to $100\ \mu$ long \times $8\ \mu$ thick. Oral angle about 160° .

HYPODICTYON.

Chiphorids in which the radial chambers with freely projecting distal cones are linked so as to form a reticulated pattern round the large intercanals. The tubar skeleton is articulate, the first joint being wholly or partially formed of chiactines.

This new genus in the family *Chiphoridae* corresponds to the genus *Tenthrenodes* in the family *Sycettidae*.

There is only one species in this genus.

HYPODICTYON LONGSTAFFI.

(Plate XXVII., Fig. 10, and Plates XXXIII. and XXXIV., Figs. 81–97.)

There are four specimens of this new species in the collection. All are in the form of longish tubes more or less bent, stouter in the middle and tapering towards each end; the upper ends terminate in short, smooth, oscular collars, and the lower ends are rounded off. The whole sponge, except the oscular collar, is covered by a meshwork of projecting spicules which give the surface a bristly honeycombed appearance (see Figs. 10 and 81).

The dimensions of the four specimens are as follows:—

Length.	Maximum diameter.
60 mm.	15 mm.
37 mm.	7 mm.
50 mm.	5 mm.
37 mm.	9 mm.

All the specimens are white in colour as preserved in spirits.

The body walls are formed of the long branching flagellated chambers (see Fig. 89), which are roughly oval at their proximal ends and are packed closely together on the gastral cortex; each chamber opens directly into the gastral cavity through an irregular apopyle. Following the flagellated chambers outwards by means of serial tangential sections (Figs. 83 to 87 and 92-97), it will be seen that the chambers usually divide into two branches close above the gastral layer, and that these branches often divide a second time near their distal ends. At the same time it will be seen that the irregular arrangement of the flagellated chambers on the gastral layer gradually changes till at the outer surface it assumes the regular linked pattern which is typical of the genus.

The Skeleton.—The gastral skeleton consists almost entirely of large tri- and quadriradiates irregularly arranged, with the basal ray pointing more or less downwards (see Fig. 91). In addition to these there are the paired rays of the chiactines which occur occasionally round the apopyles.

The gastral skeleton continues into the oscular collar and is modified near the oscular rim, as shown in Fig. 88. The junction of the oscular collar and body wall is shown in Fig. 82, in which the gradual growth of the flagellated chambers may be seen. Near the rim the triradiates almost or entirely disappear, and the quadriradiates are much smaller. There is a fringe of hair oxea (these are absent in one specimen) amongst which are a few stout oxea, apparently of the same sort as those on the distal ends of the flagellated chambers. There are a few thin bent oxea scattered irregularly near the edge.

The skeleton of the flagellated chambers is of the ordinary articulated type, consisting of small triradiates, which converge at the top of the chamber to form a point which is strengthened by a bundle of oxea of two types which project freely. Every here and there in the proximal joint a chiactine may be found replacing one of the ordinary triradiates; its apical ray projects diagonally into the gastral cavity and across the apopyle. It is the presence of these chiactines which has made it necessary to form the genus *Hypodictyon* for this species instead of putting it in the genus *Tenthrenodes*.

Spicules (Fig. 90).

Oxea.—There are two sorts of oxea :—

- (a) Projecting oxea from the distal cones, slightly irregularly bent, some slightly hastate, from $100\ \mu$ long \times $12\ \mu$ thick to $900\ \mu$ long \times $26\ \mu$ thick.
- (b) Hair oxea projecting with (a).

Triradiates.—There are two forms of triradiates :—

- (c) Large alate triradiates from the gastral layer. Basal ray straight, tapering uniformly to a sharp point, maximum size, $800\ \mu \times 10\ \mu$. Paired rays, nearly straight, of uniform thickness all along, bluntly pointed, usually

of unequal lengths, $180\ \mu$ to $430\ \mu$ long \times $10\ \mu$ to $16\ \mu$ thick. Oral angle about 135° .

- (d) Smaller alate triradiates from the tubar skeleton. Basal ray straight, tapering to a sharp point, $140\ \mu$ to $260\ \mu$ long \times $8\ \mu$ to $10\ \mu$ thick. Paired rays nearly equal and straight, $80\ \mu$ to $150\ \mu$ long \times $8\ \mu$ to $10\ \mu$ thick, slightly folded. Oral angle 130° .

Quadriradiates.—There are two sorts of quadriradiates:—

- (e) Large quadriradiates from the gastral layer. Basal ray straight, tapering uniformly to a sharp point, maximum length $1,000\ \mu$ \times $9\ \mu$ to $12\ \mu$. Paired rays of unequal length, often slightly crooked, of irregular thickness, bluntly pointed, $220\ \mu$ to $420\ \mu$ long \times $11\ \mu$ to $13\ \mu$ thick. Apical ray sharply pointed, bent orally, about $80\ \mu$ \times $12\ \mu$. Oral angle 128° to 138° .
- (f) *Chiactines*. Similar to (d) with the addition of an apical ray $90\ \mu$ long \times $6\ \mu$ thick, sharply pointed. These are not shown in the drawing of spicules.

Oscular spicules:—

- (g) Fine straight oxea from the fringe, $3\ \mu$ to $4\ \mu$ thick. All are broken off, so their length is uncertain. Among them are a few stout oxea of the same sort as (a).
- (h) Thin zigzag oxea lying tangentially near the oscule. $170\ \mu$ to $300\ \mu$ long \times $3\ \mu$ to $4\ \mu$ thick, sharply pointed at both ends.
- (i) The edge is formed of small quadriradiates. Basal ray straight, tapering to a sharp point, $130\ \mu$ to $200\ \mu$ long \times $9\ \mu$ to $12\ \mu$ thick. Paired rays nearly equal, considerably bent downwards, $90\ \mu$ to $150\ \mu$ long \times $9\ \mu$ to $12\ \mu$ thick. Oral angle 150° to 160° . Apical ray short and sharp, about $40\ \mu$ long.

FAMILY STAUORRHAPHIDÆ.

Definition.—There is a distinct and continuous dermal cortex, completely covering over the chamber layer and pierced by inhalent pores. There are no subdermal sagittal triradiates nor conspicuous subdermal quadriradiates. The flagellated chambers vary from elongated and radially arranged to spherical and irregularly scattered ones, while the skeleton of the chamber layer varies from regularly articulate to irregularly scattered, *but there are always regularly disposed subgastral chiactines*.

The above only differs from Dendy's definition of *Grantiidæ* by the addition of the words in italics.

ACHRAMORPHA.

Staurorrhaphids in which the elongated flagellated chambers are arranged radially round the central gastral cavity; they are covered over by a dermal cortex, composed principally of triradiate spicules, and without longitudinally disposed oxea. The tubar skeleton is articulate, the first (and sometimes only) joint being formed of chiaectines.

The definition of this new genus in the family *Staurorrhaphidæ* corresponds to that of *Grantia* in the *Grantiidæ*, but omits the limitation introduced by Dendy, which transfers all *Grantiæ* with tufts of spicules, including *Grantia compressa*, to the family *Sycettidæ*. This limitation appears to be artificial and unsatisfactory.

The genus contains three species, *Achramorpha nivalis*,* *Achramorpha glacialis*,* and *Achramorpha grandinis*.*

In all the species the flagellated chamber skeleton consists of the basal rays of the chiaectines. There is no gastral skeleton proper; the gastral layer is supported by the paired rays of the chiaectines, except in the oscular tube, where there are quadriradiates lying tangentially in the ordinary position, *i.e.*, in the gastral layer, with the basal ray pointing downwards. At the junction between the oscular tube and the body, the quadriradiates lie at all angles intermediate between the centrifugal position and the tangential position. This remarkable change in position of the quadriradiates in passing from the oscular tube to the body, which is conspicuous in this genus, is discussed in Part III.

The skeleton of the dermal cortex consists of triradiates lying tangentially with the basal ray, pointing more or less downwards; there are also large projecting oxea. In one species there are also projecting hair oxea, and in the other two there are minute prickly hastate oxea projecting round the ostia.

In two of the species the skeleton of the oscular edge is well differentiated. It consists of a few rows of special quadriradiates closely and regularly packed, and partially hidden in the dense fringe of oxea. In the top row these quadriradiates have remarkably snub apical rays, which usually hardly penetrate through the fringe. From these apical rays springs the diaphragm which closes the oscule (Figs. 100 & 102). This diaphragm can be made out in some specimens, but not in others, probably owing to defective preservation.

In the third species, *A. grandinis*, the oscular skeleton is hardly differentiated from the body skeleton and there is no fringe.

In all the species the flagellated chambers open one or more together into small shallow excurrent chambers, which open into the gastral cavity through ports in the gastral membrane.

* *Ignis, grando, nix, glacies spiritus procellarum que faciunt verbum ejus.*

ACHRAMORPHA GLACIALIS.

(Plate XXXIV., Figs. 98-102.)

There are six specimens of this new species in the collection. All are small, slender, vase-shaped Sponges, which when examined with the naked eye might easily be mistaken for Ascons. In colour they are white tinged with orange, as preserved in alcohol. The dimensions of the four perfect specimens are as follows: 9 mm. \times 2 mm.; 4 mm. \times .75 mm.; 8 mm. \times 1.5 mm. (flattened); 9 mm. \times 1½ mm.

The structure of the body wall is shown in Fig. 101. The flagellated chambers often taper considerably at their distal ends, thus leaving rather large inhalent chambers under the dermal cortex. The hair oxea lie in the very thin mesoderm between the chambers and project beyond the dermal cortex. Neither they nor the large projecting oxea are arranged in regular tufts or cones, but appear to be irregularly scattered.

The structure of the oscule is shown in Figs. 100 and 102. The section shows the transition from normal to centrifugal position of the quadriradiates. It also shows the diaphragm.

Fig. 98 represents a view of the gastral layer. The section includes some of the gastral ports and some of the apopyles which lie immediately above the ports. There are a very few minute oxea lying radially in the gastral layer. One of these is shown in Fig. 102. In some specimens these minute oxea are scattered throughout the body wall. Several of the specimens contain ova of the usual form.

Spicules (Fig. 99).

Oxea.—The Oxea are of three sorts:—

- (a) Stout projecting oxea, irregularly bent, sharply pointed at the inner end, and bluntly pointed at the outer end, 280 μ to 440 μ long \times 12 μ to 24 μ thick.
- (b) Minute, hastate, slightly bent oxea, some smooth, some spined, from the dermal layer, 35 μ to 40 μ long \times 2 μ to 3 μ thick.
- (c) Hair oxea, 400 μ or more long.

The *Triradiates* are of one sort:—

- (d) Alate triradiates from the dermal cortex. Basal rays straight, tapering and sharply pointed, 200 μ to 380 μ long \times 12 μ thick. Paired rays equal, nearly straight, 130 μ to 180 μ long \times 10 μ to 14 μ thick. Oral angle varying widely, 110° to 160°. Folding very variable.
- (e) *Chiaetines*. Basal ray straight, tapering, sharply pointed, 340 μ to 400 μ long \times 15 μ thick. Paired rays equal, 130 μ to 180 μ long \times 16 μ thick, bent slightly irregularly. Oral angle, 145° to 165°. Angle of fold, 150°

to 160° . Apical rays sharply pointed, slightly irregularly bent, $70\ \mu$ to $100\ \mu$ long \times $12\ \mu$ thick; set-off slight; angle between apical ray and basal ray 165° .

Oscular Spicules.—The fringe consists of hair spicules, and stout oxea of types (c) and (a):—

- (f) Small quadriradiates from the oscular edge. Basal ray straight, tapering, and rather bluntly pointed, $100\ \mu$ to $120\ \mu$ long \times $9\ \mu$ to $10\ \mu$ thick. Paired rays about equal, bent downwards, $50\ \mu$ to $100\ \mu$ long \times $7\ \mu$ to $8\ \mu$ thick. Oral angle about 150° .
- (g) The quadriradiates from the oscular collar are similar to (f), but much larger. Basal rays $220\ \mu$ or more long; paired rays up to $200\ \mu$ long; apical rays up to $120\ \mu$ long.

ACHRAMORPHA GRANDINIS.

(Plate XXVII., Fig. 4, and Plates XXXIV. and XXXV., Figs. 103–104.)

There is only one broken specimen of this new species in the collection; it consists of the upper part and oscular collar of a sponge which probably was of considerable size, judging by the size of the oscule (see Fig. 4). The specimen is straight, 18 mm. long, and circular in section, tapering from $4\frac{1}{2}$ to 3 mm. in diameter at the oscular end. The lower part is covered by long oxea, which lie along the surface pointing downwards; the upper part is smooth and transparent. There is no fringe.

The structure of the body wall is the same as in the other species of this genus. There are no hair oxea, but there are a few small prickly hastate oxea in the dermis.

The oscule (see Fig. 104) differs considerably from the other two species. There is no fringe of hair oxea and no special ring of quadriradiates at the edge, the skeleton being made up of both tri- and quadriradiates lying tangentially. The transition from tangential quadriradiates to chactines occurs in the same way as in the other species. The basal rays of the chactines project a long way outside the dermis.

Spicules (Fig. 103).

Oxea. There are two sorts of Oxea:—

- (a) Very large straight projecting oxea, size of longest fragments $3.5\ \text{mm.} \times 23\ \mu$. Very sharply pointed at the inner end.
- (b) Small hastate oxea, from the dermis. Slightly irregularly bent, some spined, some smooth, $65\ \mu$ to $120\ \mu$ long, $3\ \mu$ to $6\ \mu$ thick.

The *Triradiates* are of one sort:—

- (c) Large, alate triradiates from the dermal cortex. Basal rays straight, tapering uniformly to a sharp point, $420\ \mu$ to $500\ \mu$ long \times $12\ \mu$ to $15\ \mu$ thick. Paired rays usually equal, straight or bent slightly downwards,

bluntly pointed, $220\ \mu$ to $260\ \mu$ long, $\times 12\ \mu$ to $14\ \mu$ thick. Oral angle 130° to 160° .

- (d) *Chiactines*. Basal rays straight, tapering to a more or less sharp point, $450\ \mu$ to $550\ \mu$ long $\times 12\ \mu$ to $16\ \mu$ thick. Paired rays equal, straight, $240\ \mu$ to $270\ \mu$ long $\times 12\ \mu$ to $14\ \mu$ thick. Oral angle, 155° to 160° . Apical ray sharply pointed, maximum length $160\ \mu$ long $\times 14\ \mu$ to $16\ \mu$ thick. Angle between apical ray and basal ray, 165° to 180° .

Oscular spicules.

- (e) *Quadriradiates* from the oscular tube. Basal rays straight, tapering uniformly to a sharp point, $650\ \mu$ long $\times 12\ \mu$ thick. Paired rays often unequal, maximum size $560\ \mu$ long $\times 14\ \mu$ thick, nearly parallel, bluntly pointed. Oral angle about 160° . Apical ray sharply pointed, curved orally, $120\ \mu$ long $\times 9\ \mu$ thick.

ACHRAMORPHA NIVALIS.

(Plate XXVII., Figs. 7 and 8. Plates XXXV. and XXXVI., Figs. 105-112.)

There are fourteen specimens of this new species in the collection. They vary considerably in shape, but are mostly more or less pear-shaped, with the oscule at the narrow end (see Figs. 7 and 8). In some specimens the neck of the pear is considerably extended, but the actual oscular collar (without flagellated chambers) is always quite short. There is a dense fringe of long shining silver-white hair spicules round the oscule, which sometimes attain a length of 2.5 mm. The whole sponge is covered with long projecting oxea which lie in all directions, giving it a very untidy appearance. The base of the sponge is rounded.

The dimensions of the perfect specimens are as follows:—12 mm. \times 3 mm. 17 mm. \times 3 mm.; 18 mm. \times 9 mm.; 20 mm. \times 8 mm.; 12 mm. \times 4 mm.; 8 mm. \times 4 mm.; 11 mm. \times 5 mm.; 17 mm. \times 8 mm.; 8 mm. \times $2\frac{1}{2}$ mm.; 26 mm. \times 12 mm.; 29 mm. \times 10 mm.

The structure of the body-wall is shown in Fig. 106, where the subdermal cavities and exhalent chambers may be seen. The small projecting oxea are mostly arranged round and over the ostia. This may be seen in Figs. 107 and 108 representing the dermal cortex in plan and section. The very large projecting oxea are scattered quite irregularly, and often project through the body-wall into the gastral cavity. The large oxea are all broken; the longest fragment found is 2.7 mm. long. They lie at all angles. Fig. 109 represents the gastral membrane as seen from inside.

Figs. 111 and 112 represent the oscular structure. The highest flagellated chambers are shown in Fig. 112, and the short oscular collar projecting about 1.3 mm. beyond them. Fig. 112 shows the junction of the oscular tube and the body to a larger scale. Above the last chamber the skeleton consists of quadriradiates and oxea only; the triradiates forming the dermal skeleton do not extend

beyond the last flagellated chamber. At the junction there are specially large quadriradiates lying diagonally, apparently strengthening the junction between the dermal and gastral skeletons. The basal rays of the chiaectines are much longer than the thickness of the body in the upper part of the sponge and project, often half their length, outside the cortex. The regular arrangement of the oscular quadriradiates at the oscular edge is shown in Fig. 111. Side views of these spicules are drawn, showing the diminution in the length of the apical ray. These spicules lie in the middle of the fringe, so that they are almost hidden from both inside and outside. In the same figure is shown one of the large quadriradiates from the junction between tube and body.

There are numerous ova in some of the specimens.

Spicules (Fig. 105).

Oxea. There are three sorts of *Oxea* :—

- (a) Large projecting oxea, straight, and pointed at both ends. Largest fragment found, 2·7 mm. long \times 14 μ thick.
- (b) Minute, spined, slightly crooked, hastate oxea from the dermal layer, 75 μ to 85 μ long \times 5 μ to 6 μ thick.
- (c) Rather longer, small, straight hastate oxea, 120 μ to 140 μ long \times 4 μ thick.

The *Triradiates* are of one sort :—

- (d) Alate triradiates from the dermal layer (these are probably the same as those occasionally found in the body-wall). Basal ray straight, tapering to a point, 200 μ to 380 μ long \times 8 μ to 10 μ thick. Paired rays nearly equal in length, curving slightly upwards, forming a rounded bend at the centre 140 μ to 210 μ long \times 8 μ thick. Oral angle 102° to 106°. There are a very few triradiates with an oral angle of 160°. It is doubtful where these come from.
- (e) *Chiaectines.* Basal ray straight in facial view, but bent slightly in side view, tapering to a sharp point, 400 μ to 600 μ long \times 8 μ to 10 μ thick. Paired rays about equal, sharply pointed, nearly straight, 160 μ to 200 μ long \times 8 μ to 12 μ thick. Oral angle 160°. One of the paired rays is sometimes deflected from its usual position into line with the opposite paired ray. (τ type of triradiate system.) Apical ray straight, or slightly bent, tapering uniformly to a sharp point, 110 μ to 130 μ \times 8 μ to 12 μ thick. Set-over about equal to the thickness of the ray. Angle between basal ray and apical ray 150° to 155°.

Oscular spicules.

- (f) Long, straight slender oxea forming the fringe, 2·5 mm. long \times 6 μ or less thick, minutely hastate at the outer end.

(g) Large alate quadriradiates, lining the oscular tube. These are largest at the junction with the body-wall. Basal ray straight, tapering uniformly to a very sharp point. Maximum dimensions $850\ \mu$ long \times $12\ \mu$ thick. Paired rays bracket-shaped, equal in length, $450\ \mu$ long, oval in section, $16\ \mu$ deep \times $6\ \mu$ thick. Oral angle, 155° ; folded angle, 150° . Apical ray curved orally, $100\ \mu$ long \times $10\ \mu$ thick.

These get smaller up to the oscular edge, where their dimensions are as follows: basal ray, $150\ \mu$ long. Paired rays, which are bent downwards, $120\ \mu$ long \times $10\ \mu$ thick. Apical ray reduced to a blunt cone, $20\ \mu$ long \times $16\ \mu$ thick.

SUBGENUS GRANTIOPSIS Dendy.

The sponge has the form of a greatly elongated hollow tube whose wall is composed of two distinct layers of about equal thickness. The outer (cortical) layer is provided with a very strongly developed skeleton of triradiate spicules, and is penetrated by narrow ramifying incurrent canals. The inner layer is formed by elongated radial chambers arranged very regularly side by side. The skeleton of the inner layer is very feebly developed. The tubar skeleton is articulate and composed of very abnormal sagittal triradiates, whose paired rays are greatly reduced; *the inner joint of the tubar skeleton consists of chinctines.*

The above is slightly modified from Dendy's definition (7, p. 73).

The sub-genus contains only one species.

GRANTIOPSIS CYLINDRICA Dendy.

(Plate XXXVI., Fig. 113.)

Grantiopsis cylindrica Dendy (7), p. 90.

A single specimen of this species found in Australia was described by Dendy (7, p. 90), who called special attention to the chinctines in its skeleton. The structure of this species differs considerably from that of the other species in the genus *Achramorpha*, so that it seems advisable to retain the sub-genus, *Grantiopsis*, only transferring it from the *Grantiidae* into the *Staurorrhaphidae*.

The spicules, which have not hitherto been illustrated, are shown in Fig. 113; they differ widely from any found in the new species. The sponge is fully described in (7) and figured in (2).

MEGASPOGON.

Staurorrhaphids in which the flagellated chambers are spherical or sac-shaped, never arranged radially around the central gastral cavity, with which (or with the main excurrent canals derived therefrom) they communicate by a more or less complicated excurrent canal system. The skeleton of the chamber layer is largely

composed of irregularly scattered radiate spicules, *but it always has regularly placed subgastral chiactines.*

The above only differs from Dendy's definition of *Leucandra* by an alteration in the last sentence.

This genus contains five species, four new, and Poléjaeff's "*Leuconia crucifera*" (*Megapogon cruciferus*), which is now transferred to it.

All the species have well-marked gastral cavities, but no gastral skeleton proper. The spiculation in all the species is very similar. The size and shape of the flagellated chambers is very variable; they are sometimes so long as to resemble the radial chambers typical of *Grantia* or *Achramorpha*, and at other times they are spherical.

The close similarity between *Megapogon cruciferus* found at the Azores and the new species from the Antarctic is remarkable. It is noteworthy that *Megapogon cruciferus* was dredged from a great depth, 450 fathoms. The temperature of the sea was not measured at the station where it was found, but judging from the temperatures measured at neighbouring stations it must have been about 47° F. at the bottom. It is possible that successive larvæ of this sponge may have travelled in cool water at great depths all the way from the Antarctic to the Azores.

MEGAPOGON CRUCIFERUS Pol.

(Plate XXXVI., Fig. 114.)

Leuconia crucifera Poléjaeff (4), p. 60.

The following description is abstracted from Poléjaeff's (4). Only a fragment of the inferior part of the sponge was found. The outer surface is bristly, the inner slightly roughened by the apical rays of the gastric quadriradiate spicules [chiactines]. These are all more or less cruciform, all the rays lying in the same or almost the same plane. By this characteristic the species can be very easily distinguished from all other *Leuconidæ*. *Leuconia crucifera* and *Leuconia blanca* are of peculiar interest, as forms inhabiting the greatest depth (450 fathoms) from which *Calcarea* have been hitherto obtained.

Skeleton.—The skeleton consists of gastral quadriradiates [chiactines], of parenchymal triradiates [of minute spined oxea*], of dermal triradiates and of stout acerate spicules, piercing the parenchyma obliquely and projecting with their free end from the outer surface, and of slender acerate spicules scattered here and there on the outer surface in small bundles. The spicules (omitting the hair spicules) are shown in Fig. 114 drawn from spicule preparations made by the author. For description and dimensions see (4).

* These spicules were overlooked by Poléjaeff. They are included in the new drawing of the spicules.

MEGAPOGON VILLOSUS.

(Plate XXXVI., Figs. 115-119.)

There are four specimens of this new species in the collection, but only one is perfect, the other three being broken pieces only. All are white as preserved in alcohol, and are covered with a dense mat of very long oxea. The following description applies to the perfect specimen (see Fig. 117).

The sponge is in the form of a nearly straight circular tube, a good deal distorted at the base, where it has its maximum diameter. It tapers gradually to the short oscular collar which terminates the large gastral cavity.

The structure of the body-wall is shown in Fig. 115; it gets gradually thinner towards the oscule.

Canal System.—The dermis is pierced by numerous ostia which lead into large incurrent canals which extend radially inwards nearly through the body-wall. The excurrent system consists of large radial chambers or canals which do not appear to be branched, each opening through a large port into the gastral cavity.

The flagellated chambers are very variable in size and shape; they are mostly more or less thimble-shaped, opening by apophyses directly into the excurrent chambers round which they are grouped. Some of the flagellated chambers are nearly spherical, some are so long that they reach almost across the whole thickness of the wall; these long chambers are often branched.

Skeleton.—The skeleton of the body-wall is made up of the chiaetines which reach completely through it and often project, and a few scattered triradiates whose basal rays also often project. It is pierced at variable angles by the very long projecting oxea. All these oxea are broken in the specimens; the longest fragment measured is 15 mm. long. Chiaetines occasionally occur at the top of the excurrent chambers, and may thus appear to be in the middle of the thickness of the wall. There is no gastral skeleton proper; the only supports to the gastral wall (see Fig. 118) are the paired rays of the chiaetines, amongst which are a few minute oxea, some smooth and some spined. The dermal skeleton is formed of a thick layer of triradiates (Fig. 116) lying in all directions, with a few minute oxea standing semi-erect round the ostia.

Oscule.—The oscule is at the end of an oscular collar about 1 mm. long which has the appearance of a thin, almost transparent extension of the body. The skeleton of the oscular collar consists of quadriradiates lying tangentially on the inside, with the basal ray downwards and the apical ray projecting into the gastral cavity. Outside are triradiates, also regularly arranged, with the basal ray downwards. The edge is made up of both types of spicule, with a few special oxea which lie horizontally, but do not project beyond the edge, which has no fringe. The junction between the oscular collar and the body-wall is very similar to that shown in Fig. 110.

Spicules (Fig. 119).

Oxea.—There are two sorts of *Oxea* :—

- (a) Enormous straight projecting oxea more than 15 mm. long \times $36\ \mu$ to $43\ \mu$ thick. The inner end tapers gradually to a very sharp point, the outer end is hastate.
- (b) Minute irregularly bent hastate oxea, some spined, some smooth, from the gastral and dermal layers, $80\ \mu$ to $160\ \mu$ long \times $6\ \mu$ thick.

The *Triradiates* are of one sort :—

- (c) Alate triradiates from the body-wall and dermal layer. Basal rays straight, tapering uniformly to a sharp point, $220\ \mu$ to $700\ \mu$ long \times $10\ \mu$ to $16\ \mu$ thick. Paired rays equal, nearly straight, $170\ \mu$ to $300\ \mu$ long \times $12\ \mu$ to $14\ \mu$ thick. Oral angle 135° to 155° .
- (d) *Chiaetines*.—Basal ray straight, tapering uniformly to a sharp point from $600\ \mu$ to $1120\ \mu$ long \times $10\ \mu$ to $16\ \mu$ thick. Paired rays equal, straight, tapering to a sharp point, $240\ \mu$ long \times $13\ \mu$ thick. Oral angle 155° to 160° . Slightly folded, angle of fold 175° to 150° . Apical ray straight, slender, sharply pointed, $140\ \mu$ to $220\ \mu$ long \times $8\ \mu$ to $16\ \mu$ thick, set-off small; angle between apical ray and basal ray 170° to 180° .

MEGAPOGON RARIPILUS.

(Plate XXXVI., Figs. 120–124.)

There are three specimens of this new species in the collection. The natural shape appears to be that of a straight tube, enclosing the gastral cavity, slightly thicker in the middle and circular in section. The lower end is closed very squarely, and the upper terminates in an oscule without a collar. The largest specimen, which is much distorted, is 30 mm. \times 11 mm.; the next, which has the shape described above, is 19 mm. \times 4 mm., and the smallest specimen $2\frac{1}{2}$ mm. \times 1 mm. They are white as preserved in alcohol, their surface is hispid.

The structure of the thick body-walls is shown in Fig. 122.

Canal System.—The stout dermal cortex (Fig. 124) is pierced by small ostia leading into small incurrent chambers, from these run incurrent canals branching and getting smaller as they approach the gastral cavity. The excurrent canals are connected in groups of three or four to excurrent chambers which open into the gastral cavity through large ports.

Skeleton.—The body skeleton consists of the chiaetines, amongst which are a few large subgastral triradiates and a few scattered small triradiates; the basal rays of the latter often project beyond the dermis. There are also dense tufts of hair spicules with a few stout bent oxea among them, which project and make the surface hispid. There are minute spined hastate oxea scattered all through the body. There is no gastral

skeleton proper; the gastral cortex is supported by the paired rays of the chiaectines and subgastral triradiates (see Fig. 120). The dermal cortex is formed of a thick layer of irregularly scattered triradiates (Fig. 124).

The oscule is shown in Fig. 121. There is a ring of small quadriradiates lying tangentially round the inner edge, with short pointed apical rays from which springs the diaphragm. There is a thick fringe of hair oxea, outside which there is an open fringe of large oxea. The oscule is thick and the flagellated chambers reach almost to the edge. Near the oscule they are only in a single layer, but in the middle of the sponge they are ten or twelve layers thick.

Spicules (Fig. 123).

Oxea.—There are four sorts of Oxea :—

- (a) Large projecting oxea, pointed sharply at the inner end, and very bluntly at the outer end, which is thicker. Curved all along, more sharply near the thicker projecting end. Length fairly constant about $700\ \mu$, thickness $30\ \mu$ to $35\ \mu$.
- (b) Hair oxea, projecting in dense tufts, quite straight, length over $500\ \mu$, thickness about $1\ \mu$.
- (c) Minute spined hastate oxea, scattered all through the body-wall. Slightly bent, with the largest spines in a ring round the "set-over" of the spear-head. Usual length $60\ \mu$, occasionally $150\ \mu$, thickness $4\ \mu$ to $5\ \mu$.
- (d) Small irregular oxea from the body-wall about $350\ \mu \times 20\ \mu$, often set-over in the middle of their length.

Triradiates.—There are two sorts of Triradiates :—

- (e) Large alate subgastral triradiates. Basal ray straight, tapering uniformly to a sharp point, about $700\ \mu$ long \times $16\ \mu$ thick. Paired rays equal, nearly straight, $200\ \mu$ to $320\ \mu$ long \times $20\ \mu$ thick; oral angle 160° .
- (f) Smaller alate triradiates from the dermal cortex (probably the same as the rare ones in the body-wall). These vary widely in size. Basal ray straight, tapering uniformly to a sharp point, $170\ \mu$ to $700\ \mu$ long \times $10\ \mu$ to $18\ \mu$ thick. Paired rays equal, forming a rounded bend at the centre, but straight for the rest of their length, $120\ \mu$ to $270\ \mu$ long \times $10\ \mu$ to $16\ \mu$ thick. Oral angle very constant, 108° to 112° .
- (g) *Chiaectines*. Basal ray straight, sharply pointed, $600\ \mu$ to $750\ \mu$ long \times $14\ \mu$ thick. Paired rays bent more or less forwards, $200\ \mu$ to $280\ \mu$ long \times $16\ \mu$ to $20\ \mu$ thick. Oral angle variable, 135° to 160° . Apical ray about $80\ \mu \times 12\ \mu$.

Oscular spicules.

- (h) Large oxea like (a), but shorter; $380\ \mu$ to $480\ \mu$ long \times $18\ \mu$ thick. These form an external fringe. The inner fringe is formed of hair oxea of unknown length.

- (i) Small alate quadriradiates forming the edge. Basal ray $140\ \mu \times 8\ \mu$, straight, tapering uniformly to a sharp point. Paired rays bent slightly downwards, about $70\ \mu \times 10\ \mu$. Apical ray short and conical, $20\ \mu$ long \times $8\ \mu$ thick at base, perpendicular to facial plane. Oral angle nearly 180° .

MEGAPOGON POLLICARIS.*

(Plates XXXVII. and XXXVIII., Figs. 125-130.)

There are two specimens of this new species in the collection; the larger one is fixed in osmic acid and is consequently brown; the smaller one, which is fixed in alcohol, is white; both are hispid. The larger specimen is in the form of a flattened tube 15 mm. long. The diameter at the widest part near the middle is 3 mm. The smaller specimen is ovoid, $2\frac{1}{2}$ mm. \times $1\frac{1}{2}$ mm. There is a large gastral cavity which terminates in the oscule, which in both specimens is bent to one side. The larger specimen has an oscular collar about 1 mm. long.

The structure of the body-wall is shown in Fig. 126. The space between gastral and dermal layers is filled up with three or four layers of flagellated chambers. Each flagellated chamber is surrounded by a slender skeleton of minute prickly hastate oxea (see Figs. 129 and 127); these oxea often lie together in small bunches of three or four, and as they may lie partly on one and partly on another chamber, they build up serpentine lines of minute spicules threading about between the chambers. Some of these minute oxea also lie in the gastral and dermal layers, and also in the columns supporting the dermis.

Canal System.—There is an incurrent chamber under the dermal layer which is probably continuous round the whole body of the sponge. The dermal layer is supported over this chamber by columns of spicules consisting partly of the basal rays of the chiaetines and partly of oxea which project outside the dermis. The incurrent canals lead inwards from the incurrent chambers. The excurrent canals are connected in groups to excurrent chambers which open into the gastral cavity through large ports; these are more or less surrounded by the apical rays of the chiaetines (see Fig. 125).

The Skeleton.—The dermal skeleton is formed by a dense layer, five or six spicules thick, of triradiates, pierced at intervals by the projecting bunches of oxea. The body skeleton consists of chiaetines and a very few scattered triradiates. The basal rays of the chiaetines are bunched more or less together at their distal ends and occasionally project through the dermal layer; with each bunch are grouped a number of the oxea, which project with their thicker bent ends about one-third of their length beyond the dermis. There is no special gastral skeleton; the gastral cortex (see Fig. 130) is supported by the paired rays of the chiaetines, and a few minute oxea irregularly scattered.

* *Pollicaris* = "like a thumb," named from the shape of the oxea.

The oscular collar is thick and densely packed with spicules. On the inside are quadriradiates lying tangentially with the basal rays downwards, and outside are triradiates. The rim, which has no fringe, is formed of tri- and quadriradiates, with oral angles of nearly 180° . There is a diaphragm in one specimen.

Spicules (Fig. 128).

Oxea.—There are three sorts of *Oxea* :—

- (a) Large projecting oxea, straight for about two-thirds of their length, then bending smoothly to one side. The inner (straight) end tapers gradually to a point. The outer end is blunt, shaped like the end of a thumb. Most of the oxea are about the same size, $460\ \mu$ long \times $24\ \mu$ thick. Maximum size, $640\ \mu \times 25\ \mu$. There are a few smaller, imperfectly formed, possibly young, oxea.

The minute spined oxea scattered throughout the body and forming the flagellated chamber skeletons are of two forms :—

- (b) Straight, refringent, thin, slightly spined, $50\ \mu \times 2\ \mu$.
 (c) Curved, hastate, thicker and well spined, $50\ \mu$ to $60\ \mu \times 2.3\ \mu$ to $3.1\ \mu$. The junction of the spear-head is marked by a ring of four or more large spines.

The *Triradiates* are of one sort :—

- (d) Alate triradiates from the dermal cortex and body-wall. These vary very much in size and proportions. Most have the paired rays only slightly shorter than the basal ray, but occasionally there is great disparity. Basal ray straight, tapering uniformly to a sharp point, $130\ \mu$ to $330\ \mu$ long \times $8\ \mu$ to $15\ \mu$ thick. Paired rays equal, nearly straight, but slightly irregular, $90\ \mu$ to $320\ \mu$ long \times $8\ \mu$ to $14\ \mu$ thick. Oral angle 108° to 115° .
 (e) *Chiaetines*.—Basal ray straight, tapering uniformly to a sharp point, $460\ \mu$ to $580\ \mu$ long \times $14\ \mu$ to $18\ \mu$ thick. Paired rays straight, bluntly pointed, $160\ \mu$ to $280\ \mu$ long \times $14\ \mu$ to $16\ \mu$ thick. Oral angle 160° . Angle of fold 155° to 165° . Apical ray nearly straight, pointed, $100\ \mu$ long \times $12\ \mu$ thick. Set-over small. Angle between apical ray and basal ray 175° .

MEGAPOGON CRISPATUS.*

(Plate XXVII., Fig. 2, and Plate XXXVIII., Figs. 131–136.)

There are four specimens of this new species in the collection, all found together. The sizes are 9 mm. \times 3 mm. ; 6 mm. \times 2 mm. ; 6 mm. \times 3 mm. ; 4 mm. \times 2 mm. They are vase-shaped, white or pale orange as preserved in spirits, with a curly surface

* *Crispatus*, curly-haired.

due to the bent projecting oxea (see Fig. 2). The gastral cavity, which is nearly constant in diameter throughout its whole length, terminates at the oscule, which is at the top of an oscular collar about $1\frac{1}{2}$ mm. long.

The structure of the body-wall is shown in Fig. 131.

Canal System.—There is an incurrent chamber under the dermal layer which is probably continuous round the whole body of the sponge. The dermal layer is supported over this chamber by columns of spicules, consisting partly of the basal rays of the chactines, and partly of oxea which project in spreading tufts outside the dermis. The incurrent canals, which are small and irregularly branched, lead inwards from the incurrent chamber. The excurrent canals are large and extend radially from the gastral cavity nearly through the body-wall, often branching once. The flagellated chambers are grouped round these large excurrent canals, the larger number opening directly into them, the remainder being connected by short branches.

The Skeleton.—The skeleton of the body-wall consists of chactines. There are also a few triradiates scattered irregularly, and numerous minute spined oxea. There is no gastral skeleton proper; the gastral cortex (see Fig. 132) is only supported by the paired rays of the chactines. The dermal skeleton is made up of triradiates, which are approximately equiangular, and lie tangentially to the surface. There are also tufts of oxea which project for most of their length and give the sponge its characteristic "curly" appearance.

Oscule.—The thin oscular collar is about $1\frac{1}{2}$ mm. long and the same diameter as the gastral cavity (see Figs. 133 and 134). On the inside are quadriradiates lying tangentially with the basal ray downwards, and outside are triradiates and oxea. There are numerous minute spined oxea scattered amongst the radiates. At the rim (see Fig. 131) the collar is slightly thickened. There is a ring of small quadriradiates forming the edge on the inside; they do not appear to be very closely or regularly packed. The diaphragm extends from the apical rays of these spicules. There is a scanty fringe of prickly hastate oxea of small size. On the outside the oscular collar is thickly covered by large bent oxea of the same type as those forming the tufts on the body, but shorter. They stick in the collar, often projecting through it into the interior, and are directed upwards usually at about 45° with the axis of the sponge; some lie tangentially along the surface.

At the junction of the oscular collar and the body the collar thickens, a few small flagellated chambers appear, the quadriradiates begin to turn their basal rays outwards, and the oxea project more radially, a few even pointing downwards.

Spicules (Figs. 135 and 136).

Oxea.—There are three sorts of Oxea:—

- (a) Large projecting oxea, irregular but nearly straight for about three-quarters of their length, then bending (at the outer end) considerably to one side by two or three angular deflections. The inner end is sharply pointed and

usually slightly bent to the opposite side from the outer end, giving the spicule an S shape. The outer end is slightly swollen and roughened. The thickness varies very irregularly throughout the length, $550\ \mu$ to $950\ \mu$ long \times $20\ \mu$ to $28\ \mu$ thick. Many of these spicules have long flattened areas just below the outermost bend, looking as if the spicule had been diverted by contact with a plane surface.

There are minute spined oxea of two types:—

- (b) Straight, refringent, and thin, $50\ \mu$ long \times $1.2\ \mu$ thick.
- (c) Curved, hastate, and thicker, $55\ \mu$ long \times $4\ \mu$ to $5\ \mu$ thick.

The *triradiates* are of two sorts:—

- (d) Approximately regular triradiates from the dermal cortex and body-wall with straight rays, tapering slightly to near their extremities, then sharply pointed. The rays and angles are nearly but not exactly equal. Rays $110\ \mu$ to $220\ \mu$ long \times $8\ \mu$ to $12\ \mu$ thick.
- (e) Large alate triradiates from the body-wall. Basal rays straight, tapering moderately, then fairly sharply pointed, $400\ \mu$ to $500\ \mu$ long \times $12\ \mu$ to $14\ \mu$ thick. Paired rays nearly straight, tapering, then sharply pointed, $160\ \mu$ long \times $12\ \mu$ to $14\ \mu$ thick. Oral angle 120° to 145° .
- (f) *Chiactines*. Basal rays straight, tapering slightly to near the end, then sharply pointed, $300\ \mu$ to $500\ \mu$ long \times $11\ \mu$ to $12\ \mu$ thick. Paired rays straight, $120\ \mu$ to $160\ \mu$ long \times $10\ \mu$ to $12\ \mu$ thick. Oral angle 115° to 150° . Angle of fold very variable, 115° to 160° . Apical ray nearly straight, sharply pointed, $100\ \mu$ long \times $8\ \mu$ thick. Set-off moderate. Angle between apical ray and basal ray 165° .

Oscular spicules.—Near the oscule type (a) spicules get smaller, $330\ \mu$ long \times $20\ \mu$ thick.

- (g) Straight, strongly hastate, thin, spined oxea forming the fringe, $100\ \mu$ to $200\ \mu$ long \times $1\ \mu$ to $3\ \mu$ thick. The spear-head is swollen at the junction and very sharply pointed. These spicules are also found in the oscular collar a short distance below the edge lying tangentially and occasionally projecting.
- (h) Small quadriradiates from the oscular edge. Basal ray straight, pointed, $50\ \mu$ to $90\ \mu$ long \times $6\ \mu$ thick. Paired rays equal and bent slightly down, $30\ \mu$ to $60\ \mu$ long \times $5\ \mu$ thick. Apical ray straight, pointed, $20\ \mu$ long \times $5\ \mu$ thick. Oral angle 160° .
- (i) Large quadriradiates lining the oscular collar. Basal ray straight, tapering uniformly to a fine point, sometimes bent backwards in side view. Length near oscular edge $200\ \mu$, increasing considerably lower down. Thickness $7\ \mu$ to $9\ \mu$. Paired rays equal, straight or slightly bracket-shaped, $110\ \mu$

to $130\ \mu$ long \times $9\ \mu$ thick. Oral angle 155° to 160° . Apical ray sharply pointed, $50\ \mu$ to $70\ \mu$ long \times $10\ \mu$ to $13\ \mu$ thick, pointing considerably upwards. Angle with basal ray 130° .

PART III.

HISTOLOGY.

The specimens are not sufficiently well fixed to enable many histological details to be made out satisfactorily, but as most of them are unique, it seems advisable to record all that can be determined with reasonable certainty and accuracy.

PORES, OSCULES, ETC.

Several different methods are found among calcareous sponges for regulating the circulation of water and preventing the entry of dirt or enemies.

Ostia.—The admission of water to the incurrent canals is regulated in many species by the opening and closing of the ostia. These pores are inter-cellular, and are closed by the action of the surrounding cells. Fig. 48 shows a closed ostium at the end of the short passage leading through the dermal cortex into the incurrent chamber. The same passage is shown in tangential section in Fig. 49.

Incurrent Canals.—So far as the author is aware, there is no species in which the incurrent canals close.

Prosopyles.—It is probable that the prosopyles can be closed in all species. Considerable discussion has taken place as to whether prosopyles are inter- or intra-cellular. The explanation appears to be simple. The prosopyle is an opening in a pore cell* (intra-cellular) which leads into the flagellated chamber between the flagellated cells (inter-cellular). As, however, the flagellated cells are always much more conspicuous in a surface view than the epithelial cells, the pore when seen in this view presents the misleading appearance of being an inter-cellular opening.

In most of the *Heterocoela* (excepting some species of *Leucandra*) the gelatinous mesoderm is very little developed, so that the walls of the flagellated chambers appear to consist of epithelium lined with flagellated cells. The pore cells are special cells in this epithelium. In the *Homocoela*, where there is a certain thickness of mesoderm containing the spicules, Minchin has shown (1) that the pore cells reach through this to the level of the flagellated cells, thus forming pipes through the wall. In the very thin walls of the flagellated chambers of most species of *Leucandra* the pore cells have no appreciable length, the opening appearing as a hole through a thin membrane, see Figs. 36, 37 and 38.

In *Leucandra gelatinosa*, the gelatinous mesoderm is so much developed that the flagellated chambers appear as spherical spaces lined with flagellated cells, and situated

* Vide Minchin (1).

in the middle of a solid jelly. There is no epithelial sack, but the epithelium appears as the lining of the incurrent canals, which are more or less circular pipes through the jelly. The pore cells have not been made out with certainty in this species, but the cells lettered p.c. in Figs. 51 and 53 are probably the pore cells, which of course are closed.

Apopyles.—The apopyle usually has the appearance of an oval opening in a thin elastic membrane stretching across the end of the flagellated chamber. It is probable that the apopyles can be closed in all species.

Excurrent Canals.—In *Leucandra gelatinosa* the excurrent canals close by the contraction of the epithelial lining. When the canal contracts, the spicules are left in their normal position, and the lining cells stretch the gelatinous mesoderm behind them, so that it is drawn into the canal. The apical rays do not appear to interfere with this action. In cross-section the contracted canal, therefore, appears as an irregular ring of spicules filled up with jelly, in the centre of which lies the contracted group of lining cells (see Figs. 45 and 46). It is probable that similar contractility may be possessed by other species which have a strongly developed mesoderm; as a rule, however, the excurrent canals do not close.

Gastral Cavity.—In some *Homocoela* the gastral cavity can be closed solid.* The author does not know of any instance in which this occurs among the *Heterocoela*.

Osculum.—The osculum may be closed in a variety of ways:—

- (1) By simple contraction of the surrounding mass (*e.g.*, *Leucandra primigenia*).
- (2) By the folding inwards of the oscular collar (*e.g.*, *Leucandra gelatinosa*), etc.
- (3) By means of a diaphragm across the mouth (*e.g.*, *Megapogon varipilus*).

Diaphragms have been found in several of the new species, but not in good enough preservation to enable their structure or method of closing to be investigated.

SPICULES.

The dimensions given for the spicules in the detailed descriptions of the several species in Part II. have generally been taken from the drawings, which were traced by camera lucida accurately to scale, and show as far as possible a representative selection; they must not be understood to be either limiting (maximum and minimum) dimensions or accurate average dimensions. To ascertain the true limiting and average dimensions would require a detailed examination of a large number of specimens and great care in the preparation of the spicule slides, in order to insure that all the spicules from each specimen were mounted. There appeared to be no advantage to be gained in the present instance by attempting such accuracy, which, indeed, would only have been possible in the few cases where a sufficient number of specimens existed.

When the facial rays of a triradiate or quadriradiate spicule are "folded," *i.e.*, do

* *Vide* Minchin (1).

not lie in one plane, foreshortening always produces an apparent distortion which affects both the relative length of the rays and the angles between them. No attempt has in general been made to correct the measurements for this; the figures given are the apparent lengths and angles as the spicules lie in various positions on the slide. The distortion is large in such cases as *Streptoconus australis*, where the folding angle is 120° .

The position of the spicules relatively to the other parts of the sponge body is of some interest. It may be stated as a general rule, and probably as a universal rule, that spicules do not pass through flagellated chambers. They usually lie entirely within the mesoderm, except such parts as project beyond the dermal or gastral layers. They occasionally project into, or cross, the incurrent and excurrent passages. They appear in these cases often to be surrounded by a considerable amount of body substance; if this is covered with an epithelial layer of cells the spicules, strictly speaking, still remain within the mesoderm. The minute spicules ("Mortar spicules," Haeckel), which in *Leucandra* often appear to be scattered irregularly through the whole body-wall, all lie in the mesoderm surrounding the flagellated chambers, and thus build up what may be described as a flagellated chamber skeleton (see Figs. 127 and 129). The very thin hair spicules, which extend in straight lines through the body-wall of some species, all lie within the mesoderm. The enormous projecting oxea, which pierce the body-wall at all angles in some species and appear to be quite independent of the flagellated chamber structure, all lie in the mesoderm between these chambers. Similarly the regularly arranged tubar or body skeleton lies in the mesoderm.

The complex adjustment between the different spicules and flagellated chambers must be arrived at during the growth of the sponge. It therefore seems probable that the longer spicules are formed before the flagellated chambers and are pushed about by the latter as they grow. The mortar spicules, on the other hand, are probably formed after or during the growth of the flagellated chambers.

τ spicules.—The Greek letter τ has been used to designate malformed triradiate systems in which the paired rays are in line.

Γ spicules.—The Greek letter Γ has been used to designate a type of oxecote spicule in which the end is bent over sharply through about a right angle.

The hastate ends of the oxea in *Leucosolenia discoveryi** amongst which Γ spicules are found are formed by two angular bends close together in the axis of the spicule. The Γ spicules may arise owing to the absence of the second bend.

Chiactines.—The facial rays of these spicules are very similar to those of ordinary quadriradiates. The basal ray, which is the longest, is usually straight, but sometimes bent slightly at a point not far from its junction with the paired rays (see Fig. 76) and is round in section. The paired rays are usually slightly curved and are often oval in section, being flattened in the facial plane. Viewed along the axis of the

* Γ spicules also occur in *Leucosolenia minchini* and *Leucosolenia lieberkuehni*.

basal ray, the paired rays are seen to be folded to one side ; the fold appears in some cases to occur sharply near the base of the rays, which are otherwise straight ; in other cases the fold is gradual, the rays being curved for the greater part of their length. The apical ray springs from the junction of the facial rays on the side to which they are folded, but is immediately bent down nearly into line with the basal ray. Viewed from the side the apical ray appears as a continuation of the basal ray, with a sharp "set-over" at the junction. The amount of the set-over varies widely (see *Streptocornus australis* and *Megapogon cruciferus*). The axis of the apical ray is usually slightly inclined to the axis of the basal ray, sloping towards the side to which the paired rays are folded. In facial view the chiaetine does not differ much from the ordinary quadriradiate, since the apical rays of the latter are usually curved orally, but in side view the difference is wide.

The ordinary position of quadriradiates in calcareous sponges is tangential to the gastral surface, with the basal ray downwards and the apical ray projecting into the gastral cavity, so that the paired rays lie circumferentially embracing the gastral cavity. In *Amphoriscus* and *Syculmis* there are quadriradiates which lie tangentially to the gastral surface with the apical ray pointing radially outwards, and in all the *Amphoriscidae* there are quadriradiates which lie tangentially to the dermal surface with the apical ray pointing radially inwards. The chiaetines lie in a plane perpendicular to all these positions. Their basal ray is directed radially outwards, the paired rays lie in the gastral cortex and the apical ray points radially inwards and projects into the gastral cavity. The plane of the facial rays is therefore perpendicular to the gastral and dermal surfaces. The position of the paired rays is no longer fixed ; they may lie circumferentially as before, but they may turn round the axes of the basal ray to any extent without coming out of the gastral cortex, and in fact they are found lying in all positions between circumferential and longitudinal.

The relation between the chiaetines and the ordinary quadriradiates is an interesting problem. All the nine new species containing chiaetines have ordinary quadriradiates lying tangentially round the oscule, and also lining the whole oscular collar, if any. In six* of the new species the ordinary quadriradiates cease entirely at the base of the collar and are replaced by the chiaetines which form the body skeleton. At the junction between the oscular collar and the body-wall there is a short space in which quadriradiate spicules are found in every intermediate position between tangential and centrifugal. This fact suggests most forcibly that the spicules turn round. The top of the body appears to be the most recently developed, and the spicules formed in the oscular collar might be supposed to be turned round by the development of flagellated chambers under their basal rays. A very similar tipping up of dermal triradiates, due to the growth under them of the flagellated chambers, occurs at the base of the oscular collar in *Tenthrenodes antarcticus*. There is

* In three of the new species the ordinary quadriradiates in the oscular collar continue throughout the whole gastral cavity in conjunction with the chiaetines in the body.

one serious objection to this theory. The apical rays of the ordinary quadriradiates would have to be bent down and straightened while the spicule turned round. The shape of the apical ray in the chiacines suggests that this does occur, but it is difficult to realise how an actually formed spicule can be altered in shape.

Hair Spicules.—In many of the new species there occur long straight spicules of extreme thinness, varying from about 0.7μ to about 2μ in diameter; they are called hair spicules. Their length is always difficult to determine. When they occur in the oscular fringe the outer ends are usually broken; when they occur in the body-wall they are usually so crowded together that it is impossible to distinguish the ends of individual spicules. It is probable that they often attain to lengths of 500μ or $1,000 \mu$. They often project from the body-wall with the ordinary thick oxea. The hair spicules are usually omitted in the drawings of spicules, since their thickness is too small to draw to scale and their length is uncertain.

Flattened Spicules.—In two of the new species (*Leucandra cirrata* and *Megapogon crispatus*) the large projecting oxea are marked near their distal ends by curious flattened areas situated on the convex sides of the curved ends. Their appearance might suggest that the spicule had come in contact with some flat obstruction which had diverted its growth and caused the mark. This, however, does not seem to be possible, and no explanation of the origin of the marks has been found.

REPRODUCTION.

Larvæ similar to those of *Sycon ciliatum* were found in *Tenthrenodes scotti* and *Megapogon pollicaris*.

Ova of the ordinary type were found in *Hypodictyon* and in *Achramorpha glacialis*.

Duplicate ova of a remarkable type were found in *Achramorpha nivalis* and *Megapogon raripilus*; no satisfactory explanation of their structure has been found. They were in large numbers in three specimens of *Achramorpha nivalis*; the best preparations were made from one of the specimens which had been fixed in osmic acid. None of the specimens of *Megapogon raripilus* were as well fixed, nor could the structure of the ova be made out so satisfactorily; it appears to differ slightly from that of *Achramorpha nivalis*.

The following description applies to the ova of *Achramorpha nivalis*:—

Each ovum (Fig. 110) appears to be made up of two unequal parts; the larger part (*a*) is very similar to the ordinary large ovum cell and contains a large transparent nucleus (*b*) and small strongly staining nucleolus (*c*); the smaller part appears to be a multicellular structure, consisting of a large inner cell surrounded by a sheath of small cells (*d*); (but it is possible that it may be a single cell, the central portion (*g*) being the nucleus). The inner cell (*g*) contains two structures; one (*h*) strongly staining like the nucleolus of the larger part, the other a hyaline sphere (*i*)

packed with about a dozen grains (*k*) of one colour and one odd one (*l*) (nucleus, nucleolus?), which stains a different shade. The outer sheath of cells each has a small nucleus (*e*) and minute nucleolus (*f*). This sheath appears in some cases to surround the inner cell entirely, and in other cases only to surround the outer part, and not to exist between the inner cell (*g*) and the other half (*a*) of the ovum.

It is possible that the smaller half of the ovum may be a feeding cell, supplying nourishment to the larger half. The hyaline sphere of grains may be food material.

In the ovum of *Megapogon varipilus*, the smaller half has a somewhat different appearance, which suggests that it is made up of several concentric sheaths of cells round a central one. These ova, however, are not well enough fixed to repay detailed examination.

REFERENCE LIST OF MEMOIRS CITED.

1. MINCHIN, E. A.—*A Treatise on Zoology*. Edited by E. Ray Lankester. Part II. The Porifera and Coelentera. Chapter III. Sponges, by E. A. Minchin, M.A. 1900.
2. DENDY, A.—*Studies on the Comparative Anatomy of Sponges*. V. Observations on the Structure and Classification of the Calcarea Heterocoela. Q. J. M. S., vol. 35 (1893), pp. 159-257, Pl. X.-XIV. New Series.
3. HAECKEL.—*Die Kalkschwämme*. Berlin. 1872.
4. POLÉJAEFF.—*Challenger Rep.* VIII. 1883.
5. BREITFUSS.—*Zool. Jahrbuch, Syst.* XI. (1898.)
6. LENDENFELD, R. VON.—*Die Spongien der Adria*. I. Die Kalkschwämme. *Zeit. f. wiss. Zool.* LIII. (1891.) pp. 1-212.
7. DENDY, A.—*Synopsis of Australian Calcarea Heterocoela: with a proposed classification of the group and descriptions of some new genera and species*. Proc. Roy. Soc. of Victoria. Vol. V. (1892), pp. 69-116.
8. MINCHIN, E. A.—*The Characters and Synonymy of the British Species of Sponges of the genus Leucosolenia*. Proc. Zool. Soc. Lond. 1904, Vol. ii., p. 349.

DESCRIPTION OF PLATES XXVII. TO XXXVIII.

The figures on Plate XXVII. are reproduced from photographs made by the Author ; the rest of the figures are reproductions of drawings made by the Author with the Abbe drawing apparatus. All the figures are reduced from these drawings, most of them to two-fifths of the size of the originals ; the final magnification is marked on each figure.

The letters on the Spicule drawings correspond with those used in the text to indicate the different sorts of spicules.

N.B.—Hair spicules, which occur in many of the sponges, are *not shown* in the figures.

The significance of the letters on the other drawings is given in the following list :—

<p><i>ost.</i> Ostia.</p> <p><i>pros.</i> Prosopyles.</p> <p><i>ap.</i> Apopyles.</p> <p><i>p.</i> Ports.</p> <p><i>i. ch.</i> Incurrent chambers.</p> <p><i>i. ca.</i> „ canals.</p> <p><i>e. ch.</i> Excurrent chambers.</p> <p><i>e. ca.</i> „ canals.</p> <p><i>osc.</i> Oscule.</p>	<p><i>osc. c.</i> Oscular collar.</p> <p><i>osc. e.</i> „ edge.</p> <p><i>g. c.</i> Gastral cavity.</p> <p><i>d.</i> Dermis.</p> <p><i>fl. ch.</i> Flagellated chamber.</p> <p><i>ov.</i> Ovum.</p> <p><i>sp.</i> Spicule.</p> <p><i>a. r.</i> Apical ray.</p>
------------------------------------------------------------------------------------------------------------------------------------------------------------------------------------------------------------------------------------------------------------------------------------------	----------------------------------------------------------------------------------------------------------------------------------------------------------------------------------------------------------------------------------------------------------------

LIST OF FIGURES.

<p>1. <i>Dermatretion hodgsoni</i>.</p> <p>2. <i>Megapogon crispatus</i>.</p> <p>3. <i>Streptoconus australis</i>.</p> <p>4. <i>Achramorpha grandinis</i>.</p> <p>5. <i>Dermatretion chartaceum</i>.</p> <p>6. <i>Leucandra frigida</i>.</p> <p>7-8. <i>Achramorpha nivalis</i>.</p> <p>9. <i>Tenthrenodes scotti</i>.</p> <p>10-11. <i>Hypodictyon longstaffi</i>.</p> <p>12-13. <i>Leucosolenia discoveryi</i>.</p> <p>14-15. „ <i>minckini</i>.</p> <p>16-27. <i>Tenthrenodes scotti</i>.</p> <p>28-32. „ <i>antarcticus</i>.</p> <p>33-34. <i>Leucandra primigenia</i> var. <i>leptoraphis</i>.</p> <p>35-40. <i>Leucandra frigida</i>.</p> <p>41-43. „ <i>brumalis</i>.</p>	<p>44-53. <i>Leucandra gelatinosa</i>.</p> <p>54-66. „ <i>cirrata</i>.</p> <p>57-58. „ <i>hiberna</i>.</p> <p>59-64. <i>Dermatretion chartaceum</i>.</p> <p>65-74. „ <i>hodgsoni</i>.</p> <p>75-80. <i>Streptoconus australis</i>.</p> <p>81-97. <i>Hypodictyon longstaffi</i>.</p> <p>98-102. <i>Achramorpha glacialis</i>.</p> <p>103-104. „ <i>grandinis</i>.</p> <p>105-112. „ <i>nivalis</i>.</p> <p>113. <i>Grantiopsis cylindrica</i>.</p> <p>114. <i>Megapogon cruciferus</i>.</p> <p>115-119. „ <i>villosus</i>.</p> <p>120-124. „ <i>raripectus</i>.</p> <p>125-130. „ <i>pollicaris</i>.</p> <p>131-136. „ <i>crispatus</i>.</p> <p>137. <i>Sycon tenellum</i>.</p>
----------------------------------------------------------------------------------------------------------------------------------------------------------------------------------------------------------------------------------------------------------------------------------------------------------------------------------------------------------------------------------------------------------------------------------------------------------------------------------------------------------------------------------------------------------------------------------------------------------------------------------------------------------------------------------	--------------------------------------------------------------------------------------------------------------------------------------------------------------------------------------------------------------------------------------------------------------------------------------------------------------------------------------------------------------------------------------------------------------------------------------------------------------------------------------------------------------------------------------------------------------------------------------------------------------------------------------------------------------------------------



1 nat. size.



2 x 8



3 x 3



4 x 2



7 x 2



5 x 2

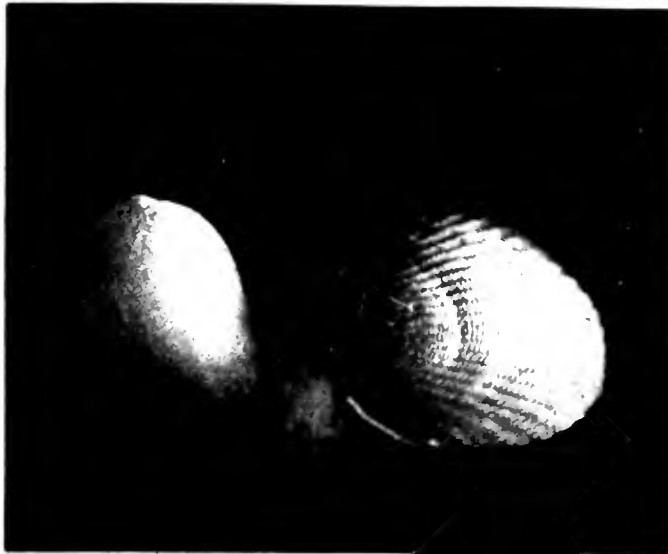

6 x 2

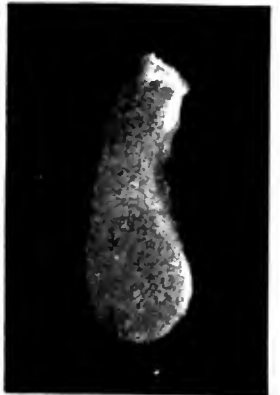

8 x 2

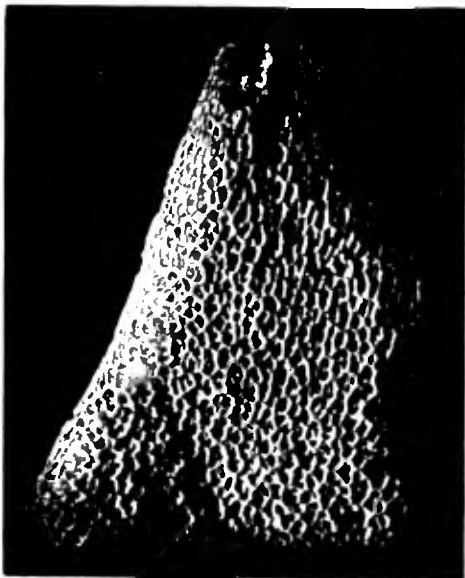

9 x 2



10 x 2



11 nat. size.

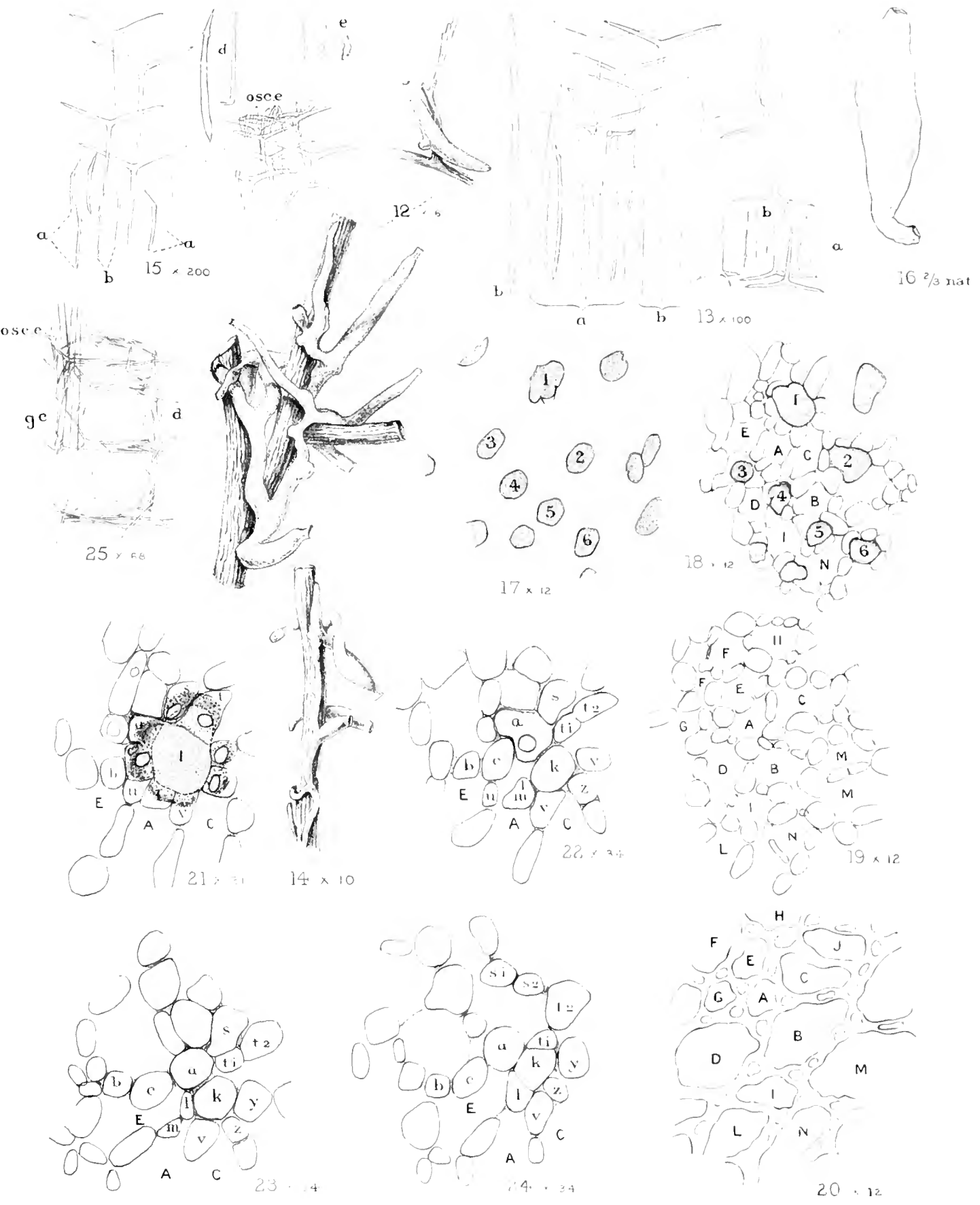

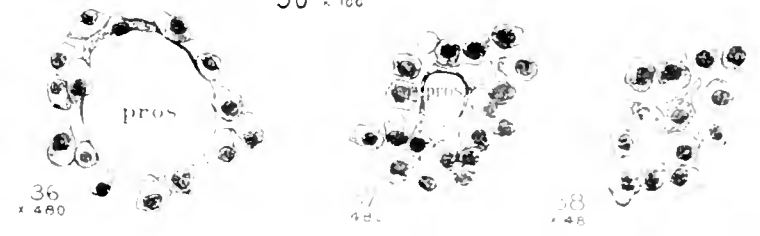
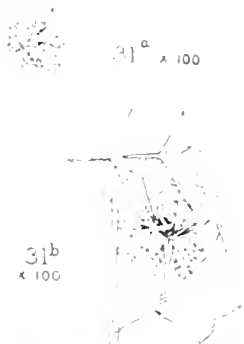
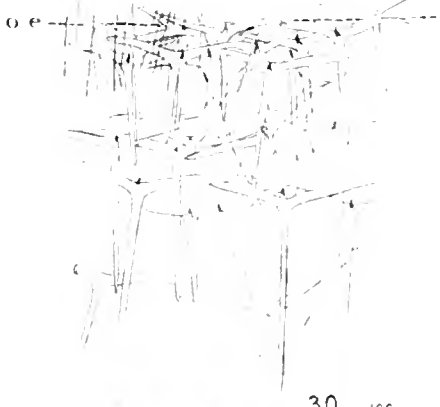
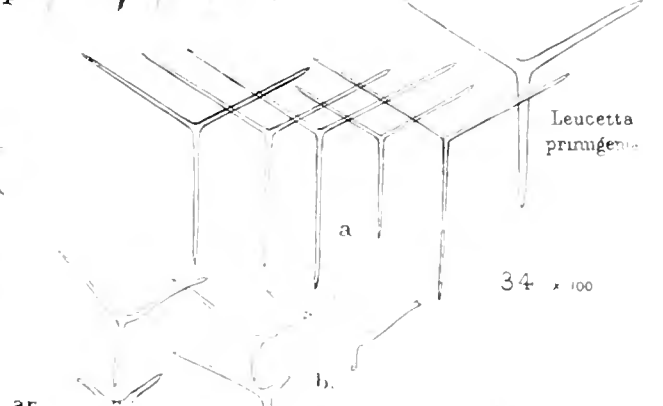
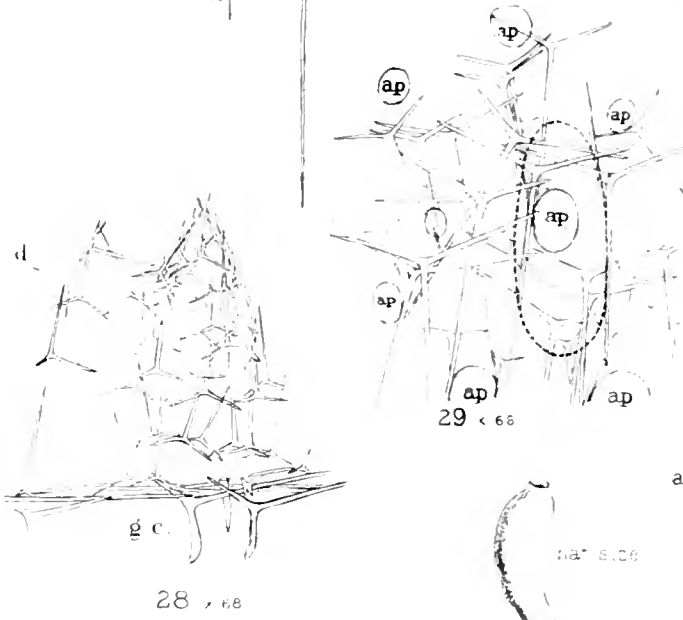
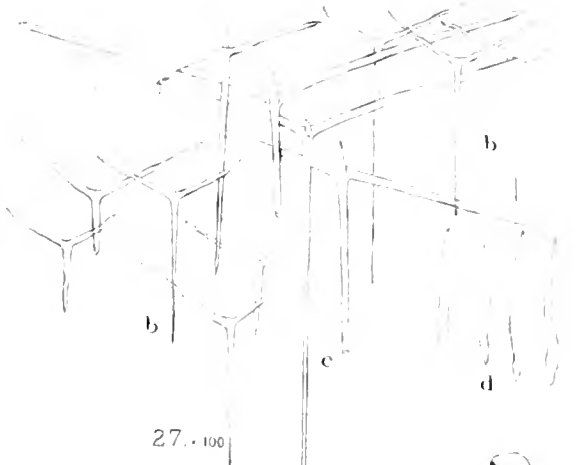

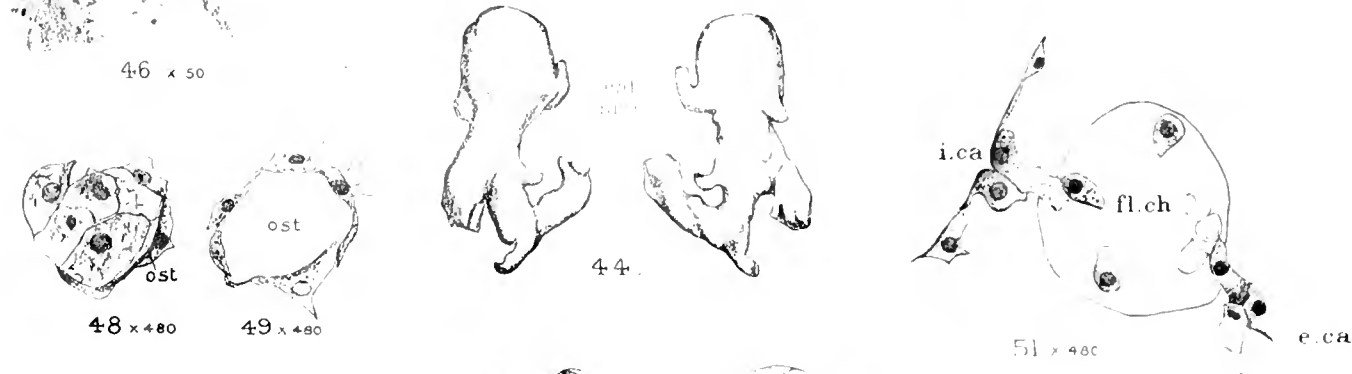
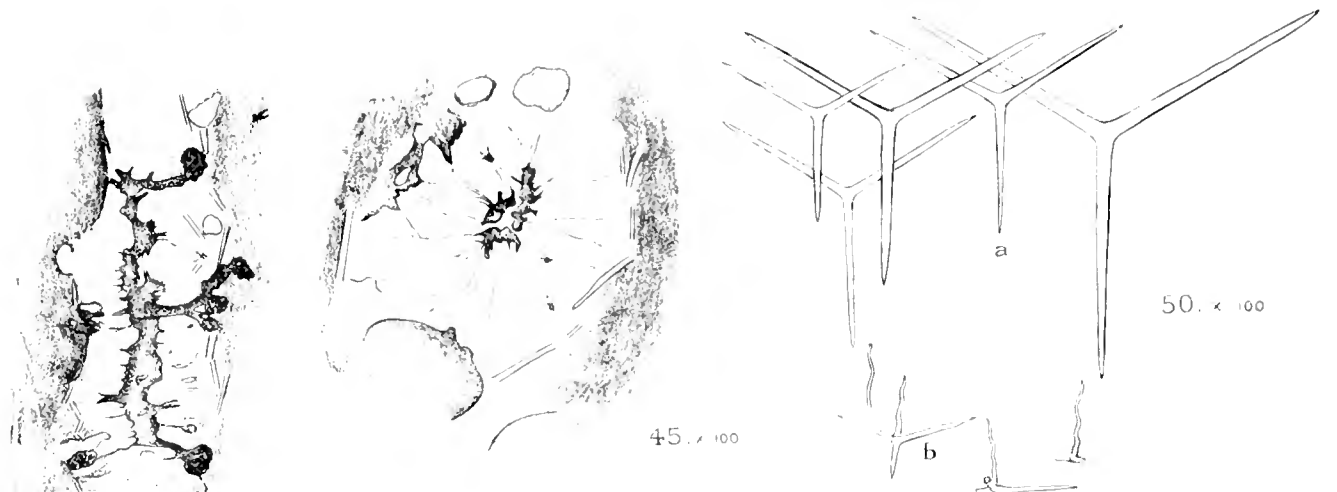
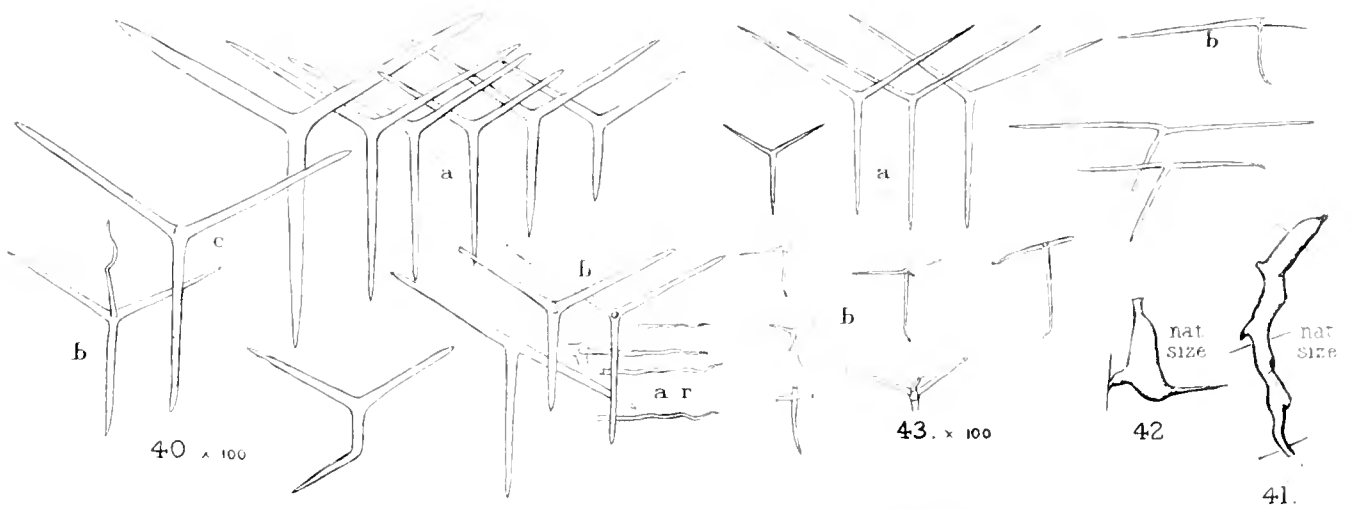

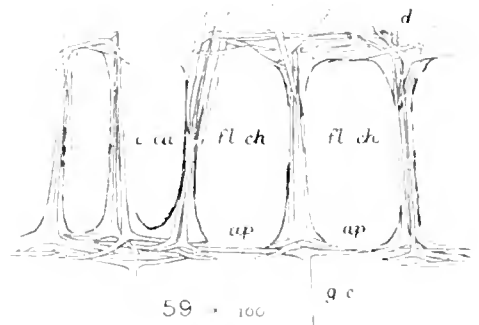
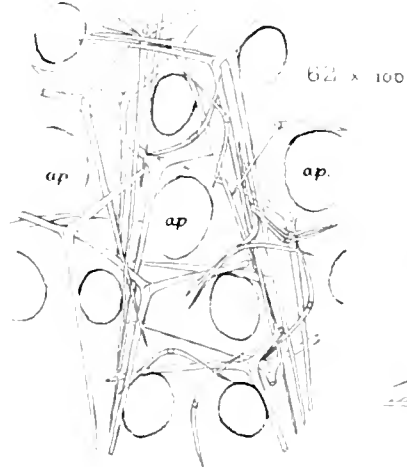
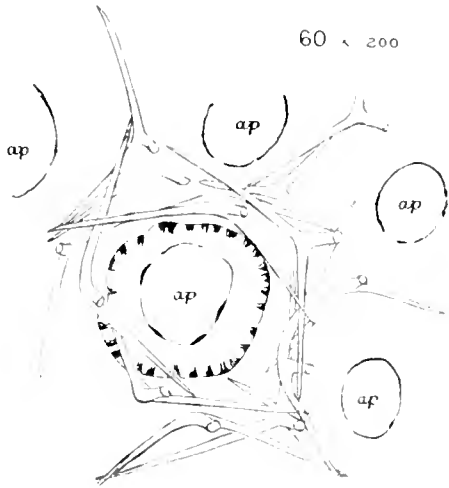
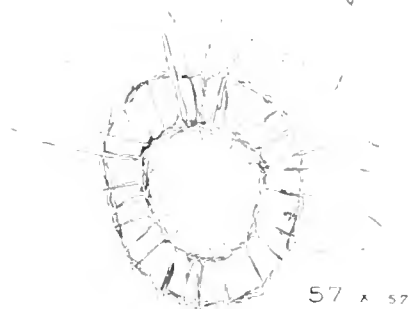
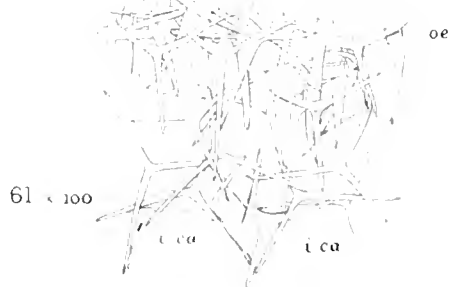
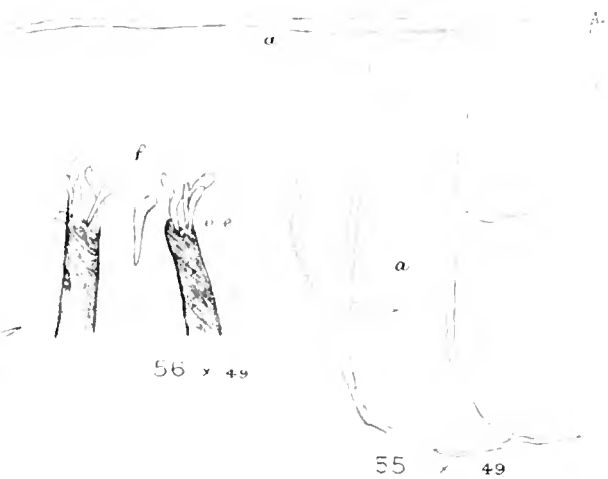
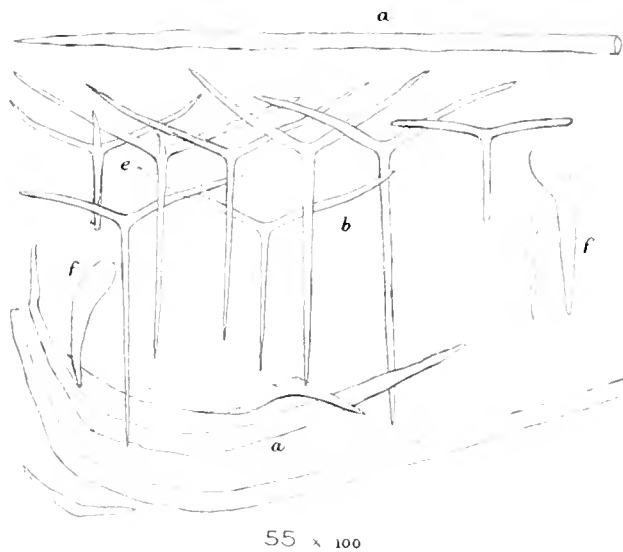



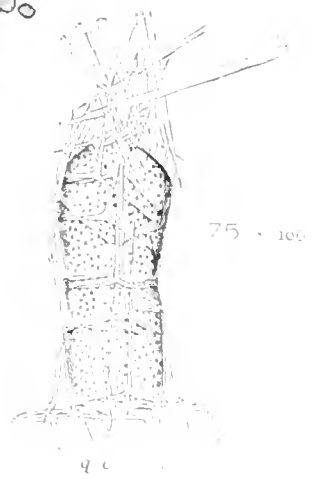
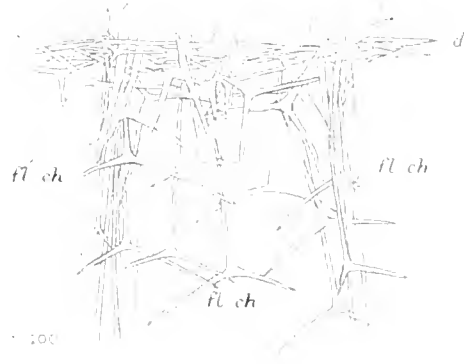
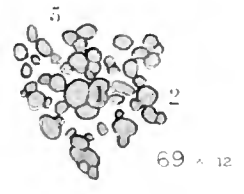
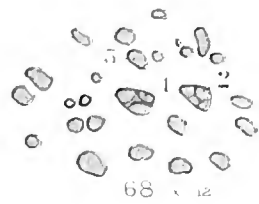
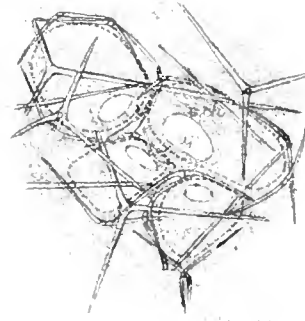
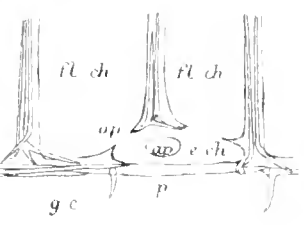
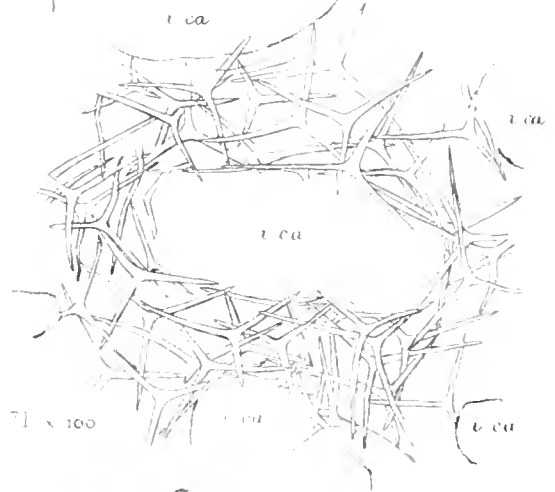
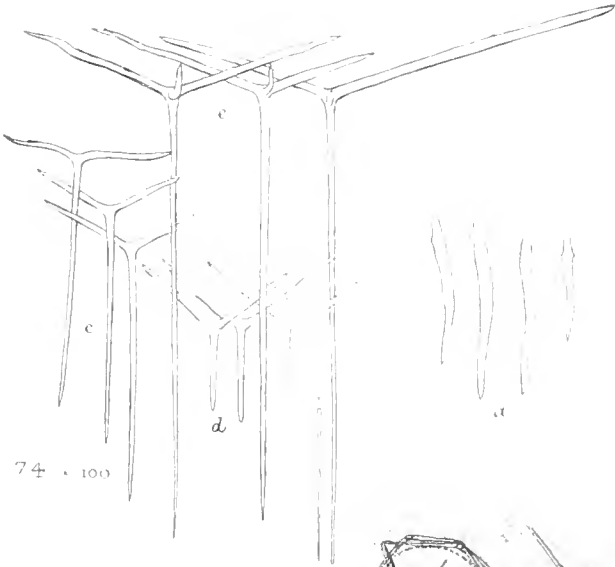
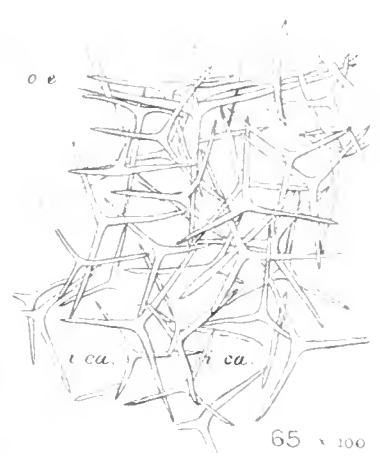
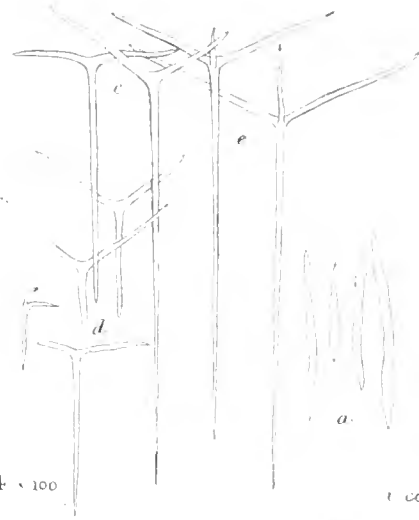
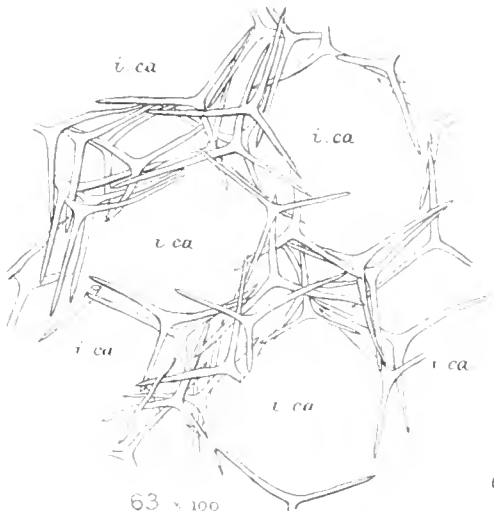

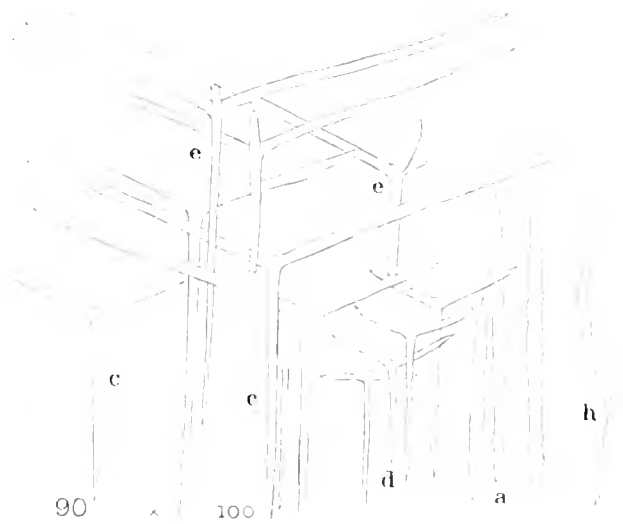
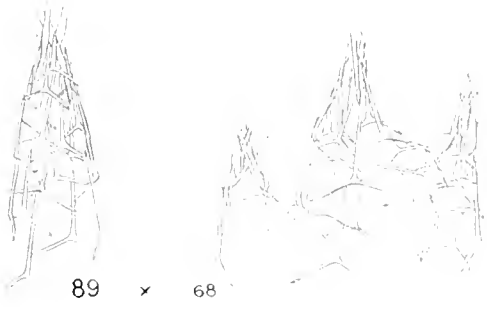
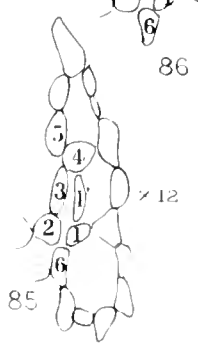
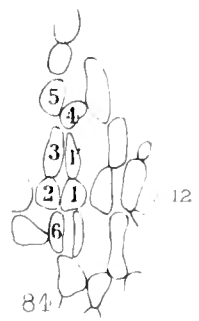
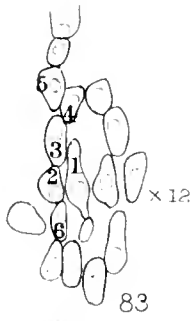
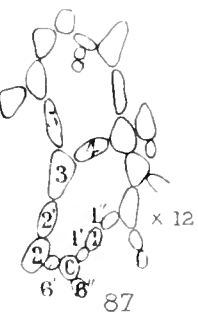
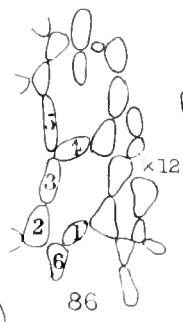
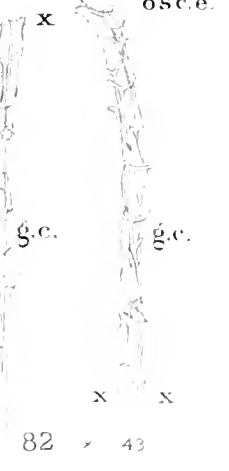
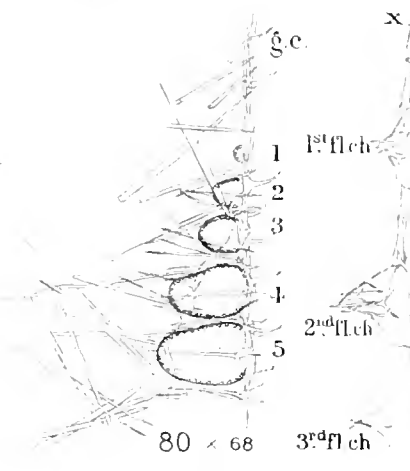
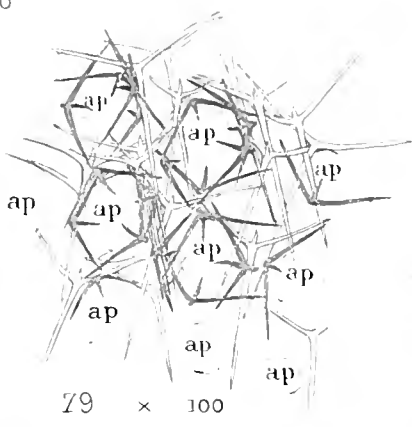
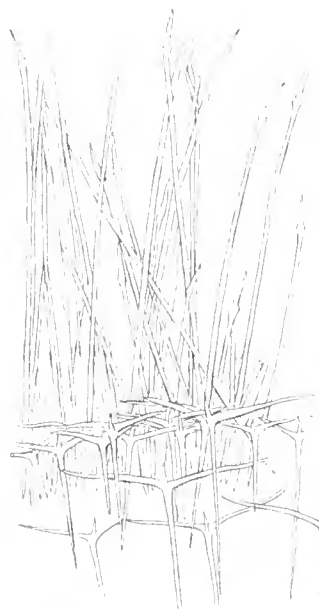
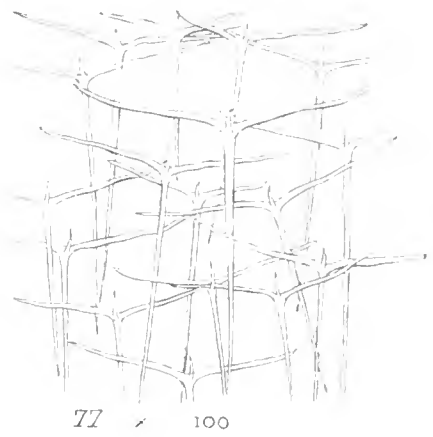
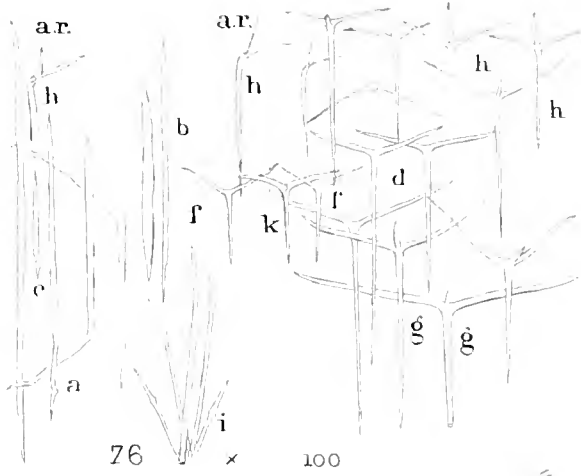

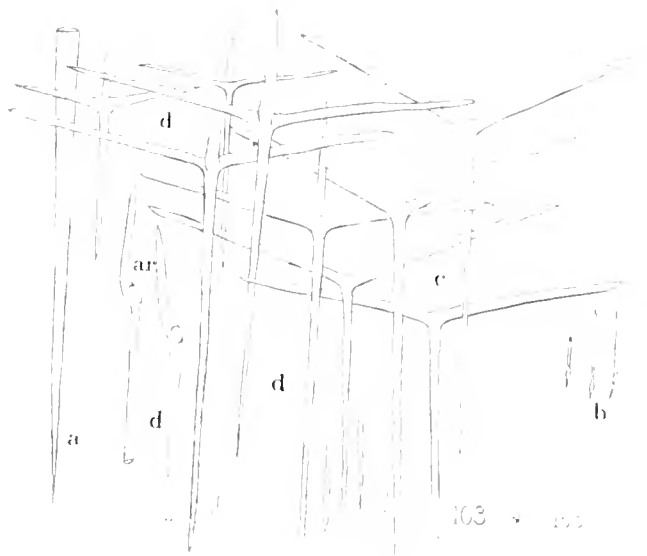
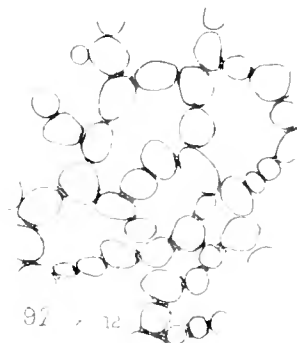
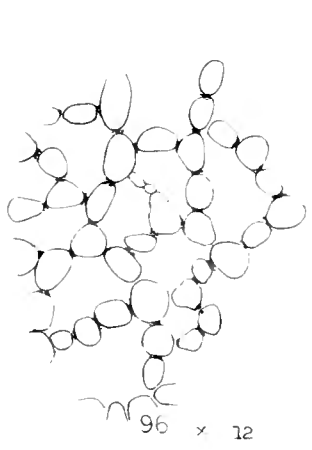
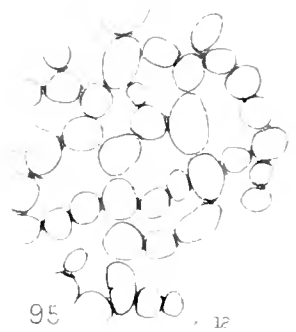
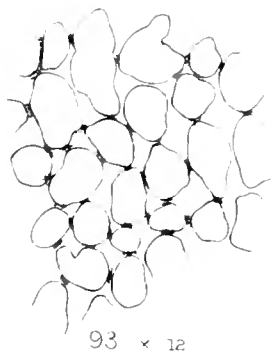
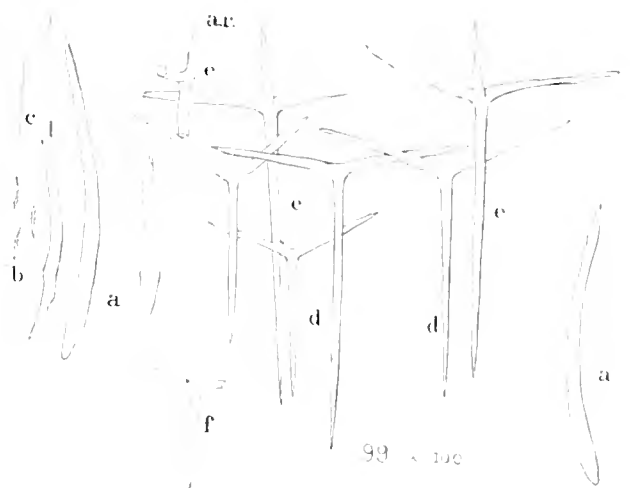
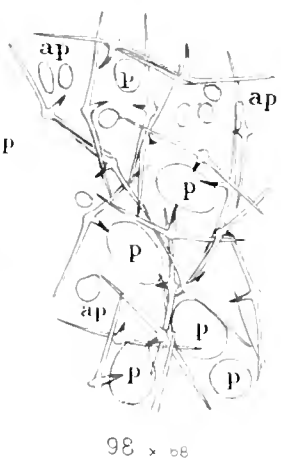
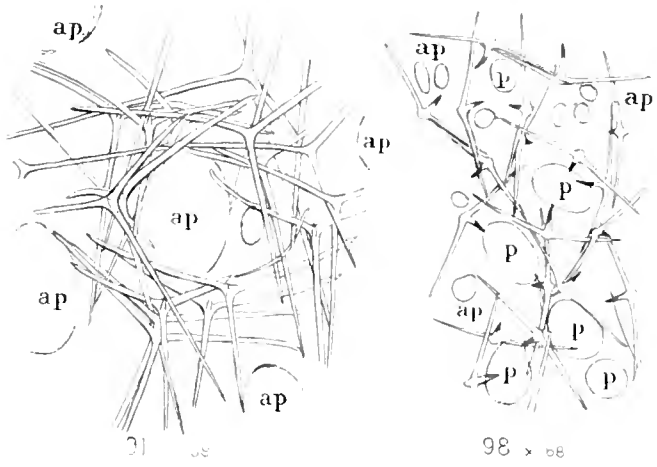

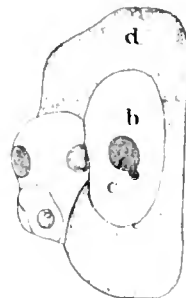
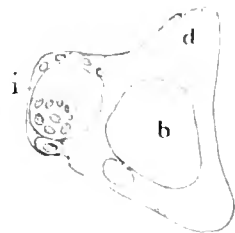
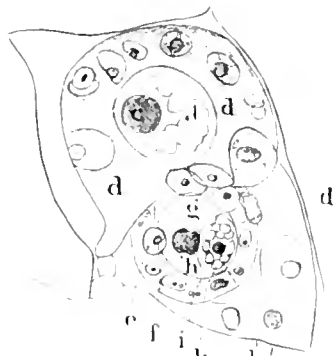
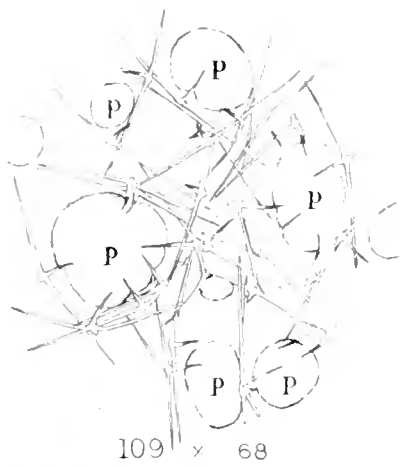
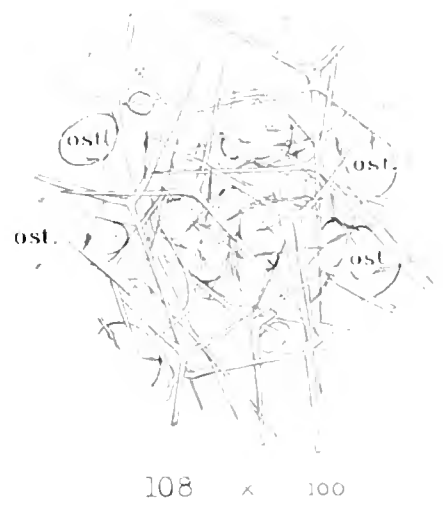
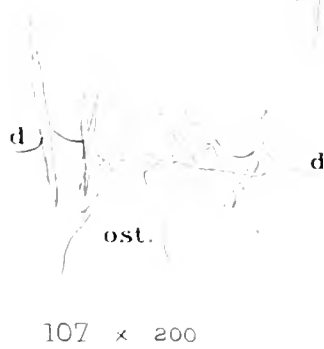
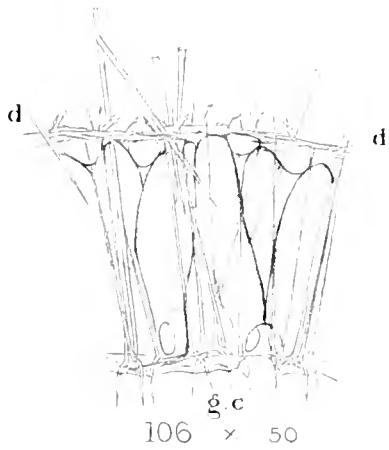
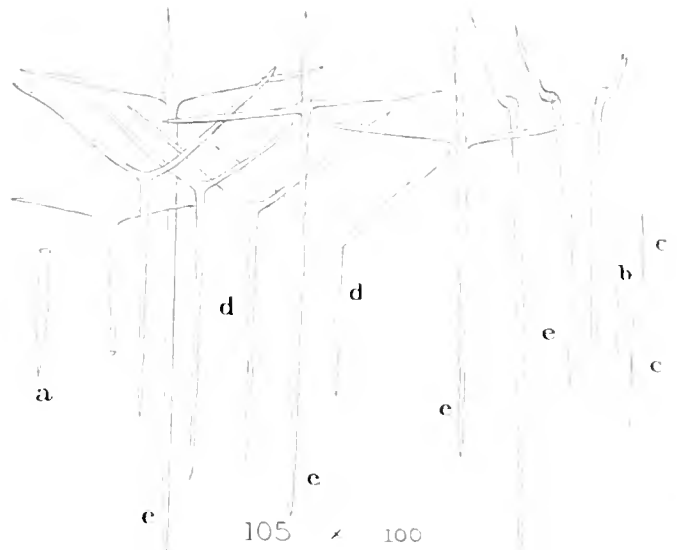
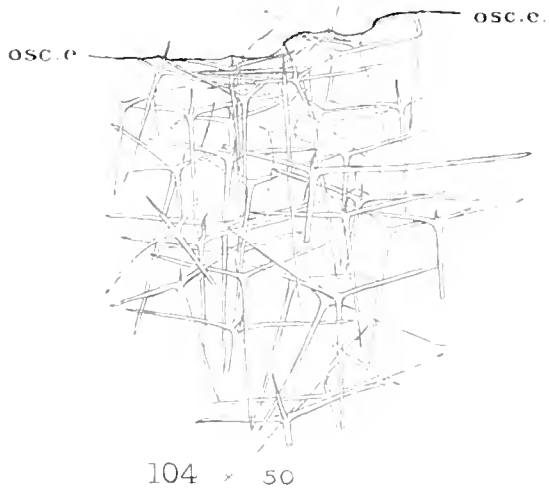

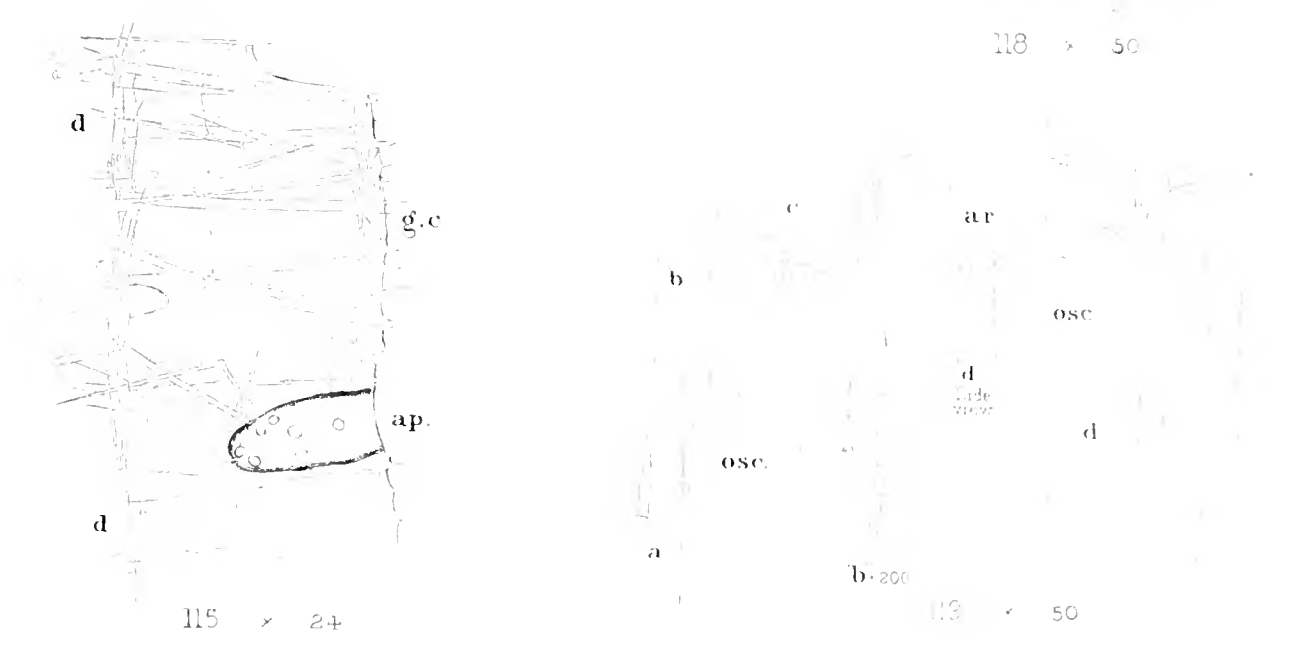
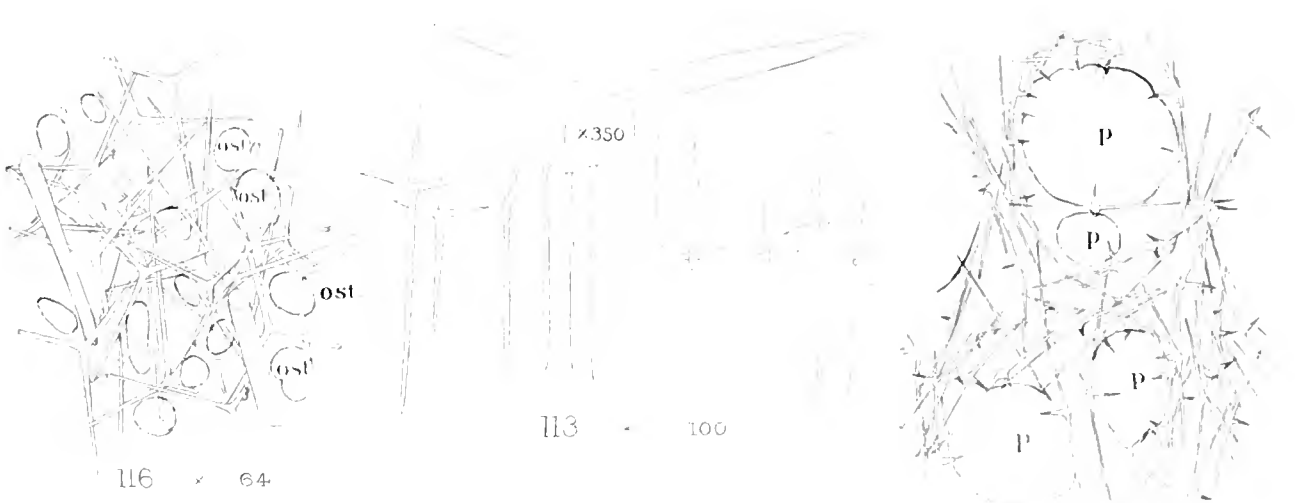
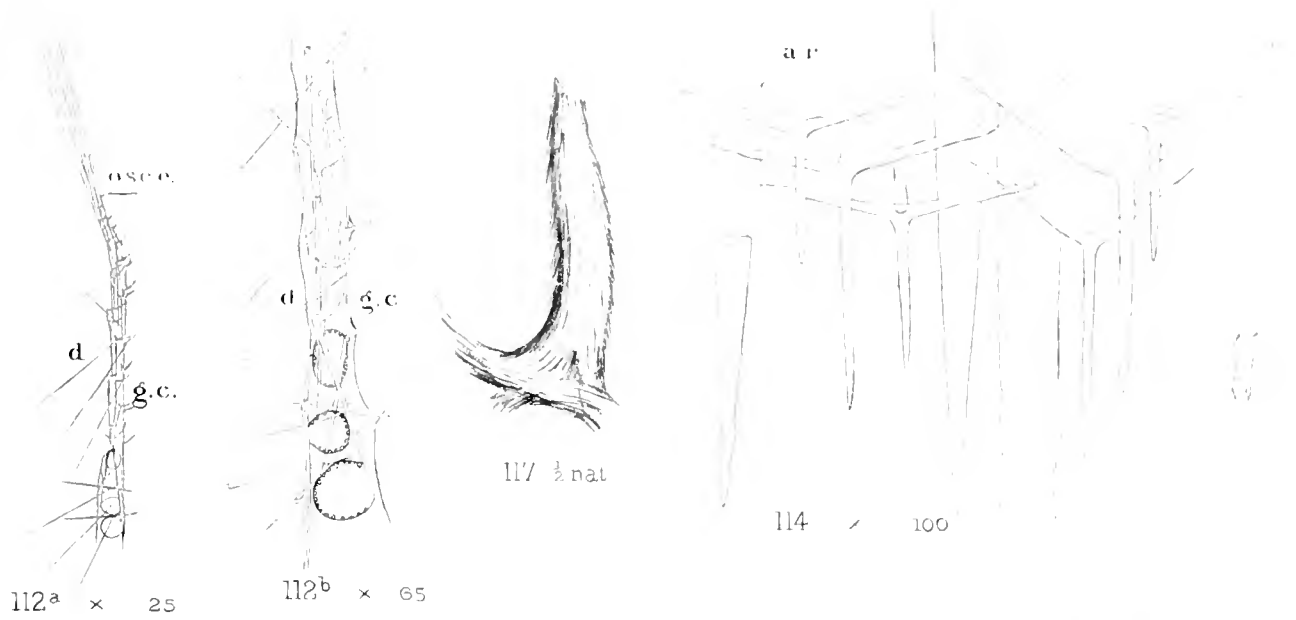

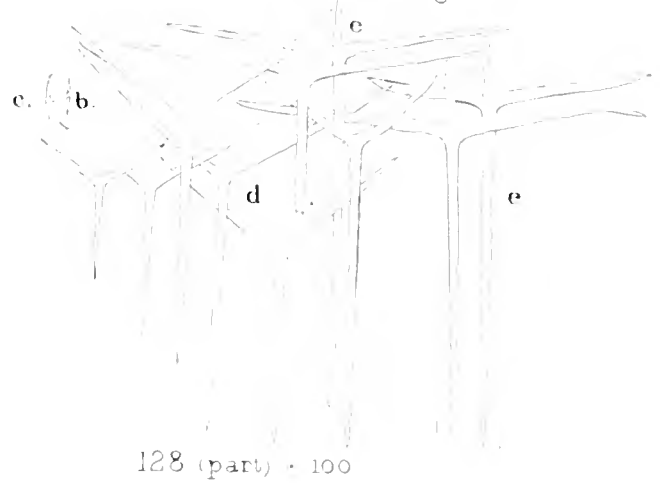
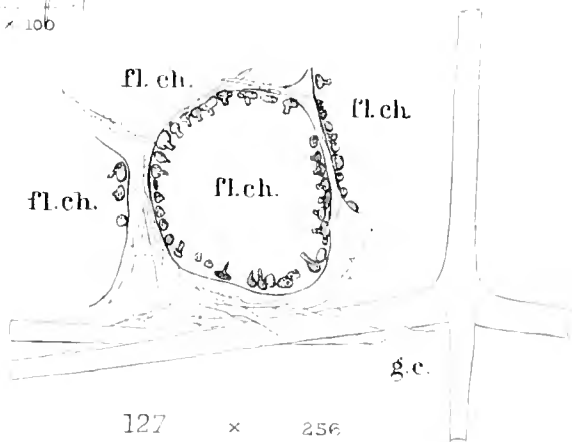
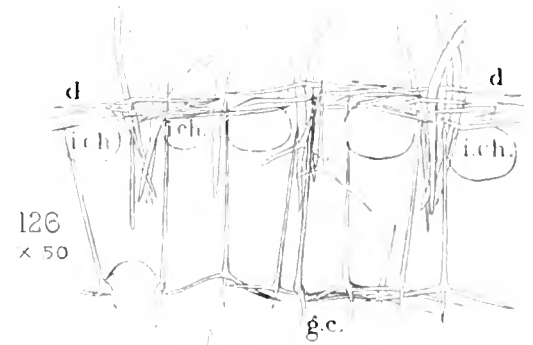
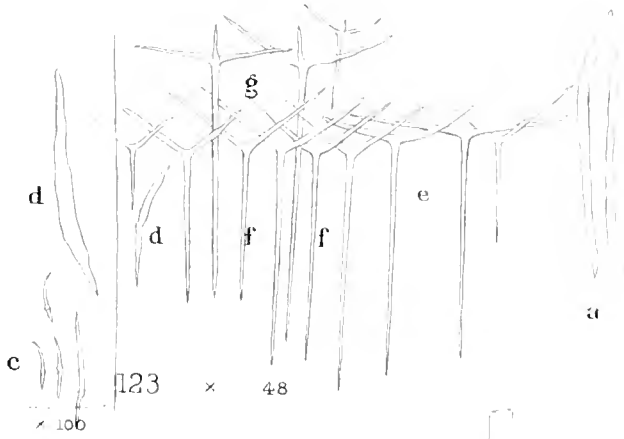
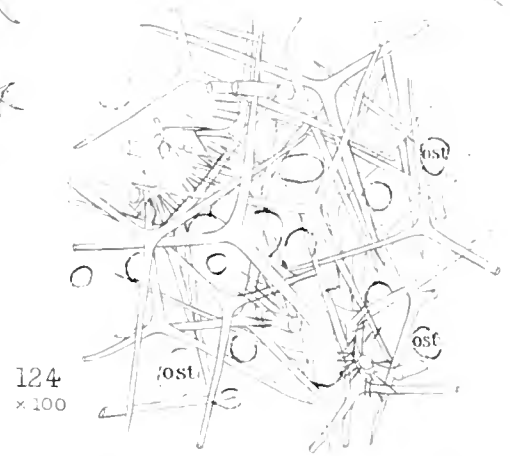
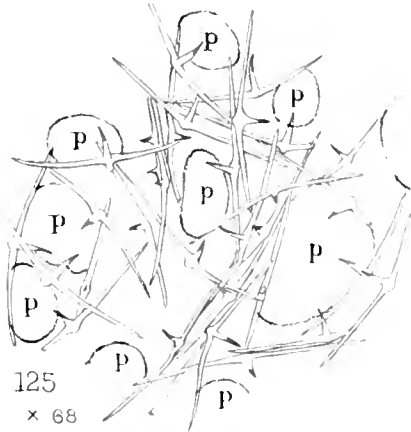
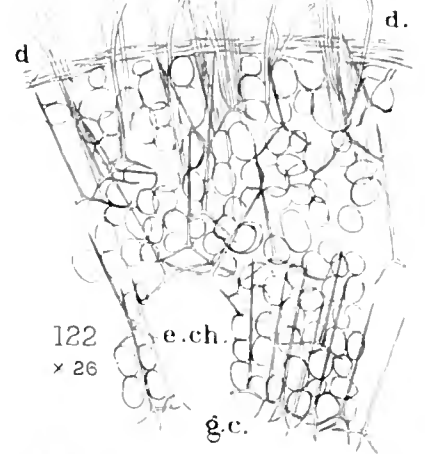
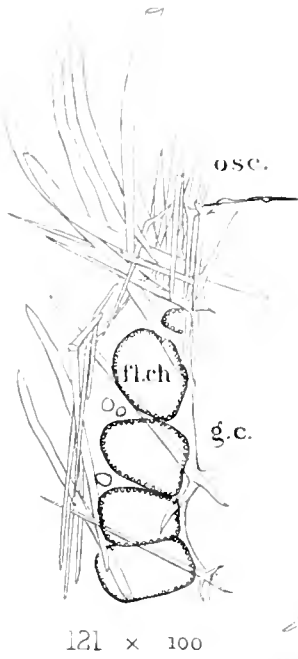
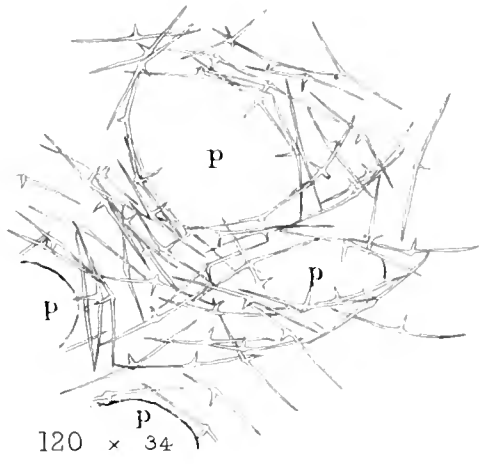

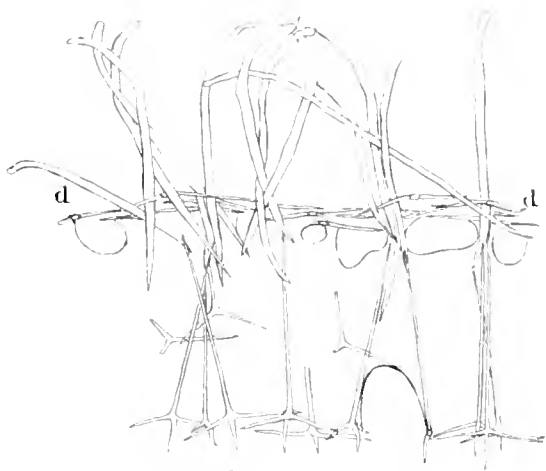

131 x 50 g.c.



129 x 256



x 200

128 (part) x 50

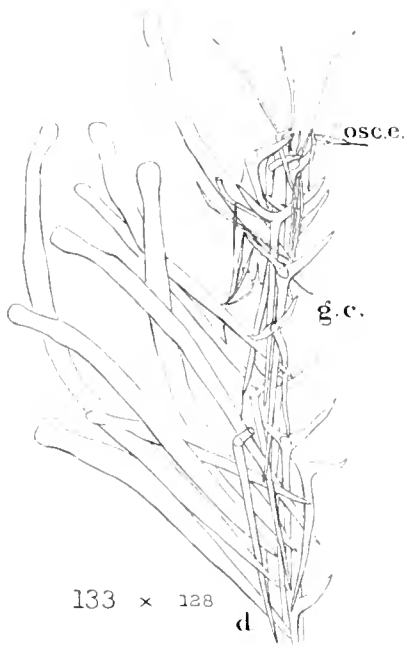

133 x 128

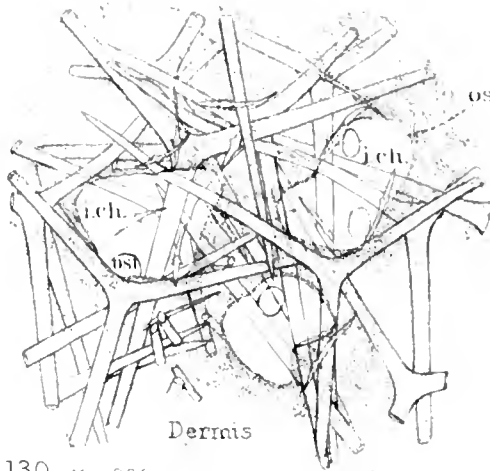

130 x 200

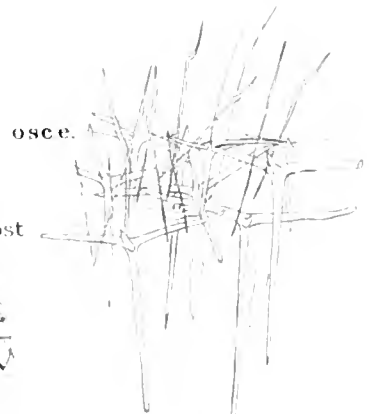

134 x 128

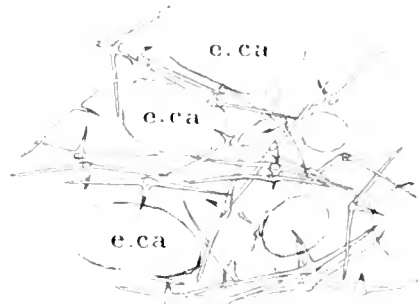

132 x 68

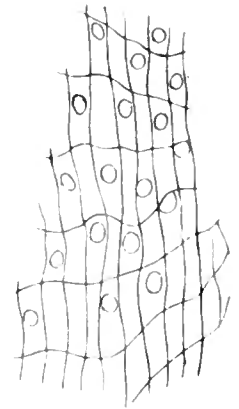

137 x 10

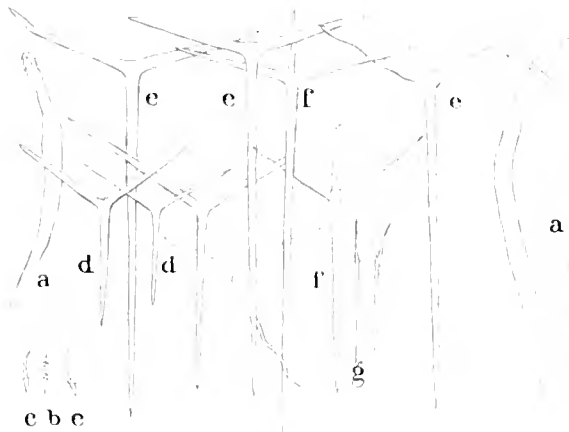

135 x 100

a

x 200

136 x 50

a

a

a

INDEX.

- Achramorpha*, 30.
 „ *glacialis*, 31.
 „ *grandinis*, 32.
 „ *nivalis*, 33.
 „ table, 2.
antarcticus, *Tenthrenodes*, 12.
 Apophyses, defined, 5.
 „ histology, 45.
Ascetta coriacea, 6.
 „ *primordialis*, 6.
australis, *Streptoconus*, 25.
blanca, *Leuconia*, 36.
brumalis, *Leucandra*, 16.
 Chiaetines, 3.
 „ histology, 46.
Chiphoridae, chiaetines in, 25.
 „ definition, 24.
 „ new family, 3.
cirrata, *Leucandra*, 18.
Clathrina, 2, 6.
 „ *coriacea*, 6.
 „ *primordialis*, 6.
Clathrinidae, 2, 6.
complicata, *Leucosolenia*, 6.
coriacea, *Clathrina* (*Ascetta*), 6.
crispatus, *Megapogon*, 41.
cruciferus, *Megapogon* (*Leuconia*), 36.
cylindrica, *Grantiopsis*, 35.
Dermatreton chartaceum, 22.
 „ *hodgsoni*, 23.
 „ table, 2.
discoveryi, *Leucosolenia*, 6.
 Drawing of spicules, 45.
 Duplicate ova, 6.
dura, *Leucetta*, 14.
 Excurrent chambers, 5.
 „ canals, 5, 45.
frigida, *Leucandra*, 15.
fruticosa, *Leucetta*, 11.
 Gamma spicules, 7, 9, 46.
 Gastral cavity, histology, 45.
gelatinosa, *Leucandra*, 17.
glacialis, *Achramorpha*, 31.
grandinis, *Achramorpha*, 32.
Grantiidae, 2, 14.
Grantiopsis cylindrica, 3, 35.
 „ table, 2.
Heterocoela, 2, 9.
hiberna, *Leucandra*, 19.
 Histology, 14.
hodgsoni, *Dermatreton*, 23.
Homocoela, 2, 6.
 Honeycomb pattern, 10.
Hypodictyon, definition, 2.
 „ *longstaffi*, 27.
 Incurrent canals defined, 5.
 „ canals, histology, 44.
 „ chambers defined, 5.
 Jelly in *L. gelatinosa*, 17.
leptoraphis var. *Leucandra primigenia*, 14.
Leucallis pumila, 16.
Leucandra, 2, 14.
 „ *brumalis*, 16.
 „ *cirrata*, 18.
 „ *frigida*, 15.
 „ *gelatinosa*, 17.
 „ *hiberna*, 19.
 „ *primigenia*, 14.
Leucetta dura, 14.
 „ *fruticosa*, 14.
Leuconia blanca, 36.
 „ *crucifera*, 36.
Leucosolenia, 2, 6.
 „ *complicata*, 6.
 „ *discoveryi*, 6.
 „ *lieberkühni*, 46.
 „ *minchini*, 8.
Leucosoleniidae, 2, 6.
lieberkühni, *Leucosolenia*, 46.
 “Linked” chambers, definition, 4.
 „ „ in *Tenthrenodes*, 9.
 „ „ in *Dermatreton*, 21.
Megapogon, table, 2.
 „ *crispatus*, 41.
 „ *cruciferus*, 35.
 „ *pollicaris*, 40.
 „ *ruripilus*, 38.
 „ *villosus*, 5, 37.
microraphis var., 14.
minchini, *Leucosolenia*, 8.

- New families, 2, 3.
 New genera described, 4.
 " table, 2.
 Oscular collar defined, 5.
 Oscule defined, 5.
 " closed in different ways, 45.
 Oscules, histology, 44.
 Ostia defined, 5.
 " histology, 44.
 Ova, 48.
 " duplicate, 6, 48.
pollicaris, *Megapogon*, 40.
 Ports defined, 5.
 Pore defined, 5.
 Pores, histology, 44.
primigenia, *Leucandra* (*Leucetta*), 14.
primordialis, *Clathrina* (*Ascetta*), 6.
 Prosopyles defined, 5.
 " histology, 44.
pumila, *Leucallis*, ref., 14.
 Quadriradiates, turning round, 30, 47.
raripilus, *Megapogon*, 38.
 Refrangent spicules, 7, 9.
 Reproduction, 48.
 Reticulated cortices in *Dermatreton*, 21.
scotti, *Tenthrenodes*, 10.
 Spicules, histology, 45.
 " hair, 48.
 " folding, 45.
 " flattened, 48.
 " gamma, 7, 9, 46.
 " how drawn, 45
 " position in sponge, 46.
 " tau, 46.
Staurorrhaphidæ, definition, 29.
 " new family, 2, 3.
Streptoconus australis, 25.
 " table, 2.
Sycantha tenella, described, 4.
Syrettidæ, 2, 9.
 Tan spicules, 46.
 Terminology, definitions, 5.
Tenthrenodes antarcticus, 9, 12.
 " *scotti*, 10.
 " table, 2.
 Thumb-shaped spicules, 40.
villosus, *Megapogon*, 37.

LONDON :
PRINTED BY WILLIAM CLOWES AND SONS, LIMITED,
DUKE STREET, STAMFORD STREET, S.E., AND GREAT WINDMILL STREET, W.





