

11-16

Nature

A WEEKLY

ILLUSTRATED JOURNAL OF SCIENCE





-- Nature,]
Dec. 18, 1902]

Nature

A WEEKLY

ILLUSTRATED JOURNAL OF SCIENCE

VOLUME LXVI

MAY to OCTOBER 1902

*"To the solid ground
Of Nature trusts the mind which builds for aye."*—WORDSWORTH

172689

London

MACMILLAN AND CO., LIMITED

NEW YORK: THE MACMILLAN COMPANY

RICHARD CLAY AND SONS, LIMITED,
LONDON AND BUNGAY.

W.C. & A.S.
LONDON & BUNGAY

DeNol Binding Company

3957 St. Clair Avenue .. Cleveland 14, Ohio

SI BINDING AND LETTERING INSTRUCTIONS

51 vols. of this title Stamping
 Gold..... Black..... Special Color.....
 Color of Labels — Top Bottom..... Leather.....
Stained.....
 Follow rub.... Sample.... New title..... We have rub.....

The following necessary for new titles only or if change in instructions.	Top	Horizontal Title 51
BINDING INSTRUCTIONS	Lengthwise — Title will be Stamped Same as Written	NATURE
All covers out		66
Front cover only		MAY-OCT
Keep first cover for title page		1902
Bind all covers in		505.42
Remove all adds if possible		
Bind everything in <u>X</u>		
Trim Yes..... No.....		
Imprint..... Yes.. <u>X</u> No.....		
If so please list		
Special Instructions REBIND.	Bottom	83 Material Color No. 8848

..... 1000000000

..... 1000000000

..... 1000000000

..... 1000000000

..... 1000000000

..... 1000000000

..... 1000000000

..... 1000000000

..... 1000000000

..... 1000000000

..... 1000000000

..... 1000000000

..... 1000000000

..... 1000000000

..... 1000000000

..... 1000000000

..... 1000000000

..... 1000000000

..... 1000000000

..... 1000000000

..... 1000000000

INDEX.

ABEL (SIR FREDERICK), Death of, 483; Obituary Notice of, 49
 Abel (Henrik Niels), the Abel Festival in Christiania, 552
 Abercromby (Hon. John), on the Oldest Bronze Age Earthenware Vessel, 663
 Ackroyd (W.), on the Telluric Distribution of the Elements in Relation to Their Atomic Weights, 662
 Acoustics: Interference of Sound, the Right Hon. Lord Rayleigh, F.R.S., at the Royal Institution, 42; Studies in Auditory and Visual Space Perception, Arthur Henry Pierce, Prof. Alex. Crum Brown, F.R.S., 73; Resultant Tones and Harmonic Series, Prof. Silvanus P. Thompson, F.R.S., 6; Margaret Dickins, 78; Coast Fog Signals, E. Price Edwards, 115; the Vibration of the Violin; W. B. Coventry, 150; the Transmission of Sound through Solid Walls, F. L. Tufts, 212; Earthquake-like Vibrations Caused by the Firing of Heavy Guns at the Mouth of the Medway, 230; Wellenlehre und Schall, W. C. L. van Schaik, 268; the Study of Resonance by Means of Oscillographs, M. Armagnat, 307; Observations on the Smallest Perceptible Musical Tone-difference as Examined in the People of Scotland and of the Torres Straits, Dr. C. S. Myers, 666
 Actinometer, a New Registering, G. de Fontenoy, 401
 Adams (the late Prof. J. Couch), the Discovery of Neptune by, 84
 Adams (W. S.), the Spectroscopic Binary β Cephei, 352
 Adeny (Dr. W. E.), Chemistry of Respiration in Bacteria, 167
 Aéronautics: Death of M. Severo and His Assistant, 65; Meteorological Results of the Balloon Ascents of February 6, Dr. Hergesell, 66; Results of International Balloon Ascents of March 6, 329; French Naval Balloon Accident, Lieut. Baudic Drowned, 183; Dr. Miethe and Lieut. Hildebrandt's Uncomfortable Balloon Voyage, 254; Aéronautical Congress Resolution Negating Unprotected Ascent Above 7 or 8 Kilometres, 279; the Use of Oxygen Inhalers in Connection with High Balloon Ascents, Dr. Süring, 306; Project for a Navigable Balloon with an Interior Keel, M. Torres, 422; Comte de la Vaulx and M. Heureux, 447; Stanley Spencer's Airship, 539; M. de Bradsky and M. Morin killed, 610; the Position and Promise of Aërial Navigation, Dr. S. P. Langley, 635; Captain Ferber's Experiments in Aërial Gliding, 635
 Africa: Coral Reefs of Zanzibar, C. Crossland, 166; Further Discoveries in the Great Ruins at Zimbabwe, 397; Animistic Beliefs Among the Yaos of British Central Africa, Rev. A. Hetherwick, 514; the "Sleeping Sickness" of Uganda, 484; *Trypanosoma Theileri*, New Parasite in the Blood of Cattle in South Africa, 15; Lieut.-Colonel Bruce, F.R.S., 84; Cold Weather in South Africa, J. R. Sutton, 247; Cape of Good Hope Department of Agriculture Marine Investigation in South Africa, Observations on the Temperature and Salinity of the Sea around the Cape Peninsula, J. D. F. Gilchrist, 260; Gold Seeking in South Africa, a Handbook of Hints for Intending Explorers, Prospectors and Settlers, Theo Kassar, 440; the Great Granite Mass of the Matopos, Frederick P. Menell, 449; Geodetic Survey of South Africa, vol. ii., Report on a Rediscovery of Bailey's and Fourcade's Surveys and their Reduction to the System of the Geodetic Survey, Sir David Gill, K.C.B., F.R.S., Major C. F. Close, 457; Gold Production and Life of the Main Reef Series, Witwatersrand, T. H. Leggett and F. H. Hatch, 659
 Agamnonone (Dr. G.), a New Form of Seismograph, 260
 Agricultural Hall, the Tramways Exhibition at the, 272
 Agriculture: Ammonia, Nitrates and Chlorine in Rothamsted Rain Water, Dr. Miller, 22; Nitrates and Chlorine in the Drainage through Uncropped and Unmanured Land, Dr.

Miller, 22; Culture of the Forage Beet at Grignon, P. Dehérain and C. Dupont, 47; Colorado Potato Beetle at Tilbury, 134; Manufacture of Oil Cakes from the Seeds of the Sunflower, 232; Manual of Agricultural Chemistry, Herbert Ingle, 245; Cape of Good Hope Department of Agriculture Marine Investigation in South Africa, Observations on the Temperature and Salinity of the Sea around the Cape Peninsula, J. D. F. Gilchrist, 260; the Failure of Pea Crops, 280; Agricultural Use of Volcanic Dust, 306; the Use of Hail Rockets, E. Vidal, 312; Experiments with Tobacco and Potatoes at St. Kitts-Nevis, 448; on the Soils of Dorset, D. A. Gilchrist, C. M. Luxmoore, 486; Agricultural Teaching in West Indian Islands, 539; Indigo Cultivation in British India, 636
 Aiming Guns under Cover, an Instrument for, 493
 Alaska, a Holiday Cruise to, 176
 Alcohol: Manual of Alcoholic Fermentation and the Allied Industries, Charles G. Matthews, 1; Preparation of Absolute Alcohol from Strong Spirit, Dr. Young, F.R.S., 70; Properties of Mixtures of the Lower Alcohols with Water, Dr. Young, F.R.S., and Miss E. C. Fortey, 70; Properties of Mixtures of the Lower Alcohols with Benzene and with Benzene and Water, Dr. Young and Miss E. C. Fortey, 70; Alcohol as a Motive Power for Automobiles, 307; the Nutritive Value of Alcohol, Messrs. Atwater and Benedict, 450; Alcohol as an Illuminant, L. Denayrouze, 486
 Alectorolophus, Monographie der Gattung, Dr. Jakob von Sterneck, 4
 Alexander, (Prof. Thos.), Thin Floating Cylinders, 6; a Cubic and Submerged Cubes, 127
 Algebra, H. G. Willis, 149; College Algebra, L. E. Dickson, 4
 Algol Variable, New, 115; Mrs. Fleming, 331; A. Stanley Williams, 515, 638
 Albutt (Prof. T. Clifford, F.R.S.), the Rise of the Experimental Sciences at Oxford, Boyle Lecture at Oxford, 90
 Alliot (Henri), New Proof of the Cellular Resistance of the Saccharomyces and on a New Application of this Property to Industry and the Distillery, 288
 Altitudes at Sea, Method of Observing, during Night-Time, Prof. Joly, 186
 Aluminium and its Alloys, Prof. E. Wilson, 655; W. Murray Morrison, 655
 America: British *versus* American Locomotives, 42; Pisciculture in the United States, Earl Grey, 65; the Birds of North and Middle America, the Fringillide, R. Ridgway, 75; American Journal of Science, 93, 212, 310, 408, 571; American Journal of Mathematics, 93, 455; Bulletin of the American Mathematical Society, 118, 165, 382, 455; Transactions of the American Mathematical Society, 165; Cyclopeda of American Horticulture, L. H. Bailey, 147; a New High-speed Record on the Burlington and Missouri Railroad, 184; the Smithsonian Institution, its Documentary History, 226; the Pittsburg Meeting of the American Association, 299, Address by Prof. C. S. Minot, 300; the Eocene Primates and Rodents of North America, Prof. H. F. Osborn, 379; What the United States of America is doing for Anthropology, Dr. A. C. Haddon, F.R.S., 430; Education in the United States of America, 453
 Anæsthesia by Electric Currents, Stephane Leduc, 336
 Anatomy: Death and Obituary Notice of Dr. Henri Fihloh, 133; an Introduction to the Study of the Comparative Anatomy of Animals, G. C. Bourne, 314; Death and Obituary Notice of Alexander Kowalevsky, Prof. E. Ray Lankester, F.R.S., 394
 Ancient Ruins of Rhodesia, the, R. N. Hall and W. G. Neal, Prof. A. H. Keane, 34

- Anderson (Prof. R. J.), on the Relation of the Parietal Bone in Primates, 641
- Anderson (Dr. Tempest), Royal Society Report on the West Indian Eruptions, 402
- André (M.), the Fate of, 255
- Andrews (Thomas, F.R.S., and Charles Reginald), Microscopic Effects of Stress on Platinum, 213
- Andrews (Wm.), Stopping Down the Lens of the Human Eye, 31
- Anglesey, Jaspers of South-Eastern, Edward Greenly, 95
- Anus (Herbert F.), German Progress in Optical Work, Paper Read at the Optical Society, 138
- Animal Forms : a Second Book of Zoology, Dr. David S. Jordan and Prof. Harold Heath, 605
- Animal Intelligence, L. C. Hurt, 459
- Animal Life, the Story of, B. Lindsay, 173
- Animali, la Protezione degli, N. Lico, 414
- Animals, an Introduction to the Study of the Comparative Anatomy of, G. C. Bourne, 314
- Annanale (N.), Bipedal Locomotion in Lizards, 577
- Annanale (Nelson), the Wild and Civilised Tribes of the Malay Peninsula, 664; the Human Souls and Ghosts of the Malays of Patani, 664
- Annelids, Collateral Budding in two, Dr. H. P. Johnson, 86
- Antarctica : Royal Geographical Society, President's Opening Address, Current Arctic and Antarctic Expeditions, 113; the First Fruits of the German Antarctic Expedition, 223; the *Morning*, the Auxiliary Ship of the National Antarctic Expedition, 255; the Scottish National Antarctic Expedition, W. S. Bruce, 255; Report on the Collections of Natural History made in the Antarctic Regions during the Voyage of the *Southern Cross*, R. B. Sharpe and F. J. Bell, 322; Progress of the Swedish Polar Expedition, 421; the Scottish Antarctic Expedition, W. S. Bruce, 631
- Anthracite Coal Industry, the, Peter Roberts, 50
- Anthropology : the Peoples of Malacca, Frank F. Laidlaw, 47; the Tribes of the Brahmaputra Valley, L. A. Waddell, 91; the Coorgs and Yerusus, an Ethnological Contrast, T. H. Holland, 91; Trephining in the South Seas, Rev. J. A. Crump, 136; the Ruling Races of Prehistoric Times in India, South-Western Asia and Southern Europe, J. F. Hewitt, 145; History and Chronology of the Myth-making Age, J. F. Hewitt, 145; Savage Island, an Account of a Sojourn in Niué and Tonga, Basil Thomson, E. Sidney Hartland, 347; What the United States of America is doing for Anthropology, Anthropological Institute Presidential Address, Dr. A. C. Haddon, F.R.S., 430; Animistic Beliefs among the Yaos of British Central Africa, Rev. A. Hetherwick, 514; Prehistoric Man in Burma, R. C. I. Swinhoe, 541; the Neglect of Anthropology in British Universities, "Anthropotamist," 654; Right-handedness and Left-brainedness, Prof. D. J. Cunningham, F.R.S., 659; see also Section H, British Association.
- Ants, Descent of Winged, on Teplitz and Brussels, 396
- Ape-House, the Zoological Society's New, 406
- Applied Mechanics, the Koorkee Manual of, Stability of Structures and the Graphic Determination of Lines of Resistance, Lieut.-Colonel I. H. C. Harrison, 340
- Arabia, Legends of Palestine and, 517
- Arachnide : the Common Spiders of the United States, James H. Emerton, 630
- Arbor Low Stone Circle, Derbyshire, Excavations at, H. Balfour, 663
- Arboreal Society, Visit of the English, to Compiègne, Prof. W. R. Fisher, 450
- Archæology : the Wiltshire Archæological and Natural History Magazine, Stonehenge and its Barrows, William Long, F.S.A., Stonehenge Bibliography Number, W. Jerome Harrison, Sir Norman Lockyer, K.C.B., F.R.S., 25; the Ancient Ruins of Rhodesia, R. N. Hall and W. G. Neal, Prof. A. H. Keane, 34; Discoveries in the Churchyard of St. George the Martyr, Southwark, 39; the Farmers' Years, n. Carnac and its Environs, Sir Norman Lockyer, K.C.B., F.R.S., 104; Preliminary Report on a Journey of Archæological and Topographical Exploration in Chinese Turkestan, M. A. Stein, 284; the Older Civilisation of Greece, Further Discoveries in Crete, 390; corr. 424; Further Discoveries in the Great Ruins at Zimbabye, 397; the Early Christian Monuments of the Isle of Man, P. M. C. Kermode, 424; Archæological Remains on the Summit of the Nevado de Chani, Dr. Erland Nordenfjöld, F.R.S., 440
- Archibald (E. H.), Decomposition of Mercurous Chloride by Dissolved Chlorides, 233
- Architecture : the Left-handed Spiral Staircase in the Château de Blois Modelled from *Voluta vesperilio*, Theodore Cook, 39; Photography as applied to Architectural Measurement and Surveying, J. Bridges Lee at Society of Arts, 235; Naval Architecture, the Proposed Experimental Tank for Testing Ship Models for Resistance, 128; Les Bateau Sous-Marins et les Submersibles, K. D'Equeville, 290; Death and Obituary Notice of Benjamin Martell, 305
- Arctic : Royal Geographical Society, the President's Opening Address, Current Arctic and Antarctic Expeditions, 113; Expedition Norvégienne de 1899-1900 pour l'Etude des Aurores Boréales, Résultats des Recherches Magnétiques, Kr. Birkeland, Dr. C. Chree, F.R.S., 227; the Fate of M. Andree, 255; Year's Work of the Baldwin-Ziegler Arctic Expedition, Evelyn B. Baldwin, 349; Flora Arctic, C. H. Ostenfeld, 490; Return of the Arctic Expeditions, 542
- Aithmetic, a First Step in, J. G. Bradshaw, 491
- Aithmetic for Schools, an, J. P. Kirkman and A. E. Field, 491
- Armagnat (M.), the Study of Resonance by means of Oscillographs, 307
- "Armorl" Electro-Capillary Relay, the, 151, 175
- Armstrong (Dr. E. F.), Synthetical Action of Enzymes, 662; Recent Synthetical Researches in the Glucoside Group, 662
- Armstrong (Prof. Henry E., V.P.R.S.), Persulphuric Acids, 45; Opening Address in Section L at the Belfast Meeting of the British Association, 589
- Armstrong-Orling System of Wireless Telegraphy, 327
- Arnold (D. J.), New York Central Railway to be Worked Electrically, 398
- Arnold (Prof. J. O.), Constituents of Hardened Steel, 63
- Arnold-Förster (Mr.), the Duties of the State towards Science, 62
- Arrhenius's (Prof.) Theory of Cometary Tails and Auroras, Prof. John Cox, 54, Dr. J. Halm, 55
- Arsenic, Decomposition of Compounds of Selenium and Tellurium by Moulds and its Influence on the Biological Test for, Dr. Rosenheim, 214
- Arsenic as a Normal Constituent of Animals, Armand Gautier, 216
- Arsenic in the Organism, Gabriel Bertrand, 216
- Arsdale (M. B. van), Physical Experiments, 458
- Artificial Mineral Waters, the Evolution of, William Kirkby, 602
- Assaying and Metallurgical Analysis for the Use of Students, Chemists and Assayers, E. L. Rhead and Prof. A. Humboldt Sexton, 628
- Assheton-Smith (G. W. Duff), Marine Biology in Wales, 282
- Astrarium, Two Species of, from Port Jackson, H. Leighton Kesteven, 96
- Astrophical Chart, the, Prof. H. H. Turner, F.R.S., 273
- Astronomy : a Remarkable Lunar Halo, Prof. E. E. Barnard, 5; H. W. Croomer Smith, 85; Signals from Mars, Percival Lowell, 18; the Orion Nebula and Movement in the Line of Sight, Prof. H. C. Vogel and Dr. Eberhard, 18; Radial Velocity of the Orion Nebula, Prof. H. C. Vogel and Dr. Eberhard, 309; Our Astronomical Column, 18, 40, 68, 87, 115, 186, 208, 233, 258, 281, 309, 331, 355, 380, 401, 425, 450, 486, 514, 541, 557, 613, 638, 662; Changes on the Moon's Surface, Prof. William H. Pickering, 40; Changes on the Moon, Prof. W. H. Pickering, 223; Theory of the Motion of the Moon, Ernest W. Brown, F.R.S., 356; Prof. Arrhenius's Theory of Cometary Tails and Auroras, Prof. John Cox, 54, Dr. J. Halm, 55; Elements of Comet a 1902 (Brooks), 68; Reduction of Measures of Swift's Comet (a 1899) from Photographs with a Portrait Lens of 30-inch Focus and 5-inch Aperture, Mr. Filon, 238; the Periodical Comet Tempel-Swift (1869-1880), 258; Ephemeris for the Search of the Comet Tempel-Swift, F. Bossert, 557; another New Comet, John Grigg, 514, 557; Comet 1902 b, 515, 614; Observation of Perrine's Comet 1902 b, 558; Photograph of, 638; Colaba Observatory, 68; New Variable Stars, 68, 234; the Naming of New Variable Stars, 425; Variable Stars, 309; Notation of Variable Stars, 208; Observations of the Variable Star χ^2 Cygni during 1899, 282; Observations of Fifty-eight Long-Period Variables,

638; Observations of Variable Stars of Long Period, Prof. Pickering, 486; New Algol Variable, 115; Mrs. Fleming, 331; A. Stanley Williams, 515, 638; a Remarkable Solar Halo, Rev. T. C. Porter, 76; the Discovery of Neptune by the late Prof. J. Couch Adams, F.R.S., 84; the Search for a Planet beyond Neptune, T. Griggall, 614; Saturn Visible through the Cassini Division, C. T. Whitmill, 87, 296; the Satellites of Saturn and Uranus, Dr. J. J. See, 380; Spectral Researches on the Rotation of the Planet Uranus, H. Deslandres, 572; Catalogue of North Polar Stars, Prof. Pickering, 88; Royal Astronomical Society, 94, 238; Visual and Spectroscopic Observations of the Sun-spot Group of May and June, 1901, Father Cortie, 94; the Sun-spot Curve and Epochs, 186; the Farmers' Years, II., Carnac and its Environs, Sir Norman Lockyer, K.C.B., F.R.S., 104; Astronomical Occurrences in June, 115; in July, 208; in August, 331; in September, 425; in October, 541; in November, 662; the Equatorial Current on Jupiter, W. F. Denning, 138; a Dark Spot on Jupiter, Theodore Phillips, 401; Leo, Brenner, 487; the Fifth Satellite of Jupiter, Prof. Barnard, 662; Occultations of Stars and Solar Eclipses, Francis Cranmer Penrose, 149; Spectroscopy of the Solar Eclipse of May 18, 1901, J. W. Humphreys, 331; the Dutch Eclipse Expedition of 1901, 380; Search for an Intra-mercurial Planet during the Total Solar Eclipse of 1901, Prof. Perrine, 662; the Royal Observatory Visitation, 161; Connection between the Photographs of the Solar Corona and of the entire Solar Chromosphere obtained on the Same Day, H. Deslandres, 167; Astronomy in the University of London, Prof. Karl Pearson, F.R.S., 174; Method of Observing Altitudes at Sea during Night-time, Prof. Joly, 186; Astronomischer Jahresbericht, Walter F. Wislicenus, Dr. W. J. S. Lockyer, 198; a la Conquête du Ciel, F. C. de Nascius, 199; the Anna Bredikhine Astronomical Prize, 208; Occultation of W Leonis, 208; a Remarkable Bolide observed at Lyons on March 19, 208; Other Worlds, Garrett P. Serviss, 221; Delay of the Minimum of U Cephei, 234; the Spectroscopic Binary β Cephei, Prof. Frost and W. S. Adams, 352; Remarkable Naked-eye Nebulosity, W. H. Robinson, 233; a Theory of Volcanoes, A. Taquin, 233; Periodicity of Volcanic Eruptions and Earthquakes, Rev. T. E. Espin, 353; the French Geodetic Mission to the Equator, 233; Observations of Nova Persei, 233, 282; Discoverer of Nova Persei, 282; the spectrum of Nova Persei, Prof. Campbell and Mr. Wright, 425; the changes in the Nebula Surrounding Nova Persei, Prof. Louis Bell, 426; Distribution of the stars in the Cape Photographic Durchmusterung, Dr. Downing, 238; Reduction of Photographs of Eros for the determination of Solar Parallax, Mr. Hinks, 238; Reappearance of Eros, 557; Influence of the photographic magnitude of Stars upon the scale of Reduction of a Negative, Prosper Henry, 240; Death of M. H. Faye, 245; Obituary Notice, 277; Mr. Tebbutt's Observatory at Windsor, N.S.W., 258; Extension of the Kathodé Radiation Hypothesis to Nebulae, 259; Personal Equation in the Measurement of Spectroscopic Negatives, M. Hasselberg, 259; Apparent Deformation of the Sun's Disc near the Horizon, 259; Bright Meteor on July 13, 281, 309; a Bright Meteor, W. Lascelles-Scott, 638; a Remarkable Meteor, Archibald McDougall and W. E. Rolston, 557; Meteor Radiants, M. Eginittis, 557; the August Meteoric Shower, W. F. Denning, 309; a Possible Meteor Shower on October 4, G. Percy Bailey, 577; Hong Kong Double Star Observations, W. Doberck, 282; Double Stars, Rev. T. E. Espin, 353; Catalogue of New Double Stars, W. J. Hussey, 450; Rotation of the Brighter Fixed Stars, as a whole, with R-spect to the Fainter Stars, Sir David Gill, 282; Photographic Magnitude of Stars, Prosper Henry, 282; Motions of the Pole, Dr. J. C. Chandler, 309; Photographs of the Perseids in 1901, 309; the Perseid Meteoric Shower of 1902, W. F. Denning, 406; Radiant Point of the Perseids, Prof. Alexander Graham Bell, 440; the Recent Fireball, Walter E. Besley, 320; Report of the Cape Observatory for 1901, Sir David Gill, 331; Light of the Galaxy and Bright Stars, C. Easton, 353; Minor Planets, 353; a New Minor Planet, 614; New Minor Planets, Prof. Max Wolf, 543; Method of Spectrum Analysis Furnishing the Still Unknown Law of Rotation of Planets of Feeble Brightness, H. Deslandres, 360; Rotation Periods of the Superior Planets, M. Deslandres, 380; a New Registering Actinometer, G. de Fontenay, 401;

Solar Phenomena during 1901, 401; the "Rotaplane," Rev. C. Thomas, 422; New Discoveries of Variable Velocities in line of Sight, 425; Hypothesis on the Nature of Solar Prominences; Prof. W. H. Julius, 450; the Lick Photographs, Prof. Pickering, 487; Sir David Gill's New Theory of Stellar Movement, 515; Report of the Melbourne Observatory for 1901, 541; Instructions on the Observation of the Sun, 557; Corrections to the Right Ascensions of the Principal Stars of the Berliner Jahrbuch, Senor Campos Rodriguez, 557; a New Transiting Device, M. B. Snyder, 613; Automatic Spectrographs Registering the Radial Movements and the Thickness of the Solar Chromosphere, H. Deslandres, 624; the Leonid Shower, Prof. Pickering, 662; R. B. Taber 662; Observations of ζ Geminorum, F. P. McDermott, 662; Astro-Physics: the Kinetic Theory of Planetary Atmospheres, Prof. G. H. Bryan, F.R.S., 54; Dr. E. Rogovsky, 222; Athens, Annales de l'Observatoire National d', Demétrius Eginittis, 331; Athens, the Annual of the British School at, 390; Corr., 424; Atlantic, North, Pilot Chart for May, 15; for June, 114, 206; for August, 307; for November, 635; Atomic Weights, on a General Numerical Connection between the, C. A. Vincent, 143; Atoms and Valencies, J. Fraser, 68; Atwater (Mr.), the Nutritive Value of Alcohol, 450; Aubel (Edmond van), Electrical Resistance of Iron Pyrites, 544; Auden (Dr. H. A.), Catalogue of the Educational Collection of Minerals at West Ham, 137; Auditory and Visual Space Perception, Studies in, Arthur Henry Pierce, Prof. Alex. Crum Brown, F.R.S., 73; Auerbach (Dr. Felix), Die Weltherrin und ihr Schatten, Ein Vortrag über Energie und Entropie, 414; Auger (V.), Arsenic Anhydride and its Hydrates, 72; Aurora, Prof. Arrhenius' Theory of Cometary Tails and, Prof. John Cox, 54; Dr. J. Halm, 55; Aurora Borealis, an Attempt to Reproduce an, Prof. W. Ramsey, F.R.S., 204; Aurora Borealis, Investigations into the Connection between the Magnetic Currents in the Earth and the, Prof. Kr. Birke-land, 328; Australia; Australian Children's Games, Walter E. Roth, 380; Australian Entozoa. New Distomum from the Sawfish-Shark S. J. Johnston, 516; Earthquake in South Australia, 538; Automobiles: Storage-Battery to Enable Automobiles to Run 100 Miles without Recharging, Thomas A. Edison, 134; Alcohol as a Motive Power, 307; Schule des Automobi. Fahrers, Wolfgang Vogel, Mervyn O'Gorman, 313; Avebury (Lord), Nature Study, 326; Avian Organogeny; on the Intestinal Tract of Birds, P. Chalmers Mitchell, 235; Ayrtton (Hertha), the Electric Arc, 124

Bacteriology: *Trypanosoma Theileri*, new Parasite in the Blood of Cattle in South Africa, 15; Lieut.-Colonel Bruce, F.R.S., 84; Microbiological Study of the Steeping of Flax, L. Hauman, 120; Chemistry of Respiration in Bacteria, Dr. W. E. Adeny, 167; the Aërobie Fermentation of Manure, C. Dupont, 216; on the Parasitism of *Pseudomonas destructans* (Potter), M. C. Potter, 238; Gummosis of the Sugar Cane, R. Greig Smith, 264; Coccidia Found in the Kidney of *Rana esculenta*, A. Laveran and F. Mesnil, 312; Traité de Bactériologie Pure et Appliquée à la Médecine et à l'Hygiène, P. Miquel and B. Cambier, Dr. E. Klein, F.R.S., 316; the Bacillus of Beri-beri, Major Rost, 378; Action of Alcoholic Fermentation on the *Bacillus typhosus* and the *Bacillus Coli*, E. Bodin and F. Pailheret, 384; Antiparamoecium Serum, M. Ledoux-Lebard, 384; the Thermal Death-point of the Tubercle Bacillus in Milk, Bovine Tuberculosis and Milk Supplies, H. L. Russell, 399; Thermal Death-point of a Micrococcus Isolated from Milk, H. L. Russell and E. G. Hastings, 423; Mechanical Treatment in the Milk Industry M. F. Bordas and Sig. de Raczkowski, 456; Chemical Composition of Tubercle Bacilli, De Schweinitz and Dorset, 540; Recent Studies of Immunity with Special Reference to their Bearing on Pathology, Prof. Welch, 611; Foul Brood of Bees, 636; Causes of Salmon Disease, Dr. J. Hume Patterson, 640; the Kinderpest Serum, 659; Baddeley (J. F.), Glacier Disaster in the Caucasus, 328; Baddeley (John), Colours between Clouds at Sunset, 370

- 'Bahama Islands, the Evolution of Snails in the, Prof. T. D. A. Cockerell, 56
- Bailey (G. Percy), a Possible Meteor Shower on October 4, 577
- Bailey (L. H.), *Cyclopedica of American Horticulture*, 147
- Baker (Edmund), Notes on *Indigofera*, 21
- Baker (J. G.), *Rosa stellata* and *R. minutifolia*, 229
- Baker (Dr. J. L.), Action of Ungerminated Barley Diastase on Starch, 214
- Baker (M. M.), Municipal Engineering and Sanitation, 173
- Baldwin (Evelyn B.), Year's Work of the Baldwin-Ziegler Arctic Expedition, 349
- Baldwin Arctic Expedition, Return of the, 542
- Balfour (H.), Excavation at Arbor Low Stone Circle, Derbyshire, 663
- Balfour (Mr.), on Technical Education at Manchester, 633
- Ballistics : Tir des Fusils de Chasse, Journé, 545
- Balloonng : Meteorological Results of the Balloon Ascents of February 6, Dr. Hergesell, 66; Dr. Miethe and Lieut. Hildebrandt's Uncomfortable Balloon Voyage, 254
- Baly (E. C. C.), Variation with Temperature of the Surface-Tensions and Densities of Liquid Oxygen, Nitrogen, Argon, and Carbon Monoxide, 118
- Bandar Abbas, Earthquake Shock at, 306
- Barbadoes, Composition of the Volcanic Dust at, on May 7 and 8, 204
- Barnard (Prof. E. E.), a Remarkable Lunar Halo, 5; the Fifth Satellite of Jupiter, 662
- Barnes (Dr.), Experiments on the Critical Velocity of Flow of Water through Tubes, 618
- Barnett (S. J.), Gauss's Theorem, 611
- Barometric Height at Stations on the Eastern Side of the Atlantic, on the Correlation between the, Miss F. E. Cave-Browne-Cave, Karl Pearson, F.R.S., 311
- Barron (G.), on the Prolongation of the Highland Border Rocks into County Tyrone, 619
- Barron (T.), Geology of the Eastern Desert of Egypt, later Physical Changes, 660
- Barton (J. K.), Digestive Tract of Salmon and Sea-Trout Kelts, 257
- Basis of Social Relations, the, Dr. G. Brinton, 221
- Basset (A. B., F.R.S.), Symbol for Partial Differentiation, 577
- Bateson (W., F.R.S.), Mendel's Theory of Heredity : a Defence, 573; Reports to the Evolution Committee of the Royal Society, 573
- Baths, the Climates and, of Great Britain, 629
- Baud (E.), Combinations of Hydrogen Sulphide with Anhydrous Aluminium Chloride, 216
- Baudic (Lieut.), Naval Balloon Accident, Death of, 183
- Baudouin (M.), Method of Concentrating Wine, 360
- Bauer (D. L. A.), Magnetic Disturbances during the Eruption of Mont Pelée on May 8, 421
- Bauxite, Dr. H. Lienau, 539
- Bay (J.), Saponification of Nitric Esters, 624
- Bayard (T. C.), English Climatology, 215
- Beattie (Prof.), the Leakage of Electricity from Charged Bodies at Moderate Temperatures, 110
- Beaulard (F.), Elastic Parameters of Silk Fibres, 672
- Beaufregard (H.), Matière médicale zoologique, Histoire des Drogues d'Origine animale, 363
- Beddard (F. E.), the Cambridge Natural History : Mammalia, 373
- Beechen Hedges on Elevated Ground, Jul. Wulff, 32; W. Gee, 32; G. W. Bulman, 56; P. T., 56
- Beer (Rudolf), *Coemanstella Alabastrina*, 118
- Bees, Foul Brood of, 636
- Beetle, Colorado Potato, at Tilbury, 134
- Beever (Sir H.), Financial History of a Four Acre Mixed Plantation, 283
- Beilby (George), Film Structures in Metals, 84
- Belfast Meeting of the British Association, the Forthcoming, J. Brown, 5
- Belfast, Geology of the County Round, Prof. Grenville A. J. Cole, F.R.S., 619; Post-Glacial Deposits of the Belfast District, R. Lloyd Praeger, 619; see also British Association Belgian Botanical Investigations, 171
- Belgian Royal Academy, Prize Subjects, 113
- Bell (Prof. Alexander Graham), Radiant Point of the Perseids, 440
- Bell (F. J.), Guide to the Coral Gallery in the British Museum (Natural History), 322; Report on the Collections of Natural History made in the Antarctic Regions during the Voyage of the Southern Cross, 322
- Bell (H. Hesketh), the Effects of the Recent Volcanic Eruptions in Martinique and St. Vincent, 306
- Bell (Prof. Louis), Changes in the Nebula Surrounding Nova Persei, 426
- Bell (Dr. Robert), Geological Survey of Canada, 86
- Bellows (John), Death of, 113
- Bell-Ranske (Jutta), Health, Speech and Song, a Practical Guide to Voice Production, 388
- Benedicks (B.), Electrical Conductivity of Steel and Pure Iron, 160
- Benedict (Mr.), the Nutritive Value of Alcohol, 450
- Benham (Charles E.), William Gilbert of Colchester, a Sketch of his Magnetic Philosophy, 270
- Benischke (Dr. Gustav), Die Schultzevorrichtungen der Starkstromtechnik gegen atmosphärische Entladungen, 573
- Ben Nevis Observatories, Sir Arthur Mitchell, 349
- Benson (Arthur Christopher), the Schoolmaster : a Commentary upon the Aims and Methods of an Assistant Master in a Public School, 366
- Berg, (D. C.), Memoir of, Señor A. Gallardo, 184
- Bergholz (Prof. Dr. Paul), the Hurricanes of the Far East, 51
- Bernard, (H. M.), the Structure of the Retina of the Eye, 308
- Bernese Oberland, the, G. Haslar, 440
- Bernoulli's Numbers, a Series related to, J. R. Sutton, 492
- Berthelot (Daniel), the Graduation of Thermoelectric Couples, 47
- Berthelot (M.), New Researches on Batteries Founded on the Reciprocal Action of Two Liquids, 240; Limit of Intensity of Current from a Battery which Corresponds to External Electrolytic Work Apparent in a Voltmeter, 623
- Bertrand (Gabriel), Arsenic in the Organism, 216; Poison of the Toad, 288; Bufonine, 288
- Besley (Walter E.), the Recent Fireball, 320
- Betton (C. Steuart), the Murchison Falls, 188
- Bial (Dr. M.), Antiseptic Properties of Dilute Solutions of Acids, 137
- Biblical Criticism at its Best and Worst, Rev. T. K. Cheyne, and J. Sutherland Black, 193
- Bier (L.), Spectrum of Hæmoglobin, 230
- Biology : Organographie der Pflanzen insbesondere der Archegoniaten und Samenpflanzen, Dr. K. Goebel, Prof. J. B. Farmer, F.R.S., 51; the Life of Thomas Henry Huxley, Edward Clodd, Sir W. T. Thiselton-Dyer, F.R.S., 121; Regeneration in *Samia alianthus*, H. H. Brindley, 142; the Foraminifera, an Introduction to the Study of the Protozoa, Frederick Chapman, 196; Enzymes and their Applications, J. Efron, Dr. F. Mollwo Perkin, 197; Variation, Germinal and Environmental, J. C. Ewart, F.R.S., 209; the Relation of Biology to Medicine, Dr. Rose Bradford, 231; Statistical Methods in Biology, Biometrika, 234; Les Limites de la Biologie, J. Grasset, 293; Archiv für Protistenkunde, 627; Mode of Action of Carbonic Acid in Experimental Parthenogenesis, Yves Delage, 671; Marine Biology, Aggregated Colonies in Madreporitic Corals, Dr. J. E. Duerden, 257; in Wales, G. W. Duff Assheton-Smith, 282; New Hydroid *Platyglypha Mirabilis*, Dr. A. Dendy, 330; Studies on the Distribution of Animal Life on "Storeggen" and "Shetlandseggen", North Sea, Dr. Johan Hjort, 351; Degeneration-Process in Larval Cœlenterates of the Genus Gonionema, 612
- Biometrika, Statistical Methods in Biology, 234
- Bipedal Locomotion of a Ceylonese Lizard, E. Ernest Green, 492; Rose Haig Thomas, 551; N. Annandale, 577; W. Saville Kent, 630
- Birds : More Tales of the Birds, W. W. Fowler, 4; Bird Hunting on the White Nile, H. F. Witherby, 52; the Birds of North and Middle America, the Fringillide, R. Ridgeway, 75; Protection of Birds Useful to Agriculture, 137; Bird-Migration Observed from the Eddystone, W. E. Clarke, 185; on the Intestinal Tract of Birds, P. Chalmers Mitchell, 235; Catalogue of the Collection of Birds' Eggs in the British Museum (Natural History), E. W. Oates, 322; Notes on Young Gulls, Prof. R. V. Lendenfeld, 415; Birds in the Garden, G. Sharp, 444; Upland Game-Birds, E. Sandys and T. S. Van Dyke, 652
- Birkeland (Kr.), Expedition Norvégienne de 1899-1900 pour l'Étude des Aurores Boréales, Résultats des Recherches mag-

- nétiques, 227; Investigations into the Connection between the Magnetic Currents in the Earth and the Aurora Borealis, 328
- Bishop (S. E.), the Lava-Lake of Kilauea, 441
- Bituminous Fuel, the Smokeless Combustion of, W. H. Booth, 645; J. S. Raworth, 645
- Black (J. Sutherland), *Encyclopædia Biblica*, a Critical Dictionary of the Literary, Political and Religious History, the Archeology, Geography and Natural History of the Bible, 193
- Blake (Rev. J. F.), Remarkable Inlier among the Jurassic Rocks of Sutherland, 23; on the Original Form of Sedimentary Deposits, 620
- Blanchard (A. A.), the Decomposition of Ammonium Nitrite in Aqueous Solution, 637
- Bleekrood (Dr. L.), a Simple Telephonic Receiver for Wireless Telegraphy, 343
- Bliss (H.), Stopping down the Lens of the Human Eye, 56
- Blondlot (R.), Action of X-rays on very Small Electric Sparks, 263
- Blood, the Electrical Resistance of the, Dr. Dawson Turner, 127
- Blount (B.), on the Proposed Standardisation of Methods of Chemical Analysis, 662
- Bodin (E.), Action of Alcoholic fermentation on the *Bacillus typhosus* and the *Bacillus Coli*, 384
- Bodmer (G. R.), the Inspection of Railway Materials, 244
- Bolas (T.), the Lens, a Practical Guide to the Choice, Use and Testing of Photographic Objectives, 75
- Bolide, observed at Lyons on March 19, a Remarkable, 208
- Bonney (Prof. T. G., F.R.S.), Alpine Valleys in Relation to Glaciers, 239
- Booth (W. H.), the Smokeless Combustion of Bituminous Fuel, 645
- Bopp (Prof. C.), Chart of the Metric System, 630
- Borchers (D. W.), Apparatus for the Electrolytic Separation of Calcium from the Fused Chloride, 636
- Bordas (F.), Variation of the Phosphoric Acid in Cows' Milk with time after Calving, 384; Influence of Cream Separation on the Principal Constituents of Milk, 432; Mechanical Treatment in the Milk Industry, 456
- Borel (Emile), *Leçons sur les Séries à Termes Positifs*, 5
- Borneo, on the Ethnography of the Nagas, Dr. W. H. Furness, 664
- Bose (Prof. Jagadis Chunder), *Re* Vegetable Electricity, 549
- Bossert (F.), Ephemeris for the Search of the Comet Temple-Swift, 557
- Botany: Monographie der Gattung *Alectorophus*, Dr. Jakob von Sterneck, 4; Absence of the Pine in Western Asia, Herr Hugo Bretzel, 15; the Pines of Western Asia, Sir J. D. Hooker, F.R.S., 53; Journal of Botany, 21, 118, 213, 310, 571; Linnean Society, 22, 47, 94, 263; Notes on Indigofera, David Prain and Edmund Baker, 21; *Welwitschia Mirabilis*, Prof. F. E. Weiss, 23; Daniella and their Secreting Apparatus, L. Guignard, 23; Die Vegetation der Erde, Sammlung pflanzengeographischer Monographien: (1) Grundzüge der Pflanzenverbreitung auf d. iberischen Halbinsel, Moritz Wilkomm, 27; (2) Grundzüge d. Pflanzenverbreit. i. d. Karpathen, F. Pax, 27; (3) Grundzüge d. Pflanzenverbreit. i. d. Kaukasusländern, von der Hochwa ueb. d. Manytsch-Schneider bis z. Scheitelfäche Holgarmaniens, Dr. Gustav Radde, 27; (4) Die Vegetationsverhältnisse d. Illyrischen Länder, Dr. Günther Ritter Beck v. Mannagetta, 27; (5) Die Heide Norddeutschlands, P. Graebner, 27; the Sweet Briar as a Goat Exterminator, Sir W. T. Thiselton-Dyer, F.R.S., 31; Beechen Hedges on Elevated Ground, J. Wulfi, 32; Wm. Gee, 32, G. W. Bulman, 56; P. T., 56; Retention of Leaves by Deciduous Trees, 344; Prof. W. R. Fisher, 370; D. T. Smith, 631; Decorative Plants for Gardens, Dr. Nicola Terraciano, 36; Organographie der Pflanzen insbesondere der Archegoniaten und Samenpflanzen, Dr. K. Goebel, Prof. J. B. Farmer, F.R.S., 51; Elements of Botany, W. J. Browne, 52; the Culture of Greenhouse Orchids, Frederick Boyle, 59; Germination of the Pollen Grain and the Series of Events Leading to Fertilisation in Two Species of Zamia, Dr. Herbert J. Webber, 67; the Book of the Rose, Rev. A. Foster-Melliar, 74; Poisonous Fodder-plants and Oriental Drug-plants, Prof. Wyndham R. Dunstan, F.R.S., 83; New South Wales Linnean Society, 96, 264, 312, 384, 516; Practical Botany for Beginners, F. O. Bower, F.R.S., Dr. J. Gwynne-Vaughan, 101; Blue Puya in Flower at Kew Gardens, 112; *Coenansia Alabastrina*, Rudolf Beer, 118; the British "Capreolate" Fungitories, Mr. Pugsley, 118; *Kin-keliba*, E. Perrot and G. Lefevre, 120; Mechanism of the Chemical Variations in the Plant under the Influence of Sodium Nitrate, E. Charabot and A. Hébert, 144; Flora der ostfriesischen Inseln, Dr. Fr. Buchenau, 149; the New Botanical Laboratories at Liverpool, 155; Kentucky Blue-grass Seed, 159; Recueil de l'Institut Botanique (Université de Bruxelles), L. Errera, 171; De Vriesian Species, Prof. T. D. A. Cockerell, 174; the Trinidad Experiments in Cacao Culture, 185; Report of Royal Botanical Gardens, Ceylon, J. C. Willis, 185; Rennet in Plants, Maurice Javillier, 192; International Catalogue of Scientific Literature, M. Botany, Prof. J. B. Farmer, F.R.S., 217; *Rosa Stellata* and *R. Minutifolia*, J. G. Baker, F.R.S., 229; Death of A. D. Hogg, 254; Gummosis of the Sugar Cane, R. Greig Smith, 264; Distribution of Pithophora, Kumagusu Minakata, 279; Prof. G. S. West, 296; Curious Development of a Foxglove (Digitalis), 306; Campanulate Foxgloves, Dr. Maxwell T. Masters, F.R.S., 344; the Zymose from *Eurotiopsis Gayoni*, M. Mazé, 312; the Chelsea Physic Garden, 321; the Textile Fibres of Commerce, William S. Hannan, 338; Regeneration in Plants, 379; Prof. Goebel, 514; Experimental Demonstration of the Decomposition of Carbon Dioxide by Leaves Exposed to Light, P. P. Dehérain and E. Demoussy, 383; the Influence of Varying Amounts of Carbon Dioxide in the Air on the Photosynthetic Process of Leaves and on the Mode of Growth of Plants, Dr. Horace T. Brown, F.R.S., and F. Escombe, 620; the Hepaticæ of the British Isles, William Henry Pearson, Prof. J. B. Farmer, F.R.S., 385; Relations of Plant Growth to Ionisation of the Soil, A. B. Plowman, 408; Germinative duration of Seeds, Jules Poisson, 408; the Primrose and Darwinism, by a Field Naturalist, 409, 575; the Writer of the Review, 575; the Progress of Scottish Botany, J. C. Druce, 447; Experiments with Tobacco and Potatoes at St. Kitts-Nevis, 448; Two Chemical Constituents from the Eucalypts, Henry G. Smith, 456; Types of British Plants, C. S. Colman, 458; Death of Theodor v. Heldreich, 538; Mannan in Sugar-maple Trees, Prof. F. H. Storer, 541; Cultivation of the Yellow Lupin, P. P. Dehérain and E. Demoussy, 544; a Tentative List of the Flowering Plants and Ferns for the County of Cornwall, including the Scilly Isles, F. H. Davey, 547; Gutta-percha in the Balata fields on the Amazon, 555; Das botanische Practicum, Dr. Eduard Strasburger, 605; the most Effectual Plan for Starting the Germination of Spores of *Agaricus campestris*, Dr. Margaret C. Ferguson, 612; Examination and Estimation of Extract of Chestnut Wood mixed with Oak Extract, Ferdinand Jean, 624; Utilisation of Mineral Substances by Grafted Plants, Lucien Daniel and V. Thomas, 624; Theories of Heredity, Hugh Richardson, 630; the Fertilisation of Linum, Prof. T. D. A. Cockerell, 631; Composition of Some Reserve Hydrocarbons in the Albumen of some Palms, M. E. Liénard, 648; Methyl Ester of Methylanthranilic Acid in the Vegetable Organism, Eugene Charabot, 648; Phosphorus versus Lime in Plant Ash, Dr. P. Q. Keegan, 655; Recent Works on Systematic Botany in Germany, 657; the Germination of Pollen Grains in the Presence of Stigmata, Pierre Paul Richer, 672
- Bouchard (Ch.), Local Treatment of Rheumatism, 288
- Boudouard (O.), Alloys of Cadmium and Magnesium, 216
- Bouffard (A.), Action of Sulphurous Acid upon Oxysand and on the Colouring Matter of Red Wine, 192
- Bougault (J.), the Oxidation of Morphine by the Juice of *Rosella delicata*, 192
- Boulenger (G. A.), Les Poissons du Bassin du Congo, 339
- Boulouch (R.), Mixtures Formed by Sulphur and Phosphorus at Temperatures Below 100° C., 336
- Bourne (Dr. G. C.), *Traité de Zoologie Concrète*, Yves Delage and Edgard Hérouard, 267; an Introduction to the Study of the Comparative Anatomy of Animals, 314
- Bourquelot (Em.), New Glucoside Aucubine, 216
- Bouveault (L.), Method of Gradual Synthesis of Aldehydes, 120; Synthesis of Fatty Aldehydes, 137; Condensation of Nitromethane with Aromatic Aldehydes, 288; Action of Nitrous Acid in Alkaline Solution on α -Substituted β -Ketonic Esters, 384
- Bouzat (M.), Constitution of the Ammoniacal Copper Salts, 144.

- Ammoniacal Copper Oxide, 168; Ammoniacal Anhydrous Copper Chlorides, 384
- Boveri (Dr. Th.), Das Problem der Befruchtung, 74
- Bower (F. O., F.R.S.), Practical Botany for Beginners, 101
- Boyle (Frederick), the Culture of Greenhouse Orchids, 59
- Boyle Lecture at Oxford, the Rise of the Experimental Sciences at Oxford, Prof. T. Clifford Allbutt, F.R.S., 90
- Bradford (Dr. Rose), the Relation of Biology to Medicine, 231
- Bradley (Mr.), Apparatus for the Fixation of Atmospheric Nitrogen, 611
- Bradley (Prof. O. C.), Instances of Abnormality in Mammals, 351
- Bradshaw (J. G.), a First Step in Arithmetic, 491
- Bradsky (M. de), Fatal Accident to, 610
- Brahmaputra Valley, the Tribes of the, L. A. Waddell, 91
- Brain Centres, on the Mechanism Connecting the Muscular Apparatus with the, for Willed Movement, Prof. Schäfer, 665
- Brame (J. S. S.), Liquid Fuel for Steam Purposes, 186
- Branch (Dr. W. J.), Effects Observed at St. Kitts During the Volcanic Eruptions in Martinique and St. Vincent, 378
- Branford (B.), Helmholtz on the Value of the Study of Philosophy, 550
- Branley (Edouard), the Receiver in Wireless Telegraphy, 143
- Brauner (Prof. Bohuslav), Position of the Rare Earths in Mendeleeff's Periodical System of Elements, 66
- Bredikhine (the Anna), Astronomical Prize, 208
- Brenner (Leo), the Dark Spot on Jupiter, 487
- Bretzl (Herr Hugo), Absence of the Pine in Western Asia, 15
- Breuil (M.), Reproduction des Figures Paléolithiques Peintes sur des Parois de la Grotte de Font-de-Gaume, Dordogne, 452
- Bridges, Railway, on the Deflection and Vibration of, Dr. F. Omori, 332
- Bigham (Albert Perry), a Text-book of Geology, 75
- Bright Points and Curves, Study of, 208
- Brindley (H. H.), Regeneration in *Samia aitanthus*, 142
- Brinell's Researches on the Influence of Chemical Composition on the Soundness of Steel Ingots, Axel Wahlburg, 63
- Brinton (D. G.), the Basis of Social Relations, 221
- Brioschi (Francesca), Opere Matematiche di, 221
- Briannoni, the Encyclopaedia, 97, 261; Prof. Arthur Smithells, F.R.S., 289; vols. xviii and xxix., 625
- British *versus* American Locomotives, 42
- British Association, the Forthcoming Meeting at Belfast, T. Brown, 8; New Path along the Goban's Cliffs, R. Welch, 417
- British Association: Meeting at Belfast, 462, 494, 521; Sectional Arrangements, 344; Inaugural Address by Prof. James Dewar, M.A., LL.D., D.Sc., F.R.S., President of the Association, 462
- Section A (Mathematics and Physics)*.—Opening Address by Prof. John Purser, M.A., LL.D., M.K.I.A., President of the Section, 478; Solutions of the Partial Differential Equations of Mathematical Physics, E. T. Whittaker, 618; Accurate Conservation of Weight in Chemical Reactions, Lord Rayleigh, 618; Experiments on the Motion of a Detached Thread of Liquid in a Capillary Tube, Prof. Morton and Mr. Hawthorne, 618; Experiments on the Critical Velocity of Flow of Water Through Tubes, Dr. Barnes, 618; Temperature of an Animal Surrounded by a Saturated Atmosphere Hotter than Itself, Lord Kelvin, 618; on the Application of the Method of Entropy to Radiant Energy, Dr. J. Larmor, 618; on the Production of a Standard Light, Mr. Petavel, 618; Experiments to Determine Whether Double Refraction was Produced in Isotropic Transparent Bodies by their Motion Through the Ether, Lord Rayleigh, 618; on Substituting for Huyghen's Wave Surface a Wave Film of Finite Thickness Within which the Phases of the Disturbances were given Proper Values, Dr. Johnstone Stoney, 618; Experiments on the Use of a Magnetic Detector in Space Telegraphy, Prof. E. Wilson, 618; on the Phosphorescence Produced in Partially Exhausted Tubes by the Passage of an Alternating Current Round Them, Mr. Butler-Burke, 618; on a Bolometer Arranged to Record Solar Radiation, Dr. W. E. Wilson, 619; Sunspots and Magnetic Storms, Rev. A. L. Cortie, 619; Report of Committee for Investigating the Upper Atmosphere by Means of Kites, 619; on Radiation in Meteorology, Dr. Shaw, 619; Recent West Indian Eruptions and Earthquake Recording Instruments, Prof. Milne, 619; Nebula Surrounding Nova Persei, Mr. Hinks, 619
- Section A (Subsection of Astronomy and Cosmical Physics)*.—Opening Address by Arthur Schuster, F.R.S., F.R.A.S., Chairman of Subsection, 614; on Difficulties which are Caused in the Geodetic Survey of India by the Attraction of the Mass of the Himalayas and the Thibet Plateau and by the Existence of an Underground Chain of Excessive Density which runs across India, Major S. G. Burrard, 640; an Attempt made at Oxford to Verify the Suggestion that the bright Stars as a Whole are Rotating relatively to the Fainter Stars, Prof. Turner, 640
- Section B (Chemistry)*.—Opening Address by Edward Divers, M.D., D. Sc., F.R.S., V.P.C.S., Emeritus Professor of Chemistry in the Imperial University of Tokyo, Japan, President of the Section, 495; Amount of Carbonic Anhydride absorbed from Sea Water, Prof. E. A. Letts and Mr. W. Coldwell, 662; Corrosion of Copper by Sea Water, Prof. E. A. Letts, 662; Action of Distilled Water upon Lead, Prof. F. Clowes, 662; on the Decomposition of Urea, Dr. C. E. Fawcitt, 662; on the Telluric Distribution of the Elements in Relation to their Atomic Weights, W. Ackroyd, 662; on the Proposed Standardisation of Methods of Chemical Analysis, Mr. B. Blount, 662; on the Alkylation of Sugars, Prof. T. Purdie, F.R.S., and Dr. J. C. Irvine, 662; Synthetic Action of Enzymes, Dr. E. F. Armstrong, 662; Recent Synthetical Researches in the Glucoside Group, Dr. E. F. Armstrong, 662; Report of the Committee Appointed to collect Statistics Concerning the Training of Chemists Employed in English Chemical Industries, 663; Crystallographic Study of the 1:3-dichloro, chlorobromo- and dibromo-benzene 5-sulphonic chlorides and bromides, Dr. Jee, 663; Colour of Iodine-containing Compounds, Miss Ida Smedley, 663; on Colloids of Zirconium, Dr. J. H. Gladstone, F.R.S., and Mr. W. Hibbert, 663
- Section C (Geology)*.—Opening Address by Lieut.-General Charles Alexander MacMahon, F.R.S., F.G.S., President of the Section, Rock Metamorphism, 504; Geology of the Country round Belfast, Prof. Grenville A. J. Cole, F.R.S., 619; Geological Structure of Ireland, Prof. Grenville A. J. Cole, F.R.S., 619; Proof Sheet of the "Drift" Edition of the Geological Map of Ireland Exhibited by Mr. Teall, 619; Post-Glacial Deposits of the Belfast District, Mr. R. Lloyd Praeger, 619; Madame Christen on the Recent Work of the Belfast Field Club on the Drift Deposits of the District, 619; Results of Exploration of various Irish Caves, 619; Mr. Joseph Wright on the Discovery of Marine Foraminifera in Boulder Clay from various Districts in Ireland and Elsewhere, 619; on the Prolongation of the Highland Border Rocks into County Tyrone, Mr. G. Barrow, 619; Mr. McHenry, 619; Mr. Teall, 619; Mr. Kynaston on a series of Volcanic Rocks in the District extending from Glen Coe to the Black Mount, Scotland, 619; Dr. W. Mackie on the Conditions Attending the Precipitation of Manganese Dioxide in the Elgin Sandstone, 620; Dr. W. Mackie on the Results of a Series of Determinations of the Soluble Chlorides and Sulphates in the Elgin Sandstone, 620; Mr. Horace B. Woodward on Bagshot Strata at Combe Pyne Hill, Dorset, 620; Mr. P. F. Kendall on the Pennine Faults in the Vale of Eden, 620; Mr. W. G. Fernides on New Fossils from Pen Morfa, near Tremadoc, 620; Dr. R. H. Traquir on Fishes From the Lower Devonian Roofing Slate from Gemünden, Germany, 620; Prof. H. G. Seeley on Cretaceous Strata found by Mr. E. G. Fraser on the Shoulder of Sekasar, India, 620; Dr. Smith Woodward on Lower Carboniferous Fish Fauna from Broken River, Victoria, 620; Prof. J. F. Blake on the Original Form of Sedimentary Deposits, 620
- Section D (Zoology)*.—Opening Address by Prof. G. B. Howes, D.Sc., LL.D., F.R.S., President of the Section, the Morphological Method and Progress, 522; British Fisheries Investigations and the International Scheme, Prof. McIntosh, 640; Proposed Programme for the International Investigation of the North Sea as Passed at the Recent Meeting of Delegates at Copenhagen, Mr. W. Garstang, 640; Some New Points in the Development of *Echinus esculentus*, Prof. E. W. MacBride, 640; Series of Wax Models Illustrating the Transition from Larva to Adult in *Cribrella Ocillata*, Dr. A. T. Masterman, 640; Causes of

- Salmon Disease, Dr. J. Hume Patterson, 640; Photographs of the first Segmentation Stages of the Zygote of the Native Cat (*Dasyurus*) up to the Period of first Formation of the Endoderm, Mr. J. P. Hill, 640; on some Recent Intercrossing Experiments with dogs, Prof. J. C. Ewart, 641; on the Relation of the Parietal Bone in Primates, Prof. R. J. Anderson, 641; on the Errant Habits of the Onuphidae (*Polycheeta*), Mr. A. T. Watson, 641; on an Accolous Turbellarian Inhabiting the Common Heart Urchin, Mr. R. T. Leiper, 641; on the Atlantis Problem, Dr. R. F. Schaffr, 641; on the Avifauna of Ireland as Affected by its Geography, Mr. R. J. Ussher, 641; on the Breaking up of Coral Reef by Organisms in the Tropics, Mr. J. Stanley Gardiner, 641; on the Early Development of Muscles and Motor Nerves in Lepidosaurs, Mr. J. Graham Kerr, 641; on the Insect Fauna of some Irish Caves, Mr. G. H. Carpenter, 641; Discussion on Natural Selection, 641
- Section E (Geography).**—Opening Address by Sir Thomas Holdich, President of the Section, 642; the Geography of Southern Persia, Major Molesworth Sykes, 642; on Hilly Yunnan, Capt. Ryder, 642; Sakhalin, Mr. Hawes, 642; Plans of the Scottish National Antarctic Expedition, Mr. Bruce, 642; World-shaking Earthquakes, Prof. J. Milne, 642; Evolution of the Jordan Valley, Prof. Libbey, 642; on the Windings of Evenlode, Mr. Herbeston, 642; Origin of the Valleys of County Cork, Mr. Porter, 642; Charnwood Forest, Prof. W. W. Watts, 642; on Geographical Plant Groups in the Irish Flora, Mr. Lloyd Praeger, 642; on the Distribution of Peat Bogs in Ireland, Prof. Johnston, on 643; Colonisation and Irrigation in Uganda and the British East African Protectorate, R. B. Buckley, 643
- Section F (Economic Science and Statistics).**—Opening Address by Edwin Cannan, M.A., LL.D., President of the Section, 507
- Section G (Engineering).**—Opening Address by Prof. John Perry, M.E., D.Sc., F.R.S., President of the Section, 530; Mr. H. A. Humphrey on Recent Progress in Large Gas Engines, 643; Hon. C. A. Parsons on Steam Turbines, 643; Report of the Committee on the Resistance of Road Vehicles to Traction, 643; Dr. Mill's Map of Ireland, showing Distribution of Rainfall, 644; Mr. Dick on the Available Water Power in Ireland, 644; Mr. J. E. Kingsbury on the Future of the Telephone in the United Kingdom, 644; Sir William Preece, 644; Prof. E. Wilson on the Effect of the London Atmosphere on the Electrical Conductivity of Aluminium Alloys, 644; Dr. Glazebrook, 644; Mr. W. Taylor on the Science of the Workshop, 644; Mr. J. R. Wigham on a new Flashing Lighthouse Light, 644; Joint Discussion with Section L on the Training of Engineers, Prof. Perry, 644; Sir William Preece, 645; on the Smokeless Combustion of Bituminous Fuel, Mr. W. H. Booth, 645; Mr. J. S. Raworth, 645; Prof. G. Forbes on his Experiences in South Africa with a new Range Finder, 645
- Section H (Anthropology).**—Opening Address by A. C. Haddon, M.A., Sc.D., F.R.S., M.R.I.A., President of the Section, 561; Irish Flints, Mr. W. J. Knowles, 663; Palaeolithic Implements from Knowle, Wiltshire, Messrs. W. and W. A. Cunnington, 663; Important Stone-axe Factories Discovered near Cusheadall, Co. Antrim, Mr. W. J. Knowles, 663; Report on the Excavations at Arbor Low Stone Circle in Derbyshire, Mr. H. Balfour, 663; on a Prehistoric Cemetery-Cave in Palestine, Mr. R. A. S. Macalister, 663; on the Oldest Bronze Age Earthenware Vessel, Hon. John Abercromby, 663; Bronze Objects of the Hallstatt Culture Phase in Ireland, Mr. G. Coffey, 663; Report on the Pigmentation Survey of Scottish School Children, Mr. J. F. Tocher, 663; on the Psychology of Primitive Man, Miss A. Amy Bulley, 664; Mental and Moral Characteristics of the People of Ulster, Dr. W. H. Graham, 664; on the Ethnography of the Nagas, Dr. W. H. Furness, 664; the Lolos and Other Tribes of Western China, Mr. A. Henry, 664; the Wild and Civilised Tribes of the Malay Peninsula, Messrs. Nelson Annandale and H. C. Robinson, 664; the Human Souls and Ghosts of the Malays of Patani, Mr. Nelson Annandale, 664; on the Sacred Initiation Ceremonies Undergone by the Lads of the Papuan Gulf, Rev. J. H. Holmes, 664; on the Religious Ideas of the Elema Tribe of the Papuan Gulf, Rev. J. H. Holmes, 664; on the "Lia Fail" of Tara and Election of Kings by Augury, Mr. E. S. Hartland, 664; on Tallies, Mr. E. Lovett, 664; on the Classification and Arrangement of Anthropological Museums, Dr. W. H. Holmes, 664
- Section I (Physiology).**—Opening Address by W. D. Halliburton, M.D., F.R.S., Professor of Physiology in King's College, London, President of the Section, the Present Position of Chemical Physiology, 567; on the Regeneration of Nerves, Prof. Halliburton and Dr. Mott, 664; on the Mechanism Connecting the Muscular Apparatus with the Brain Centres for Willed Movement, Prof. Schäfer, 665; on some New Features in the Intimate Structure of the Human Cerebral Cortex, Dr. John Turner, 665; Prof. Schäfer, 665; on the Movement and Innervation of the Stomach, Dr. Page May, 665; on the Diuretic Action of Pituitary Extracts, Dr. Magnus and Prof. Schäfer, 666; Fatigue and Nerve, Prof. Gotch, 666; on the Distribution in the Retina of the Photo-sensitive Pigment, the Visual Purple, Dr. Edridge-Green, 666; Researches on Glycogen, Dr. Osborne and Dr. Zobel, 666; Observations on the Smallest Perceptible Musical Tone-difference as examined in the People of Scotland and of the Torres Straits, Dr. C. S. Myers, 666
- Section K (Botany).** Opening Address by Prof. J. Reynolds Green, M.A., Sc.D., F.R.S., President of the Section, 582
- Section L (Educational Science).** Opening Address by Prof. Henry E. Armstrong, LL.D., Ph.D., V.P.R.S., President of the Section, 589
- British Association Meetings, 550
 British Coasts, Sea Temperature Variations on the, 452
 British Honduras, Earthquake in Guatemala and, 553
 British Liverworts, a Monograph of the, William Henry Pearson, Prof. J. B. Farmer, F.R.S., 385
 British Medical Association, Pharmacology at the, 353
 British Museum: Catalogue of the Collection of Birds' Eggs in the British Museum (Natural History), E. W. Oates, 322; Guide to the Galleries of Mammalia in the British Museum (Natural History), 329; Guide to the Coral Gallery in the British Museum (Natural History), R. Kirkpatrick and F. J. Bell, 322
 British Plants, Types of, C. S. Colman, 458
 British Surface-Feeding Ducks, Natural History of the, J. G. Millais, T. Digby Pigott, C.B., 266
 Broeck (Prof. van den), the Iguanodons of Bernissart, 231
 Brooks' Comet, 1902 a, Elements of, 68
 Brooks (H. J.), the Elements of Mind, 317
 Broom (Dr. R.), Shoulder-Girdle of *Dasyurus* and *Perameles*, 94
 Brotherhood (Peter), Death of, 635
 Brown (Prof. Alex. Crum, F.R.S.), Studies in Auditory and Visual Space Perception, Arthur Henry Pierce, 73
 Brown (Ernest W., F.R.S.), Theory of the Motion of the Moon, 356
 Brown (George E.), the Lens, a Practical Guide to the Choice, Use and Testing of Photographic Objectives, 75
 Brown (Dr. Horace T., F.R.S.), the Influence of Varying Amounts of Carbon Dioxide in the Air on the Photosynthetic Process of Leaves and on the Mode of Growth of Plants, Lecture at Royal Society, 620
 Brown (J.), the Forthcoming Belfast Meeting of the British Association, 8
 Browne (Sir James Crichton), the rôle Played by Flies in the Propagation of Disease, 397
 Browne (W. J.), Elements of Botany, 52
 Bruce (Lieut.-Colonel), *Tryppanosoma Theileri*, New Parasite in the Blood of Cattle in South Africa, 84
 Bruce (W. S.), the Scottish Antarctic Expedition, 255, 631; on the Plans of the Scottish National Antarctic Expedition, 642
 Brückner's Cycle and the Variation of Temperature in Europe, Alex. B. MacDowall, 77
 Brühl (Jul. Wilh.), Roscoe-Schorlemmer's Lehrbuch der Organischen Chemie, 546
 Brun (A.), Caucasian Snow, 16
 Bruner (L.), Rate of Bromination of Carbon Compounds, 613
 Brunton (Sir Lauder), Factors which Tend to render Medicines Ineffective or Productive of Unusual Effects, 353
 Bryan (Prof. G. H., F.R.S.), the Kinetic Theory of Planetary Atmospheres, 54; the Royal Visit to the University of Wales, 61; Elementary Principles in Statistical Mechanics, J. Willard Gibbs, 291; Sunset Effects, 390

- Buchanan (J. V., F.R.S.), Hydrographical Observations of the *Princess Alice*, 376
- Buchenau (Dr. Fr.), Flora der ostfriesischen Inseln, 149
- Büchner (L.), Last Words on Materialism, 29
- Buckley (R. B.), on Colonisation and Irrigation in Uganda and the British East African Protectorate, 643
- Burning Stones in Egypt, on the Disintegration of, A. Lucas, 379
- Bulletin of the American Mathematical Society, 118, 165, 382, 455
- Bulley (Miss A. Amy), Psychology of Primitive Man, 664
- Bulman (G. W.), Retention of Leaves by Deciduous Trees, 56
- Bunting's Nest, Cuckoo's Egg thrown out of, 151
- Burma, Prehistoric Man in, R. C. J. Swinhoe, 54
- Burnside (Prof.), Groups in which every Two Conjugate Operations are Permutable, 71
- Burrard (Major S. G.), the Attractions of the Himalaya Mountains upon the Plumb-Line, 80; on Difficulties which are caused in the Geodetic Survey of India by the Attraction of the Mass of the Himalayas and the Thibet Plateau and by the Existence of an Underground Chain of Excessive Density which runs Across India, 640
- Burroughs and Wellcome's Soloid Microscopic Stains, 87
- Burrows (Dr. H.), Pinene Nitrocyamide, 238
- Butler-Barke (Mr.), on the Phosphorescence Produced in Partially Exhausted Tubes by the Passage of an Alternating Current round Them, 618
- Butterflies of Chile, H. C. Elwes, 214; Variation of Common Copper Butterflies, 459, 555
- Butters (J. W.), Decimal Coinage and Approximations, 513
- Câbles Sous-Marins, les, Alfred Gay, 148
- Cacao Culture, the Trinidad Experiments, 185
- Cadaec (M.), Production of Glycose by the Muscles, 216
- Calder (Captain), Eruption in St. Vincent, 373
- Caldwell (W.), Amount of Carbonic Anhydride Absorbed from Sea Water, 662
- California Climate, the, Note on a Statement in the Article on Francis Drake in the Dictionary of National Biography, 256
- Callaway (Dr. Charles), the Plutonic Complex of Central Anglesey, 239
- Cambier (R.), *Traité de Bacteriologie pure et appliquée à la Médecine et à l'Hygiène*, 316
- Cambridge Natural History, the, Mammalia, F. E. Beddard, 373
- Cambridge Philosophical Society, 142, 166
- Cammon (P.), Refraction of Light from an Iron Mirror Magnetised Perpendicularly to the Plane of Incidence, 384
- Campanulate Foxgloves, Dr. Maxwell T. Masters, F.R.S., 344
- Campbell (Prof.), the Spectrum of Nova Persei, 425
- Canada: Tides in the Bay of Fundy, W. Bell Dawson, 85; Geological Survey of Canada, Dr. Robert Bell, 86; Universities in Relation to Research, Prof. James Loudon at Royal Society of Canada's Meeting at Toronto, 358; Snow Waves and Snow Drifts, Dr. Vaughan Cornish, 453
- Canal Lift, Novel, Gordon C. Thomas, 350
- Cancani (Dr. A.), Record of Italian Earthquakes, (1891-1900), 66; Periodicity of the Great Earthquakes of the Marches and Romagna, 66; Improved Seismograph, 308; Distribution in Intensity of the After-Shocks of Three Hundred Italian Earthquakes, 513
- Cannan (Edwin, M.A., LL.D.), Opening Address in Section F at the Belfast Meeting of the British Association, 507
- Cantone, (Prof.), the Royal Prize of the Reale Accademia dei Lincei for Physics Awarded to, 377
- Cape Breton, New Marconi Signalling Station at, 485
- Cape of Good Hope Department of Agriculture Marine Investigation in South Africa, Observations on the Temperature and Salinity of the Sea around the Cape Peninsula, J. D. F. Gilchrist, 260
- Cape Observatory, Report of the, for 1901, Sir David Gill, 331
- Captain (M.), Reproduction des figures paléolithiques peintes sur les parois de la grotte de Font-de-Gaume, Dordogne, 452
- Carbon, Chemical and Physical Properties of, in the Hearth of the Blast Furnace, W. J. Foster, 63
- Carbon, Fusion of, Dr. A. Ludwig, 206
- Carbon Dioxides, Solid Carbon Dioxide obtained from Sparklets, Prof. R. W. Wood, 15; Experimental Demonstration of the Decomposition of Carbon Dioxide by Leaves Exposed to Light, P. P. Dehérain and E. Demoussy, 383; Can Carbon Dioxide be "Vitalised"? Prof. R. Meldola, F.R.S., 492; the Influence of Varying Amounts of, in the Air on the Photosynthetic Process of Leaves and on the Mode of Growth of Plants, Dr. Horace T. Brown, F.R.S., and F. Escombe at the Royal Society, 620
- Carmody, (Prof. P.), Elementary Chemical Analysis, 575
- Carneal and its Environs, the Farmers' Years, ii., Sir Norman Lockyer, K.C.B., F.R.S., 104
- Carnegie Institution of Washington, D.C., the, Dr. Daniel C. Gilman, 548
- Carpenter (G. H.), on the Insect Fauna of some Irish Caves, 641
- Carruthers (J. B.), Fungal Diseases of the Tea Plant, 136
- Carslaw (Dr. H. S.), Application of Contour Integration to the Solution of General Problems in the Conduction of Heat, 71; on the Use of Fourier's Series in the Problem of the Transverse Vibrations of Stretched Strings, 485
- Carvalho (M. E.), L'Électricité (déditée de l'Expérience et ramenée au Principe des Travaux virtuels), 575
- Cassini Division, Saturn Visible through the, C. T. Whitmell, 87, 296
- Cattle-Disease: Screw Worm in Cattle at St. Lucia, Mr. Maxwell-Lefroy, 400
- Caucasian Snow, A. Brun, 16
- Caucasus, Glacier Disaster in the, J. F. Baddeley, 328
- Cave-Brown-Cave (Miss F. E.), on the Correlation between the Barometric Height at Stations on the Eastern Side of the Atlantic, 311
- Celebes, the Geography and Geology of, Dr. Paul Sarasin and Dr. Fritz Sarasin, 3
- Celtic Mythology, Lady Gregory, 489
- Centrosome, the, Morphological Value of the, Dr. Th. Boveri, 74; U Cephei, Delay of the Minimum of, 234
- β Cephei, the Spectroscopic Binary, Prof. Frost and W. S. Adams, 352
- Cerebral Commissures in certain Marsupialia, a Peculiarity of the, Prof. G. Elliot Smith, 165
- Cerebral Cortex, Human, on some New Features in the Intimate Structure of the, Dr. John Turner, 665; Prof. Schäfer, 665
- Cesaro (E.), Limitations of Constants in the Analytical Theory of Heat, 159
- Ceylonese Lizard, Bipedal Locomotion of a, E. Ernest Green, 492; Rose Haig Thomas, 551; N. Annandale, 577; W. Saville Kent, 630
- Chalon-sur-Saône, Cyclone at, 305
- Chandler (Dr. J. C.), Motion of the Pole, 309
- Chantemesse (A.), *Pathologie Générale et Expérimentale, Les Processus généraux*, 303
- Chapman (Frederick), the Foraminifera, an Introduction to the Study of the Protozoa, 196
- Chapman (Dr. H. C.), the Flying-lemur, 351
- Chapman (Mr.), Decomposition of Water Vapour by the Electric Spark, 637
- Charabot (E.), Mechanism of the Chemical Variations in the Plant under the Influence of Sodium Nitrate, 144; Study of the Simultaneous Distillation of two Non-miscible Substances, 336; the Methyl Ester of Methylanthranilic Acid in the Vegetable Organism, 648
- Chart of the Metric System, Prof. C. Bopp, 630
- Chassy (A.), the Influence of the Voltage in the Formation of Ozone, 168
- Chaumet (M.), Action of Light on Precious Stones, 119
- Chavanne (G. W.), Pyromucic and Isopyromucic Acids, 216
- Cheadle, Slight Earthquake at, 254
- Chelsea Physic Garden, the, 321
- Chemistry: Manual of Alcoholic Fermentation and the Allied Industries, Charles G. Matthews, 1; Preparation of Absolute Alcohol from Strong Spirit, Dr. Young, F.R.S., 70; Properties of Mixtures of Lower Alcohols with Water, Dr. Young, F.R.S., and Miss E. C. Fortey, 70; Properties of Mixtures of the Lower Alcohols with Benzene, and with Benzene and Water, Dr. Young, F.R.S., and Miss E. C. Fortey, 70; the Nutritive Value of Alcohol, Messrs. Atwater and Benedict, 450; Action of Alcohols upon the Sodium Derivatives of other Alcohols, Marcel Guerber, 336; Solid Carbon Dioxide obtained from Sparklets, Prof. R. W. Wood, 15; Synthesis of Carboxylic Acids by the Action of Carbon Dioxide upon Magnesium Alkyl Halogen Compounds, Messrs. Houben and Kesselkaul, 308; Experimental Demonstration

of the Decomposition of Carbon Dioxide by Leaves Exposed to Light, P. P. Dehérain and E. Demoussy, 383; Can Carbon Dioxide be Vitalised? Prof. R. Meldola, F.R.S., 492; Chemical Society, 22, 70, 118, 191, 214, 238; Influence of Acidic Oxides on Specific Rotations of Lactic Acid and Potassium Lactate, Drs. Henderson and Prentice, 22; Ammonia, Nitrates and Chlorine in Rothamsted Rain Water, Dr. Miller, 22; Reactions between Acid and Basic Amides in Liquid Ammonia, Messrs. Franklin and Stafford, 541; Dimercammonium Nitrite and its Haloid Derivatives, Dr. P. C. Ray, 22; Preparation of Sulphamide from Ammonium Amido-sulphite, Messrs. Divers and Ogawa, 541; The Precipitation of Ammonium Vanadate by Ammonium Chloride, F. A. Gooch and R. D. Gilbert, 571-2; Preparation and Properties of a Silicide of Vanadium, MM. H. Moissan and Holt, 312; a New Silicide of Vanadium, H. Moissan and M. Holt, 624; Nitrates and Chlorine in the Drainage through Uncropped and Unmanured Land, Dr. Miller, 22; Composition of the Hydrate of Chlorine, M. de Forcrand, 48; Union of Hydrogen and Chlorine, V. and VI., Dr. Mellor, 238; Case of Molecular Rupture by Bromine, R. Fosse, 23; Derivatives of Fumaric Aldehyde, R. Marquis, 23; the Transformation of New into Stale Bread, L. Lindet, 23; Chemical Instruction and Chemical Industries in Germany, Prof. T. E. Thorpe, F.R.S., 32; Death and Obituary Notice of Prof. H. von Pechmann, 37; Death and Obituary Notice of John Glover, 37; Instantaneous Chemical Reactions and the Electrolytic Dissociation Theory, Prof. Kahlenberg, 38; Persulphuric Acids, Prof. Henry E. Armstrong, V.P.R.S. and T. Martin Lowry, 45; an Introduction to Chemistry and Physics, W. H. Perkin, jun. and Bevan Lean, 52; the Oil Chemists' Handbook, Erastus Hopkins, 52; Does Chemical Transformation Influence Weight? Lord Rayleigh, F.R.S., 58; Position of the Rare Earths in Mendeléeff's Periodical System of Elements, Prof. Bohuslav Brauner, 66; Atoms and Valencies, J. Fraser, 68; Preparation of Highly Substituted Nitroamino-benzenes, Dr. Orton, 70; Atomic Weight of Tellurium, Dr. Scott, F.R.S., 70; Fractional Distillation as a Method of Quantitative Analysis, Dr. Young and Miss E. C. Forley, 70; Vapour Pressures and Boiling Points of Mixed Liquids, Dr. Young, F.R.S., 70; on an Oxycarbide of Cerium, Jean Sterba, 72; Glucose and the Carbonates of Cerium, Andre Job, 72; Derivatives of Pyruvylpyruvic Ester, L. J. Simon, 72; Addition of Hypochlorous Acid to Propylene, Louis Henry, 72; Arsenic Anhydride and its Hydrates, V. Auger, 72; Decomposition of Compounds of Selenium and Tellurium by Moulds and its Influence on the Biological Test for Arsenic, Dr. Rosenheim, 214; Research by W. C. Heraeus with Modified Form of Electric Resistance Furnace, 85; Products of the Catalpa Fruit, A. Piutti and Dr. E. Comanducci, 87; Lithium Silicide, Henry Moissan, 95; Conditions of Formation and Stability of the Hydrides and Nitrides of the Alkaline Earths, Henri Gautier, 96; Synthesis of Menthone, Georges Leser, 96; Variation with Temperature of the Surface-tensions and Densities of Liquid Oxygen, Nitrogen, Argon, and Carbon Monoxide, E. C. C. Baly and F. G. Donnan, 118; Comparison of Bromonitrocamphane with Bromonitrocampor, Dr. M. O. Forster, 119; -2 : 4-Dibromo-5-nitro- and 2 : 4-dibromo-3 : 5-dinitrotoluenes and their Behaviour on Reduction, W. A. Davis, 119; Purification of Hydrochloric Acid from Arsenic, Dr. Thorne and E. H. Jeffers, 119; Radioactivity of Thorium Compounds, Prof. Rutherford and Mr. Soddy, 119; Radioactivity of Uranium, Mr. Soddy, 119; Redetermination of the Atomic Weight of Uranium, Prof. T. W. Richards and Mr. Merigold, 208; the Addition of Hydrogen to Ethylenic Hydrocarbons by the Method of Contact, Paul Sabatier and J. B. Senderens, 119; Volumetric Estimation of Iodides in the Presence of Chlorides and Bromides, V. Thomas, 120; Method of Gradual Synthesis of Aldehydes, L. Bouveault and A. Wahl, 120; the Laboratory Companion to Fats and Oils Industries, Dr. J. Lewkowitsch, 126; Commercial Fixation of Nitrogen, 135; Synthesis of Hydroazotic Acid, 137; Antiseptic Properties of Dilute Solutions of Acids, Dr. M. Bial, 137; Synthesis of Fatty Aldehydes, L. Bouveault and A. Wahl, 137; "Chemical" Theory of Petroleum Formation, Paul Sabatier and J. B. Senderens, 138; on a General Numerical Connection between the Atomic Weights, C. A. Vincent, 143; Biochemical Action of Extract of Kidney on Certain Organic Compounds, E. Gérard, 144; Physical Properties of Hydrogen

Telluride, MM. de Forcrand and Fonzes-Diacon, 144; Mechanism of the Chemical Variations in the Plant under the Influence of Sodium Nitrate, E. Charabot and A. Hébert, 144; Constitution of the Ammoniacal Copper Salts, M. Bouzat, 144; Ammoniacal Copper Oxide, M. Bouzat, 168; Chemistry of Respiration in Bacteria, Dr. W. E. Adeney, 167; the Influence of the Voltage in the Formation of Ozone, A. Chassy, 168; Preparation of the Anhydrous Chlorides of Samarium, Yttrium and Ytterbium, Camille Matignon, 168; Action of Monochloroacetic Acetic Ester upon Diaz Benzene Chlorides, G. Favrel, 168; Elementary Inorganic Chemistry, James Walker, F.R.S., 170; Experimental Chemistry, Lyman C. Newell, 170; Elementary Experimental Chemistry, W. F. Watson, 170; the Manufacture and Uses of Sodium, James D. Darling, 189; Some Excessively Saline Indian Well Waters, Dr. J. W. Leather, 191; Influence of Solvents on the Rotation of Optically Active Compounds, Dr. T. S. Patterson, 191; Action of Sulphurous Acid upon Oxidase and on the Colouring Matter of Red Wine, A. Bouffard, 192; a New Isomerism in Asymmetric Nitrogen, E. Wedekind, 192; the Oxidation of Morphine by the Juice of *Rosula delica*, J. Bougault, 192; *m*-Benzene-az-benzoic Aldehyde, P. Freundler, 192; Apparatus for Liquefying Hydrogen, Dr. Morris W. Travers, 204; Fusion of Carbon, Dr. A. Ludwig, 206; Decomposition of Oxalacetic Hydrazone in Aqueous and Acid Solutions, and a New Method of Determining the Concentration of Hydrogen Ions in Solutions, H. O. Jones, O. W. Richardson, 214; Constituents of Gambier and *Acacia Catechus*, A. G. Perkin and E. Yoshitake, 214; Action of Ungerminated Barley Diastase on Starch, Dr. J. L. Baker, 214; Decomposition of Chlorates, W. H. Sodeau, 214; Phosphorus Tetroxide, C. A. West, 214; Combinations of Hydrogen Sulphide with Anhydrous Aluminium Chloride, E. Baud, 216; Conditions under which Aluminium is Obtained by the Electrolytic Method, Messrs. Haber and Geipert, 424; Alloys of Cadmium and Magnesium, O. Boudouard, 216; Polymerisation and Heat of Formation of Oxide of Zinc, M. de Forcrand, 216; Pyromucic and Isopyromucic Acids, G. Chavanne, 216; New Glucoside Aucubine, M. Bourquelot and H. Hérissey, 216; Identity of the Acid Obtained by the Oxidation of Benzylidene-menthone with Potassium Permanganate with the Dihydrocamphoric Acid, G. Martine, 216; Decomposition of Mercurous Chloride by Dissolved Chlorides, T. W. Richards and E. H. Archibald, 233; Lead Dioxide Produced Electrolytically from a Solution of an Alkali Chloride in which Litharge is Suspended, 233; Dinitro-*p*-anisidine, Prof. Meldola and J. V. Eyre, 238; Pinene Nitrocyamide, Prof. Tilden and Dr. H. Burrows, 238; Preparation of Pure Chlorine and its Behaviour Towards Hydrogen, J. W. Mellor and E. J. Russell, 238; Molecular Condition of Borax in Solution, H. S. Shelton, 238; Absorption Spectra of Phloroglucinol and its Trimethyl Ester, Messrs. Hartley, Dobbie and Lauder, 238; Melting Point of Pure Tribromophenolbromine, E. W. Lewis, 238; Amorphous Sulphur and its Relation to the Freezing Point of Liquid Sulphur, Prof. A. Smith, 239; Causes which Determine the Formation of Amorphous Sulphur, Prof. Alexander Smith, 383; Dissociation of the Compound of Iodine and Thiourea, Dr. Hugh Marshall, 239; Chlorinating Properties of a Mixture of Hydrochloric Acid and Oxygen, Camille Matignon, 240; Acidity of Pyrophosphoric Acid, H. Giran, 240; Di-benzoyl-hydrazobenzene, P. Freundler, 240; Manual of Agricultural Chemistry, Herbert Ingle, 245; Spring Waters from Petroleum Districts Contain no Sulphates, Prof. Höfer, 256; Liquid Hydride of Silicon, H. Moissan and S. Smiles, 263; New Properties of Amorphous Silicon, H. Moissan and S. Smiles, 263; Silicon not an Element, Th. Gross, 484; Combination of Silicon with Cobalt, P. Lebeau, 572; Magnetic Properties of the Ferro Silicons, Ad. Jouve, 264; Gummosis of the Sugar Cane, R. Greig Smith, 264; an Improved Machine for the Economical Production of Liquid Air, Georges Claupe, 264; Constitution of the Aloins, N. E. Léger, 264; Action of Carbon Bisulphide on the Polyvalent Amino-alcohols, L. Maquenne and E. Roux, 264; the Atomic Weight of Iodine, Prof. Ladenburg, 281; Polonium, Dr. W. Marckwald, 281; Gaseous Antimony Hydride, A. Stock and W. Doht, 281; Electrolysis of Silver Nitrate, A. Leduc, 288; Oxidising Properties of Dinaphthopyranol, R. Fosse, 288; Condensation of Nitromethane with Aromatic Aldehydes, W. L. Bouveault and A. Wahl, 288;

- New Proof of the Cellular Resistance of the Saccharomyces and on a New Application of this Property to Industry and the Distillery, Henri Alliot, 288; Death and Obituary Notice of Prof. V. Safarik, 305; the Rate of Hydrolysis of Sulphonic Acid Esters, B. Wegscheider, 308; Quantitative Examination of Atmospheric Air, MM. Henriet and Pécolou, 308; the Action of Copper Sulphate upon Iron Meteorites, O. C. Farrington, 311; the Direct Hydrogenation of Acetylenic Hydrocarbons by the Method of Contact, Paul Sabatier and J. B. Senderens, 312; on a New Organic Vapour in Atmospheric Air, H. Henriet, 312; Junior Chemistry and Physics, II. Jerome Harrison, 317; Synthesis of Tartaric Acid for Production on a Large Scale, Prof. Zinno, 330; Comparative Economic Study of the Manufacture of Sulphuric Acid by the Anhydride and the Modern Lead Chamber Processes, Messrs. Niedenfuhr and Luty, 330; the Phallic Sulphates and Double Sulphates, Dr. Hugh Marshall, 335; Study of the Simultaneous Distillation of two Non-miscible Substances, Eug. Charabot and J. Rocherolles, 336; Atomic Weight of Radium Mme. Curie, 336; Action of Hydrochloric Acid upon the Sulphates of Aluminium, Chromium and Iron, A. Kécoura, 336; Mixtures formed by Sulphur and Phosphorus at Temperatures below 100° C., R. Boulouch, 336; Cerium Silicide, M. Sterba, 336; Magnetic Dichroism, Quirino Majorana, 360; Mannite, the Nitrates and the Alkaloids of Normal Urine, S. Dombrowski, 360; Reduction of Nitro-derivatives by the Method of Direct Hydrogenation in contact with finely divided Metals, Paul Sabatier and J. B. Senderens, 360; Chemische und Medicinische Untersuchungen, Festschrift zur des Schzigisten Geburtstages, Max Jaffé, 363; Essays in Historical Chemistry, T. E. Thorpe, F.R.S., 365; Statue to Pasteur at Dôle, 377; Direct reduction of Oxides of Nitrogen by the Contact Method, Paul Sabatier and J. B. Senderens, 384; Ammoniacal Anhydrous Copper Chlorides, M. Bouzat, 384; Action of Nitrous Acid in Alkaline Solutions on α -Substituted β -Ketonic Esters, MM. Bouveault and René Lorquin, 384; Variation of the Phosphoric Acid in Cow's Milk with time after Calving, F. Bordas and Sig. de Raczkowski, 384; Influence of Cream Separation on the Principal Constituents of Milk, F. Bordas, Sig. de Raczkowski, 432; the Preparation of Cells for the Measurement of High Osmotic Pressures, Messrs. Morse and Frazer 401; Electrochemical Equivalent of Silver, Messrs. Richards and Heimrod, 401; Chemisch-Analytisches Praktikum, Dr. Carl Anton Henniger, 414; the Effect of Light on Cyanin, P. G. Nutting, 416; Relationships between the Atomic Weights of Allied Elements, Arthur Marshall, 424; the Composition of Pennsylvania Petroleum, C. F. Mabey, 424; International Catalogue of Scientific Literature, Prof. Herbert McLeod, F.R.S., 436; a First Course of Chemistry (Heuristic), J. H. Leonard, 439; a Text-book of Inorganic Chemistry, Dr. A. F. Holleman, 440; Two Chemical Constituents from the Eucalypts, Henry G. Smith, 456; the Electrolysis of Mixtures of Salts, Anatole Ledue, 488; the Chemical Laboratory of the Royal Institution, 460; Death of Sir Frederick Augustus Abel, 483; Obituary Notice of, 492; Death of Prof. John James Hummel, 511; Obituary Notice of, 520; Latest Apparatus for Rendering Air Respirable in a Closed Space, M. Desgrez, 513; a New Acidimetric Indicator, L. J. Simon, 516; the Elementary Principles of Chemistry, A. V. E. Young, 519; Death of M. Damour, 538; Chemical Composition of Tubercle Bacilli, De Schweinitz and Dorset, 540; Mannan in Sugar-maple Trees, Prof. F. H. Storer, 541; Roscoe-Schorlemmer's Lehrbuch der Organischen Chemie, Jul. Wilh. Brühl, Prof. R. Meldola, F.R.S., 546; an Introduction to Chemistry, D. S. Macnair, 547; Elementary Chemical Analysis, Distinguishing Tables and Tests, Prof. P. Carmody, 575; the Evolution of Artificial Mineral Waters, William Kirkby, 602; a Junior Chemistry, E. A. Tyler, 606; Apparatus for the Fixation of Atmospheric Nitrogen, Messrs. Bradley and Lovejoy, 611; the Decomposition of Urea, C. E. Fawsitt, 613; Rate of Bromination of Carbon Compounds, L. Bruner, 613; Dinaphthopyranol, R. Fosse, 624; on Nitro-pyromucic Acid and its Ethyl Ester, and on Dinitro-furfurane, R. Marquis, 624; Saponification of Nitric Esters, Leo Vignon and I. Bay, 624; Examination and Estimation of Extract of Chestnut Wood Mixed with Oak Extract, Ferdinand Jean, 624; Pectic Fermentation, M. Goyaud, 624; Assaying and Metallurgical Analysis for the Use of Students, Chemists and Assayers, E. L. Rhead and Prof. A. Humboldt
- Sexton, 628; Apparatus for the Electrolytic Separation of Calcium from the Fused Chloride, B. V. Borchers and L. Stockem, 636; Iodine Pentafluoride, Henri Moissan, 637; the Decomposition of Ammonium Nitrite in Aqueous Solution, A. A. Blanchard, 637; Aqueous Solutions of Casein Sodium, Dr. Sackur, 637; Decomposition of Water Vapour by the Electric Spark, Messrs. Chapman and Lidbury, 637; a Consequence of the Kinetic Theory of Diffusion, J. Thover, 648; the Methyl Ester of Methylanthranilic Acid in the Vegetable Organism, Eugene Charabot, 648; Composition of Reserve Hydrocarbons in the Albumen of Palms, E. Liénard, 648; the Reaction of Iodine with Mercuric Oxide in Presence of Water, R. L. Taylor, 648; Phosphorus versus Lime in Plant Ash, Dr. P. Q. Keegan, 655; Chemistry and Life, 651; Das Eisen als das thätige Prinzip der Enzyme und der lebendigen Substanz, N. Sacharoff, 651; Studies on Earth, Th. Schloesing, 671; Mode of Action of Carbonic Acid in Experimental Parthenogenesis, Yves Delage, 671; the Derivatives of Ethyl Pyruvylpyruvate, L. J. Simon, 672; the Elements of Physical Chemistry, J. Livingston R. Morgan, 100; the Elements of Physical Chemistry, Harry C. Jones, 226; Physiological Chemistry, Das Wirbeltierblut in mikrokristallographischer Hinrichtung, Dr. H. U. Kobert, 363; the Present Position of Chemical Physiology, Opening Address in Section I at the Belfast Meeting of the British Association, W. D. Halliburton, F.R.S., 567; see also Section B, British Association.
- Cheesneveu (Vincent Leche), Death of, 553
Cheyne (Rev. T. K.), Encyclopedia Biblica, a Critical Dictionary of the Literary, Political and Religious History, the Archaeology, Geography and Natural History of the Bible, 193
Chickens Hatched in a Tree, W. H. Hall, 127
Child (J. M.), Rearrangement of Euclid's Propositions, 31
Children's Games, Australian, Walter E. Roth, 380
China, the Lolos and Other Tribes of Western, A. Henry, 664
Chinese Turkestan, Recent Discoveries in, Prof. M. Winternitz, 284
Chloroform: a Manual for Students and Practitioners, Edward Lawrie, 293
Chree (Dr. C., F.R.S.), Expédition Norvégienne de 1899-1900, pour l'Étude des Aurores Boréales, Résultats magnétiques, Kr. Birkeland, 227
Christen (Madame), on the Recent Work of the Belfast Field Club on the Drift-deposits of the District, 619
Christiania, the Abel Festival in, 552
Christomans (M.), Earthquake at Salonica, July 5, 624
Chromolithography; the half-tone Trichromatic Process of Colour-printing, F. E. Ives, 207
Chronology of the Myth-making Age, History and, J. F. Hewitt, 145
Chronometry: Exposition Universelle de 1900, Congrès International de Chronométrie, Comptes rendus des Travaux, Procès-verbaux, Rapports et Mémoires, 411
Church (Prof. Irving F.), Diagrams of Mean Velocity of Uniform Motion of Water in Open Channels, based on the Formula of Ganguillet and Kutter, 439
Ciel, à la Conquête du, F. C. de Nascius, 199
Citizens, the making of, a Study of Comparative Education, R. E. Hughes, 604
Civitas (Prof. T. Levi), Mathematical Investigation of the Effect of an Infinite Plane-conducting Screen on the Magnetic Field Produced by an Electrostatic Charge Moving uniformly Parallel to the Plane, 280
Clark (J. Edmund), the Coloured Sunsets, 223
Clarke (W. E.), Bird-migration observed from the Eddystone, 185
Classics of Physical Science, the, 315
Claude (Georges), an Improved Machine for the Economical Production of Liquid Air, 264
Clayden (A. W.), Recent Sunset Effects and Those which Followed the Eruption of Krakatoa, 659
Clayton (Henry Helm), Volcanic Eruption in Java, Brilliant Sunset Glows in 1901 and Probable Glows from the Eruption in Martinique, 101
Climate, Shore, Sea Temperature and, 116
Climates and Baths of Great Britain, the, 629
Clinton (W. C.), Electric Wiring: a Primer for the use of Wiremen and Students, 629
Clodd (Edward), the Life of Thomas Henry Huxley, 121

- Close (Major C. F.), Plane Surveying. A Text and Reference Book for the use of Students in Engineering and for Engineers Generally, Paul C. Nugent, 243; Geodetic Survey of South Africa, vol. II., Report on a Rediscovery of Bailey's and Fourcade's Surveys and their Reduction to the System of the Geodetic Survey, Sir David Gill, K.C.B., F.R.S., 457
- Clouds at Sunset, Colours between, John Baddeley, 370
- Clouds (Prof. F.), Action of Distilled Water on Lead, 662
- Coal: the Misuse of, Walter Rosenhan, 29; Prof. J. Perry, F.R.S., 30; W. Hibbert, 102; D. E. Hutchins, 246; the Anthracite Coal Industry, Peter Roberts, 50; Coal Cutting by Machinery in the United Kingdom, Sydney F. Walker, 414; Elementary Coal Mining, George L. Kerr, 369
- Coast Fog Signals, E. Price Edwards, 115
- Cockerell (Prof. T. D. A.), the Evolution of Snails in the Bahama Islands, 56; De Vriesian Species, 174; Material for Natural Selection, 607; the Fertilisation of Linum, 631
- Coffey (G.), Bronze Objects of the Hallstatt Culture Phase in Ireland, 663
- Cog-wheels, Geometry of, Prof. D. Tessari, 218
- Coke, Improving the Quality of, by Compressing the Fuel before Coking, J. H. Darby, 62
- Colaba Observatory, 68
- Cold Weather in South Africa, J. R. Sutton, 247
- Cole (Prof. Grenville A. J.), Sun-pillars and Parheliion, 32; Composite Gneisses in Boylagh, 143; Geology of the County round Belfast, 619
- Colin (P.), Magnetic Observations made in Central Madagascar, 102
- College Algebra, L. E. Dickson, 4
- Colleges of the University of London, the, 10
- Collett (Oliver), Death and Obituary Notice of, 328
- Collingwood (W. G.), the Lake Counties, 271
- Collins (F. Howard), Single-handed Dividers, 378
- Colman (C. S.), Types of British Plants, 458
- Colorado Potato Beetle at Tilbury, 134
- Colour Photography: Photograph of the Spectrum of the Arc light, Edgar Senior, 582
- Colour Variation in the Guinea-fowl, F. Finn, 126
- Colour Variation in Pigeons, F. Finn, 157
- Coloured Sunsets, the, Dr. William J. S. Lockyer, 222; J. Edmund Clark, 223; see also Sunset.
- Colours between Clouds at Sunset, John Baddeley, 370
- Comanducci (Dr. E.), Products of Catalpa Fruit, 87
- Cometary Tails and Auroræ, Prof. Arrhenius's Theory of, Prof. John Cox, 54; Dr. J. Halm, 55
- Comets: Elements of Comet 1902 *a* (Brooks's), 68; Reduction of Measures of Swift's Comet (a 1899) from Photographs with a Portrait Lens of 30-inch Focus and 5-inch Aperture, Mr. Filon, 238; Another New Comet, John Grigg, 514, 557; Comet 1902 *b*, 515, 614; the Periodical Comet of Tempel-Swift (1869-1880), 258; Ephemeris for the Search of the Comet Tempel-Swift, F. Bossert, 557; Observations of Perrine's Comet 1902 *b*, 558; Photograph of Comet 1902 *b*, Perrine, 638
- Como, Lake, Electric Railway, 484
- Compan (P.), the Specific Inductive Capacity of Dielectrics at Low Temperatures, 168
- Comparative Anatomy of Animals, G. C. Bourne, 314
- Compiègne, Visit of the English Arboricultural Society to, Prof. W. R. Fisher, 450
- Comptes (August), Die Philosophie, L. Levy-Bühl, 369
- Conchology: the Left-handed Spiral Staircase in the Château de Blois modelled from *Volva vesperilio*, Theodore Cook, 39; the Evolution of Snails in the Bahama Islands, Prof. T. D. A. Cockerell, 56; Sports of *Helix nemoralis*, R. Welch, 612
- Congo, Les Poissons du Bassin du, G. A. Boulenger, 339
- Congresses: Exposition Universelle de 1900, Congrès International de Chronométrie, 411
- Conservation of Weight and the Laws of Thermodynamics, 102
- Constable (F. C.), Mont Pelée and After-glow, 79; Earth-surface Vibrations, 440
- Convention of Weather Bureau Officials at Milwaukee, 543
- Conway (Prof.), Huygens's Principle in a Uniaxial Crystal, 215
- Cook (Theodore), the Left-handed Spiral Staircase in the Château de Blois Modelled from *Volva vesperilio*, 39
- Cooke Photographic Lenses, Method by which the Focal Length may be Reduced, Messrs. Taylor and Co., 280
- Coomaraswamy (A. K.), the Point-de-Galle Group, 263
- Cooper (F. W.), Photographic Apparatus, Making and Repairing, 4
- Coorgs, the, and Yeruva's, an Ethnological Contrast, T. H. Holland, 91
- Corals: Guide to the Coral Gallery in the British Museum (Natural History), R. Kirkpatrick and F. J. Bell, 322; Aggregated Colonies in Madreporiform Corals, Dr. J. E. Duerden, 257
- Cornish (C. J.), the Naturalist on the Thames, 632
- Cornish (Dr. Vaughan), Snow-waves and Snow-drifts, 453
- Cornu (Prof. Alfred), Obituary Notice of, Prof. Silvanus P. Thompson, F.R.S., 12
- Cornwall: a Tentative List of the Flowering Plants and Ferns for the County of Cornwall, including the Scilly Isles, F. H. Davey, 547; Cornish Dust-fall of January, 1902, Dr. H. R. Mill, 119
- Cornwall (H. B.), Greenockite on Calcite from Joplin, Missouri, 310
- Coronation Honours to Men of Science, 228
- Cortie (Father), Visual and Spectroscopic Observations of the Sunspot Group of May and June, 1901, 94; Sunspots and Magnetic Storms, 619
- Cosmogony: Der Untergang der Erde und die kosmischen Katastrophen, Dr. M. W. Meyer, 601
- Coventry (W. B.), the Vibration of the Violin, 150
- Cox (Prof. John), Prof. Arrhenius's Theory of Cometary Tails and Auroræ, 54
- Crab, the Coconut, Dr. Horst, 308
- Craniology: the Morphological Importance of Length or Shortness in the Skulls of Mammals, Prof. Osborn, 399
- Crémieu (V.), an Electrostatic Relay, 556
- Crete: Further Discoveries in, the Older Civilisation of Greece, 390; corr., 424
- Crew (H.), a Laboratory Manual of Physics, 4
- Criterion of Scientific Truth, the, G. Shann, 221
- Croft (W. B.), Photography of Diffraction and Polarisation Effects, 354
- Crompton Potentiometer, the, 636
- Crossland (C.), Coral reefs of Zanzibar, 166
- Crumlin, County Antrim, Fall of a Meteoric Stone near, September 13, W. H. Milligan, 577; Dr. L. Fletcher, F.R.S., 577
- Crump (Rev. J. A.), Trephining in the South Seas, 136
- Crustacean Fauna of the Mammoth Cave, Kentucky, a New Form of Blind Shrimp, W. P. Hay, 556
- Crystallography: Three-circle Goniometer, G. F. Herbert Smith, 83; Crystallographic characters of liveinette, R. H. Solly, 215; Crystallographic Study of the 1:3-dichloro-, chlorobromo-, and dibromo-benzene, 5-sulphonic chlorides and bromides, Dr. Jee, 663
- Cubic and Submerged Cubes, a, Prof. Thos. Alexander, 127
- Cubical Expansion of Ice, Hydrated Salts, Solid Carbonic Acid, and other Substances at Low Temperatures, Coefficients of the, Prof. James Dewar, F.R.S., at Royal Society, 88
- Cuchulain of Muirtheinne: the Story of the Men of the Red Branch of Ulster, Lady Gregory, 489
- Cuckoo, the Early Life of the Young, W. P. Westell, 574
- Cuckoo's Egg thrown out of Bunting's Nest, 151
- Culicidae, a Monograph of the, of the World, F. W. Theobald, 123
- Cunningham (Prof. D. J., F.R.S.), Right-handedness and Left-brainedness, 659
- Cunningham (Lieut.-Colonel), Investigations on Repetition of the Sum-factor Operation, 215
- Cunnington (W. and W. A.), Palæolithic Implements from Knowle, Wiltshire, 663
- Curie (Jacques), the Specific Inductive Capacity of Dielectrics at Low Temperatures, 168
- Curie (Mme.), Atomic Weight of Radium, 336
- Curious Optical Effect, E. Moor, 127
- Curved Surfaces, General Investigations of, of 1827 and 1825, Karl Friedrich Gauss, 316
- Cushman (C. R.), Rectifier for Alternating Currents, 328
- Cuthbertson (Clive), Refractivities of the Inert Gases, 507
- Cyanin, the Effect of Light on, P. G. Nutting, 416
- Cyclones: the Hurricanes of the Far East, Prof. Dr. Paul Bergholz, 51; Cyclone on the Eastern Sicilian Coast on September 20, 553
- χ^2 Cygni, Observations of the Variable Star, during 1899, 282

Cytology; Das Problem der Befruchtung, Dr. Th. Boveri, 74
Czuber (Emmanuel), Probabilités et Moyennes Géométriques, 652

Damour (M.), Death of, 538
Dangerous Trades; the Historical, Social and Legal Aspects of Industrial Occupations as Affecting Health, Dr. T. E. Thorpe, F.R.S., 433

Daniel (Lucien), Utilisation of Mineral Substances by Grafted Plants, 624

Daniele (E.), Cases of Motion of a Point in a Plane, 329
Darby (J. H.), Improving the Quality of Coke by Compressing the Fuel before Coking, 62

Darling (James D.), the Manufacture and Uses of Sodium, 189
Darwin (Prof. G. H., F.R.S.), A New Theory of the Tides of Terrestrial Oceans, Rollin Harris, 444
Darwinism, the Primrose and, 409, 575, the Writer of the Review, 575

Dayve, (F. H.), a Tentative List of the Flowering Plants and Ferns for the County of Cornwall, including the Scilly Isles, 547

Davis (W. A.), 2:4-dibromo-5-nitro- and 2:4-dibromo-3:5-dinitrotoluenes and their Behaviour on Reduction, 119

Davison (Dr. C.), the Carlisle Earthquakes of July 9 and 11, 1901, 71; the Inverness Earthquake of September 18, 1901, 71

Dawkins (Prof. W. Boyd, F.R.S.), the Red Sandstone Rocks of Peel, 191

Dawson (W. Bell), Tides in the Bay of Fundy, 85

Day (Alfred Ely), Remarkable Fossil Oysters from Syria, 606

Deciduous Trees, Retention of Leaves by, Jul. Wulff, 32; Wm. Gee, 32; G. W. Bulman, 56; P. T., 56; A. F. G., 344; Prof. D. R. Fisher, 370; Dr. D. T. Smith, 631

Decimal Coinage and Approximations, J. W. Butters, 513

Decorative Plants for Gardens, Dr. Nicola Terraciano, 36
Delays (J.), Etude Pratique sur les Différents Systèmes d'Eclairage, 172

De Forest System of Wireless Telegraphy, the, 446

Dehéran (P.), Culture of the Forage Beet at Grignon, 47; Experimental Demonstration of the Decomposition of Carbon Dioxide by Leaves exposed to Light, 383; Cultivation of the Yellow Lupin, 544

Delage (Yves), Traité de Zoologie Concrète, 267; Mode of Action of Carbonic Acid in Experimental Parthenogenesis, 671

Delezenne (C.), a Kinase in Snake Poison, 408

Demoussy (E.), Experimental Demonstration of the Decomposition of Carbon Dioxide by Leaves Exposed to Light, 383; Cultivation of the Yellow Lupin, 544

Denayrouze (L.), Use of Alcohol as an Illuminant, 486

Dendy (Dr. A.), New Hydroid, *Pelagodya Mirabilis*, 330

Denning (W. F.), the Equatorial Current on Jupiter, 138; the August Meteoric Shower, 309; the Perseid Meteoric Shower of 1902, 406

Desgrez (A.), Influence of Lecithin on the development of the Skeleton and of Nervous Tissue, 120; Influence of Choline on the Glandular Secretions, 288; Latest Apparatus for Rendering Air Respirable in a Closed Space, 513

Deslandres (H.), Connection between the Photographs of the Solar Corona and of the entire Solar Chromosphere obtained on the Same Day, 167; Method of Spectrum Analysis Furnishing the still unknown Law of Rotation of Planets of Feeble Brightness, 360; Rotation Period of the Superior Planets, 380; Spectral Researches on the Rotation of the Planet Uranus, 572; Automatic Spectrographs Registering the Radial Movements and the Thickness of the Solar Chromosphere, 624

Desmarest (Henri), La Houille Blanche, the Utilisation in France of Water Power for Industrial Purposes, 485

De Vriesian Species, Prof. T. D. A. Cockerell, 174

Dewar (Prof. James, F.R.S.), Coefficient of the Cubical Expansion of Ice, Hydrated Salts, Solid Carbonic Acid and other Substances at Low Temperatures, Lectures at Royal Society, 88; Inaugural Address at the Belfast Meeting of the British Association, 462

Dichromatism, Prisms and Plates for Showing, Prof. R. W. Wood, 31

Dick (Mr.), Water-power Available in Ireland, 644

Dickens (Margaret), Resultant Tones and the Harmonic Series, 78

Dickson (L. E.), College Algebra, 4
Dictionary of the English Language, Webster's International, 222

Diffraction Effects, Simple Means of Producing, Wilfred Hall, 416

Diffraction and Polarisation Effects, Photography of, W. E. Croft, 354

Diller (J. S.), Rocks of Mont Pelée, 372

Direct-current Arc, the, Hertha Ayrton, 124

Diseases of the Upper Air Passages, Some Thoughts on the Principles of Local Treatment in, Sir Felix Semon, 149

Distant (W. L.), Fauna of British India, Including Ceylon and Burma, Rhynchota, 548

Diuretic Action of Pituitary Extracts, on the, Dr. Magnus and Prof. Schäfer, 666

Divers (Edward, M.D., F.R.S., V.P.C.S.), Opening Address in Section B, at the Belfast Meeting of the British Association, 495; Preparation of Sulphamide from Ammonium Amidosulphite, 541

Dixon (H. T.), Flames from Mud on a Sea-Shore, 151

Dobbie (Mr.), Absorption Spectra of Phloroglucinol and its Trimethyl Ester, 238

Doberck (W.), Hong Kong Double Star Observations, 282

Doht (W.), Gaseous Antimony Hydride, 281

Dombrowski (S.), Mannite, the Nitrates and the Alkaloid of Normal Urine, 360

Donnan (F. G.), Variation with Temperature of the Surface-Tensions and Densities of liquid Oxygen, Nitrogen, Argon and Carbon Monoxide, 118

Dorset (Mr.), Chemical Composition of Tubercle Bacilli, 540

Dorset, on the Soils of, D. A. Gilchrist, C. M. Luxmoore, 486

Double Refraction, Einführung in die Theorie der Doppelbrechung, Heinrich Greinacher, 653

Downing (Dr.), Distribution of the Stars in the Cape Photographic Durchmusterung, 238

Doyon (M.), Does Lipase exist in Normal Serum? 48

Drake (Francis), Note on a Statement in the Article on, in the Dictionary of National Biography, the Californian Climate, 256

Druce (J. C.), the Progress of Scottish Botany, 447

Duane (William), Simple Electric Thermostat, 135

Dublin: Royal Dublin Society, 47, 167, 311; Royal Irish Academy, 143

Dubois (Prof. A. Jay), Mechanics of Engineering, 265

Ducks, Natural History of the British Surface-feeding, J. G. Millais, T. Digby Pigott, C. B., 266

Duckworth (W. L. H.), Dispersive Power of Running Water on Skeletons, 166

Duerden (Dr. J. E.), Aggregated Colonies in Madreporiform Corals, 257

Duff (Archibald), Theology and Ethics of the Hebrews, 517

Dunlop (Lieut.-Colonel H. C.), Slide Rule Notes, 292

Dunstan (Prof. Wyndham R., F.R.S.), Poisonous Fodder-plants and Oriental Drug Plants, 83

Dupont (C.), the Aerobic Fermentation of Manure, 216

Dupont (L. C.), Culture of the Forage Beet at Grignon, 47

Dust Falls and their Origins, G. Hellmann and W. Meinardus, 41

Dust Falls, Mont Pelée Eruption and, Dr. William J. S. Lockyer, 53

Dust, Volcanic, from the West Indies, J. J. H. Teall, F.R.S., 130; Rev. T. C. Porter, 131; J. D. Falconer, 132

Dust Fall of January, 1902, Cornish, Dr. H. R. Mill, 119

Dutch Eclipse Expedition of 1601, the, 380

Dutton (J. Everett), New Febrile Blood Parasite in Man, 15

Dwerryhouse (Arthur R.), Explanations of Glacial Phenomena in the North of England, 424

Dynamics: Quelques Réflexions sur la Mécanique, Suivies d'une Première Leçon de Dynamique, Émile Picard, 101

Dynamics: Foundations of Thermodynamics, J. Willard Gibbs, Prof. G. H. Bryan, F.R.S., 291

Dynamo, Alternators and Transformers, Gisbert Kapp, 172

Earth Surface Vibrations, F. C. Constable, 440; J. M., 440
Earthquakes: Earthquake round Lake Baikal, 15; Periodicity of the Great Earthquakes of the Marches and Romagna, Dr. Cancani, 66; Record of Italian Earthquakes (1891-1900), Dr. A. Cancani, 66; Distribution in Intensity of the After-shocks of Three Hundred Italian Earthquakes, Dr. Cancani,

513; the Carlisle Earthquakes of July 9 and 11, 1901, Dr. C. Davison, 71; the Inverness Earthquake of September 18, 1901, Dr. C. Davison, 71; Earthquake of May 6, 1902, Michel Lévy, 95; Earthquake in Guatemala, Edwin Rockstroh, 159; Earthquakes in Greece during 1899, Dr. D. Egnitits, 239; Register of 208 Shocks observed in Styria between 1000 and 1870, Dr. R. Hoernes, 234; Historical Account of the Earthquakes of Poland, Prof. W. Łaska, 234; Proposed Non-pendulum forms of Apparatus, Prof. E. Odone, 234; Earthquake Notes, 234; Earthquake in Salonica, July 5, 254, 278; M. Christomanos, 624; Slight Earthquake at Cheadle, 254; Earthquake at Kingston, St. Vincent, 306; Eruptions of Volcanoes and Earthquake at St. Vincent, 327; Reports of Eruptions and Earthquake Shocks, 421; Eruptions and Earthquakes during week ending September 1, 446; Earthquake Shock at Bandar Abbas, 306; Earthquakes in Nebraska, Iowa, Dakota and California, 327; in California, Portugal and Italy, 348; Periodicity of Volcanic Eruptions and Earthquakes, Rev. T. E. Espin, 353; Earthquake of May 28 at the Cape, and Coincident Meteorological Effects, Charles Stewart, 369; the Earthquake in Mid-Atlantic, Father Melzi, 378; at Skagway, 378; at Pau, 484; in South Australia, 538; in Guatemala and British Honduras, 553; Earthquakes at Kasgar, India, August 22, 553; Kasgar Earthquake of April 22, 659; Earthquakes in Guam, Tiflis and Ferghana, 579; Earthquakes and Volcanic Eruptions, April 10 to September 23, 659; Easton (C.), Light of the Galaxy and Bright Stars, 353; Eau Potable, La Question de l', devant les Municipalités, P. Guichard, 28

Eberhard (Dr.), the Orion Nebula and Movement in the Line of Sight, 18; Radial Velocity of the Orion Nebula, 309; Éclairage, Etude Pratique sur les Différents Systèmes d', J. Delays and H. Pittet, 172

Eclipses: Occultations of Stars and Solar Eclipses, Francis Cranmer Penrose, 149; Spectroscopy of the Solar Eclipse of May 18, 1901, J. W. Humphreys, 331; the Dutch Eclipse Expedition of 1901, 380; Search for an Intra-Mercurial Planet during the Total Solar Eclipse of 1901; Prof. Perrine, 662

Edinburgh Royal Society, 119, 167, 239, 335, 383

Edison (Thomas A.), Storage Battery to Enable Automobiles to run 100 Miles without Recharging, 134

Edser (Edwin), Experiment Illustrating a Paradoxical Consequence of the Wave Theory of Light, 204

Education; the Education Bill, Dr. J. H. Gladstone, F.R.S., 6; Chemical Instruction and Chemical Industries in Germany, Prof. T. E. Thorpe, F.R.S., 32; Means Taken by the Different County Councils for Training Teachers in the Best Methods of Imparting "Nature Knowledge" to their Pupils, 39; University College and the University of London, 59; Schools and Scholarships, 82; Mathematical Training, C. E. Stromeier, 103; Report on the Teaching of Geometry, 201; Science and Military Education, 175; Science and the London Matriculation Examination, A. Irving, 320; Science in the Public Schools, Rev. Dr. A. Irving, 459; Education and Empire, Richard Burdon Haldane, 222; Rural Education in France, 225; Nature Study and Life, C. F. Hodge, 245; the "Nature Study" Exhibition, Wilfred Mark Webb, 326; "Nature Study" in Elementary Education, Prof. Lloyd Morgan, 326; Vocal System based on the Fundamental Laws of Language, G. Lionel Wright, 271; the Schoolmaster, a Commentary upon the Aims and Methods of an Assistant Master in a Public School, Arthur Christopher Benson, 366; the Influence of Education upon Trade and Industry, Dr. F. Mollwo Perkin, 442; Special Reports on Educational Subjects, Education in the United States of America, 453; General Reports of H.M. Inspectors on Elementary Schools and Training Colleges for the Year 1901, 453; General Reports of the Inspectors on Science and Art Schools and Classes and Evening Schools, 453; an Arithmetic for Schools, J. P. Kirkman and A. E. Field, 491; a First Step in Arithmetic, J. G. Bradshaw, 491; Physics, a Text-book for Secondary Schools, Prof. Frederick Slate, 575; Death of Dr. J. H. Gladstone, F.R.S., 579; Obituary Notice of, 609; the Making of Citizens, a Study of Comparative Education, R. E. Hughes, 604; Mr. Balfour on Technical Education at Manchester, 633

Edwards (G. Price), Coast Fog Signals, 115

Eiffort (J.), Enzymes and their Applications, 197

Egg, Cuckoo's, thrown out of Bunting's Nest, 151

Egnitits (B.), Spectrum of Electric Sparks, 95

Egnitits (Dr. D.), Earthquakes in Greece during 1899, 239; Annales de l'Observatoire National d'Athènes, 331; Meteor Radiants, 557

Egypt, New Fossil Mammals and Reptiles from Egypt, 83; the Zoological Gardens at Ghizeh, Captain Stanley S. Flower, 280; on the Disintegration of Building Stones in Egypt, A. Lucas, 379; Geology of the Eastern Desert of Egypt, Later Physical Changes, T. Barron and Dr. W. F. Hume, 660

Eigenmann (Prof. C. H.), the Degenerate Eyes of Lizard *Rhineura floridana*, 636

Electricity: Practical Exercises in Magnetism and Electricity, H. E. Hadley, 5; Mechanical Break for Induction-coils, Dr. Dawson Turner, 21; Mechanical Break, Wilson Noble, 22; the Institution of Electrical Engineers and Electrical Legislation, 35; Deputation on Electrical Legislation, 109; Instantaneous Chemical Reactions and the Electrolytic Dissociation Theory, Prof. Kahlenberg, 38; the South Wales Electrical Power Distribution Company, 58; the Graduation of Thermoelectric Couples, Daniel Berthelot, 47; Fusion of Quartz in the Electric Furnace, R. S. Hutton, 66; Experiment suggested by the late Prof. Fitzgerald for Testing the relative motion of the earth and the æther. Prof. F. T. Trouton, 66; Electric Micrometer, Dr. P. E. Shaw, 70; Diagramme der electrischen und magnetischen Zustände und Bewegungen, F. W. Willenweber, 76; Electricity Meter, W. M. Mordey and G. L. Fricke, 84; Research by W. C. Heraeus with Modified Form of Electric Resistance Furnace, 85; on the Spark Discharge from Metallic Poles in Water, Sir Norman Lockyer, K.C.B., F.R.S., 93; Spectrum of Electric Sparks, B. Egnitits, 95; Rational Units of Electromagnetism, G. Giorgi, 118; the Leakage of Electricity from Charged Bodies at Moderate Temperatures, Prof. Beattie, 119; the Electric Arc, Hertha Ayrton, 124; Temperature of the Electric Arc, C. R. Fery, 143; the Electrical Resistance of the Blood, Dr. Dawson Turner, 127; Storage Battery to enable Automobiles to run 100 Miles without Recharging, Thomas A. Edison, 134; Simple Electric Thermostat, William Duane and Charles A. Lory, 135; Commercial Fixation of Nitrogen, 135; Propagation of Electric Force from the Sun into Space, M. Nordmann, 136; Increase in the Electrical Conductivity of Air produced by its Passage through Water, Prof. J. J. Thomson, 143; Electric Discharge in Flames, Jules Semenov, 143; Radio-active Rain, C. T. R. Wilson, 143; Electrical Resistance of Metallic Sulphide, J. Guinchant, 144; the "Armor" Electro-capillary Relay, 151, 175; Curious Effect Produced by Lightning, Dr. Enfield, 158; Accuracy of an improved Form of Silver Voltmeter, T. W. Richards and G. W. Heimrod, 158; on the Sensitiveness of the Coherer, E. R. Wolcott, 158; the Nature of the Coherer, J. Fenyl, 288; New Electric Valve, M. Nodon, 159; Electrical Conductivity of Steel and Pure Iron, C. Benedicks, 160; Electrical Resistance of Iron at very Low Temperatures, E. Philip Harrison, 343; the Influence of the Voltage in the Formation of Ozone, A. Chassy, 168; the Specific Inductive Capacity of Dielectrics at low Temperatures, Jacques Curie and P. Compagnon, 168; Dynamos, Alternators, and Transformers, Gisbert Kapp, 172; New Rectifier and Interrupter for Alternating Currents, Dr. Guilleminot, 206; Fusion of Carbon, Dr. A. Ludwig, 206; Sedimentation Experiments and Theories, Prof. J. July, 207; Niagara Falls Power Plant as a Factor in Engineering Development, 232; Lead Dioxide produced Electrolytically from a Solution of an Alkali Chloride in which Litharge is Suspended, 233; New Researches on Batteries Founded on the Reciprocal Action of two Liquids, M. Berthelot, 240; Actino-electric Phenomena, Albert Nodon, 240; Comparative Study of the Permeability of Living and Dead Animal Membranes by Measurement of the Electrolytic Resistance, G. Galeotti, 256; Action of X Rays on very small Electric Sparks, R. Blondlot, 263; Precautions in the Use of Ruhmkorff Coils in Radiography, MM. Inffroit and Gaiffe, 264; the Tramways Exhibition at the Agricultural Hall, 272; Electric Traction, 513; Wireless Telegraphy over 1600 English Miles by Land, 277; Time-signals by Wireless Telegraphy, John Munro, 416; the De Forest System of Wireless Telegraphy, 446; Note on a Magnetic Detector of Electric Waves which can be Employed as a Receiver for Space Telegraphy, G. Marconi, 334; a Note on the Effect of Daylight upon the Propagation of Electromagnetic Impulses over Long Distances, G. Marconi,

- 335; Electrolysis of Silver Nitrate, A. Leduc, 288; Electrification of London, 296; a Graduated Collection of Problems in Electricity, Prof. Robert Weber, 317; Rectifier for Alternating Currents, G. H. Morse and C. K. Cushman, 328; the Dissipation of Energy by Electric Currents Induced in an Iron Cylinder when Rotated in a Magnetic Field, Ernest Wilson, 334; Change of Resistance of Nickel due to Magnetisation at Various Temperatures, Prof. C. G. Knott, 335; Anesthesia by Electric Currents, Stephane Leduc, 336; the Mechanical Phenomena of the Electric Discharge, Jules Semenov, 336; New York Central Railway to be Worked Electrically, D. J. Arnold, 398; Electrochemical Equivalent of Silver, Messrs. Richards and Heimrod, 401; Relations of Plant Growth to Ionisation of the Soil, A. B. Plowman, 408; an Elementary Book on Electricity and Magnetism, Prof. D. C. and J. P. Jackson, 439; the Manuelli Effect, Action of Sunlight in Facilitating the Passage of Electric Sparks, Prof. Garbasso, 448; Recovery of Tin from Tin-scrap, 449; Lake Como Electric Railway, 484; the Electrolysis of Mixtures of Salt, Anatole Leduc, 488; *Vegetable Electricity*, Dr. Augustus D. Waller, 491, 549; Prof. Jagadis Chunder Bose, 549; Electrical Resistance of Iron Pyrites, Edmund Van Aubel, 544; Studies in Atmospheric Electricity, Prof. V. Homma, 555; an Electrostatic Relay, V. Crémieu, 556; Die Schutzvorrichtungen der Starkstromtechnik gegen atmosphärische Entladungen, Dr. Gustav Benischke, 573; l'Électricité (dédouée de l'Expérience et ramenée au Principe des Travaux Virtuels), M. E. Carvallo, 575; Les Phénomènes Électriques chez les Êtres Vivants, M. Mendelssohn, 575; Apparatus for the Fixation of Atmospheric Nitrogen, Messrs. Bradley and Lovejoy, 611; Electric Lighting; Photometric Tests of the Bremer Arc Lamp, M. Laporte and Prof. Wedding, 611; Electrostatics, Gauss's Theorem, S. J. Barnett, 611; Limit of Intensity of Current from a Battery which Corresponds to External Electrolytic Work apparent in a Voltmeter, M. Berthelot, 623; Electric Wiring; a Primer for the use of Wiremen and Students, W. C. Clinton, 629; the Crompton Potentiometer, 636; Apparatus for the Electrolytic Separation of Calcium from the fused Chloride, Dr. W. Borchers and Mr. L. Stockem, 636; Decomposition of Water Vapor by the Electric Spark, Messrs. Chapman and Libbury, 637; Electrical Conductivity of Certain Aluminium Alloys exposed to the London Atmosphere, Prof. E. Wilson, 644; Dr. Glazebrook, 644; Aluminium and its Alloys, Prof. E. Wilson, 655; W. Murray Morrison, 655; Electro-magnetic Mass of the Electrons, W. Kaufmann, 648; Thin Metallic Films obtained by Kathode Projection, L. Houlléviqne, 672
- Ellipse, Formula for the Perimeter of an, Thomas Muir, F.R.S., 174
- Elwes (H. C.), Butterflies of Chile, 214
- Embryology; Die Entwicklung des Gesichtes; Tafeln zur Entwicklungsgeschichte der äusseren Körperform der Wirbelthiere, Part I., Das Gesicht der Säugethiere, Carl Rabl, 368; Death and Obituary Notice of Alexander Kowalevsky, Prof. E. Ray Lankester, F.R.S., 394; Death of Dr. Leopold Schenk, 397; Qu'est-ce qui détermine le Sexe? Dr. A. Van Lint, 437; Human Embryology and Morphology, Dr. A. Keith, 603
- Emerton (James H.), the Common Spiders of the United States, 630
- Empire, Education and, Richard Burdon Haldane, 222
- Encyclopædia Biblica; a Critical Dictionary of the Literary, Political and Religious History, the Archaeology, Geography and Natural History of the Bible, Rev. T. K. Cheyne and J. Sutherland Black, 193
- Encyclopædia Britannica, 97, 361; Prof. Arthur Smithells, F.R.S., 289; Vols. xxviii. and xxix., 625
- End of the World, the, Dr. M. W. Meyer, 601
- Enfield (Dr.), Curious Effect Produced by Lightning, 158
- Engineering; the Relations between Metallurgy and Engineering, "James Forrest" Lecture at the Institution of Civil Engineers, Sir W. C. Roberts-Austen, K.C.B., F.R.S., 18; the Institution of Electrical Engineers and Electrical Legislation, 35; the Institution of Electrical Engineers' Deputation on Electrical Legislation, 199; British *versus* American Locomotives, 42; Sanitary Engineering, a Practical Manual of Town Drainage and Sewage and Refuse Disposal, Francis Wood, 173; Municipal Engineering and Sanitation, M. M. Baker, 173; New High-speed Record on the Burlington and Missouri Railroad, 184; Liquid Fuel for Steam Purposes, J. S. S. Brame, 186; The Use of Oil as Fuel for Engines, 207; Niagara Falls Power Plant as a Factor in Engineering Development, 232; Plane Surveying, a Text and Reference Book for the use of Students in Engineering and for Engineers Generally, Paul C. Nugent, Major C. F. Close, 243; the Inspection of Railway Materials, G. R. Bodmer, 244; Use of Peat in Sweden as a Substitute for Coal for Steam Engines, 256; Mechanics of Engineering, Prof. A. Jay Du Bois, 265; the Electrification of London, 296; Novel Canal Lift, Gordon C. Thomas, 350; Trades' Waste and River Pollution, W. Naylor, 413; la Houille Blanche, the Utilisation in France of Water Power for Industrial Purposes, Henri Desmarrest, 485; the Calorific Power of Coal, M. Goutal, 572; Die Schutzvorrichtungen der Starkstromtechnik gegen Atmosphärische Entladungen, Dr. Gustav Benischke, 573; Death of Peter Brotherhood, 635; see also Section G British Association
- England and Wales, Ordnance Survey of, 341
- English Chemical Industries, Report of the British Association Committee appointed to Collect Statistics concerning the training of Chemists Employed in, 663
- English Climatology 1891-1900, F. C. Bayard, 215
- English Language, Webster's International Dictionary of the, 222
- Enock (F.), New Species of Fairy Flies, 204
- Entomology; Entomological Society, 46, 166, 214, 671; a Monograph of the Culicidae of the World, F. W. Theobald, 123; Regeneration in *Samia albanthus*, H. H. Brindley, 142; The Insect-enemies of the Pine in the Black Hills, U.S.A., Forest Reserve, A. D. Hopkins, 160; New Species of Fairy Flies (Mymaridae), F. Enock, 204; Butterflies of Chile, H. C. Elwes, 214; Protective Resemblance to Flowers of *Plata nigrocineta*, S. L. Hinde, 215; the Life-history of *Uthula hyalina*, J. F. McClelland, 257; Spiderland, Rose Haig Thomas, 270; Injurious and Useful Insects, L. C. Miall, F.R.S., 293; the Sense-hairs of Caterpillars, W. A. Hilton, 390; Descent of Winged Ants on Tepalit and Brussels, 396; the Habits of the Larvæ and Adults of Sirex and Thalesia, E. P. Stebbing, 407; Larva Stage of *Helicopris isidis*, Fred Fletcher, 441; Variations of Common Copper Butterfly, 459, 555; Relations between the Mouth-organs of Diptera and Those of Other Insects, Walter Wesche, 512-13; Australian Entozoa, New Distomum from the Sawfish-Shark, S. J. Johnston, 516; Fauna of British India, including Ceylon and Burma, Rhynchota, W. L. Distant, 548; Foul Brood of Bees, 636
- Entropy, the Conservation of, J. A. Erskine, 118
- Entwicklung des Gesichtes, Die, Carl Rabl, 368
- Enzymes and their Applications, J. Efront, Dr. F. Mollwo Perkin, 197
- Equator, the French Geodetic Mission to the, 233
- Equatorial Current on Jupiter, the, W. F. Denning, 138
- D'Equerville (R.), Les Bateaux Sous-Marins et les Submersibles, 290
- Erde, Der Untergang der, und die kosmischen Katastrophen, Dr. M. W. Meyer, 601
- Eredia (Filippo), Rainfall of Sicily 1880-1900, 350
- Eros; Reduction of photographs of, for the determination of solar parallax, Mr. Hinks, 238; Reappearance of Eros, 557
- Errera (L.), Recueil de l'Institut Botanique (Université de Bruxelles), 171
- Erskine (J. A.), Conservation of Entropy, 118
- Eruptions; the Recent Volcanic Eruptions in the West Indies, 53, 79, 132, 153, 178, 203, 635, Prof. J. Milne, 56, 107, 151, 370; Report on the West Indian Eruptions, Robert T. Hill, 370, Prof. Israel C. Russell, 372; Royal Society Report on the West Indian Eruptions, Dr. Tempest Anderson and Dr. J. S. Flett, 402; Recent Volcanic Disturbances in the West Indies and Elsewhere, 229; Mont Pelée Eruption and Dust Falls, Dr. William J. S. Lockyer, 53; Fresh Eruptions of Mont Pelée, 278, 580; Notes on the Recent Eruptions of Mont Pelée, Dr. H. A. Alford Nicholls, 638; Rocks of Mont Pelée, J. S. Diller, 372; Last Days of St. Pierre, Very Rev. G. Parel, 372; Eruption of Martinique, MM. A. Lacroix, Rollet de l'Isle and Giraud, 516; Eruption in St. Vincent, Captain Calder, 373; T. McGregor McDonald, 373; Volcanic Eruption in Java, Brilliant Sunset Glows in 1901 and probable Glows from the Eruption in Martinique, Henry Helm Clayton, 101; Volcanic Eruption at Tori Shima, 396; Activity of the Rooang Volcano in Java, 396;

- Phenomena observed at Zi-Ka-Wei, China, during the Martini- que Eruption, M. de Moïdrey, 408; Eruptions and Earth- quakes during Week Ending September 1, 446
- Escombe (F.), Influence of Varying Amounts of Carbon Dioxide in the Air on the Photosynthetic Process of Leaves and on the Mode of Growth of Plants, Lecture at Royal Society, 620
- Espin (Rev. T. E.), Double Stars, 353; Periodicity of Volcanic Eruptions and Earthquakes, 353
- Ethics: Philosophy of Conduct, G. T. Ladd, 389
- Ethnography: Australian Children's Games, Walter E. Roth, 380; on the Ethnography of the Nagas, Dr. W. H. Furness, 664; the Lolos and other Tribes of Western China, A. Henry, 604; the Wild and Civilised Tribes of the Malay Peninsula, Nelson Annandale, H. C. Robinson, 664
- Ethnology: the Tribes of the Brahmaputra Valley, L. A. Waddell, 91; the Coorgs and Yerusas, an Ethnological Con- trast, T. H. Holland, 91; Prehistoric Pygmies in Silesia, David MacRitchie, 151
- Eucalypts, two Chemical Constituents from the, Henry G. Smith, 456
- Eurldi s., 1-32, Rearrangements of, T. Petch, 7; T. J. M. Child, 31
- Euclid, the Elements of Book xi., R. Lachlan, 171
- Evershed (F.), Trade Statistics, 550, 607
- Evolution: Evolution of Snails in the Bahama Islands, Prof. T. D. A. Cockerell, 56; Palæontologie und Descendenzlehre, E. Koken, 126; Lamarck the Founder of Evolution, His Life and Work, Alpheus S. Packard, 169; the Lesson of Evolution, Frederick Wollaston Hutton, F.R.S., Prof. R. Meldola, F.R.S., 219; Mendel's Principles of Heredity, a Defence, W. Bateson, F.R.S., 573; Reports to the Evolution Committee of the Royal Society, W. Bateson, F.R.S., and Miss E. R. Saunders, 573
- Ewart (Dr. E.), Experimental Observations on Leucolysis, 335
- Ewart (Prof. J. C., F.R.S.), Variation, Germinal and Environ- mental, 209; on some Recent Interbreeding Experiments with Dogs, 641
- Exploration of the Sea, the First Meeting of the International Council for the, 346
- Explosives: Death of Frederick Augustus Abel, 483; Obituary Notice of, 492
- Eye, Stopping down the Lens of the Human, Wm. Andrews, 31; W. Bliss, 56; Gerald Molloy, 56
- Eykman (Dr. P. H.), Method for obtaining a Röntgen Photo- graph of an Internal Part of the Living Body during the Per- formance of a Definite Functional Movement, 307
- Eyre (J. V.), Dinitro- β -Anisidine, 238
- Færoe-Shetland Channel, the Hydrography of the, Prof. D'Arcy W. Thompson, B. Helland-Hansen, 654
- Face of Nature, the, Rev. C. T. Ovenden, 439
- Falconer (J. D.), Volcanic Dust from the West Indies, 132
- Farmer (Prof. J. B., F.R.S.), Organographie der Pflanzen- insbesondere der Archegoniaten und Samenpflanzen, Dr. K. Goebel, 51; International Catalogue of Scientific Literature, M. Botany, 217; the Hepaticæ of the British Isles, William Henry Pearson, 385
- Farmers' Years, the, ii., Carnac and its Environs, Sir Norman Lockyer, K.C.B., F.R.S., 104
- Farrington (O. C.), the Action of Copper Sulphate upon Iron Meteorites, 311
- Fats and Oils Industries, the Laboratory Companion to, Dr. J. Lewkowitsch, 126
- Fauna of British India, including Ceylon and Burma, Rhynchota, W. L. Distant, 548
- Favrel (G.), Action of Monochloroacetic Ester upon Diaz- benzene Chlorides, 168
- Fawsitt (Dr. C. E.), on the Decomposition of Urea, 613, 662
- Faye (M. Hervé), Death of, 254; Obituary Notice of, 277
- Faye (M.) and the Paris Observatory, Wilfred de Fonville, 343
- Febrile Blood Parasite in Man, New, J. Everett Dutton, 15
- Fényi (Father J.), Apparatus for Registering Thunder- storms, 65
- Fényi (J.), the Nature of the Coherer, 283
- Ferber (Captain), Experiments in Aerial Gliding, 635
- Ferguson (Dr. Margaret C.), the most Effective Plan for Start- ing the Germination of Spores of *Agaricus campestris*, 612
- Fermentation, Manual of Alcoholic, and the Allied Industries, Charles G. Matthews, 1
- Fernents, Unorganised, J. Effron, Dr. F. Mollwo Perkin, 197
- Fernbach (A.), Influence of Sulphocyanic Acid on the Growth of *Aspergillus niger*, 288
- Fernsides (W. G.), on New Fossils from Pen Morfa, near Tremadoc, 620
- Ferrini (Prof. Rinaldo), Calorimetric Determination of High Temperatures, 581
- Fertilisation: Theories of Heredity, Hugh Richardson, 630; the Fertilisation of Linum, Prof. T. D. A. Cockerell, 631
- Féry (M.), the Measurement of High Temperatures and Stefan's Law, 47; Temperature of the Electric Arc, 143
- Fibres of Commerce, the Textile, William S. Hannan, 338
- Fick (Prof. Adolf), Obituary Notice of, Prof. Kunkel, 180
- Field (A. E.), an Arithmetic for Schools, 491
- Field Naturalist's Science, 409, 575
- Filhol (Dr. Henri), Death of, 14; Obituary Notice of, 133
- Filon (L. N. G.), on an Approximate Solution for the Bending of a Beam of Rectangular Cross-Section under any System of Load, with Special Reference to Points of Concentrated or Discontinuous Loading, 262
- Filon (Mr.), Reduction of Measures of Swift's Comet (a 1899) from Photographs with a Portrait Lens of 30-inch Focus and 5-inch Aperture, 238
- Finger-print Evidence, Dr. Francis Galton, F.R.S., 606
- Finn (F.), Colour-Variation in the Guinea-Fowl, 126; Colour- variation in Pigeons, 157
- Fireball, the Recent, Walter E. Besley, 320
- First Fruits of the German Antarctic Expedition, 223
- Fisher (Prof. W. R.), Forestry, 283, 344; Retention of Leaves by Deciduous Trees, 370; Visit of the English Arboricul- tural Society to Compiègne, 450
- Fisheries: Action of Spurge on Salmonoid Fishes, H. M. Kyle, 45; the Pearl Fisheries in the Gulf of Manaar, Prof. Herdman, 486
- Fishes: Scales of Fishes as an Index of Age, J. Stuart Thompson, 84; Les Poissons du Bassin du Congo, G. A. Boulenger, 339; Introduction into New South Wales of European Flat- fishes, 580
- Fitzgerald (Prof.), Experiment suggested by, for Testing the Relative Motion of the Earth and the Ether, 66
- Flames from Mud on a Sea-shore, Rev. H. T. Dixon, 151
- Flax, Microbiological Study of the Steeping of, L. Hauman, 120
- Fleming (Mrs.), a New Algal Variable, 331
- Fletcher (Mr.), the Casas Grandes Mass of Meteoric Iron, 556
- Fletcher (Fred), Larva Stage of *Helicocpris isidis*, 441
- Fletcher (Dr. L., F.R.S.), Fall of a Meteoric Stone near Crumlin (Co. Antrim), September 13, 577
- Fletcher (W. C.), Elementary Geometry, 438
- Flett (Dr. J. S.), Royal Society Report on the West Indian Eruptions, 402
- Fleurs du Midi, Les, P. Granger, 368
- Flicker, Contributions to the Study of, T. C. Porter, 213
- Floating Cylinders, Thin, Prof. Thos. Alexander, 6
- Flora Arctica, C. H. Ostenfeld, 490
- Flora der ostfriesischen Inseln, Dr. F. Buchenau, 149
- Florenz (Dr. Karl), Japanische Mythologie, Nihongi "Zeitalter der Götter," 546
- Flower (Captain Stanley S.), the Zoological Gardens at Ghizeh, Egypt, 280
- Flying Lemur, the, Dr. H. C. Chapman, 351
- Fog Bow at Oxford, J. Rose, 416
- Fog-signals, Coast, E. Price Edwards, 115
- Fontenoy (G. de), a New Registering Actinometer, 401
- Fonville (Wilfred d.), M. Faye and the Paris Observatory, 343
- Fonzes-Diacon (M.), Physical Properties of Hydrogen Telluride, 144
- Food: the Nutritive Value of Alcohol, Messrs. Atwater and Benedict, 450; Apparatus by which Milk can be Brought into the Form of Food, 512
- Forage Beet, Culture of the, at Grignon, P. Dehérain and C. Dupont, 47
- Foraminifera, the, an Introduction to the Study of the Protozoa, Frederick Chapman, 196
- Forbes (Prof. G.), Experiences in South Africa with a new Range-finder, 645
- Forcrand (M. de), Composition of the Hydrate of Chlorine, 48;

- Physical Properties of Hydrogen Telluride, 144; Polymerisation and Heat of Formation of Oxide of Zinc, 216
- Forel (F. A.), Brilliant Sky Effects at Morges directly after Sunset, 278
- Forestry; the Insect-enemies of the Pine in the Black Hills, U.S.A., Forest Reserve, A. D. Hopkins, 160; Forestry, Prof. W. R. Fisher, 283, 344; World's Annual Excess of Imports over Exports of Timber, M. Mélard, 283; World's Timber Supply, Dr. Schlich, 283; Forestry in Kent and Sussex, D. A. Glen, 283; Financial History of a Four-acre Mixed Plantation, Sir Hugh Beaver, 283; Account of French Forests near Valenciennes and Compiègne, 283; Prof. Schwappach's Report on Prussian Experiments with Forest Trees, 283; Forestry Exhibition in Paris in 1900, J. S. Gamble, F.R.S., 283; Visit of the English Arboricultural Society to Compiègne, Prof. W. R. Fisher, 450; Destructive Forest Fires in Greece, 484; Working Plans for Forests in Arkansas, F. E. Olmsted, 661; Timber Resources of Nebraska, W. L. Hall, 661
- Forster (Dr. M. O.), Comparison of Bromonitrocamphene with Bromonitrocamphor, 119
- Fortey (Miss E. C.), Properties of Mixtures of Lower Alcohols with Water, 70; Properties of Mixtures of Lower Alcohols with Benzene and with Benzene and Water, 70; Fractional Distillation as a Method of Quantitative Analysis, 70
- Fosse (R.), Case of Molecular Rupture by Bromine, 23; Oxidising Properties of Dinaphthopyranol, 288; Dinaphthopyranol, 624
- Fossils: a New Type of Human Fossil, R. Verneau, 24; New Fossil Mammals and Reptiles from Egypt, 83; Fossil Faunas and Their Use in Correlating Geological Formations, Henry S. Williams, 212; Remarkable Fossil Oysters from Syria, Alfred Ely Day, 606; E. T. N., 607
- Foster (Prof. C. Le Neve), the Mining Statistics of the World, 163; Persons Employed and Accidents at Mines and Quarries in the United Kingdom in 1901, 449
- Foster (W. J.), Chemical and Physical Properties of Carbon in the Hearth of the Blast Furnace, 63
- Foster-Melliard (Rev. A.), the Book of the Rose, 74
- Fouché (M.), Oxy-acetylene Blowpipe, 159; a New Oxygen-acetylene burner, 279
- Fourcade (H. G.), Stereoscopic Method of Photographic Surveying, Paper Read at South African Philosophical Society, 139
- Fourier's Series, Use of, in Theory of Conduction of Heat, Dr. Ganesh Prasad, 71
- Fourtau (R.), Geological Constitution of the Neighbourhood of Alexandria, Egypt, 648
- Fowler (W. W.), More Tales of the Birds, 4
- "Fox Shark" or "Thrasher" in the English Channel, E. Ernest Lowe, 272
- Foxglove (Digitalis), Curious Development of a, 306; Dr. Maxwell T. Masters, F.R.S., 344
- France: Rural Education in France, 225; French Service Regulation as to Heads and Worms of Screws used in the French Navy, 229; French Geodetic Mission to the Equator, 233; a French Text-book of Zoology, Yves Delage and Edgard Hérouard, Dr. G. C. Bourne, 267; Account of French Forests near Valenciennes and Compiègne, 283; La Houille Blanche, the Utilisation in France of Water Power for Industrial Purposes, Henri Desmarest, 485
- Franklin (Mr.), Reactions between Acid and Basic Amides in Liquid Ammonia, 541
- Fraser (J.), Atoms and Valencies, 68
- Frazier (Mr.), the Preparation of Cells for the Measurement of High Osmotic Pressures, 401
- Freeman (E. M.), Mycoplasma, 7
- Frescoes, Pæleolithic, and Mural Engravings, 452
- Freshfield (Douglas W.), the Glaciers of Kangchenjunga, 19
- Freundler (P.), Benzene-azobenzene Aldehyde, 192; Dibenzoyl-hydroazobenzene, 240
- Fricker (G. L.), Electricity Meter, 84
- Fringillidae, the, R. Ridgway, 75
- Frost (Prof.), the Spectroscopic Binary β Cephei, 352
- Fuchs (Prof. I. L.), Death of, 14; Obituary Notice of, 156
- Fungi: Rust-fungus, Prof. Marshall Ward, 210; Influence of Sulphocyanic Acid on the Growth of *Aspergillus niger*, A. Fernbach, 288; the Most Effectual Plan for Starting the Germination of Spores of *Agaricus campestris*, Dr. Margaret C. Ferguson, 612
- Furness (Dr. W. H.), on the Ethnography of the Nagas, 664
- Fusils de Chasse, Tir des, Journée, 545
- Gaiffe (M.), Precautions Necessary in the Use of Ruhmkorff Coils in Radiography, 264
- Galeotti (G.), Comparative Study of the Permeability of Living and Dead Animal Membranes by Measurements of the Electrolytic Resistance, 256
- Gallardo (Señor A.), Memoir of Dr. C. Berg, 184
- Galton (Dr. Francis, F.R.S.), Finger-print Evidence, 606
- Gamble (J. S., F.R.S.), Forestry Exhibition in Paris in 1900, 283
- Game Birds, Upland, E. Sandys and T. S. Van Dyke, 652
- Ganguillet and Kutter, Diagrams of Mean Velocity of Uniform Motion of Water in Open Channels Based on the Formula of Prof. Irving P. Church, 439
- Garbasso (Prof.), the Manuelli Effect, Action of Sunlight in Facilitating the Passage of Electric Sparks, 448
- Gardens, Decorative Plants for, Dr. Nicola Terraciano, 36
- Gardiner (J. Stanley), on the Breaking up of Coral Rock by Organisms in the Tropics, 641
- Garrigou (M. F.), Methods of Concentrating Wine, 456
- Garstang (W.), Proposed Programme for the International Investigation of the North Sea as Passed at the Recent Meeting of Delegates at Copenhagen, 640
- Garwood (Prof. E. J.), the Origin of Some "Hanging Valleys" in the Alps and Himalaya, 239
- Gas Engines, Large, Recent Progress in, H. A. Humphrey, 643
- Gases, Refractivities of the Inert, Clive Cuthbertson, 607
- Gastin (M.), New Method for the Destruction of the Pyralis and other Noxious Insects, 288
- Gauss (Karl Friedrich), General Investigations of Curved Surfaces of 1827 and 1825, 316
- Gauss's Theorem, S. J. Barnett, 611
- Gautier (Armand), Treatment of Malarial Fevers by Latent Arsenic, 47; Arsenic as a Normal Constituent of Animals, 216; on the Existence in the Albumin of Birds' Eggs of a Fibrogen Substance Capable of being Transformed, *in vitro*, into Pseudo-organised Membranes, 335
- Gautier (Henri), Conditions of Formation and Stability of the Hydrides and Nitrides of the Alkaline Earths, 96
- Gawn (D. W.), Photographic Apparatus, Making and Repairing, 4
- Gay (Alfred), Les Cables Sous-Marins, 148
- Geddes (Prof.), School Gardens, 326
- Gee (Wm.), Beechen Hedges on Elevated Ground, 32
- Geikie (Sir Archibald, D.C.L., F.R.S.), Hugh Miller, His Work and Influence, 426
- Geipert (Mr.), Conditions under which Aluminium is Obtained by the Electrolytic Method, 424
- Geminorum, Observations of, F. C. McDermott, 662
- Geodesy: the Attractions of the Himalaya Mountains upon the Plumb-line in India, Major S. G. Burrard, 80; the French Geodetic Mission to the Equator, 233; Some New Forms of Geodetical Instruments, 276; Ordnance Survey of England and Wales, 341; Geodetic Survey of South Africa, vol. ii., Report on a Rediscussion of Bailey's and Fourcade's Surveys and their Reduction to the System of Geodetic Survey, Sir David Gill, K.C.B., F.R.S., Major C. F. Close, 457; Magnetic Work of the United States Coast and Geodetic Survey, Outlined for July 1, 1901-June 30, 1903, 666
- Geography: Materialien zur Naturgeschichte der Insel Celebes, Band iv., Entwurf einer geographisch-geologischen Beschreibung der Insel Celebes, Dr. Paul Sarasin and Dr. Fritz Sarasin, 3; the Glaciers of Kangchenjunga, Douglas W. Freshfield, 19; Royal Geographical Society, the President's Opening Address, Current Arctic and Antarctic Expeditions, 113; Return of the Arctic Expeditions, 542; Paris Geographical Society's Prizes for this Year, 135; the Murchison Falls, C. Steuart Betton, 100; the Teacher's Manual of Object Lessons in Geography, Vincent T. Murché, 270; Ten Thousand Miles in Persia, or Eight Years in Iran, Major Percy Molesworth Sykes, 418; Snow-waves and Snow-driits, Dr. Vaughan Cornish at the Geographical Society, 453; Nature-Study, Realistic Geography Model based on the 6-inch Ordnance Survey, G. Herbert Morrell, 606; Modern Scientific Geography, the Nearer East, D. G. Hogarth, 649; Physical Geography, Margery A. Reid, 653; the "Sudd" of

- the White Nile, 666; *see also* Section E, British Association
- Geology: Materialien zur Naturgeschichte der Insel Celebes, Entwurf einer geographisch-geologischen Beschreibung der Insel Celebes, Dr. Paul Sarasin and Dr. Fritz Sarasin, 3; Death and Obituary Notice of William Henry Penning, 15; Geological Society, 23, 71, 95, 166, 191, 239, 263; the Glaciers of Kangchenjunga, Douglas W. Freshfield, 19; Remarkable Inlier among the Jurassic Rocks of Sutherland, Rev. J. F. Blake, 23; Deep Boring at Lyme Regis, A. J. Jukes-Browne, 23; Plisements et Dislocations de l'Écorce terrestre en Grèce, Ph. Negrès, 28; the Recent Volcanic Eruptions in the West Indies, Prof. J. Milne, F.R.S., 56, 107, 151; Records of Recent Eruptions, 132, 153; F.R.S. Dust from the West Indies, J. J. H. Teall, F.R.S., 130; Rev. T. C. Porter, 131; J. D. Falconer, 132; Rocks of Mont Pelée, J. S. Diller, 372; the Carlisle Earthquakes of July 9 and 11, 1901, Dr. C. Davison, 71; the Inverness Earthquake of September 18, 1901, Dr. C. Davison, 71; a Text-book of Geology, Albert Perry Brigham, 75; Geological Survey of Canada, Dr. Robert Bell, 86; Mineralogical Constitution of the Finer Material of the Bunter Pebble-bed in the West of England, H. H. Thomas, 95; the Black Coloration of the Rocks forming the Cataracts of the Nile, MM. Lortet and Hugouenot, 95; Jaspers of South-eastern Anglesey, Edward Greenly, 95; Composite Gneisses in Boylagh, Prof. Grenville A. J. Cole, 143; the Hugh Miller Centenary, 156; Hugh Miller, His Work and Influence, Sir Archibald Geikie, F.R.S., 426; Death and Obituary Notice of Carlo Riva, 157; Overturns in the Braysdown Colliery, F. A. Steart, 166; Pliocene Glacio-fluvialite Conglomerates in Sub-alpine France and Switzerland, Charles S. Du Riche Preller, 166; the Red Sandstone Rocks of Peel, Prof. W. Boyd Dawkins, F.R.S., 191; Geology of Mount Macedon, Prof. J. W. Gregory, 207; Fossil Faunas and their Use in Correlating Geological Formations, Henry S. Williams, 212; the Plutonic Complex of Central Anglesey, Dr. Charles Callaway, 239; Alpine Valleys in Relation to Glaciers, Prof. T. G. Bonney, F.R.S., 239; the Origin of some "Hanging Valleys" in the Alps and Himalayas, Prof. E. J. Garwood, 239; History of Geology and Palæontology to the End of the Nineteenth Century, Karl Alfred von Zittel, 242; the Pointe-de-Galle Group, A. K. Coomaraswamy, 263; the Jurassic Strata Cut Through by the South Wales Direct Line between Filton and Wootton Bassett, Prof. H. Reynolds and Arthur Vaughan, 263; Results of Glacial Drainage round Montpellier Hill, co. Dublin, W. B. Wright, 311; Coal, Lignite and Asphaltic Rocks of Texas, W. B. Phillips, 379; New Path along the Goban's Cliffs, R. Welch, 417; Ten Thousand Miles in Persia, or Eight Years in Iran, Major Percy Molesworth Sykes, 418; Explanations of Glacial Phenomena in the North of England, Prof. Percy F. Kendall and Arthur R. Dwyerhouse, 424; the Great Granite Mass of the Matopos, Frederick P. Mennell, 449; Geology of the Hampshire Basin, Clement Reid, 486; F. W. Rudler and the Museum of Practical Geology, 553; Death of J. W. Powell, late Director of the U.S. Geological Survey, 553; Death of Vincent Leche Chesnevieux, 553; Glacial and Post-Glacial Features of the River Lune and its Estuary, T. Mellard Reade, 540; a Recent Peat and Forest Bed at Westbury-on-Severn, Mellard Reade and A. S. Kennard, 540; Geology of Western Rajputana, Tom D. La Touche, 612; Geological Constitution of the Neighbourhood of Alexandria, Egypt, R. Fourtau and D. E. Pachundaki, 648; Death of the Rev. Dr. Wiltshire, 658; Geology of the Eastern Desert of Egypt, Later Physical Changes, T. Barrow and Dr. W. F. Hume, 660; *see also* Section C, British Association
- Geometry: Rearrangement of Euclid i., 1-32, T. Petch, 7; T. J. M. Child, 31; the Elements of Euclid, Book xi., R. Lachlan, 171; Report on the Teaching of Geometry, 201; Study of Bright Points and Curves, 208; Geometry of Cog-wheels, Prof. D. Tessari, 218; a Method of Treating Parallels, Dr. S. W. Richardson, 223; General Investigations of Curved Surfaces of 1827 and 1825, Karl Friedrich Gauss, 316; Elementary Geometry, W. C. Fletcher, 438
- Gerard (E.). Biochemical Action of Extract of Kidney on certain Organic Compounds, 144
- Gerhardt (Prof.), Death of, 305
- Germany: Chemical Instruction and Chemical Industries in Germany, Prof. T. E. Thorpe, F.R.S., 32; German Progress in Optical Work, Herbert F. Angus at the Optical Society, 138; the First Fruits of the German Antarctic Expedition, 223; Recent Coloured Sunsets in Germany, 254; Scientific Education in Germany, 255; Recent Works on Systematic Botany in Germany, 657
- Germination and Environmental Variation, J. C. Ewart, F.R.S., 209
- Gibbs (J. Willard), Elementary Principles in Statistical Mechanics, 291
- Gifford (J. William), the Refractive Indices of Fluorite, Quartz and Calcite, 287; Correction, 301
- Gilbert (R. D.), the Precipitation of Ammonium Vanadate by Ammonium Chloride, 571-2
- Gilbert (William), of Colchester, Physician of London, on the Magnet, 249, 272; a Sketch of his Magnetic Philosophy, Charles E. Benham, 270
- Gilechrist (D. A.), on the Soils of Dorset, 486
- Gilchrist (J. D. T.), Cape of Good Hope Department of Agriculture Marine Investigation in South Africa, Observations on the Temperature and Salinity of the Sea around the Cape Peninsula, 260
- Gill (Sir David, K.C.B., F.R.S.), Rotation of the Brighter Fixed Stars, as a Whole, with Respect to the Fainter Stars, 282; Report of the Cape Observatory for 1901, 331; Geodetic Survey of South Africa, Vol. ii., Report on a Re-discussion of Bailey's and Fourcade's Surveys and their Reduction to the System of the Geodetic Survey, 457; Sir David Gill's New Theory of Stellar Movement, 515
- Gilman (Dr. Daniel C.), the Carnegie Institution of Washington, D.C., 548
- Giorgi (G.), Rational Units of Electromagnetism, 118
- Giran (H.), Acidity of Pyrophosphoric Acid, 240
- Giraud (M.), the Eruption of Martinique, 488, 516
- Glacial Drainage round Montpellier Hill, co. Dublin, Results of, W. B. Wright, 311
- Glacier Disaster in the Caucasus, J. F. Baddeley, 328
- Glaciers, Alpine Valleys in Relation to, Prof. T. G. Bonney, F.R.S., 239
- Glaciers of Kangchenjunga, the, Douglas W. Freshfield, 19
- Gladstone (Dr. J. H., F.R.S.), the Education Bill, 6; on Colloids of Zirconium, 663
- Gladstone (Dr. J. H., F.R.S.), Death of, 579; Obituary Notice of, 609
- Glazebrook (Dr.), Electrical Conductivity of certain Aluminium Alloys Exposed to the London Atmosphere, 644
- Glen (D. A.), Forestry in Kent and Sussex, 283
- Glen Nevis, Meteorological Conditions Accompanying "Föhn" and Up-bank Thaws in, R. C. Mossman, 167
- Glover (John), Death and Obituary Notice of, 37
- Glycogen, Researches on, Dr. Osborn and Dr. Zobel, 666
- Goat Exterminator, the Sweet Briar as a, Sir W. T. Thiselton-Dyer, F.R.S., 31
- Goban's Cliffs, New Path Along, R. Welch, 417
- Goebel (Dr. K.), Organographie der Pflanzen insbesondere der Archeogoniaten und Samenpflanzen, 51; Regeneration in Plants, 514
- Gold Seeking in South Africa, a Handbook of Hints for Intending Explorers, Prospectors and Settlers, Theo. Kassner, 440
- Gold-fields, Yukon, Prof. H. A. Miers, 86
- Goniometer, Three-circle, G. F. Herbert Smith, 83
- Gooch (F. A.), the Precipitation of Ammonium Vanadate by Ammonium Chloride, 571-2
- Goodal (Dr. A.), Experimental Observations on Leucolysis, 335
- Goodrich-Freer (A.), Outer Isles, 548
- Gosio (Dr. B.). Bats Capable of Transmitting Bubonic Plague, 329
- Gotch (Prof.), Fatigue and Nerve, 666
- Göttingen Royal Society of Sciences, 48, 264, 516
- Goutal (M.), the Calorific Power of Coal, 572
- Goyaud (M.), Pectic Fermentation, 624
- Graebner (P.), die Heide Nordrusslands, 27
- Graham (Dr. W.), Mental and Moral Characteristics of the People of Ulster, 664
- Gramont (A. de), Action of Self-induction on the Spectrum of Dissociation of Compounds, 72
- Granger (P.), Les Fleurs du Midi, 368
- Grasset (J.), Les Limites de la Biologie, 293
- Gravity: the Attractions of the Himalaya Mountains upon the Plumb-line in India, Major S. G. Burrard, 80

- Great Britain, the Climates and Baths of, 629
 Greece: Plissements et Dislocations de l'Écorce Terrestre en
 Greece, Ph. Negrin, 28; the Older Civilisation of, Further
 Discoveries in Crete, 390; Corr., 424; Destructive Forest
 Fires in Greece, 484
 Green (Dr. Edridge), on the Distribution in the Retina of the
 Photo-sensitive Pigment, the Visual Purple, 666
 Green (E. Ernest), Bipodal Locomotion of a Ceylonese Lizard,
 492
 Green (Prof. J. Reynolds, M.A., Sc.D.), Opening Address in
 Section K at the Belfast Meeting of the British Association,
 582
 Greenhouse Orchids, the Culture of, Frederick Boyle, 59
 Greenly (Edward), Jaspers of South-eastern Anglesey, 95
 Gregory (Prof. J. W.), Geology of Mount Macedonia, 207
 Gregory (Lady), Cuchulain of Muirtheine, the Story of the
 Men of the Red Branch of Ulster, 489
 Greinacher (Heinrich), Einführung in die Theorie der Doppel-
 brechung, 653
 Grey's Zebra in the Regent's Park Gardens, 512
 Grey (Earl), Pisciculture in the United States, America, 65
 Griffith (George), Death and Obituary Notice of, 64
 Grigg (John), Another New Comet, 514
 Grigg's Comet, 557
 Grigg (T.), the Search for a Planet beyond Neptune, 614
 Gross (Th.), Silicon not an Element, 484
 Group, Simplified Definition of a, E. V. Huntington, 118
 Grün (Dr. E. F.), New Fluid Lens, 135
 Guatemala, Earthquake in, Edwin Rockstroh, 150
 Guatemala and British Honduras, Earthquake in, 553
 Guerbet (Marcel), Action of Alcohols upon the Sodium Deriva-
 tives of other Alcohols, 336
 Guichard (P.), la Question de l'Eau Potable devant les
 Municipalités, 28
 Guignard (L.), Daniella and their Secreting Apparatus, 23
 Guilleminot (Dr.), New Rectifier and Interrupter for Alternating
 Currents, 206
 Guinchant (J.), Electrical Resistance of Metallic Sulphide, 144
 Guinea-Fowl, Colour-variation in the, F. Finn, 126
 Gulls, Notes on Young, Prof. R. v. Lendenfeld, 415
 Guns: an Instrument for Aiming Guns under Cover, 493; Tir
 des Fusils de Chasse, Journée, 545
 Gutta-Percha: the Balata Fields on the Amazon, 555
 Guye (Ph. A.), on the Formation of Liquid Drops and the
 Laws of Tate, 544, 672
 Gwynne-Vaughan (Dr. T.), Practical Botany for Beginners, 101
- Haber (Mr.), Conditions under which Aluminum is Obtained
 by the Electrolytic Method, 424
 Haddon (Dr. A. C., F.R.S.), What the United States of
 America is Doing for Anthropology, 430; Opening Address
 in Section H at the Belfast Meeting of the British Associa-
 tion, 561
 Hadley (H. E.), Practical Exercises in Magnetism and Elec-
 tricity, 5
 Hailstones, Remarkable Shower of, R. Swoody, 159
 Halbinsel, Grundzüge d. Pflanzenverbreitung auf d. iberische,
 Moritz Wilkomm, 27
 Haldane (Richard Burdon), Education and Empire, 222
 Hall (Maxwell), the Temperatures of Kingston, Jamaica, 159;
 Mean Maximum Temperature and the Rainfall of Jamaica
 and Sunspot Frequency, 206
 Hall (R. N.), the Ancient Ruins of Rhodesia, 34
 Hall (Wilfred), Simple Means of Producing Diffraction Effects,
 416
 Hall (W. H.), Chickens Hatched in a Tree, 127; a Tripartite
 Stroke of Lightning, 370
 Hall (W. L.), Timber Resources of Nebraska, 661
 Halliburton (W. D., M.D., F.R.S.), Opening Address in
 Section I at the Belfast Meeting of the British Association,
 567; on the Regeneration of Nerves, 664
 Halm (Dr. J.), Prof. Arrhenius' Theory of Cometary Tails and
 Auroræ, 55
 Halo, a Remarkable Lunar, Prof. E. E. Barnard, 5; H. W.
 Croome Smith, 85
 Halo, a Solar, R. T. Omond, 103
 Halos of May 1, 8 and 22, the, Rev. T. C. Porter, 223
 Hann (Dr. Julius), Lehrbuch der Meteorologie, 337; Meteor-
 ology of the Equator, 660
- Hannan (William S.), the Textile Fibres of Commerce, 338
 Harnet (A.), the Compression of Steel during Solidification in
 the Ingot Mould, 487
 Harmonic Series, Resultant Tones and the, Prof. Silvanus P.
 Thompson, F.R.S., 6; Margaret Dickens, 78
 Harpoon, the, Dr. Otis T. Mason, 232
 Harris (Rollin), a New Theory of the Tides of Terrestrial Oceans,
 444
 Harrison (E. Philip), Electrical Resistance of Iron at very Low
 Temperatures, 343
 Harrison (H. Jerome), Junior Chemistry and Physics, 317
 Harrison (Lieut.-Colonel J. H. C.), the Roorkee Manual of
 Applied Mechanics, Stability of Structure and the Graphic
 Determination of Lines of Resistance, 340
 Harrison (W. Jerome), the Wiltshire Archaeological and Natural
 History Magazine, Stonehenge Bibliography Number, 25
 Hartland (E. Sidney), Savage Island, an Account of a Sojourn
 in Niue and Tonga, Basil Thomson, 347; on the "Lia Fail"
 of Tara and Election of Kings by Augury, 664
 Hartley (Mr.), Absorption Spectra of Phloroglucinol and its
 Trimethyl Ester, 238
 Hartley (W. P.), New Botanical Laboratories at Liverpool
 Presented by, 156
 Hartog (Prof. Marcus), Structure of Acinetines, 262
 Hasler (G.), the Bernese Oberland, 440
 Hasselberg (M.), Personal Equation in the Measurement of
 Spectroscopic Negatives, 258
 Hastings (E. G.), Thermal Death-point of a Micrococcus
 Isolated from Milk, 423
 Hatch (F. H.), Gold Production and Life of the Main Reef
 Series, Witwatersrand, 659
 Hatfield (W. H.), Control of the Silicon in the Acid Open-
 hearth Bath, 63
 Hauman (L.), Microbiological Study of the Steeping of Flax,
 120
 Haupt (Lewis B.), on Single Curved *versus* Double Straight
 Jetties, 39
 Hawes (Mr.), Sakhalin, 642
 Hawks, Effect of Wind on the Migration of, C. C. Trowbridge,
 612
 Hawthorne (Mr.), Experiments on the Motion of a Detached
 Thread of Liquid in a Capillary Tube, 618
 Hay (W. P.), a New Form of Blind Shrimp from the Mam-
 moth Cave, Kentucky, 556
 Health: Health, Speech and Song, a Practical Guide to
 Voice Production, Jutta Bell-Ranske, Dr. B. Moore, 388;
 Dangerous Trades, the Historical, Social and Legal Aspects
 of Industrial Occupations as Affecting Health, Dr. T. E.
 Thorpe, F.R.S., 433; Principles of Sanitary Science and
 the Public Health, Prof. William T. Sedgwick, 605
 Heat: the Graduation of Thermoelectric Couples, Daniel
 Berthelot, 47; Measurement of High Temperature and
 Stefan's Law, M. Fery, 47; Use of Fourier's Series in
 Theory of Conduction of Heat, Dr. Ganesh Prasad, 71;
 Coefficients of the Cubical Expansion of Ice, Hydrated
 Salts, Solid Carbonic Acid and other Substances at Low
 Temperatures, Prof. James Dewar, F.R.S., at Royal Society,
 88; Ebullition of Rotating Water, T. C. Porter, 118; Con-
 servation of Entropy, J. A. Erskine, 118; Simple Electric
 Thermostat, William Duane and Charles A. Lory, 135;
 Temperature of the Electric Arc, Ch. Féry, 143; Limita-
 tions of Constants in the Analytical Theory of Heat, E.
 Cesáro, 159; Atomic and Molecular Heats of Fusion,
 P. W. Robertson, 191; Polymerisation and Heat of For-
 mation of Oxide of Zinc, M. de Forcrand, 216; Heat Evolved
 or Absorbed when a Liquid is brought in Contact with
 a Finely Divided Solid, G. J. Parks, 262; Suggested Use
 of the Platinum Thermometer for Measuring Deep-sea Tem-
 peratures, Prof. Knott, 335; on the Measurement of Tem-
 perature, Morris W. Travers, George Senter and Adrien
 Jaquerod, 382; the Calorific Power of Coal, M. Goutal,
 572; Calorimetric Determination of High Temperatures,
 Prof. Rinaldo Ferrini, 581
 Heath (Prof. Harold), Animal Forms, a Second Book of
 Zoology, 605
 Hébert (A.), Mechanism of the Chemical Variations in the
 Plant under the Influence of Sodium Nitrate, 144
 Hebrews, Theology and Ethics of the, Archibald Duff, 517
 Height of Sunset Alter-glows in June, 1902, Prof. A. S.
 Herschel, F.R.S., 294

- Heimrod (G. W.), Accuracy of an Improved Form of Silver Voltmeter, 158; Electrochemical Equivalent of Silver, 401
 Heldreich (Theodor v.), Death of, 538
Helicopriss Istadis, Larva Stage of, Fred. Fletcher, 441
 Helland-Hansen (B.), the Hydrography of the Faeroe-Shetland Channel, 654
 Hellmann (Dr. G.), der Grosse Staubfall von 9 bis 12 März 1901 in Nordafrika, Sud- und Mitteleuropa, 41; Rainfall of Saxony, 136
 Helmholz on the Value of the Study of Philosophy, B. Brandford, 550
 Henderson (Dr.), Influence of Acidic Oxides on Specific Rotations of Lactic Acid and Potassium Lactate, 22
 Henderson (C.), Elements of Physics, 458
 Hennessey (E. E.), Influence of Light upon Plant Assimilation, 103
 Hennig (Dr. Karl Anton), Chemisch-Analytisches Praktikum, 414
 Henriët (M.), Quantitative Examination of Atmospheric Air, 308; on a New Organic Vapour in Atmospheric Air, 312
 Henry (Prof. Alfred J.), Wind Velocity and Fluctuations of Water Level on Lake Erie, 256
 Henry (A.), the Lolos and other Tribes of Western China, 664
 Henry (Louis), Addition of Hypochlorous Acid to Propylene, 72
 Henry (Prosper), Influence of the Photographic Magnitude of Stars upon the Scale of Reduction of a Negative, 240; Photographic Magnitude of Stars, 282
 Hepaticæ of the British Isles, the, William Henry Pearson, Prof. J. B. Farmer, F.R.S., 385
 Heraeus (W. C.), Research by, with Modified Form of Electric Resistance Furnace, 85
 Herbertson (Mr.), on the Windings of Evenlode, 642
 Herdman (Prof.), Pearl Fisheries in the Gulf of Manaar, 486
 Herdity: Mendel's Principles of Heredity, a Defence, W. Bateson, F.R.S., 573; Reports to the Evolution Committee of the Royal Society, W. Bateson, F.R.S., and Miss E. R. Saunders, 573; Theories of Heredity, Hugh Richardson, 630
 Hergesell (Dr.), Meteorological Results of the Balloon Ascents of February 6, 66
 Hérissay (H.), New Glucoside Aucubine, 216
 Hérouard (Edgard), Traité de Zoologie Contré, 267
 Herrera (Señor A. L.), Paraffin Used to Mitigate the Plague of Mosquitoes in the City of Mexico, 423
 Herschel (Prof. A. S., F.R.S.), Height of Sunset After-glows in June, 1902, 294
 Herschel (Sir W. J., Bart.), Sun-pillar? 77
 Hetherwick (Rev. A.), Animistic Beliefs among the Yaos of British Central Africa, 514
 Heureau (M.), Aéronautics, 447
 Hewitt (J. F.), the Ruling Races of Prehistoric Times in India, South-western Asia and Southern Europe, 145; History and Chronology of the Myth-making Age, 145
 Heyn (Prof.), the Over-heating of Mild Steel, 487
 Hibbert (W.), Misuse of Coal, 102; on Colloids of Zirconium, 663
 High Wycombe, Prehistoric Flint-mine at, 610
 Hildebrand (Prof. F.), Ueber Aehnlichkeiten im Pflanzenreich, 246
 Hildebrandt (Lieutenant), Uncomfortable Balloon Voyage, 254
 Hill (J. B.), Relation of the Plutonic and other Intrusive Rocks in West Cornwall to the Mineral Ores, 159
 Hill (J. P.), Photographs of the First Segmentation Stages of the Zygote of the Native Cat (*Dasyurus*) up to the Period of First Formation of the Endodermis, 640
 Hill (Leonard), Physiology for Beginners, 369
 Hill (Prof. M. J. M.), Geometrical Proposition Connected with the Continuation of Power Series, 215
 Hill (Robert T.), Report on the West Indian Eruptions, 370; the West Indian Volcanic Eruptions, 485
 Hilton (W. A.), the Sense-hairs of Caterpillars, 350
 Himalaya Mountains, the Attractions of the, upon the Plumblines in India, Major S. G. Burrard, 80
 Hinde (S. L.), Protective Resemblance to Flowers of *Flata nigrocincta*, 215
 Hinks (Mr.), Reduction of Photographs of Eros for the Determination of Solar Parallax, 238; Nebula Surrounding Nova Persei, 619
 Hinton (A. Horsley), P.O.P. (the Use of Silver Printing-out Papers), 519
 Hiorns (Arthur H.), Metallography, an Introduction to the Study of the Structure of Metals, Chiefly by the Aid of the Microscope, 415
 Historical Chemistry, Essays in, T. E. Thorpe, F.R.S., 365
 History and Chronology of the Myth-making Age, J. F. Hewitt, 145
 Hjort (Johan), Studies on the Distribution of Animal Life on "Storeggen" and "Shetlandseggen," North Sea, 351
 Hobhouse (Henry), How County Councils may Encourage Nature Study, 326
 Hodge (C. F.), Nature Study and Life, 245
 Hoernes (Dr. R.), Register of 208 Shocks Observed in Styria between 1,000 and 1870, 234
 Höfer (Prof.), Spring Waters from Petroleum Districts Containing no Sulphates, 256
 Hogarth (Mr.), Specimens Discovered in 1901 in Crete by, 95
 Hogarth (D. G.), the Nearer East, 649
 Hogg (A. D.), Death of, 254
 Holdich (Sir Thomas), Opening Address in Section E at the Belfast Meeting of the British Association, 642
 Holiday Cruise to Alaska, a, 176
 Holland (T. H.), the Coorgs and Yeruvas, an Ethnological Contrast, 91
 Holleman (Dr. A. F.), a Text-Book of Inorganic Chemistry, 440
 Holmes (Rev. J. H.), on the Sacred Initiation Ceremonies Undergone by the Lads of the Papuan Gulf, 664; on the Religious Ideas of the Elema Tribe of the Papuan Gulf, 664
 Holmes (Dr. W. H.), on the Classification and Arrangement of Anthropological Museums, 664
 Holt (M.), Preparation and Properties of a Silicide of Vanadium, 312; a New Silicide of Vanadium, 624
 "Holy Shroud," Dr. P. Vignon's Researches and the, 13
 Homma (Prof. Y.), Studies in Atmospheric Electricity, 555
 Hong Kong Double Star Observations, W. Doberck, 282
 Hooker (Sir J. D., F.R.S.), the Pines of Western Asia, 53; Kew Micrometer, 348
 Hopkins (A. D.), the Insect Enemies of the Pine in the Black Hills, U.S.A., Forest Reserve, 160
 Hopkins (Erastus), the Oil Chemist's Handbook, 52
 Horse Disease, 423
 Horst (Dr.), the Coconut Crab, 308
 Horticulture: Cyclopaedia of American Horticulture, L. H. Bailey, 147; Journal of the Royal Horticultural Society, 159
 Hortvet (Julius), a Manual of Elementary Practical Physics, 341
 Houben (Mr.), Synthesis of Carboxylic Acids by the Action of Carbon Dioxide upon Magnesium Alkyl Halogen Compounds, 308
 Houlléville (L.), Thin Metallic Films Obtained by Kathode Projection, 672
 Howe (F.), Instances of Abnormality in Mammals, 351
 Howes (Prof. G. B., D.Sc., LL.D., F.R.S.), Opening Address in Section D at the Belfast Meeting of the British Association, the Morphological Method and Progress, 522
 Hughes (R. E.), the Making of Citizens, a Study of Comparative Education, 604
 Hugouenq (M.), the Black Coloration of the Rocks Forming the Cataracts of the Nile, 95
 Hulme (F. Edward, F.S.A.), Wild Fruits of the Country Side, 653
 Human Embryology and Morphology, Dr. A. Keith, 603
 Human Eye, Stopping Down the Lens of the, Wm. Andrews, 31; H. Bliss, 56; Gerald Mollay, 56
 Hume (Dr. W. F.), Geology of the Eastern Desert of Egypt, Later Physical Changes, 660
 Hummel (Prof. John James), Death of, 511; Obituary Notice of, 520
 Humphrey (H. A.), Recent Progress in Large Gas Engines, 643
 Humphreys (J. W.), Spectroscopy of the Solar Eclipse of May 18, 1901, 331
 Huntingdon (E. V.), Simplified Definition of a Group, 118
 Hurricanes of the Far East, the, Prof. Dr. Paul Bergholz, 51
 Hurt (L. C.), Animal Intelligence, 459
 Hussey (W. J.), Catalogue of New Double Stars, 450
 Hutchins (D. E.), Misuse of Coal, 246

- Hutchinson (Dr. A.), Discrepancy in the Results of Meigen's Method of Discriminating Calcite and Aragonite, 215
- Hutton (Frederick Wollaston, F.R.S.), the Lesson of Evolution, 219
- Hutton (R. S.), Fusion of Quartz in the Electric Furnace, 66
- Huxley (Thomas Henry), the Life of, Edward Clodd, Sir W. T. Thiselton-Dyer, K.C.M.G., F.R.S., 121; the Scientific Memoirs of, vol. iv., 241
- Huxley Memorial Tablet, the, 658
- Huygens' Principle in a Uniaxial Crystal, Prof. Conway, 215
- Hyatt (Prof.), Work of the Late, 330
- Hydraulics: Diagrams of Mean Velocity of Uniform Motion of Water in Open Channels, Based on the Formula of Gannett and Kutter, Prof. Irving P. Church, 439; the Formation of Liquid Drops and Tate's Laws, Ph. A. Guye and F. Louis Perrot, 544, 672
- Hydrography: Tides in the Bay of Fundy, W. Bell Dawson, 35; Hydrographical Observations of the *Princess Alice*, J. Y. Buchanan, F.R.S., 376; the Hydrography of the Faeroe-Shetland Channel, Prof. D'Arcy W. Thompson, 654; B. Helland-Hansen, 654
- Hydrogen, Apparatus for Liquefying, Dr. Morris W. Travers, 204
- Hygiène: Traité de Bactériologie Pure et Appliquée à la Médecine et à l'Hygiène, P. Miquel and R. Cambier, Dr. E. Klein, F.R.S., 316; Hygiene for Students, Edward F. Willoughby, 342; Shaw Prize for Industrial Hygiene awarded by Society of Arts to James Tonge, jun., 377; Water Supply, Prof. William F. Mason, 458
- Ichthyology: Action of Spurge on Salmonoid Fishes, H. M. Kyle, 45; Scales of Fishes as an Index of Age, J. Stuart Thompson, 84; Multiplication of Trypanosomes in Fishes, A. Laveran and F. Mesnil, 216; Digestive Tract of Salmon and Sea-trout Kelts, J. K. Barton, 257; "Fox Shark" or "Thrasher" in the English Channel, E. Ernest Lowe, 272; les Poissons du Bassin du Congo, G. A. Boulenger, 339
- Identification, Finger Print Evidence, Dr. Francis Galton, F.R.S., 606
- Illyrischen Länder, Die Vegetationsverhältnisse d., Dr. Günther Ritter Beck v. Mannagetta, 27
- Immunity, Recent Studies of, with Special Reference to their Bearing on Pathology, Prof. Welch, 611
- India: the Attractions of the Himalaya Mountains upon the Plumb-line in India, Major S. G. Burrard, 80; the Tribes of the Brahmaputra Valley, L. A. Waddell, 91; the Coorgs and Yeruvas, an Ethnological Contrast, T. H. Holland, 91; the Ruling Races of Prehistoric Times in India, South-Western Asia and Southern Europe, J. F. Hewitt, 145; Rainfall in India, 230, 278; on Some Phenomena which Suggest a Short Period of Solar and Meteorological Changes, Sir Norman Lockyer, K.C.B., F.R.S., and Dr. William J. S. Lockyer, 248; the Plague in the Punjab, 484; Earthquake at Kashgar, 553; Fauna of British India, Including Ceylon and Burmah, Rhynchota, W. L. Distant, 548; Geology of Western Rajputana, Tom D. La Touche, 612; Indigo Cultivation in British India, 636; the Rinderpest Serum, 659
- Indies, West, Volcanic Eruptions in the, 79, 178, 203, 204; Prof. J. Milne, F.R.S., 107, 151; see also Volcanoes
- Indigo Cultivation in British India, 636
- Indigofera, Notes on, David Prain and Edmund Baker, 21
- Induction-coils, Mechanical Break for, Dr. Dawson Turner, 21
- Infruit (M.), Precautions Necessary in the Use of Ruhmkorff Coils in Radiography, 264
- Infusoria: Structure of Acinetines, Prof. Marcus Hartog, 262; the Genus *Syncheta*, C. F. Rousselet, 448
- Ingle (Herbert), Manual of Agricultural Chemistry, 245
- Ingranaggi, La Costruzione degli, Prof. D. Tessari, 215
- Insanity, a Text-book of, Charles Mercier, 5
- Insects: Injurious and Useful Insects, L. C. Miall, F.R.S., 293
- Institution of Civil Engineers, "James Forrest" Lecture at, the Relations between Metallurgy and Engineering, Sir W. C. Roberts-Austen, K.C.B., F.R.S., 18
- Institution of Electrical Engineers and Electrical Legislation, 35; Deputation on Electrical Legislation, 199
- Intelligence, Animal, L. C. Hurt, 459
- Interference of Sound, the Right Hon. Lord Rayleigh, F.R.S., at the Royal Institution, 42
- International Catalogue of Scientific Literature, Prof. J. B. Farmer, F.R.S., 217; Prof. Herbert McLeod, F.R.S., 436
- International Council for the Exploration of the Sea, the First Meeting of the, 349
- International Meteorological Committee, the, 608
- Invisibility of Transparent Objects under Uniform Illumination, a Method of Showing the, Prof. R. W. Wood, 102
- Ipswich, Palaeolithic Implements in, Nina Frances Layard, 77
- Ireland: Royal Irish Academy, 47; New Path Along the Goban's Cliffs, R. Welch, 417; Cuchulainn of Muirhemme, the Story of the Men of the Red Branch of Ulster, Lady Gregory, 489; Results of Exploration of Various Irish Caves, 619; Proof Sheet of the "Drift" Edition of the Geological Map of Ireland, Mr. Teall, 619; Water Power Available in Ireland, Mr. Dick, 644; Map of Ireland Showing Distribution of Rainfall, Dr. Mill, 644; Irish Flints, W. J. Knowles, 663; Important Stone-Axe Factories Discovered near Cushendall, Co. Antrim, W. J. Knowles, 663; Bronze Objects of the Hallstatt Culture Phase in Ireland, 663; Mental and Moral Characteristics of the People of Ulster, Dr. W. Graham, 664
- Iron and Steel Institute, 62, 487
- Iron and Steel Institute, Journal of the, General Index, 342
- Iron, Electrical Conductivity of Steel and Pure, C. Benedicks, 160
- Iron, Electrical Resistance of, at Very Low Temperatures, E. Philip Harrison, 343
- Irvine (Dr. J. C.), on the Alkylation of Sugars, 662
- Irving (A.), Science and London Matriculation Examination, 320
- Irving (Rev. Dr. A.), Science in the Public Schools, 459
- Isle (M. Rollet de F.), the Eruption of Martinique, 488, 516
- Italy: Record of Italian Earthquakes (1891-1900), Dr. A. Cancani, 66; Changes in the Birth and Death Rates in Italy During the Last Forty Years, Prof. Giuseppe Sormani, 660
- Ives (F. E.), the Half-Tone Trichromatic Process of Colour-printing, 207; Parallax Stereogram, 582
- Jackson (C. S.), Slide Rule Notes, 292
- Jackson (Prof. D. C. and J. P.), an Elementary Book on Electricity and Magnetism and their Applications, 439
- Jaffé (Prof. Max), Chemische und Medicinische Untersuchungen Festschrift zur des Sechzigsten Geburtstages von, 363
- Jacquard (Adrien), on the Measurement of Temperature, 382
- Jamaica, Mean Maximum Temperature and the Rainfall of, and Sunspot Frequency, Maxwell Hall, 206
- Jamieson (W. R.), a Method of Treating Parallels, 576
- Japan, Seismic Frequency in, Prof. J. Milne, F.R.S., 202
- Japanische Mythologie, Nihongi "Zeitalter der Götter," Dr. Karl Florenz, 546
- Jaspers of South-eastern Anglesey, Edward Greenly, 95
- Java, Volcanic Eruption in, Brilliant Sunset Glows in 1901 and Probable Glows from the Eruption in Martinique, Henry Helm Clayton, 101
- Javillier (Maurice), Kennet in Plants, 192
- Jean (Ferdinand), Examination and Estimation of Extract of Chestnut Wood Mixed with Oak Extract, 624
- Lee (Dr.), Crystallographic Study of the 1:3-Dichloro-, Chlorobromo- and Dibromo-benzene 5-Sulphonic Chlorides and Bromides, 663
- Jeffers (E. H.), Purification of Hydrochloric Acid from Arsenic, 119
- Jenkin (A. R.), Peculiar Appearance at and After Sunset, 230
- Jensen (H. J.), Possible Connection Between Volcanic Eruption and Sunspot Phenomena, 360
- Jetties, on Single Curved versus Double Straight, Lewis B. Haupt, 39
- Job (Andre), Glucose and the Carbonates of Cerium, 72
- Johnson (Dr. H. P.), Collateral Budding in Two Annelids, 86
- Johnston (Prof.), on the Distribution of Peat Bogs in Ireland, 643
- Johnston (S. J.), Australian Entozoa, New Distoma from the Sawfish-shark, 516
- Johnston (Dr. T. N.), Evidence of a "Seiche" on a Scottish Loch, 162
- Joly (Prof. Chas. J.), Quaternion Integrals Depending on a Single Quaternion Variable, 47
- Joly (Prof. J., F.R.S.), Method of Observing Altitudes at Sea During Nighttime, 186; Marconi's Results in Day and Night

- Wireless Telegraphy, 199; Sedimentation Experiments and Theories, 207
- Jones (Harry C.), the Elements of Physical Chemistry, 220
- Jones (H. O.), Decomposition of Oxalacetic Hydrazone in Aqueous and Acid Solutions, and a New Method of determining the Concentration of Hydrogen Ions in Solution, 214
- Jordan (Dr. David S.), Animal Forms, a Second Book of Zoology, 605
- Joseph (M.), Vaccination against Pasteurellosis, 120
- Journal of Botany, 21, 118, 213, 310, 432, 571, 671
- Journal of the Iron and Steel Institute, General Index, the, 342
- Jouve (Ad), Magnetic Properties of the Ferrosilicons, 264
- Jukes-Browne (A. J.), Deep Boring at Lyme Regis, 23
- Julus (Prof. W. H.), Hypothesis on the Nature of Solar Prominences, 450
- Jupiter, the Equatorial Current on, W. F. Denning, 138; a Dark Spot on, Theodore Phillips, 401; Leo Brenner, 487; the fifth Satellite of, Prof. Barnard, 662
- Jüptner (Baron), Sulphur Contents of Slags, 63
- Kahlenberg (Prof.), Instantaneous Chemical Reactions and the Electrolytic Dissociation Theory, 38
- Kangchenjunga, the Glaciers of, Douglas W. Freshfield, 19
- Kapp (Gisbert), Dynamos, Alternators and Transformers, 172
- Karpathen, Grundzüge d. Pflanzenverbreit i. d., F. Pax, 27
- Kashgar Earthquake of August 22, 659
- Kassner (Theo.), Gold Seeking in South Africa, a Handbook of Hints for intending Explorers, Prospectors and Settlers, 440
- Kaufmann (M. W.), the Electromagnetic Mass of the Electrons, 648
- Kaukasusländern, Grundzüge d. Pflanzenverbreit i. d., von der unteren Wolga ueb. d. Manytsch-Schneider, bis z. Scheitel-fläche-Hocharmeniens. Dr. Gustave Radde, 27
- Kazan Society of Naturalists, Remains of the, 70
- Keane (Prof. A. H.), the Ancient Ruins of Rhodesia, R. N. Hall and W. G. Neal, 34
- Keegan (Dr. P. Q.), Phosphorus *versus* Lime in Plant Ash, 655
- Keith (Dr. A.), Human Embryology and Morphology, 603; the Larger Apes *Orthograde*, 661
- Kelvin (Lord), Temperature of an Animal surrounded by a Saturated Atmosphere Hotter than Itself, 618
- Kendall (Prof. Percy F.), Explanations of Glacial Phenomena in the North of England, 424; on the Pennine Faults in the Vale of Eden, 620
- Kennerd (A. S.), a Recent Peat and Forest Bed at Westbury-on-Severn, 450
- Kentucky Bluegrass Seed, 159
- Kermode (P. M. C.), the Early Christian Monuments of the Isle of Man, 424
- Kerr (George L.), Elementary Coal Mining, 369
- Kerr (J. Graham), on the Early Development of Muscles and Motor Nerves in Lepidosiren, 641
- Kesselkaul (Mr.), Synthesis of Carboxylic Acids by the Action of Carbon Dioxide upon Magnesium Alkylhalogen Compounds, 308
- Kesteven (H. Leighton), Two Species of Astralium from Port Jackson, 96
- Kew Gardens, Blue Puya in Flower at, 112
- Kew Micrometer, Sir Joseph Hooker, 348
- Kieff, Storm at, 305
- Kilauea, the Lava-Lake of, S. E. Bishop, 441
- Kinetic Theory of Planetary Atmospheres, the, Prof. G. H. Bryan, F.R.S., 54; Dr. E. Rogovsky, 222
- Kingsbury (J. E.), on the Future of the Telephone in the United Kingdom, 614
- Kingston, St. Vincent, Earthquake at, 306
- Kirkby (William), the Evolution of Artificial Mineral Waters, 602
- Kirkman (J. P.), an Arithmetic for Schools, 491
- Kirkpatrick (R.), Guide to the Coral Gallery in the British Museum (Natural History), 322
- Kishi (Dr. K.), the "Waltzing Mice" of Japan and China, 114
- Kites, Report of Committee for Investigating the Upper Atmosphere by means of, 619
- Klein (Dr. E., F.R.S.), *Traité de Bacteriologie pure et appliquée à la Médecine et à l'Hygiène*, P. Miquel and R. Cambier, 316
- Knopf (S. A.), Tuberculosis as a Disease of the Masses and how to Combat it, 270
- Knott (Prof. C. G.), Change of Resistance of Nickel due to Magnetisation at various Temperatures, 335, 383; Suggested Use of the Platinum Thermometer for Measuring Deep-Sea Temperatures, 335
- Knowle, Wiltshire, Palaeolithic Implements from, W. and W. A. Cunningham, 663
- Knowles (W. J.), Irish Flints, 663; Important Stone Age Factories discovered near Cushendall, Co. Antrim, 663
- Kobert (Dr. H. U.), Das Wirbeltierblut in Mikrokristallographischer Hinrichtung, 363
- Koken (E.), Paläontologie und Descendenzlehre, 126
- Kowalevsky (Alexander), Death and Obituary Notice of, Prof. E. Ray Lankester, F.R.S., 394
- Krohn (F. W. T.), Remarkable Sunsets at Madeira, 199; Sunset Glows at Madeira, 540
- Kunkel (Prof.), Obituary Notice of Prof. Adolf Fick, 180
- Kyle (H. M.), Action of Spurge on Salmonoid Fishes, 45
- Kynaston (Mr.), on a Series of Volcanic Rocks in the District extending from Glen Coe to the Black Mount, Scotland, 619
- La Touche (Tom D.), Geology of Western Rajputana, 612
- Laboratories: a Laboratory Manual of Physics, H. Crew and R. R. Tatnall, 4; the Laboratory Companion to Fats and Oils Industries, Dr. J. Lewkowitsch, 126; the new Botanical Laboratories at Liverpool, 572; the Thompson-Yates Laboratories Report, 390; the Chemical Laboratory of the Royal Institution, 460
- Lachlan (R.), the Elements of Euclid, Book xi., 171
- Lacroix (A.), the Mission to Martinique, 336; the Eruption of Martinique, 488, 516; Enclosures in the Andesites from Mont Pelée, 572; on the Rocks thrown Out by the Actual Eruption of Mont Pelée, 544
- Ladd (G. T.), Philosophy of Conduct, 389
- Ladenburg (Prof.), the Atomic Weight of Iodine, 281
- Laidlaw (Frank F.), the Peoples of Malacca, 47
- Lake Baikal, Earthquake round, 15
- Lake Counties, the, W. G. Collingwood, 271
- Lamarck, the Founder of Evolution, his Life and Work, Alpheus S. Packard, 169
- Lamb (Prof. Horace, F.R.S.), Mathematical and Physical Papers, Sir G. G. Stokes, 49
- Lambe (Mr.), Belly River Dinosaurs, 400
- Lamellibranchia, the Structure of the Gills of the, Dr. W. G. Ridewood, 165
- Langley (Dr. S. P.), the Position and Promise of Aërial Navigation, 635
- Lankester (Prof. E. Ray, F.R.S.), Death and Obituary Notice of Alexander Kowalevsky, 394
- Lantern Projections, Application of the Stereoscope to, J. Macé de Lépinay, 581
- Laplace (Pierre Simon Marquis de), Philosophical Essay on Probabilities, 652
- Laporte (M.), Photometric Tests of the Bremer Arc Lamp, 611
- Larmor (Dr. J., F.R.S.), on the Application of the Method of Entropy to Radiant Energy, 618; Vortex Spirals, 630
- Larva Stage of *Helicopsis Isatis*, Fred. Fletcher, 441
- Lascelles-Scott (W.), a Bright Meteor, 638
- Láska (Prof. W.), Historical Account of the Earthquakes of Poland, 234
- Last Words on Materialism, L. Buchner, 29
- Lauder (Mr.), Absorption Spectra of Phloroglucinol and its Trimethyl Ester, 238
- Launoy (L.), the Elaboration of Venogen and of Venom in the Parotoid Gland of *Vipera Aspis*, 624
- Lava-lake of Kilauea, the, S. E. Bishop, 441
- Laveran (A.), Multiplication of Trypanosomes in Fishes, 216; on the Coccidia Found in the Kidney of *Rana esculenta*, 312
- Lawrie (Edward), Chloroform; a Manual for Students and Practitioners, 293
- Layard (Nina Frances), Palaeolithic Implements in Ipswich, 77
- Lean (Bevan), an Introduction to Chemistry and Physics, 52
- Leather (Dr. J. W.), Some Excessively Saline Indian Well Waters, 191
- Leaves, Retention of, by Deciduous Trees, 56, 344; Jul. Wulff, 32; W. Gee, 32; G. W. Bulman, 56; Prof. W. R. Fisher, 370; Dr. D. T. Smith, 631
- Lebeau (P.), Combinations of Silicon with Cobalt, 372

- Ledoux-Lebard (M.), Antiparameccious Serum, 384
 Leduc (A.), Electrolysis of Silver Nitrate, 288; the Electrolysis of Mixtures of Salts, 488
 Leduc (Stephane), Anaesthesia by Electric Currents, 336
 Lee (J. Bridges), Photography as Applied to Architectural Measurement and Surveying, Lecture at Society of Arts, 235
 Lees (Dr. C. H.), Mathematics and Physics at the British Association, 618
 Lefèvre (G.), Kinkiliba, 120
 Legends of Palestine and Arabia, 517
 Léger (N. E.), Constitution of the Aloins, 264
 Leggett (T. H.), Gold Production and Life of the Main Reef Series, Witwatersrand, 659
 Lehlfeldt (R. A.), a Text-book of Physics, with Sections on the Application of Physics to Physiology and Medicine, 387
 Leiper (R. T.), on an Acelous Turbellarian Inhabiting the Common Heart Urchin, 641
 Lemur, Abnormal Dentition in a, Prof. G. Elliot Smith, 71
 Lendenfeld (Prof. R. v.), Notes on Young Gulls, 415
 Lens, the, a Practical Guide to the Choice, Use and Testing of Photographic Objectives, T. Bolas and George E. Brown, 75
 Leonard (J. H.), a First Course of Chemistry (Heuristic), 439
 Leonid Shower, the, Prof. Pickering, 662; R. B. Taber, 662; W. Leonis, Occultation of, 208
 Lépinay (Macé de), Application of the Stereoscope to Lantern Projections, 581
 Leser (Georges), Synthesis of Menthone, 96
 Lets (Prof. E. A.), Amount of Carbonic Anhydride Absorbed from Sea Water, 662; Corrosion of Copper by Sea Water, 662
 Leucolysis, Experimental Observations on, Drs. A. Goodal and E. Ewart, 335
 Lévy (Michel), Earthquake of May 6, 1902, 95
 Levy-Bruhl (L.), Die-Philosophie August Comte's, 369
 Lewis (E. W.), Melting-point of Pure Tribromophenolbromide, 238
 Lewkowsitch (Dr. J.), the Laboratory Companion to Fats and Oils Industries, 126
 Lhotá (Lhotak de), the Conservation of Muscular Potential in an Atmosphere of Carbon Dioxide, 432
 "Lia Fail," on the, of Tara and the Election of Kings by Augury, E. S. Hartland, 664
 Libbey (Prof.), Evolution of the Jordan Valley, 642
 Lick Photographs, the, Prof. Pickering, 487
 Lico (N.), la Protezione degli Animali, 414
 Lidbury (Mr.), Decomposition of Water Vapour by the Electric Spark, 637
 Liebreich (Prof.), Therapeutic Value of Alkaline Waters of the Vichy Type, 353
 Liénard (E.), Composition of Reserve Hydrocarbons in the Albumen of Palms, 648
 Lienuau (Dr. H.), Bauxite, 539
 Light: Influence of Light upon Plant Assimilation, E. E. Hennessee, 103; Experiment Illustrating a Paradoxical Consequence of the Wave Theory of, Edwin Edser and Edgar Senior, 204; the Effect of Light on Cyanin, P. G. Nutting, 416
 Lighthouse Light, a New Flashing, J. R. Wigham, 644
 Lighting: Étude Pratique sur les Différents Systèmes d'Éclairage, J. Defays and H. Pittet, 172; New Oxygen-Acetylene Burner, M. Fouché, 279; Use of Alcohol as an Illuminant, L. Denayrouze, 486
 Lightning: Curious Effect produced by, Dr. Enfield, 158; a Tripartite Stroke of Lightning, W. H. Hall, 370; Effect of a Lightning Flash, C. Davies Sherborn, 492; Lightning Arrestors in Electrical Engineering, Dr. Gustav Benischke, 573
 Lignières (Marcel), Vaccination against Pasteurelloses, 120
 Lime, Phosphorus *versus*, in Plant Ash, Dr. P. Q. Keegan, 655
 Lincei, the Royal Prize of the Reale Accademia dei, for Physics awarded to Prof. Cantone, 377
 Lindet (L.), the Transformation of New into Stale Bread, 23
 Lindsay (B.), the Story of Animal Life, 173
 Linnean Society, 22, 47, 94, 263
 Linnean Society, New South Wales, 96, 264, 312, 384, 516
 Linum, the Fertilisation of, Prof. T. D. A. Cockerell, 631
 Liquid Fuel for Steam Purposes, J. S. S. Brame, 186
 Literature, Science and, Prof. John Perry, F.R.S., at the Royal College of Science, 645
 Liverpool, the New Botanical Laboratories at, 155
 Lizard, Bipedal Locomotion of a Ceylonese, E. Ernest Green, 492; Rose Ilalg Thomas, 551; N. Annandale, 577; W. Saville-Keat, 630
 Lizards, *Rhinura floridana*, the Degenerate Eyes of, Prof. C. H. Eigenmann, 636
 Loch, Evidence of a "Seiche" on a Scottish, Dr. T. N. Johnston and J. Parsons, 162
 Lockyer (Sir Norman, K.C.B., F.R.S.), the Wiltshire Archaeological and Natural History Magazine, Stonehenge and its Barrows, William Long, F.S.A., Stonehenge Bibliography Number, W. Jerome Harrison, 25; on the Spark Discharge from Metallic Poles, 93; the Farmers' Years, ii., Carnac and its Environs, 104; on Some Phenomena which Suggest a Short Period of Solar and Meteorological Changes, 248; the Relation between the Solar Protuberances and Terrestrial Magnetism, 456; Short-Period Solar and Meteorological Variations, 456
 Lockyer (Dr. William J. S.), Mont Pelée Eruption and Dust Falls, 53; Astronomischer Jahresbericht, Walter F. Wislicenus, 198; the Coloured Sunsets, 222; on Some Phenomena which Suggest a Short Period of Solar and Meteorological Changes, 248; Short-Period Solar and Meteorological Variations, 456
 Locomotion: Alcohol as a Motive Power for Automobiles, 307; Schule des Automobil Fahrers, Wolfgang Vogel, Mervyn O'Gorman, 313
 Locomotives, British *versus* American, 42
 Loquin (René), Action of Nitrous Acid in Alkaline Solution on α -Substituted β -Ketonic Esters, 384
 Lodge (Sir Oliver, F.R.S.), Marconi's Results in Day and Night Wireless Telegraphy, 222
 Londe (Albert), Contribution to the Study of the Magnesium Light, 168
 London: the Colleges of the University of, 10; University College and the University of London, 59; the Electrification of, 296; Science and the London Matriculation Examination, A. Irving, 320
 Long (William, F.S.A.), the Wiltshire Archaeological and Natural History Magazine, Stonehenge and its Barrows, 25
 Longfield (Mrs. R. W.), Cuckoo Heard on August 18, 421
 Lorentz (H. A.), Sichtbare und Unsichtbare Bewegungen, 489
 Lortet (M.), the Black Coloration of the Rocks Forming the Cataracts of the Nile, 95
 Lory (Charles A.), Simple Electric Thermostat, 135
 Loudon (Prof. James), Universities in Relation to Research, Address at Royal Society of Canada's Meeting at Toronto, 358
 Lovejoy (Mr.), Apparatus for the Fixation of Atmospheric Nitrogen, 611
 Lovatt (E.), on Tallies, 664
 Lowe (E. Ernest), "Fox Shark" or "Thrasher" (*Alopias vulpes*) in the English Channel, 272
 Lowell (Percival), Signals from Mars, 18
 Lowry (T. Martin), Persulphuric Acids, 45
 Lucas (A.), on the Disintegration of Building Stones in Egypt, 379
 Ludwig (A.), Fusion of Carbon, 206
 Lunar Halo, a Remarkable, Prof. E. E. Barnard, 5; H. W. Croome Smith, 85
 Luty (Mr.), a Comparative Economic Study of the Manufacture of Sulphuric Acid by the Anhydride and the modern Lead Chamber Processes, 330
 Luxmoore (C. M.), on the Soils of Dorset, 486
 Lydekker (R., F.R.S.), a Rare Wild Sheep, 32
- Mabery (C. F.), the Composition of Pennsylvania Petroleum, 424
 Macalister (R. A. S.), on a Prehistoric Cemetery-cave in Palestine, 663
 Macaulay (Dr. F. S.), Some Formulæ of Elimination, 71
 MacBride (Prof. E. W.), Some New Points in the Development of *Echinus esculentus*, 640
 McClelland (J. F.), Life-History of *Uthia hyalina*, 257
 MacCond (Prof. C. W.), Velocity Diagrams, their Construction and Uses, 269
 McDermott (F. P.), Observations of ζ Geminorum, 662

- McDonald (T. McGregor), Eruption in St. Vincent, 373
Macdougall (D. T.), Elementary Plant Physiology, 76
McDougall (Archibald), a Remarkable Meteor, 557
MacDowall (Alex. B.), Brückner's Cycle and Wind, 320
McHenry (Mr.), on the Prolongation of the Highland Border Rocks into Co. Tyrone, 619
McIntosh (Prof.), British Fisheries Investigations and the International Scheme, 640
Mackenzie (J. S.), Elements of Metaphysics, 198
Mackie (Dr. W.), on the Conditions Attending the Precipitation of Manganese Dioxide in the Elgin Sandstone, 620; on the Results of a Series of Determinations of the Soluble Chlorides and Sulphates in the Elgin Sandstone, 620
McLeod (Prof. Herbert, F.R.S.), International Catalogue of Scientific Literature, 436
MacMahon (Lieut.-General Charles Alexander, F.R.S., F.G.S.), Opening Address in Section C at the Belfast Meeting of the British Association, Rock Metamorphism, 504
Macnair (D. S.), an Introduction to Chemistry, 547
MacRitchie (David), Prehistoric Pygmies in Silesia, 151
McWilliam (A.), Constituents of Hardened Steel, 63; Control of the Silicon in the Acid Open-hearth Bath, 63
Madeira, Remarkable Sunsets at, F. Krohn, 199, 540; A. R. Tankard, 254
Magic Squares, J. Willis, 78
Magnesium Light, Contribution to the Study of the, Albert Londe, 168
Magnetism: Practical Exercises in Magnetism and Electricity, H. E. Hadley, 5; Diagramme der Electricischen und Magnetischen Zustände und Bewegungen, F. W. Willenweber, 76; Magnetic Perturbation on May 8, Th. Moureaux, 96; Phenomena Observed at Zi-Ka-Wei, China, during the Martinique Eruption, M. de Mordrey, 408; Magnetic Disturbances during the Eruption of Mont Pelée on May 8, Dr. L. A. Bauer, 421; Magnetic Observations Made in Central Madagascar, P. Colin, 192; Expédition Norvégienne de 1899-1900 pour l'Etude des Aurores Boréales, Resultats des Recherches Magnetiques, Kr. Birkeland, Dr. C. Chree, F.R.S., 227; Investigations into the Connection between the Magnetic Currents in the Earth and the Aurora Borealis, Prof. Kr. Birkeland, 328; the First Magnetician, Prof. S. P. Thompson, F.R.S., 249, 272; William Gilbert, of Colchester, a Sketch of his Magnetic Philosophy, Charles E. Benham, 270; Magnetic Properties of the Ferrosilicons, Ad. Jouve, 264; Mathematical Investigation of the Effect of an Infinite Plane-conducting Screen on the Magnetic Field Produced by an Electrostatic Charge Moving Uniformly Parallel to the Plane, Prof. T. Lévi Civitas, 280; Erdmagnetische Untersuchungen im Kaiserstuhl, G. Meyer, 324; the Relation between the Solar Protuberances and Terrestrial Magnetism, Sir Norman Lockyer, K.C.B., F.R.S., 456; the Dissipation of Energy by Electric Currents induced in an Iron Cylinder when Rotated in a Magnetic Field, Ernest Wilson, 334; Note on a Magnetic Detector of Electric Waves which can be Employed as a Receiver for Space Telegraphy, G. Marconi, 334; Change of Resistance of Nickel due to Magnetisation at Various Temperatures, Prof. C. G. Knott, 335, 383; a Note on the Effect of Daylight upon the Propagation of Electromagnetic Impulses over Long Distances, G. Marconi, 335; Cross Magnetisation in Iron, James Russell, 335; Magnetic Shielding in Hollow Iron Cylinders and Superposed Magnetic Inductions in Iron, James Russell, 383; Magnetic Double Refraction, Quirino Majorana, 336; Magnetic Dichroism, Quirino Majorana, 360; Reflection of Light from an Iron Mirror Magnetised Perpendicularly to the Plane of Incidence, P. Camman, 384; Novel Magneto-optic Phenomena, Dr. Quirino Majorana, 398; Magneto-optical Rotation in the Interior of Absorption Bands, Prof. Zeeman, 622; an Elementary Book on Electricity and Magnetism, Profs. D. C. and J. P. Jackson, 439; Magnetic Work of the United States Coast and Geodetic Service, Outlined for July 1, 1902-June 30, 1903, 666; Thin Metallic Films obtained by Kathode Projection, L. Houlléville, 672
Magnus, (Dr.), on the Diuretic Action of Pituitary Extracts, 666
Maignon (M.), Production of Glycose by the Muscles, 216
Maillet (Edmond), the Prediction of the Minimum Yield of the Sources of the Vanne, 95
Major (Dr. Forsyth), Brussels Okapi Specimens, 185
Majorana (Dr. Quirino), Magnetic Double Refraction, 336; Magnetic Dichroism, 360; Novel Magneto-optic Phenomena, 398
Making of Citizens, the, a Study of Comparative Education, R. E. Hughes, 604
Malacca, the Peoples of, Frank F. Laidlaw, 47
Malaria Fever, its Cause, Prevention and Treatment, Ronald Ross, F.R.S., 269
Malarial Fevers, Treatment of, by Latent Arsenic, Armand Gautier, 47
Malay Peninsula: the Human Souls and Ghosts of the Malays of Patani, Nelson Annandale, 664; the Wild and Civilised Tribes of the, Nelson Annandale, H. C. Robinson, 664
Malay Type of Sea-going Boat, 114
Mammalia in the British Museum (Natural History), Guide to the Galleries of, 322
Mammalia, the Cambridge Natural History, F. E. Beddard, 373
Mammals, Instances of Abnormality in, F. Howe, Prof. O. C. Bradley, Elliot Smith, 351
Manaar, Gulf of, Pearl Fisheries in the, Prof. Herdman, 486
Manchester, Mr. Balfour on Technical Education at, 633
Manchester Literary and Philosophical Society, 23, 47, 95, 648
Manchester Sanitary Congress: the Treatment of Smoke, a Sanitary Parallel, Dr. W. N. Shaw, F.R.S., 667
Mansel-Pleydell (John Clavell), Death and Obituary Notice of, 65
Mannagetta (Dr. Günther Ritter Beck v.), Die Vegetationsverhältnisse d. Illyrischen Länder, 27
Manuelli Effect, the, Action of Sunlight in Facilitating the Passage of Electric Sparks, Prof. Garbasso, 448
Maquenne (L.), Action of Carbon Bisulphide on the Polyvalent Amino-alcohols, 264
Marchi (Luigi de), Effects of Solar Eclipses on the Motion of Air-Currents, 159
Marchlewski (L.), Spectrum of Hemoglobin, 230
Marckwald (Dr. W.), Polonium, 281
Marconi (G.), New Form of Magnetic Detector, 182; the Recent Transatlantic Signalling, 182; Marconi's Results in Day and Night Wireless Telegraphy, Prof. J. Joly, F.R.S., 199; Sir Oliver Lodge, F.R.S., 222; Note on a Magnetic Detector of Electric Waves which can be Employed as a Receiver for Space Telegraphy, 334; a Note on the Effect of Daylight upon the Propagation of Electromagnetic Impulses over Long Distances, 335; New Marconi Signalling Station at Cape Breton, 485; Prof. A. Righi on Mr. Marconi, 581; Marconi Experiments on the *Carlo Alberto*, 610
Marine Biology: Aggregated Colonies in Madreporiform Corals, Dr. J. E. Duerden, 257; Marine Biology in Wales, G. W. Duff Assheton-Smith, 282; New Hydroid, *Polygahydra mirabilis*, Dr. A. Dendy, 330; Studies on the Distribution of Animal Life on "Storeggen" and "Shetlandseggen," North Sea, Dr. Johan Hjort, 351; Degeneration-process in Larval Ctenocenters of the genus *Gonionema*, H. F. Perkins, 612
Marpmann (G.), Distinguishing between *Platysigma angulatum* and *P. balticum* under Low Powers, 39
Marquis (R.), Derivatives of Fumaric Aldehyde, 23; on Nitropyromucic Acid and its Ethyl Esters, and on Dinitrofururan, 624
Mars, Signals from, Percival Lowell, 18
Marshal (Arthur), Relationships between the Atomic Weights of Allied Elements, 424
Marshall (Dr. Hugh), Dissociation of the Compound of Iodine and Thiocurea, 239; the Thallic Sulphates and Double Sulphates, 335
Mattell (Benjamin), Death and Obituary Notice of, 305
Martine (G.), Identity of the Acid obtained by the Oxidation of Benzylidene-menthone with Potassium Permanganate with Dihydrocamphoric Acid, 216
Martinique: Volcanic Eruption in Java, Brilliant Sunset Glows in 1901, and Probable Glows from the Eruption in, Henry Helm Clayton, 101; Effects of the Recent Volcanic Eruptions in Martinique and St. Vincent, H. Hesketh Bell, 306; the Mission to Martinique, M. Lacroix, 336; the Eruption of, M. A. Lacroix, Rollet de l'Isle and Giraud, 488, 516
Mason (Dr. Otis T.), the Harpoon, 232
Mason (Prof. William P.), Water-supply, 458
Masterman (Dr. A. T.), Series of Wax Models Illustrating the Transition from Larva to Adult in *Cribrella oculata*, 640

- Masters (Dr. Maxwell T., F.R.S.), Campanulate Foxgloves, 344
- Material for Natural Selection, Prof. T. D. A. Cockerell, 607
- Materialism, Last Words on, L. Buchner, 29
- Mathematics: College Algebra, L. E. Dickson, 4; *Leçons sur les Séries a Termes Positifs*, Emile Borel, 5; Rearrangement of Euclid i. 1-32, T. Petch, 7; J. M. Child, 31; the Elements of Euclid, Book xi., R. Lachlan, 171; Death of Prof. J. L. Fuchs, 14; Obituary Notice of, 156; Experimental Mathematics, F. M. Saxeby, 30; Quaternion Integrals Depending on a Single Quaternion Variable, Prof. Chas. J. Joly, 47; Mathematical and Physical Papers, Sir G. S. Stokes, Prof. Horace Lamb, F.R.S., 49; Symbol for Partial Differentiation, Prof. John Perry, F.R.S., 53, 271, 520; Dr. Thomas Muir, F.R.S., 271, 520; A. B. Basset, F.R.S., 576; Mathematical Society, 71, 215; some Formule of Elimination, Dr. F. S. Macaulay, 71; Groups in which every Two Conjugate Operations are Permutable, Prof. Burnside, 71; Application of Contour Integration to the Solution of General Problems in the Conduction of Heat, H. S. Carslaw, 71; Use of Fourier's Series in the Theory of Conduction of Heat, Dr. Ganesh Prasad, 71; on the Use of Fourier's Series in the Problem of the Transverse Vibrations of Stretched Strings, Dr. H. S. Carslaw, 485; Magic Squares, J. Willis, 78; American Journal of Mathematics, 93, 455; Mathematical Training, C. E. Stromeier, 103; Simplified Definition of a Group, E. V. Huntington, 118; Bulletin of the American Mathematical Society, 118, 165, 382, 455; a Cubic and Submerged Cubes, Prof. Thos. Alexander, 127; Algebra, H. G. Willis, 149; Transactions of the American Mathematical Society, 165; Formula for the Perimeter of an Ellipse, Thomas Muir, F.R.S., 174; Histoire des Mathématiques dans l'Antiquité et le Moyen Age, H. G. Zeuthen, 199; Report on the Teaching of Geometry, 201; Huygens' Principle in a Uniaxial Crystal, Prof. Conway, 215; Investigations on Repetition of the Sum-factor Operation, Lieut.-Colonel Cunningham, 215; Geometrical Proposition Connected with the Continuation of Power Series, Prof. M. J. M. Hill, 215; Opere Matematiche di Francesco Brioschi, 221; a Method of Treating Parallels, Dr. S. W. Richardson, 237; Use of Quaternions in the Theory of Screws, Dr. W. Peddie, 239; Mathematical Investigation of the Effect of an Infinite Plane-conducting Screen on the Magnetic Field Produced by an Electro-static Charge Moving Uniformly Parallel to the Plane, Prof. T. Levi Civita, 280; Slide Rule Notes, Lieut.-Colonel H. C. Dunlop and C. S. Jackson, 292; Death of Rev. Charles E. Searle, 327; Cases of Motion of a Point in a Plane, E. Daniele, 329; Annals of Mathematics, 382; Elementary Geometry, W. C. Fletcher, 438; a New Theory of the Tides of Terrestrial Oceans, Rollin Harris, Prof. G. H. Darwin, F.R.S., 444; a Series Related to Bernoulli's Numbers, J. B. Sutton, 492; Decimal Coinage and Approximations, J. W. Butters, 513; the Abel Festival in Christiania, 552; a Method of Treating Parallels, W. R. Jamieson, 576; Vortex Spirals, Dr. J. Larmor, F.R.S., 630; Probabilités et Moyennes Géométriques, Emmanuel Czuber, 652; Philosophical Essay on Probabilities, Pierre Simon Marquis de Laplace, 652
- Matignon (Camille), Preparation of the Anhydrous Chlorides of Samarium, Yttrium and Ytterbium, 168; Chlorinating Properties of a Mixture of Hydrochloric Acid and Oxygen, 240
- Matriculation Examination, Science and the London, A. Irving, 320
- Matriculation Requirements in Scottish Universities, Prof. John Perry, F.R.S., 654
- Matter and Motion in Space, Sir Hiram S. Maxim, 223
- Matthews (A.), the Term "Indian Summer," 205
- Matthews (Charles G.), Manual of Alcoholic Fermentation and the Allied Industries, 1
- Maxim (Sir Hiram S.), Matter and Motion in Space, 223
- Maxwell-Lefroy (Mr.), Screw Worm in Cattle at St. Lucia, 400
- May (Dr. Page), on the Movement and Innervation of the Stomach, 665
- Maze (Abbé), Death of, 255
- Mazé (M.), the Zymase from *Eurotiopsis Gayoni*, 312
- Mechanics: Thin Floating Cylinders, Prof. Thos. Alexander, 6; the Compound Pendulum, S. A. F. White, 22; Throwing Machine for Reversals of Mean Stress, Osborne Reynolds, F.R.S., and J. H. Smith, 45; Quelques Réflexions sur la Mécanique suivies d'une Première Leçon de Dynamique, Emile Picard, 101; la Costruzione degli Ingranaggi, Prof. D. Tessari, 218; French Service Regulation as to Heads and Worms of Screws Used in the French Navy, 229; Use of Quaternions in the Theory of Screws, Dr. W. Peddie, 239; on an Approximate Solution for the Bending of a Beam of Rectangular Cross-section under any System of Load, with Special Reference to Points of Concentrated or Discontinuous Loading, L. N. G. Filon, 262; Mechanics of Engineering, Prof. A. Jay DuBois, 265; Velocity Diagrams, their Construction and Uses, Prof. C. W. MacCord, 269; Elementary Principles in Statistical Mechanics, J. Willard Gibbs, Prof. G. H. Bryan, F.R.S., 291; the Rooke Manual of Applied Mechanics, Stability of Structures, and the Graphic Determination of Lines of Resistance, Lieut.-Colonel J. H. C. Harrison, 340
- Medicine: Treatment of Malarial Fevers by Latent Arsenic, Armand Gautier, 47; the Romance of Medicine, Sir Frederick Treves, 183; the Relation of Biology to Medicine, Dr. Rose Bradford, 231; Chloroform, a Manual for Students and Practitioners, Edward Lawrie, 293; *Traité de Bactériologie Pure et Appliquée à la Médecine et à l'Hygiène*, P. Miquel and R. Cambier, Dr. E. Klein, F.R.S., 316; Pharmacology at the British Medical Association, 353; *Pathologie Générale et Expérimentale, Les Processus Généraux, A. Chantemesse and W. W. Pedwysotsky, 363; Matière Médicale Zoologique, Histoire des Drogues d'Origine Animale, H. H. Beauregard, 363; Chemische und Medicinische Untersuchungen, Festschrift zur des Schätzigsten Geburtstages, Von Max Jaffe, 363; Das Wirbelstribut in Mikrokristallographischer Hinsicht, Dr. H. U. Kobert, 365; a Text-book of Physics, with Sections on the Applications of Physics to Physiology and Medicine, R. A. Lehfeldt, 387; the Röntgen Rays in Medicine and Surgery as an Aid in Diagnosis and as a Therapeutic Agent, Francis H. Williams, 438; *Religio Medici*, &c., 457; Opening Addresses at the Medical Schools, 579; the Climates and Baths of Great Britain, 629*
- Meinardus (W.), Der grosse Staubball von 9 bis 12 März, 1901, in Nordafrika, Sud- und Mitteleuropa, 41
- Méland (M.), World's Annual Exhibition of Imports over Exports of Timber, 283
- Melbourne University, Report for 1901
- Meldola (Prof. R., F.R.S.), the Lesson of Evolution, Frederick Wollaston Hutton, F.R.S., 219; Dinitro-*p*-anisidine, 238; Can Carbon Dioxide be "Vitalised"? 292; Roscoe-Schorlemmer's Lehrbuch der Organischen Chemie, Jul. Wilh. Brühl, 546
- Mellor (J. W.), Preparation of Pure Chlorine and its Behaviour towards Hydrogen, 238; Union of Hydrogen and Chlorine v. and vi., 238
- Melzi (Father), the Earthquake in Mid-Atlantic, 378
- Mendel's Principles of Heredity, a Defence, W. Bateson, F.R.S., 573
- Mendelëeff's Periodical System of Elements, Position of the Rare Earths in, Prof. Bohuslav Brauner, 66
- Mendelssohn (M.), Les Phénomènes Electriques chez les Êtres Vivants, 575
- Mennell (Frederick P.), the Great Granite Mass of the Matopos, 449
- Mercier (Charles), a Text-book of Insanity, 5
- Merigold (Mr.), Redetermination of the Atomic Weight of Uranium, 208
- Merrill (G. P.), Meteorite Ploughed up at Admire, Kansas, 422
- Mesnil (F.), Multiplication of Trypanosomes in Fishes, 216; on the Coccidia Found in the Kidney of *Rana esculenta*, 312
- Metalurgy: Constituents of Hardened Steel, Prof. J. O. Arnold and Mr. McWilliam, 63; the Relations between Metallurgy and Engineering, "James Forrest" Lecture at the Institution of Civil Engineers, Sir W. C. Roberts-Austen, K.C.B., F.R.S., 18; Control of the Silicon in the Acid Open-hearth Bath, A. McWilliam and W. H. Hatfield, 63; Chemical and Physical Properties of Carbon in the Hearth of the Blast Furnace, W. J. Foster, 63; Sulphur Contents of Slags, Baron Jüptner, 63; Brinell's Researches on the Influence of Chemical Composition on the Soundness of Steel Ingots, Axel Wahlberg, 63; Microscopic Effects of Stress on Platinum, Thomas Andrews, F.R.S., and Charles Reginald Andrews, 213; a Note on the Recrystallisation of

- Platinum, Walter Rosenhain, 262; Metallurgy, an Introduction to the Study of the Structure of Metals, chiefly by the Aid of the Microscope, Arthur H. Hiorns, 415; Recovery of Tin from Tin-scrap, 449; the Over-heating of Mild Steel, Prof. Heyn, 487; Compression of Steel during Solidification in the Ingot Mould, A. Harmet, 487; Assaying and Metallurgical Analysis for the Use of Students, Chemists and Assayers, E. L. Rhead and Prof. A. Humboldt Sexton, 628; Aluminium and its Alloys, Prof. E. Wilson, 655; W. Murray Morrison, 655
- Metals, Film Structures in, George Bellby, 84
- Metaphysics: Elements of, J. S. Mackenzie, 198; Zur Metaphysik des Tragischer, L. Ziegler, 342
- Meteorology: Pilot Chart of the North Atlantic and Mediterranean for May, 15; for June, 114, 206; for August, 307; for November, 635; Caucasian Snow, A. Brum, 16; Temperature Indicator for Use with Platinum Thermometers, R. S. Whipple, 22; Sun-Pillars and Parhelion, Prof. Grenville A. J. Cole, 32; the Sun-Pillar of March 6, 38; Sun-Pillar? Sir W. J. Herschel, Bart., 77; a Solar Halo, R. T. Omond, 103; the Halos of May 1, 8 and 22, Rev. T. C. Porter, 223; Meteorological Observations at Stonyhurst College Observatory for 1901, 38; Der grosse Staubbau von 9 bis 12 März, 1901, in Nordafrika, Süd- und Mitteleuropa, G. Hellmann, W. Meinradus, 41; the Hurricanes of the Far East, Prof. Dr. Paul Bergholz, 51; Mont Pelée Eruption and Dust Falls, Dr. William J. S. Lockyer, 53; Volcanic Eruption in Java, Brilliant Sunset Glows in 1901, and Probable Glows from the Eruption in Martinique, Henry Helm Clayton, 101; the Recent Volcanic Eruptions in the West Indies, Prof. J. Milne, F.R.S., 67, 107, 151, 370; Observations of Volcanic Activity in the West Indies, 178; Possible Connection between Volcanic Eruption and Sunspot Phenomena, H. J. Jensen, 360 (see also Volcanoes); the Sunspot Curve and Epochs, 186; Mean Maximum Temperature and the Rainfall of Jamaica and Sunspot Frequency, Maxwell Hall, 206; Sunspots and Wind, Alex. B. MacDowall, 320; Apparatus for Registering Thunderstorms, Father J. Fényi and Father Johann Schreiber, 65; Meteorological Results of the Balloon Ascents of February 6, Dr. Hergesell, 66; Brückner's Cycle and the Variation of Temperature in Europe, Alex. B. MacDowall, 77; the Weather in May, 85; Connection between Thunderstorms and the Lunar Phases, V. Ventosa, 85; Tides in the Bay of Fundy, W. Bell Dawson, 85; the Daily Period of Rainfall, Dr. P. Polis, 86; the Prediction of the Minimum Value of the Sources of the Vanne, Edmond Maillet, 95; Symons's Meteorological Magazine, use of the Monthly Rainfall Tables, 114; Sandstorms, 114; Coast Fog Signals, E. Price Edwards, 115; Sea Temperature and Shore Climate, 116; Cornish Dust Fall of January, 1902, Dr. H. R. Mill, 119; Wind-Force Experiments on H.M.S. *Waracter*, 119; Royal Meteorological Society, 119, 215; Rainfall of Saxony, Dr. G. Hellmann, 136; Increase in the Electrical Conductivity of Air Produced by its Passage through Water, Prof. J. J. Thomson, 143; Radio-active Rain, C. T. R. Wilson, 143; Fall of a Yellow Powder on June 1 and 2 during a Thunderstorm, C. Turner, 157; Curious Effect Produced by Lightning, Dr. Enfield, 158; Remarkable Shower of Hailstones, R. Sworby, 159; the Temperature of Kingston, Jamaica, Maxwell Hall, 159; Effects of Solar Eclipses on the Motion of Air-currents, Luigi de Marchi, 159; Meteorological Conditions Accompanying "Föhn" and Up-Bank Thaws in Glen Nevis, R. C. Mossman, 167; Meteorological Items from Australia, India and South Africa, 183; Remarkable Sunsets at Madeira, F. W. T. Krohn, 199, 540; A. R. Tankard, 254; the Coloured Sunsets, Dr. William J. S. Lockyer, 222; J. Edmund Clark, 223; Peculiar Appearance at and after Sunset, Dr. B. P. Plowright, 230; A. R. Jenkin, 230; Recent Coloured Sunsets, 254; Brilliant Sky Effects at Morges directly after Sunset, F. A. Forel, 278; Height of Sunset Afterglows in June, 1902, Prof. A. S. Herschel, F.R.S., 294; Sunsets of West of Switzerland and Dust from Mont Pelée, 306; Colours between Clouds at Sunset, John Baddeley, 307; Sunset Effects, Prof. G. H. Bryan, F.R.S., 390; S. Pace, 390; Recent Sunset Effects and those which Followed the Eruption of Krakatoa, A. W. Clayden, 659; an Attempt to Reproduce an Aurora Borealis, Prof. W. Ramsay, F.R.S., 204; the Term "Indian Summer," A. Matthews, 205; Surface Temperature of the Atlantic during April, 206; English Climatology 1891-1900, F. C. Bayard, 215; Rainfall in India, 230, 278; Cold Weather in South Africa, J. R. Sutton, 247; on Some Phenomena which Suggest a Short Period of Solar and Meteorological Changes, Sir Norman Lockyer, K.C.B., F.R.S., and William J. S. Lockyer, 248; Short Period Solar and Meteorological Variations, Sir Norman Lockyer, K.C.B., and Dr. William Lockyer, 456; Death of Abbé Maze, 255; the Drought in Queensland and in New South Wales, 255; Wind Velocity and Fluctuations of Water-level on Lake Erie, Prof. Alfred J. Henry, 256; the Californian Climate, Note on a Statement in the Article on Francis Drake in the Dictionary of National Biography, 256; Death of M. Hervé Faye, 251; Obituary Notice of, 277; Storm at Kieff, 305; Cyclone at Chalon-sur-Saône, 305; the Atlantic Ice Record, June and July, 307; on the Correlation between the Barometric Height at Stations on the Eastern Side of the Atlantic, Miss F. E. Cave-Brown-Cave, Karl Pearson, F.R.S., 311; Investigation into the Connection between the Magnetic Currents in the Earth and the Aurora Borealis, Prof. Kr. Birkeland, 328; Results of International Balloon Ascents of March 6, 329; Annales de l'Observatoire National d'Athènes, Démostrius Egnitius, 331; Lehrbuch der Meteorologie, Dr. Julius Hann, Dr. W. N. Shaw, F.R.S., 337; Ben Nevis Observatories, Sir Arthur Mitchell, 349; Rainfall of Sicily, 1880-1900, Filippo Eredia, 350; Rainfall in Dominica and St. Vincent, 1900-1, 378; Rainfall of Great Britain, 512; Earthquake of May 28 at the Cape, and Coincident Meteorological Effects, Charles Stewart, 369; Fog Bow at Oxford, J. Rose, 416; Storms in Majorca and Cape Colony, 446; Sea Temperature Variations on the British Coasts, 452; Snow Waves and Snow Drifts, Dr. Vaughan Cornish, 453; Death of Dr. H. von Wild, 511; Convention of Weather Bureau Officials at Milwaukee, 543; Cyclone on the Eastern Sicilian Coast on September 26, 553; Typhoon at Yokohama on September 29, 553; Cool Summer at Yokohama, Captain H. J. Shaw, 554; Studies in Atmospheric Electricity, Prof. Y. Homma, 555; Death of Dr. Julius Ziegler, 579; the International Meteorological Committee, 608; Series of Meteorological Tables at Truro, G. Penrose, 611; the Climates and Baths of Great Britain, 629; Map of Ireland showing Distribution of Rainfall, Dr. Mill, 644; Meteorology of the Equator, Dr. J. Hann, 660
- Meteorites; the Action of Copper Sulphate upon Iron Meteorites, O. C. Farrington, 311; Meteorites ploughed up at Admire, Kansas, G. P. Merrill, 422; the Casas Grandes Mass of Meteoric Iron, Mr. Fletcher, 559; Fall of a Meteoric Stone near Crumlin (Co. Antrim) September 13, W. H. Milligan, 577; Dr. J. Fletcher, 577
- Meteors: a Remarkable Bolide observed at Lyons on March 19, 208; Bright Meteor on July 13, 281, 309; the August Meteoric Shower, W. F. Denning, 309; the Perseid Meteoric Shower of 1902, W. F. Denning, 406; Radiant Point of the Perseids, Prof. Alexander Graham Bell, 440; a Remarkable Meteor, Archibald MacDowall and W. E. Rolston, 557; Meteor Radiants, M. Egnitius, 557; a Possible Meteor Shower on October 4, G. Percy Bailey, 577; a Bright Meteor, W. Lascelles-Scott, 638; the Leonid Shower, Prof. Pickering, 662; R. B. Taber, 662
- Metric System, Chart of the, Prof. C. Bopp, 630
- Metric System, Report on a Bill for Adoption of the, in the United States, 158
- Metz (G. de), Accidental Double Refraction of Liquids Mechanically Deformed, 192
- Meyer (G.), Erdmagnetische Untersuchung im Kaiserstuhl, 324
- Meyer (Dr. M. W.), Der Untergang der Erde und die kosmischen Katastrophen, 601
- Miall (L. C., F.R.S.), Injurious and Useful Insects, 293
- Micrometer, Electric, Dr. P. E. Shaw, 70
- Micrometer, Kew, Sir Joseph Hooker, 348
- Microscopy: Distinguishing between *Pleurosigma angulatum* and *P. balticum* under Low Powers, G. Marpmann, 39; Royal Microscopical Society, 46, 166, 262; M. Pilschler's Pocket Microscope, 46; "Soloid" Microscopic Stains, Burroughs, Wellcome, 87; Microscopic Effects of Stress on Platinum, Thomas Andrews, F.R.S., and Charles Reginald Andrews, 213; Structure of Acinetines, Prof. Marcus Hartog, 262; Metallurgy, an Introduction to the Study of the Structure of Metals chiefly by the Aid of the Microscope, Arthur H. Hiorns, 415; the Genus *Syncheta*, C. F. Rousselet,

- 448; Relations between the Mouth-organs of Diptera and Those of Other Insects, Walter Wesché, 512-13
- Midi, les Fleurs du, P. Granger, 368
- Miers (Prof. H. A.), Yukon Gold-fields, 86
- Miethe (Dr.), Uncomfortable Balloon Voyage, 254
- Military Education, Science and, 175
- Milk, Apparatus by which, can be Brought into the Form of Flour, 512
- Milk Industry, Mechanical Treatment in the, M. F. Bords and Sig. de Kaczowski, 456
- Milk, Influence of Cream Separation on the Principal Constituents of, F. Bords, Sig. de Kaczowski, 432
- Mill (Dr. H. R.), Cornish Dust-fall of January, 1902, 119; Map Showing the Distribution of Rainfall in Ireland, 644
- Milais (J. G.), Natural History of the British Surface-feeding Ducks, 266
- Miller (Hugh), the, Centenary, 156
- Miller (Hugh), his Work and Influence, Sir Archibald Geikie, D.C.L., F.R.S., 426
- Miller (Dr.), Ammonia, Nitrates and Chlorine in Rothamsted Rain-water, 22; Nitrates and Chlorine in the Drainage through Uncropped and Unmanured Land, 22
- Milligan (W. H.), Fall of a Meteoric Stone near Crumlin (Co. Antrim) September 13, 577
- Mills (J. E.), Applications of the Kinetic Theory of Gases, 400
- Milne (Prof. J., F.R.S.), the Recent Volcanic Eruptions in the West Indies, 56, 107, 151, 370; Recent West Indian Eruptions and Earthquake-recording Instruments, 619; Seismic Frequency in Japan, 202; World-shaking Earthquakes, 642
- Milwaukee, Convention of Weather Bureau Officials at, 543
- Minakata (Kumagasa), Distribution of Pithophora, 279
- Mind, the Elements of, H. J. Brooks, 317
- Mineral Waters, the Evolution of Artificial, William Kirkby, 602
- Mineralogy; Yukon Gold-fields, Prof. H. A. Miers, 86; Mineralogical Constitution of the Finer Material of the Bunter Pebble-bed in the West of England, H. H. Thomas, 95; Catalogue of the Educational Collection of Minerals of West Ham, Dr. H. A. Auden, 137; Flames from Mud on a Sea-shore, Rev. H. T. Dixon, 151; Relation of the Plutonic and other Intrusive Rocks in West Cornwall to the Mineral Ores, J. B. Hill, 159; Composition of the Volcanic Dust of Barbadoes on May 7 and 8, 204; Mineralogical Society, 215; Discrepancy in the Results of Meigen's Method of Discriminating Calcite and Aragonite, Dr. A. Hutchinson, 215; Reasons for the Non-existence of "Kalgolrite" and "Coolgarite" as Mineral Species, J. L. Spencer, 215; Crystallographic Characters of Liveingite, R. H. Solly, 215; Greenockite on Calcite from Joplin, Missouri, H. B. Cornwall, 310; Meteorite Ploughed up at Admire, Kansas, G. P. Merrill, 422; Euxite, Dr. H. Lienu, 539; on the Rocks Thrown Out by the Actual Eruption of Mont Pelée, A. Lacroix, 544; Enclosures in the Andesites from Mont Pelée, A. Lacroix, 572; the Casas Grandes Mass of Meteoric Iron, Mr. Fletcher, 556; Fall of a Meteoric Stone near Crumlin (Co. Antrim), September 13, W. H. Milligan, 577; Dr. L. Fletcher, F.R.S., 577; Death of the Rev. Dr. Wiltshire, 658
- Mining: the Misuse of Coal, Walter Rosenhain, 29; Prof. J. Perry, F.R.S., 30; W. Hibbert, 102; D. E. Hutchins, 240; the Anthracite Coal Industry, Peter Roberts, 50; the Mining Statistics of the World, Prof. C. Le Neve Foster, 163; Coal Cutting by Machinery in the United Kingdom, Sydney F. Walker, 414; Persons Employed and Accidents at Mines and Quarries in the United Kingdom in 1901, Prof. C. Le Neve Foster, F.R.S., 449; Death of Prof. O. G. Nordenström, 538; Gold Production and Life of the Main Reef Series, Witwatersrand, T. H. Leggett and F. H. Hatch, 659
- Minot (Prof. C. S.), Address at the Pittsburg Meeting of the American Association, 300
- Miquel (P.), *Traité de Bactériologie Pure et Appliquée à la Médecine et à l'Hygiène*, 316
- Misuse of Coal, the, Walter Rosenhain, 29; Prof. J. Perry, F.R.S., 30; W. Hibbert, 102; D. E. Hutchins, 246
- Mitchell (Sir Arthur), Ben Nevis Observatories, 349
- Mitchell (P. Chalmers), on the Intestinal Tract of Birds, 235
- Modern Scientific Geography, 649
- Moidrey (M. de), Phenomena Observed at Zi-Ka-Wei, China, during the Martinique Eruption, 408
- Moissan (Henri), Lithium Silicide, 95; Liquid Hydride of Silicon, 263; New Properties of Amorphous Silicon, 263; Preparation and Properties of a Silicide of Vanadium, 312; Sur les Matières Colorantes des Figures de la Grotte de Font-de-Gaume, 452; a New Silicide of Vanadium, 624; Iodine Pentafluoride, 637
- Molloy (Gerald), Stopping Down the Lens of the Human Eye, 56
- Mollusca: the Structure of the Gills of the Lamellibranchia, Dr. W. G. Ridewood, 165; Death and Obituary Notice of Oliver Collett, 328
- Mont Pelée, 53, 659; Mont Pelée Eruption and Dust Falls, Dr. William J. S. Lockyer, 53; Fresh Eruptions of, 278; Eruption of Mont Pelée heard at Maracaibo, Venezuela, E. H. Plumacher, 554; Notes on the Recent Eruptions of, Dr. H. A. Alford Nicholls, 638; Mont Pelée and Aterglow, F. C. Constable, 79; Sunsets of West of Switzerland and Dust from Mont Pelée, 305; Rocks of Mont Pelée, J. S. Diller, 372; on the Rocks Thrown Out by the Actual Eruption of Mont Pelée, A. Lacroix, 544; Enclosures in the Andesites from, A. Lacroix, 572
- Moon: Changes on the Moon's Surface, Prof. William H. Pickering, 40, 233; Theory of the Motion of the Moon, Ernest W. Brown, F.R.S., 356
- Moor (E.), Curious Optical Effect, 127
- Moore (Dr. B.), Physiology for Beginners, Leonard Hill, F.R.S., 369; Health, Speech and Song, a Practical Guide to Voice Production, Jutta Bell-Ranske, 388
- Morbology: New Fibre Blood Parasite in Man, J. Everett Dutton, 15; Acute Polymicrobial Osteomyelitis, M. Ragalski, 48; *Trypanosoma Theileri*, New Parasite in Blood of Cattle in South Africa, 15; Lieut.-Colonel Bruce, F.R.S., 84; Malarial Fever, its Cause, Prevention and Treatment, Ronald Ross, F.R.S., 269; Treatment of Malarial Fevers by Latent Arsenic, Armand Gautier, 47; Tuberculosis as a Disease of the Masses and How to Combat it, S. A. Knopf, 270; Death of Prof. Gerhardt, 305; Bats Capable of Transmitting Bubonic Plague, Dr. B. Gosio, 329; the Bacillus of Beriberi, Major Rost, 378; the rôle Played by Flies in the Propagation of Disease, Sir James Crichton Browne, 397; Prizes Awarded for Essays on Tropical Diseases, 397; the Thermal Death Point of the Tubercle Bacillus in Milk, Bovine Tuberculosis and Milk Supplies, H. L. Russell, 399; Screw-worm in Cattle at St. Lucia, Mr. Maxwell-Lefroy, 400; Horse Disease, 423; the Plague in the Punjab, 484; the "Sleeping Sickness" of Uganda, 484; Recent Studies of Immunity with Special Reference to their Bearing on Pathology, Prof. Welch, 611
- Mordey (W. M.), Electricity Meter, 84
- Morel (M. A.), Does Lipase Exist in Normal Serum? 48
- Morgan (J. Livingston R.), the Elements of Physical Chemistry, 100
- Morgan (Prof. Lloyd), Nature-study in Elementary Education, 326
- Morin (M.), Fatal Accident to, 710
- Morphology: Morphological Value of the Centrosome, Dr. Th. Boveri, 74; the Morphological Method and Progress, Opening Address in Section D at the Belfast Meeting of the British Association, Prof. G. B. Howes, F.R.S., 522; Human Embryology and Morphology, D. A. Keith, 603
- Morrell (G. Herbert), Nature Study, Realistic Geography, Model Based on the 6-inch Ordnance Survey, 666
- Morrison (W. Murray), Aluminium, Notes on its Production, Properties and Use, 655
- Morse (G. H.), Rectifier for Alternating Currents, 328; the Preparation of Cells for the Measurement of High Osmotic Pressures, 401
- Morton (Dr. Henry), Death of, 113
- Morton (Prof.), Experiments on the Motion of a Detached Thread of Liquid in a Capillary Tube, 618
- Mosquitoes: a Monograph of the Culicidae of the World, F. W. Theobald, 123; Paraffin Used to Mitigate the Plague of Mosquitoes in the City of Mexico, Señor A. L. Herrera, 423
- Mossman (R. C.), Meteorological Conditions Accompanying "Föhn" and Up-bank Thaws in Glen Nevis, 167
- Motion of the Pole, Dr. J. C. Chandler, 309
- Mott (Dr.), on the Regeneration of Nerves, 664
- Mount Chullapata, Activity of, 553
- Mount Macdonald, Geology of, Prof. J. W. Gregory, 207

- Mountain Masses and Latitude Determinations, Major S. J. Burrard, 80
- Moureaux (Th.), Magnetic Perturbation on May 8, 96
- Mud, Flames from, on a Sea-shore, Rev. H. T. Dixon, 151
- Muir (Thomas, F.R.S.), Formula for the Perimeter of an Ellipse, 174
- Muir (Dr. Thomas, F.R.S.), Symbol for Partial Differentiation, 271, 520
- Municipal Engineering and Sanitation, M. M. Baker, 173
- Munro (John), Time-signals by Wireless Telegraphy, 416
- Murché (Vincent T.), the Teacher's Manual of Object Lessons in Geography, 270
- Murchison Falls, the, C. Steuart Betton, 188
- Museums: Catalogue of the Collection of Birds Eggs in the British Museum (Natural History), E. W. Oates, 322; Guide to the Galleries of Mammalia in the British Museum (Natural History), 322; Guide to the Coral Gallery in the British Museum (Natural History), R. Kirkpatrick and F. J. Bell, 322; F. W. Rudler and the Museum of Practical Geology, 553; on the Classification and Arrangement of Anthropological Museums, Dr. W. H. Holmes, 664
- Mushrooms: the Most Effectual Plan for Starting the Germination of Spores of *Agaricus campestris*, Dr. Margaret C. Ferguson, 612
- Mycology: Mycoplasma, E. M. Freeman, 7; Fungal Diseases of the Tea-plant, J. B. Curruthers, 136; Rust-fungus, Prof. Marshall Ward, 210
- Mycoplasma, E. M. Freeman, 7
- Myers (Dr. C. S.), Observations in the Smallest Perceptible Musical Tone-difference as Examined in the People of Scotland and of the Torres Straits, 666
- Mythology: the Ruling Races of Prehistoric Times in India, South-western Asia and Southern Europe, J. F. Hewitt, 145; History and Chronology of the Myth-making Age, J. F. Hewitt, 145; Celtic Mythology, Lady Gregory, 489; Japanische Mythologie, Nihongi "Zeitalter der Gotter," Dr. Karl Florenz, 546
- Nascius (F. C. de), à la Conquête du Ciel, 199
- Natural History: Linnean Society, 22, 47, 94, 263; the Sweet Briar as a Goat Exterminator, Sir W. T. Threlton-Dyer, F.R.S., 31; a Rare Wild Sheep, R. Lydecker, F.R.S., 32; Means Taken by the Different County Councils for Training Teachers in the Best Methods of Imparting "Nature-knowledge" to their Pupils, 39; Death and Obituary Notice of John Clavell Mansel-Pleydell, 65; Memoirs of the Kazan Society of Naturalists, 70; New South Wales Linnean Society, 96, 264, 312, 384, 516; Death of John Bellows, 113; Chickens Hatched in a Tree, W. H. Hall, 127; Memoir of Dr. C. Berg, Señor A. Gallardo, 184; Nature Study and Life, C. F. Hodge, 245; the Nature Study Exhibition, Wilfred Mark Webb, 324; Nature Study in Elementary Education, Prof. Lloyd Morgan, 326; Nature Study, Lord Avebury, 326; How County Councils may Encourage Nature Study, Henry Hobhouse, 326; Realistic Geography Model Based on the 6-inch Ordnance Survey, G. Herbert Morrell, 606; Natural History of the British Surface-Feeding Ducks, J. G. Millais, T. Digby Pigott, C. B., 266; Spiderland, Rose Haig Thomas, 270; the Lake Counties, W. G. Collingwood, 271; Report on the Collections of Natural History Made in the Antarctic Regions during the Voyage of the *Southern Cross*, R. B. Sharpe and F. J. Bell, 322; Catalogue of the Collection of Birds' Eggs in the British Museum (Natural History), E. W. Oates, 322; Guide to the Galleries of Mammalia in the British Museum (Natural History), 322; Guide to the Coral Gallery in the British Museum (Natural History), R. Kirkpatrick and F. J. Bell, 322; the Seasonal Study of Natural History, Prof. J. Arthur Thomson, 326; Death and Obituary Notice of Oliver Collett, 328; the late Prof. A. Hyatt, 330; How the Sabre-toothed Tigers Killed their Prey, 357; the Cambridge Natural History, Mammalia, F. E. Beddard, 373; the Face of Nature, Rev. C. T. Ovenden, 439; Animal Intelligence, L. C. Hurt, 459; Bipedal Locomotion of a Ceylonese Lizard, E. Ernest Green, 492; Rose Haig Thomas, 551; Bipedal Locomotion in Lizards, N. Anandanda, 577; W. Saville Kent, 630; the Naturalist on the Thames, C. J. Cornish, 632; Upland Game-Birds, E. Sandys and T. S. Van Dyke, 652; Wild Fruits of the Country-side, F. Edward Hulme, F.S.A., 653
- Natural Selection: Colour-Variation in the Guinea-Fowl, F. Finn, 126; Material for Natural Selection, Prof. T. D. A. Cockerell, 607
- Naval Architecture: the Proposed Experimental Tank for Testing Ship Models for Resistance, 128; Les Bateaux Sous-Marins et les Submersibles, R. D'Equevilly, 290; Death and Obituary Notice of Benjamin Martell, 305
- Naval Balloon Accident, French, Lieutenant Baudic Drowned, 183
- Navigation: Meteorological Pilot Chart for May, 15; for June, 114, 206; for August, 307; for November, 635; the Malay Type of Sea-going Boat, 114; Coast Fcg Signals, E. Price Edwards, 115; Single-handed Dividers, F. Howard Collins, 378
- Naylor (W.), Trades' Waste, its Treatment and Utilisation, 413
- Nebula, the Orion, and Movement in the Line of Sight, Prof. H. C. Vogel and Dr. Eberhard, 18
- Nebulosity, Remarkable Naked Eye, W. H. Robinson, 233
- Neelect of Anthropology in British Universities, the, "Anthropotamist," 654
- Neal (W. G.), the Ancient Ruins of Rhodesia, 34
- Nearer East, the, D. G. Hogarth, 649
- Negriss (Ph.), Plissements et Dislocations de l'Écorce Terrestre en Grèce, 28
- Neptune, the Discovery of, by the late Prof. J. Couch Adams, 84
- Neptune, the Search for a Planet beyond, T. Grigull, 614
- Nerve, Fatigue and, Prof. Gotch, 666
- Nerves, on the Regeneration of, Prof. Halliburton, Dr. Mott, 664
- Navado de Chañi, Archaeological Remains on the Summit of the, Dr. Erland Nordenskiöld, F.R.S., 440
- New South Wales Linnean Society, 96, 264, 312, 384, 516
- New South Wales Royal Society, 360, 456, 572
- New York Central Railway to be Worked Electrically, D. J. Arnold, 308
- New York School Children, Ophthalmia among, 539
- New York Zoological Park, 232
- Newell (Lyman C.), Experimental Chemistry, 170
- Neyroz (Dr. U.), Experimental Investigations on the Depth of Sleep, 137
- Niagara Falls Power Plant as a Factor in Engineering Development, 232
- Nicholls (Dr. H. A. Alford), Notes on the Recent Eruptions of Mont Pelée, 638
- Niedenfuhr (Mr.), a Comparative Economic Study of the Manufacture of Sulphuric Acid by the Anhydride and the Modern Lead Chamber Processes, 330
- Nile, the Black Coloration of the Rocks Forming the Cataracts of the, MM. Lortet and Hugouneq, 95
- Nile, the "Sudd" of the White, 666
- Nitrogen, Commercial Fixation of, 135
- Noble (Wilson), Mechanical Break, 22
- Nodon (M.), New Electric Valve, 159; Actino-electric Phenomena, 240
- Norddeutschlands, die Heide, P. Graebner, 27
- Nordenskiöld (Dr. Erland, F.R.S.), Archaeological Remains on the Summit of the Nevado de Chañi, 440
- Nordenström (Prof. O. G.), Death of, 538
- Nordmann (M.), Propagation of Electric Force from the Sun into Space, 136
- North Atlantic Pilot Chart for May, 15; for June, 114, 206; for August, 307; for November, 635
- North Queensland Ethnography, Walter E. Roth, 380
- Notation of Variable Stars, 205
- Nova Persei, 282; Observations of, 233; Discoverer of Nova Persei, 282; the Spectrum of Nova Persei, Prof. Campbell and Mr. Wright, 425; the Changes in the Nebula Surrounding, Prof. Louis Bell, 426
- Nugent (Paul C.), Plane Surveying, a Text and Reference Book for the Use of Students in Engineering and for Engineers Generally, 243
- Nutting (P. G.), the Effect of Light on Cyanin, 416
- Oates (E. W.), Catalogue of the Collection of Birds' Eggs in the British Museum (Natural History), 322
- Observatories: Meteorological Observations at Stonyhurst College Observatory for 1901, 38; Colaba Observatory, 68; the Royal Observatory Visitation, 161; Mr. Tebbutt's Observatory

- at Windsor, N.S.W., 258; Annales de l'Observatoire National d'Athènes, Demétrius Eginitis, 331; Report of the Cape Observatory for 1901, Sir David Gill, 331; M. Faye and the Paris Observatory, Wilfred de Fonvielle, 343; Ben Nevis Observatories, Sir Arthur Mitchell, 349; Report on the Melbourne Observatory for 1901, 541
- Oceanography: Cape of Good Hope Department of Agriculture Marine Investigation in South Africa, Observations on the Temperature and Salinity of the Sea around the Cape Peninsula, J. D. F. Gilchrist, 260
- Oceans, a New Theory of the Tides of Terrestrial, Rollin Harris, Prof. G. H. Darwin, F.R.S., 444
- Occlusion of W Leonis, 208
- Oculations of Stars and Solar Eclipses, Francis Crammer Penrose, 149
- Oddone (Dr. Emilio), Seismology, Observations on Explosion of Ten Tons of Gunpowder in the Granite Quarries near Baveno, 350
- Odone (Prof. E.), Proposed Non-pendulum Forms of Apparatus, 234
- Ogawa (Mr.), Preparation of Sulphamide from Ammonium Amido-sulphite, 541
- O'Gorman (Mervyn), Schule des Automobil Fahrers, Wolfgang Vogel, 313
- Oil, the Use of, as Fuel for Engines, 207
- Oil Chemist's Handbook, the, Erastus Hopkins, 52
- Okapi Specimens, the Brussels, Dr. Forsyth Major, 185
- Oliver (Dr.), Dangerous Trades, the Historical, Social and Legal Aspects of Industrial Occupations as Affecting Health, 433
- Olmsted (F. E.), Working Plans for Forests in Arkansas, 661
- Omond (R. T.), a Solar Halo, 103
- Omori (Dr. T.), on the Deflection and Vibration of Railway Bridges, 332
- Ophir, Rhodesia and, R. N. Hall and W. G. Neal, Prof. A. H. Keane, 34
- Ophthalmia among New York School Children, 539
- Optics: Obituary Notice of Prof. Alfred Cornu, Prof. Silvanus P. Thompson, F.R.S., 12; Stopping down the Lens of the Human Eye, Wm. Andrews, 31, H. Bliss, 56, Gerald Molloy, 56; the Lens: a Practical Guide to the Choice, Use and Testing of Photographic Objectives, T. Bolas and George E. Brown, 75; a Method of Showing the Invisibility of Transparent Objects under Uniform Illumination, Prof. R. W. Wood, 102; Action of Light on Precious Stones, M. Chaumet, 119; Curious Optical Effect, E. Moor, 127; German Progress in Optical Work, Herbert F. Angus at the Optical Society, 135; Contribution to the Study of the Magnesium Light, Albert Londe, 168; Accidental Double Refraction of Liquids Mechanically Deformed, G. de Metz, 192; Einführung in die Theorie der Doppelbrechung, Heinrich Greinacher, 653; de la Double Refraction Elliptique et de la Tétracfringence du Quartz dans le Voisinage de l'axe, G. Quesneville, 386; Experiment Illustrating a Paradoxical Consequence of the Wave Theory of Light, Edwin Edser and Edgar Senior, 204; Study of Bright Points and Curves, 208; Contributions to the Study of Flicker, T. C. Porter, 213; Actino-electric Phenomena, Albert Nodon, 240; some New Forms of Geodetical Instruments, 276; the Refractive Indices of Fluorite, Quartz and Calcite, J. William Gifford, 287; Correction, 308; the Structure of the Retina of the Eye, H. M. Bernard, 308; Photography of Diffraction and Polarisation Effects, W. B. Crofts, 354; Simple Means of Producing Diffraction Effects, Wilfred Hall, 416; Reflection of Light from an Iron Mirror Magnetised Perpendicularly to the Plane of Incidence, P. Camman, 384; Novel Magneto-optic Phenomena, Dr. Quirino Majorana, 398; Magneto-optic Rotation in the Interior of Absorption Bands, Prof. Zeeman, 622; Application of the Stereoscope to Lantern Projections, J. Macé de Lépinay, 581
- Orchids, the Culture of Greenhouse, Frederick Boyle, 59
- Ordnance Survey of England and Wales, 341
- Organogeny, Avian, on the Intestinal Tract of Birds, P. Chalmers Mitchell, 235
- Organography: Organographie der Pflanzen insbesondere der Archegoniaten und Samenpflanzen, Dr. K. Goebel, Prof. J. B. Farmer, F.R.S., 51
- Orion Nebula and Movement in the Line of Sight, Prof. H. C. Vogel and Dr. Eberhard, 18
- Orion Nebula, Radial Velocity of the, Prof. H. C. Vogel and Dr. Eberhard, 309
- Ornithology: More Tales of the Birds, W. W. Fowler, 4; Bird Hunting on the White Nile, H. F. Witherby, 52; the Birds of North and Middle America, the Fringillidae, R. Ridgway, 75; Chickens Hatched in a Tree, W. H. Hall, 127; Cuckoo's Egg thrown out of Bunting's Nest, 151; Cuckoo heard on August 18, Mrs. R. W. Longfield, 421; the Early Life of the Young Cuckoo, W. P. Westell, 574; Colour Variation in Pigeons, F. Finn, 157; Recent Egg-sale prices, 160; Bird-Migration observed from the Eddy-stone, W. E. Clarke, 185; on the Intestinal Tract of Birds, P. Chalmers Mitchell, 235; Osteology of the Owls, W. P. Pycraft, 263; Natural History of the British Surface-feeding Ducks, J. G. Millais, T. Digby Pigott, C.B., 266; Catalogue of the Collection of Birds' Eggs in the British Museum (Natural History), E. W. Oates, 322; Notes on Young Gulls, Prof. R. v. Lendenfeld, 415; Birds in the Garden, G. Sharp, 444; Effect of Wind on the Migration of Hawks, C. C. Trowbridge, 612
- Orton (Dr.), Preparation of Highly Substituted Nitroamino Benzenes, 70
- Osborn (Prof. H. F.), Law of Adaptive Radiation among Mammals, 184; the Eocene Primates and Rodents of North America, 379; the Titanotheres of the Oligocene, 399; the Morphological Importance of Length or Shortness in the Skulls of Mammals, 399
- Osborne (Dr.), Researches on Glycogen, 666
- Oscillographs, the Study of Resonance by Means of, M. Armagnat, 307
- Ostenfeld (C. H.), Flora Arctica, 490
- Osteology of the Owls, W. P. Pycraft, 263
- Ostfriesischen Inseln, Flora der, Dr. Fr. Buchanau, 149
- Outer Isles, A. Goodrich-Freer, 548
- Ovenden (Rev. C. T.), the Face of Nature, 439
- Owls, Osteology of the, W. P. Pycraft, 263
- Oxford, the Rise of the Experimental Sciences at, Boyle Lecture at Oxford, Prof. T. Clifford Allbutt, F.R.S., 90; Fog Bow at Oxford, J. Rose, 416
- Oxy-acetylene Blowpipe, M. Fouché, 159
- Oysters from Syria, Remarkable Fossil, Alfred Ely Day, 606; E. T. N., 607
- Page (S.), Sunset Effects, 390
- Pachundaki (D. E.), Geological Constitution of the Neighbourhood of Alexandria, Egypt, 648
- Packard (Alpheus S.), Lamarck, the Founder of Evolution, his Life and Work, 169
- Palther (F.), Action of Alcoholic Fermentation on the *Bacillus typhosus* and the *Bacillus coli*, 384
- Palaebotany: on Fossil Pollens, &c., in the Coal-measures, B. Renault, 432; *Idiophyllum rotundiflorum*, a Synonym of *Neuropteris varinervis*, E. H. Sellards, 571; 572
- Palaolithic: Palaolithic Implements in Ipswich, Nina Frances Layard, 77; Reproduction des Figures palaolithiques peintes sur les parois de la Grotte de Font-de-Gaume, Dordogne, Mm. Capitan and Breuil, 452; sur les Matières colorantes des Figures de la Grotte de Font-de-Gaume, Henri Moissan, 452; les Figurations préhistoriques de la Grotte de la Mouthe, Dordogne, Emile Rivière, 452
- Palaontology: Death of Henri Filhol, 14; Obituary Notice of, 133; a New Type of Human Fossil, R. Verneau, 24; New Fossil Mammals and Reptiles from Egypt, 83; Specimens Discovered in 1901 in Crete by Mr. Hogarth, 95; Palaontologie und Descendenzlehre, E. Koken, 126; Structure and Classification of the Tremataspidae, Prof. William Patten, 184; the Iguanodonts of Bernissart, L. F. de Pauw and Prof. van den Broeck, 231; History of Geology and Palaontology to the End of the Nineteenth Century, Karl Alfred von Zittel, 242; the Eocene Primates and Rodents of North America, Prof. H. F. Osborn, 379; the Titanotheres of the Oligocene, Prof. Osborn, 399; New Pleistocene Rhinoceros, Prof. F. Toula, 379; Corr., 399; Belly River Dinosaurs, Mr. Lambe, 400
- Palestine: Legends of Palestine and Arabia, 517; on a Pre-historic Cemetery-cave in, K. A. S. Maclacris, 663
- Papuan Gulf, on the Religious Ideas of the Elema Tribe of the, Rev. J. H. Holmes, 664

- Papuan Gulf, on the Sacred Initiation Ceremonies Undergone by the Lads of the, Rev. J. H. Holmes, 604
- Parallels, a Method of Treating, Dr. S. W. Richardson, 223; W. R. Jamieson, 576
- Paré (Very Rev. G.), Last Days of St. Pierre, 372
- Parhelion, Sun-Pillar and, Prof. Grenville A. J. Cole, 32
- Paris: Paris Academy of Sciences, 23, 47, 71, 95, 119, 143, 167, 192, 216, 240, 263, 288, 312, 335, 360, 383, 408, 432, 456, 488, 516, 544, 572, 623, 648, 671; Paris Geographical Society's Prizes for this Year, 135; Forestry Exhibition in Paris in 1900, J. S. Gamble, F.R.S., 283; M. Faye and the Paris Observatory, Wilfred de Fonvielle, 343
- Parke (G. J.), Heat Evolved or Absorbed when a Liquid is Brought in Contact with a Finely Divided Solid, 262
- Parsons (Hon. C. A.), Steam Turbines, 643
- Parsons (J.), Evidence of a "Seiche" on a Scottish Loch, 192
- Partial Differentiation, Symbol for, Prof. John Perry, F.R.S., 53, 271, 520; Dr. Thomas Muir, 271, 520; A. B. Basset, F.R.S., 576
- Pasteur, Statue to, at Dôle, 377
- Patagonia, the Larger Mammals of, Hesketh Prichard, 46
- Pathology: Some Thoughts on the Principles of Local Treatment in Diseases of the Upper Air Passages, Sir Felix Semon, 149; Pathologie Générale et Expérimentale, Les Processus Généraux, A. Chantemesse and W. Podwysotsky, 363; Death of Prof. Rudolph Ludwig Karl Virchow, 483; Obituary Notice of, 551; Recent Studies of Immunity with Special Reference to their Bearing on Pathology, Prof. Welch, 611
- Paton (Lewis Bales), Syria and Palestine, 517
- Patten (Prof. William), Structure and Classification of the Tremataspidae, 184
- Patterson (Dr. J. Hume), on the Causes of Salmon Disease, 640
- Patterson (Dr. T. S.), Influence of Solvents on the Rotation of Optically Active Compounds, 191
- Pau, Earthquake at, 484
- Pauw (L. F. de), the Iguanodon of Bernissart, 231
- Pax (F.), Grundzüge d. Pflanzenverbreit. i. d. Karpathen, 27
- Pearl Fisheries in the Gulf of Manaar, Prof. Herdman, 486
- Pearson (Prof. Karl, F.R.S.), Astronomy in the University of London, 174; on the Correlation between the Barometric Height at Stations on the Eastern Side of the Atlantic, 311
- Pearson (William Henry), the Hepaticæ of the British Isles, 385
- Pearly Arctic Expedition, Return of the, 542
- Peat, Use of, in Sweden as a Substitute for Coal for Steam Engines, 256
- Pechmann (Prof. H. von), Death and Obituary Notice of, 37
- Péroul (M.), Quantitative Examination of Atmospheric Air, 308
- Peddle (Dr. W.), Use of Quaternions in the Theory of Screws, 239
- Pendulum, the Compound, S. A. F. White, 22
- Penning (William Henry), Death and Obituary Notice of, 15
- Pennsylvania, Anthracite Mining in, Peter Roberts, 50
- Penrose (Francis Cranmer), Occultations of Stars and Solar Eclipses, 149
- Penrose (G.), Series of Meteorological Tables at Truro, 611
- Perimeter of an Ellipse, Formula for the, Thomas Muir, F.R.S., 174
- Perkin (A. G.), Constituents of Gambia and Acacia Catechus, 214
- Perkin (Dr. F. Mollwo), Enzymes and their Applications, J. Effront, 197; the Influence of Education upon Trade and Industry, 442; Trade Statistics, 550
- Perkin (W. H., jun.), an Introduction to Chemistry and Physics, 52
- Perkins (H. F.), Degeneration-process in Larval Coelenterates of the Genus *Gonionema*, 612
- Perrine (Prof.), Search for an Intra-Mercurial Planet during the Total Solar Eclipse of 1901, 662
- Perrine, Photograph of Comet δ 1902, 638
- Perrine's Comet 1902 δ , Observations of, 558
- Perrot (E.), *Kunkeliba*, 120
- Perrot (F. Louis), on the Formation of Liquid Drops and the Laws of Tate, 544, 672
- Perry (Prof. J., F.R.S.), the Misuse of Coal, 30; Symbol for Partial Differentiation, 53, 271, 520; Opening Address in Section G at the Belfast Meeting of the British Association, 530; the Training of Engineers, 644; Science and Literature, 645; Matriculation Requirements in Scottish Universities, 654
- Perseid, Nova, 282; Observations of, 233; Discoverer of Nova Persei, 282; Spectrum of, Prof. Campbell and Mr. Wright, 425; the Changes in the Nebula Surrounding Nova Persei, Prof. Lewis Bell, 426
- Perseids: Photographs of the, in 1901, 309; Perseid Meteoric Shower of 1902, the, W. F. Denning, 406; Radiant Point of the Perseids, Prof. Alexander Graham Bell, 440
- Persia, Ten Thousand Miles in, or, Eight Years in Iran, Major Percy Molesworth Sykes, 418
- Persulphuric Acids, Prof. Henry E. Armstrong, V.P.R.S., and J. Martin Lowry, 45
- Petavel (Mr.), on the Production of a Standard Light, 618
- Petch (T.), Rearrangement of Euclid i., 1-32, 7
- Petroleum Districts, Spring Waters from, Contain no Sulphates, Prof. Höfer, 256
- Petroleum Formation, Chemical Theory of, Paul Sabatier and J. B. Senderens, 138
- Pharmacology: Pharmacology at the British Medical Association, 353; Factors which Tend to Render Medicines Ineffective or Productive of Unusual Effects, Sir Lauder Brunton, 353; Therapeutic Value of Alkaline Waters of the Vichy Type, Prof. Liebreich, 353; Synthetic Purgatives, Prof. Tuncliceli, 353; Therapeutic Value of Arsenic, Dr. Ralph Stockman, 353
- Philadelphia, Report of the Zoological Society of, 159
- Phillips (Theodore), a Dark Spot on Jupiter, 401
- Phillips (W. B.), the Coal, Lignite and Asphalt Rocks of Texas, 379
- Philosophy: the Basis of Social Relations, D. G. Brinton, 221; the Criterion of Scientific Truth, G. Shann, 221; Die Philosophie August Comte's, L. Levy Bruhl, 369; Philosophy of Conduct, G. T. Ladd, 389; Death of Prof. J. J. Hummel, 511; Helmholtz on the Value of the Study of Philosophy, B. Branford, 550
- Phisalis (C.), Poison of the Toad, 288
- Phosphorus versus Lime in Plant Ash, Dr. P. Q. Keegan, 655
- Photography: Photographic Apparatus, Making and Repairing, F. W. Cooper and D. W. Gawn, 4; the Lens, a Practical Guide to the Choice, Use and Testing of Photographic Objectives, T. Bolas and George E. Brown, 75; New Fluid Lens, Dr. E. F. Grün, 135; Stereoscopic Method of Photographic Surveying, H. G. Fourcade at the South African Philosophical Society, 139; Employment of Urine in the Development of the Photographic Plate, R. A. Reiss, 144; Photography as an Aid to the Surveyor, Arthur O. Wheeler, 206; Photography as Applied to Architectural Measurement and Surveying, J. Bridges Lee at Society of Arts, 235; Distribution of the Stars in the Cape Photographic Durchmusterung, Dr. Downing, 238; Reduction of Measures of Swift's Comet (α 1899) from Photographs taken with a Portrait Lens of 30-inch Focus and 5-inch Aperture, Mr. Filon, 238; Reductions of Photographs of Eros for the Determination of Solar Parallax, Mr. Hinks, 238; Influence of the Photographic Magnitude of Stars upon the Scale of Reduction of a Negative, Prosper Henry, 240; Photographic Magnitude of Stars, Prosper Henry, 282; Photographs of the Perseids in 1901, 309; Photograph of Comet δ 1902 (Perrine), 638; the Watkins Manual of (Photographic) Exposure and Development, Alfred Watkins, 245; "Cooke" Photographic Lenses, Method by which the Focal Length may be Reduced, Messrs. Taylor and Co., 280; Photography of Diffraction and Polarisation Effects, W. B. Croft, 354; the Dictionary of Photography, E. J. Wall, 368; the Principles of Simple Photography, F. W. Sparrow, 389; Birds in the Garden, G. Sharp, 444; P.O.P. (the Use of Silver Printing-out Papers), A. Horsley Hinton, 519; the Scientific and Technical Exhibits at the Royal Photographic Society's Exhibition, 582; Parallax Stereogram, F. E. Ives, 582; Photograph of the Spectrum of the Arc Light, Edgar Senior, 582; Method of Copying Engravings by Superposition, Hort Player, 582
- Photometric Tests of the Bremer Arc Lamp, M. Laporte and Prof. Wedding, 611
- Physic Garden, the Chelsea, 321
- Physical Geography, Margaret A. Reid, 653
- Physics: a Laboratory Manual of Physics, H. Crew and R. R. Taitnall, 4; Physical Society, 21, 70, 118, 262; Prisms and Plates for Showing Dichromatism, Prof. R. W. Wood, 31; Interference of Sound, the Right Hon. Lord Rayleigh, F.R.S., at the Royal Institution, 42; the Indices of

- Refraction of Liquid Mixtures, Edm. van Aubel, 47; Mathematical and Physical Papers, Sir G. G. Stokes, Prof. Horace Lamb, F.R.S., 49; an Introduction to Chemistry and Physics, W. H. Perkin, jun., and Bevan Lean, 52; the Kinetic Theory of Planetary Atmospheres, Prof. G. H. Bryan, F.R.S., 54; Dr. E. Rogovsky, 222; Applications of the Kinetic Theory of Gases, J. E. Mills, 400; a Consequence of the Kinetic Theory of Diffusion, J. Thovert, 648; Electric Micrometer, Dr. P. E. Shaw, 70; Experiment Suggested by the late Prof. Fitzgerald for Testing the Relative Motion of the Earth and the Æther , Prof. F. T. Trouton, 66; Atoms and Valencies, J. Fraser, 68; Film Structures in Metals, George Beilby, 84; the Elements of Physical Chemistry, J. Livingston R. Morgan, 100; Harry C. Jones, 220; Ebullition of Rotatory Water, J. C. Porter, 118; Physical Properties of Hydrogen Telluride, MM. de Forcrand and Fonzes-Diacon, 144; on the Sensitiveness of the Coherer, E. R. Wolcott, 158; Accuracy of an Improved Form of Silver Voltmeter, T. W. Richards and G. W. Heimrod, 158; Dispersive Power of Running Water on Skeletons, W. L. H. Duckworth, 166; Sedimentation Experiments and Theories, Prof. Joly, 207; Matter and Motion in Space, Sir Hiram S. Maxim, 223; Heat Evolved or Absorbed when a Liquid is brought in Contact with a Finely Divided Solid, G. J. Parks, 262; the Structure of the Retina of the Eye, H. M. Bernard, 308; Scientific Memoirs, 315; Junior Chemistry and Physics, H. Jerome Harrison, 317; a Manual of Elementary Practical Physics, Julius Hortvet, 341; the Royal Prize of the Reale Accademia dei Lincei for Physics awarded to Prof. Cantone, 377; a Text-book of Physics, with Sections on the Applications of Physics to Physiology and Medicine, R. A. Lehfeldt, 387; Die Welt Herrin und ihr Schatten, Ein Vortrag über Energie und Entropie, Dr. Felix Auerbach, 414; Elements of Physics, C. Henderson and John F. Woodhull, 458; Physical Experiments, John F. Woodhull and M. B. van Arsdale, 458; on the Use of Fourier's Series in the Problem of the Transverse Vibrations of Stretched Strings, Dr. H. S. Carslaw, 485; Sichtbare und Unsichtbare Bewegungen, H. A. Lorentz, 489; the Formation of Liquid Drops and Tate's Laws, Ph. A. Guye and F. Louis Perrot, 544, 672; a Text-book for Secondary Schools, Prof. Frederick Slate, 575; Refractivities of the Inert Gases, Clive Cuthbertson, 607; Redetermination of the Density and Coefficient of Cubical Expansion of Ice at 0°C ., J. H. Vincent, 611; Vortex Spirals, Dr. J. Larmor, F.R.S., 630; Elastic Parameters of Silk Fibres, F. Beaulard, 672
- Physiology: Does Lipase Exist in Normal Serum? MM. Doyon and A. Morel, 48; Zymogens and Enzymes of the Pancreas, Dr. H. M. Vernon, 87; Das Eisen als das thätige Prinzip der Enzyme und der lebendigen Substanz, N. Sacharoff, 651; the Electrical Resistance of the Blood, Dr. Dawson Turner, 127; Chemistry of Respiration in Bacteria, Dr. W. E. Adeney, 167; Directions for Class Work in Practical Physiology, E. A. Schäfer, F.R.S., 100; Influence of Lecithin on the Development of the Skeleton and of Nervous Tissue, A. Desgrez and Aly Zaky, 120; Biochemical Action of Extract of Kidney on Certain Organic Compounds, E. Gérard, 144; Obituary Notice of Prof. Adolf Fick, Prof. Kunkel, 180; Arsenic as a Normal Constituent of Animals, Armand Gautier, 216; Arsenic in the Organism, Gabriel Bertrand, 216; Production of Glycose by the Muscles, MM. Cadéac and Maignon, 216; Spectrum of *Hæmoglobin*, L. Bier and L. Marchlewski, 230; Comparative Study of the Permeability of Living and Dead Animal Membranes by Measurement of the Electrolytic Resistance, G. Galeotti, 256; Influence of Choline on the Glandular Secretions, A. Desgrez, 288; Coccidia found in the Kidney of *Rana esculenta*, A. Laveran and F. Mesnil, 312; Experimental Observations on Leucolysis, Drs. A. Goodal and E. Ewart, 335; on the Existence in the Albumin of Birds' Eggs of a Fibrogen Substance Capable of being Transformed *in vitro* into Pseudo-organised Membranes, Armand Gautier, 335; Anæsthesia by Electric Currents, Stephane Leduc, 336; Mannite, the Nitrates and the Alkaloids of Normal Urine, S. Dombrowski, 360; Physiology for Beginners, Leonard Hill, F.R.S., Dr. B. Moore, 369; Antiparameccious Serum, M. Ledoux-Lebard, 384; Variation of the Phosphoric Acid in Cow's Milk with Time after Calving, H. Bordas and Sig. de Raczkowski, 384; a Text-book of Physics, with Sections on the Applications of Physics to Physiology and Medicine, R. A. Lehfeldt, 387; Health, Speech and Song, a Practical Guide to Voice Production, Jutta Bell-Ranske, Dr. B. Moore, 388; the Conservation of Muscular Potential in an Atmosphere of Carbon Dioxide, Lhotak de Lhota, 432; on Skin Currents, Part III, the Human Skin, Augustus D. Waller, F.R.S., 455; Religio Medici, &c., 457; Plant Physiology: Elementary Plant Physiology, D. T. Macdougall, 76; Ueber Aehnlichkeiten im Pflanzenreich, Prof. F. Hildebrand, 246; the Influence of Varying Amounts of Carbon Dioxide in the Air on the Photo-synthetic process of Leaves and on the Mode and Growth of Plants, Dr. Horace T. Brown, F.R.S., and F. Escombe, 620
- Picard (Emile), Quelques Réflexions sur la Mécanique suivies d'une première Leçon de Dynamique, 101
- Pickering (Prof. William H.), Changes on the Moon's Surface, 40; Catalogue of North Polar Stars, 88; Changes on the Moon, 333; Observations of Variable Stars of Long Period, 486; the Lick Photographs, 487; the Leonid Shower, 662
- Pierce (Arthur Henry), Studies in Auditory and Visual Space Perception, 73
- Pigeons, Colour Variation in, F. Finn, 157
- Pigott (T. Digby, C. B.), Natural History of the British Surface-feeding Ducks, J. G. Millais, 266
- Pillischer (M.) Pocket Microscope, 46
- Pilot Chart of the North Atlantic and Mediterranean for May, 15; for June, 114, 206; for August, 307; for November, 635
- Pines of Western Asia, the, Sir J. D. Hooker, F.R.S., 53; the Writer of the Note, 53
- Pisciculture: Pisciculture in the United States, America, Earl Gray, 65; Introduction into New South Wales of European Flat-fishes, 580
- Pithophora, Distribution of, Kumaguru Minakata, 279; Prof. G. S. West, 296
- Pitte (H.), Etude Pratique sur les Différents Systèmes d'Eclairage, 172
- Pittsburg Meeting of the American Association, 299; Address by Prof. C. S. Minot, 300
- Piutti (A.), Products of Catalpa Fruit, 87
- Plague: the Plague in the Punjab, 484
- Plane Surveying: a Text and Reference Book for the Use of Students in Engineering and for Engineers Generally, Paul C. Nugent, Major C. F. Close, 243
- Planets: Discovery of Neptune by the late Prof. J. Couch Adams, F.R.S., 84; the Search for a Planet beyond Neptune, T. Grigill, 614; Saturn Visible through the Cassini Division, C. T. Whitmell, 87, 296; Minor Planets, 353; Satellites of Saturn and Uranus, Prof. J. J. See, 380; Spectral Researches on the Rotation of the Planet Uranus, H. Deslandres, 572; New Minor Planets, Prof. Max Wolf, 542; a New Minor Planet, 614; Rotation Period of the Superior Planets, M. Deslandres, 380; Equatorial Current on Jupiter, W. F. Denning, 138; a Dark Spot on Jupiter, Theodore Phillips, 401; Leo Brenner, 487; the Fifth Satellite of Jupiter, Prof. Barnard, 662; the Kinetic Theory of Planetary Atmospheres, Prof. G. H. Bryan, F.R.S., 54; Dr. E. Rogovsky, 222; Search for an Intra-Mercurial Planet during the Total Solar Eclipse of 1901, Prof. Perrine, 662
- Plant Ash, Phosphorus *versus* Lime in, Dr. P. Q. Keegan, 655
- Plant Assimilation, Influence of Light upon, E. G. Hennessey, 103
- Plant Physiology: Elementary Plant Physiology, D. T. Macdougall, 76; Ueber Aehnlichkeiten im Pflanzenreich, Prof. F. Hildebrand, 246; the Influence of Varying Amounts of Carbon Dioxide in the Air on the Photosynthetic Process of Leaves and on the Mode of Growth of Plants, Dr. Horace T. Brown, F.R.S., and F. Escombe at the Royal Society, 620
- Plants: Studies in the Distribution of Plants, 27; Decorative Plants for Gardens, Dr. Nicola Terraciano, 36; a Tentative List of the Flowering Plants and Ferns for the County of Cornwall, including the Scilly Isles, F. H. Davey, 547
- Platinum, Microscopic Effects of Stress on, Thomas Andrews, F.R.S., and Charles Reginald Andrews, 213
- Platinum, a Note on the Recrystallisation of, Walter Rosenhain, 262
- Player (Hart), Method of Copying Engravings by Superposition, 582
- Pliocene Glacio-fluvialite Conglomerates in Subalpine France and Switzerland, Charles S. Du Riche Preller, 166

- Plissements et Dislocations de l'Écorce Terrestre en Grèce, Ph. Negris, 28
- Plowman (A. B.), Relations of Plant Growth to Ionisation of the Soil, 408
- Plowright (Dr. C. B.), Peculiar Appearance at and after Sunset, 230
- Plumacher (E. H.), Eruption of Mont Pelée Heard at Maracaibo, Venezuela, 554
- Plumb-line, the Attractions of the Himalaya Mountains upon the, in India, Major S. G. Burrard, 80
- Podwyssotsky (W. W.), Pathologie Générale et Expérimentale, les Processus Généraux, 363
- Poisonous Fodder-plants and Oriental Drug Plants, Prof. Wyndham R. Dunstan, F.R.S., 83
- Poisson (Jules), Germinative Duration of Seeds, 408
- Polis (Dr. P.), the Daily Period of Rainfall, 86
- Pollution, River, Trades' Waste and, W. Naylor, 413
- Polynesian Politics and Anthropology, E. Sidney Hartland, 347
- P. O. P. (the Use of Silver Printing-out Papers), A. Horsley Hinton, 519
- Porter (Mr.), Origin of the Valleys of County Cork, 642
- Porter (Rev. T. C.), a Remarkable Solar Halo, 76; Volcanic Dust from the West Indies, 131; the Halos of May 1, 8 and 22, 223
- Porter (T. C.), Ebullition of Rotating Water, 118; Contributions to the Study of Flicker, 213
- Potato Beetle at Tilbury, Colorado, 134
- Potter (M. C.), on the Parasitism of *Pseudomonas destructans* (Potter), 238
- Powell (J. W.), Death of, 553
- Praeger (R. Lloyd), Post-Glacial Deposits of the Belfast Districts, 619; on Geographical Plant Groups in the Irish Flora, 642
- Prain (David), Notes on Indigofera, 21
- Prasad (Dr. Ganish), Use of Fourier's Series in Theory of Conduction of Heat, 71
- Pratt (Henry Sherring), a Course in Invertebrate Zoology, 292
- Preece (Sir William), on the Future of the Telephone in the United Kingdom, 644; the Training of Engineers, 645
- Prehistoric Flint Mine at High Wycombe, 610
- Prehistoric Man in Burma, R. C. J. Swinhoe, 541
- Prehistoric Pigmies in Silesia, David MacRitchie, 151
- Prehistoric Times, the Ruling Races of, in India, South-western Asia and Southern Europe, J. F. Hewitt, 145
- Preller (Charles S. Du Riche), Pliocene Glacio-fluviatile Conglomerates in Subalpine France and Switzerland, 166
- Prentice (Dr.), Influence of Acidic Oxides on Specific Rotations of Lactic Acid and Potassium Lactate, 22
- Prichard (Hesketh), the Larger Mammals of Patagonia, 46
- Primrose and Darwinism, the, 409, 575; the Writer of the Review, 575
- Princess Alice, Hydrographical Observations of the, J. Y. Buchanan, F.R.S., 376
- Prisms and Plates for Showing Dichromatism. Prof. R. W. Wood, 31
- Prize Awards of the Société d'Encouragement pour l'Industrie Nationale for Research Work bearing on Industry, 447
- Prize Subjects, Belgian Royal Academy, 113
- Probability: Probabilités et Moyennes Géométriques, Emmanuel Czuber, 652; Philosophical Essay on Probabilities, Pierre Simon Marquis de Laplace, 652
- Propylene, Addition of Hypochlorous Acid to, Louis Henry, 72
- Protista, the Study of the, 627
- Protistenkunde, Archiv. für, 627
- Protezione degli Animali, la, N. Licò, 414
- Protozoa, the Foraminifera, an Introduction to the Study of the, Frederick Chapman, 196
- Psychology: a Text-book of Insanity, Charles Mercier, 5; Experimental Investigations on the Depth of Sleep, Drs. Sante de Sanctis and W. Neyroz, 137; the Elements of Mind, H. J. Brooks, 317; Psychology of Primitive Man, Miss A. Amy Bulley, 664
- Public Schools, Science in the, Rev. Dr. A. Irving, 459
- Pugsley (Mr.), the British "Capreolate" Fumitories, 118
- Punjab, the Plague in the, 484
- Purdie (Prof. T., F.R.S.), on the Alkylation of Sugars, 662
- Purser (Prof. John, M.A., LL.D., M.R.I.A.), Opening Address in Section A at the Belfast Meeting of the British Association, 478
- Pycraft (W. P.), Osteology of the Owls, 263
- Pygmies in Silesia, Prehistoric, David MacRitchie, 151
- Quartz, Fusion of, in the Electric Furnace, R. S. Hutton, 66
- Quartz, De la Double Réfraction Elliptique et de la Tétraréfringence du, dans le Voisinage de l'Axe, G. Quesneville, 386
- Quaternion Integrals Depending on a Single Quaternion Variable, Prof. Chas. J. Joly, 47
- Quesneville (G.), De la Double Réfraction Elliptique et de la Tétraréfringence du Quartz dans le Voisinage de l'Axe, 386
- Rabl (Carl), Die Entwicklung des Gesichtes, Tafeln zur Entwicklungsgeschichte der äusseren Körperform der Wirbeltiere. Part I. Das Gesicht der Säugethiere, 368
- Rackowski (Sig. de), Variation of the Phosphoric Acid in Cow's Milk with Time after Calving, 384; Influence of Cream Separation on the Principal Constituents of Milk, 432; Mechanical Treatment in the Milk Industry, 456
- Radde (Dr. Gustave), Gründzüge d. Pflanzenverbreit i. d. Kaukasusländern, von der unteren Wolga ueb. d. Manysch-Schneider bis z. Scheitelfläche Hocharmaniens, 27
- Radial Velocity of the Orion Nebula, Prof. H. C. Vogel and Dr. Eberhard, 309
- Radiography: Radio-activity, Dr. P. Vignonn's Researches and the Holy Shroud, 13; Radio-activity of Uranium, Mr. Soddy, 119; Radio-activity of Thorium Compounds, Prof. Rutherford and Mr. Soddy, 119; Portable Röntgen-ray Outfit, Rosenberg and Co., 136; Action of X-rays on very Small Electric Sparks, R. Blondot, 263; Precautions Necessary in the Use of Ruhmkoff Coils in Radiography, MM. Infort and Gaiffe, 264; Method for Obtaining a Röntgen Photograph of an Internal Part of the Living Body During the Performance of a Definite Functional Movement, Dr. P. H. Ejkmann, 307; Penetrating Rays from Radio-active Substances, Prof. E. Rutherford, 318; the Mode of Formation of Kathode and Röntgen Rays, Th. Tommasina, 408; the Röntgen Rays in Medicine and Surgery as an Aid in Diagnosis and as a Therapeutic Agent, Francis H. Williams, 438; a Coin-controlled X-ray Machine for Public Use, 512
- Ragalski (M.), Acute Polymicrobial Osteomyelitis, 48
- Railways: New High-speed Record on the Burlington and Missouri Railroad, 184; Liquid Fuel for Steam Purposes, J. S. B. Brame, 186; the Inspection of Railway Materials, G. R. Bodmer, 244; the Electrification of London, 296; on the Deflection and Vibration of Railway Bridges, Dr. F. Omori, 332; New York Central Railway to be worked Electrically, D. J. Arnold, 398; Lake Como Electric Railway, 484; Aerial Luggage Transmitter at Woking Junction, 555
- Rain, Radio-active, C. T. R. Wilson, 143
- Rainfall, the Daily Period of, Dr. P. Polis, 86; Rainfall of Saxony, Dr. G. Hellman, 136; Rainfall in India, 230; Rainfall in Donnicca and St. Vincent, 1900-1, 378; the Rainfall of Great Britain, 512; Map of Ireland Showing Distribution of Rainfall, Dr. Mill, 644
- Ramage (Hugh), the Spectra of Potassium, Rubidium and Cesium and their Mutual Relations, 214
- Ramsey (Prof. W., F.R.S.), an Attempt to Reproduce an Aurora Borealis, 204
- Range-finder, a New, Experiences in South Africa with, Prof. G. Forbes, 645
- Raworth (J. S.), the Smokeless Combustion of Bituminous Fuel, 645
- Ray (Dr. P. C.), Dimercurammonium Nitrate and its Haloid Derivatives, 22
- Rayleigh (Right Hon. Lord, F.R.S.), Interference of Sound, Lecture at the Royal Institution, 42; Does Chemical Transformation Influence Weight? 58; Accurate Conservation of Weight in Chemical Reactions, 615; Experiments to Determine whether Double Refraction was Produced in Isotropic Transparent Bodies by their Motion through the Ether, 618
- Reade (T. Mellard), Glacial and Post-Glacial Features of the River Lune and its Estuary, 540; a Recent Peat and Forest Bed at Westbury-on-Severn, 540
- Rearrangement of Euclid i., 1-32; T. Petch, 7; J. M. Child, 31
- Racoura (A.), Action of Hydrochloric Acid upon Sulphates of Aluminium, Chromium and Iron, 336

- Refraction of Liquid Mixtures, the Indices of, Edm. van Aubel, 47
- Refractivities of the Inert Gases, Clive Cuthbertson, 607
- Regeneration in Plants, 379; Prof. Goebel, 514
- Reid (Clement), Geology of the Hampshire Basin, 486
- Reid (Margery A.), Physical Geography, 653
- Reiss (K. A.), Employment of Urine in the Development of the Photographic Plate, 144
- Relations Between Metallurgy and Engineering, the, "James Forrest" Lecture at Institution of Civil Engineers, Sir W. C. Roberts-Austen, K.C.B., F.R.S., 18
- Religio Medici, &c., 457
- Religion, the Real Origin of, Jabalon, 491
- Remarkable Sunsets at Madeira, F. W. T. Krohn, 199; A. R. Tankard, 254; see also Sunsets.
- Renault (B.), on Fossil Pollens, &c. in the Coal-measures, 432
- Resultant Tones and the Harmonic Series, Prof. Silvanus P. Thompson, F.R.S., 6; Margaret Dickens, 78
- Retention of Leaves by Deciduous Trees, 56, 344; Jul. Wulff, 32; Wm. Gee, 32; G. W. Hulman, 56; P. T., 56; Prof. W. R. Fisher, 370; Dr. D. T. Smith, 631
- Retina, on the Distribution in the, of the Photo-sensitive Pigment, the Visual Purple, Dr. Edridge Green, 666
- Return of the Arctic Expeditions, 542
- REVIEWS AND OUR BOOKSHELF:—
- Manual of Alcoholic Fermentation and the Allied Industries, Charles G. Matthews, 1
- Materialien zur Naturgeschichte der Insel Celebes Entwurf einer Geographisch-geologischen Beschreibung der Insel Celebes, Dr. Paul Sarasin and Dr. Fritz Sarasin, 3
- More Tales of the Birds, W. W. Fowler, 4
- College Algebra, L. E. Dickson, 4
- A Laboratory Manual of Physics, H. Crew and R. R. Tatnall, 4
- Photographic Apparatus, Making and Repairing, F. W. Cooper and D. W. Gawn, 4
- Monographie der Gattung Alectorolophus, Dr. Jacob von Smerneck, 4
- A Text-book of Insanity, Charles Mercier, 5
- Leçons sur les Series à Terms Positifs, Emile Borel, 5
- Practical Exercises in Magnetism and Electricity, H. E. Hailey, 5
- The Wiltshire Archaeological and Natural History Magazine, Stonehenge and its Barrows, William Long, F.S.A., Stonehenge Bibliography Number, W. Jerome Harrison, Sir Norman Lockyer, K.C.B., F.R.S., 25
- Die Vegetation der Erde, Sammlung Pflanzengeographischer Monographien: (1) Grundzüge der Pflanzenverbreitung auf d. Iberische Halbinsel, Moritz Willkomm, 27; (2) Grundzüge d. Pflanzenverbreit. i. d. Karpathen, F. Pax, 27; (3) Grundzüge d. Pflanzenverbreit. i. d. Kaukasusländern, von der Unteren Wolga ueb. der Manytsch-Schneider, bis z. Scheitelfläche Hocharmeniens, Dr. Gustav Radde, 27; (4) Die Vegetationsverhältnisse d. Illyrischen Länder, Dr. Günther Ritter Beck v. Mannagetta, 27; (5) Die Heide Norddeutschlands, P. Graebner, 27
- La Question de l'Eau Potable devant les Municipalités, P. Guichard, 28
- Plissements et Dislocations de l'écorce Terrestre en Grèce, Ph. Negris, 28
- Last Words on Materialism, L. Büchner, 29
- The Ancient Ruins of Rhodesia, R. N. Hall and W. G. Neal, Prof. A. H. Keane, 34
- Der Grosse Staubfall von 9 bis 12 Marz, 1901, in Nordafrika, Süd- und Mitteleuropa, G. Hellmann and W. Meinardus, 41
- Mathematical and Physical Papers, Sir G. G. Stokes, Prof. Horace Lamb, F.R.S., 49
- The Anthracite Coal Industry, Peter Roberts, 50
- Organographie der Pflanzen insbesondere der Archegoniaten und Samenpflanzen, Dr. K. Goebel, Prof. J. B. Farmer, F.R.S., 51
- The Hurricanes of the Far East, Prof. Dr. Paul Bergholz, 51
- Bird Hunting on the White Nile, H. F. Witherby, 52
- An Introduction to Chemistry and Physics, W. H. Perkin, jun., and Bevan Lean, 52
- The Oil Chemist's Handbook, Erastus Hopkins, 52
- Elements of Botany, W. J. Browne, 52
- The Culture of Greenhouse Orchids, Frederick Boyle, 59
- Studies in Auditory and Visual Space Perception, Arthur Henry Pierce, Prof. Alex. Crum Brown, F.R.S., 73
- Das Problem der Befuchtung, Dr. Th. Boveri, 74
- The Book of the Rose, Rev. A. Foster-Melliar, 74
- The Birds of North and Middle America, The Fringillidæ, R. Ridgway, 75
- The Lens, a Practical Guide to the Choice, Use and Testing of Photographic Objectives, T. Bolas and George E. Brown, 75
- A Text-book of Geology, Albert Perry Brigham, 75
- Elementary Plant Physiology, D. T. Macdougall, 76
- Diagramme der Electricischen und Magnetischen Zustände und Bewegungen, F. W. Willenweber, 76
- The Attractions of the Himalaya Mountains upon the Plumb-line in India, Major S. G. Burrard, 80
- The Tribes of the Brahmaputra Valley, a Contribution on their Physical Types and Affinities, L. A. Waddell, 91
- The Coorgs and Yeruvas, an Ethnological Contrast, T. H. Holland, 91
- Encyclopædia Britannica, 97
- Directions for Class Work in Practical Physiology, Elementary Physiology of Muscle and Nerve, and of the Vascular and Nervous Systems, E. A. Schäfer, F.R.S., 100
- The Elements of Physical Chemistry, J. Livingston R. Morgan, 100
- Practical Botany for Beginners, F. O. Bower, F.R.S., and Dr. T. Gwynne-Vaughan, 101
- Quelques réflexions sur la Mécanique, suivies d'une Première Leçon de Dynamique, Emile Picard, 101
- Thomas Henry Huxley, Edward Clodd, Sir W. T. Thiselton-Dyer, F.R.S., 121
- A Monograph of the Calicidæ of the World, F. W. Theobald, 123
- The Electric Arc, Heitha Ayrton, 124
- Paleontologie und Descendenzlehre, E. Koken, 126
- The Laboratory Companion to Fats and Oils Industries, Dr. J. Lewkowitsch, 126
- The Ruling Races of Prehistoric Times in India, South-Western Asia and Southern Europe, J. F. Hewitt, 145
- History and Chronology of the Myth-making Age, J. F. Hewitt, 145
- Cyclopædia of American Horticulture, L. H. Bailey, 147
- Les Câbles Sous-Marins, Fabrication, Alfred Gay, 148
- Some Thoughts on the Principles of Local Treatment in Diseases of the Upper Air Passages, Sir Felix Semon, 149
- Flora der Ostrifrischen Inseln, Dr. Fr. Buchenau, 149
- Occultations of Stars and Solar Eclipses, Francis Cranmer Penrose, 149
- Algebra, H. G. Willis, 149
- Lamarck, the Founder of Evolution, his Life and Work, Alpheus S. Packard, 169
- Elementary Inorganic Chemistry, James Walker, F.R.S., 170
- Experimental Chemistry, Lyman C. Newell, 170
- Elementary Experimental Chemistry, W. F. Watson, 170
- The Elements of Euclid, Book xi., R. Lachlan, 171
- Recueil de l'Institut Botanique (Université de Bruxelles), L. Errera, 171
- Dynamos, Alternators and Transformers, Gisbert Kapp, 172
- Étude Pratique sur les Différents Systems d'Eclairage, J. Defays and H. Pittet, 172
- Sanitary Engineering, a Practical Manual of Town Drainage and Sewage and Refuse Disposal, Francis Wood, 173
- The Story of Animal Life, B. Lindsay, 173
- Municipal Engineering and Sanitation, M. M. Baker, 173
- Alaska: Harriman Alaska Expedition 1899, 176
- Encyclopædia Biblica, a Critical Dictionary of the Literary, Political and Religious History, the Archaeology, Geography and Natural History of the Bible, Rev. T. K. Cheyne and J. Sutherland Black, 193
- The Foraminifera, an Introduction to the Study of Protozoa, Frederick Chapman, 196
- Enzymes and their Applications, J. Efront, Dr. F. Mollwo Perkin, 197
- Astronomischer Jahresbericht, Walter F. Wislicenus, Dr. W. J. S. Lockyer, 198
- Elements of Metaphysics, J. S. Mackenzie, 198
- Histoire des Mathématiques dans l'Antiquité et le Moyen Age, H. G. Zeuthen, 199
- À la Conquête du Ciel, Contributions Astronomiques de F. C. de Nascius, en Quinze Livres, 199

- Variation, Germinal and Environmental, J. C. Ewart, F.R.S., 209
- The International Catalogue of Scientific Literature, Prof. J. B. Farmer, F.R.S., 217
- La Costituzione degli Ingranaggi, Prof. D. Tessari, 218
- The Lesson of Evolution, Frederick Wollaston Hutton, F.R.S., Prof. R. Meldola, 219
- The Elements of Physical Chemistry, Harry C. Jones, 220
- Other Worlds, Garrett P. Serviss, 221
- The Basis of Social Relations, D. G. Brinton, 221
- The Criterion of Scientific Truth, G. Shann, 221
- Opere Matematiche di Francesco Brioschi, 221
- Webster's International Dictionary of the English Language, 222
- Education and Empire, Richard Burdon Haldane, 222
- Special Reports on Educational Subjects, 225
- Expédition Norvégienne de 1899-1900 pour l'Étude des Aurores Boréales, Resultats des Recherches Magnétiques, Kr. Birkeland, Dr. C. Chree, F.R.S., 227
- On the Intestinal Tract of Birds, with Remarks on the Valuation and Nomenclature of Zoological Characters, P. Chalmers Mitchell, 235
- The Scientific Memoirs of Thomas Henry Huxley, 241
- History of Geology and Palaeontology to the End of the Nineteenth Century, Karl Alfred von Zittel, 242
- Plane Surveying, a Text and Reference Book for the Use of Students in Engineering and for Engineers Generally, Paul C. Nugent, Major C. F. Close, 243
- The Inspection of Railway Materials, G. R. Bodmer, 244
- The Watkins Manual of (Photographic) Exposure and Development, Alfred Watkins, 245
- Nature Study and Life, C. F. Hodge, 245
- Manual of Agricultural Chemistry, Herbert Ingle, 245
- Ueber Aehnlichkeiten im Pflanzenreich, F. Hildebrand, 246
- Index to the Literature of the Spectroscopie (1887-1900, both Inclusive), Alfred Tuckermann, 246
- William Gilbert, of Colchester, Physician of London, on the Magnet, Magnetic Bodies also, and on the Great Magnet the Earth, Prof. S. P. Thompson, F.R.S., 249
- The Record of the Royal Society of London, 251
- The Mechanics of Engineering, Prof. A. Jay DuBois, 265
- The Natural History of the British Surface-feeding Ducks, J. G. Millais, T. Digby Pigott, C.B. 266
- Traité de Zoologie Concrète, Yves Delage and Edgard Hérouard, Dr. G. C. Bourne, 267
- Wellenlehre und Schall, W. C. L. van Schaik, 268
- Malarial Fever, its Cause, Prevention and Treatment, Ronald Ross, F.R.S., 269
- Velocity Diagrams, their Construction and Uses, Intended for all who are Interested in Mechanical Movements, Prof. C. W. MacConad, 269
- Spiderland, Rose Haig Thomas, 270
- Tuberculosis as a Disease of the Masses, and How to Combat it, S. A. Knopf, 270
- The Teacher's Manual of Object Lessons in Geography, Vincent T. Murché, 270
- William Gilbert of Colchester: a Sketch of his Magnetic Philosophy, Charles E. Benham, 270
- The Vocal System based on the Fundamental Laws of Language, G. Lionel Wright, 271
- The Lake Counties, W. G. Collingwood, 271
- Preliminary Report on a Journey of Archaeological and Topographical Exploration in Chinese Turkestan, M. A. Stein, Prof. M. Winternitz, 284
- The Encyclopædia Britannica, Prof. Arthur Smithells, F.R.S., 289
- Les Bateaux Sous-Marins et les Submersibles, R. D'Équeville, 290
- Elementary Principles in Statistical Mechanics, J. Willard Gibbs, Prof. G. H. Bryan, F.R.S., 291
- A Course in Invertebrate Zoology, Henry Sherring Pratt, 292
- Slide Rule Notes, Lieut.-Colonel H. C. Dunlop and C. S. Jackson, 292
- Injurious and Useful Insects: an Introduction to the Study of Economic Entomology, L. C. Miall, F.R.S., 293
- Chloroform: a Manual for Students and Practitioners, Edward Lawrie, 293
- Les Limites de la Biologie, J. Grasset, 293
- Schule des automobil Fahrers, Wolfgang Vogel, Mervyn O'Gorman, 313
- An Introduction to the Study of the Comparative Anatomy of Animals, G. C. Bourne, 314
- Scientific Memoirs, 315
- Traité de Bactériologie Pure et Appliquée à la Médecine et à l'Hygiène, P. Miquel and R. Cambier, Dr. E. Klein, F.R.S., 316
- General Investigations of Curved Surfaces of 1827 and 1825, Karl Friedrich Gauss, 316
- The Elements of Mind, H. J. Brooks, 317
- A Graduated Collection of Problems in Electricity, Prof. Robert Weber, 317
- Junior Chemistry and Physics, W. Jerome Harrison, 317
- Report on the Collections of Natural History made in the Antarctic Regions during the Voyage of the *Southern Cross*, R. B. Sharpe and F. J. Bell, 322
- Catalogue of the Collection of Birds' Eggs in the British Museum (Natural History), E. W. Oates, 322
- Guide to the Galleries of Mammalia in the British Museum (Natural History), 322
- Guide to the Coral Gallery in the British Museum (Natural History), R. Kirkpatrick and F. J. Bell, 322
- Erdmagnetische Untersuchung im Kaiserstuhl, G. Meyer, 324
- Chart of Lines of Equal Magnetic Declination and Annual Change for 1902, 324
- Magnetical Dip and Declination in the Philippine Islands, Rev. John Doyle, 324
- Annales de l'Observatoire National d'Athènes, D. Eginitis, 331
- Lehrbuch der Meteorologie, Dr. Julius Hann, Dr. W. N. Shaw, F.R.S., 337
- The Textile Fibres of Commerce, William S. Hannan, 338
- Les Poissons du Bassin du Congo, G. A. Boulenger, 339
- The Roorkee Manual of Applied Mechanics, Stability of Structures and the Graphic Determination of Lines of Resistance, Lieut.-Colonel J. H. C. Harrison, 340
- Ordnance Survey of England and Wales, 341
- A Manual of Elementary Practical Physics, Julius Hortvet, 341
- The Journal of the Iron and Steel Institute General Index, 342
- Zur Metaphysik des Trägischer, L. Ziegler, 342
- Hygiene for Students, Edward F. Willoughby, 342
- Savage Island: an Account of a Sojourn in Niue and Tonga, Basil Thomson, E. Sidney Hartland, 347
- Theory of the Motion of the Moon: Containing a New Calculation of the Expressions for the Coordinates of the Moon in Terms of Time, Ernest W. Brown, F.R.S., 356
- The Encyclopædia Britannica, 361
- Pathologie générale et expérimentale, les Processus généraux, A. Chantemesse and W. W. Podwysotsky, 363
- Matière médicale: zoologique, Histoire des Drogues d'Origine Animale, H. Beauzeard, 363
- Chemische und medicinische Untersuchungen, Festschrift zur des sechzigsten Geburtstages von Max Jaffé, 363
- Das Wirbeltierblut in mikrokristallographischer Hinricht, Dr. H. U. Kobert, 363
- Essays in Historical Chemistry, T. E. Thorpe, C. B., F.R.S., 365
- The Schoolmaster: a Commentary upon the Aims and Methods of an Assistant Master in a Public School, Arthur Christopher Benson, 366
- The Dictionary of Photography, E. J. Wall, 368
- Die Entwicklung des Gesichtes: Tafeln zur Entwicklungsgeschichte der aeußeren Koerperform der Wirbeltiere, Carl Rabl, Part I., Das Gesicht der Saeugethiere, 368
- Les Fleurs du Midi, P. Granger, 368
- Physiology for Beginners, Leonard Hill, F.R.S., Dr. B. Moore, 369
- Die Philosophie August Comte's, L. Lévy-Brühl, 369
- Elementary Coal Mining, George L. Kerr, 369
- The Cambridge Natural History, Mammalia, F. E. Beddard, 373
- North Queensland Ethnography, Games, Sports and Amusements, Walter E. Roth, 380
- The Hepaticæ of the British Isles, being Figures and Descriptions of all Known British Species, William Henry Pearson, Prof. J. B. Farmer, F.R.S., 385
- De la Double Refraction Elliptique et de la Tétraréfringence du Quartz dans le Voisinage de l'axe, G. Quesneville, 386

- A Text-Book of Physics, with Sections on the Applications of Physics to Physiology and Medicine, R. A. Lehfeldt, 387
- Health, Speech and Song: a Practical Guide to Voice-Production, Jutta Bell-Ranske, Dr. B. Moore, 388
- The Principles of Simple Photography, F. W. Sparrow, 389
- Philosophy of Conduct, G. T. Ladd, 389
- The Thompson Yates Laboratories Report, 390
- The Annual of the British School at Athens, 390
- The Primrose and Darwinism, 409
- Exposition universelle de 1900, *Congres International de Chronométrie, Comptes rendus des Travaux, Procédures, Rapports et Mémoires*, 411
- Trades' Waste: its Treatment and Utilisation, W. Naylor, 413
- Die Weltherinn und ihr Schatten, Ein Vortrag über Energie und Entropie, Dr. Felix Auerbach, 414
- Chemisch-Analytisches Praktikum, Dr. Karl Anton Henniger, 414
- La Protezione degli Animali, N. Licò, 414
- Coal Cutting by Machinery in the United Kingdom, Sidney F. Walker, 414
- Metallography: an Introduction to the Study of the Structure of Metals chiefly by the Aid of the Microscope, Arthur H. Hiorns, 415
- Ten Thousand Miles in Persia, or Eight Years in Iran, Major Percy Molesworth Sykes, 418
- Dangerous Trades: the Historical, Social and Legal Aspects of Industrial Occupations as Affecting Health, Dr. T. E. Thorpe, C. B., F.R.S., 433
- International Catalogue of Scientific Literature, Prof. Herbert McLeod, F.R.S., 436
- Qu'est-ce qui détermine le Sexe? Dr. A. Van Lint, 437
- Die Röntgen Rays in Medicine and Surgery as an Aid in Diagnosis and as a Therapeutic Agent, Francis H. Williams, 438
- Elementary Geometry, W. C. Fletcher, 438
- Diagrams of Mean Velocity of Uniform Motion of Water in Open Channels, Based on the Formula of Ganguillet and Kutter, Prof. Irving P. Church, 439
- A First Course of Chemistry (Heuristic), J. H. Leonard, 439
- An Elementary Book on Electricity and Magnetism and their Applications, Profs. D. C. Jackson and J. P. Jackson, 439
- The Face of Nature, Rev. C. T. Ovenden, 439
- Gold Seeking in South Africa: a Handbook of Hints for Intending Explorers, Prospectors and Settlers, with a Chapter on the Agricultural Prospects of South Africa, Theo. Kassner, 440
- A Text-book of Inorganic Chemistry, Dr. A. F. Holleman, 440
- The Bernese Oberland, G. Hasler, 440
- Birds in the Garden, G. Sharp, 444
- Reports of the U. S. Coast Survey, Prof. G. H. Darwin, F.R.S., 444
- Reproduction des Figures Paléolithiques Peintes sur les Parois de la Grotte de Font-de-Gaume, MM. Capitan and Breuil, 452
- Sur les Matières Colorantes des Figures de la Grotte de Font-de-Gaume, Henri Moissan, 452
- Les Figurations Préhistoriques de la Grotte de la Mouthé (Dordogne), Émile Rivière, 452
- Special Reports on Educational Subjects. Education in the United States of America, 453
- General Reports of H. M. Inspectors on Elementary Schools and Training Colleges for the Year 1901, 453
- General Reports of H. M. Inspectors on Science and Art Schools and Classes and Evening Schools, 453
- Geodetic Survey of South Africa, Report on a Redisussion of Bailey's and Fourcade's Surveys and their Reduction to the System of the Geodetic Survey, Sir David Gill, K.C.B., F.R.S., Major C. F. Close, 457
- Religio Medici, &c, 457
- Elements of Physics, C. Henderson and John F. Woodhull, 458
- Physical Experiments, John F. Woodhull and M. B. Van Arsdale, 458
- Types of British Plants, C. S. Colman, 458
- Water Supply, Prof. William P. Mason, 458
- Sichtbare und Unsichtbare Bewegungen, H. A. Lorentz, 459
- Cuchulain of Muirtheamne, the Story of the Men of the Red Branch of Ulster, Lady Gregory, 489
- Flora Arctica, C. H. Ostenfeld, 490
- An Arithmetic for Schools, J. P. Kirkman and E. A. Field, 491
- A first Step in Arithmetic, J. G. Bradshaw, 491
- The Real Origin of Religion, Jablon, 491
- Theology and Ethics of the Hebrews, Archibald Duff, 517
- Syria and Palestine, Lewis Bayles Paton, 517
- The Elementary Principles of Chemistry, A. V. E. Young, 519
- P.O.P. (The Use of Silver Printing out Papers), A. Horsley Hinton, 519
- Tir des Fusils de Chasse, Journée, 545
- Roscoe-Schorlemmer's Lehrbuch der Organischen Chemie, Jul. Wilh. Brühl, Prof. R. Meldola, F.R.S., 546
- Japanische Mythologie, Nihongi "Zeitalter der Götter," Dr. Karl Florenz, 546
- An Introduction to Chemistry, D. S. Macnair, 547
- A Tentative list of the Flowering Plants and Ferns for the County of Cornwall, including the Scilly Isles, F. H. Davey, 547
- Outer Isles, A. Goodrich-Freer, 548
- The Fauna of British India, including Ceylon and Burma, Rhynchocha, W. L. Distant, 548
- Mendel's Principles of Heredity: a Defence, W. Bateson, F.R.S., 573
- Reports to the Evolution Committee of the Royal Society, W. Bateson and Miss E. R. Saunders, 573
- Die Schutzvorrichtungen der Starkstromtechnik gegen Atmosphärische Entladungen, Dr. Gustav Benischke, 573
- Catalogue of Scientific Papers (1800-1883), Supplementary Volume, 574
- The Early Life of the Young Cuckoo, W. P. Westell, 574
- Physics: a Text-book for Secondary Schools, Prof. Frederick Slate, 575
- L'Électricité (dédit de l'Experience et Ramené au Principe des Travaux virtuels), E. Carvallo, 575
- Les Phénomènes électriques chez les Êtres vivants, M. Mendelssohn, 575
- Elementary Chemical Analysis, Distinguishing Tables and Tests, Prof. P. Carmody, 575
- Der Untergang der Erde und die kosmischen Katastrophen, Dr. M. W. Meyer, 601
- The Evolution of Artificial Mineral Waters, William Kirkby, 602
- Human Embryology and Morphology, Dr. A. Keith, 603
- The Making of Citizens: a Study of Comparative Education, R. E. Hughes, 604
- Animal Forms: a Second Book of Zoology, David S. Jordan and Prof. Harold Heath, 605
- Das botanische Practicum, Dr. Edward Strasburger, 605
- Principles of Sanitary Science and the Public Health, Prof. William T. Sedgwick, 605
- Nature Study: Realistic Geography, Model based on the 6 inch Ordnance Survey, G. Herbert Morrell, 606
- A Junior Chemistry, E. A. Tyler, 606
- The Encyclopedia Britannica, vols. xxviii. and xxix., 625
- Archiv für Protistenkunde, 627
- Assaying and Metallurgical Analysis, E. L. Rhead and Prof. A. Humboldt Sexton, 628
- The Climates and Baths of Great Britain, vol. ii., 629
- Electric Wiring, W. C. Clinton, 629
- The Common Spiders of the United States, James H. Emerton, 630
- Trees in Prose and Poetry, Gertrude L. Stone and M. Grace Fickett, 630
- Chart of the Metric System, Prof. C. Bopp, 630
- The Naturalist on the Thames, C. J. Cornish, 632
- The Nearer East, D. G. Hogarth, 649
- Das Eisen als das thätige Prinzip der Enzyme und der lebendigen Substanz, N. Sacharoff, 651
- Probabilités et Moyennes géométriques, Emmanuel Czuber, 652
- Philosophical Essay on Probabilities, Pierre Simon Marquis de Laplace, 652
- Upland Game-birds, E. Sandys and T. S. Van Dyke, 652
- Wild Fruits of the Country Side, F. Edward Hulme, 653
- Einführung in die Theorie der Doppelbrechung, Heinrich Greinauer, 653
- Physical Geography, Margery A. Reid, 653

- Reynolds (Osborne, F.R.S.), Throwing-testing Machine for Reversals of Mean Stress, 45
- Reynolds (Prof. S. H.), the Jurassic Strata Cut Through by the South Wales Direct Line between Filton and Wootton Bassett, 263
- Rhead (E. L.), Assaying and Metallurgical Analysis for the Use of Students, Chemists and Assayers, 628
- Rheumatism, Local Treatment of, Ch. Bouchard, 288
- Rhodesia and Ophir, R. N. Hall and W. G. Neal, Prof. A. H. Keane, 34
- Richards (Prof. T. W.), Accuracy of an Improved Form of Silver Voltmeter, 153; Redetermination of the Atomic Weight of Uranium, 208; Decomposition of Mercurous Chloride by Dissolved Chlorides, 233
- Richards (Mr.), Electrochemical Equivalent of Silver, 401
- Richardson (Hugh), Theories of Heredity, 630
- Richardson (O. W.), Decomposition of Oxalacetic Hydrazone in Aqueous and Acid Solutions and a New Method of Determining the Concentration of Hydrogen Ions in Solution, 214
- Richardson (Dr. S. W.), a Method of Treating Parallels, 223
- Richer (Pierre Paul), the Germination of Pollen Grains in the Presence of Stigmata, 672
- Ridewood (Dr. W. G.), the Structure of the Gills of the Lamellibranchia, 165
- Ridgway (R.), the Birds of North and Middle America, the Fringillidae, 75
- Righi (Prof. A.), on Mr. Marconi, 581
- Riva (Carlo), Death and Obituary Notice of, 157
- River Management: on Single Curved versus Double Straight Jetties, Lewis B. Haupt, 39
- River Pollution, Trades' Waste and, W. Naylor, 413
- Rivière (Émile), les Figurations préhistoriques de la Grotte de La Mouthe Dordogne, 452
- Road Vehicles, Resistance of, to Traction, Report of the British Association Committee, 643
- Roberts (Peter), the Anthracite Coal Industry, 50
- Roberts-Austen (Sir W. C., K.C.B., F.R.S.), the Relations between Metallurgy and Engineering, "James Forrest" Lecture at the Institution of Civil Engineers, 18
- Robertson (P. W.), Atomic and Molecular Heats of Fusion, 191
- Robinson (H. C.), the Wild and Civilised Tribes of the Malay Peninsula, 664
- Robinson (W. H.), Remarkable Naked-eye Nebulosity, 233
- Rocherolles (J.), Study of the Simultaneous Distillation of Two Non-miscible Substances, 336
- Rock Metamorphism, Opening Address in Section C at the Belfast Meeting of the British Association, Lieut.-General Charles Alexander McMahon, F.R.S., F.G.S., 504
- Rockstroh (Edwin), Earthquake in Guatemala, 150
- Rodrigues (Campos), Corrections to the Right Ascensions of the Principal Stars of the Berliner Jahrbuch, 557
- Rogovsky (Dr. E.), Kinetic Theory of Planetary Atmospheres, 222
- Rolston (W. E.), a Remarkable Meteor, 557
- Röntgen Rays: Portable Röntgen Ray Outfit, Rosenberg and Co., 136; Method for Obtaining a Röntgen Photograph of an Internal Part of the Living Body during the Performance of a Definite Functional Movement, Dr. P. H. Eykman, 307; the Mode of Formation of Kathode and Röntgen Rays, Th. Tommasina, 408; Röntgen Rays in Medicine and Surgery as an Aid in Diagnosis and as a Therapeutic Agent, Francis H. Williams, 438; a Coin-controlled X-ray Machine for Public Use, 512
- Roscoe-Schorlemmer's Lehrbuch der Organischen Chemie, Jul. Wilh. Brühl, Prof. R. Meldola, F.R.S., 546
- Rose, the Book of the, Rev. A. Foster-Melliar, 74
- Rose (J.), Fog Bow at Oxford, 416
- Rosenberg and Co.'s Portable Röntgen Ray Outfit, 136
- Rosenhain (Walter), the Misuse of Coal, 29; a Note on the Recrystallisation of Platinum, 262
- Rosenheim (Dr.), Decomposition of Compounds of Selenium and Tellurium by Moulds and its Influence on the Biological Test for Arsenic, 214
- Rosenstiehl (A.), Quality of a Wine Depends upon the Yeast which Grows Spontaneously upon the Grape, 192
- Ross (Ronald, F.R.S.), Malarial Fever, its Cause, Prevention and Treatment, 269
- Rost (Major), the Bacillus of Beri-beri, 378
- Rotation Period of the Superior Planets, M. Deslandres, 380
- Roth (Walter E.) Australian Children's Games, 380
- Rousselet (C. F.), the Genus *Synchaeta*, 448
- Roux (E.), Action of Carbon Bisulphide on the Polyvalent Amino-alcohols, 264
- Rowland (Prof. H. A.), New System of Octoplex Typographic Telegraphy, 134
- Royal Astronomical Society, 94, 238
- Royal College of Science, Science and Literature, Prof. John Perry, F.R.S., 645
- Royal Dublin Society, 47, 167, 311
- Royal Geographical Society, the President's Opening Address, Current Arctic and Antarctic Expeditions, 113
- Royal Institution, Lecture at, Interference of Sound, the Right Hon. Lord Rayleigh, F.R.S., 42; the Chemical Laboratory of the Royal Institution, 460
- Royal Irish Academy, 47, 143
- Royal Meteorological Society, 119, 215
- Royal Microscopical Society, 46, 166, 262, 671
- Royal Society: 45, 93, 165, 213, 238, 262, 287, 311, 334, 382, 455, 488; the Royal Society Conversation, 83; the Royal Society Soirée, 204; Coefficients of the Cubical Expansion of Ice, Hydrated Salts, Solid Carbonic Acid and other Substances at Low Temperatures, Prof. James Dewar, F.R.S., 88; on some Phenomena which suggest a Short Period of Solar and Meteorological Changes, Sir Norman Lockyer, K.C.B., F.R.S., and Dr. William J. S. Lockyer, 248; Record of the Royal Society of London, Year-book of the Royal Society of London, 251; the Royal Society Report on the West Indian Eruptions, Dr. Tempest Anderson and Dr. J. S. Flett, 402; Reports to the Evolution Committee of the Royal Society, 573; Catalogue of Scientific Papers (1800-1883), 574; Lecture at, the Influence of Varying Amounts of Carbon Dioxide in the Air on the Photosynthetic Process of Leaves and on the Mode of Growth of Plants, Dr. Horace T. Brown, F.R.S., and F. Escombe, 620
- Royal Society, Edinburgh, 383
- Royal Society, New South Wales, 456, 572
- Royal Society of Sciences, Göttingen, 510
- Royal Visit to the University of Wales, the, Prof. G. II. Bryan, F.R.S., 61
- Rudler (F. W.), and the Museum of Practical Geology, 553
- Rural Education in France, 225
- Russell (E. J.), Preparation of Pure Chlorine and its Behaviour towards Hydrogen, 238
- Russell (H. L.), Bovine Tuberculosis and Milk Supplies, 399; Thermal Death Point of a Micrococcus Isolated from Milk, 423
- Russell (Prof. Israel C.), Report on the West Indian Volcanic Eruptions, 372, 485
- Russell (James), Cross-magnetisation in Iron, 335; Magnetic Shielding in Hollow Iron Cylinders and Superposed Magnetic Inductions in Iron, 383
- Rust-fungus, Prof. Marshall Ward, 210
- Rutherford (Prof. E.), Radio-activity of Thorium Compounds, 119; Penetrating Rays from Radio-active Substances, 318
- Ryder (Capt.), Hilly Yunnan, 642
- Sabatier (Paul), the Addition of Hydrogen to Ethylenic Hydrocarbons by the Method of Contact, 119; "Chemical" Theory of Petroleum Formation, 138; the Direct Hydrogenation of Acetylenic Hydrocarbons by the Method of Contact, 312; Reduction of Nitro-derivatives by the Method of Direct Hydrogenation in Contact with Finely Divided Metals, 360; Direct Reduction of Oxides of Nitrogen by the Contact Method, 384
- Sabre-toothed Tigers, How the, Killed their Prey, 357
- Sacharoff (N.), Das Eisen als das thätige Prinzip der Enzyme und der lebendigen Substanz, 651
- Sackur (Dr.), Aqueous Solutions of Casein Sodium, 637
- Safarik (Prof. V.), Death and Obituary Notice of, 305
- St. Pierre, Last Days of, Very Rev. G. Parel, 372
- St. Vincent, Effects of the Recent Volcanic Eruptions in, 306, 484; H. Hesketh Bell, 306; Captain Calder, 373; T. McGregor McDonald, 373; Eruptions of Volcano and Earthquake at St. Vincent, 327
- Salonica, Earthquake at, July 5, 254, 278; M. Christomanos, 624
- Salt, the Use of, in the Dietary of Sheep, 556

- Sanctis (Dr. Sante de), Experimental Investigations on the Depth of Sleep, 137
- Sandstone Rocks of Peel, the Red, Prof. W. Boyd Dawkins, F.R.S., 191
- Sandstorms, 114
- Sandys (E.), Upland Game Birds, 652
- Sanitation, Municipal Engineering and, M. M. Baker, 173; a Practical Manual of Town Drainage and Sewage and Refuse Disposal, Francis Wood, 173; Principles of Sanitary Science and the Public Health, Prof. William T. Sedgwick, 605; and the Treatment of Smoke; a Sanitary Parallel, Dr. W. N. Shaw, F.R.S., at the Sanitary Congress, Manchester, 667
- Sarasin (Drs. Paul and Fritz), Materialien zur Naturgeschichte der Insel Celebes, Entwurf einer geographisch-geologischen Beschreibung der Insel Celebes, 3
- Saturn Visible Through the Cassini Division, C. T. Whitmill, 87, 296
- Saturn and Uranus, the Satellites of, Dr. J. J. See, 380
- Saunders (Miss E. R.), Reports to the Evolution Committee of the Royal Society, 573
- Savage Island, an Account of a Sojourn in Niue and Tonga, Basil Thomson, E. Sidney Hartland, 347
- Saville-Kent (W.), Bipedal Locomotion in Lizards, 630
- Saxelby (F. M.), Experimental Mathematics, 30
- Saxony, Rainfall of, Dr. G. Hellmann, 136
- Schäfer (Prof. E. A., F.R.S.), Directions for Class Work in Practical Physiology, 100; on the Mechanism connecting the Muscular Apparatus with the Brain Centres for Willed Movement, 665; on some New Features in the Intimate Structure of the Human Cerebral Cortex, 665; on the Diuretic Action of Pituitary Extracts, 666
- Schaik (W. C. L. van), Wellenlehre und Schall, 268
- Scharff (Dr. R. F.), on the Atlantis Problem, 641
- Schenk (Dr. Leopold), Death of, 397
- Schlich (Dr.), World's Timber Supply, 283
- Schloesing (Th.), Studies on Earth, 671
- Scholarships, Schools and, 82
- School Gardens, Prof. Geddes, 326
- Schools, an Arithmetic for, J. P. Kirkman and A. E. Field, 491
- Schools and Scholarships, 82
- Schreiber (Father Johann), Apparatus for Registering Thunderstorms, 65
- Schribaux (M.), Method of Concentrating Wine, 360
- Schuster (Prof. Arthur, F.R.S.), the Future of the Victoria University, 252, 319; Opening Address in Section A (Sub-section of Astronomy and Cosmical Physics) at the Belfast Meeting of the British Association, 614
- Schwappach's (Prof.), Report on Prussian Experiments with Forest Trees, 283
- Schweinitz (Mr. De), Chemical Composition of Tubercle Bacilli, 540
- Science: the Duties of the State towards Science, Mr. Arnold-Forster, 62; Death and Obituary Notice of George Griffith, 64; the Rise of the Experimental Sciences at Oxford, Boyle Lecture at Oxford, Prof. T. Clifford Allbutt, F.R.S., 90; Science and Military Education, 175; International Catalogue of Scientific Literature, Prof. J. B. Farmer, F.R.S., 217; Prof. Herbert McLeod, F.R.S., 436; Coronation Honours to Men of Science, 228; Scientific Memoirs of Thomas Henry Huxley, Vol. iv., 241; Scientific Education in Germany, 255; Scientific Memoirs, 315; Science and the London Matriculation Examination, A. Irving, 320; Science in the Public Schools, Rev. Dr. A. Irving, 459; Some Scientific Centres, v., the Chemical Laboratory of the Royal Institution, 460; the Carnegie Institution of Washington, D.C., Dr. Daniel C. Gilman, 548; Forthcoming Books of Science, 558; American Journal of Science, 571; Catalogue of Scientific Papers (1800-1883), Supplementary Volume, Compiled by the Royal Society, 574; Science and Literature, Prof. John Perry, F.R.S., at the Royal College of Science, 645; Modern Scientific Geography, 649
- Scotland: Evidence of a "Seiche" on a Scottish Loch, Dr. T. N. Johnston and J. Parsons, 162; the Progress of Scottish Botany, J. C. Cruce, 447; Scottish Antarctic Expedition, W. S. Bruce, 631; Matriculation Requirements in Scottish Universities, Prof. John Perry, F.R.S., 654; on the Pigeonment Survey of Scottish School Children, J. F. Tocher, 663
- Scott (Dr., F.R.S.), Atomic Weight of Tellurium, 70
- Screws: French Service Regulation as to Heads and Worms of Screws Used in the French Navy, 229
- Sea, the first Meeting of the International Council for the Exploration of the, 346
- Sea Temperature and Shore Climate, 116
- Sea Temperature Variations on the British Coasts, 452
- Sea-shore, Flames from Mud on a, Rev. H. T. Dixon, 151
- Searle (Rev. Charles E.), Death of, 327
- Sedgwick (Prof. William T.), Principles of Sanitary Science and the Public Health, 605
- See (Dr. J. J.), the Satellites of Saturn and Uranus, 380
- Seeley (Prof. H. G.), on Cretaceous Strata Found by Mr. E. G. Fraser on the Shoulder of Sekasar, India, 620
- "Seiche" on a Scottish Loch, Evidence of a, Dr. T. N. Johnston and J. Parsons, 162
- Seismology: Earthquake round Lake Baikal, 15; Mont Pelée Eruption and Dust Falls, Dr. William J. S. Lockyer, 53; the Recent Volcanic Eruptions in the West Indies, Prof. J. Milne, F.R.S., 56, 107, 151; Observations of Volcanic Activity in the West Indies, 178, 203; Records and Results of Recent Eruptions, 153; Eruptions of Volcano and Earthquake at St. Vincent, 237; Report on the West Indian Eruptions, Robert T. Hill, 370; see also Volcanoes; Periodicity of Volcanic Eruptions and Earthquakes, Rev. T. E. Espin, 353; Earthquakes and Volcanic Eruptions, April 10 to September 23, 659; Periodicity of the Great Earthquakes of the Marches and Romagna, Dr. Cancani, 66; Record of Italian Earthquakes (1891-1900), Dr. A. Cancani, 66; Distribution in Intensity of the After-shocks of Three Hundred Italian Earthquakes, Dr. Cancani, 513; the Carlisle Earthquakes of July 9 and 11, 1901, Dr. C. Davison, 71; the Inverness Earthquake of September 18, 1901, Dr. C. Davison, 71; Earthquake of May 6, 1902, Michel Lévy, 95; Earthquake in Guatemala, Edwin Rockstroh, 150; Seismic Frequency in Japan, Prof. J. Milne, F.R.S., 202; Earthquakes in Greece during 1899, Dr. D. Egnitinis, 230; Register of 208 Shocks Observed in Styria between 1000 and 1870, Dr. R. Hoernes, 234; Historical Account of the Earthquakes of Poland, Prof. W. Łaska, 234; Proposed Non-pendulum Forms of Apparatus, Prof. E. Odone, 234; a New Form of Seismograph, Dr. G. Agamennone, 260; Improved Seismograph, Dr. Cancani, 308; Earthquakes in Nebraska, Iowa, Dakota and California, 327; Observations on Explosion of Ten Tons of Gunpowder in the Granite Quarries near Baveno, Dr. Emilio Oddone, 350; Earthquake of May 28 at the Cape and Coincident Meteorological Effects, Charles Stewart, 369; the Earthquake in Mid-Atlantic, Father Melzi, 378; Earth Surface Vibrations, F. C. Constable, 440; J. M., 440; Earthquakes in Guam, Tiflis and Ferghana, 579; Earthquake at Salonica, July 5, 254, 278; M. Christomanos, 624
- Sellards (E. H.), *Idiophyllum rotundiflorum* a Synonym of *Neuropteris rarineris*, 571-2
- Semenov (Jules), Electric Discharge in Flames, 143; the Mechanical Phenomena of the Electric Discharge, 336
- Semon (Sir Felix), Some Thoughts on the Principles of Local Treatment in Diseases of the Upper Air Passages, 149
- Senderis (J. B.), the Addition of Hydrogen to Ethylenic Hydrocarbons by the Method of Contact, 119; Chemical Theory of Petroleum Formation, 138; the Direct Hydrogenation of Acetylenic Hydrocarbons by the Method of Contact, 312; Reduction of Nitro-derivatives by the Method of Direct Hydrogenation in Contact with Finely Divided Metals, 360; Direct Reduction of Oxides of Nitrogen by the Contact Method, 384
- Senior (Edgar), Experiment Illustrating a Paradoxical Consequence of the Wave Theory of Light, 204; Photograph of the Spectrum of the Arc Light, 582
- Sender (George), on the Measurement of Temperature, 382
- Serotherapy: Vaccination Against Pasteurelloses, MM. Joseph and Marcel Lignières, 120; the Plague in the Punjab, 484; the Rinderpest Serum, 659
- Severo (M.), Death of, 65
- Serviss (Garrett P.), Other Worlds, 221
- Sex? Qu'est ce qui détermine le, Dr. A. Van Lint, 437
- Sexton (Prof. A. Humboldt), Assaying and Metallurgical Analysis for the Use of Students, Chemists and Assayers, 628
- Shann (G.), the Criterion of Scientific Truth, 221
- Sharp (G.), Birds in the Garden, 444
- Sharpe (R. B.), Report on the Collections of Natural History

- Made in the Antarctic Regions during the Voyage of the *Southern Cross*, 322
- Shaw (Captain H. J.), Cool Summer at Yokohama, 554
- Shaw (Dr. P. E.), Electric Micrometer, 70
- Shaw (Dr. W. N., F.R.S.), Lehrbuch der Meteorologie, Dr. Julius Hänn, 337; on Radiation in Meteorology, 619; the Treatment of Smoke, a Sanitary Parallel, 667
- Shaw Prize for Industrial Hygiene Awarded by the Society of Arts to James Tonge, jun., 377
- Sheep, the Use of Salt in the Dietary of, 556
- Sheep, a Rare Wild, R. Lydekker, F.R.S., 32
- Shelton (H. S.), Molecular Condition of Borax in Solution, 238
- Sherborn (C. Davies), Effect of a Lightning Flash, 492
- Ship Models for Resistance, the Proposed Experimental Tank for Testing, 128
- Shore Climate, Sea Temperature and, 116
- Sichtbare und Unsichtbare Bewegungen, H. A. Lorentz, 489
- Sicily: Cyclone on the Eastern Sicilian Coast on September 26, 553
- Signals, Coast Fog, E. Price Edwards, 115
- Silesia, Prehistoric Pygmies in, David MacKitchie, 151
- Silicon, Control of the, in the Acid Open-hearth Bath, A. MacWilliam and W. H. Hatfield, 63
- Silicon not an Element, Th. Gross, 484
- Simon (L. J.), Derivatives of Pyruvylpyruvic Ester, 72; a New Acidimetric Indicator, 516; the Derivatives of Ethyl Pyruvylpyruvate, 672
- Sirex and Thalesa, the Habits of the Larvæ and Adults of, E. P. Stebbing, 407
- Skagway, Earthquake at, 378
- Skeletons, Dispersive Power of Running Water on, W. L. H. Duckworth, 116
- Skin Currents, on, Part iii., the Human Skin, Augustus D. Waller, F.R.S., 455
- Slate (Prof. Frederick), Physics, a Text-book for Secondary Schools, 575
- Sleep, Experimental Investigations on the Depth of, Drs. Sante de Sanctis and U. Neyoz, 137
- "Sleeping Sickness" of Uganda, the, 484
- Sliding Rule Notes, Lieut.-Colonel H. C. Dunlop and C. S. Jackson, 292
- Smedley (Miss Ida), Colour of Iodine-containing Compounds, 663
- Smiles (S.), Liquid Hydride of Silicon, 263; New Properties of Amorphous Silicon, 263
- Smith (Prof. Alexander), Amorphous Sulphur and its Relation to the Freezing Point of Liquid Sulphur, 239; Causes which Determine the Formation of Amorphous Sulphur, 383
- Smith (Dr. D. T.), Retention of Leaves by Deciduous Trees, 631
- Smith (Prof. G. Elliot), Abnormal Dentition in a Lemur, 71; Cerebellum of the Lemurs, 94; Brain of the Elephant Shrew, 94; a Peculiarity of the Cerebral Commissures in Certain Marsupialia, 165; Instances of Abnormality in Animals, 351
- Smith (G. F. Herbert), Three-circle Goniometer, 83
- Smith (Henry G.), two Chemical Constituents from the Eucalypts, 456
- Smith (H. W. Croome), Remarkable Lunar Halo, 85
- Smith (J. H.), Throw-testing Machine for Reversals of Mean Stress, 45
- Smith (R. Greig), Gummosis of the Sugar Cane, 264
- Smithells (Prof. Arthur, F.R.S.), the Encyclopædia Britannica, 289; the Future of the Victoria University, 319, 343
- Smithsonian Institution, the, Its Documentary History, 226
- Smoke, the Treatment of, a Sanitary Parallel, Dr. W. N. Shaw, F.R.S., at the Sanitary Congress, Manchester, 667
- Smyth (Prof. C. Piazzi), Does the Spectrum Place of the Sodium Lines Vary in Different Azimuths, 119
- Snails, the Evolution of, in the Bahama Islands, Prof. T. D. A. Cockerell, 56
- Snake Poison, the Elaboration of Venogen and of Venom in the Parotid Gland of *Vipera Aspis*, L. Launo, 624
- Snake Poison, a Kinase in, C. Delezenne, 408
- Snow, Caucasian, A. Brun, 16
- Snow-waves and Snow-drifts, Dr. Vaughan Cornish at the Geographical Society, 453
- Snyder (M. B.), a new Transiting Device, 613
- Society of Arts: Photography as Applied to Architectural Measurement and Surveying, J. Bridges Lee, 235; Shaw Prize for Industrial Hygiene Awarded by the Society of Arts to James Tonge, jun., 377
- Social Relations, the Basis of, D. G. Brinton, 221
- Soddy (Mr.), Radio-activity of Thorium Compounds, 119
- Radio-activity of Uranium, 119
- Sodeau (W. II.), Decomposition of Chlorates, 214
- Sodium, the Manufacture and Uses of, James D. Darling, 189
- Solar Corona, Connection between the Photographs of the, and of the Entire Solar Chromosphere obtained on the Same Day, H. Deslandres, 167
- Solar Eclipses, Occultations of Stars and, Francis Cranmer Penrose, 149
- Solar Eclipses, Effects of, on the Motion of Air-currents, Luigi de Marchi, 159
- Solar Eclipse of May 18, 1901, Spectroscopy of the, J. W. Humphreys, 331
- Solar Eclipse, Total, of, 1901, Search for an Intra-Mercurial Planet during the, Prof. Perrine, 662
- Solar Halo, a Remarkable, Rev. T. C. Porter, 76
- Solar Halo, a, R. T. Omond, 103
- Solar Phenomena during 1901, 401
- Solar Prominences, Hypothesis on the Nature of, Prof. W. H. Julius, 450
- Solar Protuberances and Terrestrial Magnetism, the Relation between the, Sir Norman Lockyer, K.C.B., F.R.S., 456
- Solar and Meteorological Changes, on Some Phenomena which Suggest a Short Period of, Sir Norman Lockyer, K.C.B., F.R.S., and Dr. William J. S. Lockyer, 248
- Solar and Meteorological Variations, Short Period, Sir Norman Lockyer, K.C.B., F.R.S., and Dr. William Lockyer, 456
- Solly (R. H.), Crystallographic Characters of Liveingite, 215
- Sormani (Prof. Giuseppe), Changes in the Birth and Death Rates in Italy during the last Forty Years, 660
- Sound: Interference of, the Right Hon. Lord Rayleigh, F.R.S., at the Royal Institution, 42; Studies in Auditory and Visual Space Perception, Arthur Henry Pierce, Prof. Alex. Crum Brown, F.R.S., 73; Wellenlehre und Schall, W. C. L. van Schaik, 268
- South African Philosophical Society, Paper Read at, Stereoscopic Method of Photographic Surveying, H. G. Fourcade, 139
- South Wales Electrical Power Distribution Company, the, 38
- Space, Matter and Motion in, Sir Hiram S. Maxim, 223
- Space Perception, Studies in Auditory and Visual, Arthur Henry Pierce, Prof. Alex. Crum Brown, F.R.S., 73
- Spark Discharge from Metallic Poles in Water, on the, Sir Norman Lockyer, K.C.B., F.R.S., 93
- Sparrow (F. W.), the Principles of Simple Photography, 389
- Spectrum Analysis: Prisms and Plates for Showing Dichromatism, Prof. R. W. Wood, 31; Action of Self-induction on the Spectrum of Dissociation of Compounds, A. de Gramont, 72; on the Spark Discharge from Metallic Poles in Water, Sir Norman Lockyer, K.C.B., F.R.S., 93; Visual and Spectroscopic Observations of the Sun-spot Group of May and June, 1901, Father Cortie, 94; Spectrum of Electric Sparks, B. Eginits, 95; Does the Spectrum Place of the Sodium Lines Vary in Different Azimuths, Prof. C. Piazzi Smyth, 119; an Attempt to Reproduce an Aurora Borealis, Prof. W. Ramsay, F.R.S., 204; the Spectra of Potassium, Rubidium and Cæsium, and their Mutual Relations, Hugh Ramage, 214; Spectrum of Hemoglobin, L. Bier and L. Marchlewski, 230; Index to the Literature of the Spectroscopy (1887-1900, both inclusive), Alfred Tuckermann, 246; Personal Equation in the Measurement of Spectroscopic Negatives, M. Hasselberg, 258; Uneven Distribution of Light in a Diffraction Grating Spectrum, Prof. R. W. Wood, 262; Radial Velocity of the Orion Nebula, Prof. H. C. Vogel and Dr. Eberhard, 309; Spectra Arising from the Dissociation of Water Vapour and the Presence of Dark Lines in these Spectra, John Trowbridge, 310; Spectroscopy of the Solar Eclipse of May 18, 1901, J. W. Humphreys, 331; Spectroscopic Binary β Cephei, Prof. Frost and W. S. Adams, 352; Method of Spectrum Analysis Furnishing the

- Still Unknown Law of Rotation of Planets of Feeble Brightness, H. Deslandres, 360; Spectral Researches on the Rotation of the Planet Uranus, H. Deslandres, 572; Automatic Spectrographs Registering the Radial Movements and the Thickness of the Solar Chromosphere, H. Deslandres, 624
- Spencer (L. J.), Reasons for the Non-existence of "Kalgoorlite" and "Coolgardite" as Mineral Species, 215
- Spencer's (Stanley) Air Ship, 539
- Spiderland, Rose Haig Thomas, 270
- Spiders, the Common, of the United States, James H. Emerton, 630
- Spirals, Vortex, Dr. J. Larmor, F.R.S., 630
- Spurge, Action of, on Salmonoid Fishes, H. M. Kyle, 45
- Stafford (Mr.), Reactions between Acid and Basic Amides in Liquid Ammonia, 541
- Stars: New Variable Stars, 68, 234; Naming of, 425; Variable Stars, 309; Notation of Variable Stars, 208; Observations of the Variable Star χ^2 Cygni during 1899, 282; a New Algol Variable, 115; Mrs. Fleming, 331; A. Stanley Williams, 551, 638; Observations of Variable Stars of Long Period, 638; Prof. Pickering, 486; Catalogue of North Polar Stars, Prof. Pickering, 88; Occultations of Stars and Solar Eclipses, Francis Crammer Penrose, 149; Observations of Nova Persei, 233, 282; Discoverer of Nova Persei, 282; Spectrum of Nova Persei, Prof. Campbell and Mr. Wright, 425; the Changes in the Nebula surrounding Nova Persei, Dr. Louis Bell, 426; Distribution of the Stars in the Cape Photographic Durchmusterung, Dr. Downing, 238; Photographic Magnitude of Stars, Prosper Henry, 282; Rotation of the Brighter Fixed Stars, as a Whole, with Respect to the Fainter Stars, Sir David Gill, 282; Hong Kong Double Star Observations, W. Dobereck, 282; Double Stars, Rev. T. E. Espin, 353; Catalogue of New Double Stars, W. J. Hussey, 450; the Spectroscopic Binary β Cephei, Prof. Frost and W. S. Adams, 352; Light of the Galaxy and Bright Stars, C. Easton, 353; Sir David Gill's New Theory of Stellar Movement, 515; Corrections to the Right Ascensions of the Principal Stars of the Berliner Jahrbuch, Senor Campos Rodrigues, 557
- Statistics: the Mining Statistics of the World, Prof. C. Le Neve Foster, 163; Statistical Methods in Biology, Biometrika, 234; Trade Statistics, F. Evershed, 550, 607; Dr. F. Mollwo Perkin, 550; Changes in the Birth and Death Rates in Italy during the Last Forty Years, Prof. Giuseppe Sormani, 660
- Steam: Liquid Fuel for Steam Purposes, J. S. S. Brame, 186; Use of Peat in Sweden as a Substitute for Coal for Steam Engines, 256; Steam Turbines, Hon. C. A. Parsons, 643
- Stear (F. A.), Overthrusts in the Braysdown Colliery, 166
- Stebbing (E. P.), the Habits of the Larvæ and Adults of *Sirex* and *Thalessa*, 407
- Steel: the Iron and Steel Institute, 62; Constituents of Hardened Steel, Prof. J. O. Arnold and Mr. McWilliam, 63; Brinell's Researches on the Influence of Chemical Composition on the Soundness of Steel Ingots, Axel Wahlburg, 63; Electrical Conductivity of Steel and Pure Iron, C. Benedicks, 160; the Compression of Steel during Solidification in the Ingot Mould, A. Harmet, 487; the Overheating of Mild Steel, Prof. Heyn, 487
- Stein (M. A.), Preliminary Report on a Journey of Archaeological and Topographical Exploration in Chinese Turkestan, 284
- Stellar Movement, Sir David Gill's New Theory of, 515
- Stërba (Jean), on an Oxycarbonate of Cerium, 72; Cerium Silicide, 336
- Stereoscope, Application of the, to Lantern Projections, J. Macé de Lépinay, 581
- Stereoscopic Method of Photographic Surveying, H. G. Fourcade at the South African Philosophical Society, 139
- Sterneck (Dr. Jacob von), Monographie der Gattung *Alectrolophus*, 4
- Stewart (Charles), Earthquake of May 28 at the Cape and Coincident Meteorological Effects, 369
- Stock (A.), Gaseous Antimony Hydride, 281
- Stockem (L.), Apparatus for the Electrolytic Separation of Calcium from the Fused Chloride, 636
- Stockman (Dr. Ralph), Therapeutic Value of Arsenic, 353
- Stokes (Sir G. G.), Mathematical and Physical Papers, Prof. Horace Lamb, F.R.S., 49
- Stomach, on the Movement and Innervation of the, Dr. Page May, 665
- Stonehenge and its Barrows, the Wiltshire Archaeological and Natural History Magazine, William Long, F.S.A., Sir Norman Lockyer, K.C.B., F.R.S., 25
- Stonehenge Bibliography Number, the Wiltshire Archaeological and Natural History Magazine, W. Jerome Harrison, Sir Norman Lockyer, K.C.B., F.R.S., 25
- Stoney (Dr. Johnstone), on Substituting for Huyghen's Wave Surface a Wave Film of Finite Thickness within which the Phases of the Disturbance were Given Proper Values, 618
- Stonyhurst College Observatory, Meteorological Observations at, for 1901, 38
- Storer (Prof. F. H.), Mannan in Sugar-maple Trees, 541
- Strasburger (Dr. Eduard), Das botanische Practicum, 605
- Stress, Microscopic Effects of, on Platinum, Thomas Andrews, F.R.S., and Charles Reginald Andrews, 213
- Stromeyer (C. E.), Mathematical Training, 103
- Stubblefield (Mr.), Experiments with Wireless Telephony, 158
- Submarine Cables: les Câbles Sous-Marins, Alfred Gay, 148
- Submarines, les Bateaux Sous-Marins et les Submersibles, R. D'Equelley, 290
- Sudd, the, of the White Nile, 666
- Sulphur Contents of Slags, Baron Jüptner, 63
- Sun: Sun-pillar and Parhelion, Prof. Grenville A. J. Cole, 32; Sun-pillar of March 6, 38; Sun-pillar? Sir W. J. Herschel, Bart., 77; a Remarkable Solar Halo, Rev. T. C. Porter, 76; Volcanic Eruption in Java, Brilliant Sunset Glows in 1901, and Probable Glows from the Eruption in Martinique, Henry Helm Clayton, 101; Remarkable Sunsets at Madeira, F. W. T. Krohn, 199; A. R. Tankard, 254; Sunset Glows at Madeira, F. Krohn, 540; the Coloured Sunsets, Dr. William J. S. Lockyer, 222; J. Edmund Clark, 223; Peculiar Appearance at and after Sunset, Dr. C. B. Flower, 230; A. R. Jenkin, 230; Recent Coloured Sunsets, 254; Sunset Effects, Prof. G. H. Bryan, F.R.S., 390; S. Pace, 390; Propagation of Electric Force from the Sun into Space, M. Nordmann, 136; Connection between the Photographs of the Solar Corona and of the Entire Solar Chromosphere Obtained on the same Day, H. Deslandres, 167; the Sunspot Curve and Epochs, 186; Mean Maximum Temperature and the Rainfall of Jamaica and Sunspot Frequency, Maxwell Hall, 206; Sunspots and Wind, Alex. B. MacDowall, 320; Apparent Deformations of the Sun's Disc near the Horizon, 259; Height of Sunset Afterglows in June, 1902, Prof. A. S. Herschel, F.R.S., 294; Solar Phenomena during 1901, 401; Hypothesis on the Nature of Solar Prominences, Prof. W. H. Julius, 450; Instructions on the Observation of the Sun, 557
- Sun-flower, Manufacture of Oil Cakes from the Seeds of the, 232
- Surgery, the Röntgen Rays in Medicine and, as an Aid in Diagnosis and as a Therapeutic Agent, Francis H. Williams, 438
- Süring (Dr.), the Use of Oxygen Inhalers in Connection with High Balloon Ascents, 306
- Surveying: Stereoscopic Method of Photographic, H. G. Fourcade at the South African Philosophical Society, 139; Photography as an Aid to the Surveyor, Arthur O. Wheeler, 206; Photography as Applied to Architectural Measurement and Surveying, J. Bridges Lee at Society of Arts, 235
- Sutton (J. R.), Cold Weather in South Africa, 247; a Series Related to Bernoulli's Numbers, 492
- Sverdrup Arctic Expedition, Return of the, 542
- Swedish Polar Expedition, Progress of, 421
- Sweet Briar, the, as a Goat Exterminator, Sir W. T. Hisseton Dyer, F.R.S., 31
- Swift's Comet (a 1899), Reduction of Measures of, from Photographs, with Portrait Lens of 30-inch Focus and 5-inch Aperture, Mr. Filon, 238
- Swinhoe (R. C. J.), Prehistoric Man in Burma, 541
- Swordy (R.), Remarkable Shower of Haliteons, 159
- Sykes (Major Percy Molesworth), Ten Thousand Miles in Persia, or Eight Years in Iran, 418; and the Geography of Southern Persia, 642

- Symons's Meteorological Magazine. Use of the Monthly Rainfall Tables, 114
- Syria and Palestine, Lewis Bales Paton, 517
- Syria, Remarkable Fossil Oysters from, Alfred Ely Day, 606 ; E. T. N., 607
- Taber (R. B.), the Leonid Shower, 662
- Tank for Testing Ship Models for Resistance, the Proposed Experimental, 128
- Tankard (A. R.), Remarkable Sunsets at Madeira, 354
- Taquin (A.), a Theory of Volcanoes, 233
- Targioni-Tozzetti (Prof. Adolfo), Death of, 553
- Tatnall (R. R.), a Laboratory Manual of Physics, 4
- Taylor (Messrs. and Co.), Cooke Photographic Lenses, Method by which the Focal Length may be Reduced, 280
- Taylor (R. L.), the Reaction of Iodine with Mercuric Oxide in Presence of Water, 648
- Taylor (W.), the Science of the Workshop, 644
- Teacher's Manual of Object Lessons in Geography, Vincent T. Murché, 270
- Teaching of Geometry, Report on the, 201
- Teaching of Zoology, an Attempt at Originality in the, Henry Sherring Pratt, 292
- Teall (J. H.), F.R.S.), Volcanic Dust from the West Indies, 130
- Teall (Mr.), on the Prolongation of the Highland Border Rocks into County Tyrone, 619 ; Proof Sheet of the "Drift" Edition of the Geological Map of Ireland, 619
- Tebbutt's (Mr.) Observatory at Windsor, N.S.W., 258
- Technical Education at Manchester, Mr. Balfour, 633
- Technology : Death of Dr. Henry Morton, 113 ; Death of Frederick Augustus Abel, 483 ; Obituary Notice of, 492
- Telegraphy : New System of Octoplex Typographic Telegraphy, Prof. H. A. Rowland, 134 ; Les Câbles Sous-Marins, Alfred Gay, 148 ; the Receiver in Wireless Telegraphy, Edouard Branley, 143 ; New Form of Magnetic Detector, Recent Transatlantic Signalling, G. Marconi, 182 ; Marconi's Results in Day and Night Wireless Telegraphy, Prof. J. Joly, F.R.S., 199 ; Sir Oliver Lodge, F.R.S., 222 ; Note on a Magnetic Detector of Electric Waves which can be Employed as a Receiver for Space Telegraphy, G. Marconi, 334 ; a Note on the Effect of Daylight upon the Propagation of Electromagnetic Impulses over Long Distances, G. Marconi, 335 ; New Marconi Signalling Station at Cape Breton, 485 ; Prof. A. Right on Mr. Marconi, 581 ; Marconi Experiments on the *Carlo Alberto*, 610 ; Wireless Telegraphy over 1600 English Miles by Land, 277 ; Armstrong-Ording System of Wireless Telegraphy, 327 ; a Simple Telephonic Receiver for Wireless Telegraphy, Dr. L. Bleekrode, 343 ; Time Signals by Wireless Telegraphy, John Munro, 416 ; the De Forest System of Wireless Telegraphy, 446
- Telephony : Experiments with Wireless, Mr. Stubblefield, 158 ; a Simple Telephonic Receiver for Wireless Telegraphy, Dr. L. Bleekrode, 343 ; on the Future of the Telephone in the United Kingdom, J. E. Kingsbury, 644 ; Sir William Preece, 644
- Tempel-Swift, Ephemeris for the Search of the Comet, F. Bossert, 557
- Tempel-Swift, the Periodical Comet of (1869-1880), 258
- Temperature : the Measurement of High Temperatures and Stefan's Law, M. Féry, 47 ; Coefficients of the Cubical Expansion of Ice, Hydrated Salts, Solid Carbonic Acid and Other Substances at Low Temperatures, Prof. James Dewar, F.R.S., at Royal Society, 88 ; Electrical Resistance of Iron at Very Low Temperatures, E. Philip Harrison, 343 ; on the Measurement of Temperatures, Morris W. Travers, George Senter and Adrien Jaqueroed, 382 ; Brückner's Cycle and the Variation of Temperature in Europe, Alex. B. MacDowall, 77 ; Sea Temperature and Shore Climate, 116 ; Sea Temperature Variations on the British Coasts, 452 ; Temperatures of Kingston, Jamaica, Maxwell Hall, 159
- Termes Positifs, Leçons sur les Séries à, Émile Borel, 5
- Terracciano (Dr. Nicola), Decorative Plants for Gardens, 36
- Terrestrial Magnetism : Erdmagnetische Untersuchung im Kaiserstuhl, G. Meyer, 324 ; the Relation Between the Solar Protuberances and Terrestrial Magnetism, Sir Norman Lockyer, K.C.B., F.R.S., 456
- Tessari (Prof. D.), la Costruzione degli Ingranaggi, 218
- Texas, the Coal, Lignite and Asphalt Rocks of, W. B. Phillips, 379
- Textile Fibres of Commerce, the, William S. Hannan, 338
- Thames, the Naturalist on the, C. J. Cornish, 632
- Theobald (F. W.), a Monograph of the Culicidae of the World, 123
- Theology and Ethics of the Hebrews, Archibald Duff, 517
- Therapeutics : Treatment of Malarial Fevers by Latent Arsenic, Armand Gautier, 47 ; Therapeutic Value of Arsenic, Dr. Ralph Stockman, 353 ; Local Treatment of Rheumatism, Ch. Bouchard, 288 ; Therapeutic Value of Alkaline Waters of the Vichy Type, Prof. Liebreich, 353 ; the Röntgen Rays in Medicine and Surgery as an Aid in Diagnosis and as a Therapeutic Agent, Francis H. Williams, 438
- Thermal Expansions at Low Temperatures, Prof. James Dewar, F.R.S., at Royal Society, 88
- Thermodynamics, the Conservation of Weight and the Laws of, 102
- Thermometers, Temperature Indicator for Use with Platinum, R. S. Whipple, 22
- Thiele (J.), the Solenogastræ, 612
- Thin Floating Cylinders, Prof. Thos. Alexander, 6
- Thiselton-Dyer (Sir W. T., K.C.M.G., F.R.S.), the Sweet Briar as a Goat Extirminator, 31 ; the Life of Thomas Henry Huxley, Edward Clodd, 121
- Thomas (Rev. C.), the "Rotaplane," 422
- Thomas (Gordon C.), Novel Canal Lift, 350
- Thomas (H. H.), Mineralogical Constitution of the Finer Material of the Bunter Pebble-bed in the West of England, 95
- Thomas (Rose Haig), Spiderland, 270 ; Bipedal Locomotion of Lizards, 551
- Thomas (V.), Volumetric Estimation of Iodides in the Presence of Chlorides and Bromides, 120 ; Utilisation of Mineral Substances by Grafted Plants, 624
- Thompson (Prof. D'Arcy W.), the Hydrography of Færoec-Shetland Channel, 654
- Thompson (Prof. J. Arthur), the Seasonal Study of Natural History, 326
- Thompson (J. Stuart), Scales of Fishes as an Index of Age, 84
- Thompson (Prof. Silvanus P., F.R.S.), Resultant Tones and the Harmonic Series, 6 ; Obituary Notice of Prof. Alfred Cornu, 12 ; the First Magnetician, 249, 272
- Thompson Yates Laboratories Report, the, 390
- Thomson (Basil), Savage Island, an Account of a Sojourn in Niuc and Tonga, 347
- Thomson (J. J.), Increase in the Electrical Conductivity of Air Produced by its Passage Through Water, 143
- Thorne (Dr.), Purification of Hydrochloric Acid from Arsenic, 119
- Thorpe (Prof. T. E., F.R.S.), Chemical Instruction and Chemical Industries in Germany, 32 ; Essays in Historical Chemistry, 365 ; Dangerous Trades, the Historical, Social and Legal Aspects of Industrial Occupations as Affecting Health, 433
- Thovert (J.), a Consequence of the Kinetic Theory of Diffusion, 648
- Throw-testing Machine for Reversals of Mean Stress, Osborne Reynolds, F.R.S., and J. H. Smith, 45
- Thunderstorms, Apparatus for Registering, Father J. Fényi and Father Johann Schreiber, 65
- Thunderstorms and the Lunar Phases, Connection Between, V. Ventosa, 85
- Tides in the Bay of Fundy, W. Bell Dawson, 85
- Tides of Terrestrial Oceans, a New Theory of the, Rollin Harris, Prof. G. H. Darwin, F.R.S., 444
- Tigers, How the Sabre-toothed, Killed their Prey, 357
- Tilden (Prof.), Pinene Nitrosocyanide, 238
- Time Signals by Wireless Telegraphy, John Munro, 416
- Toads : Poison of the Toad, C. Phisalix and Gabriel Bertrand, 288 ; Bufonine, Gabriel Bertrand, 288
- Tocher (J. F.), on the Pigmentation Survey of Scottish School Children, 663
- Tommasina (Th.), the Mode of Formation of Kathode and Röntgen Rays, 408
- Tonge (James, jun.), Shaw Prize for Industrial Hygiene Awarded by the Society of Arts to, 377

- Topography; Preliminary Report on a Journey of Archaeological and Topographical Exploration in Chinese Turkestan, M. A. Stein, 284
- Toronto, Royal Society of Canada's Meeting at, Universities in Relation to Research, 358
- Torres (M.), Project for a Navigable Balloon with an Interior Keel, 422
- Touta (Prof. F.), New Pleistocene Rhinoceros, 379; *Corr.*, 399
- Toxicology: Poison of the Toad, C. Phisalix and Gab. Bertrand, 283; Bufonine, Gabriel Bertrand, 288; a Kinase in Snake Poison, C. Delezenne, 408; the Elaboration of Venogen and of Venom in the Parotid Gland of *Vipera Aspis*, L. Launoy, 624
- Traction, Electric, 513
- Trade and Industry, the Influence of Education upon, Dr. F. Mollwo Perkin, 442
- Trade Statistics, F. Evershed, 550, 607; Dr. F. Mollwo Perkin, 550
- Trades, Dangerous, the Historical, Social and Legal Aspects of Industrial Occupations as Affecting Health, Dr. T. E. Thorpe, F.R.S., 433
- Trades' Waste, its Treatment and Utilisation, W. Naylor, 413
- Tramways Exhibition at the Agricultural Hall, 272
- Transactions of the American Mathematical Society, 165
- Transiting Device, a New, M. B. Snyder, 613
- Transparent Objects, a Method of Showing the Invisibility of, under Uniform Illumination, Prof. R. W. Wood, 102
- Traquair (Dr. R. H.), on Fishes from the Lower Devonian Roofing Slate from Gemünden, Germany, 620
- Travers (Dr. Morris W.), Apparatus for Liquefying Hydrogen, 204; on the Measurement of Temperature, 382
- Trees, Retention of Leaves by Deciduous, Jul. Wulff, 32; Wm. Gee, 32; G. W. Bulman, 56; P. T., 56; A. F. G., 344; Prof. W. K. Fisher, 370; Dr. D. T. Smith, 631
- Trees in Prose and Poetry, 630
- Tremataspidae, Structure and Classification of the, Prof. William Patten, 184
- Trephining in the South Seas, Rev. J. A. Crump, 136
- Treves (Sir Frederick), the Romance of Medicine, 183
- Tripartite Stroke of Lightning, a, W. H. Hall, 370
- Trouton (F. T.), Experiment Suggested by the late Prof. Fitzgerald for Testing the Relative Motion of the Earth and the Ether, 66
- Trowbridge (C. C.), Effect of Wind on the Migration of Hawks, 612
- Trowbridge (John), Spectra Arising from the Dissociation of Water Vapour and the Presence of Dark Lines in These Spectra, 310
- Truth, the Criterion of Scientific, G. Shann, 221
- Trypanosomes in Fishes, Multiplication of, A. Laveran and F. Mesnil, 216
- Tuberculosis as a Disease of the Masses and How to Combat It, S. A. Knopf, 270
- Tuckermann (Alfred), Index to the Literature of the Spectroscope (1887-1900, both inclusive), 246
- Tufts (F. L.), the Transmission of Sound through Solid Walls, 212
- Tunncliffe (Prof.), Synthetic Purgatives, 353
- Turkestan, Recent Discoveries in Chinese, Prof. M. Winternitz, 284
- Turner (C.), Fall of a Yellow Powder on June 1 and 2 during a Thunderstorm, 157
- Turner (Dr. Dawson), Mechanical Break for Induction Coils, 21; the Electrical Resistance of the Blood, 127
- Turner (Prof. H. H., F.R.S.), the Astrographic Chart, 273
- Turner (Prof.), on an Attempt Made at Oxford to Verify the Suggestion that the Bright Stars as a Whole are Rotating Relatively to the Fainter Stars, 640
- Turner (Dr. John), on some New Features in the Intimate Structure of the Human Cerebral Cortex, 665
- Tyler (E. A.), a Junior Chemistry, 606
- Types of British Plants, C. S. Colman, 458
- Typhoon at Yokohama on September 29, 553
- Uganda, the "Sleeping Sickness" of, 484
- United States, America: Pisciculture in the, Earl Grey, 65; Report on a Bill for Adoption of the Metric System in the, 158; the Insect-enemies of the Pine in the Black Hills Forest Reserve, A. D. Hopkins, 160; Reports of United States Coast Survey, Rollin Harris, Prof. G. H. Darwin, F.R.S., 444; the Common Spiders of the United States, James H. Emerton, 630; Working Plans for Forests in Arkansas, F. E. Olmsted, 661; Timber Resources of Nebraska, W. L. Hall, 661; Magnetic Work of the United States Coast and Geodetic Survey, Outlined for July 1, 1902-June 30, 1903, 666
- Universities: the Colleges of the University of London, 10; University College and the University of London, 59; Astronomy in the University of London, Prof. Karl Pearson, F.R.S., 174; University Intelligence, 20, 44, 69, 92, 117, 141, 163, 190, 212, 236, 261, 287, 310, 333, 359, 381, 407, 431, 455, 488, 515, 543, 571, 600, 623, 647, 670; the Royal Visit to the University of Wales, Prof. G. H. Bryan, F.R.S., 61; the Future of the Victoria University, Prof. Arthur Schuster, F.R.S., 252, 319; Prof. Arthur Smithells, F.R.S., 319, 343; Report on University Colleges, 332; Universities in Relation to Research, Prof. James Loudon at Royal Society of Canada's Meeting at Toronto, 358; Matriculation Requirements in Scottish Universities, Prof. John Perry, F.R.S., 654; the Neglect of Anthropology in British Universities, "Anthropotamist," 654
- Upland Game-birds, E. Sandys and T. S. Van Dyke, 652
- Uranium, Redetermination of the Atomic Weight of, Prof. T. W. Richards and Mr. Merigold, 208
- Uranus, the Satellites of Saturn and, Dr. J. J. See, 380
- Ussher (R. J.), on the Avifauna of Ireland as Affected by its Geography, 641
- Vaccination League, Formation of an Imperial, 397
- Valencies, Atoms and, J. Fraser, 68
- Van Aubel (Edm.), the Indices of Refraction of Liquid Mixtures, 47
- Van Dyke (T. S.), Upland Game-birds, 652
- Van Lint (Dr. A.), Qu'est-ce qui Détermine le Sexe? 437
- Vanne, the Prediction of the Minimum Yield of the Sources of the, Edmond Maillet, 95
- Vapour Pressures and Boiling Points of Mixed Liquids, Dr. Young, F.R.S., 70
- Variable Stars: New, 68, 234; the Naming of New Variable Stars, 425; New Algol Variable, 115; Mrs. Fleming, 331; A. Stanley Williams, 515, 638; Variable Stars, 309; Notation of Variable Stars, 208; Observations of the Variable Star χ^2 Cygni during 1899, 282; Observations of Variable Stars of Long Period, Prof. Pickering, 486; Observations of Fifty-eight Long-period Variables, 638
- Variable Velocities in Line of Sight, New Discoveries of, 425
- Variation, Colour, in Pigeons, F. Finn, 157
- Variation of Common Copper Butterfly, 459, 555
- Variation, Germinal and Environmental, J. C. Ewart, F.R.S., 209
- Vaughan (Arthur), the Jurassic Strata Cut Through by the South Wales Direct Line between Filton and Wootton Bassett, 263
- Vaulx (Comte de la), Aeronautics, 447
- Vegetable Electricity, *Ac.*, Dr. Augustus D. Waller, 491, 549; Prof. Jagadis Chunder Bose, 549
- Velocity Diagrams, their Construction and Uses, Prof. C. W. MacCond, 269
- Venezuela, Volcanic Eruption in, 484
- Ventosa (V.), Connection between Thunderstorms and the Lunar Phases, 85
- Vermorel (M.), New Method for the Destruction of the Pyralis and other Noxious Insects, 288
- Verneau (R.), a New Type of Human Fossil, 24
- Vernon (Dr. H. M.), Zymogens and Enzymes of the Pancreas, 87
- Vibration of the Violin, the, W. B. Coventry, 150
- Vibration of Railway Bridges, on the Deflection and, Dr. F. Omori, 322
- Vibrations, Earthquake-like, Caused by the Firing of Heavy Guns at the Mouth of the Medway, 230
- Victoria University, the Future of the, Prof. Arthur Schuster, F.R.S., 252, 319; Prof. Arthur Smithells, F.R.S., 319, 343

- Vidal (E.), the Use of Hail Rockets, 312
 Vignon (Leo), Saponification of Nitric Esters, 624
 Vignon's (Dr. P.) Researches and the "Holy Shroud," 13
 Vincent (C. A.), on a General Numerical Connection between the Atomic Weights, 143
 Vincent (J. H.), Redetermination of the Density and Coefficient of Cubical Expansion of Ice at 0° C., 611
 Violin, the Vibration of the, W. B. Coventry, 150
 Virchow (Rudolph Ludwig Karl), Death of, 483; Obituary Notice of, 551
 Visual Space Perception, Studies in Auditory and, Arthur Henry Pierce, Prof. Alex. Crum Brown, F.R.S., 73
 "Vitalised"? Can Carbon Dioxide be, Prof. K. Meldola, F.R.S., 492
 Vitality: *Religio Medici*, &c., 457
 Viticulture: Quality of a Wine Depends upon the Yeast which Grows Spontaneously upon the Grape, A. Rosenstiehl, 192; Action of Sulphurous Acid upon Oxalate and on the Colouring Matter of Red Wine, A. Bouffard, 192; New Method for the Destruction of the Pyralis and other Noxious Insects, MM. Vermorel and Gastin, 288; Production of Sparkling Mécoc, 329; Method of Concentrating Wine, MM. Baudoin and Schribaux, 360
 Vocal System Based on the Fundamental Laws of Language, the, G. Lionel Wright, 271
 Vogel (Prof. H. C.), the Orion Nebula and Movement in the Line of Sight, 18; Radial Velocity of the Orion Nebula, 309
 Vogel (Wolfgang), Schule des Automobil Fahrers, 313
 Voice Production, Health, Speech and Song, a Practical Guide to, Jutta Bell-Ranske, Dr. B. Moore, 388
 Volcanoes: the Recent Volcanic Eruptions in the West Indies, 53, 56, 79, 132, 153, 178, 203, 229, 635; Prof. J. Milne, 56, 107, 151, 370; R. T. Hill, 485; Prof. I. C. Russell, 485; Report on the West Indian Eruptions, Robert T. Hill, 370; Prof. I. C. Russell, 372; Royal Society's Report on the West Indian Eruptions, Dr. Tempest Anderson, Dr. J. S. Flett, 402; Eruptions and Earthquakes during Week Ending September 1 in the West Indies and Elsewhere, 446; Volcanic Dust from the West Indies, J. J. H. Teall, F.R.S., 130; Rev. T. C. Porter, 131; J. D. Falconer, 132; Mont Pelée Eruption and Dust Falls, Dr. William J. S. Lockyer, 53; Mont Pelée and After-glow, F. C. Constable, 79; Fresh Eruptions of Mont Pelée, 278, 580, 659; Eruption of Mont Pelée heard at Maracaibo, Venezuela, E. H. Plumacher, 554; Notes on the Recent Eruptions of Mont Pelée, Dr. H. A. Alford Nicholls, 638; Rocks of Mont Pelée, J. S. Diller, 372; on the Rocks Thrown Out by the Actual Eruption of Mont Pelée, A. Lacroix, 544; Enclosures in the Andesites from Mont Pelée, A. Lacroix, 572; Magnetic Disturbances during the Eruption of Mont Pelée on May 8, Dr. L. A. Bauer, 421; Last Days of St. Pierre, Very Rev. G. Parel, 372; Effects of the Recent Volcanic Eruptions in Martinique and St. Vincent, H. Hesketh Bell, 306; the Mission to Martinique, M. Lacroix, 336; the Eruption of Martinique, 538; A. Lacroix, M. Rollet de l'Isle and M. Giraud, 488, 516; Phenomena Observed at Zi-Ka-Wei, China, during the Martinique Eruption, M. de Moiray, 408; Effects Observed at St. Kitts during the Volcanic Eruptions in Martinique and St. Vincent, Dr. W. Branch, 378; Composition of the Volcanic Dust at Barbadoes on May 7 and 8, 204; Eruptions of St. Vincent Volcano and Earthquake, 327; Eruption in St. Vincent, Captain Calder, 373; T. McGregor McDonald, 373; Eruptions in Venezuela and St. Vincent, 484; Volcanic Eruption in Java, Brilliant Sunset Glows in 1901, and Probable Glows from the Eruption in Martinique, Henry Helm Clayton, 104; a Theory of Volcanoes, A. Taquin, 233; Volcanic Dust, Agricultural Use of, 306; Volcanic Disturbances in Spain, the Azores and Costa Rica, 327; Periodicity of Volcanic Eruptions and Earthquakes, Rev. T. E. Espin, 353; Possible Connection between Volcanic Eruption and Sun-spot Phenomena, H. I. Jensen, 360; Volcanic Eruption at Tori Shima, 396; Activity of the Roaring Volcano in Java, 396; Reports of Eruptions and Earthquake Shocks, 421; the Lava-lake of Kilauea, S. E. Bishop, 441; Activity of Various Volcanoes, 511; Activity of Mount Chullapata, 553; Recent Sun Spot Effects and Those which Followed the Eruption of Krakatoa, A. W. Clayden, 659
 Voltmeter, Accuracy of an Improved Form of Silver, T. W. Richards and G. W. Heimrod, 158
 Vortex Spirals, Dr. J. Larmor, F.R.S., 630
 Waddell (L. A.), the Tribes of the Brahmaputra Valley, 91
 Wahl (A.), Condensation of Nitromethane with Aromatic Aldehydes, 288; Method of Gradual Synthesis of Aldehydes, 120; Synthesis of Fatty Aldehydes, 137
 Wahlburg (Axel), Brinell's Researches on the Influence of Chemical Composition on the Soundness of Steel Ingots, 63
 Wales, Ordnance Survey of England and, 341
 Wales, Marine Biology in, G. W. Duff Assheton-Smith, 282
 Wales, the Royal Visit to the University of, Prof. G. H. Bryan, F.R.S., 61
 Walker (James, F.R.S.), Elementary Inorganic Chemistry, 170
 Walker (Sydney F.), Coal Cutting by Machinery in the United Kingdom, 414
 Wall (E. J.), the Dictionary of Photography, 368
 Waller (Augustus D., F.R.S.), on Skin Currents, Part iii., the Human Skin, 455; *Re* Vegetable Electricity, 491, 549
 "Walzing Mice" of Japan and China, Dr. K. Kishi, 114
 Ward (Prof. Marshall), Rust-fungus, 210
 Washington, D.C., the Carnegie Institution of, Dr. Daniel C. Gilman, 548
 Water: la Question de l'Eau potable devant les Municipalités, P. Guichard, 28
 Water, Diagrams of Mean Velocity of Uniform Motion of, in Open Channels based on the Formula of Ganguillet and Kutter, Prof. Irving P. Church, 439
 Water, Ebulition of Rotating, T. C. Porter, 118
 Water-power, the Utilisation in France of, for Industrial Purposes, Henri Desmarest, 485
 Water-supply, Prof. William P. Mason, 458
 Watkins (Alfred), the Watkins Manual of (Photographic) Exposure and Development, 245
 Watson (A. T.), on the Errant Habits of the Onuphiidae (Polychæta), 641
 Watson (W. F.), Elementary Experimental Chemistry, 170
 Watts (Prof. W. W.), Charnwood Forest, 642
 Waves and Sound, W. C. L. van Schaik, 268
 Weather Bureau Officials, Convention of, at Milwaukee, 543
 Weber (Prof. Robert), a Graduated Collection of Problems in Electricity, 317
 Webb (Wilfred Mark), the "Nature Study" Exhibition, 324
 Webber (Dr. Herbert J.), Germination of the Pollen Grain and the Series of Events Leading to Fertilisation in Two Species of Zamia, 67
 Webster's International Dictionary of the English Language, 222
 Wedding (Prof.), Photometric Tests of the Bremer Arc Lamp, 611
 Wedekind (E.), a New Isomerism in Asymmetric Nitrogen, 192
 Wegscheider (R.), the Rate of Hydrolysis of Sulphonic Acid Esters, 308
 Weight, Conservation of, and the Laws of Thermodynamics, 102
 Weight? Does Chemical Transformation Influence, Lord Rayleigh, F.R.S., 58
 Weiss (Prof. F. E.), *Wolvischia mirabilis*, 23
 Welch (R.), New Path along the Goban's Cliffs, 417; "Sports" of *Helix nemoralis*, 612
 Welch (Prof.), Recent Studies of Immunity with Special Reference to their Bearing on Pathology, 611
 Wellenlehre und Schall, W. C. L. van Schaik, 268
 Welterhin und ihr Schatten, Die, Ein Vortrag ueber Energie und Entropie, Dr. Felix Auerbach, 414
 Wesché (Walter), Relations between the Mouth-organs of Diptera and Those of Other Insects, 512
 West (C. A.), Phosphorus Tetroxide, 214
 West (Prof. G. S.), Distribution of Pithophora, 296
 West Indies: the Recent Volcanic Eruptions in the, 56, 79, 178, 203, 204, 635; Prof. J. Milne, F.R.S., 56, 107, 151, 370; Prof. Israel C. Russell, 372, 485; R. T. Hill, 485; Report on the West Indian Eruptions, Robert T. Hill, 370; Royal Society Report on the West Indian Eruptions, Dr. Tempest Anderson and Dr. J. S. Flett, 402; Volcanic Dust

- from the West Indies, J. J. H. Teall, F.R.S., 130; Rev. T. C. Porter, 131; J. D. Falconer, 132; Agricultural Teaching in West Indian Islands, 539
- Westell (W. P.), the Early Life of the Young Cuckoo, 574
- Wheeler (Arthur O.), Photography as an Aid to the Surveyor, 200
- Whipple (R. S.), Temperature Indicator for Use with Platinum Thermometers, 22
- White Nile, Bird Hunting on the, H. F. Witherby, 52
- White (S. A. F.), the Compound Pendulum, 22
- Whittem (C. T.), Saturn Visible through the Cassini Division, 87, 296
- Whittaker (E. T.), Solutions of the Partial Differential Equations of Mathematical Physics, 618
- Wigham (J. R.), a New Flashing Lighthouse Light, 644
- Wild (Dr. H. von), Death of, 511
- Wild Fruits of the Country Side, F. Edward Hulme, F.S.A., 653
- Wild Sheep, a Rare, R. Lydekker, F.R.S., 32
- Williams (A. Stanley), a New Algal Variable, 515, 638
- Williams (Dr. Francis H.), the Röntgen Rays in Medicine and Surgery as an Aid in Diagnosis and as a Therapeutic Agent, 438
- Williams (Henry S.), Fossil Faunas and their Use in Correlating Geological Formations, 212
- Willis (H. G.), Algebra, 149
- Willis (J.), Magic Squares, 78
- Willis (J. C.), Report of Royal Botanic Gardens, Ceylon, 185
- Willkomm (Moritz), Grundzüge d. Pflanzenverbreitung auf d. iberische Halbinsel, 27
- Willmore (Charles), Death of, 183
- Willoughby (Edward F.), Hygiene for Students, 342
- Wilson (C. T. R.), Radio-active Rain, 143
- Wilson (Prof. Ernest), the Dissipation of Energy by Electric Currents Induced in an Iron Cylinder when Rotated in a Magnetic Field, 334; Experiments on the Use of a Magnetic Detector in Space Telegraphy, 618; Electrical Conductivity of Certain Aluminium Alloys Exposed to the London Atmosphere, 644; the Physical Properties of Certain Aluminium Alloys, and Notes on Aluminium Conductors, 655
- Wilson (Dr. W. E.), on a Bolometer Arranged to Record Solar Radiation, 619
- Wiltshire (Rev. Dr.), Death of, 658
- Wiltshire Archeological and Natural History Magazine, the, Stonehenge and its Barrows, William Long, F.S.A., Stonehenge Bibliography Number, W. Jerome Harrison, Sir Norman Lockyer, K.C.B., F.R.S., 25
- Wind, Sunspots and, Alex. B. MacDowall, 320
- Wind Velocity and Fluctuations of Water Level on Lake Erie, Prof. Alfred J. Henry, 256
- Wine, Methods of Concentrating, M. F. Garrigou, 456
- Winternitz (Prof. M.), Recent Discoveries in Chinese Turkestan, 284
- Wireless Telegraphy: the Receiver in, Edouard Branley, 143; New Form of Magnetic Detector, Recent Transatlantic Signalling, Mr. Marconi, 182; Marconi's Results in Day and Night, Prof. J. Joly, F.R.S., 199; Sir Oliver Lodge, F.R.S., 222; a Note on the Effect of Daylight upon the Propagation of Electromagnetic Impulses over Long Distances, G. Marconi, 335; New Marconi Signalling Station at Cape Breton, 485; Marconi Experiments on the *Carlo Alberto*, 610; Prof. A. Righi on Mr. Marconi, 581; Note on a Magnetic Detector of Electric Waves which can be Employed as a Receiver for Space Telegraphy, G. Marconi, 334; Wireless Telegraphy over 1600 English Miles by Land, 277; Armstrong-Orling System of Wireless Telegraphy, 327; a Simple Telephonic Receiver for Wireless Telegraphy, Dr. L. Bleekrode, 343; Time Signals by Wireless Telegraphy, John Munro, 416; the De Forest System of Wireless Telegraphy, 446
- Wireless Telephony, Experiments with, Mr. Stubblefield, 158
- Wislicenus (Walter F.), Astronomischer Jahresbericht, 198
- Witherby (H. F.), Bird Hunting on the White Nile, 52
- Working Junction, Aerial Luggage Transmitter at, 554
- Wolcott (E. R.), on the Sensitiveness of the Coherer, 158
- Wolf (Prof. Max), New Minor Planets, 542
- Wood (Francis), Sanitary Engineering, a Practical Manual of Town Drainage and Sewage and Refuse Disposal, 173
- Wood (Prof. R. W.), Solid Carbon Dioxide Obtained from Sparklets, 15; Prisms and Plates for Showing Dichromatism, 31; a Method of Showing the Invisibility of Transparent Objects under Uniform Illumination, 102; Uneven Distribution of Light in a Diffraction Grating Spectrum, 262
- Woodhull (John F.), Elements of Physics, 458; Physical Experiments, 458
- Woodward (Horace B.), on Bagshot Strata at Combe Pyne Hill, Dorset, 620
- Woodward (Dr. Smith), on Lower Carboniferous Fish Fauna from Broken River, Victoria, 620
- Worcester, Wind-force Experiments on H.M.S., 119
- Worlds, Other, Garrett P. Serviss, 221
- Wright (G. Lionel), the Vocal System Based on the Fundamental Laws of Language, 271
- Wright (Joseph), on the Discovery of Marine Foraminifera in Boulder clay from various Districts in Ireland and Elsewhere, 619
- Wright (W. B.), Results of Glacial Drainage round Montpelier Hill, Co. Dublin, 311
- Wright (Mr.), the Spectrum of Nova Persei, 425
- Wulff (Jul.), Beechen Hedges on Elevated Ground, 32
- Willenweber (F. W.), Diagram der electrischen und magnetischen Zustände und Bewegungen, 76
- Yeruas, the Coorgs and, an Ethnological Contrast, T. H. Holland, 91
- Yokohama, Cool Summer at, Capt. H. J. Shaw, 554
- Yokohama, Typhoon at, on September 29, 553
- Yoshitake (E.), Constituents of Gambia and Acacia Catechus, 214
- Young (A. V. E.), the Elementary Principles of Chemistry, 519
- Young (Dr., F.R.S.), Preparation of Absolute Alcohol from Strong Spirit, 70; Properties of Mixtures of Lower Alcohols with Water, 70; Properties of Mixtures of the Lower Alcohols with Benzene and with Benzene and Water, 70; Fractional Distillation as a Method of Quantitative Analysis, 70; Vapour Pressures and Boiling Points of Mixed Liquids, 70
- Yukon Gold-fields, Prof. H. A. Miers, 86
- Zaky (Aly), Influence of Lecithin on the Development of the Skeleton and of Nervous Tissue, 120
- Zamia, Germination of the Pollen Grain and the Series of Events Leading to Fertilisation in Two Species of, Dr. Herbert J. Webber, 67
- Zanzibar, Coral Reefs of, C. Crossland, 166
- Zebars, Grey's, in the Regent's Park Gardens, 512
- Zeeman (Prof.), Magneto-optical Rotation in the Interior of Absorption Bands, 622
- Zeuthen (H. G.), Histoire des Mathématiques dans l'Antiquité et le Moyen Age, 199
- Ziegler (Dr. Julius), Death of, 579
- Ziegler (L.), Zur Metaphysik des Tragischer, 342
- Zinno (Prof.), Synthesis of Tartaric Acid for Production on Large Scale, 330
- Zittel (Karl Alfred von), History of Geology and Palaeontology to the End of the Nineteenth Century, 242
- Zobel (Dr.), Researches on Glycoen, 666
- Zoology: Additions to the Zoological Gardens, 17, 40, 68, 87, 115, 138, 161, 186, 203, 233, 253, 281, 309, 331, 352, 380, 401, 425, 450, 486, 514, 541, 557, 582, 613, 638, 661; Anniversary Meeting of the Zoological Society, 37; Zoological Society, 46, 71, 239, 263; the Zoological Society's New Ape-house, 406; Grey's Zebra in the Regent's Park Gardens, 512; the Larger Mammals of Patagonia, Hesketh Prichard, 46; Abnormal Dentition in a Lemur, Prof. G. Elliot Smith, 71; Cerebellum of the Lemurs, Dr. Elliot Smith, 94; the Flying Lemur, Dr. H. C. Chapman, 351; Collateral Budding in Two Annelids, Dr. H. P. Johnson, 86; Brain of the Elephant Shrew, Dr. Elliot Smith, 94; Shoulder-girdle of Dasyurus and Perameles, Dr. R. Broom, 94; Two Species of Astralium from Port Jackson, H. Leighton Kesteven, 96;

the "Waltzing Mice" of Japan and China, Dr. K. Kishi, 114; Report of the Zoological Society of Philadelphia, 159; a Peculiarity of the Cerebral Commissures in Certain Marsupialia, Prof. G. Elliot Smith, 165; Law of Adaptive Radiation among Mammals, Prof. H. F. Osborn, 184; Brussels Okapi Specimens, Dr. Forsyth Major, 185; New York Zoological Park, 232; *Traité de Zoologie Concrète*, Yves Delage and Edgard Hérouard, Dr. G. C. Bourne, 267; the Zoological Gardens at Ghizeh, Egypt, Captain Stanley S. Flower, 280; Additions to the Zoological Gardens at Ghizeh, 330; a Course in Invertebrate Zoology, Henry Sherring Pratt,

292; the Coconut-crab, Dr. R. Horst, 308; Instances of Abnormality in Mammals, F. Howe, 351; Prof. O. C. Bradley, 351; Elliot Smith, 351; *Matière Médicale Zoologique, Histoire des Drogues d'Origine Animale*, H. Beauregard, 363; the Cambridge Natural History, Mammalia, F. E. Beddard, 373; Death of Prof. Adolfo Targioni-Tozzetti, 553; Animal Forms, a Second Book of Zoology, Dr. David S. Jordan and Prof. Harold Heath, 605; the Solenogastrea, J. Thiele, 612; the Degenerate Eyes of Lizard *Rhineura floridana*, Prof. C. H. Eigenmann, 636; the Larger Apes, *Orthograde*, Dr. A. Keith, 661



NATURE

A WEEKLY ILLUSTRATED JOURNAL OF SCIENCE.

"To the solid ground
Of Nature trusts the mind which builds for aye."—WORDSWORTH.

THURSDAY, MAY 1, 1902.

ALCOHOLIC FERMENTATION.

Manual of Alcoholic Fermentation and the Allied Industries. By Charles G. Matthews, F.I.C., F.C.S., &c. Pp. xv + 295. (London: Edward Arnold, 1902.) Price 7s. 6d. net.

M^R. MATTHEWS has written an eminently readable book, containing a large amount of useful information. The work is divided into twelve chapters, to which eight appendices are added; it is prefixed by a good and thorough table of contents and finishes with a capital index.

The first chapter deals with "Alcoholic Fermentation. General Considerations leading to Special Ones." In this chapter we have an account of the earlier work of Leuwenhoek, Fabroni, Gay-Lussac, Cagniard de Latour, Schwan, Turpin, &c., and the theories held by Liebig, Frey and Traube. The work of Reess and of Pasteur receives due acknowledgment, and towards the end of the chapter we find a summary of the various views which have been held with regard to fermentation.

"(1) Fermentation as an effect resulting from the growth or vegetation of an organism. (The accepted theory as established by scientific knowledge.)"

"(2) A mechanical theory or theory of chemical decomposition. (Liebig's theory, and that of the Liebig school.)"

"(3) A theory of so-called catalytic action or decomposition by contact—presumably of the ferment and fermentable substance. (An elegant mode of expressing ignorance of the true action.)"

The last remark in brackets appears somewhat hard on members of the catalytic school, and the following statement,

"that apart from the results of the vital processes of the yeast organism or other living cells, the production of alcohol from a saccharine liquid is unknown" (p. 8),

seems scarcely justifiable in the light of Buchner's researches. In fact, the references to Buchner's work on pp. 47 and 121-122 show that the author quite accepts the fact that fermentation may take place in the absence

of cells, and is in any case due to an enzyme. "Contact" reactions undoubtedly take place amongst organic as well as inorganic compounds, and really the term "catalytic" is very useful. It would, however, be unfair not to acknowledge that such discrepancies have been observed between the courses followed, on the one hand, during the hydrolysis of esters by mineral acids and, on the other, fermentation by yeast as to lead to the idea that the two processes are fundamentally different. The recent work of Adrian Brown on "enzyme action" (*Chem. Soc. Trans.*, lxxxi. 373), and of Horace Brown and Glendinning on the "hydrolysis of starch by diastase" (*ibid.*, p. 388) prove clearly, however, that enzymes working in dilute solutions (*i.e.* when not overloaded) follow the law of mass action, so that one must conclude that processes of this nature are fundamentally as mechanical as the inversion of cane sugar by a mineral acid.

Chapter ii. deals chiefly with the morphology of yeast, whilst chapter iii., on the "Saccharomycetes and other Organisms acting as Alcoholic Ferments," gives a clear and full account of the various species of yeast which have been identified, the chapter ending with an account of *mycoderma vini*, *mucoer racemosus*, &c., and the conditions under which they can behave as alcoholic ferments. Chapter iv., on "The Effect of Physical and Chemical Influences on the Yeast Organism," deals with the food material of yeast, the heat developed during fermentation, and the optimum temperature, and naturally leads to a further consideration of theories which have been put forward as to the fermentative action of yeast and to mention of Buchner's *zymase*. Referring to this, the author justly remarks

"that though it pushes the cause of alcoholic fermentation a little further back, there is no reason to believe that Buchner's *zymase* could be produced by other than vital agencies or in association with living matter."

This does not, however, preclude *zymase* from acting in a mechanical manner, neither is it proved that some inorganic ferment might not have somewhat the same effect, however improbable this appears in the light of present knowledge.

Chapter v., entitled "Chemical Science," one cannot

help thinking would have been better left out. To attempt to cover the range of chemical science from atoms and molecules to the elements of organic chemistry in so short a space is practically impossible, nor should it be necessary in a technical work.

Moreover, if such matter appears to the author desirable, he should take especial pains to be accurate. Chemists will take exception to N_2O_2 as the formula of nitric oxide, also to the triad radical $(CH)^m$ being called *formyl*.

The footnote to p. 75 is not quite clear, whilst p. 76 contains the following:—



(nitromethane or methyl nitrite)"

and

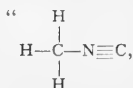

belonging to the class called cyanoparaffins." On p. 78 we are informed that

"ethers are a class of compounds bearing the same relation to the alcohols that the metallic oxides do to their hydrates."

"The Carbohydrates" are described in chapter vi., and the author deals in succession with the pentoses and hexoses, passing on to the di-, tri- and poly-saccharides. The subject of the starches occupies several pages and is illustrated by well-executed plates. In considering the question of yeasts, no one can fail to be struck with the influence the scientific work of Pasteur, Hansen and others has had on the fermentation industries, and chapter vi. perhaps brings home to the reader even more forcibly the powerful effect the brewing industry has had in promoting the scientific examination of the carbohydrates.

"Nitrogenous Substances and the Nutrition of Yeast" form the subject-matter of the next chapter, and albumenoids, amido-substances and enzymes are described in succession. A few misprints have occurred amongst the formulæ of the amido-acids, e.g. amido-acetic acid, glutamine and tyrosine. Generally the chapter is clear and interesting; the author has no need to apologise for the space devoted to the topic.

With chapter viii. we come to the first practical application of fermentation, and in eighteen pages we are made acquainted with the chief features in the manufacture of wine, including cider and perry. But it is in the succeeding two chapters (ix. and x.) that the author is really in his element, and devotes upwards of fifty pages to the science and practice of brewing. Chapter ix. is occupied with malting and the physiological and chemical changes involved; the next chapter leads us by all the intermediate stages from the mash-tun to the barrel, and gives much information on the influence of the composition of brewery waters and the courses of different fermentations.

Chapter xi. deals with "Fermentation from the Distiller's Point of View," and is all too short (twenty-seven pages) to give anything like a complete account of this extensive and important industry. The author confines himself to the manufacture of pot-still whisky and "patent-still spirit." With regard to the former, practice varies so largely that the description given must not be taken as typical of the working of *all* malt distilleries. One may note the temperature at which the "sparge" is applied; 170° is frequently exceeded, and the use of stirrers in wash stills by no means universal, especially where small stills are employed. "Maturation," according to the author, takes place

"chiefly by a selective absorption which the wood of the cask exercises, and also by some little oxidation and etherification of the higher alcohols";

certainly a more definite and rational view than that which supposes new whisky to contain objectionable substances which, as the reviewer has sometimes been assured, break up into substances communicating a fine flavour to old spirit.

The manufacture of patent still spirit as carried out in this country is next described, and we then pass on to continental processes. German methods deservedly receive a large amount of attention, and the author draws particular attention to the preparation of the "Vormaisch" by sowing vigorous yeast in a strong wort, slightly acidified by a small lactic fermentation and subsequently sterilised. The ripe "Hefeget" so obtained is used for pitching the chief mash; the effect of the small quantity of lactic acid is not only favourable to the yeast, but restricts the growth of bacteria. Mr. Matthews mentions the fact that artificial acidification has been frequently resorted to; the subject has been recently ventilated by Dr. Lange before the Verein der Spiritus-Fabrikanten. Dr. Lange states that hydrochloric acid at first gives excellent results; unfortunately, the bacteria soon become accustomed to it, as they also probably would to sulphuric acid. Butyric acid appears to be efficient if properly handled, the yeast remaining cleaner.

The course of fermentation is illustrated by diagrams taken from Märcker's "Spiritusfabrikation." One wishes that this work had also been drawn upon for diagrams of recent German distillery plant, Ilge's automaton, for example.

The last chapter (xii.) deals with the cultivation of pure yeast and the brewing of "lager-beer," the comparative uselessness, and perhaps harmfulness, of endeavouring to brew English beers with pure cultivations being well brought out in the last few pages.

The eight appendices are chiefly concerned with laboratory instructions; D, E and F are, however, of more general interest, since they deal respectively with conjugating yeast, the nutrition of yeast, and the combined action of diastase and yeast on starch granules.

Mr. Matthews is to be congratulated on the way in which he has treated his subject, but the reviewer cannot help thinking that if he gave the space devoted to matters of general chemical knowledge to the subjects of wine and the preparation of the purer forms of alcohol, the book would gain in usefulness.

J. T. H.

THE GEOGRAPHY AND GEOLOGY OF
CELEBES.

Materialen zur Naturgeschichte der Insel Celebes, Band iv.—*Entwurf einer geographisch-geologischen Beschreibung der Insel Celebes*. By Dr. Paul Sarasin and Dr. Fritz Sarasin. Pp. xi + 344 + 28; 13 plates. (Wiesbaden: Kreidel, 1901.) Price Mk. 50.

THIS, the fourth volume of the series which the authors have devoted to the natural history of Celebes, is a welcome addition to our knowledge of the East Indian Archipelago. The recent geological history of the island, and the light thrown upon it by the distribution of the animals and plants of the region, has already formed the subject of a special memoir. Here we have a description of the surface features and configuration of Celebes so far as that has been explored, a record of many interesting observations, geographical and geological, made during several years spent in travel in nearly every quarter of the island, with petrographical notes on the rock specimens collected (including a special chapter by Prof. C. Schmidt), a sketch map on the scale of 1 in 2,000,000 and tables of the observed altitudes of many important stations.

The outline of the island, sinuous and branching, is the external expression of its geological structure. A folded mountain chain, of which some peaks rise to 5000 or 6000 feet above the sea, forms the axis or backbone of Celebes. It is not simple, but consists of several parallel ranges, more or less intermittent, with longitudinal valleys between them. These valleys appear to be synclinal or to be due in some cases to depression between parallel lines of fault which trend with the folds. Not much is known about the mountainous interior of the island, but from the specimens of rocks collected, which include granite, gneiss, mica schist, chlorite schist, epidote glaucophane schist, quartzite and crystalline limestones, it is certain that there is a large development of metamorphic rocks. No fossils have been obtained from this series, but the authors believe that some of the crystalline limestones may be of Jurassic age.

This axis of metamorphic rocks is bent almost at a right-angle where it crosses the equator, and in the interior of the bend another less important series of folds runs roughly parallel to the main external ridge which forms the dominant structural feature of the island. A striking peculiarity of the surface configuration is the presence in each system of folds of a longitudinal depression flanked on each side by ridge-like elevations. This central valley runs from end to end of Celebes. It largely determines the direction of the drainage, as the principal interior streams run in it for long distances, parallel to the shores, till they take advantage sooner or later of one of the breaks in the continuity of the hill ranges to pass onwards to the sea.

The narrow and not very well defined coastal plain consists, for the most part, of Tertiary and later deposits very frequently intercalated with volcanic rocks. The Eocene is well represented by massive nummulitic and orbitoidal limestones, often coralline. Beneath these there are sometimes exposures of sandstone, and not uncommonly radiolarian clays and cherty beds which may be lower Eocene or possibly Cretaceous. Overlying the

Eocene are sandstones and conglomerates known as the "Celebes Taveyannaz beds" (from their similarity to the Taveyannaz group in the Alps) and an extensive "Celebes Molasse," with fresh water, brackish water, marine and land fossils. Pliocene shell beds and Pleistocene strata are well developed in the lower grounds and along the shores. The Tertiary geological history of Celebes is outlined as follows:—The Eocene began with deep-water conditions (radiolarian clays) followed by shallow coral seas. In the Miocene the great upheaval took place and the mountain axis attained its complete development. This was an epoch of land conditions, and was accompanied by the deposit of the "Celebes Molasse." During the Pliocene the land area was much greater than at present, but in the Pleistocene depression ensued, and is regarded as having been at least 300 feet. Thereafter minor oscillations have taken place; a well-marked raised beach can be traced at heights of 90 feet above the sea-level indicating recent elevation, while in other places submerged forests point to slight and local depression.

Over most of the island signs of volcanic activity abound. One crater named Una Una was in eruption in 1898, but there are few historic records of volcanic outbursts, though many may be traced in the traditions of the natives. In the extreme south the great peak of Bantaeng (2970 m.), an Etna covered with parasitic cones, is a well-known object and has already been described by several travellers. The authors ascended it, and give a map of the higher parts of the mountain. This map shows a very large breached crater occupying the summit and accompanied by two enormous depressions (presumably also craters) to the south of the principal one. Beds of ash and lava flows are very frequently interbedded with the Tertiary strata, and in the Minahassa region at the north-east termination of the island there is a cluster of volcanic mountains, some of which must have been very recently in eruption, while others are in various stages of denudation and decay. This is one of the most interesting parts of Celebes, and some of the best chapters of the book are those devoted to the description of these volcanic cones and craters. For the excellent photographic illustrations which accompany them there can be nothing but praise.

The volcanic activity appears to have first manifested itself in the Miocene, and to have followed the era of folding and upheaval. Many types of effusive rocks are found. The commonest are apparently andesites (propylites) and basalts. But leucite-tephrites, trachytes and phonolites were also emitted, and Prof. Schmidt has furnished descriptions of some very fine nepheline-bearing shonkinites which appear to be the plutonic representatives of this group. They are accompanied by bostonites and gautaites as dyke rocks. In the volcanic areas hot springs are numerous, and some of the quartz veins are auriferous. Some interesting notes are also given on the configuration of volcanic bombs.

A special feature of the geography of Celebes which has attracted a good deal of attention is the existence of inland lakes of considerable size. These are found in the central valley depressions between the hill ranges, and they occur in well-defined chains in these valleys. The largest is the Towuti Lake, but Lake Posso and

Lake Tempe are also considerable sheets of water. Their great depth is notable; Lake Posso is 160 fathoms deep, Lake Motana 260 fathoms. The authors believe that they are of tectonic origin and are due to depression in the synclines between the mountain uplifts. They may be flanked by lines of fault, and the very steep slopes of their shores, as shown by the soundings, is easily explained on this hypothesis. Their resemblance to the Central African lakes is close and is heightened by the presence in them of a molluscan fauna the affinities of which are said to be Miocene. Their great depth would appear to be against their Miocene origin, but as the areas that drain into them are small, it may well be that the deposition of sediment is too slow to have produced any very great effects. It is suggested that depression has also taken place and has counterbalanced the accumulation of alluvial material brought down by the streams.

In conclusion, it may be noted that the work contains a full bibliography of the geology and geography of Celebes, and the description of each district is accompanied by a synopsis of the observations of previous travellers.

OUR BOOK SHELF.

More Tales of the Birds. By W. W. Fowler. Pp. 232; illustrated. (London: Macmillan and Co., Ltd.) Price 3s. 6d.

THIS is a delightful little book of stories, admirably written and beautifully illustrated, in which birds play a more or less important part. It is in no way one of the numerous works on the popular natural history of birds with which the market is nowadays flooded, but strikes a line peculiarly its own. In the first chapter we have a pathetic story of a young soldier whose thoughts were turned to home and its associations during the Waterloo campaign by a lark's nest which escaped destruction although situated in the midst of the great battle-field. The second deals with the toils and troubles of a house-martin, as supposed to be narrated by the bird itself. In regard to the reason for the annual migration, the bird is made to say: "We always do come here, and our ancestors always came, so I suppose we shall go on doing it. Besides, this is really our home. We were born here, you see; and when the heat begins in South Africa there comes a terrible feeling in our hearts, a terrible homesickness, and we *must* go." Evidently, so far as birds are concerned, the author does not believe in the theory that Africa was a great centre of animal evolution.

Jackdaws, magpies and starlings severally form the texts for other chapters. To ornithologists, perhaps, the interest of the book will centre on the exquisite illustrations, by the accomplished pencil of Miss F. L. Fuller, which are alone worth the price charged. Although there are some to whom this class of writing does not appeal, many readers of all ages and both sexes will doubtless find pleasant occupation for a spare hour or two in this bright and entertaining little volume. R. L.

College Algebra. By L. E. Dickson, Ph.D. Pp. viii + 214. (New York: Wiley and Sons. London: Chapman and Hall, Ltd., 1902.)

THE usual profession of "rigour" is followed here by the usual inaccuracies. On page vii. we are told that = means "equal"; on p. 69 it is stated without proof that if r is a proper fraction the limit of r^n is zero when n increases indefinitely; the discussion of the exponential theorem in art. 129 is thoroughly unsound, and the proof that every equation has a root (pp. 211-12) is marred by serious

defects. On the other hand, the chapters on logarithms, mathematical induction and theory of equations are good. Probably this book has been written rather hastily; otherwise it is difficult to understand how such a competent mathematician as the author is known to be should have overlooked so many deficiencies. Even in the chapter on the binomial theorem for any index, he calmly applies the rule for multiplying two power-series without discussing its validity either there or in any other passage of the book! Finally, Mr. Charles Smith is made responsible for the assertion that the binomial expansion of $(1+x)^n$ converges for $x=1$ if $n < -1$. Very likely this is an uncorrected misprint for $n > -1$; but why refer to Mr. Smith instead of to Abel's classical memoir? M.

A Laboratory Manual of Physics. By H. Crew, Ph.D. and R. R. Tatnall, Ph.D. Pp. xii + 230. (New York: The Macmillan Company; London: Macmillan and Co., Ltd., 1902.) Price 5s.

EACH exercise commences with references to certain school text-books, but, unfortunately for the British reader, these are all American works, and, so far as the reviewer knows, they are not used in any schools here. We are amused to find that metre scales are called metre "sticks" in the States. There is a good simple chapter on inertia, and a form of inertia balance is described. It seems to us a mistake to omit all experiments on velocity and acceleration because of their difficulty. Friction occurs in all real machines, and it ought to be studied in elementary works. The apparatus is generally of quite a simple character and very suitable for school use. Appendix A contains an extract from one of Boyle's papers in which he describes an instrument virtually the same as Nicholson's hydrometer, and the authors call attention to this in their description of that instrument. The book will prove very useful in conjunction with the text-books to which references are made. S. S.

Photographic Apparatus. Making and Repairing. By F. W. Cooper, D. W. Gawn and others. Edited by E. Brown. Pp. xvi + 128. (London: Dawbarn and Ward, Ltd., 1902.) Price 1s.

IT is not every photographer who wishes to make or repair his own apparatus, but those who are acquainted with the use of tools will find this small book a useful help if they require it in aiding them to fit up all kinds of convenient accessories to the photographic camera and dark room. The information given is concise and the instructions are clear; and numerous illustrations, 180 in number, are included which materially aid the text from a beginner's point of view. The ground covered is by no means meagre, for the worker is made acquainted with such subjects as the studio and studio fittings, the dark room and its fixtures, cameras and accessories, printing and enlarging apparatus, concluding with numerous and useful miscellaneous attachments. That the instructions are the result of practice is shown by the numerous writers on the varied subjects, most of the information being reprinted with additions from articles in *The Photogram*.

Monographie der Gattung Alectorolophus. Von Dr. Jakob von Sterneck (Trautenu). (*Abhandlungen der k.k. zool.-botan. Gesellschaft in Wien*, Band 1, Heft 2, October 31, 1901.) Pp. 150. (Wien: Holder.)

AN exhaustive monograph of a genus of plants, variously known under the names of *Fistularia*, *L.*, *Rhinanthus*, *L.*, *Alectorolophus* (Haller), *Allioni*, and *Mimulus*, *Scopoli*. Fifty-one species and two hybrids are described by the author. The genus is most numerous in Europe (a familiar British representative being a common meadow-plant, known as the Yellow Rattle); but it also extends throughout a considerable portion of temperate Asia and North

America. The species are divided into six sections, and the synonymy, variation, distribution, &c., of each species are given in great detail, at least in the case of well-known species. The probable evolution and phylogeny of the genus are also discussed, and to the latter subject the elaborate "Stammbaum" is devoted. The three maps show the distribution of various species of the genus. Scientific botanists should find much to interest them in Dr. Sterneck's work.

A Text-book of Insanity. By Charles Mercier. Pp. xiv + 222. (London: Swan Sonnenschein and Co., Ltd., 1902.) Price 6s. net.

MR. MERCIER addresses his little work directly to the ordinary medical student, for whom, it appears from the preface, there has hitherto been no text-book of insanity of moderate compass. For the practical student so clear and brief a description of the leading types of mental disorder from the pen of a recognised authority will be of high value. The work has also its merits from the standpoint of the theoretical psychologist, though he will probably prefer to study the author's views in his larger work, "Psychology Normal and Morbid." The account of normal mental activities by which the description of insane deviations from the normal is preceded is eminently clear and judicious. The psychologist should also be thankful to the author for discarding the bewildering nomenclature of *manias* and *phobias*, and offering a simple and intelligible classification of mental diseases, based on the distinction between forms of insanity (*i.e.* the aggregate symptoms presented simultaneously at any stage by a patient) and varieties of insanity (*i.e.* specific types of the course run by a case from first to last). Besides purely medical and psychological information, the book contains some useful remarks on the legal responsibilities of the practitioner in connection with insane patients. A. E. T.

Leçons sur les Séries à termes positifs. Par Émile Borel. Recueillies et rédigées par Robert d'Adhémar. Pp. viii + 94. (Paris: Gauthier-Villars, 1902.) Price fr. 3.50.

THIS appears as the third instalment of Prof. Borel's lectures on the theory of functions. It is somewhat more fragmentary than its predecessors, and has, in fact, the typical qualities and defects of a set of lecture-notes. As an introduction to the memoirs of Hadamard, Mittag-Leffler and Poincaré, as well as to those of Prof. Borel himself, these chapters will be very serviceable. Perhaps the most noteworthy articles are those which deal with the theory of increment (*croissance*); it is there shown that there is no natural scale of orders of magnitude. In fact, an aggregate of orders of increasing functions can be constructed which is not numerable. Moreover, functions have been invented which have no regular order of increase; thus an example is given of a function which is comparable with $\exp x$ for an infinite number of values of the variable, and with $\exp(\exp x)$ for another infinite number of values. This will cause searchings of heart in certain quarters, no doubt; even Prof. Borel remarks that "fort heureusement, les fonctions qui se présentent naturellement aux géomètres sont, en général, de nature plus simple."

Practical Exercises in Magnetism and Electricity. By H. E. Hadley, B.Sc. Pp. xii + 232. (London: Macmillan and Co., Ltd., 1901.) Price 2s. 6d.

THIS is an excellent collection of laboratory experiments, suitable for the higher classes in secondary and public schools. Magnetism is taken first, then electrostatics and current electricity. An appendix gives some instruction for making the necessary apparatus. The author wisely confines the experiments to those which can be performed with quite simple apparatus.

LETTERS TO THE EDITOR.

The Editor does not hold himself responsible for opinions expressed by his correspondents. Neither can he undertake to return, or to correspond with the writers of, rejected manuscripts intended for this or any other part of NATURE. No notice is taken of anonymous communications.]

A Remarkable Lunar Halo.

ON the night of January 19 of this year a singular lunar phenomenon was visible here. The sky had clouded over and was covered with a nearly uniform whitish sheeting of cloud, through which the brighter stars could be seen. There was no wind. The barometer stood at 29.20 inches and the temperature was 28° F. The moon, which was near the meridian, was ten and a quarter days old and had a north declination of 19°.

Surrounding the moon was the ordinary lunar halo of 45° or 50° in diameter, which is so often seen at the approach of bad weather. This ring was clearly defined on its inner edge, which was of a reddish or brownish colour; it rapidly diffused on its outer edge and was perhaps a couple of degrees in thickness. The whole interior of the ring was darker than the sky outside of it anywhere, which is its customary appearance.

Cutting exactly through the moon, with its centre near the

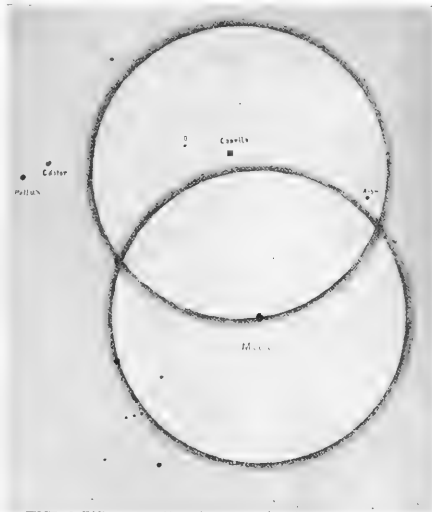

FIG. 1.—Lunar Phenomenon 1902, January 19, 9 p.m.

zenith—in the region of Capella—was another ring of apparently the same dimension and brightness, and similar to the other in every respect. It too was sharply defined on its inner edge, where it was fringed with a reddish or brownish colour. The general colour of the two rings was whitish, with a suggestion of yellow. The interior of this ring was also darker than the sky outside. There was no noticeable increase of light where the two rings intersected. They seemed to merge into one another without any evidence of the crossing.

This phenomenon was first seen at Sh. 50m. (6h. om. slow of Greenwich Mean Time). It was perhaps visible for some time before this. I had been observing with the large telescope when the increasing cloudiness had stopped work. It was noticed (a few minutes before seeing the phenomenon) that the seeing had suddenly got excessively bad.

The extra ring remained visible until 9h. 20m., at which time it disappeared—not all at once, but gradually and unequally.

During the time it was under observation, from 8h. 50m. to 9h. 20m., this ring revolved eastward in position angle, about

17°. The moon remained bisected by it throughout the entire visibility.

Only the brighter stars were visible, on account of the thickness of the sky, and hence its exact dimensions could not be accurately determined from the want of comparison stars. An endeavour was made to secure pointings on different portions of the ring with the 12-inch equatorial by sighting along the tube, but this was found to be impossible because of the narrowness of the slit in the dome, which prevented its being seen with sufficient distinctness.

At 9h. 17m. Algol was on the inner edge of the extra ring near its junction with the ring surrounding the moon.

At 9h. 20m. Castor was central on the ring, and at 9h. 24m. this star was on the inside edge. By this time the ring had almost entirely disappeared, only a fragment of it being visible at Castor. After this it was not seen again, though the ordinary ring remained visible for several hours. When the extra ring was disappearing, the ordinary ring became brighter, and at 10h. 30m. a bright spot (a moon dog?) became visible on its north edge.

At 8h. 50m. α Orionis was bisected by the ordinary ring, from which the diameter was found to be $48''$.

Following are some estimations of the position of the extra ring. At 8h. 50m. a line prolonged through Pollux and Castor would touch the extra ring $8\frac{1}{2}''$ from Castor. At this time Capella was by estimation (a difficult and rather uncertain determination) about one-fifth of the radius of the ring north-east of its centre. At 9h. 0m. the ring passed $7''$ from Castor in the line to β Aurigæ, at which time Capella was by estimation $4\frac{1}{2}''$ north of the edge of the regular lunar ring.

The phenomenon was witnessed by Mr. Frank Sullivan, assistant in the large dome, and myself. I do not know that anyone else saw it.

I have never seen a similar phenomenon to this, and as it must be a rare one with reference to the moon I have thought it worth while to record the observations in NATURE. I understand that something of the kind has been seen previously with reference to the sun.

A careful drawing was made of the phenomenon, a copy of which is reproduced in Fig. 1. The exact time of the drawing is 8h. 50m. (6h. 0m. slow of Greenwich). This will explain itself. In making the drawing the two rings have been assumed to be of the same size. E. E. BARNARD.

Yerkes Observatory, Williams Bay, Wis., U.S.A., April 8.
Longitude 5h. 54m. 13s. 2 W., Latitude $+42^{\circ} 34' 13''$.

The Education Bill.

THE Education Bill now before Parliament is of so comprehensive and important a character that it deserves to be considered from various points of view. That which is most germane to the readers of NATURE is perhaps the influence it may have upon advancing or retarding the progress of natural knowledge.

It is generally now admitted that the old notions of education, both as to subject and method, require to be improved, and that the recent advance of science, and of the applications of science to industry, claim a much larger share of attention than in days of yore. The best schools are opening their doors to this knowledge, if not welcoming it, and any change in the management of schools ought to be in this direction. How far will the present Bill fulfil this requirement? It says nothing about the curriculum of the schools, and concerns itself solely with the constitution of the local education authority, and the machinery for raising and distributing the necessary funds and for appointing representatives on the management of the schools. The personnel of the managers in the first instance may not be much changed, but their powers may be seriously limited by their superior authorities, who have the revision of the expenditure and the settlement of the rate to be levied. The influence of the electors in School Board districts will be lost; an influence which at the present time is generally directed towards rendering the schools of as much practical value as possible. The Act of 1870 secured the coming forward of men or women sufficiently interested in the subject to stand the ordeal of a popular election, and who, when elected, worked under the stimulus of public responsibility; whereas under the present Bill the managers of transferred schools will apparently retain their office indefinitely, and the nominees of the new local educational authority will always be in a minority and there-

fore unlikely to be able to develop the newer ideas of education.

Our methods are undergoing a slow but very real change; good object-lessons from the infant classes upward, involving the proper use of eyes and hands, are coming to the fore; and a training afterwards in such branches of natural history and physical science as may bear on the probable occupations of after life—agriculture, mining, manufactures, trade, &c.—or on domestic pursuits. Much of England's prosperity in the future will, in fact, depend upon the proper adaptation of this fundamental training to the wants of the various sections of the community. Hence the paramount importance of selecting such persons as shall not only be acquainted with the wants of the neighbourhood, but shall also be imbued with the importance of this kind of teaching.

It is interesting in this connection to observe that the statistical returns of the Board of Education show that in the schools under the management of popularly elected bodies the attention given to the scientific subjects of instruction is more than twice as great proportionally as that in the "voluntary" schools. These returns have shown a gradual advance in this respect since 1890, except that in 1899-1900 there is a small retrogression perceptible in most of the subjects, including mechanics, animal physiology, chemistry and general physics. (See British Association report on "Teaching of Science in Elementary Schools," 1901.) The cause of this is not obvious, and it is impossible to say whether it continues, as the figures for the year 1900-1 are not yet issued.

Small schools are always worked at a great disadvantage, as the children attending them cannot be properly divided into classes and have almost necessarily to be taught by one teacher. This cannot be avoided in districts of very sparse population; but the Government Bill gives direct encouragement to the multiplication of small schools, each of which will be recognised as necessary provided it can draw thirty children from some neighbouring school.

The Bill is defective in not providing that the education commenced under the code in the elementary schools should be continued in the department of higher education, whether in evening, technical or secondary schools. The only correlation attempted consists in the putting all schools within a given area under one local authority; but it does not ensure that there should be any organic connection or unity of aim between the lower and the higher schools.

I cannot help thinking that men and women elected for the express purpose, and subject to periodical re-election, are the most likely to support the more modern and practical views of education and so to enable the children under their charge to become more intelligent and valuable members of the community. J. H. GLADSTONE.

17 Pembridge Square, April 26.

Resultant Tones and the Harmonic Series.

MISS DICKINS'S method of determining from the harmonic series the resultant tone would be of more worth than it is if it did not yield results which are untrue to the facts. These, as is, or ought to be, well known from the observations of the late Dr. Koenig, in some cases differ from those assumed. For example, the combination of two pure tones of the ratio 9:4 does not yield as the resultant tone 5. And in the case of the ratio 8:5 the resultant tone actually heard is just as likely to be 2 as 3, or both may be heard. The remark that the method is evidently as applicable to summational as to differential resultant tones is evidently made in ignorance of the circumstance that the "summational" tones are not, in fact, ever heard if the two fundamental tones are pure. SILVANUS P. THOMPSON.

April 19.

Thin Floating Cylinders.

IN a letter to NATURE of February 18, 1897, I pointed out that a thin cylindrical floating shell was in equilibrium under the actions of its own weight and the external fluid load, the shell having its axis horizontal and just touching the surface or else completely submerged. The method was that of Rankine's conjugate load-areas, and building on this Dr. Thomson and myself made practical graphical solutions of the circular masonry arch; these were privately printed and circulated, and

met with the approval, among others, of Prof. Perry, London, and Prof. Malverd Howe, America. In revising this matter for the new edition of our "Applied Mechanics," I find that polygonal cylinders of uniform plates freely hinged at their edges and displacing their own weight of fluid and lying horizontally are also in equilibrium, provided the polygon be regular.

In the diagram the square shell is shown just reaching the surface and rolled into three positions. The proof is the same as for the ordinary statical problems on festoons of rods hinged at the ends, only now there is the external fluid pressure in addition to the weights. The fluid is kept out by face plates at the ends, the face plates having the same density as the fluid and being quite smooth, so as to allow the shell freely to change its shape. If the shell be slightly compressed it will collapse, but

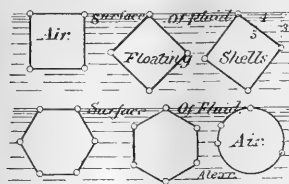

the friction of the face plates and the confined air afford a slight degree of stability. The diagram shows the regular hexagonal shell, and by increasing the number of sides we arrive, as before, at the circular cylinder. In the polygonal shells there are bending moments on the sides as well as the thrust, but on the circular there is only hoop thrust, as it may be a plenum of joints. Submerging only adds a symmetrical load all round, and the shells are still balanced. As they are also balanced with the axis vertical it follows that they are in equilibrium in any position whatever.

My first letter led to some correspondence, and I hope this may be of interest to your readers. THOS. ALEXANDER.
Trinity College, Dublin, April 19.

Mycoplasm.

SINCE 1889 a fungus hyphal layer has been known to exist in the nucellar remnants of the grains of the Darnel grass, *Lolium temulentum*, and to these hyphæ have been attributed the poisonous properties of the Darnel. Later investigations have shown that the fungus could be found in the growing point of developing plants, in the inflorescence, and finally in the ovarial rudiments. The manner of entrance of the fungus had, however, escaped detection. Nestler (*Ber. d. deutsch. bot. Gesellsch.*, B. xvi., 1898, p. 210) and others failed to observe the fungus in the embryo in the mature grain. The hyphæ in the growing point could not be observed before the eighth day of germination.

Eriksson has recently¹ quoted the work of Nestler and others on the fungus of *Lolium temulentum* in support of his theory on mycoplasma. According to Nestler, the embryo does not contain the hyphæ, which appear in the seedling on the eighth day. In only one case was he able to see hyphæ in the embryo. In view of the support which this work appears to give to Eriksson's mycoplasma theory, an advance note on some of my results in the investigation of the fungus of *Lolium temulentum*, which has been carried on in the laboratory of Prof. Marshall Ward at Cambridge University, may be of interest. In appropriately stained sections of the embryo taken from the mature seed of *Lolium temulentum*, hyphæ in great abundance may be seen in the growing point, sometimes but two cells from the tip; these hyphæ may be traced to their point of entrance at the juncture of the coleorhiza and scutellum on the outer surface of the latter in the region of the median longitudinal plane of the scutellum. Previous investigators had entirely overlooked the presence of a considerable

¹ Eriksson, *Ann. des Sc. Nat.*, T. xv., 1902, p. 73, says:—"Les tentatives infructueuses d'A. Nestler d'apprendre à connaître de quelle manière le champignon qu'on trouve presque toujours dans les fruits du *Lolium temulentum* est entré dans le cône végétatif de l'embryon du fruit amènent aussi la supposition d'un état mycoplasmatique latent."

amount of mycelium in that part of the grain which lies directly against the scutellum in the median basal region, where it has grown around the end of the aleurone layer. The infection takes place apparently before the grain has reached complete maturity, as the fungus is well established in the ripe grain. There can, therefore, be no question here of mycoplasma, since direct hyphal infection can very easily be demonstrated. There is no evidence to prove that the fungus is a Uredine. The detailed results, with other particulars of the nature and development of the fungus, will be published soon.

April 20.

E. M. FREEMAN.

Rearrangement of Euclid I. 1-32.

THE rearrangement outlined in my previous letter was devised to meet the difficulty which, as Prof. Bryan states, is the chief objection to Euclid's Elements as an elementary course. Beginners cannot solve riders because

(1) They do not grasp the reasons for Euclid's limited postulates and axioms, and never fairly understand the "rules of the game"; consequently their early attempts violate his conditions, and their rejection discourages.

(2) Too much time is occupied by the propositions, with the result that they regard them, not as tools, but as models, and imitate Euclid's methods of proof. There is nothing in 1-8 worthy of imitation.

(3) They do not distinguish between data and *quæsitæ* unless they have drawn accurate figures. It is impossible to draw accurate figures by proved methods in Euclid's scheme (e.g. I. 4), and we therefore have recourse to figures drawn on the principle of Artemus Ward's horses. This is the great difficulty in working riders. Allow a boy to assume the mid-point of a line and he will assume the most impossible constructions. He should never be allowed to quote a construction which he cannot perform, and no construction should be shown him without proof. Freehand copies of blackboard figures are useless; if he has drawn a dictated figure, there is no confusion between hypothesis and conclusion. There is also the additional advantage that the less intelligent feel that in drawing the figure they have accomplished something, and this frequently stimulates to further effort.

To remove these difficulties we must extend the axioms and postulates, reduce the number of standard propositions, and introduce problems as early as possible. The advocates of a purely theoretical scheme have two courses open to them—either they must teach constructions first without proof (which is extremely illogical), or they must postpone them until the completion of the theory, and therefore postpone riders indefinitely. Geometry without riders resembles arithmetic without examples.

In the scheme which we have found most successful, riders commence with the definitions. Every standard proposition is treated as a rider and evolved by the class; one proposition a fortnight is considered sufficiently rapid progress, the intervening lessons being devoted to riders.

The circle gives a method of drawing equal lines, and, with the idea of angular measurement, a method of constructing equal angles. Of course we assume the shape of the circle.

I. 15 and 32 give the fundamental fact of rotation and introduce easy theorems and numerical examples.

I. 8 with its riders elicits I. 9, and I. 4 is followed by I. 10, locus of points equidistant from two given points, I. 11, 12, 5. Having reached this point, possible riders are endless, and the only difficulty lies in their selection; many propositions of III. and IV. may be included in the riders. Every pupil can now draw an accurate figure from dictation, and knows exactly what data he has to work upon. The rate of progress may appear slow, but we are teaching Book VI. in the second year. It should be noted that I. 1 is a rider, 20 an axiom, and that 2, 3, 7, 18, 19, 21, 24, 25 are not read.

In teaching riders, theorems should, as a rule, be grouped on methods of proof; the required figure should be dictated and the class asked to prove any fact they can concerning it. A general enunciation should then be invented; in this way standard propositions for future proof are frequently suggested. It is a mistake to hurl a general enunciation at a class of beginners. Problems usually give more trouble, but if grouped on loci their difficulties vanish.

There would be no examination difficulty if papers were set on riders only. Euclid's Elements might then be reserved for university examinations—a geometrical "Paley."

Leyton Technical Institute, April 25.

T. PETCH.

THE FORTHCOMING BELFAST MEETING OF
THE BRITISH ASSOCIATION.

PREPARATIONS for the forthcoming meeting at Belfast are already well advanced, and careful attention is being paid by the various committees to those details which make so much towards a satisfying and successful issue.

The last meeting in Belfast was under the presidency of Prof. John Tyndall, whose famous address on that occasion will be remembered. It is interesting to note that at this year's meeting the president-elect, Prof. Dewar, F.R.S., who has so widely extended the bounds of our knowledge of the properties of liquefied gases, comes to preside over this meeting of the Association in the place where the late Dr. Andrews made his classical researches on the same subject, and where a collection of his apparatus is preserved in the laboratory where he worked.

The meeting will have ample accommodation in Queen's College and neighbouring buildings, all within a radius of three minutes' walk from the reception-room, which, as on the last occasion, will be the large examination hall of the College. Most of the sections will, as before, find place in the lecture-rooms close at hand, those sections dealing with allied subjects being close to each other, an arrangement made more easy by the recent additions to the College buildings. These include chemical laboratories, physiological and pathological departments and a students' union.

The first general meeting will be held on Wednesday evening, September 10, in the Grosvenor Hall, which seats about 2500 persons, when the president-elect will deliver his inaugural address.

The Friday evening discourse will be given by Prof. J. J. Thomson, F.R.S., on "Bequerel Rays and Radio-activity," one of the most fascinating fields of advance in modern physics and a subject which affords scope for a wide range of experimental illustration. On Monday evening a discourse will be given by Prof. W. F. R. Weldon, F.R.S., on "Inheritance." The Saturday evening lecture will be delivered by Prof. Louis C. Miall, F.R.S., and the subject will be "Gnats and Mosquitoes," about which so much interest has recently centred in connection with the propagation of malarial fever. Conversations will be given on the Thursday and Tuesday evenings.

It is intended to organise a loan collection illustrative of Irish antiquities and archeology and also of the progress of Belfast and its industries since remote times, and supplementing the interesting collections of a similar kind already existing in the local museums.

It has been thought best to arrange for excursions on Saturday, September 13, to the most important and interesting localities only, and to provide for large numbers in each party rather than to have many excursions, the want of interest in the less important of which might cause disappointment. Efforts will be made to facilitate the attendance of the more distinguished members on these occasions.

The chief excursions will be to: (1) Portrush and Giant's Causeway. (2) Glenariff, Garron Head and Coast Road. (3) Newcastle, Tollymore Park and Mourne Mountains. (4) Warrenpoint and Carlingford. (5) Drogheda and the Valley of the Boyne. Specially prepared pamphlets will be issued as guides to the excursions. A number of minor excursions will be so arranged as to suit the spare time that may be at the disposal of members. In connection with the meeting and the excursions, the following notes upon Belfast and the neighbourhood are of interest.

For the paragraphs dealing with geology and botany I am indebted to Mr. S. A. Stewart, for that on zoology to Mr. Robert Patterson, and for that on archeology to

Mr. F. J. Bigger. Further information on these or other allied subjects will be most willingly given to members by the hon. secretaries of either the Belfast Natural History and Philosophical Society, Belfast Museum, College Square, or the Belfast Naturalists' Field Club at the same address.

Geology.—The geological characters of the counties of Antrim and Down differ very widely. The river Lagan, which separates them, is also the dividing line between the Palaeozoic rocks of the south-east and the interesting secondary series to the north. The city of Belfast is built mainly on drift deposits which overlie Triassic marls and sandstones. The hills which almost encircle the city are made up of eruptive masses of dolerite covering sedimentary deposits, which consist of hard Chalk, Upper Greensand, Lias Clays, Keuper Marls and Bunter Sandstones, the interior of the county being a more or less elevated plateau. These great masses of Trap, more than 1000 feet thick, have been erupted in successive sheets, and contain beds of iron ore at certain levels. At Ballypallid many fossil plant remains are found which determine the age of these erupted rocks as Eocene. The beautiful prismatic rocks of the Giant's Causeway are well known, and this columnar Trap is seen in several places on the coast, though in minor masses and less developed form. Good sections of the sedimentary rocks may be seen in the Belfast hills, the Antrim coast road, Portrush, and elsewhere. A much indurated but fossiliferous bed of Lias clay, so hard as to appear flinty, occurs at Portrush. In the Cushendall district some older rocks are interpolated. At Cushendun, between Cushendall and Ballycastle, is a massive conglomerate which has been supposed to be of the age of the Old Red Sandstone; where it crops out on the shore some fine caverns have been excavated by the action of the sea. Carboniferous shales and sandstones occur near Ballycastle, and coal mining in these beds is of very ancient date.

To the south and east of Belfast lies the county of Down, with its range of mountains stretching from Newcastle to near Warrenpoint. There is little variety in the rocks of the county. The higher mountain peaks are of granite, while the stratified rocks of less elevation are very much hardened Lower Silurian grits and shales. The granite masses of the Mourne Mountains are valuable building material, and they yield beryl, topaz and other much-prized minerals. Save the Silurian, there are scarcely any stratified rocks in the county. A very small patch of Permian occurs below high-water mark at Cultra, Belfast Bay, and with it a strip of Carboniferous Shale. At Newtownards is Scрабо Hill, which is an outlier of the New Red Sandstone; and at Castle Espie, on Strangford Lough, is a very small exposure of Carboniferous Limestone. Carlingford is in the county of Louth; it is a Carboniferous Limestone country, as indeed is the greater part of that county. At Coalpit Bay, near Donaghadee, are Silurian shales with graptolites.

Zoology.—The zoology of the district is exceedingly interesting, and specialists in any branch might well devote additional time to it beyond the official week. To the conchologist the district is a happy hunting-ground, fully two-thirds of the species of British land and freshwater mollusca being found here, some of extreme rarity, while several species that are very rare in England are found here in some numbers. The marine mollusca will also repay investigation, this being the only British locality for several species, while the richness of this fauna is shown by the fact that recently a single day's dredging produced one species new to science and two more new to Britain. The coleopterist will also find an interesting fauna awaiting him, several species being found here which are unknown elsewhere in Britain. September is rather late for the lepidopterist, otherwise some good things might be found. But,

indeed, remarks such as the above might be made of almost all the various branches of zoology; the district is well worth thorough searching; the Mourne Mountains have been scarcely touched by the collector, and important finds might be made at any time. The field naturalist could easily spend a profitable week on or around Lough Neagh—by far the largest lake in the British Islands—which is comparatively close to Belfast and easy of access. Here the pollan is found in great numbers, and those interested in fish can investigate this species, which is not found in either England or Scotland. The Toome Eel Fishery is also worth a visit, ten thousand pounds' worth of eels being caught annually.

Botany.—Though the peculiar group of plants, styled in the *Cybele Hibernica*, "Cantabrian," which enrich the flora of south-west Ireland are absent in the north-east, yet the floras of Antrim and Down are both extensive and varied. The recent "Irish Topographical Botany," by Praeger, gives the plants of co. Antrim as 777, in an area of 1191 square miles; co. Down, 742 species, area 957 square miles. The coast-line of these two counties, more than 200 miles, with its sand dunes, mud flats and maritime rocks, affords suitable sites for very diverse groups of plants. The visitor to Newcastle in co. Down will find on its sandy warrens quite a number of uncommon species, while the muddy shores at Dundrum yield such plants as *Atriplex portulacoides* and *Juncus obtusiflorus*. This sea-coast is girt in almost its entire extent with hills and mountains of considerable elevation and varied mineral composition. The visitor to the Mourne Mountains will meet with siliceous rocks, granites and indurated Silurian grits and shales, yielding at Tollymore and elsewhere hawkweeds, some of much rarity. The Trappean hills which characterise almost exclusively the greater part of co. Antrim give a flora differing considerably from that of its neighbouring county. Glenariff is typical of the rugged and picturesque ravines cut deep, by the waters flowing from the moors above, into the basalt and secondary rocks of Antrim. The yew tree, formerly plentiful, still lingers on the wild cliffs of Glenariff, but apparently is near extinction. The rare umbellifer *Carum verticillatum* is plentiful on the Giant's Causeway headlands, and Scottish lovage is found on rocks washed by the sea near Portrush. The bryologist will find in "the glens of Antrim" capital hunting grounds, as their moss flora includes many species of considerable rarity. The south of the county has during last year yielded to the researches of Mr. J. H. Davies *Ditrichum vaginans*, a moss new to the British Isles. The valley of the Boyne in co. Louth, to the south, is in a limestone district, and has an extensive flora consisting of species that usually frequent calcareous tracts, but has no special features to note.

Archæology.—The antiquities around Belfast are numerous and representative, more especially the pre-historic remains. Forts and souterrains are abundant and cromleacs numerous, the finest being the Giant's Ring quite close to the city. Here a fine cromleac is surrounded by a great earthen ring, a wonderful evidence of man's power and labour in the earliest ages. Several fine souterrains, chambered and complicated, are to be found near Antrim town. Standing stones, some holed, are also numerous, whilst Ogam monoliths occur at Connor. Celtic pre-Norman churches can be seen in several parishes with holy wells adjoining, whilst later churches with distinctive features, several round towers, such as those at Antrim, Armoyn and Drumbo, can easily be visited. Of the abbeys, the most attractive are Grey Abbey, a Cistercian house, Inch Abbey, and Bun-na-Margie, a Franciscan foundation. Some ancient crosses and cross slabs, such as those at Downpatrick, Donaghmore, Dromore, Movilla and Bangor, are well worth inspection, whilst armorial stones abound in every churchyard.

The great Norman castle of Carrickfergus, with its bold central tower and surrounding ramparts, is still occupied, whilst Dunluce, the chief residence of the MacDonnells, overhangs the stupendous cliffs of the north coast, one of the finest sights in the three kingdoms. The Knights Templars had a stronghold at Dundrum, where a great circular keep and encircling battlements still defy the hand of Time.

Smaller castles abound on every hand both in Antrim and Down, showing how the Normans and subsequent settlers obtained a firm foothold, for the Irish were not given to castle-building.

In many districts primitive manners, utensils and customs are still common. Wooden vessels and quaint candlesticks, wheel cars and slipe carts, donkey creels and straw ropes, the scythe and the hand-reaper are the peasant's usual means of living and carrying on his ordinary husbandry. Nowhere can all the phases of archæology be better studied than in the north of Ireland.

Belfast—the population of which has increased from 185,000 to 350,000 since the last meeting—is well known as the industrial capital of Ireland. Its linen manufacture was in a flourishing condition in the thirteenth century, was still farther improved by the Huguenot refugees who settled in the neighbourhood in the seventeenth, and has now attained to the vastly greater scale made possible by modern machinery. Members of the Association will be given ample opportunities of visiting the most important works.

Inspection of the newer and no less important ship-building industry will also no doubt prove of the greatest interest, not only to engineers, but also to the travelling public who may care to see the birthplace of the White Star steamers, the first vessels in the design of which the true characteristics proper to steam-propelled vessels were fully grasped, though their great length at first evoked prophecies of disaster. Permission to inspect these yards has in recent years been only very sparingly granted, partly because of the time lost by the workmen from the distraction of their attention by visitors. Admission to these yards and engine shops will be accorded to members of the Association.

The handbook or guide to the district, a copy of which will be presented to each member, will contain specially prepared maps illustrating the topography, geology and antiquities of the district. The editors in charge of the work are Mr. F. J. Bigger, Mr. R. L. Praeger and Mr. J. Vinycomb.

The following subjects will be dealt with:—"History of Belfast and the District," by Mr. F. J. Bigger and Mr. J. Vinycomb; "Antiquities," by Mr. F. J. Bigger and Mr. W. J. Fennell; "Geology and Physical Geology," by Mr. J. St. J. Phillips; "Botany," by Mr. R. L. Praeger, Mr. S. A. Stewart and the Rev. C. H. Waddell; "Zoology," by Mr. R. Patterson, Mr. R. Welch, the Rev. W. F. Johnson and Mr. H. Lamont Orr; "Trade and Commerce," by Mr. A. G. Wilson.

Although the journey to Ireland includes the crossing of St. George's Channel, any discomfort that this may have entailed in the past has been reduced to a minimum in recent years by the excellent steamers now available. The shorter sea passages are *via* Holyhead and Kingstown or Greenore and *via* Stranraer and Larne. Members from England who prefer a night passage have a choice of three direct routes—*via* Fleetwood, Barrow or Liverpool. The first mentioned has the largest and best steamers; the others have one or two very good boats. Passengers from Glasgow *via* Ardrossan or Greenock will find the direct boats fairly good, though comparatively small, old-fashioned and often overcrowded; but the open sea passage is not long, and daylight passages are available.

The railway and steamboat companies will issue return tickets to Belfast from the principal stations in the United

Kingdom at a fare and a quarter on surrender of the usual voucher issued to members. From stations in England and Scotland such tickets will be available from September 8 to 22, in Ireland from September 8 to 28.

The local railway companies will issue return tickets at single fares to members during the meeting for short journeys, and the Belfast Street Tramways Company has kindly offered to issue passes to members for its cars free of charge. These cars pass the College gates. The accommodation for visitors has increased considerably since the last meeting in Belfast, two large and several smaller hotels having been established since then, and it is expected that a large amount of private hospitality will be offered by the citizens. J. BROWN.

THE COLLEGES OF THE UNIVERSITY OF LONDON.

IN considering the educational needs of London it is important to remember that its extended area, its large population, and its exceptional municipal government all conspire to place the metropolis in a category by itself. Local authorities and other organisations which may serve to meet the requirements of the rest of England are not suitable for the unique wants of the greatest city in the world. When framing the Education Bill now before Parliament, the Government recognised this exceptional character, and very wisely postponed for a future occasion the consideration of the coordination of existing institutions of different educational grades in London, and of the addition of necessary schools and colleges. Similarly, the University of London, as reconstituted by the Commissioners appointed under the Act of 1898, is an institution of a unique character. No other university has a similar constitution, because nowhere, at home or abroad, are the conditions of the metropolitan area duplicated.

As was pointed out in an article in NATURE in 1899 (No. 1548, vol. ix.), if, as is done in the University of London Act, 1898, the area to be served by the London University is that included within a radius of thirty miles from the University buildings, it will be found that the University has, on a very moderate estimate, to meet the higher educational needs of about seven million inhabitants. It was shown in the article referred to that to accomplish this huge undertaking with any hope of success it would be necessary to make the fullest possible use of every existing institution which could be regarded as of university standing.

It is instructive in this connection to compare the provision of university education in some other districts with that to be found in the capital. The population of Scotland is under four millions and a half, yet there are, north of the Tweed, four largely endowed and well-equipped universities, and in addition a university college. The total population of the eight large towns in England provided with university colleges is under three millions and a half; while Wales, with a population of under two millions, has three university colleges. So that, even on the grounds that London should be made as well off as the other parts of Great Britain, it may be urged, fairly and temperately, that there is need for a great and immediate advance.

For these reasons amongst others we are glad to find that University College is making an earnest appeal for largely increased funds in aid of higher education and the facilities for research in London. If the teaching University of London is to be built up on existing institutions, it is of the highest importance that University College should be incorporated with it. A short time ago a joint committee of the council of the College and the senate of the University considered the subject of incorporation, and though they have not finished their deliberations, they have agreed on certain points, viz. :—

(1) For incorporation to take place the College must be free from debt.

(2) The University will not take over University College School. Accommodation must therefore be provided on a new site.

(3) The University will require extensive rearrangements of the Medical School.

All outstanding debts are already provided for by the Drapers' Company, which has generously become responsible for them to the extent of 30,000*l.* In addition, about 60,000*l.* have been contributed, a large part of which has been given on condition that the incorporation of the College in the University is really effected. But a much larger sum is needed. To provide a site and new buildings for University College School, to refit the present school buildings and to carry out other indispensable alterations, not less than 110,000*l.* will be required. For the completion of the College buildings, thus providing adequate accommodation for both teaching and research in the many different branches of knowledge, 250,000*l.* are necessary. For departmental expenses, including the maintenance of laboratories, libraries, &c., an annual income of 6000*l.*, or a capital sum of 200,000*l.*, must be provided. For the endowment of existing unendowed chairs and for the foundation of additional professorships a yearly sum of 20,000*l.* must be forthcoming, and this represents a capital sum of 700,000*l.* In short, to perfect and complete the College and to render fruitful its incorporation in the University a sum of at least one million pounds must be found.

If our merchants and manufacturers appreciated the importance, as a factor in our national commercial success, of the higher education of the people of London, there would be no difficulty in obtaining the sum required by the council of University College. As we have chronicled from time to time, the merchant princes of America have supplied for similar institutions in the States very many times the amount asked for by University College. The Leland-Stanford University of California has received nine millions sterling from private munificence; Chicago University has been given over two and a half millions, and many other universities have similarly been provided with their necessary millions.

University College is fully justified in its appeal to the public by a splendid record of activity during the seventy-five years of its existence. The standard of the studies carried on throughout this period has been that of a university, and the yearly output of original work has not been exceeded by that of any constituent college of a British university. We cordially recommend its claims to all those who are able to be munificent, and would suggest that no more suitable way of celebrating the Coronation in London could be found than the provision of this million pounds to begin the work of establishing in the capital of the Empire a teaching university worthy of our imperial aspirations.

But, as has often been pointed out in these columns, the responsibility for the provision of educational facilities which will bring us in line with other progressive nations rests, not upon individuals, but with the State. Private benevolence is never better employed than when it is used to assist higher education and research, but it ought not to be regarded as an excuse for the neglect of a national duty; yet over and over again this is done by statesmen of both parties. Mr. Balfour occupied this position on Wednesday of last week, when speaking at the Mansion House in connection with the distribution of prizes awarded under the commercial education scheme of the London Chamber of Commerce. He acknowledged that our nation "has lagged behind all the great nations of the world, not merely in commercial education, which is a portion of technical education, but also in many of the wider and more important aspects of national education." His remarks upon the importance of studying

commerce in the spirit of impartial scientific investigation and wide knowledge were also to the point. Mr. Balfour said, in effect, that there could be no doubt about our leeway, or upon the value of broad and scientific education as the chief factor of progress, but he looked to the general community to "set itself to work to bear the great responsibilities which the needs of our country have thrown upon our shoulders."⁷

It is only when educational provision is under consideration that our statesmen are content to leave obvious national defects to be remedied by chance munificence in the way suggested. In military and naval matters the Government is held responsible for efficiency, whatever assistance may be obtained from voluntary effort. The same principle must be applied to higher and technical education before we can hope to make our educational

tunity for the State to show it. Let a liberal grant be made from the national exchequer, and private donors would understand that the statesmen who express fine sentiments upon the value of higher education to national welfare are actually convinced of the urgent necessities of the case. It is because this example has not been set that the various colleges of the University have to carry on their work with very inadequate resources. We commend these considerations to the Duke of Devonshire, who is to speak at the Mansion House on May 9 at a meeting to be held in support of the appeal for funds for advanced secondary education and research at University College.

It must be remembered that, when looked at broadly, this question of the provision of an adequately endowed and fully equipped University of London is a much



FIG. 1.—Distribution of Colleges and Polytechnics in London. The order is that given in the Report of the London Technical Education Board.

1. Royal College of Science.
2. King's College.
3. University College.
4. Bedford College.
5. Central Technical College.
6. Finsbury Technical College.
7. Battersea Polytechnic.
8. Birkbeck Institution.
9. Borough Polytechnic.
10. City of London College.
11. East London Technical College (People's Palace).
12. Goldsmiths' Institute.
13. London School of Economics and Political Science.
14. Northampton Institute.
15. Northern Polytechnic.
16. Regent Street Polytechnic.
17. Sir John Cass's Aldgate Institute.
18. South-Western Polytechnic.
19. Woolwich Polytechnic.

forces equal to those we have against us. The States which are making headway, and equipping themselves for industrial war, are those which give the greatest encouragement to the advancement of knowledge. Until our statesmen recognise this fact and act upon it, there can be no assurance against the loss of national position which must come sooner or later. The present policy of drift can only be compared with that of the man who is imprudent enough to neglect to provide for old age because he hopes that some generous friend will present him with an endowment assurance.

The Government should lead the way to improving higher education, not by words, but by deeds. Practical sympathy is what is needed at present more than anything else, and the University of London offers a good oppor-

larger one than that of securing sufficient funds to make possible the incorporation of University College in the University. Even when its incorporation has been effected, University College will be but a constituent college of what we hope is destined to be a powerful and comprehensive University, binding together all those institutions located within the metropolitan area which, by a little adaptation and some necessary expansion, can legitimately claim university rank. The consummation for which every earnest educationist in London should work is the incorporation in the University of London, in the same large way that University College desires, of all suitable colleges and polytechnics. There is King's College, which in one important respect, since it has already moved its secondary school to Wimbledon, has

advanced a step further on the road to incorporation than University College. The Royal College of Science, with its intimate connection with the Board of Education and its exceptional facilities for training teachers of science, would worthily fill an important part in the work of the University. The Central Technical College of the City Guilds, subsidised by the wealthy City companies, provides higher education, and could immediately take its place in the University to teach advanced technology. Bedford College, too, which has specialised in the direction of the higher education of women, must be included.

Finally, there are the polytechnics. On more than one occasion it has been pointed out in NATURE that the amount of research work accomplished in the polytechnics of greater London rivals successfully that done in many university colleges. It must, it is true, be admitted that to be worthy of the great University which it is hoped the current decade will see thoroughly established, the polytechnics will have to curtail their work. At present they attempt the education of all comers from twelve years of age and upwards. But just as it has been made a condition of the incorporation of University College that the school in connection with it shall be moved elsewhere, so in the case of the polytechnics, the existing day schools for boys and girls, where an education on the lines of the "School of Science" curriculum of the Board of Education is given, will have to be transplanted, in order that the buildings and the equipment of the polytechnics may be entirely at the disposal of the senate of the University. Similarly, the recreative side of the general training offered by many of the polytechnics will have to be provided elsewhere, for it will scarcely be compatible with the dignity of a great university to perpetuate the present arrangements for providing students with social enjoyments. With these modifications, and perhaps some others, the polytechnics, situated as they are in all parts of the metropolitan area, as will be seen from the accompanying outline map (Fig. 1), based upon the Report of the London Technical Education Board for 1900-1901, are peculiarly well adapted to become constituent colleges.

There are immediate advantages accruing from an arrangement such as that outlined of a comprehensive university, consisting of the three university colleges, the Royal College of Science, the City Guilds Institute, the thirteen or so polytechnics, and perhaps a few other more specialised institutions, all bound together as necessary parts of one university, possessing the same aspirations, and all engaged in the same work of higher education. Such an organised whole will effect far more for London than the present individual and sporadic efforts of separate uncoordinated institutions competing the one against the other. And such an university could still preserve its former character as an imperial examining board for granting degrees.

A development of this kind and on this scale will doubtless necessitate the expenditure of many times the million pounds asked for by University College. But when the inhabitants of the wealthiest city in the world are educated to understand that no spending is so profitable as that on higher education and on the endowment of research, there will be little difficulty in obtaining the necessary funds. The immediate necessity is the provision of the amount required to ensure the incorporation of University College in the University of London; but this must be followed by a strenuous endeavour on the part of all men of science and influential men in every other department of mental activity to instruct Londoners in their duty towards their city and country of providing a permanently endowed University of London, consisting of constituent colleges situated in every part of the enormous area for the higher education of which the University is responsible.

PROF. ALFRED CORNU.

CORNU was born in 1841 at Châteauneuf, and entered the great military school of Paris, the Ecole Polytechnique, at the age of nineteen. After four years of study there he entered the Ecole des Mines, which he quitted in 1866, thus completing a brilliant career as a student. One year later, at the age of twenty-six, he was chosen as professor of physics at the Ecole Polytechnique, a post which he filled to the end of his life and adorned with the many results of his scientific researches.

It would be impossible in a brief review of Cornu's life to give more than the barest outline of his contributions to original knowledge. His position as a teacher gave him, amidst the material surroundings of his laboratory, the leisure to work. The beauty, the dignified ease and perfection of his investigations, the keen perspicacity of his observations, the masterly restraint, so to speak, of the scientific memoirs which from time to time he contributed to the scientific world, all bespeak a man of no ordinary capabilities, a master of his profession. Clear in his exposition of scientific matters, exquisitely clear alike in his experimental demonstrations and in the language in which he expounded their theory, he was as great in teaching as in research. Optics was his first love, and though he laboured successfully in other branches of experimental physics, it was to optics that he returned, and in the field of optics were achieved his greatest successes in physical investigation. The pages of the *Comptes rendus* and of the *Journal de Physique* bear eloquent testimony to the activity and penetration of his mind. Already, from 1863 to 1865, he had begun to contribute to the *Académie des Sciences* notes, the earliest of which relate to the refraction and reflection of light and to the problems of crystalline reflection. Following on the work of Jamin, he later pursued the subjects of vitreous and metallic reflection, and studied the connection between them. He showed that they were but parts of one and the same phenomenon, though affecting different regions of the spectrum, there being, as he showed, a true continuity between them.

Soon after entering upon the duties of his chair Cornu began with laborious and patient preparation those experiments upon the velocity of propagation of light which have become classical. Fizeau on the one hand, Foucault on the other, had already made determinations, each on his own lines. Foucault's value, then supposed to be the best, was 298×10^{10} in C.G.S. units. Cornu's results, of which an account will be found in some detail in NATURE of February 4, 1875, raised this figure to 3004×10^{10} , in vacuo, or 30033 , in air. His method, which was fundamentally the same as that of Fizeau, was applied to the transit of light over a distance of 46 kilometres (or between two stations 23 kilometres apart, the one at the Observatoire, the other at Monthéry); and the instrumental perfection of his rotatory apparatus enabled him to observe up to the twenty-first extinction of the beam, thus securing a precision far in advance of that attained by Fizeau. For his determination of the velocity of light he was awarded the *prix Lacaze* in 1878, the same year in which his merits were recognised by his admission to the *Académie des Sciences*. In 1872 he wrote papers on the theory of electrostatics, in which he expounded the potential theories of Gauss and Green, then little known in France. They are to be found in vol. i. of the *Journal de Physique*, then recently founded by his friend d'Almeida.

For several subsequent years Cornu was occupied with researches on the spectrum. He measured the wave-lengths of the hydrogen rays with a precision previously unknown, enabling a comparison to be made between the values so obtained by experiment and the theoretical formulæ which had been

proposed by Balmer and others to express them. The suggestions of Dr. Johnstone Stoney and the later developments of Kayser and Runge will not be forgotten in this relation. He also made observations on atmospheric absorption in the spectrum, using photographic methods, at his country house at Courtenay, where he used to spend most of his vacations. He thus was able to fix the inferior limit to the ultra-violet end of the spectrum, so far as it is visible at low elevations, and found that in the laboratory air is opaque to ultra-violet waves of a lesser wave-length than 0.185μ . His work on meteorological optics has thus been summarised by M. Guillaume:—"Such researches, in the course of which he was often led to a scrutiny of the sky, could not fail to draw his attention to the optical phenomena of the atmosphere, the study of which, though energetically pursued by the French physicists of last century, is to-day somewhat neglected. The splendid glows which were observed in the sky toward the end of 1883 furnished to Cornu an occasion to utilise the profound knowledge which he possessed of the phenomena of optics. He showed that the twilight glow, which at that time gave such marvellous charm to the sunsets, was due to a diffraction caused by fine powders, and it became evident that the formidable volcanic explosion of Krakatoa was the prime cause of it."

Cornu published an elegant method for the investigation of the optical constants of lens systems. He devised the optical lever for the measurement of the curvatures of lenses, and he perfected the Jellitt prism for polarimetric work. To him is due the elegant geometrical construction in which spirals are applied to express graphically the relative intensities of the light in diffraction images. His preference for geometrical demonstrations of theorems which might otherwise be hidden under a burden of analytical symbols was well known. He worked at acoustics in conjunction with M. Mercadier, and at elasticity, and in conjunction with M. Baille redetermined the constant of gravitation. He was occupied, too, with the problems of the synchronisation of two resonant systems capable of vibration under elastic forces, these memoirs being published in 1888 and 1889, the second of them including the application of his ideas to the synchronisation of clocks for the distribution of time. His plan was closely akin to that of Wheatstone, depending on the sending, at every second, of feeble induction currents generated by the movement of a magnet attached to the pendulum of a master clock. In 1884 he reported on the electric transmission of power by M. Marcel Deprez on the Chemin de Fer du Nord. He took part in the first electrical congress at Paris in 1881. In 1886 he became a member of the Bureau des Longitudes, and in 1900 of the International Commission on Weights and Measures. He was president of the Académie des Sciences; twice, at different periods, president of the Société de Physique; and by general consent was elected to preside also over the International Congress of Physics in 1900.

He was elected a foreign member of the Royal Society in 1884, and was also an honorary member of the Physical Society of London. In 1878 he received for his work on the velocity of light the Rumford Medal of the Royal Society. At least twice he gave Friday evening discourses at the Royal Institution; the last of these in 1895 on the physical phenomena of the high regions of the atmosphere.

In 1899 he delivered, with delightful eloquence and learned ease, the Rede lecture at Cambridge, on the wave-theory of light and its influence on modern physics. On this occasion, which was at the time of the jubilee celebration of Sir George Stokes, he received the honorary degree of Doctor of Science.

In Cornu, France has lost one of her most distinguished men of science, and one who, not only as investigator,

but as teacher and wise counsellor, had won universal esteem and respect. A true follower of the great traditions of France in the pursuit of science, and a passionate follower of Arago, Biot, Fresnel and Fizeau, he was in his own person much more than this. He was the ideal of a well-equipped, well-balanced, intellectual leader in scientific thought. SILVANUS P. THOMPSON.

M. VIGNON'S RESEARCHES AND THE "HOLY SHROUD."

AT the meeting of the Paris Academy of Sciences on April 21, some remarkable photographs of brownish stains found on the "Holy Shroud" kept in the Treasure Chamber of Turin Cathedral, and traditionally said to be the winding-sheet of Christ, were exhibited in connection with a paper by Dr. P. Vignon, of which a translation from the current number of the *Comptes rendus* of the Academy is given below. Upon reproducing these stains by photography, Dr. Vignon found that he obtained a realistic picture of a human figure, and the suggestion is that the picture is actually a representation of the body of Christ, produced by radiographic action from the body, which, according to ancient texts, was wrapped in a shroud impregnated with a mixture of oil and aloes. We give Dr. Vignon's paper, which it will be noticed is confined to an account of principles relating to radio-activity.

ON THE FORMATION OF NEGATIVE IMAGES BY THE ACTION OF CERTAIN VAPOURS.

It is known, from the work of M. Colson, published in the *Comptes rendus* of the Academy of Sciences in 1896, that freshly cleaned zinc emits vapours at the ordinary temperature which are capable of affecting photographic plates in the dark. The researches of Russell have also shown that the striations of a plate of zinc reproduce themselves on a photographic plate. But it is a long step from this to the realisation of an object in relief. I have succeeded in obtaining images either with medals powdered with zinc, or with bas-reliefs or objects fully embossed, in plaster, and rubbed with zinc powder. These images are negatives, not by the inversion of light and shade, since they are formed in the dark, but by the fact that the reliefs give more energetic impressions than the cavities. To interpret these it is necessary then to invert photographically; positive images are then obtained in which the scale of relief is scrupulously respected, which is far from being the case in normal photographs of the same objects illuminated from the front. Naturally, upon images made at a distance, the reproduction of the most minute details could not be expected, the precision of the detail obtained being less as the distance increased. The clearness of the image depends upon the rapidity with which the action diminishes when the space increases between the emissive surface and the receiving screen.

From a point of the active surface let a perpendicular be lowered on to the receiving plate; the foot of this perpendicular constitutes the centre of a circle which makes a more energetic impression in its central region than on its edges; the clearness of the image will thus be greater the smaller the surface of the circle acted upon, and this surface varies inversely as the rapidity with which the actions decrease when the distance increases. It is on this account that the images correspond very nearly to those which would be realised if the actions were produced only according to the orthogonal projections of the different points of the active surface.

It is a curious point that the images converted into positives frequently give rise to the impression of having been lit from above.

This will be the case when a plane, such as the forelieft, is seen from the front and forms at the same time a strong relief, whilst a plane near it is rapidly shifting, such as, for example, the region which connects the superciliary arch to the eyeball. When this plane shifts it appears to sink into a deep shadow.

The truly specific character of these negative images which arise from action at a distance lies in the softness of the contours. The limit of the visible portion is the result for the eye of the receding of the surface. If this falling back takes place at a small distance from the receiving plane, the contour is still marked, though vaguely; but if this falling away is produced

only at a distance greater than that at which the vapours can act, no corresponding effect is produced in the image, which gradually weakens up to its borders by insensible gradations until it disappears altogether.

Practically in spite of the softness of the details and the outlines, the impressions produced by vapour are far from consisting of simple shadows; if the object is in strong relief, the image is energetic and well marked; it appears simply as if the object were seen through transparent gauze, or as if it had half emerged from a fog.

Negative images have also been obtained by acting with ammoniacal vapours upon cloths impregnated with a mixture of powdered aloes and olive oil; it is known that aloes contains a principle which turns brown and is oxidised under the influence of alkalis in moist air. A plaster hand covered with a suede glove which has been moistened with a solution of ammonium carbonate acts similarly. There is obtained in this way a sort of print of the hand, a negative softened at the edges and wanting in proportion in so far that the points where the hand is too far from the cloth are too faint, the points of contact of the hand and cloth, on the other hand, being too strongly marked. The fermentation of urea, easily brought about by the addition of a little urine, leads to the formation of ammonium carbonate and thus causes the browning of the aloes. The fermentation of a febrile sweat, rich in urea, leads to the same result, as is already well known.

The extension of Dr. Russell's researches on the photographic activity of certain bodies in the dark, contained in the above paper communicated to the Paris Academy by M. Vignon, has given rise to a most curious discussion.

There is a so-called "Holy Shroud" at Turin in which tradition states the body of Christ was wrapped after the Crucifixion. An article in the *Times* thus refers to it and its connection with M. Vignon's work:—

"It is said to have been brought from the East in the fourteenth century, and in the following century it passed into the hands of the House of Savoy, and was deposited at Chambéry. Finally, it was transferred in 1578 to its present resting-place by Duke Emmanuel Philibert, who wished to spare Carlo Borromeo, the sainted Archbishop of Milan, the fatigue of a pilgrimage to its distant Savoyard shrine. The Shroud bears upon it, traced in hues of brown, what is alleged to be a double impression of the figure of Our Lord, the outlines both of the face and back of which have reproduced themselves with wonderfully distinct exactness. So seldom, however, is it exposed to view that this remarkable characteristic had almost been forgotten when, in May, 1898, some photographs specially taken of it by Signor Secondo Pia, of Turin, with the consent of its possessor, the King of Italy, once more drew attention to this strangely living likeness. Eighteen months ago these photographs came under the notice of M. Vignon, who, recognising their exceptional importance, at once began that inquiry of which the results were made public in a paper communicated to the Académie des Sciences."

In Paris, therefore, it has been generally accepted that a demonstration has been given by science of the authenticity, not only of the so-called shroud, but of all the historical events connected with it, and a much closer rapprochement between science and theology is predicted for the future.

Here, however, difficulties have been raised. Father Thurston, a learned Jesuit, writes to the *Times* as follows:—

"Before we can profitably discuss the value of Dr. Vignon's scientific explanation of the marks on the 'Holy Shroud' a serious difficulty of quite another order has to be cleared up. The Abbé Ulysse Chevalier claims to have proved to demonstration that the linen winding-sheet exhibited at Turin is a spurious relic manufactured in the fourteenth century, and, as the writer believes, with fraudulent intent. M. l'Abbé Chevalier is a scholar of distinction, and of his perfect loyalty to the Catholic Church there can be no possible question. Moreover, his essay ("Etude Critique sur l'Origine du S. Suaire," Paris, Picard, 1900) has been warmly welcomed by the more critical journals devoted to hagiography. In the Bollandist periodical,

the *Analecta Bollandiana*, for instance, its Jesuit editors state (vol. xix., 1900, p. 350) that the Abbé Chevalier's discussion of the subject is final, and that "il ne reste plus qu'à proclamer "à haute et intelligible voix," comme le voulait le Pape Clément VII.: "Hæc figura . . . non est verum sudarium Domini Nostri Jesu Christi."

"They go on to state that the story of the 'image of the shroud' given by Geoffroy de Lirey to the college founded by him in 1353 is not lost in the mist of ages, and does not happen to present any of those obscurities by which the historian who wishes to impart his own laboriously-acquired conviction to others must at times find himself baffled. We have, for instance, the document addressed to the Pope by Bishop Peter d'Arcis, in which he denounces the fraudulent dealing of the Chapter of Lirey, who for motives of avarice pretended that miracles were worked by this shroud, whereas his predecessor in the see of Troyes had officially investigated the matter and proved it to be a forgery. "Et probatum fuit etiam per artificem qui illum (pannum) depinxerat, ipsum humano opere factum, non miraculose confectum vel concessum."

There is also another difficulty. It is stated that there is at least one other Holy Shroud in another holy place.

NOTES.

THE governing body of the Jenner Institute of Preventive Medicine has appointed Major Ronald Ross, F.R.S., whose name is well known in connection with his researches on malaria, to be head of a new department in the Institute at Chelsea.

WE learn from the *British Medical Journal* that the Legislature of New Jersey has passed a Bill which sets aside 10,000 dollars for the support of an experiment station where scientific investigations are to be made into the habits and breeding-places of mosquitoes and their relations to public health.

WE regret to see the announcement of the death, at the age of sixty, of M. Henri Filhol, professor of paleontology at the Jardin des Plantes, Paris; and also of Prof. I. L. Fuchs, professor of mathematics in the University of Berlin.

THE council of the Royal Institute of Public Health has conferred the Harben Gold Medal for the year 1902 upon Prof. W. R. Smith, late medical officer of the School Board for London, in recognition of his eminent services to the public health.

THE Washington correspondent of the *Times* reports that Lord Kelvin and Mr. Westinghouse both gave evidence on April 24 before a committee of the House of Representatives appointed to consider the present system of coinage and weights and measures. Lord Kelvin advocated the passing of a Bill to substitute the metric system for the standard now employed in the United States. Mr. Long, Secretary of the Navy, expressed the hope that England would take the lead in this change, but said that if England did not the United States should, and England would then follow. Mr. Westinghouse supported the Bill, but declared that it would take ten years for the people to learn to use the metric system.

IN connection with the second International Congress of Medical Electricity and Radiography, to be held at Bern on September 1-6, there will be an exhibition of apparatus relating to electro-physiology, electro-therapy and radiography. The physiological apparatus will be exhibited in the Physiological Institute, and will be in charge of Prof. Kronecker, director of the Institute, to whom communications relating to it should be addressed. The induction coils, contact-breakers, vacuum tubes and other apparatus connected with the production and uses of Röntgen rays in medicine will be in charge of Herr O. Pasche, chief of the Röntgen Institute of the Bern

Hospital. The exhibition will be opened on August 29, and intending exhibitors should communicate as soon as possible with Herr Pasche, Röntgen Institute am Insepsital, Bern.

At the present time, when much attention is being given to the reform of mathematical teaching associated with the name of Prof. Perry, the pamphlet entitled "The Cultivation of the Mathematical Imagination," by Miss Mary Everest Boole (Colchester: Benham and Co., price 6d.), appears very opportunely. The methods advocated by the authoress belong chiefly to the kindergarten stage of education, but there are many suggestions that are appropriate to a slightly more advanced stage; the central idea is always that of leading up to general truths by means of concrete processes. The pamphlet should be very helpful to teachers who wish to find out how to prepare the minds of young children to receive formal mathematical instruction.

PROF. R. W. WOOD writes:—"It may perhaps be a matter of some interest to teachers whose laboratory facilities are limited to know that solid carbon dioxide can be obtained from the sparklets now sold everywhere for a penny or two for the aëration of beverages. The larger of the two sizes gives the best yield, of course. It is best to cool the sparklet in ice and salt for a few minutes before the experiment, and doubtless the amount of solid obtained would be still further increased by chilling the metal reservoir with which the bottles are fitted. A small square of black velvet should be held, or tied with a turn or two of string, over the end of the tube which delivers the gas into the fluid. The nap of the cloth should be on the inside, and the part over the tube should form a little bag about the size of a marble. On discharging the sparklet and quickly removing the bag, the interior will be found to be lined with the snow-white solid, with which a small drop of mercury can be easily frozen. The substance shows off most beautifully on the jet black surface of the velvet."

THE death is announced of Mr. William Henry Penning. After pursuing a course of engineering under Mr. C. H. Gregory, he joined the staff of the Geological Survey in 1867 and was engaged in mapping portions of Essex, Suffolk, Cambridgeshire and Lincolnshire. He was joint author of memoirs on the geology of the neighbourhood of Cambridge, Lincoln, and parts of Essex. He was author also of "A Text-Book of Field Geology," 1876 (edit. 2, 1879), and of "Engineering Geology," 1880. In 1882, through ill-health, he resigned his post on the Geological Survey and spent some time in South Africa. He died on April 20. We have also to regret the death of Mr. Joseph Nolan, who joined the Geological Survey in Ireland under Jukes in 1867, and after many years of active service in the field became in 1890 resident geologist in the Dublin office. He was author or part author of several memoirs in explanation of the Geological Survey maps. He retired from the public service in 1901 and died on April 19.

A STRONG earthquake was felt round Lake Baikal on April 12. It began at Irkutsk by a severe shock at 6h. 40m. a.m., the pendulum of the observatory being deflected by 22 mm. About twenty fairly severe shocks followed during the first minute. Groups of shocks next occurred, the strongest of them being at 7h. 13m., 7h. 31m., 7h. 36m., and 8h. 14m. All these shocks could be felt even without instruments, their force attaining the value of 5 in the seismic scale. The earthquake was widely felt round Lake Baikal. At Selenghinsk the chief disturbance travelled in a direction from S.W. to N.E. and the following shocks were noticed:—at 7h. 0m., 7h. 50m., 7h. 54m. and 8h. 35m. At the village Snyezhnaya, on the eastern coast of the lake, several chimneys were destroyed and crockery was thrown down. Further east, at Verkhneudinsk, and on the western coast,

the shock was much feebler. During the night of April 10-11 a very strong earthquake was felt in the north of Finland. At Uleaborg window panes rattled and crockery fell from its place. Shocks of earthquake violence also to be felt at Shemakha. Two severe shocks were noticed on April 17 at 10h. 0m. and 10h. 30m. p.m.

It seems at first sight to be a bold statement to put forward that the study of the distribution of plants may be dated back to the time of Alexander the Great. But no more weighty opinion could be obtained than that of a scholar who has combined the study of classics and botany. Herr Hugo Bretzl, as a thesis for his doctorate in Strassburg, has made a careful study of Theophrast's "Plant-geography," and comes to the conclusion that from the description there given of the air-roots of *Ficus bengalensis* the writer must have been able to refer to the original accounts of Alexander's expedition. The brochure received gives two chapters from the whole work, which is to be published in book form and promises to be exceedingly interesting. Not only does the author show that the Greeks realised such facts as the absence of the pine in all the countries which intervene between Macedonia and India, but incidentally his references suggest that the Aristotelian writers have not received due justice at the hands of other writers of historical botany.

It will be remembered that in a recent issue notes of the discovery of a blood parasite occurring in man and belonging to the genus *Trypanosoma* were recorded. The case was one of a European, whose chief symptoms were irregular rises of temperature with afebrile intervals, the attack being accompanied by increased frequency of respiration and pulse. The parasite was present only during the febrile attacks, and whilst it closely resembled *T. Brucei* in form and staining reactions, it was, however, considerably smaller and in fixed specimens assumed a characteristic "set." Another striking feature, which reminds one of the diseases known as Nagana and Surra in horses and cattle, is the occurrence of oedema of the eyelids and feet. Nepveu claims to have discovered this parasite in man in Algiers, but his description is very imperfect and raises considerable doubts as to whether what he saw were really trypanosomes. Mr. J. Everett Dutton, who described the parasite occurring in the blood of a European at Bathurst, West Africa, has within the last few days added the most interesting observation that the parasite occurs also in native children. Whilst examining for malaria parasites a large number of microscopical blood preparations of the native children of a small village, a few miles nearer the mouth of the River Gambia than Bathurst, he found in one preparation a number of trypanosomes resembling in every way those found in the case of the European before recorded. This second observation opens up a large field for further investigation and points to the extreme importance of the study of the diseases of natives, especially from a parasitological point of view, in West Africa and other parts of the world.

THE Meteorological Office Pilot Chart for May gives a short account of submarine earthquakes and the curious sensations they produce on board ship. Within the basin of the North Atlantic the fairly well-defined seismic regions are near the equator, between 19° and 33° W.; about the West Indies; from the Cape Verde Islands north-westward to about 33° N., 41° W.; and from 34° to 45° N., 13° to 30° W. The ice season this spring is very late, no bergs having been reported down to April 16. The St. Lawrence River was open for navigation at Quebec on April 3, an unusually early date. Numerous observations show that during the month of February last the temperature of the surface water of the Atlantic was below the average over a space extending south-westward from the British

Isles as far as 30° W. longitude. On shore the month was the coldest we had experienced for seven years, the air temperature being from 3° to 5° under the normal for various localities.

THE Meteorological Council has issued a valuable paper entitled "Temperature Tables of the British Islands." The work is divided into two parts: (1) The results derived from thirty years' hourly observations (1871-1900) for the four observatories Valencia, Aberdeen, Falmouth and Kew, showing the means and extremes of temperature for each day of the year and for the month; (2) the means and extremes for each month and for the year for 117 stations, with records of not less than fifteen years. In order to give an adequate representation of monthly temperatures of the London area, a table for Greenwich is included, with the consent of the Astronomer Royal, which gives data for sixty years. In the diagrams representing the seasonal variations at the observatories, the curves for maximum and minimum readings are printed on tracing paper, so that they can be superposed one upon the other, or upon the curve showing the mean values. A special feature, it is stated, in the treatment of the seasonal curves is an attempt to define a normal seasonal variation of temperature by the harmonic analysis of five-day means, to which daily averages and individual observations can be referred.

THE first number of the third volume of the *West Indian Bulletin* is devoted to a summary of the business transacted during the Agricultural Conference at Barbados in January last; to full reports of a number of papers on various phases of the sugar industry, with short accounts of the discussions on them; and to two communications of a general character—"The Organisation and Functions of Boards of Agriculture" and a "Report of the Chemical Section at the Conference." With the approval of the Secretary of State it is proposed by the Commissioner shortly to commence the publication of a new fortnightly review, to be called the *Agricultural News*, intended to contain in popular form agricultural information suited to the circumstances of the West Indies.

A PAPER by Mr Horace C. Richards, on the harmonic curves known as Lissajou's figures, is not the least interesting feature of the *Journal* of the Franklin Institute for April. The diagrams traced by the aid of a harmonograph are remarkably perfect and beautiful.

AN illustrated account of M. Santos Dumont's Parisian experiments is now given in *Prometheus*, No. 642. It includes reproductions of photographs showing the results of the accidents on August 8 and September 6, 1901; the successful ascents of October last are illustrated by views of the balloon when starting and when rounding the Eiffel Tower and a chart of the course.

THE *Rendiconti* of the Lombardy Academy notes that the Bologna Medical and Surgical Society offers a prize of 500 lire for an essay on sero-diagnosis in tuberculosis. Further, the "Olympic Academy" of Vicenza offers a prize of 3160 lire for a study of the Italians living on the South American continent, including more particularly the question of emigration and the relation between the colonists and their mother country.

THE Deutsche Mathematiker-Vereinigung has decided on a new departure in regard to the publication of its *Jahresbericht*. Under the editorship of Prof. A. Gutzmer, of Jena, this publication will in future appear monthly instead of annually, and among other features it is proposed to include academic dissertations, inaugural addresses, obituary notices both of members and of non-members, discussions on questions of teaching, notices of such undertakings as catalogues of current literature or the publication of Gauss's works, accounts of the meetings of societies, and notes and queries.

WE have received the April number of *Le mois scientifique*, which is devoted to a summary of recent books and publications on horticulture and botany. Among these we notice two new books on the cultivated plants of the south of France, one by M. Sauvaigo dealing with the Mediterranean coast, the other on southern flowers generally by M. Granger, and a new flora of France by M. A. Aclouque.

UNDER the title of *Théorie nouvelle de la Loupe*, M. G. Quesneville has published, in Paris, a small brochure dealing with the optical properties of lenses, considered with especial reference to vision. The principal difference between the present and the conventional treatment is that here account is taken of what happens to the rays of light, not only during their passage through the system of lenses considered, but also after they enter the eye.

THE manufacture of butter with sterilised cream with the view of preventing the spread of tuberculosis is discussed by Drs. Serafino Belfanti and Costantino Coggi in the Lombardy *Rendiconti*, xxxv. 7. In Sweden and Denmark pasteurisation is already adopted on a large scale, but in Germany and Italy a prejudice still exists against butter made with cream that has been subjected to this precautionary measure. The paper shows that the process, so far from being detrimental to the quality of butter, may actually prove of commercial value, and that the problem of preventing the diffusion of tuberculosis by means of milk does not involve such great pecuniary sacrifices as have been sometimes anticipated.

THE Geneva Society of Physics and Natural History has just issued the first part of volume xxxiv. of its *Mémoires*, containing reports of the work done during 1900 both in physical and biological science. Among the most interesting results we notice M. A. Brun's observation during the summer of 1900 of a peculiar kind of snow on Mont Malet, called "neige de Caucase," or Caucasian snow. It is a porous snow the grains of which attain a size of as much as three millimetres, and their want of adherence may readily give rise to avalanches. A new station at the Hospice of the Great St. Bernard is another feature noted in the *Mémoires*. The observations are made at the usual hours of the Swiss meteorological service, and the building is situated to the north-east of the old hospice. This departure is largely due to the energy of Prof. R. Gautier, who has equipped the station with thermometers and hygrometers specially adapted to high mountain work, and whose efforts have been ably supported by the monks.

WE have received a copy of an address on the teaching of biology delivered by Prof. Haberlandt on the occasion of the opening of the new scientific and medical institute at the University of Graz on December 9, 1899.

FROM the Report of the Director for the year 1899-1900, it appears that so long ago as 1857 a Museum was established in the town of Trivandrum, Travancore, but that for many years its condition was far from flourishing. By the addition of a public garden and menagerie, affairs have been placed on a better footing; and it is satisfactory to learn that the museum is now devoted to the illustration of local zoology. The following sentence from the director's Report is somewhat remarkable:—"In 1890 I succeeded Colonel Ketchen as Honorary Secretary and received the honorarium usually given to the Honorary Secretaries."

IN vol. xxiv. (pp. 499-566) of the *Proceedings* of the U.S. Museum, Mr. W. H. Dall describes and figures a number of new or hitherto imperfectly known shells, mainly American, in the collection of which he has charge. A large number of these, belonging to Buccinum, Trophon and allied forms, are

from Alaska and other parts of the Pacific coast of north-western America. Conspicuous among them is the handsome shell from Unalaska Island on which the genus and species *Beringius crebricostatus* were established by the author. A very large number of species belong to that group of Trophon which the author distinguishes as Boreotrophon.

THE numerous cruises of the U.S. Fish Commission steamer *Albatross* undertaken for the purposes of dredging, sounding and other objects connected with biology and hydrography are so important, and the literature relating to them is distributed through such a large number of serial and other publications, that all naturalists will be pleased to learn that a concise bibliography relative to the work of the vessel has been published. The task of compiling this record, which appears in



The U.S. steamer *Albatross* dredging, showing port boom rigged for surface towing.

the Report of the U.S. Fish Commission for 1900, has been entrusted to Mr. C. H. Townsend, the chief of the Fishery Division of the Commission, whose familiarity with the work of the ship, on board of which he served as naturalist from 1886 to 1900, rendered him peculiarly fitted for the task. The record comprises 172 closely printed pages, and is accompanied by a chart and illustrated with several views of the vessel, one of which is here reproduced. The first cruise took place in 1883, and the prime object of the work was the investigation of the fisheries and fishing-grounds. From 1892 to 1898 comparatively little work of this nature was, however, accomplished, owing to the vessel being employed on other services. For instance, at one time it was employed in Alaskan waters in connection with the Committee on Indian Affairs, on another occasion in laying the cable between California and Hawaii, and on a third occa-

sion it was told off for service during the war with Spain. In spite of these withdrawals from its proper sphere, the vessel has made 1786 dredging and trawling hauls, at all depths down to 4173 fathoms, and extending over a very large area; while the soundings taken number at least 4000.

MESSRS. WHITTAKER AND CO. announce that they will shortly publish in their specialist series a work entitled "Mechanical Refrigeration." The volume is by Mr. Hal Williams, and will deal with the whole field of ice-making and cold storage.

THE edition of the "Life of Charles Darwin," just published by Mr. John Murray at the modest price of half-a-crown, is a marvel of cheapness. The volume contains 348 pages, clearly printed on good paper and neatly bound; so that naturalists who do not possess a copy of the life of their master should hasten to add it to their libraries. A life like Darwin's inspires everyone with reverence for his greatness and the desire to walk humbly in the same light. The record and reminiscences of such a great career cannot be too widely read.

To suggest subjects to study in outdoor nature, and facilitate the record of the observations, Miss W. L. Boys-Smith has prepared a "Nature Note-Book," which has been published by Messrs. Allman and Son. A few hints are given concerning obvious characteristics, dates of appearance and habits of some common animals and plants, and thirty-three questions set by the National Froebel Union to test observation are printed at the end of the book. The remaining pages are ruled for records of observation and remarks, and for drawings. In connection with the revival of nature study or natural history, the note-book should be of service to young students.

MR. JOHN MURRAY will publish almost immediately an important volume by Major Molesworth Sykes, entitled, "Ten Thousand Miles in Persia." During the eight years which Major Sykes spent in Persia, he travelled over and explored the country from the Caspian Sea to the Persian Gulf, and from the Tigris to the frontiers of Afghanistan and Baluchistan, his journeys extending to quite ten thousand miles. The book about to appear will contain a record of his travels, with special reference to the geography and history of the country as well as to its commercial resources, the opening up of trade routes and the journeys of Alexander the Great and Marco Polo.

NEW editions of two volumes in the comprehensive series of manuals of science and technology published by the house of Ulrico Hoepli, Milan, have recently been received. One is the third edition, revised and enlarged, of "Magnetismo e Eletticit ," by Prof. F. Grassi. The book contains a good account of the principles of electricity and magnetism, and gives much more attention to the applications of these sciences than is usually the case in similar manuals. Another third edition is the "Manuale del Chimico e dell'Industriale," by Prof. L. Gabba. This volume consists of a valuable collection of tables of standards, physical and chemical data, analytical processes, and similar information of service in laboratories and assay offices.

THE additions to the Zoological Society's Gardens during the past week include a Greater Sulphur-crested Cockatoo (*Cacatua galerita*) from Australia, presented by Lady Stanley; a Scops Owl (*Scops giu*) European, presented by Miss G. Ashley Dodd; a Robben Island Snake (*Pseudaspis cana phocarum*) from South Africa, presented by Mr. T. E. Cartwright; an Antillean Boa (*Boa divinitioqua*) from the West Indies, presented by Mr. E. S. Graham; a Derbian Wallaby (*Macropus derbianus*), three Long-necked Chelodines (*Chelodina longicollis*), two Limbless Lizards (*Pygopus lepidopus*) from

Australia, twenty-one Giant Toads (*Bufo marinus*) from South America, three Spiny-tailed Iguanas (*Ctenosaura acanthura*) from Central America, a Dark Salamander (*Ambystoma tenebrosum*) from California, two Long-tailed Weaver-birds (*Chora progné*) from South Africa, a Starred Tortoise (*Testudo elegans*), three Bungoma River Turtle (*Emyda granosa*), a King-necked Parakeet (*Palaearis torquatus*) from India, deposited; and two Nykhaies (*Nesolaphus tragocamelus*, ♂ ♀), four Yellow-billed Liathrix (*Liathrix luteus*) from India, a Grison (*Galictis vittata*), a Condor Vulture (*Sarcorhamphus gryphus*, ♂), four Grey Teal (*Querquedula versicolor*, ♂ ♂ ♀ ♀) from South America, two Manchurian Crossoptilons (*Crossoptilon mantchuricum*, ♂ ♀), a Bar-thailed Phasian (*Phasianus reevesi*) from China, a Common Crowned Pigeon (*Goura coronata*) from New Guinea, two White-fronted Geese (*Anser albifrons*), four Bearded Tits (*Panurus biarmicus*), a Waxwing (*Amphelis garrulus*) European, purchased; five Indian Wild Swine (*Sus cristatus*) born in the Gardens.

OUR ASTRONOMICAL COLUMN.

SIGNALS FROM MARS.—In the *Proceedings* of the American Philosophical Society for December 1901 (vol. xl. No. 167), Mr. Percival Lowell refers at some length to the observations that led to the announcement in the Press that Mars had been signalling to the earth on a night in December 1900. It may be mentioned that the original despatch read as follows:—"Projection observed last night over Icarium Mare, lasting seventy minutes." (Signed) "Douglas." In the present paper Mr. Lowell describes in detail some of the individual observations, and points out how the Flagstaff observations of 1894 showed that on general principles the Martian projections were most probably not due to the existence of mountain peaks. A close study of the surface markings led both Messrs. Lowell and Douglas to the result that these several projections were not caused by such permanent surface markings as mountains, but were the effect of clouds floating in the planet's atmosphere. At the opposition of 1894 more than 400 projections were seen in the course of nine months, and since that time other observations have helped to show that the non-reappearances of these projections at such favourable times when, if they were mountains, they should have been seen, have proved their non-permanent character. In fact, permanences like mountains were found to do violence to the observations, and the alternative explanation chosen was something floating in the planet's atmosphere and capable of reflecting light, or, in other words, clouds. Mr. Lowell, in his concluding remarks, says that the surface marking, Icarium Mare, is undoubtedly a great tract of vegetation, and the observation of December is completely explained if it be assumed that a cloud was formed over this region and rose to a height of thirteen miles, and then, travelling east by north at about twenty-seven miles an hour, passed over the desert of Aeria and there was dissipated after an existence of three or four days. The Flagstaff observations thus tell us that mountains on Mars, if there be any, have still to be discovered.

THE ORION NEBULA AND MOVEMENT IN THE LINE OF SIGHT.—Prof. H. C. Vogel communicates to the *Sitzungsberichte der Kön. Preuss. Akad. der Wissenschaften zu Berlin*, March 13, an account of the results which he and Dr. Eberhard have obtained with reference to the measurements of the spectrum of the Orion nebula taken for the determination of motion in the line of sight. The instruments used were the photographic refractor of 32.5 cm. aperture and 3.4 metres focal length, and a spectroscope with three prisms, the latter being supplied with electrical heating for maintaining a constant temperature during the time of exposure; the comparison spectrum was that of iron in every case. The measurements of all the photographs were made by Prof. Vogel and Dr. Eberhard independently of each other, and the region of the nebula investigated was practically the same as that examined by Prof. Keeler in 1890 and 1891, so that a direct comparison with his results can be made. The following table shows the values of the velocities in kilometres per second relative to the sun obtained from measurements at different parts of the Hy line.

	Vogel. Km.	Eberhard. Km.
Position angle 90° from star θ Orion		
$\Delta = 0^{\circ}8$; beginning of Hy line	+16	+17
At θ	+16	+16
Position angle 270°; $\Delta = 0^{\circ}6$ most intense portion of Hy line	+12	+11
Position angle 270°; $\Delta = 1^{\circ}2$ to $1^{\circ}4$ near end of Hy line	+8	+12

The mean velocity relative to the sun obtained by Keeler, who used the I18 line, was $+177 \pm 1.28$ kilometres, a value not very much removed from the above-mentioned determination.

Another interesting point obtained from a close examination of the Hy line was the distinct irregularity or hump of this line in the nebula spectrum, and both Prof. Vogel's and Dr. Eberhard's measures give velocities relative to the sun of $+6$, $+28$, $+11$ and $+6$, $+41$, $+28$ respectively to three chosen points on this line. It is pointed out that the measurements were difficult, and on account of the faintness of the line probably not very accurate. Keeler, however, looked for relative motion in the nebula itself, and came to the result that from his observations there were shifts which indicated relative motion in the nebula amounting to 21 kilometres per second, and in the brightest part of the nebula shifts corresponding to a third of this amount were detected. It may be mentioned also that Sir Norman Lockyer, in his communication to the Royal Society (*Phil. Trans.*, 1895) on the spectrum of the Orion nebula, obtained evidence of internal motion in the nebula in the distortion of the lines 4471 and 4495. These lines were found to be sharply bent, whilst the others remained straight. Unfortunately, only one photograph was secured, and it was suggested that in the absence of others it was possible that this displacement might have been due to a distortion of the photographic film. There seems little doubt, therefore, that these deformations and anomalies of the Hy lines observed at Potsdam are real indications of relative motion in the nebula itself, and the values for the velocities given will perhaps be more accurately determined when further photographs have been secured and measured.

THE RELATIONS BETWEEN METALLURGY AND ENGINEERING.¹

THE lecturer stated that this was the subject with which the council had requested him to deal in his lecture, but it must not for a moment be imagined that the metallurgic art was not included in the wide range covered by the Institution, which had, from its earliest days, given prominence to the work of metallurgists. He quoted Mr. G. P. Bidder, who, in his presidential address to the Institution delivered in 1860, said "that if he were called upon to define the object and scope of the profession of civil engineer, he would say that it was 'to take up the results discovered by the abstract men of science and to apply them practically for the commercial advantage of the world at large, and to diffuse their beneficent influence among all classes of his fellow citizens.'" He hoped to be able to show that metallurgists practising an industrial art had helped the engineer to do this, and in evidence that such was the case, he quoted from the presidential address of Sir John Fowler, words to the effect that engineers had been more assisted by members of the Institution and by distinguished men of science generally in relation to iron and steel than as regarded any other material. It was in connection with iron and steel that the illustrations of the lecture would be mainly given. It might at first be thought that the relations between metallurgists and engineers, which had become so close and enduring, arose quite simply from common interest. The case was, however, far from being so simple; communication between those who extracted metals from their ores and adapted them for the use of the engineers, who actually employed metals in construction, was seldom, at the outset, quite direct. The relations with which the lecture dealt had been strangely stimulated by the intervention of men who, in many cases, were neither engineers nor metallurgists, but were men whose lives had been devoted to

¹ Abstract of the tenth "James Forrest" Lecture, delivered by Sir W. C. Roberts-Austen, K.C.B., F.R.S., at the Institution of Civil Engineers on April 22.

abstract science. Such men recognised the value of certain metals and alloys for definite uses, they investigated their mechanical properties, and proclaimed their merits to engineers. The intervener then disappeared, leaving behind some coefficient or constant bearing his name by which he was gratefully remembered. As an instance, Galileo's estimation of the tensile strength of copper cylinders, and Young's determination of the rigidity of steel (which had resulted in Young's modulus) were cited.

It was not easy to fix the period in industrial history at which the metallurgist began to give the engineer material assistance. If in this country Stonehenge were taken as a starting point, the architect-engineer who designed that crowning example of Neolithic art could not have received any assistance from the metallurgist. That stately structure arose from the plain at a time when bronze tools were known but were not in general use, and this period had recently been fixed by Mr. Gowland at about 2000 B.C. In another phase of engineering work it was known that Rome, in the days of her occupation of this country, trusted to the metallurgists of our island to supply the lead which was so extensively used in the Eternal City. The fourth-century wrought-iron column, discovered in India, and the girders and beams of the Orissa temples, rendered it necessary to exercise great caution as to the period at which iron was used in construction. Such magnificent efforts as those given were, however, not maintained, and no widespread or continuous records of the metallurgists' contributions to early constructive work could be presented. On the other hand, the civil engineer had, to quote the charter of the institution, "advanced mechanical science and directed the great sources of power in Nature for the use and convenience of man," for ages before the metallurgists rendered more than incidental service. As examples of great engineering works into the construction of which no metal entered, the lecturer referred to, and gave illustrations of, the primitive cantilever bridges of pine trees used to cross mountain torrents in Savoy. The interesting thirteenth century cantilever bridge made up of 20-foot beams given in the note-book of Villars de Honnecourt was also shown, as was a bascule bridge of the middle ages. The dome of Milan Cathedral, as designed by Leonardo da Vinci, the great Tuscan painter, engineer and architect, was also referred to as an example of a structure in which metal was not used. The employment of cast iron from the time of Queen Elizabeth to the present day was then dealt with, and the proposed cast-iron bridge of 600-foot single span, by Telford and Douglas, was referred to, and it was pointed out that in the nineteenth century metallurgists, by creating the age of steel, more than atoned for their somewhat tardy and intermittent efforts to supply engineers with suitable materials.

As regarded the use of cast iron and malleable iron, the influence of Watt in developing the steam-engine was traced, and it was admitted that the necessity for pumping water out of mines was the main factor in the evolution of the steam-engine, and, in turn, the development of British metallurgy of iron and steel dated from the time when the steam-engine of Watt enabled air to be readily pumped into the blast-furnace employed for the production of cast iron. It was then pointed out that more than half of the last century had elapsed before the "age of steel" began, and that towards the end of the century great attention was devoted to considerations connected with the molecular structure and properties of steel, and to enforcing the action of carbon, the element which gave steel its properties, by the addition of other elements than carbon in very small proportions. With regard to the slow growth of confidence in the qualities of steel, the opinion of successive presidents of the Institution, as expressed in their addresses, was quoted; Sir John Hawkshaw, Sir John Fowler, Sir Frederick Bramwell, Mr. W. H. Barlow, Lord Armstrong and Sir George Bruce being specially alluded to. In 1837, when Sir George Bruce delivered his address, the merits of steel had at last received recognition, and, as regards the crowning triumph of the age of steel—the Forth Bridge—Sir George exultingly exclaimed:—"At the Menai Bridge, the total quantity of iron was 11,468 tons; at the Forth Bridge, there will be 50,000 tons of steel and iron." No one had done more than Sir Benjamin Baker to insist on the importance of phenomena which engineers used to consider "mysterious" in connection with the behaviour of steel, and his warnings and example were at last being regarded and followed. The lecturer pointed out that when metallurgists gave engineers mild steel, they provided a

cinder-free solid solution of iron and carbon. All subsequent advance had been due to the recognition of this fact, and to the gradual studies of the properties of metallic solid solutions. Sir John Hawkshaw, in his presidential address to the Institution, delivered in 1862, had said that if the strength of iron could be doubled, the advantages might be equal to the discovery of a new metal more valuable than iron had ever been. The lecturer contended that this was exactly what metallurgists had done with regard to steel. By suitable thermal treatment, and by suitable additions of comparatively rare metals, they had doubled the strength of steel as it was known in its early days. The nature of solid solutions was then explained, and the importance of allotropic modifications of iron was dwelt upon, this portion of the subject being illustrated by some difficult experiments. The question was then asked, could the past molecular history of a mass of steel be traced by microscopic examination of the solid metal? Some very beautiful experiments by M. Osmond, Mr. Stead, and others, were appealed to in evidence of the possibility of this. It was then demonstrated that solid metals might even reveal, by their structure, the vibrations to which they had been subjected, and Sir Benjamin Baker had constantly insisted on the importance of such vibrations. In making this clear, Vincent's experiments on the beautiful wave-structure that might be imparted to the surface of mercury by the aid of a vibrating tuning fork were then exhibited, and it was demonstrated that the surface of solid lead which had been subjected to similar vibrations possessed a similar structure to the vibrating surface of mercury.

Finally, with regard to the efforts metallurgists were making to study the influence of rare metals on iron and other metals, the reducing power of aluminium on metallic oxides was shown. Very high temperatures of 3000° C. and above were attained, and brilliant light was produced during the reduction of chromium, cobalt, nickel and other metals from their oxides.

In conclusion, the lecturer appealed to the new Alexander III. Bridge at Paris as showing the need for the careful measurement of high temperatures in connection with the treatment of large masses of steel. In the construction of the bridge, 2200 tons of cast steel had been employed, and a peculiar molecular structure was imparted to the steel by rapidly cooling it in air from a temperature of 1000° C. to 600° C.; this gave the metal certain mechanical properties which it would not otherwise have possessed. With reference to the aid given by metallurgists to engineers in connection with ordnance, reference was made to the address delivered by Mr. T. Hawksley, the father of the president, in 1872. He said that "In no way" other than by the study of such questions "could the Institution" of Civil Engineers "serve its country better, or better promote, in the interests of peace, the advancement of practical Science, and its application, if events should order, to the purposes of protective warfare." The use of copper, aluminium and other metals in electrical engineering was referred to, and the lecture ended with an appeal for the more extended study of the physical properties of metals.

THE GLACIERS OF KANGCHENJUNGA.

MR. DOUGLAS W. FRESHFIELD publishes, in the April number of the *Geographical Journal*, an account of his expedition to Kangchenjunga during the autumn of 1899. The Kangchenjunga group is cut off from the mountains of Nepal by the Khosi Valley on the west, and from the mountains of Bhutan by the Teesta Valley on the east. By crossing the lofty spur which unites it to the Tibetan highlands, it is just possible to get round the mountain without trenching on territory officially recognised as Tibetan. Mr. Freshfield's object was to make this high-level tour round Kangchenjunga, passing as near as possible to the great mountain, and, further, to obtain some accurate idea of the glacial features of the group. Progress was greatly interfered with during the earlier part of the journey by the storm which caused so much damage at Darjiling and by the lowering of the snow-line which resulted from it; but the tour was successfully accomplished, and from the head of the valley of the Kangchen, in Nepal, Europeans looked for the first time on the north-west face of Kangchenjunga, "not a sheer cliff like the three other aspects of the peak," but a superb pile of rock battresses, terraces of snow and staircases of ice, through whose labyrinthine complexities the future conquerors of the mountain will have to find the least hazardous way to the

summit." Concerning the Kangchenjunga glaciers, Mr. Freshfield says, "Four glaciers radiate from the peak, pointing roughly to the north-east, south-east, north-west and south-west. Those are the Jemu Glacier, eighteen miles long, and the Talung Glacier, both draining to the Teesta, the Kangchen Glacier, fifteen miles long, and Yalung Glacier, both draining to the Arun and the Khosi. The forked spurs that protrude south and west from Kangchenjunga, dominated respectively by Kabru and Jannu, enclose in the first case the Alukthang glaciers, united not long ago in a single stream and now divided by little more than their moraines, and the southern glaciers of Kabru, which fall into a separate glen; in the second case, three considerable ice-streams, one of which almost meets the Kangchen Glacier at its lower extremity, the second builds across the valley, out of the rockfalls of the tremendous cliffs of Jannu which encompass its source, a remarkable wall of moraine stuff, similar to those of the Allalein, or the Brenva in the Alps,

and extent of the cliffs surrounding the head of the glacier. The glacier is now in retreat; the ice has sunk somewhat and the lateral moraines appear above it.

UNIVERSITY AND EDUCATIONAL INTELLIGENCE.

THE installation of the Prince of Wales as Chancellor of the University of Wales will take place at the University College, Bangor, on May 9.

LORD ROSEBERY has been formally nominated as Chancellor of the University of London, in succession to the late Lord Kimberley. As no other nomination has been made, he will be elected by Convocation at the meeting to be held on May 13.

THE London School Board, and the School Boards of most large towns, have for some years provided special schools where



FIG. 1.—Kambachen in Nepal, with Jannu and the Dyke of the Jannu Glacier. (From the *Geographical Journal*.)

while a third fills a glen the stream from which joins the Kangchen torrent at Khunza."

Mr. Freshfield was accompanied by Prof. Garwood, Signor Vittorio Sella and his brother, and Mr. Dover, now road inspector at Sikhim, with an Alpine guide. Prof. Garwood devoted much labour to the compilation of a photo-topographic map of the region, which is to be published in an early number of the *Geographical Journal*, and is described by Mr. Freshfield as a "specimen of the right method to delineate glaciers." The paper is illustrated by a number of photographs taken by Prof. Garwood and Signor Sella. The specimen we reproduce represents Jannu and the dyke of the Jannu Glacier as seen from Kambachen. The ice crosses the valley at right-angles, over a great dyke of moraine debris, and the torrent from the higher valleys is squeezed against the western hill. There was at one time a lake above the moraine dyke. The cause of the exceptionally large amount of moraine material is the great height

their pupil teachers receive instruction at specified times. It has now been decided that these schools are illegal. Mr. Cockerton, the Local Government auditor, has formally notified the London School Board that it has no authority in law to spend the rates in providing and maintaining special schools for the instruction of pupil teachers.

IN the House of Lords on Monday, in reply to a question by Lord Reay, referring to the new Regulations for Evening Schools, the Duke of Devonshire said:—"It is intended that all local expenditure—by which is meant expenditure on evening schools other than that which is provided by Government grants—shall in future be provided by local authorities under the Technical Instruction Acts. As to whether the funds at the disposal of the local authorities will be sufficient for that purpose, the existing local authorities under the Technical Instruction Acts have by no means exhausted the funds at their disposal

which are applicable to the purposes of education. It is probable, however, that the responsibility for the whole of the evening school work, as contemplated by the regulations of the Board of Education for last year and this year, may involve them in an expenditure which their present resources are unable to meet. The Bill now before Parliament provides additional and, we believe, ample resources for all parts of the country except London. The present policy of the Board of Education is that evening schools, the great majority of which are intended for persons older than children, shall be provided and maintained by the local authorities for secondary education and receive grants under the regulations of the Board relating to secondary education."

SIR JOHN GORST spoke at Bradford on Saturday last upon the subject of the Education Bill of the Government. His remarks were aimed chiefly at the justification of the Government in making County and Borough Councils the local authorities for education. The necessity for this one authority in a particular sphere of influence has been almost universally accepted, but the difficulty is to determine the constitution of the body. Proceeding to describe the present position, Sir John Gorst said that the councils which are entrusted with technical instruction are entirely independent of central control. The consequence is that technical instruction as it is now carried out in this country is practically the entire creation of that new authority with very little assistance or direction from anybody. The councils are not bound to use the whisky money for technical instruction. They might have applied it to the relief of local rates, but in the last year for which statistics are available the total amount of the whisky money was 981,000*l.*, and of that sum 901,000*l.* was voluntarily devoted by the councils to technical instruction and only 80,000*l.* went to the relief of rates. Sir John Gorst remarked that the Duke of Devonshire and he selected the councils as the local authority rather than the School Boards, because a body which represented the ratepayers could not be a real local authority unless it had the absolute command of local finances, and if they had any other body levying rates without the consent of the body which properly represented the ratepayers they weakened the authority of the principal body and prevented it from gaining that proper influence over local affairs, expenditure and management which was essential to a properly constituted authority. A further question was whether the local authority was to be independent or to be tied down by the provisions of the statute. The effect of the working of the Technical Instruction Act was such as to be in favour of leaving these great local authorities to themselves. He preferred to trust them and give them ample powers, and leave them to exercise those powers for the benefit of the people whom they represented.

THE remarks made by Mr. Balfour at the Mansion House on April 23 upon the subject of commercial education are referred to in an article on the University of London which appears in another part of this issue. In the course of his address, Mr. Balfour said: "I would impress the doctrine, that important, necessary and essential as that narrow, technical training may be, we are ill learning the lesson of education which is now being taught us by other nations if we do not recognise that something more in the nature of general training and culture is absolutely necessary if we are to maintain the place so hardily won and so proudly maintained among the nations of the world. If commerce is to be treated as a subject of scientific study, it must not be approached simply in the spirit of those who desire to obtain a mastery of one particular instrument, one particular language, one particular form of knowledge, but must be approached, as all knowledge worthy the name should be approached, in the broader spirit of impartial scientific investigation. I do not think that higher praise can be given to the work in which Sir Albert Rollit and his colleagues are engaged than to say of it that, not merely have they given opportunities which would otherwise have been withheld to many persons in our community to learn the arts necessary for their work and success in life, but that they have also, and in addition to that merely technical training, in many cases laid the foundations on which may be built that solid and scientific knowledge of the commercial and economical forces of our time which are absolutely essential, as I think, to the proper conduct of the affairs of a great commercial country." Commercial education is so often understood to mean training in office routine that Mr. Balfour's statement as to what the term should imply ought to be widely

known. All commercial and technical education of value must be founded upon sound primary and secondary education, and must be studied, not so much with the view of acquiring facility in carrying out the present duties of the office and workshop as with the intention to discover new methods and new processes. As with the individual, the nation that rests content with its achievements must eventually fall behind others which aim at obtaining and using new knowledge. It is in this spirit that commercial education must be viewed in order that it may assist national progress.

SCIENTIFIC SERIAL.

In the *Journal of Botany* for April, H. W. Pugsley gives the first part of an article on the "British Capreolate Fumitories." Messrs. David Prain and Edmund Baker complete their "Notes on Indigofera." The various forms that have been included in the species *Indigofera tinctoria*, L., and *Indigofera Anil*, L., receive the fullest treatment, and the authors come to the following conclusions:—1. *tinctoria*, L., has been applied to three forms: (1) the wild form, which is probably indigenous to Africa; (2) the variety of the previous one, cultivated in southern India, at the present day more especially in Madras; (3) the plant cultivated in northern India, known as "Nil"; the differences between this and the other cultivated variety are so pronounced and constant that it seems justifiable to separate it off, when it becomes *I. sumatrana*, Gaertner. The specific name Anil, also given by Linnaeus, is connected with the Egyptian vernacular word "Nil," which indicates any species that supplies the Indigo dye. In Egypt "Nil" would refer to *I. articulata*, Gouan, in India to *I. tinctoria*, L., while, in neither of these countries would it include *I. Anil*, L., which will not grow in Egypt and does not find favour in southern India. De Candolle instituted three varieties of *I. Anil*, L., of which two call for comment. Var. *oligophylla* is the same plant as *I. truxillensis*, H.B.K., which was probably cultivated in the West Indies in the time of Hans Sloane. Var. *B. polyphylla* is the plant now cultivated in the West Indies and other parts of the New World. This is the true *I. Anil*, L., but to avoid any confusion which may arise from the use of that specific name, it is suggested that it should be established, under another synonym, as *I. suffruticosa*, Miller. Arthur Bennett continues his "Notes on Puffmottogon," and deals with some foreign species from Australia, America and Japan. The most interesting of four new British Hepaticae described by S. M. Macvicar is *Aneura incurvata*. It comes near to *A. multifida* and *A. stnuata*. It may be expected to be recorded again, as it has been found in Austria, Germany and Scandinavia.

SOCIETIES AND ACADEMIES.

LONDON.

Physical Society, April 25.—Prof. S. P. Thompson, president, in the chair.—Dr. Dawson Turner exhibited and described a mechanical break for induction-coils. The use of induction-coils in the production of Röntgen rays and in wireless telegraphy has made the construction of a suitable break a matter of importance. The ordinary break is unsuitable because of the wearing away at the point of contact, and there are objections to the use of mercurial breaks. The portable mechanical break which was shown by Dr. Dawson Turner consists of two metallic rollers with their axes parallel and kept in contact by a spring. One of the rollers has a cam attached to its spindle, and can be made to rotate by means of a small electric motor. Once in each revolution the cam separates the rollers, thus making the break, and at the same time causing the second roller, which rides loose upon its axis, to turn about one-eighth of a revolution. As soon as the cam has passed, the rollers are brought into contact by the spring, and the next break occurs at a different place. The wearing is thus distributed evenly over a large surface. The break is placed in a box containing alcohol or petroleum, and works best when rotating rapidly. An objection to the arrangement is the noise it makes when working. Some experiments were then shown on the discharge of electrified bodies by ultra-violet light. A disadvantage of the electric arc when used to furnish ultra-violet light for use in medicine

is that the light is accompanied by heat, so that it is necessary to shield the patient from the heat without interfering with the passage of the light. A condenser spark between iron electrodes is useful because it gives a large amount of ultra-violet radiation without much heat. Dr. Turner showed that this light is capable of discharging bodies whether positively or negatively electrified. He then showed that glass and mica are opaque to the radiation while pure rock salt is transparent.—Mr. Wilson Noble exhibited a mechanical break similar to the one already shown. A roller and a disc, with their axes parallel, are placed in contact and made to rotate in the same direction by a motor. Longitudinal slots are cut upon the surfaces of both, and the break occurs when a slot in the roller comes opposite a slot in the disc. Since the two are moving in opposite directions at their point of contact the break is very sudden. To vary the length of the break without altering the rate of rotation, the slot in the roller is wider at one end than the other, and the disc can be placed so as to touch the roller at any point of its length.—Mr. R. S. Whipple exhibited a temperature indicator for use with platinum thermometers, in which readings are automatically reduced to the gas scale. The instrument is very similar to the well-known Callendar and Griffiths' temperature indicator, with the exception that it is so arranged that the readings obtained are automatically reduced to the gas scale, thus avoiding the necessity of applying a correction. It consists of a simple Wheatstone's bridge with equal ratio arms, the other arms being the thermometer and a long helical bridge wire together with the compensating leads. A travelling contact is moved round the wire until a balance is obtained. The bridge wire is wound on an ebonite drum on the outer surface of which a helix has been cut. The contact piece, which is connected electrically with the galvanometer, is carried from the inside of a cylinder fixed to a shaft. A white celluloid tube on which the scale is divided is fixed to the outer surface of the cylinder. A screw of the same pitch as the helix on the ebonite drum is cut on the shaft, so that by rotating the shaft the contact is caused to travel along the bridge wire, and at the same time the scale is carried past an index placed above it. The scale has been so constructed that the reading at the index gives directly the temperature of the thermometer reduced to the gas scale. The instrument reads from 0° to 1400° C.—Mr. S. A. F. White read a note on the compound pendulum. In the determination of the length of the equivalent simple pendulum for a compound pendulum the form of which is a symmetrical bar and bob with one fixed, one movable knife-edge and no sliding weight it is convenient to make the mass of the movable knife-edge small. In this case, small displacements of this knife-edge will not materially alter the position of the centre of gravity or radius of gyration of the pendulum about an axis through its centre of gravity. The time of swing about the fixed knife-edge will therefore remain practically constant. The best determination of the correct position of the movable knife-edge for an equal time of oscillation will be given when for the smallest displacement of this knife-edge there is the greatest variation in the time of oscillation about it. The author has determined the position which makes $\frac{dt}{dh}$ a maximum, h being the distance of the axis of suspension from the centre of gravity. He has also drawn the curve showing the relation between $\frac{dt}{dh}$ and h . The calculations have then been applied to the determination of the position of the movable knife-edge in a particular pendulum. The experimental value of the ratio of h to k deduced from this pendulum when the movable knife-edge is adjusted to its right position agrees well with that predicted by the theory. The author states that when the length of the equivalent simple pendulum is about a metre, it should be possible with a stop-watch reading to 0.2 second to determine " g " to about 1 or 2 per cent. If the fixed knife-edge were made the movable knife-edge, the value of $\frac{dt}{dh}$ would be very large, but there would be difficulties in the way of measuring the small time of swing and the small equivalent length.

Chemical Society, April 17.—Prof. Tilden, F.R.S., in the chair.—Dimercurammonium nitrite and its haloid derivatives, by Dr. P. C. Ráy. This salt was prepared by the addition of aqueous ammonia to a solution of sodio-mercuric nitrite. On solution in hydrochloric acid the new compound furnishes a

mercuric ammonium chloride of the formula $2\text{HgCl}_2 \cdot \text{NH}_4\text{Cl}$, and with hydrobromic acid the corresponding bromide. These salts in turn, with sufficient potash, furnish respectively the chloride and bromide of dimercurammonium. The author's observations on these substances support the Rammelsberg-Pesci representation of the general structure of ammoniated-mercury salts.—Preparation and properties of 4-isopropyl-dihydroresorcinol, by Dr. Crossley. A correction in the nomenclature of this substance is made from 2:6-diketo-4-isopropylhexamethylene to that given above, since further investigation has shown that its usual structure is thereby better indicated.—Oxonium salts of fluoran and its derivatives, by Dr. Hewitt and Mr. Tervet. The authors have observed that fluoran and substances related to it, such as fluorescein, form salts with mineral acids, and of these the nitrate and sulphate of fluoran, chloride and sulphate of fluorescein and others have been prepared, analysed and described.—Influence of substitutions on the reactivity of the aromatic diamines, by Dr. G. S. Morgan. The author has studied particularly the influence exerted by the introduction of alkyl groups in various positions into the molecule of aromatic diamines on the reactivity of these substances with methylating agents.—The influence of certain acidic oxides on the specific rotations of lactic acid and potassium lactate, by Drs. Henderson and Prentice. It was found that antimonious oxide exerts no action on lactic acid and its potassium salt, and consequently has no influence of their rotations in solution. On the other hand, arsenious and boron oxides produce a change in the rotation of these substances which is greatest when they are present in quantity sufficient to form with the potassium salt compounds of the formulæ $(\text{AsO}) \text{C}_2\text{H}_3\text{O}_2\text{K}$ and $(\text{BO}) \text{C}_2\text{H}_3\text{O}_2\text{K}$ respectively.—The amounts of "ammonia" and "nitric" nitrogen and of chlorine in rain water collected at Rothamsted, by Dr. Miller. This paper gives the amounts of ammonia, nitrates and chlorine contained in Rothamsted rain water for each month from September 1888 to August 1901. The results show that the total nitrogen available to the soil from this source varied during this period from 3.31 to 4.43 lb. per acre per annum, the average being 3.84 lb., of which 1.8 lb. is secured during the winter and 2.03 lb. during the summer months. Of this total nitrogen, 70 per cent. is present as ammonia and 30 per cent. in the more easily available form of nitrates. Chlorine, on the other hand, is found in greatest quantity during the winter, the average content per annum for the period being 14.87 lb., of which 10.12 lb. is obtained during the winter season.—The amounts of nitrogen as nitrates and chlorine in the drainage through uncropped and unmanured land, by Dr. Miller. During the last twenty-four years—September 1877 to August 1901—the loss of nitrates in drainage water has been systematically investigated at Rothamsted, and this paper gives the results obtained. The average loss of nitrogen in this way amounts to 30 lb. per annum per acre, but varies greatly with the amount of rain and distribution of drainage. There appears to be also a considerable loss of lime. The average yearly amount of chlorine per acre in the drainage is about the same as that found in the rain, but wide differences occur occasionally. Drain gauges at a depth of 20 inches have during the last twenty-four years received on an average 7 lb. more chlorine than they have lost in drainage; the values for the 40-inch gauge are 17.5 lb. lost and 31.9 lb. received.—Benzylidene-camphoroxime, by Dr. M. O. Forster. The method of preparation, properties and behaviour towards reagents of this substance have been studied as part of a proposed systematic examination of substituted camphoroximes.

Linnean Society, April 3.—Prof. S. H. Vines, F.R.S., president, in the chair.—Mr. R. Morton Middleton exhibited two letters from Linneus to Dr. David van Royen and Mr. Richard Warner, of Woodford, dated respectively April 18, 1769, and September 29, 1758, and also a letter from Sir J. E. Smith to N. Wallich on Nepalese plants, written in 1819.—Mr. R. A. Rolfe, on behalf of the Director, Royal Gardens, Kew, exhibited a series of specimens of *Fuchsia aquatica*, Aubl., and *F. insignis*, Savigny, from British Guiana, collected by the late G. S. Jenman, Government botanist, to illustrate the great variation which exists in the size and shape of the fruits. There was also a certain amount of variation in the leaves and flowers, though in the latter each species retained its own essential character. These trees were common over the great alluvial forest-region, extending also to Brazil, and were commonly cultivated for ornament.—On behalf of Mr. W. B. Hemslay,

F.R.S., Mr. Rolfe also exhibited some specimens illustrating the precocious germination of the seeds of a species of *Dracena*. Germination had taken place through the pericarp while the berries were still hanging on the plant.—Mr. Spencer Moore read a paper entitled "A Contribution to the Composite Flora of Africa," in which he described a number of new species in the Herbarium of the British Museum. He found that the north-eastern tropics, especially British East Africa and the neighbouring parts of Somaliland and Southern Abyssinia, had yielded most of the novelties.—Prof. F. E. Weiss read a paper, illustrated by lantern-slides, on a biserial halonial branch of *Lepidophlois fuliginosus*. The branch in question, about 7 in. in length, was found in a large nodule by Mr. George Wilde at Haugh Hill, near Stalybridge. Dr. Scott, in a preliminary communication to the British Association in 1898, had identified it with the plant described by Williamson as *Lepidodendron fuliginosum*, now generally included in the genus *Lepidophlois*. Prof. Weiss supported this identification, and brought forward several instances of halonial branches of *Lepidophlois* which possessed only two rows of tubercles, instead of the more usual quincuncial arrangement of the tubercles. The specimen referred to, and of which photographs were shown, were from the British and Manchester Museums, and instances were also cited from Williamson's published memoirs. The second part of the paper consisted of a detailed account of the anatomy of this well-preserved specimen, which went to confirm Dr. Scott's previous identification of it.

Geological Society, March 26.—Prof. Charles Lapworth, F.R.S., president, in the chair.—On a remarkable inlier among the Jurassic rocks of Sutherland and its bearing on the origin of the breccia-beds, by the Rev. J. F. Blake. On the coast of Sutherland due south of Port George is seen on the scars at low water a long rocky crest of Old Red Sandstone, with its flaggy beds dipping at a high angle. It is of considerable height, and is surrounded by nearly horizontal Jurassic beds containing large blocks of rocks similar to those of the crest, irregularly placed. The size, outline and relation to the surrounding rocks show that this cannot be a transported block, but must have been part of, or directly derived from, a neighbouring coast—like the modern sea-stacks of the present coast at Duncansby. From considerations of the character and distribution of the breccia-beds, it is concluded that they are the product of an ice-foot of Upper Jurassic age, which invaded the normal deposits of that period.—On a deep boring at Lyme Regis, by Mr. A. J. Jukes-Browne. During 1901 a boring was made near Lyme Regis in search of coal, and was carried to the depth of 1300 feet without reaching the base of the Upper Triassic Marls. The beds passed through were compared with those exposed along the cliffs from Lyme to Sidmouth. The author concludes that the boring did not reach the beds which near Sidmouth form a passage from the Keuper Marls to the Keuper Sandstones, and that the Keuper Marls proved by the boring are at least 1130 feet, and may amount to 1200 feet in thickness.

MANCHESTER.

Literary and Philosophical Society, April 15.—Mr. Charles Bailey, president, in the chair.—Dr. Henry Wilde, F.R.S., read a paper on the atomic weights and classification of the elementary gases, neon, argon, krypton and xenon. The recent determinations of the densities of the new gases by Prof. Ramsay and Dr. Travers prove conclusively that they belong to the seventh series of elements in Dr. Wilde's table, which includes nitrogen and the comparatively inert groups of the platinum metals. Within the limits of experimental error and residual interferences, all the members of this series are multiples of seven.—A paper on the hypnotic influence of prolonged vision of persistent motion and sparkling objects, by Mr. Thomas Kay, was read.—Mr. F. J. Faraday exhibited an old copy of Chateaubriand's "Atala," partly written in the huts of the American Indians in Louisiana and Florida during the author's first visit to the New World in 1789, and containing passages showing the continued existence amongst the Red Indians at the end of the eighteenth century of some of the religious beliefs and practices referred to in Mr. J. E. King's recent paper on the metempsychosis of the souls of infants, the exhuming of the bones of members of the family from the temporary village grave for reburial in a common national grave on the occasion of the "Feast of the Dead," or the "Feast of Souls," and the transporting of the bones of dead relatives

during migration.—Prof. F. E. Weiss exhibited a specimen of *Welwitschia mirabilis*. This curious plant was discovered by Dr. Welwitsch in 1860 in the south-west of Africa, where it grows in very arid regions, rooted by a very long tap root. The upper part of the plant is protected by a very thick mantle of cork. It only possesses two leaves, which last throughout the life of a plant, being constantly renewed from the base, which lies protected in a groove of the stem. *Welwitschia* was first described by Sir Joseph Hooker, who considered it as belonging to the group of Gnetaeae allied to the Conifers.

PARIS.

Academy of Sciences, April 21.—M. Bouquet de la Grye in the chair.—On some phenomena of voltaic polarisation, by M. Berthelot. Experiments on the polarisation effects of liquid cells, both with and without the addition of reducing agents.—On the methods of proving the electrolytic action of a battery, by M. Berthelot. An examination of the conditions under which the smallest possible quantity of gas set free in an electrolytic cell can be observed, together with some experiments in which formol instead of pyrogallol was used as the reducing agent.—On Abelian functions with complex multiplication, by M. G. Humbert.—The resistance due to companion waves, by M. de Bussy. The proportionality between the height of the companion waves and the square of the velocity of the vessel producing them was proved by three sets of experiments, on a model 1/16th natural scale, on the vessels *Gaichen* and the American cruiser *Columbia*.—On Daniellia and their secreting apparatus, by M. L. Guignard. The existence of a secreting system distributed through the whole thickness of the wood is a characteristic feature of the Daniellia; with the *Copaifera* and the *Eperua* of tropical America, these are the only leguminous plants known possessing intraligular secreting apparatus.—New observations on the fossil flora of the basin of Kousnetz (Siberia), by M. R. Zeiller. The Permian flora of Siberia appear to be closely allied, at all events in the cases of the most abundant and characteristic species, with the normal Permian flora of Europe and North America, from which they are distinguished only by the presence of some particular types.—Observations of the sun, made at the Observatory of Lyons with the Brunner 16 cm. equatorial, during the third quarter of 1901, by M. J. Guillaume. The results are expressed in three tables, showing the number of spots, their distribution in latitude and the distribution of the faculae in latitude respectively.—On the continuous deformation of surfaces, by M. G. Tzitzica.—The laws of deformation, the principles of calculation, and rules for the scientific employment of mortars, by M. Rabut. It is shown that the mortar described is altered in shape when fired according to simple and precise laws, easily explained from the properties of the material. The laws resulting from these principles are in agreement with the methods of construction in practical use.—On a new method for the optical measurement of thickness, by M. Macé de Lépinay. A sketch of a new method is given which possesses the advantages of requiring no other reflecting surfaces than those of the plate studied, and of permitting exact measurements to be made even if the plate is not quite perfect from the point of view of homogeneity or parallelism of its surfaces.—On the absorption of radioactivity by liquids, by M. Th. Tommasina. Preliminary measurements of the absorptive power of various organic liquids for the radiation from radioactive substances are given.—On the formation of negative images by the action of certain vapours, by M. P. Vignon (see p. 13).—On a case of molecular rupture by bromine, by M. R. Fosse. In the reaction between naphthylol-dinaphthoxythione and bromine, instead of the expected substitution by the halogen, a molecule of bromine is added on as with an unsaturated body, the trinaphthyl-methane molecule being then split up into a bromo-naphthol and bromo-methan-1-naphthol-2.—On some derivatives of fumaric aldehyde, by M. R. Marquis. The acetin of nitrosuccinic aldehyde, the preparation of which is described in a previous paper, is decomposed by dilute acetic acid at 80° C. with formation of fumaric aldehyde, H.CO.CH=CH.CHO, the phenylhydrazone and oxime of which are described.—The transformation of new into stale bread, by M. L. Lindet. The amount of soluble dextrins in the crumb of bread as it leaves the oven amounts to more than 10 per cent. of the dry weight; this amount was found to decrease steadily on standing, until after four days there is only 2 per cent. The only alteration undergone by the crust is in the amount of water it contains.—On

the Fecampia, endoparasitic turtellaria, by MM. M. Cauley and F. Mesnil. The embryogeny of Fecampia is, on broad lines, similar to those described by Mechnikoff, Hallez and Jijima for certain Tricladæ and Rhabdoceæ.—On a new type of Rhizocephalus, a parasite of the Alpheide, by M. H. Coutière.—Pathogenic and teratogenic actions, by M. Etienne Rabaud.—Some new attempts at experimental parthenogenesis in Amphibians, by M. E. Bataillon.—On the primitive form of crystallised bodies, by M. F. Wallerant.—On the geological constitution of the western Maroc, by M. S. Brives.—The recent discoveries of the Prince of Monaco at Baoussé-Roussé. A new type of human fossil, by M. R. Verneau. The cave known as the *Grotte des Enfants* has already yielded such valuable results in the hands of M. Rivière that the Prince of Monaco resolved to continue its exploration methodically. The most important result up to the present has been the discovery, at the depth of 7.75 metres, of a human skeleton of a new type, apparently negroid, for which the name of the Grimaldi type is suggested.—Researches on the experimental production of parasitic races of plants by harmful bacteria, by M. L. Lepoutre. Three abundant species of bacteria were studied—*B. fluorescens*, *B. myxoides* and *B. mesentericus vulgatus*—and attempts were made to infect the tubercles of potato plants grown under varying conditions.

DIARY OF SOCIETIES.

THURSDAY, MAY 1.

- ROYAL SOCIETY, at 4.30.—Coefficients of the Cubical Expansion of Ice, Hydrated Salts, Solid Carbonic Acid, and other Substances at Low Temperatures: Prof. J. Dewar, F.R.S.—The Conditions determinative of Chemical Change and of Electrical Conduction in Gases, and of the Phenomena of Luminosity: Prof. H. E. Armstrong, F.R.S.—Contributions to a Theory of the Capillary Electrometer. I. The Insulation-Resistance of the Capillary Electrometer, and the Minimum Quantity of Electricity required to produce a Visible Excursion: G. J. Burck, F.R.S.
- ROYAL INSTITUTION, at 3.—Recent Geological Discoveries: Dr. A. Smith Woodward, F.R.S.
- LINNEAN SOCIETY, at 8.—(1) On the Mammalian Elephanth with special reference to the Lemurs; (2) On the Brain of the Cerebellum Shrew, *Macroscelides prosochides*: Dr. Elliot Smith.—On the Early Condition of the Shoulder-Girdle in the Polyprotodont Marsupials, *Dasyurus* and *Perameles*: Dr. R. Brown.
- INSTITUTION OF ELECTRICAL ENGINEERS, at 8.—Automatic Relay Translation for Long Submarine Cables: S. G. Brown.
- RÖNTGEN SOCIETY, at 8.30.—The Relation between X-Rays and allied Phenomena in Light and Electricity: Ernest Payne. (Discussion.)

FRIDAY, MAY 2.

- ROYAL INSTITUTION, at 9.—Experimental Researches on the Constitution of Crystals: A. E. Tutton, F.R.S.

MONDAY, MAY 5.

- SOCIETY OF CHEMICAL INDUSTRY, at 8.—On the mixed Carbides of Manganese and Calcium: J. S. Brame and Prof. Vivian B. Lewis.—Dangerous Chemical Substances: Oscar Guttman.
- SOCIETY OF ARTS, at 8.—Glass for Optical Instruments: Dr. R. T. Glazebrook, F.R.S.
- VICTORIA INSTITUTE, at 4.30.—Procopius's African Monument of Joshua's Conquest of Canaan: Martin L. Rouse.

TUESDAY, MAY 6.

- ZOOLOGICAL SOCIETY, at 8.30.—On the Mammals collected during the Whitaker Expedition to Tripoli: Oldfield Thomas, F.R.S.—The Wild Sheep of the Upper Hi Valley: R. Lydecker, F.R.S.—A List of the Fishes, Batrachians and Reptiles collected by Mr. J. Silliott Darling in Mashonaland, with Descriptions of new Species: G. A. Boulenger, F.R.S.
- SOCIETY OF ARTS, at 8.—The Printing of Modern Illustrated or Decorated Books: C. T. Jacobi.

WEDNESDAY, MAY 7.

- ENTOMOLOGICAL SOCIETY, at 8.—On a new Cricket of Aquatic habits, found in Fiji by Prof. Gustave Gilson: Prof. L. C. Miall, F.R.S., and Prof. G. Gilson.—On the Lepidoptera of the Chatham Islands: Edward Meyrick.—On Asymmetry in the Males of Hemarid and other Spingies: Dr. T. A. Chapman.
- SOCIETY OF PUBLIC ANALYSTS, at 8.
- IRON AND STEEL INSTITUTE, at 10.30 a.m.—Report of Council.—The Bessemer Gird Medal for 1902 will be presented to his Excellency F. A. Krupp, of Essen.—A selection of the following papers will be read and discussed:—Report by the Committee appointed to investigate the Nomenclature of Metallurgy.—On a New Vacuum Tuyere for Blast Furnaces: H. Allen.—On the Microstructure of Hardened Steel: Prof. J. O. Arnold and A. McWilliam.—On the Compression of Fuel before Coking: J. H. Darby.—On Gas from Wood for use in the Manufacture of Steel: J. Douglas.—On a combined Blast-Furnace and Open-Hearth

Process: P. Eyermann.—On the Physical and Chemical properties of Carbon in the Hearth of the Blast-Furnace: W. J. Foster.—On the Sulphur contents of Slags and other Metallurgical Products: Baron H. von Juptner.—On the Elimination of Silicon in the Acid Open-Hearth Furnace: A. McWilliam and W. H. Hatfield.—Report on Research Work carried out during the past year: J. A. Mathews.—On the Iron Ore of Brazil: H. Kiburn Scott.—On the Recovery of By-products in Coking: J. Thiry.—On Brinell's researches on the influence of Chemical composition on the soundness of Steel Ingots: Axel Wahlberg.

AUSTRALIAN CHAMBER OF COMMERCE (Australian Club), at 4.—The Coal Resources of Australia: James Stirling.

SOCIETY OF ARTS, at 8.—Origin and History of Carriages: A. Chancellor.

THURSDAY, MAY 8.

- IRON AND STEEL INSTITUTE, at 10.30 a.m.—A Selection of Papers from the list given under May 7 will be read and discussed.
- ROYAL INSTITUTION, at 3.—Recent Geological Discoveries: Dr. A. Smith Woodward, F.R.S.
- SOCIETY OF ARTS (Lectian Section), at 4.30.—The Past and Present Connection of England with the Persian Gulf: T. J. Bennett.
- MATHEMATICAL SOCIETY, at 5.30.—On Groups in which every two Conjugate Operations are Permutable: Prof. Burnside, F.R.S.—Fermat's Theorem on Binary Powers: H. E. Western.
- INSTITUTION OF ELECTRICAL ENGINEERS, at 8.—Form of Model General Conditions. (Conclusion of Discussion.)
- FRIDAY, MAY 9.
- COLD STORAGE AND ICE ASSOCIATION (Society of Arts), Afternoon.—The Rationale of Cooling Phenomena: Dr. W. Hampson.—The Business Side of Cold Storage: R. J. Key.
- ROYAL INSTITUTION, at 9.—Exploration and Climbing in the Canadian Rocky Mountains: Prof. J. Norman Collie, F.R.S.
- ROYAL ASTRONOMICAL SOCIETY, at 8.
- MALACOLOGICAL SOCIETY, at 8.

CONTENTS.

	PAGE
Alcoholic Fermentation. By J. T. H.	1
The Geography and Geology of Celebes	3
Our Book Shelf.—	
Fowler: "More Tales of the Birds."—R. L.	4
Dickson: "College Algebra."—M.	4
Crew and Tatnall: "A Laboratory Manual of Physics."—S. S.	4
Cooper, Gawn and others: "Photographic Apparatus. Making and Repairing"	4
Sterneck: "Monographie der Gattung Alectorolophus"	4
Mercier: "A Text-book of Insanity."—A. E. T.	5
Borel: "Leçons sur les Séries à termes positifs"	5
Hadley: "Practical Exercises in Magnetism and Electricity"	5
Letters to the Editor:—	
A Remarkable Lunar Halo. (Illustrated.)—Prof. E. E. Barnard	5
The Education Bill.—Dr. J. H. Gladstone, F.R.S.	6
Resultant Tones and the Harmonic Series.—Prof. Silvanus P. Thompson, F.R.S.	6
Thin Floating Cylinders. (Illustrated.)—Prof. Thos. Alexander	6
Mycoplasma.—E. M. Freeman	7
Rearrangement of Euclid I. 1-32.—T. Petch	7
The Forthcoming Belfast Meeting of the British Association. By T. Brown	8
The Colleges of the University of London. (With Map)	10
Prof. Alfred Cornu. By Prof. Silvanus P. Thompson, F.R.S.	12
M. Vignon's Researches and the "Holy Shroud"	13
Notes. (Illustrated)	14
Our Astronomical Column:—	
Signals from Mars	18
The Orion Nebula and Movement in the Line of Sight	18
The Relations between Metallurgy and Engineering. By Sir W. C. Roberts-Austen, K.C.B., F.R.S.	18
The Glaciers of Kangchenjunga. (Illustrated)	19
University and Educational Intelligence	20
Scientific Serial	21
Societies and Academies	21
Diary of Societies	24

THURSDAY, MAY 8, 1902.

STONEHENGE.

The Wiltshire Archaeological and Natural History Magazine. Stonehenge and its Barrows. By William Long, M.A., F.S.A. Pp. 244; many illustrations. (1876.) Price 7s. 6d.

The Wiltshire Archaeological and Natural History Magazine. Stonehenge Bibliography Number. By W. Jerome Harrison. Pp. 170 (1902.) Price 5s. 6d.

THE Wiltshire Archaeological and Natural History Society is to be warmly congratulated on its persistent and admirable efforts to do all in its power to enable the whole nation to learn about the venerable monuments of antiquity which it has practically taken under its scientific charge.

Chief among these, of course, is Stonehenge, and it is fortunate for students that while interest in this structure, unique in so many particulars, is being revived, such a rich mine of information as that supplied by the Wiltshire Society should be available.

It is within the knowledge of all interested in archaeology that not long ago Sir Edmund Antrobus, the owner of Stonehenge, at the request of this famous local society, the Society for the Protection of Ancient Buildings and the Society of Antiquaries, enclosed the monument in order to preserve it from further wanton destruction, and with the skilled assistance of Messrs. Carruthers and Detmar Blow set upright the most important menhir, which threatened to fall or else break off at one of the cracks.

Ever since that time he has been the butt of agitations in the local parish councils, got up apparently by persons who care, not for the preservation of ancient monuments, but rather that there shall be no right of property in anything interesting enough to be worth chipping.

The "unclimbable wire fence" recommended by the societies in question, the Bishop of Bristol being the president of the Wiltshire Society at the time, is by them regarded as a suggestion that the property is not national, the fact being that the nation has not bought the property and that it has been private property for centuries.

It is curious to think that the very destruction of the monument is now urged as an argument against enclosure. The *Times* in a recent article tells us some of the arguments used before a Committee of the County Council.

"There are old ways, long and systematically used, which lead directly to the stone circles, and the barbed wire stretches right across these ways. One fact alone is sufficient to prove their antiquity. The outermost circle of Stonehenge consists of an earth vallum worn down by time and weather, but still rising some feet above the natural surface of the ground. The ways in question cut through this vallum, which rises abruptly some three feet or so on either side of them."

Everybody except the devastators knows that this vallum is the equivalent of the temenos walls which surround the Egyptian temples, and is part and parcel of the temple.

It is very sad to read, both in Mr. Long's volume
NO. 1697, VOL. 66]

and the bibliography, of the devastation which has been allowed to go on for so many years and of the various forms it has taken. It appears that this temenos wall or vallum was the first to suffer by indiscriminate driving over it, so that its original importance has now become so obliterated that many do not notice it as part of the structure; and that it bears the same relation to the interior stone circle as the nave of St. Paul's does to the Lady Chapel.

It appears also, from the *Times* account of the meeting, that a recent paper by Mr. Penrose and myself on the orientation of Stonehenge may have added strength to one of the arguments so improperly employed and apparently endorsed by Mr. Shaw Lefevre and others:—

"One fact of singular interest was elicited. There seems to have been a special gathering every year, numbering thousands of persons, at Stonehenge to witness the rising of the sun on the 21st of June. As Stonehenge, according to the best opinions, was originally constructed with reference to rites performed at this very moment, there is nothing extravagant in the supposition that there has been something in the nature of a public assembly on Salisbury Plain at midsummer ever since the circles of Stonehenge were first completed."

Meanwhile we trust the Wiltshire Society will continue its labours, which date back at least to 1866, for the preservation of the monument, and that the members of the various Councils concerned will read the literature the Society has printed and become less philistine in their attitude. If Stonehenge had been built in Italy or France or Germany, it would have been in charge of the State long ago. Let the County Council send a small committee to Carnac to see how the equivalent monuments are looked after there.

It is very sad that in this twentieth century there should be Englishmen philistine enough to wish to preserve a so-called "right of way" which cuts through the vallum twice and passes close by the most important and imposing stone circle in the world. It is still sadder that since Sir Edmund Antrobus, the present owner, has accepted the advice of the Societies I have named to enclose the monument, with a view to guard it from destruction and desecration, he has been assailed on all sides, as we have seen. The world of science has already one matter of the highest importance to thank him for, namely, the setting upright of the so-called leaning stone, which was tottering to its fall. Let us hope that before long the minor gaps in the vallum may also be filled up. When they are, the present upholders of the "right of way" through the major ones will be the first to insist that the road shall be deviated outside one of the most imposing monuments of the world. In the meantime, it is comforting to know that, thanks to what Sir Edmund Antrobus has done, no more stones will be stolen, or broken by sledgehammers; that fires; that unskilled excavations such as were apparently the prime cause of the disastrous fall of one of the majestic trilithons in 1797; that litter, broken bottles and the like with which too many British sightseers mark their progress, besides much indecent desecration, are things of the past.

Let me now refer more particularly to the publications of the Wiltshire Society bearing on Stonehenge.

Dealing with Mr. Long's memoir first, it may be stated that it includes important extracts from notices of Stonehenge from the time of Henry of Huntingdon to Hoare (1812), and that all extant information was given touching on the questions by whom the stones were erected, whence they came and what was the object of the structure. The barrows on Salisbury Plain are next carefully described, and the information to be obtained from them discussed in a most masterly way. It is a very great pity that a book so full of facts of great interest along so many lines has no general index.

Many who have followed the recent work on the monuments will be glad to have beside them for ready reference so many extracts from the publications of those who have attempted to solve its mysteries in the past. Thus we learn (p. 44) that in 1771 Dr. John Smith, in a work entitled "Choir Gawr, the Grand Orery of the Ancient Druids, called Stonehenge, Astronomically Explained, and proved to be a Temple for Observing the Motions of the Heavenly Bodies," wrote as follows:—

"From many and repeated visits I conceived it to be an astronomical temple; and from what I could recollect to have read of it, no author had as yet investigated its uses. Without an instrument or any assistance whatever, but White's 'Ephemeris,' I began my survey. I suspected the stone called *The Friar's Heel* to be the index that would disclose the uses of this structure; nor was I deceived. This stone stands in a right line with the centre of the temple, pointing to the north-east. I first drew a circle round the vallum of the ditch and divided it into 360 equal parts; and then a right line through the body of the temple to the Friar's Heel; at the intersection of these lines I reckoned the sun's greatest amplitude at the summer solstice, in this latitude, to be about 60 degrees, and fixed the eastern points accordingly. Pursuing this plan, I soon discovered the uses of all the detached stones, as well as those that formed the body of the temple."

With regard to this "Choir Gawr," translated Chorea Gigantum, Leland's opinion is quoted (p. 51) that we should read Choir vawr, the equivalent of which is Chorea nobilis or magna.

That the slaughter stone was once upright is rendered probable by a reference to Mr. Cunnington's digging in 1803 (p. 56). Mr. Long adds:—

"Mr. William Cunnington, F.G.S., informs the writer that if this stone stood erect, it must have entirely concealed the 'gnomon' from persons standing in front of the altar." "It would have been impossible," he says, "to see the sun rise over the 'gnomon' from the exact centre of the building. It is nevertheless a fact that the gnomon does occupy this critical position, as to the sunrise at the solstice."

But as we now know that from the axis of the sarsen stones the sun did *not* rise over the "gnomon," that is the Friar's Heel, this reasoning is not conclusive.

Again, there is the question of the roof. In our paper communicated to the Royal Society, Mr. Penrose and myself gave reasons why the Naos, that is the space included in the horseshoe of trilithons, was covered. This suggestion, however, I now find is not new, the view having been held by no less an authority than Dr. Thurnham (p. 67), who apparently was led to it by the representations of the Scandinavian temples as covered and enclosed structures.

On pp. 71 *et seq.* I find a very interesting extract from NO. 1697, VOL. 66]

a paper by Mr. Cunnington on the "Geology of Stonehenge." He points out the origin of the sarsens according to Prestwich:—

"Among the *Lower Tertiaries* (the Eocene of Sir Charles Lyell), are certain sands and mottled clays, named by Mr. Prestwich the Woolwich and Reading beds, from their being largely developed at these places, and from these he proves the sarsens to have been derived; although they are seldom found *in situ*, owing to the destruction of the stratum to which they belonged. They are large masses of sand concreted together by a silicious cement, and when the looser portions of the stratum were washed away, the blocks of sandy rocks were left scattered over the surface of the ground.

"At Standen, near Hungerford, large masses of sarsen are found, consisting almost entirely of flints, formed into conglomerate with the sand. Flints are also common in some of the large stones forming the ancient temple of Avebury.

"The abundance of these remains, especially in some of the valleys of North Wilts, is very remarkable. Few persons who have not seen them can form an adequate idea of the extraordinary scene presented to the eye of the spectator, who standing on the brow of one of the hills near Clatford, sees stretching for miles before him, countless numbers of these enormous stones, occupying the middle of the valley, and winding like a mighty stream towards the south."

Mr. Cunnington displayed great acumen in dealing with the smaller stones not sarsens.

"The most important consideration connected with the smaller stones, and one which in its archaeological bearing has been too much overlooked, is the fact of their having been brought from a great distance. I expressed an opinion on this subject in a lecture delivered at Devizes more than eighteen years ago, and I have been increasingly impressed with it since. I believe that these stones would not have been brought from such a distance to a spot where an abundance of building stones equally suitable in every respect already existed, unless some special or religious value had been attached to them. This goes far to prove that Stonehenge was originally a temple, and neither a monument raised to the memory of the dead, nor an astronomical calendar or almanac.

"It has been suggested that they were Danams, or the offerings of successive votaries. Would there in such case have been such uniformity of design or would they have been all alike of foreign materials? I would make one remark about the small impost of a trilithon of syenite, now lying prostrate within the circle. One writer has followed another in taking it for granted that there must have been a second, corresponding with it, on the opposite side. Of this there is neither proof nor record, not a trace of one having been seen by any person who has written on the subject. This small impost, not being of sarsen, but syenite, must have belonged to the original old circle; it may even have suggested to the builders of the present Stonehenge the idea of the large imposts and trilithons, with their tenons and mortices."

There are several references throughout Mr. Long's memoir to the tradition of the slaughter of Britons by the Saxons at Stonehenge, known as "The Treachery of the Long Knives"; according to some accounts, 460 British chieftains were killed while attending a banquet and conference. But one important item is omitted. I have gathered from Guest's "Mabinogion," vol. ii. p. 433, and Davies' "Mythology of the British Druids," p. 335, that the banquet took place on May eve "Meinvethydd."

There is ample astronomical evidence that arrangements were made for observing the sun on May day both before and after the erection of the sarsens, and I think by this the truth of the tradition is strengthened.

Of the more recently published volume dealing with the bibliography of Stonehenge it may be said that no reference to Stonehenge by any ancient author, or any letter to the *Times* for the last twenty years dealing with any question touching the monuments, seems to be omitted from the bibliography. Thus, to give an instance, I find my old friend Sir Arthur Helps' work on "Spain's Conquest of America" referred to because in vol. iii. he treated of sun worship in Peru. The bibliography is not only to be commended for its thoroughness, but for its admirable method; it is a model of what such a work should be, and has evidently been a labour of love: Mr. Harrison acknowledges his obligations to the Birmingham Free Reference Library and the Bodleian, as well as to the Society's library at Devizes.

NORMAN LOCKYER.

STUDIES IN THE DISTRIBUTION OF PLANTS.

Die Vegetation der Erde, Sammlung pflanzengeographischer Monographien. Herausgegeben von A. Engler und O. Drude. (Leipzig: Verlag von W. Engelmann.)

1. *Grundzüge der Pflanzenverbreitung auf d. iberische Halbinsel.* Von Moritz Willkomm. Mit 21 Textfiguren, 2 Helio und 2 Karten (1896.)
2. *Grundzüge d. Pflanzenverbreit. i. d. Karpathen.* Von F. Pax. Mit 9 Textfiguren, 3 Helio und 1 Karte (1898.)
3. *Grundzüge d. Pflanzenverbreit. i. d. Kaukasusländern, von der unteren Wolga ueb. d. Manysch-Schneider, bis z. Scheitelfläche Hocharmeniens.* Von Dr. Gustav Radde. Mit 13 Textfiguren, 7 Helio und 3 Karten (1899.)
4. *Die Vegetationsverhältnisse d. Illyrischen Länder.* Von Dr. Günther Ritter Beck v. Mannagetta. Mit 6 Vollenbildern, 18 Textfiguren und 2 Karten (1901.)
5. *Die Heide Norddeutschlands.* Von P. Graebner. Mit einer Karte (1901.)

THE editors of the series of which the five volumes before us form the first instalment are to be congratulated no less on the courage with which they have embarked on a vast undertaking than on the success which has thus far attended their labours. The authors who have been severally entrusted with the floras of the different regions have been wisely selected, and are well qualified by special knowledge, extending in some cases over a considerable number of years, to grapple successfully with a task of no small difficulty and one which calls for the exercise of critical judgment of no mean order.

The general method of treatment is, in its broader outlines, tolerably uniform throughout the series, though of course there is considerable diversity in the treatment of details. A brief historical introduction in each case gives an account of the previous work done in a particular region, and this is followed by a discussion of

the physical characters and climate of the latter, in so far as these affect the nature of the vegetation and the distribution of the plants within the area. The floras themselves, though often containing rather lengthy lists of plants, are designed, in the first place, to give the reader a general picture of the vegetation as a whole, and also to enable him to trace its relations with the physical environment. For this purpose they are broken up into groups, characterised by the predominance of some particular tribe or assemblage of plants, e.g. the oak flora, the Mediterranean, the alpine, &c. In some cases, too, the cultivated plants are sufficiently described to give a fair impression of the chief features of the more inhabited regions. Perhaps the most generally interesting part of each book is that which deals with the affinities of the flora with the plants of foreign countries, and also the ecological peculiarities that are illustrated within the area of the several regions themselves.

The flora of Spain is discussed by Dr. Willkomm. It is one which is full of interest, not only from the large number of endemic species which it includes, but also for the great variety of *facies* which it exhibits. These characters are clearly traced in connection with the isolation, in the first place, of the peninsula itself, and, secondly, in the remarkable diversity of physical conditions which prevail within it.

The Carpathian flora, discussed by Prof. Pax, is one of remarkably mixed origin, but its affinities can be traced pretty definitely to a European source, on the one hand, and an Asiatic one on the other. Several forms from Siberia find a place here, but the greater number come from Asia Minor and do not extend farther into Europe. There is, of course, a fairly strong affinity with the flora of the Alps, whilst a Pyrenean element is also met with. The flora is thus rather a synthetic one, although there are a few endemic forms. The latter are, however, related to others occurring in the regions above named. In dealing with the flora of the lower slopes, the author deplores the mischievous effects of an imperfect acquaintance with the principles of forestry upon the woodlands, many of which are apparently suffering severely from ignorant treatment.

The volume is one which will appeal strongly to anyone who is interested in the broader problems of distribution and ecology, and it is a solid as well as a suggestive contribution to scientific literature.

Prof. Radde, in dealing with the plants of the Caucasus, describes the vegetation of the steppes to the north of the range, and his frequent journeys into these regions enable him to give a very fair impression of the appearance of these lands at different seasons of the year. The character of the vegetation of the higher altitudes of the Caucasus differs greatly on the two slopes, as might have been expected from the general trend of the mountains themselves. On the southern slope there is a great predominance of Persian plants, as shown by the abundance of species of *Astragalus*, *Acantholimon* and others. The prevailing character of the flora is markedly xerophytic, and it should be one which would repay further biological investigation.

The author distinguishes five principal zones, viz. the

steppes, woods, subalpine, alpine and high-alpine respectively, and these main subdivisions are broken up into smaller groups which exhibit some definite character by which they can be distinguished. A somewhat curious feature of the book rests in the inclusion of an account of the principal insect pests which are injurious to the cultivated plants.

The Illyrian flora, as described by Dr. Günther Ritter Beck v. Mannagetta, is one which seems to be a promising, if difficult, field of exploration. The plants of the maritime regions are, for the most part, an extension of the typical Mediterranean vegetation; but in the higher levels, where the minimum temperature sinks below 14° C., it is succeeded by one of which the oaks form the characteristic feature. The swamp plants which occur in this zone consist, for the most part, of northern European forms, mixed with others of wide distribution. Still higher, the willows and pines form the distinctive land-marks, and these are finally succeeded by an alpine flora which varies in character in the different mountain groups. This is due largely to difference in geological character, and partly also to the isolation of the mountains themselves. The volume includes a short sketch of the *Algæ* of the Adriatic coast, and ends with a discussion as to the relationships of the Illyrian flora with that of the surrounding countries, especially with regard to the physical changes which have occurred since Tertiary times.

The last, but by no means the least interesting, volume, by Dr. Graebner, deals with a more restricted formation, but this very circumstance affords an opportunity for a more detailed treatment. The heath and moorland vegetation is one which fairly bristles with interesting problems, and the volume in question forms a useful contribution to the whole subject. Here and there, perhaps, the chemical aspects of the relation between plant and soil preponderate over the hardly less important biological ones. The author corrects a common error as to the relation between the heather and a limestone soil. He shows that the destruction of the heather, or its non-appearance, is not due to the presence of the calcium salts directly, for he proves by experiment that in a sufficiently poor soil lime may be added in quantity without any injury to the plants in question. But a natural limestone soil is commonly also rich in other mineral constituents which are available for food manufacture, and it is to the presence of these that its absence or extermination is due. Heather is, in fact, very sensitive to manure, which causes its disappearance from soils which may have been previously infested by it.

It is, of course, quite impossible to do justice to the books under consideration within the limits of a short notice such as the present, but it is hoped that enough has been said to indicate their importance in helping to fill a serious gap in botanical literature.

It may be fairly said, moreover, that each volume will be quite indispensable to anybody who may desire to make a close acquaintance with the scientific aspects of the floras of the regions thus severally dealt with. And, taken collectively, they render it possible to acquire a far more intelligent grasp of the facts, and therefore also of the problems, of plant distribution and ecology than has hitherto been practicable for most of us.

OUR BOOK SHELF.

La Question de l'Eau potable devant les Municipalités.
By P. Guichard. Pp. 190. "Encyclopédie Scientifique des Aides-Mémoire." (Paris: Gauthier-Villars, n.d.) Price fr. 3.

IN this work the author has brought together accounts of the water supplies of some twenty-six towns of France, giving details, as far as possible, of the source from which the water is derived in each case, of the treatment to which it is subjected before distribution and of its chemical and bacteriological character. These accounts are derived from analyses and reports furnished by the various analysts who have actually examined the supplies, and are of very varying degrees of completeness. The object which the author had in view in making his inquiries was to ascertain what method of purification, if any, was usually employed by the municipality to ensure the freedom of the water from the germs of disease. The answer to this question is that the municipalities select the best water at their disposal and deliver it to the consumers either without any treatment or after filtration through sand, Anderson's iron process being used in a few cases. The author does not regard sand-filtration as by any means a satisfactory method of purification, in spite of the fact that experiments have shown that when properly carried out it is extremely efficacious, and that the comparative freedom from water-borne disease of towns like London, which make use of water known to be polluted, depends entirely on its use. No discussion of this or kindred points is given, and this somewhat detracts from the value of the book. After pointing out the numerous sources of contamination which may affect the water of towns both before collection and during distribution, the author recommends all householders to protect themselves by purifying all water in their own houses by filtration or other means, and believes that only in this way can security be attained. A very proper and timely protest is made against the continued use of cemeteries for burying those who have died of infectious diseases, and also against the fashionable institution of cemeteries for pet animals, the infiltrations from all of which pass into the streams and rivers of the district, so that, as the author expresses it, "nous mangeons ou buvons de l'homme et du chien à une sauce non prévue dans les traités de gastronomie."

Plissements et Dislocations de l'écorce terrestre en Grèce
By Ph. Négris. Pp. 210; 2 maps. (Athens: C. Beck; Paris: C. Béranger, 1901.)

THE large questions raised by the author cannot be adequately discussed in a brief notice, so it must suffice to state his main facts and inferences, expressing doubts in passing. Since Jurassic times, successive earth-movements have affected Greece and the adjacent parts of Turkey. The foldings produced are distinguished by local names. The earliest, or Olympic, which is pre-Cretaceous, runs from N.W. to S.E. along the eastern coast and a chain of islands as far as Karpalho. The Pentelic, closing that period, is at right-angles to it and acts more especially on the *Ægean* area, its western coasts and the *Morea*. The *Achaic*, which occurred during the *Eocene*, more or less affects the whole region and even *Crete*, running W.N.W. to E.S.E. The *Pindic*, closing the *Eocene*, trends in a N.N.W.-S.S.E. direction and can be traced in the *Pindus* mountains, the country to the west and the *Morea*. Last is the *Tenarus* folding, which began late in the *Pliocene* and affected the whole of the Greek kingdom, running from N. to S. All are generally associated with outbursts of igneous rock—*peridotite* (serpentine) in the earlier, *trachyte* in the later. There are also three important sets of faults, on which, however, we cannot dwell. The *Tenarus* folding pro-

duces the most important effects, for the author regards it as only a part of a great series of disturbances which modified the earth's crust as far away as the American continent. These are mainly responsible for the Glacial epoch, and the advance or retreat of the ice and the variations in sea-level must be attributed to earth-movements during it. Often, he insists, the sea, rather than the land, has altered its level, owing to changes in the form of the ocean basins. No doubt this is true, but we think the author presses it too far. He has also such faith in land-ice as to introduce the Scandinavian ice-sheet to the Shetland Isles, without caring to explain how it got across the deep valley which contours the southern and western coast of Norway. The earth-movements already mentioned were sometimes rapid, and the author connects the later of them with traditional deluges. The fabled Atlantis is Brazil, which had been converted into an insular tract by a rise of the sea. All this is certainly ingenious, though it may be unconvincing. He also gives us an explanation of the curious "bone beds" of Pikermi. Downward movements (connected with the second set of faults) submerged the lowlands. The animals fled for refuge to the hills, where they were killed *en masse* by nephritic vapours, which, fortunately for geologists, were exhaled in the nick of time, and their dead bodies were afterwards carried lower down by floods and mudstreams. *Credat Judæus!*

Last Words on Materialism. By L. Büchner. Translated by J. McCabe. Pp. xxxiv + 299. (London: Watts and Co., 1901.) Price 6s. net.

It can scarcely have been the intrinsic worth of these occasional essays which induced the "Rationalist Press Association" to circulate them in an English dress. The volume is marked by all the confident dogmatism and loose reasoning for which the author of "Force and Matter" is unfavourably known to serious students. Its value as a contribution to genuine thought on the ultimate constitution of the world around us of the slightest. The author's position is that thought and will are secondary derivatives of a reality which is, in its own nature, "material" in the sense of being not mental, but for this position no proof whatever is offered. The "idealist," who comes in for a good deal of abuse which, from an English point of view, must be pronounced decidedly undignified, is never fairly met. His real argument, that the physical world itself is only given us in terms of the experiences of a sentient perceiver, is quietly ignored, and he is only allowed to make the futile objection that he does not know by what special process physical energy is "transformed" into consciousness. The writer's competence in philosophic discussion is shown by the fact that he thinks the inability of savages to count beyond four a proof that mathematical science is purely empirical. Similarly, he thinks Kant's view of the presence of an *a priori* element in knowledge refuted by the irrelevant appeal to the fact that knowledge has been acquired by a process of gradual development. The real point has, of course, nothing to do with the process by which we come to know; it is purely a question of how knowledge is constituted when you have got it. The excursions into philosophic history made in such essays as those on "Hobbes" and on "Buddhism and Christianity" are even sorer stuff than the rest of the book. Büchner seems to have known little or nothing about the subject; he repeats complacently the absurd farrago by which Pythagoras has been brought into connection with Buddha, and expressly praises Hobbes for being—precisely what he was not—an empiricist. The "Rationalist Press Association" is doing scientific thought no good service in issuing such a mixture of anti-ecclesiastical rhetoric and crass metaphysical dogmatism as representing the views of serious science about the world. A. E. T.

LETTERS TO THE EDITOR.

[The Editor does not hold himself responsible for opinions expressed by his correspondents. Neither can he undertake to return, or to correspond with the writers of, rejected manuscripts intended for this or any other part of NATURE. No notice is taken of anonymous communications.]

The Misuse of Coal.

WHILE most thoroughly agreeing with Prof. Perry in his desire to see a more efficient use made of our coal-supply, I yet think that he has drawn far too gloomy a picture of the future, and I wish to draw attention to a consideration which does not seem to have been present in his mind, or to have occurred to any of those hitherto dealing with the question as either authors or inventors. Prof. Perry says that "scientific men know of no other store of energy available for man's use than fuel from the earth, except what we may get by the help of the tides or by the wind or waterfalls." With the exception of the tides, the energy of all these sources is derived ultimately, as is also that of coal itself, from the heat radiated by the sun, and what I wish to point out is that the heat of the sun may be made to furnish power in quite another way—a way, in fact, indicated by Nature herself.

Prof. Perry points to animal organisms as types of efficient engines. Now, what is the fuel consumed by these engines? Obviously it is vegetable matter which derives its energy from the solar radiation of the present day. At the same time, it is evident that at the present moment only a small percentage of the solar radiation falling on the surface of the earth is used in this way; yet it will be found that the amount of energy derived from this source is very large compared with that provided by our coal-supply. The detailed calculation cannot be attempted here, but a few figures will serve to show the order of magnitude we are dealing with. Taking Prof. Perry's figure for a year's coal-consumption at 663 million tons, and taking the average efficiency of engines at 3 lb. of coal per horse-power hour—which is probably too high an efficiency—the figures work out to an annual output of 495,000 million horse-power hours, and this is roughly equivalent to 56 million horse-power working continuously night and day. Considering the number of human beings, horses, cattle and sheep, and considering their output in heat as well as in mechanical work, it is evident that the energy supplied by food—however efficiently used—must be vastly greater than that given by our present coal-consumption. Here, then, is an enormous source of energy only partially tapped at present—the heat radiated to the earth by the sun—and the method of using it is indicated by Nature. When our stock of fuel approaches exhaustion, we shall—so it appears to me—have to set to work and—to put it crudely—grow our own fuel as we go along.

The use of vegetable matter for fuel is by no means unknown even to-day; for although wood has long ceased to compete with coal as a fuel, yet in Germany at the present time a new industry is growing up in the production of crude spirit from potatoes. This spirit is used as a cheap fuel in internal-combustion motors, and is therefore evidently able to compete with earth-fuels even in a northern country where solar radiation is not very intense and land-values are high. The progress from the use of wood and charcoal as a fuel to the use of potato-spirit is so great that we may reasonably expect much more in the same direction when once attention has been concentrated upon the matter. In fact, it may not be too much to expect that ultimately the regeneration of carbon from the dioxide of the atmosphere may be accomplished by means of synthetically prepared bodies which—somewhat like the chlorophyll of the living plant—are capable of decomposing carbon dioxide under the influence of sunlight. In those circumstances, the solar heat used in the evaporation essential to the growth of plants might be saved for the direct production of fuel, and the yield per acre of sunlit area greatly increased. I think, therefore, that in "fuel farming," in the first instance by the most prolific plants available, and ultimately by purely chemical agents, the problem of the supply of energy after the exhaustion of the world's coal-supply may perhaps be solved. All I am here trying to show is that the quantity of energy available by these means is large compared with the power actually in use at the present day, and even this I have only indicated in the roughest way; but I agree with Prof. Perry as to the extreme importance of the question, and I think with him that it is a matter of vital national importance. If, however, fuel farming is really a

possibility of the future, then perhaps Prof. Perry's gloomy picture of the decay of Great Britain may be falsified. The place of our coal-mines in our national assets would then be taken by the vast areas of sunlight land in our Colonial Empire, for fuel-production would then become a question of the number of acre-hours of sunlight available.

I should like to add that what I have said in this letter does not at all lessen the urgency of Prof. Perry's plea for efficient engines; in fact, I think that what I have pointed out tends to strengthen the demand for a great national effort at the solution of these pressing problems. At present we are, in matters of energy, "robbing posterity" while it is eminently desirable that we should discover a way—if there be one—"paying our way," and I think that in fuel farming such a way may perhaps be found.

WALTER ROSENHAIN.

443 Gillott Road, Edgbaston, April 27.

MR. ROSENHAIN is mistaken as to the ignorance of inventors; many engines have been invented and referred to in newspapers during the last thirty years for utilising solar heat. I may remark that such heat engines may be very efficient, because the available temperature may be very high indeed. I have sometimes wondered why metallurgists neglected the possibility of obtaining very high temperature furnaces from the heat of the sun. As to the energy available, at p. 14 of my book on "Steam" I say:—"On one square foot of Egypt the heat energy received in one year from the sun is about 10^9 foot pounds, or 500 horse-power hours." This is nearly equivalent to the energy of a coating of coal all over Egypt one foot thick, and promises a future for the Sahara and other cloudless regions of the earth. I therefore admit that I did not give sufficient weight to this consideration of the direct heat from the sun, and I am very glad that Mr. Rosenhain has drawn attention to my neglect.

J. PERRY.

Experimental Mathematics.

PROF. PERRY'S syllabus in practical mathematics has now been published two or three years, and the results of actual experience of its working may have some interest. We have in this institute about three hundred students of mathematics, including boys in the day school as well as older evening students, who follow a course on the lines of Prof. Perry's syllabus, and in both classes the adoption of the method has aroused an increased interest in the subject. This increase of interest seems to be due to the fact that the method is essentially experimental as well as deductive. Mathematics is treated as a science rather than, according to a common tradition, as an "arts" subject. The student is taught to investigate the facts for himself by experiment in the form of actual plotting and measurement and numerical calculation, just as in the study of such a science as electricity he investigates a law for himself in the laboratory and, usually at a later stage, proves in his theoretical work that that law follows from his previous knowledge. This is not merely a question of illustrating elementary geometry, but the practice may be carried with advantage into what are usually considered quite advanced parts of his work. However well a student may know the analytical proofs involved, he greatly improves the firmness of his grasp by actually plotting, with various numerical values of the constants, curves to represent such a case, for instance, as the small oscillations of a stiff spring, or the form of a bent beam. In pure mathematics, especially in differential geometry, many examples may be found, and, in fact, the method of conformal representation, which has been so fruitful in the theory of functions and its applications, is really an instance of this method. Besides increasing the average student's interest in his work, these "direct vision" methods, used systematically throughout a student's course, give more solidity and a clearer definition to his ideas than it seems possible to attain by abstract reasoning alone.

My special object, however, in writing is to insist on the value of the method as a logical training. We sometimes hear of the "invaluable logical training" of Euclid with the implied assumption that other methods of treating mathematics are illogical. This view seems to ignore the fact that there is an inductive as well as a deductive logic. If a boy is taught from the beginning to verify all theorems by actual plotting and measurement, he trains, not only his logical powers of deductive reasoning in proving his theorem from its premises, but also his equally logical powers of inductive reasoning from observation

and experiment. From the point of view of educational theory this seems a sounder method than to restrict his training to one form of logical reasoning to the neglect of the other. The deductive logic of the syllogism was the only form known in the time of Euclid, but it is scarcely necessary to say that inductive logic now holds a recognised place, and the whole development of modern experimental science has proceeded by its methods.

John Stuart Mill, as is well known, devotes a very scanty consideration to syllogistic reasoning on the ground that "Formal Logic therefore, which . . . have represented as the whole of logic properly so called, is really a very subordinate part of it, not being directly concerned with the process of Reasoning or Inference in the sense in which that process is a part of the Investigation of Truth," and that "The foundation of all sciences, even demonstrative or deductive sciences, is induction."

This may, perhaps, be the explanation of the difficulty which so many boys as well as older students feel in comprehending demonstrative geometry. Most teachers of evening students have met with men of considerable ability and some maturity of mind who have little or no difficulty with algebraical work, but can never comprehend the meaning of a proposition in Euclid. The syllogistic method of reasoning seems to find no avenue into their minds, although they can reason well enough from observed facts. Such people are usually set aside as having no mathematical gift, but all must have notions of space and time, and consequently of change and a rate of change, and if rigid deductive methods were so essential as is often supposed to the science which puts those notions into scientific form, they would scarcely be incomprehensible to so many. If anyone has the power of comprehending the facts of a science such as chemistry, he must have some power of putting that knowledge into scientific form, and so anyone whose experience is given in space and time can scarcely be quite without the power of understanding the science which deals with those conditions of his experience. In fact, if students who seem to be without mathematical power are allowed to approach the subject by an experimental method, they find no difficulty in understanding it and may in time come to grasp the significance of deductive methods. In secondary schools of the classical and mathematical type, boys who are not on the science side are at present almost without the opportunity of developing their inductive logical powers, with the exception of the few who reach the stage where they can draw their own conclusions from the facts of philology or history. Experimental mathematics might in this case be made to supply the place of the missing experimental training.

However one may admire the symmetry of an ideal rigid body of mathematical knowledge, built up in the mind of the learner so that each step is made to depend by flawless abstract reasoning on what has gone before, and so on down to necessary axioms at the foundations, such a process cannot be carried out in the practice of education. It is sometimes said that a student should not be allowed to use any process or to believe any theorem until he can render a complete and perfect reason for it. But if a student is to follow such a method he should not be allowed to use $0 \cdot 3$, until he can justify his use of it from a knowledge of the meaning of a limiting value and of the criteria for the convergence of series, nor may he use $\sqrt{2}$ as a number until he has mastered the modern theory of irrational numbers and made up his mind whether to hold opinion with Dedekind and Weierstrass, that the conception of an irrational number is to be based on a purely arithmetical theory, or with Du Bois-Reymond, that it is essentially geometrical and inseparably connected with linear magnitude. It is obvious that no teacher can attempt such a course; these difficulties are always passed over without proof.

In the method of practical mathematics, this practice is frankly recognised as legitimate and natural, and is systematically extended to other parts of mathematics.

Whatever may be true of the superstructure, the fundamental notions of pure mathematics have not been built up by strict deductive process, but by a series of successive approximations to the truth. The conception of a limiting value is a case in point. Until the time of Cauchy, the existence of a limiting value was thought to be self-evident on geometrical grounds in such a case as that of the area of a polygon inscribed in a circle. Cauchy in his treatment of definite integrals recognised that it was necessary to prove that a definite limiting value existed in such a case, but it was only in 1853 that a completely neces-

sary and sufficient criterion for the existence of a definite integral was supplied by Cantor and Dedekind.

Thus the great body of analysis had been built up long before the fundamental notion of a limit was completely established.

A somewhat similar course might be traced in the development of modern ideas as to the basis of mechanics.

In Prof. Perry's method, especially in teaching the calculus, it is recognised that this is the natural way to approach the subject, not only for the science as a whole, but in the mind of the individual student, and its foundations are soundly laid on direct geometrical intuition and the notion of a rate of increase, full analytical treatment being left to a much later stage.

This enables the calculus to be introduced at a much earlier stage than usual, and I may here quote the graphic advice of Prof. Burkhardt, all the more striking as it comes from a mathematician distinguished in pure mathematics:—"Dem angehenden Jünger der Mathematik würde ich raten, sogleich mit beiden Füßen in die Differential- und Integralrechnung zu springen." F. M. SIXELBY.

Royal Technical Institute, Salford.

Rearrangement of Euclid's Propositions.

I FEEL that Prof. Lodge's proposal to change the order of Euclid Book I., 1-32, is the real solution of the present problem of the teaching of elementary geometry. The budding engineer has his practical mathematics, the embryo wrangler will absorb geometrical truths served up in almost any manner; but the ninety per cent. to whom mathematics is a mere mental training must have their work put before them in an interesting, practical and yet logical manner. I should, however, like to put forward the following three points:—

(a) That Prof. Lodge's idea should be carried further, and Euclid, Books I-VI., divided into four new books, as:—

The straight line — Euclid I. 1-32 in some good order.

The circle — Euclid III. 1-34, IV. 1-5 and escribed circles.

Areas — Euclid I. 35-48, II., III. 35, 36, 37, IV. 6 to end.

Proportion — Euclid V. and VI.

For Book I., I would suggest an order commencing with I. 32, cor. 2, which is the most general proposition for all rectilinear figures; and also that certain well-accepted riders should be added, many of which form more powerful instruments for solving geometrical problems than the majority of Euclid's propositions; that, in the circle, tangents should be treated as limiting chords; that, in areas, the "alternative" proofs of Euclid Book II. should be the proofs; finally, that proportion be done semi-algebraically, using fractional

notation
AB
CD

(b) That it is not necessary—I may say, not advisable—to teach a beginner the words of a strict definition; but he should be given the idea alone, built up from practical use of a set of instruments, the verbal definition following when he is able to appreciate it. I would advocate that the following definitions be substituted for Euclid's unsatisfactory ones.

A straight line is one such that if any part be taken up and applied to any other part in any manner, so that its extremities fall on that part, it will coincide altogether.

The angle—the trigonometrical definition.

Parallel straight lines—the converse of axiom XII.

These would lead, for the student, to the ideas that a straight line can be drawn with a ruler, an angle drawn or measured with a protractor, and parallel straight lines drawn with two set-squares, one fixed and the other movable.

If these were accepted, I. 13, 14, 15, 27, 28, 29 follow almost axiomatically, and we are enabled to prove I. 32, cor. 2, by a supposititious construction, obviating such practical proofs as "walking round the sides" or Prof. Minchin's better idea of placing a pin along a side and moving it round, substituting a purely geometrical proof.

(c) That it is unreasonable to bar supposititious proof-constructions—e.g. in the bisector proof of I. 5. For no exception is taken to the particular enunciations of I. 4 or I. 8, although at that stage we are unable to draw one triangle with its parts equal to those of the other. J. M. CHILD.

Technical College, Derby.

The Sweet Briar as a Goat Exterminator.

THE introduction of the sweet briar into Australia, in many parts of which it is naturalised, affords a striking illustration of the mode in which the balance of nature may be disturbed in a wholly unforeseen way.

The fruit of the sweetbriar consists of a fleshy receptacle lined with silky hairs which contains the seed-like carpels.

I extract from the *Agricultural Gazette of New South Wales*, vol. xiii., No. 3, March, 1902, p. 313, the following note by Mr. E. A. Weston, a well-known veterinary surgeon of Launceston, Tasmania:—

"With reference to *Rosa rubiginosa*, I thought it might interest you to know that the hairy linings of the fruit caused the death of a number of goats here by forming hairy calculi, which mechanically occluded the lumen of the bowels. These goats were put on the land with the idea that they would eat down the briars and ultimately eradicate them, but the briars came out best and eradicated the goats. The cattle running on the land are also very fond of the briar berries, and from time to time one will die, and on *post-mortem* no pathological changes can be found in any of the organs, nor do the hairy calculi appear in them, although their various stomachs are one mass of the briar seeds."

Kew.

W. T. THISELTON-DYER.

Stopping down the Lens of the Human Eye.

IN photography, if the lens is affected with spherical aberration or other defects, or if the aperture is too large for good definition, the operator usually gets over the difficulty by using a smaller aperture or stop. This improves the definition and makes the picture sharp even to the corners of the plate. This process is technically called "stopping down the lens." In amateur landscape work I generally use an aperture or stop with a diameter of one-fiftieth of the focal length of the lens, or $f/50$.

But the human eye has defects, especially as we get old. For instance, the curvature of the crystalline lens becomes too flat, &c., and we have to use spectacles to enable us to read. Reasoning by analogy, diminishing the aperture of the eye by "stopping down the lens" ought to improve defective definition and make the vision sharper, and experiment proves that such is actually the fact. I find that the best effect is obtained by holding a thin metal plate close to the eye, with an aperture in it one-fiftieth of an inch in diameter. This arrangement resembles the old single landscape lens used in photography. The small stop is in front, the lens in the middle and the sensitive plate or retina at the back. I use convex spectacles myself for reading, but with a stop of that size I can easily read small print within 4 inches of the eye (or even less) in a good light without spectacles. I have tried the experiment with several of my elderly friends, and in every case with success. Anyone can try the experiment by means of a pinhole in a card.

I do not know exactly what is the focal length of the lens of the human eye, but supposing it to be half an inch, then with a stop of one-fiftieth of an inch the technical expression for the size of the stop would be $f/25$, or double the diameter of the one I use in landscape photography. I enclose a metal disc with such an aperture. By looking through it I can read the smallest type in NATURE at 4 inches from the eye. WM. ANDREWS.

Steeple Croft, Coventry, April 25.

Prisms and Plates for Showing Dichromatism.

DICHROMATISM, or the change of colour of an absorbing medium with increasing thickness, is usually shown with plates of coloured glass. It is not always easy to obtain the right kind of glass, and only a few of the aniline dyes are suitable for the purpose. The medium should transmit two distinct regions of the spectrum, the absorption coefficient for one being greater than for the other. I have found that it is better to give the medium the form of a prism, for then the transmitted colours are separated, and the more rapid fading of one as the eye is moved from the refracting edge to the base can be followed. A number of years ago I found a small amount of an unlabeled dye which transmitted a red band and a green band, that is, it had a strong absorption band in the yellow and the blue. Thin layers of this dye were bright green, thick layers were blood red. I have never been able to find the dye again, though I have examined a large number of dyes, but I have found that a mixture of commercial "brilliant green" with a little naphthol yellow has

identical optical properties. Brilliant green alone in thin layers is blue rather than green, and though it shows dichromatism, the change from blue to red is not nearly so striking as a change from green to red. The prisms can be made in the following way.

A quantity of Canada balsam is boiled in an evaporating dish until a drop placed on a cold surface becomes quite hard. The dye must not be added until the balsam has cooled almost to the point of becoming thick, otherwise it will be decomposed and a very muddy green result.

Enough brilliant green must be dissolved in the balsam to make it appear deep red in layers 1.5 cm. thick. Thin layers will be found to be blue. The naphthol yellow is now added in quantity sufficient to change the tint of thin layers from blue to green. Possibly some samples of the dye will not require the addition of the yellow, but all which I have tried are improved by the process. A hollow prism is now made by fastening two pieces of thin plate glass between two grooved strips of wood. The base of the prism should be about 2 cm. thick if the strips of glass are 4 cm. long. The plates are warmed with a flame and the coloured balsam poured between them. After the balsam has cooled it is a good plan to run a quantity of melted sealing-wax upon the top of it, which strengthens the prism. An incandescent lamp or gas flame viewed through the prism is seen divided into a green and a red image, the former gradually fading away as the eye is moved towards the base of the prism.

If a larger amount of the colouring matter be added to the balsam and the fluid be pressed out between pieces of plate glass, screens can be made which transmit a very good secondary yellow. Through these screens a sodium flame is absolutely invisible, though a gas flame appears of a colour very closely resembling the soda flame in tint. The colour of the transmitted light depends also on the original composition of the light. By a suitable adjustment of the dyes a screen can be made which appears red by lamplight and green by daylight, illustrating very well the peculiarity of the Alexandrite crystals.

Johns Hopkins University, Baltimore. R. W. WOOD.

Sun-pillar and Parhelion.

As the area over which such effects are visible is of some interest, it may be well to mention that a sun-pillar was visible in Dublin at 7 p.m. on Monday, April 28. It was preceded at 6 p.m. by an unusually fine parhelion display, a portion of which was hidden from my view by houses. Two concentric circles and an inverted arc touching the inner one were visible, with a mock sun at the left hand end of the horizontal diameter of the inner circle, and probably another, hidden from me, on the right. The wind all the previous day had been cold from the north-east, in a fairly clear air, and still blew from about north. The sky was full of streamers and wisps of cirrus cloud. Doubtless a far more complete account can be given by other observers.

GRENVILLE A. J. COLE.
Royal College of Science, Dublin, April 30.

A Rare Wild Sheep.

SPORTSMEN and naturalists will be interested to learn that Mr. Taibot Clifton, who has recently been travelling in northern Siberia, has brought home from the valley of the Lena the skin and skull of a wild sheep of which no complete examples have hitherto been known in England. This sheep is the *Ovis borealis* of Severtzoff, a near ally of the bighorns of Kamchatka and Alaska. As it has no English name, it may well be known as Clifton's bighorn. The skin is being mounted by Rowland Ward, Ltd., and will before long be exhibited to the Zoological Society.

R. LYDEKKE.

Beechen Hedges on Elevated Ground.

In your issue of April 10, Mr. Wm. Gee, of Buxton, expresses his surprise that some beechen hedges and smaller trees in his neighbourhood have maintained their foliage through this winter, "contrary to the habit of deciduous trees."

I beg to state that in Denmark, where beeches abound, these trees always behave in the same manner as those in Buxton did this year. An underwood of young beeches, densely covered with dry, brown, rattling foliage, is quite a characteristic feature of Danish woodland scenery.

It would be most interesting to learn whether the beeches in

NO. 1697, VOL. 66]

England really used to throw off their leaves in autumn, and to ascertain the causes of such a different behaviour of the same species of tree in two countries of approximately the same climate. How this holding of the leaves could be a protective device to the individual young beech I cannot imagine; but to the whole underwood, or wood, this phenomenon might be protective, keeping out the cold winds of winter.

18 V. Boulevard, Copenhagen.

JUL. WULFF.

In reply to the interesting communication from Copenhagen anent the Buxton beeches, I would remind your correspondent that, as stated, the matured trees in the plantations hereabouts drop their leaves in the autumn as usual, the retention of them being observable only upon small young trees, and in the beechen hedges, and that this effect is not noticed, in this neighbourhood, for the first time.

It may give colour to the suggestion that this holding of the past season's leaves is an extra device under pressing circumstances to remember that the tissue of such accessory organs as scales, bracts and stipules is of feebly conducting material, and that these dry beech leaves, acting as such, would also enclose a film of air which would tend to give fuller protection from the frosts which this winter have been uncommonly severe, the local observatory (in connection with Westminster) registering down to 3° Fahr.

We have the highest authority for considering the beech as an unusually resourceful tree, as shown in its veneration, the growth of its bark and the care of its seeds; and it would not be surprising to hear of its making a special defence against a special attack, and being successful as a "survival of the fittest."

Barlbro' Cottage, Buxton, April 28.

WM. GEE.

CHEMICAL INSTRUCTION AND CHEMICAL INDUSTRIES IN GERMANY.

NO more striking illustration of the position which Germany has won for herself in chemical technology, and of the industrial preeminence which she has thereby secured in one of the most highly developed branches of the chemical arts, could have been given than that afforded by Prof. Witt in the lecture theatre of the Royal Institution on Friday evening, March 21; and to the observant eye no object-lesson could be more significant or more forcible than that presented by the remarkable series of chemical products, the outcome of the work of German manufacturers, which Prof. Witt had gathered together to point the moral of his discourse.

In a few years we shall behold the extinction of one more agricultural industry, and the indigo plantations of India will have gone the way of the madder fields of Avignon. The death-knell of natural indigo has been sounded; the planter may struggle on for a while in a futile effort to withstand the inevitable; prejudice and trade customs may delay the fall of the fateful sword; but the machinations of the German chemist, backed by the German capitalist, have slowly but surely compassed his ruin, and it is but a question of time when it will be accomplished.

The conditions which have conduced to this result have been indicated, time and again, in these columns. But no more eloquent commentary on these causes could be adduced than is afforded by the report on chemical instruction and chemical industries in Germany recently made to the Foreign Office by Dr. Frederick Rose, His Majesty's Consul at Stuttgart, and which has recently been published.¹

This report deals with the facilities, and expenditure, for chemical instruction at the two Prussian Technical High Schools at Berlin and Hanover, and at the University of Berlin, and is supplementary to a report on chemical instruction and chemical industries in Germany already made public by the Foreign Office.

The following brief analysis of this report will serve to show by what methods the State has deliberately

¹ Diplomatic and Consular Reports, No. 573, Miscellaneous Series.

paved the way for the result foreshadowed in at least one branch of chemistry in Prof. Witt's discourse.

Let us take the Berlin Technical High School first. In this school there are six fully qualified professors for the following branches of chemistry:—(1) Organic chemistry; (2) inorganic chemistry; (3) chemical technology; (4) metallurgy; (5) electrochemistry; (6) photochemistry.

In addition there are six lecturers for the following branches:—(1) Chemistry of foods, including analytical and bacteriological methods; (2) agricultural-chemical technology (sugar, beer, spirits, &c.); (3) vegetable and animal fats, oils, &c., investigation of mineral oils and naphtha products; (4) designing of chemical works and plant; (5) architectural chemical technology; (6) physical chemistry, thermochemistry, &c.

Finally, twelve *privat doctores*, or private lecturers, for the following branches:—(1) Electrolytic metallurgy; (2) chemistry of foods; (3) ceramics; (4) chemistry of the growth of plants; (5) investigation of oils, fats and naphtha; (6) technology of proteids and albuminoids; (7) repetition of organic chemistry; (8) chemistry of cements, mortar, plaster, &c.; (9) qualitative and quantitative analysis; (10) coal tar dyes; (11) terpenes and camphors; (12) modern synthetic drugs.

The following table gives the number of professors and students for a series of years from 1885-99:—

	1885.	1890.	1895.	1899.
Professors ...	4	5	5	6
Lecturers ...	3	2	6	8
Private lecturers	5	3	11	12
Assistants ...	7	13	13	15
Students ...	89	172	171	278

It will be seen that in 1899 there were no fewer than 41 professors, lecturers, private lecturers and assistants to 278 students, or about one instructor to seven instructed.

The laboratories for organic chemistry, photochemistry, metallurgy and chemical technology are contained in a building erected in 1884. The increase in the number of students has now rendered the erection of new buildings necessary; these will be begun this year, and will probably cost 27,500*l.* exclusive of the site, which is valued at 10,000*l.* For the same reason, a new building will shortly be erected for the electrochemical laboratory, which is at present located in the palatial building of the Technical High School.

The department for instruction in chemistry at the Hanover Technical High School differs from that of the Berlin Technical High School, inasmuch as the chemical-technical and electro-technical branches are combined in one department.

The principal chairs of chemistry are four in number:—(1) Inorganic chemistry; (2) organic chemistry; (3) chemical technology; (4) electrochemistry.

The following table gives the total number of professors, &c., and assistants and students for a series of years:—

	1885.	1890.	1895.	1899.
Professors ...	4	5	5	6
Lecturers ...	2	1	1	2
Private lecturers	—	1	—	4
Assistants ...	4	5	9	11
Students ...	64	81	192	285

In 1899 the proportion of instructors to instructed was 23 to 285, or about 1 to 12.

The department of chemistry at the Berlin University forms one of the subdivisions of the faculty of philosophy, and the professors of chemistry are members of the philosophical faculty.

The professorial staff includes:—(1) One professor of organic chemistry; (2) one professor of inorganic chemistry; (3) one professor of pharmaceutical chemistry; (4) one extraordinary professor of chemical technology; (5) one extraordinary professor from the Berlin Technical

High School; (6) one extraordinary professor from the Veterinary High School; (7) one extraordinary professor from the Imperial Patent Office; (8) one extraordinary professor from the Royal Department for Testing Explosives; (9) three extraordinary professors who also form the managing board of the two principal chemical institutes (see under); (10) twelve private lecturers; (11) twenty assistants in the different laboratories for inorganic, organic, pharmaceutical and technological chemistry.

The chemical department of the Berlin University possesses the following subdivisions for chemical instruction:—(1) The First Institute of Chemistry, conducted by the professor with a managing board of two extraordinary professors and eleven assistants; (2) The Second Institute of Chemistry, with one managing extraordinary professor and three assistants; (3) The Chemical-Technological Institute, with one extraordinary professor and two assistants; (4) The Chemical-Pharmaceutical Institute, with one extraordinary professor and four assistants.

The report does not give the number of students of chemistry who have studied at Berlin during the past, as they are not inscribed specially as students of chemistry, but are entered as belonging to a subdivision of the philosophical faculty. It is not possible, therefore, to determine exactly what proportion of the total natural science students were actually students of chemistry, although there is reason to assume that the proportion is large:—

	Students in the Philosophical Faculty.	Students in the subdivision of natural science.
1885 ...	1955	813
1890 ...	1761	515
1895 ...	1551	512
1899 ...	2162	784

It is stated that the decrease in the number of students for the years 1890 and 1895 was partially caused by the lack of sufficient and suitable accommodation in the chemical laboratories and lecture-rooms, a defect now remedied by the erection of the splendidly equipped building in the Sophien-Strasse.

The following table gives the annual expenditure for new apparatus, instruments, chemicals, repairs, &c., of the above-mentioned four chemical institutes at the Berlin University. The sums given do not include the salaries of teachers, assistants, or laboratory servants:—

	First Chemical Institute.	Second Chemical Institute.	Technological Institute.	Pharmaceutical Institute.	Total.
	£	£	£	£	£
1885 ...	645	724	476	275	2120
1890 ...	719	564	398	275	1956
1895 ...	794	564	398	275	2031
1899 ...	1052	614	398	275	2339
1901 ...	2792	614	398	275	4079

From the above table it is seen that the annual expenditure for the First Chemical Institute for instruments, apparatus, chemicals, &c., alone, *i.e.* apart from the salaries of the professors, lecturers, &c., has increased more than fourfold since 1885.

The First Chemical Institute was erected between 1860 and 1870 at the following cost:—

Building site ...	£13,500
" expenses ...	27,505
Internal equipment ...	3,985
	44,990

During the last fifteen years, however, the great increase in the number of students of organic chemistry drawn to Berlin by the fame of Hofmann and Emil Fischer has rendered necessary the erection of a new building for the First Chemical Institute. This was built between 1897 and 1901 at a total expenditure of 70,000*l.*,

to which 750*l.* was added for the purchase of instruments, apparatus, &c. The value of the building site was probably 30,000*l.* to 40,000*l.*

The Second Chemical Institute and the Technological Institute were both built after 1870, and have repeatedly received large sums for apparatus and instruments.

A new building is at present in course of erection for the Institute of Pharmaceutical Chemistry, estimated to cost 26,250*l.* without the value of the site, which may amount to 10,000*l.* The annual vote for instruments, &c., is to be raised from 225*l.* to 750*l.*

These figures, as Consul Rose states, are eloquent enough, and show clearly what facilities are provided in these great institutions for tuition in all branches of chemistry. "Finally they show—and this is, perhaps, the most significant indication of all—that the Prussian State, in spite of the expenditure already incurred, and the leading position attained by the chemical industries, is far from regarding the present admirable means of chemical instruction as adequate for future contingencies, but is at all times, after representations from the requisite industrial and educational quarters, prepared for further lavish outlay should future developments reveal this necessity." T. E. THORPE.

RHODESIA AND OPHIR.¹

IN this handsome and copiously illustrated volume are embodied the results of six years' (1895-1900) systematic exploration amongst the numerous prehistoric remains of all kinds which are widely scattered over the whole region between the Zambesi and the Limpopo, and even range at some points into the continuous districts of North Transvaal and Bechuanaland. During the operations, which were conducted under grants from the Chartered Company licensing these researches, the authors, with their indefatigable colleague, Mr. George Johnson, personally inspected nearly two hundred ruins, a list of which is here given and a great many of which are described in more or less detail. They further tell us that, so far from being completed, the work of exploration has scarcely been more than well begun, that their precursors and contemporaries—Bent, Mauch, Baines, Maund, Willoughby, Swan, Schlichter, White—have merely scratched the surface, and that of more than five hundred temples, citadels, enclosures, chains of forts, gold workings and terraced slopes reported from various districts and covering a total area of at least 115,000 square miles, not a tenth part has yet been thoroughly examined. This will be read with surprise by those archæologists who supposed that after Bent and Swan's classical descriptions of the "Great Zimbabwe" and a few neighbouring monuments, little more remained to be discovered. But the statement is supported by abundant first-hand evidence, and it is shown that Zimbabwe itself "is still practically unexplored," while elsewhere the original floors of the earlier structures still rest for the most part buried under ten or even fifteen feet of the accumulated débris of ages.

That there are earlier and later structures, bespeaking either a long continuous or an intermittent occupation of the land by foreign intruders, is placed beyond all doubt, and a comparative study of the various groups so far explored has enabled the authors tentatively to classify them in four categories, clearly indicating time sequences ranging from at least 1000 B.C., possibly even 2000 B.C., down to the advent of the Mohammedan Arabs and Portuguese. The buildings of the first period, of which the Great Zimbabwe is typical, are marked by great solidity and superior workmanship, with massive walls

of dry masonry resting on the bed-rock, often 15 to 17 feet thick at base, batter-backed both inside and outside, with no false courses, but bonded throughout their entire width and diversely ornamented with dentelle, check, chevron and especially herring-bone patterns (Fig. 1). These are assigned with Bent, Schlichter and myself to the South Arabian Himyarites, and are compared—in their characteristic elliptical curves, the absence of mortar and other details—with the ruined temples and palaces of Marib (Maraiba Bahramalukum), capital of the ancient Sabæan empire.

To the Phœnician successors of the Sabæans are assigned the less substantial and otherwise somewhat inferior structures of the second period, which are either superimposed upon, or else form extensions of, the earlier monuments, and also occur by themselves generally in



CHECK PATTERN

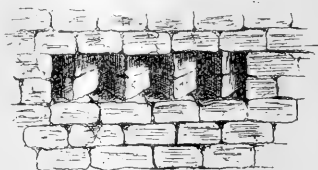

DENTELLE PATTERN

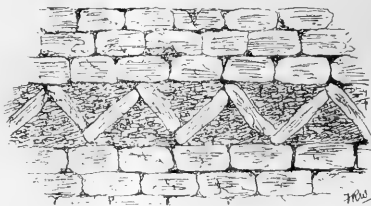

CHEVRON PATTERN

DECORATIVE PATTERNS

FIG. 1.

districts farther removed from the east coast. This is, of course, what we should expect to find on the assumption that the Himyarites were the first arrivals, and settled in the rich auriferous tracts (Manica, Sabi basin, Mashonaland) lying nearest to the seaboard. Yet remains of the first period are also met sporadically farther west in various parts of Matabilland, which may be explained either by assuming a very long pre-Phœnician Sabæan occupation or a joint Sabæo-Phœnician occupation probably in Solomonic times, when we know that peaceful relations prevailed between the Israelites, Hiram, King of Tyre, and Balkis, Queen of Sheba. It was then that the auriferous stream, which had already reached Palestine during the reign of David, rose to high-water level, and it is here suggested that

¹"The Ancient Ruins of Rhodesia." By R. N. Hall and W. G. Neal with above seventy illustrations, maps and plans. Pp. xxvii + 396 (London Methuen and Co., 1902.) Price 21s. net.

the sources of that stream are to be sought in Rhodesia, where the ancient gold-workings are stated to have yielded a total output of at least 75,000,000*l.* Then it is asked, "Where else but Rhodesia did the ancient Sabaeans obtain the vast supply of gold which they purveyed to Phœnicia, Egypt and the rest of the then known world? The only answer possible at present is: Rhodesia; and the later discoveries in Rhodesia only serve to strengthen and emphasise this answer." Hence the inference that Rhodesia was the Biblical Ophir, though the point is not regarded as settled. Indeed, in their preface, written after the appearance of my "Gold of Ophir," the authors seem inclined to adopt the modified view that Rhodesia was the source, and Ophir in South Arabia the importer and distributor, of these treasures throughout the ancient world. My conclusions bearing on this solution of the question are given in full, and seem to be tacitly accepted.

But the authors remind us more than once that their object has not been to advocate any particular theory,

crucibles showing gold in the flux, and especially the massive gold objects—beads, bangles, plates, wire, pegs, nails, ferrules—which were so characteristic of the monuments of the first period, and of which more than 2000 ozs. have already been collected (Fig. 2). Some of the ornaments, obviously manufactured on the spot and displaying considerable artistic taste and technical skill, were found on the original cemented floors, while others were taken from the skeletons of men, women and children buried under the floors. "All the branches of the goldsmiths' art were practised by them, including gold wire drawing, beating gold into thin sheets, plating iron and bronze with gold, and burnishing" (p. 93). It is evident from such details as these, as well as from the slave-pits, the chains of forts stretching along the old highways seawards, and the terraced slopes erected with prodigious labour for agricultural purposes, that the country was not merely conquered, but settled, that it was a true colony in the modern sense of the term, and was held as such by the South Arabian Himyarites for many generations. But enough has perhaps been said to show the great value of a work which places the Ophir question on a new footing and sets history back some two millenniums in the austral world.

A. H. KEANE.



FIG. 2.—Gold ornaments and pottery discovered at Dholo-Dholo and M'etegwa Ruins.

but "to allow facts to speak for themselves." Judged from this standpoint, the work must be pronounced an unqualified success. It would be impossible to improve upon the general plan, by which law and order is introduced into a chaos of small but indispensable details, brought together during six years of continuous exploration amid the ancient ruins south of the Zambesi. Students of Rhodesian antiquities will also feel grateful for the aid afforded by the accompanying large-scale map, which covers the whole ground and shows in red lettering the exact position of the five hundred ruined sites which have so far been either described or reported in every part of Rhodesia.

Limitation of space prevents more than the merest reference to many incidental matters, such as the structures now recognised as slave-pits, the extensive terraced slopes of the Inyanga and Mount Fura districts exactly resembling those of the Yemen uplands, the quartz crushers, the gold-smelting works, the numerous gold

THE INSTITUTION OF ELECTRICAL ENGINEERS AND ELECTRICAL LEGISLATION.

REFERENCE is made in our notes columns to the ceremony performed by Sir Frederick Bramwell in connection with the South Wales electrical power distribution scheme. The Bill for the promotion of this scheme was, it will be remembered, one of six before a Select Committee of Parliament, presided over by Sir J. Kitson last year. These Bills gave rise to a paper read by Mr. W. L. Madgen before the Institution of Electrical Engineers on "The Electrical Power Bills of 1900: Before and

After" (*Journal Inst. Elec. Engin.* vol. xxx, p. 475), in which the author dealt with the question of England's backwardness in the development of electrical engineering. The paper may be considered in some respects one of the most important communicated to the Institution of late years. It led to a prolonged discussion—the report of the proceedings occupies more than sixty pages of the Institution's *Journal*—in which, though various opinions were expressed as to the cause of our deficiency, the general conclusion seemed to be reached that the backwardness was due largely to the out-of-date and grandmotherly legislation which governed electrical undertakings. As a result, a powerful committee was appointed by the council of the Institution to report on the subject and advise the council whether they should take any action, and if so what action, to improve the position. The members of the committee were the following:—Prof. W. E. Ayrton, J. Perry and S. P. Thompson, Major P. Cardew, Lieut.-Colonel R. E.

Crompton, and Messrs. S. Z. de Ferranti, R. Hammond, H. Hirst, J. E. Kingsbury, W. L. Madgen, W. M. Mordey, R. P. Sellon, A. Siemens, C. P. Sparks, J. Swinburne and A. A. Campbell Swinton. This committee, after holding eleven meetings and collecting a quantity of evidence, has just published its report, which has been adopted by the council of the Institution. As the subject is one of vital importance, not only to the electrical profession, but to the whole nation, it will be of interest to consider this report in some detail.

By their first resolution the committee state that "the development of electrical science in the United Kingdom is in a backward condition as compared with other countries, in respect of practical application to the industrial and social requirements of the nation." As a case illustrating this contention, the American equipment of the Central London Railway will occur to everyone; and the undisputed competition between Messrs. Ganz and Co. and the Westinghouse Company, two foreign firms, for the electrical equipment of the Metropolitan and District Railways affords a second illustration. The South Wales distribution scheme is a third case in point, for it will be seen from the note to which we have referred already that though the engines are to be of English make, the electrical generators are to be supplied from abroad.

The resolutions which follow attribute the backwardness largely to "the restrictive character of the legislation governing the initiation and development of electric power and traction undertakings, and the powers of obstruction granted to local authorities," and point out that "local boundaries have usually no reference whatever to the needs of the community in regard to electric supply and traction," and that the development of these undertakings offers the most favourable means of relieving congested centres. The economic importance of the question is thus clearly insisted upon by the committee. As regards the power of local authorities, it is recommended that the Electric Lighting Acts 1882-8 and the Tramways Act 1870 should be amended in so far as they enable local authorities to veto or delay electrical undertakings of proved public utility. A similar recommendation was made by a joint committee of the two Houses of Parliament in 1898, but nothing has been done so far to give effect thereto.

In addition, it is pointed out that the technical staffs of the Government departments are inadequate for present needs, and finally the committee recommends that a deputation from the Institution of Electrical Engineers should wait on the Prime Minister to urge the removal of the present disabilities and restrictions. It is to be hoped that this final resolution will take effect and will produce the desired result. It is not to be supposed that the legislative difficulty is the only one which has hampered electrical development in England, but it is unquestionably one of the greatest. As more than one speaker pointed out in the discussion on Mr. Madgen's paper, we have to cope with the superior organisation of foreign manufacturers, due to the recognition of the high value of scientific training and the closer assimilation of theory and practice. In the industrial war which we have to carry on it is, as Prof. S. P. Thompson said, "brains really against which we have to fight." And we have to meet something more than this, namely, the experience which foreign manufacturers have gained in constructing electrical machinery, not for their own requirements merely, but for ours also. If we are to make up our leeway and be successful in this struggle, it is essential that we should not be hampered by out-of-date legislation. Reform may be necessary in other directions as well, but that does not lessen the need for reform in this direction. Anything that can be done to make our path more easy should be done without

delay, lest we find, when it is accomplished, that we are too late. To do what is in their power for the furtherance of this object is the interest, not only of electrical engineers, but of all who do not desire to see our commercial supremacy pass to other countries.

DECORATIVE PLANTS FOR GARDENS.¹

IN the second volume of the fifth series of the *Atti del Reale Istituto d'incoraggiamento di Napoli* (1901), Dr. Nicola Terraciano has an elaborate paper on the wild plants of Italy that are most suitable for decorative purposes in gardens. Such indications are greatly needed in many countries besides Italy. At this season of the year, if the botanist or the flower-lover pays a visit to a garden, or particularly to a flower-show, he will see hundreds of daffodils, for instance. If by chance he visits another locality he will still see hundreds of daffodils of the same kind. They are very beautiful, and to the student of evolution most interesting and most worthy of study. But after a time they get somewhat monotonous, and the visitor begins to long for a change. These daffodils of which we have been speaking may be referred to some two or three, or at most half a dozen, species only, but if we turn to the memoir before us we find some twenty species enumerated, and we wonder why more of them are not pressed into the service. Again, if we look to the "schedules" of the flower-shows at the Cape of Good Hope, or of any of our Australian colonies, we find slavish imitations of European procedures—chrysanthemums galore in their season, daffodils, roses and the like, just as in an English exhibition—but the representatives of the local floras are not represented. And yet the Cape flora and the West Australian flora are probably much richer in plants suitable for cultivation than those of any similar areas in the world. What a disappointment to the botanist to visit a flower-show in South Africa or Australia and find little or nothing but chrysanthemums when he is eager to see the beauties of the Cape Peninsula and of the Swan River.

Dr. Terraciano evidently holds the same views, for he puts before us a long list of the plants of Italy more or less suitable for garden decoration. He points out how great are the resources of the Italian peninsula, stretching as it does from Alpine almost to sub-tropical regions, with a long coast-line, with marshes, heaths, forests and endless diversity of soil, and situation clothed with a corresponding diversity of vegetation.

It is no wonder, then, that his list is a long one. There are fourteen species of tulips, for instance. Some of the plants might perhaps have been omitted, such as some of the eight species of *Juncus*. To the botanist pure and simple mere beauty is, of course, subordinated to other considerations. We remember a botanist's garden at Reigate many years since which was full of interesting things, but when the garden changed hands, the new proprietor is recorded to have said, when giving orders for their destruction, that he "must draw the line at docks!"

Dr. Terraciano indicates the soils most suitable for the cultivation of particular plants, and recommends for many of them a compost of peat, fragments of chestnut wood and leaf-mould.

Considering what a favourable nidus this would in our damp climate form for fungus spawn, we should hesitate to employ it on a large scale. Cultivation in sphagnum moss we first saw in Italy many years ago, and succeeded in growing *sarracenia*s in it in a London suburb for a time.

¹ "Le piante della flora italiana più adatte all'ornamento dei giardini."

NOTES.

THE following fifteen candidates have been selected by the council of the Royal Society to be recommended for election into the Society:—Mr. H. Brereton Baker, Prof. Henry T. Bovey, Prof. Robert Boyce, Mr. John Brown, Mr. William Bate Hardy, Mr. Alfred Harker, Mr. Sidney S. Hough, Mr. Robert Kidston, Mr. Thomas Mather, Mr. John Henry Michell, Mr. Hugh Frank Newall, Prof. William M. Flinders Petrie, Mr. William Jackson Pope, Mr. Edward Saunders and Dr. Arthur Willey.

THE gold medal of the Linnean Society of London has this year been awarded to Prof. Rudolf Albert von Kölliker, of Würzburg, in recognition of his distinguished contributions to zoological science. The medal will be presented at the forthcoming anniversary meeting, which will be held at Burlington House on May 24.

WE are glad to learn that Prof. Rudolph Virchow has now recovered in what may be termed a highly satisfactory manner from the serious accident with which he met a few months ago. A few days ago he was able to leave Berlin for the country, where he will reside for some months to come, leave of absence having been granted him for the whole summer term. In the meantime, his duties of lecturing and examining will be undertaken by his three principal assistants.

AT the annual meeting of the Institution of Civil Engineers, held on April 29, Mr. J. C. Hawkshaw was elected president and Sir William White, K.C.B., Mr. F. W. Webb, Sir Guilford Molesworth, K.C.I.E., and Sir Alexander Binnie were elected vice-presidents of the Institution.

NEWS from the Swedish Antarctic expedition under Dr. Otto Nordenskjöld has been received by the *New York Herald*. The expedition has disembarked at Snow Hill, Louis Philippe Land, accompanied by the surgeon, Dr. Eklof, Lieutenant Sobral and two sailors. From Cape Horn Dr. Nordenskjöld tried to sail the *Antarctic* directly south, but too many icebergs were encountered and there was danger of the ship being imprisoned in the ice for a long time, so he decided to change his course. The expedition will remain at Snow Hill until next summer.

THE conversazione of the Institution of Electrical Engineers will be held in the Natural History Museum, South Kensington, on Tuesday, July 1. In view of the fact that the Tramways and Light Railways Congress will then be sitting, and many of the foreign delegates to the Congress are likely to attend the conversazione, and that the Incorporated Municipal Electrical Association will also open its convention in London on the following day, one of the large side galleries will be opened for the conversazione in addition to the central hall of the Museum.

THE seventh annual congress of the South-Eastern Union of Scientific Societies will be held at Canterbury on June 5-7. On Thursday, June 5, the president-elect, Dr. Jonathan Hutchinson, F.R.S., will deliver the annual address. The following papers will be read during the meeting:—"The Marine Aquarium, without Circulation or Change of Water," by Mr. Sibert Saunders; "Recent Researches on Mimicry in Insects," by Prof. E. B. Poulton, F.R.S.; "The Preservation of our Indigenous Flora, its Necessity, and the Means of Accomplishing it," by Prof. G. S. Boulger and Mr. E. A. Martin; "Borings in the Neighbourhood of Canterbury," by Mr. W. Whitaker, F.R.S.; "Mycorrhiza, the Root Fungus," by Miss Annie Lorrain Smith. There will be an excursion to the South-Eastern Agricultural College, Wye, by the kind invitation of the principal, Prof. A. D. Hall, who will explain the valuable experimental work now being carried on in connection with the college.

THE Lawes Agricultural Trust Committee has appointed Mr. A. D. Hall, principal of the Agricultural College, Wye, to succeed the late Sir Henry Gilbert, F.R.S., as director of the Rothamsted Experimental Station. Principal Hall, who graduated at Oxford, and has since distinguished himself by his successful development of Wye College as a centre of agricultural education, will thus carry on the experiments which were jointly conducted by Sir John Bennet Lawes and Sir Henry Gilbert for nearly sixty years, and are now of world-wide fame. It is confidently expected that not only will the continuity of past work be maintained, but that agricultural science will be advanced in many new directions at this well-known centre of research.

THE *Times* announces the death, at Newcastle-on-Tyne, of Mr. John Glover, the inventor of the "Glover Tower," the introduction of which represented a great advance in the manufacture of sulphuric acid. Mr. Glover did not patent his invention, and never derived much pecuniary profit from it, but chemical manufacturers know the value of the boon he conferred on them, and the Society of Chemical Industry testified to the importance of his work by awarding him in 1896 its gold medal for conspicuous service to applied chemistry.

THE death of Prof. H. von Pechmann, in sad circumstances, on April 24, is a great loss to the science of chemistry in Germany. He had been ill for a long time past, suffering, it would appear, from an incurable nervous trouble and frequent attacks of mental depression. That he might be restored to health he was granted a long leave of absence, and on resuming his duties was seemingly better than he had been for some time. But soon after his return he again became depressed and, while in that state, put an end to his life by taking strong sulphuric acid in his laboratory. Prof. von Pechmann was only fifty-two years of age, having been born in 1850, and the University of Tübingen will feel his loss very keenly. Appointed to the chair of chemistry at the last-mentioned University in 1895 in succession to Prof. Lothar Meyer, his skill in teaching and his personal charm were such that the number of students under him increased very considerably and, as a consequence, the enlargement of his laboratory and lecture-theatre was regarded as necessary. The late professor was a native of Nuremberg, and descended from an old Bavarian family of great social influence.

THE council of the Institution of Civil Engineers has made the following awards for papers read and discussed before the Institution during the past session:—a Telford medal (in standard gold) to Mr. W. M. Mordey, and a George Stevenson medal (in standard gold) to Mr. B. M. Jenkin; a Watt medal (in standard gold) to Mr. J. A. F. Aspinall; and Telford premiums to Messrs. W. C. Copperthwaite, A. H. Haigh and J. Davis. The council has also awarded the Howard quinquennial prize of the Institution to Mr. R. A. Hadfield (of Sheffield) for his scientific work in investigating methods of treatment and new alloys of steel, and on account of the importance, in industry, of some of the new products introduced by him. The presentation of these awards, together with those for papers which have not been subject to discussion and will be announced later, will take place at the inaugural meeting of next session.

THE seventy-third anniversary meeting of the Zoological Society of London was held on April 29, the chair being taken by the Duke of Bedford, K.G., president of the Society. The report of the council announced that the Prince of Wales had become a vice-patron of the Society. In February last the council awarded the gold medal of the Society to Sir Harry II. Johnston, G.C.M.G., K.C.B. Sir Harry Johnston received the silver medal of the Society in 1894 in acknowledgment of his zoological investigations in

British Central Africa. Since that date he has not ceased his endeavours to promote the advance of zoological discovery in the several posts that he has occupied in various parts of Africa, and has especially distinguished himself by the discovery, on the confines of Uganda, of the wonderful new African animal the okapi. The silver medal of the Society was awarded to Mr. E. W. Harper, of Calcutta, who during the past two years has presented to the Society a large number of living Indian birds new to the collection. These medals will be delivered personally to the recipients at the general meeting on June 19. The total income of the Society during the past year was 29,350*l.*, and the ordinary expenditure amounted to 27,526*l.* The extraordinary expenditure paid in 1901, amounting to 4530*l.*, was devoted entirely to new buildings and works in the Gardens. The most important works carried on at the Gardens during the past year were the rebuilding of a portion of the green-houses and the new drains to the hippopotamus-house. Besides these works, a new ape-house for the better accommodation of the anthropoid apes was commenced last autumn, and a sum of 4000*l.* has already been expended upon it. The main feature of the new building is the entire separation of the part appropriated to the spectators from that in which the animals are lodged by a glass screen, so that the animals may be kept at a nearly uniform temperature. The number of visitors to the Society's Gardens in 1901 was 725,685, showing an increase of 28,507 as compared with the previous year and an increase of 61,130 above the average of the previous ten years. The number of animals living in the Gardens on December 31 last was 2922, of which 789 were mammals, 1575 birds and 558 reptiles and batrachians. Amongst the additions made during the past year, 10 mammals, 58 birds, 21 reptiles, 3 batrachians and 2 fishes were registered as new to the collection.

THE Electrochemical Society, which has just been founded in America, held its inaugural meeting at Philadelphia on April 3-5. The president is Prof. J. W. Richards, of Bethlehem, and the list of officers contains the names of most of the best-known American electrochemists. During the three days' session, twenty papers were read and discussed, and arrangements are being made, we understand, for the publication of the proceedings. The formation of this society is a sign of the importance which electrochemistry has attained in the United States. Tentative proposals have been made at various times for the formation of a similar society in this country, but it is doubtful whether there are a sufficient number of workers in this field to ensure its success. Perhaps the founding of the American society may stimulate English electrochemists to further effort in this direction. Some such organisation, in conjunction with the already existent electrochemical journal, might have the effect of bringing this country into line with Germany and America in this branch of electrical science.

WE noticed in these columns last year the starting of the first large power distribution scheme in England at Newcastle-on-Tyne. Last week, on April 29, Sir Frederick Bramwell laid the foundation-stone of the first generating station of the South Wales Electrical Power Distribution Company, thus inaugurating the second scheme in this country for the supply of electricity in bulk. The area that this company proposes to supply covers Glamorgan and a part of Monmouth, a total area of slightly more than 1000 square miles. The district is one eminently suited to the electrical distribution of power, as it includes collieries, steel-works, tin-plate and copper works and numerous other factories of different kinds. The generating station now being constructed is on the banks of the Taff, near Pontypridd, and it is expected that it will be completed in about eighteen months. The plant is to consist of five sets each having a capacity of 2250 kilowatts, making a total capacity of about 15,000 horse-

power. Willans engines are to be used, driving three-phase alternators by Messrs. Ganz and Co., of Budapest. These will generate current at 12,000 volts, which will be converted to low-tension continuous current to be supplied to consumers. The steam generating plant is to consist of twenty-four water-tube Niclausse boilers, which are being built by Messrs. Willans and Robinson at Chester. Three other generating stations will be erected later. It is estimated that the cost of generating power will be slightly over three farthings a unit, which will enable it to be sold cheaply whilst allowing a considerable margin for profit.

THE *Journal of Physical Chemistry* for January contains a paper by Prof. Kahlenberg on instantaneous chemical reactions and the electrolytic dissociation theory. A previous paper by the same author, in which he discussed the validity of the ionic theory of electrolysis, has been abstracted at considerable length in NATURE (vol. lxxv. p. 305). In this second communication Prof. Kahlenberg attacks the theory that instantaneous chemical reactions are dependent upon ions; the question that the author sought to answer was whether these reactions, causing precipitation by double decomposition, can take place in non-conducting solutions. He finds that benzene solutions of chlorides, such as HCl, SnCl₄, PCl₅, AsCl₃ and SiCl₄, precipitate cupric chloride from a benzene solution of copper oleate. There is thus a reaction precisely analogous to the precipitation of silver chloride from silver nitrate solutions by means of a soluble chloride, although in this case both the reacting solutions are excellent insulators. The benzene copper and the benzene chloride solutions are no better conductors than benzene itself, nor is there any increase of conductivity at the moment of precipitation. Elaborate precautions were taken in all the experiments to exclude any trace of moisture. In addition, freezing- and boiling-point measurements were made on the copper oleate solution, as well as the conductivity tests, which showed that there was no electrolytic dissociation. The author concludes that, instantaneous reaction in insulating solutions having been thus demonstrated, similar reactions in aqueous solutions cannot be explained on the ionic hypothesis without further proof.

A COPY of the results of meteorological and magnetical observations at Stonyhurst College Observatory for 1901 has been received. The observations are very complete and are especially valuable from the fact that the means can be compared with those for the last fifty-four years. The total fall of rain in the year was close upon 39 inches, being 8 inches below the average. The shade temperature reached 89° on July 20, which is the highest recorded at Stonyhurst. The lowest shade temperature registered during this long series was 4°·6, on January 15, 1881. Drawings of the solar surface were made on 235 days. An appendix contains the results of meteorological observations taken at Malta, with means for the last eighteen years.

IN *Simons's Meteorological Magazine* for March, there are several communications from correspondents referring to the sun-pillar of March 6. It appeared to have been most strikingly visible in the south and south-west of England, and was also observed at some inland stations. An observer at Bridport states that at 6h. 10m. p.m. it shot upwards 10° perpendicularly above the horizon, and that its colour was yellow, tinted with orange. At 6h. 25m., when its altitude had lessened to 5°, it showed a remarkably intense rosy tint, and at 6h. 40m. scarcely a trace was left. The theory of the formation of the phenomenon is that the effect of a luminous shaft is given by reflection from the under surfaces of minute crystals of ice floating horizontally. The Rev. S. Barber points out that the result is precisely similar to the formation of a long shaft of light by the reflection of the moon on the rippled surface of the sea.

A HISTORICAL account of the discovery of voltaic electricity is contributed to Nos. 642 and 643 of *Prometheus* by Dr. F. Dannemann. It deals chiefly with the discoveries of Volta, Galvani, Oersted and Ampère, and the author considers that at the beginning of the twentieth year of the nineteenth century the chief fundamental facts concerning electricity had been made known with the exception of induction, which was left for the genius of Faraday to discover.

THE tendency of streams to diverge from a straight path and to assume a zigzag course forms the keynote to a paper by Mr. Lewis B. Haupt, on single curved *versus* double straight jetties, in the *Journal* of the Franklin Institute for April. Where a river assumes a sinusoidal form there is a constant tendency of the current to eat away the concave banks and to deposit silt on the convex ones, and the author considers that if this natural tendency is counteracted by confining the stream between two parallel straight jetties, much expense in dredging out the river bed will be incurred, whereas the construction of a single wall at the concave side of bends will enable Nature to do her own work by keeping the channel scoured at the side of the wall and forming a convex training bank at the other side. This method has been tried with success at Aransas Pass in Texas, and the author is of opinion that single concave reaction-jetties may economically be adapted to the opening of the delta mouths of silt-bearing streams.

A SHORT note in the *Journal* of the Royal Microscopical Society, on a paper by Mr. G. Marpmann on distinguishing between *Pleurosigma angulatum* and *P. balticum* under low powers, may well suggest an interesting field of observation in the diffraction colours of some of the more regularly marked diatoms, and the possibility of measuring the striations of the valves even by naked eye observations. By holding a slide thickly spread with any species of the genus *Pleurosigma* in full sunshine, it is easy to trace the diffraction colours through the various tints of the spectrum from violet to red and even to follow the second diffraction spectrum down to the green, and it is possible in this way to go further than Herr Marpmann would appear to have done so far as can be gathered from the note in question. If a slide of *Pleurosigma angulatum* or *quadratum* is held up in a bright light and a few of the much more coarsely marked *P. balticum* happen to be mixed with the other diatoms, the latter forms, by the different colours which they exhibit, are easily discernible to the naked eye. Two other papers allied to the above are also noted in the same journal, one by Mr. W. Balfour Stokes, who concludes that the minute perforations in *Pleurosigma formosum* are silted up with silica, and one by Mr. J. Rheinberg, who has succeeded, by placing a disc of a certain form above the objective of his microscope, in obtaining two images of the same diatom in complementary colours, one being a dioptric image and the other a diffraction image of the first order.

IN the course of excavating in the churchyard of St. George the Martyr, Southwark, in connection with the Long Lane street improvement, now being carried out by the London County Council, a very interesting discovery has been made. At a depth of about nine feet, some fragments of pottery and of ornamental terra-cotta work were discovered in a heap, as if at some time or other they had been thrown together promiscuously. The fragments were exhibited at a meeting of the Society of Antiquaries on April 17. Whilst the pottery is Roman, the terra-cotta work, the ornamentation of which is peculiar, dates from the time of Henry VIII., in whose reign the art was introduced into England. Stow says that "almost directly over against St. George's Church, was some time a large and most sumptuous house, built by Charles Brandon, late Duke of

Suffolk, in the reign of Henry the Eighth, which was called Suffolk House." From Antony van den Wyngaerde's "View of London," circ. A.D. 1550, which contains the only representation of the house known, it appears that the mansion was built in the style of the early Renaissance, and it therefore seems very probable that the fragments in question had their origin in Suffolk House.

THE number of new species of American butterflies, mostly from Brazil, described by Mr. W. Schaus in No. 1262 of the *Proceedings* of the U.S. Museum (vol. xxiv.) may be taken as an indication of the large amount of work which remains to be done in South American entomology.

IN *Naturwissenschaftliche Wochenschrift* of April 27, Mr. C. Frings gives a *résumé* of the experiments made by Dr. Standfuss on hybridising Lepidoptera and the influence of temperature on the development of the pupa, to which allusion has been made in these columns on a previous occasion.

ONE of the most remarkable architectural structures in existence is the left-handed spiral staircase in the Chateau de Blois, Touraine, built during the sixteenth century from designs by Leonardo da Vinci. In a well-illustrated and thoughtful article published in the May number of the *Monthly Review*, Mr. Theodore Cook shows that the design of this staircase corresponds so exactly with the spirals on the common Mediterranean shell known as *Voluta vesperitilo* as to leave little doubt that the artist had that shell before him as his model. The spiral on the central column of the core of the staircase corresponds exactly, for instance, with the spiral ridges on the columella of the volute, as seen in section. This of itself would be strong, although perhaps not absolutely convincing, evidence as to the origin of the design. But the staircase has also an exquisite outer balustrade, which shows a correspondence to the coils on the external spire of the shell as close as that which obtains between the interior of the staircase and the columella of the volute. Such a dual resemblance could scarcely be the result of coincidence, and the author seems therefore to be justified in the view he has taken. It is remarkable, however, that the spirals in the staircase run in the reverse direction to those in normal examples of the shell, that of the central shaft being left-handed instead of right-handed. The spirals are, in fact, those of a "reversed," or dextral, example of the shell, of which, perhaps, one in a million occurs in nature. That Leonardo da Vinci had such a reversed shell from which to copy is unlikely; but it is known that he was left-handed, and a left-handed man would naturally draw a reversed spiral. The author, we believe, has in hand a work on natural spirals in general.

THE April number of the *Record of Technical and Secondary Education* contains an important review, by Mr. W. M. Webb, of the means taken by the different County Councils in England for training teachers in the best methods of imparting "nature-knowledge" to their pupils. The prime object of such teaching is, of course, to make the pupils conversant with natural things by seeing and handling them in their own surroundings, and for this purpose field-excursions are absolutely necessary. Some educationists would indeed reserve the American term "nature-study" for observations of this class in which the relationships of animals and plants is not the main point of instruction. But such studies cannot be altogether separated from systematic biology, and the value of a thorough biological groundwork to the teacher is accordingly emphasised by the author. Prof. Bailey's leaflets, which have been adopted by the Board of Education as a basis of nature-study, are insufficient if systematic biology is to be really taught, and short courses on the best methods of teaching natural history

are therefore recommended, and have indeed been adopted by many of the County Councils. Mr. Webb's concluding summary and his observations on methods of training teachers, which are the outcome of many years' practical experience, may be commended to all interested in the subject. Much good is hoped to result from the Nature-Study Exhibition to be held in London in July. Educationists will then "be enabled to compare the results of the efforts to promote 'nature-study' which are now being made in many directions and under varied conditions, and in this way an opportunity will be afforded to shape and to consolidate opinion upon a branch of our educational economy which has escaped hitherto that concentrated attention so necessary for its development."

THE May number of the *Contemporary Review* contains two articles upon scientific subjects. Prof. W. Ramsay describes the present state of our knowledge of different forms of radio-activity and Mr. J. B. Carruthers deals with a subject of a more immediate economic interest, perhaps, viz. plant sanitation. After an explanatory introduction, necessary to introduce the general reader to the terms he afterwards employs, Prof. Ramsay gives a historical sketch of the work done in the direction of perfecting our knowledge of radiation, from the time of Davy down to the present day. He explains the general characteristics of ultra-violet, kathode and X-rays, and proceeds to treat in more detail the work of Poincaré, Henry, Curie, Debiere, Schmidt, Rutherford, Becquerel and others. In conclusion, Prof. Ramsay points the moral upon which NATURE has always insisted—"Whatever be the true explanations of these mysteries, it cannot be denied that they form the beginnings of what may, and almost certainly will, affect the material future of the human race. . . . It is true that investigators like Hertz, Lenard, Becquerel and the Curies do not make practical applications of their discoveries; but there is never any lack of men who discover their practical value and apply them to ends useful to mankind. All the more reason, therefore, that every encouragement should be given to the investigator, for it is to him that all our advances in physical and material well-being are ultimately due." Mr. Carruthers urges that if the same care were taken with plants as has been done to eliminate disease in men and animals, there would be many fewer plant troubles than the agriculturist has to contend with at the present time. He pleads for the introduction into this country of the means taken by the State in America, continental countries and some of our colonies, to discover and eradicate disease in plants.

We have received the "Year Book of New South Wales," which contains much useful information intended mainly for those wishing to settle in the country. The history, physical features, soils, minerals, water-supplies, trade and commerce, crown lands and many other subjects are dealt with.

THE Yorkshire Geological and Polytechnic Society gives abundant evidence of its flourishing state in the last number of its *Proceedings* (new series, vol. xiv. part ii.), which contains no less than twelve papers and twenty-eight plates. We are glad to note a contribution from the pen of Prof. McKenny Hughes, on the physical geography of the district around Ingleborough. There are papers on glacial drift, on Carboniferous fishes and other subjects, and we may call special attention to a "first paper," by Mr. Robert Kidston, on the flora of the Carboniferous period, illustrated by thirteen excellent: photographic plates of coal plants. There is also a memoir, accompanied by a portrait, of the late Mr. W. Percy Sladen.

In Appendix iv. to the *Kew Bulletin* is given a list of the staffs at the Royal Botanic Gardens, Kew, and at such other botanical establishments at home, in India and the Colonies as are in correspondence with Kew.

We have received the sixth set (reduced copies) of Blackie's South Kensington drawing cards, which portrays "plant forms" in the shape of leaves, fruits and flowers. Each full-sized set consists of twenty cards, measuring 28 x 20 inches. As the previous set deals with advanced ornament, the present series might with advantage have been more complex; also the comparison of the natural object and the same conventionally treated would have been instructive. As the reduced copies present the objects full size, it would be possible to combine the natural and the conventional on the same card without unduly diminishing the proportions.

THE bibliography of the literature of psychology and cognate subjects, issued annually under the title of the "Psychological Index" by the *Psychological Review*, is a very serviceable publication. The index for 1901, compiled by Prof. H. C. Warren, with the cooperation of Messrs. J. L. des Bancels, L. Hirschlaff, C. D. Isenberger and W. H. R. Rivers, has just been received, and it contains an orderly and comprehensive catalogue of French, German and English psychological publications issued during the year. There are nearly three thousand titles.

THE third edition of Prof. Erdmann's comprehensive "Lehrbuch der anorganischen Chemie" has been published by Messrs. F. Vieweg and Son, Brunswick. The original work was reviewed in these columns nearly three years ago (vol. ix. p. 289), and the new edition does not differ materially from it, though its value has been increased by revision and by the addition of about thirty new pages—bringing the total number up to 788 pages. The first part of the book is concerned with elementary chemical principles and methods, the second with non-metallic elements and the third with the metals. A long section at the end deals with the periodic law and some aspects of physical chemistry.

THE additions to the Zoological Society's Gardens during the past week include a Sooty Mangabey (*Cercopithecus fuliginosus*) from West Africa, presented by Miss Frost; a Long-eared Owl (*Asio otus*) European, presented by Miss Kate M. Hall; two Kestrels (*Tinnunculus alaudarius*) British, presented by Mr. Austin; a Black Francolin (*Francolinus vulgaris*) from the Coast of Syria, presented by Commodore Winsloe, H.M.S. *St. George*; a Short Python (*Python curtus*) from Borneo, presented by Mr. L. Wray; a Macaque Monkey (*Macacus cynomolgus*), a Bungoma River Turtle (*Emyda granosa*) from India, two Grey Monitors (*Varanus griseus*) from North Africa, a Anaconda (*Eunectes notatus*), a Western Boa (*Boa occidentalis*) from Paraguay, ten Tesselated Snakes (*Tropidonotus tessellatus*), two Dahl's Snakes (*Zamenis dahl*), a Leopardine Snake (*Coluber leopardinus*), three Eucalopian Snakes (*Coluber longissimus*), a Lacertine Snake (*Coluber mopsessulana*), a Dark-green Snake (*Zamenis genonensis*) European, a Pel's Owl (*Scotopelia peli*) from Africa, a Many-zoned Hawk (*Melierax poliopterus*) from Morocco, deposited; a Brown Capuchin (*Cebus fatuellus*) from Guiana, ten Common Teal (*Querquedula creca*) European, a Black-pointed Tequinox (*Tupinambis nigropunctatus*) from South America, purchased; a Barbary Wild Sheep (*Ovis tragelaphus*), two Mouflons (*Ovis musimon*), a Rufous-necked Wallaby (*Macropus ruficollis*) born in the Gardens.

OUR ASTRONOMICAL COLUMN.

CHANGES ON THE MOON'S SURFACE.—That the moon is a dead planet, devoid of water-vapour and air and consequently lacking any form of life, either of the animal or vegetable world, has long been the belief of astronomers. New light upon the history of our satellite is, however, beginning to dawn, and it seems that the imagination of Mr. H. G. Wells, which illustrated so vividly the seasonal changes on the moon's surface and the appearance of vegetation of rapid growth, is supported by actual

"results of observation," judging from an interesting article by Prof. William II. Pickering in the May number of the *Century Magazine*. Messrs. Pickering and Percival Lowell have during the last few years made numerous excellent observations on the planet Mars, and they have greatly increased our knowledge by accurately observing the surface markings and suggesting very plausible explanations of the phenomena observed. Such work was rendered possible by erecting an observatory in a locality where observing conditions were as near perfect as possible. Prof. Pickering has more recently turned his attention to an examination of the lunar surface, and the first results of this work have led him to some very definite and striking conclusions. The first of these is that there seems to be strong, if not fairly conclusive, evidence in favour of the idea that volcanic activity has not yet entirely ceased, and he quotes several instances in which small craters have disappeared while others have sprung up in different regions. The second, and perhaps more startling, announcement is that there is snow on the moon. He has observed that many craterlets are lined with a white substance which becomes very brilliant when illuminated by the sun, and a similar substance is found on the larger lunar craters and a few of the higher mountain peaks. The curious behaviour of these patches under different angles of illumination and their change of form have led him to suggest that an irregularly varying distribution of hoar frost may have something to do with the changes observed. The third remarkable deduction refers to the observations of "variable spots," which appear to be restricted between latitudes 55° north and 60° south; these spots are always associated with small craterlets or deep narrow clefts, and are often symmetrically arranged around the former. The alterations which these undergo have led him to seek the cause in the change in the nature of the reflecting surface, and the most simple explanation according to him is found in assuming that it is organic life resembling vegetation, but not necessarily identical with it. The new selenography consists, therefore, as Prof. Pickering remarks, "not in mere mapping of cold dead rocks and isolated craters, but in a study of the daily alterations that take place in small selected regions, where we find real, living changes, changes that cannot be explained by shifting shadows or varying librations of the lunar surface." Prof. Pickering illustrates his article with numerous excellent and instructive drawings and photographs of portions of the lunar surface, and these give the reader a good idea of the changes referred to in the text.

DUST-FALLS AND THEIR ORIGINS.¹

FALLS of dust on a large scale are of rare occurrence, but one very often hears that in the south of Europe at such and such a place rain had fallen and had brought with it, and deposited on the ground, fine red or yellow dust. Thus on April 24, 1897, a south wind carried to southern Italy a great quantity of dust which was supposed to be of African origin.

Perhaps the most well-known instance of a fall on a large scale was that which occurred in May and August in the year 1883, when an enormous quantity of dust was hurled into the air during the Krakatoa eruption, and fell and was collected at various distances, the greatest being more than 1100 miles from the seat of the disturbance. The tremendous height to which the finer particles of dust were thrown, coupled with the movement of the air at this great distance from the earth's surface, were responsible for the magnificent coloured sunsets which were observed nearly all over the world. The volume² in which all these observations were collected is undoubtedly one of the most complete records of a "fall of dust" that has been published.

The large number of meteorological stations situated over the greater portion of the civilised world give us now greater chances for recording and tracing the paths of these falls of dust, whether they reach the earth's surface with or without the aid of rain. Fortunately, the tracks of the great dust storm of March 9-12 of last year and that of the minor storm of March

19-21 of the same year were restricted to such regions as these, passing over the coast of northern Africa and reaching Sicily, Italy, Austro-Hungary, Prussia, part of Russia, Denmark and even the British Isles.

In the volume before us, Profs. Hellmann and Meinardus have brought together all the information that could be collected by means of the distribution of circulars and communications with all meteorological stations, and discussed them in a very thorough and able manner, presenting us with a complete story, describing the locality from which the dust came, the means, direction and mode of transport, and finally the places over which it was deposited. The arrangement of the discussion is as follows:—The distribution of the dust over the land surface is first described, accompanied by the original accounts of the phenomenon as observed, a list of all places where the fall was recorded, and a map showing the general distribution. The meteorological conditions from March 9-12 are next dealt with, giving full details of the general atmospheric disturbances over the whole of Europe and North Africa, with numerous maps. The authors then give the individual reports on all the microscopic and chemical analyses of the dust from various localities, concluding with a brief account of the second fall of dust from March 19-21 and a general summary of the main results to which they have been led.

In these chapters the discussion of the facts collected has led the investigators to form a very concrete survey of the whole phenomenon, tracing the origin of the dust to dust-storms that occurred on March 8, 9 and 10 in the desert El Erg, situated in the southern part of Algeria, and which carried the dust and transported it northward.

This dust, as is here pointed out, began to fall at Algiers and Tunis in the dry state on the night of the 9th. The subsequent falls gradually took place northwards, first Sicily, then Italy, the Alps, Austro-Hungary, Germany, Denmark and European Russia, practically in the order named, coming in for their share. In Sicily and Italy the dust was noticed to have fallen even without the aid of rain, but in the other countries it was only detected during and after showers.

Not only did the dust-fall occur in these countries in the sequence mentioned, but the quantity that fell became gradually less the more north the places were situated, and the fineness of the dust, as shown by the analyses, increased at the same time. All these facts, as the authors indicate, are strong arguments in favour of the progress of the dust deposition from south to north, and the very minute and careful examination of the meteorological conditions stated here, showing a depression moving from south to north, endorse this point of view. There is little doubt, therefore, that the locality from which the dust originated was situated somewhere south of the northern shore of the African continent.

It is interesting to notice that the dust was not distributed homogeneously over the land areas, but in patches and streaks, some places, such as, for instance, the greater part of south Germany and Russian Poland, being entirely free from it, while others, such as the southern side of the eastern Alps and Holstein, being specially dense. The unequal distribution and different values for the rate of movement of the dust cloud seem to be adequately explained by the variable velocity of the air currents and the changing position of the barometric depression.

The investigation suggests that the dust was carried by a large mass of air which moved with great velocity from northern Africa to the north of Europe, and that this mass of air, cyclonic in nature, was fed on its western side by air currents from the north and on its eastern side by southerly currents; this accounts for the observed facts that the fall of dust was chiefly limited to the eastern portion of the depression.

As regards the total amount of dust that fell to the surface, rough estimates indicated that the weight of it would amount to about 1,800,000 tons, two-thirds of which were deposited to the south of the Alps.

The authors have shown that the most probable origin of the dust was the region to the south of Algeria, so that an examination of the dust that fell in Europe and elsewhere should consist of similar components as those that form the dust of this region. Nearly all the mineralogical, microscopic and chemical analyses point out that the dust is neither volcanic nor cosmic, but simply such as is found on the African continent. From exactly which part of the continent it came is evidently not certain, for some mineralogists suggested that the dust consisted

¹ "Der grosse Staubfall von 9 bis 12 März, 1901, in Nordafrika, Sud- und Mitteleuropa." Von G. Hellmann und W. Meinardus. *Abhandlungen des Königlich Preussischen Meteorologischen Instituts*, Bd. II. No. 1. (Berlin: A. Asher and Co., 1901.)

² "Report of the Krakatoa Committee of the Royal Society." (London: Trubner and Co., 1883.)

of the finest particles of Sahara sand, while others looked for its origin on laterite ground.

The value of the occurrences of falls of dust is of special moment meteorologically, because they afford us a means of obtaining further knowledge of the actual movements of the air currents in the higher reaches of our atmosphere which cannot be gained by any other such direct methods. Much valuable information was obtained of the movement of the air at great heights by the dust that was ejected during the eruption of Krakatoa, and as this volcano is situated near the equator, where the air currents have a great tendency to rise directly away from the earth's surface, the conditions were favourable for the dust reaching an extraordinary elevation.

Nevertheless, whether the falls owe their origin to dust storms in a desert or eruptions of large volcanoes, it is of great importance to meteorological science that they should be, not only accurately observed, but recorded and discussed. Fortunately, the fall in the present instance occurred where a great amount of useful data could be, and was, secured. In the handling of this material the authors are to be congratulated, for besides considerably increasing our knowledge of the way in which the dust is transported and enlightening us on other peculiarities of this interesting phenomenon, they have given us a volume which will serve as an excellent example for future recorders and observers.

W. J. S. L.

BRITISH VERSUS AMERICAN LOCOMOTIVES.

A NOTEWORTHY Parliamentary paper has recently been issued containing correspondence respecting the comparative merits of British, Belgian and American built locomotives running on the Egyptian railways. The paper is full of interest to the locomotive engineer, bearing out as it does the unsatisfactory results obtained with American locomotives on British, Colonial and Indian railways when compared with the English design of engine, and, what is more, these unsatisfactory results are in all cases certified by the representative of the American firm of locomotive builders, as well as by an official appointed by the Egyptian railway authority, so there can be little doubt as to their accuracy.

Probably the most interesting report in the series is that by Mr. Trevithick, the locomotive engineer, who says:—

"The Mechanical Department of the Egyptian State Railways has recently made some interesting comparative trials between British and American locomotives of the same weight and power. These comparisons have been carried out under exceptionally favourable circumstances, inasmuch as the locomotives employed were typical of their respective countries in design and manufacture, and the trials were personally conducted, and the results conjointly signed, by a representative sent out by the American builders and a locomotive inspector of the Egyptian Railway Administration.

"The first set of trials, consisting of eight runs extending over 1034 miles, was between goods engines, and, in order to secure similar loads and to be able to gradually increase the weight of trains to the maximum that the respective engines could satisfactorily draw, the material transported consisted chiefly of coal.

"The total amount of coal consumed in the eight trips by the British engines was 2254 tons, which works out at an average of 49 lbs. per mile, whilst the American engines consumed 2869 tons, an average of 62 lbs. per mile; in other words, for every 100 tons of coal consumed by the British engines the American engines burnt 1254 tons, i.e. an excess of 254 per cent. This economy was effected by the British engines, although they drew a heavier average load, to the extent of 14.2 per cent. than the American, the average train taken by the British engines being 57 trucks, or 868 tons, as against 54 trucks, or 760 tons, the average train taken by the American. The maximum load taken by each make of engine was 61 trucks.

"These trials were followed by others between passenger types of engines, extending over 1345 miles; each make ran an equal number of trips with practically similar formation of trains, with the result that the British engines consumed a total of 1847 tons of coal, or an average of 30.7 lbs. per mile, as against a total of 278 tons, or an average of 46.3 lbs. per mile, in the case of the American engines, which means that where the British engine consumed 100 tons, the American engine consumed 150 tons, or 50 per cent. more. Such a difference at 11.47, 2d. per ton, the

average price paid last year by the Railway Administration, represents an additional yearly cost per engine of 4007; which is to say that these ten American engines would cost in coal in one year 40007. more than the ten British engines, an amount almost sufficient to buy two new ones."

The above extract from Mr. Trevithick's report conclusively proves that the British type of locomotive is well able to hold its own in the three important matters of fuel and oil consumption, and cost of repairs. Much has been written lately on the standardisation of the locomotive, but in a progressive age this appears to be unnecessary, since the locomotive of yesterday must always be out of date. Much can, however, be done to assist locomotive builders in the way of standardisation of specifications and, more particularly, of the test requirements for the material.

It is absurd to think that consulting engineers cannot agree as to the best test requirements for, say, a crank axle or a steel boiler plate. With standard tests the locomotive builders could buy the material more cheaply, obtain quicker deliveries from the makers, and, probably, in their turn take less time to complete an order.

INTERFERENCE OF SOUND.¹

FOR the purposes of laboratory or lecture experiments it is convenient to use a pitch so high that the sounds are nearly or altogether inaudible. The wave-lengths (1 to 3 cm.) are then tolerably small, and it becomes possible to imitate many interesting optical phenomena. The ear as the percipient is replaced by the high-pressure sensitive flame, introduced for this purpose by Tyndall, with the advantage that the effects are visible to a large audience.

As a source of sound a "bird-call" is usually convenient. A stream of air from a circular hole in a thin plate impinges centrally upon a similar hole in a parallel plate held at a little distance. Bird-calls are very easily made. The first plate, of 1 or 2 cm. in diameter, is cemented, or soldered, to the end of a short supply tube. The second plate may conveniently be made triangular, the turned-down corners being soldered to the first plate. For calls of medium pitch the holes may be made in tin plate. They may be as small as 3 mm. in diameter, and the distance between them as little as 1 mm. In any case the edges of the holes should be sharp and clean. There is no difficulty in obtaining wave-lengths (complete) as low as 1 cm., and with care wave-lengths of 0.6 cm. may be reached, corresponding to about 50,000 vibrations per second. In experimenting upon minimum wave-lengths, the distance between the call and the flame should not exceed 50 cm., and the flame should be adjusted to the verge of flaring ("Theory of Sound," 2nd ed., § 371). As most bird-calls are very dependent upon the precise pressure of the wind, a manometer in immediate connection is practically a necessity. The pressure, originally somewhat in excess, may be controlled by a screw pinch-cock operating on a rubber connecting tube.

In the experiments with conical horns or trumpets, it is important that no sound should issue except through these channels. The horns end in short lengths of brass tubing which fit tightly to a short length of tubing (A) soldered air-tight on the face of the front plate of the bird-call. So far there is no difficulty; but if the space between the plates be boxed in airtight, the action of the call is interfered with. To meet this objection a tin-plate box is soldered air-tight to A, and is stuffed with cotton-wool kept in position by a loosely fitting lid at C. In this way very little sound can escape except through the tube A, and yet the call speaks much as usual. The manometer is connected at the side tube D. The wind is best supplied from a gas-holder.

With the steadily maintained sound of the bird-call there is no difficulty in measuring accurately the wave-lengths by the method of nodes and loops. A glass plate behind the flame, and mounted so as to be capable of sliding backwards and forwards, serves as reflecting wall. At the plate, and at any distance from it measured by an even number of quarter wave-lengths, there are nodes, where the flame does not respond. At intermediate distances, equal to odd multiples of the quarter wave-length, the effect upon the flame is a maximum. For the present purpose it is best to use nodes, so adjusting the sensitiveness of the flame that it only just recovers its height at the

¹ A Discourse delivered at the Royal Institution on Friday, January 17, by the Right Hon. Lord Rayleigh, F.R.S.

minimum. The movement of the screen required to pass over ten intervals from minimum to minimum may be measured, and gives at once the length of five complete progressive waves. For the bird-call used in the experiments of this lecture the wave-length is 2 cm. very nearly.

When the sound the wave-length of which is required is not maintained, the application of the method is, of course, more difficult. Nevertheless, results of considerable accuracy may be arrived at. A steel bar, about 22 cm. long, was so mounted as to be struck longitudinally every two or three seconds by a small hammer. Although in every position the flame shows some uneasiness at the stroke of the hammer, the distinction of loops and nodes is perfectly evident, and the measurement of wave-length can be effected with an accuracy of about 1 per cent. In the actual experiment the wave-length was nearly 3 cm.

The formation of stationary waves with nodes and loops by perpendicular reflection illustrates interference to a certain extent, but for the full development of the phenomenon the interfering sounds should be travelling in the same, or nearly the same, direction. The next example illustrates the theory of Huyghens' zones. Between the bird-call and the flame is placed a glass screen perforated with a circular hole. The size of the hole, the distances and the wave-length are so related to one another that the aperture just includes the first and second zones. The operation of the sounds passing these zones is antagonistic, and the flame shows no response until a part of the aperture is

even 20° from the axial line entails a considerable loss, to be further increased as the deviation rises to 40° or 60° . The difficulty thence arising is met, in the practice of the Trinity House, by the use of two distinct sirens and horns, the axes of the latter being inclined to one another at 120° . In this way an arc of 180° or more can be efficiently guarded, but a more equable distribution of the sound from a single horn remains a desideratum.

Guided by the considerations already explained, I ventured to recommend to the Trinity House the construction of horns of novel design, in which an attempt should be made to spread the sound out horizontally over the sea, and to prevent so much of it from being lost in an upward direction. The solution of the problem is found in a departure from the usual circular section and the substitution of an elliptical or elongated section, of which the short diameter, placed horizontally, does not exceed the half wave-length; while the long diameter, placed vertically, may amount to two wave-lengths or more. Obliquity in the horizontal plane does not now entail much difference of phase, but when the horizontal plane is departed from, such differences enter rapidly.

Horns upon this principle were constructed under the supervision of Mr. Matthews, and were tried in the course of the recent experiments off St. Catherine's. The results were considered promising, but want of time and the numerous obstacles which beset large-scale operations prevented an exhaustive examination.

On a laboratory scale there is no difficulty in illustrating the action of the elliptical horns. They may be made of thin sheet brass. In one case the total length is 20 cm., while the dimensions of the mouth are 5 cm. for the long diameter and $1\frac{1}{2}$ cm. for the shorter diameter. The horn is fitted at its narrow end to A (Fig. 1), and can rotate about the common horizontal axis. When this axis is pointed directly at the flame, flaring ensues; and the rotation of the horn has no visible effect. If now, while the long diameter of the section remains vertical, the axis be slewed round in the horizontal plane until the obliquity reaches 50° or 60° , there is no important falling off in the response of the flame. But if at obliquities exceeding 20° or 30° the horn is rotated through a right angle, so as to bring the long diameter horizontal, the flame recovers as if the horn had ceased sounding. The fact that there is really no falling off

may be verified with the aid of a reflector, by which the sound proceeding at first in the direction of the axis may be sent towards the flame.

When the obliquity is 60° or 70° , it is of great interest to observe how moderate a departure from the vertical adjustment of the longer diameter causes a cessation of effect. The influence of maladjustment is shown even more strikingly in the case of a larger horn. According to theory and observation, a serious falling off commences when the tilt is such that the difference of distances from the flame of the two extremities of the long diameter reaches the half wave-length—in this case 1 cm. It is thus abundantly proved that the sound issuing from the properly adjusted elliptical cone is confined to a comparatively narrow belt round the horizontal plane and that in this plane it covers efficiently an arc of 150° or 160° .

Another experiment, very easily executed with the apparatus already described, illustrates what are known in optics as Lloyd's bands. These bands are formed by the interference of the direct vibration with its very oblique reflection. If the bird-call is pointed toward the flame, flaring ensues. It is only necessary to hold a long board horizontally under the direct line to obtain a reflection. The effect depends upon the precise height at which the board is held. In some positions the direct and reflected vibrations cooperate at the flame, and the flaring is more pronounced than when the board is away. In other positions the waves are antagonistic, and the flame recovers as if no sound were reaching it at all. This experiment was made many years ago by Tyndall, who instituted it in order to explain the very puzzling phenomenon of the "silent area." In listening to fog signals from the sea it is not unfrequently found that the signal is lost at a distance of a mile or two and recovered at a greater distance in the same direction. During the recent experiments, the Committee of the Elder Brethren of the Trinity House had several opportunities of making this observation. That the surface of the sea must act in the manner supposed by Tyndall cannot be doubted, but there are two difficulties in the way of accepting the simple explanation as complete. According to it the interference should always be the same, which is

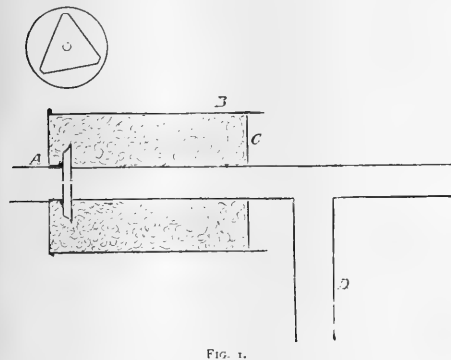

FIG. 1.

blocked off. The part blocked off may be either the central circle or the annular region defined as the second zone. In either case the flame flares, affording complete proof of interference of the parts of the sound transmitted by the aperture.

From a practical point of view, the passage of sound through apertures in walls is not of importance, but similar considerations apply to its issue from the mouths of horns, at least when the diameter of the mouth exceeds the half wave-length. The various parts of the sound are approximately in the same phase when they leave the aperture, but the effect upon an observer depends upon the phases of the sounds, not as they leave, but as they arrive. If one part has further to go than another, a phase discrepancy sets in.

To a point in the axis of the horn, supposed to be directed horizontally, the distances to be travelled are the same, so that here the full effect is produced, but in oblique directions it is otherwise. When the obliquity is such that the nearest and furthest parts of the mouth differ in distance by rather more than one complete wave-length, the sound may disappear altogether through antagonism of equal and opposite effects. In practice the attainment of a complete silence would be interfered with by reflections, and in many cases by a composite character of sound, viz. by the simultaneous occurrence of more than one wave-length.

In the fog signals established on our coasts, the sound of powerful sirens issues from conical horns of circular cross-section. The influence of obliquity is usually very marked. When the sound is observed from a sufficient distance at sea, a deviation of

certainly not the case. Usually there is no silent area. Again, although according to the analogy of Lloyd's bands there might be a dark or silent place at a particular height above the water, say on the bridge of the *Irene*, the effect should be limited to the neighbourhood of the particular height. At a height above the water twice as great, or near the water level itself, the sound should be heard again. In the latter case there were some difficulties, arising from disturbing noises, in making a satisfactory trial; but as a matter of fact, neither by an observer up the mast nor by one near the water level was a sound lost on the bridge ever recovered.

The interference bands of Fresnel's experiment may be imitated by a bifurcation of the sound issuing from A (Fig. 1). For this purpose a sort of T-tube is fitted, the free ends being provided with small elliptical cones, similar to that already described, the axes of which are parallel and distant from one another by about 40 cm. The whole is constructed with regard to symmetry, so that sounds of equal intensity and of the same phase issue from the two cones of the long diameters of which are vertical. If the distances of the burner from the mouths of the cones be precisely equal, the sounds arrive in the same phase and the flame flares vigorously. If, as by the hand held between, one of the sounds is cut off the flaring is reduced, showing that with this adjustment the two sounds are more powerful than one. By an almost imperceptible slewing round of the apparatus on its base-board, the adjustment above spoken of is upset and the flame is induced to recover its tall equilibrium condition. The sounds now reach the flame in opposition of phase and practically neutralise one another. That this is so is proved in a moment. If the hand be introduced between either orifice and the flame, flaring ensues, the sound not intercepted being free to produce its proper effect.

The analogy with Fresnel's bands would be most complete if we kept the sources of sound at rest and caused the burner to move transversely so as to occupy in succession places of maximum and minimum effect. It is more convenient with our apparatus and comes to the same thing, if we keep the burner fixed and move the sources transversely, sliding the base-board without rotation. In this way we may verify the formula, connecting the width of a band with the wave-length and the other geometrical data of the experiment.

The phase discrepancy necessary for interference may be introduced, without disturbing the equality of distances, by inserting in the path of one of the sounds a layer of gas having different acoustical properties from air. In the lecture carbonic acid was employed. This gas is about half as heavy again as air, so that the velocity of sound is less in the proportion of 1:25. If l be the thickness of the layer, the retardation is $\frac{1}{25}l$; and if this be equal to the half wave-length, the interposition of the layer causes a transition from complete agreement to complete opposition of phase. Two cells of tin plate were employed, fitted with tubes above and below, and closed with films of collodion. The films most convenient for this purpose are those formed upon water by the evaporation of a few drops of a solution of celluloid in pear-oil. These cells were placed one in the path of each sound, and the distances of the cones adjusted to maximum flaring. The insertion of carbonic acid into one cell quieted the flame, which flared again when the second cell was charged so as to restore symmetry. Similar effects were produced as the gas was allowed to run out at the lower tubes, so as to be replaced by air entering above.¹

Many vibrating bodies give rise to sounds which are powerful in some directions but fail in others—a phenomenon that may be regarded as due to interference. The case of tuning forks (unmounted) is well known. In the lecture a small and thick wine-glass was vibrated, after the manner of a bell, with the aid of a violin bow. When any one of the four vibrating segments was presented to the flame, flaring ensued; but the response failed when the glass was so held at the same distance that its axis pointed to the flame. In this position the effects of adjacent segments neutralise one another and the aggregate is zero. Another example, which, strangely enough, does not appear to have been noticed, is afforded by the familiar open organ pipe. The vibrations issuing from the two ends are in the same phase as they start, so that if the two ends are equally distant from the percipient, the effects conspire. If, however, the pipe be pointed towards the percipient, there is a great falling off, inasmuch as the length of the pipe approximates to the

half wave-length of the sound. The experiment may be made in the lecture-room with the sensitive flame and one of the highest pipes of an organ, but it succeeds better and is more striking when carried out in the open air with a pipe of lower pitch, simply listened to with the unaided ear of the observer. Within doors reflections complicate all experiments of this kind.

UNIVERSITY AND EDUCATIONAL INTELLIGENCE.

OXFORD.—The 235th meeting of the Junior Scientific Club was held on May 2 in the physiological lecture room at the Museum. Two papers were read, "A New Type of Vertebrate Kidney," by Mr. E. S. Goodrich, Merton College, and "The Phosphoric Acid Problem," by Mr. J. M. Wadmore, Trinity College.

The ninth Robert Boyle lecture of the Junior Scientific Club will be delivered by Prof. T. Clifford Allbutt, F.R.S., in Balliol College Hall on Tuesday next, May 13. The subject will be "The Growth of the Experimental Method in Oxford."

THE honorary degree of LL.D. was conferred on Lord Kelvin on Monday by the University of Yale.

A MEETING will be held at the Mansion House to-morrow, May 9, at 3 p.m., with the Lord Mayor in the chair, in support of higher university education and research in London, with special reference to the fund being raised for the endowment of University College and its incorporation in the University of London. All who are interested in national progress and the advancement of knowledge are invited to take part in this movement for making up in some degree the gaps in our educational system, and in the endeavour to place at the disposal of the inhabitants of London facilities for mental training at any rate equal to those enjoyed by our continental neighbours. Among the speakers at the Mansion House meeting will be the Duke of Devonshire, Lord Brassey (chairman of the Appeal Committee), Lord Avebury, Mr. Ritchie, M.P., the Hon. Alban Gibbs, M.P., Sir Michael Foster, M.P., Principal Rücker, F.R.S., Mr. Lionel Phillips, and Mr. H. R. Beeton.

THE debate on the second reading of the Education Bill of the Government was opened in the House of Commons on Monday. Mr. Bryce gave reasons for believing that the Bill would not establish satisfactory local authorities, secure educational improvement, or effect a final settlement of the education question. Referring to secondary education, Mr. Bryce said that the Bill promises to do nothing for it, though secondary education is the most urgent of all our educational wants. "It does not direct any inquiry or any scheme to be made for the reorganisation of secondary education. It does not impose any duty upon the new authorities to provide secondary education, however great the local need may be. It is purely permissive. It does not contain any suggestion for dealing with endowments or for the reorganisation of schools. It does not set apart the grant under the Act of 1890 as only applicable to secondary education. It gives a rating power up to 2d., with the possibility of increase by the consent of the Local Government Board. Secondary education ought to have had a Bill to itself, and it ought to have had a start of two or three years before primary education is thrown upon the same authority, if ever it is to be thrown upon it. Now, the probability is that secondary education will go to the wall." Sir John Gorst urged in reply that the Bill creates an authority, or it gives to the authority already existing for technical education full powers for secondary education, and so may be said to do something for secondary education. As to the inadequacy of the funds available under the Bill, it was held that the County Councils had enough to begin with, "and," added Sir John Gorst, "if this Bill is passed it will, at all events, make a beginning of secondary education, and when the authorities of counties and boroughs see what sum of money is really required, I have no doubt the representations made by them to this House will be received with very fair consideration." The debate was continued on Tuesday, and among the points discussed were the comparative merits of School Boards and County Councils as local authorities for education, need for better training of teachers, the extension of the limit of a 2d. rate, and the need for generous grants from the Exchequer for secondary education.

¹ In a still atmosphere the hot gases arising from lighted candles may be substituted for the layers of CO₂.

THERE will be an exhibition of scientific apparatus at the conference of science teachers to be held at Festiniog on May 15 (see p. 599, April 24). Good apparatus is urgently required in many Welsh schools, and manufacturers ought to hasten to avail themselves of the opportunity which the conference affords of exhibiting instruments and materials essential to practical instruction in science. Mr. J. Griffith, County School, Festiniog, has entire charge of the exhibition arrangements, and would provide rooms and allocate space for the display of scientific apparatus.

THE Technical Education Board of the London County Council will shortly award five senior county scholarships. The scholarships are open to young men and young women who are resident within the administrative county of London whose parents are in receipt of an income not exceeding 400*l.* a year. They are tenable for three years at British or foreign Universities and technical colleges of University rank, and are of the value of 90*l.* a year. Candidates should as a rule be not more than twenty-two years of age, preference being given to those who are under nineteen years of age. In addition to the scholarships, the Board offers for competition a limited number of free places at the principal London colleges. Application forms can be obtained from the secretary of the Technical Education Board, and must be returned not later than Monday next, May 12.

A MEETING of the Association of Technical Institutions will be held between the second reading of the Government Education Bill and the Committee stage. At this meeting the council will recommend the Association to adopt the following resolutions in regard to the Bill:—(1) That this Association cordially approves the general principles upon which the Government Education Bill is based, and strongly urges His Majesty's Government to pass the Bill in the present session of Parliament. (2) That this Association is strongly of opinion that the new local authorities should be responsible for all grades of education in their districts, and that proper educational co-ordination would be seriously and unnecessarily hindered if this principle were not adopted; it therefore urges the Government to amend the Bill by deleting the clauses making it optional for the County and Borough Councils to undertake the supervision of elementary education. (3) That this Association regrets to note that the Bill makes optional the application to the purposes of higher education of the residue under the Local Taxation (Customs and Excise) Act, 1890, and it requests the Government to make such application compulsory. (4) That this Association regrets the exclusion of London from the Bill and trusts that the metropolis may receive attention early next year, and, while recognising that the case of London requires special treatment, is of opinion that it would be unwise to depart from the general principles of the present Bill in the case of London.

SOCIETIES AND ACADEMIES.

LONDON.

Royal Society, December 12, 1901.—“On the Action of the Spurge (*Euphorbia hiberna*, L.) on Salmonid Fishes.” By H. M. Kyle, M.A., D.Sc., St. Andrews University. Communicated by Prof. McIntosh, F.R.S.

It has been known for some years that the Irish peasant employed a simple method of procuring salmon and trout through the agency of the Spurge (*E. hiberna*, L.). The plant cut into small pieces and pounded with stones, or simply trampled upon at some convenient spot on a river, forms an emulsion in the water which, being swept downward into the pools, carries death to all fishes in its course. The fatality thus produced seems to have been enormous—80 to 100 salmon are reported to have been killed at one time, and again in the Bandon rivers 500 to 1000 fish of various descriptions are said to have been poisoned during one season. In the light of the experiments to be recorded presently, these statements do not seem exaggerated, for the Spurge-extract, even in small quantities, is almost as fatal to fishes as corrosive sublimate.

The fatal effect of the Spurge on fishes has been known in other countries besides Ireland, but to what ingredient or ingredients of the plant these effects are due seems never to have been investigated. The experiments described in the present paper throw considerable light upon the action of the Spurge, and open out to view some interesting problems.

Chemical analysis of the Spurge-extract shows that it contains

tannic acid. Experiments on the circulation in the lung and mesentery of the frog reveal a close similarity between the action of the Spurge-extract and of tannic acid. In the case of trout the similarity extends to the non-recovery of the fish in fresh water, after they have come under the influence of either Spurge-extract or tannic acid. The power of the Spurge-extract to produce fatal effects persists for several days without diminution. Twenty per cent. of the fresh extract is fatal within five minutes, whilst 0.01 per cent. takes 4 to 6 hours, and seems to be the smallest percentage which has fatal results. In the case of fishes, death is considered to ensue from the inflammation of the gills and consequent stasis of the circulation, set up by the action of the tannic-acid component of the Spurge-extract. The fresh extract is calculated roughly to contain about 1 per cent. of tannic acid, but on this estimation the Spurge-extract is fatal within a shorter period than the corresponding quantity of tannic acid. Hence, the percentage of tannic acid has been under-estimated, or some other substance or substances in the extract also aid in producing fatal effects.

March 20.—“Persulphuric Acids.” By Prof. Henry E. Armstrong, V.P.R.S., and T. Martin Lowry, D.Sc.

The “remarkable disappearance of oxygen” which Faraday, in 1834, observed to take place on electrolytising strong solutions of sulphuric acid was shown by Berthelot, in 1878, to be due mainly to peroxidation of the sulphuric acid. An anhydride, S_2O_8 , was isolated, and he therefore concluded that the corresponding *perdisulphuric acid*, $H_2S_2O_8$, was formed when sulphuric acid was peroxidised either by anode oxidation or by interaction with hydrogen peroxide. The *perdisulphates* were isolated by Marshall, in 1891, by electrolytising solutions of acid sulphates, and have found a technical application in photography. This simple explanation of the peroxidation of sulphuric acid remained unchallenged until Caro found, in 1898, that when the *perdisulphates* are dissolved in sulphuric acid and the solution is again neutralised, a product is obtained which possesses the property of oxidising aniline to nitrosobenzene. None of the salts of Caro's modified persulphuric acid have yet been isolated, and only indirect methods are therefore available for determining its constitution.

Von Baeyer and Villiger have determined the ratio of sulphur to active oxygen in a solution containing the barium salt of Caro's acid, and found the ratio to be $SO_2 : O = 1 : 1$, the ratio for Marshall's salts being $SO_2 : O = 2 : 1$. They therefore assigned to Caro's acid the formula H_2SO_3 of a *permonosulphuric acid*. If this acid be dibasic its salts must remain neutral when reduced, thus $CaSO_3 = CaSO_4 + O$, whereas any higher member of the series would liberate acid, thus $CaS_2O_6 + H_2O = CaSO_4 + H_2SO_4 + O$. Caro's salts are extremely unstable in presence of caustic alkalis, but neutral solutions can be prepared by neutralising with carbonates; when such solutions are heated they lose their active oxygen and liberate acid in the ratio $H_2SO_4 : O_2$. This result can only be reconciled with the formula of von Baeyer and Villiger by assuming *permonosulphuric acid* to be monobasic, $NaHSO_3 = NaHSO_4 + O$; a more probable view is that Caro's acid is the *anhydrous acid*,

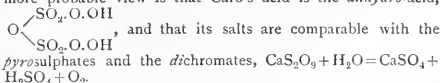

In concentrated solutions containing less than 50 per cent. of water, the peroxidation of sulphuric acid proceeds differently, the chief product being probably a *perdisulphuric acid*, $H_2S_2O_8$ (Lowry and West, Chem. Soc. *Trans.*, 1900, 950). This acid, the fourth member of the series $H_2O_n \cdot nSO_3$, bears to pyrosulphuric acid the same relationship as that which *perdisulphuric acid* bears to sulphuric acid, $2H_2S_2O_8 - H_2O = H_2S_4O_{11}$, $2H_2SO_4 - H_2O = H_2S_2O_6$. On dilution and neutralisation it is hydrolysed to a salt of Caro's acid.

At the present time it is therefore necessary to postulate the existence of at least three persulphuric acids, in which the ratio $SO_3 : O$ is 1:1, 1:2 and 1:4 respectively. In spite of the stability of the *perdisulphates*, the least stable of these is *perdisulphuric acid*, for when liberated from its salts it rapidly passes in dilute solution to a *permonosulphuric acid* (Caro's acid), whilst in presence of concentrated sulphuric acid it is converted mainly into *perdisulphuric acid*.

“On a Throwing-testing Machine for Reversals of Mean Stress.” By Osborne Reynolds, F.R.S., and J. H. Smith, M.Sc.

This research was undertaken at the suggestion of Prof.

Osborne Reynolds, who proposed an investigation of "repeated stress" on the following lines:—The stress should be direct tension, and compression of approximately equal amounts, such tension and compression being obtained by means of the inertia force of an oscillatory weight. The rapidity of repetitions should be much higher than in the experiments of Wöhler, Spangenberg, Bauschinger and Baker—in fact, ranging as high as 2000 reversals per minute.

(1) The conclusions arrived at are:—

(1) The reversals for rupture with a given range of stress diminish as the periodicity of the reversals increases.

(2) The hard steels will not withstand a greater number of reversals of the same range of stress than the mild steels if the periodicity of the reversals is great.

Zoological Society, April 15.—Prof. G. B. Howes, F.R.S., vice-president, in the chair.—On behalf of Prof. F. Jeffrey Bell were exhibited two arms of an injured starfish of the genus *Luidia* from the west coast of Ireland, which had undergone repair at their ends. These regenerated parts were unlike the rest of the arm and had a striking, though not exact, resemblance to the free ends of the arms of an *Astropecten*.—Dr. Forsyth Major exhibited some selected specimens from a collection of fossil bones recently received by the Natural History Museum from Cyprus, where they had been discovered in caves by Miss Dorothy M. A. Bate. The remains proved to be those of a pigmy hippopotamus, about half the size of *Hippopotamus amphibius*, and could not be distinguished from Cuvier's "*Petit Hippopotame fossile*" (*H. minutus*, Blainv.), which was smaller than the so called "*H. minutus*" from Malta, and otherwise different. The fossils exhibited showed affinities on the one hand with the pigmy hippopotamus of Western Africa, "*Chocropis libyensis*," on the other with some remains from the Lower Pliocene of Casino (Italy); they were considered by the exhibitor as a further illustration of the assumption that many of the Pleistocene mammals of the Mediterranean islands were the little-modified survivors of Tertiary forms from the adjoining continents, from which the islands had been severed during the Tertiary period.—Mr. W. P. Pycraft read the fifth part of his "Contributions to the Osteology of Birds," which dealt with the Falconiformes.—Mr. F. E. Beddard, F.R.S., read a paper dealing with the sexual differences observed in the windpipe of the condor. It also treated of a rudimentary equivalent of the septal flap of the right aorto-ventricular valve met with in the hearts of that bird and of a form of cuckoo (Scythrops).—A paper by Mr. Hesketh Frichard, on the larger mammals of Patagonia, contained field notes on the huemul (*Xenelaphus bisulcus*), the puma (*Felis concolor*), Pearson's puma (*Felis concolor pearsoni*), the Patagonian cavy (*Cavia patagonica*), and the guanaco. The extraordinary tameness of the huemul was dwelt upon. The habits of the grey puma (*Felis concolor*) were described, a contrast being pointed out between their method of killing their prey and that of the jaguar (*Felis onca*). Pearson's puma, a new subspecies of puma, was alluded to as being much rarer than the grey puma, smaller, fiercer, and in colour reddish at the extremities. The fact of the distribution of the cavy (*Cavia patagonica*) being arbitrarily limited in the neighbourhood of the 45th parallel of latitude was commented upon as being strange, inasmuch as there was no change either in the vegetation or in the nature of the ground to account for it.—Mr. F. Pickard Cambridge read a paper on the spiders of the genus *Latrodectus*, which had a universally bad reputation of being extremely venomous in various parts of the world, although more exact evidence was required on this question. A list of the recognised species and subspecies was given.—A paper by Mr. Frank Finn contained some notes on the painted snipe (*Kostratula capensis*) and the pheasant-tailed jacana (*Hydrophasianus chirurgus*), of which birds he had recently presented some specimens to the Society's Gardens.—A paper by Mr. G. A. Boulenger, F.R.S., contained descriptions of eight new species of fishes from the Congo, forming part of a collection entrusted to him for study by the Director of the Royal Museum of Natural History in Brussels. The paper also contained a list of forty-one species of fishes from the Lindi River, Upper Congo, collected by M. Maurice Storms for the Brussels Museum.

Entomological Society, April 16.—The Rev. Canon Fowler, president, in the chair.—Mr. O. E. Jensen exhibited specimens of both sexes of *Ornithoptera victorica* from Ysabel, Solomon Islands, recently taken by Mr. Albert Meek, and

remarked on the variation in the colour and markings in the males.—Mr. H. W. Shepherd-Walwyn exhibited a series of *Eutichia jacobaeae* taken by him at Winchester in July 1889, showing considerable variations of size and colouring.—Mr. Willoughby Gardner exhibited *Coeloxys mandibularis*, Nyl., from the Cheshire coast, a species new to Britain; and *Osmia xanthomana*, ♂ and ♀, and *Osmia parvicornis*, Curt., ♂ and ♀, from North Wales.—Mr. A. J. Chitty exhibited a specimen of *Aglais urticae* taken at sallow on March 28, having a large portion of the hind wings cut off so that when folded they were symmetrical in outline. From their appearance he concluded they had been bitten off by some animal, probably during hibernation.—Dr. T. A. Chapman called attention to the remarkable bilateral asymmetry in the male appendages of the Hemerid Sphinx, *Cephonodius hylas*, Linn. He said that bilateral asymmetry in insects was sufficiently rare to make it always notable. In the male apophyses of Lepidoptera he had only been able to find records in the case of the Hesperid genus *Thanaos*, to which Scudder and Burgess first called attention—though it seems highly probable that the facts can hardly have been unobserved in so common a species as *C. hylas*. He also exhibited specimens of the appendage removed from the insect, and of the several parts, as well as sketches of the clasps and tegumen.—Mr. C. P. Pickett exhibited many varieties and forms of *Hybernia leucophaea* taken during March at Chingford, Hightgate and Finchley. He also showed series of *Phigalia pedaria*, *Anisopteryx aescularia* and *Nyssia hispidaria* from the north metropolitan district.—Mr. H. J. Turner, on behalf of Mr. W. West, of Greenwich, exhibited specimens, ♂ and ♀, of *Stictocoris flavolea*, Bohm., a species new to the British fauna, found amongst long grass in damp places at Lee, Kidbrook and Shooter's Hill, also several specimens of *Typhlocyba candidula*, Kir., a species first discovered by Mr. West at Lewisham and Blackheath on *Populus alba*.—Dr. D. Sharp communicated a paper by Miss Alice L. Embleton on the economic importance of the parasites of Coccidae.—Colonel Charles Swinhoe read a paper entitled "Eastern and Australian Drepanulidae, Epiplemidæ, Micronideæ and Geometridæ in the British Museum collection.—Mr. W. F. Kirby contributed a paper entitled "Additional Notes on Mr. Distant's Collection of African Loucoidæ."

Royal Microscopical Society, April 16.—Dr. H. J. Woodward, F.R.S., president, in the chair.—A pocket microscope was presented on behalf of Mr. Jacob Pilschler. It was made by his uncle, Mr. M. Pilschler, and is described and figured in Dr. Golding Bird's work on "Urinary Deposits" (5th ed., 1857). The design is most ingenious. A small stage plate for carrying a 3" × 1" slide forms the base of the instrument; attached below to a jointed arm is a plane mirror and a diaphragm with suitable apertures. Above the plate and at one corner is a pillar carrying an arm, which reaches to the centre of the stage, for holding the lenses, which are Coddingtons of $\frac{1}{4}$, $\frac{1}{6}$, $\frac{1}{8}$ inch foci; the pillar contains a direct acting screw fine adjustment. The whole packs in a small case, which can be carried in the waistcoat pocket. With achromatic lenses it is a pattern which might have its uses at the present day.—Mr. C. Beck exhibited and described Standing's embedding microtome, an ingenious and simple hand microtome designed for cutting botanical sections, and extremely cheap. Mr. Beck also directed attention to some exceedingly fine rulings on glass, ruled by Mr. Grayson, of Melbourne. They had been brought from Australia by Mr. Wedeles, and were exhibited in the room. They were mounted in realgar, a medium having a refractive index of 2.5, which added considerably to the distinctness with which the lines could be seen. Three examples were exhibited, one being a micrometer divided into $\frac{1}{1000}$ ths and $\frac{1}{10000}$ ths of an inch, and fourths, tenths and hundredths of a millimetre, another, a test plate of ten bands varying from 1000 to 10,000 lines to the inch, and another of twelve bands varying from 5000 to 60,000 lines to the inch. Mr. Wedeles stated that Mr. Grayson had ruled bands up to 120,000 lines to the inch.—Mr. J. C. Webb exhibited an old microscope by Pritchard the date of which he was unable to give, but thought it probably anterior to the advent of the enginework which Pritchard brought out in 1832. The principal features of the instrument were a device for protecting the objective from injury when focussing—the first eyepiece was triple, it admitted plenty of light, and gave a good field with low powers. There was a fine adjustment to the nose-piece, and the body could be removed and the instrument used as a dissecting microscope.—Mr. Ersler ex-

hibited a reversible live box intended for use in observing large living objects, such as spiders while spinning their webs.—Messrs. Powell and Lealand exhibited a new $\frac{1}{2}$ -inch semi-apochromatic homogeneous immersion objective of 1.4 N.A. It was made of glass which would stand any climate without deterioration, and the cost was exceedingly moderate.

Linnean Society, April 17.—Prof. S. H. Vines, F.R.S., president, in the chair.—Mr. A. C. Seward, F.R.S., read a paper by Miss S. O. Ford and himself on the anatomy of Todea, with notes on the affinity and geological history of the Osmundaceae. The main points were:—(1) the investigation of the anatomical structure of Todea as represented by *T. barbara* and two of the filmy species, *T. superba* and *T. hymenophylloides*, with a view to a comparison with that of Osmunda; (2) a summary of the geological history of the Osmundaceae and Osmundaceous characters; and (3) the question of the interpretation of the stelar structures of Osmunda and Todea.—On behalf of Mr. G. M. Thomson, of Dunedin, N.Z., the Rev. T. R. Stebbing, F.R.S., read a paper on the New Zealand Phyllobranchiate Crustacea Macrura. This embodied a general revision of the group, with detailed descriptions and figures of several rare or imperfectly known species.

MANCHESTER.

Literary and Philosophical Society, April 29.—Mr. Charles Bailey, president, in the chair.—Mr. Frank F. Laidlaw made a communication on the peoples of Malacca. Special attention was directed to a number of savage nomadic communities, which inhabit the forest country of the interior for the most part. Owing to intermarriage between the various communities, as well as to the careless nomenclature employed in speaking of them, it is difficult to classify them in a satisfactory manner. In the northern half of the peninsula, however, these savages exhibit almost universally negro characteristics, viz. curly (almost woolly) hair, very dark skins and moderately long skulls (mesaticephalic); the nose also is extremely wide and very flat. These negroes occur chiefly in Kedah, Kelantan and Perak. Considerable intermixture of negro blood is also found in most of the southern wild tribes, whom many authorities believe to be derived from an admixture of Malay and negro blood, but the evidence tends to show that in Perak, at least, there exists a second race quite distinct from negro or Malay—a dolichocephalic, moderately fair-skinned race with wavy hair, and possibly allied to the Karens of Burmah. Lastly, the people of Johor, Selangor and Pahang are obviously of mongoloid stock. Like the other two groups, their stature is small (average height of a full-grown man 4ft. 6in., of a woman 4ft. 3½in.), but the hair is straight and the skull brachycephalic. It is not improbable that this latter group is largely descended from Malays who refused to adopt the creed of Islam; or they may perhaps more probably be derived from the widely spread pro-Malay race, of which the Malays themselves and the Javanese, &c., are specialised offshoots.

DUBLIN.

Royal Dublin Society, April 16.—Prof. D. J. Cunningham, F.R.S., in the chair.—Prof. John Joly, F.R.S., read a paper entitled "A Sedimentation Mystery."—Prof. G. A. J. Cole and Mr. T. Crook exhibited a large number of stones dredged by the Irish Fishery Survey from the Porcupine Bank and other places off western Ireland. They pointed out that the stones varied from one place to another so distinctly as to give a real clue to the submarine geology of the area. The basalt-plateau of the north was not here traceable, and the rocks in general represented submerged extensions of those known upon the western coast. The Porcupine Bank includes a large boss of olivine-gabbro like some of those associated with Carboniferous rocks in England. The description of the rocks is reserved for the Fishery Reports of the Department of Agriculture and Technical Instruction for Ireland.

Royal Irish Academy, April 28.—Prof. R. Atkinson, president, in the chair.—Prof. Chas. J. Joly read a paper on quaternion integrals depending on a single quaternion variable. The method employed is given in Hamilton's lectures, and the author indicated a simple step by means of which the fundamental theorems of Green and Stokes and their quaternion extensions may be deduced from Hamilton's results. The quaternion integrals must be either single, double, triple or quadruple; and in general the difference of two integrals of a given type taken

between the same fixed limits but with different "modes of passage" is expressed as an integral involving one additional quaternion differential. Physical examples are given of the meaning of the different types of integrals, for example the conditions that the scalar double integral should be independent of the mode of passage are the well-known equations connecting the electric displacement and the magnetic force in a non-conducting dielectric.

PARIS.

Academy of Sciences, April 28.—M. Bouquet de la Grye in the chair.—The president announced to the Academy the death of M. Filhol.—Studies on batteries founded upon the reciprocal reaction of oxidising and reducing liquids. Common solvents. The action of acids on bases, by M. Berthelot.—On the treatment of malarial fevers by latent arsenic, by M. Armand Gautier. In a preliminary note published in February last, an account was given of the treatment of nine cases of malarial fever by injections of minute amounts of sodium methylarsenate. These results have now been extended, some twenty-three cases having been under treatment with entirely satisfactory results. All of these were severe cases which had proved refractory to the prolonged action of quinine, even in large doses. Out of ten cases of tertiary fever, four showed a slight relapse, the remaining six being completely cured by three successive injections of five to ten centigrams of the arsenical salt. In two cases of quaternary fever, the specific organism only disappeared after four or five successive injections of '1 to 2 gram. Detailed instructions are given for the mode of application of sodium methylarsenate in the various types of malarial fever.—The culture of the forage beet in the experimental field at Grignon in 1900 and 1901, by MM. P. Dehérain and C. Dupont. It has been previously shown that the beet giving the largest gross weight of roots per hectare is not necessarily the best for forage purposes. As the result of two years' experiments on the large scale, the variety known as *Géante demi sucrière rose* was found to be decidedly superior to the old forage beet. It was also found that the mode of arranging the plants was without effect on the yield provided that the number of roots per square metre did not exceed ten.—Geographical work round the central massif of Madagascar, by M. P. Colin. The present paper is confined to geodesic and astronomical results. The magnetic observations will be given in a future paper.—On the third voyage of the *Princess Alice II.*, by S. A. S. Prince Albert of Monaco. A résumé of the results in oceanography, geography, zoology, physics and bacteriology.—Report presented by the commission charged with the scientific control of the geodesic operations at the Equator, by M. H. Poincaré.—Observations of the comet A (1902) made at the Observatory of Algiers with the 0.318 cm. equatorial, by MM. Rambaud and Sy.—On divergent series and differential equations, by M. Edmond Maillet.—The measurement of high temperatures and Stefan's law, by M. Féry. A cone of rays from the body the temperature of which is to be measured is concentrated by a fluor spar lens upon a delicate iron-constantin thermocouple. The temperatures indicated by this instrument were compared with those calculated by the law of Stefan; the error did not exceed 1 per cent.—A universal scale of periodic movements graduated in savarts and millisavarts, by M. A. Guillemin. The author proposes a new unit in acoustics to replace the octave and the comma. The use of the new unit, the millisavart, leads to a great simplification in numerical calculations.—On the graduation of thermoelectric couples, by M. Daniel Berthelot. The couples used were of platinum in contact with 10 per cent. platinum-iridium. The temperatures of five melting points and eight boiling points were determined by two couples independently, the maximum difference between the two being about 2° C. If e be the electromotive force of a thermocouple and t the centigrade temperature, $\log e$ is a linear function of $\log t$ for temperatures between 400° and 1100° C. This relation being assumed, it is only necessary to have two standard points to calibrate a couple, and for this purpose the melting points of zinc (419°) and gold (1064°) are recommended as the most suitable. With a good galvanometer there is no difficulty in obtaining a sensibility of 0.01° C. in the neighbourhood of 1000° C.—On the indices of refraction of liquid mixtures, by M. Edm. van Aubel. According to a recent paper by M. Leduc, the refractive index of a mixture of alcohol and water is the sum of its constituents if the contraction of volume which takes place on mixing is taken into account. Experimental results are now given for mixtures

of acetone and water, aniline and ethyl alcohol. In the case of the first mixture, the difference between the experimental figure and that calculated according to M. Ledue's hypothesis amounts as a maximum to four units in the fourth decimal place, in the second case the deviation amounts to double this amount. The conclusion is therefore drawn that the refractive energy, $n-1/d$, is not constant in liquid mixtures within the limits of experimental error.—Variations of the temperature of the open air in the zone comprised between a height of 8 and 13 kilometres, by M. L. Teisserenc de Bort. The results of the discussion of observations carried out in 236 captive balloon experiments. These results represent all seasons of the year and cover several years.—On the manufacture of certain metallic tools by the Egyptians, by M. Albert Colson. Analysis of an ancient Egyptian bronze tool.—The composition of the hydrate of chlorine, by M. de Forcrand. By the application of the principle described in previous papers, the conclusion is drawn that the composition of chlorine hydrate is $Cl_2 \cdot 7H_2O$.—On some derivatives of oxyisopropylphosphonic acid, by M. C. Marie. The mode of preparation and properties of the sodium, lead, copper and silver salts.—On the transformation of proteins in plants during germination, by M. G. André.—Observations on organic poles, by M. Stanislas Meunier.—Glycosuria of muscular origin; the appearance of glycuronic compounds and glycoses in the urine of animals submitted to a ligature or crushing of the muscles, by MM. Cadeac and Maignon.—Does lipase exist in normal serum? by MM. Doyon and A. Morel. Hanriot has supposed that there exists in normal serum of vertebrates a soluble ferment, lipase, which possesses the power of saponifying organic esters. None of the experiments here given support this view, and the existence in normal serum of a lipase acting upon olein cannot be demonstrated.—On acute polymicrobial osteomyelitis, by M. Kagalski. In a case of osteomyelitis of the clavicle, both the coli bacillus and staphylococcus were found to be present in the blood from the bone.

GÖTTINGEN.

Royal Society of Sciences.—The *Nachrichten* (physico-mathematical section), part I for 1902, contains the following memoirs communicated to the Society:—

January 11.—Emil Bose: on the nature of the electrical conduction in *Nernst's* electrolytic luminescent oxides. M. Abraham: the dynamics of the electron.

January 25.—Alfred Loewy: on reducible linear homogeneous differential equations.

February 8.—W. Voigt: contributions to the theory of pleochroic crystals. O. Wallach: researches from the University Chemical Laboratory (series x).—(1) new syntheses in the terpene series; (2) on the separation of α - and β -methyladipinic acid; (3) on a series of new isomeric cyclic ketones of the formulae $C_9H_{14}O$ and $C_9H_{16}O$; (4) on the formation of δ -betaines; (5) on phellandrene. C. Jacobi: contribution to the physiological action of the organic ammonium iodides and polyiodides.

DIARY OF SOCIETIES.

THURSDAY, MAY 8.

IRON AND STEEL INSTITUTE, at 10.30 a.m.

ROYAL INSTITUTION, at 3.—Recent Geological Discoveries: Dr. A. Smith Woodward, F.R.S.

SOCIETY OF ARTS (Indian Section), at 4.30.—The Past and Present Connection of England with the Persian Gulf: T. J. Bennett.

MATHEMATICAL SOCIETY, at 5.30.—On Groups in which every two Conjugate Operations are Permutable: Prof. Burnside, F.R.S.—Fermat's Theorem on Binary Powers: A. E. Western.—The Application of Contour Integration to the Solution of Problems in the Theory of Conduction of Heat, and to the Development of an Arbitrary Function in Series: Mr. H. S. Carslaw.—The Application of Fourier's Series to the Conduction of Heat: Dr. Ganesb Prasad.—Some formulae in Elimination: Dr. F. S. Macaulay.

INSTITUTION OF ELECTRICAL ENGINEERS, at 8.—Form of Model General Conditions (Conclusion of Discussion).

FRIDAY, MAY 9.

PHYSICAL SOCIETY, at 5.—A Simple Electric Micrometer. Part I: Dr. P. E. Shaw.—The Conservation of Entropy: J. A. Erskine.—Rational Units of Electromagnetism: Sig. G. Giorgi.

COLD STORAGE AND ICE ASSOCIATION (Society of Arts), Afternoon.—Rationale of Cooling Phenomena: Dr. W. Hampson.—The Business Side of Cold Storage: R. J. Key.

ROYAL INSTITUTION, at 9.—Exploration and Climbing in the Canadian Rocky Mountains: Prof. J. Norman Collie, F.R.S.

ROYAL ASTRONOMICAL SOCIETY, at 5.—Jacobi's Name (q) in Astronomical Formulae, with Numerical Tables: R. T. A. Innes.—Series in the Nebular Spectrum, and in the Bright-line Spectrum of Nova Persei: E. F. J. Loomis.—The Spectrum of Nova Persei, 1901, on and after September 5: Rev. W. Sidgreaves.—Visual and Spectroscopic Observa-

tions of the Sun-spot Group of 1901 May 10-June 26: Rev. A. L. Cortie.—Reduction of Extra-Meridian Observations of Planets: P. H. Cowell.—Micrometric Measures of Double Stars with the 17½-inch Reflector: Rev. T. E. Espin.—*Promised papers*: On the Accuracy of Photographic Measures. Second Note: H. C. Plummer.—Photographic Observations of the Satellite of Neptune: Royal Observatory, Greenwich.

MALACOLOGICAL SOCIETY, at 8.

MONDAY, MAY 12.

ROYAL GEOGRAPHICAL SOCIETY, at 8.30.—On Snow-Waves and Snow-Drifts in Canada: Dr. Vaughan Cornish.

VICTORIA INSTITUTE, at 4.30.—Some Diseases mentioned in the Bible: Dr. T. Chaplin.

HAMPSTEAD SCIENTIFIC SOCIETY, at 8.30.—The Relation of Science to Art: Sir Samuel Wilks, Bart, F.R.S.

TUESDAY, MAY 13.

ROYAL INSTITUTION, at 3.—Recent Geological Discoveries: Dr. A. Smith Woodward, F.R.S.

WEDNESDAY, MAY 14.

SOCIETY OF ARTS, at 8.—Boats and Boat Building in the Malay Peninsula: H. Warington Smyth.

GEOLOGICAL SOCIETY, at 8.—On Pliocene Glacio-Fluvial Conglomerates in Subalpine France and Switzerland: Dr. Charles S. Du Roi Preller.—Overthrusts and other Disturbances in the Radstock Series of the Somerset Coalfields: F. A. Steart.

THURSDAY, MAY 15.

ROYAL SOCIETY, at 4.30.—*Probable papers*: Microscopic Effects of Stress on Platinum: T. Andrews, F.R.S., and C. R. Andrews.—Lyanogenesis in Plants. Part II. The Great Miller, *Sonchium oleraceum*: Prof. W. R. Dunstan, F.R.S., and Dr. T. A. Henry.—The Minute Structure of Metals and other Plastic Solids: G. Beilby.—On Electro-Motive Wave accompanying Mechanical Disturbance in Metal immersed in Electrolyte: Prof. J. C. Bose.—On some Phenomena affecting the Transmission of Electric Waves over the Surface of the Sea and Earth: Capt. H. B. Jackson, K.N., F.R.S.

INSTITUTION OF ELECTRICAL ENGINEERS (Society of Arts), at 8.—Electrical Traction on Steam Railways in Italy: Prof. C. A. Carus-Wilson.

CHEMICAL SOCIETY, at 8.

FRIDAY, MAY 16.

ROYAL INSTITUTION, at 9.—The Nebular Theory: Sir Robert Ball, F.R.S.

CONTENTS.

	PAGE
Stonehenge. By Sir Norman Lockyer, K.C.B., F.R.S.	25
Studies in the Distribution of Plants	27
Our Book Shelf:—	
Guichard: "La Question de l'Eau potable devant les Municipalités"	28
Negris: "Plissements et Dislocations de l'écorce terrestre en Grèce"	28
Büchner: "Last Words on Materialism."—A. E. T.	29
Letters to the Editor:—	
The Misuse of Coal.—Walter Rosenhain; Prof. J. Perry, F.R.S.	29
Experimental Mathematics.—F. M. Saxeby	30
Rearrangement of Euclid's Propositions.—J. M. Child	31
The Sweet Briar as a Goat Extirminator.—Sir W. T. Thistelton-Dyer, K.C.M.G., F.R.S.	31
Stopping down the Lens of the Human Eye.—Wm. Andrews	31
Prisms and Plates for Showing Dichromatism.—Prof. R. W. Wood	31
Sun-pillar and Parhelion.—Prof. Grenville A. J. Cole	32
A Rare Wild Sheep.—R. Lydekker, F.R.S.	32
Beechen Hedges on Elevated Ground.—Jul. Wulff; Wm. Gee	32
Chemical Instruction and Chemical Industries in Germany. By Prof. T. E. Thorpe, F.R.S.	32
Rhodesia and Ophir. (Illustrated.) By Prof. A. H. Keane	34
The Institution of Electrical Engineers and Electrical Legislation	35
Decorative Plants for Gardens	36
Notes	37
Our Astronomical Column:—	
Changes on the Moon's Surface	40
Dust-Falls and their Origins. By W. J. S. L.	41
British versus American Locomotives	42
Interference of Sound. (Illustrated.) By Lord Rayleigh, F.R.S.	42
University and Educational Intelligence	44
Societies and Academies	45
Diary of Societies	48

THURSDAY, MAY 15, 1902.

THE REPRINT OF STOKES' PAPERS.

Mathematical and Physical Papers, vol. iii. By Sir G. G. Stokes. Pp. viii + 451. (Cambridge University Press, 1901.) Price 15s.

THE issue of the first volume of this work in the year 1880 was the beginning of the valuable series of reprints of mathematical and physical papers for which we are indebted to the Cambridge Press. It was felt at the time that no more auspicious beginning could have been made, and the publication was widely appreciated; but a gradual and increasing sense of disappointment supervened when, after the second volume, the continuation seemed to be suspended indefinitely. A third instalment has however now appeared, after the lapse of eighteen years, and although the regrets we have referred to cannot be altogether appeased, the contents of the volume will assure it of as hearty a welcome as was accorded to its predecessors.

There is little to be said now by way of comment on papers which have, most of them, long ranked as classics. The volume opens with the memoir on pendulums. The first, or theoretical, part of this contains the germ of almost all that has since been written mathematically on the subject of viscosity. In addition to the main topic, viz. the effect of viscosity of the air on the linear vibrations of a sphere or of a circular cylinder, we find the theory of the oscillating disc employed in Coulomb's experimental method (afterwards greatly improved by Maxwell), the calculation of the terminal velocity of a globe of water descending in air, and the general formula for the dissipation of energy in a viscous fluid, with (as an example) a discussion of the effect of viscosity on water waves. To appreciate fully the originality of this paper we must bear in mind that up to that time the subject had hardly advanced beyond the formulation of general equations; moreover, that a good deal of the analysis here applied to special problems was new, and devised expressly for the occasion; in particular, in the question of the oscillating cylinder an extremely difficult point in the theory of what are now known as Bessel's Functions was resolved with great success and for the first time. The second part of the paper consists of a comparison of the mathematical theory with Baily's experiments on pendulums, and includes the first numerical estimate of the coefficient of viscosity (μ) for air. The value thus obtained, although of the right order of magnitude, is considerably less than that now generally accepted; and, indeed, for the experimental determination of this constant the pendulum method would seem to be not specially appropriate. One source of uncertainty in the present determination is that μ was assumed, on the strength of an experiment of Sabine, to be proportional to the density, whereas Maxwell has since shown that for the same gas μ varies only with the temperature. The author tells us that one reason for the long delay in the appearance of this volume has been a design of revising the calculations from the point of view of Maxwell's result. This design is now abandoned, but an interesting note is inserted, explaining how it comes about that the erroneous assumption had so little

effect on the consistency of the results. Another note, which also now appears for the first time, deals with the question as to the existence of two constants of viscosity for a gas. The usual formal theory, which makes no appeal to molecular hypothesis, leads to stress-formulae of the types

$$f_{xx} = -p + \lambda \left(\frac{du}{dx} + \frac{dv}{dy} + \frac{dw}{dz} \right) + 2\mu \frac{du}{dx}, \&c.,$$

$$f_{yz} = \mu \left(\frac{dw}{dy} - \frac{dv}{dz} \right), \&c.,$$

involving the two constants λ, μ . The former of these is eliminated if we denote by p the mean normal pressure about the point (x, y, z) , viz. we then have $\lambda = -\frac{2}{3}\mu$; but the question remains whether the p thus defined is identical with the "pressure" referred to in the statement of the Boyle-Mariotte law. The identity is assumed by most writers on the subject, and is supported by Maxwell's molecular theory; but it cannot be said that there is as yet any decisive experimental evidence on the point. There is a real physical question involved, viz. as to whether a uniform expansion or contraction of a gaseous mass does or does not involve dissipation of energy by viscosity.

The calculations of this memoir are, of course, based on the usual assumption that the terms of the second order in the velocities may be neglected. It has only lately been realised, thanks to a remark of Lord Rayleigh, to what an extremely narrow range of velocities we are sometimes confined by this limitation.

The next paper in the book discusses the effect of radiation of heat on the propagation of sound. It is shown that very slow and very rapid vibrations will alike be propagated without sensible thermal dissipation, the former with the "Newtonian" and the latter with the "Laplacian" velocity, whilst for intermediate frequencies there would be a real degradation. The investigation is reproduced, and extended to include thermal conduction, in Lord Rayleigh's "Theory of Sound."

The memoir on the most general form of the equations of conduction of heat in crystals is remarkable historically, and also on account of the attention paid to the possible occurrence of the "rotatory" coefficients. These are finally dismissed as improbable, but their analogues have in recent times been appealed to to explain certain phenomena of electric conduction under magnetic influence.

The remaining papers deal with optical questions. Those on the colours of thick plates and on the composition and resolution of independent streams of polarised light are important applications of established principles of physical optics; but the most notable in some respects is the great memoir on Fluorescence, with which the volume closes. This masterly analysis of the nature of the phenomenon was more fortunate than some of the author's previous work in the attention which it immediately attracted, not only at home, but abroad.¹ A

¹ Prof. Stokes' work on "Attractions and Hydrodynamics" was long neglected on the continent. I recall a sally of Maxwell's in one of his early lectures at Cambridge. Incidentally he remarked (with, I think, some investigation of Stokes in his mind), "But foreign men of science don't read the Cambridge *Transactions*"; then, guessing from the smiles added very emphatically, "It would be a good thing if they did!" One particular instance of erroneous ascription has a curious vitality. In a book dated 1900 we read, "Die Bewegung der Kugel in einer Flüssigkeit ist zuerst von Dirichlet zuerst durchgeführte Fall." Yet both works are written by highly accomplished authors, with a sense of mathematical history.

most interesting note is now appended, in which the "Stokes theory of fluorescence," to which references have been made from time to time by Lord Kelvin and others, is expounded for the first time in the author's own words. Apart from the special application, the dynamical problem here employed by way of illustration is remarkable as the first example of the peculiarities of wave-propagation in a medium of "periodic" structure, a question which has been further elucidated by Lord Rayleigh.

The dates attached to the papers in this volume are all included in the interval from 1850 to 1852. The marvellous productiveness of the author, and the massive quality of the work which has left so little opening for subsequent correction or criticism, alike command our admiration. At the same time, we realise how great were the powers which from that period onwards were claimed in an increasing degree by the duties of the Lucasian professorship and by the secretaryship of the Royal Society. The generous and sympathetic manner in which these powers were placed at the service of younger workers now become a tradition of English science.

At the end of the preface we read, "There are other papers which still remain, and I hope, should life and health last, to put these together without delay." The "other papers" here so modestly referred to include such things as the "Communication of Vibrations" and the "Report on Physical Optics"! That the life and health may long continue, and that the promised continuation may speedily appear, will be the earnest desire of every reader of this volume.

HORACE LAMB.

ANTHRACITE MINING IN PENNSYLVANIA.

The Anthracite Coal Industry. By Peter Roberts, Ph.D. Pp. xii + 261. (New York: the Macmillan Company; London: Macmillan and Co., Ltd., 1901.) Price 15s. net.

IT is not often that a great industry is discussed in so thorough and useful a manner as has been done by Dr. Roberts in this case. He has brought together information from a large number of sources, and he presents pictures from many points of view; his twelve chapters relate to geology, methods of mining, capitalisation, transport, management and inspection, workmen and wages, incidental profits, accidents, strikes, unionism, reworking old waste heaps and general reflections.

The days of the "mammoth vein," often exceeding 100 feet in thickness, are coming to an end, and we learn that much of the anthracite is obtained from seams only two to four feet thick. It is estimated that, allowing a yearly output of sixty million tons, the stock of anthracite will last for eighty years.

The actual cost of production is reckoned to be \$1.25 a ton, to which must be added royalties, insurance, office expenses and taxes amounting to about thirty-one cents, so that the total cost is about \$1.56.

Much has been said in this country about the danger of employing a few Poles in our collieries, on account of their imperfect knowledge of English. What should we think of a mining population talking twenty different

languages, as happens in parts of the anthracite region? The majority of the alien colliers hail from Russia and Austro-Hungary. The author's ethnology is at fault, however, when he says that the Bohemians do not belong to the Slav nations.

The chapter upon the incidental profits made by mining companies from running stores is by no means the least interesting; it seems that the truck system still flourishes in Pennsylvania, in spite of legislation against it, and that the workmen have a real grievance.

The accidents follow the usual lines; as in other districts, the proportion of fatalities due to falls of coal and rock approaches one-half of the total. The truth of the assertion that most of the accidents are due to carelessness on the part of the men themselves may be doubted, though the apologists of the owners and managers of mines on this side of the water are too ready to endorse this statement. Recent statistics show that, at all events in Germany, it is incorrect.

The author takes an unnecessarily pessimistic view concerning mining fatalities when he remarks that legislation is impotent to prevent them; the experience of European countries is totally opposed to this conclusion. However, a cursory glance at the statistics for Pennsylvania might lead an outsider to agree with Dr. Roberts, for he shows that after years of law-making the annual mortality-rate from accidents exceeds 3 per 1000. Unfortunately, he fails to make it clear whether this is the death-rate of the underground workers alone or that of all the persons employed both below and above ground. But in either case it is very high and very discreditable, and, what is worse, there are practically no signs of improvement during the last quarter of a century.

One cannot help suspecting that an inefficient method of enforcing the law may be at the root of the evil. Instead of being appointed for life, the inspectors hold office for five years only, and at a salary which in America may fail to secure thoroughly trustworthy and independent persons. It is not surprising, therefore, to find the suggestion that the inspectors are in the hands of the mine-owners. By a law which has come into force recently, the number of inspectors is to be increased, and they are to be elected by popular vote and for three years only. It will be interesting to watch how far this change will remedy the dangers of anthracite mining. Even if the next decade does show an improvement, it will not be necessary to ascribe it to the new inspectorial system. The author points out that a very powerful syndicate has lately acquired the control of four-fifths of the entire anthracite industry, and that with better administration, better discipline, improved methods of mining and increased use of machinery, the present dire waste of human life is likely to be diminished without any further legislative pressure.

While dealing specially with the anthracite industry, the author discusses various social and economic problems, and his book deserves the attention of mining men generally, whether employers or employed. It is a matter for regret that we have not similar works relating to each of our own coalfields, or at all events a general treatise dealing in a like manner with coal-mining in the British Isles.

ORGANOGRAPHY AND ITS RELATIONS TO BIOLOGICAL PROBLEMS.

Organographie der Pflanzen insbesondere der Archegoniaten und Samenpflanzen. Von Dr. K. Goebel, Professor a.d. Universität München. Zweiter theil, Heft 2 (schluss); mit 107 Abbild i. Text. (Jena: Gustav Fischer, 1901.)

THOSE who have read the parts of Prof. Goebel's "Organographie der Pflanzen" which have previously appeared will welcome the volume now before us, although perhaps with mixed feelings, in that it marks the conclusion of an interesting and suggestive work.

The present part is mainly devoted to a consideration of the shoot in relation to the reproductive functions, and the author has succeeded in presenting his subject in an admirable form. Many new observations will be noticed by the reader, and much besides of what is now familiar to botanists represents the outcome of original investigations conducted in the Munich laboratory. Some of the questions touched on are of a rather thorny nature, and Prof. Goebel is to be congratulated on the generally fair and judicious attitude which he preserves in regard to controversial issues thus incidentally raised.

As might have been anticipated, the account of the varied adaptations for the protection of sporangia, as well as for their dehiscence and the dispersal of the spores, is full of interest, and not less so is the treatment of the annulus regarded from a slightly different point of view. The diverse aspects of the same problem, when looked at from the standpoint of phylogeny or of utility, are well exemplified by the discussion based on the structure in question. The physiological stimulus which evokes what may turn out to be an adapted structure can only operate on and through the particular mechanism of the organism which can respond to it. And it is just this consideration which gives the clue that may enable us to understand the hereditary nature of a character which at first sight appears to be merely adaptive, and to see also how its importance as a criterion of taxonomic value is determined.

The vexed question as to the homologies of the structures met with in the female cone of the Coniferae is briefly discussed, especially in relation to the abnormalities which have in the past played an important part in this connection, and the author well indicates the difficulties in correctly appreciating both the value and the cogency of this kind of evidence.

The chief deviations from the primitive character of a simple flower are also dealt with, and provide a good summary of our knowledge of the more salient facts. Some will probably hesitate to fully accept; the case of *Pyrus malus* as representing a real transition from the perigynous to the epigynous form of gynæcium. The mature structure, as well as the developmental evidence, indicates (it may be argued) that this is a case of true perigyny, only somewhat obscured, by the circumstance that the original and widening floor of the carpels has been tilted up instead of forming a horizontal expansion. It may be remarked in passing that the ovary of *Primula* is regarded as formed of five "paracarpic" carpels, and that the placenta is considered in this plant

to represent a new formation, i.e. it consists of neither axis nor leaf as morphologically distinguishable. It is also remarked that the evidence which has been derived from a study of the distribution of the vascular strands is apt to prove ambiguous; the strands themselves are extremely variable and depend entirely on the physiological requirements of the ovules.

In dealing with the sporangia, the author makes the interesting suggestion that a feature of great diagnostic importance in separating angiosperms from gymnosperms may be found in the epidermal character of the cells which effect dehiscence in the microsporangia of the latter, whilst they are of hypodermal origin in the angiosperms.

Finally, the volume is brought to a close by an excellent account of many of the recent investigations on the biology of the embryo sac, in the elucidation of which Prof. Goebel's own pupils have taken an active part.

The book, as a whole, is characterised throughout by a freshness and vigour which is the outcome of a first-hand knowledge of the facts upon which it is based. Furthermore, whilst marking a definite advance as containing a large number of new facts, and especially as emphasising new points of view, it is a work which cannot fail to stimulate further research in many new directions.

J. B. FARMER.

OUR BOOK SHELF.

The Hurricanes of the Far East. By Prof. Dr. Paul Bergholz. English Translation, revised by Dr. Robert H. Scott, F.R.S. Pp. xvi + 271. (Bremen: Max Nössler; London: Norie.)

THIS book is a translation of Prof. Bergholz' "Orkane des fernen Ostens," and is intended as a seaman's guide to the typhoons and hurricanes of the China seas, of similar type to Eliot's "Handbook of Cyclonic Storms in the Bay of Bengal." It is, in fact, a digest of the results of the work of Vinez, Eliot, Doberck, Faura, and more especially of the recent papers of Algué, in much the same way as Eliot's "Handbook" is a digest of the elaborate "Cyclone Memoirs."

Prof. Bergholz divides his manual into four sections. The first deals with the general aspects of cyclonic phenomena—the structure of the cyclone itself, and the seasonal and geographical variations in its progressive movements. The typical cyclone is divided into four concentric zones, A, B, C, D; the zones A and B belong to the "outer whirl," C and D to the "inner vortex." Zone A extends from 120 to 500 miles from the centre, and is characterised by a slow fall of the barometer which does not seriously modify the diurnal curve of pressure. In zone B the centre is distant 60 to 120 miles, and the barometer shows a "distinct fall," which does not obliterate the daily curve, but displaces the hours of maximum and minimum. Zone C is a belt of "rapid fall," 10 to 60 miles from the centre; in it the diurnal curve disappears altogether. Zone D is a circle extending to 10 miles from the centre, within which the fall is "very rapid."

The classification of the cyclones runs along two lines, according to either the seasonal distribution or the course of the track followed by the system. The first becomes in effect a basis for subdivision of the main headings of the second, which are four in number:—(1) Cyclones of the Pacific, subdivided into cyclones of Japan and cyclones of the Magalhaes, (2) Cyclones of the China Sea exclusively, (3) Cyclones of the China Sea including the typhoons of Mindanao, Visayas and Luzon,

and (4) Cyclones of the Philippines. A further classification, useful for some purposes, is made according to the rate of motion of the cyclone in its path. In connection with this part of the subject, a valuable series of plates gives monthly averages of pressure and temperature, diurnal barometer curves, and a chart of cyclone tracks.

The second part of the book deals with the indications of the approach of cyclones. While the whole section is of immense practical value, two chapters, on the photography of clouds by the photo-theodolite and photographic means of distinguishing true from false cirrus, and on Fournier's rule and the use of Algue's barocyclonometer, are of special scientific interest. The third section describes special characteristic cyclones, with a chapter on anomalies, and the fourth treats of winter or land storms.

Bird Hunting on the White Nile. By H. F. Witherby. Pp. 117; illustrated. (London: Knowledge Office, 1902.)

MR. WITHERBY may be congratulated, not only on having made a very successful bird-collecting trip to the White Nile, but also on having presented a narrative of his experiences to the public in an agreeable and well-written form. The several chapters of the book originally appeared as articles in *Knowledge*, from which they have been reprinted with the addition of two appendices and various slight amendments. The illustrations are also somewhat more numerous. The author tells us that he was unfortunate enough to lose all the photographs he took himself, owing to the intense heat and dryness; but he fortunately had with him a taxidermist who met with better luck in this respect, and it is to this gentleman that readers are indebted for the very interesting series of pictures with which the book is illustrated. Khartoum is likely to become a popular winter resort, and tourists interested in the natural history and people will find Mr. Witherby's work an excellent and entertaining guide for the trip.

As is indicated by the title of his volume, the author had for his main object the birds of the country visited, and of these he was successful in obtaining a large number of species, of which a list is given in the appendix. Mammals, as is so generally the case, appeared to be excessively rare, and but few specimens were secured; these, however, proved to be of some interest, as they included a bat, a mouse and a hare which have been described as new. Mr. Witherby intersperses his ornithological observations with accounts of shooting and notes on the manners and customs of the natives in a way calculated to attract the attention of readers of all classes. Unfortunately, he was unable to obtain any evidence on the question whether the "crocodile-bird" really enters the mouth of the unwieldy reptile from which it takes its name. R. L.

An Introduction to Chemistry and Physics. By W. H. Perkin, jun., Ph.D., and Bevan Lean, D.Sc. Two volumes. Pp. xviii + 207 and xii + 216. (London: Macmillan and Co., Ltd, 1901.) Price 2s. each.

THE special feature of these two small volumes is the treatment of the subject on historical lines, which is certainly a scientific method; for the young mind is asked to travel along the same track which the growth of the ideas has taken. This method lends itself to a more literary style than that of mathematical reasoning; and this, we think, is a gain, as the children in many science schools, where the time is chiefly taken up with science and mathematics, have little opportunity for such training.

Broadly, the first volume deals with physics and the second with chemistry. The metric system is explained at length, but we must confess that we should have pre-

ferred to see the gram described as a standard of mass and not of weight. It is certainly not true to say that a gram is *strictly* the weight of a cubic centimetre of water at 4° C., as the authors insist in the footnotes on pp. 18 and 20. It would not have been necessary to call attention to this had not great stress been laid on the fact that a metre is not exactly what it was originally meant to be.

In the experiments an accuracy of 1 per cent. is aimed at, yet in fixing the boiling point graduation on a thermometer, p. 43, the influence of the atmospheric pressure is not stated.

The present writer recently examined some 600 candidates in experimental science, and is able to trace many of their answers in these two books. As a rule these candidates seemed to follow the work well, but in some cases the principles of the experiments seemed beyond their power. Of all the quite elementary works of this class, perhaps these before us can be most strongly recommended to the consideration of the teachers in primary and secondary schools. S. S.

The Oil Chemist's Handbook. By Erastus Hopkins, A.M., B.Sc. Pp. viii + 72. (New York: John Wiley and Sons; London: Chapman and Hall, Ltd., 1900.) Price 3 dollars.

AS stated in the introduction, the book has been written with the idea of supplying a want which has been felt for some practical working manual containing methods of examining oils and also data which will assist in the easy detection of adulteration and also give information as to what the adulterant is. The first chapter consists, in the main, of a series of tables of the general properties and uses of the oils and fats met with in commerce and of the solubility of oils, fats and waxes in various solvents. Following this are given the principles of the chief tests—the Maumené, Elaidin, Warren's sulphur chloride test, &c.—and then, without an excessive amount of detail, the methods of analysis, in all cases references being given to the literature of the processes. The tables of chemical and physical constants which follow form an exceedingly useful collection, though the list might with advantage be a more complete one. In these tables the results of different observers are shown rather than mean figures, and the authors' names are given. In fact, this quotation of sources of information forms a distinct and important feature of the whole book.

Decidedly useful is a series of five tables arranging oils, fats and waxes according to (a) saponification value, (b) iodine value, (c) Reichert Meissl value, (d) Hehner value, and (e) acetyl value. The final chapters deal with fatty acids, unsaponifiable matter (such as mineral oils, &c.), lactones, resin and glycerol.

Speaking generally, the book forms a valuable working companion for the oil chemist, without being a mere reference book.

Elements of Botany. By W. J. Browne, M.A. Lond., M.R.I.A. Fifth edition. Pp. viii + 272. (London: John Heywood, 1901.) Price 2s. 6d.

WHAT is required of the elementary text-book nowadays is that it should furnish suitable directions and sufficient instruction to enable a student to collect, examine and work out the structure of plants for himself. The present work unfortunately follows the old style, being for a great part a mere catalogue of terms, or a series of descriptions, somewhat dry, relating to parts of the plant. In other respects, too, the book is quite unsuited to modern teaching; the appearance of *Torula* early in the book, presenting a huge nucleus, the idea that anatomical sections may be cut with a knife, the enumeration of the twenty-four classes of the Linnæan system, all suggest that the book has not yet been sufficiently modernised.

LETTERS TO THE EDITOR.

[The Editor does not hold himself responsible for opinions expressed by his correspondents. Neither can he undertake to return, or to correspond with the writers of, rejected manuscripts intended for this or any other part of NATURE. No notice is taken of anonymous communications.]

Mont Pelée Eruption and Dust Falls.

FALLS of dust are caused in two ways; either the dust, as for instance Sahara sand, is transported by means of the lower air-currents over wide areas, or matter is ejected from volcanoes, thrown high up into the air and carried by the upper currents, falling eventually in places at great distances from the seat of disturbance. The eruption of Krakatōa is a good example of the latter case, while the dust fall that occurred last year in March and was recorded in northern Africa, southern and northern Europe is a good representation of the former kind of dust fall.

The occurrence of such falls of dust is very interesting meteorologically, because they afford us means of increasing our knowledge of the actual movements of the air-currents, both low down and high up in our atmosphere. Falls of dust originating from volcanic eruptions are perhaps of greater interest, because the dust in such cases is thrown to very great heights, and we are able to deduce the directions of the currents at this elevation, there being no other method of doing so available.

To those interested in the movements of these upper currents, the recent disastrous eruption of Mont Pelée in Martinique may afford us some valuable information on this subject. From the accounts of the eruption already published, it is found that it occurred on May 8, and we gather from the information supplied by the British schooner *Ocean Traveller*, and printed in the *Times*, that when the ship was about a mile off St. Pierre, the volcano on Mont Pelée exploded. That the eruption was on a stupendous scale is undoubted from the numerous descriptions already made public, and the report from the British steamer *Esé*, which passed St. Pierre, that "she was covered with ashes although five miles distant from the land, and from on board nothing could be seen owing to the impenetrable darkness," gives some idea of the result of the disturbance. Later reports have indicated a further spreading of the dust, the island of Dominica recording a fall of sand on its southern boundary.

It is interesting for a moment to make a brief survey of the atmospheric circulation in the lower and upper reaches of the atmosphere in the region of the West Indies and to the north and south, and see whether we can trace out the probable path of the fine dust thrown into the air.

An examination of the fine pressure charts published in Bartholomew's "Atlas of Meteorology" tells us that during the month of May the West Indies lie between, but a little to the west of, two high-pressure regions, the more northern one being situated in the Atlantic Ocean and that to the south over the centre of South America, the intervening belt being one of low pressure. We also know that the sun has a declination of about 17° north at this time, and as the island of Martinique is situated in latitude about 15° north, the sun therefore passes daily near the zenith of that place, or, in other words, the sun is exerting its greatest heating power. In consequence of this fact, the low-pressure belt has a maximum in this region, and a low-pressure area means that the air is rising from the earth's surface into the higher regions. The two high-pressure areas already mentioned correspond to downcast shafts of air, i.e. air moving from higher to lower regions. With our present knowledge of atmospheric circulation it seems most probable that the heated air, rising into the upper reaches of the atmosphere from the low-pressure region (which includes the West Indies), bifurcates in a north-easterly direction in the northern hemisphere and in a south-easterly direction in the southern hemisphere. Since these currents of air must again reach the earth's surface, where they fall they will give indications of high pressure, i.e. indications of descent of air. As the two high-pressure areas already mentioned lie in the correct positions and directions in relation to the West Indies, it seems very probable that these are the downcast shafts corresponding to the upcast shaft or low-pressure area.

If the circulation above mentioned be correct, then, as the region of the volcanic eruption of Mont Pelée lies in this low-pressure area, some of the finest particles ejected to the upper reaches of the atmosphere might possibly be carried in these

currents and begin to fall in these high-pressure areas. They may also, if the dust be thrown sufficiently high, reach that elevated current of air travelling from east to west and make a circuit of the earth, as was the case in the eruption of Krakatōa.

The most favourable position in the northern hemisphere to observe this fall of dust, should there be such, would be probably in the middle of the Atlantic Ocean, and this could only be recorded by passing ships. Since, however, the descending air moves in a spiral manner and in the direction of the hands of a watch, some of this current reaches Britain as a south-west wind, and it will be interesting to see whether any fall be recorded. There seems little doubt, however, that, just as in the case of Krakatōa, a great fall of dust fell to the westward of the volcano, so we shall probably soon hear in this case of such records from Mexico and Central America.

Further, the eruption of Krakatōa was responsible for the magnificent coloured sunsets that were observed nearly all over the world, and as these were due to the fine dust particles ejected from the volcano—particles at very great altitudes—so it is quite probable that similar effects will ensue from the eruption of Mont Pelée.

It seems desirable, therefore, that information relating to the present eruption should be collected while facts are still in the memory of those who have observed them, and that a complete account be recorded similar to that published on the Krakatōa eruption. It is satisfactory to learn that already expeditions are about to be sent from the United States of America to investigate the scene of the eruption.

WILLIAM J. S. LOCKYER.

Symbol for Partial Differentiation.

IN my college days we used the symbol $\left(\frac{du}{dx}\right)_y$ or $\left(\frac{au}{dx}\right)_y$ (if there was only one other independent variable y) as the differential coefficient when y was constant. I still keep to this symbol. Thus, if k is a certain kind of thermal capacity, $\left(\frac{dk}{dt}\right)_v$ or $\left(\frac{dk}{dt}\right)_p$ or $\left(\frac{dk}{dt}\right)_s$ are in my thermodynamic work perfectly definite. The mathematicians have introduced the convenient symbol for a partial differential coefficient $\frac{\partial u}{\partial x}$ and in much work there is no doubt about the meaning. But even in hydrodynamics there is trouble. In thermodynamics there is so much trouble with this symbol that I venture to ask for help.

The German translator of one of my books uses the same symbol $\frac{\partial k}{\partial t}$ for each of the above quite different things. Baynes in his thermodynamics does the same, and so do all other writers; it seems to me that everybody is doing this without thought. Are they writing for the average examination man who does not need to think, or for the real student? If the letter ∂ is to be retained, would it not be possible to use ∂_k or ∂_t or ∂_s in the above three cases? I encourage my own students to use ∂ , and I speak in the interest of such men. For myself it does not much matter, as I mean to continue using the symbolism of my youth.

JOHN PERRY.

May 6.

The Pines of Western Asia.

ON p. 15 of NATURE of May 1, it is stated that Herr Hugo Bretzl, in a thesis for his Doctorate at Strassburg, has shown that "the Greeks realised such facts as the absence of the pine in all the countries which intervene between Macedonia and India." That this statement is erroneous is proved by the following facts relating to the distribution of Macedonian and other species of *Pinus* in the countries alluded to. *P. Pinea*, Anatolia and Syria; *P. sylvestris*, Asia Minor, the Caucasus and Tauria; *P. halepensis*, Anatolia, Transcaucasia, Syria; *P. Brutia*, Asia Minor, the Lebanon, N. Persia; *P. Laricina*, Asia Minor. To these should be added various species of *Picea* and *Abies*, which the Greeks may have included under *Pinus*.

J. D. HOOKER.

THE pine referred to is *Pinus excelsa* Wall., which forms a feature of the Macedonian Mountains and also of the Himalayas,

but has not been found between Macedonia and Afghanistan. (Brandis, "Forest Flora of North-West and Central India," p. 511). Our thanks are due to Sir Joseph Hooker for pointing out that the statement as it stands suggests a wrong inference.

THE WRITER OF THE NOTE.

The Kinetic Theory of Planetary Atmospheres.

THE much-debated question of the applicability of the kinetic theory to decide what gases can and what gases cannot exist in the atmospheres of planets is necessarily once more raised by a somewhat striking paper by M. E. Rogovsky in the *Astro-physical Journal* for November, 1901. In performing certain calculations contained in this paper, which are embodied in Table III. (p. 254), the author bases his work on the assumption (p. 252) that "... the equation

$$W = \frac{\sqrt{(2ac)}}{10^{22}}$$

where W is the most probable velocity of the molecules of a gas, gives the minimum most probable velocity in a gas which escapes from the surface of the given celestial body."

This is equivalent to assuming that a gas will escape if the velocity required by a molecule in order to overcome the planet's attraction and fly off to infinity (if it does not collide with other molecules) is not more than 10^{22} times the most probable velocity.

Now if we calculate the probability of a molecule attaining a speed of 10 times the most probable velocity (to use round numbers), we find that the expression for this probability involves a factor of the form e^{-100} , that is about 10^{-43} , and this alone is sufficient to show that it is so rare for a molecule to attain a speed of 10 times the most probable velocity that such events cannot possibly have any appreciable effect on the planet's atmosphere.

Let us examine the matter a little closer, and in the first instance let us calculate the average proportion of molecules in any gas which have at any instant speeds of not less than 10 times the most probable velocity. The numerical result we obtain is

$$1 \text{ in } 2.4 \times 10^{32}$$

To interpret this result, let us suppose we are dealing with a gas one cubic centimetre of which contains 10^{24} molecules; this figure giving a rough estimate of the number of molecules in a cubic centimetre of air of ordinary temperatures and pressures. Then a volume of this gas equal to 2.4 times a cube the side of which is 100 kilometres will have to be taken in order that there may be an average of one molecule moving with a speed of 10 times the most probable velocity.

So far our calculations do not involve any considerations of time, although this must necessarily enter into the problem of escape of gas from a planet's atmosphere. Let us therefore now suppose the mass of gas under consideration to be bounded by a surface S , and let it further be supposed that every molecule which impinges on S with a speed greater than 10 times the most probable velocity escapes. Let the most probable velocity of the molecules be 1093 metres per second, the number assumed by M. Rogovsky for helium on p. 252 of his paper.

Then in order that the number of molecules removed in this way may be equal to the removal of a layer of the gas 1 millimetre thick all over the surface S , it will be necessary for about 2.8×10^{28} years to elapse.

Next suppose the surface S to be equal in area to the surface of our earth, namely a sphere 4×10^4 kilometres $= 4 \times 10^9$ centimetres in circumference. How many years would it take for a cubic centimetre of gas to escape? The answer comes out to be about 5.371×10^{10} years.

The only conclusion which can be drawn, not only from the present calculations, but also from others of a similar character¹ which have been made, is that a gas cannot escape from the atmosphere of a planet by the motion of its molecules among themselves without the aid of extraneous causes unless the most probable velocity of the molecules is considerably greater than one-tenth of the velocity required to overcome the planet's attraction.

If helium is actually at the present time escaping from our atmosphere, its escape must be due to entirely different causes, and has to be investigated by entirely different methods from those contained in M. Rogovsky's paper. At all events, a most probable molecular velocity of not more than one-tenth, corresponding to a kinetic energy of not more than one-hundredth of that required to carry a molecule of the gas to infinity cannot have much influence in helping a gas to escape from a planet's atmosphere. And so soon as outside influences are invoked, the ratio of velocities which forms the basis of that portion of M. Rogovsky's work here considered ceases to be the determining factor of the problem.

G. H. BRYAN.

Bangor.

On Prof. Arrhenius' Theory of Cometary Tails and Auroræ.

THE letter of Dr. J. Halm in your number of March 6 is based on two misunderstandings into which the writer could not have fallen if he had seen Arrhenius' original papers (*Physikalische Zeitschrift*, November 1900), or my description of them in the *Popular Science Monthly* (January 1902), instead of the friendly but erroneous notice of my paper in the *Observatory*.

(1) Dr. Halm quotes Prof. Schwarzschild to show that Arrhenius' theory "appears to be incompatible with any assumption which regards the cometary matter as being of a gaseous constituency."

Arrhenius never suggested that gaseous molecules could be propelled by the pressure of light. To quote my account of his theory:—"As the comet approaches the sun, the intense heat causes a violent eruption of hydrocarbon vapours on the side towards the sun. The hydrogen boils off, and the vapours condense into small drops of hydrocarbons with higher boiling points, or ultimately solid carbon is thrown out, finely divided as in an ordinary flame. The largest of these particles fall back to the comet, or if they are not condensed till at a great distance from it, they form tails turned towards the sun. The smaller are driven rapidly from the sun by the pressure of its light, with a speed depending on their size, and form the ordinary tails pointing away from it. That particles of different sizes should be formed from the same comet is natural, since the comet is likely to be formed of heterogeneous materials, and there must be great variety in the circumstances of condensation."

Dr. Halm does mention the idea of condensation into drops, and remarks, "Whether such an assumption can be justified appears to me very doubtful." This, of course, is merely his opinion, and receives no authority from the calculations of Prof. Schwarzschild. Indeed, in a recent letter to me, Arrhenius points out that these results fit the theory remarkably well. As Dr. Halm says, Prof. Schwarzschild reckons that "the corpuscles thrown off in the tails of comets should have diameters not smaller than 0.07μ and not exceeding 1.5μ , supposing the specific gravity of the corpuscle to be that of water."

Now Arrhenius, in his original paper (November 1900), taking the specific gravity of the hydrocarbon drops to be 0.8, calculates the size of the particles required by his theory to account for the curvatures observed in the case of four different comets' tails, and finds them to be 0.1μ , 0.59μ , 0.94μ , 1.25μ . These values are distributed almost exactly over the interval within which light could exert a pressure greater than gravitation, according to the "exhaustive mathematical investigation" of Prof. Schwarzschild published a year later.

(2) Dr. Halm says:—"At any rate Prof. Schwarzschild's profound mathematical investigation makes it absolutely clear that the idea of minute electrically-charged corpuscles—about one-thousandth the size of a hydrogen atom (see *Observatory*)—being propelled by the sun's light towards the earth and causing the various phenomena of auroræ, Gegenschein, &c., receives no support from the mathematical point of view."

A reference to Arrhenius' paper and to my article will show that it is carefully explained in both that the charged (negative) particles are known to form excellent nuclei for condensation. It is the small drops so formed, and not the corpuscles, which, according to Arrhenius, are supposed to be driven off as far as the earth, and beyond it, giving rise to the auroræ, &c. As was seen above, Prof. Schwarzschild's results support such a view.

JOHN COX.

McGill University, Montreal, March 19.

¹ *Phil. Trans. A*, vol. cxlvi., pp. 1-24 (1901); also S. R. COOK, *Astro-physical Journal*, January, 1900.

The object of my letter to which Prof. Cox refers was to draw attention to certain statements made in recent accounts of Arrhenius' theory which were disproved by Prof. Schwarzschild's computations. I was fully aware at the time that Arrhenius himself had already arrived at the conclusion that, to accord with his theory, the particles in the tails must be assumed to be liquid or solid. This was the necessary result of his computations, which had convinced him that the diameters of the particles must be between 0.1 and 6μ in order to satisfy Prof. Bredichin's values for the repulsive forces observed in comets. But how does Arrhenius' theory account for the presence of luminous vapours in the tail? In some recent comets the typical spectrum of the hydrocarbons was traced by Prof. Vogel to the farthest end of their tails. The emission of Comet 1881 iv. (Schaeberle) was almost entirely gaseous, and in Comet 1882 ii. even the sodium vapour was observed in the brighter parts of its luminous appendage. How are these vapours carried into the extreme parts of the tail, since the analysis of Prof. Schwarzschild shows that the pressure of light is far too insignificant to exert a repulsion upon the molecules of a gas or vapour?

Prof. Cox assumes the evaporation on the side facing the sun to be caused by the "intense heat" to which the comet is exposed on its approach towards our luminary. He thus attempts the revival of an hypothesis now abandoned by astrophysicists. Astronomers will find it somewhat difficult to comprehend how, for instance, the famous comet of 1811—one of the most remarkable phenomena of last century—which never approached the sun to the distance of our planet, could have received so intense a heat-supply that the "hydrogen of the hydrocarbons would boil off." But apart from this, the spectroscopist has now clearly demonstrated the luminosity of the cometary substance to be due to disruptive electric discharges at a low temperature. The assumption of an "intense heat" causing the evaporation on the side towards the sun receives no support from the spectroscopic evidence. Moreover, the misty film surrounding the nucleus, the so-called atmosphere or coma, is certainly of extreme tenuity, and the mass of the comet cannot but be immeasurably small. Hence the hydrostatic pressure opposed to the outpouring vapours must be extremely insignificant. This necessarily involves low boiling points, so that condensation can only take place at very low temperatures. Hence we require at the same time an intense heat to boil off the hydrogen and an extremely low temperature to allow the condensation of the hydrocarbons into drops.

But even suppose that in spite of the intense heat and the low hydrostatic pressure condensation does take place on the side towards the sun, and that drops of hydrocarbons with less than the "critical" diameter are driven from the sun by the pressure of light. Can Prof. Cox demonstrate the possibility of these drops preserving their liquid state after having been launched into the vacuum of space? The permanent existence of drops of hydrocarbons in the tail is possible only under the condition that the space between the drops is saturated with hydrocarbon vapours. Here, then, we are again confronted with the question, How are these vapours carried into the tail, since the pressure of light has practically no repulsive power on the molecules of a gaseous substance? But if only drops, and no vapours, of hydrocarbon are repelled by the light-pressure, as Arrhenius assumes, what force prevents these drops from being instantaneously evaporated after once having departed from the outskirts of the comet's atmosphere and having started on their journey through the vacuum of space? Obviously the assumed drops ought to retain their initial bulk throughout the whole length of the tail, *i.e.* through a distance of hundreds of thousands of miles, all the time unassisted by any vapour, the tension of which might counteract the inherent tendency of the liquid to assume the gaseous state. Such an hypothesis is plainly impossible.

Prof. Cox mentions the possibility of solid particles being repelled by the light-pressure. He remarks that "ultimately solid carbon is thrown out, finely divided as in an ordinary flame." There is no objection to this assumption from the physical point of view. But is it sufficient to explain the characteristic forms of the tails and their classification into several distinct types? What reason can be adduced for particles of dust assuming only such dimensions as would lead in all the comets to only three or four particular repulsive forces out of an infinite number of possible varieties? Why have, for instance, in the forty comets investigated by Prof. Bredichin, the particles never assumed such dimensions as would cor-

respond to types intermediate between Bredichin's first and second? The explanation of Prof. Arrhenius is very unsatisfactory. He says:—"Wenn nun zufolge gewisser Umstände einige Tropfengrößen die gewöhnlichsten sind, so können die wohlbekannteren, relativ scharf begrenzten Schweife von verschiedener Krümmung entstehen." No attempt is made in his paper to show what these "certain circumstances" are, nor why they should lead to the same types of tails in comets with widely different conditions of evaporation and condensation. The results of Bredichin seem to me indeed to be irreconcilable with the present version of Arrhenius' theory, which in no way explains the remarkable selection of repulsive forces discovered by the distinguished Russian astronomer.

Another difficulty has been pointed out in my previous letter. It relates to the peculiar behaviour of the coma. In some comets a contraction of the coma has been observed on the approach of the comet towards perihelion, succeeded by an expansion after the perihelion had been passed. Thus the diameter of the coma of Encke's comet in 1838 was found by Valz to have shrunk from 280,000 miles at the solar distance 1.42 to only 300 miles at perihelion. How is this phenomenon to be explained by the pressure of sunlight? In many instances (Comet 1862 ii., Respighi's and Henry's comet among others) the coma retained its globular form while the tail spread out and assumed enormous dimensions. But the spectroscopist has now demonstrated that no difference exists between the coma and the tail with regard to the physical and chemical constitution of their materials. Hence the question remains still open why the pressure of light should repel the materials of the tail and yet at the same time leave the same materials in the coma entirely unaffected.

My objection to the theory of Arrhenius refers to those parts where he introduces Maxwell's pressure of light. I am perfectly at one with the Swedish physicist and with Prof. J. J. Thomson regarding the important part probably played by the negative electrons emitted by the celestial bodies. But I fail to understand why the pressure of light should be required to account for the discharge of negative electrons into space. Physicists tell us that a hot body like our sun is most probably the source for an energetic emission of free electric atoms. We are, moreover, acquainted with the fact that these free electrons possess enormous velocities. The measurements of Wiechert have shown the velocity to be between one-fifth and one-third of that of light. Now if the heat of the sun is capable of splitting off the negative electron from its atom, a great number of these free electric atoms must be flung into space simply on account of their enormous kinetic energy. For no form of matter leaving the upper strata of the solar atmosphere with a velocity exceeding 600 kilometres per second can possibly return to the sun. Why, then, should the free negative electron, with more than one hundred times this critical velocity, still require a force such as the pressure of light to be propelled into the universe? If we adopt Arrhenius' idea, according to which the free electrons first condense ordinary matter around themselves near the solar surface and are afterwards driven off by the pressure of light on this bulk of matter, we must find it difficult to understand how in some authenticated cases the action of a solar outburst on the magnetic instruments could have been instantaneous (see Young, "The Sun"). Granting the highest possible repulsive action of light-pressure on small particles, the solar electrons would require at least sixteen hours to reach the surface of our planet.

In my opinion, if we adopt the suggestion of Prof. J. J. Thomson that free negative electrons are probably emitted by the sun, a copious propagation of these infinitesimal corpuscles into space would be the obvious and necessary result of such an emission, even without the assumption of light-pressure.

The train of reasoning ensuing from this hypothesis would lead in a most natural way to Zöllner's celebrated theory of comets. By the abundant presence of electrons, space has then to be considered as a negatively charged electric field acting upon the ionized cometary matter. From this point of view, Zöllner's theory—according to Newcomb, the one "which on the whole most completely explains all the phenomena"—would no longer "lack the one thing needful to accept its reception," namely, "the evidence that the sun acts as an electrified body."

The main conclusion I have arrived at after a careful study of the theory of Arrhenius amounts to this: that by abandoning the assumption of the pressure of light and by assuming the propagation of free negative electrons from the sun into space

simply as a consequence of their great inherent velocity, the theory becomes admirably fitted to strengthen the views of Olbers, Zöllner and Bredichin with regard to the nature and the origin of the repulsive force acting upon the cometary matter. But the introduction of Maxwell's pressure of light gives rise to a number of difficulties which, as Prof. Arrhenius abundantly shows, can only be overcome by arbitrary and unwarranted assumptions.

I shall take an early opportunity of demonstrating the superiority of Zöllner's theory over the one which now claims to "sweep the astronomical horizon of so many mysteries."

Royal Observatory, Edinburgh.

J. HALM.

Stopping down the Lens of the Human Eye.

MAY I be permitted to direct Mr. Wm. Andrews' attention to the fact that his experiment in "stopping down" the lens of the eye involves exactly the same principle as "orthoptics," of which every rifle-shot will have had experience.

The "orthoptic" consists of a round hole in a black disc, which replaces the lens of a pair of spectacles. The hole is generally adjustable in size, to suit varying conditions of light. The purpose of the orthoptic is to increase the depth of focus, enabling both back and fore sights and the target to be in sharp focus together. Persons with naturally large pupils will, as a rule, notice the effect more strongly.

H. BLISS.

May 9.

It may interest your readers to know that the principle referred to, under the above heading, in your issue of May 3 was adopted, a great many years ago, by the late Lord Sherbrooke, whose sight I believe was very defective. I remember seeing, about the middle of the seventies of the last century, at an exhibition of physical apparatus at South Kensington, a pair of spectacles which were said to have been invented by him for his own use. They consisted of two convex metal cups, closely resembling in shape and size the bowl of an ordinary tea-spoon. In the centre of each cup was a small pin-hole, which was the only aperture through which light could enter; and the two cups were fastened together by an elastic string, evidently intended to go over the head. The invention impressed me at the time as a remarkable example of scientific skill combined with great simplicity of contrivance.

GERALD MOLLOY.

The Evolution of Snails in the Bahama Islands.

It seems desirable to call the attention of evolutionists to Dr. H. A. Pilsbry's monograph of the genus *Cerion* (or *Strophia*), just published in the "Manual of Conchology." The facts presented are most of them not new, but all that is known is set forth in great detail, with an abundance of excellent figures. *Cerion* is a genus of rather large cylindrical land-shells, for the most part inhabiting the Bahamas and Cuba. It has split up into innumerable local species and races, 134 of which are recognised as sufficiently distinct to bear names. Not only do even the smallest islands or "keys" produce distinct species, but frequently one small island will have two or more different forms inhabiting different parts, and sometimes a distinct race will occupy a very small area, surrounded on all sides by another type. The problem of the differentiation of the Achatinellidae in the Hawaiian Islands is complicated by the complexity of their environment; but here in the Bahamas we have differentiation just as marked, with an environment—small sandy islands with palms and low bushes—as simple as we are likely to find anywhere. It would therefore seem that an excellent opportunity lies before some student of evolution to investigate exhaustively the local species and races of these Bahama snails, and determine what causes have brought about the known results. Colonies could be taken to new localities, and watched from year to year to see whether they became modified. The food and moisture conditions might be altered, and the results observed. The exact conditions surrounding each distinct form might be studied and described. Thus it might be determined whether the differentiation was the result of natural selection or has taken place independently of it. Such an investigation would be delightful work for some enthusiastic naturalist, especially with such an excellent guide in hand as Dr. Pilsbry has supplied.

T. D. A. COCKERELL.

East Las Vegas, New Mexico, U.S.A., April 26.

NO. 1698, VOL. 66]

Retention of Leaves by Deciduous Trees.

THE retention of leaves by beechen hedges referred to by your correspondent in NATURE, April 10, is by no means confined to those on elevated ground. It may commonly be observed in hedges of this tree whatever their situation. In Northumberland the beech is not infrequently used as a hedge, and always retains its leaves throughout the winter. Young beech trees also frequently retain their leaves, and by no means always in exposed situations. Indeed, the examples I have myself seen have been much more frequently in sheltered spots, as in plantations of older trees.

Nor is this phenomenon of deciduous trees retaining their leaves under certain conditions confined to the beech. It is, perhaps, equally common in the oak. Young oak trees in plantations may often be seen in the spring covered with brown and withered leaves. Larger trees may also sometimes be seen retaining the leaves on some of the lower branches, while the upper ones are bare. Travelling from Eastbourne to Victoria, soon after reading the above communication in NATURE, I noticed hundreds of young oaks covered with withered leaves. None of these were in elevated or exposed situations. Indeed, I am inclined to suggest, as an inference from the above facts, that it is rather the protection enjoyed by the trees which enables them to retain their leaves. In the one case the lesser height of the tree, and in the other the close intergrowth of the hedge, gives the wind less power to strip off the leaves. We can hardly consider that there is here a "protective device," unless on the part of the gardener who sets a beechen hedge to shelter his plants.

G. W. BULMAN.

13 Vicarage Drive, Eastbourne, May 3.

With regard to the interesting communications concerning the retention of their leaves by young beeches, I beg to forward another possible solution. The beech is a "frost-tender" species, and early frosts, which would not rise high enough to affect large trees, would freeze the leaves of "small young" trees, thus preventing the formation of the abscission layer of cork at the base of the petiole. In such a case there is no reason why the leaves should fall off for a considerable time.

Leaves killed before the formation of this layer remain on the branch for an indefinite time, of which phenomenon pea-sticks cut in full leaf may serve as an example.

P. T.

May 10.

THE RECENT VOLCANIC ERUPTIONS IN THE WEST INDIES.

NEWS of the terrible volcanic eruption in Martinique reached this country on Thursday last, and the details which have since become known have shown that an appalling disaster has occurred. St. Pierre, the chief commercial centre of the island, has been totally destroyed, and about thirty thousand people have perished. The eruption of Mont Pelée began on the night of Saturday, May 3, when large quantities of scoriae and volcanic ash were thrown into the surrounding country. On Monday, May 5, a stream of lava is reported to have rushed down the side of Mont Pelée, following the dry bed of a torrent, and reaching the sea, five miles from the mountain, in three minutes. When the stream met the sea the water receded 300 feet on the west coast, returning with greater strength in a large wave.

Two days later, on May 8, a similar torrent of incandescent lava engulfed the town of St. Pierre. The following telegram describing the calamity was received at Paris from Fort de France on May 11, and was published in Monday's *Times*.

"The town of St. Pierre was destroyed on the 8th about 8 a.m. A terrible torrent of incandescent lava, from Mont Pelée, a volcano a few kilometres from the town, accompanied by a shower of fire, in a few seconds covered the town, and an immense furnace extended over the neighbouring coast, thus forming a line of fire from the village of Carbet to the town of Prêcheur. The effects of this volcanic torrent were felt as far as

Fort de France, and we received a shower of cinders and stones weighing seven to ten grammes. The whole island was covered three millimetres thick with cinders. The panic was general, yet relief was soon organised. The French cruiser *Suquet* went to the spot, as also other vessels towing boats, which soon returned, bringing terrifying news. The shore is unapproachable. The vessels in St. Pierre roads are on fire. The heat is extreme."

A later message from Fort de France, published in Wednesday's *Times*, says:—

"Access to the ruined town of St. Pierre has become more easy since the day before yesterday. At the Mouillage no signs of fire are now visible. Everything appears to have been rent and scattered as by a tornado. The iron gate of the Custom House remains standing. In the hospital the iron bedsteads are twisted, but bear no other traces of fire. The bed clothes and all other textile fabrics have completely disappeared. About 2000 corpses have been found in the streets. The central quarters of the town and the fort are buried under cinders to a depth of several yards. In the neighbourhood of the creek several houses remain intact, but the inhabitants were killed as if they had been struck by lightning, the bodies lying, sitting, or reclining in curiously diverse attitudes.

"Smoke is issuing from the crater of the volcano. Over the northern slope, as well as Basse Pointe, hover clouds of hot cinders, and flashes and rumblings are still distinguishable from time to time."

The Soufrière volcano in the neighbouring island of St. Vincent has also broken out in eruption. According to a *Times* telegram from St. Lucia, the northern district of St. Vincent, from Chateau Belair to Georgetown, has been devastated by an enormous flow of lava, destroying everything in its path. It is reported that both the large craters on St. Vincent are emitting enormous volumes of vapour, lava and hot ashes, and that small craters are bursting out everywhere. No vessel can approach the northern shore of the island on account of the intense heat and steam from the craters. Heavy ashes fell in great quantities on a steamer 250 miles from St. Vincent, and many masses of rock have fallen at Kingston. It is stated that sixteen hundred deaths have been caused in St. Vincent by the eruption.

This brief statement of the eruptions and their consequences contains the chief points of the news yet available. We are fortunate in being able to supplement the reports with an article by Prof. Milne upon the subject, and a summary in which he gives the sequence of events.

Sequence of Events.

April 19.—A very heavy earthquake occurred in Guatemala. It was recorded in the Isle of Wight, and might have been recorded anywhere in the world. It probably indicated a sudden adjustment in the orogenic fold of Central America, and a change in this fold possibly resulted in movements in the neighbouring fold represented by the West Indies, and hence the recent volcanic eruptions and earthquakes in that region.

April 23.—Mont Pelée showed a plume of "smoke."

May 3.—Mont Pelée not only "smoked," but at night was lighted up by the incandescent lava within its crater.

May 4.—Mont Pelée covered the surrounding district with ash.

May 5.—A stream of mud and lava were erupted and engulfed a sugar factory, twenty-three persons being buried. The sea receded 300 feet.

May 6.—A Government Commission issued a reassuring report.

May 7.—About 11 p.m. (Martinique time) a small earthquake from a very distant origin was recorded in the Isle of Wight, Edinburgh, and at other stations.

May 8.—At 8 a.m. "the rain of fire" destroyed St. Pierre. Ships were burned and sunk by a shower of rocks and heated materials, which poured down for about fifteen minutes. At Fort de France, twelve miles distant, these stones were the size of walnuts.

This eruption still continues, but on the 10th it had so far decreased that the site of St. Pierre was explored, but no living beings were seen.

The eruption of La Soufrière in St. Vincent commenced on Monday, May 5, and on May 7 the eruption was violent.

It would therefore seem that these two eruptions were simultaneous, and may have been brought about by a common cause.

Martinique, which, the *West India Pilot* tells us, is 35 miles in length and 7 to 16 miles in breadth, "is very lofty and irregular in height, and may be readily distinguished by three remarkable mountains of different forms, rising far above the general chain which runs through the whole of the island from N.W. to S.E., and may be seen about 45 miles off. The most northern of these is Mont Pelée, 4428 feet above the sea, rising nearly 4 miles to the south of Cape St. Martin, and its summit, when seen from a distance, appears rounded, and presents nothing remarkable."

It seems to be an irony of Nature that the most dangerous creations should so frequently simulate the appearance of that which is quite ordinary.

Prior to A.D. 79, Vesuvius was in its appearance even more innocent than Pelée. Spartacus and his gladiators camped within its crater, which, Plutarch tell us, was to a great extent covered with wild vines. On its flanks were cultivated fields, at its base the wealthy and populous cities of Pompeii and Herculaneum. If we except a few slight shocks which preceded the burial of these two towns, there was nothing to indicate the terrific outburst by which this was accomplished. The mountain, which was "nothing remarkable" in its appearance, suddenly exploded, there was a rain of ash, and the surrounding country became a desert.

Another illustration of the awakening of a slumbering Titan was Krakatoa. After a rest of 200 years, this mountain, on Sunday, May 20, 1883, gave symptoms of unrest by an eruption accompanied by shakings and roarings, which were loud enough to be heard even at a distance of 100 miles. Then for a few months there was comparative quiescence until August 26, when a crater opened near sea level and the challenged ocean poured in upon internal fires. The story of the battle which ensued, with its fearful detonations, which were heard at Rodriguez, 3000 miles distant, the appalling darkness created by black ash suspended in the atmosphere, the finer particles of which belted our globe and gave rise to brilliant and peculiar sunsets, the great sea waves which were formed to devastate surrounding coasts and destroy 36,000 lives, forms a well-known chapter in the history of vulcanology.

Pelée, the Hawaiian goddess who from her well of fire serves out molten rock for the consumption of those with whom she is angered, gives as spin drift from her molten fountains tresses of her glassy hair. Possibly the Pelée of the Antilles, although she has not sought an encounter with the oceans, may give to our atmosphere exhalations and glassy particles, the evidence of which will be seen in meteorological observations.

A third illustration of a mountain which to all who knew it was in its appearance as innocent as Primrose Hill, but without any premonitory warnings suddenly blew itself to pieces and changed the topography of the surrounding district, was Bandaisan, in central Japan. When, in 1878, the writer visited this mountain, to clamber through woods and vines with which its sides were covered and pass over a grass-covered depression at its summit where deer were browsing, the only indications that this round-headed hill might be included in the list of active volcanoes were that at its base there were some hot springs, whilst on its flanks a few pieces of scoria were seen. Ten years later, this apparently

peaceful mountain drove sixteen hundred million cubic yards of itself to such a height that many of the falling fragments struck the ground with such velocity that they were buried out of sight.

To know the extent to which the phenomena accompanying the eruption of Pelée find a parallel in those exhibited by her predecessors will be determined in the future. The probable loss of life, which it is to be hoped has been over-estimated, is given at 40,000. Whatever this number may be, it has been suggested that the same might have been reduced had the inhabitants of the stricken district taken warning from the slight earthquakes by which the great eruption was preceded. But may we not ask whether small earthquakes are not so frequent in the Windward Islands that were the inhabitants to fly with every tremor the Antilles would be depopulated?

Although the last great eruption of Pelée, which was one of frightful violence, occurred in 1851, statistics which do not take account of mere tremors credit the Island of Martinique, in an interval of twenty-six years, with 148 disturbances, whilst the Lesser Antilles generally are, during the same interval, credited with nearly 1200.

That volcanic outbursts are usually preceded by slight earthquakes is well known. How very slight these may be is testified by the tall and not too substantial buildings in Naples near the base of the almost continually erupting Vesuvius. Unfortunately, the occurrence of slight earthquakes is very much more frequent without, rather than with, volcanic outbursts. Many of the 1000 earthquakes which are annually recorded in Japan, two or three of which would shatter a London, are felt round the base of volcanoes, but it is only on rare occasions that they have been followed by disaster. Could science devise a means by which increasing pressure beneath a volcanic area could be measured, or could the crust of the same be rendered transparent, until familiarity ended in contempt, such areas would in all likelihood be sparsely populated; but so long as we cannot distinguish between the shakings which announce the abortive attempts of volcanoes to establish an opening and those tremblings and gurgitations which precede attempts that are successful, people will go on living as before.

One writer predicts great storms to follow the eruption. In August, 1891, a hurricane passed over Martinique, to be followed by an earthquake. The hurricane months for Martinique are July, August, September and October, when no doubt we shall have records of hurricanes both before and after earthquakes.

In considering the probable cause of this West Indian disaster, attention is drawn to the fact that the Lesser Antilles as seen on a chart are a group of islands running approximately from south to north, forming the outcrops of a suboceanic ridge. The western side of this ridge is steeper than the eastern, with the result that off Martinique, for example, at a distance of 5 or 6 miles there are soundings of 1200 fathoms, whilst on the opposite side such depths are not even found at distances of 50 miles off shore.

The steepness of this fold is such that earthquakes might be expected to originate along its western frontier, whilst volcanoes would occur along its ridge. Now it is chiefly along this western frontier that the cables pass. Those of Martinique, of which there are six, radiate from Fort de France. One goes northwards 12 miles, to end at the ill-fated St. Pierre. Three others also pass northwards to Guadeloupe, Dominica and St. Thomas. Another goes southwards to Paramaribo, and the last to St. Lucia, St. Vincent and other places.

Notwithstanding the existence of so many cables, communication with Martinique, and later with St. Vincent, was interrupted. At St. Pierre the cause of

this was no doubt due to the avalanche of mud and lava which overwhelmed the town and roadstead. The cause of interruptions out at sea would be sought for in seismic convulsions, but of such disturbances of any magnitude there is no evidence. Since 8 a.m. (Martinique time) on the 8th, when St. Pierre was overwhelmed, until the 11th, seismographs in Great Britain have been at rest. That small earthquakes occurred is known, and it is just possible that some of these caused landslides sufficient to bury and damage the cables running along and across the steep suboceanic slopes described.

The cause of these earthquakes and the volcanic outbreak of Mont Pelée and of the Soufrière in St. Vincent—at which the last great eruption took place in 1812—probably results from some widespread rearrangement in the fold, the ridge of which is repressed by these islands. The geological evidences pointing to elevations and depressions amounting to as much as 12,000 feet, and all within late Tertiary times, are found in the Barbados and other parts of the West Indies. If we assume that earthquakes are accelerations in these orogenic processes, and volcanic outbursts indicate that pressure has been relieved along the foldings they create, one inference is that the terrible disasters in the West Indies announce that a change has taken place in the configuration of the ridge which above the surface of the water is known as the Lesser Antilles.

Whatever may be the scientific inferences in connection with the great catastrophe, the situation it has created, which Byron might describe as one in which

"Sires have lost their children, wives
Their lords, and valiant men their lives,"

commands the heartfelt sympathy of the civilised world.

J. MILNE.

DOES CHEMICAL TRANSFORMATION INFLUENCE WEIGHT?

IN NATURE (vol. lxxiv. p. 181, 1901) I directed attention to experiments by Heydweiller (*Drude Ann.*, vol. v. p. 354) from which he inferred that some chemical transformations, such as the solution of copper sulphate in water, were attended by real, though minute, changes of weight, and I pointed out certain difficulties involved in the acceptance of this statement. In connection with another subject, it has lately occurred to me that such changes of weight would really be in opposition to the laws of thermodynamics, and I propose now briefly to sketch the argument from which this opposition appears.

It is known¹ that by suitable arrangements the dissolution of salt may be effected reversibly at a given temperature. During the process, a certain amount of work is gained and a certain amount of heat at the given temperature has to be supplied. In the reverse process, of course, an equal amount of work has to be performed and an equal amount of heat is recovered. The temperature being given, these operations are not affected (it is assumed) by the height above the earth's surface at which they may be supposed to take place.

Conceive now that the temperature is uniform throughout and that the materials are initially at a low level and in one state (A). Let them be raised to a high level and there be transformed into the other state (B). Subsequently let them be brought down to the low level and transformed back into state A. The reverse transformations above and below compensate one another thermodynamically, and if the weights are the same in the two states, so do the operations of raising and lowering. But if the weights in states A and B are different, the cycle of operations may be so executed that work is gained.

¹ "On the Dissipation of Energy," NATURE, xi. p. 454, 1875; "Scientific Papers," vol. i. p. 238.

Such a difference of weight is therefore excluded, unless, indeed, hitherto unsuspected thermal effects accompany a rising or falling against or with gravity. It is scarcely necessary to say that we are not here concerned with the differences of temperature and pressure which may actually be met with at different levels over the earth's surface.

There are many chemical transformations which cannot easily be supposed to take place reversibly. But this, though it might complicate the statement, does not affect the essence of the argument; and the conclusion appears to be general.

If the reasoning here put forward be accepted, it increases the difficulty of admitting the reality of such changes of weight as have been suspected, and it justifies a severe criticism of experimental arrangements. In my former letter I pointed out a possible source of error.

It is to be hoped that the matter may soon be cleared up, for it is scarcely creditable to science that doubt should hang over such a fundamental question. But for my own part I would wish to say that I fully recognise how much easier it is to criticise than to experiment.

RAYLEIGH.

UNIVERSITY COLLEGE AND THE UNIVERSITY OF LONDON.

AN influential meeting was held at the Mansion House on Friday last in support of the fund for higher University education and research in London, with special reference to the incorporation of University College in the University. The Lord Mayor presided, and the company present included many who have contributed to national progress in various ways and are anxious that adequate provision shall be established for future advance.

The appeal made by University College was described in our issue of May 1 (p. 10), and at the same time a brief statement was made of the needs of the University and its Colleges. The University can only become a living organism when the Colleges connected with it are actually part of its being. The incorporation of University College would be the commencement of this desirable development, and the ultimate structure would be on a scale worthy of the greatness of our great metropolis.

We are glad to see that the Duke of Devonshire, in his speech at the Mansion House, made special reference to some of the points to which attention was directed in our article. He explained that though the University of London has statutory powers to teach, it has not the material means of teaching, and cannot take part in the extension and advancement of knowledge until placed in possession of buildings and resources for carrying on the work of higher education. The provision of funds for University College thus means the strengthening of the University itself, for by incorporation the senate would acquire complete control over the whole resources of the College, and would be able to carry on the work of the various departments under better conditions than at present are possible.

The urgent need for liberal endowments for higher education in London was stated in our recent article and has often been put forward in these columns at other times. The educational wants of London are, indeed, almost a discredit to the rich citizens, and the inadequate provision made for higher education generally shows that the State does not realise the importance of such studies as factors in national progress. But though the State does little or nothing for those who are making knowledge, the Duke of Devonshire expressed himself as aware of the value of extending the resources of education and research, and other speakers at the Mansion House

(including the Lord Mayor) took the same view. Referring to the necessity of giving greater consideration than has hitherto been done to the requirements of the country in this respect, the Duke of Devonshire said:—

"Within the last half-century the gigantic strides which have been made in the discoveries of science have brought about great changes in our requirements as to higher education. It is now recognised that in all professions and industries success must be dependent on a knowledge of scientific principles and on the trained capacity to apply those principles. The Universities are no longer a necessity for one class alone, but the welfare of the whole nation demands that we should seek through all classes men of high intelligence, and, having found those men, that we should equip them with the highest training. These changes in the requirements of higher education found us in this country to a certain extent unprepared. As a nation we cannot be said to have been quick to recognise the necessity of corresponding changes in our higher University training. The older Universities of Oxford and Cambridge have recognised the necessity and have made great efforts to equip themselves with the necessary machinery, but they have found themselves hampered by a want of the necessary resources.

"But, even if complete satisfaction could be given to the claims of the older Universities, still that would not suffice for our national necessities or meet the requirements of present conditions. Our success as a nation depends upon the possession of trained brains, and these we cannot get in sufficient number from any one class, and the older Universities cannot supply the number of trained men we require for our national industries. In all the great towns and industrial centres, University institutions properly equipped and properly endowed are now a necessity, and this need has already received a considerable amount of local expression. I need only give you the instance of the University of Birmingham and the movement which is now taking place in Liverpool for the establishment of a separate University there. But in London, owing to its size and the absence of what may be called local patriotism, the University movement has up to the present time failed to receive that support which might be expected from the wealthiest city in the world. But now, to-day, an opportunity is afforded to the citizens to repair any past neglect, and to create for London a University which shall be worthy of the capital of the Empire and adapted to the special needs of the metropolis of the Empire."

Resolutions were afterwards carried in support of the scheme of incorporation, and urging citizens of London to make a generous response to the appeal for one million pounds to endow and equip University College with a view to its incorporation. It remains to be seen whether London is sufficiently jealous of its honour and supremacy to make the University bearing its name rank with those of Europe and America.

THE CULTURE OF GREENHOUSE ORCHIDS.¹

BEFORE passing judgment on a work of this kind it is only fair to the author to attempt to ascertain his object in writing it, so that a fair conclusion may be arrived at as to how his object has been attained and the use of the resultant work to those who consult it, for that is the main consideration.

In the first few lines of the preface, Mr. Boyle very definitely gives his reason for writing the book. He says: "The literature of orchidology is voluminous in these days. But a book written by an amateur for amateurs is still needed." That was a very good reason. Every new work on orchids, or on any other special subject, tends to increase the knowledge and growth of the subject dealt with, and as the devotees to orchid culture are mainly recruited from the amateurs commencing in a small way, a work written by an amateur, and especially by such a pleasant and entertaining writer as Mr. Boyle, who has the art of conveying instruction with amusement, must be of the highest value.

¹ "The Culture of Greenhouse Orchids." By Frederick Boyle. Pp. xii + 231. (London: Chapman and Hall, Ltd., 1902.) Price 5s. net.

The handy little volume, extending over two hundred and thirty pages, has three excellent coloured plates and fifty illustrations of single flowers of cool-house orchids,

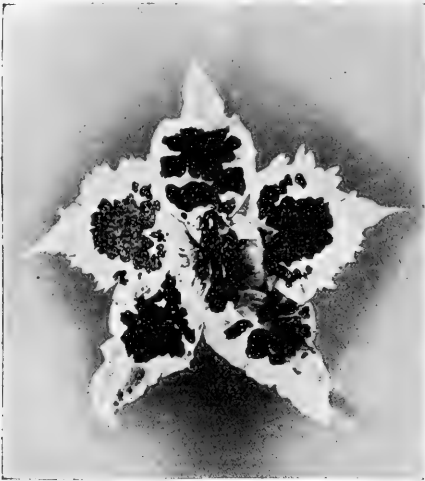

FIG. 1.—*Odontoglossum Crispum* Pittianum, showing the widest departure from the normal white form. The sum of 750*l.* was offered for this plant.

reproduced from photographs by Colonel F. C. Taylor. The book, though useful as a work of reference, will be found to give the best results to the amateur just beginning orchid culture, or who has been pursuing it with indifferent results, if he repeatedly peruse it from beginning to end. Thus he will have a sound basis on which to continue his work, freed from the struggles and failures which the unaided amateur must expect, and the sorrows the past experience of which Mr. Boyle justly advances as a reason why he should be able to write a book which would be useful to those who contemplate following him as amateur orchid cultivators—a pastime of the greatest interest and pleasure if reasonably followed.

The work opens with six lengthy and instructively written articles, setting forth the general principles of orchid culture and matters relating to it, after which throughout the remainder of the work follow the enumeration of the genera and species suitable for culture in the greenhouse, together with cultural remarks and much information relating to each, all of which, having passed the scrutiny of that well-known and clever expert, Mr. Joseph Godseff, have a sufficient guarantee of excellence.

On testing the question ample proof is obtained. If but for the articles on *Coelogyne cristata* and on *Oncidium*s for the cool-house, the perusal of the work might well be recommended. In the case of *Coelogyne cristata*, one of the most beautiful and easily grown orchids when treated as Mr. Boyle advises, there are few species which give more unsatisfactory results to the budding amateur growing it by his own judgment. Even experienced growers in large establishments often have their

plants with the shrivelled bulbs which are cited as to be avoided by the method prescribed. In the matter of the *Oncidium*s enumerated, the mere direction that they are to be grown in a cool-house is almost sufficient to ensure success, for they are more often than not grown in too high a temperature and killed in consequence. And so on throughout the book; even the enumeration together of the species which can be successfully grown in a greenhouse, to say nothing of the excellent cultural details, makes it of great value, for it saves the amateur from attempting things which require more heat than he can give—a mistake which causes many small amateur collections to look shabby and annoy and disgust the owner, who has probably taken more pains to bring about that undesirable state of things by working on unsuitable subjects than he need take to ensure a delightful success on the lines set forth in Mr. Boyle's book.

But from the critic the book calls for some remarks on points which luckily do not much interfere with its general usefulness. In the preface and following articles, Mr. Boyle makes much of his desire to advance the new Belgian culture of orchids in oak-leaf mould, or *terre de bruyère*, but in the progress of the work he only places it as an alternative method, wisely placing the well-tried British method of potting in peat fibre and sphagnum moss in the first place. It should be remembered that there is a vast difference between the Belgian collections, with large numbers of a few species only, and many of the British collections, which include a few of each of a large number of species. Then there are climatic and other differences; and above all it should be said that one of the largest and oldest and some of the smaller Belgian orchid growers, after experiment, will have nothing to do with it. In Great Britain the question is on trial, and while in some places there are excellent specimens grown in leaf-soil, in others it has been tried and abandoned.



FIG. 2.—*Odontoglossum Cervantesii* Decorum.

Again, when touching on the use of manures something more definite than general remarks might have been used—the "yea or nay" promised in the preamble—or the

small amateur who is induced to experiment will surely find himself in trouble.

In the chapter "Orchid Names," the author follows the popular lead by finding fault with the existing orchid nomenclature, and with the inevitable result that he is unable even to hint at a better method than that for which we have to thank a long line of patient and clever men who have been working on the subject in all ages since the classification of plants began. It should be remembered that the question is not as to whether the name is good or bad Latin or Greek, expressive or not expressive, but that it is intended as a means of identifying the plant in every civilised quarter of the globe, an end which no system of popular names could accomplish, but which has worked under the present system of scientific names in a marvellously satisfactory manner. To apply it to his own case. Deprived of the scientific names he finds fault with, Mr. Boyle's book would have been impossible in its present useful form.

Orchid culture cannot be reduced to an exact science. Each operator has to adapt his methods to his convenience, but in order to know how to meet his difficulties and to overcome them, Mr. Boyle's book will be found invaluable. In some cases the prices at which the plants may be obtained are also given.

THE ROYAL VISIT TO THE UNIVERSITY OF WALES.

THE installation of the Prince of Wales as the second Royal Chancellor of the University of Wales is associated with an important epoch in the development of university education in North Wales. When the University College of North Wales was founded in 1884, it would have been difficult to find a more ideal situation for a centre of university education than the Penrhyn Arms Hotel at Bangor, which possessed ample accommodation for existing requirements. But eighteen years ago, Hertz's realisations of Maxwell's theory of electric oscillations, culminating in wireless telegraphy, did not exist; the existence of Röntgen and other rays had not been anticipated; no argon was known to exist in our atmosphere, no helium in our earth; the liquefaction of the more permanent gases was regarded as a mere classical experiment, impossible on a large scale; even in mathematics, the fertile theory of groups was almost untroudden ground. Taking also into account the increase in the number of students in the eighteen years from 55 to 320, it is small wonder that new buildings with more modern equipments have now become indispensable for the further progress of the College. These needs bid fair to be soon met by the recent generous gift on the part of the City of Bangor of a new plot of ground 10·6 acres in extent, about 6·6 acres of which are available for building purposes, on a site which, in the opinion expressed by Principal Reichel, "any university College in the kingdom might well envy." This gift represents, for the City of Bangor, the equivalent of a gift of one million pounds from the citizens of a wealthy town comparable with Liverpool.

The smallness of the population of Bangor and the absence of the large wealth-producing industries of our midland towns are a sufficient guarantee that the new College need never fear the disturbing influences of electric trams and the smoke and din of factories which have afforded such an obstacle to scientific research in wealthy and thickly populated manufacturing centres.

The University congregation was held, not at Bangor, but at Carnarvon, where the large pavilion had been transformed into a senate house. The lavish display of bunting at Carnarvon and subsequently at Bangor; the gowns and hoods of graduates, extending over the whole range of colours from violet to red, and the

presence of large contingents of students from Aberystwyth, Bangor and Cardiff, including a considerable proportion of "sweet girl undergraduates" in caps and gowns, all contributed to the festivity of the scene. Even the mountain ranges of Snowdonia were clad in white hoods of snow rarely seen in May. The actual installation ceremony having been completed by the presentation of the key of the University seal and a copy of the statutes to the Prince as Chancellor, addresses were read by Dr. Isambard Owen and Principal Roberts on behalf of the University court and senate, and addresses were also presented or read on behalf of several other bodies, including the guild of graduates. The Prince in reply, after referring to the work done by teachers and students of the Welsh University, laid special stress on the encouragement given to post-graduate and scientific work, and the fact that it is by the work done in after life by its graduates that the reputation of a university is really made. The Chancellor then admitted the Princess of Wales to an honorary degree in music and proceeded to the conferment of honorary degrees, in which science was represented by the Earl of Rosse, the recipients being presented by Vice-Chancellor Roberts, of Aberystwyth. The intervals in the proceedings were filled by part songs sung by a well-trained choir, and at the conclusion the problem of transporting the guests to Bangor was solved with remarkable success. Here luncheon was laid for six hundred and fifty in a marquee pitched close to the new site, under the chairmanship of Lord Kenyon. In his speech, the Prince of Wales once more struck a chord which he had already sounded at the National Physical Laboratory in referring to his recent tour and his experience of the work done in universities across the seas in bringing intellectual ability to the front and rendering it available for the public service. This line of thought was ably echoed by Principal Reichel in his remarks that "The idea, which at one time was not uncommon, that intellectual training is unfavourable to action is now happily becoming discredited at home; on the Continent it has long ago perished. . . . The function of provincial university colleges is, in short, to train up a more vigorous and efficient race, fitted to meet the heavy demands which the course of world events is making on the inhabitants of these islands, a race of more efficient thinkers, of more efficient workers, and if the necessity should arise, of more efficient fighters." Principal Reichel further announced the receipt of an offer of twelve scholarships of 30*l.* for three years from Sir Alfred L. Jones, of Liverpool. It was also announced that the town of Cardiff, like Bangor, has presented its University College with a new site.

The next item was the visit of the Prince and Princess to the present College, where a guard of honour was formed by the College volunteer corps. Interest naturally centred round the museums and laboratories. The College possesses a very fair zoological museum, and it is proposed to establish in connection with the same department a marine station where problems connected with the fisheries of the North Wales coast can be studied systematically. Already efforts have been made to arouse interest in the fishing industry by popular lectures. Most of the work of the College in agriculture has been hitherto carried on at a farm right away near Llangefni, but the College is now indebted to Colonel Platt for an experimental farm in a much more accessible situation near Llanfairfechan. Of other recent developments on the science side, we note the Drapers' Company's temporary endowment of a school of electrical engineering, a school which is bound to develop when a university training is, as it should be, insisted on in this country as an indispensable qualification for every electric engineer. The organisation of a department of mining is also, thanks to the support of local bodies, approaching completion. A recent gift from Mr. George Rae for the purpose of

providing teaching in banking and finance affords evidence that the commercial side of modern university education has not been overlooked, and a further gift from the trustees of the late Sir Henry Tate has been announced.

The last item in the Royal visit to Bangor was the visit of the Princess of Wales to the University Hall, where an enthusiastic reception from the women students, assembled in cap and gown under Miss Fowle, was awaiting the Royal party.

If there is one function on which the University of Wales, in common with other universities, will have to lay ever-increasing stress, that function is the dissemination in the less accessible parts of the Principality of those internationalising influences which are now bringing all parts of the civilised globe into closer touch with each other. The deliberations of English, French, and German-speaking science workers are daily becoming more and more international in character, and this influence is spreading gradually down the educational ladder. The late Mr. Cecil Rhodes's scheme for fostering the international spirit in Oxford is still in our minds, and it may be confidently hoped that modern and well-equipped University College buildings both in North and South Wales will do much to promote that educational influence which may so well be summed up in the word "internationalisation." G. H. BRYAN.

THE IRON AND STEEL INSTITUTE.

THE annual meeting of the Iron and Steel Institute was held on May 7 and 8, and a short report of the proceedings is subjoined. At the annual dinner of the Institute, on Wednesday of last week, Mr. Arnold-Forster made a few remarks upon the duties of the State towards science, and the necessity for the introduction of scientific organisation and method in all departments and works of a progressive character. We give his speech as reported by the *Times* :—

Mr. Arnold-Forster said that however little he might contribute to the Government in any other matter, he did contribute in full measure great respect, great admiration and great reverence for science and scientific organisation. By scientific organisation he meant the application to the ordinary work of everyday life, the work which had been thought out and co-ordinated by students of science. In this country we were probably behind almost every other great country in the recognition of the great truth that science had a lesson for everyone in producing economy and efficiency by the application of a scientific method. There was a time when the duty of the State to take its part in ordering the work of the nation was more clearly recognised and acted upon than it was now. The enormous attention which was given to regulating our coinage and to giving us a system of weights and measures formed a considerable part of the earlier economic history of this country. But when we had accomplished those one or two rudimentary duties, the State appeared to think that nothing more could be accomplished or was to be expected from it as the administrator and as the instrument to apply in the teaching of science. But the time had gone by when we could afford any longer to fail to recognise the direct duty of the State to the country in the matter of organising on some scientific principle many of the most important departments of our scientific life. Governments were now so enlightened that they could interfere in scientific matters with certainty of producing the results which they desired. It should be insisted upon that in every department which came within the purview of the Government there should be scientific coordination and organisation. He would not speak of weights and measures—though there, indeed, a wise Government might step in—but there was the kindred branch of scientific application about which he would say a word—namely, standardisation and the uniformity of tests. In that regard we were behind the Continental nations. He had been studying the publications of the great Continental nations for the coordination of tests of materials

and the institution of standard dimensions, and the conviction had been forced upon him that we had already allowed opportunities of cooperation to go by which we ought to have seized. He was glad that at the eleventh hour the Iron and Steel Institute, the Institution of Civil Engineers and the Institute of Naval Architects had taken up the work. He wished every success to it. The French Government were standardising their railway material, but nothing corresponding to that existed in the records of our Governmental arrangements. In inspecting a steel works recently he found that in the matter of tensile strength for steel there was one test for the Admiralty, another for the War Office, another for the Board of Trade, another for one set of railway companies, and another for another set (the Board of Trade recognising neither), another for the Egyptian Government, another for the Indian Government, and another for the whole of the Continent of Europe. That was absolutely crazy. It was like measuring pints by fourteen different kinds of pint pots. They were all sinners in that respect—all the departments—because it ought not to be allowed. He urged that scientific societies should forward the work of standardisation as forcibly as possible. Already in the Admiralty great strides were being made, thanks to Sir William White, and already they had succeeded to some extent in the standardisation of electrical appliances. They had also standardised in the whole of the gunnery branch, and were now endeavouring to do so to a much larger extent in the whole of the fittings of the ships. When the Iron and Steel Institute and kindred associations, had made up their minds as to what was the true method of standardisation they should go boldly to the Government and ask them to undertake that within a definite time all Government specifications should be within the terms of that standardisation. He was not unaware that there was a danger in standardisation, that one must not stereotype too closely, and must not interfere with improvement by solidifying all patterns; and therefore he trusted that they would insist upon it that the Government should be the cooperators in the work in which the Iron and Steel Institute and kindred societies must be the kindred spirits. In conclusion, he said that he had been too modest in this country of advancing the claims of science. What was done for applied science in every other civilised country should make us ashamed of the pittances doled out in England, which were supplemented to the extent of 99 per cent. by private charity, for the purpose of performing those elementary duties of co-ordinating the scientific part of this country's life. He believed that if the scientific associations took a high line in the matter the country would support them right through.

Other speakers at the dinner were Sir Alfred Hickman, Admiral Sir N. Bowden-Smith, Sir Bernhard Samuelson, Lord Raglan, Lord Blythswood, Sir Christopher Furness, Sir W. C. Roberts-Austen, General Sir John Maurice, Sir Norman Lockyer and the president.

At the annual meeting of the Institute the chair was occupied by the president, Mr. W. Whitwell. The Bessemer gold medal was presented to His Excellency F. A. Krupp, of Essen. The Andrew Carnegie medal was awarded to Dr. J. A. Mathews for the research described in his report; and Andrew Carnegie research scholarships, each of 100*l.*, were awarded to Messrs. O. Boudouard (Paris), W. Campbell (New York), A. Campion (Coopers Hill), P. Longmuir (Manchester), E. Schott (Berlin) and F. H. Wigham (Wakefield). The following are the chief points of the papers read :—

In the first paper, Mr. J. H. Darby embodied the results of experiments made with the object of improving the quality of coke by compressing the fuel before coking. The net gain in production of coke per oven was found to be between 10 and 12 per cent. in favour of the compressed charge.

Mr. J. Thiry read a paper on the recovery of by-products in coke-making. He gave some striking figures showing the profit and economy derived from this method of coke manufacture, and described the most recent form of the Otto-Hilgenstock coke oven. These two papers gave rise to an interesting discussion; in which Sir Lowthian Bell, Sir Bernhard Samuelson, Dr. Ludwig Mond and other members took part.

Mr. A. McWilliam and Mr. W. H. Hatfield described an exhaustive research dealing with the control of the silicon in the acid open-hearth bath. The experiments were made in a 25-ton furnace at Sheffield. The results detailed, showing the influence of the composition of the slag on the elimination of impurities from metal under an oxidising influence, seem to point to the necessarily very acid slag produced being beyond the point at which silicon can be oxidised, for it would appear that not only can phosphorus and sulphur not be oxidised in an acid-lined vessel in the presence of an acid slag, but that silicon is not oxidised to below a certain percentage when the acidity of the slag is beyond a certain point. The authors have thrown light on a subject still requiring further elucidation, namely, the relation between the composition of the slags and the type of oxidation or even reduction taking place, and they in particular have not seen recorded this exact balancing of the composition of the slag, so as at will to eliminate or reinstate small amounts of silicon and manganese while the carbon continues steadily to fall. A well-sustained discussion followed, in which the value of the paper was generally recognised.

Mr. H. Allen described a new system of cooling blast-furnace tuyeres in such a manner as to prevent the leakage of water into the furnace crucible. The meeting then adjourned until May 8, when the secretary, Mr. Bennett Brough, presented the report of the committee appointed to ascertain whether it would be possible to make the terminology of metallography less complicated and more precise. This comprises a glossary of the more important terms used by authors of memoirs dealing with the subject, with the exact equivalents in French and German. Care has been taken to exclude all controversial matter, and, in cases where a definition is not quite universally accepted, to quote the definition given by its respective author.

The next paper, by Prof. J. O. Arnold and Mr. McWilliam, was of a highly controversial nature. The conclusions arrived at in the paper were as follows:—The clear and definite constituents of hardened steel are (a) hardenite, Fe_3C , of which the whole mass consists, only in the case of 0.89 per cent. carbon steel; (b) ferrite, Fe , which segregates more or less in unsaturated carbon steels in spite of the rapid action of quenching; and (c) cementite, Fe_3C , which segregates more or less in supersaturated steels in spite of the rapid action of quenching. The indefinite portions of hardened steels consist in unsaturated carbon steels of hardenite containing more or less unsegregated ferrite, or in supersaturated carbon steels of hardenite containing more or less unsegregated cementite. Martensite is not a constituent, but a crystalline structure developed at high temperatures. It is marked in saturated carbon steels by preferential etching lines, in unsaturated carbon steels by striae of ferrite, and in supersaturated carbon steels by striae of cementite. The existence of the constituents sorbite, troosite and austenite is extremely doubtful. Students of micrographic analysis should guard against apparent or false constituents really due to optical causes or to obscure polishing or etching effects. The authors' investigations detailed in this paper have been strictly confined to pure iron and carbon steels such as are produced in the best crucible practice. The views expressed by the authors were opposed by Sir W. C. Roberts-Austen, Mr. J. E. Stead and other members.

Dr. J. A. Mathews' paper on a comparative study of some low carbon alloys, which was next read, contained the results of a research undertaken in New York by the author as Andrew Carnegie research scholar to ascertain the effects of various elements upon iron. The elements studied were nickel, chromium and molybdenum. Prof. Arnold took exception to this paper on the ground that no reference was made to his own work on the same subject.

Mr. H. Kilburn Scott presented an elaborate description of the iron ores of Brazil. The quality of the mineral and the great size of the deposits will, the author is convinced, enable Brazilian iron to take a leading position in the market. Some valuable additional details were furnished by Mr. H. Bauerman.

Mr. P. Eyerhmann, of Benrath, near Düsseldorf, submitted a paper describing a proposed method of combining the blast furnace and the open-hearth furnace. The novel feature consisted in the employment of blast-furnace gas in the open-hearth furnace, in arrangements for improving the quality of the gas and in the application of air nozzles to one of the hearths.

Mr. Axel Wahlberg, of Stockholm, communicated an important paper on Brinell's researches on the influence of chemical composition on the soundness of steel ingots. The percentage

of carbon and the casting temperature, which have hitherto been regarded as the agents responsible for the presence and position of blow-holes, are to be regarded as exercising a secondary influence. The principal cause is the percentage of silicon and manganese, and in some cases of aluminium, contained in the ingot metal at the moment of casting. In the discussion, Mr. C. P. Sandberg pointed out that some of the results given by Brinell had been anticipated by himself in a paper read ten years ago.

From the investigations recorded in Baron Jüptner's paper on the sulphur contents of slags, the following conclusions are drawn:—If during metallurgical processes a state of equilibrium is established between the slag and the contiguous metallurgical product under treatment, the sulphur distributes itself between the two in a constant ratio (the coefficient of distribution), the value of which is dependent on the composition of the two phases under consideration and on the temperature. In general the value of these coefficients of distribution increases with the basicity of the slags. It increases also apparently with the proportion of lime and manganese oxide (probably also with that of ferrous oxide and zinc oxide) in the slag. In the case of alloys of iron, the value of the coefficient of distribution increases, and very considerably, with increasing percentages of carbon and manganese and with diminishing percentages of phosphorus. The influence of the composition of iron alloys on the coefficient of distribution increases and diminishes with the increase or decrease of the basicity of the slag. The same law holds good with respect to the influence of a higher percentage of lime and manganese oxide in the slag. The conclusion contained regarding the effect of the composition of iron alloys may be explained by the supposition that the capacity of manganese, and perhaps also that of iron carbide, or at least of iron rich in carbon, to absorb sulphur is very low, while, on the other hand, that of pure iron and phosphide of iron is very high. These facts show that in metallurgical operations in general it is impossible to eliminate entirely from the product the whole of the sulphur contained in the charge. The extent to which desulphurisation can be carried depends upon the coefficient of distribution—that is, upon the composition of the two phases occurring during the process in question. On this account the desulphurisation of irons rich in carbon and manganese (ferromanganese and pig iron) is more complete than with irons low in carbon and manganese, such as those produced by the open-hearth and Bessemer processes. In the Bessemer process, the phosphorus exercises an additional counter-influence to the desulphurisation; but this appears only to be possible when the phosphorus has largely decreased, in which case, however, the carbon and manganese have also almost entirely disappeared. In order, therefore, to keep down the sulphur to the lowest possible margin in iron, which is very low in carbon and manganese, there remain only two courses open (since the basicity of the slag cannot be increased beyond a certain limit), viz. (a) either in the selection of a charge that contains the least possible sulphur, consisting of pure iron or of iron that has been desulphurised in the mixer; or (b) by repeated removal of the old slag and the formation of new slag. In this connection a mixer could be employed with good effect, since this not only supplies a raw material lower in sulphur, but its use necessitates the removal of the mixer-slag and the formation of new slag. It is by no means impossible, especially with a falling temperature, that a third phase, a mixture of oxides and sulphides, may occur in conjunction with the slag and metal. This phenomenon seems to occur during certain segregations.

In a paper on the chemical and physical properties of carbon in the hearth of the blast furnace, Mr. W. J. Foster showed that by increasing the temperature and diameter of the hearth, more carbon would be exposed to the oxides, with proportionally less interruption by the gases that are decomposed in the neighbourhood of the tuyeres; hence more carbon would be converted into carbon monoxide in the hearth per unit of air introduced at the tuyeres, and consequently an increased rate of driving and economy would be the result.

The making of a fixed gas from wood for service in the gas engine or in the manufacture of steel is in some localities desirable. Mr. James Douglas, of New York, was induced, therefore, to give a detailed account of the use of a fixed gas, made in a modification of the Loomis gas producer in Mexico. The meeting terminated with the usual votes of thanks. The autumn meeting of the Institute will be held at Düsseldorf on September 2 to 5.

GEORGE GRIFFITH.

THE news of the sudden death of Mr. George Griffith, Assistant General Secretary to the British Association, came as a shock to all who were acquainted with his vigorous personality. On the afternoon of May 7 he left the office of the British Association apparently in his usual health, and took his place in the train from Baker Street Station for Harrow. Scarcely had the train started when he was seized with an attack which ended fatally in a few minutes.

Griffith's career was divided into three periods—his Oxford life, his long tenure of an assistant mastership at Harrow School, and the last twelve years of his life occupied with his duties as assistant general secretary of the British Association.

His career at Jesus College, Oxford, was a brilliant one. After taking honours both in classical and mathematical moderations, his name appears, alone, in the first class in the final school of natural science in 1856. For the next eleven years he resided at Oxford, where he married a daughter of Mr. A. H. D. Acland Troyte. Toward the latter end of this period he was appointed deputy for the professor of natural philosophy, from which position he was summoned in 1867 by Dr. Butler to inaugurate the teaching of natural science at Harrow.

The task before the new-comer was by no means easy. The teaching of science, which had been forced on the attention of reluctant governing bodies by the recommendations of the Endowed Schools Commission, was regarded with scant favour by the majority of schoolmasters, while among the boys it was frankly disliked. At Harrow there was at that time neither laboratory nor special class-room; Griffith was allowed the use of a room when it was not being used by another master, but all apparatus had to be cleared away after each lecture before the entrance of the legitimate tenant. This state of things continued until about 1874, when properly equipped laboratories were erected. For twenty-six years (1867-93) Griffith taught at Harrow, in his earlier years taking physics, chemistry, geology and biology, according to the demand; latterly he confined himself almost exclusively to physics. In 1871 he entered into possession of a "Small House" (a boarding-house for nine boys), which he held until, in 1887, he succeeded Mr. Holmes as the master of "Druries," a larger and more responsible charge. In 1893 he retired from his mastership, having already been appointed (in 1890) assistant general secretary to the British Association for the second time.

His active connection with the British Association began at a much earlier date. We find him acting as local secretary at the Oxford meeting of 1860, memorable for the Huxley-Wilberforce battle over Darwin's works, while in 1862 he entered on his first term of office as assistant general secretary. Having resigned in 1878, he was prevailed upon to take charge of the work for the year 1881, during a temporary vacancy. In 1890 he was re-appointed, and carried on the work of his office with full vigour until an hour before his death.

During his latter years he threw himself with characteristic energy into the Royal Society's scheme for an international catalogue of scientific literature, a task for which he was singularly well fitted by wide learning, both scientific and linguistic, his unflinching memory and his fastidious accuracy of thought and expression.

He was laid to rest, on May 13, in the old churchyard of Harrow-on-the-Hill, above the little town that had been his home for thirty-five years, and the old school into which he had been the first to introduce the systematic teaching of science.

B. P. L.

NOTES.

M. T. MOUREAUX, who has for twenty years been connected with the magnetic work of the Parc Saint-Maur Observatory, has been appointed to succeed the late M. Renou as director of the Observatory.

PROF. T. C. CHAMBERLIN, of Chicago, Dr. T. Thoroddsen, of Reykjavik (Iceland), and Prof. S. W. Williston, of the University of Kansas, have been elected foreign correspondents of the Geological Society.

THE Prince of Wales has consented to become an honorary member of the Linnean Society. The following gentlemen have been elected foreign members of the Society:—MM. A. Giard, H. J. Hansen, C. S. Sargent, F. E. Schultze and J. Wiesner.

ON Tuesday next, May 20, Prof. Karl Pearson will deliver the first of three lectures at the Royal Institution on "The Laws of Heredity, with Special Reference to Man." The Friday evening discourse on May 30 will be delivered by Mr. G. Marconi, on "Electric Space Telegraphy," and that on June 6 by Sir Benjamin Baker, on "The Nile Reservoirs and Dams."

THE new botanical laboratories, presented to University College, Liverpool, by Mr. W. P. Hartley, were opened by Sir William Thelison-Dyer, K.C.M.G., F.R.S., on Saturday last. The new Institute is an imposing building and the accommodation it affords will facilitate the advancement of the science of botany in Liverpool. The teaching of large classes of University students of botany is now not only possible, but easy; and in view of the probable early realisation of a University for Liverpool, this is a matter of some importance. Not only does Mr. Hartley's gift provide ample room for all probable increase in number of students, but the laboratories are equipped with the necessary appliances, both for elementary and advanced work. A special laboratory is set apart for investigations in plant physiology and another for anatomical research. The laboratories will thus not only become centres of teaching, but of work carried on with the view of contributing knowledge which will assist the progress of botanical science. We hope to give a description of the new Institute in a later issue.

LIVERPOOL has often given evidence of its appreciation of the men of light and leading whose activities bring honour to the city. The return of Prof. Herdman from Ceylon, where he has recently spent several months in the investigation of the Pearl Oyster Fisheries, on behalf of the Government, provided Liverpool biologists and others with an opportunity of expressing their esteem for his work. A large company, including the Lord Mayor and Lady Mayoress, assembled at a complimentary dinner given to Prof. and Mrs. Herdman last week under the auspices of the Liverpool Biological Society. In responding to the toast proposed by Sir William M. Banks, Prof. Herdman was prevented from speaking on the principal object of the expedition, namely, his work on the pearl oyster, because the Government report had not been presented, but he gave an interesting account of other sections of his work and of visits to places of interest in and about Ceylon.

THE annual conversation of the Society of Arts will be held on June 24 at the Royal Botanic Gardens, Regent's Park.

A MEETING of delegates representing a number of natural history and photographic societies was held at Croydon on Friday, May 9, Mr. W. W. Whitaker, F.R.S., being in the chair, to consider and set in motion a photographic survey of Surrey. It was resolved that a society be formed to be called "The Photographic Survey of Surrey," and that its object be to preserve a record in permanent photographs of buildings of

interest, antiquities, scenery, geology, natural history, anthropology, and of portraits of notable persons, representations of passing events of local or historical importance, and of old records, rare books, prints, maps, so as to give a comprehensive survey of what is valuable and representative in the county of Surrey.

In the death of Mr. John Clavell Mansel-Pleydell, of Whatcombe, near Blandford, Dorsetshire loses a man of wide influence and learning, a naturalist of the old school, distinguished for his labours on the botany, zoology and geology of his native county, and one who as magistrate and councillor had rendered great local services. He was born in 1817, educated at St. John's College, Cambridge, and succeeded to the family estates on the death of his father in 1863. He was a fellow of the Linnean and Geological societies, and one of the founders of the Dorset Natural History and Antiquarian Field Club, to the *Proceedings* of which he contributed many articles. He was author also of separate works on the flora, the mollusca and the birds of Dorsetshire. He died on May 3, 1902, aged eighty-four.

MR. J. MACFARLANE, honorary secretary of the Asiatic Society of Bengal, informs us that Sir Frank Athelstane Swettenham, K.C.M.G., the Governor of the Straits Settlements, has made the Society a grant of 2800 dollars, or Rs. 8750, for the purpose of completing the publication of the "Materials for a Flora of the Malayan Peninsula," by Sir George King, K.C.I.E., formerly superintendent of the Botanic Garden near Calcutta. The series of papers bearing this title is really a monograph, modelled on the lines of Hooker's well-known "Flora of India," of the flowering plants of the Malay Peninsula and the adjacent smaller islands, and it is as useful to the student as it is to the systematic botanist. The series was commenced in the *Journal of the Asiatic Society* for 1899, and up to last year nearly 1400 pages, including fifty-two natural orders, or rather more than half the work, had been published. One order, Leguminosae, has been contributed by Major Prain, and Dr. O. Stapf, of Kew, has collaborated in the preparation of the suborder Melastomaceae. The Society's financial position would, however, scarcely permit the publication of the Malayan flora without support. At this juncture the Government of the Straits Settlements, which was naturally interested in the completion of the work, held out the prospects of financial aid being afforded, and has now sanctioned the liberal donation of Rs. 8750. This assistance places the Society in a position to complete without delay the publication of Sir George King's important contribution to the advancement of botanical research.

DURING a trial of M. Severo's air-ship at Vaugirard on Monday, an explosion occurred, causing the total destruction of the balloon and the death of M. Severo and his assistant, who were thrown to the ground from a height of more than one thousand feet. It is not known whether the accident was caused by an escape from the motors setting fire to the hydrogen in the balloon, or whether part of the machinery became heated and ignited the envelope, but the former appears to be the more probable cause of the calamity. The balloon shot up suddenly when it was released, and the expansion which must have occurred on account of the diminished pressure seems to have caused an escape of gas, which becoming ignited, resulted in the explosion. As the petroleum motor was little more than a metre from the envelope of the balloon, there was great danger that an accident of this kind would occur. In M. Santos Dumont's airship the motor was sixteen or eighteen metres from the balloon and far to the rear, so that the possible chance of gas ignition was much less. M. Severo designed his balloon with the object of avoiding the danger of pitching to which M. Santos Dumont's

machine was liable. This feature must necessarily exist in the greatest degree in a machine in which the screw propellers are so placed that their resultant thrust has a considerable moment about the centre of the balloon. If the thrust acts nearly along the axis of the balloon and the car of the balloon is as close up to the balloon as possible, the pitching may be expected to be small. This was the essential feature of the Severo airship. The propulsion was effected by two screws attached to the balloon itself, and placed at either end of an axis that bisected the balloon longitudinally from end to end, while the car was drawn up close to the balloon. Another feature was the method of securing rigidity by means of a light rod running through the balloon from end to end and preventing it from crumpling in even if it should become somewhat deflated.

In a letter to the *Times*, Earl Grey has directed attention to the important influence which the United States Fish Commission claim to have exerted upon the fish supply of their western coasts by means of the fish-hatching operations carried out by the Commission. The new illustration cited by the acting commissioner in his letter to Earl Grey has reference to salmon. It is stated that, of one lot of 5000 fingerlings released at the Clackamas (Oregon) hatchery in 1896, after having the adipose dorsal fin removed with a razor, 375 fish, averaging 27.7 lb., were captured in 1898 in the Columbia River basin and five in the Sacramento River (California); in the following year between forty and fifty others were taken, and in 1900 a number of others were reported, the fish caught in 1899 averaging 10 lb. heavier than those in 1898. It appears that not less than 450 marked fish, with an aggregate minimum weight of 10,000 lb., were secured in the second, third and fourth years following their release. "The foregoing figures mean that for every 1000 fingerling salmon liberated by this Commission on the Columbia River, 2000 lb. of adult fish were caught for market two to four years later. Reducing this to a financial basis, it appears that the cost of producing and planting young salmon is under 1 dollar per 1000 (including compensation of permanent employes), while the minimum value of the fish caught for market is 5 c. per pound, or 100 dollars for the 2000 lb. actually taken." The acting commissioner adds that it is the intention "to verify these results by additional and more conclusive marking experiments, which are already under way," and concludes his letter with a reference to the Commission's well-known success in introducing the Atlantic shad and striped bass into the waters of their west coast, where these fish now yield profitable fisheries. Everyone recognises the zeal and enterprise which the Americans have shown in the matter of fish-culture, as well as the success of their acclimatisation experiments cited above; and there will be general satisfaction, even among the Commission's critics, if they should ultimately be in a position to prove the commercial utility of their extensive salmon-hatching operations. The moral, however, which Earl Grey deduces for the behoof of our Fisheries Department, *i.e.* to go and do likewise, is more questionable. There is scarcely any need to introduce good fish into any of our British waters, and there are many who think that the salmon has already monopolised too much of the attention of our administrative authorities. On the other hand, a Fish Commission for Great Britain, on which science and practice were fitly represented, and which was provided with adequate means both for investigations and practical experiments, would fulfil a serious deficiency in our industrial organisation.

In a small pamphlet of 21 pages which we have received, Father J. Fényi, S.J., describes a most ingenious apparatus for registering thunderstorms. The instrument seems to be due chiefly to the ingenuity of Father Johann Schreiber, S.J., an assistant at the Haynald Observatory in Kalocsa, who constructed it. The

apparatus consists mainly of three portions; the first consists of a horizontal magnetic needle mounted on a vertical support between a small and sensitive coil of wire, the needle and its stop being connected with a battery, a bell and a registering apparatus, the needle when in contact with its stop completing the circuit. The registering apparatus is a small electromagnet which actuates a pen in contact with a disc, and the latter is connected with a clock and moves with regular velocity. The third and very important portion of the arrangement is the coherer, which is composed of two delicately suspended needles nearly in contact; these are connected in a circuit, which includes the coil in which the horizontal needle is placed, a cell, and the long intercepting wire, corresponding to the tall post with wire of the Marconi telegraph system. The apparatus works in the following manner. A distant flash of lightning starts a wave-impulse, and this is led to the coherer by the intercepting wire; the needles move and touch each other, thus completing the circuit, and allow a current to pass through the coil. This coil immediately causes the needle inside it to be deflected to the stop. The second circuit is thus completed, the needle on the registering apparatus marks a deflection on the disc, the bell is rung, and the vibration caused by the latter separates the needles of the coherer. According to the account here given, the instrument is very efficient and has been found to record storms as many as twenty miles away, while on another occasion the instrument during very fine weather was working "apparently rebelliously," but was really recording a great storm raging at Budapest (as shown by the time of occurrence and record at each place), a distance of 110 kilometres from the apparatus.

In the *Scientific Transactions* of the Royal Dublin Society for April, Prof. F. T. Trouton discusses the remarkable experiment suggested by the late Prof. Fitzgerald for testing the relative motion of the earth and the ether. The idea of the experiment is that a charged electrical condenser, when moving through the ether with its plates edgewise to the direction of motion, possesses a magnetic field between the plates in consequence of its motion in accordance with the generally held view that a moving charge is equal to an electric current. As Prof. Trouton points out in the second part, the experimental realisation of the results anticipated opens up the possibility of utilising the earth's energy of motion through space, but it appears, so far as the observations go, that the effects sought are masked by some countervailing phenomena. In examining the paper at the present time, the recent discussions of Cremieu, Righi and other physicists on the question whether moving charges do actually generate a magnetic field, and allied points in the theory of electromagnetism, must not be overlooked.

WE have received a copy of a paper, by Mr. R. S. Hutton, on the fusion of quartz in the electric furnace. Mr. Hutton found that quartz can be readily fused in a Moissan arc furnace taking 300 amperes at 50 volts, and if air is supplied during the process reduction can be prevented. A modified form of furnace was built with a trough cut at right angles to the carbons, so that a carbon mould filled with broken-up quartz can be pushed under the arc. For making tubes, a carbon core is used, which is easily withdrawn afterwards, as it does not stick to the quartz. The tubes thus prepared are not quite free from bubbles, but can be improved in appearance by reheating under the arc, and, being thick-walled, can be used for drawing down and blowing. Mr. Hutton expresses the hope that this process may be extended by those having large supplies of power at their disposal, and may prove cheaper and more easily worked than the present method of fusion in the oxyhydrogen flame. Fused quartz apparatus might then be easily available, and its valuable properties would ensure its use for many purposes.

Chief among these may be noted its low coefficient of expansion, its high melting point, and its power of withstanding sudden changes of temperature without cracking.

THE last number of the *Journal* of the Russian Physical and Chemical Society (vol. xxxiv. 2) contains a paper by Prof. Bohuslav Brauner on the position of the rare earths in Mendeléeff's periodical system of elements, which led to a very interesting discussion when it was read at the last Congress of Russian Naturalists. After having mentioned his experimental and theoretical work concerning the elements lanthanum, cerium, praseodymium, neodymium, thorium, &c., the author discussed the position of these elements in the periodic system, and the four different ways in which it may be attempted to place them in it. With Mr. Steele, of Melbourne, he comes to the conclusion that this group of elements represents a sort of node in the periodic system, between cerium and an unknown element which has the atomic weight of 180. This inter-periodic group is a continuation of the eighth series, which ends with the platinum elements; gold appears in such case as the first member of the ninth series, and not of the eleventh. In the twelfth series the first members are, probably, radium, thorium and uranium. This addition seems, in Mendeléeff's opinion, to deserve serious attention.

In the latest *Bollettino* of the Italian Seismological Society, Dr. Cancani reconsiders the periodicity of the great earthquakes which have visited the coasts of the Marches and Romagna. By the discovery of some missing records, he has been able to fill up two gaps in the series, which now extends from 268 B.C. to 1874 A.D. The intervals between successive great earthquakes vary from 93 to 114½ years, the average interval being 101.9 years.

SOON after the Riviera earthquake of February 23, 1887, the geodynamic section of the Central Meteorological Office of Rome commenced the systematic record of all Italian earthquakes. During the first three or four years, the new section was getting into working order, but from 1891 onwards it attained that uniformity and regularity which now characterise it. The results of the first ten-year period (1891-1900) are summarised by Dr. A. Cancani in a paper published in the last *Bollettino* (vol. vii. No. 6) of the Italian Seismological Society. Taking into account only those shocks that were perceptible without instrumental aid, he finds that no less than 3361 earthquakes were observed in Italy during the ten years. The maximum monthly numbers occur in July and August; but this distribution is accidental and due to the very numerous shocks which followed the Monte Saraceno (Foggia) earthquake in July and August, 1893. During the last five years, the maximum numbers are found in January and March. The hourly distribution of earthquakes shows a minimum between 5 and 8 p.m. and a maximum in the first hour after midnight. Seismologists usually consider the midnight maximum as apparent and due to the condition of the observers, but Dr. Cancani remarks that the ratio of night earthquakes to day earthquakes is the same, namely 1.5, both for weak shocks (of intensities 2 to 4) and for strong ones (intensities 5 to 8). This is in direct contradiction to results previously obtained by de Montessus.

DR. HERGENELL, president of the International Aeronautical Committee, has communicated the following preliminary results of the balloon ascents which took place on the morning of February 6:—Strassburg, (1) temperature on ground $-0^{\circ}9$ C., $-39^{\circ}7$ at 8290 metres; (2) temperature at starting $-0^{\circ}1$, $-6^{\circ}8$ at 3600 metres. Berlin, temperature $-4^{\circ}4$, and $-12^{\circ}9$ at 3635 metres. Vienna, (1) temperature $-8^{\circ}6$, and $-12^{\circ}0$ at 3760 metres; (2) with Archduke Leopold Salvator and Archduchess Blanca in the car, temperature $-9^{\circ}0$ at 3000 metres.

(temperature at starting not stated). Ascents were also made at Trappes (Paris) and Pavlovsk (St. Petersburg), but the results are not yet known. Mr. Rotsch sent up a kite from Blue Hill Observatory, U.S. The lowest temperature, corresponding to the time of the European ascents, was -16°C at a height of 1242 metres. During the period in question there was an area of low barometric pressure over western Europe, which extended from Spain to Scandinavia, while over the eastern part of the continent there was an area of high pressure; the ascents from Vienna were made under the influence of the latter atmospheric conditions.

RESEARCHES carried on by Prof. F. E. Weiss on a Carboniferous plant-remain found at Halifax, and named *Xenophyton radiculosum* by Mr. Thomas Hick, show that the specimen may with little hesitation be regarded as the "root" of *Lepiaophlois fuliginosa*—a view which supports the contention of the late Prof. W. C. Williamson that the plant was of stigmatic character. (*Manchester Memoirs*, vol. xli., 1902, No. 9.)

THE *Annuaire* of the Royal Academy of Belgium for 1902 contains a biography, with portrait, of the late Baron de Selys Longchamps, who died at Liege in 1900. It appears that the family of Selys has been intimately connected with Liege since the seventeenth century. Full justice is done in the memoir to his work on the natural history of his own country, as well as to that on ornithology, ichthyology, and other branches of biology in general.

THE movements of gregarines are discussed by Mr. H. Crawley in the first part of the *Proceedings* of the Philadelphia Academy for 1902. The theory that these tiny organisms possess a kind of passive locomotion by means of the gelatinous threads they exude from the hinder part of the body is rejected—for one reason because such a mode of motion is unparalleled in the animal kingdom. Instead of this, the author believes that locomotion is effected by transverse muscular movements in the body, although the exact nature of the action and its results can only be surmised.

IN the *Proceedings* of the U.S. Museum (vol. xxiv.), Mr. Jordan, assisted in one case by Mr. M. Sindo and in another by Mr. J. O. Snyder, continues his valuable illustrated review of the fishes of Japan. Four parts are now before us, the first dealing with the surf-fishes (Embiotocidae), the second with the angler-fishes, the third with the "trachinoids," and the fourth with the salmonoids. With regard to the lack of sharply defined specific or subspecific characters between the numerous forms of the latter, the authors are inclined to adopt the view that this is in part at least due to the modern origin of the group.

PROF. H. F. OSBORN, in the April number of the *American Naturalist*, urges the importance of "homoplasy" as a law of latent or potential homology, taking for his text the independent origin of certain cusps in the cheek-teeth of the Primates which are clearly homologous. Assuming that all teeth started from the tritubercular type, we are forced to the conclusion that there is some principle in the constitution of these teeth which unifies up to a certain point the subsequent variation and evolution.

AN explanation of the survival of the brachiopod genus *Lingula* from Cambrian times is offered by Mr. N. Yatsu in *Annotations Zoologicae Japonensis* (vol. iv. part ii.). A part of the Japanese coast where this brachiopod flourishes was a few seasons ago coated with a deposit of muddy sediment from a flooded brook. All the burrowing molluscs were immediately killed, but the *Lingula* were unharmed. As it is also known that *Lingula* will live in an aquarium after the water has become unfitted for other organisms, it is inferred that its survival is due

to its power of withstanding unfavourable conditions. In the same journal, Mr. H. Kuwano describes a new Japanese *Balanoglossus*.

THE presidential address delivered by Dr. Erwin F. Smith before the Society for Plant Morphology and Physiology is published in full in a recent number of *Science*. Taking "Plant Pathology" as the subject of his discourse, comparisons are instituted between the conditions under which the pathologist worked twenty years ago and the improved modern-day methods. At that time pure cultures were almost unknown, and precise fixing and staining methods had not been devised. Then follows a considerable list of important researches from the time of De Bary down to the present day. Finally, looking forward, Dr. Smith suggests that the pathologist of the future will require to consult or, better still, train himself as a chemist and physicist. A preparation of eight years is considered to be none too long to fit the future pathologist for his life's work.

WE have received a copy of a syllabus of a special course in natural history for training college and King's students, issued, under the supervision of Prof. J. A. Thomson, by Marischal College, University of Aberdeen, for their summer session. The book, which is beautifully illustrated, appears in every way admirably adapted to the purpose for which it is intended. It commences with an examination of a series of types of British vertebrates, followed by a selection of invertebrates. Then comes a discussion of the principles of classification, with brief definitions of varieties, species, genera, &c. The structure of the cockroach is then exemplified, after which we have a brief table of the animal kingdom with appropriate illustrations. Another lesson deals with living animals, this being followed by a discussion on adaptation to surroundings and mode of life. The pupil is then introduced to the leading features in the structure of limbs, after which development claims his attention. Finally, there are illustrated studies of various types of common animals from four different points of view.

THE first number of the fortnightly *Agricultural News* (16 pages, one penny) was published by the Imperial Department of Agriculture for the West Indies on April 25, and has been very well received by the colonials. Its contents are of a most varied character, appealing to all classes of cultivators in the islands, dealing not only with the staple industry, sugar, but also with bats, beetles, tarpon fishing, grape cultivation, market reports, notices of books, &c. It is proposed to make a special feature of reports on the work which is being carried on at chemical laboratories, botanic institutions, agricultural shows, &c., and of the promotion of agricultural education in the colleges and schools of the West Indies. In future the *West Indian Bulletin* will be the quarterly journal of the Department for scientific and technical readers, while the *Agricultural News* will be the publication for the masses and the classes. Although the Department has only been in existence a little more than three years, it is evidently already widely appreciated, for its publications have now an extensive circulation in all parts of the tropics, the income from the sales disclosing a steady increase.

DR. HERBERT J. WEBBER has published a complete account of his investigations on the germination of the pollen grain and the series of events leading to fertilisation in two species of *Zamia* (U.S. Department of Agriculture, Bureau of Plant Industry; *Bull.* 2, 1901). The paper is a valuable addition to our knowledge of a most important race of plants, and the author's treatment is critical as well as descriptive. He shows that the male prothallium consists at first of two (or possibly three) cells, of which the terminal one divides into a stalk and "central" cell (the latter = antheridial cell of other authors). From the central cell the two antherozoids are formed, and the entire mass is used in their formation. The blepharoplasts,

which ultimately serve as the starting place for the coil of cilia in each antherozoid, are regarded as organs *sui generis*; and although their possible relation to centrosomes is also considered, the arguments against their identity with the latter are cogent. In fertilisation, the entire antherozoid enters the egg, and the cytoplasm and nuclei of the male and female cells respectively become fused. No centrosomes were observed during the cleavage of the fertilised egg during the formation of the embryo.

We have received from the publishers (Messrs. Cassell, Ltd.) a copy of the first part of an illustrated quarto work on "European Butterflies and Moths," by Mr. W. F. Kirby, the well-known lepidopterist. The plates are excellent examples of modern colour-printing, and the work, so far as it has yet gone, may be described as an attractive subject attractively treated. Perhaps it would have been better if a little more prominence had been given in the text to the English names. The work is to be issued in fortnightly parts.

A VOLUME containing the physical papers of the late Prof. H. A. Rowland is now in preparation. It will be issued under the editorial direction of a committee appointed for that purpose, consisting of President Rensen, Prof. Welch and Prof. Ames. The book will contain Prof. Rowland's articles and memoirs on physical subjects, together with his popular writings and addresses, numbering sixty in all. It will occupy between six and seven hundred pages, and will be published at the price of one guinea net per copy. Orders may be sent to Prof. Joseph S. Ames, secretary of the committee of publication, Johns Hopkins University, Baltimore, Maryland.

THE industry of chemical perfumes is one of recent development and is rapidly assuming an importance second only to the colour industry in the field of commercial organic chemistry. The current number of the *Moniteur Scientifique* contains an account by MM. Marc Tiffenau, R. Bernard and A. Gloss of the exhibits in this field at the Paris Exhibition of 1900, preceded by a short sketch of the general methods employed in the preparation of chemical perfumes. It is interesting to note that practically the whole of this branch of applied science is divided between two nations, France and Germany.

THE conclusion of Maxwell from the electromagnetic theory of light that the dielectric capacity should be equal to the square of the refractive index has led to a mass of experimental work not always in accord with the law. In the current number of the *Comptes rendus*, M. Edm. van Aubel collects the experimental data for these two constants for four classes of nitrogen compounds, amines, alkyl nitrates, fatty nitro-derivatives and nitriles, and shows that in all cases the dielectric constant diminishes as the molecular weight increases, whilst the refractive index increases, a result obviously incompatible with Maxwell's law.

THE additions to the Zoological Society's Gardens during the past week include two Lesser Kestrels (*Tinnunculus cenchris*), a Short-eared Owl (*Asio brachyotus*) captured in the Red Sea, presented by Capt. E. W. Burnett; a Red-footed Falcon (*Tinnunculus vespertinus*), South European, presented by Miss E. Leek; a Virginian Eagle Owl (*Bubo virginianus*) from the West Indies, presented by Mr. B. C. Storey; a Common Mynah (*Acridotheres tristis*) from India, presented by Mr. F. G. McVillie; two Syrian Bears (*Ursus syriacus*) from Western Asia, twenty-two Moorish Toads (*Bufo mauritanica*) from North-west Africa, five Amphiumas (*Amphiuma means*), ten Punctated Newts (*Amblystoma punctatum*) from North America, an Upland Goose (*Chloephaga magellanica*) from the Falkland Islands, received in exchange; a Japanese Deer (*Cervus sikak*) born in the Gardens.

OUR ASTRONOMICAL COLUMN.

NEW VARIABLE STARS.—The following variable stars have been detected on plates taken with the astrographic telescope at Greenwich Observatory:—

Star.	R.A.	Decl.	Variation.
	h. m. s.		mag. m.
6. 1902. Draconis ...	18 5 9 ...	+65 56.9 ...	9.0 - < 14
7. 1902. Draconis ...	18 6 54 ...	+66 8.9 ...	9.5 - 14
8. 1902. Camelopardalis ...	5 49 22 ...	+74 30.8 ...	8.9 - < 14

ELEMENTS OF COMET 1902 a (BROOKS).—The following elements computed for this comet are given in *Astronomische Nachrichten*, Bd. 158, No. 3790:—

T = 1902 May 7^h 15^m 59^s, Berlin M.T.

$$\left. \begin{aligned} \omega &= 228 \quad 22.7 \\ \Omega &= 52 \quad 15.4 \\ i &= 66 \quad 30.4 \end{aligned} \right\} 1902.0$$

log $q = 9.65436$.

COLABA OBSERVATORY.—The Report of the Director of the Government Observatory at Colaba, Bombay, has been issued, and contains the results of magnetic and meteorological observations made during the year 1901.

The magnetic observations have been on regular record since 1842, but there is now reason to believe that disturbances will occur from the proximity of the electric tramways in Bombay. It is hoped, however, that a new site will be granted early enough to permit of a fresh series of determinations running parallel with the present, so that the value of such a long continuous record may not be seriously affected.

ATOMS AND VALENCIES.

AN offprint has come to hand of a thoughtful essay by Mr. J. Fraser, of the Scottish Ordnance Survey, entitled "A Theoretical Representation leading to Suggestions bearing on the Ultimate Constitution of Matter and Ether," which appeared recently in *Proc. Roy. Soc. Edin.* xiv., 1, 1902, pp. 1-64. Under this guarded title the writer discourses, in a manner often stimulating and suggestive, on the bearing on the facts of chemistry and chemical physics of a notion he has formed of the constitution of the ether, and of matter which he considers as constructed out of that medium. He begins by quoting Sir J. Herschel's opinion that the ether is "an adamantine solid," far denser, in fact, than the densest metal. The other alternative, that of inertia or density insensibly minute, has been more commonly in evidence in recent times, especially since Lord Kelvin showed that it was adequate for the transmission of radiant energy across space. It is something to know that the more unfamiliar view, which has recently again been broached in illustration of the laws of general ether-theory, presented no intrinsic difficulty to the mind of so competent an authority as Herschel. Enormous density implies still more enormous elastic resistance, which Mr. Fraser ascribes in a way to a kinetic origin, like Kelvin's and FitzGerald's turbulent motion. How is an atom of matter to be represented? Briefly and bluntly, in the words of the writer, as "a veritable ethereal bubble"—walled in by a single layer of ether-particles, in very rapid rotation, the centrifugal force of which prevents the bubble from collapsing under the enormous ambient pressure. How is its permanence assured? Astronomical analogies are invoked in favour of its possibility; but the sceptical critic had better refrain from too close scrutiny in order to pass on to see whether any light on atomic behaviour is shed by a somewhat loose representation of this sort. After all, a hollow vortex-ring atom is a ring-shaped bubble kept open much in this way; and representations dynamically vaguer than this have turned out in chemical science to contain the germ of fruitful and far-reaching progress. A sort of Le Sage corpuscular theory of gravity is set forth with considerable freshness and some plausibility. But the most interesting sections relate to chemical suggestion, with regard to which the writer modestly confesses to little knowledge except what has been acquired with a view to the present attempt. It may be remarked on his behalf that knowledge of speculative scientific theory, when acquired with some constructive intention of this sort, even if it be visionary, is apt to be a much more real possession than when the aim is merely to become well-informed in a colourless way about the opinions that

chemists have held and have at different times put into their treatises. Time and reflection, to an extent that can hardly be spared by most people, would be required to come to a definite judgment as to how far the notions put forward are allowable or should be at once put aside, whether the "resemblance to the ways of nature" on which the writer insists involves any germ of general ideas beyond those already recognised. But in any case there can be no question as to the acuteness of the writer; and the Royal Society of Edinburgh has been well advised in making his ideas accessible to others who are attracted by the same range of theoretical speculation, in subjects which are only now coming to the threshold of the dynamical stage.

J. L.

UNIVERSITY AND EDUCATIONAL INTELLIGENCE.

CAMBRIDGE.—The subject of the Rede lecture, to be given by Prof. Osborne Reynolds, F.R.S., on June 10, at 11.30 a.m., is "On an Inversion of Ideas as to the Structure of the Universe."

Prof. Forsyth, F.R.S., will represent the University at the celebration of Abel's centenary, to be held at Christiania in September, 1902.

The museums syndicate propose to assign the greater portion of the buildings about to be vacated by the botanical department to the engineering laboratory. The number of the students engaged in the latter is now more than 200, and extension of the accommodation now provided is urgently necessary. The syndicate regret that they are unable to make arrangements for additional accommodation for the departments of human anatomy and physiology, or for the museum of zoology, which are also in need of considerable expansion.

The Graces authorising the recently proposed changes in the natural sciences tripos will be voted on in the senate on May 22. It is understood that some of them will be opposed.

Mr. W. Bateson, F.R.S., is again to be deputed to lecture in zoology for Prof. Newton during the ensuing academical year.

The Frank Smart studentship in botany will be vacant at midsummer. The studentship is of the annual value of 100*l.* and is intended to further the scientific study of botany by supplying students with some means of pursuing original investigations in this subject after they have taken the degree of Bachelor of Arts. It is open to all students of the University who have taken honours in the first part of the natural sciences tripos, provided that not more than fourteen terms have elapsed since their first term of residence. The studentship is not awarded by a competitive examination. Candidates should send in their names to the master of Gonville and Caius College on or before June 10, with a statement of their University standing.

THE second reading of the Education Bill was passed by the House of Commons on Thursday, May 8, after a debate which extended over three days. The majority in favour of the second reading was 237, the numbers being 402 votes for the Bill and 165 against.

To assist the scholarship scheme founded by the late Mr. Rhodes, Sir Alfred Jones, head of the shipping firm of Elder, Dempster and Co., announces that he will agree to give a free passage backwards and forwards from any colonial port served by his firm's steamers to both Jamaican and Canadian scholars once a year during the tenure of their scholarships. He adds:—"I trust that my example will be followed by shipowners trading to other colonies, and I hope that it may thereby be made universal, so as to put all the Rhodes scholarships from the colonies on an equal footing."

THE announcement is made that Prof. Karl B. Lehmann, of Würzburg, has been appointed to the chair of hygiene at the University of Munich, which recently became vacant by the death of Prof. Hans Buchner on March 30. He was formerly connected with the University, having been trained there as a medical student, and subsequently acted as assistant to Prof. Pettenkofer and as privat-docent for many years. Prof. Lehmann, who is a Swiss by birth, is still in the prime of life, but has already made a high reputation as a hygienist. His first special scientific work was the study of the physiology of the

sense-organs, his contributions to this department of science being of great and practical value. He has also studied and written upon the action and influence of various gases upon the animal organism, and more recently has given much attention to the study of physiological chemistry in connection with general metabolic processes.

In connection with the subject of State aid for secondary education, it is of interest to read in *Science* that the General Assembly of the State of Iowa has passed a mill tax for the building support of the three educational institutions of Iowa, as follows:—State University at Iowa City, one-fifth of a mill to run for five years. This will realise 550,000 dollars. The Iowa State College of Agriculture and Mechanic Arts at Ames, one-fifth of a mill for a similar period, which will realise 550,000 dollars. The State Normal School at Cedar Falls, one-tenth of a mill for five years, which will realise 225,000 dollars. The State educational institutions receive in addition 434,269 dollars for the biennial period, distributed as follows:—State University, 215,000 dollars; Iowa State College of Agriculture and Mechanic Arts, 135,000 dollars—of this 35,000 dollars are for additional general support annually, and 10,000 dollars annually for the experiment station, 5,000 dollars for live stock, 5,000 dollars to begin the building of a barn, and 35,000 dollars to start a main central building; the Iowa State Normal School, 84,269 dollars.

The general scope of the new matriculation examination for all students of the University of London are published in the official gazette. The full text of the regulations will be published at the beginning of June, and the first examination under them will commence on September 15 next. An examination under the old regulations will be held in January, 1903, and under both sets of regulations in June, 1903. Matriculation candidates will be expected to show a competent knowledge in each of the following subjects, according to the details specified under the several heads:—(1) English, one paper of three hours. (2) Elementary mathematics, two papers of three hours each. (3) Latin, or elementary mechanics, or elementary physics (heat, light and sound), or elementary chemistry, or elementary botany, one paper of three hours in each subject. (4) Two of the following subjects, neither of which has already been taken under (3). One paper of three hours in each subject. If Latin be not taken, one of the other subjects selected must be another language from the list, either ancient or modern:—Latin, Greek, French, German, Arabic, Sanskrit, Spanish, Portuguese, Italian, Hebrew, history (ancient or modern), logic, physical and general geography, geometrical and mechanical drawing, mathematics (more advanced), elementary mechanics, elementary chemistry, elementary physics—(a) heat, light and sound, or (b) electricity and magnetism; elementary biology—(a) botany, or (b) zoology.

DR. D. C. GILMAN contributes to the May number of *Scribner's Magazine* some further reminiscences of noteworthy scholars with whom he has been brought in contact as president of the Johns Hopkins University. An English mathematician remarked to him one day that he had heard of Baltimore as a place which exported corn and imported mathematics, and this epigram was founded upon fact. Cayley and Sylvester both went to the new University from England. Cayley spent a winter at Baltimore, and profoundly impressed his hearers; Sylvester spent the seven years there which preceded his seventieth birthday, and left to become Savilian professor at Oxford. Many stories are told of Sylvester's eccentricities, but most of them are apocryphal. He became possessed of a sort of monomania for rhyme, and one of his most extraordinary compositions was a long series of lines, every one of which ended with a syllable that he pronounced as *ind.* This *tour de force* reached four or five hundred verses. Sometimes he was very absent-minded. For example, he arrived from Philadelphia in a late train one night and walked bareheaded to his hotel. The next morning he demanded his hat, and insisted that it was in the house, and he would not be persuaded that it had not been stolen until a telegram revealed the fact that the hat had been found in the train at Washington. In 1884, Lord Kelvin gave a course of lectures at the University. "The lectures," says Dr. Gilman, "went on from day to day upon the topics that occurred to the lecturer, or that were suggested by the questions of his hearers. Everyone who was capable of following him was enchanted. 'How long will these lectures continue?' asked one of the audience. 'I do not know,' replied Lord Rayleigh, who was one of the

followers, 'I suppose they will end some time, but I confess I see no reason why they should.' Dr. Gilman concludes his article with the following wise words:—"In the conduct of a university, secure the ablest men as professors, regardless of all other qualifications excepting those of personal merit and adaptation to the chairs that are to be filled. Borrow if you cannot enlist. Give them freedom, give them auxiliaries, give them liberal support. Encourage them to come before the world of science and of letters with their publications. Bright students, soon to be men of distinction, will be their loyal followers, and the world will sing a loud Amen."

SCIENTIFIC SERIAL.

Memoirs of the Kazan Society of Naturalists, vol. xxxv.—Researches into the Protozoa of the Black Sea, by R. Minkiewicz. The organisation, the multiplication and the systematic position of Euploetes (Ehrbg.) are discussed.—Materials for the knowledge of the soil and vegetation of western Siberia, by A. Gordyagin. This is the second and last part of a very valuable work which was begun in a previous issue of the same periodical (vol. xxxiv.). The fir, Scotch fir and birch forests, the mutual relations between the chief arborescent species, and the Steppes vegetation are discussed in this part, which contains also a large-scale botanical map of the western portion of the basin of the Irtysh and a full index.—The physicochemical structure of the chlorophyll grain, by M. S. Tsvett. Experimental researches and critical review of the work hitherto done.—Botanic-geographical researches in the province of Saratov, by B. Keller. An interesting general review of the vegetation (summary in German) and a list of 987 plants belonging to the flora of Saratov are given.—On the soils of south-eastern Russia, by A. Ostriakoff, being descriptions and chemical analyses of salt-bearing soils of southern Samara.

SOCIETIES AND ACADEMIES.

LONDON.

Physical Society, May 9.—Prof. S. P. Thompson, president, in the chair.—Dr. P. E. Shaw exhibited a simple electric micrometer. Two years ago, Dr. Shaw described an instrument with which he measured very small lengths by the application of electric contacts, and the micrometer shown was a simple form of the original apparatus. A screw, fitted with a milled head, turns in a fixed nut, and its lower end presses upon the extremity of the long arm of a lever. A metal point is attached to the short arm, and the distance through which it moves, on turning the milled head, can be deduced from a knowledge of the pitch of the screw and the ratio between the arms of the lever. In using the instrument, this point is always brought up to a metal surface, and the contact is accurately determined by the telephonic arrangement described in connection with the original micrometer. Dr. Shaw illustrated the use of the instrument for measuring small lengths by describing the following eight applications to ordinary laboratory measurements:—(1) The measurement of the thickness of plates, films or fibres. The object is placed between two metal plates. The point of the micrometer is adjusted to touch the top plate and the reading taken. The object is removed, the point is again brought into contact with the top plate, and the difference between the readings in the two cases gives the thickness of the film. (2) The determination of Young's modulus by the elongation of a wire. Dr. Shaw described experiments on two wires, each 24 metres long, hanging side by side, one of copper and the other of steel. The wires terminated in horizontal platforms to which the stretching weights were attached. The base of the instrument rested on one platform, while depressions of the other, due to loading, were measured. In this way any error, on account of the bending of the beam from which the wires were hung, was eliminated. (3) The determination of Young's modulus by the bending of a beam. (4) The determination of simple rigidity by a static method. Observations were made upon a rod held horizontally by rigid wall brackets. One end of the rod was fixed and the other held in position by a pin pressed into a hole in the end of the rod. From this end an arm projected outwards. Weights were applied to the extremity of this arm, and the twist

measured by observing with the micrometer the movement of the end of the arm. (5) Application to the extensometer. (6) Measurement of thermal expansion. (7) Microscopic measurements. In measuring the diameter of a capillary tube, the cross wire of the microscope is made to touch one side of the tube, and the point of the micrometer is brought into contact with the metal stage. The stage is then moved by a screw until the cross wire comes to the other side of the tube. The micrometer point is moved into contact again, and the difference in the readings gives the diameter of the tube. In this measurement the full magnifying power of the microscope is utilised, and the work of moving the stage is performed by a rough screw. (8) The direct measurement of the wave-length of light. Newton's rings are formed by a convex lens and a piece of plate glass. The convex lens is fixed to the short arm of the lever, and the distance through which it must be moved to cause a certain number of bands to appear at the centre gives a means of calculating the wave-length of the light employed.—Papers on the conservation of entropy, by Mr. J. A. Erskine, and rational units of electromagnetism, by Sig. G. Giorgi, were postponed.

Chemical Society, April 30.—Prof. Emerson Reynolds, V.P.R.S., in the chair.—The preparation of absolute alcohol from strong spirit, by Dr. Young, F.R.S. The 4 or 5 per cent. of water remaining in the strongest rectified spirit procurable by distillation can be removed by adding to it a volatile liquid capable of forming with alcohol and water a ternary mixture boiling below 78° C. and distilling. Benzene is a suitable substance for this purpose, the ternary mixture so formed boiling at 64.85°. The alcohol thus obtained contains a trace of benzene, which in turn can be removed by a redistillation with pure hexane.—On the properties of mixtures of the lower alcohols with water, by Dr. Young, F.R.S., and Miss E. C. Fortey. Methyl alcohol can be prepared in an absolute condition by simple distillation through an efficient still-head. The higher homologues, such as isopropyl, propyl and tertiary butyl alcohols, can be dehydrated by addition of benzene and redistillation. The constant boiling mixtures of these alcohols with water are not definite hydrates.—On the properties of mixtures of the lower alcohols with benzene and with benzene and water, by Dr. Young, F.R.S., and Miss E. C. Fortey. Among the lower alcohols of the paraffinic series, all except isopropyl alcohol form constant boiling mixtures with benzene, but beyond the amyl alcohols this phenomenon no longer occurs; ethyl, propyl, isopropyl and tertiary butyl alcohols alone form constant boiling ternary compounds with benzene and water.—Fractional distillation as a method of quantitative analysis, by Dr. Young, F.R.S., and Miss E. C. Fortey. When a mixture which tends to separate into two components is distilled, the portion of the distillate obtained below the temperature midway between the boiling points of the two constituents is almost exactly equal to the weight of the more volatile component of the mixture. This principle can also be extended to ternary mixtures.—On the vapour pressures and boiling points of mixed liquids, by Dr. Young, F.R.S. Mixtures of bromo- and chloro-benzene exhibit a close agreement with van der Waals's law, which states that "the relation between vapour pressure and molecular composition of mixtures of liquids having equal critical points and in which $a_{1,2} = \sqrt{a_1 a_2}$ (a_1, a_2 represents attraction of unlike molecules and a_1 and a_2 the attractions of like molecules) is represented by a straight line."—The correction of the boiling points of liquids from observed to normal pressure, by Dr. Young, F.R.S. An extension and improvement of Craft's table of constants of correction.—Vapour pressures and specific volumes of isopropyl isobutyrate, by Dr. Young, F.R.S., and Miss E. C. Fortey. These constants have been determined on a pure specimen of this ester prepared by electrolysis of potassium isobutyrate.—The preparation of highly substituted nitroaminobenzenes, by Dr. Orton. The author has devised a method of preparing aromatic nitroamines by the action of nitric acid on amines dissolved in acetic anhydride, and has by this method isolated and characterised a number of these substances.—The atomic weight of tellurium, by Dr. Scott, F.R.S. When tellurium is treated with methyl iodide, it forms a trimethyl tellurium iodide which crystallises well and affords a convenient method of comparing the combining weight of tellurium with that of iodine which is accurately known from Stas's determination. The ratio thus found indicates that the atomic weight of tellurium is about 127.75.—Nitrogen bromides containing the propionyl group, by Dr. Chattaway. A

continuation of the author's researches on nitrogen halides in which propionyl is a substituent. A number of these derivatives are described.

Mathematical Society, May 8.—Dr. E. W. Hobson, president, in the chair.—Dr. Ganesh Prasad read a paper on the use of Fourier's series in the theory of conduction of heat. It is pointed out that the received theory may break down through discontinuity in the initial conditions; and a method is described for forming an equation which shall, at the discontinuities, take the place of the usual partial differential equation of conduction. The modified theory thus deduced is equivalent to the ordinary theory at all places and times at which there is no discontinuity in initial or boundary conditions.—Mr. A. E. Western pointed out an exception to a theorem of Fermat's on binary powers.—Dr. F. S. Macaulay read a paper on some formulæ of elimination. The resultant of any number of equations, which are homogeneous in an equal number of variables, is proved to be expressible as the quotient of a certain determinant by a certain minor of the same; certain formulæ are also given connecting the determinants with the roots of the equations which, for this purpose, are made non-homogeneous by equating one variable to unity.—The following papers were communicated from the chair.—Prof. Burnside, on groups in which every two conjugate operations are permutable. The general character of the operations of a group which satisfy this condition of permutability is determined, and it is shown that the sufficient and necessary conditions that the group may be of finite order are that the generating operations are of finite order. In general for such a group, the commutator of any two operations is a self-conjugate operation. The case in which the order is a power of three is exceptional.—Mr. H. S. Carslaw, the application of contour integration to the solution of general problems in the conduction of heat and to the expansion of an arbitrary function in series. The solutions of certain special problems are transformed so that they are expressed in terms of integrals taken along certain paths in the plane of an auxiliary complex variable. The solutions of more general problems, built up by synthesis, are then transformed so that they are expressed by means of infinite series. The methods are applied to problems of conduction of heat in a finite rod and in a cylinder, and it is pointed out that they admit of extension to other branches of mathematical physics.

Geological Society, April 16.—Prof. Charles Lapworth, F.R.S., president, in the chair.—The Carlisle Earthquakes of July 9 and 11, 1901, by Dr. C. Davison. The shocks were at least four in number, and there are single records of four other shocks. The isoseismal 5 of the first and principal shock is very nearly a circle 29 miles in diameter, with its centre 7 miles south-south-west of Carlisle, and is eccentric with regard to the isoseismal 4. The continuity of the shock over a band extending from Carlisle to Coniston implies a corresponding continuity in the focus. The investigation of the earthquakes has led to the recognition of a deep-seated fault, the average direction of which is N. 5° E. and S. 5° W. and the hade throughout is to the east. In the surface-rocks there is no sign whatever of such a structure. The movements along the fault were somewhat peculiar. In the first shock the focus was of considerable length, and consisted of two principal portions, the centres of which were about 23 miles apart, connected by a region wherein the slipping was continuous throughout, and much less in amount. The northern part of the focus was smaller than the other, but was marked by a much stronger impulse. The third slip was complementary to the first, for it appears to have occupied the whole of the region between the two principal portions of the first focus, and to have been greatest near the centre of that region and to have gradually diminished towards both ends.—The Inverness Earthquake of September 13, 1901, and its accessory shocks, by Dr. C. Davison. Since the Comrie earthquake of 1839, which was followed by 330 tremors and earth-sounds within little more than two years, no British earthquake has been attended by so many accessory shocks as this one. The unusual intensity of the earthquake, its apparent connection with the great northern boundary-fault of the Highlands, and the possibility of tracing oscillations in successive centres of disturbance along the fault-surface, combined in rendering a detailed investigation desirable. With a few exceptions, the earthquakes originated beneath the district lying between Inverness and the north-eastern end of Loch Ness. The mean direction of the fault, which follows the line of the

Great Glen, is N. 35° E. and S. 35° W. and its hade is to the south-east. The isoseismal 8 contains 67 square miles, and its centre is about one-and-a-half miles east-north-east of Dochgarroch and three-quarters of a mile south-east of the fault-line. The correspondence between the position of the great boundary-fault and of the fault inferred from the seismic evidence is so close that there can be little doubt that the earthquake was due to a slip along this fault. The nature of the shock, the sound phenomena, time-relations and after-shocks, are described in detail, and some account is added of the earthquakes of 1890 and of sympathetic earthquakes in the valley of the Findhorn. There were two distinct slips in rapid succession, with continuous slight motion between them, the second being greater in amount and extending over an area which probably overlapped, even if it did not entirely include, that within which the first took place. The great slip reached nearly from Loch Ness to Inverness, and was greatest at a point about half-way between. The three chief after-slips resulted in an extension of this area in both directions along the fault-surface, the extension to the north-east being small, while that to the south-west amounted to 6 miles or more. In addition to this migration of the focus, there was also a continuous decrease in the depth of the focus. The earthquakes provide no evidence with regard to the direction of displacement along the boundary-fault. There can be little doubt, however, that Loch Ness is still growing; but it can hardly be determined whether the lake is now contracting in area, or whether it is gradually pushing its way outward to the sea.—The Wood's Point Dyke, Victoria (Australia), by Mr. F. P. Mennell.

Zoological Society, May 6.—Prof. G. B. Howes, F.R.S., vice-president, in the chair.—A note was read by Mr. Roland Trimen, F.R.S., upon a moth of the genus *Cossus*, which had been reared in the Society's insect-house from a chrysalis sent home from South Africa. The specimen was apparently referable to the common goat-moth of Europe (*Cossus ligniperda*), which had probably been introduced in logs of wood into South Africa.—Mr. Oldfield Thomas, F.R.S., read a paper on the mammals obtained during the Whitaker Expedition to Tripoli. At Mr. J. I. S. Whitaker's expense, Mr. E. Dodson had made a successful collecting expedition into Tripoli, and the specimens of mammals obtained had been presented to the National Museum. Twenty-one species were referred to, and, among others, a hare (*Lepus whitakeri*), allied to *L. aethiopicus*, but of a bright pinkish buffy colour, and a gundi (*Ctenodactylus valis*) like *C. gundi*, but with much larger bulge, were described as new.—A communication from Mr. G. A. Boulenger, F.R.S., contained lists of four species of fishes, eight species of batrachians and thirty-five species of reptiles, of which specimens had been collected by Mr. J. F. Elliott Darling in Mashonaland. Amongst these were described as new two species of fishes (*Labeo darlingi* and *Barbus rhodesianus*), one of batrachians (*Rana darlingi*) and two of reptiles (*Homopus darlingi* and *Ichnotropis longipes*).—A communication was read from Hans Graf von Berlepsch and M. Jean Stolzmann containing a second part of their memoir on the ornithological researches of M. Jean Kalinowski in Central Peru. It gave an account of 188 species and subspecies, of which twelve were described as new.—A paper contributed by Sir Charles Eliot contained notes on the nudibranchs of the eastern and western coasts of Zanzibar. *Zatteria brownii*, *Dunga nodulosa* and *Crosslandia viridis* were described as new genera and species, and remarks were made upon the little-known species *Melibe fimbriata* and *Marella ferruginosa*.—Prof. G. B. Howes, F.R.S., communicated a paper by Prof. G. Elliot Smith on a case of abnormal dentition in a lemur. The author recorded the occurrence in an individual of *Lemur fulvus* of a fourth lower molar, present on both sides, in its characters a diminutive counterpart of the normal third molar as regards its postero-external cusp. Reverting to the fact that certain fossil lemurs, marsupial-like, possess four molar teeth, and to the presence in Otocyon of four molars, and in the insectivore Centetes of a fourth upper molar, the author asserted a belief in a four-molared ancestry for the Primates.

PARIS.

Academy of Sciences, May 3.—M. Bouquet de la Grye in the chair.—The permanent secretary announced to the Academy the death of M. L. Fuchs, correspondent for the Section of Geometry.—Studies of batteries founded on the use of saline solutions with the reciprocal action of oxidising and reducing liquids, by M. Berthelot.—On the functions of the

spheridia of the sea-urchin, by M. Yves Delage. Various views have been put forward at different times as to the functions of the spheridia in sea-urchins. An experimental study has been made with *Echinocymus*, and it was found that the spheridia are not the exclusive organs of the sensation of orientation, since sea-urchins deprived of these organs can turn over as certainly, although less rapidly, than before.—On a class of transformations of Buckland, by M. E. Goursat.—On the deformation of conoids, by M. A. Demoulin.—The problem of surfaces loaded on end. Solution in the case of the cylinder of revolution, by M. Albin Gros.—On the function of self-induction in electric discharges through gases, by M. B. Egnitins.—The action of an intense magnetic field upon the anodic flux, by M. H. Pellat.—The action of self-induction on the spectrum of dissociation of compounds, by M. A. de Gramont. It was found that by altering the self-induction of the spark circuit the spectrum of air could be very easily eliminated without altering that of other bodies. By still further increasing the self-induction of the circuit, the lines due to various metalloids, such as sulphur, selenium, tellurium and phosphorus, could be made to disappear, a result which has obvious applications in the spectroscopic analysis of minerals.—On the law of $\text{Maxwell } n^2 = K$ for some compounds containing nitrogen, by M. Edm. van Aubel (see p. 68).—Glucose and the carbonates of cerium. On a new mechanism of oxidation, by M. Andre Job. Cerous carbonate in the presence of air is capable of oxidising arsenites and also glucose. In the latter case the cerous salt behaves like an oxydase.—On the alloys of cadmium with barium and calcium, by M. Henri Gautier.—On an oxycarbide of cerium, by M. Jean Sterba. By the action of carbon upon cerium oxide in the electric furnace, a well-defined crystallised oxycarbide can be obtained of the formula $\text{CeC}_2 \cdot 2\text{CeO}_2$. This oxycarbide is relatively stable in water and air, and when decomposed with dilute acids furnishes unsaturated hydrocarbons. No other carbides except this and cerium carbide, CeC_2 , can be obtained in the electric furnace.—On arsenic anhydride and its hydrates, by M. V. Auger. The only hydrates which could be obtained were $(\text{H}_2\text{AsO}_3)_2$, H_2O and $\text{H}_2\text{AsO}_3 \cdot 10\text{H}_2\text{O}$. The three hydrates HAsO_2 , $\text{H}_2\text{As}_2\text{O}_5$, and H_3AsO_4 described by Kopp could not be prepared.—The preparation and properties of the chloro-, bromo- and iodo-sulphobismuthites of lead, by M. Fernand Ducatte.—On some derivatives of pyruvylpyruvic ester, by M. L. J. Simon. An unsuccessful attempt was made to prepare this ester, $\text{CH}_3\text{—CO—CO—CH}_2\text{—CO—CO}_2\text{C}_2\text{H}_5$. The product of the action of aniline upon ethyl pyruvate appears to be this triketone condensed with two molecules of aniline. Only one of the anilins groups could be split off by hydrolysis with sulphuric acid.—On the mutual action of acid chlorides and methanal, by M. Marcel Descudé.—On the combinations of sodium tetraazodilysulphite with aromatic amines and phenols, and their transformation into azo colouring matters, by MM. A. Seyewetz and Biot.—On the addition of hypochlorous acid to propylene, by M. Louis Henry. A reply to a note of M. Tiffenau on the constitution of the chlorhydrins. The constitution of the addition product of hypochlorous acid to propylene has usually been determined by oxidation. The author points out that the apparently contradictory results obtained are due to the fact that the same compound gives different oxidation products according to the oxidising agent used. It is possible that two addition products are simultaneously formed, but the principal one is undoubtedly that in which the —OH group attaches itself to the group $=\text{CH}_2$.—The development of black rot, by M. A. Frunet.—The Carboniferous eruptive rocks of Creuse, by M. L. de Launay. The results of this investigation are in accord with the theory of M. Michel Lévy on the differentiation of magmas.—Study of specimens of water and sea floor from the North Atlantic, by M. J. Thoulet.

DIARY OF SOCIETIES.

THURSDAY, MAY 15.

ROYAL SOCIETY, at 4.30.—On some phenomena affecting the Transmission of Electric Waves over the Surface of the Sea and Earth: Capt. H. B. Jackson, K.N., F.R.S.—Microscopic Effects of Stress on Platinum: T. Andrews, F.R.S., and C. R. Andrews.—A Note on the Recrystallisation of Platinum: W. Rosenbain.—Cyanogenesis in Plants. Part II. The Great Millet, *Sorghum vulgare*: Prof. W. R. Dunstan, F.R.S., and Dr. T. A. Henry.—On Electro-motive Wave accompanying Mechanical Disturbance in Metal immersed in Electrolyte: J. C. Bose.

INSTITUTION OF ELECTRICAL ENGINEERS (Society of Arts), at 8.—

Electrical Traction on Steam Railways in Italy: Prof. C. A. Carus-Wilson.
CHEMICAL SOCIETY, at 8.—The Radioactivity of Thorium Compounds. II. The Cause and Nature of Radioactivity: E. Rutherford and F. Soddy.—The Radioactivity of Uranium: F. Soddy.—The Variation with Temperature of the Surface Tensions and Densities of Liquid Oxygen, Nitrogen, Argon and Carbon Monoxide: E. C. C. Baly and F. G. Donnan.—Comparison of Bromonitrocamphane with Bromonitrocamphor: M. O. Forster.—*aa*-Bromonitrocamphor and *aa*-Benzoylodoncamphor: M. O. Forster and E. A. Jenkinson.

FRIDAY, MAY 16.

ROYAL INSTITUTION, at 9.—The Nebular Theory: Sir Robert Ball, F.R.S.

TUESDAY, MAY 20.

ROYAL INSTITUTION, at 3.—The Laws of Heredity with Special Reference to Man: Prof. Karl Pearson, F.R.S.

WEDNESDAY, MAY 22.

ROYAL MICROSCOPICAL SOCIETY, at 7.30.—Exhibition of Freshwater Entomostraca: D. J. Scurfield.

ROYAL METEOROLOGICAL SOCIETY, at 4.30.—Report on the Wind Force Experiments on H.M.S. *Worcester* and at Stoness Lighthouse: W. H. Dines and Capt. D. Wilson-Barker.—The Cornish Dust Fall of January, 1902: Dr. H. K. Mill.

THURSDAY, MAY 22.

INSTITUTION OF ELECTRICAL ENGINEERS (Society of Arts), at 8.—Annual General Meeting.

FRIDAY, MAY 23.

ROYAL INSTITUTION, at 9.—The Ethical Element in Shakespeare: Rev. Canon Ainger.

CONTENTS.

PAGE

The Reprint of Stokes' Papers. By Prof. Horace Lamb, F.R.S.	49
Anthracite Mining in Pennsylvania	50
Organography and its Relations to Biological Problems. By Prof. J. B. Farmer, F.R.S.	51
Our Book Shelf:—	
Bergholz: "The Hurricanes of the Far East"	51
Witherby: "Bird Hunting on the White Nile."—	
R. L.	52
Perkin and Lean: "An Introduction to Chemistry and Physics."—S. S.	52
Hopkins: "The Oil Chemists' Handbook"	52
Browne: "Elements of Botany"	52
Letters to the Editor:—	
Mont Pelée Eruption and Dust Falls.—Dr. William J. S. Lockyer	53
Symbol for Partial Differentiation.—Prof. John Perry, F.R.S.	53
The Pines of Western Asia.—Sir J. D. Hooker, G.C.S.I., F.R.S.; The Writer of the Note	53
The Kinetic Theory of Planetary Atmospheres.—Prof. G. H. Bryan, F.R.S.	54
On Prof. Arhenius' Theory of Cometary Tails and Auroræ.—Prof. John Cox; Dr. J. Halm	54
Stopping down the Lens of the Human Eye.—H. Bliss; Gerald Molloy	56
The Evolution of Snails in the Bahama Islands.—Prof. T. D. A. Cockerell	56
Retention of Leaves by Deciduous Trees.—G. W. Bulman; P. T.	56
The Recent Volcanic Eruptions in the West Indies. By Prof. J. Milne, F.R.S.	56
Does Chemical Transformation Influence Weight? By Lord Rayleigh, F.R.S.	58
University College and the University of London	59
The Culture of Greenhouse Orchids. (Illustrated.)	59
The Royal Visit to the University of Wales. By Prof. G. H. Bryan, F.R.S.	61
The Iron and Steel Institute	62
George Griffith. By B. P. L.	64
Notes	64
Our Astronomical Column:—	
New Variable Stars	68
Elements of Comet 1902 <i>a</i> (Brooks)	68
Colaba Observatory	68
Atoms and Valencies. By J. L.	68
University and Educational Intelligence	69
Scientific Serial	70
Societies and Academies	70
Diary of Societies	72

THURSDAY, MAY 22, 1902.

SPACE PERCEPTION.

Studies in Auditory and Visual Space Perception. By Arthur Henry Pierce, Ph.D. Pp. vi + 361. (New York, London and Bombay: Longmans, Green and Co., 1901.) Price 6s. 6d. net.

THE larger and more interesting part of this book deals with the problem of the localisation of sound. We all know that we, in common with other animals having the sense of hearing, can, with considerable accuracy, determine the direction from which a sound comes to us. We hear a lark, and after a little feeling about, if we may use such an expression, we are certain that the bird is not far from a place in the sky to which we can confidently point, and examining with our eyes the region near that point we soon see the lark.

In all ordinary efforts to find out where the source of sound is, we move our head, either alone or with our body. If the necessary movement is angularly small, we may move the head without moving the body, if it is large we must move the body; so far as the result is concerned it is indifferent how the head is moved, with or without the movement of the body.

What we do is to turn to the side from which the sound comes and continue this movement until the median plane of the head is in such a position that the slightest movement of the median plane will put the source of sound into the right or left hemisphere; we then know that the source of sound is in the median plane and in front. Having thus found a vertical plane containing the source of sound, we have next (and experience seems to show that this is really the order followed) to determine the place of the source of sound in the semicircle in front from zenith to nadir. This could be done in a precisely similar way. We might turn our head so that its vertical axis became horizontal and our median plane coincided with the horizontal plane, and now rotating the head about its vertical axis (now horizontal) we could get the source of sound into the median plane of the head. The intersection of the two planes each of which contains the source of sound would, of course, be the line passing through the head and the source of sound. Put more generally, by inclining the head we could find two positions of the median plane of the head each containing the source of sound, and the intersection of these planes is the direction sought. Birds seem to use this method, and it is worthy of note that birds have no concha, but human beings find what may be called the altitude of the source of sound in another way.

If we look at a source of sound, such as a splashing fall of water or a fizzing steam-pipe, the more complex the sound the better, and rotate the head about its right and left axis, so as to look now up, now down, now forward, we find that a very notable change of sound takes place just at the position of the head when we are looking straight at the source of sound. This rather abrupt change of quality of the sound seems to be caused by the acoustic shadow of the tragus. This shadow is, of course, not analogous to the black shadow to which we are accustomed when comparatively large bodies inter-

cept a beam of light, but rather to the coloured shadow due to diffraction, and therefore does not diminish the intensity of the sound, but changes its quality. It may be noted that the tip of the tragus is almost exactly in front of the external meatus. Whether this explanation of the mechanism is correct or not, it seems certain that in locating sounds we do really turn the head (with or without the body) about a vertical axis until we find the source of sound in front, and then look up and down until we are looking at the source.

Now what has just been described is not at all what Prof. Pierce, and most of the authors whose experiments and speculations he discusses, mean by the localisation of sound. What they investigate is the question how far we can, without moving the head, determine the position of the source of a sound. All are agreed that we can tell with certainty whether the sound comes from the right or from the left or is in the median plane, but some think this is all, while some, including Prof. Pierce, think a good deal more than this can be made out without moving the head.

One defect in the account of many of these experiments is that no indication is given of how errors arising from involuntary and unconscious movements of the head are guarded against. In the experiments described it is found that the accuracy of localisation is greatest when the source of sound is nearly in front or nearly behind the observer. But these are exactly the positions in which a slight movement of the head gives the greatest help, so that unless care is taken to avoid any, however slight, movement of the head, we can gather little from the experiments as to the accuracy of localisation with the head fixed. There are three ways in which this source of error can be eliminated. First, by making the sound of such short duration that there is no time to turn the head during its continuance. This was the plan adopted by the present writer when he in 1874, at the meeting of the British Association in Belfast, recommended the snapping of two coins as the source of sound, and he is pleased to learn from Prof. Pierce that this form of the experiment is still used as a parlour amusement in America. Second, by mechanically fixing the head. It is difficult, though not impossible, to accomplish this without the introduction of apparatus which will interfere with the uninterrupted access of sound to the ears. Third, by recording any movement of the head which may take place by means of tapes placed round the head, the ends of the tapes being connected with a recording apparatus, so that the movement of the head may be noted. Experiments in which such movement occurred might then be excluded. It is well known that such involuntary and unconscious movements do occur. Most of us have heard of the device by means of which a famous French army surgeon used to detect feigned deafness in unwilling conscripts. He led the supposed deaf man along a stone-paved passage and secretly dropped a coin. The conscript jerked his head a little, on which the surgeon said, "My friend, you are not very deaf, you heard that franc fall." So unless we have some means of ensuring fixity of the head we cannot be certain that the greater accuracy of localisation in some positions is not, partly at least, due to involuntary and unconscious movement of the head.

The experiments on the spatial perception of two simultaneous sounds of similar quality are of special interest. Such sounds coalesce and give rise to a resultant or, as Prof. Pierce aptly calls it, phantom sound. As a rule this phantom sound is located at a position intermediate between those to which the observer would refer the two real components. These experiments with two coalescing sounds, not being liable to the same extent as those with one sound to the error introduced by unconscious movements of the head, may be of use to check such errors and to show that they exist. A very curious case, or set of cases, is examined by Prof. Pierce, who gives very fully the results of his own experiments and of those of other investigators. When the two component sounds, one on each side, are produced near the ears (4 cm. or less from each ear), the phantom is heard *within the cranium* and can be made to move inside the head towards the one or the other ear by varying the relative loudness of the components. When the distance of the two sounds from each of the ears is 8 cm. or more, the phantom is extra-cranial.

What seemed the most interesting points discussed in this essay have been noted; but the whole of it is interesting, and physicists and physiologists will find it well worth careful reading. The fairly complete bibliography annexed to it greatly adds to its value.

The second part of the book deals with some optical illusions, which are discussed with great critical acumen.

ALEX. CRUM BROWN.

THE MORPHOLOGICAL VALUE OF THE CENTROSOME.

Das Problem der Befruchtung. Von Dr. Th. Boveri.

Pp. 48. (Jena: Gustav Fischer, 1902.) Price Mk. 1'80.

PROF. BOVERI is so well known as a cytologist that anything from his pen will be read with interest. He is concerned in the little work before us in presenting in a non-technical fashion the main morphological peculiarities connected with fertilisation, and he also discusses the meaning of the processes involved. The appendix will probably be regarded by many as the most interesting part of the whole, as he there critically examines the results which have been obtained by Loeb on artificial parthenogenesis, and which have been confirmed and further investigated by Wilson. It will be within the recollection of some people that Loeb discovered the important fact that it is possible to induce normal development in *unfertilised* eggs of certain marine animals by treating them for some time with a 12 per cent. solution of magnesium chloride in seawater, and then retransferring the eggs to normal seawater. Morgan and others had previously found that the addition of salts of various kinds to the water sufficed to produce bodies remarkably like centrospheres, but it was not until Wilson showed this also to occur in Loeb's experiments, and that they almost certainly initiate the process of segmentation, that the significance of the earlier results became apparent.

Now the egg is normally destitute of any centrosome, and it has been thought on many grounds that one of the chief uses of the sperm was to import this body into the protoplasm of the inert ovum. Boveri himself first

put forward this view, and he now seems inclined to admit that it may demand some degree of modification. His original conception of the sperm as starting the cytoplasmic activities remains untouched, but obviously the nature of the mechanism involved is, as he says, open to a different interpretation from that originally assigned to it by himself. For it may now be fairly argued that it is not a centrosome as an *organised structure* which is introduced into the egg, and which there starts the segmentation processes, but rather a chemical substance which, in combination with the ovian cytoplasm, produces the body in question. Such a view would reconcile much that has hitherto been difficult of explanation in connection with the diverse behaviour of centrosomes in different organisms, and even in different cells and tissues of the same individual.

In cycads, for example, centrosome-like structures (blepharoplasts) are associated with the karyokinesis of the generative cell of the pollen tube, but they are absent from the rest of the antecedent cell-generations. Hence their morphological permanence can hardly be seriously maintained in such a case as this. Again, in many of the higher plants the spindle fibres which appear in the early prophase of karyokinesis (*e.g.* in pollen-mother cells of the lily) originate at many different spots in the cell, and this may probably be correlated with the extrusion of nucleolar substance which was described in this instance as long ago as 1893. Furthermore, such a conception of the possible nature of centrosomes enables one to harmonise the peculiar quadripolar spindles so characteristic of the lobed spore-mother cells of many liverworts.

It is clear, of course, that the acceptance of such a possible origin of centrosomes does not necessarily involve a denial of their possible permanence in other cases. But it does add another striking example to those cases in which a morphological character may be traced to physiological causes, the character itself only persisting for so long as the physiological stimulus continues to operate.

J. B. F.

ROSE CULTURE.

The Book of the Rose. By the Rev. A. Foster-Melliar.

Second edition, with 33 illustrations. Pp. xiv + 352.

(London: Macmillan and Co., Ltd., 1902.) Price 6s.

THE design of the author is "to show how roses may be grown in the best possible manner so as to produce the finest blooms"; and from his enthusiastic love and his long, successful culture of the flower, he has written such an exhaustive treatise that the reader who has the ambition, the energy and the means to follow his instructions cannot fail to achieve success. He gives clear and comprehensive details as to soil, situation, selection and treatment, where to erect a throne for the queen of flowers, and the homage which must be paid by those devoted subjects who would win her most gracious smiles. With a loyal service, which is never disheartened, the knight of the rose must be eager to maintain her supremacy against all comers. Without metaphor, he who would grow roses in their perfect beauty, and, like the author of this book, would be rewarded with medals and trophies, must obey the immutable law, must work for his wage, must train for the race if he would so run that he

may obtain the prize; he must dig and drain and enrich the soil, must plant, protect and prune, and, like the husbandman, he must have long patience before the harvest comes. He must be prepared for failures and disappointments, for nipping frosts and scorching suns, hail-stones and drenching rains, for blight and mildew, fungus and thrip, for aphid and grubs, spiders and beetles, suckers and weeds. The obstacles are many, and the enemies are fierce, as ever to those who would attain excellence.

But perseverance will prevail, and he who has an expert for his guide will reach the summit, however steep may be the mountain. He who has a productive soil, a situation sheltered but not overshadowed, an atmosphere not polluted by smoke or smut, who adds to these inseparable adjuncts of success a determination to succeed, and then follows, in strict obedience, the teaching of Mr. Foster-Melliari, will repeat his achievements; the pupil will become a professor, and the entered apprentice will be a master-mason.

On the subject of "garden roses," roses which have not the perfect symmetry and fulness required for exhibition at our shows, the author declares that he is no authority, and he tells us little or nothing of their infinite variety and beauty in beds, borders and shrubberies, on pillars, pergolas and walls; but as a manual for the production of those roses, which have been most admired by rosarians, in their loveliest form, his admirable essay is complete.

OUR BOOK SHELF.

The Birds of North and Middle America. Part i. "The Fringillidae." By R. Ridgway. *Bulletin* U.S. Museum, No. 50. Pp. 715; 20 plates. (Washington, 1901.)

MR. RIDGWAY is such a well-known authority on the birds of North America that anything coming from his pen is sure to obtain a welcome at the hands of his brother ornithologists. The size of the present volume, which, as stated in its title, deals only with a single family, affords an index of the bulk and extent of the work of which it forms the commencement. The amount of labour involved in such a task is enormous and can only be properly appreciated by working naturalists. Preparations for the work, the author tells us, have been in more or less active progress for the last twenty years, and so long ago as the autumn of 1894 the task of putting together in proper form for press the vast accumulation of material was taken in hand. The labour of measuring specimens of more than 3000 forms of birds and making the necessary references to previous descriptions was, however, so vast that it has only been possible to issue the first part after this long lapse of time. It is hoped, now that much of the drudgery is accomplished, future progress may be more rapid.

The object of the work is to describe in detail every definable form of bird—whether species or subspecies—met with on the American continent, from the Arctic districts to the eastern end of the Isthmus of Panama, together with the West Indian and Galapagos Islands. Moreover, besides the indigenous denizens of the area, the accidental or casual visitors, as well as artificially introduced species, are included, so that the list is as full and comprehensive as possible. Needless to say, the work is written on modern American lines, so that the number of forms regarded as entitled to distinction is very great; while the number of genera and subgenera is likewise

unusually large. An especial feature of the work is the large number of forms which are relegated to the rank of subspecies.

As regards the description and keys to the different groups and species, the work appears to be admirably written, the number of specimens of which the measurements are given rendering it especially valuable. Perhaps it was somewhat unnecessary to give a general account of birds and their various orders, but this is a fault on the right side, and the work should prove invaluable to all zoologists on both sides of the Atlantic. In replacing the name "Central America" by the unfamiliar "Middle America" the author may be etymologically right, but if this be the reason of the innovation, it is somewhat curious to find such a change advocated by American naturalists, who are notorious for the contempt with which they treat the synthesis and orthography of scientific names. R. L.

The Lens. A Practical Guide to the Choice, Use and Testing of Photographic Objectives. By T. Bolas, F.C.S., F.I.C., and George E. Brown, F.I.C. Pp. vi+176. (London: Dawbarn and Ward, Ltd., 1902.) Price 2s. 6d. net.

THIS is a useful book, not only for beginners in the use of the camera, but for many photographic workers who have never studied the optics of lenses. The elementary treatment of lenses is far in advance of that of most professed English text-books of optics, as from the outset it does not make the assumption of an infinite thinness of lenses, but treats them by the method of Gauss by means of principal planes and principal points. Unfortunately, the authors persist in calling the principal points "nodal" points, a confusion of language which will puzzle students if when they come to the eye they discover that the nodal points of that organ are not the same as the principal points. There are good discussions of the subjects of angle of view, inequality of illumination and "depth of focus." We are glad to see that the authors have summoned up courage to omit "indigo" from the tints of the spectrum. It has long been recognised that there is no indigo tint between the blue and the violet. It is a pity that the authors admit the vulgarism in chapter iv. of writing the aperture-ratios $f/24$, $f/16$, &c., as $f/24$, $f/16$, &c. On p. 49 they give the notation correctly. The lens diagrams would be improved by cross-hatching the sections of the lenses; it is impossible by looking at the mere outline, for example, of the composite back lens of Fig. 104A, on p. 91, to tell whether it represents three lenses cemented together or two lenses separated by an air-space. The practical hints on focussing, copying and enlarging are excellent; and we quite concur in the advice on p. 95 to avoid second-hand lenses. Some admirable examples of the performance of lenses are reproduced in half-tone blocks. That of King Henry VII.'s Chapel on p. 171 is really marvellous.

A Text-book of Geology. By Albert Perry Brigham, A.M., F.G.S.A., Professor of Geology in Colgate University. Pp. 477; illustrated. (London: Hirschfeld Brothers, Ltd., 1902.)

ALTHOUGH this work bears on its title-page the name of a London publisher, it is evidently prepared with a view to the requirements of teachers and students in the United States. It forms one of the "Twentieth Century Text-books" edited by Dr. A. F. Nightingale, formerly of Chicago. According to its author's preface, this text-book has been especially prepared as an elementary treatise for secondary schools in America, and it seems admirably adapted for this purpose. While modestly disclaiming any great originality in the plan of the work or novelty in the mode of treatment of geological problems, the author may be

congratulated upon having produced a very clear and readable introduction to the study of geology. The illustrations, many of which are new, are especially excellent, some being from original photographs taken by the author during his travels.

It is only fair to add, however, that while the earlier chapters may be read with advantage by all students of the science in every part of the globe, the part of the book which deals with "historical" or stratigraphical geology is quite unsuited for European students. The sequence of formation described is that of the American continent, and the fossils figured are, almost without exception, American forms. This, while fitting the work for students on the other side of the Atlantic, makes the work of little value, so far as its later chapters go, to English readers.

Elementary Plant Physiology. By D. T. Macdougall Ph.D. Pp. xi + 138. (New York and London: Longmans, Green and Co., 1902.) Price 3s. net.

WITHIN the pages of his elementary text-book Prof. Macdougall has collected together a very large number of experiments—so large, indeed, that forty-eight laboratory periods do not by any means exhaust the list. A certain number of these would be included in an ordinary anatomical course, e.g. the examination of sections of various parts of the plant, of mycorrhiza, &c., while others are merely binomial observations. The inclusion of these, however, is not so much deprecated, but rather the scant treatment which is meted out to some of the more important activities of the plant. Respiration is practically limited to a few experiments with seeds placed in a retort inverted over mercury; such apparatus precludes any but the roughest quantitative measurement. Again, no practical form of potometer is suggested, and absolutely no mention is made of the movement of protoplasm. Apart from the actual study of the movement, the streaming of protoplasm affords a simple indicator when investigating the action of anæsthetics or of neutral or poisonous gases upon the plant. These inhibiting effects are worked in by the author with growth, and this makes the experiments more complicated and less adapted to measurement.

These omissions are the more disappointing because Prof. Macdougall has the happy knack of giving explicit and full directions in a few sentences, and, further, he takes every opportunity of throwing out suggestions which should lead the student to think for himself and thereby obtain a fuller appreciation of the problems with which he is dealing.

Diagramme der elektrischen und magnetischen Zustände und Bewegungen. By F. W. Willenweber. Pp. 64 + plates. (Leipzig: J. A. Barth, 1901.)

THIS book, consisting of ten plates and sixty diagrams and descriptive text, is put forward by the author as a contribution to the answers to the questions, What is electricity? and What is magnetism? The diagrams consist of figures representing the lines of force due to various distributions of electricity or magnetism; but in no case is there any quantitative representation attempted. All that we are given is a distribution of arrow heads representing the direction of the ether strains on a molecule. The diagrams being purely qualitative, there is really nothing in the book that a student could not put down himself easily, and frequently with greater accuracy than the author. The conception of lines and tubes of force as treated by Maxwell and Thomson can be most useful and instructive, but as they are given in the present book they can only result in confusion. We are afraid the questions What is electricity? and What is magnetism? are no more nearly answered after the appearance of this book than before.

NO. 1699, VOL. 66]

LETTERS TO THE EDITOR.

(The Editor does not hold himself responsible for opinions expressed by his correspondents. Neither can he undertake to return, or to correspond with the writers of, rejected manuscripts intended for this or any other part of NATURE. No notice is taken of anonymous communications.)

A Remarkable Solar Halo.

ON Sunday, August 7, 1898, being in Norway, I was climbing, with a friend, the upper slopes of the Hornind, above Skogstad, in the well-known Valdres route between Christiania and Laerdal, lat. $61^{\circ} 15' 30''$, long. exactly 6° E. We had reached a height of about 4000 feet above sea level when we saw the very remarkable halo of which I send you the photograph of the copy of a very careful drawing, made on the spot. I first caught sight of the halo at 11.30 a.m., on lying down for a short rest on a large flat horizontal stone, but I have no reason to doubt that it had been visible for some time before. The early morning had been brilliantly fine, the air still, and the sun very hot; about 10.30 a.m. a very light breeze from almost due south began to blow, with intervals of dead calm. When the halo was seen, the sky was completely covered with a thin white haze. There was, however, no rain that day, though the weather on the next and succeeding days was not good. The sky outside the circles seemed everywhere brighter than inside them; the sun shone through the haze scarcely brightly enough to throw a distinct shadow, and his rays aroused no sensation of warmth. The inner edge of all the rings was fairly sharp, and of an orange-red colour, brightening into yellow, which

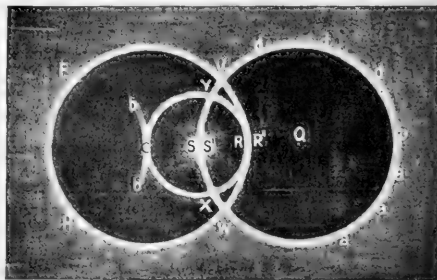

FIG. 1.

grew paler towards the outer rim, where it faded into a bluish-white radiance, which in turn became imperceptibly blended with the white misty sky. The width of the rings was from one-and-a-half to two degrees.

I watched the halo until it had completely faded. First the ring SVPV faded, the other two complete circles remaining visible after it had completely disappeared. Next the ring FHVV slowly vanished, leaving the small ring CYRX quite perfect and bright, and also the luminosity at *bb*. This last looked like a small part of a fourth circle; certainly it was curved and convex towards the sun, but of what radius this small arc was I am uncertain, but suspect that it was either the same, or greater than, the radius of the two big circles. I had no accurate instrument with me at the time for measuring angles, but the disc of the sun was distinctly visible through my neutral-tinted snow glasses, and in estimating the distance *S'R* as subtending at the eye an angle of 19° I do not think there is an error of more than a few minutes of angle. The radius of each of the big circles must have been, therefore, nearly 44° , and that of the small circle about 22° .

In the illustration, the width of the rings is somewhat exaggerated. But by far the most remarkable thing about this halo is the asymmetric position of the sun with respect to the rings. With respect to the two large circles this is obvious, for the sun appeared to lie on the circumference of one of them, and at a point half way (subject to what is said below) between the centre and the circumference of the other; but, besides this, I could not persuade myself, though I exerted all my powers of

imagination to do so, that the sun was *exactly* in the middle of the *small circle*, and was forced, after repeated observations, to conclude that the sun's centre appeared to be about the ninth part of the distance SR to the west of the true centre S. I can only offer in explanation of this that it was due to some curious, perhaps subjective, effect caused by the part of the arc VYXW, which was very bright, for *after this ring had vanished* the sun certainly appeared at s, without any alteration that I could see in the position of the two circles left.

There was no trace of any lameness other than that of the sky at o. The brightest part of the whole halo, apart from the sun itself and the part of the arc VYX near to the sun, was the arc VRW; but at c, v, y, x and w, and especially at x and w, the light seemed decidedly brighter than in the other parts of the rings, though there were no proper "mock suns." Since the time when I saw this weird and magnificent display, I have often tried to deduce the observed curves from the known hexagonal forms of ice crystals, and even to produce them empirically by reflecting and refracting light from glass models, but so far without any success. It will be readily seen that the halo bears a certain resemblance to the lunar halo which was the subject of a letter to NATURE of May 1 by Prof. Barnard, but the two are in reality widely different. Probably the form I have just described is of *exceedingly* rare occurrence, for it presents far too grand and curious a spectacle to be visible without exciting attention, and I have never come across any mention or diagram of a halo like it. T. C. PORTER.

Eton, May 8.

Sun-pillar (?)

MISS HERSHEY (a careful observer) has just called me out to see one. At 7.10 p.m. she saw the sun above a bank of clouds, in a somewhat hazy sky, but no clouds above it for a space of some 5 degrees. Above that was a light-fringed belt of clouds of great depth. From the sun a parallel-sided pillar of light, just like the reflection of the sun in a slightly rippled sea, stood upright into, and stopped at, the light-fringe; it was not so bright as the reflection spoken of would be, but markedly brighter than the background sky; colour yellow. Miss Herschel had to bicycle home three-quarters of a mile uphill to call me, and it was fading before she reached home.

I was prompt, but too late (7.25) to get a good view. The possibility of Martinique dust induces me to send you this. Sunset moderately red; temperature here 42°; air calm all day; with dark sky and damp mistiness. W. J. HERSHEY.

Littlemore, May 13.

Palæolithic Implements in Ipswich.

ALTHOUGH in isolated cases implements of Palæolithic workmanship have occasionally been found in Ipswich, it is only during the last few weeks that a deposit containing abundant Palæolithic remains has been discovered.

On March 21 last, after long searching, I was fortunate enough to hit upon this interesting site, and the result has been a harvest of implements of very varied types. Mr. Clement Reid, whom I acquainted with the discovery, at once came down to examine the spot, and under his guidance it will be carefully studied.

The relations of the deposits remain to be worked out, but so far show some resemblance to those found at Hoxne and Hitchin.

Among the implements found, some have a thick, ochreous patina, while others are almost devoid of it. Most are very slightly rolled, but some are still sharp.

Pointed implements roughly worked at the butt predominate, but in one case the butt-end has been carefully sharpened.

A fine oval implement shows signs of having been worked for hafting, as also does a smaller chisel-like form. Implements corresponding to those described by Sir John Evans as "crescent like," a boring implement, a possible sling-stone, several ovoid forms flat on one side and raised on the other, triangular forms, some thick and heavy, one flat, and a delicate leaf-shaped implement, show the variety of purposes which these flints were made to serve.

The position occupied by the Palæolithic remains appears to be that of a silted-up channel cut through Glacial deposits. Some of the implements were found at a depth of 12½ feet, others considerably higher, which may account for the difference in their condition. NINA FRANCES LAYARD.

Brückner's Cycle and the Variation of Temperature in Europe.

WE now possess excellent long series of weather-observations for many places. It occurred to me lately to apply to several of the annual temperature series in Europe an averaging process which would tend to bring out the larger waves of variation, or at least to show how year-groups of a given magnitude compare with one another. I have accordingly considered in groups of ten years (1 to 10, 2 to 11, 3 to 12, and so on) the following (see diagram):—A. Annual mean temperature of Greenwich (from 1841). B. That of Geneva (from 1826). C. That of Bremen (from 1829). D. That of Vienna (from 1826).

[The Greenwich curve is drawn on a larger scale than the others. The degrees are Fahr., those of the others Cent. The position of the curves is simply contrived so that they should not cross one another. In the case of Vienna, the continuous curve from 1855 is for the Hohe Warte near Vienna; the previous dotted curve is *approximate* for the same place, deduced from data of the University Observatory in Vienna. The Bremen figures used extend only to 1895, the other series to 1900.]

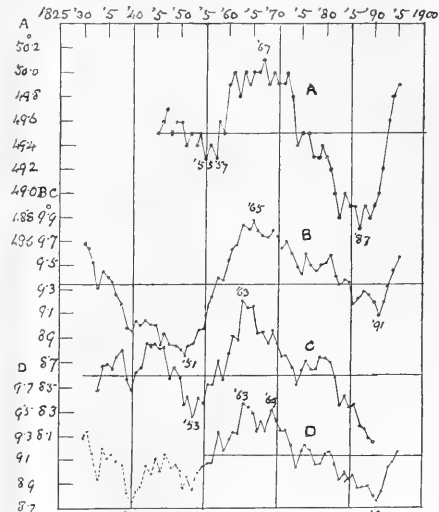

FIG. 1.—A, Greenwich; B, Geneva; C, Bremen; D, Vienna.

Taking the case of Greenwich, it will be understood that the first point, for 1845, indicates the average mean temperature of the ten years 1841 to 1850, the second that of 1842 to 1851, and so on.

The curves, it will be seen, all agree in showing a long wave with crest in the sixties, and extending from a minimum in the fifties (Vienna a little earlier) to another about the end of the eighties (or beginning of nineties).

The Greenwich maximum is reached in 1867, and minima are found at, say, 1855 and 1887. The temperatures prior to 1841 are in some uncertainty; but we should probably be safe in saying that an earlier minimum, of magnitude corresponding rather to the last, occurred about 1816. Thus we have 1816-55 = 39 years; 1855-87 = 32 years; which agrees very fairly with Brückner's cycle of about 35 years. As to previous maxima, we may probably reckon one in the later twenties. The curve (with final point in 1895) would appear to be now near a second maximum from that date (? 1902); and we might with some reason, perhaps, look for another minimum, or conspicuously cold group, in the early twenties of this century.

The minimum of 1855 for Greenwich is considerably less pronounced than that of 1887, and in Bremen, too, the earlier

minimum seems to have been less than the later; while in Geneva the earlier minimum is the deeper.

The facts above given may be usefully compared with Dr. Lockyer's recent important researches, pointing to a cycle of about thirty-five years in the sun-spot variations. It may be doubted if the annual mean temperature of these European stations shows any good evidence of being ruled by the eleven-year cycle of sun-spots; and if it did, the method of smoothing here adopted might even obscure such an effect somewhat. This, however, does not seem to affect the validity of evidence from other orders of data.

ALEX. B. MACDOWALL.

Resultant Tones and the Harmonic Series.

IN reply to Prof. Thompson's criticism of the plan of recovering differential resultant tones by means of the harmonic series, may I say that my position is that of a road-maker, not a discoverer—a Macadam rather than a Columbus.

So long as authorities teach that resultant tones have a vibration frequency which is equal to the difference between the vibration frequencies of their generators, so long will the harmonic series afford an easier means to the same end.

This applies also, of course, to summational tones. The question whether these latter are only "one of the myths of science" or not I leave to abler heads than mine to decide.

Meanwhile, the fact that the perfect fourth, the minor third and the minor sixth give, as the sum of their vibration frequencies, a vibration frequency which is intermediate between two notes, thus exactly agreeing with the harmonic series, $3 + 4 = 7$, $5 + 6 = 11$ and $5 + 8 = 13$, is at least interesting.

MARGARET DICKINS.

Tardebige Vicarage, Bromsgrove, May 9.

• Magic Squares.

HAVING attempted some years ago to determine the number of magic squares of five having a nucleus forming a magic square of three, I was interested to find that further progress towards a solution of the problem has been made by your correspondent Mr. C. Planck, who seems to have found fifty-one solutions more than I from the same twenty-six nuclei, whereas I have only in one case, namely for the nucleus R (5, 7), found one more solution than he. The twenty-one solutions for this nucleus are appended in the following table, from which both the equations and the numbers forming the first row and the first column of the border may be read off without difficulty, if the first dotted number be put at the head of the column, and at the foot of the same the complement of the second. Thus, from the first row of the table,

$$1 \cdot \dot{2} \cdot \dot{4} \cdot 6 \cdot \dot{12} \mid 3 \cdot 8 \cdot 10$$

we gather that the first row of five minors (numbers less than 13) may be converted into a normal row with sum 5×13 by replacing the three barred numbers by their complements, since $2 + 4 + 13 = 1 + 6 + 12$, whilst the remaining three minors, together with the dotted pair, furnish a normal column when 4 and 3 are replaced by their complements, since here again $4 + 3 + 13 = 2 + 8 + 10$. The border with nucleus, accordingly, when completed, is

	<i>a</i>	<i>b</i>	<i>b'</i>	<i>a'</i>
<i>a</i>	2	25	20	14
<i>b</i>	8	11	21	7
	10	9	13	17
<i>b'</i>	23	19	5	15
<i>a'</i>	22	1	6	12

1	1	2	4	6	12	3	8	10
2	1	2	4	8	10	3	6	12
3	1	2	4	6	10	3	8	12
4	2	3	4	6	12	1	8	10
5	1	2	6	8	12	3	4	10
6	2	3	6	8	10	1	4	12
7	2	3	4	8	10	1	6	12
8	2	3	6	8	12	1	4	10
9	1	2	8	10	12	3	4	6
10	2	3	4	6	12	1	8	10
11	2	3	8	10	12	1	4	6
12	1	4	6	8	12	2	3	10
13	3	4	6	8	12	1	2	10
14	1	4	8	10	12	2	3	6
15	1	2	4	6	10	3	8	12
16	1	2	4	8	10	3	6	12
17	1	2	6	8	10	3	4	12
18	2	3	6	8	10	1	4	12
19	3	4	6	8	10	1	2	12
20	1	2	6	8	12	3	4	10
21	3	4	6	8	12	1	2	10

When the number 603 is multiplied by 288 we get 173,664 for the number of such nuclear squares. When we proceed to inquire as to the number of all types of magic squares of five, we must begin by doubling the above number, since every magic square with odd root may be varied by permuting the rows above the mid-row, together with the rows below the same, and at the same time the columns on either side of the mid-column, so that the above square may be transformed by reversing the order of the marginal letters *a*, *b* and *a'*, *b'*, as follows:—

	<i>b</i>	<i>a</i>	<i>a'</i>	<i>b'</i>
<i>b</i>	11	8	21	18
<i>a</i>	25	2	20	4
	9	10	13	16
<i>a'</i>	1	22	6	24
<i>b'</i>	19	23	5	3

If now we add to the number 347,328 thus obtained the squares in which each row and each column contains all the units 1 . 2 . . . 5 increased by the four increments 5 . 10 . 15 . 20 without repetitions of either, of which there are at least 21,376, we get 368,704 without considering other types, probably some hundreds of thousands in number, which would certainly bring the minimum to more than half a million.

ShIPLEY, Yorks.

J. WILLIS.

Mont Pelée and After-Glow.

MAY I point out that the after-glow following the eruption of Krakatoa was—as I wrote at the time—remarkably emphasised on the west coast of British India.

Following the letter of Dr. W. J. S. Lockyer in NATURE of May 15, the after-glow, now, after the eruption of Mont Pelée (and Soufrière?) should be as remarkably emphasised in central and perhaps the southern part of North America.

In Europe this eruption will not (?) cause the same effect as to after-glow as the former. F. C. CONSTABLE.
Wick Court, near Bristol, May 18.

THE VOLCANIC ERUPTIONS IN THE WEST INDIES.

SINCE we went to press last week further details have become available as to the volcanic disaster in the West Indies. We give a summary of the reports which have been published in the *Times* during the past week upon the sequence and character of the eruptions from the commencement of the disturbances, the particulars here given being supplementary to those in our last issue.

April.—In the last days of April smoke was noticed on Mont Pelée and rumbling sounds were heard.

May 3.—Mont Pelée threw out dense masses of steam. Next morning the sky was dark with clouds and ashes. Ashes fell on St. Pierre, which by evening was covered a quarter of an inch thick. The mountain was invisible.

May 4.—A sea-breeze swept the ashy fog from St. Pierre, but at evening dust and scoria fell again.

May 5.—A stream of lava 20 feet high suddenly rushed down the south-western slope of Mont Pelée, and, following the dry bed of the River Blanche, swept away buildings, plantations and people in a tremendous rush to the sea, five miles distant. It was all over in three minutes. The Guérin factory on the beach near the mouth of the river was embedded in lava; only the chimney could be seen. The sea then receded along the western coast a distance of 100 yards, and returning invaded St. Pierre.

May 5, St. Vincent.—The lake in the old crater of the Soufrière became greatly disturbed.

May 6, St. Vincent.—At 2 o'clock in the afternoon the Soufrière began a series of volcanic efforts. Severe earthquakes accompanied these. Terrible noises and detonations succeeded quickly, and at 7 p.m. an immense column of steam issued from the crater, continuing until midnight.

May 7, St. Vincent.—Terrific explosions occurred, and at 7 a.m. there was another sudden violent escape of steam. This ascended for three hours, when a quantity of material matter was ejected. At noon three craters appeared to open and began to vomit lava. Tremendous detonations followed in quick succession, rapidly merging into a continuous roar. The thundering was heard throughout the Caribbean Sea.

A huge cloud in dark dense columns charged with volcanic matter rose to a height of eight miles from the mountain top, and darkness like midnight descended. The sulphurous air was laden with fine dust, and black rain followed the rain of scoriae, rocks and stones.

May 8, Fort de France.—St. Pierre was within ten minutes annihilated by a terrible volcanic torrent from Mont Pelée and by a combination of suffocating heat, noxious vapours, a shower of burning cinders, and a discharge of burning stones, which reached even to Fort de France.

May 13, St. Vincent.—The Soufrière is still in eruption. The reports of the explosions, resembling a terrific cannonade, can be heard at a distance of 100 miles. Following the explosions are columns of steam, which rise miles in height, and immense luminous bombs also issue from the crater. Lightning is playing fiercely in the upper sky.

May 15, Fort de France.—Mont Pelée continues in a state of eruption, but the wind is now carrying the smoke and the greater part of the matter thrown out to the north, thus relieving the parties of workers at St. Pierre.

May 15, Kingston, Jamaica.—For some days past the atmosphere here has been peculiarly hazy and sombre and the temperature very high, which was thought to be due to dust brought by winds from the volcanoes. This is now proved to be the case, dust

being detected falling on the hills, which on microscopic examination is shown to be volcanic ash.

May 15, St. Vincent.—The entire northern part of the island is covered with ashes averaging 18 inches in depth, and varying from a thin layer at Kingstown to 24 inches or more at Georgetown. The streets of Georgetown are encumbered with heaps of ashes like snow-drifts, and several roofs have fallen in from the weight of the deposits upon them.

May 15, Fort de France.—At intervals Mont Pelée and La Croix, 1350 metres high, are visible. Now that all the points of eruption can be discerned, seven craters can be seen which seem still active. Yesterday a flow of lava 400 metres wide descended as far as White River, its foaming sound being audible to a great distance. A new crater is perceptible near the shore, pouring out blinding steam. The sea, affected by the disturbances of all the streams, seems itself troubled, invades Frécheur, and, undermining several houses, adds the ravages of inundation to those of fire. On the other hand, the flow of lava drives back the bay 20 metres and increases the area of devastation.

May 17, St. Vincent.—The bed of the lava in the windward district is still hot. An abyss 500 feet deep by 200 feet wide, which existed between Langly Park and Rabacci, is filled with lava, and the physical features of the mountain side are apparently more beautiful than before the eruption. A curious feature is that the earthquakes were not general. While at Château Belair there were, before the eruption, continuous convulsions every few hours, in Kingstown and Georgetown there were only sixty shocks in four hours.

Although it resulted in fewer fatalities, the eruption of the Soufrière was no less violent than that of Mont Pelée. Sixteen square miles are covered with lava.

May 19, St. Thomas.—A further serious eruption of Mont Pelée occurred. The search parties at St. Pierre were compelled to leave at once.

May 20, St. Thomas.—Very loud detonations were heard in Dominica, Guadeloupe, Antigua and St. Kitts, and faintly in St. Thomas. At St. Thomas the sounds heard were louder than those of May 7.

There is great reason to hope that a small scientific party from England will be promptly despatched to investigate the terrible volcanic outbursts in the West Indies. The idea was mooted in conversation in the ante-room of the Royal Society at last week's meeting, and Dr. Tempest Anderson, who probably has examined and photographed volcanic phenomena in more regions than any other Englishman, at once expressed his readiness to undertake the journey. Strong hope is entertained that leave of absence may be granted to Dr. Flett, petrologist to the Geological Survey, to join in the investigation, the expenses of which might be defrayed, notwithstanding some technical difficulties, from the Government Grant. It is to be hoped these may be overcome, because no time should be lost, and the party should start by the next boat on May 28. They will naturally go first to St. Vincent and endeavour to obtain trustworthy accounts of the eruption of the Soufrière, to ascertain the changes which have been made in the physical geography of the district, and to collect specimens of the materials ejected, as far as possible in chronological order. But we may hope that they will not restrict themselves to the British Island. The eruption at Mont Pelée in Martinique has been, not only more destructive to life, but also, according to what has been published, more abnormal in its phenomena. So contradictory are the reports that it is at present almost impossible to say what really has happened, beyond the one melancholy fact that a paroxysm in an eruption of unusual violence has caused unwonted devastation and fearful loss of life. By examination on the spot, by conference with other scientific investigators, who may already have reached the island from America or France, rumours may be sifted and evidence obtained from examination of the materials beneath which St. Pierre has been buried. A good collection of them, and other ejectamenta of the volcano, will be of great value. A comparison of those from the two islands may throw light on some interesting

and important questions. The fact that the eruptions have been almost simultaneous suggests that the orifices are situated on the same fissure, but it is, of course, possible that they may indicate a zone rather than a line of weakness in the earth's crust, and so may not have tapped precisely the same source of supply. Again, both eruptions have been preceded by a long pause, during which a column of heated material may have been kept standing for several years in the "neck" of the volcanoes. If so that would be very favourable to magmatic differentiation, and this might be revealed on chemical and microscopic examination of the materials discharged during the successive stages of the eruptions. Dr. Tempest Anderson's wide experience as a traveller, especially in volcanic districts, with his skill as a photographer, and Dr. Flett's intimate knowledge of all sides of petrology, will ensure, by their working in combination, that nothing will be missed, and important accessions be made to our knowledge of vulcanology. The shortness of the time before starting is the main difficulty, but as the enterprise is said to be favourably regarded by the Colonial Office and the officers of the Royal Society, and is heartily backed by several London geologists, technical difficulties should not prove insuperable.

There are various signs that the eruptions in the West Indies are connected with the occurrence of other terrestrial and cosmic phenomena. A report in the *Daily Mail* states that the mineral spring waters at Teplitz, Bohemia, turned brown suddenly last week. A similar phenomenon was observed before the great earthquake at Lisbon in 1755, and a repetition of the disaster is feared.

Telegraphic communication between Karachi and the rest of India has been interrupted for four days by the occurrence of the most severe and destructive storm ever known in Sind. Upwards of 40 miles of the Sind Railway have been washed away, bridges and embankments have disappeared, and the telegraph line for 50 miles either completely vanished or hopelessly dismantled.

There has been a great storm in the United States. A telegram from Goliad, Texas, states that on May 18, at 3.45 p.m., a tornado, preceded by heavy hail, swept over the town and caused great destruction. The storm lasted only five minutes. It came from the south-east without warning, and travelled as far as Kentucky, traversing four States.

Also from the United States news has been received of a great mining disaster. On May 19, at 7.30 a.m., the Fraterville and Thistle coal mines at Coalbrook, Tennessee, exploded, causing the death of about three hundred men at work in them. Rescue parties have been unable to penetrate far into the mines on account of stifling smoke and gas and extreme heat.

Mr. W. Eddy, of New York, reports that on May 15 a slight earth tremor affected three of his seismographs, the wave coming from the south-east.

All these disturbances are possibly related to a common cause, as suggested by Sir Norman Lockyer in the following letter, which appeared in Monday's *Times* :—

THE WEST INDIAN ERUPTIONS AND SOLAR ENERGY.

Sir,—In 1853, in connection with the eruption of Krakatoa, you were good enough to allow me to appeal through your quickly and widely circulated columns for early information to enable me to test an idea connected with the spread of the glorious sunsets round the world which followed the event.

Because the terrible catastrophes in Martinique and St. Vincent occurred at a well-defined sun-spot *minimum* I was led to inquire whether similar coincidences were to be traced in the past. I did not know then, but I know now, that Wolf, exactly half a century ago, had suggested a connection between solar and seismic activity; in his time, however, the record of solar changes was short and imperfect.

In my own inquiry I have used our most recently compiled tables, which are now complete for the last seventy years, and I have only considered seismic disturbances within that period. I

find it beyond question that the most disastrous volcanic eruptions and earthquakes generally occur, like the rain pulses in India, round the dates of the sun-spot *maximum* and *minimum*. More than this, the 35-year solar period established by Dr. Lockyer, which corresponds approximately with Bruckner's meteorological cycle, can also be obviously traced, so that, indeed, the intensification of the phenomena at the *minimum* of 1867 is now being repeated.

In 1867, Mauna Loa, South America, Formosa, Vesuvius were among the regions involved; in the West Indies it was the turn of St. Thomas. The many announcements of earthquakes in the present year before the catastrophe of St. Pierre will be in the recollection of everybody.

In the *maximum* in 1871-72, to name only West Indian stations, Martinique first and then St. Vincent followed suit; in the next *maximum*, in 1883, came Krakatoa.

At Tokio, in a country where the most perfect seismological observatories exist, we find that at times near both sun-spot *maxima* and *minima* the greatest number of disturbances have been recorded.

Very fortunately, the magnificent work of the Indian Meteorological Department enables us to associate the solar changes with pressures in the tropics, and obviously these pressures have to be taken into account and carefully studied.

This, Sir, brings me to the point of this letter, which is, through your kindness, to ask from meteorological observers in the West Indies and the surrounding regions the favour of copies of their barometrical readings, showing the departures from the local means for the two months preceding the eruption at St. Pierre. In this way one or two years may be saved in getting at the facts.

I am, Sir, your obedient servant,

NORMAN LOCKYER.

Solar Physics Observatory, May 17.

MOUNTAIN MASSES AND LATITUDE DETERMINATIONS.¹

WHEN we take a comprehensive view of the information that has been collected in order to determine the mean figure of the earth, we must acknowledge the important part that has been played by a long succession of Indian geodesists. For practically a century, with greater or less vigour, according to the political conditions prevailing at the time, continuous measurements have been carried on, with the result that we have at least eight meridional and four longitudinal arcs available for the general discussion. The differences of latitude extend from roughly 9° to 20° north, and include the determination of the astronomical latitude of some 150 stations, while the amplitude of the longitudinal arcs embraces nearly 25°, necessitating the investigation of fifty differences of longitude. The vigour displayed is the more curious since it must have been anticipated that the results would be affected with systematic error, as the deflection of the plumb-line would be materially influenced by local circumstances. Not only are the evident masses of the Himalayan range and the Tibetan plateau exercising an effect, which may, perhaps, be allowed for satisfactorily on the assumption of a uniform distribution of density in the strata below the surface, but the presence of the Indian Ocean on two sides of the peninsula, with its varying and uncertain depths, emphasises the difficulties of adjustment and compensation.

Since, however, in order to obtain the full value of the admirable work that has been accomplished in India, it is necessary to eliminate the effect of local attraction, various attempts have been made by different authorities, with, it must be admitted, only partial success. It is a matter of ancient, but of interesting, history to recall the suggestions and the controversy between Archdeacon Pratt and the late Astronomer Royal, the views of neither authority now being acceptable in their entirety, though

¹ "The Attractions of the Himalaya Mountains upon the Plumb-line in India. Considerations of recent Data." By Major S. G. Burrard, Royal Engineers, Superintendent Trigonometrical Surveys. Pp. vii + 115. (Dehra Dun, 1901).

Airy, guided by the insufficiency of the Archdeacon's results to explain the numerical discrepancies, was fully justified in asserting that the magnitudes of attractions computed on the theory of gravitation would be too great. He was less happy in the reason assigned for this conclusion. Airy seems to have considered that the Himalaya Mountains were floating in a sea of dense lava, and that the bases of the mountains displaced a quantity of denser material, much in the same way that an iceberg displaces the water of the ocean on which it floats. The more legitimate explanation seems to be that the elevations are composed largely of an expansion of the matter in the immediately subjacent strata of the earth's crust, the masses above and below being mutually interdependent; where high elevations exist, therefore, the strata below are deficient in density, having parted with some of their contents. At low elevations the density is normal, since there is no appreciable upheaval of matter, while under the sea there is a contraction of matter and consequently an increase of density. These views have generally been supported by the pendulum experiments of Von Sterneck in the neighbourhood of the Alps and the still more recent measurements carried out near Kolberg in connection with the German geodetic operations. The misfortune, however, in all these inquiries is that it is impossible to detect the distance below the surface at which the excess or defect of matter may exist, and, therefore, the intimate connection between the unevenness in the earth's crust and the unequal distribution of subjacent material is not clearly demonstrated.

But in India, the very wealth of observation spread over a district so wide introduces new difficulties and taxes ingenuity to the utmost. The latest authority to struggle with the problem is Major S. G. Burrard, already well known to geodesists for the skill with which he unravelled the perplexities connected with the collimation of the transit instruments used in the longitude inquiries, and later for the very successful determination of the longitude of Madras, in which the circuit errors are reduced to a minimum. One therefore watches his attempt to deal with this old problem with a great deal of interest, and is inclined to treat his deductions with considerable respect.

The particular point at issue may be stated thus: How is the astronomical zenith situated with regard to the geodetic zenith at the principal station for reference of latitude in India? This station is Kalianpur, the astronomical latitude of which, after complete discussion, had been settled at $24^{\circ} 7' 11''$.10, and from this quantity, by the aid of observed azimuths and the constants of Clarke's spheroid, the geodetic latitudes of all the fundamental stations have been computed. An examination of the results shows that the mean excess of the astronomical over the geodetic values of latitude is $-2''$.0, or, put in another way, it is shown that of the 148 astronomical latitudes available for geodetic investigation, there are 90 cases of negative excess to 58 of positive. It appeared, therefore, to the late General Walker, and his conclusion has been generally accepted, that the astronomical latitude of Kalianpur was too great by $2''$, and that the plumb-line was not deflected to the north, under the influence of the Himalaya Mountains, but was in reality deflected to the south. With the view of settling the question, he recommended that the latitude of a number of subsidiary stations within a moderate distance of the central station should be derived, and the mean latitude be used for the central station, since it might be assumed that such a final result would be more free from the effects of deflection than the latitude of any single point. Such a view regards the deflection as arising from local causes operative over a small area, but Sir David Gill has since pointed out the very obvious objection that if local attraction is persistent in one direction over large continuous areas, group observations such as those recommended would be

insufficient to eliminate the effects, and it is not the least important part of Major Burrard's investigation to show that the latent causes of disturbances must be sought over very extended areas.

This work of latitude determination has now been completed under the superintendence of Captain L. Conyngham, and Kalianpur has been surrounded by a chain of stations, of which four are situated at an average distance of nine miles and four at an average distance of thirty-five, and the unexpected result of the discussion is to show that local attraction causes a northerly deflection of the plumb-line to the amount of $0''$.60, thus differing by $2''$.60 from the value found by General Walker drawn from the whole of the Indian observations. The results in the prime vertical are not less contradictory, and in the following table is exhibited the amount of deflection in the two planes, at each of the group of latitude stations around Kalianpur, situated within the extreme parallels $23^{\circ} 36'$ to $24^{\circ} 38'$:—

	Deflection in the Meridian.		Deflection in the Prime Vertical.	
	The Group System.	Whole of India System.	The Group System.	Whole of India System.
Daiadhari	+1'01 S.	+3'01 S.	+2'13 W.	+5'35 W.
Surantal	+0'52 S.	+3'42 S.	+3'04 W.	+6'56 W.
Sironj	+1'69 S.	+4'29 S.	+2'54 W.	+5'76 W.
Bharasra	+1'17 S.	+3'77 S.	+0'22 W.	+3'44 W.
Kalianpur	-0'60 N.	+1'00 S.	-0'22 E.	+3'00 W.
Losalli	-1'02 N.	+1'58 S.	-0'38 E.	-3'16 E.
Jinsia	+0'58 S.	+3'58 S.	—	—
Salot	—	—	-4'49 E.	-1'27 E.
Kamkhera	-2'15 N.	+0'45 S.	+0'04 W.	+3'26 W.
Ahmadpur	-2'49 N.	+0'11 S.	+2'27 W.	+5'49 W.

The stations in this table proceed regularly from the north towards the south, and, confining attention solely to the deflections in the plane of the meridian, it is clear that north of Kalianpur we get a southerly deflection, while on the southern side the plumb-line tends to the north. Clearly, then, the Himalaya chain, which has been so frequently invoked to explain inconvenient discrepancies, will not avail here. And the insufficiency of such a hypothesis is still more clearly shown if the deflections be examined at stations nearer to the mountains. At Dehra Dun, the most northerly, in latitude $30^{\circ} 19'$, the deflection is $38''$; in latitude $29^{\circ} 31'$, the deflection is reduced to $7''$, and disappears entirely in latitude $27^{\circ} 51'$; while south of Kalianpur we meet with northerly deflections diminishing in amount as Cape Comorin is approached. Major Burrard clearly puts the dilemma thus: "If Himalayan attraction is capable of producing a deflection of $38''$ at Dehra Dun, its effects must be felt at Cape Comorin; on the other hand, if Himalayan attraction exercises no effect on plumb-lines south of latitude $29^{\circ} 31'$, it cannot produce a deflection of $38''$ at Dehra Dun."

We cannot follow Major Burrard through the various steps by which he seeks to remove the anomalous results, but his method is as exhaustive in theory as it is laborious in practice. He considers the effect of the surrounding ocean on the derived longitudes, and shows that these results stubbornly enforce the necessity of admitting the entire compensation of the ocean. He also asks whether it is possible to introduce any admissible alteration in the dimensions and ellipticity of Clarke's spheroid, and the answer is not less certain. He finds that Clarke's major axis is the most suitable for the Indian longitude arcs, and that, as concerns latitude, while one belt of negative maxima requires an ellipticity greater than $1/289$, the large sub-Himalayan deflections demand an ellipticity smaller than $1/311$. He therefore concludes that the accepted spheroid is not a source of serious error, and that the Indian observed latitudes favour the Clarke spheroid.

Finally, the author is driven to the conclusion that the undiscovered cause of disturbance is traceable to a great invisible chain of excessive density, traversing India from Balasore, near the mouth of the Hooghly, to Jodhpur in Rajputana, and underlying Mandia and Bhopal, or roughly running parallel with the Himalayan chain. This hypothesis is supported by the observation or detection of the opposite effects on either side of the hidden chain. Between the parallels 24° and 26° , the plumb-lines are deflected southwards, while between the parallels 21° and 18° , the deflections are north and large. This view is further confirmed by the arc of longitude between Amritsar and Mooltan, for the plumb-line at these stations is deflected inwards towards the low-lying alluvium and away from the mountain masses.

The author gives a table in which is shown the amount of deflection due to the Himalayas, to the Tibetan plateau and to the underground chain, and the algebraical sum of these three effects agrees very closely with the observed discrepancies throughout the whole range of latitude, from $30^{\circ} 19'$ in the north to $8^{\circ} 9'$ at the southern end of the arc. It is assumed in this calculation that the northern and southern slopes of the underground chain are inclined at the same angle to the vertical—a somewhat improbable hypothesis, as the author is aware—but it seems not unlikely that further discussion will disclose the contour of this subterranean chain. The particular claim that Major Burrard has on our gratitude is that he sweeps away the accidental and local attractions that have too frequently been put forward to explain isolated discordant instances, and substitutes one general central cause, which can be confirmed or displaced by further investigation.

SCHOOLS AND SCHOLARSHIPS.

THE receipt of a copy of the new issue of "The School Calendar" (London: Whittaker and Co.) suggested the idea that it would be useful and interesting to extract some information from its pages as to the present position of science at the older universities in regard to the awards of scholarships. And it seemed all the better worth while to attempt this because such statistics as have previously come under our notice distinctly suggest that science is now doing a good deal more for the colleges as a whole by helping to maintain their overflowing numbers, than the colleges do for science in distributing their scholarship funds.

Everyone who is interested in this subject knows very well that a generation or so ago the colleges at Oxford and Cambridge did much to promote the teaching of science in schools, and especially in certain schools, by offering science scholarships in numbers that, for the time being, were not only sufficient, but liberal, and that the results of this policy have been beneficial alike to the colleges and to the students of science who were thus attracted to the universities. This action has, in fact, been so successful that at Cambridge the science tripos is, if not the largest, at any rate substantially equal to its older rivals in numbers, and also in the quality of its members, as is shown by the army of able teachers and investigators which the university has produced during the last thirty years or so.

The experiment made in the nineteenth century then has certainly been a considerable success; it has encouraged many able students, stimulated the science work of schools, and extended the field of usefulness of the universities. But it is a long while since the experiment was begun, and perhaps the time has come to ask whether all is now well; whether the methods of selecting science scholars are satisfactory to the colleges and fair to the candidates, whether the examinations secure a sufficiently good standard in science without tempting

the candidates to specialise unduly; whether this work, which was, we believe, initiated by some of the colleges only, is now being helped on by all; and, finally, whether the scholarships offered to those who desire to read in science at the universities are reasonably equal to those offered to students in classics and mathematics.

The little book before us does not afford answers to all these questions, but it contains a great mass of useful information, and within its pages will be found full details concerning the various scholarships that are to be awarded at Oxford and Cambridge during the current year. These, however, we are sorry to add, do not afford very encouraging reading.

Thus we find from the "School Calendar" that at Oxford no less than ten colleges out of twenty offer no scholarships or exhibitions for science at all, and that of the other ten, one important college, which disposes about twenty-eight scholarships and exhibitions, without counting those reserved for students of divinity, only encourages science to the very modest extent of dividing two scholarships between candidates in classics, mathematics, history and science, whilst the remainder are reserved for classics and mathematics. Some of these scholarships, doubtless, are on special foundations, but there are twelve which appear to be under the free control of the college, and all these are allotted to the older branches. At this college about 1700*l.* are to be distributed between classics and mathematics, while classics, mathematics, history and science will have equal chances, may be, in the distribution of 160*l.*

Again, fourteen Oxford colleges offer their scholarships for definite subjects in advance. These offer fifty-nine scholarships or exhibitions valued at 4217*l.* for classics, ten of the total value of 790*l.* for mathematics, eight of the value of 585*l.* for science, and ten of the value of 670*l.* for history. Whilst if we take the grand total for the twenty colleges, and assume that Magdalen, Jesus and Corpus Christi will together devote as many as four scholarships or exhibitions to science, we find that out of one hundred and forty, or more, scholarships, &c., which have a total value above 10,000*l.*, only twelve, having a value of rather less than 850*l.*, are offered for science subjects. These numbers, it should be added, though near to the truth, are only approximations, as in certain cases the number and value of the scholarships offered are subject to modification. The former figure, however, is below and the latter above the actual result of our computation, and the latter would be smaller did we not make the liberal assumption that Magdalen, Jesus and Corpus Christi will give half as many science scholarships as all the remaining seventeen colleges taken together.

It may be added that several colleges, e.g. Lincoln, Keble, Oriiel and Pembroke, unless our authority misleads us, offer no encouragement to mathematics, but one of these, Keble, offers a science scholarship.

Turning to Cambridge, we find, as was to be expected, that most of the colleges offer awards for science; still, even at Cambridge four colleges out of seventeen, or nearly 25 per cent., viz. Corpus Christi, Magdalene, Queens' and St. Catherine's, exclude this branch. Owing to the Cambridge custom not to allot scholarships to definite subjects in advance, it is impossible to put forward such particulars as are given above for the sister university. But it may be taken that at Cambridge, as a rule, science receives more favourable treatment than at Oxford. Still, even at Cambridge in certain years not long past, as has previously been shown in these columns, the treatment accorded to science has seemed wanting in liberality, as, for example, in December 1898, when, out of one hundred and one scholarships (value 5150*l.*) given by ten colleges, only sixteen (value 745*l.*) were awarded to science candidates.

Returning now for a moment to the "School Calendar," which has afforded us the above information, it seems, so

far as we can judge, to be a really useful compilation. It gives great masses of very varied data about all sorts of examinations; contains an excellent "Calendar of Examinations" and much general information such as masters and their pupils need, and it is provided with a useful index.

THE ROYAL SOCIETY CONVERSAZIONE.

A LARGE number of exhibits of scientific interest were on view at the conversazione of the Royal Society, held on Wednesday of last week. Following our usual course, we give a list and brief descriptions of the objects exhibited, abridged from the official catalogue:—

The Badische Anilin and Soda Fabrik, Ludwigshafen on the Rhine, had an exhibit of synthetic indigo, consisting of (a) specimens of the raw material (naphthalene) and the intermediate products formed in the manufacture of synthetic indigo, as well as of the latter in four different forms; (b) examples of various textile materials illustrating the application of synthetic indigo on loose wool, slubbing, military cloths of different nations, cops, cross-reel bundles, cotton piece goods both dyed and printed.

Mr. R. L. Mond and Dr. M. Wilderman exhibited a new and improved type of chronograph, in which, instead of moving the heavy drum, the clock moves a very light spindle carrying the writing pen round the drum.

Dr. J. Mackenzie Davidson showed (1) stereoscopic X-ray transparencies and negatives in a Wheatstone stereoscope and in a revolving stereoscope; (2) X-ray photographs of a bullet fired from a revolver. Dr. Davidson also demonstrated that if an ordinary photographic plate be exposed to X-rays and then to ordinary diffused actinic light, a reversed negative is obtained on development in bright white light.

An improved form of Thomson coal-calorimeter was exhibited by Mr. W. Kosenhain.

Apparatus for natural colour photography, and examples of its applications, were shown by Messrs. Sanger Shepherd and Co., who also exhibited a new camera for securing the three negatives through one lens at one exposure, and a camera for photomicrographic work fitted with colour filters for natural colour photography.

By means of a three-circle goniometer exhibited by Mr. G. F. Herbert Smith, the determination of the symmetry and the interfacial angles of crystals is considerably simplified; the crystal needs to be only once adjusted for the whole series of observations. By means of the particular optical arrangements in this instrument, measurements may be made through more than 180° across the end of the crystal by rotation of the horizontal circle only.

The Department of Applied Mathematics, University College, London, showed (1) a curve-adder, made by G. Coradi, of Zürich, for Prof. K. Pearson, F.R.S.; (2) lecture models, illustrating graphical treatment of girder-deflections; (3) a circular slide rule and planisphere, made about 1670, the former on Oughtred's system; (4) a slide-rule, designed by Prof. de Morgan, and believed by him to be first circular slide rule.

Notabilia of Gilbert of Colchester were exhibited by Prof. S. P. Thompson, F.R.S.

Prof. G. Forbes, F.R.S., showed his folding range-finder, which has already been described in these columns.

Mr. J. Stanley Gardiner showed photographs of natives of the Maldivé Archipelago, and photographs of the coral reefs.

Coloured sketches of birds and fishes obtained during the voyage of the *Discovery* to New Zealand were exhibited by Mr. E. A. Wilson.

Mr. J. Gray exhibited cephalometric instruments and cephalograms specially designed for measuring and taking contours of the living head.

The director of the British Museum (Natural History) showed (1) models of deep-sea fishes (*Gastrosomus bairdi* and *Saccopharynx flagellum*); (2) three statuettes of horses and one of a Hungarian bull, one-fourth natural size, by G. Vastagh, of Buda-Pesth. These were exhibited with a view to direct

attention to the desirability of having similar models made of the British breeds of horses and cattle.

Newly discovered fossil mammals and reptiles from Egypt were also exhibited by the director of the British Museum (Natural History). The principal mammalian remains exhibited were those of *Mecritherium* and *Palaeomastodon*, from the Upper Eocene and Oligocene respectively, which seem to be the oldest known ancestral Proboscidea. *Mecritherium* is a comparatively small animal, still retaining the canines and all the incisor teeth in the upper jaw, though the second pair of incisors is much enlarged. *Palaeomastodon* has nearly reached the stage of dentition known in *Mastodon*, but more teeth are simultaneously in use, and the third molar is simpler than in the latter. *Barytherium*, represented by a mandible and part of the upper jaw, is a large and massive animal of uncertain affinities. The vertebrae named *Gigantophis* indicate the largest known snake, probably 50 feet in length.

On behalf of Colonel Sir Edmund Antrobus, Bart., Mr. W. Gowland showed a number of stone implements, &c., from Stonehenge.

On behalf of Miss Breton, the Rev. H. H. Winwood showed some striking water-colour sketches, executed by her, of cañons, glaciers and waterfalls in the United States and British Columbia, illustrating effects of various agents in land-sculpture.

Mr. T. Andrews, F.R.S., exhibited photomicrographs of the crystalline structure of platinum and of the crystalline structure of large steel ingots. Prof. A. H. Church, F.R.S., showed series of zircons from Ceylon, illustrating range of density and colour. Dr. C. A. MacMunn showed (1) the spectrum of a zircon; and (2) spongioporphylin, the colouring matter of *Suberites Wilsoni*, an Australian sponge. This name has been given by Prof. Ray Lankester to the above pigment. The pigment gives a very remarkable absorption spectrum, recalling to mind that of oxyhemoglobin, of turacin, of carminic acid, &c.

Some successful attempts to reproduce polarisation effects by three-colour printing were shown by Prof. H. A. Miers, F.R.S. The pictures were colotype prints from photographs of the coloured interference figures produced by crystal sections in a polariscope.

The experiments shown by Prof. J. A. Fleming, F.R.S., to illustrate the effect of ultra-violet light on the electric discharge attracted much attention. Effects of ultra-violet radiation were also shown by Dr. Dawson Turner.

Sir Norman Lockyer, K.C.B., F.R.S., showed (1) metallic spark spectra in air and water. Photographs of spark discharges from poles of iron, magnesium, zinc and copper showing (a) broadened bright lines, (b) broadened bright lines with central absorption, and (c) broadened bright lines with non-symmetrical absorption (maximum of emission towards red); (2) spectra of meteorites on silver poles, showing the varying intensity of lines due to special constituents; (3) spectra of rocks and minerals on silver poles, showing distribution of vanadium, titanium, chromium, &c.; (4) spectra of plant ashes on silver poles.

A new temperature indicator (Whipple's) was shown by the Cambridge Scientific Instrument Company. This instrument is intended for use with a platinum resistance thermometer. The bridge-wire is wound on a cylinder in the form of a screw, and the sliding contact is moved until the resistance of the thermometer is balanced.

Mr. C. E. Stromeyer gave an experimental illustration of one cause of steam-pipe explosions.

A new and very effective electrical influence machine suitable for campaign work with Röntgen rays was shown by Mr. W. R. Pidgeon.

One of the most novel exhibits was a large prism of vitreous silica shown by Mr. W. A. Shenstone, F.R.S., and Mr. J. W. Gifford. The employment of vitreous silica in optical work has been delayed by the impossibility of building up very large and perfectly homogeneous masses of the material in the oxy-hydrogen flame. But this difficulty has now been overcome to a great extent.

Prof. Wyndham R. Dunstan, F.R.S., director of the scientific department of the Imperial Institute, exhibited (1) poisonous fodder-plants and food-grains, and their cyanogenetic glucosides. These illustrate an investigation of the cause of the hitherto obscure poisonous action of certain Indian and Colonial fodder-plants and food-grains. The plants shown have now been proved to furnish prussic (hydrocyanic) acid, and in the cases of

Lotus arabicus and *Sorghum vulgare* the poison has been shown to have its origin in cyanogenetic glucosides, which occur in the young plant, but gradually disappear as the seeds ripen; (2) Indian and Egyptian drugs and their constituents. (a) *Hyoisycamus Nuticus* and *Hyoisycamine*. This remarkable plant, probably the "nepenthe" of Homer, grows both in India and Egypt, and has been long known as a constituent of narcotics under the name of "bheng" or "bhang." It has been found to contain the alkaloid, hyosycamine, in larger proportion than any other known plant. As the plant is abundant in Egypt it is now being exported for the manufacture of this alkaloid, which is used medicinally. It grows abundantly in the sand of the desert, which analysis shows to be nearly free from nitrogenous compounds. The manner in which the plant obtains its nitrogen is being investigated. (b) Indian Aconites and their poisonous alkaloids. (3) India-rubber from Bahr el Ghazal and Zululand. Varieties of gutta-percha from Sarawak, Ceylon and West Africa; (4) coal, iron ores, mica, and other minerals from India, British Central Africa, Nigeria, Somaliland, Trinidad, and the Grecian Archipelago; (5) specimens of tobacco cultivated in Bermuda, with photographs of the crops; (6) specimens of Indian and Australian gums and resins. (a) *Cochlospermum gossypium* (India) and *Sterculia acerifolia* (Australia). These gums possess the peculiarity of generating acetic acid when exposed to the air. (b) *Callitris verrucosa* (Australia). This resin is remarkable in containing a volatile resin. The resin resembles sandarac in its properties, and is likely to be of commercial value.

Mr. W. M. Mordey and Mr. G. L. Fricker showed an electricity meter invented by them, and intended especially for consumers having a comparatively small number of lamps. It consists of an ordinary clock, deprived of its hair-spring, and carrying a few pieces of iron wire or strip on its balance wheel. This balance wheel is surrounded by a coil of wire conveying the current to be measured. With this arrangement the oscillations of the balance wheel are directly proportional to the current through the coil, with either direct or alternate current. The clock therefore goes at a speed proportional to the current, but does not go at all when there is no current. Geared to the clock is a counter which records the ampere-hours or (on constant pressure circuits) the kilowatt-hours or Board of Trade units.

Prof. W. Ramsay, F.R.S., had an exhibit to illustrate that many persons see the colour of a vacuum tube containing krypton as lilac, many as green. The phenomenon appears to be conditioned by the size of the yellow spot on the retina.

Film structures in metals and other plastic solids were shown by Mr. George Belby. Metal surfaces are covered with a transparent lacquer-like film of their own substance. This covering film is formed by the welding together of minute reflecting films or "spicules." Spicules are visible in all metal surfaces, but are specially well seen in surfaces which have been frosted by the action of heat and chemical reagents. When the rounded end of a burnisher is drawn across a frosted surface, the separate films are welded into a transparent continuous film.

Prof. A. Schuster, F.R.S., exhibited (1) the spectrum of iron in the flame of the Bunsen burner; (2) a Rowland grating of one metre focus.

The scales of fishes as an index of age was the subject of an exhibit by the Marine Biological Association. The scales of many fishes show a series of parallel eccentric lines, which indicate successive increments of growth. These lines of growth have been found to be more widely separated in that part of the scale formed during the warm season of the year than in the portion formed during the cold season. The alternation of the two series gives rise to the appearance of "annual rings," which indicate the age of the fish in years. The markings are subject to individual variation, and Mr. J. Stuart Thomson has been engaged on their investigation in fish of different species captured at all seasons of the year. His results show that it is possible to determine the age of individual fishes of many species with considerable precision—a conclusion which will greatly facilitate the study of other points in the natural history of fishes, and has important practical applications.

Mr. A. C. Cossor showed (1) a "Braun" tube for kathode rays; (2) a new therapeutic X-ray tube. The object of the "Braun" tube is to permit of a wide range in the different experiments that can be made, showing the action of magnetic disturbances on the kathode rays. In this tube these magnetic effects are delicately and precisely shown.

Mr. J. E. Stead's exhibit consisted of (1) micro-structure of iron, and meteoric irons containing free phosphides and carbides of iron and nickel; (2) the micro-constituents of steel.

The Cambridge Observatory exhibited diagrams referring to preliminary results of the solar parallax, from observations of the planet Eros.

The Royal Astronomical Society showed photographs of the nebula surrounding Nova Persei, photographed by Mr. G. W. Ritchey, Yerkes Observatory, U.S.A.

Manuscripts relating to the discovery of Neptune, by the late Prof. J. Couch Adams, F.R.S., were shown by St. John's College, Cambridge, through Prof. R. A. Sampson. The manuscripts date from 1841, when, as an undergraduate in his second year, Adams first determined to attack the problem, to 1846, when the planet was discovered. In all, Adams made no less than six separate solutions of the problem, similar in method but largely independent, each advancing in some particular upon the last. Of these the earliest, though necessarily the least perfect, is perhaps of most interest. It was completed at the end of September, 1843, three years before the planet was observed with the telescope. The position assigned to Neptune by this first determination was some 18° from the truth. The solution dated April 28, 1845, departs from the subsequently observed position by 3°; that of September 18 and October of the same year by less than 1°; that of August, 1846, by about 1½°.

Mr. A. Vernon Harcourt, F.R.S., showed an apparatus for the regulated administration of chloroform.

Mr. J. E. Petavel and Captain J. Bruce-Kingsmill exhibited (1) a recording pressure gauge for artillery; (2) a recording pressure gauge for low-pressure explosions (suitable for gas-engine research and experimental physics), shown by Mr. J. E. Petavel. A description of the apparatus will be found in the current number of the *Philosophical Magazine*.

The National Physical Laboratory showed a plane mirror, given to the Laboratory by Dr. Common, F.R.S.

Living specimens of ovivorous parasites (Mymaridae), together with larvae and pupae in the eggs of Libinia (frog-hoppers), were shown by Mr. F. Enoch.

Mr. W. E. Hoyle showed luminous organs in *Pterygioteuthis margaritifera*, a Mediterranean Cephalopod. The most striking feature of these organs is that they are concealed by the integument, and are only effective by reason of its transparency in the living condition.

Lieut.-Colonel Bruce, F.R.S., exhibited *Trypanosoma Theileri*, a new species of parasite discovered in the blood of cattle in South Africa. This new *Trypanosoma* was lately discovered by Dr. A. Theiler, who is in charge of the bacteriological laboratory of medical officer of health, Pretoria, Transvaal. The species can be at once distinguished from the *Trypanosomas* of Surra, tse-tse fly disease, or rat by its larger size, it being almost twice as large as any of the others. In general appearance it conforms closely to the others in possessing an oval protoplasmic body, a longitudinal fin-like membrane and a single flagellum. It only infects cattle. Horses, dogs, goats, rabbits and guinea-pigs are all immune, neither showing symptoms nor the presence of the parasites in the blood.

A specimen of a *Trypanosoma* found in the blood of man was shown by Mr. J. Everett Dutton on behalf of the School of Tropical Medical, Liverpool. The *Trypanosoma* was first discovered in the blood of a European in Government employ at Bathurst, West Africa. The presence of the parasite was associated with symptoms closely resembling those occurring in animals suffering from tse-tse fly disease. The parasite was again found in a preparation of blood taken from a native child at Bathurst (see p. 15).

Messrs. R. and J. Beck, Ltd., exhibited the "Imperial" microscope with mechanical adjustments for critical work, showing Grayson's micrometer rulings in realgar up to 60,000 lines to the inch.

A collection of ear-rings from British New Guinea was shown by Dr. A. C. Haddon, F.R.S.

Microscopic preparations of *Astroclera Willeyana*, with specimens illustrating the determination of the mineral constituent of the skeleton by Meigen's method, were shown by Mr. J. J. Lisier, F.R.S., and Mr. A. Hutchinson. *Astroclera* was first collected by Dr. A. Willey in the Loyalty Islands, and has since been obtained at Funafuti in the Ellice group. It is regarded as the type of a distinct division of sponges, and differs from other known calcareous sponges in the structure of the soft

tissues and the skeleton, and in the fact that the mineral constituent of the latter is not in the form of calcite.

Mr. E. T. Newton, F.R.S., showed a series of otoliths, chiefly of living British fishes, both marine and freshwater, showing the various forms assumed in the different genera.

Prof. W. K. Huntington exhibited (1) a tilting stage for the microscope; (2) optical bench for metallurgical work.

Dr. A. Muirhead gave a demonstration of retransmission on submarine telegraph cables (cable relaying).

Kite and winding-in apparatus for raising meteorological instruments was shown by Mr. W. H. Dines.

The distribution of electric currents induced in a solid iron cylinder when rotated in a magnetic field was shown by Prof. E. Wilson.

During the evening, demonstrations, by means of the electric lantern, were given in the meeting room by Sir Henry Trueman Wood, on the application of photography to the production of pictures in colour, and Dr. R. D. Roberts, on lantern slides in natural colours of the Grand Cañon of the Colorado, the Sierra Nevada, California and the Yellowstone Park.

NOTES.

THE *London Gazette* announces that Sir William Turner Thistleton-Dyer, K.C.M.G., C.I.E., F.R.S., Director of the Royal Botanic Gardens, Kew, has been appointed Botanical Adviser to the Secretary of State for the Colonies.

DURING the first half of this month the weather over this country was very abnormal for the season. The reports issued by the Meteorological Office show that in the early part of the month a decided depression approached from the north-west, the centre advancing over Scotland, travelling to the south-east, and causing thunderstorms and hail in many places. The subsequent distribution of pressure, which was relatively high off our south-west coasts and over north and south-west Europe, while depressions lay in various parts of the intervening regions, occasioned persistent inclement northerly and north-easterly winds. These continued with little variation until May 14, by which time a great change occurred in the type of pressure, under the influence of which westerly winds and some rise of temperature subsequently occurred, but heavy and sudden downpours of rain continued between the bright intervals. For any comparison of the persistent cold spell it is necessary to go back to the year 1879, when, during the first half of May, the mean of the daily shade maxima at Greenwich was approximately 54° and the minima 36° , against 53° and 37° in the corresponding period of this year. The maximum shade temperature on any day has not exceeded $57^{\circ}\cdot3$, but in 1879 the maximum temperature exceeded 60° on three occasions and reached $66^{\circ}\cdot2$ on May 5. On the night of the 13-14th, the exposed thermometer on the grass registered $22^{\circ}\cdot6$ in the neighbourhood of London, and the maximum of the previous day was about 14° below the normal, while in May 1879 the lowest grass temperature was $24^{\circ}\cdot6$. An examination of the Greenwich records since 1840 shows that there has been no year, except the present, in which the shade temperature has not reached 60° during the first half of May.

IN NATURE of February 20 (vol. lxxv. p. 367), Mr. A. B. MacDowall pointed out that the Greenwich observations of the last thirteen years favour a connection between thunderstorms and the lunar phases, as has been found for other places. Investigation of the meteorological records of several observatories show that a larger percentage of thunderstorms occur about the time of new moon than about full moon, and in the two earlier phases than in the two later. M. V. Ventosa writes from the Madrid Observatory to say that he has obtained similar evidence of this relationship from an examination of observations made at that Observatory in the twenty years 1882-1901. Classified in

four groups about four lunar phases, the results are as follows:—

	New Moon.	First Quarter.	Full Moon.	Last Quarter.
Thunderstorms	132	104	99	120
Percentage	29.0	22.8	21.8	26.4

Mr. MacDowall, to whom we have shown M. Ventosa's letter, remarks:—"The results are an interesting extension of the subject. While at none of the stations which have thus been compared are the differences between those weekly percentage numbers large, the general agreement, in showing, especially, more thunderstorms about new moon than about full moon seems remarkable, and may (I also hope) incite to further inquiries in the same direction, where the requisite data are available."

SEVERAL correspondents have sent us references to observations of peculiar lunar halos such as that described by Prof. Barnard in our issue of May 1 (p. 5). The singularity consisted in the moon being in the centre of one halo and on the circumference of another at the same time. Mr. H. W. Croome Smith directs our attention to a similar appearance observed on February 28, 1890, and described in the *Bristol Times and Mirror* of the following day. The moon was then nine days old, so that the conditions were very similar to those existing at the time of Prof. Barnard's observation.

THE last Report of Mr. W. Bell Dawson, C.E., on the survey of the tides and currents in Canadian waters contains an interesting account of the work that is being carried on in obtaining data as to the tides in the St. Lawrence and in the Bay of Fundy, and in the preparation of trustworthy tide-tables for Halifax, Quebec, St. John's and British Columbia. The part of the Report of most general interest is that relating to the tides in the Bay of Fundy. Further observations which have been obtained during the past year confirm the statement previously made by Mr. Dawson that the range of these tides has been greatly exaggerated. The range of spring tides in Noel Bay when they are at a maximum is $50\frac{1}{2}$ feet and $43\frac{1}{2}$ feet at neaps; at Horton Bluff, 48 feet and 40 feet; at Cumberland Basin, $45\frac{1}{2}$ feet and 38 feet. The difference between the level of the highest known tide, the "Saxby tide" of 1869, and the lowest point to which the water has been known to ebb out is 53 feet. The rise of this tide above mean sea-level was 29.24 feet, and the level of the lowest known low water below mean sea-level was 23.76 feet. The record tide of 1869 rose from 2 to 3 feet above the banks which protect the enclosed marshes and flooded the country.

IN our issue of February 13 (vol. lxxv. p. 350), two new forms of electric resistance furnace suitable for laboratory work were noticed. The *Zeits. f. Elektrochemie* of April 3 contains details of a research carried out by Herr W. C. Heraeus with a modified form of this furnace relating to the melting point of manganese. The coil of platinum wire was replaced by a strip of very thin foil, wound spirally round the porcelain tube. A temperature of 1300° C. could be attained in three minutes with a tube 16 mm. in diameter having a spiral 15 cm. in length wrapped upon it, and by careful attention to the resistance, temperatures could be observed to within 5° C. of absolute accuracy. The tube employed in the observation of the melting point of manganese was provided with an alumina boat to carry the small piece of metal used for the determinations—with rubber connections by which hydrogen gas was passed through the tube during the observation—and with a small telescope by means of which the exact moment of melting could be noted. A Chatelier thermo-element was used for recording the temperatures. The mean of six determinations gave 1245° C. as the melting point of the metal. Attempts to use nitrogen and carbonic acid gas in place of hydrogen failed, since the former gas yielded a nitride with the manganese and the carbonic acid gas dissociated at 1000° C. The reducing action of the hydrogen

gas at the high temperature also caused difficulties with the thermocouple, and many determinations failed owing to the brittleness produced at the point of contact of the two metals.

PROF. H. A. MIERS, who paid a visit in 1901 to the Yukon gold-fields, has published a brief account of his observations, in a letter addressed to the Hon. Clifford Sifton, Minister of the Interior, Ottawa. His principal object was to study the mining methods and the auriferous deposits of the Klondike district. He describes the various methods of thawing the frozen gravel, the latest process being the forcing of water into the ground by means of a pulsometer pump. While admitting the enormous wealth of the district, he points out that it is ceasing to be a poor man's camp, and requires extensive capital and labour for its development. The failures connected with English capital have been disastrous, not necessarily on account of any want of judgment in selecting claims, but mainly because the representatives of English companies "in many cases lacked the judgment and the stability of character which were needed, or had not the interests of their employers sufficiently at heart." At present a comparatively small portion of even the Klondike district has been worked out, while the Yukon territory is auriferous over considerable areas and has been very imperfectly prospected. Moreover, there is nothing to indicate that the gravels and the gold which they contain have been transported any considerable distance, or have been derived from any rocks which differ from those now found in the district. The search for auriferous quartz is therefore hopeful.

The Summary Report of the Geological Survey of Canada for 1901 (Ottawa, 1902, price 25 cents) extends to 269 pages, being considerably larger than previous reports. This increase has been made by the director, Dr. Robert Bell, in response to the general desire for early information on all points which may be of immediate value to the public. Prominence is therefore given to observations and discoveries which may have an economic bearing. Moreover, the amount of work recorded in this report is believed to have far exceeded that of any previous year. No less than thirty-one parties were engaged in explorations, including those conducted by a number of competent geologists, principally college professors, whose temporary services were secured during the summer season. Dr. Bell contributes an interesting statement on the aims and methods of the work in the field and at headquarters; and the reports of the members of the staff are published under their own names. The Yukon district naturally occupied attention, and mention is made of the occurrence of dendritic gold on a boulder found in one of the creeks, a fact which serves to show that some of the gold has been deposited from solution. Examinations have been made of the Cretaceous coal-fields of Crow's Nest Pass, where there is a vast amount of workable coal of excellent quality; of the oil-fields of Lambton county, Ontario, and of Westmoreland county, New Brunswick; of the natural gas in Essex and Welland counties; and of the Carboniferous Coal-measures of New Brunswick, in which water-worn coal-pebbles have been noticed. In an account of the Cambrian rocks and fossils of Cape Breton, reference is made to the solitary character of the Ostracods, which in other formations occur in profusion. Some remains of Trionyx from the Cretaceous rocks of Alberta are described and figured. The glacial origin of cirques or corries and of certain mountain tarns in western Canada is pointed out; and many other topics of general interest are dealt with in the various reports, such as agriculture, including fruit farming, water supply, &c. The occurrence of the mineral fajsasite is mentioned as new to Canada.

In the Report of the Selborne Society for 1901-2, the council emphasises the need of new members in order that the work of the association may be carried on with efficiency.

IN No. 1266 of the *Proceedings* of the U.S. National Museum, Messrs. Jordan and Snyder continue their account of the fishes of Japan, dealing in this instance with the wrasses and their allies. Several new forms are described.

JUDGING by the enlarged size of the April number, the Australian ornithological journal, *The Emu*, appears to be gaining a well-deserved popularity. Among the contents of this issue are a paper on various Tasmanian birds, by Colonel Legge, and a continuation of Mr. D. le Souef's notes on protective coloration in Australian birds and their nests. Of several excellent illustrations, a group of gannets nesting calls for especial commendation.

A MOST remarkable instance of collateral budding in two annelids belonging to the genus *Trypanosyllis* is described by Dr. H. P. Johnson in the *American Naturalist* for April. Both species are inhabitants of the Pacific coast of America; and the sexual "zooids" they produce by this peculiar mode of budding are very numerous, and, with the parent animal, look like a bunch of fern-leaves. The most remarkable feature about the phenomenon is that the full-grown and detached zooids, although provided with generative organs, entirely lack any functional structures for alimentation. "The zooid is, therefore," as the author remarks, "as incapable of leading a prolonged independent existence as the famed palolo of the South Seas. It is no more than a living engine for the dissemination of the genital products which it carries, and that duty must be accomplished solely by the expenditure of the stored up energy which it had derived from the stock." Other members of the family are known to produce zooids by linear budding; but in this case the zooids are provided with digestive organs. The zooids of *Trypanosyllis* are regarded as an extreme specialisation of those of the linear type. But there is another curious circumstance. In the group producing zooids by linear budding the adult stock is sessile, or nearly so, and the object of having freely moving zooids is therefore apparent. But in *Trypanosyllis* the adult stock is not fixed; and the reason for the development of zooids thus remains to be discovered.

THE Austrian Meteorological Office (Dr. J. M. Pernter, director) has published its *Jahrbuch* for 1900. This valuable series of observations has been issued in practically the same form for thirty-seven years; the present volume contains monthly and yearly results at more than 400 stations, and daily observations at twenty-two stations, including, among a few foreign places, Port-au-Prince (Haiti) and Jerusalem. An interesting feature of this laborious compilation is the reduction and publication of the results obtained from the autographic records of several mountain observatories, including the Sonnblick (3106 metres), Obir (2144 metres) and Berghaus (2044 metres). Dr. M. Margules contributes a detailed discussion of the barometric pressure and wind conditions based on the results of a number of stations in Lower Austria.

DR. P. POLIS, superintendent of the Meteorological Observatory at Aix-la-Chapelle has contributed to the April number of the *Meteorologische Zeitschrift* an interesting paper on the daily period of rainfall. The paper is based chiefly on very careful observations at his own station, and the results have been compared with those obtained at several other European observatories. We can only refer to a few of the conclusions arrived at. He finds that (1) in northern and central Europe the summer and winter seasons have opposite daily periods. In summer the heaviest falls occur in the afternoon, and the lightest near noon and midnight. In winter the maximum occurs from 8h. to 10h. a.m. and from 4h. to 5h. p.m. (2) Maritime climates have a more marked daily period in the winter season, and continental climates in the summer season. (3) At his own

station the maximum amount in spring falls between 6h. and 8h. p.m., while the greatest frequency occurs between 8h. and 10h. a.m.; in summer the maximum amount occurs between 2h. and 4h. p.m., and the greatest frequency between 2h. and 4h. p.m. In winter there are two maxima of quantity, 8h. to 10h. a.m. and 6h. to 8h. p.m., while the time of greatest frequency coincides with first period.

"SOLOID" microscopic stains prepared by Messrs. Burroughs, Wellcome and Co. are aniline and other dyes in a tabloid form easily dissolved in water or alcohol or both, as the case may require, and therefore most useful. They are easily preserved, always ready and portable. The list at present published includes a great variety of the most generally used dyes, as hæmatoxylin, eosin, eosin and methylenblue, fuchsin, gentian violet, thionine blue, &c. While admitting, from direct tests made with some of these soloids, their usefulness, it should not be forgotten that, like other short cuts, also the "Soloid" short cut should only supply a necessity, but should not, and cannot, supplant the recognised laboratory methods. The dye marked "Louis Jenner stain" (eosin and methylenblue) is a good eosin but a bad methylenblue stain, and cannot for a moment compare with Czinzinski's solution (eosin and methylblue.) Pages 3 and 4 of the leaflet issued with the soloids, containing descriptions of methods of staining bacilli and blood, may be safely omitted.

IN a series of five papers published during the last few months in the *Journal of Physiology*, Dr. H. M. Vernon has described numerous observations on the zymogens and enzymes of the pancreas. The method used for estimating the tryptic power of extracts depends on the digestion of measured quantities of finely chopped fibrin in small graduated centrifugal tubes. The process is completed in about half an hour, and the average error of experiment is only 5 to 10 per cent. The necessity of adopting a rapid digestion method is shown by the fact, hitherto not adequately recognised, that the tryptic ferment is an extraordinarily unstable body. Thus 70 to 80 per cent. of the ferment in a very active extract may be destroyed in an hour by 4 per cent. Na_2CO_3 at 38° . If such extracts be kept for weeks they gradually deteriorate in activity, and the trypsin still remaining undestroyed is found to be a more and more stable body, till finally the last portions of the ferment left may be ten or twenty times more stable than the first. It was accordingly concluded that trypsin is not a single substance, but that there must exist series of trypsins of varying degrees of stability. There are likewise series of rennins, but not of diastases, though it was shown that the diastatic ferments of the pancreas, of saliva and of malt differ from each other considerably in their hydrolysing action on starch. As regards the zymogens, it was found that the rennet ferment has a zymogen very similar to that of the tryptic ferment, whilst the zymogen of the diastatic ferment is an insoluble body. The most energetic agent in the conversion of tryptic zymogen into enzyme was found to be active enzyme itself. Thus if even 1 per cent. of an active extract were added to a solution of zymogen at 38° , it might convert a third of it into enzyme in an hour. Curiously, the rennet ferment was likewise liberated from its zymogen by the tryptic ferment, and not by the rennetic.

MESSRS. BLACKIE AND SON have commenced the issue of a cheap edition of Kerner and Oliver's "Natural History of Plants," which is well known to all students of plant life. The work will be published in sixteen monthly parts at eighteen pence each, and is thus brought within the means of everyone who is interested in the study of botany. Used either as a guide or a reference book, the work is appreciated by all who know it, and it deserves a sphere of influence even greater than that it already possesses.

NO. 1699, VOL. 66]

WE are glad to learn, from the *Bulletin* of the St. Petersburg Society of Naturalists, that the herbarium of "Flora Rossica," which was begun by the late M. S. I. Korzinsky, member of the St. Petersburg Academy of Sciences, continues to be issued by the Academy under the supervision of M. D. I. Litwinow. Six more fascicules (xiii.-xviii.) appeared lately, together with one fascicule of "Schedæ Herbarium Floræ Rossicæ." We also learn from the same source that M. P. V. Syuzev has undertaken the publication of a "Flora Uralensis exsiccata." This herbarium will comprise chiefly the flora of the province of Perm, but also of Ufa and Orenburg.

A WORK on "The Narym Region," by M. A. Th. Plotnikoff (*Memoirs of the Russian Geographical Society, Statistics, vol. x.* St. Petersburg, 1901), contains a valuable description of a very interesting portion of the province of Tomsk, namely, the portion on the water-divide between the Ob and the Irtysh, as also on the rivers Ket, Parabel and Vas'yugan, which represents mostly an immense marsh—to a great extent a lake during the period of high water in the rivers—and the surface of which is covered with a floating carpet of decayed grass and knolls of ground upon which low bushes of birch will grow. A general description of this wide region (about 100,000 sq. miles) and of its nearly 8000 inhabitants—Russians, Ostyaks and Ostyak-Samoyedes—is given by the author, who has for several years resided at Narym.

ABOUT seventeen years ago, Prof. Salvatore Sardo extracted from the silique of *Bignonia Catalpa* an acid which he called catalpic acid, and to which he assigned the formula $\text{C}_{14}\text{H}_{11}\text{O}_6$. A reinvestigation of the products of the Catalpa fruit has now been made by Signor A. Piutti and Dr. E. Comanducci, whose results are described in the *Rendiconto* of the Naples Academy, viii. 3. Instead, however, of obtaining an acid with the formula assigned by Sardo, they obtained from the immature pods a substance corresponding to the formula $\text{C}_7\text{H}_6\text{O}_3$, which is shown by numerous evidence to be identical with β -oxybenzoic acid. In addition they have extracted what appears to be a combination of paroxybenzoic acid and protocatechuic acid, previously obtained in other ways by Hlasiwetz and Barth, having the formula $\text{C}_7\text{H}_6\text{O}_3 \cdot \text{C}_7\text{H}_6\text{O}_4 + 2\text{H}_2\text{O}$, but the attempt to separate the two acids has hitherto ended in negative results, although the other acid appears to have been isolated by Eykman from the fruits of *Illicium religiosum*. Many questions suggest themselves as to the state in which these acids occur in the Catalpa fruit, and whether they are free or in combination, and it is proposed to collect a quantity of the fruits for further observation.

THE additions to the Zoological Society's Gardens during the past week include a Lesser White-nosed Monkey (*Cercopithecus petaurista*) from West Africa, presented by Sir William Hoste; a Mozambique Monkey (*Cercopithecus pygerythrus*) from East Africa, presented by Mr. J. Bolt; a Common Viper (*Vipera berus*) European, presented by Mr. C. Spencer Bubb; a Hartebeest (*Bubalis*, sp. inc.) from Angola, purchased; two Japanese Deer (*Cervus sika*), born in the Gardens.

OUR ASTRONOMICAL COLUMN.

SATURN VISIBLE THROUGH THE CASSINI DIVISION.—An interesting circular has been issued by Mr. C. T. Whitwell, of Leeds, calling attention to the possibility of this phenomenon being observed. On July 17, 1902, at 13h. G.M.T., Saturn will be in opposition to the sun, and about 7h. G.M.T. on that day the earth and sun will be equally elevated above the ring plane, their Saturnian declination being about $22^\circ 26' 17''$ N. Adopting Prof. Barnard's estimate of 2270 miles for the breadth of the Cassini division, and fifty miles for the thickness of the rings, Mr. Whitwell calculates that the effective opening of the division will be 820 miles, corresponding to $0^\circ 20'$ in angular

measure at the earth's distance. Under these conditions a line from the sun to the earth will pass through the rift in the rings to the planet, and a terrestrial observer, suitably placed, may be able to view through the rift a portion of the planet's surface lit up by the sunlight. The effect will be that, of the arc of the Cassini division crossing the planet, a small portion will appear bright instead of dark, and may almost disappear; as the albedo of Saturn is less than that of the adjacent portions of rings A and B, however, it is likely that there will be sufficient contrast to show the phenomenon.

There appears to be no record of any previous observation of this kind, and it will obviously be one of great delicacy and difficulty. As the exact limits of time and place are not absolutely determinable, it is hoped that the planet will be watched for some time before the date given.

CATALOGUE OF NORTH POLAR STARS.—Prof. Pickering has issued a catalogue of 589 stars in the vicinity of the North Pole as a separate part, No. 1, of vol. xlviii. of the *Annals of the Harvard College Observatory*. The measures are from enlargements made from the central portions of four negatives obtained with the 11-inch Draper telescope on November 29, 1887, February 23, 24 and March 10, 1897, with exposures of 60, 120, 120 and 101 minutes respectively. Full details are given of the reductions employed, and in consequence of the arrangements made at the Astrophotographic Congress of 1900, the positions are published in rectangular coordinates, which plan is to be adopted in general for future issues.

THERMAL EXPANSIONS AT LOW TEMPERATURES.¹

THE apparent specific gravities of boiling liquid oxygen which resulted from weighing in the liquid a series of metals and other substances were given in a lecture entitled "New Researches on Liquid Air," printed in the Royal Institution *Proceedings* for 1896. For instance, silver, calc spar, rock crystal and iodide of silver gave the respective apparent densities 1.1278, 1.1352, 1.1316 and 1.1372. On correcting the weight of liquid displaced by each substance for contraction to $-182^{\circ}6'$ —by calculating a Fizeau mean coefficient of expansion for the range of temperature employed, on the assumption that the parabolic formula might be legitimately extended to low temperatures—it was found that the real density of liquid oxygen so deduced for all the bodies used was, as a mean, 1.137.

The determination of the densities of substances at the temperature of the boiling point of oxygen—and hence of their mean coefficients of expansion between that temperature and ordinary temperatures—opens out a very large field of investigation, from which, if a sufficiently large number of observations were available, valuable deductions might be drawn. On account, however, of the expense and trouble of producing quantities of liquid oxygen, its use for this purpose is not likely to become general, although, when available, it is the easiest body to use in conducting such experiments, especially when the vacuum vessel containing it is immersed in a larger vessel containing the same fluid or well-evaporated air. The ease with which liquid air can now be obtained in many laboratories suggests that its application to work of this kind would in some cases be a convenience, and the present investigation was undertaken with the desire of ascertaining what accuracy could be attained, and how the method could be applied to inorganic or organic substances which occur in the form of fine crystals.

The use of a mixture of varying composition and density like liquid air necessitates a determination of its density with accuracy and rapidly before and during the course of the experiments. For this purpose, in the experiments about to be detailed, the liquid air that had been allowed to evaporate for twenty-four hours in advance was used in large silver-coated vacuum vessels of some 3 litres capacity. In order to ascertain the density of the liquid, a polished silver ball, which had been weighed once for all in liquid oxygen, was weighed in the sample of liquid air, and from the relative weights thus found the density of the liquid air could be approximately determined, assuming that of liquid oxygen to be 1.137.² To prevent any disturbing ebulli-

tion in the liquid-air flask in which the weighings took place, and to reduce the rate of its evaporation to a minimum during the course of an experiment, the substance to be used was previously cooled in a supplementary vessel containing liquid air and then transferred to the large flask. To avoid as far as possible the formation of cracks in the bodies during the process of immersion in the liquid air, it was found advisable to cool them slowly in the air of the vacuum flask first, and then to lower them into the liquid.

In this way, with proper care and attention, results were obtained comparable in accuracy with the density taken in liquid oxygen. Substances like solid carbonic acid and ice were weighed in the cool, gaseous air of the vacuum vessel, and their weights subsequently corrected for buoyancy. The temperature of the densest and lightest samples of liquid air was ascertained by the hydrogen thermometer, and that of the others deduced by graphic interpolation. As the entire range of temperature through which the bodies were cooled amounted to about 200° , a degree or two up or down has no real influence on the results; the extreme range of temperature in the air samples was from $83^{\circ}8$ to $86^{\circ}1$ Abs.

When the body to be examined was a salt, it was employed in the form of a compressed block. One experiment was, however, made in a section of a large crystal of chrome alum. The salt, previously reduced to a fine powder, was moistened with water and compressed in a cylindrical steel mould under great hydraulic pressure. During compression the saturated salt solution drained away, and finally a cylindrical block of some 50 grammes of the salt was obtained free from porosity and hard enough to allow its surface to be polished. In this form salts and other materials similarly treated are especially adapted for accurate specific gravity determinations. After such treatment it was found that all the mechanically attached water was got rid of in the case of hydrated salts, and also in such as did not combine with water. In order to get cylindrical blocks of the salts showing no porosity, the presence of water, or rather the saturated salt solution, was found to be essential during the application of pressure. In the same way it was found to be an advantage in compressing such a substance as solid carbonic acid to moisten it with a fluid like ether before applying the hydraulic pressure.

Recalling the work of Playfair and Joule,¹ which originated in a suggestion of Dalton's that the volume of a hydrated salt in solution was simply the volume of the water of crystallisation, ice and some hydrated salts were selected, as well as some other bodies the coefficients of expansion of which they had determined. Substances of special interest were included in the list, like mercury, sulphur, iodine and solid carbonic acid, the latter being particularly important as an example of a solidified gas.

In the further conduct of an experiment, the observations made on a substance were three, namely, (a) the weight in grammes of the substance and suspending platinum wire, either in air of about 17° C. temperature or in the gaseous air in the flask containing the liquid air; (b) the weight in grammes of the body and wire when immersed in the liquid air; and (c) the weight in grammes of the suspending platinum wire in ordinary (17°) air.

In the case of substances of less density than liquid air, a polished copper ball weighing about 38 grammes was used as a sinker.

Two experiments were made on compressed cylinders of solid carbonic acid. In the first of these the carbonic acid was compressed dry, in the second, after a few drops of ether were added. The specific gravities of solid mercury, iodine and sulphur were also determined in liquid air. The iodine was in the form of a compressed cylinder, but the sulphur was a piece of a crystalline mass of native origin.

The specific gravity of the actual portion of the substance weighed in the liquid air was, with one or two exceptions, determined also at the temperature of the laboratory, about 17° C. From the two sets of observations, the value of the mean coefficient of cubical expansion between 17° C. and the temperature of liquid air was calculated.

In calculating coefficients of expansion, various forms may be given to the formula employed, and correspondingly different results may be obtained from the same set of observations. For short ranges of temperature these results are practically identical, but this no longer holds for a range of temperature such as we

¹ "Coefficients of the Cubical Expansion of Ice, Hydrated Salts, Solid Carbonic Acid, and other Substances at Low Temperatures." By Prof. James Dewar, F.R.S. Abridged from a paper read before the Royal Society on May 1.

² As the correction due to the contraction of the silver ball between the temperature of boiling oxygen and that of the air sample is small, it may be neglected.

¹ "Researches on Atomic Volume and Specific Gravity" (*Chem. Soc. Journ.*, vol. 1, 121).

have in these experiments. All that is possible in the present instance is to adopt a linear formula. The usual formula is $v_T = v_0(1 + \alpha T)$, where the value v_0 at 0°C. becomes v_T at $T^\circ \text{C.}$ when α is the coefficient of expansion. If we use densities (d) instead of volumes (v) this formula becomes

$$d_0 = d_T(1 + \alpha T), \quad \text{or } \alpha = \frac{d_0 - d_T}{T d_T}; \quad \alpha = 0.000538.$$

Another formula, when T and T' are the temperatures dealt with, is

$$d_T = d_{T'}\{1 + \alpha(T' - T)\}, \quad \text{or } \alpha = \frac{d_T - d_{T'}}{(T' - T)d_{T'}}; \quad \alpha = 0.000595.$$

Again

$$d_{T'} = d_T\{1 - \alpha(T' - T)\}, \quad \text{or } \alpha = \frac{d_T - d_{T'}}{(T' - T)d_T}; \quad \alpha = 0.000558.$$

Also we may choose a mean formula

$$\alpha = \frac{d_T - d_{T'}}{(T' - T)\frac{d_T + d_{T'}}{2}}; \quad \alpha = 0.000576.$$

The differences in the results of applying these formulæ are shown in the numerical values attached to each, which are calculated from the first experiment on solid carbonic acid, coupled with the specific gravity 1.53 of the solid at -78°C.

Perhaps as a matter of general convenience, the first of these formulæ is the best; however, the second was chosen to conform with the old work of Playfair and Joule, and it is the results of this formula which are mentioned below.

The temperature range is taken from about -186°C. to 17°C. , unless otherwise stated.

Ice.—In determining the density at the temperature of liquid air of pieces of clear ice cut from large blocks, both the silver and copper balls already referred to were used as indicated. The true weight *in vacuo* of the silver ball was 132.2855 grammes, and that of the copper ball was 38.0802 grammes. The mean of the three densities obtained at -188.7°C. is 0.92999.

Recently Vincent (*Roy. Soc. Proc.*, 1901) has redetermined the density of artificial ice at the freezing point, and also its coefficient of expansion. He finds the density to be 0.916, or from his tabulated results 0.91599. Playfair and Joule find the mean of the densities given by eight observers previous to them to be 0.919, and they themselves get 0.9184; Bunsen found it to be 0.9167. If we take this most recent determination, namely, 0.91599 at 0° , and 0.92999 at -188.7° , and use the formula

$$d_0 = d_T(1 + \alpha T)$$

we get $\alpha = 0.00008099$.

Vincent refers to "only one" estimate for natural ice, namely, 0.0001125, adding that "the mean of three available results for artificial ice is 0.000160"; finally, he gives the mean of four determinations of his own, namely, 0.000152. Apparently, then, we may take 0.0001551 as the mean coefficient of expansion of ice between 0° and (say) -20°C. Thus the mean coefficient of expansion between 0° and -188.7°C. is about half of that between 0° and -20°C. The mean coefficient of expansion of water in passing from 4° to -10° is -0.000362 , and from 4° to 40°C. it is 0.0002155. Hence the mean coefficient of expansion of ice between 0° and -188.7°C. is about one-fourth of that of water between 0° and -10°C. , and half of that between 4° and 100°C.

If we had the densities of ice at still lower temperatures, the values of the coefficient of expansion thence determined would, there is every reason to believe, be less than what we have found. We shall therefore not be overstraining the argument if we use the value just found to determine an upper limit to the density of ice at the absolute zero. The result is 0.9368, corresponding to a specific volume 1.0675. Now the lowest density of water, namely, at the boiling point, is 0.9586 (corresponding to specific volume 1.0432), so that ice can never be cooled low enough to reduce its volume to that of the liquid taken at any temperature under one atmosphere pressure. In other words, ice molecules can never be so closely packed by thermal contraction as the water molecules are in the liquid condition, or the volume of ice at the absolute zero is not the minimum volume of the water molecules. It has been observed by Prof. Poynting ("Change of State, Solid, Liquid," *Phil. Mag.*, 1881) that if we supposed water could be cooled without freezing, then taking Brunner's

coefficient for ice, and Hallstrom's formula for the volume of water at temperatures below 4°C. , it follows that ice and water would have the same specific volume at some temperature between -120° and -130° ; applying the ordinary thermodynamic relation, then no change of state between ice and water could be brought about below this temperature. On the other hand, Clausius ("Mechanical Theory of Heat," p. 172, 1879) has shown that the latent heat of fusion of ice must be lowered with the temperature of fusion some 0.603 of a unit per degree. If such a decrement is assumed to be constant, then about -130° the latent heat of fluidity would vanish.¹ Baynes discusses the same subject ("Lessons on Thermodynamics," p. 169, 1878) and arrives at the conclusion that at a temperature of -122°C. and under a pressure of 16,632 atmospheres there is no distinction between the solid and liquid forms of water. At temperatures below this limit, no amount of pressure would transform ice into water. We are thus relieved from a difficulty that would follow but for this demonstration of Clausius, namely, that the application of enormous pressures to ice, even at temperatures below that of liquid hydrogen, might cause the transformation of ice into water.

Carbonic Acid.—Two experiments were made with this substance, the masses in each case being about 20 grammes. These were compressed cylinders; the former was compressed dry, while the latter was slightly moistened with ether. The density at -188.8°C. was found to be 1.6308 and 1.6226.

The density of solid carbonic acid at its boiling point was formerly given as 1.5 (see *Proc. Roy. Inst.*, 1878, "The Liquefaction of Gases"), but the mean of my results at the time came to 1.53. Recently the same value has been found by Behn. Taking this value and 1.6267, the mean of the above results at -188.8°C. and using the formula

$$d_T = d_{T'}\{1 + \alpha(T' - T)\}$$

we get $\alpha = 0.0005704$.

This is a very large coefficient of expansion, being greater than that of any substance recorded in the accompanying table, and comparable with that of sulphur between 80° and 100° , which, according to Kopp, is 0.00062. The coefficient of liquid carbonic acid at its melting point taken from the recent observations of Behn (*Chem. Soc. Journ.*, 1901) is 0.002989, so that the rate of expansion of the liquid at its smallest value is very nearly five times that of the solid.

Solid Mercury.—One experiment was made with solid mercury, and the result is given below.

Mallet determined with great accuracy the density of solid mercury at -38.85° , his result being 14.193; coupling this with the density found for the liquid-air temperature, we find that the value of the coefficient of expansion between the melting point and -189°C. is 0.0000887. For fluid mercury above 0°C. the mean value is about 0.000182, so that in the solid state this coefficient is about half of that in the fluid state.

The coefficients of expansion (α) obtained were as follows:—

	α 0.00
Sulphate of aluminium (18) ²	0811
Biborate of soda (10).....	1000
Chloride of calcium (6).....	1191
Chloride of magnesium (6).....	1072
Potash alum (24).....	0813
Chrome alum (24), large crystal.....	0365
" " " "	0478
Carbonate of soda (10).....	1563
Phosphate of soda (12).....	0787
Hyposulphate of soda (5).....	0969
Ferrocyanide of potassium (3).....	1195
Ferricyanide of potassium.....	2244
Nitro-prusside of sodium (4).....	1138
Chloride of ammonium, sample 1.....	1820
" " " " sample 2.....	1803
Oxalic acid (2).....	2643
Oxalate of methyl.....	3482
Paraffin.....	3507

¹ In my paper "On the Lowering of the Freezing-point of Water by Pressure" (*Roy. Soc. Proc.*, 1880), it was proved that up to 700 atmospheres the rate of fall was constant and equal to the theoretical value within the range of pressure if the difference between the specific volumes of ice and water remains constant; thence the latent heat of fusion must diminish just as Clausius had predicted.

² The figures in brackets refer to the number of molecules of water of crystallisation.

	a
Naphthalin	3200
Chloral hydrate	1482
Urea	1579
Iodoform.....	2930
Iodine	2510
Sulphur	1152
Mercury.....	0887
Sodium.....	1865
Graphite (Cumberland)	0733

Sodium, extending down to low temperatures, has a coefficient about the same as that of mercury at the ordinary temperature. The coefficient for sulphur is about half of that between 0° and 100°, being 0.0002237, and that of iodine is not far removed from the value 0.000285 given for the solid at ordinary temperatures. The rate of expansion of liquid iodine is about three times this value. Paraffin ought to have a value of 0.0004633 from Fizeau, but Rodwell's coefficient between 0° and 38° is 0.00035. The value found for naphthalin is about half that of the liquid near its melting point, viz. 0.000785. If the liquid coefficient be taken at a corresponding temperature to that of the liquid carbonic acid when comparing it with the solid, then its value is 0.001213, or the coefficient would be now in the ratio of 4 to 1. The graphite calculated from Fizeau should be 0.000929, which is greater than my value; but the samples were different. My two specimens of chloride of ammonium gave nearly the same value, and the result is in agreement with that found by Playfair and Joule, viz. 0.000191. If a Fizeau coefficient for this salt is calculated, the value is 0.000761, which in this case is far too small. The coefficient found for oxalic acid is again only a little smaller than that given by Playfair and Joule, viz. 0.0002748. As regards the hydrated salts, phosphate of soda, hyposulphate of soda and chloride of calcium, having the respective values 0.001384, 0.0001516 and 0.0006887, as found by Kopp, the low temperature coefficients are much smaller in each case. With the exception of carbonate of soda and chrome alum, all the other hydrated salts have a coefficient of expansion not differing greatly from that of ice at low temperatures. Generally, the densities of the compressed blocks of different bodies agreed well with the results of other observers, but my potash alum had only a density of 1.614, whereas Playfair and Joule give 1.731. It will be noted that iodoform is a highly expansive body like iodine, and that oxalate of methyl has nearly as great a coefficient as paraffin, which is one of the most expansive solids. The correcting factor was used for paraffin, naphthalin, chloral hydrate, iodoform and sodium.

It will be possible by cooling the moulds with liquid air during the process of hydraulic compression to produce cylindrical blocks of solid bodies of lower melting-points than any given in this investigation, such as alcohol, ether, nitrous oxide, ammonia, chlorine, &c., and to ascertain their coefficients of expansion in the solid state between the individual melting points and the boiling point of liquid air.

This method, which works well with liquid oxygen or air, fails when applied to liquid hydrogen, as the density of the liquid is too small (apart from other difficulties) to give accurate values of the weights of fluid displaced. For temperatures about 20° absolute, recourse must be had to measurements of the coefficient of linear expansion, and such observations could only be applied with ease to metallic bodies and alloys.

THE RISE OF THE EXPERIMENTAL SCIENCES IN OXFORD.¹

IN the Middle Ages, the scholars swept in flocks, like migrating birds, from school to school. What we now call a University was then no particular spot on the earth; but, like the ark in the wilderness, moved whithersoever a great teacher, such as Fulbert, the Anselms, Abélard, Peter Lombard, unfurled his standard. This mobility was, indeed, a guarantee of the freedom and the power of learning.

The "Civitas Philosophorum," as Saint Thomas called Paris, was engaged in 1209 in burning all the works imputed to Aristotle. This attack "on the Lehrfreiheit" of Paris, when the culture of the first renaissance was streaming into Europe from

the Arabian sources, drove its scholars abroad, and fights of them came to the comparatively unknown schools of Oxford and Cambridge. Oxford, already a centre of public affairs, sprang more suddenly than Cambridge into fame—on the scholastic side under the influence of the Friars Minors.

The Grey Friars, then breathing the humane spirit of their founder, stood for the people and for freedom, while the Friars Preachers were on the side of authority. Robert Grosseteste, who made Oxford as Abélard made Paris and Fulbert made Chartres, and his pupils, Adam Marsh and Roger Bacon, became Greek scholars of no inconsiderable attainment at a time when the potable gold of Greek tradition had virtually died out in the west, and with it the inspiration of natural knowledge. Adam Marsh, himself a Minor, was a statesman, a close friend of Simon of Montfort, and a champion of freedom of learning. Balliol was founded under Franciscan influences, and under this first temper in the next century, then in the teeth of the Minorites, Oxford was keenly Lollard; and with the suppression of Lollardism all intellectual life deserted her courts. Nevertheless, Oxford during the Middle Ages was a child of Paris rather than of Italy, whence Cambridge drew much of her nourishment, and was the picturesque stronghold of hierarchical traditions. Albert of Cologne, himself a Franciscan, vindicated against Paris the science of the Arab schools, and dignified the study of natural knowledge and experiment.

Pioneers of science may be divided into two kinds, into a group who, like Galileo, Boyle and Harvey, were themselves discoverers, and a second group, like Roger Bacon, Telesio, Patrizzi, Campanella, Francis Bacon, Ramus and Marsiglio, who did service rather as protestants and reformers of method. Whether Roger Bacon were more of a chemist than Albert of Cologne, or whether either got beyond the chemistry of Geber, whether Bacon advanced in optics, his special study, beyond Al Hazen, it is less important to ascertain than to declare that Bacon's title to fame is that he revived true methods of investigation. Many ancients had made experiments; Aristotle made many, Pliny made many; Bacon first declared that it was not experiment, but the experimental method, which was to regenerate science. We must not suppose that Roger Bacon was alone, as one crying in the desert; with the Arab illumination, natural science was in the air. Many voices, such as that of Peter of Méricourt, to whom Bacon regarded himself as indebted, preached experiment and contemned authority in natural research. The works of Nemorarius of Borgentreich, who first advanced from the statics of Greek and Arab to dynamics, were known to Bacon. The parabolic mirror and its focus were known to Al Hazen. Grosseteste had larger views than either Hales or Albert, and was no inconsiderable geometer. He wrote a treatise, "de Iride et de Cometis," and was a keen inquirer into the new sources of knowledge, including the "Res Physica," or medicine. Thomas Bungay, the eighth Provincial of the Friars Minors, was engaged with Bacon at Oxford in natural investigation, and, like other such inquirers, was regarded as a wizard. In Italy natural science continued, even in some abundance of life; but in Paris on the Isis, as in Paris on the Seine, its rudiments were soon buried under the Aristotelian and Galenical cenotaph by that busy gravedigger, Duns the Northumbrian, and were not dug up again until the day of Abbot Maurolycus and Vesalius nearly three centuries later. Thus one of the most piercing intellects and one of the most progressive societies our land has produced founded no school.

The great experimenters of the thirteenth as well as of the sixteenth and seventeenth centuries could hardly obtain skilled craftsmen for the construction of apparatus. Many observers, however, were themselves ingenious constructors—such as Archimedes, Hero, Leonardo, Brahe, Gilbert, Galileo, Huyghens, Hooke, Papin and, in our own time, Faraday and Ludwig. Roger Bacon, in his expenditure of money and labour upon machines, preceded Boyle and Hooke. We are not to suppose that Roger's machines were clumsy and rudimentary. The Alexandrian and Byzantine Greeks, and after them the Arabs, had constructed apparatus of surprising elaboration and ingenuity, and Bacon's machines would be well abreast of their time. In the sixteenth century, again, the reappearance of Greek preceded a new birth of natural science; although, unless at Wittenberg or Basel, freedom of speech was more closely stifled in Europe than in the time of Abélard, for Calvin himself bowed before Aristotle. William Soling, Linacore, Grocyen and Colet were therefore forerunners of the brilliant scientific revival of which, in the seventeenth century, the establishment

¹ Abstract of the Boyle Lecture delivered at Oxford on May 13 by Prof. T. Clifford Allbutt, F.R.S.

of the great scientific societies, the Linnee, the Paris Academy and the Royal Society, were the organs and the witnesses. We find in the life of Bruno a vivid narrative of the Oxford of the sixteenth century. Bruno visited Oxford in June, 1583, with the French Ambassador Castelnau, the translator of Ramus. Of the disputations in the schools, of their pompous frivolity, he gives a very amusing description. The earth, said Aristotle, Paris and Oxford, is motionless; the universe is finite and moves. Bruno, in the name of Philolaus and Copernicus, protested that the earth revolves and that the universe is infinite; and the dispute grew venomous. Bruno asked and was granted permission to teach in Oxford; but as *domitiantium animorum excubitor* he seems to have been even less successful in combating the physics of Aristotle than was Ramus in respect of his dialectic and Luther of his ethics.

Orthodoxy is the defensive weapon of society rather than of religion; when the needs of the two came into conflict it was religion which went to the wall. Happily "certain extravagant chemists," of whom more anon—and the Ramists, Paracelsians and Italian philosophers, were shrewdly assisted by new factors in the worlds of polite society and letters. As Petrarch and Boccaccio disarmed the academic combs of Padua, now again in France the sceptical bonhomie of Montaigne, the revolutionary philosophy of Charron, the merciless railleury of the *Marriage Forcé* and the polished satire of Boileau did more to penetrate the armour of the Church than the harder rebels to bruise it. By them the shabby Aristotelean effigy, battered by the weapons of Roger Bacon, of Galileo, of Harvey, of Telesio and Descartes, and bedaubed with the missiles of Patrizzi, of Ramus and of Verulam, was finally broken up and demolished. In the middle of the seventeenth century at Wadham, Warden Wilkins gathered about him a constellation of scientific men such as has perhaps never gathered together in any other time or place. Robert Boyle, Christopher Wren, John Locke, Robert Hooke, and, but little later, John Mayow, all of them men of genius, were at the head of a society which was the foundation of the Royal Society, and among its lesser lights contained names no less than those of Seth Ward, John Wallis, Thomas Willis, Roger Lower and William Petty. The lecture concluded with a study of Boyle, not only as a scientific discoverer, but also as a philosopher and a reformer of method of far greater insight than Dr. Whewell admits, and, moreover, a man of charming temperament and an accomplished man of letters.

ANTHROPOLOGICAL RESEARCHES IN INDIA.³

LIUT.-COLONEL DR. WADDELL has been constrained to make a careful study of the savage tribes that live in the mountainous valleys of the upper waters of the Brahmaputra, as he realised that the unique mass of ethnological material which is stored in these mountain recesses is being allowed to disappear unrecorded. It is said to be no uncommon sight to see a Naga, who only two or three years ago was a naked head-hunting savage of the most pronounced type, now clad in a tweed coat and carrying a Manchester umbrella, taking his ticket at a railway station. Dr. Waddell states that one of the oldest European residents of Assam, Mr. S. E. Peel, urged at every opportunity in the public Press and in communications to the Asiatic Societies, the Royal Geographical Society and the Anthropological Institute of London, in the strongest terms possible, the necessity for action without further delay. In despair at the apathy displayed in the matter, he willed away at his death, a few months ago, to a museum in New Zealand all his collections of miscellaneous notes and specimens of the vanishing ornaments and primitive costumes of these wild tribes. Colonel Woodthorpe has emphasised the loss to ethnology if the many interesting tribes are not carefully studied soon. Mr. Wharry, adviser on Chinese affairs to the Government at Burma, says:—"The chance of studying these peoples to full advantage is fast slipping away."

The observations published by Dr. Waddell relate to about 1 "The Tribes of the Brahmaputra Valley: a Contribution on their Physical Types and Affinities." By L. A. Waddell, M.B., LL.D., Lieut.-Colonel, Indian Medical Service. (*Journal of the Asiatic Society of Bengal*, vol. lxxix., part iii., 1900 (1901), pp. 1-127, pls. ii-xviii.)

"The Coorgs and Yervuas, an Ethnological Contrast." By T. H. Holland, A.R.C.S., F.G.S., Geological Survey of India. (*Ibid.*, vol. lxxix., part iii., 1901, pp. 59-98, pls. i-v.)

600 individuals belonging to more than thirty tribes or groups. After briefly describing the influence of topography on the ethnology of the district and the racial elements, he gives a short account of a large number of tribes in alphabetical order. This section contains a great deal of very interesting matter which is of value alike to the ethnologist and to the student of comparative customs. Then follows the detailed anthropometric data and seventeen plates of portraits and groups. As the tables of indices and the "comparison of the results and the bearing of these on the question of the affinities of the tribes" are not given in this part, we assume they will follow in the next number of the journal, when it is to be hoped the equally bulky data for the tribes of Tibet and Burma, which the author has amassed, will be published for the benefit of his colleagues at home.

The laborious work accomplished single-handed and mainly at his own expense by Colonel Waddell deserves our warmest thanks, and we hope he will feel that anthropologists thoroughly appreciate his self-denying labours. It is quite beyond the power of the few students at home to help in supporting, save by encouragement, such workers as Colonel Waddell. To our shame be it spoken, there is no organisation by which the wealth of those who have abundance can be directed towards the pressing needs of field-work among primitive peoples, such as is so pathetically advocated by the author of this paper, and our Government also is apathetic to the study of native races; one can only hope that this negligence is due to ignorance.

Since Colonel Waddell wrote his paper, the Government of India has undertaken to conduct an Ethnographic Survey of India in connection with the census of 1901. This action was due to the initiative of the British Association at the Dover meeting in 1899; particulars of the proposed scheme of work will be found in *Man*, September 1901, p. 137. As Mr. Risley, the author of "The Tribes and Castes of Bengal," has been appointed Director of Ethnography for India, we may feel sure that the Survey will be wisely planned, and we sincerely hope that sufficiently skilled workers are employed and that the usefulness of the Survey will not be impeded through lack of funds. While we are thankful for this official recognition of the claims of anthropology, it is still necessary to repeat, what has so often been urged in the pages of NATURE, that there is an enormous mass of ethnological material in our Empire beyond the seas which is yearly decreasing at an alarming rate, or is rapidly becoming so modified as to lose its original value. The loss of this vanishing anthropological information is supinely permitted by our Government. What a contrast there is between the British Government and that of the United States is known only too well by those acquainted with the annual reports of the Bureau of Ethnology.

Mr. T. H. Holland, of the Geological Survey of India, has published a very valuable study on two well-contrasted human types found in a small district of southern India. The presentation of the data, their discussion, the comparative tables, diagrams and plates, render this a model paper.

In the little province of Coorg, which embraces a semi-isolated portion of the western Ghats, there is an interesting instance of the way in which a mountainous and jungle-covered country has been turned to totally different purposes by two distinct races. The agricultural Yervua early retreated into the little mountain province before the aggressive invaders. At a later period the splendid Kodagas (Coorgs) found in the jungles of Coorg the means of satisfying their hunting propensities, whilst the narrow passes suited their highly developed instincts for predatory raids into the country of their wealthier but less warlike neighbours. The sporting and fighting proclivities of the Coorgs reveal themselves even in their festive and religious ceremonies. From his very birth, when a miniature bow and arrow made from the castor oil plant is placed in the hands of the baby boy, the Coorg male is, or was, regarded as a huntsman and a warrior whose pride was in his size and strength; hence this is the finest race in the south of India.

A comparison of the physical characters of these two tribes proves that the Coorg is on an average 3.9 inches taller than the Yervua, and with a relatively shorter span he has a larger and broader head, a more perfect approach to orthognathism, his nose is longer and narrower. There is a marked contrast between the fair (light brown), straight-haired Coorg and the very dark-skinned Yervua, whose hair is distinctly wavy. The features of the latter are generally of the stamp which we should characterise as distinctly low, the broad nose being accompanied by thick, slightly everted lips.

The Coorgs and the Yeruvus belong to two distinct ethnic types. The latter tribe falls into a group with the Kurumbas, Irulas, Paniyans and Kaders, who have been so ably studied by Mr. Thurston and are the South Indian cousins of the Kols and Gonds living on the central highlands. In all their physical characters the Coorgs differ from the Yeruvus, and, indeed, they possess more of the superior characteristics which are supposed to indicate an Aryan origin than do many of the South Indian tribes who claim a higher caste position, and fewer signs of aboriginal blood than even the Brahmans of the Madras Presidency. Their almost brachycephalic index of 79.9, however, leaves the question of their ethnic relationship an unsolved problem.

A. C. H.

UNIVERSITY AND EDUCATIONAL INTELLIGENCE.

OXFORD.—The Rolleston memorial prize for original research in morphology has been awarded to Mr. Francis J. Cole, Jesus College.

CAMBRIDGE.—The Balfour managers have made grants for zoological research in Africa to Mr. C. Crossland and Mr. J. S. Budgett.

An exhibition of astronomical photographs from the Yerkes and Lick Observatories will be given at the Cavendish Laboratory on May 29 by Sir Robert Ball.

Applications for tables at the Naples and at the Plymouth zoological stations should be addressed to Prof. A. Newton by June 5 next.

The complete degree of M.A. *honoris causa* is to be conferred on Mr. T. H. Middleton, the new professor of agriculture.

Mr. W. B. Hardy and Mr. F. G. Hopkins have been appointed examiners for the Gedge prize in physiology.

The Thurston prize for original research in physiology, pathology or practical medicine, open to members of Gonville and Caius College of not more than fifteen years' standing from matriculation, will be awarded this year. The prize is triennial and amounts to about 54*l.* Applications are to be addressed to the master on or before September 30.

A CONVERSAZIONE will be held at University College, London, on Thursday, June 19. A large number of friends and old students will be present, and exhibits will be arranged in connection with the various departments, to illustrate the work being carried on at the College.

THERE is every likelihood that another University will soon be added to the large number of such institutions at present existing in the German Empire. Frankfurt a. M. is the city which is thus to be enriched. It already possesses the Senckenberg's Institute for natural sciences and medicine, and also an academy for the study of social and commercial science. To the former—at which, it may be mentioned, important scientific work is carried on—there has recently been added a laboratory specially constructed for the investigation of cancer. This department is richly endowed, partly, it is said, by the Emperor William, and is placed in the care of an eminent bacteriologist. The academy is very largely attended by foreign as well as German students, America in particular being well represented. And now it is announced that the trustees of the Karl Juegel's bequest have decided to devote the interest on the capital sum of 2,000,000 marks (100,000*l.*) to the erection in Frankfurt a. M. of an academy for the study of history, law, philosophy and allied subjects. When this third institution is established, Frankfurt will possess practically all the faculties, with the exception of theology, which go to form an University; and therefore the authorities have decided to draw up a Bill which, if passed by Parliament, will unite the three institutes of learning into one University. There is strong reason to suppose that no particular difficulty will be encountered in carrying out this plan, for Frankfurt is in many ways eminently suitable for the position of being an University city.

NOW that the second reading of the Education Bill has been passed, efforts should be made in Committee to remove the permissive clause, especially in so far as it affects higher education. At present, as Mr. Henry Hobhouse points out in a letter to the *Times*, there is little more than a framework for legislation. "No statutory duty is laid on the local authority to aid

education 'other than elementary,' and no permanent fund is appropriated for this object. The 'whisky money' is not safeguarded, despite the obvious danger that the ratepayers in certain localities will press for compensation out of this fund for the additional burdens necessitated for the purposes of elementary education. Nor are the objects of higher education in any way defined. The intention of the Government apparently is (though it is not expressed in the Bill) to impose on the new authority the provision of evening continuation schools, pupil teachers' centres, and even training colleges. The restrictions of the Technical Instruction Acts on aiding private profit schools and on teaching trades are swept away. In a word, under part ii., as it now stands, it would seem that a local authority may do anything and need do nothing. Surely Parliament ought to give more guidance than this to the new authorities, or there will be great danger that in certain localities most important developments of educational work will be wholly or partially neglected." As the Bill at present stands, there is a danger that the last case of higher education will be worse than the first.

At the presentation day of the University of London, on May 14, Lord Rosebery was welcomed as the new Chancellor. Principal Rucker read his report upon the work of the University during the past year, and referred to the following points among others. The organisation of the University has been completed by the addition of a new department for University extension and the inspection of schools. Regulations have been passed for the admission of post-graduate students from other Universities to study for the doctorate in London, and it is satisfactory to be able to record that a considerable number of such students are, or are about to be, placed upon the books of the University. Two chairs of chemistry are to be established at University College, one for general chemistry, which will be filled by Prof. Ramsay, the other for organic chemistry. In no subject has the difference between the completeness of English and foreign educational equipment been more marked than in chemistry. Only two or three educational institutions in this country have more than one professor of chemistry, while in Germany even a University of the second-class usually has several professors in that department. It is hoped that the chairs now founded in University College will be the beginning of a great chemical department worthy of London. A very large scheme, which will have an important bearing on the future organisation of the University, has been set on foot in consequence of the munificent offer of the Drapers' Company to give 30,000*l.* in aid of the incorporation of University College in the University. The authorities, both of the University and of the College, have agreed in principle to the main outlines of a plan for incorporation, provided that an initial sum of 110,000*l.* can be raised. There is every reason to hope that this condition will before long be fulfilled. While the University has been engaged in entering into closer relations with the various schools, and in negotiations for the complete absorption of one of them, it has also been undertaking teaching on its own account. All the leading physiologists in London have banded themselves together to give courses of lectures on that subject for advanced and post-graduate students, and Mr. Walter Palmer has generously given a sum of 2000*l.* to enable the experiment to be tried as to whether such lectures would attract an adequate number of students. The University has contributed another 400*l.*, and has also placed a suite of rooms in the University buildings at the disposal of the teachers as laboratories and lecture rooms. To obtain an idea of the research work being done in London, recognised teachers of the University were asked to supply a short statement as to the publications of themselves, their assistants and students during the past twelve months. Nearly six hundred memoirs, papers and minor communications to scientific and literary journals have been reported. As might have been expected from the large number of its members, the medical faculty takes the lead in the number of its publications, somewhat less than half the above total being communications to professional medical societies and journals. Teachers of the University, their assistants and students have made about 220 additions to general scientific literature. They have been the authors, or joint authors, of eleven papers in the *Transactions* of the Royal Society, or of about eighty papers which have appeared in the *Proceedings* of the Royal Society, and in the journals of the Chemical, Linnean, Physiological and other kindred societies. University College heads the list

with a total of about 100 memoirs and papers, while the Polytechnics have contributed about a score. In concluding his report, the Principal remarked: "It is time that London should realise that it is not the want of men, or a dearth of intellectual effort, which has hindered the University of London from taking its place as a great centre of teaching and research. Our needs are organisation, which shall make the results of the work of the teachers, their assistants and students more fruitful and better known as results of which London may be proud, and funds to supply them with the materials for their work."

SCIENTIFIC SERIALS.

American Journal of Science, May.—Notes on living Cycads, by G. R. Wieland. A study of *Zamia floridana*. Particular attention is drawn to the presence on one of the cones of a pinnule of normal form and structure which had grown out from beneath the outer hexagonal tip of one of the upper abortive sporophylls. As in a similar example described by Sir W. T. Thiselton-Dyer, this structure is regarded as a reversion, exhibiting evolutionary stages which may be found in fossilised forms. To speak of these growths as "monstrous cones" is regarded as almost misleading.—On crystals of Crocoite from Tasmania, by K. G. Van Name.—Notes on unusual minerals from the Pacific States, by R. W. Turner. Among the phosphates found were pyromorphite, apatite and monazite, the latter occurring in abundance in the Idaho basin.—On the use of the stereographic projection for geographical maps and sailing charts, by S. L. Penfield. A continuation of previous papers on the same subject.—Note on the application of the phase rule to the fusing points of copper, silver and gold, by T. W. Richards. It has been found by Holbourn and Day that gold gives a very constant melting point, copper two constant points at 1065° and 1034° C., whilst silver gives no fixed point. It is shown that all these results could have been deduced by the application of the phase rule.—The initiative action of iodine and other oxidisers in the hydrolysis of starch and dextrans, by F. E. Hale.—Note on the possibility of a colloidal state of gases, by C. Barus.—Some glacial remains near Woodstock, Connecticut, by J. W. Eggleston.

American Journal of Mathematics, vol. xxiv. No. 2, April.—L. E. Dickson, on the canonical form of a linear homogeneous transformation in an arbitrary field of rationality. In a previous paper (*A. J.* xxii. p. 121) the author obtained a reduction to a canonical form for transformation in a Galois field; it is here proved that the same process applies when the field is arbitrary.—H. B. Newson, a new theory of collineations and their Lie groups. A geometrical theory of collineation in the plane, independent of Lie's analytical method of transformation-groups.—L. P. Eisenhart, infinitesimal deformation of surfaces. A discussion of the transformation $x' = x + \epsilon x_1$, $y' = y + \epsilon y_1$, $z' = z + \epsilon z_1$, with $dx dx_1 + dy dy_1 + dz dz_1 = 0$, and ϵ a small constant, of which the square is neglected.

SOCIETIES AND ACADEMIES.

LONDON.

Royal Society, March 6.—"On the Spark Discharge from Metallic Poles in Water." By Sir Norman Lockyer, K.C.B., F.R.S.

In this paper various modifications produced in the spectra of metals by alterations of the conditions under which the substances are volatilised are discussed and new observations made at the Solar Physics Observatory are described. The investigation was undertaken partly in consequence of a suggestion put forward by Dr. Wilsing, of Potsdam, to the effect that certain conditions, viz. the production of spark spectra in liquids, gave rise to the formation of structural peculiarities in the constituent lines which are characteristic of the spectra of new stars.

One of the chief characteristics of the spectra of Novæ is the occurrence of a series of double lines, each consisting of a bright and a dark component, the latter being always situated on the violet or more refrangible side of the bright line and in contact with it. The usual interpretation of this appearance has been to consider the composite spectrum produced by two bodies in relative motion, but the necessary velocity is greatly in excess of

other known cosmical motions. Recent experiments dealing with the spectra of elements under pressure having shown that by this means the wave-lengths of the lines are altered, Dr. Wilsing suggested that if the pressure were sufficiently great, displacements might be obtained of equal magnitude to those observed in the case of new stars. As the direct application of high pressures is attended with difficulties, he utilised the fact that exceedingly high tensions are produced when electric sparks are discharged in liquids.

Using an induction coil, with jar and air break in the secondary circuit, a brilliant discharge is produced in water, giving a very intense continuous spectrum crossed by faint metallic lines. In this way Dr. Wilsing obtained the spectra of iron, nickel, platinum, copper, tin, zinc, cadmium, lead and silver, and from the examination of the photographs he arrived at the conclusion that displacements of lines and double lines occurred which were in every way similar to those in the spectra of Nova Auriga, and that therefore, in all probability, pressure is the cause of the duplication and broadening of the lines in the spectra of new stars.

On examining the first few spectra obtained under these special conditions, the appearances presented were so suggestive of many of the well-known effects of reversal that a further inquiry was advisable. It has long been known that in ordinary arc spectra many instances occur in which the absorption line is asymmetrical with respect to the emission line; and reference is made in the paper to communications by the author to the Royal Society more than a quarter of a century ago describing these peculiarities in certain silver and rubidium lines.

The experiments at the Solar Physics Observatory were made first with the large Spottiswoode coil, capable of giving a 42-inch spark in air, this being intensified by the insertion of a large glass-plate-condenser in the secondary circuit, so that the sparks obtained were about 3 mm. long in air and 0.5 mm. in water.

Later a 10-inch coil was used with a smaller condenser in circuit, and about the same sparking conditions. The photographs of the spectrum were taken on a large scale by means of a 6-inch Rowland concave grating of 21.5 feet radius, with 14,438 lines to the inch. The first-order spectrum was employed, arranged to photograph the region from λ 350 to λ 4800, occupying a length of 18 inches on the plate. Distilled water was used in all cases.

Of the metals examined (iron, silver, lead, copper, zinc and magnesium) only iron, magnesium and zinc showed reversals, and those of zinc were extremely weak. In all cases the lines of the spectrum of the spark in water are much broader than the corresponding lines in the spectrum of the air-spark. From an examination of several plates of different intensity, however, it appeared that the broadening was, for the most part, of similar nature to that observed in the arc spectrum in air when an excess of material is introduced between the poles.

When the cases of non-symmetrical absorption were considered, it was noted that very different appearances were presented according to the exposure of the spectrum. For example, in the best exposed plate of iron, the line at λ 4260.64 is well reversed in the water-spark, with the part of the emission line towards the red several times stronger than the portion on the violet side of the absorption. An even diminution of the whole composite line, as shown by photographs of less exposure, results in the persistence of the less refrangible portion only of the emission line, which alone would suggest the presence of a line greatly displaced towards the red with regard to the original spark line in air. Several of the iron lines show the intermediate stage, where the violet component is on the verge of visibility, and in these cases the appearance is suggestive of a bright line with a dark companion on its more refrangible border. It is important to note, however, that in these cases the absorption line is usually normal with the position of the original line, the bright component being displaced towards the red.

In the water-spark spectrum of copper it is only with difficulty that any existing line spectrum can be distinguished from the intense continuous emission, and the few lines so recorded present the appearance of broad bands, displaced towards the red. The probability of their being produced in the manner suggested, however, is rendered feasible by the fact that, although no actual absorption is visible, their more refrangible edges are fairly sharply defined, while the other edges are quite diffuse.

A general classification of the phenomena which are thus presented under varying conditions is put forward, the grouping being as follows:—

- (1) *Broadened bright line.* Examples of this stage are presented in the spectrum of copper and the under-exposed spectrum of iron.
- (2) *Broadened bright line with central absorption line.* Well shown in the central line of the violet triplet of iron, λ 4063.76.
- (3) *Broadened bright line with non-symmetrical absorption (maximum of emission towards red).* A good example of this is the iron line at λ 4260.64.

An additional feature of the water-spark spectrum is that many of the lines show inversion of intensity with respect to the air spark spectrum. This is well shown in the lines of iron at $\lambda\lambda$ 4422.74 and 4427.48.

From these considerations it appears that, if suitable exposures are given, lines may be photographed in the spectrum of iron, say, which show all the phenomena described by Dr. Wilsing, but so related to each other and the complete stage—that of reversal, symmetrical or unsymmetrical—that it is impossible to regard them as anything abnormal.

Again, when these appearances are contrasted with the structure peculiar to the spectra of Nova, many divergences of vital importance are found.

In the water-spark the position of the absorption undergoes little if any change of position, while in the case of non-symmetrical reversals, a bright line may be observed greatly displaced towards the red. In the new stars, on the other hand, the absorption lines are greatly displaced, the accompanying

formula the probable error of measures of stars on photographs, and considered the question of personality in estimating the centre of star photographic images. The paper gave rise to some discussion, in which Mr. Hinks, Prof. Turner and others took part.—Father Cortie read a paper by Father Sidgreaves on the spectrum of Nova Persei from September 6, 1901, to February 12, 1902, and showed photographs on the screen. During the period mentioned, the lines of the spectrum had remained very broad and preserved their relative intensities.—Father Cortie read a paper on visual and spectroscopic observations of the sun-spot group of May and June 1901. It appeared that the disturbed area of the corona of May 18, as shown on the eclipse photographs, corresponded with the region in which the spot group had its origin, and marked the time of the outburst, though the region had been disturbed quite a solar rotation before the birth of the spot. In this case of the only great sun-spot in an otherwise quiet year there appeared no correspondence between solar storms and terrestrial magnetic disturbance. The most widened lines in the red end of the spectrum of sun-spots are always faint lines, chiefly of vanadium and titanium. The author concluded that the level of sun-spots is that of the upper, more diffused gases, which give the flash spectrum in solar eclipses. In the discussion which followed, doubt was thrown upon the presence of vanadium in the flash spectrum.—Mr. Dyson described the Greenwich photographic observations of the satellite of Neptune, and also gave an account of a paper by Mr. Cowell on a method of reduction of extra-meridian observations. The method was a general one, suitable for observations at any azimuth, and the computation was facilitated by tables.

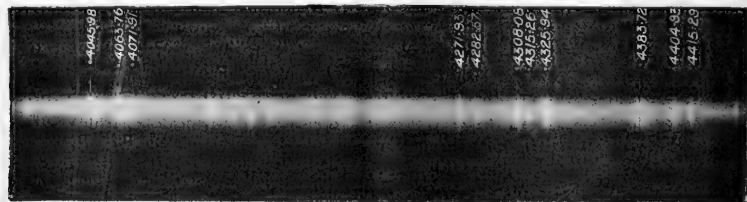

bright lines occupying in comparison normal positions. Thus, in the case of Nova Aurigæ the emission lines had practically normal wave-lengths, but the displacements of the dark lines at H_e were about 10.7 tenth-metres towards the violet, indicating a velocity of approach of about 500 miles per second. The recent new star in Perseus exhibited the same normal positions of the bright lines, and indications of even greater displacements of the dark lines, at one time amounting to 15 tenth-metres at H_e , representing a velocity of approach of the body producing the dark-line spectrum of more than 700 miles per second. These values differ enormously from those produced by pressure.

It appears then that the known direct effect of pressure on the radiation or absorption lines is the same, in quality, in water as in air, that is, displacements are obtained in the opposite direction to those the dark lines are observed to occupy in the spectra of Nova; moreover, the amount of shift observed in the spectra of new stars differs, not only in this respect, but also in degree, thus:—

Spark in water.	New stars.
1. Absorption lines least shifted.	Absorption lines most shifted.
2. Radiation lines most shifted.	Radiation lines least shifted.
3. Absorption shift small.	Absorption shift enormous.

It would thus appear that the pairs of bright and dark lines shown in the spectra of new stars do not arise from the cause, presumably pressure, which produces the appearances presented in the spectrum of the spark discharge in water.

Royal Astronomical Society, May 9.—Dr. J. W. L. Glaisher, president, in the chair.—Mr. H. C. Plummer read a paper on the accuracy of photographic measures, in which he criticised M. Loewy's recent memoir on the subject. Mr. Plummer doubted the possibility of expressing by a single

Linnean Society, May 1.—Prof. S. H. Vines, F.R.S., president, in the chair.—Mr. J. E. Harting exhibited photographs of a living specimen of the African shoe-bill (*Balaeniceps rex*), forwarded from Cairo by Sir William Garstin, K.C.M.G., and gave some account of the bird and of the different views which had been expressed by zoologists regarding its affinities and systematic position.—On the cerebellum of the lemurs, by Dr. Elliot Smith. In this paper, to be published as an addendum to that on the cerebrum read on March 6, the author introduces a revised terminology. Resolving the cerebellum into three main lobes—*anticus*, *medius* and *posticus*, he discards the term "fissura horizontalis magna," since the fissure so named is found to be inconspicuous and sometimes absent, and substitutes for "preclival" the term *prima*, regarding the fissure thus named, which divides the lobus anterior and medius, as the deepest and as constant for all mammalian forms. The detailed characters of the lemuroid cerebellum are described, and the cerebellum of *Notoryctes* is incidentally shown to be the simplest for all mammals.—On the brain of the elephant shrew (*Macroscelides elephantopus*, Shaw), by Dr. Elliot Smith. The brain of *Macroscelides* is shown to be marsupial in the existence of a dorsal fornx commissure of crescentic type, unique in the coexistence with this of a distinct and independent callosum, equal in extent to that of the higher Primates. Comparison is drawn with the cerebrum of those higher Metatheria in which the fusion of callosum and fornx commissure (*psalterium*) is the rule; and the author concludes that the examination microscopically of well-preserved material, of which he is expectant, will reveal a connection between these two which may not necessarily contain nerve-fibres, and may thus realise a condition he has previously described for the Hapalidae.—On the early condition of the shoulder-girdle of the polyprotodont marsupials *Dasyurus* and *Perameles*, by Dr. R. Broom. The author shows that in the mammary fetus of the native cat of Tasmania and Victoria

(*Dasyurus viverrinus*), the cartilaginous coracoid reaches the sternum, as he has previously proved to be the case in the foetal *Trichosurus*. At a later stage, an elongation of the spine and clavicle is all conspicuous, with accompanying withdrawal of the coracoid. In the mammary foetus of the bandicoot (*Perameles obesula*) described, the coracoid is found to exhibit no connection with the sternum, and the scapula to be essentially similar to that of the adult, the clavicle reduced.

Geological Society, April 30.—Prof. Charles Lapworth, F.R.S., president, in the chair.—Mr. J. E. Marr exhibited some specimens from a metamorphosed metalliferous vein several inches wide, which he had discovered in the basic andesites near the Shap Granite, in a quarry close to the high road, north of the spot where it crosses Longfell Gill.—Mr. H. W. Monckton exhibited a flint implement which he had himself found on a heap of gravel, in a pit 278 feet above Ordnance datum, at Englefield (Berkshire). The gravel is part of an elongated patch mapped "Plateau-Gravel." Mr. O. A. Shrubsole remarked that the implement was of Palaeolithic type, and of an advanced form of that type, as it had a cutting-edge all round. It had not been greatly rolled, and was probably made not far from the spot where it was found. Its patination showed that it belonged to the gravel in which it was found.—The origin and associations of the jaspers of south-eastern Anglesey, by Mr. Edward Greenly. Red jasper and jaspery phyllite are widely distributed in the southern and south-eastern parts of Anglesey, in the districts of Newborough, Pentraeth and Beaumaris. They are associated with limestones, diabases, serpentines, and with grits and shales. They have been much modified by earth-movements, which have produced brecciated and schistose structures; but where original structures have survived, the true relations of the rocks can often be seen. The diabases have the same characters as the pillow and variolitic rocks so often associated with radiolarian cherts and jaspers in many parts of the world, and at several different geological horizons; and the relationships of the jaspers and igneous rocks resemble those seen in the radiolarian cherts of southern Scotland.—The mineralogical constitution of the finer material of the Bunter pebble-bed in the west of England, by Mr. H. H. Thomas. Specimens were collected at intervals, from Budleigh Salterton, in Devon, to Fitzhead, near Milverton, in Somerset, and other sands, for comparison, were taken from the red rocks above and below. The sands, on the whole, contain a very small percentage of minerals with a specific gravity of more than 2.8; while the proportion of material over, to that under, 2.8 is about 70 or 80 to 30 or 20 per cent. A list and description of twenty minerals found in the sands is given, with, in some instances, the chief characters by which they were identified. The gradual decrease in the percentage of heavy minerals from Budleigh Salterton to Uffculm indicates the carriage of sediment by a southerly current, and this view is strengthened by the decrease in staurolite and a gradual diminution in the size of the tourmaline-grains. The increase in proportion of heavy grains from Uffculm to Milverton, and the further decline northward, together with the incoming of an assemblage of minerals markedly different from the normal southerly type, indicates an additional source of supply, perhaps a westerly current. The mass of material seems to have been furnished by a highly metamorphosed area, differing widely in its character from any now exposed in the south-west of England. The most probable source of much of the material is the Armorican massif of Triassic times.—Revision of the Phyllocladia from the Chemung and Waverly groups of Pennsylvania, by Prof. C. E. Beecher. The specimens described in the paper, as well as those on which the original descriptions were based, were all obtained in the vicinity of Warren, Philadelphia. The chief horizon is in the shale-beds of the Upper Chemung group, about 50 feet above mean water-level in the Allegheny River. The deposits are called by the writer the "Phylloclad-Beds." Additions and emendations to the original diagnoses of several genera and species are given.

MANCHESTER.

Literary and Philosophical Society, May 13.—Mr. Charles Bailey, president, in the chair.—A paper on the luminous organs in *Pterygoteuthis margaritifera*, a Mediterranean cephalopod, by Mr. W. E. Hoyle, was laid upon the table.—Prof. Boyd Dawkins, F.R.S., brought before the Society the collection of specimens discovered in 1901 in Crete by Mr.

Hogarth in the course of the exploration of the Mycenaean remains of that island. The skulls exhibited belong to the oval-headed, well-developed type termed Mediterranean by Sergi and closely allied to the Iberic type of Spain and of Britain. They bear unmistakable marks of civilisation in the thinness of their walls and the extent to which the sutures are drawn out by the growth of the brain, as well as by the badness of their grinding and the small size of their canines. They probably represent a small, dark race, and were in the Bronze stage of civilisation. Among the remains from the Diclean cave are the skulls of a goat and a hog, portions of those of the fallow-deer, and the forehead with two horn-cores of a domestic ox, for which Prof. Dawkins proposes the provisional name of *Bos buticus*, as it cannot be identified with any species on record.

PARIS.

Academy of Sciences, May 12.—M. Bouquet de la Grye in the chair.—Notice on the works of M. Lazare Fuchs, by M. Camille Jordan.—A study of lithium silicide, by M. Henri Moissan. The discovery of a silicon hydride of the constitution Si_2H_2 suggested the possibility of the existence of a series of corresponding metallic silicides, and in the present paper the preparation and properties of the lithium silicide, Si_2Li_6 , are described. A mixture of silicon with lithium in slight excess is heated in a vacuum at a low red heat for two or three hours and the excess of lithium distilled off between 400° and 500°C . The silicide formed, the analysis of which gave figures corresponding to the formula Si_2Li_6 , forms deep blue crystals. With a small quantity of water, this silicide reacts very violently, a spontaneously inflammable mixture of hydrogen and hydrogen silicide being given off. The slow decomposition with water furnishes only pure hydrogen. It was noted that although a solution of hydrochloric acid gas in dry ether was without action on the compound, the addition of a small quantity of water caused a rapid decomposition.—On the earthquake of May 6, 1902, by M. Michel Lévy. Two records from seismographs show earthquakes on May 6, one at Grenoble at 3h. 4m. 40s., and the other at Floirac at 3h. 5m. 30s. On the supposition of a velocity of transmission of 3 kilometres per second, the epicentre should be in the Mediterranean, east of Murcia and south of Minorca.—On viscous compressible fluids, by M. P. Duhem.—The black coloration of the rocks forming the catacrats of the Nile, by MM. Lotet and Hugouenep. The specimens of granite and porphyry at the catacrats of Ouadi-Halfa and Assouan present a uniformly black and highly polished surface, facts difficult to explain from the composition of these rocks. The polish is attributed to the scouring action of the sand brought down by the water, the black colour to black oxide of manganese. The latter does not exist in the rock mass and must have been formed from the manganese silicates present.—On a project for the organisation of a service of scientific exploration in Indo-China. The committee appointed to consider this question recommend the appointment of a permanent commission under the control of the Academy, the subjects of geology (with mineralogy), botany, zoology and anthropology being represented.—Remarks by M. Janssen on presenting to the Academy photographs of the solar corona taken at the Isle of Reunion during the total eclipse of May 17, 1901, by M. Jean Binot. The photographs from this station were of especial importance on account of the want of success due to climatic conditions at the other places of observation. A whole-page reproduction of this photograph accompanies the note.—The influence of instrumental errors on the rectilinear coordinates of star photographs, by M. Ch. Trépied.—On some orthogonal systems and their application to the problem of the deformation of the paraboloid of revolution, by M. de Tannenberg.—On a class of transformations of partial differential equations of the second order, by M. J. Clairin.—On the prediction of the minimum yield of the sources of the Vanne, by M. Edmond Maillet. If the rainfall of a given winter season is plotted as an abscissa against the yield of the springs for the second quarter following, the results for a number of years fall on regular curves, which can thus be applied to the prediction of the supply for the coming season.—On the continuous spectrum of electric sparks, by M. B. Egnitiss. The spectrum of ordinary electric sparks between metallic electrodes is usually accompanied by a continuous spectrum, the intensity of which is usually very small compared with the intensity of the line

spectrum. The intensity of this continuous spectrum varies in different places, and also varies with the self-induction of the circuit. It is very intense in the case of certain metals such as magnesium, iron, cobalt, nickel and manganese. For all the metals examined, the continuous spectrum can be completely eliminated by choosing particular values for the self-induction.—On a magnetic perturbation observed on May 8, by M. Th. Moreaux. A magnetic disturbance, affecting chiefly the horizontal component, was recorded at the Observatory of Val-Joux, near Saint-Cyr, at a time corresponding to the catastrophe of Martinique.—On a rain of ink on May 7, 1902, by M. Th. Moreaux.—On the conditions of formation and stability of the hydrides and nitrides of the alkaline earths, by M. Henri Gautier. In the case of the hydrides of barium and strontium, certain phenomena were observed which appeared to point to the possible existence of a higher hydride than BaH₂ or SrH₂, but on further examination these results were found to be due to the simple absorption of hydrogen by the hydrides without the formation of any definite compounds. Calcium hydride does not possess this property. The nitrides were found to be much more stable than the hydrides, commencing to form only at temperatures above 600° C., and remaining undecomposed at 1000° C., a temperature at which the hydrides are strongly dissociated.—On some derivatives of anthraquinone obtained by the action of sodium peroxide upon the aloids and their halogen derivatives, by M. E. Léger.—On a new dimethylglutaric acid, by M. E. E. Blaise.—The synthesis of menthone, by M. Georges Leser.—The synthesis was effected by the action of potassium dissolved in absolute alcohol upon a mixture of isopropyl iodide and acetylmethylcyclohexanone.—On the composition and age of the metamorphic rocks of Crete, by M. L. Cayeux. The metamorphic series of western Crete belongs to the Trias of the Mediterranean type, probably to the Upper Trias.—On certain chromatic reactions of the red corpuscles in the blood of diabetics, by M. J. Le Goff.

NEW SOUTH WALES.

Linnean Society, March 26.—Mr. J. H. Maiden, president, in the chair.—The president delivered the annual address.
Ordinary meeting.—Note on two species of *Astralinum* from Port Jackson, by Mr. H. Leighton Kesteven. The author finds that *Astralinum fimbriatum*, Lamarck, and *A. tentoriforme*, Jonas, have, in Port Jackson, been united under the latter name. He finds that in the nepionic stage the former is very depressed, almost discoidal, and perspective umbilicate; whilst the latter is trochiform and not umbilicate, at the same stage. They present the anomaly of two species easily separable in the nepionic stage, becoming so alike in the adult condition that only by their opercula can some specimens be identified.—Studies on Australian Mollusca, part vi., by Mr. C. Hedley. Material from tropical Queensland furnishes two genera, *Congeria* and *Mecolitia*, new to Australia, as well as sundry small forms of *Fyrgulina*, *Crossea* and *Liotia*, new to science.

DIARY OF SOCIETIES.

THURSDAY, MAY 22.

INSTITUTION OF ELECTRICAL ENGINEERS (Society of Arts), at 8.—Annual General Meeting.

FRIDAY, MAY 23.

ROYAL INSTITUTION, at 9.—The Ethical Element in Shakespeare: Rev. Canon Ainger.

PHYSICAL SOCIETY, at 5.—On the Ebullition of Rotating Water; a Lecture Experiment: T. C. Porter.—The Conservation of Entropy: J. A. E. Skirne.—Rational Units of Electromagnetism: Sig. G. Giorgi.

MONDAY, MAY 26.

ROYAL GEOGRAPHICAL SOCIETY, at 8.30.—Anniversary Meeting.
VICTORIA INSTITUTE, at 4.30.—Annual Meeting. Address by Sir Chas. W. Wilson, K.C.M.G., K.C.B.

TUESDAY, MAY 27.

ROYAL INSTITUTION, at 3.—The Laws of Heredity, with Special Reference to Man: Prof. K. Pearson, F.R.S.
SOCIETY OF ARTS, at 8.—Pageantry and the Masque: May Morris.
ROYAL STATISTICAL SOCIETY, at 5.

WEDNESDAY, MAY 28.

CHEMICAL SOCIETY, at 5.30.—Taxim: T. E. Thorpe, C.B., F.R.S. and E. Stubbs.

GEOLOGICAL SOCIETY, at 8.—(1) On the Red Sandstone Rocks of Peel (Isle of Man); (2) The Carboniferous, Permian and Triassic Rocks under the

Glacial Drift in the North of the Isle of Man: Prof. W. Boyd Dawkins, F.R.S.—The Plutonic Complex of Central Anglesey: Dr. Charles Callaway.

THURSDAY, MAY 29.

ROYAL SOCIETY, at 4.30.—*Frohale papers*: The Effect of Daylight on the Propagation of Electro-magnetic Impulses over Long Distances: G. Marconi.—The Minute Structure of Metals and other Plastic Solids: G. Beilby.—The Influence of Varying Amounts of Carbon Dioxide in the Air on the Photosynthetic Process of Leaves and on the Mode of Growth of Plants: H. T. Brown, F.R.S., and F. Escombe.—On the Influence of an Excess of Carbon Dioxide in the Air on the Form and Internal Structure of Plants: Prof. J. B. Farmer, F.R.S., and S. E. Chandler.—On the Structure of the Gills of the Lamellibranchia: Dr. W. G. Ride-wood.

SOCIETY OF ARTS, at 4.30.—Western Australia: its Progress and Resources: Hon. H. W. Venn.

INSTITUTION OF MINING ENGINEERS (Geological Society), at 11.—Working Coal under the River Hunter, the Pacific Ocean and its Tidal Waters, near Newcastle, New South Wales: A. A. Atkinson.—Lead and Zinc Deposits of the Mississippi Valley, U.S.A.: Prof. C. R. Van Hise and H. Foster Bain.—The Campbell Coal-washing Table: Clarence R. Claghorn.—The Mining, Concentration and Analysis of Corundum in Ontario: Dr. W. L. Goodwin.—Re-opening of Hartley Colliery: R. E. Ormsby.—Deposits of Hydrobromate of Lime: its Exploration and Refinement: Carlos A. Lynes Hoskold.—Remarks on Mr. M. Walton Brown's "Report on Mechanical Ventilators": Prof. A. Rateau.

FRIDAY, MAY 30.

ROYAL INSTITUTION, at 9.—The Progress of Electric Space Telegraphy: G. Marconi.

INSTITUTION OF MINING ENGINEERS (Geological Society), at 10.30.—The Training of Industrial Leaders: Prof. J. Wertbeimer.—Smelting in British Columbia: W. Denham Verschyle.—Treatment of Low-grade Copper in Australia: J. J. Muir.—The Tarkenton Goldfield, West Africa: A. R. Sawyer.—Gold-dredging: T. Ross Burt.—Gold-dredging in Otago, New Zealand: F. W. Payne.—Electric Traction on Roads and Mineral Railways: W. R. Cooper.—The Analytical Valuation of Gas-coal: G. P. Lishman.

EPIDEMIOLOGICAL SOCIETY, at 8.30.

CONTENTS.

PAGE

Space Perception. By Prof. Alex. Crum Brown, F.R.S.	73
The Morphological Value of the Centrosome. By J. B. F.	74
Rose Culture	74
Our Book Shelf:—	
Ridgway: "The Birds of North and Middle America."	75
—R. L.	75
Bolas and Brown: "The Lens. A Practical Guide to the Choice, Use and Testing of Photographic Objectives"	75
Brigham: "A Text-book of Geology"	75
Maddougal: "Elementary Plant Physiology"	76
Wullenweber: "Diagramme der electrischen und magnetischen Zustände und Bewegungen"	76
Letters to the Editor:—	
A Remarkable Solar Halo. (Illustrated.)—Rev. T. C. Porter	76
Sun Pillar (?).—Sir W. J. Herschel, Bart.	77
Paleolithic Implements in Ipswich.—Nina Frances Layard	77
Brückner's Cycle and the Variation of Temperature in Europe. (With Diagram).—Alex. B. Macdowall	77
Resultant Tones and the Harmonic Series.—Margaret Dickens	78
Magic Squares.—J. Willis	78
Mont-Pélee and After-Glow.—F. C. Constable	79
The Volcanic Eruptions in the West Indies	79
Mountain Masses and Latitude Determinations	80
Schools and Scholarships	82
The Royal Society Conversazione	83
Notes	85
Our Astronomical Column:—	
Saturn Visible through the Cassini Division	87
Catalogue of North Polar Stars	88
Thermal Expansions at Low Temperatures. By Prof. James Dewar, F.R.S.	88
The Rise of the Experimental Sciences in Oxford. By Prof. T. Clifford Allbutt, F.R.S.	90
Anthropological Researches in India. By A. C. H.	91
University and Educational Intelligence	92
Scientific Serials	93
Societies and Academies. (Illustrated)	93
Diary of Societies	96

THURSDAY, MAY 29, 1902.

THE SUPPLEMENT TO THE ENCYCLO-
PEDIA BRITANNICA.

Encyclopaedia Britannica. Vol. xxv. Pp. xiii + 786. (Aachen to Australia.) Edited by Sir Donald Mackenzie Wallace, K.C.I.E., K.C.V.O., A. T. Hadley, President of Yale University, and Hugh Chisholm, B.A. (London and Edinburgh: A. and C. Black; London: The Times Office, 1902.)

THE critical student familiar with the ninth edition of the "Encyclopaedia Britannica" would have no difficulty in detecting a change of intellectual attitude upon examining the volume before us. When the articles were prepared for the ninth edition, in the seventies and eighties of last century, scholastic traditions had a greater influence in determining the point of view than they have to-day. The result was that early periods of history and early developments of the arts and sciences received far more attention than modern views and methods. The significance of the present was disregarded in the contemplation of the past, while the promise of the future was mostly left out of consideration altogether. This retrospective spirit pervaded very many of the articles, and may be said to represent the characteristic style of a generation educated upon literary ideals. Knowledge was regarded as a structure to be observed in various aspects—as material for philosophy—rather than as something to which continual additions should be made, which alter the character of the whole edifice.

Many changes have occurred during the quarter of a century which has elapsed since a large part of the ninth edition was written. The centre of gravity of the intellectual world has for some years been changing its position, and is now much closer to science than it was, though the humanities have not ceased to exert their influence against the movement. There is still a strong disposition to resent any attempt to disturb a balance which has been preserved for so long. Science is considered as a useful servant, which adds to the comforts of life by the practical applications to which it leads, but the pursuit of natural knowledge is not usually considered so dignified and inspiring, or worthy of honour, as art, or literature, or music. In fact, science in England is a drudge to be tolerated; but her pretensions to a position upon the councils of State, or to rank among essential subjects in education, are scarcely countenanced. A man ignorant of the elements of science, and contemptuous of the value of the study of nature in the formation of character, may, even in these days, arrogate to himself the right to define its limits; and he may depend upon the support of all who wish to preserve the old studies from the influence of the progressive school. It is the familiar story of conflict between old and new knowledge, or, to use another simile, between ancient and modern faiths. The priests of the traditional shrine look with disdain upon the altar erected to science, and warn orthodox worshippers against its influence. But mental developments create new attitudes of mind, and unless the guardians of ancient views adapt themselves to new circumstances, they are in opposition to the whole spirit of progress.

NO. 1700, VOL. 66]

In the new volume of our national encyclopaedia, it is satisfactory to observe the change that has occurred to bring the work in touch with current scientific results and opinions. The articles upon scientific subjects are numerous, as well as being substantial statements upon the state of various branches of natural knowledge—from the points of view both of the student and the practical man. Among the subjects dealt with are every important country or region with names between Aachen and Australia; in addition to accumulators, acetylene, achromatic objectives, acid and alkali manufacture, acoustics, Adams, adulteration, aeronautics, æther, agriculture, agricultural machinery, air-gun, Airy, algae, algebra, algebraic forms, alloys, aluminium, amphibia, amphioxus, anatomy, angiosperms, antelope, anthozoa, anthropology, anthropometry, appendicitis, aquarium, aqueduct, arachnida, argon, armour, assaying, astronomy and atmospheric electricity.

It will easily be understood that adequate notice of these contributions could not be given in a review; so all we can do is to describe a few of the subjects surveyed.

The ten pages devoted to "Accumulators" contain a clear account of the principles and structure of several typical cells. In an excellent section on the setting up, forming and discharge of cells (p. 29), the word "hygrometer" is an obvious mistake for "hydrometer." Failures, their remedy and avoidance, are illustrated from a number of charge and discharge curves from actual experiments. The chemical reactions receive due attention, and, finally, the uses of cells in central station work and trams are shortly discussed. It is, however, surprising to find no mention of Salomon's work in the references to the literature of the subject.

Under "Acetylene," a concise account of the stability of the gas under various conditions is followed by a short description of the "ingot" and "run" methods of making carbide, a good *résumé* on the purification of the gas, and a few words upon generators and burners, which might with advantage have been extended.

A short article on "Achromatic Lenses" mentions the recent success of Jena glass and Abbe's experiments.

Under "Acid and Alkali Manufacture," in addition to the well-worn description of sulphuric acid plant, we find an interesting account of the "contact" method for producing SO_3 , followed by some details upon the condensation of hydrochloric acid from the salt cake process, and subsequently some valuable judicial statements upon the position of the Leblanc process and the inroads of electrolytic methods.

Under the heading "Acoustics," we have an investigation of the change in form of sound waves of finite amplitude, effects of temperature and wind, short descriptions of König's tuning fork, McLeod and Clark's stroboscopic methods and Lord Rayleigh's phonic wheel, the electrically maintained tuning fork, sensitive flames and jets. Brief investigations are given of Fourier's theorem and the methods of determining the specific heat ratio of air from the velocity of sound. The section on combination tones is of special interest in connection with recent researches.

The article on "Aeronautics" is of especial interest in connection with modern experiments, both on the

propulsion of balloons and on flight proper. It is illustrated by excellent photographs of both Zeppelin's and Santos Dumont's machines, and contains valuable statistical information in the form of tables, which will enable the reader to compare at a glance the means employed and the results achieved in attempts to navigate the air both by the *plus léger* and the *plus lourd* methods. A remarkable result shown by the tables is the very great advance made in increasing the weight sustained per horse-power in the gliding experiments under gravity made by Lilienthal, Pilcher and Chanute, though the writer of the article expresses the opinion that the substitution of an artificial motor would reduce these results by one-half. Another table gives the resistance of surfaces at different incidences, calculated for planes by Duchemin's formula and for curved wings from Lilienthal's investigations; and among other features we notice illustrated accounts of Chanute's gliding machines, Langley's and Hargreaves' aerodromes, and Ader's "Avion." With such information the reader will have little difficulty in forming a correct estimate of the present state of aerial navigation.

It is difficult to summarise briefly the contents of the important article on "Æther." The necessity for assuming the existence of an æther, the differences between æther and matter, the question as to whether the æther is in motion and the dynamical theories of the æther form the chief themes of the article. At the present time "æther" has become an every-day word, but few who use it have much idea of what it means. The present article is clear and authoritative, and if it does not answer the unanswerable question, "What is æther?" it does much to place this question on a sound and scientific basis.

The article "Agriculture" deals, in two separate chapters, with the changes that the past quarter century has witnessed in British and American agriculture, and its most remarkable feature is the contrast which these two chapters present. The first begins with the observation that the period 1875-1900 was a "fateful" one for the "greatest British industry," and in the opening pages shows that floods and stock diseases characterised the first, and drought the last decade of this period; that for every 100 acres under wheat in 1875 there were but fifty-four in 1900; that wheat worth 45s. per quarter in the former year was worth 27s. in the latter, and that two Royal Commissions investigated the distressed condition of the British farmer. Passing from this melancholy narrative to the chapter on agriculture in the States, we find the American writer revelling in the resources of his country. Between 1875 and 1897 the States farmer took possession of as much new land as would cover all France and Germany.

"Since 1870 the production of nearly all farm crops increased more rapidly than the population, the most absolute proof of the prosperity of the people."

As a result of better implements and better tillage, the yield of wheat is gradually increasing, and will, it is believed, continue to increase. Much land is yet available for wheat-growing, and the idea that a generation hence Americans will cease exporting wheat is regarded as quite erroneous.

The illustrations of British live stock are excellent, and
NO. 1700, VOL. 66]

the specimens the photos of which are given prove that "depression" has not yet succeeded in wresting from our breeders the preeminent position they held when the ninth edition was published. We are proud of our draught horses and we congratulate ourselves on their increase; but so different is the American standpoint that the writer almost apologises for their presence.

"Until the use of more and cheaper motors becomes possible, farm animals must increase with farming operations."

It is significant in this connection that all the illustrations of animals are British and all the illustrations of machines American. Some of the implements shown are popular in this country, and some of them are largely manufactured here, but though the workmanship is British the ideas are exclusively American.

Agricultural education and research are actively carried on in the States; on research alone nearly 700 workers are engaged. The English writer describes the work done at Rothamsted, "the greatest and the oldest of experiment stations"; but Lawes and Gilbert are dead and there is no intention of progress. Are we standing still? The writer of the article "Agricultural Machinery" prefaces his chapter by remarking that Americans, as implement makers, have gone "far ahead" of their rivals in the United Kingdom, and "the following article is accordingly written from an American standpoint." The volume does not inspire much hope, but hope and work we must if the next edition of the "Encyclopædia Britannica" is to deal with agriculture from a British point of view.

Among the contributions on botanical subjects, the article on the "Algæ" is eminently satisfactory, not only as regards the array of facts, but also as incorporating the results of recent researches and the modifications in arrangement derived therefrom. The connection of the Cyanophyceæ with the Schizomycetes and the relationship of the Diatomaceæ to the Peridiniaceæ are pointed out. Evidence for and against alternation of generations is fairly weighed up, while on polymorphism the conservative view of Klebs is maintained. The physiological principles underlying "Anatomy" are clearly brought out in dealing with non-vascular plants. But when the writer elaborates the stelar conception in connection with vascular plants these principles fall into the background. A tolerably safe course is steered through stelar difficulties, but no attempt is made to separate purely topographical changes from those of a morphological nature. The "Angiosperms" are treated almost entirely from the physiological point of view. Autotrophic plants are described as geophytes, aërophytes and hydrophytes. The author's views on phylogenetic relationships would have been extremely interesting, but discretion overrules speculation. The systems of Bentham-Hooker and Engler-Prantl are merely outlined, while van Tieghem's novel classification is shortly criticised.

The article upon "Universal Algebra" gives in three pages a summary account of the various special algebras which have been invented by modern analysts. Such, for instance, are Hamilton's calculus of quaternions, Grassmann's extensive calculus, and the barycentric calculus of Möbius. The article on "Algebraic Forms"

occupies thirty-seven pages, and is divided into sections dealing respectively with determinants and elimination, symmetric functions, binary and other forms, enumerative functions with their generators, and the theory of restricted substitutions. For the first time, perhaps, the methods of the English school have been discussed, in the same work, in conjunction with the symbolic calculus of Aronhold and Clebsch. Each method has its own special advantages, and the comparative study of both is very instructive. A good deal of space is devoted to Gordan's important theory of transvectants and their reduction, and to Stroh's recent extension of symbolic methods. Many parts of the article illustrate the value of the partition analysis as developed by MacMahon; what he calls "the theorem of expressibility," and the correspondence which he establishes between differential operation and partition operators, are real and fruitful contributions to mathematical science. This article is valuable, not only as a record of known facts, but also as suggesting new fields of research. The section on determinants contains little, if anything, that is not in the text-books; if this had been suppressed, and some other topics treated at greater length, it would have been an advantage.

"Astronomy" occupies twenty-eight pages, which contain a general account of some recent developments relating to the solar system, gravitational and theoretical astronomy, and the sidereal universe. In the section upon the planets, descriptions are given of progress in such subjects as the rotation periods of Mercury and Venus, the markings on Mars, the minor planet Eros, new satellites of Jupiter and Saturn, and Keeler's proof of the discrete constitution of Saturn's rings. The view that the dark regions on Mars are not oceans, as was formerly supposed, but the solid surface of the planet, is accepted, and also that which regards the canals or channels as not being physically continuous formations, but optical effects produced by more or less irregular differences in the minute shadings and colour tints on the surface of the planet.

In the section on gravitational and theoretical astronomy, the chief advances recorded relate to apparent deviations from the law of gravitation exemplified by motions of the planetary perihelia and inequalities of the moon's mean motion, and variation of latitude. The application of photography to celestial portraiture is briefly dealt with in the section on the fixed stars, and it is suggested that what is now required is a photographic survey of the heavens with the view of determining all the stars which have an appreciable parallax. Special attention is given to the structure of the sidereal universe and to systems of stars and clusters, but very little is said of spectroscopic advances in either connection. As progress in astronomy during the last quarter of a century means to a large extent progress in astrophysics, which depends almost entirely upon the spectroscope for its development, we assume that spectroscopic astronomy will be dealt with separately. The article certainly does not convey an accurate or adequate view of the physical and chemical aspects of the science, and it must be supplemented by one on celestial spectroscopy if the complete work is to be regarded as worthy of the intentions of the editors.

NO. 1700, VOL. 66]

To everyone familiar with astronomical progress during the past quarter of a century, the article will be disappointing; for it is more of the nature of an essay than a contribution to an encyclopædia. What is required in an encyclopædic article upon any science is a concise and unbiassed summary of work and results, otherwise the contribution is misplaced. Measured by this standard, the article on astronomy fails entirely of its purpose, for it is both prolix and incomplete. Many small text-books contain far better statements of the position of astronomical science than is here given, because the authors have been to the trouble to become acquainted with the literature of the subject. This, however, has evidently not been done by the writer of the article under notice, and the result is a contribution which will give readers very imperfect ideas as to progress made since the contribution for the ninth edition was written. The new edition of the encyclopædia afforded an opportunity for giving a view of the vast amount of new material which has been accumulated by astronomers from unlooked-for sources, but instead of this inspiring survey we have a superficial essay upon a few points which have appealed to the writer. The article should have been a record of all essential advances of the science, whereas it is more remarkable for what is omitted than for what is included.

Few articles in the ninth edition of the encyclopædia could have required more extensive revision and addition than those devoted to zoological subjects. How great was the need for such revision, and how marked has been the progress in zoological discovery since the appearance of the former edition, is manifest by the articles in the volume under notice, which include the subjects "Amphibia," "Amphioxus," "Anatomy," "Anthropology," "Arachnida" and "Arthropoda." Some of these are in great part practically new treatises, while others, such as the one on anthropology, confine themselves to the additions necessary to bring their predecessors up to date. The change of view that has taken place with regard to the relationships of the lower vertebrates will be manifest when the new and the old articles on amphibia are contrasted, while the advance in our knowledge of the structure of the extinct representatives of the latter is apparent by the amount of space allotted to this portion of the subject. The article on Amphioxus is entirely new, and occupies nearly four pages.

The discoveries of modern histological methods of investigation are fully recorded under the heading of "Anatomy," while the Pithecanthropus is alluded to under "Anthropology," and Mr. Henry's method of classifying finger-prints receives mention in the article "Anthropometry." The Funafuti boring and the inferences to be drawn therefrom are discussed in some detail under "Anthozoa"; while in "Arachnida," Prof. Ray Lankester adduces a long string of facts to show that the nearest living relatives of kingcrabs and trilobites are scorpions rather than crustaceans. Several of the authors had by no means an easy task before them in bringing up to date the work of their predecessors, but they all seem to have done their parts in a highly satisfactory manner.

Finally, we may say that an earnest endeavour has been made by the editors to produce a work which represents the

advances of science since the ninth edition was prepared, in so far as they come within the purview of the present volume. Whether considered as one volume of a supplement to the ninth edition or as a statement of the position of many scientific subjects, the work is a worthy addition to our national literature.

PRACTICAL PHYSIOLOGY.

Directions for Class Work in Practical Physiology. Elementary Physiology of Muscle and Nerve and of the Vascular and Nervous Systems. By E. A. Schäfer, LL.D., F.R.S. Pp. 76. (London: Longmans, Green and Co., 1901.) Price 3s. net.

THE contents of this book are well-nigh sufficiently indicated by its subsidiary title, and it is inconceivable that in dealing with the elementary aspects of the subjects named its distinguished author could go wrong. He informs us that his directions are based upon an experience of many years in University College, London, and that they deal "only with such elementary exercises as can readily be worked out by even a large class."

There are twelve chapters in all, and the most distinctive feature of the book is the manner in which the student, having been given concise instructions as to the nature and mode of utilisation of apparatus, and of preparation of the organic object to be studied, is left to "notice" or observe for himself the nature of the effect of this or that operation. A most wholesome procedure—a method of the kind which must be always begotten of a lengthy teaching experience such as the author proclaims.

Of the twelve chapters, the first opens with a description of the "voltaic element" and of the Daniell cell, the rationale of the replacement of the former by the latter being clearly explained. The Grove and Leclanché cells, with the chief types of the latter, are in turn considered; and, with adequate descriptions of electrodes, keys, rheochords, the induction coil and their uses, and a section on unipolar induction, the chapter closes. Chapters ii. and iii. are devoted to nerve-muscle preparations, the sartorius being utilised for the demonstration of the independent irritability of muscle and nerve, and the hyoglossus for that of the "latent period." The effects of heat and cold, of fatigue, the action of curari and veratrin, are in due course considered and clearly set forth; and in chapters v., vi. and vii. the effects of successive stimulation, leading up to tetanus and the muscle sound, the rate of the nervous impulse, the effects of CO_2 and the "electrotonus" phenomenon, are simply described, Ritter's and Pfleger's laws being incidentally laid down.

Chapter viii. deals with secondary contraction and the use of the capillary electrometer and galvanometer. The two chapters which follow are devoted to the heart, cardiac nerves, and the use of the plethysmograph; and the two which conclude the work deal with the chief vascular and respiratory mechanisms in man, with reflex action and its time limitations, as determinable by the use of the Wallerian lever apparatus.

There are in all forty-five simple text-illustrations, thirty-eight of apparatus and seven of dissections of the common frog. The book is well worthy its aim, and Prof. Schäfer, clearly of a mind to give the elementary

student little and good, has done that functionary a great service.

There are, in addition to the seventy-six printed pages, twenty-six which are blank; but whether, according to the bookbinder's custom, these are intended to give stability to an otherwise thin volume, or whether they are for the convenience of the student in making annotations, we are not informed. As matters now progress, however, in electrophysiology, it would seem that ere long one or two of these blank pages may be destined to bear a thirteenth chapter, since the Eastern mind, coming fresh and untrammelled to the work, is showing us that under a mechanical stimulus phenomena of electrical response akin to those until recently demonstrated only for the higher animals and the sensitive plants, appear to be at least also obtainable from vegetable organisms at large—a result which points to the conclusion that in these well-known phenomena we are dealing with a fundamental property of protoplasm, and calls for immediate investigation of the unicellular organisms, in the study of which the clue to all that is physiological has ever to be sought.

OUR BOOK SHELF.

The Elements of Physical Chemistry. By J. Livingston R. Morgan, Ph.D. Second edition. Pp. x + 352. (New York: Wiley and Son; London: Chapman and Hall, Ltd., 1902.) Price 2 dollars.

TO write a book the object of which is to present the elements of the entire subject of physical chemistry, together with the important and but little known applications of it to the other branches of chemistry, within the scope of 322 small pages is by no means an easy task. The author has, however, succeeded in presenting within these limits a very readable account of the subject.

To the reader familiar with the works on physical chemistry and electrochemistry published by German authors during the last ten years, a close likeness between these and the present volume is at once apparent. The author, as a matter of fact, in his preface states that no claims of originality are made for the major portion of the text.

It is doubtful whether a text-book which is obviously intended for the use of comparatively elementary chemical students should be so replete with mathematical formulæ. For a beginner, a more descriptive method of treatment of the subject would have been, in the opinion of the reviewer, more satisfactory.

The subject-matter is divided into ten chapters, the first being devoted to introductory remarks on the subject of energy and methods of determining atomic weights; then follow sections on the gaseous, liquid and solid states, solution, thermochemistry, chemical change, phases and electrochemistry, the last chapter containing a series of 156 problems bearing upon the subject-matter of the text. This last chapter is a most welcome innovation. For the beginner, the very numerous and abstract formulæ of physical chemistry have but a vague significance; only when these formulæ have been applied to concrete cases do they become properly understood by the student. Ample scope for exercise in the application of these formulæ is provided by the last chapter, although perhaps in a few cases the problems are not very happily chosen.

Thermochemistry and the phase rule are treated of in a superficial manner, only five pages being devoted to the consideration of the latter. In a future edition it is hoped that the author will see fit to deal with the important work which has been done on transition tem-

peratures and the formation and decomposition of double salts. Although the present volume is a second edition of the work, yet the text is not free from misstatements. On p. 87 we are told that "when liquids mix in all proportions . . . then it is possible to make a complete separation of the constituents by a fractional distillation, provided the vapour pressures of the two differ," a statement which is afterwards contradicted by examples which are given of the different types of liquid mixtures. On p. 210 we are told that the ferrous ion is greenish-black in colour, and on p. 260 that all binary organic acids satisfy the dilution law of Ostwald. Misprints are also not uncommon and authors' names are not always correctly spelt, "Tammen" for "Tammann" and "Pebel" for "Pebal" being instances.

If, however, the defects here alluded to are remedied in the next edition, the book will, without doubt, serve as a very useful aid to students of physical chemistry.

H. M. D.

Practical Botany for Beginners. By F. O. Bower, Sc.D., F.R.S., and Dr. T. Gwynne-Vaughan, M.A. Pp. xi + 307. (London: Macmillan and Co., Ltd., 1902.) Price 3s. 6d.

THIS excellent little book, written by Prof. Bower in 1894, appears in a second edition after being subjected to careful revision. Mr. Gwynne-Vaughan now shares with Prof. Bower the author's responsibility. The more prominent changes are the adoption of the nomenclature introduced with the stellar conception and a more elaborate description of grosser morphological features. The number of seeds described is increased to eight Dicotyledons and three Monocotyledons, and more than twenty flowers are taken as types of these two groups. The main types remain the same, except that the elm gives place to the lime. Other additions are the stems of *Ricinus*, *Veronica Beccabunga* (aquatic Dicotyledon), *Elodea Canadensis* (aquatic Monocotyledon), and leaves of *Ligustrum*, *Hedera*, *Deschampsia* and *Phormium*. The paragraphs on reserve and transitory materials have been considerably added to and improved, so that suitable material and the necessary tests are given for demonstrating the presence of starch, proteids and various sugars in the vegetative parts and in seeds. Exception may be taken to certain types chosen—for instance, *Marchantia* and *Fucus*—but obviously the general occurrence of these has weighed with the authors in their choice. Passing to methods of manipulation, glycerine and chlor-zinc iodine are almost exclusively recommended as mounting media; in several cases, notably *Pinus*, double staining and mounting in Canada balsam would give better results, while mounting in water avoids undue swelling of the walls of phloem cells such as follows the use of glycerine and Schulze's solution.

The book is already so well known that it is unnecessary to emphasise the careful arrangement of subject and the clear descriptions which characterise it.

Quelques réflexions sur la mécanique suivies d'une première leçon de Dynamique. Par Emile Picard, Mem. Inst. France. Pp. 56. (Paris: Gauthier Villars, 1902.)

THE first part is based on a report drawn up by M. Picard in connection with the Paris Exhibition of 1900 dealing with modern views on the principles of mechanics and in particular on the "energetic" method, and the dynamical system of Hertz. The second part consists of the first lecture given by M. Picard, since 1894, in his course on general mechanics, introducing the elementary principles of dynamics. It differs somewhat from the conventional treatment, and in this country Newton's third law will probably be regarded as constituting a less artificial definition of mass than is used by M. Picard.

LETTERS TO THE EDITOR.

The Editor does not hold himself responsible for opinions expressed by his correspondents. Neither can he undertake to return, or to correspond with the writers of, rejected manuscripts intended for this or any other part of NATURE. No notice is taken of anonymous communications.

Volcanic Eruption in Java, Brilliant Sunset Glows in 1901, and probable Glows from the Eruption in Martinique.

THE brilliant sky glows and sunsets following the eruption of Krakatoa, near Java, on August 26 and 27, 1883, threw a flood of light on the movements of the upper atmosphere in a way which was probably not otherwise possible. Up to that time it had been supposed generally by meteorologists that the air forming the trade winds ascended at the equator and turning toward the poles became a south-westerly current in the northern hemisphere and a north-westerly current in the southern hemisphere flowing over the trades. After the explosion eruption of Krakatoa, the large mass of observations gathered by the committee of the Royal Society and the admirable discussion of the optical phenomena by Russell and Archibald ("The Eruption of Krakatoa and Subsequent Phenomena," London, 1888) brought out the following facts:—

(1) The haze, sky glows and brilliant sunsets progressed from east to west three times around the world within the tropics at a rate of about seventy-five miles an hour.

(2) They spread northward and southward from 20° N. and 20° S. very slowly, taking from September 2 to about October 7 for the conspicuous phenomena to spread from 20° N. to 35° N. in America, a velocity of about one-half a degree a day, or one mile an hour.

(3) Above 35° latitude the progressive motion was rapid and apparently from the south-west in the northern hemisphere and from the north-west in the southern hemisphere.

There are two other important conclusions which I think may be drawn from the data, and these are:—

(1) The atmosphere between 20° N. and 20° S. moved with a nearly uniform velocity from the east; otherwise it would have been impossible to trace the movement of the dust cloud around the world three times, because a very slight difference in velocity or direction at different latitudes would very soon have destroyed the individuality of the cloud, whereas Russell's lines of first appearance are nearly parallel with each other between 20° N. and 20° S.

(2) There are frequent temporary disturbances in this region by which the air is carried rapidly outward in narrow belts into extratropical regions. One of these disturbances was shown on August 27, when the dust was carried rapidly to Japan, another on August 28, when dust was carried to South Africa, and another on September 1, when dust was carried to Santiago, Chili.

The movement of the atmosphere above the tropics established by this investigation differed so from that supposed to exist by meteorologists that it was sought to explain it as a temporary movement and not representative of average conditions. But Abercromby was so much impressed by the phenomena that he began to gather observations of the movements of cirrus within the tropics. These are published in the volumes of NATURE between 1887 and 1890. Hildebrandsson has pursued the subject farther, and his results show that in the equatorial regions between 20° N. and 20° S. the prevailing movement of the cirrus is from the east. North and south of these latitudes the directions change to a movement from the west. It is probable that between these two opposing belts of wind there is a nearly calm zone across which the air moves very slowly from the equator.

These facts are dwelt on in order to show the importance of such observations preliminary to calling attention to recent sky glows and volcanic eruptions.

In the autumn of 1901, Mr. Rotch, Mr. Sweetland and myself noticed independently that the sunsets were more brilliant than usual at Blue Hill (lat. 42° 13' N., long. 71° 7' W.), and the following notes were entered in the records of the Observatory:—"October 7.—Since about September 20 the sunsets on clear days, including to-day, have shown unusually bright colours, a bright red predominating and lasting near the horizon for three-quarters of an hour or longer; November 2, a very brilliant sunset, red prevailing, and the colours continued for about forty-five

minutes after sunset; November 3, a brilliant orange sunset after a very clear day.³³

These observations were recalled by the receipt within a few days of a pamphlet from Mr. T. F. Claxton on "The Recent Sunset and Sky Glows." This paper was presented to the Mauritius Meteorological Society on August 27, 1901.

The first few paragraphs are as follows:—

"The gorgeous sunsets and sky glows of the past three months recall those vivid displays of 1883 and 1884 which were associated with the disastrous volcanic eruptions at Krakatoa, in the Straits of Sunda, and it is not surprising to learn that toward the end of May of this year similar, though less serious, eruptions occurred in about the same locality, according to the following cablegram which appeared in the *Daily Graphic*—

"Batavia, May 23, 1901.—The volcano of Keloet is in eruption. It is reported that there has been great loss of life among the natives. District of Kediri enveloped in total darkness."

The sunset glows at Blue Hill followed this eruption, and the sky glows at Mauritius after about the same interval as similar but more brilliant glows in these latitudes followed the eruption of Krakatoa. It would be extremely interesting to know if there are observations at intervening places. We should be glad to receive notes of such at the Blue Hill Observatory, Hyde Park, Mass., U.S.

I wish also to call attention to the recent violent volcanic eruption in the island of Martinique, and suggest that observers be on the watch for the earliest optical phenomena. We should be glad to receive notices of such observations. There were some marked barograph undulations at Blue Hill on the morning of May 7 which are perhaps connected with this volcanic eruption.

HENRY HELM CLAYTON.

Blue Hill Observatory, Hyde Park, Mass., May 10.

A Method of Showing the Invisibility of Transparent Objects under Uniform Illumination.

As is well known, a perfectly transparent object is visible only in virtue of a variable illumination. This condition might be approximately realised, as Lord Rayleigh points out in his article on "Optics" in the "Encyclopædia Britannica," on the top of a high monument in a dense fog. It is doubtful, however, if the experiment would be very successful even under these conditions, as the observer's body screens the light in certain directions, making the illumination far from uniform. The following method I have found to give very good results:—

The inside of a hollow sphere of metal, which can be separated into two cups, is thickly coated with Balmain's luminous paint. A small hole, not much larger than the pupil of the eye, enables the observer to view the interior and any objects within the sphere. I used for the sphere one of the metal floats which are used as automatic regulators in water tanks, and which can be obtained from any plumber. The float was made in two parts, which were easily separated by melting the solder. It is rather difficult to get a good uniform layer of the paint. Several coats are required, and even then it is apt to appear streaky in the dark. I am inclined to think that a better plan would be to mix the dry powder with boiled down Canada balsam, which will harden on cooling, and coat the outside of two glass hemispherical evaporating dishes with the hot mixture. The lips of the dishes would make the eyehole. This mixture I have found produces much more uniform surfaces, and I am employing it at the present time in some experiments in infra-red photography.

If the inner surface is exposed to sunlight, and a transparent object such as a glass or crystal ball, a thick lens or a cut glass decanter stopper is put in the interior, it will be found to be practically invisible when viewed through a small hole, for light of equal intensity is incident in every direction. I have found that a large stopper with many facets does not quite disappear, some of the edge facets appearing darker than the diffused blue glow which fills the interior of the ball. This I believe to be due to the fact that the light reaching the eye from these facets by refraction happens to have undergone several internal reflections and suffered a loss by absorption owing to a long path through the glass. The luminosity of the interior of the sphere is not quite uniform, however, and this may be sufficient to explain the appearance of these facets. The observation is best made in a darkened room, the eye being brought close up to the small aperture.

Since writing the above I have tried the balsam mixture on

the outside of hemispherical glass dishes. It is, however, better to scratch a small hole in the paint than to attempt to use the lips of the dish as an aperture, as in the latter case the line of union, which is always slightly darker than the rest of the surface, cuts directly across the field of view, which is a disadvantageous arrangement.

R. W. WOOD.

Johns Hopkins University, Baltimore.

Misuse of Coal.

THE tone of Prof. Perry's letter in reply to Mr. Rosenhain is so acquiescent that it may seem to diminish the force of his original contention as to the national misuse of our stock of coal. There are two considerations which ought to be stated in reply to the plea that men may learn to grow their fuel as they go on, by a proper cultivation of the best vegetation.

The first is this. The soil will not long continue to yield food if it be asked to produce fuel also. About three years ago Sir W. Crookes devoted his address, as president of the British Association, to the consideration of the present position of the world's food-supply question, and arrived at the conclusion that the outlook was not far from a gloomy one.

In that conclusion he was but echoing Malthus, though with much better data and a more complete record as to what were in Malthus's day unexplored countries.

If examination of the food-yielding powers of the soil leads to such a result, it is evident that to add an additional demand for fuel will seriously injure both. Even though Malthus and Sir W. Crookes be only partially right, enough is left to prevent us getting any long-lived satisfaction by growing fuel. There remains the possibility of "intensive" cultivation, and this may be one form of the new engine Prof. Perry asked scientific men to look for. Already Lord Rayleigh has made a bold attempt to make this economically possible by preparing nitric acid from the air. Perhaps with the resources Prof. Perry asked for, Lord Rayleigh might succeed.

The second point is this. Prof. Perry's concern was mainly for British resources. The economic life of a large proportion of our people is bound up with an economic advantage in fuel and other minerals. Every scientific discovery which raises the efficiency of transformation from coal fuel to mechanical power helps to defer the day in which England's mineral endowment will no longer be exceptional. The moment that oil or other natural fuel can compete with coal in the open markets, our prosperity must begin to decline. Similarly, if fuel can be grown to compete with coal, we lose position, simply because we cannot expect to grow so easily and well as many other countries.

The motive impelling towards a constant search for improved efficiency in the use of coal is therefore doubly strong on our people and Government. Any improvement would be helpful to the whole world; for us it would defer a calamity, possibly for a very long time.

W. HIBBERT.

101 Goldhurst Terrace, N.W., May 20.

The Conservation of Weight and the Laws of Thermodynamics.

IN NATURE of May 15, Lord Rayleigh uses the laws of thermodynamics to prove the conservation of weight.

In regard to the doctrine of the conservation of energy (the first law of thermodynamics) the following statement is made in Maxwell's "Theory of Heat," p. 145, tenth edition: "The evidence which we have of the doctrine is nearly if not quite as complete as that of the conservation of matter."

Taking this passage to imply that the two doctrines, conservation of weight and of energy, are to be held true as far as experiment has proved them true, and no farther, the question arises—To what extent have the laws of conservation been proved?

The experiments of Landolt (1893) and of Heydweiller (1901) show that the conservation of weight holds, in the cases investigated by them, to one part in one hundred thousand. The accuracy of the law to one part in a million is left under suspicion.

Energy being more difficult to measure than weight, it is unlikely that the conservation of energy has been proved to one part in one hundred thousand. At the present time, would not Maxwell say, "The evidence which we have of the conservation of energy is not as complete as that of the conservation of weight"?

From the laws of thermodynamics it can be shown, doubtless, that the conservation of weight is absolutely true, but this only on the assumption that the conservation of energy is absolutely true. Again, granted it can be shown that the conservation of weight is true in the same degree as the conservation of energy, yet these proofs will remain of strictly mathematical interest so long as our knowledge of the conservation of energy remains of a lower order of accuracy than that of the conservation of weight.

It seems natural for the human mind to state scientific laws in absolute terms. Nevertheless, in most cases it is proved that the accuracy of the laws is limited. If a scientific law is believed in outside the limits of proof, the law is no longer a matter of knowledge—it has become an article of faith. These are platitudes; they have point only because scientific men state the laws of conservation in absolute terms, and hold these laws as articles of faith.

A. N. M.

University College, Liverpool.

A Solar Halo.

In a letter to NATURE of May 1 (p. 5) a description is given of a remarkable lunar halo seen at Verkes Observatory. A solar halo of almost identical character is reported in the meteorological returns for April from Sule Skerry Lighthouse off the north coast of Scotland. The following note and sketch are appended by Mr. N. A. Macintosh, the lightkeeper, to his report:—

"A curious phenomenon was observed in the sky on the 28th. At 12.30 p.m. there was a perfect ring or halo right round

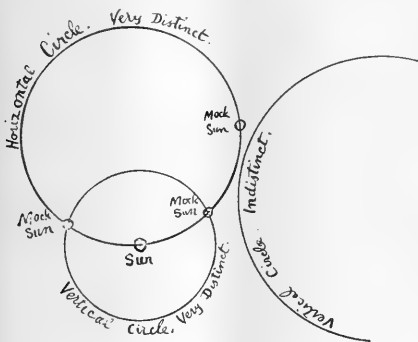

FIG. 1.—Solar Halo, April 28.

the top of the sky with the sun in its southern edge. At right angles to it, and round the sun, was another ring with two 'mock suns' where it bisected the larger ring. These 'mock suns' showed prismatic colours, but about due east on the edge of the larger ring there was a 'mock sun' pure white. In the south-eastern sky there was an indistinct half-circle from the horizon up to the horizontal circle which showed prismatic colours, whilst the others were colourless. At the time there was haze all over the sky, but the sun shone very clearly. It lasted till 1.30 p.m."

The position of Sule Skerry is lat. $59^{\circ} 6' N$, long. $4^{\circ} 20' W$, and as the sun is about 14° north of the equator on April 28, its elevation at local noon, about which time the halo was first seen, would be practically 45° . Hence the "horizontal circle" the centre of which is at the zenith would have a radius of 45° . Evidently, therefore, from Mr. Mackintosh's sketch the "vertical circle" is the ordinary halo of 22° radius. The "horizontal circle" is also well known, though not so often seen as the halo; it is due to the reflection of the sun's light from the vertical faces of the ice-crystals. The coloured mock suns where the two halos intersect are also well known, but with the sun as high as 45° they would be expected to lie a little outside the 22° halo on the white circle. The other mock sun on the eastern side of the horizontal white circle is more rare; it may coincide with the point where a larger halo cuts the horizontal circle, but the laws determining the formation of this halo and

its exact position are not known, and portions of it have been seen on only three or four occasions of which we have any record.

The last item in the sketch, the coloured semicircle rising from the south-eastern horizon to almost touch the horizontal circle, I am unable to suggest any explanation for. The sketch is evidently reversed, as in it this and the white mock sun are shown on the western side. In recording observations of coloured halos, mock suns, &c., it would greatly add to their value if notes were made of the arrangement of the colours, such as "red inside, blue outside halo," "red next sun, blue away from it," and *vice versa*.

R. T. OMOND.

Scottish Meteorological Society, Edinburgh, May 17.

Mathematical Training.

IN view of the great influence which Schopenhauer has exerted on German thought, I referred to his chapter on mathematics, and find that half a century ago he was even more sweeping in his condemnation of the methods of Euclid than are some of your present correspondents. He mentions that the exact sciences are confined to those dealing with time, space and causality, or without being too precise as regards names, the exact sciences are arithmetic, geometry and logic. Schopenhauer's view is that each of these sciences is independent of the other, and he illustrates this by saying that mathematically it is just as self-evident that two parallel lines cannot meet as it is logically self-evident that an impossibility is not possible. He strongly objects to our aping the Greeks and basing mathematics on logic, and I feel sure that he would consider that mathematics were being degraded by the excuse so often given for teaching it at all, that "Euclid is an invaluable logical training." If I understand him correctly, Schopenhauer holds that any mathematical proposition is as self-evident as any correct logical sequence, and only requires illustrations or explanations (not proofs) to make this clear to our somewhat imperfect brain. This he might have illustrated by the Pythagorean proposition, which can be shown to be correct without the elaborate logical scaffolding used by Euclid, provided that one's mind can grasp the proportionality of similar triangles. Let a, b, c be the lengths of the sides of a right-angled triangle, draw a perpendicular from the apex intersecting the hypotenuse c , and divide it into two lengths d and e . We then have three similar right-angled triangles and the following two sets of proportions:—

$$\frac{c}{a} = \frac{a}{e} \quad \text{and} \quad \frac{c}{b} = \frac{b}{d}$$

from which it follows that $a^2 = c \cdot e$ and $b^2 = c \cdot d$, and as $d + e = c$, we have $a^2 + b^2 = c^2$.

Most other propositions, if not self-evident, might be dealt with in the same way; and if we were as gifted as Newton was, we would, as he did, wonder why anybody should trouble to demonstrate the, to him, quite self-evident truths in Euclid.

In our public schools we are taught classics, not because of the logic they contain, for it is often wrong, but because they exercise our memory (and, I fear, cripple our reasoning powers), and we teach mathematics; not to improve our knowledge of space, but to improve our logic and sometimes also to improve our memory. Naturally our views about space are often hazy, and our reasoning powers, which receive no direct training, are not infrequently stunted, or rather compelled to work in narrow grooves.

C. E. STROMEYER.

Lancefield, West Didsbury, May 12.

Influence of Light upon Plant Assimilation.

I HAVE for some time been endeavouring to devise a simple and cheap apparatus for demonstrating the effect of red and blue light respectively upon the assimilatory power and nycytic movements of plants. The apparatus usually supplied by the dealers for this purpose consists of a double-walled bell-jar into which a solution of potassium bichromate or of ammoniacal copper sulphate may be poured. This is a rather expensive piece of apparatus for school use, especially if a large one is required. I have not been able to find a blue or red glass that absorbs blue or red light only. I have tried home-made glass cells about a foot square and a quarter of an inch internal diameter, but could not prevent leakage. Perhaps some reader of NATURE could help me. Is there a transparent coloured paper or some kind of coloured membrane that would serve the purpose?

E. E. HENNESSY.

Bigods School, Dunmow, Essex, May 19.

THE FARMERS' YEARS.

II.

CARNAC AND ITS ENVIRONS.

It has long been known that the stones which compose the prehistoric remains in Brittany are generally similar in size and shape to those at Stonehenge, but in one respect there is a vast difference. Instead of a few, arranged in circles, as at Stonehenge, we have an enormous multitude of the so-called menhirs arranged in many parallel lines for great distances.

The literature which has been devoted to them is very considerable, but the authors of it, for the most part, have taken little or no pains to master the few elementary principles which are necessary to regard the monuments from the point of view of orientation.

It is consoling to know that this cannot be said of the last published contribution to our knowledge of this region, which we owe to Monsieur F. Gaillard, a member of the Paris Anthropological Society and of the Poly-mathic Society of Morbihan at Plouharnel.¹

M. Gaillard is a firm believer in the orientation theory and accepts the view that a very considerable number of the alignments are solstitial. But although he gives the correct azimuths for the solstitial points and also figures showing the values of the obliquity of the ecliptic as far as 2200 B.C., his observations are not sufficiently precise to enable a final conclusion to be drawn, and his method of fixing the alignments and the selection of the index menhir is difficult to gather from his memoir and the small plans which accompany it, which deal with compass bearings only.

All the same, those interested in such researches owe a debt of gratitude to M. Gaillard for his laborious efforts to increase our knowledge, and will sympathise with him at the manner in which his conclusions were treated by the Paris anthropologists. One of them, apparently thinking that the place of sun rising is affected by the precession of the equinoxes, used this convincing argument:—"Si, à l'origine les alignements étaient orientés, comme le pense M. Gaillard, ils ne le pourraient plus être aujourd'hui; au contraire, s'ils le sont actuellement, on peut affirmer qu'ils ne l'étaient pas alors!"

M. Gaillard is not only convinced of the solstitial orientation of the avenues, but finds the same result in the case of the dolmens.

I cannot find any reference in the text to any orientations dealing with the farmers' years, that is with amplitudes of about 24° N. and S. of the E. and W. points; but in diagrams on pp. 78 and 127 I find both avenue and dolmen alignments, which within the limits of accuracy apparently employed may perhaps with justice be referred to them; but observations of greater accuracy must be made, and details of the heights of the horizon at the various points given, before anything certain can be said about them.

I append a reproduction of one of M. Gaillard's plans, which will give an idea of his use of the index menhir. It shows the cromlech and alignments at Le Mézec. The line A—Soleil runs across the stone alignments and is fixed from A by the menhir B, but there does not seem any good reason for selecting B except that it appears to fall in the line of the solstitial azimuth according to M. Gaillard. But if we take this azimuth as N. 54° E., then we find the alignments to have an azimuth roughly of N. 66° E., which gives us the amplitude of 24° N. marking the place of sunrise at the beginning of the May and August years, and the alignments may have dealt principally with those times of the year.

I esteem it a most fortunate thing that while I have

been casting about as to the best way of getting more accurate data, Lieutenant Devoir, of the French Navy, and therefore fully equipped with all the astronomical knowledge necessary, who resides at Brest and has been studying the prehistoric monuments in his neighbourhood for many years, has been good enough to write me a long letter giving me the results of his work in that region, in which the problems seem to be simpler than further south; for while in the vicinity of Carnac the menhirs were erected in groups numbering five or six thousand, near Brest they are much more restricted in number.

Lieut. Devoir, by his many well-planned and completely accurate observations, has put the solstitial orientation beyond question, and, further, has made a most important observation which establishes that the May and

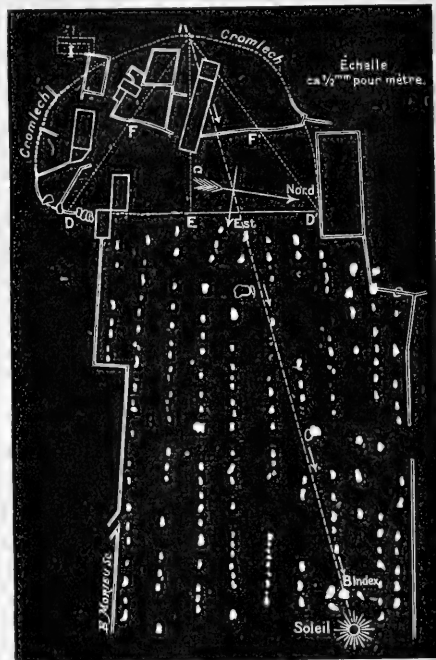

FIG. 1.—Alignments at Le Mézec.

August sunrises were also provided for by a system of alignments. He permits me to make the following extracts from his letter:—

"It is about twelve years ago that I remarked in the west part of the Department of Morbihan (near Lorient) the parallelism of the lines marked out by monuments of all sorts, and frequently oriented to the N.E., or rather between N. 50° E. and N. 55° E. I had ascertained, moreover, the existence of lines perpendicular to the first named, the right angle being very well measured.

"The plans, which refer to the cantons of Ploudal-mézeau and of St. Renan (district of Brest) and of Crozon (district of Chateaulin), have been made on a plane-table; the orientations are exact to one or two degrees.

¹ "L'Astronomie Préhistorique," Published in "Les Sciences Populaires, revue mensuelle internationale," and issued separately by the administration des "Sciences populaires," 15 Rue Lebrun, Paris.

"In the cantons of Ploudalmézeau and of St. Renan, the monuments are generally simple; seven menhirs are visible of enormous dimensions, remarkable by the polish of their surface and the regularity of their section. The roughnesses hardly ever reach a centimetre; the sections are more often ovals, sometimes rectangles with the angles rounded or terminated by semicircles. In the canton of Crozon the monuments are, on the contrary, complex; we find a cromlech with an avenue leading to it of a length of 800 metres, another of 300 metres. Unfortunately, the rocks employed (sandstone and schist from Plungastel and Crozon) have resisted less well than the granulite from the north part of the Department. The monuments are for the most part in a very bad condition; the whole must, nevertheless, formerly have been comparable with that of Carnac-Leomariaquer.

"For the two regions, granitic and schistose, the results of the observations are identical.

"The monuments lie along lines oriented S. 54° W. \rightarrow N. 54° E. (54° = azimuth at the solstices for $L = 48^{\circ} 30'$ and $i = 23^{\circ} 30'$) and N. 54° W. \rightarrow S. 54° E. Some of them determine lines perpendicular to the meridian.

"One menhir (A), 6m. 90 in height and 9m. 20 in circumference, erected in the small island of Melon (canton of Ploudalmézeau, latitude $48^{\circ} 29' 05''$) a few metres from a tumulus surrounded by the ruins of a cromlech (B and C), has the section such that the faces 1 and 2, parallel and remarkably plane, are oriented N. 54° E. (Figs. 2 and 3.)

"At 1300 metres in the same azimuth there is a line of

3k. 700m. an overturned block of 2m. 50 in height, which is without doubt a menhir; towards the S.-W. it passes a little to the south some lines of the island Molène. . . . (Fig. 4.)

"There exists in the neighbourhood other groups, forming also lines of the same orientation and that of the winter



FIG. 3.—Melon Island, showing Menhir (A) and Cromlech (B and C).

solstice. It is advisable to remark that orientations well determined for the solstices are much less so for the equinoxes, which is natural, the rising amplitude varying very rapidly at this time of year.

"The same general dispositions are to be found in the complex monuments of the peninsula of Crozon. I take for example the alignments of Lagatjar. Two parallel lines of menhirs, $G'G''$ $H'H''$, are oriented to S. 54° E. and cut perpendicularly by a third line, $I'I'$. There



FIG. 2.—Menhir (A) on Melon Island.



FIG. 4.—Menhirs of St. Dourzal, D, E, F.

three large menhirs (D, E, F) of which one (E) is overturned. The direction of the line passes exactly by the menhir A. Prolonged towards the N.E. it meets at

existed less than fifty years ago a menhir at K, 6 metres high, which is to-day broken and overturned. This mégalith, known in the country by the name of 'pierre

du Conseil' (a bronze axe was found underneath it) gives with a dolmen situated near Camaret the direction of the sunrise on June 21.

"I have just spoken of the lines perpendicular to the solstitial one; there exists more especially in the complex



FIG. 5.—Alignment at Lagatjar, G G'.

monuments another particularity which merits attention. Between two monuments, M and N, on a solstitial line, sometimes other menhirs are noticed, the line joining them being inclined 12° to the solstitial line, always towards the east."

I must call particular attention to this important observation of Lieut. Devoir, for it gives us the amplitude 24° N., the direction of sunrise at the beginning of the May and August years. It shows, moreover, that, as at Le Ménez according to M. Gaillard, the solstitial and May-August directions were both provided for at the monuments in the neighbourhood of Brest so carefully studied by Lieut. Devoir.

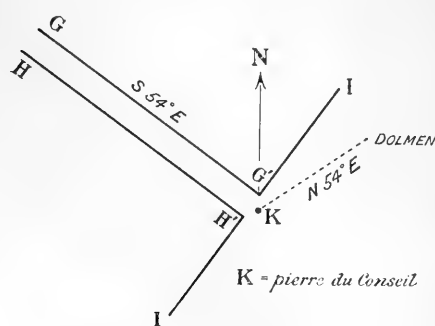

FIG. 5.—Alignments at Lagatjar, showing the pierre du Conseil and the direction of the dolmen. From the pierre du Conseil the dolmen marks the sunrise place at the summer solstice, and the avenue G G' H H' the sunset place on the same day.

I think I have already stated that there is evidence at Stonehenge that the sunrise at the beginning of the May and August years was observed, so that in this we have another point common to the British and Breton monuments.

Lieut. Devoir points out the wonderful regularity of form and the fine polish of many of the menhirs. The one at Kerloas (11 metres high) heads the list in point of size; others in the island of Melon (7 metres), at Ker-gadion (8 metres and 10 metres), Kerennour, Kervaon and Kermabion follow suit. He considers them to have been erected at the time of the highest civilisation of the Megalithic peoples. It will be of interest to inquire whether they are generally associated with solstitial alignments. He also states that these regularly formed menhirs do not exist at Carnac, or in the region of Pont l'Abbe, so rich in other remains. It may be, then, that in these localities the May-August worship predominated, and that the index menhirs of M. Gaillard which do not form part of the alignments were erected subsequently.

THE YEARLY FESTIVALS IN EGYPT.

The vague year in Egyptian chronology makes it a very difficult matter to determine the exact Gregorian dates for the ancient Egyptian Festivals, but, fortunately, there is another way of getting at them.

Mr. Roland Mitchell, when compiling his valuable "Egyptian Calendar" (Luzac and Co., 1900), found that the Koptic Calendar really presents to us the old Egyptian year, "which has been in use for thousands of years and has survived all the revolutions."

Of the many festivals included in the Calendar, the great Tanta fair, which is also a Mohammedan feast, "is the most important of all held in Egypt. Religion, commerce and pleasure offer combined attractions." As many as 600,000 or 700,000 often attend this great fair. Mr. Mitchell holds that it is "no doubt the survival of one of the ancient Egyptian national festivals."

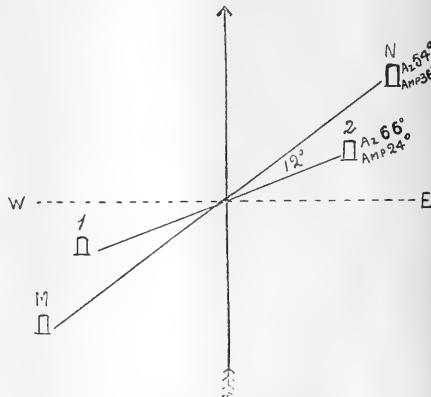

FIG. 7.—Menhirs M, N, on N.E.-S.W. solstitial alignment. Menhirs 1, 2, on May-August years alignment, sunrise May-August, sunset November-February.

It is held so as to end on a Friday, and in 1901 the Friday was August 9!

This naturally suggests that we should look for a feast

in the early part of May. We find the festival of El-Khidr and Elias in the middle of the wheat harvest in Lower Egypt; of this we read:—

"El-Khidr is a mysterious personage, who, according to learned opinion, was a just man, or saint; the Visir of Zu'l-Karneyn (who was a great conqueror, contemporary with Ibrahim—Abraham—and identified in other legends with Alexander the Great, St. George, &c.). El-Khidr, it is believed, still lives, and will live until the Day of Judgment. He is clad in green garments, whence probably the name. He is commonly identified with Elias (Elijah), and this confusion seems due to a confusion or similarity of some of the attributes that tradition assigns to both."

"The 'Festival of El-Khidr and of Elias,' falling generally on May 6, marks the two-fold division of the year in the Turkish and Armenian Calendars, into the Rüz Kâsim and the Rüz Khidr (of 179-80 and 185-6 days respectively)."

This last paragraph is important, as it points to ancient sun worship, Helios being read for Elias; and 179 days from May 6 bring us to November 1. So we find that the modern Turks and Armenians have the old May-November year as well as the ancient Egyptians who celebrated it in the Temple of Min at Thebes.

The traces of the Pthah worship are not so obvious. Finally, it may be stated that the second Tanta fair occurs at the spring equinox, so that the pyramid worship can still be traced in the modern Egyptian Calendar. The proof that this was an exotic is established, I think, by the fact that no important agricultural operations occur at this period in Egypt, while in May we have the harvest, in August and November sowing, going on.

THE NEW YEAR'S OFFERINGS.

In my last article I showed that each year, whenever it began, was, if possible, associated with some fruit of the earth, and that at the winter solstice the chief available vegetable product was the mistletoe.

But about the mistletoe there is this difficulty. Innumerable traditions associate it with the Druids and the oak tree. Undoubtedly the year of the Druids was the solstitial year, so that so far as this goes the association is justified. But as a rule the mistletoe does not grow on oaks. This point has been frequently inquired into, especially by Dr. Henry Ball (*Journal of Botany*, vol. ii. p. 361, 1864), in relation to the growth of the plant in Herefordshire, and by a writer in the *Quarterly Review* (vol. cxiv.), who spoke of the mistletoe "deserting the oak" in modern times and stated, "it is now so rarely found on that tree as to have led to the suggestion that we must look for the mistletoe of the Druids, not in the *Viscum album* of our own trees and orchards, but in the *Loranthus Europæus* which is frequently found on oaks in the south of Europe."

On this point I consulted two eminent botanical friends, Mr. Murray, of the British Museum, and Prof. Farmer, from whom I have learned that the distribution of *V. album* is in Europe universal except north of Norway and north of Russia; in India in the temperate Himalayas from Kashmir to Nepal, altitude 3000 to 7000 feet.

The *Viscum aureum*, *Viscum luteum* or *Loranthus Europæus*, according to Dixon,¹ is a near relation of the familiar mistletoe, and in Italy grows on the oak almost exclusively. There are fifty species of *Loranthus* in the Indian flora, but *L. Europæus* does not occur.

In the *Viscum aureum* we have the "golden bough," the oak-borne *Aurum frondens* and *Ramus aureus* of Virgil; and it can easily be imagined that when the Druids reached our shores this would be replaced by the *V. album* growing chiefly on apple trees and not on oaks; indeed, Mr. Davies, in his "Celtic Researches," tells us that

¹ *Notes and Queries*, Ser. iv. vol. li. p. 112.

the apple was the next sacred tree to the oak, and that apple orchards were planted in the vicinity of the sacred groves. The transplanting of the mistletoe from the apple to the oak tree before the mystic ceremonies began was not beyond the resources of priestcraft.

It must not be forgotten that these ceremonies took place at both solstices—once in June, when the oak was in full leaf, and again in December, when the parasitic plant was better visible in the light of the young moon. Mr. Fraser, in his "Golden Bough" (iii. p. 328), points out that at the summer solstice not only was mistletoe gathered, but many other "magic plants whose evanescent virtues can be secured at this mystic season alone."

It is the ripening of the berries at the winter solstice which secured for the mistletoe the paramount importance the ceremonials connected with it possessed at that time, when the rest of the vegetable world was dormant.

NORMAN LOCKYER.

THE RECENT VOLCANIC ERUPTIONS IN THE WEST INDIES.

IN continuation of the articles which have already appeared in NATURE upon the recent volcanic disaster in the West Indies, we are able to give this week some further information upon the character and consequences of the eruptions. Prof. Milne traces the development of the disturbances and uses his intimate knowledge of volcanic and seismic effects to show how they may be interpreted. In addition, we give two separate notes upon the ash ejected during the eruptions, and seismographic records in France on May 6. The nature of the dust ejected from the Soufrière will soon be satisfactorily determined, for last week's West Indian mail brought to this country numbers of packets of the volcanic ash which fell at Barbados, 100 miles to windward, during the night of May 7-8. The Imperial Department of Agriculture has despatched specimens to the Natural History Museum, the Geological Society, Prof. Judd, &c.

Arrangements have been made for the small scientific expedition referred to in last week's NATURE, and the members are to sail as we go to press with this number. The expedition consists of Dr. Tempest Anderson, Dr. Flett, and another member of the staff of the Geological Survey. The Colonial Office has promised to assist the Royal Society in defraying the expenses of this expedition.

For convenience, we bring together in diary form the reports of volcanic and other possibly related disturbances which have occurred during the past few days. This record of events is in continuation of those already abridged from dispatches published in the *Times*, *Daily Mail*, *Daily Graphic* and other papers:—

May 18, *Autun (France)*.—Uneasiness is beginning to be felt in regard to the volcano of St. Pierre-de-Varennes, between Couches-les-Mines and Le Creusot, which has always been considered extinct. Low rumblings have been heard, accompanied by tremblings of the earth, and at 11.30 p.m. similar noises of more than usual loudness caused considerable alarm among the inhabitants of the district.

May 18, *St. Vincent*.—An eruption of the Soufrière occurred between about 8.30 p.m. and midnight, accompanied by thundering noises and incessant electrical discharges.

May 19.—There was a great eruption of Mont Pelée. The volume of lava emitted surpassed that of May 8. It overflowed Grande Rivière and destroyed the buildings and cultivation which were previously untouched.

May 20, *Pointe à Pitre*.—Mont Pelée ejected thick black cloud and hot mud and stones, covering the greater part of Martinique. A heavy pall hung over Fort de France, followed by flashes of light.

May 21, *Fort de France*.—A further eruption of Mont Pelée occurred.

May 22, *Victoria (B.C.)*.—An explosion occurred in the Crow's Nest coal mines at Fernie, in the Kootenay district.

May 22, *Pointe à Pitre*.—From the new crater on the north side of Mont Pelée the lava is flowing in a broad stream into the sea.

May 24, *Fort de France*.—Mont Pelée emitted a torrent of lava and mud, which rushed down the northern slope and swept away what remained of the town of Basse Pointe. New fissures also opened in the side of the mountain.

May 24, *St. Vincent*.—Rumblings are heard and vapour is still issuing from different points on the Soufrière, and lava is still flowing.

May 24, *Hamburg*.—A fall of so-called "blood rain" occurred in Hamburg and district. It was found that the phenomenon was due to the presence of numerous insects (*Carabus coccinella*), and it is suggested that they were driven with volcanic dust from Martinique.

May 25, *Fort de France*.—Mont Pelée is fairly quiet, although there have been eruptions of ashes which covered the extreme north of the island. The new crater is active.

May 25, *Geneva*.—Grey snow fell in the canton of Lucerne. The heaviest fall was at Langenthal. When it melted, a substance resembling ashes covered the grass.

May 26, *Vienna*.—At noon to-day the seismological apparatus at the observatory of Laibach, Carniola, recorded strong earthquake shocks within a distance of 473 miles.

May 27, *Fort de France*.—A fresh and very violent eruption has taken place. The crater has projected a heavy rain of ashes and gravel over the north of the island. At the same time thick clouds charged with electricity floated in the air.

The fears that existed amongst those who escaped the disasters which took place between May 7 and 10 that volcanic wrath was not expended have been fully realised. Devastation has succeeded devastation, fertile slopes have been doubly buried, new craters have been opened and molten rock yet flows. On Thursday, May 8, at about 11.50 a.m. in our time, Mont Pelée did its worst. La Soufrière commenced earlier, and fought the heavens and all within its reach for several days. Next came a period of comparative tranquillity, Pelée for twelve days and La Soufrière for seven, but the hopes that this created were destined to be rudely shattered by terrific explosions and fresh bombardments. Surely we may now expect, although spasmodic ejections of vapours, ash and lava will yet occur, that these Titans must, by a process of natural exhaustion, sink back to their original quiescent state. But what about the nerve-shaken survivors who yet feel tremblings of the ground and yet breathe fumes wafted downwards from the peaks which dominate their homes?

During the preliminaries which ushered in the great explosion, when the air was filled with noxious exhalations and soft white ash carpeted streets as if the doomed who remained within their houses were to pass away without hearing the hurrying footsteps of those who rushed aimlessly along in their endeavours to escape, *puter nostros* were heard from thousands on their knees. Both men and women lost their reason, a mental paralysis was far-reaching, while the sincerest prayers that were ever offered were accompanied by hysteria.

Many sought refuge in the churches, where sacraments were exposed and services were held. Here, with eyes beyond tears, multitudes with terror graven on their faces confessed and prayed, listened to the exhortations of their pastors and the thunderings of the mountain, awaiting their end. During this reign of terror, which lasted for five long days and nights, no doubt many succumbed.

Then came the final crash, and with a blast of poisonous, suffocating gas, a whirlwind of flame, and beneath a rain of hot ash and blocks of rock, a fair township and its surrounding hamlets which had nestled on Pelée's western strand were seen no more. Only one, we are told, escaped the deadly gas and fire. He was a negro charged with

murder, shut up in a subterranean prison. The destruction was even more complete and terrible than that which was accomplished by brimstone and fire in the days of Lot.

When the more violent thunderings ceased, let us consider what next happened amongst the survivors around the desert of desolation. The majority rose from their knees, to be terrified by every puff of steam they saw and to rush from their houses at the slightest tremor of the ground. For years to come, not only will the eruptions in Martinique and St. Vincent form a subject of conversation, but the month of May and the year 1902 will, like the twenty-seventh year of Uzziah, when a mountain near Jerusalem was moved 500 paces and the temple rent in twain, mark a period from which to date events. No doubt survivors are yet pouring into each other's ears fresh tales of horror, whilst grumbings in the distant hills result in delirium and prayers. Many will no doubt sing hymns and devote themselves to religious exercise, and perform acts of penance. Noorthouck, in his "History of London," writing about the effects of earthquakes and referring to that which occurred in the West Indies in 1691, tells us that "such intermittent fits of reformation excited by fear resemble death-bed repentances too much to merit any encomium."

Although Noorthouck's view is sustained by the action of those who had courage to back cupidity by returning to the still smoking débris which represented St. Pierre and rob from corpses, yet those who write the history of this disaster will no doubt find that the shock which the nervous system of survivors sustained has had some lasting effect. By this time, no doubt, not only in the West Indies, but throughout the world, these eruptions have afforded materials for many sermons and moral discourses, and for some time to come a cloud of smoke from the throats of Pelée or the Soufrière will claim a *miseriordia* in response.

After the disaster which overtook Jamaica in 1691, we understand that a sentence was interpolated in the Litany as used in that island, whilst the special prayers which have been formulated in consequence of volcanic disturbances are numerous throughout the world. In the history of nations we read that these outbursts have resulted in officially ordered prayers, gifts to temples, special services, the repeal of taxes considered to be unjust, and in many other directions have had a more or less permanent effect upon the social, religious and civil lives of many people.

Those who dwell in countries like our own, where displays of volcanic activity are unknown, possibly think themselves beyond the pale of the emotional influences which they exert. When, however, they call to mind the fact that the vulgar of many nations, to use the words of Buffon, have regarded volcanoes as the mouths of hell, their bellows to be the cries of the damned and the eruptions the effects of the fury and despair of the wretched prisoners, and add to this the fact that throughout all history equally strange ideas have immediately followed on the heels of unusual displays of volcanic and seismic activity, it is difficult to suppose that any nation can exist that has not suffered or been benefited by these mental aberrations. In Japan we have the myth of the buried cat-fish which shakes the empire, and the effect of this poetical idea is met with in the pictures and art of that empire; whilst parallel stories with their parallel effects are found in many other countries. The strange thing is that these emotional creations seem to spread far beyond the limits of the ashes and the tremblings which produced them, to flourish where the imaginative faculty is the strongest. Although we are without volcanoes, we have only to recall names like Pluto, Vulcan and Poseidon and the line in the Decalogue which tells we are not to make any likeness of that which is in the earth beneath to realise that volcanic activities have had

a marked effect upon our religion, our literature, our pictorial and our glyptic art.

Those who visit the West Indies with the object of extending our knowledge of vulcanology will no doubt collect information bearing on these far-reaching effects, and it is not unlikely that it will be found that the eruptions in the Antilles have done more to stimulate the imaginations of Europeans than those of the negroes who witnessed all that happened.

Another neglected chapter in hypogenic geology to which attention may be directed relates to the effects of volcanic activity on epidemic diseases, a subject which has attracted the attention of many investigators. American and Italian statistics, Dr. Bardswell says,

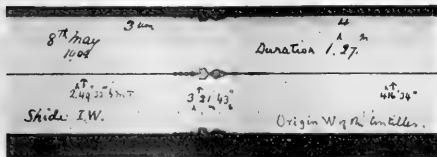

FIG. 1.

show that there is "an increased death-rate from malaria, enteric, &c., with a lessened death-rate from phthisis in areas associated with volcanic activity as compared with non-volcanic regions"—a statement, however, not beyond criticism.

No doubt types of neurosis like nausea, disordered sensation, nervous apprehension, insanity, paralysis of the limbs and other kindred troubles will have a sporadic existence, but it does not seem likely that these will be so marked amongst the negroes as amongst the Europeans.

The destruction of water-pipes or the contamination of water supplies by sewage might result in diseases like cholera and typhoid. Although cases of bron-

other, may be stirred into activity in regions far removed from volcanic centres, to result in diseases which may affect, not only animals, but also plants.

The causes of death in St. Pierre were no doubt manifold. First there was the blast of irritating gas and dust which caused suffocation. In all probability this gas was in the main that of hydrochloric acid derived from the sodium chloride of the sea-water, the infiltration of which is the main cause of all volcanic activity. This gas has been pouring out of Pelée and La Soufrière in the columns of steam during all stages of their eruptions and by this time, no doubt, it exists as a belt round our world, many of the inhabitants of which are breathing exhalations which had their origin in the West Indies.

Many were killed, particularly at La Soufrière, by a rain of hot ashes or by lightning, which played in the darkness of the ashy cloud like fiery serpents.

On May 8, when Pelée burst an opening on its flanks, a whirlwind of fire or a sheet of flame, followed by red-hot ashes, stones and boiling water, swept over St. Pierre and its harbour to sear and scald and fire all that it passed. We have here a phenomenon deserving close attention. If this flame really existed, what was its origin? Mr. F. J. M. Page gave the writer the suggestion that it was the ignition of a "water gas" produced when the water forming the lake in the crater of Mont Pelée was suddenly admitted into the fiery furnace of its interior. The action would be similar to that which takes place when a teaspoonful of water is thrown upon a hot fire; dissociation would take place, an explosion would occur, and the resultant gases would be ignited as a flash. That the inhabitants of a city should be overwhelmed by a wall of fire created by the cool waters of the lake in which they bathed seems incredible, but still, this is at present the only explanation we have for this unparalleled occurrence.

About premonitory signs a correspondent of the *New York Herald* tells us that dumb animals were wiser than man, live stock were uneasy and almost uncontrollable. Cattle lowed in the night, dogs howled, and when driven out showed symptoms of fear. Wild animals disappeared from Mont Pelée. Even snakes crawled away. Birds



FIG. 2.

chitis have resulted from the inhalation of volcanic gases, diseases arising from these causes are extremely rare.

An ingenious theory, showing the possibility of a relationship between volcanic action and the production of epidemic diseases, is one advocated by Dr. W. G. A. Robertson. He does not assume that poisonous products issue from volcanic vents to render the atmosphere poisonous, or even that these products appreciably affect its constitution. What, however, he does assume is that these gases and vapours may be diluted to an immense extent to produce an atmosphere suitable to the vital activity of unicellular organisms. According to this view, microparasites, which are always present somewhere or

ceased singing and left the mountain, and a great fear seemed to be upon the island.

Signs like these, which usually are only recognised after a catastrophe has taken place, are by no means peculiar to the Antilles. The late Prof. S. Sekiya, of Tokio, kept pheasants to study their behaviour before an earthquake, and I have had many opportunities of confirming his observations, which show that these birds by their screaming feel the preliminary tremors of an earthquake, to which movements human beings are insensible. This, then, being the case, it does not seem at all unlikely that the creatures living on the slopes of Mont Pelée heard sounds and felt vibrations the occurrence of which was not noticeable by man. Although

Cicero, in the "De Divinatione," says that "God has not predicted so much as the divine intelligence of man" and omitted reference to the intelligence of the lower animals, it seems probable that in certain directions the instinct of brutes is not to be overlooked.

The small earthquakes which frequently precede a volcanic eruption are usually referred to as abortive attempts made by internal forces to establish an opening. But should all such earth shakings be regarded in this manner? It seems likely that some of them may be simply intermittent yieldings in the general process of rock folding, which, when it has sufficiently relaxed its hold upon the imprisoned vapours, allows the same to burst forth as an eruption. Whether before the eruption there were unusual escapes of gas from subterranean sources, whether there had been changes in colour, taste, level or temperature of the water in wells and springs, we have not yet been told.

Neither have we been told of any prophet who boldly came forth and announced the impending danger; but what we do know is that whilst the Governors of the Windward and Leeward Islands are yet striving to allay the fears of terrified inhabitants, thoughtless Cassandras are predicting tornados, new eruptions, and even the sinking of the islands. As we have said before, tornados always occur in these islands between July and October, and volcanic displays usually sink back into quiescence in an intermittent manner. To call attention to what is inevitable in terms suggesting that even greater catastrophes than have yet been experienced are to be expected, may make sensational paragraphs and cheapen property. It can, however, only excite alarm, create panic, trouble the civil administration and accelerate the depopulation of the islands, and therefore prognostications of this character should at least be discouraged. What grounds there are for supposing that the Antilles may sink beneath the ocean is a mystery. Cinder heaps which have risen above the ocean as volcanic islands have by the action of the waves been reduced to shoals, but with the Antilles we are dealing with a fold in the crust of our earth which, if the water was removed from its flanks, would stand up like a chain of mountains 18,000 feet in height. Parallel with this is the fold of the Cordilleras, with its peaks 12,000 feet in height, bounded by an ocean more than 14,000 feet in depth.

It seems that it was an adjustment in this latter fold which took place on April 19, when several towns were ruined and more than 1000 people lost their lives, which led to adjustments announced by earthquakes in the parallel Antillean fold. Pelée then smoked, indicating that pressure had been relieved. This relief suggests elevation, and that elevation rather than subsidence is the direction of movement in these islands is testified by a variety of geological evidence.

From this it would seem that, instead of issuing an alarming prediction that the West Indies are to disappear from view, the recent eruptions suggest that they have risen to a greater height, whilst the water on their Caribbean side may have deepened. Two wrinkles on the face of the world have probably gained in height, whilst the depth of the bounding furrows on their western flanks has probably been increased. As indications of these changes, newspapers state that Richmond in St. Vincent has risen, whilst a French cable ship has found at a certain spot an increase in the depth of water of nearly 500 fathoms.

The public are evidently anxious that volcanic eruptions and seismic disturbances should be predicted, but as districts where these activities prevail are not transparent and we cannot see what is happening beneath our feet, neither are we able to measure the pressures and strains which may be increasing in such regions, the time when a ball rising on a mast will announce impending subterranean disturbances seems very distant. Still,

there are directions in which investigations bearing on this point may be pursued. One of these would be to determine whether before a volcanic outburst or after the same there were any unusual changes in level in operation. Lyell remarks that if we reflect upon the dates of the principal oscillations noted near the Bay of Naples, there appears to be a connection between the movements of upheaval and a local development of volcanic heat, whilst periods of depression are concurrent with periods of volcanic quiescence. The part that the horizontal pendulum would play in such an investigation is obvious.

A second line of research would be to determine whether the movements of magnetic needles placed in the vicinity of a volcano show any relationship to its eruptions. We know that many lavas are highly magnetic, and it is not unlikely that physical and chemical changes, together with mechanical displacements of such materials, would result in changes in magnetic elements in their vicinity; and that remarkable coincidences between such changes and volcanic eruptions have taken place has been indicated by Captain E. W. Creak, F.R.S.

There may be other lines of research which would throw light upon subterranean operations, but these are two which might be pursued without great difficulty.

On the Sequence of Events.

From the enormous displacements of ground which have frequently accompanied world-shaking earthquakes, and from the fact that their origins can be traced to districts where we have evidence of secular movements which may be yet in progress, it is not unreasonable to suppose that such earthquakes are announcements that strains have suddenly been relieved in certain orogenic foldings. This relief may be compared to the movement of a key which fires many mines. Not only might volcanic vents beneath which there was excessive pressure burst into activity along the fold, but similar displays might be expected in neighbouring folds. In support of these views attention may be called to the fact that the mountain-making epochs in geological history were periods of intense volcanic activity. From the middle to the end of the eighteenth century, earthquakes and volcanic eruptions were frequent throughout the world. The history of the large earthquakes of Japan shows an approximate coincidence in time between these phenomena and volcanic eruptions, and similar coincidences can be adduced from the registers of other countries.

Evidences of this description suggest a relationship between pronounced seismic efforts in or near a volcanic region and volcanic activity, and when we know the sequence of events which have recently occurred in the West Indies and Central America, our knowledge of the relationship between earthquakes and other subterranean phenomena may be extended. The seismograms reproduced in Figs. 1 and 2 are of interest in this connection.

On April 19 at about half-past two in our time, the Cordilleras of Central America were suddenly relieved of seismic strain, villages and towns were shattered, earthquake waves passed all over our world and all through the same, whilst in the epifocal area we learn that at one town alone 1100 people lost their lives. Whether this widespread disturbance was quickly followed by adjustments in the neighbouring Antillean ridge we are not certain. All that can be gathered from newspapers is to the effect that *about* the end of April many small earthquakes took place and Mont Pelée smoked and rumbled. On May 3 this mountain was in eruption and ashes fell upon St. Pierre. Two days later it ejected a stream of mud and commenced its work of serious destruction. The sea receded 300 feet, and the Puerto Plata and the Dominica-Martinique cables were interrupted. On this

day La Soufrière, ninety miles to the south, gave evidences that it was disturbed, but it was not until 2 p.m. on May 6 that it can be said to have erupted. At 7 a.m. on May 7 the eruption was violent. At noon three craters opened, lava flowed, ashes were driven to a height of eight miles, to fall upon Kingstown, twelve miles distant, whilst the schooner *Ocean Traveller* had to fly to escape destruction from the showers of lapilli. A violent explosion took place at 1.30 p.m., whilst at 3 p.m. the detonations were terrific. One hour later a dust cloud, which apparently had travelled in the teeth of the trades, reached Barbados. Dust or extremely fine ash was falling at or before 5.30, and in three days, when the eruption in St. Vincent moderated, a thin layer of this covered Barbados. The weight of this dust layer, which has already been analysed and is expected to improve the texture of the soil, is estimated at two million tons. This is what La Soufrière, assisted by an upper current of air, effected at a distance of 100 miles eastwards from its crater. It may here be noticed that this mountain commenced its violent outbursts, which extended over three days, before the explosion of Mont Pelée, which happened at 11.50 a.m. on May 8, although Mont Pelée was in eruption some days before La Soufrière.

The *Dies Iae* for St. Vincent was May 7, whilst for Martinique it was on May 8. Other events of considerable significance which happened on May 7, but about which we have as yet but little information, were, first, the St. Lucia-Martinique, the St. Lucia-St. Vincent, the St. Lucia-Grenada and the Guadeloupe-Martinique cables were interrupted; second, at 10 p.m. a very strong earthquake shook St. Vincent; and lastly, in St. Vincent time in the Isle of Wight a seismograph commenced to indicate at 10h. 45m. p.m., the maximum motion being attained at 11.16 p.m. The character of the seismogram is that of a disturbance which originated at a distance from the Isle of Wight of between 60° and 70° . From this it is inferred that the time at which this disturbance originated was about 10.33 p.m.

Now St. Vincent is 60° from Great Britain, but whether the earthquake which took place in that island is identical with that recorded in Britain and represents a suboceanic convulsion which interrupted the cables on that date can only be definitely settled by those who know the hours at which these cables ceased to work.

The suboceanic disturbance which at 6.32 a.m. on December 29, 1897, interrupted the cables off Hayti gave in England a seismogram which was comparatively large. In this case, although the seismogram is small if we for the present assume the disturbance it represents to have originated off St. Vincent, it indicates that the sudden adjustments in the earth's crust accompanying the eruption of La Soufrière were more violent than those which took place around Mont Pelée, from which earthquakes of any magnitude do not seem to have originated. The considerations attending the laying of cables are no doubt numerous, but from the fact that those which have been mentioned for the most part pass along the western side of the Antilles, it cannot be said that they occupy the best position to avoid the effects of submarine convulsions. A comparison of the registers of the interruptions these cables have experienced with those of earthquakes which may have been recorded at many very distant stations would throw great light upon the geological activities in progress beneath the Caribbean Sea.

To turn back to Mont Pelée and La Soufrière, we see that after their paroxysmal efforts, when 2000 lives had been lost in St. Vincent and 40,000 in Martinique, the eruptions at these mountains moderated, but this was only for a time. On May 17 another great eruption took place at La Soufrière, whilst on the 20th Mont Pelée destroyed everything that had remained

standing at St. Pierre, and, as if filled with a desire to destroy more life, showered stones and ashes on Fort de France, thirteen miles distant. The northern ends of two islands have now been destroyed and the eruptions continue, whilst in St. Lucia, which lies at a distance of about twenty miles from each of these scenes of destruction and exactly between them, the boiling sulphur springs and volcanoes remain in their normal conditions.

With the great eruptions of Pelée on May 3, 8, 19 and 20 there appear to have been disturbances of sea level, the water either rising or receding. With that of La Soufrière on the 17th, we read that at Château Belair every few hours there were continuous convulsions of the ground, at Kingstown and Georgetown there were sixty shocks in four hours, whilst the village of Wallibou partly sank and that of Richmond rose. All these phenomena, taken in conjunction with the interruption of cables, indicate that the more violent displays of activity were accompanied by adjustments in the neighbouring strata, and it is more likely that such adjustments were the cause rather than the result of the marked phases of activity.

About unusual phenomena which occurred at a distance we have as yet but little information.

On May 11 a geyser or boiling lake in Dominica, some 300 feet in length and 200 feet in breadth, disappeared. The next day some boiling springs at Bath, in Jamaica, became extremely hot. On May 13, and for several days previously, Pico de Colima, a volcano 12,700 feet high, in Mexico, created alarm by belching forth puffs of smoke, whilst at St. Thomas at 4.30 p.m. a slight earthquake was felt. On May 18 an earthquake was felt throughout California. Up to noon on Sunday, May 25, with the exception of what has here been noted, the instruments in the Isle of Wight have been at rest.

J. MILNE.

Volcanic Ash at Barbados.

Volcanic ash fell very thickly at Barbados in the afternoon of May 7, in consequence of the eruption of the Soufrière on St. Vincent, and caused almost total darkness in the afternoon. On the morning of May 8, we learn from the *Barbados Advocate*, kindly sent to us by Sir William Thielton-Dyer, the streets were found to be covered with this grey dust, and it was estimated that about twenty-two tons per acre fell in twelve hours. The ash lay so thick in the streets that traffic was interfered with, and great difficulty was experienced in clearing it from houses and approaches.

There was a fairly strong east wind prevailing during the whole period, and ordinarily speaking, St. Vincent being to the west of Barbados, it would have been considered impossible that the dust could have travelled in this direction nearly a hundred miles against the wind. But whilst the prevailing direction of the wind was from the east, the upper currents of air travelled from the west, and the phenomenon observed in the eruption of 1812 was repeated in the present. The dust was hurled from the volcano into the upper strata of air and borne eastward against the direction of the surface currents.

According to the official statement in the *Agricultural News*, the quantity of ash that fell varied from three-eighths to half an inch in depth, covering everything with a grey mantle of impalpable dust. By actual measurement it was ascertained that the weight of ash was at the rate of 17.53 tons per acre, probably nearly two million tons being deposited over the whole of Barbados. Prof. d'Albuquerque's preliminary chemical examination led to the conclusion, which was contrary to expectation, that the ash was of no fertilising value, but that it may tend to improve the texture of the surface layers of heavy clay lands. Dr. Longfield Smith's preliminary mineralogical examination disclosed volcanic minerals and volcanic glass, the minerals predominating, and consisting chiefly of silicates of iron and magnesia, also a considerable proportion of quartz and some potash feldspar. Under

the microscope the samples of the dust which fell in 1812 and 1902 differed greatly, the 1812 dust being much finer and containing very few mineral crystals, being chiefly composed of fragments of dark brown volcanic glass. During the recent fall it was noticed that the ash at first was rather coarse and of a brownish colour, then it became slightly redder, while the final deposits consisted of a whitish-grey impalpable powder.

From a meteorological standpoint the conveyance of the dust from St. Vincent to Barbados is a subject of great interest, as bearing upon the question of the upper currents. At sea level the trade wind blows almost directly, and freshly, from Barbados to St. Vincent, east to west. The Soufrière became active early in the afternoon of Wednesday, May 7; the dust cloud must have been shot up to an elevation of some miles, where it was caught by a west to east counter current of great velocity, for within two hours, 3.15 p.m., dust was observed to be descending in Barbados, gradually increasing in volume and becoming heavy soon after sundown, the consequent darkness being intense. There was brilliant lightning and violent crashing thunder. It would appear that on this day the upper current had an east-going velocity of more than fifty miles an hour.

It is worthy of mention that at 1.30 p.m. on May 7 there occurred a sudden outburst from one of the oil burners, 900 feet deep, at Turner's Hall, Barbados, dust being thrown up to the height of more than 100 feet into the air. At 3.45 p.m. there was an unusually high tide at Bridgetown, the highest within memory.

*Seismographic Records in France.*¹

I received, on May 6, a telegram from M. Kilian, professor of geology at the University of Grenoble, announcing that the Kilian-Faulin seismograph had registered in the morning at 3h. 4m. 49s. Paris time a seismic shock from a north-east direction. The evening papers and those of the next day announced that this shock had been felt again in the north-west of France and along the south Mediterranean coast of Spain. It is in the district of Murthia that the most violent effects were notified.

Another more precise observation as regards time and direction of the shocks has been recorded at Floirac near Bordeaux, north-west direction, time 3h. 5m. 30s.; the passage of the vibrations therefore made themselves felt at Floirac forty-one seconds after those of Grenoble. In supposing them to have a speed of 3 km. a second, the epicentrum must be 123 km. further from Floirac than from Grenoble and also to the south-east of Floirac, to the south-west of Grenoble. These theoretical and hypothetical considerations would place it in the Mediterranean, to the east of Murthia, to the south of Minorca. Wherever it is, it seems to me that the earthquake of May 6 affected the subsidence in a Mediterranean oval, which has cut the south coast of Spain, by marking it with volcanic eruptions (Olot, Colubret, Cartagena, Cap de Gâte). It is interesting to remark that it is equally the result of a subsidence in a Mediterranean oval, that of the Lesser Antilles, that two days after, May 8, there was the terrible catastrophe of Saint-Pierre.

NOTES.

At the next meeting of the British Association, to be held at Belfast, commencing on September 8, it has been decided to include in Section A a subsection for seismology. The organising committee of this subsection invite cooperation of seismologists, who, it is hoped, if they are not able to attend will be able to send communications for discussion.

A REUTER telegram from Upsala says that a Swedish expedition for taking meridian measurements will leave Tromsø for Spitsbergen on July 26. It will be under the leadership of Dr. P. Rubin and will include, as astronomer, Dr. von Zeipel, and, as cartographer, Lieutenant Duner. The expedition will have as a centre the seven islands to the north of Spitsbergen, and will return to Tromsø on September 10.

MR. J. S. BUDGETT, Balfour student of the University of Cambridge, left England last week for Uganda, *via* Mombasa, on

¹ Translation of a note by M. Michel Lévy in the *Comptes rendus* of the Paris Academy of Sciences, May 12.

a mission from the Zoological Society of London. He will proceed to the south-east corner of the protectorate, and take up a station on the Semliki River, where he will collect mammals and birds, study the fishes, and endeavour to investigate the habits of the okapi in the forest of Mboga. Mr. Budgett, who has already paid two visits to the Gambia, is a practised collector of fishes and an experienced African traveller.

At the anniversary meeting of the Royal Agricultural Society, held last week, the Prince of Wales was elected president of the Society for the year following the Carlisle meeting this summer.

The *British Medical Journal* announces that a scientific commission, consisting of Dr. G. C. Low, Dr. C. Christy and Dr. Castelani has been sent to Uganda by the Royal Society for the purpose of investigating sleeping sickness. To Dr. Low and Dr. Christy is entrusted the parasitological part of the investigation, while Dr. Castelani is the bacteriologist of the expedition.

We learn from the *Victorian Naturalist* that after an absence of rather more than twelve months, the greater part of which was spent among the aboriginals of the northern interior of Australia, Prof. Baldwin Spencer, F.R.S., and Mr. F. J. Gillen returned to Melbourne on March 17. They were in excellent health, and were welcomed home by a number of gentlemen prominent in literary and scientific circles. The explorers have brought back a considerable amount of material, including phonograph and cinematograph records, on which to base an extensive work on the myths, customs, &c., of the various tribes studied.

The *Times* states that Mr. W. Bruce, who is to lead the Scottish Antarctic expedition, has received intimation, dated January 4, from Prof. von Drygalski, leader of the German South Polar expedition, announcing the arrival of the *Gauss* at Kerguelen. The expedition will, therefore, have made the ice at about the same time as the Swedish and British ships. Von Drygalski has penetrated the Antarctic region at the point of the still hypothetical termination island in order to discover the western side of Victoria land and clear up its possible connection with Kemp and Enderby lands. By taking this route he believes he may be ultimately able to sweep westwards by a high southern latitude into the South Atlantic and emerge by way of South Georgia.

A CORRESPONDENT directs our attention to the announcement that a very fine example of the blue *Puya* is in flower in the Mexican portion of the temperate house at Kew Gardens, where it is now bearing two stout spikes, three feet high, of beautiful peacock-blue flowers. The plant is a very remarkable one and has rarely flowered in this country, though Messrs. J. Veitch had one in flower in 1868 (*Botanical Magazine*, t. 5732).

The International Commission for Scientific Ballooning met in Berlin last week in the Sitzungssaal of the Reichstag. We learn from the *Daily Graphic* that Prince Frederick Henry presided in the name of the Kaiser. The War Offices of all the great European Powers except France were represented at the conference. The object of the commission is to combine the study of meteorology with aeronautics, and to induce the various Powers to agree upon some common course of action with regard to the study of aeronautic questions. A paper was read by Mr. Patrick Alexander on the steering by Hertzian waves of flying machines carrying instruments for registering the temperature and moisture of the atmosphere at different altitudes. Mr. Alexander claims that his machines can be sent a distance of fifty miles and steered back to the

starting point. The foreign deputies, who were the guests of the aeronautical battalion of the German Army, were shown over the headquarters of the battalion, which has the largest balloon house in the world.

THE anniversary meeting of the Royal Geographical Society was held on Monday, and the medals and awards already announced (vol. lxx., p. 471) were distributed. In his opening address, the president referred at some length to the Antarctic expedition, and remarked that they could not hope to receive any news of the *Discovery* until the spring of next year. The question of wintering was left to Captain Scott's discretion, and he was instructed to use his utmost endeavour to explore the region within reach of his winter quarters by sledge travelling in the spring. He intended to endeavour to reach and force through the ice pack on the 175th meridian, and on reaching the open water to make for Cape Adare. The relief ship would have no difficulty in finding the *Discovery* and supplying her with the stores and provisions of which she would be in need if the winter quarters were in Wood Bay or on any part of the coast between that position and Cape Crozier. About 20,000*l.* had been subscribed for the relief expedition, but at least 22,000*l.* would be needed. Turning to the opposite Polar area, the president remarked that the Arctic regions were the scene of the labours of four expeditions. The *Windward* would shortly proceed to Smith Sound to bring back the Peaty expedition. Captain Sverdrup in the *Fram* had now been absent three winters, and his exact position was unknown. There were also Mr. Baldwin's expedition with the avowed object of reaching the North Pole by the Franz Josef Land route, and Baron Toll's expedition in the islands to the north of the new Siberian Islands.

THE Nature-Study Exhibition, to be opened at the Gardens of the Royal Botanic Society in Regent's Park on July 23, promises to be of a very interesting and instructive character. The exhibits will be arranged in five groups, the scope of which may be roughly defined as follows:—(1) General information, such as reports and other publications, object-lessons and notes on school gardens, natural history rambles, &c.; (2) pictorial illustrations, including pictures and photographs of work and equipment in school and out; (3) organisation, with schemes of instruction and time-tables; (4) apparatus, including models, specimens, maps and collections of natural objects; (5) work done by pupils, such as notes of observations, nesting-boxes, breeding-cages, &c. The intention is to bring together, so far as possible, the results of nature-study in schools and colleges of all grades, so that teachers and pupils may be given the opportunity of seeing what others are doing, and so obtain inspiration for the further development of their work. University colleges, natural history societies and local museums might usefully affect the trend of nature-study by showing typical collections, or materials and apparatus suitable for study in various branches of natural history in schools. A report will be published, and the following have kindly consented to act as judges:—Mr. A. D. Hall, principal South-Eastern Agricultural College, Wye, Prof. C. Lloyd Morgan, F.R.S., Prof. L. C. Miall, F.R.S., Prof. J. Arthur Thompson and Prof. R. Wallace. The scheme has so far extended beyond the scope originally contemplated that further donations are invited and would be gratefully received by the hon. treasurer, Mr. C. S. Roundell, 7 Sussex Square, Brighton. All particulars may be obtained from the hon. secretary, Mr. J. C. Medd, Stratton, Cirencester.

THE *Times* announces the death of Dr. Henry Morton, president of the Stevens Institute of Technology. Dr. Morton was born in New-York, December 11, 1836, and graduated from the University of Pennsylvania in 1857. The bent of his

studies was then fixed by the fact that he took a post-graduate course in chemistry. He afterwards became secretary of the Franklin Institute of Philadelphia, where he delivered many lectures which attracted much attention. In 1868 he was the chief of an expedition organised to observe and make photographic records of a very notable total eclipse of the sun. In 1870, the Stevens Institute of Technology was organised and its work begun at Hoboken in New Jersey. This was done under the will of Edwin A. Stevens, who had designated Dr. Morton as the president of an institute to be devoted entirely to the higher instruction in technological subjects. Dr. Morton was one of the most proficient of the engineering experts known to America. He lavished his large income upon the institute with great freedom. In 1880 he made his first gift, which took the form of a new workshop fitted up with steam engines and tools. Two years later he gave money for the purchase of electrical apparatus. In 1888 he gave 10,000 dollars for the endowment of a chair of engineering practice, to which, in 1892, he added 20,000 dollars more. For many years he had contributed the whole of his salary as professor of applied electricity to electrical experiments. In all, his gifts to the institute have amounted to about 145,000 dollars. A few years ago he interested Mr. Andrew Carnegie in the work, with the result that Mr. Carnegie contributed a laboratory and endowed it in addition with 100,000 dollars. Dr. Morton was for several years a member of the United States Lighthouse Board and had been a member of the National Academy of Sciences for nearly thirty years.

MR. JOHN BELLOWS, who died on May 5, aged seventy-one, was a well-known member of the Society of Friends, and a printer at Gloucester. He was an active member of the Cotteswold Naturalists' Field Club, and had communicated to its *Proceedings* several papers on local archaeology. In one paper he dealt elaborately with the history of the "Speech House" in the Forest of Dean, and endeavoured to show that in the Court still held in that house we have the last vestige of the grand system of the Druids in Britain.

IN connection with the Belgian Royal Academy, a number of prizes are offered for this and next year of which particulars are given in No. 3 of the *Bulletin de la Classe des Sciences*. In mathematical and physical sciences the subjects announced for 1902 relate to critical phenomena, viscosity of liquids, the algebraic and geometric study of n -linear forms where $n > 3$, and the thermal conductivity of liquids and solutions, the prize in each case being 600 francs, also prizes of 800 francs for researches on the action of alcohols on compound ethers and on the unipolar induction of Weber. In natural science, prizes of 600 francs are offered for a study of the beds of Comblain au Pont and their geological position, the modifications produced in minerals by pressure, the development of the Platoda, the effects of osmotic pressure on the phenomena of animal life, and the Devonian flora of Belgium. For researches on the influence of external factors on karyokinesis and vegetable cell division a prize of 800 francs is offered, and for new investigations on the formation of albuminoids in plants a prize of 1000 francs. In every case the essays, written in French or Flemish, must be sent in by August 1. For 1903 the subjects propounded in mathematical and physical sciences are the combinations of the four halogens among themselves, the form of the principal terms introduced by the earth's elasticity into the equations for the nutation in obliquity and longitude, contributions to the study of mixed forms containing any number of series of variables with applications to the geometry of any space, and the determination in altitude and azimuth of the principal terms in the periodic deviations of the vertical on the hypothesis of the non-coincidence of the centres of mass of the earth's crust and its nucleus. In natural science the subjects are the physiological function of

albuminoids in the nutrition of animals or plants, the organisation and development of a Phoronis, and the relations between this genus and Rhabdopleura and Cephalodiscus and the group of Enteropneustes, a description of the elements and their sulphides and binary compounds occurring in Belgian soils, new researches on the different strata included between the "Bruxellian" and "Tongrian" in Brabant, and a determination of the geological age of certain deposits of sand, plastic clay and quartz pebbles in the Oligocene formations the positions of which are indicated by reference to the geological maps. The values of these prizes range from 600 to 1000 francs.

In addition to the above prizes, a prize of 1400 francs associated with the name of Charles Lemaire is offered for questions relating to public works. A prize, named the Édouard Mailly prize, of 1000 francs is offered to the Belgian or naturalised subject who makes the greatest advance in promoting the study of astronomy in Belgium, a Louis Melsens prize is offered for work on chemistry or applied physics and a Charles Lagrange prize for a mathematical or experimental investigation relating to our mathematical knowledge of the earth, the word mathematical in this sense excluding purely statistical measurements unless associated with the investigation of some new law. Finally, a prize founded by Baron Selys Longchamps is offered for the best original work dealing with the whole or part of the Belgian fauna, not necessarily the recent fauna.

HAVING regard to the wide reputation which the Malays have earned for themselves as a maritime people in Eastern seas, it is at first sight not a little remarkable that, so far as the Malay Peninsula is concerned, they have developed no really able type of sea-going boat. Three main factors have been at work influencing the development of boats, and tending to produce the characteristic shallow draft, lack of beam, and a consequent want of stability and weather lines. (1) The rivers are protected by very shallow bars of sand or mud, which make it impossible for a deep-bodied boat to obtain shelter within them. (2) The variable character of the light breezes prevailing in the Straits of Malacca. (3) The great strength of the tides. The lot of the sailing vessel is thus precarious; racing tides and baffling winds and calms make progress very slow. Hence propulsion by oars or paddles was the first necessity of the old-time Malay seaman in the Straits; sails were merely an occasional convenience. The Malay boat, however large and with its quantity of top-hammer, always remains essentially a canoe. Those who are interested in the subject of transport by water will find an important paper on boats and boat-building in the Malay Peninsula, by Mr. H. Warrington Smyth, in the *Journal of the Society of Arts*, vol. I. p. 570.

IN *Symons's Meteorological Magazine* for May, attention is drawn to the use of the rainfall tables published each month. The British rainfall organisation established by the late Mr. Symons has been very successful in obtaining the voluntary assistance of some thousands of observers, and it is well known that the results are very carefully collated and published in an annual volume, "British Rainfall." It is, perhaps, not so generally known that in the monthly magazine the rainfall values for some 156 stations are regularly published, so as to give prompt and accurate information as to the state of the British Islands as regards rainfall in the previous month. For forty-five of the stations the departures from the averages for the ten years 1890-99 and also the number of rainy days are shown. In the current issue a table is given showing the aggregate rainfall of the first four months of this year and the averages of the same period, for ten years, at more than fifty stations distributed as uniformly as possible over the country. A glance at this table shows that the south-eastern portion of England has been very

dry; within a radius of fifty miles from London the fall has only exceeded two-thirds of the average at London itself. With regard to large districts, the actual state is perhaps more readily seen from the *Weekly Weather Report* of the Meteorological Office, which shows that for the four months in question the rainfall has only exceeded the average in the north of Scotland and the north of Ireland; in the east of Scotland, and the east and south of England, the deficiency exceeded two inches, while in the south-west of England it exceeded three and a half inches.

THE Meteorological Office pilot chart of the North Atlantic and Mediterranean for June shows that down to the middle of May no reports of ice about the Newfoundland banks had been received, a newspaper report of a berg having been seen in a locality much frequented by shipping not being confirmed. Of interest in connection with the exceptionally prolonged spell of cold weather over the British Isles is the statement that during April there was much Polar ice blocking the north and east coasts of Iceland, the region from which the prevailing winds have recently been drawn. In a note on sandstorms it is suggested that the dust which fell in the south-west of England and South Wales late in January last may have come from a sandstorm which had been observed at Ouargla, in the Sahara, on the 16th of the month, falls of sand being reported on succeeding days about the Canaries, Madeira, Portugal, the north-west of France, and finally on our side of the Channel on the 22nd and 23rd. Curiously enough, on the 17th and 18th, when brisk easterly winds were carrying dust from Africa to the Canaries, a westerly wind, strong to a gale, was driving clouds of sand across the Gulf of Suez and the upper part of the Red Sea. From a total of 3200 observations of the temperature of the North Atlantic during the month of March, it is found that, compared with February, the changes were very irregular, the mean values in several localities, chiefly between 30° and 40° N., showing a decline. A strip of very cold water extended southward from the extremity of the Newfoundland bank down to the forty-first parallel, several records being as low as 32° to 35°. To the south-westward of the British Isles the mean values differed but slightly from the average, while the air over the land showed an excess of 2° or 3°.

THE third and last part of the sale catalogue of the library of the late Prof. A. Milne-Edwards, of which a copy has been sent us, contains the works on invertebrates. The total number of lots catalogued in the three parts is 2881.

ACCORDING to its report for the year 1901, the Rugby School Natural History Society is in an unusually flourishing condition. A large collection of invertebrates has been purchased, and the museum has been added to and improved in other ways. A satisfactory feature is the attention devoted to agricultural science, the attendance at the meetings of that section exceeding all the rest in numbers.

IN the course of an article on animal sense perceptions, in which special attention is directed to nauseous or offensive odours as a means of protection, the editor of *The Zoologist*, in the May issue, warns his readers against regarding animal etiology too much from the human standpoint. Because animals cannot speak, we must not assume that they have no modes of communication; it is by no means certain that the ordinary explanation of "warning colours" is the true one, while the evil smell of the durian fruit does not render it distasteful either to the orang or to man himself. To the same journal Mr. G. Renshaw contributes an interesting article on mammals in captivity.

THE auditory organs of the so-called "waltzing mice" of Japan and China form the subject of a paper by Dr. K. Kishi in part iii. of vol. lxxi. of *Zeitschrift für wissenschaftliche Zoologie*.

Although these remarkable mice are commonly called either Japanese or Chinese, it appears that their real home is China, since they are known in Japan as Nanking mice. In Japan, where there were originally a grey and a white breed, these mice are kept in cages on account of their well-known dancing propensities. After an exhaustive examination of their internal auditory organs, the author comes to the conclusion that the dancing of these mice is not due, as commonly supposed, to disease of the labyrinth, but to the effect of confinement for untold centuries in small cages:

THE German scientific periodical *Die Natur* has been discontinued as a separate publication, and is now combined with the *Naturwissenschaftliche Wochenschrift*, edited by Prof. H. Potonié and Dr. F. Koerber and published by Gustav Fischer, Jena.

MR. F. HOWARD COLLINS has compiled from Admiralty sources a collection of tables showing "the magnetic direction and neap and spring rates for every hour of the tidal streams at forty-eight localities alphabetically arranged between the Nore and Scilly Isles." The latitude, longitude and characteristics of each light are stated, and under them are given particulars as to directions and rates of neap and spring tides. The tables are published by Mr. J. D. Potter at two shillings.

THE simple experiments in "Mensuration, Hydrostatics and Heat" given by Mr. G. H. Wyatt in the little book published under that title as one of Messrs. Rivingtons' Handbooks of Practical Science, should be familiar to every schoolboy. The book has now reached a third edition, and contains a course of practical work which can be done with profit by boys in the lower forms of schools. Not only do exercises of this kind develop delicacy of manipulation and minute attention to details in the pupils, but they are also of decided value in connection with other branches of school work.

THE additions to the Zoological Society's Gardens during the past week include a Chimpanzee (*Anthropopithecus troglodytes*) from the Gold Coast, presented by Captain Daniel A. Donovan; an Illiger's Macaw (*Ara macawana*) from Brazil, presented by the Countess of Malmesbury; a Common Kingfisher (*Alcedo ispida*) British, presented by Mr. J. F. Smith; a Hocheur Monkey (*Ceropithecus nictitans*) from West Africa, deposited; three White-throated Capuchins (*Cebus hypoleucus*) from Central America, a Humboldt's Lagotherix (*Lagotherix humboldti*) from the Upper Amazons, purchased; a Burrehel Wild Sheep (*Ovis burrehel*), a Japanese Deer (*Cervus sika*) born in the Gardens.

OUR ASTRONOMICAL COLUMN.

ASTRONOMICAL OCCURRENCES IN JUNE:—

- June 2. 15h. 1m. to 15h. 54m. Moon occults 54 Ceti (mag. 5.8).
 2. 19h. 0m. Venus in conjunction with moon. Venus 2' 44" S.
 5. 11h. 58m. to 15h. 40m. Transit of Jupiter's Sat. III. 9 Saturn. Outer minor axis of outer ring = 15" 41.
 10. 16h. 0m. Uranus in opposition to the sun.
 12. 15h. 37m. to 19h. 20m. Transit of Jupiter's Sat. III.
 14. 23h. 36m. Moon in conjunction with a Virginis (mag. 1.2).
 15. 10h. 15m. to 11h. 31m. Moon occults 86 Virginis (mag. 6.0).
 15. Venus. Illuminated portion of disc = 0.711. Mars = 0.989.
 18. 9h. 37m. to 10h. 59m. Moon occults ν Scorpii (mag. 4.5).
 22. 23h. Saturn in conjunction with moon. Saturn 5' 11" S.

- June 24. Vesta situated 21' south of Saturn.
 24. 17h. Jupiter in conjunction with moon. Jupiter 5° 54' S.
 26. 12h. 25m. Minimum of Algol (β Persei).
 29. 9h. 14m. Minimum of Algol (β Persei).

NEW ALGOL VARIABLE.—Circular No. 65 from the Harvard College Observatory announces the detection of a new variable on the photographs obtained there. An examination of a plate taken on April 3, 1902, for the possible presence of comet α 1902 showed that as compared with a plate of the same region obtained on March 7, 1900, the star + 43° 41' 01" was abnormally bright. This star is a double, and it is the north preceding component which shows the variability. The position is

$$\left. \begin{array}{l} R.A. = 21^{\text{h}} 55^{\text{m}}.2 \\ \text{Decl.} = + 43^{\circ} 52' \end{array} \right\} (1900).$$

More detailed examination showed that the star was generally bright and constant in light, so that it must be of the Algol type. It is not very distant from the remarkable variable SS Cygni, which precedes it 16m. and is 44' south.

The variable is shown at full brightness (about 8.9 magnitude) on 388 plates taken between 1889 and 1902, and on 19 it is shown as fainter than 9.3 mag. The period appears to be about 31.304 days. On plotting the light curve from the data obtained it appears that the star retains its full brightness for 28 days. About one day before the minimum it commences to diminish, attaining the magnitude 11.5 at od. 43 before minimum. The light then remains constant for more than half a day, with the minimum magnitude 11.6. The time of increase is more uncertain, but apparently is nearly the same as that of decrease. The times of the last minimum, with predicted future ones, are as below:—

	Minima.		
	h.	m.	G.M.T.
1902 April 28	21	33	
May 30	4	51	
June 30	12	8	
July 31	19	26	
Sept. 1	2	44	
Oct. 2	10	2	

COAST FOG SIGNALS.

WHEN lighthouse lights and all other seamarks are obscured by fog, sound is the only medium by which warning signals can be conveyed to mariners. It has been thought that it might be possible to transmit such signals by means of etheric vibrations; but assuming such intercommunication were established, it would fail in two most essential requirements for assisting the mariner in foggy weather, as it would not give him any information as to the direction from which the warning message came, nor would it tell him how far distant the signalling station was. Further developments may in the course of time remedy these defects, but from present-day knowledge and experience it cannot be said that etheric vibrations are available for fog-signal purposes at sea. In a paper recently read before the Society of Arts, Mr. E. Price Edwards discusses the present position of this question of sound signals and gives some interesting particulars of the trials carried out at St. Catherine's Point, in the Isle of Wight, last summer. From this it appears that for many years past sound-producing instruments of various kinds have been employed for uttering warning sounds at points of danger on our coasts, and that constant efforts have been made to develop instruments yielding sounds of great loudness and penetrating power, so as to overcome the numerous obstructive influences affecting the propagation of sound through the atmosphere. The instrument which has proved most effective for this purpose is the siren, sounded by means of air forced through it at a pressure of about 40 lb. on the square inch. It is used in the form of a double cylinder, one cylinder fixed, the other (inside it) rotating, each cylinder having longitudinal slits corresponding in number and area, through which, as often as they coincide, the air passes. In the trials at St. Catherine's, two flat circular discs with radial slits were tried, with very satisfactory results; but this arrangement involves a separate motor to rotate the movable disc, whereas the rotation of the cylinder siren is effected by the air pressure which produces the sound. It is considered that some loss of power and a more or less defective blast result from the

self-driving arrangement, and that the use of a separate motor will remedy these defects. The trials referred to were made with various forms and sizes of siren and several instruments sounded on the reed principle, the result being that the reed instruments proved greatly inferior to the siren instruments in loudness and penetrating power. It is contended by some that the reed principle as applied for the production of loud sounds has never yet been done justice to, and that with proper development a reed instrument could be made to yield sounds as powerful and penetrating as those of the siren; but, as Mr. Price Edwards points out, the reed instruments tried, and which were supposed to be the most effective types of that form of sound producer in existence, were not able to approach the sirens as regards efficiency for coast fog-signal purposes. If a reed instrument could be brought up to an equality with a siren in respect of sound power, it would probably be more economical than a siren in working. The question of trumpets received some special consideration at St. Catherine's, a new form of trumpet designed by Lord Rayleigh having been experimentally tried there. Lord Rayleigh had observed that with the conical trumpets of circular section usually employed there was a liability to some interference of the sound waves issuing from the mouth, caused by the difference in distance of the nearest and furthest parts of the mouth, whereby the waves were likely to get out of step and thus cause interference. He also pointed out that a good deal of sound was sent to the zenith from the mouth of circular section, which sound was certainly wasted. To remedy these defects, Lord Rayleigh's idea is to make the horizontal diameter at the mouth only half the length of the sound wave generated by the sounding instrument, and that the vertical diameter should be elongated to two wave-lengths or more, thus producing a mouth of elliptical section. The tendency for the waves issuing from the mouth to get out of step would thus be reduced to a minimum, and the narrowness of the mouth at top and bottom would offer but little scope for the sound to be projected upward or immediately downward. So far as the trials went, Mr. Price Edwards tells us that the effects produced were most encouraging, and it is now intended to set up this elliptical trumpet for practical trial at a fog-signal station. The mushroom form of trumpet for an all-round signal has been largely used for lightships. Instead of a long horizontal trumpet, or a vertical one with the head bent over (capable of being turned in any direction), the trumpet is fixed vertically with its mouth directed upward. Just above and in the centre of this open mouth is fixed an inverted cone, and the sound issuing from the trumpet strikes the curved sides of the cone and is reflected out with equal force all round the horizon. The trials made with this form of trumpet showed that it was well adapted for the purpose for which it had been designed.

But however powerful and characteristic the sound-producing instruments may be, the conditions of the atmosphere have very much to do with their effectiveness. An opposing wind, as is well known, shortens the range of penetration of the most powerful sound. An instance is given by Mr. Price Edwards when the sound of a siren was on one day heard for a distance of more than twenty miles, while on another day, with a little opposing wind and a noisy sea, the sound of the same instrument was not heard beyond a distance of one mile and a quarter. Fortunately, when sound signals are most needed, viz. in foggy weather, obstructive influences seldom occur; the air is generally still, the sea quiet, and a homogeneous condition as regards temperature and moisture exists, all of which conditions are favourable for the propagation of sound. It does not seem at all probable that the acoustic clouds of Prof. Tyndall are formed when fog prevails; indeed, they appear to want hot sun, causing evaporation from the sea surface, which produces areas of varying temperature and density. Two remarkable phenomena have been experienced in connection with the experiments at St. Catherine's for which no satisfactory explanation is yet forthcoming. In the one case it was found that at times there was a sort of hiatus in the passage of the sounds. Thus the observers on board the Trinity yacht *Irene* would be in full hearing of the sounds at a mile distance from the instruments. On proceeding out, the sounds would very soon fall away in strength until at a distance of between two and three miles they would be very faintly heard or lost altogether. Proceeding further out on the same line of bearing, the sounds would be gradually recovered, until a little beyond three miles they would again come into full hear-

ing and be carried as loud and distinct sounds for a considerable distance. The question is, what becomes of the lost sound, and what is the influence which renders the area in question "a silent area"? The phenomenon apparently does not occur frequently, for very many times the observers went over the same space without experiencing any such hiatus of sound. Mr. Price Edwards suggests that to solve the question prolonged and continuous observation would be necessary in all parts of the sea area over which the sounds are projected—at the sea surface, on the deck of a vessel, and at varying distances upward by means of a captive balloon. It is of importance to determine, if possible, the cause of this interdiction of audibility, in order that it may be prevented or guarded against when the sounds are being promulgated as official warnings to mariners.

The other noteworthy phenomenon which occurred at St. Catherine's and on previous occasions when sound signals have been tested by observation at sea were the aerial echoes. With a smooth sea and still atmosphere, the direct sounds from the sirens were immediately reinforced by powerful echoes from the sea. Mr. Price Edwards describes them as starting from a point on the horizon corresponding to the prolongation of the axis of the trumpet from which the sound proceeded, and with great rapidity spreading out over the sea expanse as though a scattered army of trumpeters in quick succession sounded their blasts from all parts of the horizon. Carefully timed, the echoes lasted at times for 30 seconds, or ten times as long as the original blast. Prof. Tyndall suggested that "the duration of the echo is a measure of the atmospheric depth from which it comes." If this be so, the length and strength of the echoes might afford a general indication of the relative penetrating power of the sounds of different instruments. With a disturbed atmosphere and an agitated sea surface, the echoes were very short or not heard at all. It is noteworthy that both the silent area and the aerial echoes occur chiefly in quiet weather, and that disturbance of air or sea appears to be antagonistic to their manifestation.

An important conclusion appears to have been arrived at in regard to the most suitable note pitch for the blasts of sirens or red horns. In fog—as has been stated—the meteorological conditions are usually equable, and when such is the case a low-pitched note is found to be more effective than a high-pitched one; on the other hand, when air or sea is disturbed, the higher pitched notes seem to be rather less obstructed by the opposing influences, although the advantage is not very great. Having regard to the fact that the sounds are only required for use in foggy weather, a low-pitched note of about 98 vibrations per second (which is that which was heard plainly more than twenty miles away) is perhaps the best for the blasts of a siren fog signal. In this connection it should be mentioned that in order to obtain the best effect from an instrument it is essential that the note given by the sound producer should, if possible, be in unison with the proper note of the associated trumpet, otherwise the issuing sound is apt to be gruff and discordant.

SEA TEMPERATURE AND SHORE CLIMATE.

IN Mr. W. N. Shaw's paper "On the Seasonal Variation of Atmospheric Temperature in the British Isles" (*Proc. Roy. Soc.*, vol. lxx., pp. 61-85), it is stated that it seems "probable that the ocean plays a paramount part in the causation of the second-order temperature effect which we experience in these islands. . . . Whether this variation of the temperature of the water which surrounds these islands is the cause of the atmospheric second-order variation, or whether it is only another effect of the same fundamental cause, does not appear, but in view of the fact that the marked second-order effect is not seen at Continental stations, it would seem not unlikely that the ocean temperature is the immediate cause of our second-order periodic temperature variation. . . . All the successive stages of temperature change are delayed by the effect of the sea. . . . The effect of the sea is to delay the seasons." Of course, it is a very old belief that the vicinity of the sea affects the temperature of a climate, moderating the heat of summer and the cold of winter, but the ideas on the subject have been of the usual vague popular character. What is curious is that it has taken so long to initiate some investigation designed to discover what may be the nature of the relationship between the temperature of the sea and that of the air over the adjacent land. Although the North Atlantic is the most frequented of the great oceans,

very little has thus far been accomplished in discussing its variations of temperature month by month throughout the year; indeed, the region between the 50th and 60th parallels, from our islands across to Labrador, has been almost wholly neglected. Some years ago, the Meteorological Office published mean results for four months; the Deutsche Seewarte has made a separate discussion of each of a number of 10°-squares; and the Copenhagen Institute annually supplies information for the far north, mainly on the routes from Denmark to Iceland and Greenland. These are the principal contributions to our knowledge of Atlantic sea temperature.

The Meteorological Council has now made a new departure in this matter. In connection with the publication of the monthly pilot chart of the North Atlantic and Mediterranean, the cooperation of the captains and officers of the Mercantile Marine has been enlisted to promptly supply daily records of sea temperature during their voyages. A gratifying response resulted in the return of more than 2500 ocean temperatures for the month of January last, and 2750 for February. This mass of valuable information has been grouped in spaces of 2° of latitude by 2° of longitude and means obtained. The results between 30° and 60° N. form the new feature of the pilot charts. Those for January appear on the April chart, and those for February on the May chart. In addition to the means, the variations from the averages of a long series of years are also shown, and lines are drawn separating the regions of excess and of defect. Generally speaking, in January the water was a degree or two colder than usual from Ireland down the face of the Bay to Portugal and thence westward across the Atlantic, while further north, from about the 20th meridian westward, the values were nearly all in excess. In February nearly the whole area was colder than during the preceding month, but compared with the February normals the region of excess was much more extensive than in January. The relatively cold water south-westward from the British Isles had, however, expanded westward to about 30° W. Close inshore the fall of temperature was very marked—off Eastbourne, for instance, it was 44° in January, an excess of 3°, while in February it was only 37°, a defect of 3°. Here we have the commencement of an investigation which, if continued, and improved as may be found necessary, should be fruitful of the most useful results. At present, with only the bare ocean results presented to us, it is not easy to explain what effect should be produced ashore. We know that the air temperature over the British Isles during last January was above the average to the extent of about 2°, while February was nearly 4° too cold, the coldest month for seven years. What part did the temperature of the ocean play in influencing the mildness of the one or the coldness of the other month?

With only these first charts before us, it is obviously impossible to form a just conception of the very complicated problem which requires solution. We must wait for a consecutive series of such charts and examine closely the variations disclosed month by month at sea and on land. It may be that the effect produced on our air temperature by the changes in that of the sea to the westward and south-westward is an indirect and not a direct result. The prevalence of winds from particular quarters for any length of time, and the cold or warm ocean surface currents which they set up, the movements of weather systems, &c., must be borne in mind. From the monthly pilot charts it is clear that at times the Gulf Stream fails to reach our shores owing to the existence of a stronger opposing flow. It has been advanced by Dr. Emil Lesshaft, in his paper "Der Einfluss der Wärmeschwankungen des Norwegischen Meeres auf die Luftcirculation in Europa" (*Meteorologische Zeitschrift*, Band xvi.), that the paths followed by atmospheric disturbances are associated with the temperature of the sea water, and if that should prove to be the case we must consider first of all the temperature of the Atlantic and the march of weather systems, and then the effect the latter produce on our climate. The permanent Atlantic anticyclone maintains its position over a part of the ocean where there is only a slight variation of sea temperature, but its outer limits expand or contract enormously, at times stretching northward as far as Iceland and Greenland, especially in the month of May, when a broad belt of Arctic water flows southward beyond our western coasts. With our present knowledge we can only conjecture as to the causes of these variations, but the information about the sea temperature now becoming available may, perhaps, help us to arrive at a better idea of the forces at work. As the observations become more numerous, would it be possible to issue weekly results of sea temperature?

UNIVERSITY AND EDUCATIONAL INTELLIGENCE.

ON Thursday next, June 5, the Sir John Cass Technical Institute, Aldgate, will be formally opened by the Right Hon. Lord Avebury, F.R.S.

WITH the object of creating interest in science teaching and nature-study in Southampton and the district, a conference will be held at the Hartley College, on June 14, together with an exhibition of home-made and other simple scientific apparatus. It is felt that much useful work is being done, the character of which is not generally known, and that teachers should be afforded an opportunity of comparing methods and becoming acquainted with that which the experience of others has proved to be of value. A preliminary meeting was held on May 10, when Dr. H. E. Armstrong, F.R.S., gave an address on the chief points to be borne in mind in early lessons in science. As he has often remarked before, science must not be taught so much on account of its matter as for training in scientific methods of work and reasoning. What is desired is that habits which characterise the true worker in science should become general habits, with the object of developing the practice of the best mental faculties.

THERE are many signs that the movement for reform in the teaching of mathematics will have a decided influence upon the scope and character of elementary geometry in schools. Several public examining bodies have lately had the subject under consideration, and changes in the direction of reform are likely to be instituted. The regulations just issued for the Oxford Local Examinations next year contain an announcement referring to the examinations in geometry which will have a very decided effect upon the scope and method of the subject in secondary schools. The notice reads as follows:—"Questions will be set so as to bring out as far as possible a knowledge of the principles of geometry, a smaller proportion than heretofore consisting of propositions as enunciated in Euclid. Any solution which shows an accurate method of geometrical reasoning will be accepted. No question will be set involving necessarily the use of angles greater than two right-angles. Geometrical proofs of the theorems in Book ii. will not be insisted upon." It is evident from this announcement, and the deliberations of other examining bodies and teachers, that Prof. Perry selected the right "psychological moment" for directing attention to the irrational ways of approaching geometry in schools and the need for recognition of work better adapted to modern needs. As both examiners and teachers are in general sympathy with his desire to get rid of artificiality in mathematics, we may expect that the time will come when geometry will not be commenced, as it is in many schools to-day, by learning Euclid's definitions, postulates and axioms and reading propositions, but by the intelligent use of compasses, protractor and scale.

IN introducing the Education Vote in the House of Commons on Monday, Sir John Gorst directed attention to some of the changes and developments which have taken place in the administration of the Board of Education. Schools of science and other secondary day schools inspected by the Board are to have block grants instead of payments by results of examination, the grants being assessed every three years. By this system, it is hoped that all inducement to cram will be removed. Both in the administration of the Parliamentary grant and in the inspection of schools the Board of Education will aim at encouraging originality and variety. The hope was expressed that the time would be far distant when those who had to administer the public funds of this country and to carry out the provisions of the Act with regard to secondary schools forgot the enormous danger of interfering to produce uniformity of system, and that they would give every encouragement to variety and independence. Referring to the Royal College of Science—one of the two Government colleges in London which are entirely under the management of the Board of Education, the other being the Royal College of Art—Sir John Gorst said:—"The vote for this school, which is a very advanced science school, has been increased in the present year by 1000*l.* for the purpose of enabling work to be continued—began by Sir Norman Lockyer—respecting the relation of certain precedent phenomena in the sun observed through the spectroscope to the subsequent rainfall in India and Australia. No certain law has yet been established, but if the research is successful it will have enormous beneficial economic effects, both for India and Australia."

Other subjects referred to were the educational work of the Victoria and Albert Museum, the new advisory spirit in which the inspection of schools is to be carried on, and the provision by local authorities of a better system of training teachers than at present exists.

Two pamphlets referring to the purpose and programme of the Faculty of Commerce of the University of Birmingham have been received. The Faculty will begin its work in October next and there will be matriculation examinations on June 2 and September 15. In the course of his prospectus, Prof. Ashley remarks that the object of the work to be carried on by this department of the University is the education, not of the rank and file, but of the officers of the industrial and commercial army: of those who, as principals, directors, managers, secretaries, heads of departments, &c., will ultimately guide the business activity of the country. The Faculty represents the first serious attempt to provide training of this kind, though every year shows the need of it. Prof. Ashley points out that the marked acceleration of the speed of industrial and commercial change, the application of science to machinery involving more frequent changes in manufacturing processes, and the extension of means of communication, call more and more for mental flexibility, alertness and adaptability on the part of traders. But such qualities are certainly not likely to be stimulated by early absorption in the subordinate routine of a particular occupation. There is, however, some chance of promoting them by courses of instruction which shall accustom the future trader to survey a wide range of industrial undertakings, to watch the development of the world's great markets, and to estimate the resources and capabilities of other nations. The curriculum which has been drawn up for the three years' course leading to the degree of Bachelor of Commerce in the University of Birmingham comprises studies which fall mostly into four main categories:—(1) languages and history; (2) accounting; (3) applied science and business technique; (4) commerce. The purpose of the scientific subjects included in the course is not to make men scientific experts. Its aim is (a) to make their business more interesting to them; (b) to enable them to follow the general movement of technological progress, and to realise the directions in which changes of process are probable or possible; (c) to show them when they ought to call in an expert, and how much weight they should attach to his opinion.

SCIENTIFIC SERIALS.

Journal of Botany, May.—Mr. Rudolf F. describes a rare and remarkable conidia-bearing fungus, *Coenansitella Alabastrina*, which has only been recorded twice before. The conidiophore begins like *Eruotium*, but the sterigmata are few in number and grow out forming a circlet of arms: from each of these a series of conidia is cut off on the upper side. The conidia are fusiform and pointed at both ends. Chlamydo-spores and other conidial bodies were obtained in the culture, but no traces of perithecia were observed.—Mr. Pugsley has devoted considerable attention to the British "caprolate" Fumitaries and submits the following classification:—Subsection 1. *Eucaprolatae*. Bracts as long as pedicel; pedicel recurved; fruit pendulous, narrow at the base. (1) *F. caprolata*, L. (= *F. pallidiflora*, Jord.). (2) *F. purpurea*, Pugsley, which refers to certain English plants named as *F. Boraci*, Jord., but differing from Jordan's original description. Subsection 2. *Murales*. Bracts shorter; pedicels erect; fruit without a neck. (3) *F. muralis*, Sond. (includes *F. Boraci*, Jord.). (4) *F. confusa*, Jord.—Dr. Rendle describes three new species of *Convolvulus* from South Africa, a *Convolvulus*, and two *Ipomoeas* which we regret to find are named after the collectors instead of receiving distinctive names.—Mr. G. C. Druce gives a list of Anglesey and Carnarvonshire plants and Mr. J. Hunter records North Donegal mosses.

Bulletin of the American Mathematical Society, vol. viii. (2) No. 7, April.—S. E. Slocum, on the transformation of a group into its canonical form. A discussion of the Lie group defined by $X_1 = \delta/\delta x_2$, $X_2 = x_2 \delta/\delta x_2 + \delta/\delta x_1$.—O. Dunkel, some applications of Green's theorem in one dimension. The theorem thus designated is an integral relation deduced from a linear differential equation and its adjoint. Some applications follow.—V. Snyder, on the forms of quintic scrolls.—E. V. Huntington, simplified definition of a group. This interesting paper defines a group as an assemblage of elements satisfying the three

postulates: (1) Given any two elements a, b , there is an element x such that $ax = b$; (2) there is an element y such that $ya = b$; (3) if a, b, c, ab, bc , and either $(ab)c$ or $a(bc)$ are elements of the assemblage, then $(ab)c = a(bc)$. A finite group requires the additional postulate that the assemblage shall contain only n elements.—L. P. Eisenhart, on isotropic congruences.

SOCIETIES AND ACADEMIES.

LONDON.

Physical Society, May 23.—Prof. S. P. Thompson, president, in the chair.—Mr. T. C. Porter showed a lecture experiment on the ebullition of rotating water. If the water in a beaker, having approximately vertical sides, be caused to rotate about an axis concentric with the vertical geometrical axis of the beaker, it is obvious that in any horizontal section of the water the pressure is least in the centre and increases from the centre outwards. If the temperature of the water is just below boiling point and heat is supplied to it whilst it is rotating steam is formed only in the region of least pressure, and a gaseous core is produced. The rotation can be given to the water by stirring it with a glass rod covered with a piece of india-rubber tubing, and maintaining the stirring motion during the act of withdrawal of the rod. Some curious phenomena are shown by the column of steam, if the water is first stirred and then left to come to rest whilst the heating is continued. At first there is a markedly concave surface to the water in the beaker, and the column of steam is practically continuous from base to summit. After this stage pulsations set in. Pulsations can also be produced by stirring cold water in a beaker-shaped jar, having a small hole in its bottom through which a stream of air-bubbles can be blown. The forms of the steam columns in some cases present a likeness to those of solar prominences, and Mr. Porter suggested that the immediate cause of the latter might be the diminution of pressure on the sun's surface at, or near, the centre or centres of depressions caused by violent cyclonic disturbances in the solar atmosphere.—Mr. C. V. Boys exhibited a small heat engine in which rotating water evolved steam without ebullition.—A paper by Mr. J. A. Erskine on the conservation of entropy was read by the secretary. Heat energy may be expressed as the product of two factors—a quantity factor, entropy, and an intensity factor, temperature. The conservation of entropy holds in thermodynamics when dealing with reversible processes, and is analogous to the conservation of other quantity factors such as momentum, moment of momentum, and electric quantity. The author shows the completeness of the analogies by considering Carnot cycles carried out on electrostatic and hydraulic engines. Prof. Wiedeburg has proposed to extend the doctrine of the conservation of entropy to irreversible processes by introducing a new quantity analogous to electric resistance.—A paper by Sig. G. Giorgi on rational units of electromagnetism was read by Mr. Price. Mr. Price prefaced the reading of the paper by saying that both Prof. Fleming and Prof. Fessenden had advocated a partial change of units which would leave the most important ones unchanged, and the method employed by the author was similar to that adopted by Prof. Fessenden. The author starts with a set of three equations, which contain explicitly the four concrete units of E.M.F., M.M.F., electric current and magnetic current, together with that of activity, and considers them as fundamental in electromagnetism. Two fundamental units are required to express these quantities, and their product must reproduce the mechanical unit of activity. If the watt is assumed as unit of activity, there are two units ready made, the volt and the ampere, which satisfy the condition and may be considered fundamental. All concrete units in electricity and magnetism can be expressed in terms of these and the second as unit of time. In order to complete the system, a unit of length is required. The metre and kilogramme are consistent with the watt, and putting them together with the units enumerated in the paper, the author has built up an absolute metre-kilogramme-second system which comprises electric, magnetic and mechanical measures in a consistent frame.

Chemical Society, May 15.—Dr. W. H. Perkin, F.R.S., vice-president, in the chair.—The variation with temperature of the surface-tensions and densities of liquid oxygen, nitrogen, argon and carbon monoxide, by Messrs. E. C. C. Baly and

F. G. Donnan. The measurements were made by a modification of Ramsay and Shield's method between 70° and 90° absolute, and the results were found to be in accordance with the view that these liquids consist of non-associated molecules. The critical temperatures deduced from these observations are in agreement with those directly determined for oxygen and nitrogen, but not with the values assigned to argon and carbon monoxide for this constant.—Comparison of bromonitrocamphane with bromonitrocamphor, by Dr. M. O. Forster. The action of various reagents on bromonitrocamphor has been examined in the hope of isolating derivatives of the latter substance analogous to those obtained from bromonitrocamphane, but in most cases the reactions proceed either further or in a different sense.—*aa*-Benzoylnitrocamphor and *aa*-benzoylodocamphor, by Dr. M. O. Forster and Mr. E. A. Jenkinson. A description of these substances and several of their derivatives is given illustrating the peculiar *aa*-isomerism of substituted camphors.—2:4-Dibromo-5-nitro- and 2:4-dibromo-3:5-dinitrotoluenes and their behaviour on reduction, by Mr. W. A. Davis. These substances are produced by the direct nitration of 2:4-dibromotoluene, and on reduction furnish respectively 4:6-dibromomethylamine and *syn*.tolylene diamine.—The purification of hydrochloric acid from arsenic, by Dr. Thorne and Mr. E. H. Jeffers. The purification of hydrochloric acid to be used in testing for arsenic may be accomplished by digesting it in pieces of bright copper gauze, so long as these become stained by the deposition of arsenic on their surface.—The radioactivity of thorium compounds, and the cause and nature of radioactivity, by Prof. Rutherford and Mr. Soddy. Thorium, from which the radioactive substance Th.X has been separated, regains its activity after a time, while that of Th.X slowly disappears. This production and disappearance of activity is not affected by any known agents, and proceeds independently of the physical and chemical conditions of the molecule; the authors believe that the source of this energy is to be found in a chemical change producing new types of matter.—The radioactivity of uranium, by Mr. F. Soddy. Prof. Rutherford has already shown that uranium exhibits a dual radiation, one, α , having little action on a photographic plate and a second, β , almost inactive to the electrometer under ordinary conditions. The author now finds that the substance Ur.X isolated from uranium possesses only the β -radiation, the α -effect being retained by the parent substance.

Royal Meteorological Society, May 21.—Mr. W. H. Dines, president, in the chair.—Captain D. Wilson-Barker read a report prepared by Mr. Dines and himself on the wind force experiments which had been made on H.M.S. *Worcester* off Greenhithe and at Stoneness Lighthouse, 817 yards from the ship on the north bank of the river. These experiments were in continuation of those on the exposure of anemometers at different elevations which were carried out on the *Worcester* a few years ago. All the observations were made with the pressure-tube anemometer. The broad general result is that the lighthouse experiences steadier and stronger winds than the *Worcester*, the velocity being about 6 per cent. greater, notwithstanding the fact that the elevation is less than half, but that in both positions the extreme velocities reached in the gusts are about equal.—Dr. H. R. Mill read a paper on the Cornish dust fall of January, 1902. When the west of England newspapers of January 24 announced falls of "pink snow" and "muddy rain" in several parts of Cornwall and South Wales, it seemed to the author possible that fresh light might be thrown on what is at present the chief object of progressive meteorology, viz. the movements of the upper air. He therefore took steps to collect as much information as possible from the whole of the district, and found that the phenomenon was reported from seventy-five different places in the south-west of England and Wales. These were all south of a line joining Milford Haven and Chepstow, and west of the meridian of Bath. By means of a map, Dr. Mill showed that four separate areas were visited by the dust between January 21 and 23, viz. (1) Cornwall, 1400 square miles; (2) North Devon, 150 square miles; (3) Milford Haven, 50 square miles; and (4) Bristol Channel, 600 square miles. The dust appears to have been confined mostly to low rather than high ground, for none was reported to have fallen on the Mendip Hills, Dartmoor, Exmoor and the Welsh mountains. The observations show that January 22 was undoubtedly the day when most falls occurred and that the colour of the dust was yellowish or brownish. From a consideration of the meteorological conditions at the time and for several

days before, the author is inclined to believe that the evidence points to the dust having been transported in the upper air from the African deserts.

EDINBURGH.

Royal Society, May 5.—Prof. Geikie in the chair.—A paper was communicated by Prof. Beattie on the leakage of electricity from charged bodies at moderate temperatures (part iii.). The paper described a great variety of experiments in which such substances as common salt, lithium chloride and potassium bichromate, when laid on zinc and sprinkled with iodine or bromine, and then raised to a temperature between 300° and 350° C., caused electrification of the surrounding atmosphere of air, coal gas, oxygen or carbonic acid gas. Hydrogen was not electrified under similar conditions. The effects differed from those produced in other ways. Thus, in addition to the well-known electrifying properties of flames and their fumes, there seem to be three distinct methods of obtaining an electrified gas by heating: (1) by oxidation or deoxidation as in the atmosphere drawn from the neighbourhood of oxidising or deoxidising metals (Schuster), (2) by driving off a gas which carries a charge with it as in the case of the gas obtained by heating potassium permanganate (Townsend), (3) by the methods described in the present paper.—Prof. MacGregor communicated a paper by the late Prof. C. Piazzì Smyth, Does the spectrum place of the sodium lines vary in different azimuths? The paper bore the date May 25, 1882, and the investigation had been suggested by Prof. Tait, among whose papers the manuscript had been found. The apparatus used consisted of a Rutherford grating with 17,296 lines to the inch, the necessary collimator and telescope, and an end-on vacuum tube containing sodium vapour. The whole was set up on a rotating table, and measurements of the positions of the D lines were made in various azimuths. The results were negative. An idea of the sensitiveness attained may be gained from the statements that the two principal D lines were separated by 266 micrometer divisions, and that the probable error of observation was two of these divisions.

PARIS.

Academy of Sciences, May 20.—M. Bouquet de la Grye in the chair.—On the optical arrangements necessary for remedying the visual troubles in cases of keratoconia, by M. J. Janssen. A description of a lens system by means of which the effect of this disease can be almost entirely compensated.—On the composition of the ashes projected from Mont Pelée on May 3, 1902, by M. Michel Levy. Andesine and hypersthene were recognised as the chief constituents of the volcanic ash.—On the spermatogenesis of the diptera of the genus *Sciara*, by M. Alfred Giard. The emission of the spermatid elements in *Sciara* is accompanied by phenomena nearly as complicated as in the *Cephalopods*. There is no production of a capsule forming a true spermatophore.—The addition of hydrogen to ethylene hydrocarbons by the method of contact, by M.M. Paul Sabatier and J. B. Senderens. The catalytic action of reduced nickel and copper in causing the addition of hydrogen to unsaturated hydrocarbons has been extended to propylene, trimethylethylene, hexene and octene. Propylene mixed with hydrogen in excess is readily transformed by reduced nickel at 160° C. into propane; copper behaves similarly, but the reaction is slower. Trimethylethylene is similarly converted into pure methylbutane in the presence of nickel, but copper is without action in this case. It has been found that copper and nickel are equally capable of effecting the addition of hydrogen in the case of ethylene derivatives containing the grouping $=CH_2$, but that compounds of the type $R.C=CR'$ do not add on hydrogen under the action of copper. Application is made of this to the case of limonene, with the result that the formula ordinarily attributed to it, representing it as containing a $=CH_2$ group, is confirmed.—On the arithmetical properties of entire and quasi-entire functions, by M. Edmond Maillet.—On the repulsive force and electrical actions emanating from the sun, by M. II. Deslandres. A criticism of the views of S. Arhenius, with some remarks on the nature of nebulae.—On the constitution of matter and spectroscopy, by M. B. Egnitis. The author regards the elimination of air lines in Schuster and Hemsleach's work on spark spectra as being chiefly due to the metallic vapours produced.—The action of light on precious stones, by M. Chaumet. A connection is shown to exist between the

fluorescence of a diamond under violet light and its lustre under ordinary artificial light. In the case of a yellow diamond, after a short exposure to violet light, the colour changed from yellow to a dark brown; after twenty-four hours, however, the diamond recovered its original colour and lustre.—The volumetric estimation of iodides in the presence of chlorides and bromides, by M. V. Thomas. In dilute solution, in the presence of an excess of a thallic salt such as the chloride, the whole of the iodine in the iodide is set free. Test analyses are given showing the accuracy and range of the method.—On the action of sulphites on the nitropressats, by M. Juan Fages.—On a method of gradual synthesis of aldehydes, by MM. L. Bouveault and A. Wahl. Nitrosobutylene, reduced by aluminium amalgam or by zinc dust and acetic acid, is converted into isobutyric aldoxim. Nitrostyrene, $C_6H_5-CH=CH-NO_2$, was found to undergo a similar change on reduction by either of the above-mentioned reagents, giving phenylacetaldoxim.—The sexual elements and fertilisation in Pterocarpus, by M. Louis Léger and Octave Duboscq.—On the destruction of certain noxious insects in agriculture and especially the wire worm in the plum-tree, by M. J. Laborde. The composition and mode of application of an insecticide is given which has been proved by experiment to be efficacious in combating the parasite,—*Sarcocystis tenella*, a parasite of man, by M. Paul Vuillemin.—On *Kinkeliba* and its botanical origin, by MM. E. Perrot and G. Lelèvre. *Kinkeliba* is an arborescent plant the leaves of which are employed by the natives all over western Africa as a medicine, and which merits a complete therapeutical study. It is identified as *C. micranthum*.—On the tectonic relations between Greece and western Crete, by M. L. Cayeux.—A point of the geology of the neighbourhood of Bayonne, by M. R. Chudeau.—On a principle of rational classification of gorges cut by water courses, by M. Jean Brunhes.—The microbiological study of the steeping of flax, by M. L. Hauman. The aerobic rotting of flax has been accomplished with pure cultures of various organisms, including *Penicillium glaucum*, *Aspergillus niger*, *Botrytis cinerea*, *Bacillus coli communis* and others. The process appears to consist essentially in the fermentation of pectic bodies, considerable quantities of which are present in the original flax, but of which traces only can be found after fermentation. The rotting of flax is thus a purely biological process which is accomplished by means of the bacteria and moulds of the soil. The disintegration is due to the disappearance of the tubes of the young tissues filled with pectic substances which separate the fibro-vascular bundles.—The influence of lecithin on the development of the skeleton and of nervous tissue, by MM. A. Desgrez and Aly Zaky. It is shown that the increase in weight of animals receiving lecithin is not due to an abatement of nutrition, but is due to the phosphoric acid retained by the organism, under the influence of the lecithin, being normally utilised for the development of the osseous and nerve-cells.—The vaccination against pasteuruloses, by MM. Joseph and Marcel Lignières. The name pasteuruloses is applied to a group of diseases of the same type, including typhoid fever and pneumonia of the horse, chicken cholera and hemorrhagic septicemia of the sheep, ox and pig. It has been proved by experiment that it is possible to prevent these diseases by a process of vaccination.—The etiology of the canker and gum in fruit trees, by M. F. P. Brzezinski.

DIARY OF SOCIETIES.

THURSDAY, MAY 29.

ROYAL SOCIETY, at 4.30.—The Minute Structure of Metals and other Plastic Solids: G. Beilby.—The Influence of Varying Amounts of Carbon Dioxide in the Air on the Photosynthetic Process of Leaves and on the Mode of Growth of Plants: H. T. Brown, F.R.S., and F. Escombe.—On the Influence of an Excess of Carbon Dioxide in the Air on the Form and Internal Structure of Plants: Prof. J. B. Farmer, F.R.S., and S. E. Chandler.—On the Structure of the Gills of the Lamellibranchia: Dr. W. G. Ridewood.

SOCIETY OF ARTS, at 4.30.—Western Australia: its Progress and Resources: Hon. J. W. Venn.

INSTITUTION OF MINING ENGINEERS (Geological Society), at 11.—Working Coal under the River Hunter, the Pacific Ocean and its Tidal Waters, near Newcastle, New South Wales: A. A. Atkinson.—Lead and Zinc Deposits of the Mississippi Valley, U.S.A.: Prof. C. R. Van Hise and H. Foster Bain.—The Campbell Coal-washing Table: Clarence R. Theobald.—The Mining, Concentration and Analysis of Corundum in Ontario: Dr. W. L. Goodwin.—Re-opening of Hartley Colliery: R. E. Ornsby.—Deposits of Hydroborate of Lime: its Exploration and Refinement: Carlos A. Lynes Hoskold.—Remarks on Mr. M. Walton Brown's Report on Mechanical Ventilators: Prof. A. Râteau.

FRIDAY, MAY 30.

ROYAL INSTITUTION, at 9.—The Electronic Theory of Electricity: Prof. J. A. Fleming, F.R.S.

INSTITUTION OF MINING ENGINEERS (Geological Society), at 10.30.—The Training of Industrial Leaders: Prof. J. Wertember.—Smelting in British Columbia: W. Denham Verschoyle.—Treatment of Low-grade Copper-ores in Australia: J. J. Muir.—The Tarkwa Gold-field, West Africa: A. R. Sawyer.—Gold-dredging: T. Ross Burt.—Gold-dredging in Otago, New Zealand: F. W. Payne.—Electric Traction on Roads and Mineral Railways: W. R. Cooper.—The Analytical Valuation of Gas-coals: G. P. Lishman.

EPIDEMIOLOGICAL SOCIETY, at 8.30.—A Doubtful Case of Haemorrhagic Smallpox: S. Murphy and Dr. Klein, F.R.S.—An Outbreak of Syphilis in an Indigenous Tribe in India: Dr. L. Rogers.

MONDAY, JUNE 2.

INSTITUTE OF ACTUARIES, at 5.

SOCIETY OF CHEMICAL INDUSTRY, at 8.—A Contribution to the Chemistry of Whiskey: I. Dr. P. Schidrowitz.—The Estimation of Perchlorate in Saltpetre, &c.: Dr. A. Dupré, F.R.S.—The Will Test for Nitrocellulose: Dr. R. Robertson.—On the Effect of the Alcohol Duty on Chemical Industries: Dr. O. Silberad.

TUESDAY, JUNE 3.

ZOOLOGICAL SOCIETY, at 8.30.—The Wild Sheep of the Upper III and Lower Lena Valleys: R. Lydekker, F.R.S.—On Differences in Dicyonodont Skulls, apparently due to Sex: Dr. R. Brown.—On the Gonads and Nephridia of Eudrilus, by M. E. Beddard, F.R.S.

ROYAL INSTITUTION, at 3.—The Laws of Heredity, with special Reference to Man: Prof. Karl Pearson, F.R.S.

WEDNESDAY, JUNE 4.

ENTOMOLOGICAL SOCIETY, at 8.—The Butterflies of Chile, with an Exhibition of Specimens: Henry J. Elwes, F.R.S.—The Protective Resemblance to Flowers borne by an African Homopterous Insect: S. L. Hinde.

THURSDAY, JUNE 5.

ROYAL SOCIETY, at 4.30.

CHEMICAL SOCIETY, at 8.—The Action of Unmilled Barley Diastase on Starch. Part I.: J. L. Baker.—The Decomposition of Chlorates. Part V. Potassium Chlorate in presence of Oxides of Manganese: W. H. Sodeau.

RÖNTGEN SOCIETY, at 8.30.—The Sources of Phosphorescence: Herbert Jackson.

LINNEAN SOCIETY, at 8.—On certain Species of *Dischidia* and their Double Pitches: H. H. W. Pearson.—(1) On "Silver-leaf" Disease of Plums: (2) Observation on the Occurrence of Crystals of Calcium Oxalate in Seedlings of *Alsisia* (*Tryfolium albidum*, Linn.): Prof. J. Percival.—On the Morphology of the Cerebral Commissures in the Vertebrata: Dr. Elliot Smith.

FRIDAY, JUNE 6.

ROYAL INSTITUTION, at 9.—The Nile Reservoir and Dams: Sir Benjamin Baker, K.C.M.G., F.R.S.

GEOLOGISTS' ASSOCIATION, at 8.—On a Peculiarity in the Course of Certain Strata in the London and Hampshire Basins: H. J. Osborne White.—Note on the Occurrence of *Microtus intermedius* in the Pleistocene Deposits of the Thames Valley: M. A. C. Hinton and G. White.

CONTENTS.

	PAGE
The Supplement to the Encyclopædia Britannica	97
Practical Physiology	100
Our Book Shelf:—	
Morgan: "The Elements of Physical Chemistry."	
—H. M. D.	100
Bower and Gwynne-Vaughan: "Practical Botany for Beginners"	101
Picard: "Quelques réflexions sur la mécanique suivies d'une première leçon de Dynamique"	101
Letters to the Editor:—	
Volcanic Eruption in Java, Brilliant Sunset Glows in 1901, and probable Glows from the Eruption in Martinique.—Henry Helm Clayton	101
A Method of Showing the Invisibility of Transparent Objects under Uniform Illumination.—Prof. R. W. Wood	102
Misuse of Coal.—W. Hibbert	102
The Conservation of Weight and the Laws of Thermodynamics.—A. N. M.	102
A Solar Halo. (With Diagram).—R. T. Omond	103
Mathematical Training.—C. E. Stromeier	103
Influence of Light upon Plant Assimilation.—E. E. Hennessey	103
The Farmers' Years. II. (Illustrated.) By Sir Norman Lockyer, K.C.B., F.R.S.	104
The Recent Volcanic Eruptions in the West Indies. (Illustrated.) By Prof. J. Miine, F.R.S.	107
Notes	112
Our Astronomical Column:—	
Astronomical Occurrences in June	115
New Algol Variable	115
Coast Fog Signals	115
Sea Temperature and Shore Climate	116
University and Educational Intelligence	117
Scientific Serials	118
Societies and Academies	118
Diary of Societies	120

THURSDAY, JUNE 5, 1902.

THE POPULAR HUXLEY.

Thomas Henry Huxley. By Edward Clodd. Pp. xiii + 226. (Edinburgh and London: William Blackwood and Sons, 1902.) Price 2s. 6d.

DR. RICHARD GARNETT has described Huxley's work as "that of the populariser; the man who makes few original contributions to science or thought, but states the discoveries of others better than they could have stated them themselves." I am disposed to think that the picture my friend Mr. Clodd has drawn with practised dexterity will rather confirm than dissipate this inadequate judgment. On the last page of this volume he writes, with perhaps a touch of remorse:—"To regard Huxley as a compound of Boanerges and Iconoclast is to show entire misapprehension of the aims which inspired his labours." I entirely agree; but the words might have been added to the title-page without doing serious injustice to what follows.

With such a Huxley I must frankly confess I have very little sympathy. I prefer the one which, with much critical insight, Mr. Chalmers Mitchell has presented to us "in his admirable monograph."

Huxley was so big a man in my judgment that his real merits can well afford to bear the brunt of dispassionate criticism. Disagreeing as I do with Dr. Garnett, I go farther, and think that as a "populariser" Huxley was by no means always successful. And Mr. Clodd supplies the reason in "that passion for logical symmetry" which appears to me often Huxley's besetting sin.

I only echo the opinion of competent judges in saying that he will be always clearly recognised as occupying a foremost place amongst English scientific men of the nineteenth century. He rescued animal morphology from the deductive method, and firmly established it on an inductive basis. In doing this there is scarcely any part of the animal kingdom which he did not illuminate by original and brilliant work. And he applied the theory of evolution with masterly insight to the explanation of the facts. All this was, however, only accomplished in the most cautious way, and was the result of patient observation and study. An examination of his published researches will show that he never advanced a step without making the ground firm beneath his feet.

In his more popular writings I am bound to say that I often fail to find the same qualities. Facts and knowledge were taken frequently at second hand, and were not the acquisition of his own personal labour. No one can deny the literary skill with which they were used. But the habit which grew upon him of pushing home remorselessly the conclusions he drew from them often landed him in very dubious positions. This is the more singular as he saw the danger in the case of mathematical reasoning, and rightly insisted that "what you get out depends on what you put in."

Huxley was firmly imbued with what is ordinarily called a "materialistic" conception of the universe. I think myself that this is probably a true view, though I confess I am getting rather at sea about "electrons"

and "ions." Nor am I at all disposed to agree with Principal Rucker that atoms are more than a physical hypothesis. I do not admit that Prof. "Britschli" has produced "a substance which simulates protoplasm" or has done more than give us some pretty examples of surface tension. I do not see even the beginning of a materialistic theory of protoplasm. This, however, was what Huxley attempted in the lecture on the "Physical Basis of Life," of which I see a cheap reprint is about to be issued. Mr. Clodd summarises it as if its contents were accepted scientific truths. But this is far from being the case, and I should myself be in great difficulty if they were presented to me in the examination room.

Huxley—to take only one out of many disputable assertions—after speaking of "the dull vital actions of a fungus," states that its "protoplasm is essentially identical with and most readily converted into that of any animal." Further on he puts the idea into a more picturesque form and speaks of "transubstantiating mutton into man." Except the definition of a crab attributed to the French Academy, I call to mind no statement so compact of error. Every physiologist knows that between the protoplasm of a sheep and that of the human being who consumes it there is a whole series of compounds which bear no resemblance to protoplasm at all. The animal has to build itself up from lifeless matter just as the plant has, only it mostly uses more complex molecules. It is no doubt true that a particle of fungoid differs in no appreciable physical respect from one of human protoplasm, yet the former will never emerge from the fate of the humble mushroom, while the other may be instinct with the thoughts of a Prime Minister. It may be that the difference is a function of molecular arrangement. If so it is of an order entirely different from anything chemistry presents us with. The fact is that protoplasm is not in any intelligible sense of the word a substance at all, but rather a structure or mechanism. Huxley puts this clearly enough later on in a letter to Herbert Spencer ("Life," i. 127).

Huxley's theological writings seem to me to exhibit defects of the same kind. He did not invent biblical criticism, though one might almost imagine from Mr. Clodd that he did. The argument seems to be this: read the Bible as if it were the *Times* newspaper; then ask yourself the question—Can I accept the statements of the one as literally as of the other? The answer of most persons will be, No. Very well then, Huxley replies:—You are in this position: Christianity is based on the Bible, and my sense of veracity compels me to say that it "vanishes" ("Life," ii. 212), or at any rate "is doomed to fall" ("Essays," v. 142), and some other "hypostasis of men's hopes" will take its place (*l. c.* 254).

But I fail to see the validity of the conclusion. Huxley's analysis of orthodox Christianity is that it is a "varying compound of some of the best and some of the worst elements of Paganism and Judaism, moulded in practice by the innate character of certain people of the western world" ("Essays," v. 142). Without discussing this, it clearly represents Christianity as a product of evolution. There will be, therefore, no new hypostasis necessarily; the moulding will go on and there will be fresh adjustments, as there have been in the past, to higher ethical demands.

I confess I hoped to find in Mr. Clodd's book what I have entirely failed to construct for myself, a consistent and systematic summary of Huxley's teaching in these matters. That he has not succeeded convinces me that the thing is impossible. Huxley's position was avowedly negative; he had no illusions on the subject ("Life," ii. 301). Mr. Clodd says that he "asked the churches to revive" the creed of Micah. I fail to find the passage, or that he did more than recommend that creed as a "work of art." Two years later he wrote:—"That there is no evidence of the existence of such a being as the God of the theologians is true enough" ("Life," ii. 162).

The fact is—and I think Mr. Clodd has failed to bring it out clearly—Huxley's theological and ethical writings are not a gospel, but the revelation of the working of a nature of singular complexity. A heart of warm emotion was in perpetual conflict with an intellect which strove to be the "clear cold logic engine" which he so much desiderated ("Life," i. 198). The late R. H. Hutton, who often showed real insight, hit the mark when he said that Huxley's "slender definite creed in no respect represented the cravings of his large nature," and there was more than sly humour in Bishop Thirlwall's remark on the presence at the Metaphysical Society of "Archbishop Huxley and Prof. Manning." The man's real catholicity of temperament endeared him to his friends and overbore the effect of his cold logic and often petulant agnosticism.

In dealing with biblical or any other ancient documents it is not sufficient to dismiss them because their literal accuracy cannot be sustained. The scientific problem is to ascertain how they came to be evolved by mankind and what is the true meaning behind them. This Huxley rarely did, and in consequence laid himself open to the reproach attributed to Jowett that "he did not consider the literature." Huxley said "the story of the Deluge is a pure fiction" ("Essays," iv. 234). But it occurs in Babylonian literature, and he subsequently followed Sussman in giving what is probably its true explanation (*l.c.* 247). He gave himself an excellent example of the true method in his analysis of "the account of Saul's necromantic expedition," which he thought "quite consistent with probability" ("Essays," iv. 291), and he defines in the same essay with luminous precision what may be described as the method of biblical paleontology (*l.c.* 290).

It seems to me that it would be a mistake to take Huxley's theology too seriously. It was essentially an intellectual product and not a working system. Thus he took "the conception of necessity to have a logical and not a physical foundation" ("Life," i. 412). He was above all things masculine and human. In re-reading his "Life and Letters," I am struck with the sanity of his judgments on administrative and political questions. To whatever extreme he pushed his logical conclusions in reasoning, when it came to "business" he was essentially practical. He raised many important questions. That is easy enough even for men of smaller intellectual calibre. What he did with them is that which really interests us. The ethical problem is the one of greatest actual importance. His fundamental position as regards this was a divorce between theology and ethics. "The end of the evolution of theology will be like its beginning—it

will cease to have any relation to ethics" ("Essays," iv. 371, 372). But the practical difficulty at once occurred to him—How is the dense mass of human action to be influenced by an appeal to abstract principles? Here is his answer:—"I must confess I have been . . . seriously perplexed to know by what practical measures the religious feeling, which is the essential basis of conduct, was to be kept up, in the present utterly chaotic state of opinion on these matters, without the use of the Bible. The Pagan moralists lack life and colour, and even the noble Stoic, Marcus Antonius, is too high and refined for an ordinary child" ("Essays," iii. 397). "Life and colour"—there you have the problem in a nutshell. When it came to the question of Board School education, he fought for the Bible. According to Mr. Clodd (p. 37), shortly before his death he regretted this, and "came to see" that it was "deplorable." But in 1894 he did "not repent . . . in the least" ("Life," ii. 383), and as to the "highest biblical ideal," he wrote in 1897, "I do believe that the human race is not yet, possibly never will be, in a position to dispense with it" ("Essays," v. 58).

Meanwhile it is interesting to note that he had tried various other solutions. One was obedience to natural law, an old-fashioned precept which traces back to Kingsley and farther:—"The safety of morality lies in . . . a real and living belief in that fixed order of nature which sends social disorganisation upon the track of immorality, as surely as it sends physical disease after physical trespasses" ("Essays," ix. 146).

But the "colour" question was insistent, as it must be, and so the moral sense was identified with "an innate sense of moral beauty" ("Life," ii. 305). This was compared with the æsthetic sense, and as with that ("Essays," ix. 80), "evolution accounts for morality" ("Life," ii. 360). This was an intuitional theory which was finally replaced by one that was practically utilitarian. "Of moral purpose I see no trace in nature. That is an article of exclusive human manufacture" ("Life," ii. 268). Mr. Clodd will save me the trouble of enforcing the position by further citations. "The terms 'good' and 'evil' have no meaning till communal life begins. Where there is no society there is no sin. A solitary man on an uninhabited island can do no wrong" (p. 284). I believe it is a moot point whether political economy can exist on an island with two inhabitants. But it seems a little harsh when there is only one to deprive him of such consolation as he may derive from his "innate sense of moral beauty" and bring him down without appeal to the level of the beasts that perish.

The Romanes lecture, which Mr. Clodd admires so much, to me is pathetic, because it is a sort of cry of despair. The cosmic order which we were formerly exhorted to conform to is identified with evil, and this is to be strenuously combated by the ethical principle. But the conflict will be unavailing, and the cosmic order will resume its sway. So after traversing the whole field of ethical exploration we are finally thrown into the arms of Schopenhauer. All this is intensely interesting to anyone who cares for such problems or for the working of a remarkable mind. But helpful or constructive I distinctly say that it is not. I turn to Mr. Clodd and find that he extracts from it "a religion that, coordinated with the needs and aspirations of human nature, would

find its brightest motive and its permanency in an ethic based on sympathy."

Sympathy may explain the altruistic aspect of morality; but I fail to see how it accounts for the "renunciation" of the lower impulses which is characteristic of the highest ethical development. And how for practical purposes is "sympathy" to be infused? My experience of human nature inclines me to think that it requires a more powerful appeal to the imagination than is afforded by a mere academic counsel of perfection of this sort. As I am writing these lines my eye falls on a speech in the daily paper by Viscount Goschen. I quote the following:—

"As a layman he wished, on behalf of the laymen, to express their admiration of the work which was being carried on, and which the clergy were doing in the East-end of London. Thirty years ago, when he was at the Poor Law Board, he made a special study of the statistics of poverty, ignorance and crime at the East-end, and he learned that the miserable breakages of civilisation resorted in their deepest despair to Bethnal Green, and hid themselves there amongst the very poor."

If we dispense with the clergy, have we at present any effective agency for dealing with this sort of problem? I see none, and I am firmly persuaded that no abstract principles would have prevented Huxley substantially agreeing with Lord Goschen.

Mr. Clodd frames a severe indictment against the theology of the last century. It did not lift its voice against the excessive use of capital punishment. I confess I do not see where theology comes in; it is a question of purely civil policy. Sentimentalism apart, the free use of hanging is scientifically arguable. Huxley thought that for "moral cripples and idiots . . . there is nothing but shutting up and extirpation" ("Life," ii. 306). Mr. Clodd complains that theology "still wages bitter war to enforce the teaching of her discredited dogmas; and, to her even greater shame, fans and fosters the spirit of militarism." This would be all very well in a secularist pamphlet, but I fail to see its place in a life of Huxley, even if I thought it just. Huxley's views about the Afghans ("Life," i. 489) show that, right or wrong, he was not wanting in the virile instinct of the normal Englishman.

From my point of view, which is that of a thorough-going evolutionist, I hold it unscientific to array one plane of theology against another which demands a higher ethical standard in practice. It would be as reasonable to complain that *Amphioxus* was unable to take advantage of a Board School education. If we agree with Huxley that theology is "a natural product of the operations of the human mind" ("Essays," iv. 288), Mr. Clodd is simply pointing his sword to his own breast.

Huxley was so transparently honest that no prejudice would blind his eyes to the merit of any agency that made for good, however sceptical he might be as to the basis on which it rested. Orthodoxy could not desire a more touching appreciation than his of "the bright side of Christianity" ("Essays," v. 254). He had even a good word to say of Roman Catholicism in the past ("Life," i. 346). He was deeply impressed with the life of Catherine of Siena. Whatever may have been his own intellectual convictions, life still remained to him "a

hopeless riddle" ("Life," ii. 134). That is the utmost positive outcome I can derive from his ethical teaching, and I do not see that Mr. Clodd carries us farther.

W. T. THISELTON-DYER.

A MONOGRAPH OF MOSQUITOES.

A Monograph of the Culicidae of the World. By F. W. Theobald, M.A., F.E.S. 3 vols. Pp. xxvi+815; 42 plates. (London: Trustees of the British Museum.) Price 3*l.* 3*s.*

THIS work has been undertaken chiefly with the object of enabling "medical men engaged in tracing the connection between mosquitoes and human disease to identify and speak with precision of the species implicated." A considerable knowledge of the principles of entomology has now become a necessity in such investigations, and the present work forms an excellent guide and help in the processes of identification.

The work in three volumes, of which the last consists entirely of coloured plates, has an introduction containing notes on the mounting of mosquitoes, in which the author strongly urges the necessity of preserving specimens in 40 per cent. spirit for purposes of more complete identification. The first portion of the work is devoted to a short account of the external structure of the adult, pupal and larval conditions of the insects and of the bionomics of the different stages, and ends with a synoptic table of subfamilies and genera of the family of Culicidæ and a list of species of Culicidæ, and a further list arranged according to the countries in which the species occur.

The rest of the work deals with detailed descriptions of the members of the different genera. It is lavishly illustrated by many figures throughout the text, which serve to lighten very considerably the difficult task of identification. The coloured plates forming the third volume have been exceedingly well prepared, and their execution must have absorbed much time and labour. It is, however, much to be regretted that many of the drawings, in fact almost all those of insects collected in tropical countries, have been made from preserved specimens, and consequently do not reproduce at all exactly the colours of the insects in nature. It is well known how quickly their delicate colours fade after death and under the influence of the usually employed preservatives, so much so, indeed, that to investigators who are very familiar with the insects in their tropical surroundings the coloured representations in this work appear very untrue.

Without in any way wishing to detract from the great value of the portion of the book which details the specific characteristics of the numerous species described, it is to be regretted that the earlier portion, dealing chiefly with the bionomics of the Culicidæ, and for which the author has been largely dependent for his information on the authority of others who have studied the insects in the tropics, should occupy such a prominent position. In the short description of the parts of the proboscis of the mosquito, the author has shown himself unfamiliar with the minuter details of its structure. He advises the

disuse of the term "epipharynx," "as it is really part of the upper lip." This is not shown to be so if carefully prepared serial transverse sections are made of the proboscis. By this means it is seen that the epipharynx is a tunnel-shaped tube through which blood is drawn up and which is strengthened on each side by a chitinous rod, in the centre of which is a core of chitin-forming cells—prolongations forward of the cells lining the external chitin of the whole body. The epipharynx is by its dorsal surface very intimately connected with the "labrum," or upper lip proper, throughout its whole length. That the labrum does not, however, extend as far as the tip of the epipharynx is shown by the presence of the core of chitin cells which here approaches the dorsal surface. The two pieces, the labrum and the epipharynx, therefore represent two distinct organs, which are bound closely together for a great part of their length by a delicate connective tissue, so that the combined organ might rather be called the "labrum-epipharynx," a term first suggested by Dimmock. Near the base of the proboscis the labrum is composed of a curved lamella of chitin, concave upwards, convex towards the convex upper surface of the epipharynx—the open sides being closed by folds of delicate chitin, which unite below with the lateral rods of the epipharynx, the space thus enclosed being filled with delicate loose cellular connective tissue.

Mr. Theobald also describes the hypopharynx as "a small needle-like thread connected with a poison gland at its base." The hypopharynx does not lie between the four stylets (the mandibles and the maxillæ) and the epipharynx, but, as is well shown in well-prepared sections, the lower edges of the mandibles fit in between the hypopharynx and the epipharynx at the sides, and only in the middle line do the thin lower edges of the epipharynx and the upper surface of the hypopharynx meet. Moreover, the structure at the base of the hypopharynx is not a poison gland, but, a receptacle for the collection of veneno-saliva secreted by the salivary glands situated in the prothorax. This receptacle is somewhat trumpet-shaped, with sides of strong rigid chitin. The mouth opens on to the upper end of a groove which runs along the whole length of the hypopharynx, the veneno-salivary gutter; whilst the broad end is composed of delicate membranous tissue, and receives about its middle the insertion of the common salivary duct. Into this membrane also are inserted the tendons of delicate muscles. The receptacle is simply a store for saliva which is discharged by the falling back of the membrane, previously retracted by the muscles attached to it.

Mr. Theobald emphasises the importance of the scale structure of the insects, and considers it to be one of the most important characters for both generic and specific distinction; the whole classification in the monograph is mainly based on the scale structure. In the description of the wings, the terminology of Skuse, which is the simplest and best suited for purposes of identification, has been adopted.

The paragraphs on the bionomics of mosquitoestreat chiefly with the habits of *Anopheles* and *Culex*. These paragraphs contain many incorrect and misleading statements, and other recent works might be consulted

for more trustworthy information on this subject. For example, the author concludes that *Anopheles maculipennis* does not bite here in England, and suggests the question whether this may not have some bearing on the dying out of malarial fever in this country. Now there is no doubt that *A. maculipennis* have been found gorged with blood in some parts of England in bedrooms and other places. Moreover, however closely the distribution map of the English *Anopheles* corresponds with the old malarial district map which Dr. Nuttall has worked out, it is quite certain that there is hardly any district of England entirely free from *Anopheles*, which are easy to find if diligent search be made.

He further states, on the authority of Dr. Daniels, that in the greater part of India blackwater fever is unknown; on the contrary, however, this disease is more prevalent in some parts of India than in Africa.

In that greater portion of the work which deals with the classification and descriptions of the mosquitoes, the author has prepared extremely serviceable and minutely detailed entomological accounts of the characteristics of all the then known species. Of the old genera, the following have been retained:—*Culex*, *Anopheles*, *Ædes*, *Mochlonyx*, *Megarhinus*, *Psorophora*, *Sabethes*, *Cerethra*, *Uranotenia*, *Hæmagogus* and *Tæniorhynchus* (modified). The new genera added by Mr. Theobald are *Wyeomyia*, *Deinocerites*, *Ædeomyia*, *Panoplitæ*, *Eretmapodites*, *Janthinosoma*, *Stegomyia*, *Mucidus*, *Toxorhynchites* and *Trichoprosopon*.

Of the 300 species described, 136 are new. The majority of species described are those found in and around towns or are known pests to travellers and traders; a few, of the genera *Megarhinus* and *Sabethes*, which probably occur more abundantly in forests, are also described.

The author deserves very great credit for the enormous amount of work which must have been entailed in the preparation of the details of this large number of species, and it is extremely desirable that in its second edition the great value of the work, especially to those who are engaged in the study of disease in tropical and sub-tropical countries, will be still further increased by the correction of the errors and contradictions which have evidently been overlooked in the hurry of publication.

THE DIRECT-CURRENT ARC.

The Electric Arc. By Hertha Ayrton, M.I.E.E. Pp. xxv + 479. (London: The Electrician Printing and Publishing Company, Ltd.) Price 12s. 6d.

THERE are few electrical phenomena which are of more interest than those exhibited by the electric arc, or which are more difficult to investigate. The complexity of the laws by which it is governed and the number of factors which can be varied independently make any research into its properties of a laborious character. Mrs. Ayrton is to be congratulated, not only on the painstaking investigations which she has carried out on the direct-current arc, but also on the remarkable success which has attended her work. Much of the book before us is already familiar as the result of papers

published in the *Electrician* or communicated to scientific societies. But in one sense the book may be said to be entirely new, as it presents for the first time the results of Mrs. Ayrton's work in the form of a connected whole in which the interdependence of the various parts is made manifest.

After a short chapter on the general appearance of the arc, Mrs. Ayrton gives, in a chapter of nearly eighty pages, a history of its discovery and development and of the investigations to which it has been subjected. Though the discovery is usually attributed to Davy, it is clear from the quotations given by Mrs. Ayrton that the arc was evolved from the electric spark without any distinct recognition of the difference between the two; to Davy, however, belongs the credit of the first description of an undoubted arc, from which dates, probably, its recognition as a distinct phenomenon. The remainder of the chapter, in which all the important papers on the arc are considered, is of great value, especially, perhaps, to the student, as it leads by easy gradation from the simpler theories which were advanced at first to the more complex and complete explanations which have to be put forward now that all the problems arising are more fully realised.

Mrs. Ayrton then passes on to the behaviour of the arc immediately after striking, and to the necessity of working with "normal" arcs, that is, arcs in which the P.D. has assumed its steady value for the given current and length of arc. The laws that govern the P.D., current and other electrical quantities are then considered in detail, as a result of which Mrs. Ayrton's now familiar equation connecting the P.D. with the current and length of arc is derived. The equation, which is of the form $V = a + bl + \frac{c + dl}{A}$, where a , b , c and d are constants depending on the carbons and V , l and A the P.D., length of arc and current respectively, is shown to fit in with the results of the experiments of previous investigators, even though the equations which they had themselves advanced were different or less complete. This equation, which applies only to solid carbons, is very accurate over the range studied by Mrs. Ayrton. The effect of cores in cored carbons is considered, and it is shown, by an examination of the P.D. between the carbons and the arc, how the various terms of the equation can be correlated with the physical phenomena in the arc.

Especial interest attaches to the above equation on account of its connection with the theory advanced in the final chapter. But apart from this, the whole of this portion of the work is of the highest intrinsic value. We cannot, with the space at our disposal, consider it in any detail, but we might particularly draw attention to chapter viii., which deals with the stability of the arc, and to chapter x., on hissing arcs. The chapters dealing with the efficiency of the arc, considered first as a consumer of power and secondly as a source of light, should appeal strongly to those who are interested in arcs from the practical standpoint, especially as they show how much the commercial standard falls below that actually obtainable. The arc enjoys at present the distinction of being the cheapest form of artificial light, so that the only

competition to be met is that between different forms of lamps; but this is quite sufficient to lead to the advisability of an attempt at improvement by the scientific study of the best conditions of working.

In chapter xii., Mrs. Ayrton puts forward her theory of the arc. It is hardly fair to consider this theory apart from the rest of the book, as it arises naturally out of the views advanced therein. For a long time experimenters have been divided into two camps, those who believed in the existence of a back E.M.F. in the arc and those who did not. According to Mrs. Ayrton's view, it is not necessary to assume the existence of a back E.M.F. to account for the high fall of potential between the positive carbon and the arc, as it can be explained in another way. The conducting part of the arc consists, on this view, of a very thin film of true carbon vapour at the crater and of carbon mist throughout the rest of the arc. The very high specific resistance of the carbon vapour accounts, not only for the fall of P.D., but also for the volatilisation and cratering of the positive carbon. It is shown from actual measurements of the cross-sections of the mist and vapour that their variation with current and length of arc lead to a law of variation of P.D. precisely similar to that given in the above equation. If we may venture criticism, we should like to point out that the explanation suffers from being only qualitative, and though the form of the equation is the same there is nothing to show that the constants are of the same magnitude. It remains to be shown by experiment whether this is the case or not.

The method of measuring the "true" resistance of the arc by a superimposed alternating current fails, as Mrs. Ayrton shows, unless it can be proved that the added current in no way affects either the resistance or the back E.M.F. (if existent). It is well known that this method leads in some cases to negative results, and Mrs. Ayrton points out that it may lead to any value from a large negative one to that of the "true" resistance, according to the frequency of the added current, which must be as high as "many thousands of alternations per second for the resistance of the arc not to be altered by it." In a recent paper by Mr. Duddell, read before the Royal Society, the results of experiments with a frequency as high as 120,000 alternations per second were given, and the author claimed that they showed a true resistance of about four ohms and a back E.M.F. of twelve volts. Unfortunately, this paper was not published at the time of the completion of Mrs. Ayrton's book, but it would be interesting to learn whether she can harmonise it with her theory. Incidentally, it may be noted that Mrs. Ayrton's explanation accounts for the effects produced by cores and for the shapes to which the carbons burn, and there can be little doubt that, whether or not it proves sufficient to rank as a complete theory, it is a great advance towards the clear appreciation and the solution of the problems presented.

In conclusion, we may commend the excellent drawings of arcs and carbons with which, in addition to curves and diagrams, the book is copiously illustrated. Altogether the book deserves to rank as one of the most important contributions to electrical literature that has appeared of late years.

M. S.

OUR BOOK SHELF.

Palaeontologie und Descendenzlehre. By E. Koken. Pp. 33; illustrated. (Jena: G. Fischer, 1902.)

IN this essay, read before the Congress of Science and Art held at Hamburg in September last, the author briefly explains in a popular manner some of the more important evidence in favour of evolution afforded by palaeontological researches and discoveries. After alluding to the old belief in the separate creation and immutability of species, Dr. Koken mentions Lamarck's theory, and then passes on to the revolution in scientific thought and belief brought about by Darwin's work. With a brief reference to Waagen's investigations and theories in regard to the mutations of ammonites, and the expression of the belief that what holds good in this case will also apply to other groups, he proceeds to cite some of the most striking instances of the descent of one group from another. In regard to mammals, it is considered that the earliest forms were nearly allied to the Insectivora, and that from these were developed the Creodont Carnivora, from which subsequently branched off the placentals on the one hand and the marsupials on the other. Allusion is next made to the importance of Archaeopteryx, as in some respects a connecting link between birds and reptiles. Attention is then called to the important evidence which has been obtained during the last few years as to the relationship between the anomodont reptiles and mammals on the one hand, and between the former and the labyrinthodont amphibians on the other. A wide cleft still, however, separates amphibians from fishes—a cleft which, in the author's opinion, is in no wise spanned by the lung-fishes, the amphibian resemblances of which he believes to be largely adaptive.

Having cited the foregoing and other instances of genetic relationship between various classes, Dr. Koken next proceeds to consider numerous cases of intergradation between minor groups. In the Mammalia he first of all refers to the now well-known fact that in the early Eocene it is almost impossible to distinguish between ungulates and ungulates, and then proceeds to discuss several of the phylogenetic lines into which the latter have developed. Special mention is made of the clawed chalicotheroids of the Miocene and Pliocene, as a remarkable side-branch of ungulate development; and Kowalevsky's doctrine of the "adaptive" and "inadaptive" modifications of the artiodactyle carpus is fully explained. A very remarkable instance of the evolution of one type from another, which has not received so much attention as it deserves, is exemplified among the dinosaurian reptiles by the Liassic *Scelidosaurus* and the Upper Jurassic *Stegosaurus*, skeletons of which are figured in juxtaposition.

This excellent little sketch concludes with some remarks upon former land connections and general observations on the evolution of the surface of the globe and its inhabitants. R. L.

The Laboratory Companion to Fats and Oils Industries

By Dr. J. Lewkowitsch, M.A., F.I.C. Pp. xi + 147. (London: Macmillan and Co., Ltd., 1901.) Price 6s. net.

THE book is essentially a collection of tables of the numerical values obtained in the analysis of oils and fats, and of tables useful in industries where oils and fats are employed; it forms a companion to the author's earlier publication on the "Chemical Analysis of Oils, Fats and Waxes." The amount of information in the book is very extensive, as may be judged from the fact that the number of oils only, for which constants are given is 111, and the number of fats 65.

The author states in his preface that "numerical values, so-called constants, and variables, have been

carefully scrutinised, and only the most reliable ones have been given. In some cases the most probable values had to be decided on." As the consequence of this, we find in the majority of cases single numbers given for the iodine value, saponification value, &c., of oils and fats. This precludes reference to the results of the various observers. The arrangement of materials under the heading of separate manufactures is a very useful feature. Thus, under the heading "soap manufacture," are eight tables, including such information as the percentages of caustic soda and caustic potash in caustic lyes, the influence of temperature on the specific gravities of caustic soda solutions, and the amounts of caustic alkali solutions required to saponify fats of certain mean molecular weights.

LETTERS TO THE EDITOR.

(The Editor does not hold himself responsible for opinions expressed by his correspondents. Neither can he undertake to return, or to correspond with the writers of, rejected manuscripts intended for this or any other part of NATURE. No notice is taken of anonymous communications.)

Colour-variation in the Guinea-fowl.

AS this bird is such a recent addition to the poultry-yard (for, although known to the Komans, it went out of domestication in the Middle Ages) and has not been selectively bred by fanciers, its spontaneous variations are particularly interesting. Here, in India, where guinea-fowls are much bred, several well-defined types of coloration constantly present themselves in these birds, kept solely for the table.

There is first the normal dark-grey form, speckled with white and with white bars on the primary quills. This is the commonest; but it varies from the wild type in having more white on the naked head and neck, and generally in having the toes and shanks more or less orange instead of black.

Secondly, there is a form, marked exactly as the above, but on a lavender or French-grey background; it resembles, however, the dark normal bird in the coloration of the head and legs.

A third form is of a purplish-slate without spots, but retaining the white bars on the primary quills; the head and legs also are coloured as in the common normal form.

There are also, of course, albino birds, which have entirely orange-yellow legs and feet, and no dark purplish hue about the bare head, but only white and red.

The pied birds which occur are particularly interesting, the marking being very constant—white underparts and white primary quills. The white may invade more of the wing, and may be reduced in amount on the breast and wings until the coloured form is reached, but I have never seen a splashed or blotched bird, such as one often finds among pigeons or ducks.

All the colours, spotted-grey, spotted-lavender and slate, may be pied like this, but the normal spotted-grey oftenest, as one would naturally expect from its greater frequency. The bare dewlap of these pied birds is white when the white feathering comes as far, not blue or purple as in coloured birds.

The only unspotted-lavender bird I have seen as yet was a white-pied one.

I have not had the same opportunities of studying guinea-fowls in England as I have out here, but certainly, to the best of my recollection, all the colour-types I have described occur there, which, considering the difference of climate, shows that this factor does not determine variation in this bird.

As I have remarked above, the pied birds grade into the coloured ones; but typical specimens are more common than intermediate ones, and there is no gradation whatever between the two spotted forms, the dark-grey and lavender. The unspotted slate form does often display a few white-marked body-feathers, but by no means tends to intergrade with the normal type.

If this bird, with its uniform body-colour and barred primaries, occurred in a wild state, the markings of the quills, concealed as these are in repose, would be set down to sexual selection or claimed as "recognition marks"; and a similar cause would be

invoked to account for the white underparts and white quills of the pied forms, which would be well concealed if the bird lay flat on the ground.

Yet in this case of a bird which has been protected by man for a few centuries only, we see these beautifully arranged markings appearing suddenly and almost in full perfection, by simple variation happening to take, in this species, these definite forms.

Last winter I procured in the Bazaar here a pintail snipe (*Gallinago stenura*), marked much like a pied guinea-fowl, with white outer primaries, some white down the breast, and orange toes. This is the kind of resemblance which is put down to mimicry when occurring between two wild species of similar size inhabiting the same country.

And thus the view of Darwin, that mimicry has always commenced between forms with a considerable resemblance to start with, receives confirmation; as also from the fact that, in birds at any rate, so many cases of "false mimicry" between species inhabiting distant countries can be shown to occur.

At any rate, whether we are dealing with recognition-marks, sexual selection or mimicry, it seems to me that the study of variation constantly tends to show that natural selection has always at hand far greater material in the shape of colour-variation than is commonly supposed. F. FINN.

Indian Museum, Calcutta, May 1.

A Cubic and Submerged Cubes.

The following is a curious puzzle. Given a square box having an area of 27 square inches on its floor and having vertical sides, and filled with water to a depth of 2 inches, it is required to find the size of a heavy cube which, when resting on the bottom of the box, will have its upper surface high and dry above the surface of the water. The curious thing is that there is no such cube. A very small cube will have its top nearly 2 inches below the surface; the largest cube that can go into the box, its edge being 5 inches and a fraction, forces all the water above it except a film and, again, has its top nearly 2 inches below the surface. There is one cube, that with its edge 3 inches, which has its top just on a level with the surface of the water; its top may be dry, but is not both high and dry. All other cubes are more or less submerged. This is a numerical example of a unique case.

For an example of the general case, let the area of the floor of the box be 28 square inches and let it contain 48 cubic inches of water. Now it will be found that there are two cubes which, when placed on the bottom, have their tops on a level with the surface of the water. They are the cubes with edges 2 inches and 4 inches respectively. All cubes between those two have their tops high and dry above the surface, while all other cubes are more or less submerged.

It may be interesting to know that these cubes give a physical interpretation to the roots of the cubic obtained by equating the trinomial $x^3 - ax + v$ to zero. The equation has two positive roots, m and n , and a negative root, $(m+n)$. If a be the area of the bottom of the box and v the volume of the water, then x is the edge of the cube which has its top flush with the surface of the water. There are, therefore, in general two such cubes, m^3 and n^3 , the negative root being inadmissible. Since $a = m^2 + mn + n^2$ and $v = mn(m+n)$, by giving values as $m=4$ and $n=2$ we obtain $a=28$ and $v=48$, as in the second numerical example above. Again, if we suppose the two positive roots equal, as $m=n=3$, we have $a=27$ and $v=54$, as in the first example.

If a value be assigned to x lying between m and n , it is readily shown that the trinomial is no longer zero, but is negative, which is the condition that the top of the cube shall stand above the surface, while for values of x on either side of m and n the trinomial becomes positive, so that these cubes are submerged. THOS. ALEXANDER.

Trinity College, Dublin, May 22.

The Electrical Resistance of the Blood.

IN a letter published in NATURE of July 13, 1899, the author communicated some of the results he had obtained in measuring the electrical resistance of the blood. These results showed that the average resistance of normal blood at 60° F. measured by Kohlrausch's method in the apparatus used amounted to 550 ohms, while the specific resistance was 93.5

ohms. Further, a marked change was observed in pernicious anemia, the resistance in this disease falling to about one-half (300 ohms) that of normal blood. The author has shown (*Proceedings of the Royal Society of Edinburgh*, December 21, 1891) that the electrical resistance of the urine in this disease is greatly increased (about 100 ohms specific resistance instead of the normal 45 ohms); hence we have the striking fact that, while the urine contains too few salts, the blood contains an abnormal amount. The kidneys, then, must obviously be in fault. In a patient, aged fifty-one, suffering from pernicious anemia, under the care of Dr. A. James, in the Edinburgh Royal Infirmary, the blood resistance, measured on February 25, 1902, amounted to 300 instead of the normal 550 ohms. The resistance of the urine, measured at the same time, amounted to 88 ohms instead of the normal 45 ohms. The blood corpuscles numbered 900,000. The blood resistance in diabetes mellitus is high, like that of the urine. A number of experiments have been made by me to ascertain the time occupied by ingested sodium chloride to reach the blood. The blood resistance in five cases was measured before taking 30 grains of the salt and at five-minute intervals afterwards. The average time taken for the first lowering of the resistance of the blood was 15.4 minutes, and the maximum effect was produced in 21.4 minutes.

Further observations on these lines promise interesting results. DAWSON TURNER.

Chickens Hatched in a Tree.

YOU may, perhaps, think the following account of an incident which happened here last week in our poultry-run worth printing.

About May 1, one of our hens, which was known to be laying, totally disappeared. For some ten days she baffled all our efforts to discover any traces of her. At last she was found sitting on the eggs she had laid in a squirrel's nest, in a Scotch fir-tree, at a height of 16 feet from the ground.

For the remaining eleven days of her incubation the hen was watched descending, and ascending from bough to bough to her high perch, at first every day once, but latterly once every other day, as far as could be observed.

On Thursday, May 22, the hen was found with six live chickens and two dead ones at the foot of the tree. Unluckily no one witnessed the actual descent. She could not, however, be persuaded to enter an ordinary hen-coop.

With some trouble, the hen and her six chickens were got eventually on to some straw in an old railway-carriage, which I had erected some years ago on the edge of the hen-run, which is sheltered from the north wind by a fir-plantation, where many squirrels build their nests.

In order to convey her chickens from the railway-carriage to the ground, the hen was seen to spread out her tail and descend with all six young chickens at once on her back. Doubtless she had conveyed them down the 16 feet from the fir-tree in the same fashion, but probably only one or two at a time.

Six-Mile-Bottom, Cambs., May 25.

W. H. HALL.

A Curious Optical Effect.

A FORTNIGHT ago, while standing with my back to the sun, which for a few minutes happened to be shining brightly, and with my face within a few inches of some darkly painted boards, which were covered with minute sparkling particles, presumably from an adjacent coke-grinding machine, I noticed that on approaching my face a little closer, the particles became iridescent and apparently magnified to a size of about one-eighth of an inch. On closing one eye and looking closer, concentric circles appeared, with a cross \times over them, and in some cases there was a smaller circle just touching the inner margin of the larger one; in others the small circle seemed to be nearer the centre of the larger one. On a subsequent examination, when the sun was not so bright, the concentric circles seemed to be wavy and indistinct, as was also the case with the cross. The whole thing reminded me of illustrations I have seen of effects produced by tourmalines under certain conditions.

If this is a commonly observed phenomenon, I should feel obliged for any references to literature on the subject.

E. MOOR.

49 Arbitration Street, Doncaster, Yorks., May 26.

THE PROPOSED EXPERIMENTAL TANK FOR TESTING SHIP MODELS FOR RESISTANCE.

THE recent opening of the National Physical Laboratory, as described in NATURE on March 27, marked an epoch in the advance of science into the commercial development of this country. Equipped as the Laboratory will be with the best appliances for testing materials and instruments of precision, for fixing standards of measurement and comparison, it will supply that which, in other countries, has already been recognised as a vital necessity to national commercial prosperity.

There is, however, a branch of scientific investigation not contemplated in the original scheme for the Physical Laboratory and which it is now proposed to include in it, namely, an experimental tank for testing, by means of models, the resistance of vessels either already in existence or only in the stage of design.

The system followed in the practical application of theory to the solution of these problems of naval archi-

ture, when placed in the water, serves as a check on the accuracy of the workmanship.

The model, when ready for testing, is placed in the tank and attached to a travelling framework or "carriage" which spans the width of the tank and is propelled either by a self-contained motor or by a stationary engine and cable. The travelling carriage is fitted with a dynamometer and registering apparatus, which records automatically the pull or resistance of the model and the speed at every point of the course traversed. Thus, at the conclusion of a series of trial runs at different speeds, accurate diagrams are obtained, from which the curves of resistance can be plotted for the various speeds considered, and, by interpolation, for any intermediate speed. In a similar way, the effect of alteration of trim and displacement can be easily determined, and the most interesting and useful experiments on the effect of alterations to existing vessels, on the efficiency of various forms of screw propellers, on the relative oscillations of different types of hull, and many other problems that are met with in naval architecture can be carried out with results that approximate closely enough for all practical requirements to those actually obtained on full-sized ships. The economy in using models instead of full-sized vessels for obtaining such experimental data is sufficiently obvious, and need not be insisted upon.

It is to Mr. Froude also that we are indebted for establishing the exact relations that subsist between the model and the full-sized vessel, upon which depends the success of the experimental method. This relation or law of "corresponding speeds" is to the effect that, comparing ship and model, "the resistance is in proportion to the cube of the linear dimension at speeds proportional to the square root of the linear dimension."

The practical value of Mr. Froude's labours was recognised by the Government at an early period, and his tank at Torquay was established under Admiralty supervision in 1870. Fifteen years later, the Government decided to build and equip a much larger tank at Haslar, near Portsmouth, where models 14 feet long could be run over a course of 400 feet. This tank is under the direction of Mr. R. E. Froude, whose valuable researches by means of model experiments have greatly added to our knowledge or the laws relating to fluid resistance, oscillation of ships, propeller efficiency, and other problems of naval architecture.

The tank at Haslar, erected at Government expense, has been devoted purely to Admiralty work, and it is not found possible to extend its use to the testing of models for private shipbuilders.

The only other tank of this kind in the kingdom is that constructed by Messrs. Denny at Dumbarton, and this is only employed upon the work of that firm.

Recognising the need for a tank where private shipbuilders could at any time send a model to be tested, the Institution of Naval Architects, at their summer meeting in Glasgow last year, passed a resolution to the effect that such a tank ought to be established, and the council of that Institution has since been considering how this proposal could best be carried out.

The two chief difficulties were the selection of a site suitable for the purpose and the raising of the necessary funds to carry the scheme out. As regards the latter requirement, it was felt that those interested in the welfare of the shipowning and shipbuilding interests of



FIG. 1.—View of Washington Tank, north end, showing Wave Breaker.

ture was devised by the late Mr. Wm. Froude. In his first experimental tank, erected at Torquay more than thirty years ago, Mr. Froude carried out the researches which led to his well-known discovery of the laws which govern the resistance offered by water to the propulsion of ships.

Although the method pursued has often been described in NATURE and elsewhere, a brief outline of it, by way of reminder to our readers, may not be out of place.

A model of the vessel the resistance of which is to be tested is made either of wood or, preferably, of paraffin. If the latter material is used, the block is cast roughly to the shape of the proposed hull and then placed in a cutting machine, where it is planed down to the exact shape required, by a cutting tool, the movements of which are controlled by the operator. The latter guides the instrument by following with a pointer the lines of the hull on a drawing, the connection between the pointer and the cutting tool being so exact that the contour lines of the design are faithfully reproduced on the hull of the model. The final touches are done by hand, and

the country would not be slow to guarantee the necessary funds, provided a site could be found easily accessible, and where a tank could be placed under independent, competent and impartial control.

In the grounds of the National Physical Laboratory



FIG. 2.—View of Carriage and Model at rest.

at Bushy House, a site has been selected which it is proposed to devote to the purpose. This situation, besides being very convenient as regards the nature of the ground (to quote from Lord Glasgow's recent presidential address), offers "many important advantages; a position conveniently near the metropolis, the proximity of an established power installation and a highly trained technical staff, and, above all, a board of management of the highest standing, entirely unconnected with any individual commercial enterprise, whose control would in itself guarantee the treatment in strictest confidence and impartiality of all questions submitted to them."

It is hoped, therefore, that shipbuilders and shipowners and others will come forward liberally to form the necessary guarantee fund for the construction and equipment of the tank, which together are estimated to cost about 15,000*l*. The scheme, which has received the hearty support of His Royal Highness the Prince of Wales, is now ripe for carrying into execution, and it is felt that no more time should be lost in adding this necessary auxiliary to the equipment of British shipyards. The Prince of Wales, in opening the Laboratory on March 19, expressed his confidence—a confidence which we feel sure will be justified by results—that "through the generosity of the public, the necessary means will be forthcoming to meet these difficulties and to secure almost an essential to the shipbuilding industry of a country possessing the largest mercantile world."

Other countries have not been slow to realise the value of model experiments; Italy has her experimental tank at Spezia; Russia one at St. Petersburg; Germany, besides having a private tank at Bremerhaven belonging to the Norddeutscher Lloyd, is about to erect one in Berlin; and the United States of America, not to be outdone by the old countries, has built the largest tank of all at Washington, where 20-foot models are tested over a 470-foot length of run.

All these tanks, excepting that at Bremerhaven, are worked by Admiralty staffs of their respective Governments, but the private shipbuilder has not been forgotten, and in each case he may, subject to certain regulations and to the payment of fees sufficient to cover the cost of the experiments, make free use of the tank for carrying out researches of his own. But, however convenient it may be to have a tank erected at the expense of a paternal Government, it can hardly be doubted that the arrangement has its drawbacks; private individuals would, at times of pressure, have to give way to Government needs, and at all times the results of the experiments are of necessity obtained as much for the benefit of the Admiralty as for that of the private individual. Both these drawbacks are obviated by placing the management of the tank in private, but disinterested, hands.

Some views of the Washington tank are reproduced here from a paper by Mr. D. W. Taylor (naval constructor, U.S.N.), read before the American Society of Naval Architects and Marine Engineers, and they give a good idea of its chief features of interest. The "carriage,"



FIG. 3.—Carriage towing a Model (stern view).

which is

which draws the model through the water and contains the recording apparatus, spans the entire width of the tank (46 feet 6 inches) and weighs nearly thirty-two tons. It is propelled by four electric motors, shown in Fig. 2 at

the extreme ends of the framework. As the speed attainable is upwards of 20 knots—developed in a 200-feet run—powerful emergency brakes actuated by hydraulic pressure are provided, in addition to the ordinary friction brakes, and the whole carriage is under perfect control for stopping and starting, and maintaining constant speed during a run.

The extreme length of water surface in the Washington tank is 470 feet, of which about 370 is of the full section across, the remainder being the narrow extremities available for starting and stopping. In order to reduce the time lost between runs through waiting to obtain still water, side troughs 12 inches square in section are laid throughout the length of the tank to absorb the wave disturbance caused by a model run, while at the north end of the tank (Fig. 1) a series of wooden strips placed vertically act as a wave breaker at the close of the run.

Great care is taken to ensure the purity of the water by treating it with alum and filtering through sand

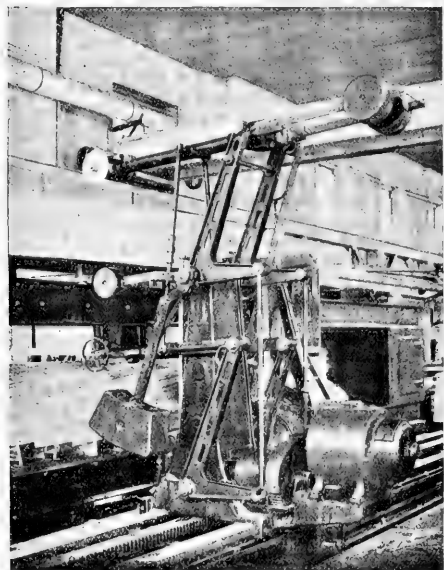

FIG. 4.—Model Shaping Machine.

before admission to the tank. The capacity of the latter is about one million gallons, and the tank can be pumped dry when required in about four hours by a 12-inch centrifugal pump. The temperature in the building is kept as far as possible uniform and slightly above that of an ordinary living room.

A special feature at the Washington establishment is the employment of wood for the models instead of paraffin. This is on account of the heat in summer being too great to allow of the latter material being used, preferable though it is in other respects; for the cost of wood is higher, the difficulties of shaping it to the specified lines are greater, more time is required, and it is, of course, impossible to reduce it to bulk after use, as in the case of paraffin. On the other hand, a wooden model is less liable to accidental damage and retains its shape better if required for future use.

Fig. 3 shows a model being towed through the water, the wave formation being clearly visible; Fig. 4 gives a view of the shaping machine at work on a model.

R. W. D.

VOLCANIC DUST FROM THE WEST INDIES.

IT was mentioned last week that the West Indian mails had brought packets of volcanic dust which fell at Barbados and elsewhere to several institutions and investigators in this country. The characteristics of this material have been minutely examined, and the following descriptions of them will be found of interest.

I.

At the meeting of the Geological Society on Wednesday, May 28, Dr. Flett communicated a preliminary note on the ash which fell at Barbados. The specimens had been forwarded by Dr. Morris, of the Imperial Department of Agriculture, to Prof. Judd, who placed them in the hands of Dr. Flett for examination. The ash consists principally of plagioclase feldspar allied to labradorite, hypersthene, monoclinic augite and magnetite. The crystals are often perfectly idiomorphic, and it may be safely inferred that they were formed in the magma before the actual eruption took place, and blown into the air along with the molten material by the force of the escaping gases. A small amount of glass containing steam holes is adherent to some of the crystals, but many are perfectly clean.

The crystals are similar in every respect to the phenocrysts of hypersthene-augite-andesite, a type of rock well known among the recent volcanoes of the Pacific region. In the discussion which followed the reading of Dr. Flett's paper, it was pointed out by Mr. Prior that the same type of rock occurs in other West Indian islands, and also in the Mexican volcanoes, so that the petrographical evidence serves to connect the West Indian volcanic region with the Pacific rather than with the Atlantic. An analysis of the ash by Dr. Pollard was communicated by Dr. Flett. It is quoted below.

SiO ₂	52.81	MgO	5.19
TiO ₂95	K ₂ O60
Al ₂ O ₃	18.79	Na ₂ O	3.23
Fe ₂ O ₃	3.28	P ₂ O ₅15
FeO	4.58	SO ₃33
MnO28	Cl14
(CoNi)O07	H ₂ O 105°20
CaO	9.58	H ₂ O above 105°17
		Total	100.35

It must be remembered that this analysis does not represent the composition of the material as it existed in the subterranean reservoir immediately before the eruption, but rather the bulk analysis of the crystals which had separated out, together with only a small admixture of the glass.

If this glass could be separated and analysed it would probably be found to differ from the bulk analysis of the crystals in the same way as the glassy base of hypersthene-andesites differs from the bulk analysis of the phenocrysts; that is, it would contain more silica, less lime, iron and magnesia, and more alkalis, especially potash. In Old Red Sandstone times the volcanoes of the Cheviot district erupted hypersthene-andesites, and the glassy base of one of these rocks was analysed by Dr. Petersen with the following result:—

SiO ₂	66.25	MgO28
Al ₂ O ₃	13.59	K ₂ O	4.95
Fe ₂ O ₃	3.11	Na ₂ O	2.25
CaO	2.75	H ₂ O	5.89
		Total	99.07

The samples of ash from Barbados hitherto examined consist mainly of the crystals. The glassy matter which represents the mother liquor appears to have been vanned away and deposited elsewhere. This, if it should turn out to be the case, is somewhat unfortunate, for the glass, with its higher percentage of potash, would have been more useful as a fertilising agent.

J. J. H. TEALL.

II.

The photographs here reproduced are those of the volcanic dust which fell in Barbados on Wednesday, May 7. The circumstances attending the fall have been so graphically described in a letter, dated May 10, from Mr. G. C. Edghill, the manager of the sugar plantation on which the dust fell, to its owner, Captain Forte, that it seems best to quote parts of the letter *verbatim*. It is to the kindness of Captain Forte (a friend of my father's) that I owe both the letter and the specimen of the dust.

Mr. Edghill writes as follows:—

"Wednesday morning, May 7, opened normally, the day being fine and a steady breeze blowing. Soon after mid-day we began to hear deep subterranean explosions, increasing in intensity, some single, others in volleys of about five or six. Some of these made the earth vibrate like a slight shock of earthquake, and they continued for two or three hours. Then a black cloud began to rise in the direction of St. Vincent, which rose and spread towards and around us, *although the wind was blowing from us towards it.* (The italics are mine.)

"About four o'clock the edge of this cloud began to obscure the edge of the sun, and dust began to fall, at first lightly, but increasing gradually in volume, and making a noise like a fine drizzle. Rapidly then the light grew dim, and the appearances were like those of a total eclipse of the sun, but very grand and startling—making one feel creepy. At five o'clock it was quite dark, and our mill hands had to be lent a lantern to see their

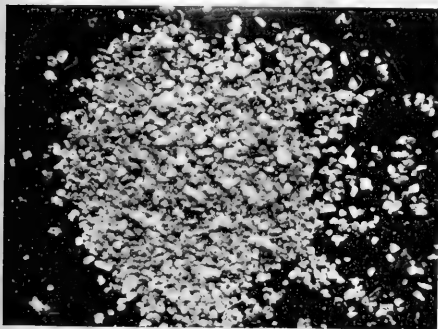

FIG. 1.

size of these dark particles is about 0.008 cubic millimetre. When thrown into water, about half the powder sinks at once, and if the floating particles be examined with a high power, it will be seen that they are all buoyed up by air bubbles; on violently agitating the dust with the water, the dust sinks, so that it does not seem to contain any of the *lighter* kinds of pumice, which through their extremely porous nature cannot be made to sink so easily.

When the dust is thrown into a solution of density 2.52 (a solution of mercuric iodide in potassium iodide), about one-fifth of its particles float; these are larger and lighter in colour than the rest, and under the microscope have the appearance of a yellowish-brown semi-transparent glassy material, with bubbles in it, and numerous fine air tubes running through its substance all more or less in one direction; moreover, it shows evident signs of fusion on its surface, and is no doubt a rather heavy kind of pumice; along with these particles are some of a clear greenish glass, full of cavities *which do not act on polarised light*—they are transparent obsidian or true volcanic glass. Of the particles which sink in the double iodide solution, those of black, metallic-looking magnetite have already been mentioned, and also the dark-coloured mica; with these there are remarkably perfect crystals of a feldspar, some of which contain cavities of a regular geometrical shape. These crystals have curiously retained in many instances the primitive sharpness of their edges. Probably a sodium feldspar is present, as well as the potassium compound, for the ash, after digestion with pure ammonium

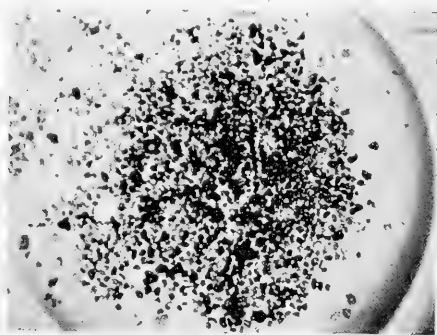

FIG. 2.

way home. At six o'clock it was as dark as midnight, and we went to bed as usual, the only disturbance in the night being incessant thunder and lightning in the direction of the mountain. . . . When the daylight came it was alarming to see everything covered by a layer of dust a quarter of an inch thick. I say a quarter of an inch, because I put out a dinner plate on the lawn above the house when the fall began, and the next morning the dust lay a quarter of an inch thick on it. All the green had given place to a light brown, and the canes had almost quite disappeared. . . . I forgot to mention that the dust was cool and smelling strongly of brimstone. It is estimated that upwards of fifteen tons per acre fell on the island. . . ."

To turn to the two photographs, which show the dust magnified exactly seven and a half diameters (or about 56 times in area). Fig. 2 is precisely the same view of the same dust particles as those seen in Fig. 1, except that the light comes through them in Fig. 2 whereas it is shining down upon them in Fig. 1. In other words, Fig. 1 is by reflected light, but Fig. 2 by transmitted light; Fig. 2 therefore shows clearly which particles of the dust are transparent and which opaque; and it is very instructive carefully to compare Figs. 1 and 2. It will be seen at once what a very large proportion of the particles are transparent—more than two-thirds, in fact. Most of the opaque particles are very strongly magnetic, and are certainly magnetic oxide of iron (they are not titaniferous iron, still less hematite). But these are mixed with others, also attracted by the magnet, but far less so, apparently of a dark-coloured mica. The mean

fluoride, leaves a residue giving a brilliant and long-lasting yellow colour to a Bunsen flame, and with a spectroscope, the lines of potassium and calcium are brilliantly shown as well as the double sodium line. There are also in the ash a considerable number of splintered crystals, of conchoidal fracture, and hard enough to scratch glass, which, like all the crystals present in this ash, act powerfully on polarised light; they are quartz, and the edges of most of these particles are blunt and the corners visibly rounded. There are also a large number of transparent crystals of a brownish-green colour, very well preserved in form, which a rather hasty examination would indicate as olivine, but of this I do not feel quite sure. The residue after the ammonium fluoride treatment proved to consist chiefly of compounds of iron, calcium and magnesium; there is a trace of some metal present which forms a sulphide insoluble in hydrochloric acid, but what it is I could not determine, the total quantity of ash at my disposal being only 1.304 grams. Perhaps it is copper—whatever it may be, it is only present in very minute quantity. Magnesium is present in considerable quantity, almost certainly as a silicate. There is more than a trace of manganese, and aluminium is also present, but only in very small amount. Barium and strontium compounds are absent. The dust, when heated carefully in a hard glass tube, gives off a trace of water, which it appears to hold mechanically, and afterwards yields a slight crystalline sublimate, probably of some ammonium compound (? the chloride). No sulphur could be certainly detected, in spite of the strong sulphurous smell which, it seems from the account, the dust had

when it fell, and which points to the ashes having been accompanied by an invisible cloud of sulphur dioxide on their emission from the crater, so that they mechanically occluded some of the gas. The ash gave no effervescence with a powerful acid, the action of the acid being closely watched under the microscope,¹ so that carbonates, such as limestone, and ammonium carbonate seem entirely absent. Finally, the drift of the ash against the wind will have been already noticed. This was due, one would naturally suppose, to the existence of a contrary upper current of air into which the ashes were projected, as they were, indeed, in the great eruption of 1812, when, in spite of the N.E. wind blowing strongly at the time, the ashes fell on the Azores, some hundreds of miles eastward of La Soufrière of St. Vincent.

Eton, Bucks, May 27.

T. C. PORTER.

III.

The dust from the Soufrière, which fell in Barbados on May 7 and 8, appears to be composed of fragments of glassy and pumiceous lava, broken crystals of plagioclase feldspar, augite and hypersthene, much magnetite, often in perfect octahedra, and a very few crystals of brown hornblende. The feldspars range in specific gravity from labradorite to anorthite. Hypersthene is the predominating coloured silicate.

Dust from the eruption of 1812 also collected in Barbados is of much finer grain, but evidently composed of the same minerals with the green augite in smaller proportion.

The magma appears to have been of the nature of hypersthene-andesite, a rock exceedingly common among the recent lavas of American volcanoes. Further, the magma seems to have remained practically unchanged in composition during the Soufrière's ninety years of dormancy.

University of Edinburgh.

J. D. FALCONER.

RECORDS OF RECENT ERUPTIONS.

FROM accounts which have been published during the past week, some additional details referring to the character and effects of the recent volcanic eruptions in the West Indies have become available and are here brought together.

A letter from Mr. A. D. Whatman, one of the members of the Government relief expedition to Martinique, describes some of the events as related to him by one of the survivors of the steamship *Roraima*, which was about 150 yards from the shore when the catastrophe occurred at St. Pierre. It appears that a little before 8 a.m. on May 8 an explosion was heard, and immediately the whole place was in darkness. At the same moment white-hot sand began to fall, which penetrated everywhere like snow, and immediately killed everyone on deck. After about an hour and a half the fall of white-hot ash stopped.

Referring to the condition of St. Pierre when he visited it, Mr. Whatman says:—

There was no lava thrown out; nothing but this fine sand, which was evidently white hot. Judging from what the few saved said and from what I myself saw and could judge from the position of the bodies, I have little doubt that everyone who was not under cover at the time the sand began to fall was killed in less than two minutes. The rest must have survived for a very short time longer, as they must have been quickly suffocated by the heat from the falling sand, not to mention the fact that the whole town must have caught fire at the same moment. A tremendous blast of air must have crossed from north to south, as all trees have been uprooted, and their remains are all pointing with roots towards the volcano. The lighthouse also fell in the same direction.

A message from the Acting Governor of Martinique states that from the further exploration of St. Pierre it would seem as if the southern portion of the town was destroyed by an as yet unexplained phenomenon, which acted with lightning-like rapidity, and has left traces as of a violent storm sweeping from north to south. The rain of ash which preceded, accompanied

¹ One opaque crystal only seemed to evolve a slow stream of bubbles, as if they came from a cavity in it. Whatever the gas was it dissolved in the liquid very rapidly, the bubbles visibly diminishing almost to nothing in ascending through the very shallow stratum of liquid above the crystal.

and followed this phenomenon covered the surface of the land to a depth of between twenty-five and thirty centimetres. The northern part of St. Pierre is buried beneath a mass of mud.

From the *Observer* we learn that the Deputy-Mayor of St. Martinique, who left St. Pierre just fifty minutes before the catastrophe took place, and was a witness of all the circumstances which led up to it, has given a new account of the condition of the volcano before the eruption. He says that shortly before St. Pierre was overwhelmed, immense fissures, caused by the earthquake, appeared in the side of Mont Pelée, reaching down to the edge of the sea. Into these the sea water rushed, and it was the contact between the water and the burning lava from the volcano which caused Mont Pelée practically to blow up like an overheated boiler.

The *Standard* records some observations made by Prof. R. T. Hill, a member of the United States Geological Survey, who went with Prof. Heilprin to Martinique to observe the volcanic phenomena and effects. Prof. Hill made his observations at a distance of five miles from Mont Pelée. On May 26 he observed what is usually described as lightning playing through the mushroom-shaped cloud overhead, like a sheet covering the country up to ten miles from the crater. These flashes occurred with alarming frequency, and they followed distinctly horizontal paths, hence they are

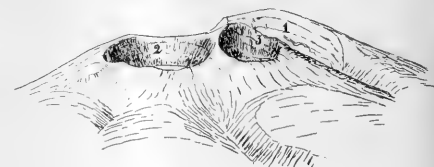

FIG. 1.

believed to be effects produced by the explosive combustion of gases leaving the Mont Pelée crater.

Mr. G. Kennan, who reached the new crater near Ajouabouillon, at the head of the river Falaise, which is boiling hot, reports that a large section of the side of Mont Pelée has fallen, leaving a huge perpendicular cliff, in which there are five immense tunnels or cavities.

Dr. Hans Reusch, director of the Geological Survey of Norway, has sent us the following description of the crater of the Soufrière of St. Vincent as he found it in 1892:—

During a visit to the West Indies in 1892 I ascended the volcano now so much spoken of on the northern end of St. Vincent. When I was at the top I drew the accompanying bird's eye view from the south (Fig. 1).

It may be of some interest to compare this with the changes which undoubtedly have taken place during the recent eruptions. The crater numbered 1 is the remnant of an old very wide crater—some kind of Monte Somma (of Vesuvius). The height is given on the maps as 4043 feet above the sea. No. 2 is "the big crater," the breadth of which I estimated to be 1 kilometre. The bottom is filled with a lake of bluish-green opaque water, the colour being due to sulphur in fine powder. I calculated the vertical distance from the lake to the lowest point of the brim to be about 150 metres. The dip of the inner sides of the crater was about 60°. The slopes were mostly covered with bushes, but a stratification of the tuff was marked by horizontal lines. The small crater, No. 3, is about half as large as the other one, but comparatively deep. The stratification of its sides is inclined at about 20° in a northerly direction. It is a "steam hole" blown out somewhat to the side of the chief place of eruption. On the bottom lies a little pond of clear water, the rest of the bottom being covered with loose material washed down from the sides of the crater. The only sign of volcanic activity was a little smoke now and then

issuing from a small cleft near the pond; a sulphurous odour was also perceptible. The great eruption in 1812 was exclusively, or at least in greater part, an ash-eruption, as no lava stream was seen on the exterior of the mountain. A few insignificant beds of andesitic lava still occur interstratified in the tufa.

Someone told me that the island was rising slowly out of the sea on its western and sinking on its opposite side; this, however, was denied by others. If any change of importance has taken place on the western side during the last convulsion of Nature, it should not be difficult to ascertain the fact and determine the amount of change of level. I went in a boat along the coast from Château Belair to Kingstown and observed that where the coast consisted of tufa (not where it was formed of solid lava or coarse volcanic agglomerate) it displayed a kind of strandline or beach-shelf. It was a horizontal or slowly dipping platform about a yard broad. Fig. 2 shows the shelf along a promontory seen from some height, Fig. 3 represents a small island surrounded with its beach-shelf, while Fig. 4 gives a diagrammatic section of the shelf.

The sea at high water rises about one foot above the shelf and sinks at low water about 2 feet underneath it. At ebb-tide the outer slope is seen to be covered with seaweed (at x in the diagram), as far up as the sea rises the inner wall (at y) is covered with a crust of calcareous matter consisting of serpulites and the remains of other sea animals. I cannot suppose that this peculiar beach was due solely to the action of the waves. Organic life has probably had something to do with it, the rate of recession of the cliff being comparatively rapid where the animals lived, while on the other hand the seaweed has been to a certain extent



FIG. 2.

FIG. 3.

FIG. 4.

protective. In any case this beach-shelf should be of good service in determining whether any sudden change of level has taken place during the latest eruptions.

Christiana.

HANS REUSCH.

A comparison of Dr. Reusch's observations with those which, it is hoped, will shortly be obtained, should be of value in showing the changes which have occurred.

The Paris Academy of Sciences has decided to send a special scientific expedition to the scenes of the eruptions. The expedition will sail on June 9.

In extension of the diary of recent volcanic events already published in these columns, we give a record of occurrences reported during the past week.

May 10, *Tacoma*.—Mount Redoubt, in Cook Inlet country, Washington State, has been pouring forth dense volumes of smoke for a week past, and a few nights ago became luminous. Volcanic ashes have been falling for several days, and the snow near the mountain is covered with ashes. The last eruption of Mount Redoubt was in 1867.

May 28, *Fort de France*.—A sharp shock of earthquake was felt in the Cape Peninsula at midnight.

May 28, *Fort de France*.—There was a tremendous explosion, followed by a cloud of black smoke, from Mont Pelée at 8.45 this morning.

May 29, *Fort de France*.—The eruptions of Mont Pelée have become more frequent, although less violent.

May 30, *Kingstown (St. Vincent)*.—There was a fresh eruption of the volcano La Soufrière this morning. It was accompanied by a thunderous noise and trembling of the earth, while volumes of vapour were emitted from the crater. The eruption lasted an hour.

May 30, *Fort de France*.—Cable communication with St. Thomas was again broken. A violent eruption of Mont Pelée took place at 2 p.m. It is reported that the craters on the north side of the mountain are pouring out torrents of mud.

May 31, *Fort de France*.—Detonations were heard from the

volcano this morning, and volumes of smoke were emitted. The Rivière Blanche is again a torrent of steaming hot mud.

May 31, *Kingston*.—During the past week Jamaica has been experiencing magnificent sunsets, the colours being extraordinarily rich and beautiful. The phenomenon is due to the volcanic dust in the atmosphere.

May 31, *Athens*.—For some days past earthquake shocks have been repeatedly felt in various parts of Greece.

DR. HENRI FILHOL.

DOCTOR HENRI FILHOL, professor of comparative anatomy at the Museum of Natural History, Paris, died on April 28 at the relatively early age of fifty-nine. A naturalist and palæontologist of the first rank, he will assuredly be lamented by a large circle of friends, not only in his native land, but also in this and other countries, his many and important contributions to our knowledge of both living and extinct animals being of world-wide interest.

Henri Filhol, son of Edouard Filhol, the famous chemist of Toulouse, was born in that town in the year 1843. Having studied for the medical profession, he early obtained his degree of doctor of medicine. His first contribution to science appears to have been in 1863, when he was about twenty years of age, for at that time was published, in conjunction with M. F. Garrigou, his paper on "L'Age de la Pierre dans les Cavernes de la Vallée de Tarascon (Ariège)" (*Comptes rendus*, lviii.). The French commission sent out for the study of the transit of Venus in 1875 included Dr. H. Filhol among its members; and the fact that in 1876 he received the Lalande-Guérineau prize of the Academy of Sciences is evidence of his confrères' appreciation of these early labours for science.

One of Dr. Filhol's most remarkable pieces of work was his "Recherches sur les Phosphorites du Quercy" (*Ann. Sci. Géol.* 1876, t. vii. pp. 220, pls. 10-36, and 1877, t. viii. pp. 1-273 and 297-340, pls. 1-26). In this are described the remarkable deposits of phosphate of lime, of Upper Eocene age, which occur as great pockets in Jurassic beds in the departments of the Lot, of the Tarn and Garonne, and of the Aveyron; then follows, as the subtitle of the work says, an account of the fossils met with in these deposits and especially the Mammalia. Numerous new forms are brought to light, and others critically revised; in this memoir of more than 500 pages and 52 plates.

Another work of similar character is the "Étude des Mammifères Fossiles de Saint-Gérard le Puy (Allier)" (*Ann. Sci. Géol.* 1879, t. x., and 1880, t. xi.), which occupies some 338 pages and 51 plates, and was the result of studying numerous collections of fossils, made during many years, from these Lower Miocene deposits. Here again numerous forms are described, many being regarded as new to science. A third work is entitled "Étude des Mammifères Fossiles de Ronzon" (*Ann. Sci. Géol.* 1881, t. xii. pp. 270, pls. 6-31). The locality is near the village of Puy, and the calcareous marl which has yielded this great assemblage of fossil vertebrata is believed to be of Miocene age. Many mammalian remains from the locality had already been collected and described by M. Aymard (1856); but not only are these critically revised in the light of new material, but again new forms are made known. A fourth piece of work of the same kind is the "Études sur les Mammifères Fossiles de Sansan" (*Ann. Sci. Géol.* 1891, t. xxi. pp. 314, pls. 46). M. E. Lartet had begun the study of the remains from this Miocene deposit, but died suddenly, leaving the work uncompleted. Dr. Filhol, taking up the study of the extensive material preserved in the Paris Museum, and with the help of additional specimens collected by himself under the auspices of the same museum, produced this important memoir.

These four volumes of painstaking work, including more than 1400 pages and 174 plates, would alone have constituted a most important contribution to natural knowledge, reflecting high honour upon the author; but this is only a part of the work which he accomplished. He had a lively interest in deep-sea exploration, and, as a member of the commission, took a prominent part in the dredgings of the *Talisman* expedition in the year 1883. The results of this and of the *Travailleur* work were made known in his "La Vie au fond des Mers" in 1885. Another work published about this time is the "Faune des Crustacés de la Nouvelle-Zélande," and his "Zoologie Descriptive" was issued in the same year. In 1893 he published, in conjunction with M. Grandidier, "Observations relatives aux ossements d'Hippopotames trouvés dans le Marais d'Ambolisatra à Madagascar" (*Ann. Sci. Nat. Zoologie*, 1893, ser. vii. vol. xvi., pp. 151-190, pls. 7-15). In this memoir are described the remains of the remarkable pigmy hippopotamus found by M. Grandidier, from which place also Dr. Forsyth Major obtained the material recently described by him in the *Geological Magazine*.

Besides the examples of Dr. Filhol's labours above alluded to, he made many other contributions to zoology and palæontology. Under his name will be found, in the Royal Society's catalogue, upwards of fifty papers published before the year 1883, and about as many more have been published since that date. This noble record has been appreciated by his fellow workers throughout the world, and has not been without hearty recognition in his own country; for besides the Lalande-Guérineau prize in 1876, already mentioned, he was awarded the gold medal of the Scientific Congress of the Sorbonne in 1879, the chief prize for physical and natural science of the Academy of Sciences; he was the recipient of the Petit-d'Hormoy prize in 1883, and received the decoration of the Legion of Honour in 1885.

Dr. H. Filhol at one time held the chair of zoology of the Faculty of Sciences of Toulouse, his native town; in 1885 he became subdirector, and subsequently director, of the laboratory of anatomical zoology at the Museum of Natural History, Paris; more recently he was appointed to the professorship of comparative anatomy at the same national institution, and continued to hold that post until the time of his death.

NOTES.

THE German Emperor has, with the consent of the British Government, appointed Sir Joseph Dalton Hooker, G.C.S.I., C.B., late Director of the Royal Botanic Gardens at Kew, a foreign Knight of the Order *Pour le Mérite* for Science and Arts. It has been officially decided that the regulations regarding foreign decorations do not apply to this order.

LORD RAYLEIGH has been elected a corresponding member of the section of natural sciences of the Imperial Academy of Sciences of Vienna.

MR. J. B. SCRIVENOR has been appointed geologist on the Geological Survey, and Mr. D. A. MacAlister has been appointed temporarily to investigate metalliferous mines.

WE learn that Lord Salisbury has asked the President of the Board of Trade to receive a deputation from the Institution of Electrical Engineers on the subject of the present unfavourable condition of the law relating to electric lighting and traction (see *NATURE*, vol. lxxi. p. 35). The deputation is to wait on Mr. Gerald Balfour to-day (Thursday). In view of the backwardness of this country in electrical engineering and of the large degree in which this backwardness is due to restrictive legislation, it is to be hoped that the Government may be induced to introduce more rational laws without delay.

THE Berlin correspondent of the *Times* writes that experiments were carried out last year at the General Telegraph Office in Berlin with a new system of octoplex typographic telegraphy. It is claimed that this system will enable twenty operators to send 18,000 words an hour through a single wire. The despatching instrument is of the typewriter form, and to telegraph any letter it is only necessary to depress a single key. The receiving instrument prints the message on a sheet of paper (not on a tape), and this can be immediately detached and forwarded to its proper destination. An installation to enable communication between Hamburg and Frankfurt by this system is being put up, and will shortly come into use. Further particulars and developments will be awaited with interest. The invention is due to the late Prof. H. A. Rowland, of Baltimore.

It is reported that Mr. Thomas A. Edison has been experimenting with a view to the invention of a storage battery to enable automobiles to run 100 miles without recharging. As soon as a 500 miles endurance test, which is about to be started, is completed, he will begin the manufacture of storage batteries for the use of automobiles, launches and street cars. It is understood that Mr. Edison's invention will also greatly diminish the weight of automobiles.

THE fifty-first annual meeting of the American Association for the Advancement of Science will be held at Pittsburgh from June 28 to July 3. At the first general session the retiring president, Dr. C. S. Minot, will introduce the president-elect, Prof. Asaph Hall. The presidents of sections will deliver their addresses on Monday, June 30, and Dr. Minot will give his address, as retiring president, on the following day, at the Carnegie Museum. The programme of the work of the sections has not yet been published.

THE forty-seventh annual exhibition of the Royal Photographic Society will be held from September 29 to November 4. There will be five sections, namely, (1) selected pictorial photographs; (2) general professional work; (3) photographic apparatus and materials; (4) photo-mechanical processes of reproduction; (5) scientific photography and photography in its technical applications. The judges of sections four and five will be Sir William Abney, K.C.B., F.R.S., Mr. Chapman Jones and Mr. E. Sanger Shepherd.

THE *Bulletin* of the Belgian Academy contains an obituary notice by M. C. Le Paige of M. François Deruyts, who died in February last. M. Deruyts was an ardent student of pure geometry. On leaving the University he published a remarkable dissertation on the theory of involutions and unicursal homography, and this formed the nucleus for a series of investigations dealing with the geometry of hyperspaces and the determination of the singular elements in an involution of any order. From general theorems, numerous elegant applications to special curves and surfaces were deduced. M. Deruyts also possessed an intimate knowledge of analysis and mechanics.

AN International Shipbuilding Congress in connection with the Dusseldorf Exhibition was opened on Monday by the Crown Prince of Germany. More than 550 delegates are in attendance. Of foreign countries Great Britain is most numerously represented. The Institution of Naval Architects is represented by the Earl of Glasgow (president), Lord Brassey, Messrs. Elgar, Thornycroft, Yarrow, and others. The Crown Prince, in declaring the Congress open, expressed the regret of his father, the Emperor, that his Majesty was unable to be present, and hoped that the deliberations of the Congress would be fruitful in good results.

THE Board of Agriculture has given notice that the Colorado beetle has again made its appearance at Tilbury. Potato growers are, therefore, requested to examine their plants and

to send to the Board without delay for identification specimens of any insects suspected to be the Colorado beetle. The Board will be pleased to supply copies of a leaflet, with a coloured illustration of the beetle, post free and free of charge upon application. Letters or packets containing specimens, and applications for leaflets, should be addressed to the Secretary, Board of Agriculture, 4 Whitehall Place, London, S.W., and need not be stamped.

AN interesting ceremony was performed at Chamounix on May 19, M. Joseph Valat, the founder of the Roches-Rouges Observatory, being in the chair. The bust of Charles Durier, a former president of the French Alpine Club, was presented to M. Simon, the manager, by M. Schrader, the president of the society. A letter was read from M. Janssen, who was prevented by reasons of health from being present. M. Simon was surrounded by a group formed by the Mont Blanc guides, who ascend Mont Blanc every week in order to bring back to Chamounix the automatic readings registered at the Janssen Observatory. Speeches were delivered by MM. Chauteemps, the member for Chamounix to the Chambre des Députés, Morel, Fredel, president of the Mont Blanc section of the Alpine Club, Paul Joanne, an intimate friend of Charles Durier, Pridoux of the Academy of Sciences, and other influential members of the Alpine Club.

AT the recent general meeting of the Paris Geographical Society, the following prizes awarded for this year were announced:—The chief gold medal of the Society to Captain Joalland, for the Joalland-Meynier expedition to Central Africa, with a silver-gilt reproduction of the medal to Captain Meynier. The Herbet-Fournet prize, a gold medal and 6000 francs, to Governor Emile Gentil, for work on the Tchad (1895-1901). Silver medals are awarded to the principal officers of M. Gentil's expedition: The Ducros-Aubert prize, three gold medals, to M. V. A. Bernard and Dr. Huot, for the Chari-Sangha exploration, and to M. Ch. Perdrizet, for his work in West Africa. The Conrad Malte-Brun prize, gold medal, to Captain Ch.-Lemaire, for the scientific exploration of Katanga. The Henri Duveyrier prize, gold medal, to Captain E. A. Lenfant, for scientific explorations on the Senegal and Niger. The Louis Bourbonnaud prize, gold medal, to M. P. Bons d'Anty, for explorations in South China. The Jean-Baptiste Morot prize, gold medal, to Captain E. Julien, for explorations in the basin of the Oubanghi. The Léon Dewez prize, gold medal, to M. Hugues Krafft, for his journey into Russian Turkestan. The Pierre-Félix Fournier prize, special medal and 1300 francs, to M. H. Réaldi, for his book "Cent Ans aux Pyrénées." Silver gilt medal of the Society to MM. Marcel Dubois and Auguste Terrier, for their book "Un Siècle d'expansion coloniale." The Alphonse de Montherot prize, silver medal, to M. Georges Brousseau, for his explorations on the Congo. The Charles Grad prize, two silver medals, to M. Maurice Superville and Léod. Bos, for their exploration of the Kotto. The Alexandre Boutroux prize, silver medal, to M. Albert Lesieur, for his explorations on the French Congo. The J. C. Janssen prize, silver medal, to M. Emile Belloc, for his study of the physical geography of the Pyrenees. The William Huber prize, silver medal, to M. de Martonne, for his geographical studies. The Jomard prize to M. Cl. Madrolle, for his book "Histoire de la Compagnie des Indes en Chine." Competitive prizes of the Society, two silver medals, each accompanied with 400 francs, to MM. P. Pasquier and M. A. Breschin.

ON Thursday evening last the members of the Camera Club and their guests were assembled to listen to a discourse by Dr. E. F. Grün on the new fluid lens with which he has recently been obtaining some very excellent photographs of theatrical

and other night scenes. The use of a fluid lens is a very old idea, but it soon fell out of use when homogeneous glass could be made properly and the combination of flint and crown successfully mated. The object of using fluid in lenses at this early time was simply to overcome certain optical deficiencies of the single glass lens. Dr. Grün's idea in adopting this form of lens is to increase very considerably the rapidity of its action, and so successful has he been that he can produce very excellent photographs with short exposures with ordinary night illumination, his lenses working at $f. 1.4$ and even $f. 0.5$. The slides made from the photographs he has taken showed several snapshots taken at different theatres without any previous preparation either as regards the actors and actresses, or the stage illumination, and these were quite sufficient to give one an idea of the important future for such a lens. One of the chief points in the lens is the great depth of focus which is shown in the individual pictures, for not only are the performers in front of the stage in focus, but the scenery at the back is quite sharp as well. The very great rapidity of the lens led Dr. Grün to attempt to take kinematograph pictures of stage performances. The results, although not of a very high order, showed, however, that with a little more experiment just as good pictures of night scenes can be secured as are displayed to-day in kinematograph pictures taken in daylight. There is little doubt that Dr. Grün has indicated the great possibilities of his new lens, and many scenes which could not be depicted on account of their apparent lack of sufficiently brilliant illumination may now be captured in the meshes of this photographic net.

WITH reference to the correspondence which has recently been appearing in these columns on the misuse of coal, we see from last week's *Electrical Review* that a company has just been incorporated in America for the commercial fixation of nitrogen. The company is to erect a factory at Niagara, where it already has one commercial unit in operation. This consists of a chamber about 10 feet high, through which cool dry air is passed. The air is subjected to the influence of electric discharge in the form of small-current high tension arcs, whereby oxides of nitrogen are formed. These oxides are led to an absorption tower, where they are brought into contact with a suitable compound of a substance of which the nitrate is desired; caustic soda or potash, for example, are used for the preparation of sodium and potassium nitrate respectively. If led into water, nitric acid can be obtained. It is said that part of the object of Lord Kelvin's recent visit to the States was to see the working of the process, and that he was greatly interested and much impressed by its success.

IN a short note contributed to the *Atti dei Lincei*, xi. 9, Signor G. Celoria urges the desirability of including the teaching of astronomy in the curriculum of every Italian university and of making the subject a compulsory part of the science courses. At present the regulations require astronomical classes to be held at all universities which possess an observatory, but Signor Celoria considers that much useful teaching may be given without the help of instruments, and further, that the present limitation tends to confine the study of astronomy to its purely practical aspect.

IN the University of Colorado *Studies*, Messrs. William Duane and Charles A. Lory describe a simple electric thermostat for keeping the temperature of a bath constant to within a thousandth of a degree Centigrade for a considerable time. The heat is supplied by an electric current, which in the case of a conducting liquid flows through the liquid itself, and in the case of a non-conducting fluid flows through wires suspended in the bath. A system of tubes containing a liquid with a large temperature coefficient of expansion is placed in the bath, and by means of a suitable mechanism the expansion of this liquid

interrupts or reduces the strength of the heating current when the required temperature has been reached. It might be thought that this arrangement would give rise to considerable fluctuations of temperature with the making and breaking of the current, but it is found that the makes and breaks follow each other so rapidly, often two, three or even more times in a second, that the variations cannot be detected with a differential thermometer which ought to be sensitive to within a two-thousandth part of a degree.

In the *Revue générale des Sciences* of April 30, M. Nordmann proposes a theory of the propagation of electric force from the sun into space which is based on the assumption that Hertzian waves are emitted from the surface of our luminary, and that the emission of these electric waves must be particularly intense at epochs of maximum solar activity. M. Nordmann admits that hitherto attempts to discover Hertzian waves in the solar radiation have led to a negative result; but, in his opinion, this may be explained by the copious absorption of the electric undulations in the higher layers of our atmosphere. On this hypothetical basis the theory attempts an explanation of cometary phenomena, of terrestrial magnetism, and of the luminosity of matter in the nebulae and in the vicinity of temporary stars. M. Nordmann's paper thus covers the same ground as the previous researches of Prof. Arrhenius. But the distinguished Swedish physicist advocates the theory of corpuscular electric emission, and M. Nordmann endeavours to show that some grave objection may be urged against this point of view, and that, on the whole, the cosmical phenomena here considered are better explained by the undulatory electric theory of Maxwell and Hertz.

MESSRS. ROSENBERG AND CO. have submitted to us for examination a portable Röntgen ray outfit which they have produced. The outfit consists of a 10-inch spark coil of special construction with tube, holder, fluoreoscope and accessories, the whole fitted in a strong box measuring 2 feet 1 inch \times 11 inches \times 14 inches. The coil when tested with a 12-volt accumulator sparked well at 10½ inches—the distance between the discharging pillars. The break has large platinum points, and the sparking can be regulated with great nicety. For those who prefer an electrolytic break there is a means of throwing out the condenser, and other breaks can be used with little alteration. We should advise those who wish to use this apparatus continuously to have a separate tube-holder, as that supplied with the outfit is fixed to the box, and consequently would render the operator liable to "X-ray dermatitis." The screen is thickly and evenly coated, and measures 7 \times 10 inches. One advantage of this outfit is that when the box is locked everything is safe, as all attachments are covered up and cannot possibly be damaged. There is ample room inside for plates, volt- and am-meters, and the box contains all that is required except the accumulator. As being trustworthy, cheap and handy, the outfit can be recommended for the purpose for which it is intended, and those who have not made a special study of X-ray work will find little difficulty in obtaining good results with it.

A DISCUSSION of the rainfall of Saxony and the Thuringian provinces, with coloured map, by Dr. G. Hellmann, has been published on the same plan as that adopted for several of the other German States which have preceded it. The work is based upon the results of ten years' observations, and forms a valuable contribution to the rainfall statistics of that part of Europe. The mean annual rainfall for the whole area is rather more than 23 inches, but in the neighbourhood of the Hartz Mountains to the west and the Thuringian forests to the south, the annual fall exceeds double that amount; in the central

parts of the province of Saxony the rainfall does not exceed 20 inches. The discussion gives full details of the monthly values and of the greatest fall in various short intervals of time.

THE Royal Meteorological Society has published a fifth edition of "Hints to Meteorological Observers," by Mr. W. Marriott. This useful little work, consisting of only sixty pages, of which twenty pages are tables of reduction, contains all that is necessary for the purpose for which it is intended, and, what we think is of much importance, nothing that is not necessary. Among the chief additions to this new issue are instructions for the construction of thermometer screens for tropical countries, a description of Mr. Dines's pressure tube anemometers, which are likely to come into more general use, and pictures to accompany the cloud nomenclature adopted by the International Meteorological Committee. The Meteorological Congress held at Rome in 1879 expressed the opinion that an international dictionary of meteorology should be published, and as a first step towards the carrying out of this resolution a "Glossary of Meteorological Terms" has been added, which will be of considerable assistance, especially to younger observers.

THE annual report issued by Mr. J. B. Carruthers, Government mycologist at the Royal Botanic Gardens, Ceylon, records important work completed or in progress. Of fungal diseases, those which attack the tea plant naturally receive the most attention. The most important of the leaf diseases, known as grey blight and caused by *Pestalotzia Guepini*, seems to be confined to the tea shrub, as it has not been found on the leaves of plants growing in the jungle or elsewhere in the vicinity of diseased tea plants. Experiments are being carried on to determine how far the disease may be carried by spores, and the liability of weak plants to succumb to the disease. The discovery of the ascus-bearing fruit on the stem reveals a method by which the fungus can perpetuate itself. Under ordinary circumstances it is confined to the leaf, but if it can attain a vigorous state of development it may grow down the leaf-stalk into the stem and there form its fruit. A destructive root disease is due to *Rosellinia radiciperda*, a fungus which can grow both as a saprophyte and as a parasite. It starts on dead timber, such as the root-tissues of a dead *Symplocos*, and when the soil is thoroughly wet it can travel and spread to the roots of living plants, notably the tea plant. An effectual remedy consists in cutting deep drains at least a foot broad. Other subjects investigated were cacao canker, finger and toe disease, dry rot and pollination of cacao flowers.

THE *Journal* of the Anthropological Institute is highly creditable both to the Institute and to Britain; it is, as a matter of fact, the best extant journal that deals with anthropology in a comprehensive manner, and it is to be regretted that it does not meet with the circulation that is deserved by its interest and value. The range of the second part of vol. xxxi. extends from Wiltshire palaeoliths and Irish copper celts to notes on Malay metal work and a classification of Sarawak swords; there are papers on African and Papuan craniology, trephining in Melanesia, colour vision of the natives of Upper Egypt, early Egyptian racial types, an ethnographical account of the natives of Manipur and of the Paraguayan Chaco, the animal cults of Sarawak, and a memorandum on the languages of the Philippines. Several of these articles are fully illustrated with most excellent plates, and it will be noticed that practically the whole range of anthropology is covered by original articles in the current number of the *Journal*.

It has long been suspected that certain prehistoric peoples trephined the skull of living persons for surgical reasons, and now we have a definite modern instance from Melanesia. The Rev. J. A. Crump, in his paper on "Trephining in the South Seas"

(*Journal of the Anthropological Institute*, vol. xxxi. p. 167), states that in New Britain the local wizard trephines with a piece of shell or with a flake of obsidian in cases of fracture caused by a sling stone. This operation is described; the number of deaths is about 20 per cent., most of these resulting from the first injury and not from any complication after the operation. Complete recovery takes place in two or three weeks' time. In New Ireland the operation is performed, not only in the case of fracture, but where there is epilepsy and certain forms of insanity as the result of pressure on the brain. After trephining has been performed, there is frequent partial temporary paralysis, which almost invariably passes away. Idiocy is an occasional result also. But the natives affirm that while the cures of insanity and epilepsy are many, the instances where either malady supervenes after the operation are exceedingly few. Dr. Victor Horsley's discussion of this paper lends it additional interest.

ONE of the latest departures of the experimental psychologist consists in prodding people with a pointed instrument when they are asleep to find out how much excitation is required before they begin to move, and how much it takes to wake them up. This method is embodied in a paper on "Experimental Investigations on the Depth of Sleep," by Drs. Sante de Sanctis and U. Neyroz, of Rome, a translation of which is given in the *Psychological Review* for May. The instrument employed is called a Griessbach ethesiometer (made by Brändli, of Basle), and may be used with either a sharp or blunt point. It measures the stimulus necessary to induce subconscious reaction, and that applied at the waking point. Four normal subjects, all relatives of the writer of the paper, were experimented on for about six consecutive months, and afterwards five subjects, mostly epileptic, were operated on, and from the results obtained curves were drawn showing the relative depth of sleep, as measured by the stimuli required, after the subject had been allowed to sleep for various lengths of time. The curves are all of zigzag form, and the experiments may perhaps suggest a practical application in the case of subjects who find it hard to wake in the morning, and who may overcome the difficulty by timing their sleep so that the waking point is at a minimum when they wish to rise.

In the Report of the Marlborough College Natural History Society for 1901, Mr. S. B. Dixon gives an account of the recent important discovery of Palaeolithic flint implements at Knowle, near Savernake Forest. The state of the Society appears to be flourishing, the entomological section showing a specially good record of work. The report is illustrated by some excellent reproductions from photographs of local scenery.

ACCORDING to the Berlin correspondent of the *Times*, an international agreement for the protection of birds useful to agriculture was signed at Paris on March 19, the contracting parties being Belgium, France, Greece, Lichtenstein, Luxemburg, Monaco, Austria-Hungary, Portugal, Sweden, Switzerland and Spain. Certain insectivorous species and others scheduled as being specially useful to agriculture are to receive unconditional protection, the destruction of the birds themselves, or of their nests and eggs, being prohibited at all seasons. It is noticeable that Italy, where numbers of useful birds are annually killed during migration, does not appear among the signatories.

In the introductory comments to the second (May) number of the *Field Naturalist's Quarterly*, the editor discusses the proper sphere of work for local natural history societies. The importance of taking cognisance of all subjects connected with local biology is strongly urged, as the specialists are sure to look after their own interests, and will, when necessary, institute sections devoted to their own favourite subjects. "The great justification of a field club ought to be that it is doing

work that is otherwise neglected. There is not an area of ten miles square in this country but what offers some subject of investigation." Several of the articles in this number deal with the habits and movements of animals in spring, and the illustrations include some interesting photographs of nests and eggs.

We have received the "Catalogue of the Educational Collection of Minerals belonging to the West Ham Municipal Technical Institute," compiled by Dr. H. A. Auden. From a high scientific standpoint the classification here adopted of minerals, according to electronegative constituents, will no doubt meet with the approval of the learned. Under this arrangement, zincite, corundum and hæmatite (as simple oxides) follow one another; and the same is the case with anhydrous carbonates, such as aragonite, witherite, strontianite and cerussite. For purposes of technical education a practical grouping would appear more desirable. The author's object is, however, to illustrate the systematic grouping of mineral specimens, and in the "addenda" he enumerates the principal metals and ores, jewels and other minerals of industrial importance. An index would have added to the value of this useful work.

A NEW general method for the synthesis of fatty aldehydes is described by MM. L. Bouveault and A. Wahl in the current number of the *Comptes rendus*. It was shown by Henry some time since that aldehydes of the fatty series could be readily condensed with nitromethane to form addition products, which the authors have now found to readily lose water to zinc chloride under suitable conditions, giving nitro-derivatives of substituted ethylenes. These are readily reduced by zinc and acetic acid to oximes, from which the aldehyde can be obtained without difficulty. The method has been applied by MM. Bouveault and Wahl to the synthesis of isobutyraldehyde from the product of condensation of isobutyl with nitromethane, and of caprylic aldehyde from enanthol.

SINCE the discovery of the remarkable compound of hydrogen and nitrogen known as hydrazoic acid, numerous modes of preparing it have been worked out, mostly through the use of somewhat complicated organic compounds. The only purely inorganic syntheses of this acid are those of Wislicenus from sodium amide and nitrous oxide and of Tanatar from hydrazine and nitrogen chloride. Tanatar now describes in the current number of the *Berichte* another elegant synthesis of this compound. A mixture of hydrazine sulphate and hydroxylamine hydrochloride is treated in acid solution with an oxidising agent and distilled, when hydrazoic acid passes over with the distillate. Hydrogen peroxide and chromic acid appear to give the best yields, which in no case exceed 30 per cent. of the theoretical amounts. Dihydroxylamine is probably the first product of oxidation, which then condenses with the hydrazine and is further oxidised to N_3H .

DR. M. BIAL has recently carried out some interesting experiments on the antiseptic properties of dilute solutions of acids, details of which are given in the last number of the *Zeitschrift für physikalische Chemie*. The observations were carried out with yeast cells, measurements of the retarding action of different acids on the development of the cells being made by observing the amount of carbon dioxide liberated from a solution of grape sugar. It is found that the concentrations of the solutions, which are just sufficient to check completely the development of the cells, are much smaller in the case of the strong acids like hydrochloric and sulphuric acids than in the case of weak acids such as acetic and butyric acids. The results, in fact, lead the author to conclude that the antiseptic power is essentially determined by the hydrogen ion which is contained in the acid solutions, and the electrolytic dissociation theory is able

to account for the observed phenomena in a satisfactory manner. As is required by this theory it is found that the addition of neutral acetates to a solution of acetic acid diminishes the antiseptic power of the acid, the concentration of the active component of the solution, the hydrogen ion, being under these circumstances reduced to a much smaller value.

NUMEROUS theories have been put forward at different times to account for the formation of natural paraffins, the one received with most favour being that due to Berthelot and developed by Mendeléeff in which the action of steam upon metallic carbides was regarded as the main source of the hydrocarbons. The chief stumbling block to this view was the difficulty of explaining the mode of formation of the naphthenes of the Russian oilfields. The researches of MM. Paul Sabatier and J. B. Senderens on the action of reduced nickel, iron and other metals upon hydrocarbons have now placed the "chemical" theory of petroleum formation on a firm experimental basis. By the direct hydrogenation of acetylene in the presence of nickel they have obtained liquid mixtures of hydrocarbons which can be made to correspond either with American or Caucasian petroleum by varying the conditions of the experiment. To account for the formation of petroleum it is thus sufficient to admit that there are in the depths of the earth free alkali metals and metallic carbides, which in contact with water give rise to mixtures of hydrogen and hydrocarbons. These gases encounter nickel, cobalt or iron in a finely divided state, and thus give rise to the mixtures of hydrocarbons forming natural petroleum.

THE additions to the Zoological Society's Gardens during the past week include a Bosman's Potto (*Perodicticus potto*) from West Africa, presented by Mr. Edward Straw; three American Bisons (*Bison americanus*) from North America, presented by H. G. the Duke of Bedford, K.G., P.Z.S.; three Darwin's Rheas (*Rhea darwini*) from Patagonia, a Red Ground Dove (*Geotrygon montana*) from South America, presented by Capt. John L. Marx, R.N.; two Garden's Night Herons (*Nycticorax gardenii*) from the Falkland Islands, presented by Mr. W. Grey Wilson, C.M.G.; an Algerian Tortoise (*Testudo iberica*) from North Africa, presented by Master C. Treverly Gill; a Silvery Gibbon (*Hylobates leuciscus*) from Java, deposited; six Ruddy Flamingoes (*Phoenicopterus ruber*) from North America, twenty Alpine Newts (*Molge alpestris*), twenty Newts (*Molge montandonii*) from Roumania, purchased; a Thar (*Hemitragus jemlicata*) born in the Gardens.

THE EQUATORIAL CURRENT ON JUPITER.

THAT differences occurred in the rate of motion of different markings on Jupiter was first discovered by Cassini in the seventeenth century. But other observers in later years appear to have neglected the systematic study of the planet. His disc was occasionally surveyed, it is true, and the positions of the belts described, but the details were not perseveringly followed. Telescopes were formerly of inordinate length and not very effective in performance, but what was accomplished by Cassini might also have been achieved by others. Jupiter's dimensions are such that comparatively small and imperfect instruments are capable of revealing the principal markings. Herschel never made a thorough investigation of the Jovian spots, though he obtained some observations in 1779 and recognised the difference in their motions. Until the last half of the nineteenth century the planet seems to have been generally surveyed in a desultory manner.

The apparition of the great red spot, however, revolutionised the existing state of things, for it was destined, not only to attract an immense amount of attention to itself, but to the whole visible phenomena presented by the surface markings of Jupiter. When this remarkable object first became perceptible it is not our purpose to inquire; it is certain, however, that as an exception-

ally conspicuous feature it was widely observed during the last half of 1878.

It was long thought that the equatorial region of the planet supplied us with the most swiftly moving objects. This was, however, found to be a mistaken impression. The white and dark equatorial spots completed a rotation in about 5½ minutes less time than the red spot, and this meant a difference of velocity amounting to about 250 miles per hour. But it was soon seen that though the equatorial current is much more rapid than the rate exhibited in certain other latitudes, it does not equal the velocity of some other occasional markings in the northern hemisphere.

It is only our intention, however, to refer briefly to the equatorial markings observed during the last quarter of a century. But it must be confessed that the observations are not nearly so continuous and complete as the importance of the subject demands. The results have been sufficiently full for all purposes during the last few years, for several observers, including Mr. A. S. Williams, Rev. T. E. R. Phillips, Captain P. B. Molesworth and others, have obtained a mass of useful materials with reference to the equatorial current. And there seems no doubt that the investigation will be adequately maintained. It is chiefly to the continuity of the observations that we must look for the satisfactory elucidation of the phenomena presented. The equatorial spots have not, it is true, been always in strong evidence. In certain years they are liable to be almost, if not entirely, absent. The breaks, therefore, which occur amongst the accumulated observations are not always to be ascribed to negligence on the part of Jovian students.

At present the equatorial spots are both numerous and conspicuous, and it is to be hoped that a large addition to our observations will be effected during this opposition. The results for preceding years are very extensive and exhibit an irregular, though on the whole a decided, increase in the rotation period, but it would be premature to undertake the collection and reduction of all the materials. The observations must be prolonged over a much more lengthy interval before they can be expected to reveal the information we require. As observed at Bristol, the equatorial spots have shown the following variations in their rotation period, but satisfactory mean results from a number of different objects were only obtained during the last four oppositions:—

	h.	m.	s.	
1880	9	50	5.8	1 very bright spot
1881	9	50	8.8	" "
1882	9	50	11.4	" "
1883	9	50	12.1	" "
1885	9	50	14.3	" "
1886	9	50	22.8	" "
1895	9	50	34.3	2 black spots
1898	9	50	23.6	23 spots
1899	9	50	24.6	27 "
1900	9	50	24.1	18 "
1901	9	50	29.1	28 "

W. F. DENNING.

GERMAN PROGRESS IN OPTICAL WORK.¹

I PURPOSE dealing with statistics compiled from information afforded me by two German firms and one Austrian, Messrs. Zeiss, Leitz and Reichert respectively, all of whom are well-known makers of microscopes, and the first named of many other optical instruments, including prismatic field glasses, of which, as is well known to you all, they were the originators. I must say that the figures quoted refer approximately to the end of the year 1899, since which date the average rate of increase has been more than maintained. Taking first the firm of Zeiss, in Jena, twenty years ago they employed fifty men; five years later the number had leaped up to 170, or more than three times as many; in another five years the number had practically been doubled, 327 being the precise number; yet another five years saw the number 580; while to-day (1899) they employ the astonishing number (astonishing, that is, for the class of instruments they manufacture) of 940 men, this grand total being made up as follows: theoretical staff, 22; office and dispatch, 36; mechanics, 322; opticians, 371; wood-workers, leather-

¹ Abridged report of a paper entitled "The Secret of German Progress," read before the Optical Society by Mr. Herbert P. Angus, Hon. Sec. of the Educational Committee of the Society.

workers, foundry-men, &c., 129. Of these men, 832 in number, including only those actually at work in the shops, 58, or 7 per cent., are foremen, and 178, or 27 per cent., are youths under eighteen. Turning now to Leitz, in Wetzlar, who, I may say, manufactures microscopes almost exclusively, we find the same steady progress, if not exhibited in such a striking degree. The numbers employed were: in 1879, 35; in 1884, 100; in 1889, 160; in 1894, 200; and at the present day (1899) 253. This number is divided up as follows: theoretical staff, 4; office and dispatch, 9; mechanics, 164; opticians, 60; case work, &c., 16. The foremen number 10, or 4.2 per cent., and the boys 18, or 7.25 per cent. of the total number actually employed in the shops, viz., 240. The firm of Reichert, in Vienna, although smaller, shows an almost identical rate of progress with that of Leitz, the numbers being: employed in 1879, 20; in 1884, 40; in 1889, 75; in 1894, 100; present day (1899), 150; of these, 3 form the theoretical staff, 8 are employed in the office and dispatch department; while of the remainder 120 are mechanics, 30 opticians and 8 case-makers, &c., the boys being 15 per cent. of the whole. I am afraid the numbers given in detail do not always agree with the totals, but I give them as received. . . .

In the most successful of these firms, that of Zeiss, it will be noticed what a large percentage (27 per cent.) of boys is employed in comparison with the other two—Reichert 15 per cent., Leitz 7.4 per cent. It will also be noticed that the percentage (7 per cent.) of foremen is proportionately high. Herein, to my mind, lies the superiority of the firm of Zeiss over competitors of their own nationality, and much more so over us. I do not wish you to understand that I consider the number of boys employed by a firm an unailing criterion of efficiency and progress; stated in this bald way the proposition is absurd, but, when we take this fact in conjunction with the well-known excellence of the productions of Zeiss (instruments than which no more delicate or difficult of manufacture can be found in the whole range of optics), when, I say, we take these two facts in conjunction, what is to be said of the organisation and system which allows of their coexistence? I think, therefore, that I may be allowed to say that the number of boys employed by Zeiss demonstrates their superiority, and not only that, but that it gives them a *potential or latent* power of progress, if I may use the expression. . . .

I will premise one or two remarks which I have to make on the system of training adopted by saying that in Germany, as no doubt you all know, every young man is compelled by law on entering a trade to attend classes for instruction. Such classes the boys employed by Zeiss, of course, attend. A certain number of apprentices are taken who have, in addition, to attend higher classes, and from whom a higher standard of preliminary knowledge is required (that is, they must pass that examination which reduces the term of service in the army to one year). These higher classes are, however, open to the ordinary working boys, if they have sufficient brains to avail themselves of them. The teaching of optical subjects in the technical school of the town is practically under the firm's control, being subsidised by them, and some, if not all, of the teachers being drawn from the works; half the time spent at this school is during working hours, and is counted the same as attendance at the works. . . .

This training of the boys and apprentices, the scientific management of the business and the experimental work is supervised by a staff of no less than eighteen mathematicians, physicists and chemists, each of whom holds a University degree; the salaries of these gentlemen, together with the cost of the experimental work undertaken, reach a total of from 6000*l.* to 10,000*l.* per annum. Here, then, in my opinion, you have the secret of German progress—a thorough well-grounded *elementary* training of the workmen, controlled and employed by those possessing a *real scientific* training.

optical axis of the camera. After development and fixing, the negatives, or positives from them, are viewed in a stereoscopic measuring machine, which, by combining the pictures, renders possible the instant identification of any point common to the pair of plates. Movable micrometer wires traverse each field, and pointings may be made simultaneously with both eyes. The readings of the micrometers, referred to the *réseau*, give the three coordinates of the point by direct multiplication by, or division from, constants for the plates, which depend only on the focal length of the camera lens and the length of the base. When a sufficient number of points have been plotted from their coordinates, contour lines may be drawn.

Theory of the Method.—Let A and B (Fig. 1) be the ends of

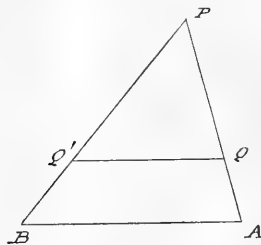

FIG. 1.

the base and Q and Q' the positions on the photographs of any point P.

Take A as origin and A B as positive direction of *x*-axis. Let (X, Y, Z) be the coordinates of P; (*x*_a, *f*, *z*_a)(*x*_b, *f*, *z*_b) the coordinates of Q and Q'.

The equation of A P is:

$$\frac{x}{X} = \frac{y}{Y} = \frac{z}{Z}$$

and if we put *y* = *f*, we get:

$$x_a = \frac{f}{Y} X$$

$$z_a = \frac{f}{Z} Z$$

Similarly the equation of B P is:

$$\frac{x-b}{X-b} = \frac{y}{Y} = \frac{z-h}{Z-h}$$

where *b* and *h* are the *x* and *z* coordinates of B.

Whence,

$$x_b = \frac{f}{Y} (X - b) + b$$

$$z_b = \frac{f}{Z} (Z - h) + h$$

From these equations we find

$$x_a - x_b + b = \frac{b f}{Y} = e$$

e is the *stereoscopic difference*, constant for points in any plane perpendicular to A *y* and vanishing for points at infinity.

The values of the coordinates of P follow:

$$Y = \frac{b f}{e}$$

$$X = \frac{b}{e} x_a$$

$$Z = \frac{b}{e} z_a$$

A check is afforded by the values of X and Z derived from B P.

$$X = \frac{b}{e} x'_b - b$$

$$Z = \frac{b}{e} z'_b - h$$

*x'*_b and *z'*_b denoting here the coordinates of Q' referred to B.

A STEREOSCOPIC METHOD OF PHOTO-GRAPHIC SURVEYING.¹

IN the method proposed in this paper, photographs are taken, with a surveying camera, at a pair of points, the plates being exposed in the vertical plane passing through both stations. A *réseau*, or a graduated back frame, gives the means of measuring the coordinates of any point on the plates with reference to the

¹ A paper read on October 2, 1901, before the South African Philosophical Society, by Mr. H. G. Fourcade, Forest Department, Cape Town.

The measurement of the coordinates of a point being made independently on each plate, although simultaneously, it will be a sufficient condition for the viewing apparatus to make corresponding portions of the two pictures combine with or without change of perspective.

Using a magnifying optical system to view the pair of plates, the condition for distinct vision is that the two images of any point appear in a corresponding plane of vision, so that the visual rays meet in space. This condition evidently remains satisfied when the images are magnified, or when they are brought nearer together along a line parallel to that joining the nodal points of the two eyes, and for different distances between the viewing lenses or the eyes, since in all these cases the lines joining the two images of a point remain parallel to the eyes.

Surveying Camera.—The essential features are a camera on a theodolite base, and a telescope with its line of collimation at right angles to the optical axis of the camera, so that by changing pivots the orientation of the pair of plates is not affected by errors of inclination, collimation or graduation.

The photographic plate is pressed, during exposure, against a back frame in the focal plane of the camera lens, by a spring contrivance, similar to those used in other surveying cameras, which permits the shutter of the dark slide to be drawn and replaced. The *réseau* is hinged in front of the plate, its correct register being determined by geometrical contacts. It is impressed

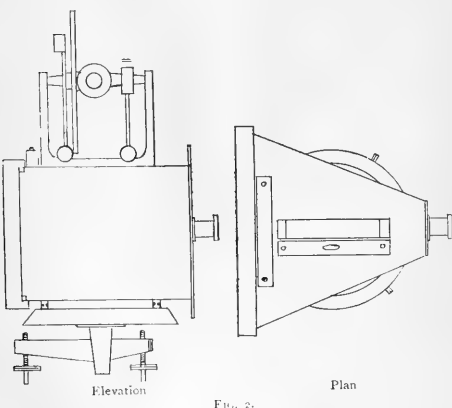

FIG. 2.

upon the plate by exposure to sky light reflected through the camera lens and then moved out of the way for the exposure of the picture itself. A graduated front slide is used to displace the horizon line by moving the lens, but in normal circumstances it is set at the zero of its scale. Fig. 2 shows the general arrangement of the instrument.

Conditions to be satisfied.—One instrumental condition, sufficiently satisfied in construction, is that the front slide be parallel to the vertical *réseau* lines. Any defect in this respect is eliminated by determining the origin of the *réseau* coordinates and the focal length for different readings of the front scale.

The camera adjustments are: (1) Plane of *réseau* to be vertical. (2) Horizon line of *réseau* to be horizontal. These adjustments are made with the aid of a level, fitted with a Bohnenberger eye-piece.

The auxiliary level having been placed directly in front of the camera and its line of collimation made horizontal, the vertical axis of the camera is set vertical by reference to the level of the vertical circle. Then (1) is effected by turning the camera in altitude with the footscrews, and in azimuth, until the cross wires of the level coincide with their image reflected from the silvered back surface of the *réseau* when the bubble of the longitudinal level on the camera is adjusted to the centre of its run. Replace the front slide and lens and set again the vertical axis

vertical. (2) is now effected by making the ends of the horizon line of the *réseau* coincide with the cross wires of the level in two positions, using for the purpose the side capstan-headed screws in the base. The transverse level on the camera is then adjusted, and the longitudinal level made perpendicular to the vertical axis by means of the front capstan-headed screws under the camera.

The theodolite adjustments, effected by ordinary methods, are: (3) Horizontal axis made perpendicular to vertical axis. (4) For collimation. (5) Horizontal axis made parallel with optical axis of camera. An approximate adjustment of (5) is sufficient.

Instrumental Constants.—These are (1) the zero of the front scale, (2) the zero of the *réseau* and coordinates of the R-points, and (3) the focal length. They may be determined in the usual manner, but it is convenient to first make the centre R-point coincide with the zero of the *réseau* coordinates by collimating directly upon the *réseau* plate when adjusting the camera with the help of an auxiliary level as already explained. In that case the lens requires to be adjustable horizontally as well as vertically.

The focal length f is found from the measurement of exposed plates containing the images of well-defined points of which the angular distances are known. Call α the angle between two points of which the horizontal coordinates are a and b . Then:

$$f = \frac{a-b}{2 \tan \alpha} + \sqrt{\frac{(a-b)^2}{4 \tan^2 \alpha} - ab}.$$

Measurement of the Plates.—It is unnecessary in a preliminary note such as this to enter into the construction of the measuring apparatus in much detail, as a description of actual instruments with examples of their use may fitly be given in a subsequent paper. A suitable machine would generally resemble those which have been used for the measurement of celestial photographs, and like such may be of various types.

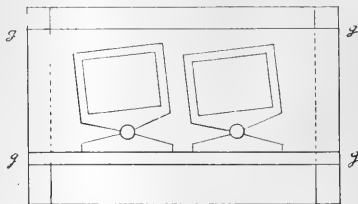

FIG. 3.

In the type now considered, the plates are set side by side at an inclination corresponding to that of the base line and at heights such that corresponding R-points are horizontal. Both plate-carriers can slide about in a horizontal direction on a stage formed of a sheet of plate glass (Fig. 3), which itself can be moved vertically by a double rack and pinion. Any small error in the setting of the plate and in the fitting of the slides will be automatically corrected by the position of the eyes in front of the eye-pieces of the viewing microscopes and by their power of accommodation, and does not affect the accuracy of the measurements.

The measuring microscopes are of low power and include in their field at least one clear R-square of 1 centimetre side. Their distance apart is adjustable to suit the eyes of the observer. One is fitted with a pair of micrometers at right angles capable of rotation in order to bring the horizontal and vertical wires parallel to the R-lines. The other is similarly fitted, with the exception that one horizontal micrometer is sufficient. The runs are adjusted on a scale.

The centres of the plates are separated to a sufficient distance by introducing in each microscope a pair of prisms of total reflection p (Fig. 4).

The micrometers might also be used in the position of the plates, giving more room for the screws and greater facility in the reading of their heads, and the plates themselves set further back, behind an additional lens, as in the Cambridge measuring machine recently described by Mr. Hincks (*Monthly Notices*, lxi. p. 444).

The zero wires form a frame fitting an R-square, as in Sir David Gill's machine used at the Cape Observatory (*Monthly Notices*, lix. p. 61).

For convenience the whole arrangement is tilted at an angle of 45°, and the light illuminating the plates reflected by mirrors *m* from a window at the back of the observer.

The setting of the plates may be effected by turning a micrometer to the inclination of the base by means of a graduated circle, and making both sets of R-lines agree in inclination and height with the micrometer wires. The second micrometer is then set by making its wires parallel to the vertical R-lines on either plate.

The vertical R-lines are combined by the microscopes, but the horizontal lines only when the distance between the centres of the pictures is equal to that between the microscope object glasses. In making a measurement, the plates are moved by the slow-motion screws on the slides of their carriers and of the stage until the zero square of one microscope fits a zero square of the corresponding plate and the zero wires of the other microscope coincide with a pair of vertical R-lines on the second plate. The points in the field of view may then be bisected without disturbing the zero settings.

The coordinates of a point on the plate are given by the direct readings of the micrometer heads added to the value of the R-line considered. The stereoscopic difference results from the difference of the *x*'s on the two plates.

Range of the Method.—In practice, the range of the method is limited by the blurring of distant detail by light diffused in the atmosphere. This "aerial perspective" is reduced by the use of orthochromatic plates and an orange screen cutting off the rays of shorter wave-length which form the blue haze, but even then

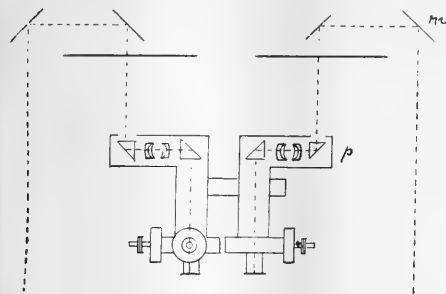

FIG. 4.

the effective range would probably not exceed some 5 miles, or 8 kilometres.

On the other hand, the difference in phase of the objects would prevent their ready combination at distances less than three to four times the length of the base. The view would then correspond with that of a model seen with the eyes at a distance of 10 inches from the nearer eye.

Let *b* be the length of the base and *α* the angle subtended by it at a distance *y*. Then :

$$y = b \cot \frac{\alpha}{2}$$

$$\frac{dy}{y} = -\frac{b}{y} \frac{d\alpha}{2 \sin^2 \frac{\alpha}{2}}$$

$$= -\frac{d\alpha}{\sin \alpha}$$

Let 1/100th of an inch or 0.25 mm. be the admissible error on the plan, 8 kilometres the limiting value of *y* and *Δα* = 20". On the scale of the Canadian photographic surveys, 1/40000, the maximum error allowable will be 10 metres at 8 kilometres, or *Δy/y* = 1/800. Then *α* = 4° 27' and *2b* = 620 metres.

By increasing the base to 2 kilometres, a maximum possible accuracy at 8 kilometres of 1/2500 of the distance, or 3 metres, would be attained, but the area mapped would be reduced to a narrow strip.

With the base of 620 metres, the area mapped with a plate of

diameter equal to the focal length of the lens would be contained between the limiting circles, at 8 and 2.5 kilometres, shown at *d* and *u* (Fig. 5), and would amount to 22 square kilometres on either side of the base, or more correctly to that portion not masked by the nearer topographical features.

The error in *x* will be due to that in *y* and that of the *x*-coordinate on the plate. We may write:

$$(\Delta x)^2 = \left(\frac{y}{f} \Delta l\right)^2 + \left(\frac{x}{y} \Delta y\right)^2$$

With a lens of 150 mm. focal length and an error of .025 mm. in the plate *x*'s, the maximum error is, for the base and the scale of plan considered, 5 metres, or on the plan 0.12 mm.

The error in height is given by the same expression. At the maximum distance, the second term cannot exceed (1/4 *Δy*)² if the difference in height between the base and the distant points does not exceed 2000 metres. In absolute amount the total error for points at extreme distances would be ± 275 metres.

The contour lines should then, in the case already considered, be accurate to 0.25 mm. on slopes greater than 15°, but the actual accuracy will be reduced to some extent by the uncertainty of the correction for refraction. This correction, combined with that for curvature, can be applied at sight from a small table with *y*-argument.

By reducing the base, pairs of photographs may be taken within a confined space, as when mapping hidden valleys. The

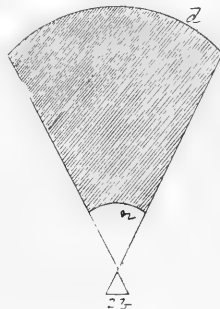

FIG. 5.

method can also be combined to any extent with the ordinary methods of photographic surveying. It would be of particular advantage in the mapping of large areas of mountainous country.

UNIVERSITY AND EDUCATIONAL INTELLIGENCE.

OXFORD.—The following examiners have been appointed in the Natural Science Schools:—Mr. William B. Croft, Pembroke College (physics), Dr. Alexander Scott (chemistry), Dr. Leonard E. Hill (animal physiology), Mr. John Watts, Balliol College (chemistry)—*vice* Mr. Elford, resigned.

THE 237th meeting of the Junior Scientific Club was held on May 29, in the museum. Mr. A. F. Walden, New College, demonstrated a new method of distinguishing between calcium and strontium. Mr. E. A. Cockayne, Balliol, exhibited a natterjack, and Mr. Lattey, Trinity, read a paper on the occurrence of natural gas in England.

MR. DAVID ROBERTSON, lecturer in electrical engineering at the Bradford Municipal Technical College and formerly assistant lecturer at the Glasgow and West of Scotland Technical College, has been appointed professor of electrical engineering at the Merchant Venturers' Technical College, Bristol.

THE annual exhibition of work from schools and classes of the School Board for London will be opened by Lord Ray on

June 18. A section will be devoted to scientific apparatus constructed by teachers and pupils. The Board, in including this section has in view the possibility that, by encouraging the construction of apparatus by its teachers and pupils, it may be possible to reduce the present heavy accounts for scientific apparatus and also that, at the same time, it may assist in familiarising the pupils with the practical use of apparatus. The sight of apparatus of a cheap and "home-made" character will be the means of encouraging the study of practical science at home.

ENCOURAGEMENT is being given to the study of natural history or nature-study in many districts. A programme has been sent to us of a series of Saturday afternoon rambles organised for the benefit of teachers by the Technical Instruction Committee of the Essex County Council. Conducted in the sympathetic spirit of the true student of animate nature, the excursions may be made a source of pleasure and profit to all who participate in them, but great care must be taken to prevent them from becoming expeditions of extermination. Prof. Miall points out this danger in a letter to the third number of the *Nature-Study Journal* published by the South-Eastern Agricultural College, Wye. The journal also contains short papers on uses of the balance, the metamorphosis of frogs, bees and flower shapes.

LORD ROSEBERY referred to the Education Bill in his address at Leeds on Friday last. He summed up the Bill by saying that "it discountenances efficiency in primary education, rewards inefficiency, starves secondary education, and ignores altogether the training of teachers." Education, he urged, is a national and Imperial duty, and its development should not be dependent upon local rates. The Bill provides that municipal authorities may apply the balance of the "whisky money," and may spend up to a twopenny rate in order to provide for the higher secondary and technical education so urgently needed in this country. This is not only inadequate in amount, but unsound in principle, and, remarked Lord Rosebery, "the putting of education on the rates is perhaps the surest method that the Government could have chosen for restraining the educational development of this country."

NEW regulations for secondary day schools have been issued by the Board of Education. The schools will be in two divisions—one containing what have hitherto been designated schools of science or organised science schools; and the other, secondary schools having courses in which science is given fair attention. The schools in Division A must provide a thorough and progressive course in science, together with the subjects of a general education. The obligatory subjects are mathematics, physics, chemistry, drawing and practical geometry; and not less than fifteen hours per week must be allotted to instruction in them, of which not more than five hours are to be given to mathematics. Practical work must be done in every science subject. On the completion of the elementary course, students may select physical, mechanical or biological courses, such as have been carried on for some time in schools of science. In Division B of secondary day schools, not less than nine hours a week must be given to science instruction in forms for which grants will be made. The instruction must be both theoretical and practical, and the laboratories must be suitably equipped for the subjects sanctioned.

THE executive committee of the National Association for the Promotion of Technical and Secondary Education adopted the following resolutions referring to the Government Education Bill at a meeting held on May 30:—(1) That this executive committee, while expressing no opinion on the more controversial aspects of the Education Bill relating to elementary education, regards it as essential to the interests of technical and secondary education, (a) that the fund available under the Local Taxation (Customs and Excise) Act, 1890, should be permanently appropriated by the Bill and devoted by the local authorities to the purposes of technical and secondary education; (b) that the areas of administrative control over technical and secondary education by local education authorities should, as provided by the Bill, continue to be the administrative counties and county boroughs or combinations of such areas. (2) The executive committee also considers it highly desirable, (a) that clauses 3 and 15 should be so amended as not to deprive any local authorities of the power they now possess to levy a penny rate for the purposes of technical and secondary education; (b) that the local authorities should be represented

on the governing bodies of all institutions to which grants are made.

It has already been announced that Mr. Alfred Mosely has arranged to send out to America two commissions of inquiry—one to study methods of education in their bearing on commercial and industrial efficiency, and the other industrial organisation and the problems of labour and capital. We learn from the *Times* that Mr. Mosely has just returned from the United States, where, in conjunction with President Butler, of Columbia University, he has settled the provisional itinerary of the educational commission. The exact date when this commission will start has not yet been decided. The programme arranged by President Butler seems to be of an exceedingly instructive and comprehensive character. Among the places to be visited are New York, with Columbia University, Auchmuty trade schools, the Educational Alliance, the University Settlement Society and the Normal College; New Haven, Conn., where Yale University will be inspected; Boston, with Harvard University and the Massachusetts Institute of Technology; Philadelphia, for the University, the Drexel Institute, the Manual Training Schools and the Commercial Museum; Baltimore, where the Johns Hopkins University and Hospital will be seen; Washington, for the Smithsonian Institution, National Museum and the Department of Agriculture; Pittsburgh, with the Carnegie Museum; Chicago, with the University, the School of Education, Prof. Dewey's University School and the Armour and Lewis Institutes; and Ithaca, N.Y., where Cornell University will be visited.

FOUR years ago an important gift was bestowed on the University of Paris, but it seems to have attracted little public attention. The Minister of War having decided to abandon three of the bastions constructed at the south frontier of the Parisian fortifications, generously placed them at the disposal of the University of Paris for the purpose of higher education. Each bastion represents about 3000 square metres of site. The council of the University determined to devote two of these to extending the facilities of the Faculty of Science and the third to the use of the Faculty of Medicine, and on these areas buildings suitable for the new installations required in connection with the above Faculties, which in the absence of a site cannot be erected in the centre of Paris, were to have been built. But though, with the intention of proceeding to erect the necessary buildings, the gift of the Minister of War was immediately accepted by the Faculties of Science and Medicine, funds voted for the purpose, and designs prepared by the architect of the Sorbonne, nothing has yet been done in the way of building. This delay is, it appears, the result of numerous objections which have been raised in different quarters. In a recent number of the *Revue générale des Sciences* these objections are answered in detail, and it is shown that it would be a great pity from the point of view of facilities for scientific research if the unhoped for chance of fine large laboratories on the outskirts of Paris was, even provisionally, abandoned.

SOCIETIES AND ACADEMIES.

CAMBRIDGE.

Philosophical Society, May 5.—Dr. J. Larmor, vice-president, in the chair.—Regeneration in *Samia aitanthus*, by Mr. H. H. Brindley. With the object of ascertaining the degree of regeneration and how far it is uniform in the imago after injury to the larva in particular stadia and to particular extents, amputation experiments were made on the legs of this moth in larva. Owing to the large number of cases in which the imago did not emerge the results were somewhat limited, but sufficient instances were observed to suggest (a) that compared with Orthoptera and other non-pupating forms the results of injury are very variable, (b) that the earlier the instar injured the imaginal limb more closely approaches the normal in form and size, (c) there is no uniformity in the presence of the terminal claw apparatus without regard to the number of limb joints such as has been observed in Arachnids, Myriapods and several orders of non-pupating insects, and (d) that the length of time spent in pupa and the degree of injury to the larval limb seem not to influence the degree of regeneration. As regards (b) the results are in general accord with those of Newport on Vanessa and Chapman on Liparis, though not as regards (c) with Newport. The experimental evidence obtained also seems to confirm Gonin's opinion, based on anatomical

grounds, that the imaginal limb is a distinct structure from the larval limb during the instar preceding pupation.—On the unit of classification for systematic biology, a reply to Mr. Bernard, by Mr. J. Stanley Gardiner.—Remarks on Marconi's system of telegraphy, by Mr. H. M. Macdonald.—On triondal quartics, by Mr. A. B. Basset.—On a definite integral, by Mr. T. J. I'A. Brounwich.—Reflection and transmission of light by a charged metal surface, by Mr. P. V. Bevan.—Note on a general numerical connection between the atomic weights, by Mr. C. A. Vincent. If a list of all the atomic weights in ascending order of magnitude be taken and the order in this list be called n , then the n th atomic weight, from $n=3$ to $n=60$, is given by the equation

$$W = (n+2)^{2.1}.$$

If the atomic weights are from Clarke's 1901 list with hydrogen as unit, then the greatest difference between the computed and determined value will not exceed 4 units, nor will the error ever be greater than 5 per cent.; in thirty-six cases the result will not be a unit wrong and in twenty cases will not be 1 per cent. wrong; the mean error for the whole fifty-eight elements considered is about 1.005, the mean percentage error about 1.6. By replacing $n+2$ of the above formula by N , and taking N as indicating the order in an augmented list of the elements, the formula may be made to embrace the whole of the seventy-seven elements now definitely known. This necessitates predicting an element between hydrogen and helium and one between helium and lithium. No other gaps are left until after samarium, when in order to complete the list it is necessary to assume elements in various places, making fifteen gaps in all. The thirteen gaps introduced after samarium are in general accord with those predicted by the periodic table.—On radioactive rain, by Mr. C. T. R. Wilson. As the experiments of Elster and Geitel and of Rutherford have shown, a negatively charged body exposed in the atmosphere becomes radioactive, apparently showing the presence of some radioactive substance in the atmosphere; it occurred to the author to test whether any of this radioactive substance is carried down in rain. Freshly fallen rain-water (less than 50 c.c. was generally used) was found when evaporated to dryness to leave behind a radioactive residue. The radioactivity was detected by means of the increase in the ionisation of the air within a small vessel, of which the top, or, in other experiments, the bottom, was of thin aluminium or of gold-leaf, the other walls being of brass. The metal surface on which the rain had been evaporated was placed close up to the aluminium or gold-leaf, and the rate of movement of a small gold-leaf which served to measure the ionisation was observed (*v. Roy. Soc. Proc.*, vol. LVIII. p. 151). In many cases the radioactivity obtained from the rain was sufficient to increase the ionisation five- or six-fold. From the evaporation of distilled water, of tap-water or of rain-water which had stood for many hours no radioactivity was obtained. Like the induced radioactivity obtained on a negatively charged body, that derived from rain gradually dies away, falling to about half its initial value in the course of an hour.—On the increase in the electrical conductivity of air produced by its passage through water, by Prof. J. J. Thomson. In continuation of the experiments brought before the Society last term, the author investigated the effect produced on the conductivity of air by bubbling it through water. The air from a large gas-holder of about 350 litres capacity was bubbled vigorously through water by making the air in the vessel circulate through a water-pump; this treatment increased the conductivity of the air, and when the bubbling had been going on for some time the conductivity of the air was ten or twelve times the initial conductivity. When once the air has been put in this highly conducting state it stays in it for a very considerable time; a large part of the conductivity produced by the bubbling remains in the air forty-eight hours after the bubbling has ceased, nor does it disappear when an intense electric force is kept applied to the gas. The effect produced by the passage of the air through water is similar to that which would be produced if the bubbling produced a radioactive "emanation" similar in properties to those emitted by thorium and radium. The conducting gas can be passed from one vessel to another; it retains its conductivity after passing through a porous plug; passage through a long tube heated to redness destroys the conductivity; it takes, however, a very high temperature to do this, temperatures less than 300° or 400° C. seem to produce comparatively little effect; if the gas is passed very slowly through a long tube filled with beads moistened with sulphuric acid, the conductivity is

destroyed; unless, however, the stream of gas is very slow, the air retains a good part of its conductivity in spite of the sulphuric acid. Another point of resemblance between the "emanation" from radioactive substances and a gas in this state is that if a strongly negatively electrified conductor be kept in the gas for some time, the conductor becomes radioactive.

DUBLIN.

Royal Irish Academy, May 26.—Dr. R. Atkinson, president, in the chair.—Prof. Grenville A. J. Cole read a paper on Composite Gneisses in Boylagh, West Donegal, in which he urged that the essential features of the foliation in the gneissoid granite from Ardara to Finntown were due to conditions of original flow, and not to subsequent dynamo-metamorphism. He attributed the darkened types of granite, with a specific gravity of about 2.74, to admixture of the pure aplitic intrusive rock (specific gravity about 2.59) and the already foliated schists. The foliation in the granite is commonly accompanied by numerous residual flecks of schist, and larger elongated inclusions occur which have retained the strike of the masses of which they once formed a part. Subsequent shearing has here and there produced mylonitic structures, but the granite was converted into a gneiss by its mode of intrusion, under mountain-building pressures, along the planes of separation of an altered sedimentary series. The gneisses of Boylagh are thus almost all of composite origin, and the foliated masses and limestone bands lying in the central granite of Donegal, and running with so persistent a N.E. and S.W. strike, represent the undissolved residue of an anticlinal mass composed originally of numerous parallel folds. The trend of these folds and of the granite axis points to their establishment in the Caledonian epoch of mountain-building. The later pegmatitic veins which cut them, and which are not affected by the folding, may, then, be of Devonian age.

PARIS.

Academy of Sciences, May 26.—M. Bouquet de la Grye in the chair.—The motor muscle employed in the production of positive work. The comparison with inanimate motors, from the point of view of the dissociation of the several constitutive elements of the energy expenditure, by M. A. Chauveau.—On the ethology of the larva of *Sciara medullaris*, by M. Alfred Giard. The biological history of the larvae of *Sciara* is dominated and directed by the conditions of the humidity of the medium in which the organism is placed.—The synthesis of petroleum: contribution to the theory of formation of natural petroleum, by MM. Paul Sabatier and J. B. Senderens (p. 138).—On the rays of convergence of a double series, by M. Eugene Fabry.—On the general exponential representation and some of its applications, by M. L. Desaint.—On functions of complex variables, by M. D. Pompieu.—The receiver in wireless telegraphy, by M. Edouard Branley. The receiver in common use in wireless telegraphy has a radioconductor containing a fine metallic powder. Owing to the numerous contacts, these tubes are sometimes a little variable in their behaviour, and in attempting to increase the regularity of working the author has recognised that a radioconductor of the type oxidised metal-polished metal is the best, as it not only possesses the required regularity of working, but is more sensitive than the ordinary type. A description and figure of the instrument that has been found to give the best results is given.—On the electric discharge in flames, by M. Jules Semenov. In electric discharge in flames it was found that the negative pole heats much more than the positive pole, the negative pole being the seat of a phenomenon of a reflux of material particles the direction of which appears to be independent of the relative position of the two poles.—On the temperature of the electric arc, by M. Ch. Féry. The optical pyrometer of Chatelier was modified by the introduction of a thin prism of absorbent glass for the production of the photometric equilibrium. The temperatures thus observed with prisms of red and green glass were compared directly with the readings of a platinum-rhodium platinum couple, the results being in very close agreement up to 1500° C., the highest temperature attainable with the couple. Within these limits the law of Wien was found to be verified, and these results were then extended to the case of the temperature of the electric arc. The value found, 3882° C., differs considerably from the value found by Chatelier, 4100° C., from which the conclusion is drawn that carbon does not behave at its boiling point as a perfectly black substance.—Fields of force of bipolar diffusion, by M. S. Leduc.—On the modifications brought about by self-

induction in some dissociation spectra, by M. A. de Gramont. A continuation of previous researches on the same subject. The changes in the spectra brought about by changes in the self-induction of the spark circuit are studied in the cases of arsenic, antimony, graphite, silicon, germanium and thallium.—The employment of urine in the development of the photographic plate, by M. K. A. Reiss. Urine has a slight reducing action upon the photographic plate and may replace water in the developing solutions.—On the temperature of maximum density and the electric conductivity of some solutions of barium bromide and iodide, and calcium chloride, bromide and iodide, by MM. L. V. de Coppet and W. Muller.—On some physical properties of hydrogen telluride, by MM. de Forcand and Fozes-Diacon. A mixture of hydrogen and hydrogen telluride was prepared by the action of acids upon aluminium telluride, and this mixture passed through tubes cooled to -55°C . Pure hydrogen telluride separated out in the solid state, allowing of correct determinations of its melting and boiling points and molecular volume.—The preparation and properties of the chloro-, bromo- and iodo-sulphobismuthites of copper, by M. Fernand Ducatte.—On the alkaline cobaltosalts, by M. Copaux.—On the constitution of the ammoniacal copper salts, by M. Bouzat. From a study of the amounts of heat developed in the reaction between solutions of ammonia and copper salts the author concludes that the ammoniacal compounds of copper ought to be considered as salts of complex bases.—On β : β -dinitrohydrozobenzene, by MM. P. Freundler and L. Beranger.—On the thiosulphocarbamic esters derived from primary amines, by M. Marcel Delépine.—The electrical resistance of metallic sulphides, by M. J. Guinchant. The resistance of the sulphides of iron, tin and lead was measured at varying temperatures. The resistance was generally a linear function of the temperature up to 100°C . The resistance of lead sulphide increased with the temperature, that of the sulphides of tin and iron decreased. The sign of the temperature coefficient would appear to depend upon the magnitude of the specific resistance, or of the causes which determine it, and not upon accessory phenomena, such as electrolysis, which accompany the passage of the current. The differentiation of solids into electrolytes and non-electrolytes according to the sign of this coefficient would thus appear to be unjustifiable.—The synthesis of aldehydes of the fatty series with the aid of nitromethane, by MM. L. Bouveault and A. Wahl (see p. 137).—The mechanism of the chemical variations in the plant when under the influence of sodium nitrate, by MM. E. Charabot and A. Hébert. Sodium nitrate behaves like the chloride in favouring esterification and reducing the percentage of water.—The composition and volumetric estimation of sodium methylarsenate, by MM. Adrian and Trillat.—Growth and auto-intoxication, by M. Frederic Houssay.—On the formation of the egg, maturation and fertilisation of the oocyte in *Distomon hepaticum*, by M. L. F. Hennequy.—On a new gigantic Pyrosome, by MM. Jules Bonnier and Charles Perez.—The modes of action and nature of the secretions of a pathogenic microbe, by MM. Charrin and Guillemonat.—Contribution to the study of life in seeds, by M. L. Maquenne.—The volcanic rocks of Martinique, by M. A. Lacroix.—The biochemical action of extract of kidney on certain organic compounds, by M. E. Gérard. The aqueous extract of the kidney of the horse, from which all cellular elements have been removed, is capable of hydrolysing glycogen, guaiacol, oxaluric acid and lactose.—On a comparison of the action of cold and anaesthetics on nutrition and reproduction, by M. Raphael Dubois.—The disease of young dogs. Statistics of the vaccinations practised from May 15, 1901, to May 15, 1902, by M. C. Phisalix.—On the existence of lipase in the blood, by MM. Maurice Doyon and Albert Morel.—Experimental researches on the action of compression on the respiratory exchanges in man, by M. J. Tissot.

DIARY OF SOCIETIES.

THURSDAY, JUNE 5.

ROYAL SOCIETY, at 4.—Election of Fellows.—At 4.30.—On the Movements of the Flame in the Explosion of Gases: F. H. B. Dixon, F.R.S.—Contributions to the Study of Flicker. Paper II. I. T. C. Porter.—Effects of Strain on the Crystalline Structure of Lead: J. G. W. Humphrey.—The Spectra of Potassium, Rubidium, and Cesium, and their Mutual Relations: H. Ramage.—On Some Definite Integrals and a New Method of reducing a Function of Spherical Co-ordinates to a Series of Spherical Harmonics: Prof. A. Schuster.—ROYAL SOCIETY, at 8.—The Action of Ungerminated Barley Diastase on Starch. Part I: J. L. Baker.—The Decomposition of Chlorates.

Part V. Potassium Chlorate in presence of Oxides of Manganese: W. H. Sodeau.

RÖNTGEN SOCIETY, at 8.30.—The Sources of Phosphorescence: Herbert Jackson.

LINNEAN SOCIETY, at 8.—On certain Species of *Dischidia* and their Double Pitchers: H. H. W. Pearson.—(1) On "Silver-leaf" Disease of Plums; (2) Observation on the Occurrence of Crystals of Calcium Oxalate in Seedlings of *Alsike* (*Trifolium h. v. linn.*, Linn.): Prof. J. Persbald.—On the Morphology of the Cerebral Commissures in the Vertebrate: Dr. Elliot Smith.

FRIDAY, JUNE 6.

ROYAL INSTITUTION, at 9.—The Nile Reservoir and Dams: Sir Benjamin Baker, K.C.M.G., F.R.S.

GEOLOGISTS' ASSOCIATION, at 8.—On a Peculiarity in the Course of Certain Streams in the London and Hampshire Basins: H. J. Osborne White.—Note on the Occurrence of *Microtus intermedius* in the Pleistocene Deposits of the Thames Valley: M. A. C. Hinton and G. White.

MONDAY, JUNE 9.

ROYAL GEOGRAPHICAL SOCIETY, at 8.30.—From the Somali Coast through Southern Abyssinia to the Sudan: Oskar Neumann.

TUESDAY, JUNE 10.

MINERALOGICAL SOCIETY, at 8.—On Meigen's Method of Discriminating Calcite and Aragonite: Dr. Hutchinson.—(1) On Krennerite; (2) On the Gnomonic Projection: H. Smith.—On Volcanic Dust which fell at Barbadoes: G. T. Prior.—*Echinos*: A new form of Three-Circle Goniometer: H. Smith.

WEDNESDAY, JUNE 11.

GEOLOGICAL SOCIETY, at 8.—A Descriptive Outline of the Plutonic Complex of Central Anglesey: Dr. Charles Callaway.—Alpine Valleys in Relation to Glaciers: Prof. T. G. Bonney, F.R.S.—On the Origin of some Hanging Valleys in the Alps and Himalayas, and their Bearing on the Question of the Relative Erosive Power of Ice and Water.—Prof. E. J. Garwood.

THURSDAY, JUNE 12.

ROYAL SOCIETY, at 4.30.—*Probable Papers*.—(1) The Influence of an Atmosphere of Oxygen on the Respiratory Exchange. (2) The Influence of High Pressures of Oxygen on the Circulation of the Blood: L. Hill, F.R.S., and J. J. R. Macleod.—On the Parasitism of *Pseudomonas destructans* (Potter): Prof. M. C. Potter.—On the Toxic Properties of the Saliva of certain "Non-Poisonous" Colubines: Prof. A. Alcock, F.R.S., and Dr. L. Rogers.—The Dissipation of Energy by Electric Currents induced in an Iron Cylinder when Rotated in a Magnetic Field: Prof. E. Wilson.

MATHEMATICAL SOCIETY, at 5.30.—Sur un théorème fondamental dans la théorie des équations différentielles: M. E. Picard.—Some Arithmetical Theorems: Mr. G. H. Hardy.—The Principle of Huygens in a Uniaxial Crystal: Prof. A. W. Conway.

FRIDAY, JUNE 13.

ROYAL INSTITUTION, at 9.—The Progress of Electric Space Telegraphy: G. Marconi.

PHYSICAL SOCIETY (National Physical Laboratory), 3.30-0.

ROYAL ASTRONOMICAL SOCIETY, at 5.

MALACOLOGICAL SOCIETY, at 8.

CONTENTS.

PAGE

The Popular Huxley.	By Sir W. T. Thiselton-Dyer, K.C.M.G., F.R.S.	121
A Monograph of Mosquitoes	123	
The Direct-Current Arc.	By M. S.	124
Our Book Shelf.—		
Koken: "Paleontologie und Descendenzlehre."—		
R. L.		126
Lewkowitzsch: "The Laboratory Companion to Fats and Oils Industries"		126
Letters to the Editor:—		
Colour-variation in the Guinea-fowl.—F. Finn		126
A Cubic and Submerged Cubes.—Prof. Thos. Alexander		127
The Electrical Resistance of the Blood.—Dr. Dawson Turner		127
Chickens Hatched in a Tree.—W. H. Hall		127
A Curious Optical Effect.—E. Moor		127
The Proposed Experimental Tank for Testing Ship Models for Resistance. (Illustrated.)—By R. W. D.		128
Volcanic Dust from the West Indies. (Illustrated.) By J. J. H. Teall, F.R.S.; Rev. T. C. Porter; J. D. Falconer		130
Records of Recent Eruptions. (Illustrated)		132
Dr. Henri Fihloh		133
Notes		134
The Equatorial Current on Jupiter. By W. F. Denning		138
German Progress in Optical Work		138
A Stereoscopic Method of Photographic Surveying. (With Diagrams.) By H. G. Fourcade		139
University and Educational Intelligence		141
Societies and Academies		142
Diary of Societies		144

THURSDAY, JUNE 12, 1902.

THE HISTORY OF THE MYTH-MAKING AGE.

The Ruling Races of Prehistoric Times in India, South-western Asia, and Southern Europe. By J. F. Hewitt. Vol. i. Pp. lxxv + 627 (1894), 18s. Vol. ii. Pp. xxxv + 382 (1895), 12s. (Westminster: Constable and Co., Ltd.)

History and Chronology of the Myth-making Age. By J. F. Hewitt. Pp. xlviii + 682. (London: Parker and Co., 1901.) 15s. net.

THE object of the present short article is not so much to call the attention of the readers of NATURE to two works by Mr. J. F. Hewitt, late Commissioner of Chota Nagpore, who has devoted many years of hard work to the elucidation of the history of the ruling races of prehistoric times in India, south-western Asia, and southern Europe, as to mention some of the difficulties connected with the history and chronology of the myth-making age. To discuss at length and in detail the contents of the three volumes the titles of which appear at the head of this review would require several numbers of NATURE, or a whole volume, and while an attempt is here made to indicate the general line of his arguments and the trend of his opinions, the reader, if he wishes to become master of the subjects as treated by Mr. Hewitt, must read the works themselves. Mr. Hewitt brings to bear upon his studies a knowledge of several Indian dialects, and a general knowledge of what other investigators have written about subjects which are germane to his own; his observations and opinions have not been formed hastily, and every fair-minded reader will, after a perusal of his works, arrive at the conclusion that he is an honest, even if sometimes mistaken, seeker after facts, and that, so far as his knowledge will allow him to do so, he sets the truth before those who will take the trouble to read what he has written. The chief importance of his books, in the writer's opinion, is the proof which they afford of the little value of philology in arriving at any decision as to the religious views and practices of early nations; moreover, we cannot help wishing that when Mr. Hewitt was making his quotations he had taken the trouble to give the words and passages on which he bases his arguments in the languages in which they were originally written. We have no intention of finding fault or of making carping criticisms, but Orientalists other than experts in Indian languages would have felt much more comfortable if they could have seen before them the Babylonian, or Assyrian, or Egyptian forms of the words which he quotes. The answer to this objection is, of course, that the use of mixed Oriental types is a costly luxury to an author, and to many it will seem a sufficient one; meanwhile, let us thank Mr. Hewitt for what we have, and then proceed to consider generally the aim and scope of his work.

The older of the works before us is that which deals with the ruling races of prehistoric times in India, and consists of a series of eleven essays, six of which were published in 1894 and the remaining five in 1895. In a

NO. 1702, VOL. 66]

somewhat lengthy preface, Mr. Hewitt explains that he intended to call especial attention by means of them to the chronological data which can be obtained from "social laws and customs, mythic history and ritual," and to show how the leading epochs of civilisation succeeded one another in prehistoric times. In the first essay he describes how he was drawn into the line of study in 1863, when he went to Chota Nagpore as Deputy Commissioner, and how the system of indigenous Indian village communities spread thence through all the countries lying between it and north-west Germany. Mr. Hewitt next thought he had found that the clues to the history of early Hindu ritual given in the Rigveda and elsewhere could only be explained by comparison with data obtained from Accadian texts, and he apparently still thinks that Hindu and Accadian mythology developed on nearly identical lines, the Zend ritual being a common link between them. He also came to the conclusion that Egyptian religious and national history in the two stages of its growth can be traced to Indian and Accadian sources, and that it was impossible that the maritime commerce, whence the wealth was earned which made the Euphratean countries and Egypt rulers of the ancient world, could have been founded except by the Indian seaman. In the essays which follow he sets out the reasons, philological, religious, and historical, which have induced him to hold these views, and adduces a number of theories, many of an astronomical character, in support of the same. We must, however, at the very outset protest against the statement that the Egyptian religion, as such, can be traced to India, and we much doubt if Hindu mythology can be compared with Accadian mythology in any way. Thanks to the labours of men like Brugsch and Maspero, we know a little about the Egyptian religion and the gods of Egypt, and the more we know the more we find that the oldest gods of Egypt were indigenous, and that the religion of the earliest period was the very characteristic product of an indigenous race of north-east Africa. Whether Mr. Hewitt is right or we are, others must decide; but any comparison between the name of the Egyptian god Osiris (Ās-ār) and the Accadian god Asar (or Asaru) is scientifically impossible, and when he says that Heru (or "Horus" as he spells it) was the equivalent of the Ashēra, "or rain pole of the Semites," and the "Tur or meridian pole of the Akkadians," we are obliged to disagree entirely with him. The Accadians appear to have had a god called Zu-ab or Apzu, who had something in common with the Egyptian Nu (not Nun, as Mr. Hewitt writes the name), but to say that both Accadians and Egyptians worshipped Nu is incorrect. In the first essay we also have a long dissertation about St. George, who, according to Mr. Hewitt, was:—

"the rain-god, the knight of the cross, for, it was in the centre of the tortoise earth that the mountain of rain-god stood, and it is from the cross forming the ground plan of the tortoise, with the pole or mountain in the centre, that the Egyptian star of Horus was formed" (p. 17).

But in Egyptian mythology Horus had no special star, and the five-rayed star was the common symbol of stars and gods in general. If anything, St. George was a solar god, and all the details of his history go to prove

his identity, not with a rain-god, but with the sun-god Rā in Egypt and Marduk in Mesopotamia. We cannot follow Mr. Hewitt here in all his derivations, because it seems that he is influenced too much by the similarity of the sounds of roots and not by the probability of their relationship. Thus, on p. 27, he speaks of "Rāma, meaning 'the darkness' in Sanskrit and 'the heights' in Hebrew." The fact is that "Rāma" does not mean "heights" in Hebrew, but *Rāmāh* does mean "high"; even so, however, it is not in any way related to the Sanskrit Rāma, and the words Rāma and Rāmāh must not be compared in this way. The second essay, which deals with the primitive village, is more interesting, and contains a number of original remarks which show that Mr. Hewitt has thought out the subject with care; but in the third we again touch serious philological difficulties. Mr. Hewitt has followed the speculations of many masters, and has in consequence made a good many mistakes. Thus, Isis was not a star-goddess originally, but her soul went to the star Sept, and the name Ast (Isis) has no connection with Accadian at all. In this, as in many other places, Mr. Hewitt has adopted Prof. Hommel's views, which are not generally accepted either by Assyriologists or Egyptologists. At this time of day it is little less than foolish to quote Lenormant's works on Accadian, for it is now well known that his skill in reading cuneiform of any sort was very small, and that his imagination and boldness of assertion were very great. On p. 292 we have an extraordinary set of equations, e.g. Tur, the pole=taurus=Syriac *tawrā*, a bull=Hebrew *shur*, an ox=Tyre! In the fourth essay a number of astronomical myths are described, and Mr. Hewitt lays down the theory that the primitive year contained two seasons, that it was followed by one of three seasons, and that mankind eventually made use of a year of five seasons. He supports his theory by means of a large number of impossible philological comparisons, and says, among other remarkable things, that the constellation Leo

"was the Māsu or Moses, who, as the pillar of cloud and fire, led the star-worshippers to the top of Mount Nebo, consecrated to the planet Mercury, the great Nabi or prophet of the Semites" (p. 352).

We do not intend to weary the reader with further extracts from these essays, for the passages already quoted will explain Mr. Hewitt's methods, and serve to show how philology is made to run riot in them; the other remarks on the volumes generally we shall make after we have briefly described the contents of the work "History and Chronology of the Myth-making Age." The period of time which Mr. Hewitt discusses in this portly volume begins with the "first dawn of civilisation" and ends at the time when the sun entered Taurus at the vernal equinox between 4000 and 5000 B.C., his "pivot date" being B.C. 4200. About this time, he says, it ceased to be a universally observed national custom to record history in the form of historic myths (*sic*), and national history began to pass out of the mythic stage into that of annalistic chronicles recording the events of the reigns of kings and the deeds of individual heroes, statesmen and law-givers. It would be extremely interesting to know why B.C. 4200 was fixed upon as the pivot

date, for there is reason to believe that the making of myths did not cease at that period. For all practical purposes Mr. Hewitt's book on the myth-making age is divided into three parts, which treat of the age of pole-star worship, the age of lunar-solar worship and the age of solar worship. These are followed by four appendices, which give a list of the Hindu stars, versions of the "House that Jack built," the legend of Ino and a dissertation on Melgareth. The section on pole-star worship treats of the year of two seasons and of five-day weeks, the year of three seasons and of five-day weeks, and the year of three seasons and of six-day weeks; the first of these years, Mr. Hewitt asserts, was measured by the movements of the Pleiades and the solstitial sun, the second by Orion, and the third by the eel-god. The second section treats of the epoch of the three-year cycle and of the nine-day weeks, of the year of the horse's head of eleven months and eleven-day weeks; and the third section discusses the fifteen-months year of the sun-god of the eight-rayed star and the eight-days week, the years of seven-day weeks and seventeen and thirteen months, the years of eighteen and twelve months, and of five- and ten-day weeks. In proof of the views which he holds on all these difficult subjects, Mr. Hewitt quotes largely from a great many works by authorities of varying trustworthiness; and he reproduces an appalling number of equations, a few of which, taken singly, are correct, but which, when looked at as a whole, are erroneous and misleading, and confuse the mind of the reader. Thus, on p. 29, we are told that Zeus is a form of the North Pole god Tan, that Tan = the Creto-Phœnician (*sic*) I-tan-os = the Accadian I-tan-a (*sic*), and the "tree mothers" of Accad, China, Germany and other countries are declared to have a common origin and to typify the same things. Statements of this kind are difficult to understand, at least when their writer intends the reader to believe that the ideas concerning the subjects of them were common to all peoples of antiquity, irrespective of the distance of their countries from each other. Moreover, they make it exceedingly difficult for any student to accept the generalisations which they express. There are, of course, many beliefs and conceptions which are common to all races of mankind, which are on the same level of civilisation, but there are large numbers of others which are not, and there are many which belong to a particular race, or to a people who live under peculiar geographical and physical circumstances. The cosmogony and theology of mountain races are different from those of the dwellers in plains, and those of the Semites differ from those of the Aryan nations. Another point is also to be considered in connection with the matter. Mr. Hewitt quotes authorities on the Chinese, Accadian, Sanskrit, Babylonian, Assyrian, Egyptian, Dravidian, and numbers of other languages, and without meaning to be disrespectful to him or to belittle his work, we must say that we have no belief in the philological omniscience which can decide about such abstruse questions as he formulates and answers. Men like Wellhausen and Kuenen have shown us what can be done in elucidating ancient religious beliefs by means of a knowledge of a group of cognate languages, but in our opinion no man is to be

trusted when he professes to deduce relationship of words, names and beliefs in Egyptian, which is an African (Hamitic) language, and in Babylonian, which is a Semitic language, and in Sanskrit, which is an Aryan language, and in Chinese and Accadian, which, whether they be related or not, have no relationship with any one of the other three. Mr. Hewitt, like Mr. John O'Neill, in his "Night of the Gods," has done a useful piece of work in collecting a mass of facts and theories, but they want sorting and arranging and winnowing, and especially condensing, before they can be used by the students of the various religions of antiquity. What is more important, moreover, is that the derivations of the words and names should be checked by experts in the various languages in which the books of the various religious systems are written, so that the student may be quite sure that no mistake has been made. Descending from generalities to particulars, we note that Mr. Hewitt speaks of the "Hittite" as if it were a known language; but it is not, and no inscription written in the script which is commonly called "Hittite" has yet been deciphered. It is true that "translations" of certain "Hittite" texts have been printed and published, but no trained philologist admits that they really represent the meaning of the texts from which they are alleged to have been made. Even the identity of the Hittites of the Bible has not yet been established, for whilst the Khatti of the Assyrian monuments may be identical with the Kheta of the Egyptian records, there is no evidence that either name is connected with the Hittites, or that the Hittites were related to the Kheta and Khatti. Similarly, Mr. Hewitt alludes to the Accadian language as if it too were known; but every student of comparative Semitic philology is well aware that the study of Accadian is so little advanced that certain eminent Assyriologists, no doubt erroneously, even now do not regard it as a language at all!

The general impression which a careful perusal of the book leaves on the mind is that Mr. Hewitt has proved too much; but be this as it may, it is our firm conviction that if he wishes his labour and learning to receive the study and recognition which they deserve, he must condense his statements and formulate his theses in such a way that the student who is not an Oriental philologist may be able to make up his mind what are the theories which Mr. Hewitt sets out to prove, and whether he has proved them or not. A sharp distinction should, of course, be made between theory and fact, but this Mr. Hewitt fails to make. In conclusion, we cannot help wishing that he had confined his attention exclusively to Indian languages, cosmogonies, and theologies, of which, obviously, he has had abundant opportunities of obtaining knowledge at first hand, and that he had not made such lengthy excursions into the domains of Chinese, Semitic, Egyptian and other studies of which he as obviously has no first-hand knowledge whatever, nor even enough to distinguish good authorities from bad. He has, in fact, lost an excellent opportunity of writing a most interesting book on the early religious myths of India, and this we sincerely deplore. The indices to the volumes before us are remarkably comprehensive and good, and merit praise.

CYCLOPEDIA OF HORTICULTURE.

Cyclopædia of American Horticulture. By L. H. Bailey, assisted by Wilhelm Miller [and others]. In 4 vols. quarto. Pp. 2016. (London: Macmillan and Co., Ltd.; New York: the Macmillan Company, 1900 to 1902.) Price 21s. net each volume.

THESE are some books which gain the title "monumental" on the sheer score of size. The present work, which has recently been completed, has earned it, not only by its bulk, but by the quality of its contents, their freshness and diversity, and the originality of their treatment.

There are two ways of producing such a work as this, one by the free use of paste and scissors, a plan not to be despised if the compiler be at once honest and judicious, and the other wherein each article inserted is treated as a monograph. Facts are accumulated, contrasted, classified, so that in the result the reader has placed before him as complete a view of the whole subject as the limitations of space will allow. This is the plan that has been followed by Prof. Bailey and his 450 contributors and assistants. The Cyclopædia was to be new, "brand new from start to finish. The illustrations were to be newly made; the cultural suggestions written directly for the occasion from American experience and often presented from more than one point of view; few of the precedents of former cyclopædias to be followed; all matters to be worked up by experts and from sources as nearly as possible original." Considering all these things, the volumes constitute a real triumph of sagacity and organisation on the part of Prof. Bailey.

The matter, so far as we have tested it, is accurate, well set forth and in due proportion—a most difficult thing to secure when the work of so many contributors has to be correlated and adjusted. It is quite clear that a large share of the work, independently of planning and supervising the whole, has fallen to Prof. Bailey. Two things specially strike us in consulting the volumes, the one the way in which science, and especially evolutionary science, permeates the whole book, the other the way in which scientific knowledge has been set forth for the special benefit of commercial horticulture. In most or all books of the kind, botanical and physiological details are given, but here they seem expressly set forth for the benefit of those who make their living out of the land or the forcing-house. Science is not allowed to suffer in the least, but its application to commercial necessities is insisted on to a degree unknown in British horticulture. Prof. Bailey knows and caters for the requirements of the commercial cultivators in all or most of the States of the Union, and not the least valuable of his articles are those concerning the natural features and economic conditions of the several States and Territories.

So far as the plants are concerned, analytical keys are framed, so as to facilitate, by means of contrasting characters, the discovery of the name of each plant and of its salient features. The enormous and irksome labour involved in the construction of these keys can only be appreciated by those who have had to construct similar ones. An error the most trifling in itself may involve the

most serious consequences as regards the construction and the use of these tables.

In a work of such magnitude and diversity, it is futile to think that errors can have been completely avoided, but from frequent consultation of the earlier volumes we can testify to their remarkable freedom from printers' errors. We think a short account of each of the principal natural orders should have been given, and the space so allotted might have been saved, in part at least, by thus obviating the necessity of some amount of repetition in dealing with the several genera.

Prof. Bailey has availed himself of the resources of Cornell University, of the "Dictionary of Gardening" by Nicholson and of the numerous standard publications issued from Kew, and, amongst other sources of information, has consulted and compared some hundred or more catalogues of nurserymen. This latter procedure needs to be followed with the utmost caution and is one to which, perhaps, the omission of the genus *Trochodendron* is to be attributed. After all, the plants that have special interest for commercial purposes are few in number as compared with those which appeal primarily to the lover of plants or to the scientific botanist.

We might extend our notice of this book to a much greater length than the editor could allow space for. We can only add that the illustrations are very numerous, uniform in treatment, often very useful, but, on the whole, not equal in value to the text. Further, that although expressly compiled to meet American conditions, it will, with the necessary modifications, be of great value in all English-speaking countries.

THE MANUFACTURE OF SUBMARINE CABLES.

Les Câbles Sous-Marins. Fabrication. Par Alfred Gay. Pp. 203. (Paris : Gauthier Villars et Fils, n.d.)

THE author of this little book, as we are informed on the title-page, is an engineer in the employment of the Société industrielle des Téléphones, the leading French firm for the manufacture of submarine cables. The volume is one of a series appearing under the name of "Encyclopédie scientifique des Aide-memoire," edited by M. Léauté, who is also, we understand, connected with the Société industrielle des Téléphones. From the title of the series we gather that this publication is designed to serve as a pocket text-book for submarine cable engineers, though the style in which it is written and the absence of an index—a fatal omission for any work of reference—make it resemble a popular treatise on the subject of cable manufacture rather than a scientific handbook. One example will serve to justify this view. In his reference to the Wheatstone Bridge—the most usual form of testing the conductor resistance of a cable—the author makes no attempt to explain the theory of the test, but merely gives the connections and the formula for obtaining the result. A book on cable testing which evades an explanation of the *Pont de Wheatstone* is as great a curiosity as a treatise on Euclid which omits all reference to the *Pons Asinorum*.

One or two other points call for comment. With regard

to the testing of the dielectric resistance, M. Gay observes that some physicists have expressed the opinion that, if sufficient time were allowed, the "spot" would return to zero and remain there. This could only happen in the case of a material which possessed an absolute dielectric resistance, and through which, consequently, no current could escape. Manufacturers have hitherto failed to discover this material. Further on, the author asks why the negative current is always the first to be applied to the cable, and answers his question by saying that he believes that there is no good reason for using one current in preference to the other. But M. Gay must know that, when testing a faulty cable under water, the chemical action of the zinc current tends to clean the fault and make it more apparent, while the copper current throws a deposit on the exposed surface and masks the fault. Thus the reason for using the zinc current first is to discover at once any fault that may exist.

Throughout his book the author pays too little attention to the question of capacity in connection with the manufacture of cables. On p. 14, in enumerating a long list of the conditions which a good dielectric must satisfy, he does not mention the desirability of a low capacity. In fact, on p. 107 he goes out of his way to lay stress on the superior importance of insulation tests to capacity tests, ignoring the fact that, *cæteris paribus*, the work to be got out of a cable depends on its capacity, its insulation being purely a secondary matter. Finally, on p. 145 M. Gay says that the engineer is not master of the capacity of a core, the dimensions of which are given him, as though the capacity could not be varied by the selection and mixture of the gutta-percha used, independently of its relative weight to the conductor.

For the rest, it may be sufficient to point out that, in connection with the table of coefficients, given on p. 85, for reducing the D.R. of the cable at the temperature at which it is tested to its equivalent at 75°, one must *divide* and not *multiply* (as instructed on pp. 147 and 149) by the coefficient given, for the D.R. at 75° is, of course, less than at a lower temperature and more than at a higher temperature. With regard to the brazing of a joint, M. Gay would find it difficult to scarf the two ends of the conductor, if he omits, as he does in the directions on p. 173, to solder them first.

Enough has been said to show that the book is not likely to prove of great value as a work of reference for cable engineers. But as a popular treatise on a process of manufacture of which the public knows little, and may like to know more, it deserves very favourable notice. The chapter on the composition and properties of gutta-percha is specially good, and on pp. 90 and 91 the author sums up very clearly and succinctly the reasons for the various conditions which specifications require the dielectric to satisfy.

"Voici, en deux mots, sur quels motifs est basée l'introduction de chacune de ces règles : on impose une limite inférieure d'isolement pour se garantir contre les défauts de fabrication ; on impose une limite supérieure d'isolement pour empêcher l'emploi des guttas très résineuses qui, en général, s'altèrent vite avec le temps ; on impose un résidu maximum dans le chloroforme ou le toluène pour s'assurer que le mélange a été bien nettoyé

et qu'il ne contient plus une proportion trop grande des matières étrangères; si impose enfin un résidu minimum dans l'alcool bouillant ou, si l'on veut, un résidu maximum après décantation et évaporation du liquide ayant servi aux expériences pour obliger le fabricant à faire usage de lots contenant une proportion suffisante de gutta pure."

OUR BOOK SHELF.

Some Thoughts on the Principles of Local Treatment in Diseases of the Upper Air Passages. By Sir Felix Semon, M.D., F.R.C.P. Pp. 115; with Appendix pp. 130. (London: Macmillan and Co., Ltd.) Price 2s. 6d. net.

THIS little volume, reprinted from the *British Medical Journal*, consists of two lectures delivered in November, 1901, at the Medical Graduates' College and Polyclinic; and there is an appendix consisting of two letters dealing with the controversy aroused by the publication of these lectures.

The book is evidently intended for the medical profession only, the object of the distinguished author being two-fold, that is to say, it is a serious protest against "operative intemperance" and an attempt to lay down some simple principles for the treatment of diseases of the upper air passages.

Such a protest from within the profession against "the lust of operation"—perhaps a euphemism for something still more discreditable—has long been needed, and will doubtless require periodical repetition.

For the craze for specialists for everything (even "for a child of 6 months old") has recruited the ranks of specialism with many undesirables, possessed of the minimum of really special knowledge, except such as is generally associated with one's conception of the pachydermatous and pushing commercial traveller.

The author, perhaps wisely, confines himself to the less offensive expressions, "lust of operation," "operative intemperance"—charges from which he, with everyone else, wholly exonerates all honourable members of the profession possessed of judgment and a proper sense of responsibility.

Coming to questions of treatment, the author divides the symptoms and signs arising in pathological conditions of the upper air passages into five categories:—(1) Affections of a purely local character. (2) Local manifestations of general systemic diseases. (3) Local manifestations in nose and throat dependent upon local diseases in correlated areas. (4) Affections of the upper air passages supposed to exercise direct or reflex influence upon other organs and parts of the body. (5) Local symptoms and sensations of obscure origin.

In conclusion, some observations are made on the necessity of a proper proportion being observed between the gravity of the disease and that of the interference, so as "to make the punishment fit the crime."

In admirably clear and concise language, the diseases included in the foregoing subdivisions are specified, and a surprising amount of detailed treatment, of the utmost value, given in the subsequent pages, for many of these conditions, e.g. the various stages of tuberculous laryngitis.

In addition, sundry more or less fashionable methods of treatment, such as breathing exercises, and catch phrases, such as "nasal insufficiency," are subjected to the most searching criticism; whilst the dangers of ignorant "specialism" are fully exposed by a series of cases which has come under the direct observation of the author.

We congratulate the writer of these lectures, believing that he has done excellent service to his profession and to the public generally; and we confidently recommend

the volume both to the up-to-date general practitioner and to the specialist, whether broad- or narrow-gauged.
H. C.

Flora der ostfriesischen Inseln. By Dr. Fr. Buchenau. Fourth edition. Pp. iv + 213. (Leipzig: Wilhelm Engelmann, 1901.)

IN order to incorporate the results of the systematic examination of the mosses, hepatics and lichens of the East Friesian Islands, Dr. Buchenau has brought out a fourth edition of his flora. The previous edition included the descriptive text of the phanerogams and pteridophytes and a highly interesting ecological account of the types of vegetation. A comparison of the flora of the islands and of the mainland brings out some curious points of difference. On this account the author rescinds his former opinion that the plants had travelled over from the continent; more probably, he suggests, the insular vegetation represents the remains of an ancient *diluvial* flora. No changes are made in the previous issue, the new edition consisting in the addition of some extra pages, which contain a list, without diagnoses, of the Muscinæ and Lichenes and an appendix giving corrections and addenda. Amongst the mosses it is interesting to find recorded a group of Bryums, represented by *Bryum calophyllum*, which are found locally in this country on sandhills near the mouths of certain rivers. The fungi of the islands are now being worked by Herr E. Lemmermann, and his results will be included in a future issue.

Occultations of Stars and Solar Eclipses. By Francis Cranmer Penrose. Second edition. Pp. viii + 36. (London: Macmillan and Co., Ltd, 1902.) Price 12s. 6d. net.

THE first edition of this book was published in the year 1869, but in the present issue Mr. Penrose has not only simplified and condensed the work contained in it, but has extended it in that portion which relates chiefly to total solar eclipses. Most of us are familiar with the importance of determining one's position on the earth's surface, especially when on the ocean or on land far removed from the privileges of civilisation, and any attempt, either by a graphical or computational process, to facilitate this object is very welcome both to navigators and travellers. In this book Mr. Penrose treats the methods of predicting such phenomena as occultations of stars and eclipses of the sun by graphical construction, and he adds more rigorous methods of reduction for the accurate calculation of longitude. The very full explanation of the principle involved, the details of the working out of each case in point, the tables to facilitate the necessary computations, and the skeleton forms for actual practice, will all be found sufficiently clear to enable the worker to understand the practical use of the method.

Algebra. Part ii. By H. G. Willis. Pp. liii + 375. Rivington's Junior Mathematics. (London: Rivington, 1902.) Price 1s. 4d.

IN these pages we have a collection of algebraical exercises arranged in a progressive order of difficulty and suitable for elementary classes. The compiler has divided the examples in the following way: collection in groups suitable for lessons of about an hour, more advanced questions at end of each group; exercises grouped in series of twenty-six, furnishing two lessons per week for a term; two sets of parallel series either for alternate terms or for more lessons than in one series; oral questions at the beginning of each exercise. The scope of the questions carries the exercises up as far as the progressions. The book should prove useful to teachers who require graduated courses; answers to all the questions are given at the end.

LETTERS TO THE EDITOR.

{The Editor does not hold himself responsible for opinions expressed by his correspondents. Neither can he undertake to return, or to correspond with the writers of, rejected manuscripts intended for this or any other part of NATURE. No notice is taken of anonymous communications.}

Earthquake in Guatemala.

THOUGH I have been a subscriber and devoted reader of NATURE for about twenty years, I have not hitherto troubled you with any communications. Now I think it will interest you to obtain some data about a very disastrous earthquake which recently shook nearly the whole of the republic of Guatemala and the neighbouring countries, destroying many towns and causing immense loss of property and of many lives.

At 8.25 p.m. of April 18 an earthquake of more than thirty seconds duration affected a large part of Guatemala, eastern

machinery and the aqueducts ruined. The total number of lives lost may be about 800 to 900.

At the port of Ocos, only three houses remained standing and the big landing-pier was broken near the land.

In the city of Guatemala most of the churches and some houses sustained slight damages; the same happened in Antigua (Guatemala). Escuintla and Amatitlan suffered considerably.

The railways between Retalhuleu and the port of Champerico, and the one between Ocos and Coatepec were interrupted by the falling of bridges and damage to the road. The railway between Guatemala and the port of San José remained unaffected and intact.

In the eastern portions of Guatemala the shock was only weak. I was at the time on my plantation "Germania," and did not feel anything at all.

Until May 5 earthquakes of small intensity were still frequent from the city of Guatemala to the west.

A commission of engineers has been sent by the Government to Quezaltenango and San Marcos, to select new places for the rebuilding of these towns.

During the night of April 11-12 a severe thunderstorm did considerable damage to houses and other property at San Salvador, the capital of the republic of El Salvador, and at 7.25 p.m. on April 16 a powder explosion blew up the military barracks at Managua, the capital of Nicaragua, destroying a number of houses and killing many people. I mention this because later on these events might get mixed up with the earthquake.

EDWIN ROCKSTROH.
Gualan (Guatemala), May 7.

The Vibration of the Violin.

I HAVE been taken to task for saying, in my little book on the violin, that the vibrations of the wood of the instrument "reinforce the tones of the string." Perhaps some readers of NATURE may be able to point out whether I am guilty of an incorrect or merely unconventional statement.

Briefly, I use the word "reinforce" in the fullest sense, or rather senses, of the term. There is, I take it, (1) a reinforcement of the tones of the string itself by resonance; and (2) a reinforcement (in the sense in which an army is reinforced by a regiment or battalion) consisting of the tones contributed by the vibrations of the pine and sycamore.

The reinforcement of the sound of a brass band by cymbals would seem to supply another and more direct analogy.

The tones of the string are no doubt by themselves very feeble, but not unimportant when reinforced by resonance. If in the case of the violin we substitute for the ordinary gut string a string of, say, silk, we distinguish a slight, but

quite perceptible, difference in the *timbre* of the instrument; but this difference is not a measure of the intensities of the particular tones to which the difference is due.

If I is the intensity of the fundamental tones of the two strings, Σi the sum of the intensities of the overtones of the gut string, and $\Sigma i'$ the sum of the intensities of the overtones of the silk string, then what we distinguish in the consonant note of the instrument is

$$(I + \Sigma i) - (I + \Sigma i')$$

$$\Sigma i - \Sigma i';$$

but we form no idea as to the absolute values of I , Σi and $\Sigma i'$. We cannot, in fact, say in what proportion they contribute to the intensity of the consonant note of the instrument.

(The difference observed in the *timbre* of the gut and silk strings is not, of course, necessarily due only to a difference of

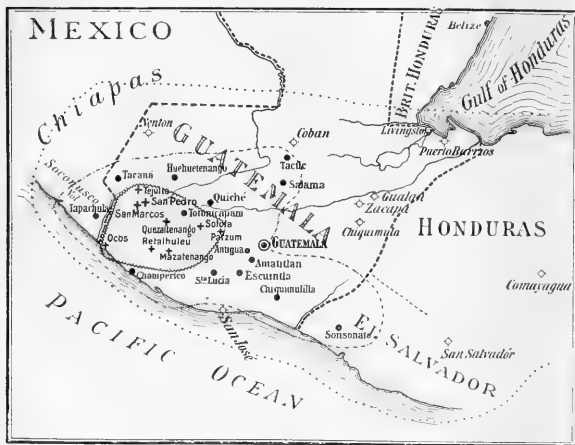

Earthquake, 8.25 p.m., April 18.

- Limits of Guatemala.
- ~~~~~ Region of greatest intensity.
- - - - - Region where buildings were destroyed.
- + Quezaltenango. Towns completely destroyed.
- Escuintla. Towns which suffered damage.
- Region from which notices about the earthquake have reached me.
- ◆ Nentón. Places where the shock was felt distinctly.

From Chiapas there is only one report about Tapachula, and from Honduras about Comayagua. It is not possible to say how far to the east and to the west the movement was felt.

Chiapas and western Salvador and Honduras. The intensity of the movement was greatest in western Guatemala, where the second and richest city of the country, Quezaltenango, was completely destroyed, with the loss of about 500 lives. Completely ruined also were Sololá, San Marcos and its sister town San Pedro Sacatepequez (more than 200 lives being lost), and the same happened to Retalhuleu and Mazatenango, important towns on the Pacific coast-plain, to the south of Quezaltenango. The places before mentioned are situated on the highlands, a little to the north of the great volcanoes.

Besides the cities named, nearly every town and hamlet in the Departamentos of San Marcos, Quezaltenango, Retalhuleu, Suchitepequez and several in Chimaltenango are ruined, and perhaps every one of the many important coffee- and sugar-plantations in the western coast-region has had its buildings,

intensity in their overtones. There may be a difference in number, but this does not appear to affect the question of whether the tones of the string form an appreciable part of the consonant note of the violin.)

If a vibrating tuning-fork is placed in contact with the wood of a violin, the instrument reinforces the tone of the fork; but the vibrations of the wood are here much less powerful than in the case of the string, and consequently the instrument only feebly asserts its own *timbre*. A very ordinary violin will reinforce the tone of a fork almost as perfectly as a masterpiece of Cremona.

I therefore take it that the reinforcement of the tone of the fork is chiefly the result of resonance, and that the intensity of the tone of the violin is due to the reinforcement of the tones of the string itself by resonance, plus the reinforcement contributed by the tones of the pine and sycamore, and that the latter determine the *timbre* of the instrument.

The tones of the pine and sycamore are also reinforced by resonance, in the same way as those of the string.

June 2.

W. B. COVENTRY.

The "Armorl" Electro-Capillary Relay.

ON p. 129 of vol. lxxv. of NATURE, a description is given of an electro-capillary relay. The writer states that the actual apparatus was not seen by him, "but only a working model." It would be highly interesting to know the exact meaning of this expression. Does it mean a model which will work, or only a model in which the different parts of the apparatus are shown, say, in wood or cork or any other substance. In the illustration, the mercury when acted on electrically is shown as moving the lever of a relay. A well-made capillary electrometer is highly sensitive to a small change of potential, but the movement of the mercury column is so minute that it is very difficult to see how any lever of a relay could possibly be worked by means of its movement. Some further information about the "Armorl" relay would, I feel sure, be acceptable to many, showing the potential difference required to cause the mercury to work the lever λ , and also the approximate E.M.F. set up at, say, ten miles from the sending station of a wireless telegraphic system. J.-S.

Prehistoric Pygmies in Silesia.

UNDER the above heading, Prof. G. Thilenius, of the University of Breslau, has recently (*Globus*, Bd. lxxxi. No. 17) made an important contribution to European ethnology. His deductions result from an examination of a quantity of osseous remains preserved in the Museum of Silesian Antiquities at Breslau, consisting of four groups obtained at different sites in the region between Breslau and the Zobten. They are, unfortunately, very fragmentary; but it has been ascertained that they are the remains of a number of persons of both sexes, all adult and all of very short stature. The mean height of one group is about 4 feet 8 inches (1.429 m.), of two others about 4 feet 11 inches (1.496 m.); 1.506 m.), and of the fourth about 5 feet (1.523 m.). With these Prof. Thilenius compares the remains of the Swiss pygmies described by Prof. Kollmann, of Basel, who estimates their height as ranging between 4 feet 5½ inches (1.355 m.) and 4 feet 11 inches (1.499 m.), and comparison is also made with the similar remains found at Egisheim (in Lower Alsace, near Colmar), which belonged, according to Herr Gutmann, to people whose stature ranged from about 3 feet 11 inches (1.200 m.) to something under 5 feet (1.520 m.). Further, the museum at Worms furnishes the remains of an individual of the estimated height of 4 feet 9 inches (1.445 m.). In all these cases, the bones show no trace of any pathological degeneration, and the consequent inference is that they represent a special race of low-statured men, or dwarfs. Prof. Kollmann and Thilenius seem to prefer the term "pygmy" as most appropriate in denoting a special race, "dwarf" (*Zwerg*) being regarded as applicable to abnormal specimens of a race of ordinary size. Most writers, however, make no such distinction; and, indeed, "pygmy" is far from being strictly accurate when applied to people of 4 or 5 feet in height. Prof. Windle states that a people may be described as "pygmy" in which the average male stature does not exceed 1.450 m. (4 feet 9 inches).

Prof. Thilenius gives a wide range for the period in which those little people lived. While those of the Rhine valley are placed far back in time, some of the Silesian dwarfs are

assumed to have been contemporaneous with the Romans and the Slavs, the most recent being placed at about a thousand years ago. But, before arriving at anything like a final conclusion on any of the questions relating to the mid-European pygmies, Prof. Thilenius desires a much greater accumulation of evidence in the shape of skeletal remains, and there is good reason to hope that this will be forthcoming in due time. Most of our information on the subject has been obtained within recent years, and fresh evidence can hardly fail to present itself to investigators in the future. DAVID MACRITCHIE.

Flames from Mud on a Sea-Shore.

WE should like to draw your attention to the following spectacle which some of us witnessed on the sea-shore at Blundellsands on Thursday evening, June 5, at about eight o'clock.

The evening was dull and grey, a strong north-westerly wind was blowing in from the sea and the tide was flowing in. In the distance we first saw smoke with frequent jets of fire bursting forth from the mud of a shallow channel. Drawing near, we perceived a strong sulphurous odour, and saw little flames of fire and heard a hissing sound as though a large quantity of phosphorus was being ignited. It was impossible to detect anything which caused the fire, only the water where the flames appeared had particles of a bluish hue floating on the surface. The area over which the tiny flames kept bursting forth was about 40 yards.

A gentleman present stirred up the mud with his walking-stick, and immediately large yellow flames nearly 2 feet in length and breadth burst forth. The phenomenon lasted some time, until the tide covered the part and quenched the fire. As we returned from our walk the atmosphere was impregnated with a strong odour of sulphur. An old resident of Blundellsands, who also witnessed the sight, said he had never before seen anything of a similar nature. H. T. DIXON.

9 Agnes Road, Blundellsands, near Liverpool, June 8.

Cuckoo's Egg Thrown out of Bunting's Nest.

ON the morning of May 25 I found a nest of the reed bunting (*Emberiza schoeniclus*) with a cuckoo's egg in it besides three eggs of the bunting itself. When I took some friends to see it two or three hours later, the hen bird was sitting on the three eggs, but the cuckoo's egg was lying smashed outside the nest. It is impossible that any person could have broken it, for there were no traces of bootmarks in the soft mud on the side of the dyke where the nest was, besides it being very unlikely for anyone to have passed the spot during the short time I was away. It would interest me to know if any of your readers are acquainted with cases of small birds pitching the cuckoo's egg out of the nest instead of hatching it in the orthodox style. T. G.

Iligham, May 27.

VOLCANIC ERUPTIONS IN THE WEST INDIES.

IN the notes already published relating to the disasters which so recently overwhelmed Martinique and St. Vincent, reference has twice been made to the possible connection between seismic efforts and displays of volcanic activity. In connection with this, it has been suggested that had the sudden movements which on April 19 shattered cities in Guatemala been postponed, Mont Pelée and La Soufrière might still have been quiescent. By this it is not intended to convey the idea that if we take earthquakes generally and compare the registers of the same with the registers of volcanic eruptions we shall recognise any direct connection between the two. In Japan there are annually at least 1000 distinct earth shakings, but years may pass without the record of a volcanic eruption. Mount Fuji in that country has remained quiescent for the last 195 years, during which period it has been shaken at least 15,000 times, but in spite of this repeated aggravation the *mons exclusus et singularis* of Dai Nippon still watches peacefully over thirteen provinces round its base.

Like many other mountains in the world, if we may rely upon the records of its past history, it is yet engaged in raising steam, and when by this process the volcanic strain has sufficiently increased, some unusually large relief in seismic strain—even at a distance—may be the ultimate cause of a renewal of its activity. Volcanoes, like mines, require to be charged before they can be exploded, and the final cause of such explosions seems at times to be connected with bodily movements of their foundations, which movements may originate locally or be the *propetia* of corresponding disturbances originating at a distance. The shiverings which constitute local earthquakes, which are so frequent throughout the world, play but little part in these violent awakenings, and the giants sleep whilst humanity may be terrified.

To see how far such a view is sustained let us turn to the volcanic history of the West Indies. First of all attention may be directed to the fact that the volcanic activity of these islands is confined to the Lesser Antilles, from St. Martin in the north to Grenada in the south. In the larger islands, which run approximately east and west, like Cuba, Jamaica, Dominica and Puerto Rico, although there are volcanic rocks and hot springs, volcanoes proper do not exist. What we have to deal with are the peaks of "Antilla," now represented by a suboceanic ridge about 500 miles in length.

The following notes, derived from Fuchs' "Vulcan und Erdbeben" and other sources, may be taken as a summary of what is generally known respecting the vulcanicity of these outcrops. Although it is imperfect, yet it may suffice to illustrate the hypothesis that world-shaking earthquakes may be closely followed by volcanic outbursts.

Grenada.—The island is practically built up of two mountains which are joined together. The crater of Grand Etang is filled with water. Morne Rouge is built of ashes. The greatest height is 2749 feet. It contains hot chalybeate and sulphurous springs.

St. Vincent.—In 1718, on the night between March 6 and 7, a piece of land rose from the sea and then sank. There was a furious hurricane on April 24, and Morne Garou (La Soufrière) erupted. From 1718 to 1812 this mountain was quiescent, but in the latter year it erupted, changed the form of its crater, and its ashes fell in Barbados. The last violent eruption was on May 7, 1902. The intervals between eruptions have, therefore, been ninety-four and ninety years.

St. Lucia.—Qualibou, 1800 feet. At present this is in the solfatara stage. In the larger crater there are small lakes, and sulphurous gas and steam escapes. It erupted in 1766. The highest peak is 2117 feet.

Martinique.—Mont Pelée, 4438 feet. It erupted at the end of the eighteenth century, on August 5, 1851, and lastly on May 8, 1902.

Dominica.—Here there are many solfataras. The highest peak is 4747 feet.

Guadeloupe.—The "Grand Terre," or the eastern side of the island, is not volcanic. Soufrière de Guadeloupe (4869 feet) erupted in 1778, 1797, February 1802, 1812 and 1856.

Montserrat.—The Soufrière is volcanic. On November 29, 1896, 20 inches of rain fell, and this was followed by many small earthquakes. For forty years before there had been but few noticeable shocks. Since the rainfall the springs give off more gas, and silver is blackened three miles away.

Nevis.—Sulphurous vapour escapes from the crater.

St. Christopher (St. Kitts).—Mount Misère erupted in 1692. At present there is a lake in the crater.

St. Eustatius.—The volcano is apparently extinct and covered with vegetation.

The eruptions we have to consider are therefore those of the years 1692, 1718, 1766, 1797, 1802, 1812 (two), 1856, 1851 and 1902 (two).

We will now compare these with seismic disturbances of which more detailed accounts are to be found in Mallet's Catalogues of Earthquakes, published in the Reports of the British Association 1852-1854, and in Lyell's "Principles of Geology."

1692.—June 7, between 11 a.m. and noon, Port Royal in Jamaica was destroyed. A piece of land of more than 1000 acres sank, carrying with it buildings and their inhabitants beneath the sea. There was great disturbance in the ocean, and houses throughout the island were shaken down. Mountains were shattered and a lake created. This was accompanied by the eruption of St. Kitts.

1718.—As already stated, this eruption in St. Vincent was accompanied by a "very violent" earthquake.

1766.—March 9, Island of Antigua, a violent shock. March 17, Island of Grenada, a violent shock. June 11 (midnight), Jamaica, especially at Port Royal, also at Cuba. In Jamaica a violent shock lasting one and a-half minutes. In Cuba it lasted seven minutes, and the shocks recurred up to August 1. July (middle of month, during the night), Ste. Marie, S. America, very violent shocks, followed by slighter ones every day up to July 21. August 13 (10 p.m.), Island of Martinique, an earthquake during a terrible hurricane. August (towards end of month), Island of Martinique, another and very violent shock.

August 18, Guadeloupe. August (end of month), Cuba, an earthquake, City of St. Jago overturned. October 6, Island of St. Eustache, an earthquake accompanied by a hurricane. Very violent shocks. In the territory of Caracas they recurred hourly (probably only at first) for fourteen months up to the end of 1767. According to tradition, the shocks were simple horizontal oscillations. At Surinam there were two other violent shocks felt besides the one here mentioned, viz on the 24th at midnight and on the 27th at 7 a.m. October 21, 3 a.m., Cumana and Caracas in New Granada, S. America; also Island of Trinidad; also Surinam and all N.E. portion of S. America. The whole of the city of Cumana was ruined. Eruptions of sulphurous water frequently occurred, especially about Casanay, two leagues east of Coriaco. The inhabitants lived in the streets for the two years 1766-67. The Indians celebrated by feasts the approaching destruction and subsequent regeneration of the world. During these shocks a little island in the Orinoco sank and disappeared beneath the waters, and in many places disturbances of the surface were produced. The first and third of the shocks at Surinam were attended with subterranean noise, as were the shocks at the mission station of Encarnado. December 12, Martinique, a slight shock.

1797.—February 4, 7.45 a.m. On this date there was a destructive earthquake in Quito, in which 40,000 lives were lost. A great extent of country was shaken, and the ground about Tanguaruga opened into enormous clefts, from which water and stinking mud (moya) issued. The mountain itself remained quiet, but the smoke from Pacto, seventy-five leagues distant, disappeared suddenly.

About this time a series of shocks began in the Lesser Antilles, and these did not cease for eight months, until the eruption of the volcano in Guadeloupe on September 27 "put an end to them."

1802.—On February 2 there was a "severe shock" in Antigua, whilst in Guadeloupe there were vibratory shocks accompanied by an eruption. Shocks were felt in the west Indian islands during February and March.

1812.—On March 26 of this year Caracas was utterly ruined, and 10,000 of its inhabitants perished. Shocks continued until April 5. The waters of Lake Maracaybo were lowered, and Mount Silla is said to have lost 300 to 360 feet of its height by subsidence. On April 24 St. Vincent erupted, the noise of which was heard as far as Caracas. Preceding this eruption, in St. Vincent and in the West Indian islands there had been very many shocks. In St. Vincent more than 200 had been noted. Another tremendous earth disturbance, took place before this eruption commenced on November 16, 1811, in the valley of the Mississippi, Ohio and Kansas. The ground was raised or lowered, and about New Madrid shocks occurred almost hourly for months and continued until the date of the Caracas earthquake.

The eruptions in St. Vincent and Guadeloupe appear to have been closely associated with two unusually large seismic disturbances on the neighbouring American Continent.

1855.—On February 20 an earthquake was felt for nearly 1000 miles along the coast of Chili. Many towns were destroyed and the coast was elevated from 1 to 10 feet. Up to March 4 300 shocks were counted. A submarine volcano broke out near Bacalao Head, and the Andes for a distance of 1300 miles were before and after the convulsion in an unusual state of activity. In November of this year Concepcion was severely

shaken, and on the same day Osorno, at a distance of 400 miles, renewed its activity. "These facts," says Lyell, "prove not only the connection of earthquakes with volcanic eruptions in this region, but also the vast extent of the subterranean areas over which the disturbing cause acts simultaneously." In 1836, on June 22 (or May 22-23) different places in Central America were shaken, and this was accompanied by the eruption of a volcano east of Omoa. In this year there was an eruption in Guadeloupe.

Without continuing these extracts further, it seems that the sequence of events which has recently taken place since the catastrophe in Guatemala on April 19 is but a repetition of very similar sequences which have taken place in the same quarter of the globe during the past two hundred years. The Antillean range is apparently one that is extremely susceptible to seismic disturbances originating at a distance, and that it may be so is suggested by its recent geological history. According to Dr. J. W. Gregory, when the Isthmus of Panama was submerged it is possible that "Antillia" existed connecting North and South America, and the Caribbean Sea was then a gulf of the Pacific. In Lower or Middle Miocene times this was submerged, and abyssal ooze was deposited which are now raised in the Barbados to a height of 1095 feet above sea level. The magnitude of these movements and their rapidity, which has often been referred to by the opponents to the theory of the permanence of continental masses and oceanic basins, indicate that we have in the Antillean ridge a line of weakness characterised by unusual instability, and it is in all probability this instability which renders the Windward Islands so responsive to hypogenic changes in the neighbouring continent.

Seismic Disturbances.

The earthquake recorded at Shide on May 8, commencing at 2h. 49.5m. a.m., was also recorded at Kew, Bidston, Edinburg and Potsdam. The times of maximum motion at Shide, Kew and Bidston were 3h. 21.7m., 3h. 18.2m. and 3h. 23m.

The time taken for this movement to travel from the West Indies to Kew would be about 37 minutes. The local time of origin in the West Indies would therefore be May 7, 10.37 p.m. This time, calculated from other data, was given in NATURE, May 29, p. 111, as being about 10.33 p.m. Two other seismograms relating to this disturbance as recorded at Shide have not yet been examined. When this is done more certainty respecting this time is to be expected.

Assuming the clock in St. Pierre, which stopped at 11.50 (or 7.50 a.m. local time) to have been correct, this earthquake took place about twelve hours before that event occurred.

It is curious that although this earthquake was noted in Potsdam it does not appear to have reached Laibach and certain other European stations.

At Shide a slight earthquake was recorded on May 25 about 5.28 p.m., and a second shock at about 4.20 next morning. They are both small, and the relationship between the preliminary tremors and maximum motion is too ill defined to state definitely the distance at which they originated.

J. MILNE.

RECORDS AND RESULTS OF RECENT ERUPTIONS.

SEVERAL interesting observations and records connected with volcanic eruptions and earthquakes have come under our notice during the past week. As has already been remarked, the exact cause of the sudden destruction of the inhabitants of Martinique after the eruption of Mont Pelée is a little difficult to determine. Witnesses who were on the *Roddam* in the bay of St. Pierre at the time of the disaster on May 8, state that when the eruption occurred the vessel was struck with such force by the material

ejected that she was nearly capsized and seemed to be enveloped in "a whirlwind of fire." Apparently what burst from the volcano was highly heated gas carrying with it immense quantities of white-hot volcanic ash. The vessel eventually reached the harbour of Castries, St. Lucia, and a survivor gave a correspondent of the *Times* the following account of his terrible experience:—

No human being could stand against that terrific deluge of molten ashes. Even those who reached the cabin or hold did not escape, almost every nook and cranny of the ship being filled with the blazing dust. Captain Freeman sought shelter in the chart-room, but, the portholes being open, the fire streamed in and burnt him badly on face and hands.

The heat was awful, for the mass of ashes which poured into the ship all aglow still retained its heat, and it was only with great difficulty and caution that it was possible to move about at all.

When the ship reached Castries, every part was found to be covered thickly with volcanic ash. More than 120 tons of ash were taken from the ship, and as this was precipitated in a white-hot condition it is remarkable that anyone passed through the burning storm alive.

The eruption of the Soufrière of St. Vincent was accompanied by the same kind of "hot blast" as that of Mont Pelée. Many victims of the St. Pierre disaster bore no outward sign of injury or scorching, but after autopsy they were found to have been burnt internally. A *Daily Mail* correspondent at St. Vincent records, from the words of a survivor, how most people died:—

A dark cloud came from the Soufrière about 4 p.m., and a fine leaden powder penetrated doors and windows and filled the air. People breathed it in, and it was so hot it burnt the flesh. The people in the house began to cry out, and struggled, shouting for water, and placing their hands on their stomachs. They gasped, fainted, and died. All was over in three minutes. It is said that this hot blast killed most people, and wherever the powder touched people it burnt their flesh.

Prof. A. E. Verrill states in *Science* the opinion that the ejection of explosive gases was one of the causes of the sudden destruction of life in the Martinique eruption. His view is as follows:—

The heat was sufficient to cause the dissociation of hydrogen and oxygen from the water on coming suddenly into contact with highly heated lava, and in case of sea-water the chlorine would also be dissociated from the sodium. These gases suddenly ejected with great violence and exploding in the air, above the crater, would produce precisely the effects witnessed on an unusually large scale at Martinique. The people were mostly killed by the sudden explosion of a vast volume of hydrogen and oxygen, which will account for the sudden burning of flesh and clothes, as well as of the buildings and vessels. The chlorine, at the same time, combining with some of the hydrogen, would produce hydrochloric acid, a poisonous and suffocating gas, which would quickly kill most of those not instantly destroyed by the explosion.

As to the changes which have occurred at St. Vincent, it is reported that a party of American investigators who ascended the Soufrière found that the lake had disappeared, leaving a cavity 2000 feet deep. Vapour was still issuing from the new crater.

The Imperial Commissioner of Agriculture for the West Indies has informed Kew that the botanic station and agricultural school in St. Vincent are untouched beyond a fall of volcanic dust.

It is reported in the *Barbados Advocate* that the volcanic ash is adding to the difficulties of sugar-making. The dust is everywhere. It has worn some mill-rollers so smooth that they can hardly draw in the canes. In places the machinery is much injured, and everywhere the dust gets into the juice and has to be strained out, flannel bags having to be used to strain the liquor. On the evening of May 19 a fine dust of a light grey colour was observed to be falling on the Oxford plantation, and it was conjectured that it came from Mont Pelée, in Martinique.

The Royal Mail steamer *La Plata* had a fall of dust on board when between St. Vincent and St. Lucia, while the barque *Jupiter* had a heavy fall far to the eastward of Barbados. From the great mass which fell in the sea around the latter ship, actually colouring the water, it was known that some extraordinary phenomenon must have occurred. There was also such a darkness that lamps were alight at an unusually early hour.

Magnetic Disturbance.

Dr. L. A. Bauer reports in *Science* that a magnetic disturbance was recorded at two magnetic observatories of the U. S. Coast and Geodetic Survey on May 8, at 7.45 St. Pierre local mean time, that is, at the time of the great eruption. The disturbance was distinctively a magnetic and not a seismic one, and hence was not recorded on seismographs. The magnetograms obtained at Cheltenham, seventeen miles from Washington, exhibit magnetic disturbances amounting at times to 0.00050 to 0.00060 C.G.S. units (about 1/350 of the value of the horizontal intensity) and from 10' to 15' in declination, beginning at the time stated and continuing until midnight of May 9.

"Until further information has been received from other observatories," says Dr. Bauer, "it cannot be determined definitely whether this magnetic disturbance was due to some cosmic cause or came from within the earth's crust and was associated with the Martinique eruption. The coincidence in time is, however, a remarkable fact."

Earthquake of April 19.

Some valuable notes on the earthquake in Guatemala on April 19 are given by Mr. Rockstroh in a letter published on another page (p. 150), with a map of the district seriously affected. Prof. Milne obtained a record of this earthquake at Shide, and it was reproduced in *NATURE* of May 29 (p. 109). Miss G. M. Johnson sends us a cutting from the *Yorkshire Post* of April 19 containing several letters upon an earthquake which was distinctly felt in parts of Yorkshire and Lincolnshire on April 14. At Beverley the time noted was 11.51 a.m., at Greetwell 11.45, and Hatfield 11.40. At Belton the disturbance shook a bedstead four inches from its place.

Volcanic Ash from Mont Pelée.

Prof. T. G. Bonney writes:—

I am indebted to Sir W. Crookes for a mounted specimen of the dust from Mont Pelée, which fell on the deck of the *Roddam*. The fragments are commonly about "007" in diameter, but range between "005" and "01", minerals and rocks being in about equal quantity, the former consisting of labradorite, augite (bottle-green) and a pleochroic (green to brown) hypersthene, the latter rather scoraceous, a brownish-grey in colour. I have mentioned some minor details in a short communication to the Geological Society. This dust has a general resemblance to that from the Soufrière which fell in Barbados, and both represent hypersthene-andesites.

Analyses of Soufrière Dust.

For educational purposes all the agricultural colleges in this country, and a number of the principal schools—Westminster, Harrow, Eton, Rugby, &c.—have received from Mr. Harries, of the Meteorological Office, a sample of the Soufrière dust which descended on Barbados during the night of May 7-8. It had been collected by Dr. Morris, the Imperial Commissioner of Agriculture, as it fell, and a portion submitted to investigation at the Government Laboratory on the spot yielded the following results:—

Prof. d'Albuquerque's chemical analysis showed the substances soluble in strong hydrochloric acid to be:—

	Percentage.		Percentage.
Iron oxide ...	4.7	Silica ...	1
Alumina ...	12.5	Sulphuric anhydride ...	1
Lime ...	5.9	Insoluble in hydrochloric acid:—	
Magnesia ...	7.8	Silicates ...	75.2
Soda ...	1.2		
Potash ...	0.8		

Also a trace of sulphides and a faint trace of sulphurous anhydride—a product of the combustion of sulphides and sulphur.

The mineralogical examination by Dr. Longfield Smith gave the following as the results of the sieve analysis:—

Diameter of particles.	Percentage.
1 to 5 millimetre ...	0.01
5 " 35 " ...	3.06
35 " 20 " ...	7.21
20 " 15 " ...	66.20
15 " 10 " ...	0.89
10 and less " ...	22.63

The particles from 5 to 35 mm. diameter were wholly composed of volcanic glass crowded with gas inclusions and containing small lath-shaped crystals of felspar. The gas inclusions in many instances were so numerous as to render the particles quite opaque. The particles of 35 to 2 mm. were of similar volcanic glass and partly of crystals of felspar. Those of 2 to 1 mm. were almost entirely composed of mineral crystals, consisting chiefly of lime and soda felspar and of a ferromagnesian mineral not yet definitely determined. They also contained a quantity of magnetite and a very few crystals of a dark blue doubly-refracting mineral not yet determined. The particles finer than 1 mm. were chiefly composed of comminuted fragments of felspar.

A comparison of the dusts of 1812 and 1902 points to the recent eruption as being much the more violent, it being very rare to find so many mineral particles in volcanic dust scattered so far from the seat of eruption. The fact that particles of magnetite, a mineral of specific gravity 5.5 to 6.5, of more than 1 mm. diameter, should be found in the dust more than ninety miles from the seat of explosion is significant of the prodigious height to which the particles must have been ejected.

The subjoined diary of events is in continuation of those already given.

Diary of Events.

June 4, Kingstown (St. Vincent).—Vessels leaving Martinique have experienced upheavals of the sea between that island and St. Lucia, indicating submarine eruptions. Clouds of steam, accompanied by flashes of flames at night, have been continually rising from the Soufrière since May 16.

June 4, Cornwall.—A slight shock of earthquake was felt in the neighbourhood of Camborne about 10.20 p.m. It was accompanied by a low rumbling noise. In some houses ornaments were shaken from the shelves on which they stood.

June 4, Valparaiso.—According to a despatch from La Paz, a volcanic eruption has occurred in the Chico (Chaco?) territory, by which two villages were destroyed and seventy-five persons killed.

June 4, Baku.—The journal *Kaspi* reports an eruption of the mud volcano in the neighbourhood of the village of Kobi, district of Baku. The eruption, which lasted about five minutes, was accompanied by a detonation resembling the report of cannon, and the country around for some distance was enveloped in flames.

June 4, Rome.—A slight earthquake shock was felt last evening at Velletri, twenty miles south-east of Rome. No damage was done.

June 6, Melbourne.—A slight earthquake shock was experienced in South Australia to-day.

June 6, Seattle.—The steamer *Berthaw*, which has arrived from Alaska, brings advices to the effect that the volcanic mountains Redoubt, Llanna and Augustine at Cook's inlet have been smoking and giving off steam for a month past. On May 26 Mount Redoubt threw up a quantity of ashes.

June 6, Fort de France.—Another eruption of Mont Pelée took place to-day. A gigantic cloud extended to the south, covering Fort de France with darkness, but no ashes fell. The sea here receded for several feet, and did not return for some time.

June 6, Kingstown (St. Vincent).—Simultaneous with an eruption of Mont Pelée, the Soufrière in St. Vincent belched out a heavy cloud of smoke, and at 2 p.m. Kingstown was wrapped in pitch darkness.

June 7, Fort de France.—A terrible eruption took place. Fort de France was in darkness from 10 a.m. until 2 p.m. The plains of the Morne Rouge were covered with hot mud.

June 7, Hawaii.—The volcano Mauna Loa has become active.

THE NEW BOTANICAL LABORATORIES AT LIVERPOOL.

AS already announced, the new botanical laboratories, presented to University College, Liverpool, by Mr. W. P. Hartley, of Aintree, were formally opened on Saturday, May 10, by Sir William Thiselton-Dyer, K.C.M.G., F.R.S., Director of the Royal Botanic Gardens, Kew. The laboratories, of which a sketch elevation has already appeared in *NATURE* (vol. lxi. p. 454, March 5, 1900), vie, both in size and equipment, with those of the University of Glasgow, opened last year by Sir Joseph Hooker.

The building, which is plain and unpretentious externally, covers an area of 3000 square feet, and con-

research laboratories and dark room, whilst the second floor is occupied by the elementary laboratory, with accommodation for sixty-five students, the advanced laboratory, arranged to seat twenty students, and the assistant lecturer's private room.

The laboratories, museum and lecture rooms are fitted with pitch-pine and teak fixtures, and the building is lit throughout by electric light. All the laboratories, both public and private, are equipped with gas and water fittings, and baywood wall cases are provided for storage of apparatus and materials. The total cost of the building has been somewhat more than 13,000*l.*, including the cost of the freehold and 75*o*l. expended on museum glass and essential physiological apparatus.

The opening ceremony took place in the arts theatre of the College, where a large audience was presided over by Mr. E. K. Muspratt, vice-president of the College, in the unavoidable absence of the president, Lord Derby. Amongst other botanists present were Sir William Thiselton-Dyer, Profs. Marshall, Ward, Bretland Farmer, Weiss, Potter, Bottomley and Smith, and Mr. Wager. Sir Michael Foster, who expected to be present, was detained at the last moment by parliamentary business. Among the general guests were Sir John Brunner, M.P., Sir John Willox, M.P., Prof. Miller Thompson, Prof. Lord, &c. The principal was accompanied by a large number of the College staff.

Mr. W. P. Hartley, in formally presenting the laboratories to the College, said that the citizens of Liverpool desired their city to be foremost, not only in commerce, but in knowledge, in the discovery of truth and the encouragement of science in its pure as well as in its applied branches. His object in providing the laboratories to the College was to help in the realisation of that ideal.

After the formal acceptance of the munificent gift by the chairman and the principal of the College (Prof. Dale), a vote of thanks to the donor was carried by acclamation and responded to in suitable terms by Mr. Hartley.

Sir William Thiselton-Dyer then delivered an address on the value of the study of botany as a means of cultivating the powers of observation and deduction from observed facts. He said his feeling in coming to the north from the metropolis was one of envy. He found a great commercial city full of busy life, possessing buildings and equipment for the pursuit of knowledge marked by a sumptuousness and magnificence the like of which was not possessed by them in London, and which they had little hope of obtaining. That grand municipal spirit existing among Liverpool citizens showed a height of local patriotism to which they had not attained in the metropolis. It was a lasting glory to her that Liverpool had undertaken so great a work, and he could not doubt that a blessing would come upon her citizens in the stimulus to that higher life the seeds of which they had planted.

The new laboratories, as the generous donor had said, were not intended to teach merely that which would lead to direct profit, they were intended also, and primarily, as a centre for the prosecution of research and study not necessarily utilitarian in its aim. The study of botany was calculated to foster to the highest degree the faculties of observation and deduction. Bluntness of observation was a national calamity, for the inability to see a thing at the moment it presented itself might mean the loss of a unique opportunity. Not in botany alone, but in all



FIG. 1.—Hartley Botanical Laboratories, Liverpool.

sists of three main floors, accommodating the museum, lecture theatre and elementary laboratory behind, whilst by the interpolation of two mezzanines facing the main thoroughfare, space is found for private rooms, research laboratories, herbarium, class room and workshops. All the rooms open off a central staircase, lit from a lantern in the roof, thereby avoiding waste of space in the provision of corridors. A basement contains the store-rooms, lavatories and heating chamber; the ground floor is occupied by the museum, museum preparation room and workshop. The first mezzanine carries the herbarium and class room, with an entrance to the gallery of the museum. On the first floor is placed the theatre, seated for two hundred students, the professor's private room with a private laboratory adjacent, and the departmental library. On the second mezzanine are placed the

studies and occupations, the seeing eye was of infinite—even fundamental—service.

After a brief *résumé* of the history of botany in England and an appreciation of the services rendered to the science by men like Griev, John Ray, Robert Brown and others, Sir William expressed the hope and belief that England would again attain and retain the premier place in botanical study and research, and that the botanists of Liverpool would so use their splendid opportunities as to maintain the reputation of their country. He went on to speak of the great industries which had their origin in botanical discoveries, of the value of the science to medicine, and pointed out a fact too often overlooked that plants were intimately connected with every phase and stage of human life until, in the final act of the drama, they facilitated our decay.

After a vote of thanks to Sir William Thiselton-Dyer for his address, proposed by Sir John Brunner, M.P., and seconded by Prof. Harvey Gibson, and the presentation of memorial keys to Mr. Hartley and Sir

The movement has the support of the following:—
Lord Balfour of Burleigh, Secretary for Scotland; Sir Archibald Geikie, F.R.S., LL.D.; Prof. Masson, LL.D.; Sir John Leng, M.P.; Sir Walter Foster, M.P.; C. J. Guthrie, K.C., Sheriff of Ross and Cromarty; W. C. Smith, LL.B.; Prof. Duns, Edinburgh; A. Taylor, Innes, Esq., Edinburgh; Prof. Clarke, State College, New York; W. Robertson Nicol, LL.D.; A. Bignold, Esq., M.P.; Principal Rainy, D.D.; Alexander Whyte, D.D.; Colonel Ross, C.B., of Cromarty; Mr. James Barron, *Inverness Courier*; W. J. Watson, B.A., Secretary Inverness Field Club.

J. BAIN, Hon. Sec.

Hugh Miller Centenary Committee.

Cromarty, May, 1902.

LAZARUS FUCHS.

THE name of Lazarus Fuchs will always be associated with the theory of linear differential equations, to which he gave an extraordinary impulse by his famous memoir published in the sixty-sixth volume of *Crelle's Journal*. In this paper the methods of modern function-theory are brought to bear upon the long-familiar process of solving a differential equation by series. The coefficients of the equation being supposed to be uniform analytical functions with isolated singularities, it is shown how to obtain, in the neighbourhood of an ordinary point, a complete set of independent integrals; the analytical form of these solutions is determined, and shown to depend upon a certain fundamental or indicial equation. It is proved, also, that the singularities of the integrals may be deduced from the coefficients without integration, and the notion of regular integrals is developed. The distinction is made between the integrals which involve logarithms and those which do not, and attention is drawn to those equations the integrals of which have no essential singularity. Thus in a single memoir of moderate length all the essential features of an extensive theory are presented in a clear and comprehensive outline.

In the rapid development which followed the publication of this memoir, the author naturally took a prominent part. Among his important contributions may be mentioned his researches on linear equations with algebraic integrals, on constructing linear equations the integrals of which have assigned singularities, and on equations the integrals of which are connected by algebraic relations. An instructive illustration of the general theory is given by his memoir on the equation satisfied by the elliptic integrals K, K' .

When the independent variable describes a closed curve, a set of integrals undergo a linear substitution, and all the substitutions arising from different paths form a group associated with the equation. M. Poincaré assigned the name of Fuchsian functions to functions invariant for a group of linear transformations of the variable in recognition of Fuchs's results concerning equations of the second order.

Fuchs's mathematical papers are very pleasant to read and free from that tendency to heaviness which is apt to belong to memoirs on differential equations. He had the faculty of bringing out clearly the really important points without over-elaborate detail, and he did not disdain to show the power of his methods by applying them to specific and definite problems. In these respects he may be compared with Halphen. While admitting that his way was prepared by the work of Cauchy, Briot and Bouquet, and Riemann, we may fairly claim for him that he has been the effective pioneer in a vast and fascinating region.

It is interesting to remember that Henry Smith, in a presidential address to the London Mathematical Society



FIG. 2.—Elementary Laboratory. Hartley Laboratories, Liverpool.

William Thiselton-Dyer, the guests adjourned to the Hartley Laboratories, which were thrown open for inspection.

THE HUGH MILLER CENTENARY.

THE proposal to celebrate the centenary of the birth of Hugh Miller during the present year has met with general approval, and the erection of an institute bearing his name in Cromarty has been admitted to be the best means of appropriately celebrating his memory.

It is intended that the Hugh Miller Institute shall take the form of a museum, where any relics pertaining to Miller can be kept; and a free library and reading room.

The centenary committee have had the promise of support from Hugh Miller's admirers in America and the colonies, as well as at home, and Mr. Carnegie, the generous supporter of such institutions as the proposed institute, has made the handsome offer to give 100*l.* for every 100*l.* raised by the committee.

It is desirable that the memorial should be as widely representative as possible, and the committee therefore appeal to all who appreciate the work accomplished by Hugh Miller in science and literature for contributions, in order that the scheme may be sufficiently advanced by the anniversary of his birth in October.

Contributions should be sent to the Treasurer, Commercial Bank, Cromarty.

in 1876, directed attention to the importance of Fuchs's then recent publications. How true was his forecast, that "they must form the basis of all future inquiries on this part of the subject," the history of the years that followed has fully shown.

Fuchs was born at Moschin (Posen), May 5, 1833; he became extraordinary professor at Berlin in 1866, ordinary professor at Greifswald in 1869, at Göttingen in 1874, at Heidelberg in 1875, and finally at Berlin in 1884. G. B. M.

CARLO RIVA.

ITALIAN geology has sustained a heavy loss in the death of the young and accomplished Docent in petrography and Assistant in the mineralogical laboratory of the University of Pavia, Dr. Carlo Riva, who was killed by an avalanche on the 3rd inst. while ascending Monte Grigna. Besides contributing descriptions of various Italian minerals, he specially interested himself in the study of the volcanic rocks of Italy, and in conjunction with his friend G. de Lorenzo he had been for some time engaged in a detailed investigation of the volcanic cones and rocks of the "Campi Phlegrei." The first fruits of this conjoint labour appeared a year or two ago in a monograph on the remarkable but seldom visited cone of the island of Vivara, which was noticed in NATURE last year. Never before had such a combination of geological and petrographical skill been devoted to any of the old volcanoes of that classic district, so that geologists who had seen the memoir looked forward with much interest to the application of the same talents to the other cones. It is understood that the account of Astroni was far advanced towards completion. But all this bright promise of a career that would have advanced the cause of science and shed lustre on the scientific work of Italy has been abruptly quenched. Those who knew Carlo Riva personally will keenly feel the untimely extinction of a nature so gentle and kindly, so enthusiastic and unwearied in pursuit of science, so full of power and yet so modest and retiring. He has died a martyr to the energy with which he followed his favourite studies, and carries with him to the grave the respect and affection of a wide circle of friends.

A. G.

NOTES.

THE Prince and Princess of Wales were present at the Royal Institution on Friday last when Sir Benjamin Baker delivered a lecture on "The Nile Dams and Reservoir." Before the lecture several striking experiments were shown to their Royal Highnesses by Lord Rayleigh, Sir William Crookes, Prof. Dewar and Prof. Macfadyen.

THE Rome correspondent of the *Daily Mail* announces that the Accademia dei Lincei has decided to give Mr. Marconi a prize of 400*l.* as a reward for his work with wireless telegraphy. From the same source we learn that Mr. Pierpont Morgan has presented a set of cut precious stones, valued at 2000*l.*, to the museum of the Jardin des Plantes, at Paris.

SEVERAL correspondents have sent to the daily papers accounts of the fall of a yellow powder on June 1 and 2 during a thunderstorm. At Great Yeldham, in Essex, and at Langport, Somerset, this yellow sediment was found after the storm had subsided, and was thought to be sulphur. Mr. C. Turner has, however, pointed out in the *Times* that the substance supposed to be sulphur is in reality the pollen from pine trees. This is often produced in large quantities and has many times been mistaken in country places for "showers of sulphur."

NO. 1702, VOL. 66]

MR. F. FINN sends us from Calcutta an account of colour variation in a family of pigeons which have sprung from a pair of homing pigeons imported from England last year. "Of the original pair," he says, "the cock is a blue chequer and hen a silver chequer. None, however, of their descendants have been silver, but all blue chequers, with the exception of one, a blue almost exactly resembling the wild *Columba livia*, but with no white on the back. As against this one case of reversion, there have been two of progressive variation; for two birds, grandchildren of the original pair, though of different broods, show white in the tail, though their parents and grandparents had none." A naturalist to whom the observations have been shown remarks:—"The production of white feathers in the tail I should hardly regard as a case of progressive variation. It is more probably a reversion to some previous ancestor. Homing pigeons are not bred for colour, and it is almost certain that some of the ancestors of the pair sent would have had white feathers in the tail."

At the forthcoming meeting of the American Association at Pittsburg, several of the sections and affiliated societies will meet in the Carnegie Institute, where the offices and reception room of the Association will also be situated. The accompanying view of the Institute is reproduced from the preliminary programme of the meeting. The local committee is a large one and contains many leading men and women connected with Pittsburg; Mr.



Carnegie Institute, Pittsburg.

George Westinghouse, jun., is the president. It is noteworthy as evidence of sympathy with scientific efforts that the following resolutions were adopted unanimously on March 24 by the Federation of Churches at Pittsburg, Allegheny and vicinity:—"Inasmuch as all truth is one and is divine and inasmuch as all organisations for its conservation and propagation are kindred, the Federation of Churches of Pittsburg, Allegheny and vicinity records its pleasure in the fact that the American Association for the Advancement of Science is to hold its anniversary in Pittsburg this year. In behalf of the churches we desire a large and representative meeting here of the seers and prophets of science. In behalf of those interested in the advancement of education and knowledge we extend to them a hearty welcome."

THE seventh annual congress of the South-Eastern Union of Scientific Societies, held at Canterbury on June 5-7, was as successful as any of the preceding ones. Thirty-seven societies are now affiliated to the Union, a slight increase on last year; the accounts showed a small balance, and the attendance was good. An invitation to meet at Dover next year was accepted, and Sir Henry Howorth, F.R.S., was elected president for that meeting. Papers were read on "The Marine Aquarium," by Mr. Sibert Saunders, and on "Mycorrhiza," by Miss A. Lorrain Smith; Prof. Poulton gave a lecture on "Recent Researches on

Mimicry in Insects," illustrated by lantern-slides in natural colours; a discussion on the measures to be adopted for the preservation of our indigenous flora was initiated by Prof. Boulger and Mr. E. A. Martin; and papers on "Well-sections," by Mr. Whitaker, and on "Eolithic Flint Implements," by Mr. E. R. Harrison, were taken as read, but will appear in *The South-Eastern Naturalist* for 1902. The event of the meeting, however, was the address by the president, Dr. Jonathan Hutchinson, F.R.S., on leprosy, with special reference to its antiquarian aspects, with reasoned argument against the theory of contagion. The congress was held, by permission of the governors, in the Simon Langton Schools, where an excellent local museum had been got together, including marine aquaria exhibited by Mr. Saunders, Mr. Harrison's eoliths, and many fresh specimens of the British orchids, so well represented in the district. The members visited the Cathedral, and were entertained at the deanery by the Dean and Mrs. Farrar, and were also received, on the Friday evening, by the Mayor and Mayress. The congress terminated on the Saturday afternoon in a visit to the South-Eastern Agricultural College, Wye, at the invitation of the principal, Prof. A. D. Hall, where the members were shown over the farms and laboratories by the staff of the college.

A CURIOUS effect produced by lightning is described to us by Dr. Enfield, writing from Jefferson, Iowa, U.S. A house which he visited was struck by lightning so that much damage was done. After the occurrence, a pile of dinner plates, twelve in number, was found to have every other plate broken. It would seem as if the plates constituted a condenser under the intensely electrified condition of the atmosphere. The particulars are, however, so meagre that it is difficult to decide whether the phenomenon was electrical or merely mechanical.

A REPORT upon a Bill for the adoption of the metric system of weights and measures in the United States was recently submitted to the U.S. House of Representatives by the Committee on Coinage, Weights and Measures. The report recommends strongly that the Bill be passed and the use of the system made compulsory because of its international character, educational benefits and commercial advantages. The scientific world to-day enjoys the advantages of a universal system of weights and measures, and this fact has doubtless facilitated the development and spread of natural knowledge. With regard to the introduction of the system into a country, the experience of other nations has shown that the confusion and inconvenience caused by a change in the measures used in daily life are largely over-estimated. Finally, the committee remarks:—"It should be kept in mind that the metric system is just as capable of a binary subdivision as any other, although the advantages of such a division are only apparent in the most ordinary business transactions and for the first few subdivisions. After the adoption of the metric system, the use of the half and quarter metre and half and quarter kilogramme would be as common as our half and quarter dollar—smaller quantities would be expressed in decimals precisely the same as in the case of our money. In 1866, Congress legalised the metric system. From that time on it has been growing in favour and in practical use. It is here to stay, not only in scientific work, but in commerce and manufacturing. It is now used by about two-thirds of the people of the world. . . . Your committee believe the time has come for the gradual retirement of our confusing, illogical, irrational system and the substitution of something better. The first step in this direction should be the introduction of the metric weights and measures into the departments of the Government. The use of these weights and measures will simplify their work. It will familiarise the people with them and encourage their application to the common affairs of life. Your committee have no doubt

that the benefits to be derived will far more than compensate for such inconvenience and expense as may be involved in the change."

EXPERIMENTS with a system of wireless telephony are being carried out (according to the *Scientific American*) in America by Mr. Stubblefield. The results so far have been of a promising nature, conversation having been successfully transmitted over several hundred yards on land and several hundred feet on water. The system used is an earth-conduction one, and is, therefore, similar in principle to, though doubtless differing in detail from, many other wireless telephony systems which are being tried in various countries. We have had occasion to comment on these in NATURE from time to time during the past year. It cannot be said that the results which have as yet been obtained by any of the experimenters are of sufficiently striking value to justify the prediction of a great future before this method of communication. But it is evident that many inventors are attacking the problem, and it is likely, therefore, that something of practical utility may be developed by their efforts. It is easy to conceive of many circumstances in which an earth-conduction telephonic system, even of limited range, would be very valuable.

A PAPER on the accuracy of an improved form of silver voltmeter, by Messrs. T. W. Richards and G. W. Heimrod, is published in the *Proceedings of the American Academy of Arts and Sciences* for April. The silver anode is suspended in a porous pot, which is itself hung inside the platinum crucible serving as cathode. The level of the nitrate solution inside the porous pot is kept slightly lower than that outside, and thus outward filtration of the anode liquid is prevented. The authors not only examined the accuracy of the voltmeter, but made a valuable investigation of the effects of the various impurities likely to result from irregularities in the electrolysis or anode. As a result of this, and from the data furnished by the experiments with the porous pot voltmeter, corrections are deduced for the determinations of the electrochemical equivalent of silver made by Lord Rayleigh and Mrs. Sidgwick, F. and W. Kohlrausch, Kahle, and Patterson and Guthe respectively. The corrected figures give a mean result of 0.0011175, none of the four individual values differing from this by more than 0.02 per cent. Hence the number of coulombs associated with one gram-equivalent of any electrolyte is 96,580.

A PAPER on the sensitiveness of the coherer, by E. R. Wolcott, appears in No. 51 of the *Bulletin of the University of Wisconsin*. The experiments were carried out with coherers of two pieces of metal in light contact, as it was found that these gave more consistent results than "filings" coherers. Different metals were tried, and also the effect of coating different metals with a film of the same substance, such as collodion. The author concludes that both the metal and the coating affect the sensitiveness. Aluminium was found to be the most regular in response, but nickel showed the lowest critical potential, that is to say, responded to the least energy; this probably accounts for its value in long-distance wireless telegraphy. The author examines his results with reference to the theories of the coherer's action put forward by Branly, Lodge, Bose, and Guthe and Trowbridge. Guthe and Trowbridge's theory explains more of the phenomena than do any of the others, though all the observed facts are admissible on Lodge's theory. Some of the facts, it is said, are in disagreement with the theories advanced by Branly and Bose.

DR. C. DIENER contributes to the *Jahrbuch der k.-k. geol. Reichsanstalt* (Band li, Heft 2) an appreciative article dealing with the scientific work of Albrecht von Kraft, whose untimely

death in September last year brought to an end a career of great promise. Dr. von Krafft had already earned his reputation as an able geologist while occupied on the Geological Survey of Austria, previous to joining the staff of the Geological Survey of India in 1899. In that year, and subsequently, he accomplished brilliant work in the Himalayas, and showed himself to be exceptionally well qualified for the difficult tasks allotted to him. His early death at the age of thirty has caused the profoundest regret in geological circles.

THE Royal Meteorological Institute of the Netherlands has issued its fifty-first year-book, containing observations for 1899. This is the first volume of a new series, in which the results are presented in the form adopted by the International Meteorological Committee, and is a great improvement upon the form in which the observations have hitherto been published.

MR. MAXWELL HALL has published a paper (No. 275) on the temperatures of Kingston, Jamaica, for the years 1881-98. The annual mean is $78^{\circ}8$, highest maximum $96^{\circ}7$, in August 1891, lowest minimum $56^{\circ}7$, in December 1887. The lowest mean maxima occurred in 1834 and 1893, near the times of the sun-spot maxima, and the highest in 1889, at the time of the sun-spot minimum, and these effects are reproduced in the mean temperature column. A table is also given showing the rainfall in Jamaica from about ninety stations between 1866 and 1900; the greatest fall was $90\cdot6$ inches, in 1886, and the least $45\cdot2$ inches, in 1872.

MR. R. SWORDY sends us a few particulars of a somewhat remarkable shower of hailstones which fell in Cheltenham and the surrounding district on June 7, shortly before noon. At first the hailstones were more or less round and like small crystallised raspberries; but during the latter and main part of the shower they were in the form of wedges or small cones, somewhat varied in shape. Many of these hailstones were about three-quarters of an inch in height and measured about half an inch across. Mr. Swordy suggests that these were only conic sectional parts of what had been much larger hailstones. To test this view he put some selected ice cones in a circle and added two more layers upon the first circle and a key wedge or cone at the top. By this arrangement he obtained half an ice-ball, consisting of fifteen sections. The hailstones when first formed may therefore have been about the size of "ping-pong" balls, and about an inch and a half or two inches in diameter. Mr. Swordy adds:—"The grain of the ice in these sections (which, I presume, had formed the balls originally) radiated from the centre towards the outside, and were hardest on what I suppose had been the outside; so that it is probable that the freezing, which must have commenced from the outside of each water globule and progressed towards the centre, thus bringing pressure to bear on the centre of each ball, may have caused them to explode and form the cones mentioned."

In a note on "mathematical meteorology," Prof. Luigi de Marchi contributes to the Lombardy *Rendiconti* an investigation of the equations of motion of air-currents due to variations of temperature, with especial reference to the effect of solar eclipses. The action of an eclipse, it is pointed out, is to produce what Mr. Helm Clayton has called a cyclone with a cold centre.

We have received from Messrs. A. E. Staley and Co. a copy of the fourth edition of "Manipulation of the Microscope," by the well-known optician, Mr. Edward Bausch. It is a small illustrated handbook specially designed to meet the wants of beginners, and the sections dealing with the use and care of the microscope have been reprinted for distribution in class-rooms and laboratories.

No. 182 of the *Bulletin* of the French Physical Society contains a note on a new "electric valve" for transforming reciprocating currents into direct currents, due to M. Nodon. This "valve" is based on the property, discovered by Buff in 1857, that an aluminium electrode plunged in an electrolyte offers a great resistance to the passage of a current in which it is the anode. The efficiency of M. Nodon's apparatus, as measured by a wattmeter, reaches 75 to 80 per cent.

An oxy-acetylene blowpipe is described by M. Fouché in the *Bulletin* of the French Physical Society, No. 182. The flame is formed by the combustion of a mixture of one part of acetylene to 1·8 of oxygen, and in order that the explosion may not travel back into the blowpipe a jet velocity is required, due to the pressure of a water column 4 metres in height. The flame melts most metals readily; it will solder iron and steel, and even silica and lime are melted by it. With a reduction of the proportion of oxygen the flame becomes luminous, and on falling on lime the free carbon goes to form carbide of lime.

In the *Rendiconto* of the Naples Academy, viii. 2, Signor E. Cesàro deals with certain limitations of constants in the analytical theory of heat. His investigation refers to the property that in order to satisfy the partial differential equation $\nabla^2 u + ku$ throughout a given region S, subject to the boundary condition $du/dn + hu = 0$ at the surface of S, the constant k must for a given value of h belong to a discrete series of positive quantities, which all increase with h . The author also discusses the question of the expansion of the temperature due to an initial distribution in a series of functions of the form considered.

PROF. LE NEVE FOSTER has given a useful practical address on the study of mineral veins (*Trans. Royal Geol. Soc. Cornwall*, vol. xii. part vii.). Mr. J. B. Hill, in dealing with the relation of the plutonic and other intrusive rocks in west Cornwall to the mineral ores, expresses the opinion that the intrusion of the greenstones was separated by no great interval from the eruption of the granites, and that the copper and tin lodes originated in pre-Triassic times and followed closely on the cooling of the intrusive rocks.

A *Bulletin* issued by the U.S. Department of Agriculture concerning Kentucky bluegrass seed affords a striking instance of the amount of trouble which Americans will take to improve a product of comparatively trifling value. The cultivation of bluegrass is confined to a small area in the States of Kentucky, Missouri and Iowa. The harvesting is performed entirely or partially by hand, as automatic strippers do not seem to find favour.

THE latest number of the *Journal* of the Royal Horticultural Society completes the twenty-sixth volume. Two articles of an economic nature suggest to fruit-growers the possibility of making a profit out of surplus fruit. Mr. Austin claims to have devised a practical and efficient method of putting up fruit in bottles, while Mr. Udale brings forward the results obtained by drying fruits and vegetables in special evaporators. There is no apparent reason why the British farmer should not take up these industries and possibly oust imported articles. Captain Hurst having made a study of the characters of certain orchid hybrids, finds that they confirm the laws evolved by Mendel as the outcome of his experiments in hybridisation.

THE Report of the Zoological Society of Philadelphia for 1901 shows that the institution is in a flourishing condition. It is satisfactory to learn that the educational value of the menagerie is fully realised by the public schools of the city, which are in the habit of sending parties of scholars accompanied by teachers.

WE have received a copy of the second edition of the excellent little manual of the fauna and flora of Haileybury, issued by the Haileybury Natural Science Society under the supervision of Mr. F. W. Headley. The compilation and publication of similar local lists may be recommended to all school societies of a like nature.

IN the *Verhandlungen* of the Natural History Society of Prussian Rheinland, &c., for 1901, Dr. O. Follmann describes and figures an interesting new type of crinoid from the "Coblenschichten" under the name of *Hystericrinus schoerdi*. To the same journal Herr Leverkus-Leverkusen, of Bonn, contributes an account of the present and past distribution of the elk.

The Country for June contains several interesting and well-illustrated articles on subjects connected with natural history and domesticated animals. Mr. W. F. Kirby, for instance, writes on common garden insects, while Mr. Harrison Weir discourses on the old English game-fowl, and Mr. Edwin Brough, of Scarborough, the well-known breeder of blood-hounds, describes some of the characteristic traits of his favourites.

AN important account of the ascidians of the Bermudas, by Dr. W. G. van Name, appears in the January and February issues of the *Transactions* of the Connecticut Academy (vol. xi.). The seas around these islands are remarkably rich in ascidians, and since but little has previously been done in the way of collecting, the writer has been able to describe quite a number of new types, both generic and specific. The memoir is illustrated by several plates.

ACCORDING to *Nature Notes* for June, the Society for the Protection of Birds has just issued the regulations and conditions for the first annual competitions open to elementary schools in the East Riding of Yorkshire and in Berkshire for challenge-shields and prizes in connection with "bird and tree day." The day is to be in November—probably the 8th—and essays are to be sent in during September. Any bird killed, or any eggs or nests taken for the purposes of the competition, will disqualify not only the actual offender, but all his fellow-scholars.

AT an egg-sale recently held at Mr. Stevens's auction rooms, Covent Garden, a moa's egg from New Zealand, reputed to be the finest in existence, was offered. Since, however, it did not reach the reserve price of 200*l.* it was withdrawn. Another example was sold some years ago for 250*l.* Thirty-eight guineas was the sum realised by the largest known egg of the extinct "roc" (*Zipornis maximus*) of Madagascar; while two eggs of the pectoral sandpiper—the first of their kind ever offered in England—fetched 8*l.* 18*s.* 6*d.*

THE insect-enemies of the pine in the Black Hills Forest Reserve form the subject of *Bulletin* No. 12 (second series) of the Entomological Division of the U.S. Department of Agriculture. According to the author, Dr. A. D. Hopkins, the forests of rock-pine in the district in question have suffered very severely of late years from insect-ravages, the dying or dead trees covering large areas. The primary cause of the mischief is a small bark-burrowing beetle of a species hitherto undescribed, for which the name *Dendroctonus ponderosa* is suggested. After the first attack by this species, several other insects aid in the work of destruction. Various remedies are suggested by the author.

THE *Eastern Morning News* of June 3 contains an account of the reopening, by the Mayor, of the museum at Hull, which was some time ago taken over by the Corporation from the Literary and Philosophical Society. Since the transference, the contents of the museum have been thoroughly overhauled and

rearranged by the curator, Mr. T. Sheppard, who has introduced order and system where chaos formerly held sway. The value of the exhibits is estimated at considerably more than 5000*l.*; many specimens of interest cannot, however, be shown for lack of proper cases. At the opening ceremony it was announced that the fine collection of British birds' eggs formed by the late Mr. J. Swailes had been presented to the museum by his brother, Mr. G. Swailes. In the rearrangement of the collections the educational value of the museum has been specially borne in mind.

A LECTURE on the natural history of the Chatham Islands, delivered by Dr. A. Dendy on March 4, is reported at length in No. 12 of vol. xlvii. of the *Manchester Memoirs*. Chatham Island and the adjacent Pitt Island appear to have once formed a portion of New Zealand, and are of especial interest as being the home of the Moriuri, a race nearly exterminated by their cousins the Maori between 1835 and 1840. After giving a brief sketch of the flora of the islands, the author turns to the fauna, which, as might be expected, is nearly akin to that of New Zealand. Especially noticeable is the number of flightless birds, most of which are in danger of extermination owing to the introduction of predatory mammals.

TOTEMISM is a blessed word, and there is a real danger at the present time that any animal cult may be relegated in an off-hand manner to totemism. The very careful study of the relations between men and animals in Sarawak by Drs. Charles Hose and McDougall in vol. xxxi. of the *Journal of the Anthropological Institute* (p. 173) is, therefore, especially welcome, as it is the result of many years of observation on the part of one of the authors among most of the important peoples of Sarawak.

NO less than 150 periodicals and publications of scientific and technical societies are now regularly abstracted in *Science Abstracts*, so that the magazine takes a comprehensive view of progress in physical sciences and their applications. Among recent additions to publications abstracted are several Russian, Danish, Dutch, Norwegian and Swedish journals which are only accessible to a limited circle of readers, though many important papers are published in them. The abstracts will enable workers in physics and physical chemistry to keep in touch with practically every advance in their subjects.

SCIENCE is represented in the *Fortnightly Review* for June by two popular articles—one by Mr. Marconi, on "The Practicability of Wireless Telegraphy," and the other by Mr. Carl Snyder, on "Dr. Loeb's Researches and Discoveries." Beginning with the message sent in June, 1898, by Lord Kelvin "commercially paid at Alum Bay for transmission through ether" to Sir George Stokes at Cambridge, an account is given by Mr. Marconi of the messages since sent, without wires, from the Royal yacht, in connection with the international yacht race, and the United States Navy trials. Mr. Snyder describes and interprets the work accomplished by Dr. Loeb at Chicago University in the domain of chemical physiology, and that on which Dr. Matthews is engaged in the same institution in connection with nerve functions.

VOL. xl. of the *Zeitschrift für physikalische Chemie* contains a publication, by C. Benedicks, on the electrical conductivity of steel and pure iron, the investigation of which has given some very interesting results. It is shown that equivalent quantities of different elements, when dissolved in iron, increase the electrical resistance by the same amount. This is proved experimentally in the case of carbon, silicon, manganese and phosphorus, the increase of the resistance for one dissolved atom per one hundred atoms of the solution being 5.9 micro-ohms per cubic centimetre. The presence of carbide in the iron has, on the other hand, very little influence on the resistance. From the

electrical data certain conclusions have been drawn which are no doubt of considerable importance for the chemistry of steel and iron.

MESSRS. LONGMANS, GREEN AND CO. have just published new editions of two well-known works of science—Ganot's "Physics" and Schäfer's "Essentials of Histology." Dr. Atkinson's translation of Ganot's "Éléments de Physique" has long been accepted as a standard description of the groundwork of physical science, and the sixteenth edition, edited by Prof. A. W. Reinold, F.R.S., will increase the high reputation the book has gained. Though physical science, even in its most elementary stages, needs to be studied practically to be of any value, the results obtained in the laboratory can only be fully understood by considering them in relation to the investigations of makers of scientific history. The best instruction in physics is that which combines a course of practical work with such exact and philosophical descriptions as are found in Ganot's book. Practice without knowledge of theory is as bad as theory without practice. Prof. Reinold has added new matter, as well as revised the book, with the result that a comprehensive view is given of fundamental physical principles and relationships as now understood, suitable for elementary students of the science. The sections on magnetism and electricity have been greatly altered, and accounts of apparatus and machines which have ceased to be of interest have been omitted. Prof. E. A. Schäfer's "Essentials of Histology, Descriptive and Practical, for the Use of Students" has reached its sixth edition. The work has been greatly enlarged, the chief additions being in the text relating to the structure of the central nervous system. Many new illustrations have also been added. The volume is both an elementary text-book of histology and a practical manual giving students precise directions for the microscopical examination of the tissues.

THE additions to the Zoological Society's Gardens during the past week include two Cape Zorillas (*Ictonyx zorrilla*) from South Africa, presented by Capt. W. B. White; a Red-footed Ground Squirrel (*Xerus erythropus*) from West Africa, presented by Mr. P. G. Knight; a Ruddy Finch (*Carpodacus erythrinus*) from Siberia, presented by Mrs. G. A. Way; two Mountain Ka-Kas (*Nestor notabilis*) from New Zealand, presented by Dr. W. H. Hornibrook; two European Pond Tortoises (*Emys orbicularis*), European, presented by Mr. E. C. Brown; two and three Moloch Lizards (*Moloch horridus*) from Australia, presented respectively by Mr. F. Richards and Mr. W. Nichols; a Common Viper (*Vipera berus*), British, presented by Mr. E. Ball; two Striated Babbblers (*Aryza earlii*), a Roofed Terrapin (*Kachuga tectum*) from India, two Blyth's Nicobar Parrakeets (*Palaeornis caniceps*) from the Nicobar Islands, two Black Iguanas (*Metopoceros cornutus*) from the West Indies, a Royal Python (*Python regius*) from West Africa, a Corn Snake (*Coluber guttatus*) from North America, deposited; a Banksian Cockatoo (*Calyptorhynchus banksii*) from New South Wales, purchased; a Thar (*Hemitragus jemlaica*) born in the Gardens.

THE ROYAL OBSERVATORY VISITATION.

ON Saturday last the Board of Visitors made their annual visit to Greenwich, and the Astronomer Royal submitted his report for the past twelve months.

It cannot be said, however, that the weather was all that could be desired for such an occasion and for this time of the year.

The following is a brief *résumé* of the report:—

Transit-Circle.

With this instrument the usual observations have been made, the undermentioned table giving the details of the number involved.

Transits, the separate limbs being counted as one observation	11,133
Determinations of collimation error	303
Determinations of level error	663
Circle observations	9,666
Determinations of nadir point (included in the number of circle observations)	681
Reflection observations of stars (similarly included)	505
The number of stars observed in 1901 was 4,327.	

Good progress seems to have been made in the observations of the reference stars for the astrographic plates, for which 10,000 stars are to be observed three times above and twice below pole—with the exception of about 1000 stars fainter than the ninth magnitude which cannot be observed below pole. A table giving the details of the progress up to date shows that for each of the five degrees of N.P.D. reckoning from the pole, 100, 90, 46, 46, and 45 per cent. respectively of the necessary observations have been secured.

The change in the method of adopting the azimuth error introduced at the beginning of 1900 has effected a satisfactory diminution of the small discordance in right ascensions taken on opposite sides of the pole.

The colatitude of the transit-circle as found from observations of about 581 stars in 1901 is 38° 31' 21"·76, differing by -0"·14 from the adopted value. The values of this correction since 1897 are—

1897	-0"·17	1900	-0"·10
1898	-0"·15	1901	-0"·14
1899	-0"·14		

Very satisfactory progress has been made with the re-reduction of Groombridge's observations, the three years 1809, 1810 and 1811 with 10,500 observations of R. A. and N.P.D. having been finished since the last report. A catalogue of the positions of the stars in the *Berliner Jahrbuch* derived from Groombridge's observations from 1806-1810 was forwarded to Dr. Auwers for use in the preparation of his fundamental catalogue, and he found that a large increase in accuracy had been effected by the re-reduction.

The Allazimuth.

Through the frequent breaking of the spider lines in this instrument, the micrometer slides have been altered to reduce the span, and the result has been very satisfactory. The instrument has been used in the meridian in four positions as a reversible transit-circle for observations of sun, moon, planets, and fundamental stars, and also for observation of the Eros reference stars, and reference stars for Sir David Gill's heliometer observations of major planets. The total number of observations made was 6556.

Further determinations of the division errors have been completed, and these have been combined with the previous results and definitive corrections for division error deduced.

The Reflex Zenith Tube.

This instrument was, as is well known, originally designed by Sir G. B. Airy for the purpose of determining the constant of aberration by observations of γ Draconis, which passes very near the zenith of Greenwich, but after many years of observations it was found that the results for parallax of γ Draconis and aberration were anomalous, and an attempt was made in the years 1882 to 1886 by a long series of transits over the wires to refer these discordances to temperature effects, but without success. The observations of zenith distance of γ Draconis were, however, continued up to 1899, when they were dropped owing to the pressure of observations for the new Ten Year Catalogue. This instrument has, however, become of great importance, for Mr. Chandler has recently shown that the apparently anomalous results previously obtained are explained by the variation of latitude, and that this instrument is specially adapted to the determination of the amount of this variation.

It has therefore in consequence been decided to resume the observations of γ Draconis without delay, and to observe such other stars as passed near enough to the zenith and were sufficiently bright. By suitable modifications it has been found possible to increase the utility of the instrument, by which several other stars down to the seventh magnitude can be observed.

The 28-inch Refractor.

This instrument has been used throughout the year for micrometric measurements of double stars. The total number of double stars measured in the year is 382; of these 221 have components less than $1''$ apart, and 120 less than $0''.5$. The close pairs whose distance apart is less than $1''$ have been measured on the average on three nights each, and the wider pairs on an average of two nights. The wider pairs consist of bright stars with a faint companion, of third companions to close pairs, and of stars of special interest.

In addition to the list of most difficult and interesting stars measured, it is stated that the good series of measures have been obtained of κ Pegasi, δ Equulei, γ Ophiuchi, and ζ Herculis. Capella also has been examined at every favourable opportunity.

Thompson Equatorial.

This instrument has been used chiefly for photographing Neptune and his satellite, and 52 measurable photographs were secured. With the 30-inch reflector long exposed photographs of Nova Persei were obtained, but unfortunately, owing to the object-glass of the guiding telescope not being quite firm in its cell, displacements during exposure occurred.

Astrographic Equatorial.

The photography for the Greenwich zone (Dec. + 64° to the Pole) having been practically completed, the work during the past year was directed to replacing such plates as were found to be inferior to the general standard. Four hundred and thirteen plates were taken, but of these fifty-seven were for various reasons rejected.

The report contains many details about the measurement of the plates, the counting of the number of stars, and various other preparations which would occupy too much space, but the following table may be given, as a good idea of the magnitude of the new work can be at once gathered:—

Limits of Declination.	Number of Stars Measured.	Number	Number in A.G.C.	A.G.C.
$64^\circ-65^\circ$	8,954	1,900	1,200	Helsingfors
$65^\circ-70^\circ$	49,210	7,782	3,700	Christiania
$70^\circ-75^\circ$	50,190	5,870	—	Dorpat
$75^\circ-77^\circ$	18,100	1,856	1,700	Kazan
$77^\circ-78^\circ$ (oh. to 16h.)	5,430	613	420	"

Spectroscopic and Heliographic Observations.

For the year 1901, Greenwich photographs have been selected for measurement on 149 days, and photographs from India and Mauritius (filling up gaps in the series) on 210 days, making a total of 359 days out of 365 on which photographs are at present available.

The proportion of days upon which the sun was entirely free from spots was 80 per cent. for the year 1901, and about the same proportion for 1902 to the date of this report. But the appearance of two considerable groups this year, and the high latitudes of the spots generally, are indications that the actual minimum is passed.

Magnetic Observations.

The variations of magnetic declination, horizontal force and vertical force, and of earth currents, have been registered graphically, and accompanying eye observations of absolute declination, horizontal force, and dip have been made as in former years. The regular determinations of magnetic declination, horizontal force, and dip have been made with the new declinometer, the Gibson deflection instrument, and the Airy dip circle mounted in the Magnetic Pavilion.

The principal results for the magnetic elements for 1901 are as follow:—

Mean declination	$16^\circ 26'$ West.
Mean horizontal force	4.0082 (in British units).
	1.8481 (in metric units).
Mean dip (with 3-inch needles) ...	$67^\circ 6' 5''$.

NO. 1702, VOL. 66]

These results depend on observations made in the new Magnetic Pavilion, and are free from any disturbing effect of iron.

The magnetic disturbances in 1901 have been small and few in number. There were no days of great magnetic disturbance and 8 of lesser disturbance.

Meteorological Observations.

The registration of atmospheric pressure, temperature of the air, and of evaporation, pressure and velocity of the wind, rainfall, sunshine and atmospheric electricity has been continuously maintained.

The mean temperature for the year 1901 was $49^\circ.3$, being $0''.2$ below the average for the fifty years 1841-90.

During the twelve months ending 1902 April 30, the highest temperature in the shade (recorded on the open stand in the Magnetic Pavilion enclosure) was $87^\circ.9$ on July 19. The highest temperature recorded in the Stevenson screen in the enclosure was $86^\circ.0$, and in that in the Observatory grounds $87^\circ.1$ on the same day.

The lowest temperature of the air recorded in the year was $14^\circ.3$, on February 16. During the winter there were 52 days on which the temperature fell below 32° , a number slightly below the average.

The low temperature in February is the lowest temperature recorded in that month since 1895, when, on February 8, the minimum February temperature $6^\circ.9$ occurred.

The number of hours of bright sunshine recorded during the twelve months ending 1902 April 30, by the Campbell-Stokes instrument, was 1519 out of 4457 hours during which the sun was above the horizon, so that the mean proportion of sunshine for the year was 0.341 , constant sunshine being represented by 1.

The rainfall for the year ending 1902 April 30 was 17.89 inches, being 6.65 inches less than the average of fifty years. The number of rainy days was 116. The rainfall has been less than the average in each year since 1894. The total deficiency of rainfall for the seven years ending 1901 December 31 amounts to 23.70 inches.

The remaining portion of the report deals with the printing and distribution of the Greenwich publications, the examination of chronometers, time-signals, &c.

A short reference is made to the re-determination of the Greenwich-Paris longitude, and to the expedition which went out to Sumatra and Mauritius to observe the total solar eclipse of May 18, 1901.

EVIDENCE OF A "SEICHE" ON A SCOTTISH LOCH.

WHILE engaged in the survey of Loch Triage, Inverness-shire, on May 22, Dr. T. N. Johnston and Mr. J. Parsons, of the British Lakes Survey, observed what appears to be an undoubted seiche, i.e. a periodic variation in the level of a lake, considered by Prof. Forel, among others, to be due to sudden changes in barometric pressure, whilst others, again, consider them due to earth-movements.

The attention of Dr. Johnston was first drawn to the phenomenon by observing that certain small stones near the shore were covered and uncovered at regular intervals, the surface of the loch being perfectly calm at the time, and had been so during the day.

At a quarter to 9 p.m., a foot rule was placed vertically in the water and the surface level observed at intervals of one minute for forty minutes.

The results obtained confirmed the rougher observation that the surface of the water was undergoing slow oscillations.

The amplitude of the wave proved to be $\frac{9}{16}$ inch, and the period, i.e. the time taken in rising from the lowest to the highest level and falling again, averaged 9.5 minutes.

Despite the smallness of the amplitude compared to that noticed on the Lake of Geneva and other lakes, the observers had no doubt that the movements were not due to surface ripples.

Loch Triage is about six miles long and three-quarters of a mile wide, its longer axis lying nearly north and south. The survey of the loch is now completed, and a depth of 436 feet has been found within two miles of the southern extremity.

Should this variation of level prove to be a true seiche it will

be the first recorded on a Scottish loch, with the possible exception of a considerable rise and fall of the water of Loch Tay in 1784, which has been considered an example of this phenomenon.

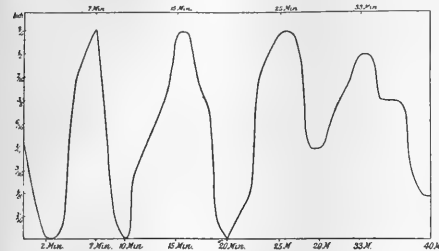

The accompanying curve represents the variations in level observed on Loch Tieg, the ordinates representing periods of one minute and the abscissae changes of $\frac{1}{10}$ inch in the level.

THE MINING STATISTICS OF THE WORLD.

OWING to the lack of uniformity and the want of completeness in the official statistics published in the countries where mining and quarrying are carried on, the compilation of the mineral statistics of the world is a task of extreme difficulty. The work is, however, carried out every year with conspicuous success by Prof. C. Le Neve Foster, F.R.S., in the Home Office general report on mines and quarries. The fourth part of this report, which has recently been issued, deals with the colonial and foreign statistics for 1900, and constitutes a work of reference of permanent value. It is impossible to imagine a more concise, a better arranged, or a more inexpensive collection of comparative mineral statistics. Last year's report was noticed at length in NATURE (April 4, 1901, p. 551), and as the general arrangement has been closely followed in the new issue, the nature of the work may best be called to mind by citing a few of the more important figures that furnish a comparison as regards labour, output and safety in various parts of the world.

The following figures are given for the world's mineral production in 1900:—

	The World.	British Empire.	United Kingdom.	United States.
Coal, metric tons ...	767,656,204	247,938,725	228,794,019	244,901,839
Iron, metric tons ...	49,427,435	4,987,641	4,741,835	14,014,475
Copper, metric tons ...	534,735	41,456	777	275,005
Lead, metric tons ...	787,841	73,203	24,755	245,757
Tin, metric tons ...	82,643	51,624	4,339	—
Zinc, metric tons ...	446,373	13,417	9,211	112,419
Petroleum, metric tons ...	28,553,950	241,344	—	7,485,579
Salt, metric tons ...	12,572,070	3,131,029	1,891,217	2,050,075
Fine gold, kilogrammes ...	393,196	188,491	415	110,913
Fine silver, kilogrammes ...	5,874,234	582,932	5,936	1,862,829

The figures given show that although Great Britain has had for a second time to give to the United States the first place in the production of coal, the British Empire as a whole is still the largest producer of solid mineral fuel, yielding nearly one-third of the world's output. The gold output of the British Empire is also the largest, and will probably increase. The United States, however, comes first in the production of the ores of copper, iron and lead. The German Empire, with 153,350 tons, is the largest zinc producer, and Russia, with 9,827,822 tons, is the largest producer of petroleum. Thanks to Tasmania and the Federated Malay States, the British Empire possesses the most productive deposits of tin ore.

The comparison of the figures relating to labour gives some

interesting results. In 1900 the number of persons employed in the mines and quarries of the various countries was as follows:—The world 4,475,355, the British Empire 2,883,200, the United Kingdom 908,412, the United States 506,830 (returns incomplete), Germany 733,683, France 309,815, Belgium 171,467, Austria-Hungary 226,330, Russia 286,983, Italy 102,728, and Japan 119,667.

As regards the safety of its miners, Great Britain takes a high place. The number of fatal accidents in collieries per 1000 persons employed was as follows in the year under review:—Great Britain 1.29, Germany 2.19, Austria 1.08, France 1.42, Belgium 1.05, and United States 3.29. In the United States the death rate, both in bituminous coal mines and in anthracite mines, is considerably higher than in the United Kingdom. The rapid extension of machine mining in the United States is very remarkable. In 1891, it is stated, only 6.7 per cent. of the output of bituminous coal was obtained by the aid of coal-cutting machinery; in 1900 the proportion had risen to 25 per cent.

The abundant and accurate references to current literature given in footnotes form a very valuable feature of the report. Hundreds of books, pamphlets and newspapers in various languages have been consulted, and much interesting information derived from them is recorded.

In one or two cases, statements are quoted that are, perhaps, open to criticism. For example, the statement that Dr. Carl Peters gives many excellent reasons for supposing that Macombe's country, south of the Zambesi, in Portuguese East Africa, is the Ophir of Scripture hardly gives a correct impression of the prolonged controversy as to the site of Ophir. Moreover, so competent an authority as Prof. A. H. Keane has recently decided in favour of the south of Arabia. Ophir, he shows, was not the place at which the gold, to which it gave its name, was found; it was the emporium to which the products of the east and south were brought and from which they were distributed. Another statement which is not strictly accurate is that the yield of the oil wells of the United States almost equals that of all the rest of the world put together. In view of the fact that the Russian output is given as 2,342,243 metric tons more than that of the United States, this statement is somewhat misleading.

It is interesting to note the effect of the war in South Africa on the mineral production. In the Transvaal the output of gold was small; and in Natal until March 1900 all the collieries were in the possession of the invaders, the output of coal being consequently comparatively small. In the Orange River Colony mining was carried on under very great difficulties and upon a very reduced scale. In Cape Colony the siege of Kimberley and the war generally interfered greatly with mining. In Rhodesia, however, the output of gold showed a steady increase, and the future prospects of the industry have been much brightened by the discovery of rich deposits of coal. In the Wankie coalfield alone, which lies 190 miles north-west of Buluwayo, the workable seams are considered capable of yielding 1500 million tons of coal.

It is impossible within the limits of this notice to refer to all the points of interest suggested by the report; but enough has been said to show to how wide a circle of readers this invaluable work of reference appeals.

B. H. B.

UNIVERSITY AND EDUCATIONAL INTELLIGENCE.

OXFORD.—An examination for one geographical scholarship of the value of 60*l.* will be held on October 14. Candidates, who must have taken honours in one of the final schools of the University, should send in their names to the Reader in geography not later than October 1. The scholar elected will be required to attend the full course of instruction at the school of geography during the academic year 1902-1903, and to enter for the University diploma in geography in June, 1903.

CAMBRIDGE.—The Mathematical Tripos list, Part i., was published on June 10. The senior wrangler this year is Mr. E. Cunningham, St. John's College. Mr. F. Slator, also of St. John's, is the second wrangler.

The Rede lecture was delivered in the Serate House on June 10 by Prof. Osborne Reynolds, F.R.S., the subject being "On an Inversion of Ideas as to the Structure of the Universe."

The honorary degree of Doctor of Science has been conferred upon Principal Rucker, F.R.S., and Sir H. H. Johnston.

SOME remarks upon the subject of medical education were made on June 5 by Mr. Asquith, M.P., at the festival dinner of the London Medical Graduates' College and Polyclinic. He expressed the opinion that in all the professions England compares most unfavourably with America, Germany and most other countries in the lack of provision for the continuation of education in its technical and applied forms after the ordinary term of academic life has been reached. Medicine, which is at the same time a science and an art, is every year receiving vast accumulations of new observations and new experiments which must profoundly modify the conception of both the theory and the treatment of disease. Adequate provision must therefore be made for post-graduate research if scientific knowledge of disease is to be increased.

THE thirty-seventh annual programme just received from the Massachusetts Institute of Technology contains a full statement of the courses of instruction at this well-known institution and a register of the alumni, the whole publication forming a prospectus of more than four hundred pages. The Institute offers thirteen separate courses in applied science, each of four years' duration. The laboratories of the Institute are numerous and extensive; their equipment is correspondingly ample, and is kept well up to the rapid advances in technical practice. Provision is made for exact general training in the problems of physics and chemistry for highly specialised work in these and other sciences, and for engineering tests and processes on a practical scale. The large number of students at the Institute, no less than the increasing demands of modern scientific education, have made necessary new laboratories for the departments of electrical engineering and physics. Buildings of a most complete kind have been designed for these purposes, and their erection will be begun early in the spring of 1902. They will cost, with their equipment, between 400,000 dollars and 500,000 dollars.

THE second volume of the report of the United States Commissioner of Education for the year 1899-1900 is a closely printed book of 1368 pages. The series to which it is the latest addition does for educationists what the annual reports of the Smithsonian Institution do for men of science. There is to be found brought together in these portly volumes everything of importance which has taken place, not only in American education, but in that of all the great countries of the world. The plan adopted in the Smithsonian reports, of reprinting valuable contributions collected from various sources, is followed in the volume before us, with the result that many of the addresses and essays by English educational authorities, to which attention has been directed from time to time in these columns, are here to be found printed in full. The prominence given to the higher grades of education shows very clearly that, while making strenuous efforts to perfect their systems of primary and secondary education, the authorities in the States are not losing sight of the paramount importance of technical and university work. Chapters are given to "Institutions for Higher Education," "Professional Schools," "Agricultural and Mechanical Colleges," and "Commercial and Business Schools." Though few teachers can find time to study the reports brought out from year to year, much of the information contained in the volumes is of permanent value and will often be referred to by students of education.

SEVERAL points in the revised regulations for matriculation at the University of London are worthy of notice. The list of subjects has already been given (p. 69). There are only two obligatory subjects—English and elementary mathematics. Latin is optional with one of several sciences; and two other subjects have to be selected from a list of twenty branches of knowledge. Under the new regulations, therefore, it will be possible to matriculate at the University of London, and to proceed to a degree, without taking any science subject. The short syllabus of mathematics shows the influence of the reformer. Under arithmetic mention is made of the metric system, contracted methods, approximations to a specified degree of accuracy, and practical applications. Algebra includes graphs of simple rational integral algebraic functions. In geometry the subjects of Euclid I.-IV. will be taken, but Euclid's proof will not be insisted upon. The short syllabuses of optional sciences are prefaced by the remark "The examinations in science shall aim at ascertaining whether candi-

dates possess a knowledge of fundamental scientific methods, acquired by observation of nature or by a simple course of experiment in physical measurement, or by the investigation of simple problems and commonly occurring phenomena illustrating natural laws." In all the science subjects the questions set will have regard to the conditions under which these subjects may best be experimentally taught in schools.

A SERIES of resolutions in regard to the Government Education Bill were adopted at a special general meeting of the Association of Technical Institutions on May 29. The resolutions are to the following effect:—(1) That the Association approves the general principles upon which the Government Education Bill is based, and strongly urges the Government to pass the Bill in the present session of Parliament. (2) That the new local authorities should be responsible for all grades of education in their districts, and that proper educational coordination would be seriously and unnecessarily hindered if this principle were not adopted; the Government is therefore urged to amend the Bill by deleting the clauses making it optional for the County and Borough Councils to undertake the supervision of elementary education. (3) That the Government should make compulsory the application to the purposes of higher education of the residue under the Local Taxation (Customs and Excise) Act, 1890. (4) That, inasmuch as the Local Authorities constituted by the Bill will have to make good the deficiencies in elementary and general secondary education, as well as to support and improve technical education, and will be obliged to raise increased rates in order to do this efficiently, it is feared that in many cases these authorities will shrink from the necessary expenditure unless encouraged by increased aid from the national exchequer. The Government is therefore asked to promise to provide larger sums for educational purposes. (5) That there should be no statutory limit to the amount to be expended on higher education. (6) That the majority of the Education Committee should be appointed by and from the council of the County Council or County Borough Council. (7) That any attempt to alter the provisions of the first two sections of clause 18 of the Education Bill will be resisted. (8) That London may receive attention early next year, and that it would be unwise to depart from the general principles of the present Bill in the case of the metropolis.

THE ideal University for London, described by Prof. E. H. Starling, F.R.S., in the Foundation Day oration delivered at University College, London, on June 5, was much the same as that advocated in these columns on several occasions. Prof. Starling said that in the University there would be a centre in each of the four quarters of London. Each of those centres would be in so far a complete University in that it would be a place for study and research in all branches of knowledge and would be a community of teachers and scholars. The local business affairs of each centre would be under the control of a committee or council appointed by the senate of the University, but containing representatives of the local body of professors. All those centres would be but parts of this University, with common aims, with similar curricula, and the same standard of examination. The senate of the University, which would contain representatives from all centres, would be responsible for the appointment of the local governing bodies and would keep in its own hands the power of appointing and dismissing professors. It would be possible in that way to provide for the training of 10,000 students within the University of London, and to ensure the freedom of teaching and research and the living contact of each student with men of different ideals and modes of thought, which were the most valuable factors in a University training. Such a University could not be founded without the possession of adequate means. Each centre would necessitate the erection of buildings at a cost of about 500,000*l.* on ground covering from five to ten acres. For a moderate endowment of its professorships and the maintenance of its laboratories a yearly income of 50,000*l.* should be provided in addition to the income from students' fees, which might amount to another 30,000*l.* These might seem large sums to those who were ignorant of the money spent abroad by the State on Universities or of the income which was available from ancient endowments at Oxford and Cambridge. The united income of the colleges at Oxford was 330,000*l.* a year, and at Cambridge nearly 300,000*l.* a year. The yearly Government grant to the University of Strasburg, with only 1000 students, was 50,000*l.* He was convinced that there would be no difficulty

in raising those amounts in London, either by the generosity of its rich men or by grants from public funds, if only those interested in the making of a University would combine their efforts towards a common end. The task was rendered easier by the fact that in the building of the University they could utilise for University purposes in London many of the buildings and endowments already existing, and it was in the hope of inaugurating a common movement in that direction that University College had declared itself ready to be incorporated in the University.

SCIENTIFIC SERIALS.

Transactions of the American Mathematical Society, vol. iii. No. 2, April.—E. W. Brown, on the small divisors in the lunar theory.—J. W. Young, on the homomorphisms of a group. This deals with non-abelian groups such that there is a one-one correspondence between the elements of the group and their ath powers.—F. R. Moulton, a simple non-desarguesian plane geometry. A simpler system than that given by Hilbert in his "Grundlagen der Geometrie," with a proof that his axioms I, 1-2, II, III., IV, 1-5, V, are fulfilled, while Desargues' theorem is not true.—M. Bôcher, on the real solutions of systems of two homogeneous linear differential equations of the first order. Propositions relating to $y' = Py - Qz$, $z' = Ry - Sz$ analogous to those given by Sturm for $y' + py + qz = 0$.—Charlotte A. Scott, on a recent method of dealing with the intersections of plane curves. The method in question is that of F. S. Macaulay (*Proc. L.M.S.* vols. xxxi., xxxii.).—E. V. Huntington, a complete set of postulates for the theory of absolute continuous magnitude. Six postulates are laid down, and shown to be consistent and independent of each other. A short paper by the same author follows, on the postulates for the theories of positive integral and positive rational numbers.

Bulletin of the American Mathematical Society, second series, vol. viii. No. 8, May.—C. J. Keyser, concerning the angles and the angular determination of planes in 4-space.—D. R. Curtiss, note on the sufficient conditions for an analytic function.—Reviews—Scheffer's "Theory of Surfaces," by J. M. Page; "Some Recent Books on Mechanics," by E. B. Wilson; "The Galois Theory in Burnside and Fantoni's Theory of Equations"; and shorter notices.

SOCIETIES AND ACADEMIES.

LONDON.

Royal Society, March 20.—"On a Peculiarity of the Cerebral Commissures in certain Marsupialia, not hitherto recognised as a Distinctive Feature of the Diprotodontia," by Prof. G. Elliot Smith, M.D., Ch.M. Communicated by Prof. G. B. Hovew, F.R.S.

It has been known for a considerable time that some of the fibres of the ventral commissure of the cerebrum in certain marsupials, instead of passing bodily into the external capsule, form an aberrant bundle, which associates itself with the internal capsule so as to reach the dorsal area of the neopallium by a shorter and slightly less circuitous course.

This peculiarity has been recorded by the late W. H. Flower, by Johnson Symington and by Theodor Ziehen in *Macropus*, *Phascologomys*, *Aepyprymnus*, *Phascolarctus* and the *Derbian Wallaby*, and in *Phalangista* by myself.

In 1894 I showed that while in the monotreme and Perameles the common mammalian relationship of the ventral commissure to the external capsule was found to obtain, in *Trichosurus* and *Macropus* some fibres of the ventral commissure were found to pursue the aberrant course indicated above. It was perhaps not unnatural to suppose that the increased size of the neopallium in these two genera was wholly responsible for the presence of this aberrant bundle; for it seemed that since the commissural fibres of the neopallium had become too abundant to be wholly accommodated by the path provided by the external capsule, they, so to speak, had overflowed into the internal capsular route.

Upon examining later a much larger series of marsupials, I soon became convinced that the explanation of the causation of this peculiarity which I then suggested could not be regarded as alone sufficient. I found the aberrant bundle in all members of the genera *Macropus*, *Halmaturus*, *Hypsiprymnus*, *Dendro-*

lagus, *Trichosurus*, *Petaurus*, *Phascolarctus* and *Phascologomys*, quite irrespective of the size of the brain and extent of the neopallium; but I sought it in vain in *Perameles*, *Sarcophilus*, *Dasyurus*, *Sminthopsis*, *Didelphis*, *Myrmecobius*, and *Notoryctes*, even though many of these genera possess larger brains than some Diprotodonts.

These facts seemed to suggest that the aberrant bundle was a distinctive feature of the Diprotodont marsupials, and it appeared that the crucial test of this hypothesis would be afforded by the brain of *Thylacinus*, which, although that of a Polyprotodont, is almost, if not quite, as large as the brain of the largest Macropod. I accordingly submitted the cerebrum of *Thylacinus* to the test, and found no trace of the aberrant bundle, wherefore it is clear that the presence of this aberrant fasciculus of the ventral commissure is distinctive of the Diprotodontia.

The most pronounced growth tendency in the earliest mammals must have been an enormous increase in extent of the neopallium, for while at the beginning of the Eocene period this was almost as insignificant as it is in the Reptilia, in most recent mammals it attains a bulk which far exceeds that of the whole of the rest of the nervous system. This sudden expanse of the neopallium would lead to the development of an enormous mass of fibres which must find some outlet from the pallium; and there are only three possible routes for commissural fibres of the neopallium to the mesial plane. There is first the external capsule, which chiefly consists in all mammals of such fibres passing to the ventral commissure; we find the second route in the path mapped out by the internal capsule from the dorso-lateral neopallial area to it; and the third route can only involve the invasion of the alveus of the hippocampus.

All the neopallial commissural fibres in the Polyprotodontia and some only of these in the Diprotodontia and Eutheria follow the first route. The commissural fibres, which spring from the dorso-lateral region of the neopallium in the Diprotodontia, crowded out of the first route pursue the second. In the Eutheria the neopallial commissural fibres from the dorso-lateral region of the hemisphere forsake both the first and second routes and invade the alveus, so as to form a new dorsally situated neopallial commissure, which is the corpus callosum.

This hypothesis of the origin of the corpus callosum I have previously stated and discussed; and I refer to the matter now merely to point out that the same determining cause which in the Eutheria calls the "corpus callosum" into being is probably functional in bringing into existence the "aberrant bundle" in the Diprotodontia.

The development of any such commissural mass as the corpus callosum of the more highly organised Mammalia in the position occupied by its homologous fibres in the monotremes and marsupials would cause the most profound disruptions of the corpus striatum, optic thalamus, and the basal region of the brain, and the complete disorganisation of its whole; and hence the new course taken by its fibres in the Eutheria.

May 15.—"Cyanogenesis in Plants. Part II.—The Great Millet, *Sorghum vulgare*," by Wyndham R. Dunstan, M.A., F.R.S., Director of the Scientific Department of the Imperial Institute, and T. A. Henry, D.Sc. Lond.

May 29.—"On the Structure of the Gills of the Lamellibranchia," by Dr. W. G. Ridewood. Communicated by E. Ray Lankester, M.A., F.R.S.

This paper records the results of an investigation undertaken at the instance of Prof. E. Ray Lankester, F.R.S., and carried on under his supervision. 215 species of Lamellibranchia, belonging to 118 genera, were examined. The results demonstrate that although the minute structure of the gill, like the grosser structure, cannot be taken as a criterion of genetic affinity, three main types of structure can be recognised, representing apparently three grades of complexity.

The first type is distinguished by the mutual freedom of the gill leaflets into which the embryonic gill papillæ expand. In the other two types the embryonic papillæ elongate into filaments, which are held in juxtaposition by interlocking cilia, or by horizontal bars of cellular tissue.

Evidence is produced to show that Pelsener's order Pseudolamellibranchia is based largely on a misconception of the relative value of the flatness or plication of the gill lamellæ, and the presence or absence of principal filaments.

In the family Solenidae particularly it is shown that different species and subgenera of the same genus may have their gill

lamelle flat or plicate, and the filaments all of one kind or with enlarged principal filaments at intervals.

Avicula argeata proved to be a form of supreme interest, in that both ciliated discs and organic interfilamentary junctions are present.

Anomia aculeata is of no less interest, since it differs from the other species of *Anomia* examined, and resembles the rare *Dimya*, in that the gill filaments are not reflected.

The gills of *Vesicomya* and *Euciroa*, which were said by Dall to exhibit close resemblances with those of the Protobranchia, prove to be of the reticulate type.

The forms included by Pelseener in his order Septibranchia are, at least so far as can be judged by their branchial organs, degenerate molluscs of the Lyonsella type, and the suppression of the Septibranchia as a distinct order is advocated.

Entomological Society, May 7.—The Rev. Canon Fowler, president, in the chair.—Mr. H. W. Shephard-Walwyn exhibited a gynandromorphous specimen of *Anthracis cardamines*, taken near Winchester in 1899. The left side was that of a normal ♂, the right that of a normal ♀, with the exception of a splash of orange pigment on the underside of the primary.—Mr. H. Goss exhibited two ♂ specimens of *Saturnia carpinii* from Essex, bred on whitethorn, and three ♂♂ of the same species caught in Surrey by the aid of bred (virgins) ♀♀. He remarked that as a rule bred specimens were smaller than wild, but the bred Essex specimens were much larger than those captured in Surrey. The Essex specimens were light in colour, while the Surrey specimens were not only much smaller in size, but very dark, probably because their larvae had fed upon *Erica* or *Calluna*.—Colonel C. Swinhoe announced the emergence of *Cossus ligniperda* in the Zoological Society's Gardens from a pupa reared in a piece of wood from South Africa, and said that it was remarkable that the species should have been introduced there and then brought back to Great Britain.—Prof. E. B. Poulton exhibited two *Euplectes* captured in Fiji by Prof. Gilson, and presented by him to the Hope Department. The species, which belonged to the different genera *Nipara* and *Deragenia*, bore the closest superficial resemblance to each other, affording an interesting example of Mullerian or synapomorphic likeness.—Prof. Poulton also exhibited several specimens of *Smerinthus populi* which had been exposed during the pupal stage to the intense heat of July, 1900. In consequence of this "forcing," the moths emerged towards the end of that month, and were markedly different in colour from the normal, being much paler in tint with less distinct markings, and the red of the hind wings of a very different shade.—The Rev. A. E. Eaton exhibited drawings illustrating the wing of *Pampterinus latipennis*, Etn. MS., a remarkable dipterous fly of the family Psychodidae, from New Guinea, in the collection of the Hungarian National Museum, Budapest.—Prof. L. C. Miall, F.R.S., contributed a paper on a new Cricket of aquatic habits found in Fiji by Prof. Gustave Gilson, Dr. T. A. Chapman a paper on asymmetry in the males of Hemiarine and other Sphingids, and Mr. E. Meyrick a paper on Lepidoptera from the Chatham Islands.

Geological Society, May 14.—Prof. Charles Lapworth, F.R.S., president, in the chair.—Pliocene glacio-fluvial conglomerates in Subalpine France and Switzerland, by Mr. Charles S. Du Roi de Preller. In the present paper the author describes a number of further deposits of typical Deckenschotter conglomerate recently examined in the Aare and Rhine valleys, near the confluence of those rivers, and shows that these, in conjunction with the Deckenschotter deposits of the Zurich district, indicate the almost unbroken outline of a Subalpine Deckenschotter cone, which extended from the base of the Alps in a north-westerly direction over a distance of about 25 miles, and was formed by the waters of the retreating Rhine (western) glacier and its affluents on a Molasse plateau, the upper and lower ends of which were at the contours of 900 metres and 500 metres respectively. He further describes a series of Deckenschotter deposits examined in the Rhone valley between Lausanne and Lyons, including the extensive plateau of the Dombes, east and north of Lyons, composed of marine marl overlain by the characteristic *conglomerat ferrugineux*, which some French geologists still regard as pre-Glacial and others as Quaternary, but which is typically Deckenschotter, and in the full acceptance of the term an *alluvion des plateaux*. The deposits thus described afford proof of the existence, in Upper Pliocene

times, of an extensive alluvial cone about 100 miles in length, which reached from Lausanne (probably even from the base of the Alps) to Lyons, and was formed by the waters of the retreating Rhone and Arve glaciers on a Molasse-and-marl plateau, the altitude of which above sea-level was 800 metres near Lausanne and 300 metres near Lyons. From this concurrent evidence in northern Switzerland and in the Rhone valley, the author is led to conclude that at the time of the deposition of those alluvial cones, the principal Subalpine valleys and lake-basins could not as yet have existed in their present form or depth, and must have been from 100 to 200 and 400 metres higher; and that the Subalpine valleys were eroded to their present depth in the course of the inter-Glacial period—now recognised to have been of very long duration—between the Pliocene and the Middle Pleistocene (or maximum) glaciations, and that the Subalpine lake-basins were formed in the same period by the contemporaneous action of fluvial erosion and of a zonal settling along the base of the Alps after these had been raised by horizontal pressure.—Overthrusts and other disturbances in the Braysdown Colliery (Somerset), and the bearing of these phenomena upon the effects of overthrust-faults in the Somerset coalfield in general, by Mr. F. A. Steart. This coalfield, although covered by comparatively undisturbed Secondary rocks, is in part the most disturbed and contorted of those known and worked in the United Kingdom. The "Radstock Seams" of the Upper Coal-measures at Radstock are traversed by a huge "overlap fault," which thrusts them forward for a great distance; this runs nearly east and west, and has parallel to it two smaller overthrusts. In one of them the coal at first dips towards the thrust, then it thickens from 2 to 6 or 8 feet, next it becomes inverted, and eventually regains its former character. The continuity of the coal has been proved in the case of three of the coal-veins. As there is practically the same sequence of strata on both sides of the fault, it is concluded that the "overthrusts" did not take place until all the coal-seams of the Radstock series had been deposited.

Royal Microscopical Society, May 21.—Dr. Hy. Woodward, F.R.S., president, in the chair.—Mr. T. W. Ersser brought for exhibition a new acetylene illuminator for the lantern which he said would give a light of 300 candle power for three hours at a cost of ninepence.—Mr. D. J. Scourfield gave an exhibition of freshwater Entomostraca. He confined himself to the Cladocera and to the illustration of their various habits of life and powers of movement, ranging from the free-swimming forms found in lakes to those which simply crawled in or on the mud. Most of the living specimens were shown in live boxes, but one specimen was attached to a pin by means of a small drop of sealing wax varnish, which permitted the creature to carry on all its movements without getting out of the field of view. A number of living and mounted specimens were exhibited under microscopes.

CAMBRIDGE.

Philosophical Society, May 19.—Prof. Macalister, president, in the chair.—Some observations on protandry and senescence in *Fisbellum*, by Mr. J. Stanley Gardiner.—A note on the dispersive power of running water on skeletons: with particular reference to the skeletal remains of *Pithecanthropus erectus*, by Mr. W. L. H. Duckworth. This communication consisted in an account of the distribution of the bones of the skeleton of a horse along the bed of a mountain stream in North Wales. It was observed that the distance over which distribution had occurred was at least one hundred and fifty-three feet. This observation was applied to the case of the fossil bones found in a river bank in Java and described by their discoverer as those of an animal more closely allied to man than is any known ape and called *Pithecanthropus erectus*. One objection to this description rests on the fact that the two bones on which our knowledge of that animal is based were separated by a distance of nearly forty-nine feet, though on the same level. The present observation goes to show that this objection is not valid, inasmuch as the larger bones here mentioned were distributed over a considerably greater distance than forty-nine feet, by a stream of small dimensions.—The coral reefs of Zanzibar, by Mr. C. Crossland. The paper shows that the fringing reef which extends along the whole eastern or ocean side of Zanzibar Island is not due to recent growth, but is the result of the eroding action of the sea upon the margin of the mass of elevated coral limestone which forms this side of

the Island. The edge of the flat thus formed is protected by living organisms from further erosion, though no addition to the reef results from them. The only recently formed rocks which occur are (1) coral and nullipore growths in the boat channel, (2) the beginnings of new reefs round certain shoals and islands off the west coast. Zanzibar thus affords a comparison with the Bermudas, where the same cause, marine erosion, acting upon a differently formed but physically similar limestone, has produced a semblance, not merely of fringing reefs, but a "pseud-atoll."—On an attempt to detect the ionisation of solutions by the action of light and Röntgen rays, by Mr. J. A. Cunningham.—On the influence of molecular attraction on collisions, by Mr. O. W. Richardson. This paper is an extension of the method used by Sutherland (*Phil Mag.* [5] xxxvi. p. 507) to explain the variation of viscosity of gases with temperature. Its use is further illustrated by calculating the rate of recombination of X-ray ions in air.—On the influence of ultra-violet radiation on the discharge in a vacuum tube having a polished zinc electrode, by Mr. W. C. Baker.—On the variation of double refraction in strained glass with wave-length, by Mr. L. N. G. Filon.

EDINBURGH.

Royal Society, May 19.—Prof. Duns in the chair.—Mr. R. C. Mossman, in a note on the meteorological conditions accompanying "föhn" and up-bank thaws in Glen Nevis, gave an account of some observations he had made last winter, when he had carried out a series of hourly readings of temperature, pressure and humidity at the head of Glen Nevis. On certain occasions he found the air in the glen to be much warmer and drier than at Fort William, the barometer also being higher. The barometric gradient was from east to west, so that the air was drawn away from the base of the mountain and replaced by air from higher altitudes. Excursions were made on the surrounding hills during the föhn, which was found to extend to a height of 2000 feet. The weather was very fine, but a somewhat similar phenomenon was found in rainy weather. A number of cases of up-bank thaws were also described. In these the temperature, which normally falls as the height increases, is higher at the higher altitudes. For example, on February 1, at 10 a.m., the temperature on the top of Ben Nevis was 20°/4 F. higher than in the Glen. The phenomenon was explained as due to the sliding of the cold air down the hillsides into the valleys, which, because of the freer radiation during intense frost, become colder than the hillsides.—Mr. Mossman also read a paper on the meteorology of Edinburgh, in which he brought down his previously published historical record to the end of the last century. The present communication covered the ten years from 1891 to 1900. The paper also dealt with epidemics in relation to the weather from 1497, and with wheat prices from 1801.—Prof. A. Smith, in a paper on the influence of varying temperature and pressure on the vapour density of calomel vapour, sought to distinguish whether the vapour of calomel under ordinary conditions contains HgCl or Hg₂Cl₂ in addition to mercury and mercuric chloride, the presence of which has been demonstrated definitely although their quantity is unknown.—Two communications were also received from Dr. Thomas Muir, on vanishing aggregates of secondary minors of a persymmetric determinant, and on the theory of orthogonants in the historical order of its development up to 1854.

DUBLIN.

Royal Dublin Society, May 21.—Prof. T. Johnson in the chair.—Dr. W. E. Adeney read a paper on the chemistry of respiration in bacteria. The experiments described in this communication have been made with a view of gaining some information as to the actual course of respiration within the protoplast. The course of physiological oxidation has been studied by determining the atmospheric oxygen consumed, the carbon dioxide formed, and also the ammonia formed, during different stages of fermentation, from commencement to completion, in very dilute unsterilised distilled water solutions of asparagine, of albumose and of Rochelle salt, these substances being selected on account of the simple nature of the result, of their aerobic fermentation. The asparagine was found to be quickly hydrolysed during the earlier stages of the fermentation into ammonia and aspartic acid, the last-named substance then undergoing complete oxidation in regular gradations, the final amounts of carbon dioxide and ammonia formed accounting for about 70 per cent. of the carbon and 85 per cent. of the nitrogen originally present in the aspara-

gine. The course of oxidation of the albumose took place in approximately regular gradations throughout the course of fermentation, and is graphically represented by an approximately straight line, both when the carbon dioxide formed is taken against the oxygen consumed and when it is taken against the ammonia which is also formed in the process of oxidation. The course of oxidation of the asparagine, after being hydrolysed into aspartic acid, is also graphically represented by an approximately straight line, whether the carbon dioxide formed be taken against the oxygen consumed or against the ammonia formed. The oxidation of the Rochelle salt occurs in two separate and approximately equal steps, and its course in each takes place in equal gradations, since in both it is graphically represented by straight lines. The quantity of salt completely oxidised amounts to about 75 per cent. of the whole. A similar proportion of the albumose was also found to be completely oxidised during its fermentation. It appears to the author as most probable from the results here referred to, and from others obtained from his experiments on dissolved gases and fermentative changes, already published in the *Transactions and Proceedings* of the Society, that the course and nature of physiological oxidation under aerobic conditions in solutions of similar composition will be found to be similar in nature for all unicellular organisms, and will only vary in degree as the supply of energy required for vital activity may vary for different organisms.—Prof. J. Joly, F.R.S., described some experiments on the influence of light on sedimentation.—Mr. Richard J. Moss gave an account of a deposit from a steam boiler fed with the water of the river Vartry with which Dublin is supplied.

PARIS.

Academy of Sciences, June 2.—M. Bouquet de la Grye in the chair.—On Abelian functions with complex multiplication, by M. G. Humbert.—The experimental study of the dissociation of the constitutive elements of the energy used in motors employed in the production of positive work, by M. A. Chauveau. A comparison of the energy losses in the production of a given amount of work in the cases of inanimate and animate motors.—The mean distribution of the stellar images in the negatives of the map of the sky obtained at the Observatory of Toulouse, by M. B. Baillaud. The examination of forty-two negatives taken at Toulouse gave results agreeing with those recently published by Turner from observations made at Oxford.—The viscosity in the neighbourhood of the critical point, by M. P. Duham. Theoretical considerations are developed which appear to render a satisfactory account of all the peculiarities presented by fluids in the neighbourhood of the critical point.—Magnetic work round the central mass of Madagascar, by M. P. Colin. The magnetic declination was determined at thirty-five stations, the inclination at twenty-four, and the intensity at twenty-five, the results being given in a table.—On the cranial characters and the affinities of Lophiodon, by M. Ch. Deperet.—On the constitution of nebulae, by M. Charles Nordmann. It has recently been shown by the author that the hypothesis of an electromagnetic radiation from the sun is sufficient to explain in a simple manner many celestial and meteorological phenomena. The same hypothesis may also be extended to explain some of the phenomena exhibited by nebulae.—Connection between the photographs of the solar corona taken at the total eclipse of May 18, 1901, and those of the entire solar atmosphere obtained on the same day at Meudon, by M. H. Deslandres. Among the results of the expedition to Sumatra organised by the Lick Observatory for the observation of the total eclipse of May, 1901, was a negative showing a good image of the solar corona. From this it appeared that in the latitude of 9° in the north-east quadrant, there was a disturbance of the coronal rays special to this region. A comparison of this photograph with ordinary negatives of the solar photosphere taken at Greenwich and in India showed no sign of spot or even of special activity of the surface on May 17 and 18, but on May 19 a spot appeared in latitude 9° in the north-east quadrant, which was remarked by Perrine as being intimately connected with the coronal disturbance. An examination of the negatives obtained at Meudon at the same time completely confirms this view.—On differential equations of the second order which admit of a finite continuous group of algebraic transformations, by M. Obriot.—On two problems in geometry, by M. Servant.—On a method of comparing motors of different powers, by M. Max Ringelmann. The amount of fuel used per hour in internal

combustion engines is regarded as a linear function of the power of the engine. Considerations deduced from this formula were applied to the discussion of the relative merits of alcohol motors at a recent competition.—On the specific inductive capacity of dielectrics at low temperatures, by MM. Jacques Curie and P. Coman. The soakage effects in glass tend to disappear at low temperatures. The dielectric capacity varies as a linear function of the temperature, the temperature coefficient being determined for glass, ebonite, mica and quartz.—The influence of the voltage in the formation of ozone, by M. A. Chassy. When the voltage is sufficiently high for the discharge to take place, the production of ozone is proportional to the square of the difference of potential which exists between the armatures.—Contribution to the study of the magnesium light. Measurement of the speed of combustion and the chronophotography of the light, by M. Albert Londe. It has usually been considered that the average time of exposure in taking a photograph by means of a magnesium flash light powder was of the order of 1/100 of a second. Exact measurements, however, have shown that the time is much slower, varying from $\frac{3}{4}$ to $\frac{1}{25}$ of a second and averaging $\frac{1}{10}$ of a second. This time is too great to permit of photographs of rapidly moving objects being made in this way.—Stereoscopic examination in radiology, and illusions in the appreciation of relief, by M. Th. Guilloz.—On the electrocapillary properties of organic bases and their salts, by M. Gouy.—Preparation of the anhydrous chlorides of samarium, yttrium and ytterbium, by M. Camille Matignon. The anhydrous chlorides of ytterbium and samarium were obtained for the first time by heating the hydrated salts in a current of hydrochloric acid gas.—Ammoniacal copper oxide, by M. Bouzat. Starting from copper hydrate and ammonia, the cuprammoniacal base is formed with a slight disengagement of heat, the base formed being much stronger than ammonia.—The action of monochloroacetic ester upon diazobenzene chlorides, by M. G. Favrel. The reaction is similar to that described by Japp and Klingemann for methylacetoacetic and ethylacetoacetic esters. The acetyl group is eliminated and hydrazones are formed.—On some salts of benzylamine, by M. René Dhommcé. A description of the preparation and properties of the nitrate, sulphate, borate, chromate, oxalate and benzoate of benzylamine.—On *Stauronomia parasiticum*, by MM. M. Caullery and F. Mesnil.—Bacterial parasites of the intestine of the larvæ of *Chironomus plumosus*, by M. Louis Léger.—The quantitative variations of plankton in the lake of Geneva, by M. Emile Yung.—On the presence of osseous tissue in certain fishes of the Palæozoic strata of Canyon City, Colorado, by M. Leon Vaillant. In the fauna of these strata, which is one of the oldest known, not only are there undoubtedly vertebrates, but these were sufficiently advanced for the conjunctive tissue to have evolved up to a perfectly osseous state.—On the presence of the Lower Devonian in the Western Sahara, by M. G. B. M. Flamand.—On the seismic movements and magnetic disturbances at the commencement of May at the station of Uclée, Belgium, by M. Eug. Lagrange.—On the ashes from the eruptions of Mont Pelée in 1851 and 1902, by M. A. Lacroix. The products of the present eruption are different from those thrown out in 1851.—On vaccination against plague, cholera and typhoid, by M. Besredka.

DIARY OF SOCIETIES.

THURSDAY, JUNE 12.

ROYAL SOCIETY, at 4.30.—(1) The Influence of an Atmosphere of Oxygen on the Respiratory Exchange. (2) The Influence of High Pressure of Oxygen on the Circulation of the Blood: L. Hill, F.R.S., and J. J. R. Macleod.—On the Parasitism of *Pseudomonas destructans* (Potter): Prof. M. C. Potter.—On the Toxic Properties of the Saliva of certain "Non-Poisonous" Colubines: Prof. A. Alcock, F.R.S.; and Dr. L. Rogers.—The Dissipation of Energy by Electric Currents induced in an Iron Cylinder when Rotated in a Magnetic Field: Prof. E. Wilson.

FRIDAY, JUNE 13.

ROYAL ASTRONOMICAL SOCIETY, at 5.—Observations of Jupiter made at Mr. Crossley's Observatory, 1001; J. Gledhill.—Further Observations of Nova Persei: A. Stanley Williams.—A Dark Kettle: C. S. Howe.—Ephemera for Physical Observations of Mars, 1902: A. C. D. Crommelin.—On the Distribution of the Stars in the Cape Photographic Durchmusterung: A. M. W. Downing.—Reductions of Photographs of Swift's Comet (a 1899) taken at Cambridge Observatory with a Portrait Lens: L. N. G. Filon.—On the Principle of the Arithmetic Mean: H. C. Plummer.—Observations of the Total Eclipse of the Moon, 1902 April 22: Perth Observatory, Western Australia.—Probable paper: Experimental Reduction of Photographs of Eros for the Determination of Solar Parallax, Second Paper: A. R. Hinks.

NO. 1702, VOL. 66.]

MONDAY, JUNE 16.

ROYAL GEOGRAPHICAL SOCIETY, at 8.30.—Geographical and Archaeological Explorations in Chinese Turkestan: Dr. M. A. Stein.

TUESDAY, JUNE 17.

ZOOLOGICAL SOCIETY, at 8.30.—Certain Habits of Animals traced in the Arrangement of their Hair: Dr. Walter Kidd.—On the Carpal Organ in the Female *Haplolepnus griseus*: F. E. Beddard, F.R.S.—On some Points in the Anatomy of the Alimentary and Nervous Systems of the Penguin: R. S. Silliman.

ROYAL STATISTICAL SOCIETY, at 5.

WEDNESDAY, JUNE 18.

ROYAL METEOROLOGICAL SOCIETY, at 4.30.—English Climatology, 1897-1900: F. Campbell Bayard.—Earth Temperatures recorded in Upper India: W. L. Dallas.

ROYAL MICROSCOPICAL SOCIETY, at 8.—The Genus *Synchæta*: A Monographic Study with Description of Five New Species: C. F. Rousselet. CHEMICAL SOCIETY, at 5.30.—Elimination of a Nitro-group on Diazotization. Dinitro- β -anisidine: R. Meldola and J. V. Eyré.—A New Type of Substituted Nitrogen Chlorides: F. D. Chattaway.—The Colour-changes exhibited by the Chlorides of Cobalt and some other Metals, from the Standpoint of the Theory of Electroadfinity: F. G. Donnan and H. Bassett, jun.—An Accurate Method of determining the Compressibility of Vapours: B. D. Steele.—The Molecular Condition of Borax in Solution: H. S. Shelton.—Preliminary Notice of some New Derivatives of Pinene and other Terpenes: W. A. Tilden and H. Buevsky.—The Preparation of Pure Chlorine and its Behaviour towards Hydrogen: J. W. Mellor and E. J. Russell.

THURSDAY, JUNE 19.

ROYAL SOCIETY, at 4.30.—Probable Papers.—On the Correlation between the Barometric Height at Stations on the Eastern Side of the Atlantic: Miss F. E. Cave-Browne-Cave and Prof. K. Pearson, F.R.S.—Note on the Edge of Mercury Vapour on the Spectrum of Helium: Prof. J. Norman Collie, F.R.S.—On Colour-physiology of the Higher Crustacea: F. W. Keeble and Dr. F. W. Gamble.—The Seed-Fungus of *Lolium temulentum*: L. the Darnel or Poisonous Rye-grass: F. M. Freeman.—On the Measurement of Temperature. Part I. On the Pressure Coefficients of Hydrogen and Helium at Constant Volume, and at different Initial Pressures: Dr. M. W. Travers and Dr. A. Jacquerd.—On the Measurement of Temperature. Part II. On the Vapour Pressures of Liquid Oxygen at Temperatures below its Boiling Point, and the Constant Volume Hydrogen and Helium Scales: Dr. M. W. Travers, G. Senter and Dr. A. Jacquerd.—On the Measurement of Temperature. Part III. On the Vapour Pressures of Liquid Hydrogen at Temperatures below its Boiling Point on the Constant Volume Hydrogen and Helium Scales: Dr. M. W. Travers and Dr. A. Jacquerd.

LINNEAN SOCIETY, at 8.—On Obesiella, a New Genus of Copepoda: Dr. W. G. Ridewood.—On Modern Methods in Mycology: Mr. G. Masse.—Further Observations on the Owls, especially their Skeleton: W. P. Pyrcraft.

CONTENTS.

PAGE

The History of the Myth-making Age	145
Cyclopædia of Horticulture	147
The Manufacture of Submarine Cables	148
Our Book Shelf:—	
Semon: "Some Thoughts on the Principles of Local Treatment in Diseases of the Upper Air Passages."	149
—H. C.	149
Buchenau: "Flora der ostfriesischen Inseln"	149
Penrose: "Occultations of Stars and Solar Eclipses"	149
Willis: "Algebra"	149
Letters to the Editor:—	
Earthquake in Guatemala. (<i>With Map</i>).—Edwin Rockstroh	150
The Vibration of the Violin.—W. B. Coventry	150
The "Armorl" Electro-Capillary Relay.—J. S.	151
Prehistoric Pygmies in Silesia.—David MacRitchie	151
Flames from Mud on Sea-Shore.—Rev. H. T. Dixon	151
Cuckoo's Egg Thrown out of Bunting's Nest.—T. G.	151
Volcanic Eruptions in the West Indies. By Prof. J. Milne, F.R.S.	151
Records and Results of Recent Eruptions	153
The New Botanical Laboratories at Liverpool. (<i>Illustrated</i>)	155
The Hugh Miller Centenary	156
Lazarus Fuchs. By G. B. M.	156
Carlo Riva. By A. G.	157
Notes. (<i>Illustrated</i>)	157
The Royal Observatory Visitation	161
Evidence of a "Seiche" on a Scottish Loch. (<i>With Diagram</i>)	162
The Mining Statistics of the World. By B. H. B.	163
University and Educational Intelligence	163
Scientific Serials	165
Societies and Academies	165
Diary of Societies	165

THURSDAY, JUNE 19, 1902.

THE PLACE OF LAMARCK IN THE HISTORY OF EVOLUTION.

Lamarck, the Founder of Evolution; his Life and Work. With Translations of his Writings on Organic Evolution. By Alpheus S. Packard, M.D., LL.D., Professor of Zoology and Geology in Brown University, &c. Pp. xiv + 451. (London and New York: Longmans, Green and Co., 1901.) Price 9s. net.

THE name of Lamarck has of late been much in people's mouths. Now that the doctrine of organic evolution has secured acceptance from all those who are qualified to form an opinion on the subject, an attempt is being made in some quarters to deprive Darwin, the real hero of the campaign, of at least a portion of his laurels, and to bestow them on a leader of inferior rank and far lower achievement. It cannot be doubted that this attempt is, in the long run, doomed to failure; but in the meantime there is considerable danger of an unwholesome reaction among those who have not perfectly comprehended the points at issue.

It is often forgotten that the idea of "special creation," or, as we should rather say, of the "immutability of species," is one of comparatively recent growth. Before the seventeenth century the current notions on this subject were by no means rigid, while the terms "genus" and "species," in their technical use, were the exclusive property of logicians. It is not until the time of Ray that we find the latter term borrowed by a naturalist in order to give precision to a conception which was then a novelty to the scientific mind. The definition of natural species in the Linnæan sense would have sounded as strange in the ears of Francis Bacon as would the denial of spontaneous generation. The work of Ray, Linnæus and Cuvier, greatly as it assisted the cause of science, carried with it a fatal defect. It left order where it had found confusion, but in substituting exactness of definition for the vague conceptions of a former age, it did much to obscure the rudimentary notions of organic evolution which had influenced naturalists and philosophers from Aristotle downwards.

Nevertheless, the old transformist beliefs, though no longer popular, were not left quite without a witness. Buffon, being possibly influenced by considerations other than scientific, vacillated, as is well known, between the theories of mutability and fixity of species. Erasmus Darwin, on the other hand, was a vigorous and outspoken upholder of the transformist opinion, shorn of some, but not all, of its former crudities. Geoffroy St. Hilaire declared in favour of the derivation of different species from the same type; and six years later Lamarck, who had previously taught the fixity of species, announced his adherence to the evolutionary view. The author of the "Vestiges of Creation" and Herbert Spencer may be said in some sort to have carried on the transformist succession, but it was reserved for Charles Darwin and Alfred Russel Wallace to import into the problem an entirely fresh set of considerations, and by means of a new and illuminating theory, supported on a secure basis of fact, to win universal acceptance for a doctrine which all

the skill and eloquence of its former advocates had failed to commend to the scientific world.

Prof. Packard, on the title-page of the present work, calls Lamarck "the founder of evolution." If the foregoing may be taken as a not unfair presentation of the course of opinion on the subject of transformism, it is difficult to see how such a claim can be justified. It is idle to discuss whether or not Lamarck was acquainted with the works of Erasmus Darwin. Transformism was in the air, and it is impossible to credit Lamarck with the origination of a view which had been present to the minds of Geoffroy St. Hilaire and of Buffon. Neither can it be said that Lamarck's advocacy won general approval for a doctrine that was previously discredited. The strength of his own convictions and the persistence with which he urged them are not in question; but the fact that he failed to convert either his contemporaries or his successors is equally indisputable. The only ground on which, if on any, the claim advanced on behalf of Lamarck can be sustained is the allegation that he was the first to render the doctrine of transmutation credible by pointing out the methods on which organic evolution has proceeded. Much, no doubt, depends on the acceptance or rejection of the so-called "Lamarckian factors." In the earlier stages of the present phase of the evolutionary controversy, these factors were somewhat uncritically accepted as adjuncts to the theory of natural selection propounded by Darwin and Wallace. But when the belief in the inheritance of acquired characters had once been seriously called in question, it was speedily perceived that no logical necessity existed for evolutionists to accept these factors at all. The question became clearly one of evidence; and in the opinion of many, if not most, of the leaders of scientific thought, the upholders of the Lamarckian view have so far failed to deal successfully with the burden of proof that undoubtedly rests upon them. The hereditary transmission of individually acquired characters is a necessary part of the Lamarckian system, and until this point is established to the satisfaction of scientific opinion, it is at least premature to hail Lamarck as in any sense the founder of organic evolution. And even should the proof be forthcoming, the facts would still remain that many of Lamarck's views had been already foreshadowed, that his system contains much speculation unsupported by adequate evidence, and much that is demonstrably erroneous; moreover, that it failed in any appreciable degree to influence his contemporaries.

It is hardly necessary to point out how complete a contrast to this is afforded by the history of Darwinism. Founded on a basis of observation and experiment to which the Lamarckian speculations can lay no claim, and calling in the aid of a principle—that of natural selection—which, given the observed facts of variation, actually showed how the adaptation everywhere manifest in nature might have been brought about, the Darwinian system supplied an element of rationality which had hitherto been absent, and compelled the attention of those to whom the unsupported hypotheses of previous transformists had failed to appeal. The importance of Darwin's work is seen in its results. Under the influence of the "Origin of Species," Huxley, Lyell, Hooker and Asa Gray ranged themselves on the side of evolution; and

the whole of the scientific world, with few exceptions, followed their example, and before his death Darwin had the satisfaction of knowing that the doctrine of evolution had become almost a commonplace in the minds of the reflecting and cultivated portion of the community.

Lamarck was unquestionably a capable, industrious and enthusiastic naturalist. He possesses the merit of having grasped the truth of organic evolution, though his views as to its methods were crude and his arguments in its favour unsubstantial. He also carried out the principle on a far larger scale and with greater amplification of detail than did any of his transformist predecessors, and to him we owe the first attempt at the construction of a scheme of phylogeny. But while we readily allow all this, it seems to us, for the reasons above given, that in the present work the importance of Lamarck and of his contribution to the progress of evolutionary theory is greatly over-estimated. Nevertheless, in putting before us within reasonable compass a careful and critical account of the little that is known of the life and circumstances of Lamarck, and of his relations with the leaders of scientific thought in France during a period which is full of interest, Dr. Packard has done real service. He seems inclined to complain that writers on evolution "do not know their Lamarck." Whether this be true or not, the extracts from Lamarck's writings here given are so representative and so copious that there will in future be no excuse for ignorance as to what Lamarck's tenets really were. It may be doubted whether the well-known chapters in Lyell's "Principles" do not really contain all that is requisite for forming a working estimate of the Lamarckian doctrine. But there are some to whom, for various reasons, a more extended acquaintance with this doctrine will be necessary, and who yet possess neither the time nor the opportunity for attacking the works of Lamarck in their original form. To such readers, if they are willing to show indulgence towards a certain amount of needless repetition and some occasional inaccuracy in translation and other matters, Dr. Packard's interesting and thorough-going volume may be recommended with confidence. F. A. D.

ELEMENTARY CHEMISTRY.

Elementary Inorganic Chemistry. By James Walker, D.Sc., Ph.D., F.R.S. Pp. 265. (London: George Bell and Sons, 1901.) Price 3s. 6d.

Experimental Chemistry. By Lyman C. Newell, Ph.D., State Normal School, Lowell, Mass. Pp. xv + 410. (London: D. C. Heath and Co., 1902.) Price 5s.

Elementary Experimental Chemistry. By W. F. Watson, A.M., Furman University, South Carolina. Pp. 320. (New York: A. S. Barnes and Co., 1901.) Price 7s. net.

THE first of these books may be said to meet a distinct want, felt in this case by others than the author, and to meet it extremely well. It is an elementary treatise on chemistry imbued with the spirit of the times, but written with restraint and marked by the lucid and philosophic style characteristic of the best class of scientific writing. It is not an ancient garment embroidered with new ions, nor is it an aggravated *boulevardement* of the chemistry that was presented to

us twenty years ago. It would probably do most chemists good to read it, and it is admirably adapted as a first college book for students. It contains the essentials of chemical theory and a really judicious selection of chemical facts, and it is to be commended, perhaps, most of all to examiners, whose sins in asking for unimportant facts abate but slowly. It is no book for those who have to charge their memories with Dutch liquid, puce-coloured oxide of lead and powder of Algoroth; yet it does not relegate the conception of mass action and reversible changes to a period of grave and senior study. It is, in fact, a book which can be unreservedly recommended, and Prof. Walker deserves our thanks for having written it.

Dr. Newell's book is a thoughtful and interesting attempt to improve upon the older kind of text-book, and the author endeavours to interweave a laboratory course with adequate descriptive matter. It is difficult to judge such a book fairly without putting it to practical use, but there seems every prospect that by using it as the author intends it to be used the student would be brought to the right view of chemical science and to a sound knowledge of the leading principles and facts. The book abounds in practical and theoretical problems, and encouragement is given to the discussion of laboratory results in class—a most valuable form of teaching. There is a tendency in books of this kind for some of the statements, questions and injunctions to become a little puerile, and to conjure up a picture of ingenuousness which, in the present writer's experience, is not often found in real life, at least among male students. However, there is not very much to complain of in this way. The book has obvious merits, and the author may fairly claim that it deserves a trial.

The third work under review is intended especially for students who only take one short course of chemistry. A reviewer will, according to his disposition, be either intimidated or exasperated by the author's statement that he is "profoundly grateful to ten different educators for reading the proof sheets and making valuable suggestions." To make any objections after this announcement seems perhaps rash; but at whatever cost, the author and the ten educators must be faced with the statement that to an eleventh educator the book has proved disappointing. The introduction to the work comprises ten pages, and it consists of a series of statements defining matter, chemical compounds and mechanical mixtures, atoms, molecules, indestructibility of matter and conservation of energy. It is difficult to know what purpose is served by confronting the student at the very outset of chemical study with a series of dogmas such as are found here. The idea of the atom, for instance, is introduced by the statement that "a single symbol as C and Cl indicates one atom of the element." Immediately upon this comes "An atom is the smallest portion of matter that can take part in a chemical change. It is indivisible."

The atom being thus disposed of, the molecule is dealt with in like fashion. It is really astonishing to find this kind of thing in a book with such pretensions as are set forth in the preface. The rest of the book is of the same mould; there is nothing to distinguish it from dozens of other elementary chemical books of the kind that in this country have had their day and are happily

ceasing to be. A careful perusal has disclosed nothing that can give a well-intentioned critic occasion to say "this is a happy idea—that is capitally put—this is something to help us." On the contrary, if this book were to be reviewed in detail, it would be necessary to write columns of complaint. One feature of novelty appears in the book in the form of full-page illustrations of apparatus and materials used in all the experiments. These pictures are reproduced from photographs, and show three tiers of apparatus arranged as if for sale. In many cases it is not easy for an experienced chemist to recognise the individual pieces, and in plate xx. we reach a climax. It represents on the top shelf two tin canisters, a stoppered bottle, a Bunsen burner, a beaker, a tin dish, a blowpipe and another stoppered bottle. On the next shelf are three stoppered bottles, a hammer, four tin canisters, a small structure like a dog kennel, and a rack of twelve test-tubes. On the bottom shelf are two developing trays, a beaker, a stoppered bottle, a sugar basin, a stone gingerbeer bottle, a pocket handkerchief and apparently a bank-note or a shirt cuff. The plate bears the legend "The Metals." By the use of a lens one word of two of the labels can be deciphered.

A. S.

SOLID GEOMETRY.

The Elements of Euclid, Book XI. By R. Lachlan, Sc.D.

Pp. 51. (London: Edward Arnold, n.d.) Price 1s.

IT is to be hoped that some of the scientific committees which are now dealing with the improvement of mathematical teaching, and more especially with that of the teaching of elementary geometry, will, in the process of pruning Euclid, direct attention to this little-read Book xi. As in other books of the Elements, many of the propositions are of the trivial, or even ludicrous, character, while some of the definitions lack precision. For example, can prop. 1—"one part of a straight line cannot lie in a plane and another part without the plane"—be seriously regarded as necessary? Indeed, the proof assumes the thing which it seeks to prove: let $A B C$ be the given straight line; let a part of it, $A B$, lie in the plane, and a part, $B C$ (if possible), out of the plane; produce $A B$ in the plane to any point, D , &c. To this several other instances might be added.

Then as regards definition, the descriptions of dihedral, trihedral and (generally) polyhedral angles leave something to be desired. Possibly some better term than *angle* can be found in such cases. We are told that "when two planes meet and are terminated at their line of intersection, they are said to form a dihedral angle"; "when several planes meet in a point, they are said to form a polyhedral angle." All that such planes visibly "form" is a certain figure; the "angle" which they form (as it is employed in subsequent mathematics) is, in reality, an *area* on a sphere of unit radius. It is true that Book xi. is not concerned with this precise quantitative definition of (so-called) *solid angles*—better called *conical angles*—but merely with certain plane, or face, angles connected with them; nevertheless, it may be desirable to give the student, who when he reaches Book xi. can scarcely be called a *beginner*, this quantitative notion.

In the small compass of this book there is little opportunity for anything strikingly original or novel. Dr. Lachlan finishes it with an appendix which contains a large number of propositions, examples, &c., and this appendix will be found much more valuable than Book xi. itself.

A few criticisms of a minor character may not be out of place. We notice that in the enunciation of each proposition, Dr. Lachlan always uses the simple word "is" or "are" when the proposition states a fact which can be proved; thus, "if two planes intersect, their line of intersection is a straight line." The typical editor of a modern Euclid would say "their line of intersection shall be a straight line," employing a ridiculous compulsory form of expression. There is now the beginning of a revulsion against this style, which has been considered for some curious reason to be appropriate and essential to Euclid, but to no other subject of study or conversation. So far, Dr. Lachlan is in agreement with common sense; but why does he, when setting out on the proof of the proposition, re-state the fact with a "shall be"? Twice he forgot his rule—in prop. 1, where "must be" is employed, and prop. 14, where the simple and sensible, "are" of the formal enunciation remains "are" in the re-statement.

The proof of prop. 20 would avoid a tendency to mislead the student if it stated that the point C is first taken (arbitrarily), then E , and finally B and D by drawing any line, $E B D$, through E .

In the third line of the proof of prop. 21, the proof is rendered very much more clear by the insertion of the word "all" before the words "the $\angle s$," the statement then being the very obvious one that if there are two sets of fifty plane triangles, the sum of all the angles in the first set is equal to the sum of all those in the second set.

Finally, the employment of the word "power" in the definition (p. 536) "the square on the distance between a point and the centre of a sphere less the square on the radius of the sphere is called the power of the point with respect to the sphere" does not seem justifiable or necessary, although it has been employed by a geometer of high repute. The word *power* is already employed in science for something quite different from the square of a tangent. Indeed, a student of electricity might be tempted to think that this geometrical "power of points" is a mere pun on the well-known term used in connection with frictional machines. Everything must not be sacrificed to brevity; if new terms are wanted in science, they should be appropriate and expressive.

BELGIAN BOTANICAL INVESTIGATIONS.

Recueil de l'Institut Botanique (Université de Bruxelles).

Par L. Errera. Tome v. Pp. xii + 357. (Bruxelles:

Henri Lamertin, 1902.)

IN this book there are brought together recent papers by botanists of the Royal Academy of Belgium, which have already been published in different journals during the last two years. Although this is the first volume to be published, it appears as vol. v., since the first four volumes will be given up to earlier papers. Thus

the five volumes will provide a systematic record of various lines of research, mainly physiological, which have been the subjects of investigation in the Botanical Institute of Brussels.

The nature of the alkaloids found in plants and the methods of localising them is one of these subjects, and in the present volume there are two papers dealing with those bodies, the one by the late M. George Clautriau, on "The Nature and Significance of Alkaloids in Plants," the other by E. Vanderlinden, treating of alkaloids in the Ranunculaceæ. A considerable part of Clautriau's paper is historical, the present research being confined to caffeine obtained from coffee and tea plants. Having previously studied the alkaloids in various other plants, he is well qualified to summarise our present knowledge of them. Although alkaloids have only been located in a limited number of plants, Clautriau considers that they are probably formed in all plants, but not always in sufficient quantity to be stored up. Alkaloids derived from purine bases are found throughout the whole range of plants, while those derived from a pyridine base are confined almost exclusively to Angiosperms. Definite micro-chemical tests for alkaloids are wanting; thus Clautriau was unable to obtain any which would enable him to detect caffeine *in situ*. He concludes that alkaloids are decomposition products formed in the breaking down of proteids; that they can be worked up again, but this requires a considerable expenditure of energy, and that generally their function is to protect the plant. Vanderlinden's results are quite in harmony with Clautriau's views. He finds that the amount of alkaloid present in a plant is liable to fluctuations, these depending upon the phase of vegetation and the nature of the soil. Curiously, Ranunculus and Clematis, two genera well known to possess toxic properties, yield no alkaloid.

In a second paper, Clautriau describes his experiments on pitcher-plants, some of which were performed on plants in their natural habitat in Java, others after his return to Brussels. Vines, who has reinvestigated the subject on the strength of Clautriau's results, does not confirm them, but decides that the ferment is tryptic, not peptic.

In the course of his experiments on the permeability of protoplasm to liquids at different temperatures, van Rysselburgh disproves the view held by Schwendener and others that protoplasm is not permeable to water at 0° C.; in fact, he finds that it is permeable to potassium nitrate, urea, methylene-blue, &c., at the same temperature. Another important observation was made that the sap in a cell if isotonic with a certain solution at any temperature will be isotonic with it for all temperatures.

M. Jean Massart advances some decidedly unconventional ideas on the phylogeny of the lower organisms, which presumably have originated during his investigation of the protoplasm of the Schizophyta. His deductions as to the nature of the central body in the Schizophyceæ and the stainable bodies in Bacteria are somewhat convincing, but at present many problems of the nucleus seem to be beyond our powers of solution. The last few pages of the publication are devoted to the description of a gigantic Bacterium, *Spirillum colossus*, obtained by Prof. Errera from an ancient moat.

NO. 1703, VOL. 66]

OUR BOOK SHELF.

Dynamos, Alternators and Transformers. By Gisbert Kapp. Translated from the third German edition by H. H. Simmons, A.M.I.E.E. Pp. v + 503. (London: Biggs and Co.) Price 10s. 6d.

Étude Pratique sur les Différents Systèmes d'Éclairage. By J. Defays and H. Pittet. Pp. 168. (Paris: Gauthier-Villars, n.d.) Price fr. 3.

MR. KAPP'S book has passed through a somewhat curious development. Originally written in English, it first appeared in German as a translation; subsequently Mr. Kapp revised, and to a large extent re-wrote, the German translation, the revised book appearing as the third German edition in 1899. It is this work which has now been translated by Mr. Simmons. The general merits of the book are probably known to most electrical engineers; those who are only familiar with the earlier English edition will find much that is new and valuable in the one now before us. After some opening chapters on the electric and magnetic theory underlying the design of dynamos, the winding of armatures is considered in detail in a couple of chapters well illustrated by diagrams. The next chapter deals with field magnets, after which armature reaction, commutation and sparkless collection are considered at some length. Some typical examples of direct-current machines are described, but at no great length, as this ground has already been covered by Mr. Kapp in his "Dynamo Construction: Electrical and Mechanical." The remainder of the book deals in a similar manner with alternators, synchronous and asynchronous motors, and rotary converters. Graphical methods are employed in this part to a considerable extent; the mathematical treatment throughout the book is clear and concise, a certain familiarity with the differential and integral calculus being assumed in the reader. As a whole the work forms a most valuable text-book for the student of this branch of electrical engineering.

It will be noticed that the book does not deal at all with transformers; this is because a separate work on this subject has been published by the author, a fact which is stated in the preface. Yet in spite of this, the title as it appears on the cover and page headings is "Dynamos, Alternators and Transformers," which is, to say the least, misleading. On the title-page a different, and more accurate, name is given to the book. This defect is to be regretted, as it mars an otherwise excellent work.

MM. Defays and Pittet's volume cannot fail to prove attractive to those who are interested in the problems of artificial lighting. The authors have aimed at providing a practical guide to those who are called upon to select, as, for example, for lighting a factory, a suitable system of illumination. Naturally, in such a case, the question of relative cost is of prime importance; the authors have, however, rightly abstained from dwelling too strongly on this point, as not only is the price so largely a question of locality, but it is often very difficult, if not impossible, to decide what is the monetary equivalent of the advantages which one illuminant possesses over another. The whole subject of artificial illumination is first dealt with in a general manner, the considerations of importance in relation to different conditions of use being pointed out. After this, separate chapters are devoted to a detailed examination of lighting by gas, acetylene, oil, alcohol and electricity. The principles underlying each system are expounded clearly and not too technically, and its security, healthiness and efficiency are discussed. From the hygienic point of view there can be no question as to the superiority of electric light; it is also more convenient, and probably safer, than any other method; but unfortunately it is considerably dearer, unless regarded from the enlightened standpoint which takes into account

the value of health and convenience. Second in healthiness, probably, comes incandescent gas lighting, and this is also the cheapest. For comparative figures we must refer readers to the book itself, in which many useful and interesting tables are given. The book would be improved by the addition of illustrations, which are more especially needed to accompany the descriptions of different forms of gas burners and lamps. We also think that it would be advantageous if the very short chapter on the distribution of light, and the use of shades, &c., were expanded, as this is a subject on which the public more especially needs instruction, since it is that which, more than any other, they have under their own control. M. S.

Sanitary Engineering. A Practical Manual of Town Drainage and Sewage and Refuse Disposal. By Francis Wood, A.M. Inst. C.E., F.G.S. With numerous illustrations. Pp. xi + 304. (London: Charles Griffin and Co., Ltd., 1902.) Price 8s. 6d. net.

SANITARY engineering is a comprehensive and difficult science, yet the author states in his preface that he himself "felt the want of a work which would in one small volume deal with the science in a comprehensive, concise and easily intelligible form." It is fair to infer from this statement that he considers the want has been met by the compilation of the present work. Yet in his introductory remarks (chapter i.) he adds that the student "will know only a small part of this vast subject when he has read and learned the contents of the present volume." We concur with the writer in the latter statement. The work contains a great deal of information upon sanitary engineering which will be useful to municipal engineers and students, medical officers of health, sanitary inspectors and members of local authorities; but the subject is of course not dealt with comprehensively. The general correctness of the statements and views expressed leave little to be desired, but while in a scientific text-book there is no occasion to be hypercritical on the subject of literary style, there are so many instances in this work where the meaning is obscured or the sense is lost by the slovenly construction of sentences that the pleasure and satisfaction of perusing it are somewhat marred. To give one or two instances:—

"The student must therefore take and make the most of the opportunities which he now has—and never will have again" (p. 5).

"The engineer is a born geologist; his work is connected with the earth and its composition" (p. 5).

"Since the system of bacteriology has been brought forward" (p. 227).

"The formation of Urban, Rural District, and Parish Councils are doing a great work in abolishing these abominations; and it is pleasing to note that in almost every district and village sanitary inspectors are being appointed, who with the powers they possess are rapidly converting these anomalies, which soon must become things of the past" (p. 49).

The author is inclined to conclude that the explanation why sewer air may at times be quite sweet is "that micro-organisms also act on the foul atmosphere and consume each other, together with the foul matter in the gases which must prevail it" (p. 124).

We read with some curiosity and misgivings the statement that a chapter had been allotted to bacteriology—but, as we suspected, the chapter deals with the bacteriological purification of sewage. On pp. 170-180, an article which appeared in *The Engineer* about four years ago is inserted, and the writer advises that "the paragraphs under their different headings should be read in conjunction with the same subjects, which are to be found elsewhere" in the book. One need hardly point out that this is not the most convenient way in which the subject-matter can be presented to the

student. The author would have done well if he had himself selected the different paragraphs contained in the article and put them under their proper headings. The work, however, in addition to containing much valuable information, is very well illustrated, and the subject-matter dealt with comprises a fairly wide survey of the more important matters of practical sanitary engineering.

The Story of Animal Life. By B. Lindsay. The Library of Useful Stories. Pp. viii + 208. (London: George Newnes, Ltd., 1901.) Price 1s.

To try to tell the story of animal life within the compass of one of Messrs. Newnes' well-known shilling series of "Useful Stories" seems almost irreverent. Even Prof. Macalister required two primers, and the result was somewhat indigestible pemmican. Perhaps Huxley's educational genius might have achieved what must seem to most naturalists impossible. We therefore admire Miss Lindsay's courage, and while we think that she has attempted too much, we willingly recognise that her little book is good value for a shilling—a *multum in parvo*, packed with interesting information and illumined with big ideas. It is perhaps unduly handicapped with technicalities and zoological subtleties, for when we read of "diploblastic," "apopyles," "metamerism," "Archannelida," "Euthyneura," "Adelochorda," and so on, we wonder what these abstruse terms are doing in this shilling gallery. On the other hand, the booklet is interesting, and it has the two-fold merit of refusing to give a false simplicity to the subject, and of clearly indicating that zoology is not remote from human life. We regret to notice some inaccuracies of spelling and grammar which might have been readily avoided in so small a book. We regret still more to have to point out that many of the figures are so roughly reproduced that they recall the earliest stages of book illustration. Some of them, e.g. the tadpoles, are worse than mediæval, and if they were not so dull might be referred to as beacons warning us of the dangers of cheapness.

Municipal Engineering and Sanitation. By M. M. Baker, Ph.D., C.E. Pp. viii + 317. (New York: The Macmillan Company; London: Macmillan and Co., Ltd., 1902.) Price 5s. net.

THE author intends this small volume for that large and rapidly growing class of persons who, either as officials or citizens, are striving to improve municipal conditions. It is a short review of the whole field of engineering and municipal sanitation, and no claim is made that it is an exhaustive study of any one of the branches with which it deals.

Although engineers and sanitarians will not find in the book much that is new to them, yet it contains matter of a trustworthy and up-to-date nature which will make the book interesting and helpful even to professional men. In addition to the treatment of the subjects of water-supply, sewage and sewerage, general scavenging and the making and keeping of streets and pavements, the following matters are also dealt with:—subways for pipes and wires; urban and inter-urban transportation; bridges, ferries and ice boats; docks and harbour facilities; telegraph, telephone and messenger service; ice; milk; markets; slaughter-houses; lighting; cemeteries; crematoria; fire; smoke; noises; disinfection; parks; playgrounds; baths and lavatories; public offices; and the administration, finance and public policy of municipal authorities.

Having regard to the extensive range of subjects dealt with, it follows that in such a small volume the treatment of each subject must be, generally speaking, sketchy. For instance, the chapter upon disinfecting methods and apparatus consists of three small pages containing some 750 words only. The book is of a handy size, well printed and bound, but without illustrations.

LETTERS TO THE EDITOR.

{The Editor does not hold himself responsible for opinions expressed by his correspondents. Neither can he undertake to return, or to correspond with the writers of, rejected manuscripts intended for this or any other part of NATURE. No notice is taken of anonymous communications.}

Astronomy in the University of London.

It seems desirable to call special attention to the change which has recently been made in the conditions with regard to astronomy for the B.Sc. Pass and Honours degrees of the University of London. This is the more important as, owing to an unfortunate slip of the much-overworked academic Registrar, the point was omitted from the published examination schedules, and has only been corrected by an attached slip in recent issues.

The point is this, that in future astronomy is to be counted as an independent subject for the B.Sc. degree. It will rank equally with geology, botany or zoology. It is true that the Faculty of Arts has retained a certain amount of astronomy in its mathematical syllabus—in my opinion a very poor syllabus—which represents, not modern astronomy, but the condition of affairs in "three day papers" at Cambridge fifty years ago, when the University of London was founded. Why the Faculty of Arts does not insist also on a little antiquated geology and a little pre-Darwinian biology is cause for wonder. At any rate, the Faculty of Science has recognised that astronomy is a suitable subject for graduation, and we may hope that students of astronomical physics and theoretical and observational astronomy will realise that they can now specialise in London before graduating. A Pass student will be able to graduate by studying mathematics, physics and astronomy, and an Honours student by taking astronomy and either mathematics or physics. We may hope that a school of astronomy will form itself in London free from the traditions of the Cambridge Mathematical Tripos, and recognising mathematics for the astronomer as ancillary only to observational and physical work. KARL PEARSON.

University College, London, June 15.

De Vriesian Species.

THE recent work of Prof. H. de Vries on the origin of species by mutation has attracted a great deal of attention, although it cannot be said that the facts he presents are of a new kind, or that, taken by themselves, they prove anything about the origin of species. The great merit of the work is to be found in its clear presentation of the subject, with carefully worked out examples, at an opportune time. In former years botanists were not so ready as they are to-day to recognise apparently minor characters as specific, and the great variety of slightly modified plant forms passed almost unnoticed. It was not considered worth while to investigate the polymorphism of the old specific aggregates, and men like Jordan, who did so, were not regarded altogether favourably. The old conception of species seemed to give us a superabundance of plant types, taking the world over; and many botanists thought, as one recently said to me, that it was impossible to catalogue and name the minor forms, because they were infinitely numerous. However, there has arisen a new school, especially dominant in America, which recognises the fact that many of the old specific names cover a number of types which are readily distinguishable from one another. These may intergrade, but in many cases they do not seem to do so, and though the distinctions may seem small, they are perfectly constant. The result of the new investigations is in many cases to increase the number of recognised species four-fold, ten-fold, or more. Now when one comes to study these numerous species, it is evident that much of the difference is not absolute, but consists in different combinations of the same or similar characters, like the patterns of a kaleidoscope. With a little ingenuity, one could almost predict the characters of undiscovered forms. Heredity seems every now and then to take a new throw of the dice, with results exactly such as de Vries has described. The successful throws are those which give results adapted to the environment, and these, under the laws governing the survival of the fittest, give us what we proceed to describe as new species.

The proof that species do thus originate is not to be found in garden experiments alone, but must be confirmed by field observations. Unfortunately, the average systematic botanist seems to be much more interested in defending his "new species" than in asking whether they may not be "new" in a more literal sense than he imagines. Nevertheless, search will be made for

"de Vriesian species," and thereby the true status of many which have lately come to my notice may be worth recording.

(1) *Helianthus petiolaris phenax* (new variety). Rays 13, mustard yellow, 11 mm. diameter; corollas and stigmas yellow, giving the flower a yellow disc. Found at Boulder, Colorado, August, 1901, growing in a field full of normal *H. petiolaris*, with deep saffron-yellow rays about 8 mm. diameter, and corolla and stigmas a very dark wine red. I took both plants to the meeting of the American Association for the Advancement of Science at Denver, and showed them to an eminent botanist who knows the flora of Colorado well, and is not regarded as a "splitter." I said, "these appear to be forms of one species." "Oh, no," he replied, "one is a *Helianthus*, the other a *Rudbeckia*!" However, the flowers were carefully examined in company with Prof. Pammel, and were also shown to Miss Eastwood, and no doubt remained that the new variety was really an offshoot from *H. petiolaris*, which had probably originated where it was found. The variation is the more interesting because in the sunflowers (*Helianthus*) the colour of the disc is used as a character to separate groups of species.

(2) *Ribes cereum viridioides* (new variety). Plant perhaps more resinous; tube of calyx shorter, pale greenish, stigma exerted beyond petals. Fruit deep red, small, perfectly spherical. Found (first by my wife) between San Ignacio and Las Vegas, New Mexico. A clump of bushes presenting these characters (observed in two seasons) grows only a few yards away from plenty of what Mr. Coville considers genuine *R. cereum*, with a longer calyx-tube, streaked with purplish pink, and fruit a little larger and more inclined to be oblong. I was at first quite sure I had a valid species in this *viridioides* variety, and Mr. Coville, before we got the fruit, thought the specimens might be his *R. mesacalerium*, which has black fruit. Now, however, it appears reasonably certain that the plant represents a de Vriesian "species" or mutation. Miss Eastwood has lately described a somewhat similar mutation of a Californian species, under the name *Ribes sericeum viridescens*. T. D. A. COCKERELL.

East Las Vegas, New Mexico, U.S.A., May 22.

Formula for the Perimeter of an Ellipse.

THE formula given by your Queensland correspondent (NATURE of April 10, p. 536) for the perimeter of an ellipse is not at all objectionable on the score of degree of approximation. It leads, however, to another, which for practical purposes is much preferable. If for shortness' sake λ be written for $\log 2 / \log \frac{1}{2} \pi$, he says in effect that the perimeter of an ellipse with semi-axes a and b is approximately equal to the circumference of a circle of radius

$$\left(\frac{a^2 + b^2}{2} \right)^{\frac{1}{2}}.$$

Now $\lambda = 3010300/1961199$, two convergents to which are $3/2$ and $20/13$. Taking the former of these—a course which entails the extraction of no roots other than the square and the cube—we obtain the following result:—The perimeter of an ellipse is approximately equal to the circumference of a circle the radius of which is the semi-cubic mean of the semi-axes of the ellipse (see *Messenger of Math.*, xii. pp. 149–151; *Proc. Manchester Lit. and Phil. Soc.*, February 1, 1901).

But by far the best result of this kind known to me may be put in the shape of a rule as follows:—To obtain the radius of a circle the circumference of which will be a close approximation to the perimeter of a given ellipse, diminish twenty-one times the arithmetic mean of the semi-axes of the ellipse by twice the geometric mean and thrice the harmonic mean and divide the remainder by 16. As an illustration of the value of this, we may take the classical example where $a = 1$ and $b = .8$. The three means A, G, H, referred to in the rule are then $.9$, $\sqrt{.8}$, $8/9$ and

$$\begin{aligned} \frac{21A - 2G}{16} &= \frac{18.9 - \frac{2}{3}\sqrt{.8}}{16} \\ &= \frac{18.9 - (1.7885544 - 2.6666666)}{16} \\ &= \frac{18.9 - 4.4555210}{16} \\ &= \frac{14.4444790}{16} \\ &= .90277993. \dots \end{aligned}$$

Now, according to Legendre, the perimeter in this case is $2\pi(90277992)$, so that the rule gives the desired result correct to within one hundred-millionth of 2π .
 THOMAS MUIR.
 Cape Town, South Africa, May 19.

The "Armor" Electro-Capillary Relay.

In reply to your correspondent "J.S." (p. 151), I may say that the model which I saw did actually work; it illustrated the flow of mercury from a fine jet when subjected to the influence of a small electromotive force, in the same way as described with reference to Fig. 1 of my article. I think your correspondent slightly misunderstands the principle of the instrument; it is not the small movement of the mercury, such as is used in the ordinary capillary electrometer, which works the relay lever; this movement merely serves to force some of the mercury out of the jet, and the falling mercury then moves the lever.

The inventors claimed that they had succeeded in effecting so nice a balance of forces that the mercury flowed from the jet under a very small influence. I join with your correspondent in the desire (which I expressed also in my article) that some trustworthy data concerning the instrument should be published.
 June 13. THE WRITER OF THE ARTICLE.

SCIENCE AND MILITARY EDUCATION.

THE report of the Military Education Committee was issued to the public on Saturday, June 7, and has been the subject of much comment in the Press. The conclusions and recommendations of the Committee have been well received on the whole, though there are some exceptions, as in the case of the *Spectator*, which would wish to see Sandhurst done away with, or rather used in an entirely different manner and at a later stage in the officer's career, and in that of the military correspondent of the *Times*, who, in the course of a long article, falls foul of an important passage relating to science, and in effect advises the War Office not to accept or act upon the recommendations of the Committee on this subject. The writer of the article goes so far, indeed, as to suggest that the Committee has not sufficiently considered the evidence, quoting Sir George Clarke in support of the merits of Latin in such a way that we were not a little surprised on turning to Sir George's evidence to find that, when questioned as to the proper preliminary training of cadets (Question 839), he expressed the opinion that they should have a "broad, liberal education," adding that "the broader it is and the wider its scope, and the sounder generally, the better it will fit them for the special training they receive afterwards."

The passage objected to by the *Times* correspondent (20) will be found on p. 5, and, appearing as it does over the signatures of two such eminent representatives of classical training as the head masters of Eton and St. Paul's, is so important that we print it in full. It is as follows:—

"The fifth subject which may be considered as an essential part of a sound general education is experimental science, that is to say, the science of physics and chemistry treated experimentally. As a means of mental training, and also viewed as useful knowledge, this may be considered a necessary part of the intellectual equipment of every educated man, and especially so of the officer, whose profession in all its branches is daily becoming more and more dependent on science."

Considering the uncompromising terms of this statement, it is disappointing to find that a committee holding such clear and strong views should have found itself, in the event, unable to agree upon a scheme which would ensure that this "necessary part of the intellectual equipment of every educated man" should be provided for each and all our future officers. For it cannot be denied that the actual position proposed for science in the scheme recommended, viz. that it should be alternative

in Class I. with Latin, will put it in the power of opponents of science to prevent candidates who may come under their influence from having the opportunity of securing this "essential part of a sound general education."

In saying this we do not overlook the fact, as some are disposed to do, that the proposed arrangements will allow those who select Latin as their subject in Class I. to offer science as a Class II. subject, and that, consequently, neither of these two necessary subjects need be neglected. But after making all allowance for the manner in which the scheme as a whole will qualify the effect of the relations of Latin and science in Class I., we think the Committee has not sufficiently regarded the fact that as Latin is begun at a very early age, but chemistry and physics much later, candidates choosing their subjects at about fifteen, as many, and perhaps most, of them must do, will be much more likely to select the former than the latter from Class I. (see Questions 8630, 8631, 8632), leaving science for Group II., where, however, it becomes an alternative with several other subjects, and so is very likely to be squeezed out.

It is a striking illustration of the effects of the neglect of science in our educational system, which even now is being remedied but slowly in some of our schools, that so many soldiers and others still make the mistake of supposing that as regards science the Army only needs "a proportion of scientific experts among military officers for suggesting and following up improvements in matériel," and that "the majority of such experts can be better obtained from civilian sources outside the Army than from within its ranks." The last part of this statement is, indeed, in spite of all the fine qualities of our officers, only too sadly true. But it is just because the basis of military education (and indeed of nearly all English education in the case of the abler members of the higher classes) has been too narrow in the past that the Army has failed to throw up a sufficient supply, we will not say of trained scientific specialists, but of officers capable of understanding the specialists, of absorbing their ideas, mastering their methods and applying these in the operations of war. How can we expect average men whose training has been mainly in language and mathematics to be resourceful and confident when brought face to face with the problems created for their profession by the revolutions of the last half century? Every question, said Liebig, one of the creators of much that is strongest in modern Germany, put to science clearly and definitely has been satisfactorily answered before long. Only when the inquirer has no precise idea of the problem to be solved does he remain unsatisfied for long. It is just because the majority of our officers have not had the broadest training possible, that so many are unable to make use of the new powers that science holds out to them, and are still under the mistaken impression that the main use of science in education lies in the facts which it provides.

It is clear that even now many educators and soldiers have not grasped the real elements of this great problem, and that they still fail to see that the object with which science is now taught is, not to convey a few more facts or a few facts of a new kind, but to preserve those habits of mind and that fertility of resource which daily become more important in face of the problems of modern life, and which are not to be gained by a purely literary and mathematical training. All will agree that faculties which must especially be cultivated in our officers "are power of command, habits of leadership, and the ability to act decisively and correctly at the right time and place." But when it is contended, as it often is, that "study in a chemical laboratory does not make for this kind of fitness," it is forgotten that laboratory work properly done will certainly develop these qualities at least as well, and probably better, than any study in

which books only are concerned, and that we do not teach either science or Latin, mathematics or modern languages primarily to produce the habit of command, but because the habit of command and the ability to act with decision have a tenfold value in the man who is mansided in his knowledge and experience and who, in the language of the street, "knows where he is" in many departments of human activity.

The object of a training in experimental science is not to stuff the mind with knowledge, as so many still seem to think, but to open and prepare it to receive and rightly apply knowledge in the after working years of life. Those persons are indeed ignorant who suppose that in a modern course of work, let us say, in physics, a boy's mind is "stuffed with knowledge" or that a course of work in electricity gives less play to the imagination than getting up vocabularies or irregular verbs. But we must not follow a bad example; these things also make for goodness in their degree.

As we have said above, the report of the Committee has, as regards its main features, been received with a chorus of approval, and little remains to be said about it. We think the proposal of an expert educational committee with advisory powers excellent. We are glad that whilst science and Latin are alternative subjects in Class I., the subject not taken as a Class I. subject can be taken as a Class II. subject. At the same time, we regret that Sir Michael Foster did not succeed in prevailing on his colleagues to embody in their final recommendations the admirable opinion which we quote at the beginning of this article.

If we may judge from the tenor of the discussion at the Conference of Science Masters last Christmas, we think the proposed changes in regard to practical work in chemistry will be widely welcomed. But if this reform is to work well, no attempt must be made to add the new scheme of practical work to the old requirements in qualitative analysis. The time which did not suffice for the latter alone cannot be sufficient for both together. We believe, too, that many teachers both of chemistry and physics would be most willing to see the scope of the syllabus in their special subject reduced a little, in order to secure that all candidates taking science should include in their work the "pass part" portions of both the chemical and physical divisions of science.

A HOLIDAY CRUISE TO ALASKA.¹

THESE two handsome and magnificently illustrated volumes should be brought to the notice of every man of wealth as a lesson in the art of spending a holiday. He will learn therefrom how this may be done with permanent satisfaction to himself and permanent advantage to science.

In a pointedly brief and unassuming preface the patron of the expedition explains that, having planned a summer cruise through Alaskan waters for himself and his family, he found that the steamer which he had chartered would accommodate a larger party, and therefore resolved to seek "some guests who, while adding to the interest and pleasure of the expedition, would gather useful information and distribute it for the benefit of others."²

By the advice of his physician he obtained the aid of Dr. C. Hart Merriam, chief of the Biological Survey of the U.S. Department of Agriculture, in carrying out this plan.

The outcome is succinctly stated in the introduction (pp. xxv-xxxi) by Dr. Merriam, who has most capably

fulfilled his duties as general editor to the records of the cruise:—

"In the early spring of 1899 Mr. Edward H. Harriman of New York, in cooperation with the Washington Academy of Sciences but entirely at his own expense, organised an expedition to Alaska. He invited as his guests three artists and twenty-five men of science, representing various branches of research and including well known professors in universities on both sides of the continent, and leaders in several branches of Government scientific work. . . . The expedition sailed from Seattle May 30 . . . and was gone just two months."

The ship threaded the "inside passages" from Puget Sound to Juneau, Skagway and Sitka; thence along the open coast to Cook Inlet and the Alaska Peninsula, and past the Aleutian Islands into Bering Sea, up to the entrance to Bering Strait, touching at Eskimo settlements on both the Asiatic and American coasts, and then turning homeward. The voyage was not in itself in any way remarkable; the interest centres in the personnel and methods of the expedition.

As for the personnel—the following list will show that the selected scientific party was qualified to take advantage of every opportunity. Botany was represented by F. V. Coville and T. H. Kearney, jun., of the U.S. Department of Agriculture, and by Prof. B. E. Fernow, of Cornell, Dr. A. Saunders and Dr. W. Trelease; zoology in its various branches by Dr. W. R. Coe, of Yale, D. G. Elliot, of the Field Columbian Museum, Dr. A. K. Fisher and Dr. C. H. Merriam, of the U.S. Department of Agriculture, R. Ridgway, of the Washington National Museum, C. A. Keeler, of the San Francisco Museum, Prof. W. E. Ritter, of the University of California, Prof. T. Kincaid, of the University of Washington State, and Dr. G. B. Grinnell; geology and geography by Dr. W. H. Dall, G. K. Gilbert and H. Gannett, of the U.S. Geological Survey, and Prof. B. K. Emerson, of Amherst; mineralogy by Dr. C. Palache, of Harvard, and W. B. Devereux; meteorology by Prof. W. H. Brewer, of Yale; and nature-lore in its literary aspect by John Burroughs and John Muir. Of the three artists on the ship Mr. L. A. Fuertes was a specialist in bird-portraiture—sixteen of the many beautiful coloured plates which adorn these volumes attesting his skill. We learn, moreover, that a fourth artist was sent to Alaska in the following year for the special purpose of securing drawings and paintings of Alaskan plants! The expedition also included two photographers, two taxidermists, two stenographers; with a chaplain, two physicians and a trained nurse. The Harriman family party numbered eleven.

As for the methods—these seem to have been in every way admirable. Under unskillful management the scheme would probably have come to naught through the stress of divergent interests. But the patron of the expedition met the occasion like a whole-hearted democrat. His procedure is thus described by Dr. Merriam:—

"The day after leaving New York Mr. Harriman called together the members of the Expedition and announced that it was not his desire to dictate the route to be followed, or to control the details of the work. In accordance with his wishes a business organization was effected, comprising an executive committee, a committee on route and plans, and special committees on the various scientific activities. These committees, throughout the voyage, held frequent meetings and determined from day to day the operations of the expedition. . . .

"Among the unusual features which contributed to the success of the Expedition, three are worthy of special mention:—

"(1) The ship had no business other than to convey the party whithersoever it desired to go. Her route was entrusted to a committee comprising the heads of the various departments of research; so that from day to day and hour to hour her movements were made to subservise the interests of the scientific work.

"(2) The scientific staff represented varied interests and was made up of men trained in special lines of research.

¹ "Alaska. Harriman Alaska Expedition, 1899." 2 vols. Royal 8vo. Pp. xxxvii + 333; with 39 coloured plates, 85 photogravure plates, 240 text figures and 5 maps. Vol. i. Narrative, Glaciers, Natives. Vol. ii. History, Geography, Resources. By many authors. (New York: Doubleday, Page and Co., 1901.)

"(3) The equipment was comprehensive, including naphtha launches, small boats and canoes, camping outfits, stenographers, photographers, and extra men for oarsmen and helpers, thereby reducing to a minimum the time necessary to accomplish material results. . . ."

To indicate what *was* accomplished let us again quote Dr. Merriam:—

"During the two months' cruise a distance of nine thousand miles was traversed. Frequent landings were made, and, no matter how brief, were utilised by the artists, photographers, geologists, botanists, zoologists, and students of glaciers. From time to time longer stops were made and camping parties were put ashore that more thorough work might be done. Thus one or more camping parties operated at Glacier Bay, Yakutat Bay, Prince William Sound, Kadiak Island, the Alaska Peninsula and the Shumagin Islands. Large and important collections were made, including series of the small mammals and birds of the coast-region,—

and here we may break off to note that Burroughs, in a later part of the volume (p. 62), mentions that one day the ship "made a voyage of sixty miles to enable our collectors to take up some traps, the total catch of which proved to be nine mice,"—

"enormous numbers of marine animals and seaweeds, and by far the largest collections of insects and land-plants ever brought from Alaska. There were also small collections of fossil shells and fossil plants. In working up this material the services of more than fifty specialists have been secured, and although the task is by no means finished, thirteen genera and nearly six hundred species new to science have already been discovered and described. The natural history specimens have not merely enriched our museums, they have increased many fold our knowledge of the fauna and flora of Alaska. . . ."

"A number of glaciers not previously known, as well as many others which had been vaguely or imperfectly known, were mapped, photographed and described, and much evidence was gathered of changes that have occurred in their length and size. . . . In Prince William Sound a new fiord fifteen miles in length and abounding in glaciers was discovered, photographed, and mapped. . . . The large number of photographs taken by the professional photographers on board was materially increased by cameras belonging to various members of the Expedition, and in all not less than five thousand photographs were secured. These cover many parts of the coast region from British Columbia to Bering Strait, and constitute incomparably the best series of pictures of the region thus far obtained."

The publication of the results has been undertaken in the same well-ordered and liberal spirit. The two volumes before us

"contain the narrative of the expedition and a few papers on subjects believed to be of general interest. The technical matter, in the fields of geology, palæontology, zoology and botany, will follow in a series of illustrated volumes. Twenty-two special papers, based on collections made by the Expedition, have been already published in the Proceedings of the Washington Academy of Sciences, and others will follow. All this material will be brought together in the volumes of the technical series."

Having dealt somewhat fully with the organisation and methods of this truly exemplary expedition, let us now glance briefly over the principal contents of the book, which constitute the best general description of Alaska hitherto published.

The narrative of the cruise by John Burroughs (pp. 1-118) is a piece of literary workmanship such as only an able and well-practised writer with a keen eye for nature and under the stimulus of scenes new to him could have penned. This part will appeal more strongly to the general reader than to the man of science, for to the latter the blending of emotional sentiment with technical description, however skilfully done, can rarely fail to give a sense of incompatibility and distortion. As literature, however, these word-pictures are excellent; we will quote, as an example, Mr. Burroughs' impression of a distant view of Mount St. Elias (p. 55):—

"The base and lower ranges had been visible for some time, bathed in clear sunshine, but a heavy canopy of dun.

coloured clouds hung above us and stretched away toward the mountain, dropping down there in many curtain-like folds, hiding the peak. But the scene-shifters were at work; slowly the heavy mass of clouds that limited our view yielded and was spun off by the air-currents till at last the veil was completely rent, and there, in the depths of clear air and sunshine, the vast mass soared to heaven.

"There is sublimity in the sight of a summer thunder-head with its great white and dun convolutions rising up in miles against the sky, but there is more in the vision of a jagged mountain crest piercing the blue at even a lesser height. This is partly because it is a much rarer spectacle, but mainly because it is a display of power that takes greater hold of the imagination. That lift heavenward of the solid crust of the earth, that aspiration of the insensate rocks, that effort of the whole range, as it were, to carry one peak into heights where all may not go—every lower summit seeming to second it and shoulder it forward till it stands there in a kind of serene astronomic solitude and remoteness—is a vision that always shakes the heart of the beholder."

The general narrative is succeeded by a series of profusely illustrated articles on special subjects. First we have "Notes on the Pacific Coast Glaciers," by John Muir (pp. 119-135), who was one of the earliest explorers of the Alaskan ice-fields and is able to compare the present limits of some of the glaciers with their extent in 1879, when he first visited them. He states that in Glacier Bay,

"the Hugh Miller and Muir have receded about two miles in the last twenty years, the Grand Pacific about four, and the Geikie, Rendu and Carrol perhaps from seven to ten miles."

The remaining portion of the first volume (pp. 137-183) is occupied by a concise account of the Indians and Eskimo of the Alaska coast region, by Dr. G. B. Grinnell, closing with the usual lament over the destruction of the weaker race by the influx of the horde of gold-seeking white men, "uncontrolled and uncontrollable."

The second volume opens with a history of the discovery and exploration of Alaska by the veteran Dr. W. H. Dall, whose thirteen previous visits to the territory render him thoroughly qualified to deal with the subject. He treats fully of the early period up to the transference of the country by Russia to the United States in 1867, but sums up the subsequent events in a few sentences, remarking (p. 203) that

"a history of conditions in Alaska from 1867 to 1897 is yet to be written, and when written few Americans will be able to read it without indignation. A country of which it could be said with little exaggeration that

'Never a law of God or man
Runs north of fifty-five'

a country where no man could make a legal will, own a home-stead or transfer it, or so much as cut wood for his fire without defying a Congressional prohibition: where polygamy and slavery and the lynching of witches prevailed, with no legal authority to stay or punish criminals; such in great part has Alaska been for thirty years."

He notes also:—

"To one conversant with the facts, one of the most amusing things in current literature is the placid innocence of many a casual traveler or gold hunter, who pours out his tale of experiences in the confident belief that nothing of the kind is on record. A bibliography, far from complete, yet with fully 4000 titles, does not cover the publications in books and serials upon the Territory and its adjacent regions."

The next article is on "Days among Alaska Birds," by Mr. Charles Keeler (pp. 205-234), richly illustrated with coloured plates. Many readers will be somewhat astonished to learn that one of the humming-birds is found abundantly as far north as Juneau and Sitka, and will feel with Mr. Keeler that the bird "seemed singularly out of place."

"Indeed, even after reading that the tiny rufous humming-bird journeyed so far into the northern wilds, it was with almost a shock of surprise that we saw the dainty creature, which we

instinctively associate with the tropics, contentedly buzzing about the salmon berries and appearing as unconcerned and happy as if his fine wings had not carried him some thousands of miles from his winter quarters in southern California or Mexico. I cannot imagine a more wonderful instance of bird migration than this—one of the smallest known birds, no larger than a fair-sized moth, yet with strength, endurance, and intelligence to travel up and down the greater part of the North American coast line, pressing close upon the train of early spring, awaiting only the blooming of the wild currant in California and the salmon berry farther north, to venture upon his perilous way!

What erroneous deductions as to the climate of an "inter-glacial period" would probably be drawn if the remains of a humming-bird were found in a peat bed between deposits derived from glaciers!

The "Forests of Alaska" are described by Prof. B. E. Fernow (pp. 235-256), who points out that their economic value has been much over-estimated. He notes "the astonishing indifference to the influence of the near-by ice-masses" shown by the trees growing in close proximity to some of the great glaciers and even upon their surfaces where covered by moraine material. This article contains some interesting observations on the propagation and spread of forest growth.

The general geography and physiography of the territory are the subject of a lucid article by Mr. H. Gannett (pp. 257-277). In mentioning that the present glaciers are "only trifling fragments" of the great glaciers which occupied this region a short time ago, it is remarked that, nevertheless,

"all the glaciers of Switzerland together would form but a few rivulets of ice on the surface of the Muir Glacier, and the Muir is but one of many glaciers of equal magnitude."

All observers of the glacial phenomena of the region will probably agree with Mr. Gannett that the period since the retreat of the ice from the present water-channels of the coast cannot have been long. It is evident that in Alaska, as in several other glacier-fields of the globe, if the existing ice were entirely removed, few of the glaciers could ever regain their present dimensions under the climatal conditions which now prevail. And it seems probable that in some degree the present glaciers represent the lingering remnants of the great ice-fields of the Glacial period.

"The Alaska Atmosphere" is dealt with by Prof. W. H. Brewer (pp. 279-289), who lays especial stress upon the effects produced by the relatively dustless condition of the air.

An article on "Bogoslof, our Newest Volcano," by Dr. C. H. Merriam (pp. 291-336), copiously illustrated with views of the two new volcanic islands at various periods in their history, and provided with a bibliographical appendix, will appeal to every volcanist.

In describing "The Salmon Industry" (pp. 337-355), which has attained such gigantic proportions in Alaska, Dr. G. B. Grinnell once more calls attention to the wretchedly wasteful methods adopted by the salmon canners in defiance of Congressional laws which there is scarcely a pretence of enforcing, and to the consequent extraordinarily rapid depletion of supplies supposed at first to be inexhaustible. It is the common story of the white pioneer in every part of the globe:—

"All these people recognise very well that they are destroying the fishing; and that before very long a time must come when there will be no more salmon to be canned at a profit. But this very knowledge makes them more and more eager to capture the fish and to capture all the fish. This bitter competition sometimes leads to actual fighting,—on the water as well as in the courts. A year or two since, one company which was trying to stop another from fishing on ground which it claimed as its own, sent out its boats with immense seines, and dropping them about the steam launches of its rival tried to haul them to the shore. . . . Thus the cannery work in a most wasteful and thoughtlessly selfish way, grasping for everything that is within

their reach and thinking nothing of the future. Their motto seems to be, 'If I do not take all I can get somebody else will get something.'"

The final article of the book, however, reveals the pioneer in the unaccustomed rôle of conservator. It consists of a highly interesting account, by Mr. M. L. Washburn, of "Fox Farming in Alaska" (pp. 357-365), a new industry which in itself is a striking illustration of western resourcefulness and may lead to important future developments.

"Something like fifteen years ago a few men in western Alaska, realizing that fur-bearing animals were doomed, decided to try the experiment of propagating some of the more valuable kinds. Having resided on the Seal or Pribilof Islands and observed that the blue fox became somewhat tame, they resolved to try its domestication by placing a small number on protected islands and caring for them as the stockman cares for his herd of cattle or sheep. About twenty foxes were taken from St. Paul Island of the Pribilof group, and placed on North Semidi, one of the hundreds of unoccupied islands of Alaska, and thus the experiment began. . . . From North Semidi, the original 'fox-ranch,' if one may employ such a term, foxes were taken to other islands along the Alaska coast and the experiments continued. The results though sometimes discouraging and not always financially successful, have shown on the whole that the animal could be raised and its valuable pelt obtained with as much regularity as in the case of the humble domestic animals. About thirty islands are now stocked with blue foxes—all the outgrowth of the small stock of twenty foxes taken from St. Paul Island fifteen years ago."

A description is given of one of these ranches where there are now 800 to 1000 foxes. The animals soon learn to recognise their keepers and come to know the feeding time, gathering round for their daily allowance, and afterwards scattering about the island until the time for the next day's dinner. In short, the blue fox has been added to the list of domesticated animals. The probable outcome is thus stated:—

"It is believed that the time is not far distant when hundreds of the now useless islands of Alaska will be utilised in the propagation of fur-bearing animals, and that many of the farmers of the Northern States [*let Canadians take note!*] will have wire-fenced enclosures of an acre or two devoted to this industry, from which they will reap a far greater return than from all the rest of their live stock."

For the excellency of the paper, printing, illustrations and binding, as well as for their contents, these volumes are indeed highly to be commended. As an instance of rare unobtrusiveness and good taste we may mention that in spite of its almost immoderate wealth of illustration not a single portrait of Mr. Harriman or of any member of his family party is to be found in the work.

That the literary and scientific members of this summer cruise should have occasionally burst into song causes us no surprise; and the sprinkling of verse in the volumes is distinctly pardonable in the circumstances.

G. W. L.

OBSERVATIONS OF VOLCANIC ACTIVITY IN THE WEST INDIES.

FURTHER details of the recent volcanic eruptions at Martinique and St. Vincent continue to reach us through West Indian and other papers. Though the great eruptions of Mont Pelée and the Soufrière occurred on May 7-8, the *Dominica Guardian* states that shocks of earthquake were felt so far back as February of last year. These disturbances were noticed several times during the year, and were regarded as serious in February of this year. From April 20 also until the eruption, rumbling sounds were frequently heard, especially at Fancy and at Frasers. Nineteen shocks were experienced within half an hour on May 3 at Wallibou,

and the disturbances became more noticeable as the days went on, until, on May 5, the Soufrière gave definite warnings of its renewed activity. The Rev. J. H. Darrell, writing from Kingstown, St. Vincent, on May 9, gives, in the *Dominica Guardian*, the following account of the subsequent eruptions of this volcano:—

It was on Tuesday, May 6, at 3 p.m., that the mountain commenced its series of volcanic efforts. A strong shock of earthquake, accompanied by a terrible noise, occurred, and the volcano began to emit steam. At 5 p.m. louder and more frequent explosions were heard, the detonations succeeding each other at rapidly diminishing intervals. At 7.30 p.m. columns of steam issued from the old crater with terrific noise. These lasted until midnight, when another heavy explosion occurred.

At 7 a.m. on Wednesday, May 7, there was another sudden and violent escape of pent-up steam, which continued ascending until 10 a.m., when other material began to be ejected. It would seem that this was the time when the enormous mass of water in the lake of the old crater was emitted in a gaseous condition. By 12 o'clock noon it appeared that there were three craters vomiting lava—the old crater that had contained the lake, the second crater that opened in 1812, and a third crater that had burst open in the present eruption. Six distinct streams of lava were visible, running down the sides of the mountain. The mountain heaved and laboured to rid itself of the burning mass of lava heaving and tossing below. By 12.30 p.m. it was evident that it had begun to disengage itself of its burden by the appearances as of fire flashing now and then around the edge of the crater. There was, however, no visible ascension of flame. These flame-like appearances were, I think, occasioned by the molten lava rising to the neck of the volcano. Being quite luminous, the light emitted was reflected from the banks of steam above, giving them the appearance of flame.

From the time the volcano became fully active, tremendous detonations followed one another so rapidly that they seemed to merge into a continuous roar which lasted all through the night of May 7 and up to 6.30 a.m. on May 9. These detonations and thunders were heard as far as Barbados, 100 miles distant, as well as in Grenada, Trinidad and the south end of St. Lucia. At 12.10 p.m. I left in company with several gentlemen in a small row boat to go to Chateaubelair, where we hoped to get a better view of the eruption. As we passed Layou, the first town on the leeward coast, the odour of sulphuretted hydrogen was very perceptible. Before we got half way on our journey a vast column of steam, smoke and ashes ascended to a prodigious elevation. The majestic body of curling vapour was sublime beyond imagination. We were about eight miles from the crater, as the crow flies, and the top of the enormous column, eight miles off, reached higher than one-fourth of the segment of the circle. I judge that the awful pillar was fully eight miles in height. We were rapidly proceeding to our point of observation, when an immense cloud, dark, dense, and apparently thick with volcanic material, descended over our pathway, impeding our progress and warning us to proceed no further. This mighty bank of sulphurous vapour and smoke assumed at one time the shape of a gigantic promontory, then appeared as a collection of twirling, revolving cloud-whirls, turning with rapid velocity, now assuming the shape of gigantic cauliflower-like forms, then efflorescing into beautiful flower-shapes, some dark, some effulgent, others pearly white, and all brilliantly illuminated by electric flashes. Darkness, however, soon fell upon us. The sulphurous air was laden with fine dust that fell thickly upon and around us discolouring the sea; a black rain began to fall, followed by another rain of favilla, lapilli and scorie.

The electric flashes were marvellously rapid in their motions and numerous beyond all computation. These with the thundering noise of the mountain mingled with the dismal roar of the lava, the shocks of earthquake, the falling of stones, the enormous quantity of material ejected from the belching craters, producing a darkness as dense as a starless midnight, the plutonic energy of the mountain growing greater every moment combined to make up a scene of horrors. It was after five o'clock when we returned to Kingstown, cowed and impressed by the weirdness of the scene we had witnessed, and covered with the still thickly falling grey dust. Of what this material is composed I am unable to give a certain opinion; but it appears to consist of

comminuted rock, produced by attrition of the material as in successive outbursts it is hurled aloft and then tumbles back again to the burning crater to be ejected finally as impalpable dust. So minute are the particles that they find their way through the finest chinks of a closed room. Large areas of cultivation have been buried under the fall of the dust. Its effects upon vegetation will probably be beneficial ultimately, but in the meantime great suffering as well as inconvenience is occasioned thereby. The awful scene was renewed yesterday (May 8) and again to-day. At about 8 a.m. the volcano shot out an immense volume of material which was carried in a cloud over Georgetown and its neighbourhood, causing, not only great alarm, but compelling the people by families to seek shelter in other districts.

More than 400 lives have been lost on the windward side of the island, chiefly from lightning, and we have not yet heard from other parts of the island in that neighbourhood. The flowing lava on the leeward side of the mountain has buried up the Wallibou and Richmond villages and estates, while on the windward side of the mountain the estates of Lot Fourteen, Rabacca, Overland, Tourama, Orange Hill, Mount Bentinck, Langely Park and portions of others have been obliterated.

It is now 2 p.m. (May 9). A dense gloom still envelops the mountain, but there has been no further eruption since 8 a.m. Several streams and rivers have dried up in various parts of the island, and we are threatened with a water as well as a food famine.

As already announced, the National Geographic Society of Washington has sent a special expedition to Martinique and St. Vincent to investigate the volcanic conditions of the West Indian regions. The members consist of Mr. Robert T. Hill, of the U.S. Geological Survey; Prof. Israel C. Russell, professor of geology in the University of Michigan, Ann Arbor; Commander C. E. Borchgrevink, the Antarctic explorer; Dr. T. A. Jagger, of Harvard University; Mr. G. C. Curtis, of Cambridge, U.S.A., and Dr. Angelo Heilprin, president of the Philadelphia Geographical Society.

The expedition is one of the most important and best equipped commissions ever sent out to study actual volcanic action. Results of scientific and practical consequence may therefore be expected from the work of the members of the party. On their return to the United States they will report the results of their observations to the National Geographic Society. This report, forming a series, will be published in full in the journal of the Society, the *National Geographic Magazine*, the June number of which contains a preliminary account of the observations already made.

Upon arriving at Martinique, Dr. Hill embarked on a steamer and examined the coast as far north as Macouba Point, the north end of the island, making frequent landings. After landing at Le Prêcheur, a little village five miles north of St. Pierre, he walked through an area of active volcanism to the destroyed city. Dr. Hill, according to the Associated Press despatches from Fort de France, was the first man to set foot in the active area of craters, fissures and fumaroles.

On his return to Fort de France he issued a brief statement as to his observations to the National Geographic Society, and it is here abridged from the Society's magazine.

The zone of the catastrophe in Martinique forms an elongated oval, containing on land about eight square miles of destruction. This oval is partly over the sea. The land part is bounded by lines running from Le Prêcheur to the peak of Mont Pelée, thence curving around to Carbet. There were three well-marked zones:—

(1) A centre of annihilation, in which all life, vegetable and animal, was utterly destroyed. The greater northern part of St. Pierre was in this zone.

(2) A zone of singing, blistering flame, which also was fatal to all life, killing all men and animals, burning the leaves on the trees, and scorching, but not utterly destroying, the trees themselves.

(3) A large outer, non-destructive zone of ashes, wherein some vegetation was injured.

The focus of annihilation was the new crater, midway between the sea and the peak of Mont Pelée, where now exists a new area of active volcanism, with hundreds of fumaroles, or miniature volcanoes.

The new crater is now vomiting black, hot mud, which is falling into the sea. Both craters, the old and new, are active. Mushroom-shaped steam explosions constantly ascend from the old crater, while heavy ash-laden clouds float horizontally from the new crater. The old one ejects steam, smoke, mud, pumice and lapilli, but no molten lava.

The salient topography of the region is unaltered. The destruction of St. Pierre was due to the new crater. The explosion had great superficial force, acting in radial directions, as is evidenced by the dismounting and carrying for yards the guns in the battery on the hill south of St. Pierre and the statue of the Virgin in the same locality, and also by the condition of the ruined houses in St. Pierre.

According to the testimony of some persons, there was an accompanying flame. Others think the incandescent cinders and the force of their ejection were sufficient to cause the destruction. This must be investigated.

On Monday, May 26, Dr. Hill started on horseback from Fort de France for Morne Rouge and Mont Pelée. He reached Morne Rouge safely on May 27, where he succeeded in getting a number of photographs. A close approach to Mont Pelée was impossible, so he started back in a southerly direction. During the two nights he was camping out he made some important observations of volcanic action, and on his return issued the following statement:—

My attempt to examine the crater of Mont Pelée came to a futile end. I succeeded, however, in getting very close to Morne Rouge. At 7 o'clock on Monday evening I witnessed from a point near the ruins of St. Pierre a frightful explosion from Mont Pelée, and noted the accompanying phenomena. While these eruptions continue no sane man should attempt an ascent to the crater of the volcano. Following the salvoes of detonations from the mountain, gigantic mushroom-shaped columns of smoke and cinders ascended into the clear, starlit sky, and then spread in a vast black sheet to the south and directly over my head. Through this sheet, which extended a distance of ten miles from the crater, vivid and awful lightning-like bolts flashed with alarming frequency. They followed distinct paths of ignition, but were different from lightning, in that the bolts were horizontal and not perpendicular. This is indisputable evidence of the explosive oxidation of the gases after they left the crater. This is a most important observation, and it explains in part the awful catastrophe. This phenomenon is entirely new in volcanic history.

I took many photographs, but do not hesitate to acknowledge that I was terrified.

Nearly all the phenomena of these volcanic outbreaks are new to science, and many of them have not yet been explained. The volcano is still intensely active, and I cannot make any predictions as to what it will do.

Associated Press messages from Martinique, dated May 31, announced that Prof. Heilprin had succeeded in climbing to the top of the crater of Mont Pelée. The despatch is as follows:—

Prof. Angelo Heilprin this morning ascended to the top of the crater on the summit of Mont Pelée.

The expedition left Fort de France last Thursday, May 29, at noon. Friday was spent in studying the newly formed craters on the north flank of the mountain. Saturday morning Prof. Heilprin determined to attempt the ascent to the top of the crater, and with this purpose in view he set out at five o'clock.

The volcano was very active, but Prof. Heilprin reached the summit and looked down into the huge crater. Here he spent some time in taking careful observations. He saw a huge cinder cone in the centre of the crater. The opening of the crater itself is a vast crevice 500 feet long and 150 feet wide.

While Prof. Heilprin was on the summit of the volcano, several violent explosions of steam and cinder-laden vapour took place, and again and again his life was in danger. Ashes fell about him in such quantities at times as to obscure his vision completely.

Prof. Heilprin found that the crater at the head of the River Fallaise has synchronous eruptions with the crater at the summit of the volcano, and that it ejects precisely the same matter at such times.

On May 31 a party consisting of Prof. Jaggard, of Harvard University, Dr. Hovey, of the American Museum of Natural History of New York, and Mr. George C. Curtis, ascended to the summit of the Soufrière of St. Vincent from the western side.

The ascent was exceedingly difficult, owing to the mud that covered the mountain side, but the ground was cold. After a tiresome scramble up the slippery hill, the rim of the old crater was reached about midday. There was no trace whatever of vegetation, but there had been no change in the topographical outlines of the mountain on that side, and the old crater retained its tragic beauty. The great mass of water that formerly lay serenely about 500 feet below the rim of the crater had disappeared, and the crater appeared to be a dreadful chasm more than 2000 feet deep. With the aid of a glass, water was made out at the bottom of this abyss.

The party did not venture across the summit of the Soufrière to inspect the new crater, which was then emitting a little vapour, for the ground in that direction looked to be dangerous.

Apparently the ridge of the mountain, called "The Saddle," was intact, although the old crater seemed of larger circumference than before the recent eruption. At the western base of the Soufrière a subsidence of a depth of 100 feet occurred for an area of a square mile. The bank of volcanic dust that prevents the sea encroaching farther inland at Wallibus is being gradually washed away. The lava beds on the eastern side of the Soufrière continue to emit steam, despite the protracted and heavy rainfall that has occurred.

Mr. Knight, Senator for Martinique, has arrived in Paris, and a few of his observations of the condition of men and things in that island are given in yesterday's *Times*. He says that the streams of mud which are still flowing do not emerge from the flanks of the volcano, but from the constantly convulsed ground, now opening in large abysses and then closing. Evidence that the death of the victims of the Mont Pelée eruption must have been instantaneous was obtained from the appearance of the bodies discovered.

Thus, persons have been found on the thresholds of their nearly demolished houses in the attitude of gazing at Mont Pelée. Others were found seated at a table. One man, discovered in the middle of the street, had the muscles of his legs and arms fixed in the attitude of a runner. Others were shaking hands.

PROF. ADOLF FICK.¹

WITH Adolf Fick, the physiologist of Würzburg, whose death took place in the autumn of last year at Blankenburg, there passed away one of the last representatives of the brilliant physiological school by the combined labours and critical acumen of which, during the latter half of the past century, the foundations of modern physiology were established. For the complete appreciation of the man's whole character, however, regard should be had as well to Adolf Fick's energetic and practical support of public, and, in particular, educational questions, as to his distinction as investigator, man of science and teacher. In all matters that he took in hand he made a striking and original appearance, and he merits a special place in the honour roll of history.

Fick, in whom as a youth conspicuous mathematical talent had already displayed itself, sought the university with the intention of studying mathematics. His elder brother, Heinrich, who died a few years ago while professor of Roman law at Zürich, urged him to the study of medicine, and this he pursued at Marburg and Berlin.

¹ Abridged from an obituary notice by Prof. Kunkel.

At the former university he graduated in September 1851. As early as the year 1852 he worked as prosecutor under C. Ludwig, whose close friendship he retained throughout life.

In 1856 he went into residence at Zürich; and, in succession to Ludwig and Moleschott, obtained in 1862 the full professorship of physiology there, which he retained for six years. In the year 1868, upon Von Bezold's early death, Fick was called to Würzburg, where he filled the chair of physiology for thirty-one years. He resigned his post at the end of the summer term of 1899, not from distaste for work or through the burden of years, but while in full vigour of mind and body, in the strict fulfilment of a long-expressed intention of making way, on the completion of his seventieth year of life, for the energies of a younger man.

At the time when Fick entered upon the study of physiology, modern medicine, as it is now understood and taught in the schools, was still in its infancy. The great strides made by chemistry at the beginning of last century had rendered possible the introduction of exact methods in the investigation of the problems of biology. The first positions securely gained by physical science had been at once utilised to set aside the doctrine of "vital power," and to establish the important principle that we must endeavour to explain the specific phenomena of life as being determined by preceding chemical and physical conditions. Just as the chemists Lavoisier, Liebig and others, with the knowledge that they had won by their special training, addressed themselves at once to the solution of biological questions, so a school of physicists, starting from the basis of its own discoveries, proceeded to the investigation of the physiological problems which appertained to it. The brothers Ernst, Heinrich and Eduard Weber, Helmholtz, Du Bois-Reymond, Ludwig, Brücke, are the most prominent names of this school and already belong to history, and amongst these earlier adaptors of the methods of physical research to the study of biology, Fick must be accorded a place on account both of his conspicuous bent and training as a physicist and of the work accomplished by him. So early as the year 1849, when a nineteen-year-old student, Fick published his first scientific treatise—that on the muscular system of the thigh—an essay which even at the present day forms a very instructive analysis of the mechanical relations of the muscles of the hip joint. For these researches into the mechanism of the human body Fick always retained a liking. He wrote a monograph on the saddle-shaped articulations, gave in his "Medical Physics," the first edition of which appeared in the year 1856, an admirable exposition of the mechanism of the joints generally, and contributed an article on the subject to L. Hermann's great "Handbuch," besides encouraging several of his own pupils to undertake similar investigations.

His scientific work upon the mechanics of the body led Fick to a special line of inquiry—one to which he devoted the working time and energy of his mature years—that respecting the changes of muscle during its contraction. There are about thirty essays by Fick himself, as well as a number of writings by his students, which deal with particular points in the physiology of muscle. Of these one of the most important was the development of heat which attends contraction. With the aid of thermo-electrical apparatus devised by himself, he was enabled to determine approximately the absolute amount of heat that was developed during continuous contraction. He subsequently introduced and defined the important conceptions which are expressed by the terms "isotonic" and "isometric" as applied to contraction, and investigated the nature of the conditions so designated. For the measurement of work, he constructed his "Arbeits-sammler."

As the final result of all his muscular studies, he stated

his views as to the nature of the process of muscular contraction. These have not escaped criticism. One of his conclusions, however, which in a manner he reached by a process of exclusion in so far as he rendered untenable other possible ways of explaining the contraction of muscle by reference to the second of the laws of the mechanical theory of heat, is, indeed, of quite prime importance.

According to Fick, the kinetic energy generated by chemical reactions in the muscle cannot be accounted for by the hypothesis that the chemical energy consumed is first developed in the form of heat, and this transformed into the coordinated kinetic energy of the contraction. It must rather be supposed that the chemical forces stored up in the muscle are so coordinated that in their transformation into kinetic energy they directly cause the change of form of the muscle; so that we have not to do with a thermodynamic process as in the case of the steam engine, but the chemical energy is converted directly into the coordinated kinetic energy of the contraction. With this notable definition respecting the changes which precede muscular contraction, an important stage is reached in the explanation of the phenomena of contractile substances, and every future discussion of these questions must be referred back to this as a starting point.

Another subject of Fick's repeated investigations was that of the dynamics of the circulation. His first efforts were directed towards improving the methods of obtaining graphic records of the blood-pressure curve, with the result that the manometer and the spring kymograph bearing his name have been adopted into general use. He was the first to analyse by means of an apparatus constructed by him—now called the plethysmograph—and with the greatest clearness and precision, the variations in speed of the flow of blood in artery and vein (Zürich Laboratory Reports, 1868). By means of new methods of investigation and observation he threw valuable light upon the phenomenon of diastole and upon the pressure of the blood in the ventricles of the heart and in the great vessels.

Under the head of the physiology of the organs of sense, he paid special attention to the subject of vision. His dissertation "Tractatus de errore optico," &c., Marburg, 1851, deals principally with the phenomena of astigmatism (Helmholtz, "Physiolog. Optik," p. 147). Fick occupied himself repeatedly with speculations as to the explanation of the colour sense. He published a number of critical and experimental studies upon the subject. His last communication to the Society of Medical Physics of Würzburg dealt with Hering's theory of the colour sense. His contributions to the study of the subject of hearing consisted in an experimental investigation upon the mechanism of the tympanum. A paper by Fick, on the sense of touch, is comprised in the volume for 1860 of Moleschott's *Untersuchungen*.

Upon the physiology of the nerve substance Fick published only a few essays. To the issues for the year 1862 and 1864 of the reports of the Vienna Academy and to the E. H. Weber "Festschrift" in the year 1871 he contributed studies upon the sensibility of the spinal chord. The essay upon the different degrees of excitability observable in functionally different parts of the chord deserves special mention.

Of Fick's work on metabolism, and the physiology of the digestive glands, may be mentioned, as particularly well known, the experiment¹ that he made with the

¹ Vide the *Philosophical Magazine* for June 1866. The late Sir Edward Frankland regarded this as "one of the most important chemico-physiological experiments ever made" (Frankland's "Experimental Researches," p. 918). Although prevented from accompanying his brother-in-law, Fick, on the expedition, Frankland undertook the experimental determination of certain calorimetric equivalents required as a basis for the conclusions drawn from the Fauthorn experiment. These, it may be added, had a much wider application, and until replaced by more exact determinations they served for years as the only data on which calculations could be founded.

cooperation of J. Wislicenus for estimating the amount of albumin expended in physical work such as mountain climbing. The result, that the material used in muscular work must be free from nitrogen, was at once generally accepted. The results of investigations on the peptones, upon what becomes of them in the circulation of the blood, on the action of pepsin, and on the value of various nutritive substances, were made public from time to time in lectures for which Fick prepared and demonstrated very numerous and laborious experiments.

The students' manuals which Fick wrote are distinguished by their lucid exposition, clear style and critical discussion. His first book, entitled "Die medicinische Physik," was written when he was in his twenty-seventh year, and passed through three editions. This book at once secured for the young author a place in the front rank of the physiologists of the day. Of the "Kompendium der Physiologie" four editions appeared, the last in the year 1892.

As early as 1862 he published a "Lehrbuch der Anatomie und Physiologie der Sinnesorgane" as part of a larger compilation. To Hermann's "Handbuch," already mentioned, he furnished two elaborate articles on physiological optics.

From the physiological laboratory at Zürich in the year 1869, and from the Würzburg Institute in the years 1873 to 1878, there appeared the "Physiologische Untersuchungen" (four issues). From 1852 and onwards for fourteen years he was one of the contributors to Canstatt's "Jahresbericht" on the literature of physiology.

Of the remarkable talents and training that enabled him, for instance, to deliver experimental lectures on physics during the vacancy of the chair of physics, he also gave evidence by his own productions as investigator and writer in this branch of science. Best known is his work on hydro-diffusion in Poggendorff's *Annals*. The fundamental conceptions of mechanics, and the insight gained into these by means of the mechanical theory of heat, were favourite subjects of his speculation. A brief enumeration must suffice here of the titles of the most characteristic of the treatises that fall under this head, and many of which lie in the borderland between physics and pure philosophy:—

"Ueber die der Mechanik zu Grunde liegenden Anschauungen," "Ueber die Zerstreuung der Energie," "Versuch einer physichen Deutung der kritischen Geschwindigkeit in Weber's Gesetz," "Ueber Druck im innern von Flüssigkeiten." The following treatises belong more to the philosophical side:—"Die Naturkräfte in ihrer Wechselwirkung," "Die Welt als Vorstellung," "Philosophischer Versuch ueber die Wahrscheinlichkeit," "Die stetige Raumerfüllung durch Masse," &c.

Even this slight sketch of Fick's literary activity will show how comprehensively he mapped out for himself the sphere of his work and how exhaustively he laboured in it. But he was also unusually well equipped in all other departments of human knowledge. He was extraordinarily learned and well read. In accordance with his own definition of an educated man as one who is capable of taking a comprehensive view of the most characteristic results furnished by the intellectual work of the whole of mankind, Fick studied and mastered a very widely embracing province of knowledge. He was assisted in his efforts by a particularly accurate memory, which he retained unimpaired to the last.

Conspicuous among Fick's talents was his critical faculty. He dealt with the first principles of the science of mechanics in an unusually clear and distinct way, and when a series of novel conceptions was put before him he was able to correctly analyse and estimate them. He was recognised by those who knew him as a scientific critic by vocation. He was aided in his experimental work by great manual dexterity. He prided himself upon belonging to the school of Bunsen, and in the construction

of the various instruments which he introduced followed Bunsen's method by himself putting together out of simple materials the first models of new scientific apparatus. It is an interesting fact that Fick warmly espoused the cause of total abstinence, and was himself for the last decade of his life a total abstainer.

NOTES.

M. AMAGAT has been elected a member of the section of physics of the Paris Academy of Sciences, in succession to the late Prof. Cornu.

MR. MARCONI brought forward two interesting pieces of information in his lecture at the Royal Institution last Friday. The first relates to the new form of magnetic detector which he has been employing in place of the coherer. The instrument is found to be more sensitive and trustworthy than the coherer, and gives promise of a great increase in the speed of working. Already a speed of thirty words a minute has been attained, and this may possibly be increased to several hundred. The second point relates to the recent Transatlantic signalling. It seems that on the occasion of Mr. Marconi's journey across the Atlantic in the *Philadelphia*, the signals transmitted during the day failed entirely at a distance of 700 miles, although a message was successfully sent at night more than 1550 miles, and a signal more than 2000 miles. This effect Mr. Marconi suggests may be due to the deselectrification of the aerial wires by the daylight. The difficulty can, however, be got over by the use of greater transmitting power—as is evidenced partly by the fact that the signal received at Newfoundland was transmitted during the daytime. The Canadian station, for the erection of which Mr. Marconi was liberally subsidised by the Canadian Government, will be open shortly for experiments. The rest of the lecture gave an interesting *résumé* of the work already accomplished, but contained nothing which will be new to those who have followed its progress.

THE eighty-third meeting of the Société Helvétique des Sciences Naturelles will be held at Geneva on September 7-10. M. E. Sarasin is the president of the society, M. Marc Micheli and Prof. R. Chodat vice-presidents, M. Maurice Gauthier and M. A. de Candolle secretaries, and M. A. Pictet treasurer. Correspondence referring to the forthcoming meeting should be addressed to M. de Candolle, Cour de St. Pierre, 3, Geneva.

IN accordance with previous announcements, the autumn meeting of the Iron and Steel Institute will be held at Düsseldorf on September 3-4. The directors of the Norddeutscher Lloyd have generously offered to the members attending the meeting complimentary first-class passages, including table, to the number of 250, by the s.s. *Kronprinz Wilhelm*, upon that ship's homeward voyage (from New York) to Bremen, on September 1, from Plymouth. The provisional programme of the meeting is as follows:—On Tuesday, September 2, the members will arrive at Düsseldorf. On September 3 the president, council and members will be received by the civic authorities and by the reception committee in the Municipal Concert Hall (Städtische Tonhalle). A selection of papers will subsequently be read and discussed. In the afternoon a visit will be paid to the Düsseldorf Exhibition, for the purpose of examining the various sections of mining, metallurgy and machinery. In the evening the members and ladies accompanying them will be invited by the Mayor and Corporation of Düsseldorf to a *conversazione* and concert. On September 4 the morning will be devoted to the reading and discussion of papers, and the afternoon to visits to the exhibition and to works in the immediate vicinity. In the evening the reception committee will entertain the visitors at a banquet.

On September 5 the whole day will be devoted to visits to works. In the evening the exhibition grounds will be specially illuminated in honour of the Institute. On September 6 there will be an excursion to the picturesque district of Vohwinkel, to the Elberfeld suspended railway and to the Kaiserbridge, near Münstgen. A detailed programme will be issued when the arrangements are further advanced.

ON June 14 the Essex Field Club visited those portions of the old Lambourne and Hainhault Forests which, according to the scheme proposed by Mr. E. N. Buxton, are to be re-afforested and to become an open space for London second only in importance to Epping Forest. It is proposed to make free some 859 acres, of which seventy are detached from the main portion. These form Grange Hill Forest, and the purchase of them for 7000*l.* is now assured. For the rest, 20,000*l.* is asked. It is hardly necessary to point out the importance from a natural history point of view which the grounds will possess if they become public property. Not only will the naturalist find happy grounds for study, but others who feel the necessary primness of London parks will be able to enjoy nature less adorned.

QUEENWOOD COLLEGE, near Stockbridge, Hants, was destroyed by fire on June 10, Mr. Charles Willmore, the principal, meeting his death in the disaster. Several distinguished men, both in Mr. Willmore's time and in that of his predecessor, Mr. George Edmondson, made their temporary home at Queenwood. Prof. Fawcett, Postmaster-General and political economist, was a scholar there; and in the roll of its science masters we find the names of Tyndall, Frankland, Debus, Field and Hake. There have been few schools in this country in which the pursuit of science was more earnestly and heartily encouraged. It is now about seven years since the college, as such, ceased to exist.

DURING a trial with a French naval balloon off Toulon on June 9, Lieut. Baudic, who was alone in the car, was thrown into the sea and drowned. The object of the ascent was to ascertain whether it is possible, from the car of a balloon, to perceive submarine boats at a distance of a mile or so. The balloon started from the Maritime Aéronautical Works established in 1890 at Garrouban. The Garrouban Aéronautical Station is provided with two balloons, the *Auxiliaire*, and a larger one measuring 500 c.m. capable of carrying three persons, called the *Normal*. These marine balloons are intended to be sent up captive from a large war steamer for inspecting the surrounding sea and sending up signals at a distance.

We learn from *Science* that at the recent annual meeting of the American Academy of Arts and Sciences it was decided to award the "Rumford premium" to Prof. George E. Hale, of the Yerkes Observatory, "for his investigations in solar and stellar physics, and in particular for the invention and perfection of the spectro-heliograph." It was also resolved to grant the sum of 750 dollars from the income of the Rumford fund to be expended for the construction of a mercurial compression pump designed by Prof. Theodore W. Richards and to be used in his research on the Thomson-Joule effect. A grant from the Rumford fund was also made to Prof. Arthur A. Noyes in aid of his research as to the effect of high temperatures upon the electrical conductivity of aqueous solutions.

THE *Times* reports that the jubilee festival of the Germanic Museum at Nuremberg was celebrated on Monday in the presence of the German Emperor and Empress and members of the Royal Houses of Bavaria, Baden and Würtemberg. The collections in the museum illustrate every aspect of the growth of the Germanic peoples; special collections, for example, have been formed to illustrate the development of the trade guilds and of characteristic German industries, such as the Bavarian

breweries. From a collection of antiquities in the narrow sense of weapons, heraldic devices and the like, the museum has grown into a complete historical exhibition.

DURING the researches of the seventh expedition of the Liverpool School of Tropical Medicine, which visited the Gambia in the summer and autumn of last year, a new parasite associated with symptoms resembling those occurring in animals suffering from the tse-tse fly disease was found in the blood of a native child. The committee of the school has now resolved to despatch a new expedition to the Gambia and to Senegambia to study the disease further. The expedition, which will start in a few weeks, will, as at present organised, consist of Dr. J. Everett Dutton and Dr. J. L. Todd, of McGill University, Montreal. Its principal object will be to investigate the conditions under which the disease occurs in both Europeans and natives and its distribution, and also to ascertain how it is conveyed from man to man.

AMONG the subjects discussed at the annual meeting of the Sea Fisheries Committees of England held in London on June 10 and presided over by Mr. Gerald Balfour were the establishment and maintenance by the Government of one or more laboratories for carrying on the work of fishery research, or, failing that, the provision from Imperial resources of the funds necessary to render more efficient and useful the laboratories which at present exist. Mr. Gerald Balfour, in welcoming the delegates, said some of the subjects discussed last year, such as the registry, lettering and numbering of fishing boats, had been carried out; and the artificial fertilisation of ova had been referred to the Committee on Ichthyological Research now sitting, as was also the establishment and maintenance of laboratories and hatcheries.

In the popular mind, the medical and other sciences are regarded as too severely precise to have romantic aspects, yet in the history of scientific discovery records can be found of many noble deeds and sacrifices for the sake of others. Sir Frederick Treves referred to the romance of medicine in an address at the Charing Cross Hospital Medical School on June 11. He remarked that the exploits of discoverers of new countries had always been surrounded with a halo of romance, but the discoveries in medicine had not been less romantic. No story of the past could exceed the romance of the history of the work of Pasteur, Lister and Koch. They had not discovered any new garden of the Hesperides, but they had travelled far into the valley of the shadow of death. He did not think there was anything in the history more tragic than the account of Laënnec holding on the point of a needle a minute scrap of tissue and saying "I have found the seed of tuberculosis." When Koch demonstrated the bacillus of tuberculosis he was practically reaching one of the limits of philosophic inquiry. Could there be anything more profoundly interesting than the way in which malaria was studied and finally explained?

SEVERAL matters of meteorological interest have been recorded during the past few days. The drought in Australia came to an end at the beginning of last week, when good rains occurred in portions of South Australia, New South Wales and Victoria. Less hopeful news comes, however, from India, for an Exchange telegram from Simla states that the official monsoon forecast, which this year for the first time is withheld from the public, foreshadows a deficient rainfall all over India and drought in Gujerat and Western Punjab. At Karachi, however, a terrific storm occurred on Monday. The *Daily Mail* states that the city is half submerged by extraordinarily high tides. Telegraphs and telephones have all been destroyed, and there has been serious loss of life and property. Exceptionally stormy weather is also being experienced in South Africa. At Middleburg,

Cape Colony, for the first time for sixteen years, the town was covered with deep snow on June 11. Storm and cold are general throughout the Colony. The cold is unprecedented, and thousands of cattle and sheep have perished. In many places the telegraph poles are buried beneath snowdrifts. A very severe snowstorm swept over the midland districts of Cape Colony on June 14. Trains were blocked at Naauwpoort by a snowdrift 6 feet in depth, and much difficulty was experienced in clearing the lines. Heavy falls of snow also occurred in other parts of the country.

THE annual report of the Decimal Association records that lately there has been a very decided growth of public opinion in favour of the compulsory adoption of the metric weights and measures throughout the British Empire. There are warm supporters of the reform in Canada, Australia, Cape Colony and India, and efforts will be made to bring the question before the Conference of Colonial Premiers to be held at the time of the Coronation. British consuls abroad, residing in countries where the metric system is in use, continue to dwell upon the importance of the change being made from our present confused and complicated weights and measures to those of the metric system. The Committee on Decimal Coinage appointed by the Federal House of Representatives for Australia issued its report in April recommending the adoption of decimal coinage. The report of this committee concluded with a recommendation that the Commonwealth should cooperate in any movement for the decimalisation of the weights and measures of the Empire. Quite recently the Association of Trade Protection Societies of the United Kingdom passed the following resolution at its annual meeting:—"That this meeting is of opinion that the time has now arrived when the decimal system of coinage and the metric system of weights and measures should be compulsorily adopted throughout the British Empire."

AMERICA has just furnished a new high-speed record, which has been attained on the Burlington and Missouri Railroad. The train (says *Feilden's Magazine* for June) consisted of nine cars, namely, a mail car, a luggage car, two reclining chair cars, three sleeping cars, dining car and a private car, and the engine (B. and M. R. No. 41) was of the ten-wheeled type with 6-foot driving wheels. The section over which the record was taken was between Eckley and Wray, Colorado, separated by a distance of 14.8 miles, which was "covered in exactly nine minutes, that is, the train was travelling at the rate of 98.66 miles per hour for the whole section." It is stated that the time was correctly tallied by five separate chronographs, and may therefore be considered trustworthy.

IN the *Jahrbuch der k.-k. geol. Reichsanstalt* (Band li. Heft 1), Herr Lukas Waagen contributes a detailed account of the Jurassic *Avicula* (*Oxytoma*) *inaequivalvis* and its allies. This paper will be welcomed by all who may have occasion to study this very variable and difficult group of shells. The author supplies a comprehensive synonymic list, and concludes that the numerous specific separations in this group, proposed by various authors, are in reality unwarranted.

A SCORE of new forms of fossil ear-bones of fishes, from the Tertiary strata of Austro-Hungary, have been described by R. J. Schubert (*Jahrbuch der k.-k. geol. Reichsanstalt*, Band li. Heft 2). These otoliths are for the most part referred to *Umbriina*, *Corvina*, *Scienidarum* and *Scienua*, and were obtained in Pliocene deposits at Brunn am Gebirge and in Miocene beds at several other localities. Some appear to indicate relationship with recent Mediterranean forms, while others have their nearest allies in the Oligocene and Miocene of Germany and in the older Tertiaries of North America. The paper is well illustrated.

IN a memoir on the flora of Thibet or high Asia Mr. Botting Hemsley, F.R.S., has compiled an account which brings out vividly the unique conditions of altitude and climate. The data for the subject-matter are obtained from collections deposited in the herbarium at Kew. Amongst the peculiarities of the vegetation may be noted the scarcity of certain types of plants, e.g. annuals, succulents and bulbous plants (except *Allium Semenovi*, which is widely distributed). Woody plants, too, are rare and poorly developed.

WE have received the Report of the South London Entomological and Natural History Society for 1901.

THE most interesting item in the Report of the Albany Museum for the year 1901 is the identification among the collection of a pair of horns of the blaauwbok (*Hippotragus leucophaeus*), an antelope formerly found in the neighbourhood of Cape Town which has been extinct for considerably more than a century. The horns were entered in one of the old catalogues as belonging to the animal in question; assuming the identification to be correct, the specimen appears to be the only known relic of the blaauwbok remaining in South Africa.

IN the *American Naturalist* for May, Prof. H. F. Osborn further elaborates his views as to the "law of adaptive radiation" among mammals. One result of his investigations is to explode the old idea that it is possible to reconstruct an extinct animal from either a claw or a tooth. Correlation is not, as Cuvier supposed, morphological, "but physiological, function always preceding structure. It becomes closest when teeth and feet combine in the same function, as in the prehensile canines and claws of the Felidae, and most diverse where the functions are most diverse, as in the teeth and paddles of the Pinnipedia."

VOL. liii. of the *Annales* of the Scientific Society of Argentina contains a long memoir, by Señor A. Gallardo, of the late Dr. C. Berg, director of the museum at Buenos Aires. From this it appears that Berg was born at Tuckum, Curlandia, Russia, in 1843, and that, after much good work in his native country, he first visited Argentina in 1873. Here, under the auspices of Burmeister, he worked at the entomology and botany of the country assiduously for nearly two years, when he was appointed professor of zoology at Cordoba. This appointment, however, he held but two months, as in March, 1875, he was elected to the chair of natural history at the National College of Buenos Aires, in succession to Dr. J. Ramorino. In 1890 he was specially entrusted with the reorganisation of the National Museum at Monte Video, and on the death of Burmeister in 1892 he succeeded to the directorship of the National Museum at Buenos Aires, a post which he held until his own death. Berg's work covered a very wide field both in zoology and botany, and an appendix to the memoir before us contains a very long list of papers of which he was the author. One of his latest contributions proved the distinctness of the smaller form of mara, or Patagonian cavy, the *Dolichotis salinicola* of Burmeister. He is succeeded in the directorship of the museum by Dr. Florentino Ameghino, so well known on account of his remarkable contributions to the history of the extinct vertebrate fauna of Patagonia.

CURIOS if true must be the verdict in regard to a paper contributed by Prof. William Patten to the May issue of the *American Naturalist* on the structure and classification of the Tremataspidae. This family is represented by a single genus and species (*Tremataspis schrenkii*), all the known remains of which have been obtained from the Lower Silurian of a small pit at Rootsikuelle, in the Isle of Oesel, in the Baltic. These remains consist chiefly, if not entirely, of more or less imperfect examples of the dorsal shield. Although Tremataspis has always been classified with primitive vertebrates like

Cephalaspis and Pteraspis, the curious resemblance presented by its shield to the carapace of the modern crustacean commonly known as *Apus* has long been recognised. This resemblance, the author contends, is not a mere accident, but indicates genetic affinity between the two groups. Accordingly, he proposes to regard Tremataspis, Pteraspis, Cephalaspis and Pterichthys as the representatives of a new class of arthropod-like animals under the title of Peltacephalata. And he urges that the genetic relationship between this group and the arthropods "can mean nothing else than the derivation, through changes in structure and function, of the one group from the other." A further proposal is to group together into one great phylum the vertebrates and the arthropods, under the name of Syncephalata. It will be interesting to note what the authors' fellow-workers have to say in regard to this startling new departure in classification.

To the April number of the *Ibis*, Mr. W. E. Clarke communicates an account of a month spent by himself last autumn on the Eddystone for the purpose of observing bird-migration. On the night of October 12 the author was fortunate enough to witness a great "rush" of emigrating birds, which continued until the early hours of the 13th. Although the majority of the migrants were British, the presence of the redwing and the fieldfare indicated a foreign contingent, and it was also noted that the starlings taken on this occasion belonged to the race characterised by the purple head and green ear-coverts, which is believed to be continental in habitat. "Throughout the movement, and especially when it was at its height in the earliest hours of the morning," writes Mr. Clarke, "the scene presented was singular in the extreme and beyond adequate description. Resplendent, as it were, in burnished gold, hosts of birds were fluttering in, or crossing at all angles, the brilliant revolving beams of light; those which simply traversed the rays were illumined for a moment only, and became mere spectres on passing into the gloom. The migrants which winged their way up the beams—and they were many—resembled balls or streaks of approaching light, and they either struck the lantern, or, being less entranced, passed out of the rays ere the fatal goal was reached. Of those striking, some fell like stones from their violent contact with the glass, while others beat violently against the windows in their wild efforts to reach the focal point of the all-fascinating light."

THE skeleton and skin of the okapi recently received at the Congo Museum, Brussels, add important information to our knowledge of that animal. The specimens have been submitted to Dr. Forsyth Major, who published a preliminary note on the results of his examination in *La Belgique Coloniale* of May 25, and also gives a figure of the male skull in the same journal of June 8. The Brussels specimens comprise the skeleton of a male, unfortunately lacking two of the vertebrae of the neck, and the skin of a female, both belonging to adults. These show that full-grown individuals of both sexes are provided with horns. Those of the female are comparatively small, conical, nearly vertical and completely covered with skin. Those of the male, on the other hand, are larger, subtriangular and inclined somewhat backwards, each being capped with a small polished epiphysis, which appears to have projected through the skin investing the rest of the horn. As regards its general characters, the skull of the okapi appears to be intermediate between that of the giraffe on the one hand and that of the extinct *Palaœtragus*, or *Samotherium*, on the other. It has, for instance, a greater development of air-cells in the *diploe* than in the latter, but a much smaller one than in the former. Again, in *Palaœtragus* the horns (present only in the male) are situated immediately over the eye-sockets, in *Ocapia* they are placed just behind the latter, while in *Giraffa* they are partly on the parietals. In general

form, so far as can be judged from the disarticulated skeleton, the okapi was more like an antelope than a giraffe, the fore and hind cannon-bones, and consequently the entire limbs, being of approximately equal length. It is further suggested that, owing to the skin having been unduly stretched in drying, the neck and fore-limbs of the immature mounted specimen in the British Museum may be somewhat too long. From all this it seems probable that *Palaœtragus* and *Ocapia* indicate the ancestral stock of the giraffe line; while it is further suggested that the apparently hornless *Helladotherium* of the Grecian Pliocene may occupy a somewhat similar position in regard to the horned *Sivatherium* of the Indian Siwaliks.

THE second volume of the *Minnesota Botanical Studies* is completed with the issue of the May number. Mr. Bruce Finck contributes an article dealing with the lichens of north-western Minnesota. The *Corallinæ verae* of Port Renfrew, Vancouver Island, B.C., form the subject of a short systematic account by Mr. K. Yendo. The concluding paper, by Prof. Conway Macmillan, deals with the anatomical investigation of *Pterygophora californica*, one of the Laminariaceae.

IN the first quarterly *Bulletin* for this year issued by the Botanical Department at Trinidad will be found an account of some experiments the results of which promise to be of value to cacao planters. Attempts have been made to graft cacao plants on strong stocks, in the hope that liability to the attacks of fungi may be reduced. So far, successful grafts on *Theobroma bicolor* and *Herrania albiflora* have been obtained, and trials are being made with stocks of *Cola acuminata*. Another somewhat novel experiment is in progress of treating the soil with mulchings of vegetable matter during the dry season. This serves to attract earthworms, and they act as carriers of manure to the roots of the cacao plants. Attention is also drawn to the advantages of using chupons or gormanders on the plantations.

IN the report for last year, issued from the Royal Botanic Gardens, Ceylon, Mr. J. C. Willis, the director, gives further proof of his capability as an organiser and investigator. To aid in purely scientific work he has the assistance of four experts—a mycologist, a chemist, an entomologist and an assistant. Besides investigating the diseases of tea and cacao plants, experiments have been made with other plants which may prove to have an economic value. While so far no industry of a first-class nature has been brought to light, several minor industries which may be undertaken on existing plantations have been instituted. Hevea plants now under cultivation have yielded rubber superior to the best wild Para. Indigenous species of Palaquium were investigated by the assistant, and rubber of fair commercial value was obtained; this, too, without cutting down the tree. Camphor, citronella oil, cinchona, coca have also been brought to the notice of planters. The laboratory at Peradeniya has been well patronised by English and foreign visitors, and with the establishment of a laboratory and rooms at Haggala facilities are offered for research in the hill country. The director has completed his review of the flora of the Maldiv Islands, and has published it in the new journal, the *Annals* of the Royal Botanic Gardens, Peradeniya.

WE have received a copy of the fifth volume of the *Transactions* of the Inverness Scientific Society and Field Club. It embodies the work of four sessions, ending with the summer of 1899, but there is appended a summary of Dr. John Horne's address to the geological section of the British Association in 1901. Some time has therefore elapsed since the reading of the papers now published, which deal with history and archeology as well as natural history, physics and engineering.

There is a suggestive paper by Dr. Mackie, of Elgin, on "The Felspars present in Sedimentary Rocks as Indicators of the Conditions of Contemporaneous Climate."

MESSRS. J. J. GRIFFIN AND SONS, LTD., have issued a new edition of their illustrated catalogue of chemical apparatus and reagents published under the title "Chemical Handicraft." Hints on manipulation of instruments and arrangement of apparatus are occasionally given, and they assist in making the volume a useful catalogue for chemical laboratories and technical schools.

NEW and revised editions have been received of several well-known scientific books. The fourth edition of Prof. Grenville Cole's "Aids to Practical Geology" has been published by Messrs. C. Griffin and Co. The book is the most helpful guide which the student who desires to become intimately acquainted with the characters of rocks and minerals could possess. It is not intended to take the place of a field geology, but to show how every specimen obtained may be minutely examined in the laboratory or study, and its place among rocks or fossils understood. Work of this kind is practical geology in as scientific a sense as observations in the field.—Messrs. Cassell and Co. have published a popular edition of Mr. Richard Kearton's interesting book "With Nature and a Camera." The 180 pictures reproduced from photographs by Mr. Cherry Kearton have given pleasure to many outdoor naturalists.—The valuable textbook of "Agricultural Botany," by Prof. J. Percival, published by Messrs. Duckworth and Co. and reviewed in these columns in October, 1900 (vol. lxii. p. 570), has reached a second edition. It is satisfactory to know that students of agriculture are using a book in which plant structure and growth are dealt with scientifically.—The eighth edition of "Astronomy with an Opera Glass," by Mr. G. P. Serviss, has been published by Messrs. Hirschfeld Brothers, Ltd.—A new edition of Prof. J. G. Macgregor's "Elementary Treatise on Kinematics and Dynamics" has been published by Messrs. Macmillan and Co., Ltd. Few changes have been made, and the book retains its character as a comprehensive treatise in which the whole subject is treated systematically, without reference to the requirements of examining bodies.

THE additions to the Zoological Society's Gardens during the past week include a Dusty Ichneumon (*Herpestes pulverulentus*) from South Africa, presented by Capt. A. Perkins; two Larger Egyptian Gerbilles (*Gerbillus pyramidum*) from North Africa, presented by Col. Momber; a Buffon's Touracou (*Turacus buffoni*) from West Africa, presented by Capt. H. A. Thorne; two Long-tailed Whydah-birds (*Chera prognus*) from South Africa, presented by the Rev. R. Armitage; a Richardson's Skua (*Stercorarius crepidatus*) European, presented by Lt.-Col. L. H. Irby; a Sykes's Monkey (*Cercopithecus albigrularis*), a Grant's Gazelle (*Gazella granti*), a Banded Ichneumon (*Crossarchus fasciatus*), a Vulturine Guinea Fowl (*Aryllium vulturinum*), a Bateleur Eagle (*Holotarsus eadadatus*), three White-winged Whydah-birds (*Eurostachya albonotata*) from East Africa, a Buffon's Touracou (*Turacus buffoni*), a Red-faced Weaver-bird (*Foudia erythropis*), seven Orange Weaver-birds (*Euplectes franciscana*), two Pintailed Whydah-birds (*Vidua principalis*), three Paradise Whydah-birds (*Vidua paradisica*) from West Africa, two Maguari Storks (*Dissura maguari*), two Snowy Egrets (*Ardea caudidissima*), four Black-pointed Teguxins (*Tupinambis nigropunctatus*), four South American Rat Snakes (*Spilotes pullatus*) from South America, two Brazilian Cariamas (*Cariama cristata*) from Brazil, deposited; a Black-winged Peafowl (*Pavo nigripennis*) from Cochin China, purchased; a Great Bird of Paradise (*Paradisaea apoda*) from the Arrow Islands, received in exchange; a Brindled Gnu (*Connochaetes taurina*) born in the Gardens.

OUR ASTRONOMICAL COLUMN.

THE SUNSPOT CURVE AND EPOCHS.—The great importance of collecting as many facts as possible regarding solar activity, and revising them from time to time as new information is gathered, is clearly shown by the paramount rôle that the sun plays in causing the numerous variations in meteorological phenomena. Wolf's relative numbers have been, and are now, so commonly used when reference has to be made to solar activity that it is of the first importance that such a series of values should be as near correct as possible. It is with great satisfaction, therefore, that we note that Wolf has so diligently continued the useful work, ably begun by Wolf, that he has now published (*Meteorologische Zeitschrift*, May, 1902) a new set of values carefully revised and brought up to date. As he remarks, an examination of the original manuscript at the observatory with various published tables has shown that a great number of differences and printer's errors have crept in, suggesting that it is time that a new edition was published. This reduction has been very carefully made by Wolf and his assistant, each making the computations twice. In addition to the observed relative numbers, the paper gives smoothed relative numbers, while a third table shows the epochs of maxima and minima with their corresponding weights; the addition of the weights to the dates of these epochs is a very valuable piece of information which will add to the utility of the earlier epochs.

METHOD OF OBSERVING ALTITUDES AT SEA DURING NIGHT-TIME.—In a paper read before the Royal Dublin Society, Prof. Joly introduced recently a method for observing the altitude of a celestial body at sea which may prove extremely useful for taking bearings at night-time or when the horizon is obscured. Assuming that the vessel is provided with the usual Board of Trade rescue signals, one of these is perforated and dropped overboard. This will furnish a bright white light visible in clear weather up to five miles, and burning for about half an hour. To the signal is attached a suitable sinker, so that it will not drift appreciably. Selecting a star, the observer takes its bearing and then alters his course to the opposite bearing, thus bringing the star right astern. The signal is then dropped overboard, and at the same time a reading of the log is taken. After the vessel has travelled a distance of about a mile from the signal, as indicated by the log, the observer takes the angular elevation of the star over the signal, using the sextant in the usual manner. Corrections will have to be applied for the relative motion of the star from east to west at the rate of 1" in four minutes of time, for the larger angle of "dip," and also for the state of the water surface. In very rough water this last correction becomes of special importance, and formulae with reduction tables are given to show the influence of waves of varying heights. The routine to be followed in observing two altitudes for a "Sunner" position is also described (*Scientific Proceedings of the Royal Dublin Society*, vol. ix., n.s., part v., No. 46, pp. 559-567).

LIQUID FUEL FOR STEAM PURPOSES.

THE possibility of burning a liquid fuel with very great advantage in most circumstances as compared with a solid fuel has been so long recognised that it is astonishing the practice has not been more generally adopted. The success which has been gained in the last few years, however, will undoubtedly lead to a greatly extended use in the near future.

Naturally the choice of a fuel for steam raising is not altogether dependent upon the evaporative efficiency and other advantages which a particular one may possess, but will, of course, be largely influenced by relative market prices, and this, no doubt, has had considerable influence against the adoption of liquid fuel on a large scale in this country. The fuel natural to the locality will always have great advantages over an imported fuel, and England, having such valuable coal supplies to hand, whilst on the other hand having no great natural sources of liquid fuel, gives preference to that material which renders it most independent of outside supplies. Although gas tar and oil gas refuse may be frequently employed in a very economical manner, yet there is little doubt that with a greatly extended use of liquid fuel the prices of suitable bye-products would be so enhanced that imported liquid fuel would remain practically in possession of the field.

For this reason engineers who have perfected the methods of

burning liquid fuel have always considered the possibility of its use becoming limited in certain circumstances, and all modern appliances are so constructed that with slight trouble coal alone may be used in them to the best advantage. One of the great claims to be considered in favour of liquid fuel is the ease with which the burners can be extinguished and a coal fire substituted, thus enabling consumers to take every advantage of fluctuations in the prices of both fuels. For marine purposes this is most desirable, since at many ports liquid fuel would be far more economical to ship for boiler use than a suitable steam coal, whilst a vessel trading from a port—such as Cardiff or Newport—would naturally replenish her bunkers with the steam coal at hand.

Any liquid hydrocarbon of sufficiently high flash point may be used as a liquid fuel; thus residues from many manufacturing processes may be utilised in an economical manner. Astatki, the residuum from petroleum distillation, has been extensively used in Eastern Europe, but tar oils and the oils from oil gas plant are frequently employed. These oils are especially suitable for locomotive work, since most large railways make oil gas in considerable quantities for lighting purposes, and, moreover, have exceptional facilities for transporting gas tar from small towns on their lines where it can be obtained at a reasonable cost. On the Great Eastern Railway this form of liquid fuel is largely employed. Crude petroleum, which has been treated to remove the more volatile constituents and so bring its flash point above the imposed limit for use as fuel, is now being imported into this country. The various methods of burning liquid fuel have been classified by Aydon as follows:—

(1) *Injection with compressed air* (W. Bridges Adams, 1863; Tarbutt, 1885.)

(2) *Perculation through a porous bed* (C. J. Richardson, 1864; Weir and Gray; St. Caire Deville), in which the liquid fuel percolates upwards through a porous bed, accompanied by heated air (and sometimes steam also).

(3) *Vaporisation* (Foot; Simm and Barff, 1865-67), the oil being vaporised from a small retort heated in the furnace, or in some cases (Dorsett, 1865-69; Eames, 1875) by a special external heater for the retort.

(4) *Steam spray injection* (Aydon, Wise and Field, 1865-67), in which the oil is sprayed into the combustion chamber by a jet of steam, whilst at the same time the burner is so constructed that air, heated if possible, is drawn in to supply the oxygen necessary for combustion.

Such a classification does not include burning in open troughs, a method first introduced by Wittenström about the year 1834, and which for many purposes in stationary boilers, furnaces, &c., has met with considerable success; or the more recent method of Korting, by direct injection of heated oil at considerable pressure.

Excepting in a few special cases, the steam spray injection method has been universally adopted. Various extravagant claims have been made for the chemical action of the steam, but it is not easy to see from a theoretical standpoint that it has any advantage over injection by compressed air. From a practical point of view, however, the steam spray is the more simple, since it dispenses with the auxiliary apparatus necessary for the supply of the air blast. On a locomotive, where economy of space is of importance and suitable water for the boilers is readily obtainable, steam spray injection is universal. For marine boilers the choice formerly lay between steam and air injection, each having certain advantages. Using steam injection, the auxiliary apparatus necessary for the air-blast is done away with, thus giving economy of space, whilst it has the disadvantage of requiring more condensed water from the evaporators to replace the steam used. On the other hand, the extra steam necessary for the air-blowers can be condensed and returned in the usual way to the feed water-pipe, but of necessity extra machinery has to be employed. With the introduction of the Korting system referred to above, and the success which has attended its use, notably on the Hamburg-American Line steamers, the marine engineer now has the choice of another method, and everything seems favourable to the extensive adoption of this new system in the future.

From the numerous estimations of the calorific value of different liquid fuels, we may approximately state that in centigrade units it has a value of 10,500, whilst for good steam coal a value of 8000 to 8500 may be taken. It will thus be seen that the liquid fuel has a decided advantage. The usual calculations

of the theoretical heating value of a fuel fail to take one important factor into consideration, namely, the physical condition of the fuel. Thus the determined calorific value of carbon is always that of solid carbon, the value for hydrogen being obtained experimentally for hydrogen gas; but although in coal the carbon is in the solid form, it is certain that in liquid fuels it has undergone the first change in the passage of a solid to a gaseous condition, and consequently carbon in a liquid fuel will have a higher calorific value by just as much heat as would be required theoretically to raise solid carbon to the liquid condition. Aydon has estimated that this is equivalent to an expenditure of some 3500 calories.

It is, of course, impossible even with the most perfect appliances to obtain anything like the full heating effect of a fuel in any boiler, and the only real test of the value of competing fuels is their performance under similar conditions in practice. One is struck at the outset with the extremely contradictory figures which have been published to show the evaporative duty of liquid fuel, figures ranging from 46 lbs. of water per lb. of fuel burnt to 14 or 16 lbs. per lb. It may be taken, however, that in modern practice an efficiency of 15 lbs. by steam injection is a very fair result. Many comparisons have been made with coal in the same boilers and under the same conditions with results varying from 7 to 8½ lbs. of water evaporated per lb. of coal consumed. A valuable series of tests made by the Engineers' Club of Philadelphia in 1892 gave the following results:—

1 lb. anthracite evaporated	9.7 lbs. of water.
1 lb. bituminous coal	10.14 " "
1 lb. oil 36° B.	16.48 " "
1 cu. ft. of gas 20 C.P.	1.28 " "

We are indebted to the carefully recorded results obtained by Mr. Urquhart on the Grazi and Tzaritzin Railway for probably the best published figures of the relative merits of solid and liquid fuels. In winter he found that liquid fuel was 41 per cent in weight and 55 per cent in cost better than anthracite coal; or, compared with bituminous coal, 49 per cent. by weight and 61 per cent in cost better. This was under the worst climatic conditions, and, as might be expected, in summer better results still were obtained. It must be borne in mind that these figures were deduced from the work of a large number of engines.

The Canadian Pacific Railway find that liquid fuel in use on their steamers effects a saving of 56 per cent. on the cost of coal firing.

In this country the pioneer of liquid fuel on our railways is Mr. James Holden and his company; the Great Eastern Railway has now more than sixty engines burning it, either alone or in conjunction with coal. In a note presented at the International Railway Congress in 1900, Mr. Holden gives the following particulars of express trains running between Liverpool Street and Cromer. The distance of 138 miles is covered in 175 minutes with a four minutes' stop, on a consumption of 14.4 lbs. of tar residues per train mile, and an equivalent of 5 lbs. per mile of coal, which is used in raising the steam necessary for starting the oil injectors. In the same paper it is stated that on railways working with wood fuel a saving of 50 per cent. has been effected by burning liquid fuel. Through the kindness of Mr. Holden, the writer recently made a long run on an engine burning crude coal tar over a coal fire with the Holden steam injectors, and was impressed with the ease of maintaining a regular steam pressure and the freedom from smoke.

The South Eastern and other railways are now fitting engines for this class of fuel, and an oil-fired engine is used for shunting on the Central London Railway. Boilers are also being fitted for liquid fuel at Woolwich Arsenal, and its use is extending amongst private firms.

In the English shipping trade the pioneers have been Messrs. Samuel and Co., the managers of the Shell Transport Company, and a reference to the excellent performance of their vessel the *s.s. Clam* will be found in a recent number of NATURE. An interesting account of the record voyage under liquid fuel appears in the *Shipping Gazette* of February 13, the vessel being the *s.s. Murex*, also belonging to the Shell Transport Company. This ship arrived at Thames Haven from Borneo via Singapore and the Cape on March 10, having steamed 11,830 miles on a consumption of 800 tons of prepared fuel.

The average daily consumption was from 17 to 18½ tons, whilst the same vessel when under coal used from 24 to 25 tons.

The economy of cost in liquid fuel does not lie entirely in its superior evaporative value, for several other factors are all in its favour, and probably the greatest of these in the marine service is the reduction in the stokehold staff. Potter states that with fourteen tubular boilers (16 feet x 5 feet) twenty-five men were required for stoking with coal, but on the introduction of liquid fuel six men sufficed. On the *s.s. Murex*, referred to above, whilst more than twenty stokers were required when under coal fires, only three were carried to attend the oil burners. When the cost of wages, food, &c., for the large number of stokers carried on an average liner are taken into consideration, the possibilities for economy by the adoption of liquid fuel, when it can be obtained at a reasonable price, are very great. In the Royal Navy, where the stokers carried on a battleship run into big numbers, not only does liquid fuel tend to economy, but an even more important factor—the number of lives risked in an engagement—would be largely reduced. It is terrible to contemplate the fate of the engine-room staff in the event of one of our big ironclads being sunk by a torpedo or the ram of an adversary's ship.

For storage, liquid fuel has a slight advantage over coal. In general terms it may be said that one ton of liquid fuel will require 36 cubic feet of storage and steam coal from 43 to 45 cubic feet; but it must be remembered that coal bunkers have of necessity to be specially arranged for the easy delivery of the fuel at the stokehold level, whereas liquid fuel may be carried in places where the storage of a solid fuel is quite out of the question. By the adoption of some system of removing water from the oil, such as that of Flannery and Boyd, where two settling tanks are alternately employed, liquid fuel may be stored in water-ballast tanks and the fore and aft peaks of the vessel. Remembering that one ton of oil fuel has such a much larger evaporative efficiency than the same weight of coal, and, further, has advantages in storage, a very much larger cargo space can be reserved in a vessel, or in the case of the belligerent marine, with no greater total weight of fuel on board, a very greatly extended radius of action can be obtained.

A point in connection with coal as a fuel in steamships which is often overlooked is the large amount of inert material which must necessarily be carried in the bunkers; for example, a ship takes into her bunkers 2000 tons of steam coal (H.M.S. *Queen*, which was recently launched, has a coal capacity of 2040 tons), and taking a fair estimate of the ash of this coal at 5 per cent., it means finding space for at least one hundred tons of non-usable mineral matter, even assuming that the ash and clinker do not exceed the ash of the coal. In the case of liquid fuel, the whole amount stored is actually available as fuel, and there is no trouble with ash or clinker in the furnaces, or solid waste of any description to be got rid of.

On any vessel, and especially on a ship carrying passengers, the operation of coaling is a particularly disagreeable one. With liquid fuel there is really no inconvenience, for the oil can be pumped into the tanks in much less time than coal shipment takes, and, further, all the dirt associated with "bunkering" is avoided. At the present time it is well known that the Admiralty is carrying out experiments in coaling war vessels at sea, the collier being made fast astern and the coal hauled along a suitable transport arrangement. It would undoubtedly be a much simpler operation to transfer liquid fuel through a flexible hose of slightly greater length than the cables made fast between the two vessels, providing that an oil of reasonable viscosity was employed.

Even in a country possessing such splendid supplies of steam coal as England, liquid fuel is now making rapid headway, and this is not surprising when one considers the high prices reached for coal of all descriptions during the last two or three years. To be able to fall back on liquid fuel, when it can be obtained at a reasonable price, places the consumer in an independent position as regards the colliery proprietor, and the necessary fittings to enable this to be done are by no means costly. Coal at a fair price will probably always have the advantage over imported liquid fuel, but in countries entirely dependent upon imported fuel, the liquid form must in the future be the main supply, for bulk for bulk it is twice as efficient as any solid fuel, and, moreover, its transport in suitable vessels is attended with far less risk than with coal cargoes shipped from a great distance.

J. S. S. BRAME.

THE MURCHISON FALLS.

THE new Government road from the capital of Uganda to Butiaba on the Albert Nyanza will shortly cause the existing caravan track, which crosses the Nile at Fajao, to be abandoned. The latter place obtained some notoriety during the Uganda mutiny 1897-8, but, not being exactly a health resort, the station was soon after given up, and a few Sudanese of the Uganda Rifles now guard the ferry.

On an isolated mass of rock overlooking the Nile, the European quarters are (or were when I passed through on my way from East Africa to the Sudan in October last) still marked by a couple of thatched huts in dilapidated condition, a flower-garden, and a flag-staff from which fluttered the remains of a "Union Jack." From the station a beautiful view of the Murchison Falls, about a mile distant, can be obtained.

Close to the station are two more isolated masses of biotite gneiss, and undoubtedly the river, which is here confined in a deep cañon, has carved its way eastward for one-and-a-half miles to the present falls, leaving these masses as "witnesses."

On arrival, I was struck by the peculiarly irregular sound of the falls; at night it is especially noticeable.

The track to the falls, used by native fishers, at the foot of the cliffs on the south side, follows close to the water's edge, and the sight of five crocodiles with wide-opened mouths on the opposite shore suggested unpleasant possibilities. Usually crocodiles can be seen in hundreds.

Scrambling along the slippery track, much overgrown in places, and glittering with disintegrated mica flakes, we passed several naked Wanyoro fishers in their canoes, and the decaying remains of fish, chiefly a species of perch, showed their favourite landing places.

Arriving at the 200-foot basin into which the fall takes its final plunge, one notices how the constant spray from the falls, ascending in clouds like steam, allows the luxuriant vegetation to grow over even the vertical cliffs surrounding the basin on three sides, except where the soft mica schist has caved in by weathering. A double rainbow added to the beauty of the scene, but the near view of the falls is distinctly disappointing.

The peculiar intermittent roar could now be accounted for; a mass of water tumbling headlong into the pool is immediately followed by an enormous broken wave, then comes a lull, and the process is repeated.

As this phenomenon was inexplicable from below, I suggested that a climb to the top of the falls was advisable; and after much discussion our Nubi guide extracted from an airily clad Mnyoro the information that a track did exist to the top of the south cliff. It proved to be a most trying 200-foot climb up a steep slope covered with dense grass, and it could only have been made by an energetic European. A short downward scramble led to a rock plateau with potholes, the largest of which was 15 feet in diameter and 10 feet deep, filled with water, marking the level of the former bed of the river when it swirled round a mass of gneiss in its centre. This being gradually worn away on the south side, apparently exposed a softer vein, and the river has cut its way through, in a deep vertical cleft, from 20 to 30 feet wide and of unknown depth. A well-known officer in the Uganda Rifles whom I met two days later informed me that he had measured the narrowest portion accessible and found it only 18 feet wide.

Now the Nile above this is a succession of falls, and, after a sharp bend to the north-west, turns again west when 200 feet wide and, gradually narrowing, tumbles 10 feet over a rock ridge spanning the river and then over a 5-foot ridge. For 50 feet it rushes with increasing velocity and finally enters the extraordinary cleft. Down this, for 150 feet, the river "slithers," a solid mass of water, as if through a sluice. Suddenly it meets with an obstruction, a harder layer of gneiss through which it is undercutting its way, and with terrific force strikes this, and rebounds, sometimes with a huge shower of spray. Meanwhile the body of water behind has to find an outlet, and, still confined between high walls, is forced over the ridge with irresistible force ere, 250 feet further on, it tumbles over the last fall into the large basin below, and the back wave, now a vast boiling mass, follows hard after it. This explains the peculiar sound of this fall.

The pent-up power of the Nile as it leaps the barrier is extremely impressive, but from an engineering point of view it is regrettable that such enormous power is running to waste.

I returned to Fajao at sunset, in time to see the Nile tinged a

rich crimson as the sun sank behind the lofty range of mountains west of the Albert Nyanza, and, contrasted with the deep green foliage of the river banks, the scene was striking. But by far the most superb sight was the fall itself under the light of a full moon that night. For the identification of the rock specimens from the falls, consisting of biotite gneiss, mica schist, garnetiferous mica schist, and quartz, I have to thank Mr. G. T. Prior, of the Natural History Section of the British Museum.

C. STEUART BETTON.

THE MANUFACTURE AND USES OF SODIUM.

THE manufacture and uses of metallic sodium is the subject of an interesting article by Mr. James D. Darling in the January number of the *Journal* of the Franklin Institute, from which we take the following facts.

melting point (800° C.) of the chloride and to its corrosive action when in the molten state.

The process introduced by Mr. Darling involves the electrolysis of sodium nitrate with the liberation of sodium and of nitrogen peroxide, which is then converted into nitric acid.

The decomposition cell consists of a cast-iron pot set in a brick furnace. At the bottom of the pot is a 6-inch layer of refractory insulating material, and on this rests a cup 30 inches high, 16 inches outside diameter, with walls 4 inches thick. This cup is made of two sheets of perforated steel, between which is a mixture of ground deadburned magnesite and Portland cement which has been mixed with water and allowed to set hard. The space between the cup and the pot is filled with sodium nitrate (M.P. 313° C.) and the cup itself with melted caustic soda (M.P. 320° C.). The cast-iron pot acts as the anode, and 5 per cent. of the current is advantageously shunted through the metal walls of the cup. The cathode consists of a short length of 4-inch

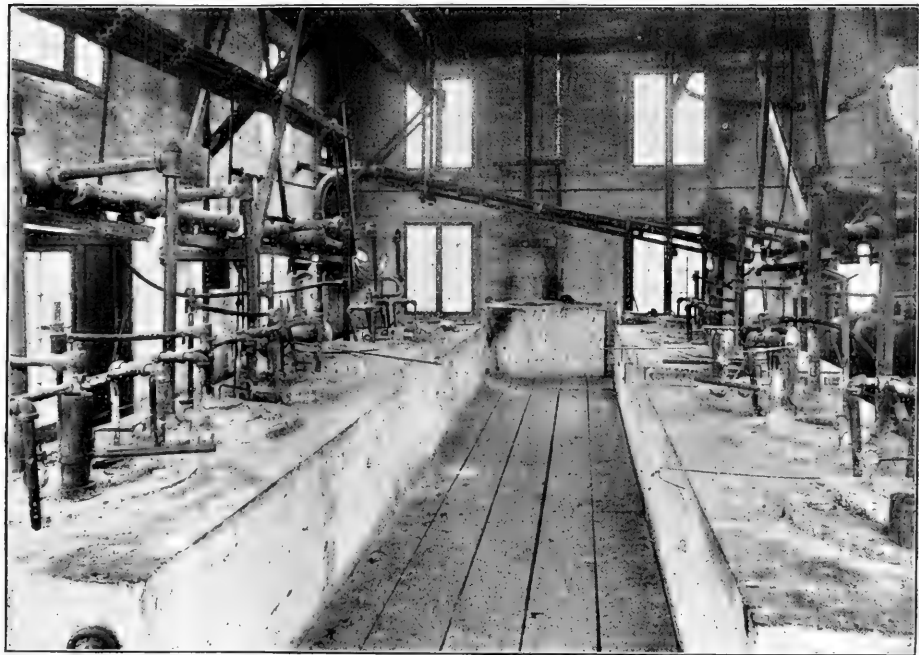

FIG. 1.—General View of Sodium Furnaces.

From the time of its isolation in 1801 until 1855, the cost of sodium was exceedingly high. In 1858, Deville perfected the process of manufacture by heating sodium carbonate, chalk and coal in an iron retort and condensing the sodium vapour thus produced. The price then fell from 2000 francs to 10 francs per kilo. No further important advance in the manufacture was made until the late Mr. Castner took up the subject, and after using with great advantage a modification of Deville's process in which carbon was replaced by a compound of carbon and iron and carbonate of soda by caustic soda, he succeeded in 1890 in making Davy's original method available on the large scale, that is to say, the method of decomposing fused caustic soda by the electric current. Most of the sodium used to-day is made by this process.

Attempts to make sodium from its cheapest compound, the chloride, have so far been unsuccessful, owing chiefly to the high

wrought-iron pipe reaching nearly to the bottom of the cup. Each furnace takes a current of about 400 amperes at an average E.M.F. of 15 volts, and external heat is used only when starting up or when changing the cups, which have a life of 425 to 450 hours. When the current is passed, nitrogen peroxide and oxygen are liberated at the anode and escape through a hole in the cover of the pot. Sodium is liberated at the cathode, and rises to the top of the cup, where at intervals of an hour it is dipped off with a spoon and preserved under mineral oil.

The aim of this new process is to decompose sodium nitrate in such a way that the sodium is liberated in a medium which will not oxidise it, and to get the nitrogen peroxide for the manufacture of nitric acid. How this is done will be evident from the description just given; the sodium ions of the fused nitrate travel through the walls of the porous cup to the fused caustic soda; they act upon the caustic soda until it is converted

(probably) into the monoxide, hydrogen being liberated, and when this is once achieved the following sodium ions form metallic sodium at the cathode. The use of two electrolytes with a common cation enables the sodium to be liberated in such a way as to escape oxidation by the fused nitrate. It is obvious that the only substance used up is the nitrate. Fig. 1 gives a general view of the sodium furnaces.

The nitrogen peroxide and oxygen evolved at the anode are conducted by earthenware pipes to a number of Woulff's bottles, connected together and containing water. The arrangement is shown in Fig. 2. The action of NO_2 on water is as follows:— $3\text{NO}_2 + \text{H}_2\text{O} = 2\text{HNO}_3 + \text{NO}$. The NO takes up more oxygen to form NO_2 and more nitric acid is produced. If very strong acid is required, a system of absorbing towers is used.

Sodium is now used on the large scale for making sodium peroxide and sodium cyanide. The peroxide is made by burning

Mr. Darling states that he has devised a new method of preparing cyanides in which he avoids using so much sodium in the metallic state.

UNIVERSITY AND EDUCATIONAL INTELLIGENCE.

OXFORD.—Considerable changes will be introduced into the examination for Mathematical Honours, Moderations, by a scheme which comes into effect in 1904. The main features of this scheme are (1) the legalising of the use of the infinitesimal calculus in answering questions on mechanics; (2) the abolition of restrictions on the freedom of choice of method, analytical or synthetic, in the treatment of geometry; (3) the introduction of the elements of analytical solid geometry.

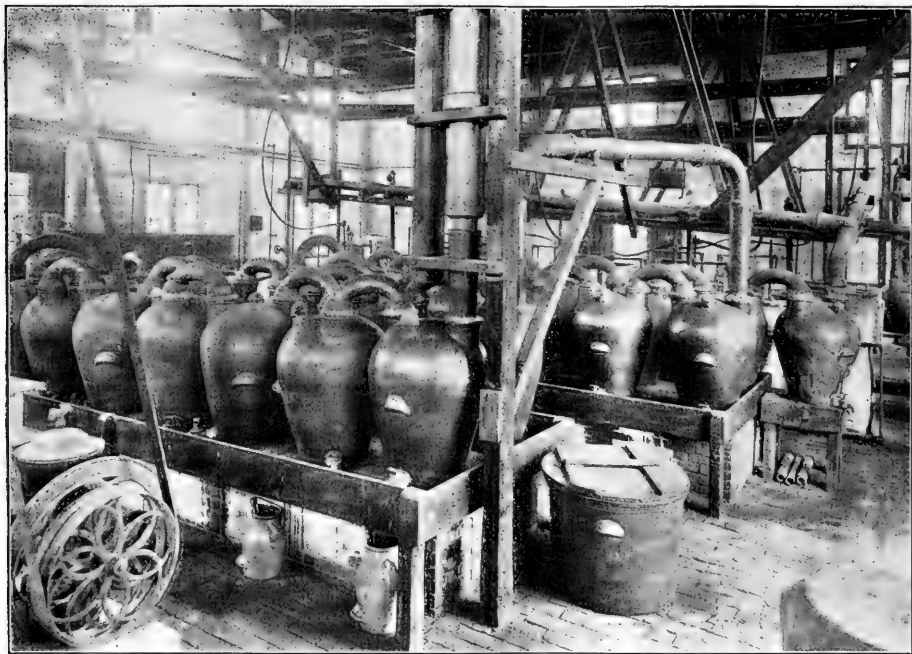

FIG. 2.—Apparatus for converting Nitric Oxide into Nitric Acid.

sodium in an excess of dry air free from CO_2 , in an externally heated retort. It is a valuable oxidising and bleaching agent, replacing the most costly hydrogen peroxide.

Sodium is used in making cyanides by Erlenmeyer's process, in which the metal is heated with potassium ferrocyanide, $\text{K}_4\text{FeC}_6\text{N}_6 + 2\text{Na} = 4\text{KCN} + 2\text{NaCN} + \text{Fe}$. Potassium carbonate is usually added so as to make the percentage of CN in the mixture equivalent to that of pure KCN.

Another method of using sodium in the manufacture of cyanides is to make sodamide by heating the metal in ammonia gas, $\text{Na} + \text{NH}_3 = \text{NaNH}_2 + \text{H}$. The sodamide may then be heated with carbon, $\text{NaNH}_2 + \text{C} = \text{NaCN} + \text{H}_2$, or, according to another process, it may be made to first form a cyanamide, $2\text{NaNH}_2 + \text{C} = \text{Na}_2\text{N}_2\text{C} + 2\text{H}_2$. The cyanamide is then treated with more carbon at a higher temperature, $\text{Na}_2\text{N}_2\text{C} + \text{C} = 2\text{NaCN}$.

CAMBRIDGE.—The following are the speeches delivered by the Public Orator, Dr. Sandys, on June 10, in presenting for the degree of Doctor in Science *honoris causa* (1) Sir Harry Hamilton Johnston, G.C.M.G., K.C.B., Special Commissioner for the Uganda Protectorate, and (2) Dr. A. W. Rucker, F.R.S., Principal of the University of London:—

"Semper aliquid novi Africam adferre" etiam inter antiquos dicebatur. In Africa nuper ab hoc viro, ne plura commemorem, camelopardalis speciem novam repertam esse constat. Idem Africae in regione septentrionali, occidentali, orientali, Africa etiam in media, patriae personam summa cum dignitate gessit; Africae montes, flumina, lacus exploravit; exploratos et pingendi et scribendi arte eximia ante oculos nostros posuit. Quid dicam de libris illis, quorum in uno Livingstonii vitam egregie narravit; in alio colonias omnes ab Europae gentibus in Africam deductas luculenter descripsit; in alio denique Afrorum

servitutis imaginem vividam expressit? Talium virorum laboribus indes plura de Africae regione immensa cognovimus, et telluris illius tenebras luce indies maiore illustratas cernimus. Duco ad vos virum a societate zoologica numismate auro honoris causa donatum, equitem insignem, HARRY HAMILTON JOHNSTON.

Universitatis Londiniensis nuper denuo constitutae praesidem primum ea qua par est observantia salutamus, virum studiis mathematicis olim exultum, Collegii sui inter Oxonienses honoris causa socium; primum in comitatu Eboracensi, deinde inter Londinienses scientiae physicae professorem; Societatis Britannicae scientiarum finibus preferendis nuper praepositum; Regiae denique Societatis inter lumina iamdudum numeratum. Qui insulae Britannicae explorationem magneticam non semel tantum ad finem felicem perduxit, nunc Universitati maximae est praepositus, in qua, animi vi quadam magnetica praeditus, collegarum suorum omnium corda ad se attrahit, et Universitatis totius ad communem fructum Londiniensium liberalitatem allicit. Duco ad vos Universitatis Londiniensis praesidem insignem, ARTHURUM WILLELMUM RÜCKER.

HOLIDAY courses in botany, physics, physiology and zoology will be held at the University of Jena from August 4 to August 16. Particulars and detailed programmes of these and other courses can be obtained from the secretary, Mrs. Dr. Schnetzer, 2 Gartenstrasse, Jena.

The discussion of the Education Bill was resumed in Committee of the House of Commons on Tuesday. An amendment providing that the council of a borough with a population of more than 10,000, or an urban district with a population of more than 20,000, must obtain the consent of the council of the county in order to become the local authority for elementary education was put to the vote and negatived. A proposal to omit the whole of the clause which constitutes the county councils local education authorities was also rejected.

At a meeting of the council of the Institution of Mining and Metallurgy on Tuesday, it was decided to offer scholarships in mining and metallurgy to the following colleges:—The Royal School of Mines, two scholarships of 50*l.* each; King's College (London), 50*l.*; the Camborne School of Mines (Cornwall), 50*l.*; and the Durham College of Science (Newcastle-on-Tyne), 50*l.* These scholarships will be offered annually for three years. In addition to other work for the advancement of technical education in mining and metallurgy, the Institution has submitted to the Board of Education a comprehensive scheme for affording practical experience in workshops throughout the kingdom to mining and metallurgical students, and it is expected shortly to be put in force.

At a special meeting of the council of King's College, London, held on Friday last, it was resolved by twenty-two votes to two, "That, in view of the situation created by the University of London Act, 1893, the council, while determined to maintain the connection of the college with the Church of England as set forth in section 5 of King's College, London, Act, 1882, resolves that, so soon as may be, every religious test as a qualification for office, position, or membership in or under the council or college, other than professorships or lectureships in the Faculty of Theology, shall cease to exist, and, further, that all necessary and proper steps be taken to give effect to this resolution." The section referred to in this resolution specifies the following as the purpose of the college:—"To give instruction in the various branches of literature and science and the doctrines and duties of Christianity as the same are inculcated by the Church of England."

A SUCCESSFUL exhibition, designed to show the provision made for science teaching in the secondary and elementary schools of Hampshire and the Isle of Wight, was held at the Hartley College, Southampton, on Saturday last. A well-arranged series of exhibits enabled the visitor to see at a glance the encouragement given by His Majesty's inspectors and others to the construction of simple home-made apparatus to illustrate the principles of physics and chemistry. It was clear from the work of students which was on view that considerable prominence is being given to nature study in these districts; and the collections and drawings of biological subjects of the kind shown should serve to extend and improve the teaching of botany and zoology in schools. The conference of teachers held at the Hartley

College in connection with the exhibition, to discuss methods of teaching science, was largely attended and gave evidence of a widespread desire to introduce observational and experimental methods in all scientific instruction.

SOCIETIES AND ACADEMIES.

LONDON.

Chemical Society, May 28.—Prof. Meldola, F.R.S., vice-president, in the chair.—Taxine, the alkaloid of yew, by Dr. Thorpe, C.B., F.R.S., and Mr. G. Stubbs. The authors have confirmed the observations of Hilger and Brande, Marné and others on the occurrence of an amorphous alkaloid in yew.—The sampling of soils, by Dr. J. W. Leather. Comparative experiments were made in India to determine the possible accuracy of the auger method of sampling soils, the available phosphoric acid and potash being taken as a standard of comparison. The results showed that in most cases the agreement was good between the samples, but that there was occasionally a divergence of about five per cent.—Some excessively saline Indian well waters, by Dr. J. W. Leather. An examination of some well waters collected in the Muttra district, United Provinces, India, showed that they contained from 2 to 2 per cent. of saline substances consisting of sulphate, nitrate, chloride and carbonate of sodium.—Nitro-bromo-derivatives of fluorescein, by Dr. Hewitt and Mr. Woodford. Several of these substances have been isolated and characterised.—Phosphorus sesquisulphide and its behaviour with Mitscherlich's test, by Mr. F. G. Clayton. Analyses of commercial specimens of this substance have been made, and show that they contain from 83 to 97 per cent. of sesquisulphide.—Atomic and molecular heats of fusion, by Mr. P. W. Robertson. The author finds that for a number of the elements and their binary inorganic derivatives a relation between (atomic or molecular) heat of fusion, absolute melting point and atomic volume exists which is capable of a more or less general representation by an equation of the form $Aw/T^3\sqrt{V} = \kappa$.—The preparation of mixed ketones by heating mixed calcium salts of organic acids, by Mr. E. B. Ludlam. An extension of the method proposed by Young in 1891.—Isomeric additive products of methyl, ethyl and propyl benzyl ketones with benzylidene aniline, part iv., by Dr. Francis and Mr. Ludlam.—The influence of solvents on the rotation of optically active compounds, part iii., influence of benzene, toluene, *o*-xylene, *m*-xylene, *p*-xylene and mesitylene on the rotation of ethyl tartrate, by Dr. T. S. Patterson. The above solvents exert in the order named an increasing influence in diminishing the rotation of ethyl tartrate; in the case of the first four solvents this effect reaches a minimum and a maximum at appropriate concentrations.—iv. Influence of naphthalene on the rotation of ethyl tartrate, by Dr. T. S. Patterson. The effect of this hydrocarbon is to increase the observed rotation.

Geological Society, May 28.—Prof. Charles Lapworth, F.R.S., president, in the chair.—The Red Sandstone-Rocks of Peel (Isle of Man), by Prof. W. Boyd Dawkins, F.R.S. The Red Sandstone series, ranging along the coast from Peel to Wilt's Strand, is faulted into the Ordovician massif of the Isle of Man. It has been referred to the Old Red Sandstone, the Calciferous Sandstone, the basement Carboniferous, and to the Permian. The series consists of red sandstones containing irregular conglomerates and breccias, more or less chemically altered, known in the lake district as "Brockram." Sections at Ballagnane, Creg Mahin, and at the Gob and Traie Fogog, are described in detail; the rocks are classified, and their range to the north-east and inland is described. It is pointed out that the rocks are different in many respects from the basement Carboniferous rocks of Langness and elsewhere, and a list of the materials contained in the "Brockrams" is given. The fossiliferous pebbles in the rocks in question are described, and their fossil contents determined. The whole group of fossils is Lower Carboniferous and Ordovician, and centres mainly in the Carboniferous Limestone. A comparison is instituted with the Permian rocks of Barrowmouth, the Vale of Eden and elsewhere.—The Carboniferous, Permian and Triassic rocks under the glacial drift in the north of the Isle of Man, by Prof. W. Boyd Dawkins, F.R.S.—Note on a preliminary examination of the ash that fell on Barbados, after the eruption at St. Vincent (West Indies), by Dr. J. S. Flett, with an analysis of the dust by Dr. William Pollard (see p. 130).

PARIS.

Academy of Sciences, June 9.—M. Bouquet de la Grye in the chair.—Remarks by M. Hatt on the tidal constants for a certain number of ports in France, the Indian Ocean and China.—A discussion of the magnetic observations made in the central region of Madagascar, by M. P. Colin. A striking anomaly exists at Tsiafajavona, the highest summit of the Ankaratra chain. By reason of its mass and magnitude, this chain exerts a considerable influence in its neighbourhood. A second less-marked centre of disturbance appears in the neighbourhood of Vontovorona. The eastern plateau possesses a more regular magnetic field than the western, the volcanic zones having only a local action of small radius.—On the diabetogenic leucomaines, by MM. R. Lépine and Boulud.—M. Amagat was elected a member in the section of physics in the place of the late M. Cornu.—M. Albert Gaudry announced that M. André Tournouer, who was in charge of the Patagonian expedition, had discovered important remains of Pyrotherium near Rio Desado. The deposits containing these remains also yielded a large number of fossils of mammalia of great interest.—On functions of infinite species, by M. Emile Borel.—On a remarkable case of rational transformation in space, by M. D. Gravé. On internal combustion motors, by M. L. Lecornu.—On the electric force due to the variation of magnets, by M. E. Carvallo. A discussion of an experiment of M. Cremieu which led to results apparently in contradiction to Maxwell's theory. It is shown that this results from the manner in which M. Cremieu has applied the definition of electric force, and that the results are in complete accord with Maxwell's theory.—On the variations of the zodiacal light, by M. L. Décombe.—The accidental double refraction of liquids mechanically deformed, by M. G. de Metz. A careful study of this property for a considerable number of solutions shows that there is no necessary connection, as has usually been supposed, between the double refraction produced and the viscosity. For certain liquids the optical phenomenon lasted several seconds after the mechanical strain; the effect was especially noticeable with copal and dammar varnish and with collodion.—On a new isomerism in asymmetric nitrogen, by M. E. Wedekind. The presence of two atoms of asymmetric nitrogen in a molecule appears to render possible the existence of stereoisomeric ammonium salts.—On benzene-azobenzoid aldehyde, by M. P. Freundler. Compounds of the type $C_6H_5N=N.C_6H_5.CO.R$ cannot be obtained by the reaction of Friedel and Crafts, but can be readily prepared by the simultaneous reduction of a mixture of nitro-compounds; thus a mixture of nitrobenzene and nitrobenzoic aldehyde reduced in this way gives benzene-azobenzoid aldehyde, the preparation and properties of which are described.—The oxidation of morphine by the juice of *Russula delica*, by M. J. Bougault. The oxydase present in the plant juice gives the same oxymorphine as is obtained by the oxidation of morphine with potassium ferricyanide.—On the lipase of the blood, by M. Hanriot. The author admits the truth of some criticisms of his former work on this subject by MM. Doyon and Morel, but holds that these experiments furnish no conclusive arguments against the existence of lipase in the blood.—On caryophyema in Euglena, by M. P. A. Dangeard.—On a permanent action which tends to provoke a negative tension in the woody vessels, by M. H. Devaux.—The volcanic rocks of Martinique, by M. A. Lacroix.—The production of a polyvalent preventive serum against pasteurelloses, by MM. Lignières and Spitz.—On the presence of a rennet in plants, by M. Maurice Javillier. The rennet obtained from the juice of rye-grass possesses all the properties of animal rennet. The ferment is met with in many different plants, ten being enumerated in the present paper.—On a qualitative difference between the excitomotor effects of open and closed induced currents, by Mlle. I. Ioteky.—On the yeasts used for the fermentation of cider, by M. Henri Alliot.—On the bouquet of wines obtained by the fermentation of sterile musts from grapes, by M. A. Rosenstiehl. The conclusion is drawn that the quality of a wine of well-known vintage depends less upon the quality of the grape than upon the nature of the yeast which grows spontaneously upon the grape.—The action of sulphurous acid upon oxydase and on the colouring matter of red wine, by M. A. Bouffard. The protective action of the sulphurous acid acts in two ways; it has a distinctly destructive effect upon the oxydase, and also forms an unstable compound with the colouring matter which protects it from the oxygen of the air.—On the phosphates of

the soil which are soluble in water, by M. Th. Schlessing, fils.—On a new form of collecting bottle for sea-water at great depths, by M. Jules Richard.

DIARY OF SOCIETIES.

THURSDAY, JUNE 19.

ROYAL SOCIETY, at 4.30.—On the Correlation between the Barometric Height at Stations on the Eastern Side of the Atlantic: Miss F. E. Cave-Browne-Cave and Prof. K. Pearson, F.R.S.—Note on the Effect of Mercury Vapour on the Spectrum of Helium: Prof. J. Norman Collie, F.R.S.—The Reed-Fungus of *Lobelia tomentosa*, L.: the Darnelc: Poisonous Rye-Grass: E. M. Freeman.—On Methods for the Limitation and Regulation of Chloroform when administered as an Anesthetic: A. Vernon Harcourt, F.R.S.—On the Measurement of Temperature. Part I. On the Pressure Coefficients of Hydrogen and Helium at Constant Volume, and at different Initial Pressures. Part II. On the Vapour Pressures of Liquid Oxygen at Temperatures below its Boiling Point, on the Constant Volume Hydrogen and Helium Scales. Part III. On the Vapour Pressures of Liquid Hydrogen at Temperature below its Boiling Point, on the Constant Volume Hydrogen and Helium Scales: Dr. M. W. Travers and others.—On Colour-Physiology of the Higher Crustacea: F. W. Keeble and Dr. F. W. Gamble.—On some Phenomena which suggest a Short Period of Solar and Meteorological Changes: Sir Norman Lockyer, F.R.S., and Dr. W. J. S. Lockyer. And other papers.

LINNEAN SOCIETY, at 8.—On Obseilla, a New Genus of Copepoda: Dr. W. G. Ridewood.—On Modern Methods in Mycology: Mr. G. Masse.—Further Observations on Ows, especially their Skeleton: W. P. Pycraft.

FRIDAY, JUNE 20.

PHYSICAL SOCIETY, at 5.—Exhibition of a Three-Circle Goniometer: G. F. Herbert Smith.—The Heat Absorbed when a Liquid is brought into Contact with a finely-divided Solid: C. J. Parks.—(1) On the Electrical Resonance of Metal Particles for Light Waves (Second Communication); (2) On a Remarkable case of uneven Distribution of Light in a Diffraction-Grating Spectrum: Prof. R. W. Wood.—Exhibition of a Simple Form of Apparatus for Measuring the Mechanical Equivalent of Heat: Prof. H. L. Callendar.

CONTENTS.

	PAGE
The Plate of Lamarck in the History of Evolution. By F. A. D.	169
Elementary Chemistry. By A. S.	170
Solid Geometry	171
Belgian Botanical Investigations	171
Our Book Shelf:—	
Kapp: "Dynamos, Alternators and Transformers;"	
Delays and Pittet: "Etude Pratique sur les Différents	
Systèmes d'Éclairage."—M. S.	172
Wood: "Sanitary Engineering, A Practical Manual	
of Town Drainage and Sewage and Refuse Dis-	
posal"	173
Lindsay: "The Story of Animal Life"	173
Baker: "Municipal Engineering and Sanitation"	173
Letters to the Editor:—	
Astronomy in the University of London.—Prof. Karl	
Pearson, F. R. S.	174
De Vriesian Species.—Prof. T. D. A. Cockerell	174
Formula for the Perimeter of an Ellipse.—Dr.	
Thomas Muir, C. M. G., F. R. S.	174
The "Armor" Electro-Capillary Relay.—The	
Writer of the Article	175
Science and Military Education	175
A Holiday Cruise to Alaska. By G. W. L.	176
Observations of Volcanic Activity in the West	
Indies	178
Prof. Adolf Fick	180
Notes	182
Our Astronomical Column:—	
The Sunspot Curve and Epochs	186
Method of Observing Altitudes at Sea during Night-	
time	186
Liquid Fuel for Steam Purposes. By J. S. S. Brame	186
The Murchison Falls. By C. Steuart Betton	188
The Manufacture and Uses of Sodium. (Illustrated)	189
University and Educational Intelligence	190
Societies and Academies	191
Diary of Societies	192

THURSDAY, JUNE 26, 1902.

BIBLICAL CRITICISM AT ITS BEST AND WORST.

Encyclopædia Biblica; a Critical Dictionary of the Literary, Political and Religious History, the Archaeology, Geography and Natural History of the Bible. Edited by the Rev. T. K. Cheyne, D.Litt., D.D., and J. Sutherland Black, M.A., LL.D. Vol. iii. (L to P). (London: Adam and Charles Black, 1902.)

WHEN the plan of the "Encyclopædia Biblica" was first announced several years ago, the most favourable anticipations were formed with regard to the new project by all advocates of a moderate and scientific criticism of the Biblical writings. This dictionary was to embody the ideal of the late Prof. Robertson Smith, an encyclopædia which should include within its purview the results of the latest criticism, provided only that this criticism was conceived in common sense, developed with moderation and expressed with that consideration for the holders of traditional views which in this case is absolutely required. The first volume of the "Encyclopædia" seemed entirely to fulfil these anticipations, and its appearance was welcome to all students of Biblical history and archaeology; but in the second, various disquieting symptoms were noticeable, especially in Prof. Cheyne's article "Jerahme'el"; the third can only be frankly described as disappointing these initial hopes and as being, in fact, most damaging to the cause of the "higher criticism." Those who have a working knowledge of Biblical criticism will, of course, be able to discriminate between those parts of the "Encyclopædia" which are really useful and suggestive and those which are the reverse; but what of the vast majority of readers who do not know? It is probable that very many of these, wearied by Prof. Cheyne's incessant discussion of his "Jerahmeelites" and "Musrites," irritated by Prof. van Manen's calm abolition of St. Paul and revolting against the inconsiderate tactlessness of Prof. Schmiedel's article "Mary," will, ignoring the vast overplus of sound and sterling critical learning which is to be found in the book, be driven into the opposing camp of anticritical obscurantism and refuse to hear anything further of Biblical criticism. Thus will the splendid work of critics of the type of the late Profs. Robertson Smith, Tiele and Socin, many of whose articles appear in this volume, of Profs. Driver, Nöldeke and Wellhausen, of President Moore and many others, be discredited by the insistent advocacy of a single overmastering theory for which no convincing proof has yet been furnished by its author, and by the continual display by several of the continental contributors of their ignorance of the fact that in approaching British and American readers on such a subject as the Nativity of Christ or the life of the Virgin Mary the utmost tact is necessary.

We have spoken of Prof. Cheyne's insistent advocacy throughout this volume of the "Encyclopædia" of his Jerahmeel-cum-Musri theory, and have described this theory as one for which no convincing proof has yet been

NO. 1704, VOL. 66]

furnished by its author. Certainly in the "Encyclopædia Biblica" he has furnished none, either in the article "Jerahme'el" in vol. ii. or in the present volume. For a convenient summary of all that is apparently known about the name "Jerahmeel" and the tribe of the Jerahmeelites we may refer the reader to Mr. J. F. Stenning's paragraph on the subject in Hastings' "Dictionary of the Bible," vol. ii. p. 568. The Jerahmeelites were a clan of southern Judæa, mentioned three or four times in the Old Testament; the name Jerahmeel occurs four times (1 Chr. ii. 9, 33; xxiv. 29; Jer. xxxvi. 26). Prof. Cheyne, however, has built up for himself a vast edifice of pure theory all about the Jerahmeelites, in whom he sees a powerful tribe of Arabian origin equal in importance to, and rivalling, the Israelites. This theory is connected by him with Winckler's unproved theory of the existence of a North Arabian country bearing the same name in the Assyrian records as did Egypt and a land of Northern Syria, i.e. "Musri," which itself again largely rests upon the unproved theories of Glaser with regard to the age of the "Minæan" inscriptions of Yaman. So Prof. Cheyne pictures to himself hosts of "Jerahmeelites" and "Musrites" constantly warring against Israel, finding them even serving in the armies of Nebuchadnezzar; they were, according to him, constantly the objects of prophetic denunciation for the evil which they had done unto Israel, although at the same time a disproportionate number of the Jewish proper names known to us from the Old Testament are pronounced by him to be of Jerahmeelite origin. But if the Jerahmeelites are only mentioned half-a-dozen times in the traditional text of the Old Testament and the "Musrites" may quite possibly never have existed, how does Prof. Cheyne arrive at these somewhat revolutionary conclusions? By a simple process very characteristic of the extreme "higher critic," he merely supposes that the name "Jerahmeel" originally occurred far more in the Old Testament than it does at present, and that it has been constantly substituted and corrupted; he then proceeds to replace the words "Jerahmeel" or "Musri" (Musri) wherever he thinks they ought to stand, and in this way "restores" the text of the Bible in accordance with his theory. Many of his re-substitutions and corrections are founded on more or less ingenious emendations of the text; for others no justification is given; they rest merely on the *ipse dixit* of Prof. Cheyne. This procedure might be excused in a critic of such preeminent standing as Prof. Cheyne, and we would be ready to accept from the mine of his great learning many conclusions the reasons for which were not fully apparent were it evident to us that the steps of his reasoning were tending in the direction of what was both probable and possible; but in the case of "Jerahmeel" we confess that we have very little faith in his reasoning, and in the connected case of the supposed North Arabian *Musri* we believe that he has been misled by a hasty adoption of a theory which is in no way accepted by the majority of Assyriologists.

However this may be, it is in any case on the face of it evident that the professor has in the third volume of the "Encyclopædia" allowed himself to be absolutely overmastered by his theory; he sees Jerahmeel everywhere; everything is a corruption or a disguise or a distortion

K

of "Jerahmeel"; *Anram* is a "development" of "Jerahmeel"; *Abram* is a corruption of "Jerahmeel"; *Levi* is a Jerahmeelite name, for it corresponds to Leah, which is "a fragment of a feminine form of Jerahmeel"; *Maacah* is "a popular corruption of Jerahmeel or Jerahmeelith (a Jerahmeelites);" *Meholah* is the same, *Mephiosheth* (col. 3023), *Michael*, *Abihail* (col. 3198), *Jerubbaal*, *Ephraim* (3516), *Rimmon* (3379), *Ramah* (3264), *Jericho* (3258), *Hiddekel*, *Leummim* all apparently occur as corruptions of, or substitutions for, "Jerahmeel." In the majority of cases it is impossible to discover how or why. "Both *Micha* and *Chinham* [the italics are ours] (2 S. 19, 37 ff.) may quite naturally," says Prof. Cheyne (col. 3025), "be traced to Jerahmeel"; *Ebed-melech* ought to be "Arab-jerahmeel" (3340); the *Nephilim* were really Jerahmeelites, for *Nephilim* = "Rephilm" = "Jerahmeel"; and after this the transition *Nemuel* — "Jemuel" — "Jerahmeel" is comparatively easy! Further, *Amalek* is "an early popular distortion" (2035) of, and "ultimately the same name" (3258) as, "Jerahmeel." The inevitable Jerahmeel pursues us even into the Garden of Eden. In *Gen.* ii. 8 "we cannot hesitate to read 'Yahwé [Elohim] planted a garden in Eden of Jerahmeel';" the traditional text reads, "And Yahwé [Elohim] planted a garden eastward in Eden." According to Prof. Cheyne there is a "Jerahmeelite form of the story" of Paradise (3574), and the passage *Gen.* iii. 20 probably ran originally, "And Jerahmeel called the name of his wife Hörith, that is, a Jerahmeelites." The original names of Adam and Eve were, therefore, not Adam and Eve, but "Jerahmeel" and "Hörith." We cannot find that any real reasons are given for all these assumptions.

Dr. Winckler's hypothetical North-Arabian "Musri" is pressed into service in much the same way. Here is the traditional text of *Deut.* xxxiv. i side by side with Prof. Cheyne's version of it:—

Traditional Text. (R. V.)

"And Moses went up from the plains of Moab unto mount Nebo, to the top of Pisgah, that is over against Jericho. And the Lord shewed him all the land of Gilead, unto Dan, and all Naphtali, and the land of Ephraim, and Manasse, and all the land of Judah, unto the hinder sea; and the South, and the Plain of the valley of Jericho the city of palm trees, unto Zoar."

Prof. Cheyne's Version.

"And Moses went up from Arabia of Musri to the top of the mountain of the Negeb of Jerahmeel [fronting Jerahmeel].² And Yahwé shewed him Jerahmeel as far as Dan, and all Tappühim [the land of Jerahmeel and Musri], all the land of Judah as far as the Jerahmeelite sea,³ and the Negeb of Jerahmeel [the land of Jerahmeel, the land of Musri]."

Prof. Cheyne's note² is to the effect that the words in square brackets are to be regarded as glosses; note³ states that this is the true original name of the Dead Sea.

Because, relying on his own arbitrary interpretation of *ii. Chron.* xxi. 16, Dr. Winckler boldly supposes a North-Arabian Kush as well as a North-Arabian Musri, Prof. Cheyne naturally follows, and so we find that the name of *Nehushta*, the mother of Jehoiachin, is corrupt; it ought to be "Cushith," a North-Arabian: her father was "Elnathan of Jerusalem"; this is very unlikely; "Elnathan" is of course wrong, and "Jerusalem" is in this passage a corruption of Jerahmeel! Of course Prof. Cheyne does not mean a corruption in the sense in

which the word "lord" is a corruption of "hlaford"; he means that the text has been more or less wilfully altered from the supposed original "Jerahmeel" to the existing "Jerusalem." But he gives no real proof of any such corruption or of the validity of his supposition that the original text read "Jerahmeel."

Mordecai follows the rest; *Paddan-aram* ought to read "Haran (Hauran?) of Jerahmeel" (3523); *Daniel* "is most easily explained as a corruption of Jerahmeel," and with Daniel go *Babel*, *Nebuchadnezzar* and *Belshazzar*, the real original of the latter having been a hypothetical "Baal, prince of Missur" (3983). For Prof. Cheyne's apparent belief that the names of Nebuchadnezzar and Belshazzar have, in the Book of Daniel, been substituted for those of his hypothetical North Arabian heroes, and that the *mise-en-scène* of the story of Daniel is to be bodily transferred from Babylonia to the Negeb of Jerahmeel, no proof whatever is given.

The reader is invited to compare the accepted text of *Jer.* xxxix. 1 with Prof. Cheyne's version of it; *Nergal-sharezzer* is, according to him, a corruption of "Mergal-sharezzer" (!) which "proceeded from" "*shar Yerahmeel shar Missur*," "the king of Jerahmeel and the king of Missur." He turns the Babylonian Nergal-shar-utsur, the Rab-mag, and other Babylonian officials into princes of Jerahmeel, Missur, Nodab, Cushim and the Arabians. For these extraordinary proposals not the slightest justification is given.

For Prof. Cheyne the Book of Obadiah seems to contain a kind of Bacon-Shakespeare cryptogram all about Jerahmeel, and this is how he, with apologies for doing so, it is true, recasts the well-known sentence from Psalm cxxxvii.: "On the heritage of Jerahmeel we wept, remembering Zion." In Psalm cx., Prof. Cheyne restores an original text for verses 5-6 (R. V.), "The Lord at thy right hand shall strike through kings in the day of His wrath; He shall judge among the nations, He shall fill the places with dead bodies, He shall strike through the head in many countries," as follows:—

"The Lord will shatter Jerahmeel in the day of His wrath, He will judge mighty kings for the treason of their pride. The Lord will smite Geshur on the land of the Arabians; the kings of Rehoboth He will destroy, the princes of Jerahmeel."

It may be admitted that the received text is here corrupt, but we cannot see that the corruption goes very far or think it probable that the original sense of the passage quoted was very different from its present tenour; even as it stands, it is not nonsense, any more than is the Pisgah passage quoted above.

Finally, we may compare the received text of *Gen.* x. 10 ff., describing the kingdom of Nimrod, with Prof. Cheyne's version of it:—

Traditional Text. (R. V.)

"And the beginning of his kingdom was Babel, and Erech, and Accad, and Calneh, in the land of Shinar. Out of that land he went forth into Assyria, and builded Nineveh, and Rehoboth-Ir, and Calah, and Resen between Nineveh and Calah. . . ."

Prof. Cheyne's Version.

"And the beginning of his kingdom was Jerahmeel in the land of Seir. From that land he went forth into Geshur, and smote Hebron, Rehoboth, Jerahmeel, and Beersheba, which is between Hebron and Jerahmeel."

In this passage we have a plain statement of a legendary account of the origin of the kingdoms and cities of

Mesopotamia, the foundation of which is in the legend ascribed to a half-mythical hero called Nimrod. It is impossible to see what grounds there are for any radical alteration of the text, yet Prof. Cheyne arbitrarily assumes that all the Mesopotamian names in the passage quoted are substitutions for names of obscure places to the south of Judæa, and he apparently does so merely because Nimrod is called a son of Cush, and Dr. Winckler thinks there was a country called Cush in northern Arabia. In this case we cannot but reject Prof. Cheyne's alterations, which seem to us entirely arbitrary, unnecessary and improbable.

We have by no means given a full list of the passages in the "Encyclopædia" which Prof. Cheyne devotes to "Jerahmeel" and the names which he would identify with it, but further enumeration would be wearisome. Space, too, fails us wherein to recapitulate the obvious arguments against the wildest of all Prof. Cheyne's proposals, *i.e.* to explain *Goshen*, *Pithom* and *Raamses* as names, not of Egyptian places, but of "the Negeb of S. Palestine or N. Arabia" (*col.* 3211), and so to deny, in effect, that there ever was any Israelitish sojourn in, or exodus from, Egypt at all, the exodus having been, according to him, an exodus, not from Egypt, but, of course, from the other country of the same name in northern Arabia! (see the article "Moses"). But here again Prof. Cheyne is merely following Winckler, whose theory on the subject he regards as "at any rate very plausible" (*art.* "Mizraim," *col.* 3163).

Now Prof. Cheyne is, of course, at liberty to hold this theory if he pleases, and to connect it with the equally vague and unestablished theory of Dr. Winckler about the "North-Arabian Muşri" or with any other theory he pleases, but it is doubtful whether he ought to state it with such assurance of its validity in a work of this kind, which was intended to give its readers the matured results of a reasonable criticism, not necessarily the latest theories all hot. Prof. Cheyne has, however, in the majority of cases chosen to give his readers mere neoteristic theories instead of solid and *certain* additions to knowledge.

We cannot find that any of his colleagues have adopted Prof. Cheyne's views on the Jerahmeel question, with a single exception, and that a most unexpected one. It was rather startling to find the name of Mr. T. G. Pinches set down as that of one of the contributors to a dictionary which was designed to set forth the views of the higher critics and is partly edited by the most extreme critic of them all, for Mr. Pinches has hitherto been conspicuous for his resolute adherence to the opposing school of sentiment on these matters, and has, indeed, always been looked upon as a pillar of evangelical orthodoxy; but now, not only do we find Mr. Pinches writing an article in a heterodox encyclopedia, we even find him apparently accepting Prof. Cheyne's most heterodox theory, and admitting into his article the statement that "'Pul' or 'Phaloch' may be a corruption of Jerahmeel." The remark about a "southern Asshur" in northern Arabia, which occurs just above this, must be due to Prof. Cheyne, but Mr. Pinches ought not to have allowed it to appear in his article without comment. Apparently the land *Asir* mentioned in the Minean inscriptions *Gl.* 1083, 1155 (6th century

B.C.) is meant; this may be Assyria itself, if it is not the land of Asir in *western* Arabia, between al-Hegâz and Yaman. Mr. Pinches's alternative suggestion that Tiglath-Pileser III. may have received the name "Pul" "on account of the Babylonian opinion of his character (*cp.* Ass. *bûlu*, 'wild animal')" cannot be accepted, because *bûlu* is a generic term for "cattle," and we do not suppose that any sensible Babylonian would have called a king or anybody else "a cattle."

However, although we may regret that this volume of the "Encyclopædia Biblica" has been made the vehicle of a wild and unproven theory, or rather group of theories, we ought not to allow this regrettable fact to prejudice us against the volume as a whole. When Prof. Cheyne can free himself from the baneful influence of "Jerahmeel" his work cannot be bettered; witness his article "Ophir," which finally disposes of the idea, started and still maintained by persons with but little archaeological knowledge, that Mashonaland is Ophir. The article of Profs. Nöldeke, Buchanan Gray and Kautzsch on "Names" should be carefully read; it is of great interest and value. Prof. Driver's article, "Meshah," is thoroughly exhaustive and extremely interesting; we cannot but regret that only a single contribution from his pen is to be found in this volume. The articles "Persia" and "Philistines," by the late Prof. Tiele and Prof. F. Brown, and by President G. F. Moore respectively, are of the first order, especially the latter, which is thoroughly up to date, the author agreeing with all those writers who have recently treated of the subject in believing the Philistines to have been certainly of European, and probably of specifically "Ægean," origin. The traditional view that they came from Crete is borne out on the one hand by the Egyptian records of the wars and alliances of the *Purusati* and on the other by the lately ascertained fact that the "Mycenæan" culture had obtained a foothold in Philistia at some time between the fifteenth and twelfth centuries B.C. In this connection, Mr. J. L. Myres's remarks on Mycæan finds in Philistia and on the influence of Ægean pottery-types on the native styles should be noted (*art.* "Pottery").

Prof. Eduard Meyer's "Phœnicia" is worthy of so distinguished a historian; Mr. W. M. Müller's articles on subjects connected with Egypt are, while critical, at the same time moderate, careful and informing. Evidently he will not have anything to do with the Jerahmeelite theory; he still believes Pithom to be Pithom in the Wady Tûmilât, and holds with the rest of the world that the Israelites once lived in the land of Goshen, which was in Egypt.

The Rev. C. H. W. Johns must also be congratulated on his non-adherence to the Jerahmeelite theory; at any rate, he treats *Gen.* x. 8 *ff.* as referring to Mesopotamia, not to Jerahmeel, and evidently continues to think that "Nineveh" means Nineveh and not Hebron (see above). His article "Nineveh" is good; we find nothing to object to in it except the statement that "Sir H. Layard by his explorations definitely fixed" the city "at Kuyunjik (1845-47 and 1849-51)." As a matter of fact, he claimed by his excavations to have proved that *Calah* was the site of Nineveh, and it was only after Hincks, Rawlinson and others had deciphered the inscriptions that the earlier

view of Rich, duly mentioned in its place by Mr. Johns, was shown to be correct.

Other articles which may be highly commended are those of Prof. Deissmann on "Papyri," which contains a most valuable discussion of the character of New Testament Greek, of Dr. Benzinger on "Law" and "Passover," of Prof. Prince on "Music," besides various contributions by younger English Semitic scholars, e.g. Mr. S. A. Cook and Mr. Maurice Canney. We also welcome several short contributions by Sir W. T. Thiselton-Dyer on botanical subjects and a paragraph on the flora of Palestine by Mr. H. H. W. Pearson.

We have touched but superficially upon the many articles in this volume which deal with New Testament criticism. It is a highly controversial subject, and if things have to be said which are likely to shock the feelings of the average Christian, they should at least be said as tactfully as possible. But it cannot be said that we find much tact in the contributions, already referred to, of Profs. van Manen, Usener and Schmiedel, for example. This is a pity, for it prejudices readers in this country against this kind of critical work, which, though often exaggerated in its methods and not seldom self-contradictory in its conclusions, is still deserving of careful attention and study.

The general editing of the "Encyclopædia" could be improved with advantage. The highly laudable aim of employing only specialists in certain branches of biblical knowledge to deal with questions connected with their own special studies has resulted in a certain irritating choppiness of treatment. Thus we get an article, "Purim," of which five paragraphs are written by Mr. Johns, one by Mr. Frazer and one by Prof. Cheyne. Mr. Johns tells us all he knows about the possibility of a Babylonian origin for the feast; Mr. Frazer discusses Mordecai and Marduk, Vashti and Esther and Ishtar, the mock-king of the Saccæe and the king and queen of the May; and Prof. Cheyne implies that Mr. Frazer is all wrong, because there never were any such names as Mordecai and Esther, which are simply corruptions of Jerahmeel and "Israelith," and the book of Esther originally referred, not to Babylonia or Persia, but "to a captivity of the Jews in Edom" (italics in original). At least, we understand that Mr. Frazer wrote § 6 of this article; it is signed with his initials. But a fact which militates against this theory is that in the paragraph in question "J. G. F." refers to himself always in the third person—J. G. Frazer thinks this or J. G. Frazer thinks that—and an editorial note at the bottom of col. 3980 says that the editors "have no hesitation in appending a sketch of J. G. Frazer's view. . . ." Is it their sketch or is it Mr. Frazer's? If it is theirs, why is it signed "J. G. F."? Prof. Cheyne often adds paragraphs with remarks of his own, chiefly about Jerahmeel, to the work of other contributors; one conspicuous instance is in the article "Moab," by Profs. G. A. Smith and Wellhausen, which is followed by Prof. Cheyne for two columns with an addendum correcting Wellhausen's work in accordance with the supposed results of the latest criticism, i.e. Muşri and Jerahmeel.

The faults of this volume are, then, many and great, but, we repeat, this fact ought in no way to detract from the inestimable value of the immense overplus of sound

learning which is to be found in it. Prof. Cheyne's own articles do not all stray into the paths of Jerahmeel by any means, and the large majority of the other contributors, who show no trace of Jerahmeelite influence, are experts in their own particular branches, and their splendid work must be regarded as redeeming the "Encyclopædia" from many of its faults.

The publishers have done their utmost; the typography and general get-up of the book are first-rate: it is a pity that their efforts should be so severely handicapped by the wild theorising of one of their editors and by the tactlessness of some of their less notable foreign contributors.

In conclusion, a word of commendation must be given to the excellence of the proof-correcting; we have hardly discovered any errors in this regard. A slip of the pen left uncorrected is, however, noticeable in col. 3165, l. 2 from the top, where "al-Miṣr" should read simply "Miṣr." The phrase "al-Miṣr" does not, apparently, occur in the Himyaritic (Minæan) inscription *Gl. 1155* (= *Hal. 535*) which is here mentioned; only "Miṣr" or "Miṣran" is spoken of, the latter expression = al-Miṣr.¹

THE FORAMINIFERA.

The Foraminifera, an Introduction to the Study of the Protozoa. By Frederick Chapman, A.L.S., F.R.M.S. Pp. xv + 354. (London: Longmans, Green and Co., 1902.) Price 9s. net.

THE contents of this book may be divided into two parts, general and special. Beginning with the latter, we find presented in a convenient form (chapters vii.—xvi.) an account of the families and genera of the Foraminifera. One species of each genus is described and figured, the conditions of its occurrence and its palæontological history being also given. The figures are reproductions of pen and ink sketches, and in most cases will no doubt enable the student to refer his specimens to their proper genera. Some are, however, too indefinite to serve even this purpose, and the attractiveness of the book would have been increased if more care had been taken to give something of the elegance and finish of the natural objects.

In dealing with the phenomenon of the occurrence of two or three plans of arrangement of the chambers which is presented by many forms in the growth of the individual test, the use of the words *binomorphous* and *trimorphous* is advocated. The terms dimorphic and trimorphic were originally applied to such tests, but now that it is recognised that the species of the Foraminifera present themselves under two forms, arising by different modes of reproduction, the words dimorphic and dimorphism have been, in accordance with customary biological usage, employed in the latter sense. Fresh words are therefore needed, as the author points out, for the use to which

¹ That Egypt, by the way, is here meant, and not any place in North Arabia, is evident from the inscription itself, which obviously contains a reference to the conquest of Egypt by Cambyses. We are strongly of opinion that M. Hartmann's dating of this inscription in *Zeitschr. für Assyriologie*, x. (1895), p. 32, is absolutely correct. Weber's defence (*Mitteilungen der Vorderasiatischen Gesellschaft*, 1901, i. p. 22 ff.) of Glaser's later view, as altered and amplified by Winckler and Hommel, is weak. Weber also, like Prof. Cheyne, takes the existence of a North-Arabian Muṣri for gospel; we prefer to wait till Dr. Winckler has proved its existence, which he has not yet succeeded in doing, before we accept it.

these terms were originally applied. But *bimorphous* and *trimorphous* are objectionable, not only on account of the clumsy and hybrid character of the former, but because they may be taken to imply, by analogy with the use of the terminations *ous* and *ic* in chemistry, some relation with the phenomenon of dimorphism. The Latin equivalents *biformed* and *triformed* proposed by Rhumbler¹ are far preferable.

The most valuable part of the book as a contribution to the literature of the Foraminifera is the chapter on their geological range. Twenty years ago, Schwager summarised the information which had been accumulated on this head in the article appended to Bütschli's account of the Sarcodina in Bronn's Thier-reich. Since that date our knowledge has greatly extended, and to no inconsiderable extent as the result of Mr. Chapman's own investigations. The chapter ends with a tabular view of the range of the several families, in which it appears that all the main ones were represented in the Primary rocks, and that four of them (Textulariidae, Lagenidae, Globigerinidae and Rotalidae) have been found in Cambrian strata.

The descriptive part of the book ends with useful practical directions, but no mention is made of the microaquarium, which has yielded such excellent results in the hands of Schaudinn, who invented it.²

The earlier chapters purport to give, as implied in the title, an introduction to the study of the Protozoa in general and of the Foraminifera in particular; and it is undoubtedly most desirable that workers in this group should have their eyes open to the general biological bearing of the phenomena which lie before them. To attain this end they must, however, go elsewhere. In these chapters there is no grasp of the problems presented, or of the conclusions which have been arrived at. On p. 11 we are told that the division of the nucleus "takes place either by the simple process of binary division or by the more complex and beautiful process of karyokinesis." The author thus ignores the process which has been observed in several of the higher forms (though it is, indeed, alluded to and figured further on), namely, the simultaneous breaking up of the nucleus or nuclei into fragments. Continuing the same sentence, the karyokinetic division of the nucleus is described as a process "in which the nuclear body is invested with strands of chromatin threads,"—whatever that may mean; but on turning to Fig. 10, which is given in illustration, we find two figures from Schaudinn's paper on the "Central-Korn" of the Heliozoa (*Verh. deutsch. zool. Gesellschaft, Bonn, 1896*), which represent stages, not of the karyokinetic division of the nucleus at all, but of the division of the central granule, a process preliminary to karyokinesis.

In chapter iv., on the shell structure of the Foraminifera, the author is more at home, but it opens with the statement that the arrangement of the segments of the shell is partially determined by the form of the initial or

primordial chambers. The primordial chambers, whether they be microspheric or megalospheric, are nearly always globular or ovoid, whatever the arrangement of the succeeding chambers may be. How then can the arrangement be in any degree determined by their form?

We cannot pass over the omission (p. 53) of the name of Max Schultze, the author of the classical work "Ueber den Organismus der Polythalamien," from the list of those who since Dujardin have been pioneer workers on the group.

On the whole it must be confessed that the book is written in a slipshod style, which in these earlier chapters is very marked; and in closing it one cannot but feel that the author would have been better advised if he had confined himself to the special treatment of the subject, for which he is well qualified, leaving the larger biological problems to other hands. J. J. L.

UNORGANISED FERMENTS.

Enzymes and their Applications. By J. Effront. Translated by S. C. Prescott, S.B. Vol. i. Pp. xi + 322. (New York: John Wiley and Sons; London: Chapman and Hall, Ltd.) Price 12s. 6d.

IN his work on "Enzymes and their Applications," Dr. Effront has presented us with book of great interest and value. The book, as he explains in his preface, is "a summary of the course at the Institute of Fermentation of the New University of Brussels." If the lectures are delivered in the style in which the book is written, we should very much like to be among his students.

Judging from his definition of an enzyme, Dr. Effront is in practical agreement, although he does not say so, with those who class the enzymes among catalytic agents.

His definition is as follows:—

"The enzymes, soluble ferments, zymases or diastases are active organic substances secreted by cells, and have the property, under certain conditions, of facilitating chemical reactions between certain bodies without entering into the composition of the definite products which result."

But although it seems appropriate to class the enzymes with catalytic agents, yet there are certain substances which appear to have a catalytic action upon the enzymes. For example, on p. 118 it is stated that the addition of 50 milligrams of asparagin to starch which has been treated with amylase increases the saccharification, in a given time, nearly seven-fold.

In chapter iii., which treats of the "Manner of Action of Diastases," the different theories advanced to explain diastatic action are carefully reviewed. As an example we may cite the theory of Arthus, who, relying upon the discrepancies which exist between the accounts of many authors as to the properties of the various diastases, takes up the position that enzymes are not substances, but are properties of substances. Enzymes, indeed, bring about chemical changes, but so also do light, heat and electricity. Magnetism is a property of magnetised substances such as steel, but it cannot be obtained apart from the substance. The same reasoning applies to enzymes, which are only the properties of the substances obtained by precipitation or other means, and therefore a pure enzyme is impossible. On p. 66 Dr. Effront shows

¹ Entwurf eines natürlichen Systems der Thalamoporen." (*Nachrichten der K. Gesellsch. d. Wissenschaften zu Göttingen. Math.-phys. Klasse*, 1895, Heft 1, p. 63.)

² The reader is left in doubt as to the precise term advocated by the author, for on p. 48 "dimorphous" is used, but on p. 164 the word has become "bimorphous."

³ "Ein Mikroaquarium." (*Zeits. f. wiss. Mikroskopie*. Bd. xi, 1894, p. 326.)

how extremely sensitive the enzymes are to antiseptic and toxic substances; we have not heard of magnetism or electricity being affected in a like manner. But whatever the truth may be, it cannot but be admitted that our present knowledge as to what diastatic action really may be is incomplete and vague in the extreme. Possibly the elucidation of many of the difficulties will follow the preparation of a pure enzyme.

One difficulty encountered in studying the enzymes is the multitude of names which a single enzyme may possess, e.g. on p. 51 we are told that sucrase is variously called "glucose ferment, cytozymase, yzame and invertin." The chief reason for this diversity of names is that different investigators, having obtained from different sources a diastase capable of transforming cane sugar into invert sugar, have often been under the impression that they have come across a new diastase and have therefore invented a name for it.

Chapters v. and vi. deal with sucrase from a theoretical aspect, and chapter vii., on the fermentation of molasses, introduces us to the technical portion of the work. Although sucrase is not prepared commercially, it plays a very important part in fermentation, especially in the manufacture of alcohol from molasses.

Dr. Effront has evidently studied the technical part of the question with the same care which he has devoted to the scientific side. As a consequence the chapters on the technology of the enzymes should be very valuable to those interested in this branch of the subject. The space at our disposal forbids us to more than briefly notice some of the important applications of enzymic fermentation. There is an interesting chapter on "Panary Fermentation," and here one cannot but be struck by the fact that although the art of bread-making is one of great antiquity, yet we know very little as to what really does take place in the process of bread-making.

Chapter xviii. deals with the industrial application of "maltase" (the ferment of maize, which also occurs in small quantities in yeast) and the manufacture of glucose.

Chapter xxi. should be of great interest to chemists, as it treats of the "Ferments of Glycerides and Glucosides." Among the various enzymes here discussed, we notice "lipase," the active principle of the pancreatic juice, "emulsin," which occurs in almonds, and "erythrozyme," the ferment contained in the madder root. This chapter might with advantage have been extended, but, unfortunately, our knowledge of these very interesting substances is not yet very far advanced.

In conclusion, we must not forget the translator, Mr. Samuel C. Prescott, who has carried out his labours in a most satisfactory manner. F. MOLLWO PERKIN.

OUR BOOK SHELF.

Astronomischer Jahresbericht. By Walter F. Wislicenus. Band iii. Pp. xxxi + 671. (Berlin: Georg Reimer, 1902.)

THE value of this work to astronomers and others interested in astronomical matters is now so well known, in spite of this being only its third appearance, that the present issue will be warmly welcomed. In the compilation of such an undertaking as this, Dr. Wislicenus and his co-workers are to be heartily congratulated, for they

have brought together a very great number of most useful references and excellent brief extracts of all the more important publications of the past year. The volume now contains 671 pages, and the compiler informs us that this will probably be about its normal size. The second volume contained 552 references more than the first one, and the one before us shows an excess over the second by 193 references. This latter excess was chiefly due to the great number of papers on Nova Persei, which required 228 references alone. In future, to keep down the number of such references, the compiler proposes to include under one reference all those publications which appear during a year under the same heading and by the same author. This seems a very rational suggestion.

It may be mentioned that references are not only given to all the original publications, but also to all translations of such publications and astronomical articles which have appeared in various quarters. Thus, to take a case in point, we find that the communication by Dr. J. Hartmann to the *Sitz. der Kgl. preuss. Akademie der Wiss. zu Berlin* on "The movement of the Pole Star in the line of sight" was translated into English in the *Astrophysical Journal*, and was noticed in *Sirius, Die Natur, Astronomische Rundschau, Das Weltall* and the *Revue Scientifique*, their respective references being added in each case.

The book concludes with a capital index of names and brief tables of errata to the second and present volume. In addition to those mentioned in the present volume, which, by the way, are remarkably few in number considering the work involved, may be added "Norman" instead of "Normann" in references Nos. 1454 and 2131, and "nächste Maximum" instead of "jetzige Minimum" in reference number 1510.

In conclusion, it is hardly necessary to point out that no astronomical observatory or similar institution should be without this volume, which embodies in it all that relates to the recent progress of astronomical science, not only in this country, but over the whole world. That the work has in its third year become so complete is due to the untiring labours of Dr. Wislicenus and his co-compilers, and it is hoped that such may in the future be lightened by the endeavour of all interested in such a useful undertaking to remember to send them separate copies, reprints, &c., of published papers.

W. J. S. LOCKYER.

Elements of Metaphysics. By J. S. Mackenzie. Pp. xv + 172. (London: Macmillan and Co., Ltd., 1902.) Price 4s. 6d.

PROF. MACKENZIE is to be congratulated on having produced an exceedingly useful little book of a kind which has no precise counterpart in our current philosophical literature. Within the compass of less than two hundred small pages he deals very suggestively with the nature of the metaphysical problems, the methods of metaphysical science and its relation to the rest of our theoretical and practical interests, science in general, art, ethics, and religion. The aim of his discussion is not so much to indicate conclusions as to lead his reader to comprehend the nature of the problems to be solved and the methods of solution which are at our command. Hence the beginner in philosophy could hardly have a better introduction to what is, after all, the main business of philosophy, the practice of thinking intelligently for himself on the ultimate problems of knowledge. So far as the author's own conclusions in philosophy are put forward, they indicate a rare catholicity of view with a certain bias in favour of the line of thought, represented by Aristotle and Hegel among the great names of metaphysics, which insists upon development as the key to the understanding of the forms of existence. As might be expected from his choice of philosophical masters,

Prof. Mackenzie is an idealist in his general position, though he evidently realises the difficulties which beset an over-hasty idealism, and states his result in an avowedly tentative form.

A. E. T.

Histoire des Mathématiques dans l'Antiquité et le Moyen Âge. Par H. G. Zeuthen. Traduite par J. Mascart. Pp. xvi + 296. (Paris: Gauthier-Villars, 1902). Price fr. 7.

THIS translation of Prof. Zeuthen's well-known and deservedly popular work has been revised by the author, and several interesting notes have been added by M. Paul Tannery. The greater part of the volume deals with the mathematics of the Greeks, especially their geometry; the Elements of Euclid, in particular, are analysed in considerable detail, and discussed with intelligence and sympathy. Conservatives who still rally to the cry of "Euclid, and nothing but Euclid," may be respectfully invited to study, with the help of such comments as Prof. Zeuthen's, the actual text of the Elements, which is now easily procurable in Heiberg's excellent edition. It ought, on the one hand, to increase their admiration of the Greek geometer, and, on the other, to convince them of the absurdity of supposing that a garbled travesty of a portion of his work is the best introduction to geometry to put into the hands of the English schoolboy. Another interesting section is that which deals with the mathematics of the Arabs. It is difficult to claim for them any very substantial contributions to the science; but they showed themselves apt pupils both of the Greeks and of the Indians, they kept the study of mathematics alive when Christian Europe was passing through its darkest age of ignorance and superstition, and they powerfully helped on the subsequent revival. To Moslem scholars, and their enlightened rulers, modern Europe owes a debt which is not always sufficiently realised. M.

A la Conquête du Ciel! Contributions Astronomiques de F. C. de Nascius, en Quinze Livres. Livre Deuxième (fascicule 6 et dernier). Pp. 84. (Nantes: Imprimerie-Librairie, Guist'haü, 1902.)

M. F. C. DE NASCIUS has favoured us from time to time with copies of his astronomical contributions, which are to extend when complete to fifteen volumes. Since each volume consists of numerous parts, it will be easily understood that no inconsiderable task awaits the reader who aspires to a complete mastery of the author's methods and teaching. Only one small part of the second volume lies before us, but we confess that we are utterly unable to comprehend its purpose or to do justice to the ingenuity that apparently underlies its construction. The general conception seems to be remotely connected with Bode's law, but is far more difficult of apprehension, for with this is connected a discussion of the "triangle of divine harmony," while over the whole hovers a bewildering but awe-inspiring theme which is expressed as algorithmic. It will, perhaps, be sufficient to say that the object of the author, if object he has, is by some simple manipulation of figures to produce quantities that shall approximate to various astronomical constants, such as the periods and distances of the planets. For example, he sets out to establish or reproduce the period of sunspots, which he gives at 1111 years. The triangle of divine harmony is, we are assured, admirably adapted for this species of discussion. This triangle happens, fortunately, to be right-angled, and two sides have the values 69 and 1789. There is a good deal about the number 69, which we are very solemnly assured is equal to $64 + 5$, and it is no doubt entirely one's own fault if he fails to correctly apprehend its true significance, but 1789 seems to be introduced here for the first time, at least in this volume, and one may be excused if he fails to perceive its actual bearing. Our author handles these

quantities in the following way. The area of the divine triangle is first found, this is then doubled to get a parallelogram, and the side of a square found the area of which is equal to the tenth part of that parallelogram. This side has for its numerical value 11110! and the author congratulates himself on his success.

For many years, we are afraid, M. de Nascius has laboured on similar lines, which are destined to bring him or his readers little profit, but which he will no doubt pursue so long as he can trace his figures. It is nearly thirty years, he tells us, since he first placed a hesitating foot on the path which was destined to lead him to such brilliant discoveries. Let us hope that he has been frequently cheered by finding some close coincidence between his calculations and observed facts, and that his delight has been as keen as that experienced by other physicists who have trod a more legitimate road and been led to more valuable results.

LETTERS TO THE EDITOR.

The Editor does not hold himself responsible for opinions expressed by his correspondents. Neither can he undertake to return, or to correspond with the writers of, rejected manuscripts intended for this or any other part of NATURE. No notice is taken of anonymous communications.

Mr. Marconi's Results in Day and Night Wireless Telegraphy.

READING a brief account of these results in the *Times* of June 14, I perceive that Signor Marconi advances in explanation of the greater distance at which night signals were received, that the day signalling is affected by dielectricification of the transmitting elevated conductor.

If—as I gather—Signor Marconi is referring to his observations made at positions in the Atlantic, west of England, the waves (travelling westward, may not ether drift in the earth's orbital path be concerned in producing the effects observed?

The waves advancing against the orbital ether stream in the day time, with it at night, might be supposed to give rise to conditions analogous to those which affect the transmissibility of sound against or with a high wind. It will assist if we assume a retarded ether drift near the earth's surface and free motion above. But still, the difficulty in this explanation resides in the very great magnitude of the effects observed.

I write merely by way of suggestion, and in very considerable ignorance of almost every particular involved in this explanation.

J. JOY.

Geological Laboratory, Trinity College, Dublin, June 17.

Remarkable Sunsets at Madeira.

THE last few evenings we have witnessed here some beautiful sunsets, closely resembling the sunsets observed after the Krakatoa eruption, which I remember well, *i.e.* there is the same large area of beautiful pink haze in the west and high up in the sky at and immediately after sunset. The first sunset which I felt certain was of the above character I noticed on Friday, June 6. On June 10 and yesterday the display was particularly striking. There were indications, I believe, of the pink glow on one or two evenings before June 6, but as there were a good many clouds about it was difficult to feel certain of the special character of the sunsets. F. W. T. KROHN.

Funchal, Madeira, June 12.

THE INSTITUTION OF ELECTRICAL ENGINEERS' DEPUTATION ON ELECTRICAL LEGISLATION.

WE published an article a short time ago (*NATURE*, vol. lvi. p. 35) on the report of the committee appointed by the Institution of Electrical Engineers to inquire into the cause of this country's backwardness in electrical industries, and stated that it had been decided to ask the Prime Minister to receive a deputation on the subject. This deputation, after being once or twice postponed, waited upon the President of the Board of Trade, the Right Hon. Gerald W. Balfour, M.P., on

Tuesday, June 17. A number of influential members of the Institution were present, including Mr. J. Swinburne (president), Lord Kelvin, Prof. J. Perry, Prof. S. P. Thompson, Colonel R. E. Crompton and Mr. S. Z. de Ferranti.

Lord Kelvin having introduced the deputation, Mr. Swinburne gave a clear statement of the case. He pointed out that local authorities had become involved in electrical enterprise through what was in reality only an accident, namely, that the laying of mains involved opening up the streets. As a result they had obtained legal powers which were not always used properly or in the interests of the community. Even a municipality acting in the true interests of its own ratepayers need not necessarily be doing what was best for the country at large. It was, moreover, now possible to carry out electrical undertakings on a scale that was not contemplated when the Acts by which they are governed (the Electric Lighting Acts of 1882-1888 and the Tramways Act of 1870) were passed. They urged, therefore, that the whole question of electrical legislation should be reconsidered by the Government with special reference to the right and advisability of allowing the municipalities to retain their present powers. This question concerned the Government as a whole, but there was also a matter concerning the Board of Trade in particular. It was thought that there should be a larger electrical staff to enable the Board of Trade to deal more satisfactorily with modern developments. Many of the regulations were behindhand, and it was thought desirable that some questions, such as the use of overhead wires, the size of transformers, &c., should be reopened.

Other speakers followed, including Colonel Crompton, who cited the case of Hove as one in which the Corporation had done its best to thwart the efforts of the company which was supplying electric light. Mr. Ferranti laid stress on the desirability of allowing the use of overheadwires so that the capital expenditure of pioneering schemes might be diminished, and urged greater flexibility in the Board of Trade regulations generally. It was finally agreed that the Institution of Electrical Engineers should go through the regulations and make recommendations to the Board of Trade on the points which electricians consider require amendment.

Mr. Gerald Balfour, in replying on the main question, admitted England's backwardness, but doubted whether it was entirely, or even chiefly, due to the cause alleged. We had to contend in England with the conservatism of strongly developed interests. He did not question, however, that the existing legislation was capable of amendment, and two Bills had already been drafted, one dealing with electric traction and the other with electric lighting. The Traction Bill was to give effect to the recommendations of the departmental committee appointed by the Board of Trade, and he hoped it would prove a satisfactory compromise between the wishes of promoters and municipalities. The Lighting Bill was based on the recommendations of the House of Commons Committee of 1898, which advised considerable modifications of the existing laws. He could not, however, hold out any hope of either Bill being passed this session. Mr. Swinburne asked that the whole question might be considered by a Royal Commission, and Mr. Balfour replied that he would be willing to consult the Cabinet, but could not say, without further consideration, whether he should recommend the suggestion to be adopted.

It need scarcely be said that this promise is quite insufficient to satisfy the urgency of the case. Indeed, the spirit of the reply to the deputation is not what should inspire statesmen who desire to encourage national progress. It is conceded that the obstacles to electrical development in this country are serious, and that they prevent our electrical engineers from keeping the nation in the forefront of progress. The obvious duty of an

enlightened Government is to insist that difficulties in the way of industrial advances must be removed; or, at any rate, encouragement should be given to those who have to overcome them. Instead of this, our statesmen find excuses for the barriers across the road, and are eager to show reason why no attempt should be made to break them down.

Such justification as Mr. Gerald Balfour gave for masterly inactivity is almost sufficient to make anyone abandon hope that departmental officials will ever understand the needs of science and technical industries. What do they know of progress whose only desire is not to interfere with vested interests? Any advances that are made in England are due to the restless men who have in them the spirit of evolution and who force development in spite of unsympathetic circumstances. But we cannot hope to keep in line with other progressive nations unless the conditions for improvement are made more favourable. In commenting upon the apathetic spirit in which Mr. Gerald Balfour met the deputation, the *Times* referred to our leaviness in electrical industries and expressed the views of many thoughtful men as to the need of making it up. The remarks are worth reproduction here, because they show that the position taken by the Government is one from which the interests of science and industry cannot be seen.

It is not merely by America that we have been completely beaten in electrical engineering. We are far behind continental countries as old as ourselves and having quite as many vested interests to deal with. The reason is that every continental Government keeps in touch with the best knowledge of the day, and habitually consults, upon every question involving the application of science, the highest scientific authorities it can find. Had the Government of this country learned to take that course the position of the nation at this moment would be incalculably better than it is. When it was suggested to Mr. Gerald Balfour that his Board of Trade electrical staff is not adequate for the duties thrown upon it, he was apparently unable to grasp the meaning of the criticism. What is meant is that, instead of relying upon inspectors who from the nature of the case were not originally the foremost men in electrical engineering, and who, again from the nature of the case, are not the men most abreast of the developments achieved since their appointment, the Board of Trade should be guided by the advice of the real experts and pioneers who are actually doing the things which its official experts can only criticise from their bureaucratically narrow standpoint.

This nation really has no chance in modern conditions unless official persons generally consent to recognise that there are a great many important subjects about which they know nothing, and which are in a state of such rapid change and development that no student, of the calibre which an official salary will attract, can possibly be and remain in a position to legislate about them. What we want is that the real practical and scientific intellect of the country should be called to the aid of the politicians and their official "experts." It is not by Boards of Trade, with their self-sufficiency, their timidity and their necessary ignorance of the later phases of development, that other nations have adapted their legislation to the progress of science. It is by giving intellect that advisory place in the framing of legislation which it will never seek by the politician's method of appealing to the ballot-box. The electrical, chemical, physical and biological questions, upon the solution of which so much modern progress and prosperity depend, deserve and demand the habitual consultation of the best men engaged in their study.

Men of science and leaders of industrial development are familiar with these opinions, and it is time that our statesmen regarded national needs from the same point of view. Unless this is realised the nation cannot hold its position in the industrial wars of the world. The Duke of Devonshire's Commission many years ago gave a warning that continued neglect of scientific and technical interests by the Government must lead to disaster, and we have persistently called for reform to prevent the loss that must come unless the views of our

political leaders undergo a complete change. If the awakening does not come soon, the task of making up for the years of forced inaction will be almost impossible to accomplish.

From what has been said it will be seen that no definite hope can be given of an immediately beneficial result accruing from the deputation. It serves, however, to bring the matter somewhat prominently to the notice of the Government and of the general public, and if it accomplishes nothing more it will in this have paved the way for future reform. It is desirable that the public should be educated to know the advantages which electrical engineers are ready and anxious to confer upon them, and why it is that these have not yet been bestowed. Thirteen years ago Prof. Ayrton, in his oft-quoted Sheffield address, predicted that a time was coming when the Sheffield grinder would work amidst beautiful surroundings, deriving the power he needed from a small electrically driven motor. The time is now ripe for the realisation of that prophecy; in some few places, indeed, it is already begun, but for its free and rapid development there are many abuses and much restrictive legislation which must be removed. For electrical distribution the days of the small station supplying a limited area are numbered, and with them the days of effective municipal control. So also with electric traction; wide-spreading tramways connecting town with town and running far out into the country districts are needed to bring about decentralisation and to help to solve the pressing problem of overcrowding. We can hardly expect the municipalities to effect these changes; the arbitrary boundaries of the areas they control have no reference to the suitability of these areas as units for electrical distribution, and their interests are, moreover, to a certain degree directly opposed to decentralisation. Thus, quite apart from any considerations of the purity of the management or efficiency of municipal electrical undertakings, it will be seen that there is good reason in many cases for looking for better results to the nation from company working. In the train of developments such as would follow the removal of restrictive legislation, we may hope to find the improvement of our position as manufacturers of electrical machinery. The country lacks neither opportunities nor electrical engineers capable of making use of them. We may therefore reasonably look to the development of electrical undertakings to confer a double benefit upon the country; directly, by increasing the comfort and health of the people, and by facilitating commercial work of all kinds; and indirectly by increasing the number and size of electrical factories, and so contributing to the wealth and prosperity of the nation and helping it in the struggle with foreign competitors.

REPORT ON THE TEACHING OF GEOMETRY.

THE immediate result of Prof. Perry's Glasgow address has been the appointment of two committees, the work of which is now near to completion. The British Association committee has, we believe, concerned itself with the more general aspects of the problem. The committee of the Mathematical Association, largely composed of schoolmasters, is formulating a set of detailed recommendations, of which the geometry section was published in the May number of the *Mathematical Gazette* (George Bell and Sons).

The Mathematical Association committee contains delegates from the chief public schools within easy reach of London; it has, therefore, something of a representative character. Its recommendations are very definite; as the editor of the *Gazette* remarks, "it is very desirable that mathematical masters and others should fully avail themselves of this opportunity of placing on record their

views as to the proposed changes." The secretary of the committee, Mr. A. W. Siddons, Harrow School, Middlesex, will be glad to receive criticisms of the report.

The study of formal geometry is to be preceded by a substantial introductory course, in which the subject-matter of geometry is to be treated experimentally and inductively. The pupil is to be carefully trained in the use of simple mathematical instruments; he is to be allowed to convince himself of the truth of geometrical theorems by numerical measurements and calculations. In this way he will make his first acquaintance with the main facts of geometry. When he has thus gained familiarity with the subject-matter, he will be in a position to apply the machinery of logic to his knowledge; he will be able to enter, with his eyes open, upon the task of consolidating into a consistent whole the facts he knows. Throughout his whole course he is to treat problems of construction in a practical way; he is not to be content with describing how the thing is done, he is to do it.

Passing to the formal study of geometry, Euclid, or rather a skeleton Euclid, is to be retained as a framework. Large omissions are recommended, but the logical order is to stand.

Theorems are cut loose from the limitations of construction by the admission of "hypothetical constructions." For example, the *pons asinorum* may be proved by bisecting the vertical angle, and thus dividing the isosceles triangle into two triangles that can be shown to be congruent by Prop. 4. For it is obvious that an angle has a bisector, even though the method of constructing it with ruler and compass may appear later in Euclid; the bisector might be found equally well by folding the triangle in two.

Constructions are to be taken out of the formal course and treated in whatever order seems advisable. It is clearly absurd to keep to Euclid's order of constructions unless we are confined to the use of his instruments, an ungraduated ruler and a pair of compasses that cannot be trusted to transfer a distance.

The following order is recommended in teaching the theorems of the first three books:—Book i., Book iii. to 32 inclusive, Book ii., Book iii. 35 to the end.

The course is to be lightened by the omission of a considerable number of dull and obvious propositions, such propositions being found more especially in Book iii. Definitions are not to be taught *en bloc* at the beginning of each book, but are to make their appearance only when needed.

It is suggested that two locus propositions should be added to Book i.—the locus of points equidistant from two points, and the locus of points equidistant from two lines. This will enable the pupil to inscribe and circumscribe circles to triangles at an early stage.

Playfair's axiom is preferred to Euclid's; and illustration by rotation is recommended in dealing with angles connected with parallel lines, triangles and polygons.

After Book i. we are to pass to Book iii., which by the omission of Props. 2, 4, 5, 6, 10, 11, 12, 13, 18, 19, 23, 24 is reduced to very modest dimensions. To cover the ground of the omitted propositions there is to be a preliminary discussion of the symmetry of the circle about a diameter, which can be managed experimentally by folding the circle and pricking holes round the semi-circumference.

The "limit" definition of the tangent is allowed; and Euclid's three propositions 16, 18, 19 are condensed into one—"The tangent at any point of a circle, and the radius to the point of contact are at right angles to one another."

Book ii. is to be illustrated by algebra; and in order to simplify the geometrical proofs a rectangle is to be defined as a parallelogram with one of its angles a right angle. The use of the signs + and - is sanctioned.

For Book iv. we find the proposal "that all propositions be omitted, as formal propositions, except 2, 3, 4, 5, 10, and that these be taken with earlier books, the rest of the book being treated as exercises in geometrical drawing."

Coming to Book vi., it is recommended "that an ordinary school course should not be required to include incommensurables; in other words, that in such a course all magnitudes of the same kind be treated as commensurable." This at once relieves teachers from an enormous task—that of explaining Euclid's definition of proportion. There is now nothing to be said beyond that the ratio of a to b is the fraction a/b . To meet this change, two alternative proofs are given for vi. 1, though attention is called to the continental practice of making the proof of vi. 2 self-supporting.

With regard to areas, the tendency of the report is to make the treatment algebraic. Euclid vi. 14, 15, 16, 17, 23 contain merely the one fact that the area of a parallelogram is $ab \sin \theta$; nothing is gained by concealing this fact from the student. It is definitely suggested that "numerical" trigonometry shall be taught concurrently with Book vi. "In connection with the formal course, as soon as the proposition that equiangular triangles are similar has been proved, the sine, cosine and tangent can be defined (if this has not been done earlier in the experimental course). In order to make the meanings and importance of these functions sink deeply into the pupil's mind, numerical examples should be given on right-angled triangles (heights and distances); these should be worked with the help of four-figure tables."

"In accordance with the spirit of the above proposals, the committee suggest that the following proposition be adopted:—If two triangles (or parallelograms) have one angle of the one equal to one angle of the other, their areas are proportional to the areas of the rectangles contained by the sides about the equal angles."

"All statements of ratio may be made in fractional form, and the sign = used instead of the :: sign. In the ordinary school course reciprocal proportion should be dropped, and compounding replaced by multiplying."

The report may be described as an attempt, on conservative lines, to simplify the study of geometry and to make it interesting. If the attempt is judged to be successful, now is the time to make examiners unstop their ears. C. G.

SEISMIC FREQUENCY IN JAPAN.

IN no country has seismology been more carefully nurtured than in Japan. At the University we find a professor and assistant professor of this branch of science; in the Meteorological Department there is a bureau controlling more than 1000 observing stations, and, lastly, there is a committee composed of engineers, architects and men of science who, as an aid to carrying on investigations which will lead to a better understanding of earthquake phenomena, are supported by a Government grant.

This body, since its establishment eleven years ago, has already published thirty-six quarto volumes in Japanese and eight in English, and it is to the last of these, by Dr. F. Omori, professor of seismology, to which we now refer. Unlike many of the volumes by which it is preceded, which treat of construction to resist earthquake effects and kindred branches of applied seismology, this particular publication deals with questions which are purely scientific. Its title is "Annual and Diurnal Variations of Seismic Frequency in Japan," the investigation of other periodicities being left for a future occasion.

The materials analysed are 18,279 entries contained in earthquake registers from twenty-six meteorological stations which are distributed in a fairly uniform manner over the Japanese Empire. These registers, which for the most part are dependent on instrumental observation, are discussed separately, and it is in consequence of this method of treatment that conclusions new to seismology have been reached.

The first out of a series of seventy-six curves shows the monthly frequency of earthquakes in Tokio. In plotting this, as in plotting curves for other stations, those months where the ordinary seismic frequency has been affected by "after shocks" have been omitted; that is to say, the curves represent the normal frequencies in various districts. These omissions, all of which refer to the settlements which follow destructive earthquakes, are carefully epitomised. Dotted curves drawn through the mean position of monthly curves show annual and semi-annual periods. A comparison of the curves for seasonal seismic frequency shows that these may practically be divided into two groups. In one group the maximum frequency is in winter, whilst in the other group the maximum frequency is in summer. When we turn to the geographical distribution of the stations the records from which give these curves, it is found that they are distributed over two distinct areas—those which show a winter frequency lie in a district chiefly shaken by earthquakes having an inland origin, whilst those where the greater number of disturbances are noted in summer occupy an area shaken by earthquakes having a suboceanic origin.

In an endeavour to explain this striking result, the annual, monthly and diurnal frequencies are compared with corresponding fluctuations in barometric pressure. The general result arrived at is that the curves showing the winter frequency follow those of changes in barometric pressure, from which it may be inferred that an increase in barometric pressure has a marked effect upon the yielding of a land area. With the curves relating to earthquakes of suboceanic origin, it is seen that the annual variation is the reverse of the barometric pressure on land.

With regard to diurnal variation in seismic frequency, Dr. Omori concludes that this is probably due to corresponding variations in atmospheric pressure, but such frequency is not confined to earthquakes originating on the land. Single barometric fluctuations, even if they amount to 20 mm., are not generally related to any marked increase in seismic frequency.

Although the last two observations apparently contradict the more important result indicating a relationship between fluctuations in barometric pressure and the seasonal frequencies of earthquakes originating beneath the sea and on the land, arguments are adduced to show how such contradictions may be harmonised.

The distinction in the rules which governs the frequency of earthquakes with these distinctive origins, now brought forward for the first time, may probably be emphasised when, rather than analysing the registers from different stations—the entries in which may frequently be common to a number of such stations—an analysis is made of registers of earthquakes classified according to their origins. As illustrative of such materials we may refer to a catalogue of about 9000 shocks, published as vol. iv. of the *Seismological Journal of Japan*, in which each entry is referred to a district from which the shock it represents may have originated.

In conclusion, not only do we congratulate Dr. Omori on this new departure in seismology, but we also congratulate the Earthquake Investigation Committee on the admirable manner in which it has presented its results to those outside the pale of eastern ideography.

J. MILNE.

THE WEST INDIAN VOLCANIC ERUPTIONS.

A FEW additional notes referring to the recent volcanic eruptions in the West Indies have been received during the past week. Sir W. T. Thiselton-Dyer has sent us an extract from a letter written on May 29 by Dr. Nicholls, C.M.G., of Dominica, and as it contains testimony from one of the leading scientific men in the West Indies, the statements it contains are of exceptional value.

Dr. Nicholls remarks that the volcanic phenomena in both islands were somewhat similar, but in the ejecta from the volcanic vents there were differences. Thus the lava (and its products, viz. pumice, scoria, mud, ash and dust) thrown up from Mont Pelée was of an andesitic nature, whilst from the St. Vincent volcano a light basaltic lava was ejected.

Evidence of the hot blast which accompanied the eruption has already been given. One of Dr. Nicholls's friends was a passenger in the s.s. *Roddam*. "When the red-hot hurricane struck the ship he was enveloped in flames, as his clothes were set alight, and in his agony he jumped into the sea, which was almost boiling, and was not seen again." As to the cause of this extremely high temperature and the instantaneous destruction of life at St. Pierre, Dr. Nicholls says:—

The eruption came suddenly and unexpectedly, and probably in a few minutes the 35,000 persons in the city of St. Pierre were corpses. It would appear that a sudden fissure was opened on the side of the mountain overlooking the city, and near to the Etang Sec on this flank of the volcano a large vent belched out lava, superheated steam and acid gases downwards on to St. Pierre and the roadstead. The flashing off into steam of the water imprisoned in the incandescent lava covered that lava into sand and dust before it reached the city, and the radiation of heat from molten rock at a temperature of above 1000° C. caused an incredibly hot blast that would create a red-hot hurricane—if I may employ such a term—that would kill people and animals instantly and that would cause all inflammable matter to burst into flame. This, from what I gather, is what really happened, and I do not think that poisonous gases or electrical phenomena are accountable for the destruction of life. You can imagine what is the enormous heat right over the vent of an active volcano. Well, St. Pierre practically for a short time was in such a position, the vent being directed laterally towards the city until the fissure was closed and the volcanic ejecta were again directed vertically upwards. Many persons were actually burnt in places by hot scoriae and mud, but the blast of heat from the volcanic vent appears to me to account in the only satisfactory way for the details I have obtained of the conditions found in the living and the dead.

In connection with the eruptions, it is of interest to learn from the Meteorological Office pilot chart of the North Atlantic and Mediterranean for June that a year ago a report was received from Mr. Francis Watts, of the Government Laboratory, Antigua, showing that on May 5, 1901, the schooner *Kate*, from Barbados to Antigua, ran into a violent commotion of the sea 32 miles eastward of the south end of Martinique. There was no wind, and it was concluded that the phenomenon, which lasted four hours, was caused by a submarine eruption. The report is recalled as possibly bearing upon an early indication of the activity which culminated in the recent disasters. At 6 p.m. on May 9 last, Captain Hernaman, of the Royal Mail Steamer *La Plata*, when 100 miles westward of St. Lucia, observed a green coloured sunset, and at midnight dust was falling on board. At 10.30 p.m. on the same date, the ship *Anaurus* experienced a severe submarine earthquake in 4° 38' N., 32° 28' W., the sea being violently agitated, the shock lasting 30 seconds.

The *Daily Mail* correspondent at St. Lucia says it is

certain that there have been some changes on the sea floor in connection with the eruptions. He adds:—

The colonel commanding the Royal Artillery and the colonel commanding the Royal Engineers at St. Lucia both saw an eruption in the sea off that island, the water being shot up into the air, accompanied by rumblings. This occurred two days in succession, and was noted by independent eye-witnesses.

Also, at Grenada, in the little harbour, near the Botanical Gardens, the water bubbled up as in a chateau and rumblings were heard, but at Dominica all was quiet.

I may mention that when the *Pallas* was at Chateau-Blair on May 21, with Sir Robert Llewellyn on board, I noticed a bubbling in the harbour just twenty yards astern of us, but it was so slight I thought it probably a vent in the bottom of the sea letting off steam, but I called the attention of others to it.

Prof. Bonney exhibited a mounted specimen of volcanic dust from Mont Pelée at the meeting of the Geological Society on June 11. Notwithstanding the risk of generalising from a single slide, he expressed the belief that the ejecta of the Soufrière and Mont Pelée are generally similar. Both, compared with specimens from Cotopaxi, are more uniform in size. The travelled dust from the Soufrière is a little smaller than that from the actual summit of the Andean volcano, but coarser than similar material from Chillo (more than 20 miles), Quito (35 miles), Ambato (45 miles), Riobamba (65 miles), and the summit of Chimborazo, about the same. All these vary much more in size and run distinctly smaller, especially the last. That from Mattakava, Hick's Bay, New Zealand (which fell on June 16, 1886), is rather coarser, more scoriaceous, with fewer mineral-fragments (especially of pyroxene), to which a dirty glass is often adherent. The dust from Barbados, ejected by the St. Vincent Soufrière in 1812, is very much finer-grained, but contains the same minerals, though pyroxene is less abundant.

The St. Lucia Weather Report for May states that, from the 15th to the 20th, the whole island was enveloped in a light hazy mist, the result of volcanic ash suspended in the air. Traces of this ash could be seen on all foliage, it being apparently deposited more freely at night.

The harbour master at Bridgetown, Barbados, has collected from captains of ships information relating to falls of volcanic dust encountered at sea, and the following reports thus obtained appear in the *Agricultural News* of June 7:—

May 7, 8 p.m., schooner *Viola*, from Demerara, met the dust 70 miles S. of Barbados. 10 p.m., the Norwegian steamer *Falisman*, from Demerara, 150 miles S.S.E.

May 8, 2.30 a.m., barque *Jupiter*, from Cape Town, 830 miles E.S.E. Hour not stated, barquentine *Fanny*, from Pernambuco, 250 miles E.

May 9 (?), 4 p.m., ship *Monrovia*, from Rio Janeiro, 240 miles S.E.

(Bearing and distance in each case from Barbados.)

It is to be hoped that all the captains collected samples of the dust, and that these will be available for analysis, as it is desirable to ascertain the characteristics of the ash according to the distance of its descent from the crater from which it was ejected, the coarser particles presumably descending at the shortest distances, the finer at the furthest.

Drs. Fleet and Anderson, the Royal Society's Scientific Commission to investigate the outbursts, were due at Barbados on June 9. The Secretary of State for the Colonies had cabled to Dr. Morris, the Imperial Commissioner, to meet them on their arrival.

Reports have been published of additional volcanic and seismic disturbances which have occurred during the past few days. A telegram from Martinique on June 19 states that a column of mud has been ejected by Mont Pelée and has fallen on Basse Pointe, destroying a number of houses and flooding the lower part of the village.

A message received at Calcutta on June 19 reports that an earthquake has shaken the whole ridge of the Himalayas from Simla to Chitral. The shock was not very violent, but nothing so extensive has been known before.

We have also to record that a violent earthquake occurred at Cassano Al Jonio (Calabria) in the morning of June 22, accompanied by subterranean rumblings. The population was terrified, but no damage was done.

THE ROYAL SOCIETY SOIREE.

A BRILLIANT company of ladies and gentlemen was present at the Royal Society conversazione last week. Many of the exhibits were the same as on the occasion of the previous conversazione on May 14 (see p. 83), but there were some others in addition, and these are briefly mentioned below.

Dr. Morris W. Travers showed apparatus for liquefying hydrogen. Hydrogen, when compressed at the ordinary temperature and allowed to expand, becomes warmer, while air under the same conditions becomes colder; at temperatures below -80°C ., hydrogen becomes an imperfect gas, in the same sense as air, and undergoes cooling on free expansion (Joule-Kelvin effect). The gas, under a pressure of 120-150 atmospheres, passes through coils in the interior of the apparatus, which are cooled in solid carbonic acid and alcohol (-78°C .), in liquid air (-185°C .), and in liquid air boiling under reduced pressure (-200°C). It then enters a regenerator coil, and expanding at a valve at the bottom is partially liquefied. The liquid collects in a vacuum-vessel at the bottom of the apparatus; the unliquefied gas passes upwards through the regenerator coil, cooling the gas it contains, and returns to the compressor.

Apparatus for obtaining serial sections of fossils, and restorations of fossils in wax built up from serial sections, were shown by Prof. Sollas, F.R.S.

Prof. F. W. Oliver exhibited *Stephanospermum* and other fossil Gymnosperm seeds. All the seeds exhibited were from the permo-Carboniferous of Grand Croix, near St. Étienne. They were preserved in silica, and showed remarkable preservation of detail. The majority of the sections were of *Stephanospermum akenioides*, the seed in which a pollen-chamber was first discovered by Brongniart in 1875.

Photographs of the Rocky Mountains of Canada, and objects collected, were shown by Mr. Edward Whymper.

The Silchester Excavation Fund Committee exhibited a series of objects illustrative of recent discoveries on the site of the Romano-British city of Silchester, near Reading.

Examples of telephotography in the Alps and Himalayas were exhibited by Prof. E. J. Garwood.

Dr. F. W. Gamble and Mr. Frederick Keeble had an exhibit designed to show the chromatophores and colour-changes of Crustacea.

Mr. W. Gowland showed Japanese pictures of Buddhist divinities and saints by old masters.

Mrs. E. Walter Maunder exhibited drawings from two photographs of the corona of 1901, May 18, taken at the Royal Alfred Observatory, Mauritius.

A series of photographs illustrative of old customs still extant in Hungerford, Knutsford and Corby was shown by Sir J. Benjamin Stone, M.P.

An attempt to reproduce an Aurora Borealis was shown by Prof. W. Ramsay, F.R.S. The spectrum of the Aurora Borealis has been shown to contain lines due to the pressure of krypton; the great majority of the lines, if not all, are coincident with those of the krypton spark spectrum. An electrode-less discharge in air gives a spectrum in which the leading green line of krypton, 5570\AA , is distinctly visible at low pressures. This discharge can be deflected by a magnet, sending out streamers in the lines of magnetic force. The main phenomena of the Aurora are thus reproduced.

A model of the exploring vessel *Discovery* was shown by the Joint Antarctic Committee of the Royal Society and Royal Geographical Society.

Prof. H. L. Callendar, F.R.S., had on view (1) simple apparatus for determining the mechanical equivalent of heat, and (2) vacuum-jacket calorimeters.

Mr. Edwin Edser and Mr. Edgar Senior showed an experiment illustrating a paradoxical consequence of the wave theory of light. Light enters a glass prism, of which the angles are equal to 90° , 45° and 45° , by one of the mutually rectangular faces, the angle of incidence being equal to zero. It is then reflected from the hypotenuse face at an angle of 45° , which exceeds the critical angle. A photographic grating (3000 lines to the inch) is formed on the hypotenuse face, the rulings being parallel to the axis of the prism. The secondary wavelets which, according to the wave theory, are formed at the clear spaces, produce diffraction spectra, of which the first five or six are visible. If the grating were absent, no light could leave the hypotenuse face of the prism. Thus, light which cannot penetrate the face when the latter is clear is freely transmitted when parts of the face are rendered opaque.

The "Grubb" collimating telescope gun sight was shown by Sir Howard Grubb, F.R.S.

The West Indian Volcanoes Committee of the Royal Society exhibited specimens and photographs illustrating the fall of volcanic dust at Barbados on May 7 and 8. The principal constituents of the dust are magnetite, hypersthene, augite, plagioclase (anorthite-labradorite), small pellets of pumice, and fine powder composed of minute mineral-particles and disintegrated pumice. On heating the dust to about 1200°C ., the pumiceous constituent fuses, and the mass on cooling forms a vesicular rock allied to hypersthene-andesite, but exceptionally rich in crystals.

(1) Microscopic slides are shown illustrating the composition of the dust:—(a) dust as it fell; (b) magnetite; (c) hypersthene and augite; (d) plagioclase; (e) pellets of pumice; (f) thin section of partially fused mass. (2) Photographs of vegetation covered by volcanic dust, taken at Barbados on May 8, by Mr. W. J. Freeman. The specimens were forwarded by Dr. Morris, of the Imperial Agricultural Department of the West Indies, to Prof. Judd, C.B., F.R.S. The charts were lent by the hydrographer of the Admiralty.

Specimens of volcanic dust from the West Indies were also shown by Mr. Henry Crookes.

Mr. E. J. Bles exhibited living tadpoles of the Cape clawed frog, *Xenopus laevis*, Daud. The remarkable transparency allows the course of the nerves, blood-vessels, muscles, &c., of the head to be easily studied in the living animal. A method of feeding, not hitherto described in the Amphibia, can be watched. Bred from specimens kept in Cambridge for more than five years.

A series of specimens illustrating the life-history of the *Trypanosoma Brucei* was shown by Mr. H. G. Plimmer. This organism is the cause of nagana, or the tsetse-fly disease in South Africa.

Colonel Bruce, F.R.S., and Mr. H. G. Plimmer, exhibited *Apiosoma biseminatum*, the parasite found in the blood of Texas fever of cattle.

New species of fairy flies (*Myrmariidae*) were shown by Mr. F. Enock. The species are all ovivorous, some laying their eggs in those of the water demons (*Dytiscus*); as many as seventy-two larvae of one species have been found in one egg of *D. marginalis*. Living specimens, *in situ*, and possibly some emerging.

The Royal Society exhibited a bronze example of the newly founded David Edward Hughes medal, and a medallion of the reverse.

Dr. A. Dendy had on view specimens, sketches and photographs of Moriori workmanship from the Chatham Islands.

A series of otoliths, chiefly of living British fishes, both marine and freshwater, showing the various forms assumed in the different genera, was shown by Mr. E. T. Newton, F.R.S.

Prof. W. M. Flinders Petrie, F.R.S., exhibited a series of worked flints from Egypt.

Experiments exhibiting interference between portions of light from independent sources were shown by Dr. G. Johnstone Stoney, F.R.S.

During the evening, demonstrations, with the help of the electric lantern, were given by Prof. W. M. Flinders Petrie, F.R.S., on early civilisation in Egypt; Mr. J. Y. Buchanan, F.R.S., a series of lantern slides illustrating the performance of M. Santos Dumont's steerable balloon and the accident to it on February 14; and Prof. E. B. Poulton, F.R.S., on recent work upon protective resemblance and mimicry in insects, illustrated by three-colour slides.

NOTES.

A MEMORIAL edition of the scientific writings of the late Prof. G. F. FitzGerald, F.R.S., will shortly be published in the Dublin University Press series. The volume has been prepared under the editorial supervision of Dr. J. Larmor, F.R.S., and footnotes in elucidation or correction of the text have been added where necessary. It extends to about 570 octavo pages, together with 64 pages of an introduction, in part biographical and in part historical and explanatory, of Prof. FitzGerald's relation to contemporary science. As much of his stimulating and suggestive thought was published in journals not readily accessible, just as it flowed from his pen, this substantial collection of papers will in the main be fresh to physicists. Being a record of the activity of a mind that was always in the van of progress, it will also be of interest as a reminder of the paths of advance of physical science during the last quarter of a century.

It is beginning to be recognised that scientific knowledge, and a progressive frame of mind are attributes which must be possessed by all who are preparing for the struggle of the future, whether in peace or war. In the debate upon the Navy Estimates in the House of Commons on Friday, the scientific aspect of the problem of naval warfare was mentioned, and we are glad to see that Mr. Arnold Forster referred to the importance of keeping it in mind. As to the part science ought to play, and the respect it ought to receive in the Navy, he remarked that he believed it to be true of the Navy, as of every large department, that we had not yet fully realised the position that science had taken, and was bound to take to a still larger extent, in this country and in the world. He did not know that that was peculiar to the Navy. He thought it was far less true of the Navy than it was of many other great departments of life.

AT the general meeting of the Zoological Society of London held on June 19, the gold medal of the Society was delivered by His Grace the Duke of Bedford, K.G., president, to Sir Harry Johnston, G.C.M.G., K.C.B., in consideration of his great services to zoological science while occupying various official posts in Africa and especially in commemoration of his discovery of the okapi. After the close of the meeting, the third of the series of zoological lectures for the present year was delivered by Prof. E. Ray Lankester, F.R.S., on the okapi and its position in the natural series. Prof. Lankester's memoir in the Society's *Transactions*, which contains a full account of all that is known of "the new African mammal" up to the present date, is expected to be ready very shortly.

THE annual general meeting of the Röntgen Society will be held on Thursday, July 3.

IN connection with the Egypt Exploration Fund, an exhibition of antiquities found by Prof. Petrie at Abydos, and by Dr. B. P. Grenfell and Dr. A. S. Hunt in the Fayum and El Hibeh, will be on view at University College from July 1 to July 26.

THE annual conversazione of the Institution of Electrical Engineers will be held at the Natural History Museum, South Kensington, on July 1. There will be a reception of the foreign delegates to the International Tramways and Light Railways Congress at 9.15 p.m.

SINCE May 3, 1832, when Louis Bonaparte, then President of the French Republic, decreed that the Pantheon was again to be considered a Roman Catholic Church, the great pendulum installed by Léon Foucault to afford a proof of the rotation of the earth has been laid aside. M. de Fonvielle informs us that

workmen are now busy making preparation for a new series of demonstrations. The operations will be conducted under the supervision of M. Berget, assistant to M. Poincaré. The pendulum itself is a ball of lead weighing 27 kilogrammes, and was used in 1869 by M. Maumené for observations in the cathedral of Rheims during several months. The new demonstrations at Paris will be given in a few days.

THE United States Senate has passed a Bill directing the President to purchase all the capital stock, concession, unfinished work and machinery, and other property of the Panama Canal Company for 8,000,000. The President is further directed to acquire from the Republic of Colombia a strip of land six miles wide along the route, over which the United States shall have permanent control. The Bill next authorises the completion of the canal. If the Panama Company is unable to give a satisfactory title and Colombia refuses to cede the land, the President is authorised to construct a canal by the Nicaragua route. The *Daily Mail* states that since the Martinique disaster the supporters of the Panama Canal have persistently declared that the Nicaragua route passed through a volcanic country, and that the canal would be liable at any moment to be destroyed. This argument had a marked influence in gaining votes for Panama. The passage of the Bill does not end the canal controversy. The House of Representatives recently passed a Bill authorising the construction of a Nicaragua Canal, with only two dissenting votes, but it is believed that the Senate's decision in favour of Panama will now be accepted.

MR. F. FINN writes to us from the Indian Museum, Calcutta, with reference to the late Prof. V. Ball's identification of the Catreus of Elian with the Himalayan monal-pheasant. This identification Mr. Finn regards as erroneous, and he adduces reasons for considering the Honduras wild turkey as the bird in question. Possibly specimens of this bird may have been obtained in Elian's time by the natives of Hindustan from America by way of China. If, however, this explanation will not hold good, the somewhat startling theory is suggested that the Honduras turkey was once a native of India.

IN the U.S. *Monthly Weather Review* for January and February last, Mr. A. Matthews discusses at considerable length the term "Indian summer," and gives references to, and quotations from, numerous works relating to its use. In America this season is connected both by name and popular belief with the aborigines; but the term is said to date only from about the last decade of the eighteenth century, and has reference to a spell of warm weather occurring in the late autumn. The term appears to have reached Canada in 1821 and this country in 1830. This warm period is frequently referred to in meteorological text-books; Dr. Buchan points out that if easterly winds have largely predominated in autumn, and south-westerly winds begin to prevail at the end of November, or a little later, the weather is likely to continue exceptionally mild. These conditions occur nearly every year, and the beginning of the warm spell is popularly known in this country as St. Martin's summer.

THE *Agricultural News* of the West Indian Agricultural Department adopts a suggestion that Coronation day, should be marked throughout the islands as an arbor day. It points out that this is exactly the right season for planting purposes. In many localities the planting of ornamental shade trees would be of great public benefit, and at the same time add to the comfort and amenities of life in the tropics. Particulars are given as to the methods of planting, suitable trees and palms for the purpose being always obtainable at the Botanic Gardens.

IN connection with the abnormally cold weather which has prevailed over the British Isles, and to a great extent over Western Europe also, since the closing days of April, considerable interest attaches to the temperature of the surface water of the Atlantic during the month of April. The mean results, derived from a total of 4150 observations, are given on the pilot chart for June, just issued by the Meteorological Office. There appears to have been an almost complete absence of ice about the banks of Newfoundland, a fact which is emphasised by the sea water of that region being warmer than usual, the excess ranging upwards to as much as 6° in places. Westward of the thirty-fifth meridian, from 30° to 35° N., the temperature was also rather above the normal, but from the coast of Virginia eastward between these relatively warm patches, along what may be described, roughly, as the Gulf Stream course, there was a deficiency of temperature right across the ocean to our coasts, the eastern half of the Atlantic being below the average. Northward of the fiftieth parallel it would appear that there are no normals available for comparison with the present series, which is unfortunate, as the condition of the sea immediately to the west of our islands, between the Fastnet and Iceland, probably exercises an appreciable influence on our climate. Down to June 16, when the pilot chart went to press, there were still no ice reports of any importance on the banks, the latest being May 8, a piece of ice 4 feet square, one of May 5 relating to bergs stranded on the Newfoundland coast, north of Cape Race. The strait of Belle Isle was clear, but floes were drifting down the Labrador coast, so that steamers could not approach the strait from seaward. Iceland reports show that there has been a good deal of ice off the north-western part of the island.

THE result of an investigation by Mr. Maxwell Hall relative to the mean maximum temperature and the rainfall of Jamaica and sunspot frequency has recently been published officially at Jamaica, and has already been mentioned in these columns (p. 159). The temperature observations, a full account of which he gives in the paper, extend over the years 1881 to 1898, and to eliminate minor irregularities Mr. Hall employs for the yearly value the mean of the year and the means of the year each side of this middle year; thus, to take an example, the value for 1885 is the mean for the three years 1884, 1885 and 1886. The temperature variations found in this manner, when compared with the variation in the spotted area of the sun's surface, bring out a close relationship between these two phenomena. Thus it is observed that the temperature is at a maximum at sunspot minimum and *vice versa*, and that this variation amounts to about 2° F. With regard to the variation of rainfall as deduced from a discussion of the yearly means of rainfall, Mr. Maxwell Hall has previously shown (NATURE, vol. xlix. p. 399) that up to the year 1887 there was a general resemblance between the sunspot curve and that of rainfall, the maxima and minima of the rainfall variations corresponding approximately with those of the curve representing the sun's spotted area, but there were certain irregularities which suggested that the old view that there was most rain at the maximum and least at the minimum of the eleven-year curve was only approximately true. The further discussion of the rainfall observations up to the year 1899 shows, however, that this apparent law breaks down completely. When in 1889 and 1890 the rainfall curve should have been at a minimum, in reality it showed a subsidiary maximum, while also when at the sunspot maximum of 1893-4 the rainfall should have been excessive, it was conspicuous by a great deficiency.

THE important aid that photography can render to the surveyor has recently been well illustrated by a paper read before the Institution of Mining Engineers by Mr. Arthur O. Wheeler,

attached to the staff of the Canadian Topographical Survey. In this paper we have the actual experience of one who has been much engaged in practical surveying, and his notes having reference to the selection of stations and to the photographic processes necessary in the field are as valuable as those which deal with the after manipulation of the photographic enlargements and the production of the contour maps. The application of the photographic method is based on the consideration of the triangle, the angles at the base of which are formed by lines drawn from the two known stations, at which the perspective view of the country has been obtained in the camera, to the point which is to be projected, and which may be considered the apex of the triangle. Accuracy demands that the triangle should be well conditioned, and reaches its highest value when the angle at the apex approaches a right angle. There will be difficulties connected with the selection of suitable stations, difficulties in the identification of orientation points, which Mr. Wheeler makes no attempt to minimise, but a peculiar feature of the method is that it is best adapted to a country where the actual measurement in the field is tedious or impossible. It was pointed out in the discussion of Mr. Wheeler's paper that the method did not offer great advantages in a country of gentle slopes and rounded outlines, with relatively small differences in elevation, because of the uncertainty of locating the points on different photographs. But when the country possesses no inconvenient features, other methods are easy of application. Moreover, it was urged that the plotting of the points is more laborious than in the older methods of surveying. Mechanical devices based on the theory of perspective can do much to shorten the office work of plotting, and in any case this delay and expense are more than compensated by the rapidity of the field work and the employment of a smaller number of assistants required to remove obstacles in an untravelling country. The method has been employed practically in Canada, where the Topographical Survey has been carried into regions the severe climate of which renders it desirable to shorten as far as possible outdoor operations.

A CONVENIENT form of rectifier and interrupter for use with alternating currents is described by Dr. Guilleminot in the *Archives d'Electricité Médicale* for May. The current to be used is led through a vibrating reed, which carries at its free end a contact dipping in and out of a mercury cup. The reed is placed between the poles of a permanent magnet and is magnetised by a coil of wire which surrounds it; the coil is connected (in series with self-induction and resistance) as a shunt to the main circuit. A damping arrangement is also attached to the reed. The reed vibrates in synchronism with the alternating current, and as the contact only dips into the mercury when the reed is deflected downwards, the main circuit is synchronously opened and closed, thus converting the alternating into an intermittent direct current. The great advantage of the apparatus is the ease with which it may be adjusted; the mercury cup can be raised or lowered, thus regulating the time of closed circuit; the length of free reed can be varied, and the phase of the vibration relative to that of the alternating supply can be altered by varying the self-induction in series with the exciting coil. It is thus possible to open the circuit always at the most suitable point of the wave—which depends, of course, on the purpose for which the current is being used. The apparatus, which is said to give excellent results in X-ray work, is the invention of Prof. Villard, and is made by M. Chabaud.

THE *Zeitschrift für Elektrochemie* for May 8 contains an interesting article by Dr. A. Ludwig upon the fusion of carbon. After referring to Moissan's classical work on this subject, and to the famous French chemist's production of diamonds in the electric furnace, the author gives details of his own work.

Theoretical reasoning had led him to the belief that, working under sufficient pressure, it would be possible to melt carbon and to maintain it in the liquid condition, and actual experiment verified this theory. At a pressure of 1500 atmospheres, the arc between two carbons inserted in the pressure vessel failed, and not even an E.M.F. of 70 volts sufficed to carry the current across the gap separating them. The author's explanation of this phenomenon is, that the carbon had assumed the third allotropic state, and had in its passage into the liquid and transparent condition become a non-conductor. The difficulty of maintaining it in this condition was, however, great, and in some cases the phenomenon only lasted a few seconds. Attempts were made to obtain diamonds, by sudden cooling of the interior of the pressure vessel by an inrush of water, but although unmistakable diamonds were found amongst the hard grey powder that was obtained, the results were not altogether satisfactory. The apparatus used by the author in these investigations has been patented (English Patent No. 16908, 1900), and as circumstances have compelled him to relinquish his own investigations of the subject, he hopes that others may continue the experiments along the lines he has indicated.

The development of the large Beaumont oil-field in Texas, which is situated only sixteen miles from the coast, will probably lead to oil being much more largely used as fuel for engines than it has hitherto been. The possibility of a cheaper supply of oil is a matter that is of great importance to this country, and may lead to the increased use of motor cars for suburban traffic and for trade purposes. The oil will be conveyed from the oil-field to the coast by pipe lines, along which the oil will flow by gravity into tank steamers, the cost of conveyance to this country being not much more than a halfpenny a gallon. It has been found by experiment that four and a half barrels of oil, or 189 gallons, are equivalent to one ton of the best coal. Oil is now used largely in America as fuel. On the Southern Pacific Railway 300 engines have been adapted to burn oil, and it is anticipated that a very large sum will, in consequence, be annually saved in the working expenses. In Russia no other fuel than oil is used on the 1600 miles of the Trans-Caspian Railway.

In the *Proceedings of the Royal Society of Victoria*, of which we have just received part ii. of vol. xiv., 1902, geology dominates, and zoology is the only other science dealt with. The natural history of the country is attracting particular attention, as shown by papers on Crustacea, Polyzoa and Mollusca. Mr. T. S. Hall and Mr. G. B. Pritchard discuss a suggested nomenclature for the marine Tertiary deposits of southern Australia. Local names are always desirable for formations which cannot be expected to correspond in time with the stratigraphical divisions made in distant regions; and the authors are to be commended for using names peculiar to South Australia, despite the fact that they introduce the Werrikoian and Jan Jucian formations. Prof. J. W. Gregory gives an account of the geology of Mount Macedon, an isolated mountain ridge, which though forty miles distant is one of the most conspicuous features in the views from Melbourne. It consists of a volcanic pile resting on Ordovician rocks. The igneous outbursts may have commenced in late Cretaceous times, but there is no certain evidence. The mountain, however, probably marks the beginning of the great period of volcanic activity of which the last eruptions built up still existing craters, and of which records are preserved in the legends of the Victorian aborigines.

The *Journal of the Franklin Institute* (vol. clxiii. No. 1) contains an account of the half-tone trichromatic process of colour-printing, by Mr. F. E. Ives. Until recently, all the finest colour-printing has been done by the chromolithographic process employing from seven to twenty stones with as many

inks and impressions. It has long been thought that, in accordance with the trichromatic theory of colour vision, three printing surfaces, colours and impressions might be substituted for the seven to twenty of the lithographer, and that the preparation of these surfaces might be accomplished photographically. The only commercially successful development of this idea at the present time is by the employment of three half-tone process blocks made from a trichromatic negative colour-record and printed with three coloured inks in the type process. Up to the present the quality of the product of this process has, however, been so uncertain that the process has been brought somewhat into disrepute. The author shows that conditions can be secured which make it possible to obtain the best results almost automatically.

In the *Scientific Transactions of the Royal Dublin Society* (vol. vii.) is a paper by Prof. Joly on sedimentation experiments and theories. The rates of settlement of suspensions from solutions containing ions in various degrees of concentration indicate that above a certain concentration the rate of fall of the surface of the suspension is fairly independent of the degree of concentration. Below certain concentrations a distinct surface to the descending suspension fails, and the sediment is only seen to collect from the bottom of the vessel upwards. A suspension precipitated at a concentration in the neighbourhood of this critical concentration does not again precipitate with a distinct surface if reshaken. On removing the electrolyte from such an "exhausted" suspension, it is found that the liquid is as effective as at first in producing surface if a fresh sample of the powder is used. On the other hand, the original powder will not again exhibit the formation of surface when treated with fresh electrolyte of the same strength, but requires a more concentrated solution to do so. The failure is, therefore, to be traced to some alteration in the solid particles, and on testing the fresh powder it is found to be electrically negative towards distilled water, whereas the used powder is neutral or nearly so towards its salt solution. The author advances a theory of the process of sedimentation to account for the observed phenomena.

"THE Pioneers of Evolution, from Thales to Huxley," is the title of a pamphlet of 114 pages by Mr. E. Clodd, published for the Rationalist Press Association by Messrs. Watts and Co.

THE Agricultural Department of the Cape of Good Hope has issued a catalogue of South African fishes (marine and freshwater), drawn up by Dr. J. D. F. Gilchrist, the Government biologist.

IN his report of the Ghizeh Zoological Garden for 1901, Captain Stanley Flower announces that two important additions have been made to the buildings, namely, the lion-house and the elephant-house, both of which were completed during the year.

IN the June number of the *Zoologist* Mr. R. Service alludes to the change which appears to have taken place of late years in the habits of the black-headed gull, this bird being much more of a land-dweller than formerly.

WE have received a copy of a reprint of an article from *Chambers's Journal* in which Mr. H. F. Witherby recapitulates the main facts connected with the migration of birds, adding a few observations made during his own travels in the eastern Sudan and elsewhere.

A SUPPLEMENT to the *Oxford University Gazette*, issued June 17, contains the report of the delegates of the museum for 1901. Among the more important additions to the collections is a "totem-post," about 36 feet in height, from Queen Charlotte Island, presented by Prof. E. B. Tylor. The Hope professor of zoology announces that the insect collection has

been very largely increased during the year, the most notable item being a consignment of specimens from Sarawak, presented by Mr. R. Shelford.

THE results of a redetermination of the atomic weight of uranium by Prof. T. W. Richards and Mr. Merigold are published in a recent number of the *Proceedings* of the American Academy of Arts and Sciences. Of previous determinations the only one worthy of serious consideration is that of Zimmermann, who in 1886 found the value 239.59. Zimmermann's method, based on the preparation of pure UO_2 and its conversion into U_3O_8 , appears likely to give too high numbers, owing to the difficulty of obtaining the lower oxide free from occluded gases and also of oxidising it completely. After much preliminary work and a long search for suitable substances, Messrs. Richards and Merigold chose the analysis of uranic bromide as the basis of their method. The preparation of pure uranic bromide and its manipulation present considerable difficulties. Its analysis was effected by first oxidising it to uranyl bromide by means of hydrogen peroxide and then precipitating the bromine by means of silver nitrate. The results showed satisfactory concordance, and led to a conclusion expressed by the authors as follows:—"If oxygen be taken as 16.000 and bromine as 79.955, the atomic weight of uranium appears to be not far from 238.53." It is remarked that, although this number differs by more than a unit from that given by Zimmermann, the percentage difference (0.45) is smaller than many which have often been passed unheeded in the case of elements of smaller atomic weight. It is, however, a noteworthy difference, and the probability seems to be that Zimmermann's number was too high. The paper of Messrs. Richards and Merigold brings to light many interesting facts about the chemistry of uranium.

THE additions to the Zoological Society's Gardens during the past week include a Chacma Baboon (*Cynocephalus porcaricus*) from South Africa, presented by Mr. E. G. Williams; a Patas Monkey (*Cercopithecus patas*) from West Africa, presented by the Rev. E. Millar; a Green Monkey (*Cercopithecus callitrichus*) from West Africa, presented by Mr. W. S. Hewitt; a Serval (*Felis serval*) from Africa, presented by Mr. P. Hayton; a Ground Hornbill (*Bucorvus*, sp. inc.) from South Africa, presented by Mr. F. H. O. Wilson; a Senegal Turtle Dove (*Turtur senegalensis*) from West Africa, a White-fronted Dove (*Leptoptila jamaicensis*) from Jamaica, presented by Mr. D. Seth Smith; a Barn Owl (*Strix flammea*) European, presented by Mr. G. Dundas; two West African Pythons (*Python sebae*) from West Africa, presented by Lieut. Lamby; a Long-nosed Crocodile (*Crocodilus cataphractus*) from West Africa, presented by Capt. Gibson; an Orang-outang (*Simia satyrus*) from Borneo, an Alpine Chamois (*Rupicapra tragus*) from Savoy, a Suricate (*Suricata tetradactyla*), four Cape Crowned Cranes (*Balearica regulorum*) from South Africa, two Grey Ichneumons (*Herpestes griseus*) from India, deposited; a Chimpanzee (*Anthropopithecus troglodytes*) from West Africa, purchased.

OUR ASTRONOMICAL COLUMN.

ASTRONOMICAL OCCURRENCES IN JULY:—

- July 2. 6h. 27m. to 11h. 22m. Transit of Jupiter's Sat. IV.
2. 14h. 3m. to 14h. 52m. Moon occults δ^3 Tauri (mag. 4.2).
14. Minor planet Vesta in opposition to the sun.
15. Venus. Illuminated disc = 0.807. Mars = 0.979.
15. 10h. Mercury in conjunction with Neptune. Mercury $1^{\circ} 34' S$.
15. 15h. Mercury at greatest elongation $20^{\circ} 35' W$.
17. 13h. Saturn in opposition to the sun.
18. 8h. 51m. to 12h. 34m. Transit of Jupiter's Sat. III.
19. Saturn. Outer minor axis of outer ring = $16'' . 38$.

NO. 1704, VOL. 66]

- July 19. 10h. 56m. Minimum of Algol (β Persei).
19. 10h. 58m. to 11h. 54m. Moon occults ρ^1 Sagittarii (mag. 3.9).
23. 14h. Mars in conjunction with Neptune. Mars $1^{\circ} 37' N$.
25. 12h. 9m. to 15h. 51m. Transit of Jupiter's Sat. III.
27. 7h. Venus in conjunction with Neptune. Venus $0^{\circ} 11' N$.
28. 14h. Venus in conjunction with μ Geminorum. Venus $0^{\circ} 2' S$.
- 28-30. Epoch of the Aquarid meteoric shower (radiant $339^{\circ}-11^{\circ}$).
30. 14h. 46m. to 15h. 28m. Moon occults m Tauri (mag. 5.1).
31. 21h. Venus in conjunction with Mars. Venus $1^{\circ} 18' S$.

THE ANNA BREDIKHINE ASTRONOMICAL PRIZE.—The conditions of this new astronomical prize, founded by Prof. Th. Bredikhine in memory of his wife, are published in *The Observatory* for May. The prize is to be awarded for the most thorough investigations of any large comet, the investigations to be pursued on the lines followed by the donor in his own famous cometary researches.

OCCULTATION OF W LEONIS.—Mr. J. F. Cole, of Cambridge, Mass., writing to *Popular Astronomy* (June, 1902), notes an observed decrease in the magnitude of this variable double about one half-second before its occultation. He suggests that other observers might endeavour to discern the probable change of colour at the next occultation, which takes place at 9h. 21m. (Washington mean time) on July 7, magnitude 5.6, position angle 99° .

A REMARKABLE BOLIDE OBSERVED AT LYONS ON MARCH 19.—A correspondent of the Société Astronomique de France records the appearance of "a magnificent bolide" at 9.10 p.m. on March 19. The observer, who was situated at Lyons, states that the meteor first appeared in the neighbourhood of Arcturus and then travelled eastwards until lost in the haze on the horizon. Form, round; light, yellowish orange; magnitude, brighter than Venus; trail, none; duration, 2 seconds (*Bulletin de la Société Astronomique de France*).

NOTATION OF VARIABLE STARS.—At the suggestion of Mr. A. Stanley Williams, and with the idea of correlating the various notations, a list of eighty-one variables to which different names have been assigned in published lists of variable stars, has been prepared by Mr. H. C. Wilson and published in this month's *Popular Astronomy*.

Of the various systems of notation in vogue, Mr. Wilson favours that used in the *Annuaire*, where the first nine variables discovered in a constellation are named by the last nine letters of the alphabet in their normal sequence; the second nine variables discovered in that constellation are designated in the same way, but the suffix "2" is added to the capital letter, and so on for the third, fourth, &c., sets of nine. Thus the twentieth variable discovered in Sagittarius is catalogued as θ^2 Sagittarii. As the author remarks, "This method is capable of indefinite extension without becoming cumbersome; but, unfortunately, it does not have the advantage of priority, nor of adoption by those who are doing the most valuable variable-star work," and he therefore suggests that the double-letter system, as adopted by the Variable Star Committee of the Astronomische Gesellschaft, should be universally used; further, he suggests that the assignment of the notation to individual stars should be left entirely to the Committee, and, for provisional purposes, he advocates the adoption of the notation now used in the *Nachrichten* when naming newly suspected variables, viz. to assign consecutive numbers and to add the year of discovery, e.g. 3, 1901.

STUDY OF BRIGHT POINTS AND CURVES.

THE study of "brilliant points and lines" is an application of the principles of geometrical optics which has not hitherto received the amount of consideration which it deserves, when account is taken of (1) the simplicity of the principles involved, (2) the elegance of the results obtained, and (3) the ease with which the subject can be studied experimentally. The writer of the present note has a dim recollection of having worked out in his undergraduate days a tripos rider in which it was required to find the equation of the bright curves seen

when a source of light was reflected from a metal surface covered with regular scratches or corrugations of a given form, but beyond this he does not remember having seen any other bookwork or examples on the same subject. A general investigation of the theory of brilliant points is now given by Mr. W. H. Röver in the *Annals of Mathematics* for April, pp. 113-128.

When a ray of light emanating from a source which we will call P_1 is reflected at any surface, and an eye is placed at another point, P_2 , a point of the surface from which the reflected ray travels directly towards the eye appears luminous and is called by Mr. Röver a *brilliant point*. A mathematical investigation also involves the consideration of points from which the reflected ray travels directly away from the eye, and although such points obviously do not correspond to any visible phenomena, it is necessary to consider them under the name of *virtual brilliant points*. If the reflecting surface is a thin wire, a point P_3 will be a brilliant point if the lines P_1P_3 and P_2P_3 make equal angles with the tangent line to the wire at P_3 . We thus get the notion of a brilliant point on a *curve*. Taking next a

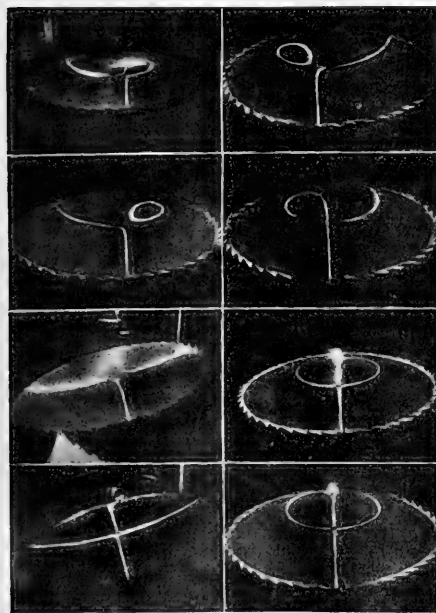

FIG. 1.—Bright lines on a circular saw.

finely but regularly scratched or corrugated surface, the locus of the brilliant points with respect to the curves defined by the scratches or corrugations is the brilliant curve of the system. For a doubly infinite series of curves, the equations of which contain two independent parameters, the mathematical theory leads to the consideration of a brilliant surface as the locus of the brilliant points, although it is not easy to see how this generalisation could be made the subject of experimental verification.

The author, after giving a general investigation, considers the particular cases of the brilliant curve for a circular saw or disc of steel in which the scratches form concentric circles, and also for a rotating carriage wheel in which the curve is generated by the brilliant points of the spokes, *i.e.* of a family of radiating lines in one plane. In both cases the curves are of the fourth degree. The accompanying diagrams are reproductions of photographs of some of the curves obtained with the circular saw. An obvious further example of loci of brilliant points is afforded when moonlight is reflected from waves or ripples on the sea or a lake.

VARIATION—GERMINAL AND ENVIRONMENTAL.¹

"THE most critical and momentous period in the life-history of any plant or animal," says Prof. Gosser Ewart, "is during the conjugation of the male and female germ-cells." The variation which flows from this blending of the reproductive elements he speaks of as "germinal." That which occurs in the germ-cells up to the moment of conjugation, together with the variations during development and growth, he designates as "environmental."

It may perhaps be questioned in passing whether the distinction is one that can always be observed in practice, and also whether Prof. Ewart's terms are the best that could have been adopted. However, they serve sufficiently well for the purpose of the paper before us.

Some "congenital" characters, he proceeds, may be "acquired"; for example, dwarfing due to embryonic malnutrition. The double uterus of a wild rabbit contained eight young in one division and four in the other, the weight of the two divisions with their contents being nearly equal. In such cases the offspring that has been starved before birth, should it survive, may eventually reach the normal size and produce normal descendants. Antenatal injury, as in constriction by the cord, may lead to "congenital" abnormalities which are neither "inherited" nor transmitted.

Individual plasticity in response to environmental conditions is an obvious and undoubted fact. But can variations so induced be transmitted to descendants? This is still a burning question, in regard to which Prof. Ewart has as yet met with no evidence to support an affirmative answer. On the other hand, the results of his experiments have afforded much reason for the positive belief that the handing on in any form of acquired traits is extremely improbable.

But although there is no evidence of the transmission of somatic characters acquired in virtue of individual plasticity, it is still possible that the general vigour of the somatic tissues may be reflected in the germ plasma, and also that the condition as to ripeness of the generative products may influence the nature of the combinations formed during conjugation. A young Jacobin-barb pigeon mated with an old turbit produced first two young ones which were devoid of all the distinctive points of both parents; but afterwards, on several successive occasions, hatched out offspring which presented points of resemblance with the dam. Prof. Ewart declares that he can only account for this by saying that as the female parent increased in age and vigour her germ-cells increased in prepotency. When she went out of condition, the single offspring then produced more closely resembled the sire.

Some experiments with rabbits led to unexpected results. Several white does were mated with wild males, and several wild does with a white buck. In every case the offspring resembled wild rabbits in form and colour. But the mating of the half-wild offspring with each other, uniform as they were, led to an "epidemic of variation," not only in colour, but also in size, disposition and other qualities. When the half-wild rabbits were crossed with white bucks or does, there were also always several colours represented in the cross-bred litters. An intimate relation was discoverable in all these and their offspring of the next generation between the colour, the "wildness," the time at which maturity was reached, and the rate of growth. Though the half-wild progeny were all wonderfully like wild rabbits, it was evident that in them the stability of the wild rabbit had been broken down.

Further experiments with rabbits—one of which, narrated at length by Prof. Ewart, is of remarkable interest—tend to show that, as in the case of pigeons, the relative maturity of the male and female elements has a definite influence on the character of the offspring. The general results may be summarised as follows:—When insemination precedes ovulation, the young resemble the buck; when it follows, they resemble the doe; when it coincides, some take after the buck, some after the doe, while others may differ from both parents and resemble some of the less remote ancestors. It was incidentally shown that in the rabbit, spermatozoa may retain their potency several days after they reach the fallopian tube. Prof. Ewart notes the

¹ "Variation: Germinal and Environmental." By J. C. Ewart, M.D., F.R.S., Regius Professor of Natural History in the University of Edinburgh. *Scientific Transactions of Royal Dublin Society*, 1901, p. 353-378. (Williams and Norgate).

correspondence of the foregoing results with those obtained by Vernon in echinoderms.

The difference between different members of the same family must be in part attributed to the potential difference of the cells from which they are respectively developed. Whether the reducing division of the germinal cells is qualitative as well as quantitative is an open question, but there is reason to think that the life-history of these cells previous to conjugation may give opportunity for environmental variation like that of the Protozoa.

Turning now to the subject of "germinal variation," the author points out that the existence of such environmental variation in the germ-cells, apart from reducing division, together with the physiological differences dependent on diverse conditions of vigour and maturity, may be expected in most cases to preclude the new individual from assuming an exactly intermediate position between its parents. When the male and female germ-cells unite, a series of contests takes place between groups of vital units, the issue being decided by their respective qualities, individuality or character.

When different varieties or species are intercrossed, the effects may differ not only in degree but also in kind from those of ordinary cross-fertilisation. The following are some of the results that have been obtained experimentally from such intercrossing:—

(1) The offspring may be almost exactly intermediate between the parents.

(2) The offspring may resemble one of the parents and not the other. This is often the case when wild animals are crossed with tame varieties of the same species. (It must, however, be remembered that the resemblance may be only superficial, as was clearly the case in the experiments with half-wild rabbits cited above.)

(3) Some of the offspring may resemble one parent, some the other. (This seems especially likely to occur if one or both of the parents is a sport. Standfuss's results with insects are in accord with this.)

(4) The offspring may combine, almost unimpaired, the more striking characters of both breeds. This has been seen in both pigeons and rabbits.

(5) New or unexpected characters may appear in the progeny. Three out of four of a litter of cross-bred rabbits developed a habit of "spinning."

(6) When half-breeds are crossed, the offspring tend to be extremely variable. Evidence of this is plentiful both in animals and plants.

(7) Sometimes the offspring, instead of resembling the parents, resemble former ancestors. Prof. Ewart mated a cross between an "archangel" and an "ox" striking with a white fantail. The issue was a bird with a striking resemblance to the ancestral "blue-rock." (Analogous results have been several times obtained in the case of insects.)

Prof. Ewart's paper is interesting and suggestive to a high degree. It would be hard to overestimate the value of the experiments which he is conducting with so much care and judgment in his well-selected menagerie at Penyukik.

F. A. D.

RUST-FUNGUS.

PROF. MARSHALL WARD'S investigations into the relations between host and parasite in the case of the Bromegrasses and their rust-fungus are bringing to light some interesting facts which have important bearings on the long-veiled questions of wheat-rust and the rust problem generally, which, as is now well known, have passed into an acute stage of late, principally owing to Eriksson's enunciation of his belief that the fungus can be transmitted in an invisible form *visu* the seed.

In addition to testing this mycoplasma hypothesis of Eriksson's, the researches undertaken by Prof. Marshall Ward are also directed to put to the proof the questions of degrees of specialised parasitism raised during the last decade by the researches of Plowright, Kleebahn, Eriksson, Magnus, Fischer, and others, and more especially, to see if any deeper insight can be obtained into the causes of epidemics and the relative pre-disposition or immunity of certain plants to attack.

In a paper read to the Cambridge Philosophical Society on January 20, 1902, Prof. Ward gave a summary of his results with more than eighteen hundred infection experiments, made

on twenty-two species and varieties of Bromus with the Uredospores of *Puccinia dispersa* (Erikss.), the brown-rust of these grasses. These results show clearly that, other conditions being the same, the infection of a given species of Bromus—say *B. mollis*—by the Uredospores of the Puccinia depends on the origin of the spores, that is to say, on the circumstances of nutrition and breeding generally to which they have been hitherto accustomed. For instance, if the spores are reared on *B. mollis*, they infect another plant of *B. mollis* readily; but if they are reared on *B. sterilis*, they refuse to infect *B. mollis*, though they will readily infect another plant of *B. sterilis*.

But, in addition to the infective capacity of the spores conditioned by their past history, there is the question of the pre-disposition or immunity of the host. For instance, it is easy to infect *Bromus mollis* with spores from *B. mollis*, but far less easy to infect *B. racemosus* with such spores, and practically impossible to successfully infect *B. sterilis*. Part of Prof. Marshall Ward's work goes to prove that the immunity of given species of Bromus is not due to anatomical peculiarities, such as the number and size of the stomata, hairs, the volume of chlorophyll tissue and so forth, but to some substances or conditions in the living cells which escape microscopic investigation. In other words, the inquiry is being pushed into the domain of enzyme reactions, anti-toxins and so forth.

In a forthcoming paper it will also be shown that the external conditions of germination of the spores, and of infection by way of the stomata, require far more attention than they have yet received.

In a paper read to the Royal Society on February 20 last, another aspect of the investigation was opened up, namely, the possibility of obtaining pure cultures of these Uredines, a method which applies to other parasitic fungi as well.

In order to obtain more decisive answers to such questions as—Are any of the results obtained on plants in the open, or merely covered with bell-jars and so forth, due to spores accidentally introduced, or to mycelium, &c., already in the plant? a number of infections were made on seedlings germinated and grown antiseptically in tubes as follows:—

Clean picked seeds were placed singly, by means of forceps, on filter paper at the bottom of Petri-dishes properly sterilised by heat. When these had germinated, and observation showed that the whole series was free of moulds or other signs of contamination, the seedlings were removed by means of sterile forceps and transplanted singly into sterilised tubes of various kinds as described below, and the further growth allowed to proceed in the light under conditions varied as will be seen.

Prof. Ward had already shown that seedlings will continue to grow in such tubes, but, as we have seen, in the cases previously described he had no guarantee that the seedlings introduced into the culture-tubes did not already carry on their leaves wind-borne or otherwise transmitted spores.

In the case of these seedlings germinated from clean "seed" in sterile dishes and tubes, it is obvious that the only chance of infection depends on spores attached to the "seed" or on mycelium in the seed.

Experiments with seed gathered even from badly rusted plants and germinated as above have never given rusted seedlings, although other experiments have shown that the germ-tubes of attached spores can infect seedlings when the plumule is only 3-5 mm. high. Nor has Prof. Ward ever been able to discover any trace of mycelium in the seeds.

But if the "seed" of the Bromus is sterilised before germination—as can be done by steeping in various antiseptics, or by heating to 60-70° C.—it is found that pure cultures of the Brome may be obtained in the tubes, and it is then only necessary to infect such a clean seedling with the spores of the parasite to obtain a pure culture of the latter.

Preliminary experiments soon showed that the Brome seedlings thus raised from seeds treated antiseptically, and protected from the first by glass, may be grown for weeks and even for a couple of months in such tubes under proper precautions, and Prof. Ward set himself the task of ascertaining how such cultures would behave in infection experiments.

In the following experiment upright tubes of the kind known to chemists as "drying towers" were prepared as in the diagram (Fig. 1), so that by means of an aspirator attached to the tubing at G, a continuous current of damp air could be slowly drawn through the whole series, aerating the roots of the seedlings F, which burrowed into the cotton-wool B, day and night. The tubes were charged each with one seedling,

grown from seeds heated to 65° C., and forty-eight hours after germination had begun and the latter allowed to grow in the light on a table outside the laboratory. The tubes were charged on June 14, and on June 19, when the first green leaf was well developed, the latter was infected at a definite spot with spores

In this series the liquid employed was the normal Knop's mineral solution (+), so well known as used in water-cultures. The tubes were charged with this before sterilisation, enough being put in to wet the cotton-wool plug (B) and fill the reservoir (C), the side-tube *y* being fused at its pointed end during sterilising.

Since each tube is linked to its neighbour with clean flexible tubing, and the air bubbles through the liquid in the reservoir (C) and has to pass the cotton-wool plug (B) before reaching the leaves (F) in the air above, there can be no question of infection from outside, and the results also show that infection only occurs exactly where the spores are placed on the leaf in each case.

The spores employed were carefully tested as regards their germinating power, and, as the table shows, the results in the closed tubes fully bear out previous experience. In the aspirated tubes, however, the second pair of seedlings of *B. mollis* (No. 712) gave negative results, inasmuch as only flecks, and not pustules bearing spores, were developed. In the closed tubes, however—see below—the positive results, especially on *B. velutinus* and *B. secalinus*, were excellent, and subsequent examination showed that the spores germinated well and were capable of infecting other seedlings.

In order to test further the behaviour in mineral solutions, Prof. Ward prepared, as the table shows, several series in closed tubes, Nos. 713, which served as a parallel series to Nos. 711 and 712, but without aeration.

In No. 713 the sterile seedlings were raised antiseptically as before, but the roots merely penetrated cotton-wool saturated with Knop's solution, and held by the constriction over the bulb filled with the same, no air being drawn through. The growth was excellent, and the results very conclusive, as the table shows.

The seedlings were allowed two days at 22–20° C. in the laboratory and then put out side by side with 711 and 712 in full sun during the middle of the day, and after two days' further growth were infected.

By the tenth day the thin leaf was well developed, and the first pustule was seen on *B. mollis* and *B. secalinus* on the eighth day after infection.

The growth of pustules was excellent on *B. velutinus* and *B. secalinus* especially.

This experiment is interesting, not only as showing that plants can be grown and infected successfully in these closed water-cultures, but especially as showing the contrast between the aerated and non-aerated tubes, for, since the infected

—proved to be capable of vigorously germinating by cultures in hanging drops—and the whole series linked up and aerated. The growth of these seedlings in the moist air-current was very satisfactory, the plants having a deep rich green colour, though the leaves were short, and the results, as shown in the following table, were very instructive.

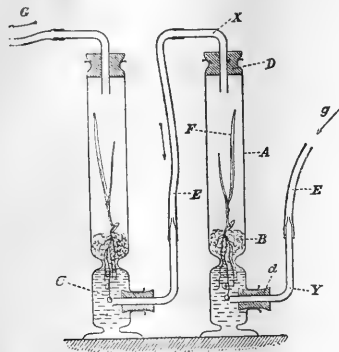

FIG. 1.

Diagram showing arrangement of tubes for pure cultures of grass seedlings—see text—here shown connected up for aeration. Reduced.
A = glass jar. *B* = cotton-wool saturated with liquid. *C* = liquid reservoir containing nutritive culture solution, through which air bubbles pass. *D* and *d* = caoutchouc stoppers pierced by glass tubing. *E* = caoutchouc tubing. *F* = seedling with its roots in *B* and its leaves in air. *C* and *g* = arrows showing direction of air current. *x* and *y* = glass tubes.

Experiments in Aerated and in Closed Tubes. Selected and Sterilised Seeds and Clean Seedlings. Infected when one week old. Roots in Knop's Solution.

Expt. No.	Date.	Host.	Origin of spores.	Treatment.	Results.	Period of incubation.	Period of experiment.	Remarks
711	June 19	<i>B. sterilis</i> ...	<i>B. mollis</i>	Aerated continuously	—	—	21 days	
"	"	"	"	" "	+	12 days	"	
"	"	<i>B. mollis</i> ...	"	" "	+	16 "	"	
"	"	"	"	" "	—	"	"	
712	"	<i>B. sterilis</i> ...	"	" "	—	"	"	
"	"	"	"	" "	?	"	"	
"	"	<i>B. mollis</i> ...	"	" "	?	"	"	Flecks developed, but no spores formed.
"	"	"	"	" "	?	"	"	Flecks developed, but no spores formed.
713	"	"	"	Closed tubes ...	+	8 "	"	
"	"	"	"	" "	+	12 "	"	
"	"	<i>B. sterilis</i> ...	"	" "	—	"	"	
"	"	"	"	" "	—	"	"	
"	"	<i>B. velutinus</i> ...	"	" "	+	10 "	"	Very fine growth of sporiferous pustules.
"	"	"	"	" "	—	"	"	
"	"	<i>B. maximus</i>	"	" "	—	"	"	
"	"	<i>B. madritensis</i>	"	" "	—	"	"	
"	"	<i>B. commutatus</i>	"	" "	+	10 "	"	
"	"	<i>B. arvensis</i> ...	"	" "	—	"	"	
"	"	<i>B. secalinus</i> ...	"	" "	+	8 "	"	Very fine pustules.
"	"	<i>B. interruptus</i>	"	" "	+	10 "	"	
"	"	<i>B. racemosus</i> ...	"	" "	+	11 "	"	

seedlings were selected in each case from the same Petri-dish cultures, we must assume that the difference in rate of development was due to the difference of ventilation, and perhaps conclude that this interferes with the success of the parasite, as measured by the somewhat longer incubation period. It is remarkable how dwarfed the continuously aerated plants are, compared with those in closed tubes, owing to the elongation of the leaves of the latter.

It is clear, therefore, that pure cultures of Uredospores can be obtained by this method, and it is equally clear that we can also obtain pure cultures of the host-plants, and since we can do this, there is no reason why the infection of Uredineæ should not be conducted as rigorously and exactly as that of bacteria.

As a matter of fact, Prof. Ward has succeeded in proving that it can, though of course the length of time occupied in a large series of cultures and infections will prove troublesome, and it remains to be seen whether we can get such plants to flower (see Fig. 2).

A number of isolated tube-cultures were made with spores from *B. sterilis*, *B. mollis* and *B. scabrinus*, and arranged similarly, and confirmatory results obtained. Moreover, Prof. Ward was able in several cases to transfer successfully spores from these pure tube-cultures to other tubes of pure cultures of seedlings, and to prove that the spores raised under strictly antiseptic conditions are capable of germination and infection.

At the same time, it was noteworthy that in several cases the antiseptically raised spores were not always successful in infecting the seedlings, and it remains for further investigation to determine whether this was due to the conditions of culture of the fungus or the host, or both.

UNIVERSITY AND EDUCATIONAL INTELLIGENCE.

A DISCUSSION upon the clause of the Education Bill referring to the provision to be made for secondary education took place in the House of Commons on Monday. An amendment was moved to make the clause compulsory instead of optional, the contention being that many local authorities will do nothing for secondary education if the decision as to the needs of their localities is left to them. After discussion, Mr. Balfour consented, as a compromise, to introduce words which, while not making the clause mandatory or throwing upon the Education Department the task of declaring what educational provision should be made in each county, emphasised the fact that the education authorities were expected to supply higher education. The words to which he agreed were:—"The local authorities shall consider the needs of education, and take such steps as may seem desirable, after consultation with the Board of Education, to aid or supply education other than elementary."

THE following teachers have been appointed by the Senate of the University of London, in connection with the grant of 10,000*l.* a year recently voted to the University by the London County Council in aid of the work of the faculties of arts, science, engineering and economics:—Prof. Ramsay, F.R.S., teacher of chemistry, at University College; Prof. Capper, teacher of mechanical engineering, at King's College; Prof. Unwin, F.R.S., teacher of civil and mechanical engineering, at the Central Technical College.

AN anatomical museum, endowed in memory of the late Prof. A. Hughes, was formally opened at the South Wales and Monmouthshire University College on Saturday. Prof. Hughes,

i.e., of course so far as fungi are concerned; the antiseptic treatment adopted does not always exclude harmless bacteria.

who died of enteric fever contracted in South Africa, was the first occupant of the chair of anatomy at the College, and when he left to take a similar position at King's College, London, he gave 350*l.* with which to purchase the nucleus of the anatomical museum. To his memory and in recognition of his special services to medical education in Wales, it was decided to endow the museum permanently, and a fund was opened, towards which 1775*l.* has been subscribed. Of this amount 120*l.* has been set apart for the foundation of an Alfred Hughes medal, to be awarded annually in the subject of anatomy.

A VERY creditable display of pieces of simple scientific apparatus was to be seen in connection with the annual exhibition, at the Examination Hall on the Thames Embankment, of specimens of work by the pupils and teachers in the schools of the London School Board, which was opened on June 13 by Lord Reay, chairman of the Board. Compared with the exhibition of a November last, which was reported in NATURE (No. 1671), a marked improvement has to be recorded. There were three times the number of exhibits, and the general standard of excellence was much higher. Many of the defects of the last exhibition were remedied in that of this year. More attention was given to the different branches of physics, and in place of the three more or less unsatisfactory models representing the teaching of physiography, which were all that we could find last time, ten times as many better pieces of apparatus were included, among which a good model of Foucault's pendulum, an astronomical telescope and a relief map of Sydenham—the last named by a couple of boys of eleven and thirteen years of age—deserve special mention. The chemical section provided abundant evidence of the influence of Prof. Armstrong on the teachers of this subject. It was clear from the exhibits in this department that every effort is being made to develop the child's intelligence by encouraging him to discover facts for himself. Though more attention was given to nature-study than was the case last year, there is still plenty of room for development in this direction. The undesirable plan of mixing up the work of teachers and taught was followed again, but it is to be hoped that the committee of management may be persuaded, before holding another exhibition, of the difficulty experienced by the visitor in knowing, without consulting a bulky catalogue, when an exhibit is the work of a pupil and when that of the instructor. It is impossible in this place to describe the exhibits in detail, but a good Wimshurst machine constructed by a boy of fourteen was an excellent instance of the trouble a youngster will take when once he has been interested in the subject of study.

SCIENTIFIC SERIALS.

American Journal of Science, June.—Fossil faunas and their use in correlating geological formations, by Henry S. Williams. It is shown that the plan usually followed of classifying geological formations in time by means of a comparison of one predominant fossil is wanting in accuracy. Very many single species, the range of which has been established by thorough study of the successive formations in which they occur, range through a third, and often a half, of one of the standard geological systems. A second reason for not resting implicit confidence on this method of correlation is the frequently observed fact that parts of the geological column of different sections, which upon satisfactory stratigraphic grounds are known to be stratigraphically equivalent, contain different fossils.—Studies of the Eocene mammalia in the Marsh collection, Peabody Museum, by J. L. Wortman. The present instalment of this series contains detailed descriptions of *Sinopa rapax* and *Sinopa agilis*.—The transmission of sound through solid walls, by F. L. Tufts. The rigidity of the material was found to be the main factor in determining the intensity of the sound transmitted from the air on one side to the air on the other, the only other factor possessing any influence being the mass.—A new gauge for the measurement of small pressures, by E. W. Morley and C. F. Brush. A description of a form of differential mercury pressure gauge resembling in principle that recently described by Lord Rayleigh. Two modes of reading are given; in the second method a reading can be taken in ten seconds. With suitably mounted instruments pressures may be read with a mean error of not more than a ten-thousandth of a millimetre.—On a hitherto untried form of mounting either equatorial or azimuth, for a telescope of exceptional size, either reflector or refractor, in which telescope, observing floor and dome are combined in one,



FIG. 2.—Pure culture of *Puccinia dispersa* on *Bromus velutinus*. The "seed" of the grass, antiseptically sterilised as regards fungus spores by heating to 65° C., was germinated in the sterile tube and infected on the first leaf with spores developed on *Bromus mollis*. The infection was successful, and pustules of spores have appeared only on the area inoculated.

by D. P. Todd.—On the occurrence of uranophane in Georgia, by T. L. Watson.—The internal structure of cliftonite, by J. M. Davison. The view of Fletcher that this form of crystallised carbon is a pseudomorph after pyrite is not confirmed by these experiments.

Journal of Botany.—The June number opens with notes on Mycetozoa by Mr. Arthur Lister, F.R.S., and Miss G. Lister. Two species are figured and described; of these *Physarum grossum* is allied to *Fuligo septica*, while the other, *Chondrioderma asteroides*, is a new species which was found on pine needles and acacia leaves at La Mortola. In addition, the nomenclature of certain Mycetozoa collected by Dr. Celakovsky in Bohemia is discussed and revised. To the lists of Sussex plants already published by Mr. E. S. Salmon and Mr. Whitwell during the past half year is added another referring mainly to the west Arun district of west Sussex, contributed by Rev. E. S. Marshall. The catalogue of British marine algae compiled by Mr. Batters which began in the March number has now reached the genus *Ectocarpus*.

SOCIETIES AND ACADEMIES.

LONDON.

Royal Society, May 15.—“On Microscopic Effects of Stress on Platinum.” By Thomas Andrews, F.R.S., F.C.S., and Charles Reginald Andrews.

The microscopic effects of stress on platinum do not appear



FIG. 1.—Magnification 100 diameters.

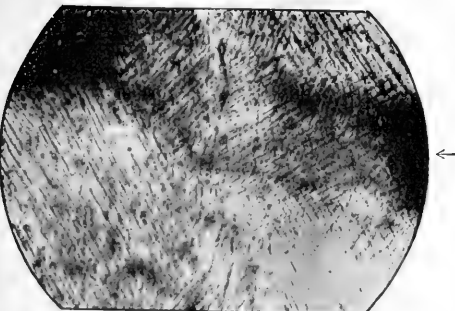

FIG. 2.—Magnification 250 diameters.
Microscopic effects of compressive stress on platinum showing crystalline slip as seen in section.
Arrow indicates direction of compressive force.

to have been studied. An ingot of pure platinum was therefore prepared, and from this a portion was accurately machined in the form of a cube, 0.30 inch square, which was afterwards

carefully microscopically polished and then subjected to compressive stress in the testing machine.

Prior to the application of stress, and for comparative purposes, a polished face of the platinum cube was microscopically examined, but an even polished surface only was observed. A force producing a compression of 10 per cent. on the total height of the cube was then applied, and microscopic observations were taken at high magnifications of the effects of the stress on the microcrystalline structure of the platinum cube.

The polished side of the cube upon which the high-power microscopic examination was made was the one in line, or in parallel, with the direction of the compressive force.

Owing to the varied orientation of the different crystals in the mass of the platinum, the lines of cleavage as indicated by the minute “slip bands,” were often seen at varied angles to the line of the straining force.

The general appearance of the disintegration of the large or primary crystal grains, produced by the pressure, on the pure platinum cube, was the apparent breaking up of the crystalline structure of the metallic mass, as seen in section, roughly diagonally to the line of the compressive force. The area enclosed by the main lines of disruption roughly approximating to the size of the large primary crystal grains.

The distances between the extremely fine lines, or “slip bands,” appeared roughly to coincide proportionately with the size of the secondary or most minute crystals forming the mass, the finer “slip bands” appearing to indicate the crystalline slip which had taken place along the facets of the smaller or secondary crystals. The direction, however, of the main lines of the crystalline disruption did not appear always to coincide with the intercrystalline facet junctions of the large or primary crystal grains. The lines of least resistance, or greatest crystalline slip, seemed chiefly to develop at an approximate angle of about 45 degrees to the pressure line, as previously mentioned; but the line of greatest weakness in the mass structure of the metal was not always at that angle with the line of the disruptive force.

The authors hope that these experiments may prove of use in affording an indication of the comparative behaviour of the noblest metal platinum, with the behaviour of the constructive metals, copper, nickel, iron and steel, when under the influence of stress; and the experiments have also shown that the microscopic influences of stress in the heavy metal platinum are analogous to those which have been observed in metals of lower specific gravity.

June 5.—“Contributions to the Study of Flicker.” Paper ii. By T. C. Porter, M.A., Eton. Communicated by Lord Rayleigh, F.R.S.

This paper is the sequel to that already published in the *Proceedings*, vol. lxiii. It first details various precautions which experiments, carried out since that paper, have shown to be necessary in estimating the rate at which a black disc with a white sector must be rotated in order that the sensation of flicker may just vanish. Results are given which prove that the central portion of the retina is less sensitive to flicker than its outer region. The effect on the flicker of the measured want of blackness in the black sector is also discussed. The most important results of a long series of experiments, in which many observers took part (in order to eliminate as far as possible the personal equation), is to prove that, if n be the number of rotations per second of the disc when flicker just vanishes, the angular magnitude of the white sector being kept constant, but the illumination of the disc being varied, by altering its distance from a measured and constant illuminant, then $n = a + b \log I$, where a is a constant, and b is also a constant for all illuminations between a very feeble one and one under which the disc becomes almost unbearably bright. A full description of the illuminants used and of the measurement of the illuminations caused by them on the disc is given in the paper. At very low illuminations it is proved that the value of b changes with unexpected rapidity, apparently becoming again constant. The bearing of the above equation on the practical value of the flicker photometer, and also the number of kinematograph photographs which must be projected on a screen per second in order to get rid of flicker, is stated.

The second important result is the experimental determination of n , when the illumination of the disc is kept constant, but its apparent brightness is altered by altering the angular magnitude of the white sector. If this last, measured in degrees, is called w , the magnitude of the black sector will be $360 - w$, and if

ϵ and d are constants, then the relation connecting these quantities with n is $n = \epsilon + d \log w (360 - w)$. If the distance of the disc from the illuminant is now varied, so that l varies, the equation connecting all these quantities with n (the number of rotations of the disc per second when flicker just vanishes) is $n = k + k' \log l \cdot \log w (360 - w)$, where k and k' are constants (though it must be remembered that k' has a different value for very feeble illuminations). All these results are clearly exhibited in the paper by numerous interesting curves. It is also shown that the different curves obtained by placing the disc in the different colours of the same spectrum, and varying the angle of the white sector by steps of 10° from 0° to 180° in each colour, can all be obtained by viewing the disc illuminated by white light and simply varying the intensity of the illumination, which proves that n is unaffected by the wave frequency of the different colours and is solely influenced by their intensity.

Finally a curve, showing the relative intensity of the light of different parts of the same spectrum, deduced from the results of the present paper, is given, and proves to be actually coincident, within the errors of experiment (except for the very faint illuminations at the two ends of the visible spectrum) with the curve expressing the same thing given by Vierordt, but obtained by him, as by Abney and others, in an altogether different way.

"The Spectra of Potassium, Rubidium and Cesium, and their Mutual Relations." By Hugh Ramage, B.A., St. John's College, Cambridge. Communicated by Prof. G. D. Living, F.R.S.

Tables of the oxyhydrogen flame spectra of the above three metals are given, which contain a number of lines not hitherto recorded. The lines which form the second subordinate series of cesium and several members of the corresponding series of rubidium are new; so also are some of the lines of the first subordinate and the principal series of both metals. The flame spectra were photographed with a spectrometer fitted with a Rowland plane grating; spark spectra of iron, titanium, &c., were superimposed on the flame spectra to furnish fiducial lines. Some of the lines in the red region of the spectrum were measured by eye observations.

Diagrams of the subordinate series in the spectra were drawn to scales of oscillation frequencies for abscissæ and (1) atomic masses, (2) squares of atomic masses for ordinates. The conclusions deduced in the author's previous paper (*Noy. Soc. Proc.*, vol. lxx. p. 1, 1902) from less complete data were amply confirmed. There is undoubtedly a very close connection between these series and the atomic masses, and the lines which connect the corresponding members of homologous doublets in diagram (2) do intersect on the ordinate of zero atomic mass. The points which bisect the limits towards which the subordinate series converge in each spectrum lie on straight lines in diagram (1). The constants in Kydberg's general formula were then expressed in terms of the atomic masses; the oscillation frequencies of the lines, calculated from the modified formula, are given in the paper, together with the observed numbers. The convergence points of the series were calculated by different methods and the results are given. It would appear from these that the two subordinate series do not converge towards the same limits.

All the strong lines and nearly all the weak lines which have been observed in the flame and arc spectra of these three metals are included in the three harmonic series. The differences between the corresponding series in the spectra appear to depend on the atomic masses alone. Reasons are also given for thinking that the principal and the second subordinate series are more closely related to each other than to the first subordinate series.

Chemical Society, June 5.—Dr. Thorpe, C.B., F.R.S., in the chair.—The action of ungerminated barley diastase on starch, part i., by Dr. J. L. Baker. The hydrolytic products of this action are a new amyloextrin and maltose. The former is slowly converted by the further action of the enzyme into maltose and a small proportion of dextrose. The decomposition of chlorates, part v., potassium chlorates in presence of oxides of manganese and the theory of perchlorate formation, by Mr. W. H. Sodeau. It is shown that, since the amount of chlorine produced by heating potassium chlorate in presence of manganese dioxide is not increased by reduction of pressure, no secondary reaction can occur, and therefore McLeod's theory of permanganate formation is untenable.—Studies in the tetrahydro-naphthalene series, i., the diazo-amino-compounds of α -tetrahydro- β -naphthalene,

by Mr. C. Smith.—Experiments on phosphorus tetroxide, by Mr. C. A. West. When phosphorous oxide, P_2O_5 , is heated at 300° , it decomposes into phosphorus tetroxide and free phosphorus. The former is an extremely stable substance, volatilising only with difficulty at 1400° . Its composition is represented by the formula P_8O_{16} . The decomposition of compounds of selenium and tellurium by moulds and its influence on the biological test for arsenic, by Dr. Rosenheim. Certain moulds, such as *Aspergillus*, *Mucor* and *Penicillium*, decompose tellurium and selenium compounds with the production of a fecal odour which masks the garlic odour given off by these moulds when grown in arsenical solutions.—Constituents of gambier and acacia catechus, by Messrs. A. G. Perkin and E. Yoshitake. The authors have isolated from these sources three closely related substances, distinguished as catechins a , b and c .—The decomposition of oxalacetic hydrazone in aqueous and acid solutions, and a new method of determining the concentration of hydrogen ions in solution, by Messrs. H. O. Jones and O. W. Richardson. When the hydrazone is heated in aqueous solution it decomposes into pyruvic hydrazone and pyrazolone carboxylic acid, the production rate of the former being proportional to the concentration of the original hydrazone, and of the latter to the concentration both of the hydrazone and the hydrogen ions.—The dissociation constants of oxalacetic acid and its hydrazone, by Messrs. H. O. Jones and O. W. Richardson.—Derivatives of butyryl pyruvic acid, by Dr. A. Lapworth and Mr. A. C. O. Hann.—Sulpho-campholenone carboxylic acid, by Mr. A. W. Harvey and Dr. Lapworth.—Some properties of camphorquinonephenylhydrazone, by Dr. A. Lapworth and Mr. A. C. O. Hann. The authors have been unable to obtain the "keto" form of this substance in a pure state, but have obtained evidence of its existence and have studied the rate at which equilibrium between the "keto" and "enol" forms is attained under various conditions.—Optically active esters of β -ketonic and β -aldehydic acids, part i., menthyl hydroxymethylenephylacetate, by Dr. Lapworth and Mr. A. C. O. Hann. The authors propose to investigate these esters in the hope of obtaining an insight into the peculiar tautomeric relations of the acids from which they are derived.—Part ii., menthyl acetate, by Dr. Lapworth and Mr. A. C. O. Hann.—The mechanism of simple desmotic change, by Dr. Lapworth and Mr. A. C. O. Hann. An extension of Brühl's views on the mechanism of tautomeric change.—Trimethylbrazilon, by Dr. W. H. Perkin, jun. An investigation is being made into the constitution of this substance, which is obtained by the oxidation of brazilin.

Entomological Society, June 4.—The Rev. Canon Fowler, president, in the chair.—Mr. H. W. Sheppard-Walwyn exhibited a male specimen of *Lampides batiscus* taken recently emerged at Winchester in September, 1899, and two varieties of *Lycæna icarus*.—Mr. C. P. Pickett exhibited one asymmetrical male and two females of *Dilina titia*, and a series of the same insect showing great variation in colouring and markings, bred during May, 1902.—Mr. F. Merrifield exhibited photographs showing the protective resemblances of the larva and pupa of *Hygrochroa syringaria*.—Prof. E. B. Poulton exhibited a lantern slide showing the perfect protective resemblance of *Hybernia leucophaæaria* to the oak trunk upon which it rested.—Mr. A. Bacot exhibited hybrid larvæ resulting from a pairing between a male *Malacosoma neustria* and a female *M. castrensis*, also larvæ of *M. neustria* and reputed larvæ of *M. franconica* for comparison.—Mr. H. C. Elwes read a paper on the butterflies of Chile, illustrated with many specimens taken during an expedition last winter to that country. The poverty of the Chilean rhopalocerous fauna is notable. Of the insects represented there was probably only one really Chilean Colias, the most numerous family being the Satyridæ, of which some twenty-five species were taken. The Nymphalidæ are few in number, while three native Theclidæ and three Lycaenidæ represent their respective groups. Mr. Elwes drew especial attention to one unique species, *Argyrophorus argenteus*, which flies at 3000 to 7000 feet, the upper-side of all the wings in male and female being unicolorous and brilliant metallic silver, the under-side resembling somewhat that of the Holarctic family (Eneis). A particularly beautiful golden sheen was observable on *Cyclopius pulmaea*, a species of Hesperid, but on the ground of protective coloration there seemed nothing in the surroundings of either insect to account for the peculiarity. Between alpine and lowland species there was no distinction,

although the season on the coast would be over when that upon the high mountains commenced.—Mr. S. L. Hinde read a paper, illustrated by lantern slides, upon the protective resemblance to flowers borne by an African Homopterous insect, *Flata nigrocineta*, Walker. He said that "the cluster of insects grouped to resemble a flower spike," which forms the frontispiece of Prof. J. W. Gregory's "Great Rift Valley," had attracted some criticism, and that as he was familiar with the insect figured, and with its larva, in a wild state, it seemed desirable to publish the evidence. In the plate the insects are collected on the vertical stem, the green individuals uppermost considerably smaller than the red ones beneath, like the unopened green buds towards the top of a flowering spike as compared with the expanded blossoms below. The separate representations of the green and red forms, however, indicate no difference in size, and experience confirms this conclusion, so that the impression conveyed by the frontispiece plate is erroneous. After further noting that the uniform deep pink colour of the exposed parts of the insects figured was also incorrect, Mr. Hinde remarked that he had never seen the insects grouped according to their colours, but invariably mixed, that he had never found larvae and imagines on the same stem or even together on the same tree or bush, nor did the imagines affect vertical stems, but always those actually or approximately horizontal. Sir George Hampson said the insects figured were orange when brought home, and the pink-winged imago was an error of the colorist.

Mineralogical Society, June 10.—Dr. Hugo Müller, president, in the chair.—Dr. A. Hutchinson gave an account of the experiments he had made in order to discover the cause of the discrepancy in the results obtained by Meigen and Panebianco in the application of Meigen's method of discriminating calcite and aragonite. He found that calcite, when treated with a boiling dilute solution of cobalt nitrate, only remains white or becomes yellow (as stated by Meigen) when the cobalt nitrate contains traces of iron, and that Panebianco's lavender-colour is only obtained when the cobalt nitrate is free from iron.—Mr. G. F. Herbert Smith discussed some crystals of krennerite from Nagyag on which he found a large number of forms not previously recorded. He further exhibited the new three-circle goniometer recently constructed from his designs by Messrs. Troughton and Simms for the British Museum. He pointed out the advantages of the gnomonic projection in crystallography, and showed a table which he had prepared to facilitate the employment of this method of projection.—Mr. C. T. Prior exhibited specimens and described the mineral constituents of the volcanic dust which fell in Barbados on May 7 and 8 after the eruption of the Soufrière of St. Vincent. The fact that the constituents are like those of a hypersthene-apatite-andesite connects the eruptions with the Pacific rather than with the Atlantic volcanic chain.—Mr. L. J. Spencer pointed out reasons for the non-existence of "kalgoorlie" and "coolgardite" as mineral species. At Kalgoorlie, in Western Australia, with the tellurides of gold and silver, sylvanite ((Au,Ag)Te₂), calaverite ((Au,Ag)Te₂), and petzite ((Ag,Au)₂Te₃), is frequently associated the telluride of mercury, coloradoite. The iron-black petzite and coloradoite are identical in external appearance, and sometimes occur intimately associated together. In such cases minute fragments detached from an apparently homogeneous mass are found on blow-pipe analysis to be sometimes coloradoite and sometimes petzite. Analysis of larger pieces would therefore show the presence of tellurium, gold, silver and mercury in variable proportions, as is actually the case in the analysis of "kalgoorlie" and "coolgardite" described as new mineral species by Pittman in 1897 and by Carnot in 1901 respectively. Neither of these investigators appears to have been aware of the occurrence of coloradoite at Kalgoorlie, and the materials they analysed were without doubt mechanical mixtures of coloradoite and the above-mentioned tellurides of gold and silver, especially petzite.—Mr. R. H. Solly described the crystallographic characters of liveingite, a new sulph-arsenite of lead (5Pb₂S₄As₂S₂) found by him in the *Proc. Cambridge Phil. Soc.*, 1901, xi, p. 239. Measurements of three good crystals more recently obtained, showed that the system was orthorhombic, and that 100, 110 = 44° 49'; 010, 011 = 46° 48'; 001, 101 = 43° 23'. In the prism zone the faces (210), (430), (540), and in the macrodome zone the faces (302), (504), (908), (101) are well developed, and (100)

is a cleavage plane. A pyramid zone with numerous small faces is also present. The crystals often exhibit a polysynthetic growth parallel to (100). In appearance they resemble rathite.

Mathematical Society, June 12.—Dr. E. W. Hobson, president, in the chair.—The president announced that the council had awarded the De Morgan medal, 1902, to Prof. A. G. Greenhill.—Prof. Love communicated a paper by Prof. Conway on Huygens's principle in a uniaxial crystal. It is shown that, when electric waves are propagated in a crystalline medium with an axis of symmetry, the radiation is resolvable into constituents (1) with electric force at right angles to the axis, (2) with magnetic force at right angles to the axis, (3) with both forces at right angles to the axis. The types of radiation that are due to electric and magnetic doublets with their axes parallel and perpendicular to the axis of symmetry are determined, and it is shown that the radiation received at any point can be regarded as made up of secondary waves due to such doublets distributed upon an arbitrary surface separating the point from the actual sources of the radiation.—Lieut.-Colonel Cunningham gave an account of some investigations on repetition of the sum-factor operation. The result of the repetition of the operation upon a number is very frequently unity when the operation is repeated sufficiently often; in the case of one small class of numbers the result is a perfect number; in another small class, a pair of amicable numbers; in a third small class, the result may increase beyond the power of practical calculation.—The following papers were communicated from the chair:—M. E. Picard, Sur un théorème fondamental dans la théorie des équations différentielles. This note deals with the question of the possibility of the existence of a non-holomorphic integral, which, besides satisfying a given ordinary differential equation, also satisfies a special condition at a certain point.—Mr. G. H. Hardy, some arithmetical theorems. Cauchy's theory of residues is used to obtain various relations between sums of terms of the form $\left(\frac{a^b}{a}\right)$, in which a and b are fixed integers, and

σ is an integer which ranges over a certain set of values, the summation is taken with respect to σ , and (x) denotes the algebraic difference between x and the absolutely nearest integer.—Prof. M. J. M. Hill, on a geometrical proposition connected with the continuation of power series. A power series with a circle of convergence C_1 having been derived from a given power series with a circle of convergence C_0 , it is possible to choose successive positions of a point x , so that every point of the region that is common to C_0 and C_1 shall be within one at least of the circles described with x as centre to touch C_0 and C_1 internally.—Mr. J. H. Grace, on types of perpetuants. The numbers of perpetuants of one or more forms have been determined by Stroh and MacMahon, and the latter has accounted for each perpetuant by a corresponding umbral form. In the present paper the perpetuants of any number of forms are found by the direct reduction of Aronhold's symbolical forms.

Royal Meteorological Society, June 18.—Mr. R. Inwards, vice-president, in the chair.—Mr. F. C. Bayard read a paper on English climatology, 1891–1900, which is a discussion of the climatological data printed in the "Meteorological Record." In 1874, the Royal Meteorological Society commenced the organisation of a series of stations at which the observations are made twice a day on a uniform plan, so that the results may be strictly comparable with each other. In addition to these the Society in 1880 organised another class of stations, termed "climatological," at which the observations are made once a day, viz. at 9 a.m. Mr. Bayard on a former occasion worked up the results from these climatological stations for the ten years 1881–90, and in the present paper he gives the averages from sixty-nine stations for the ten years 1891–1900. The elements dealt with are temperature, relative humidity, amount of cloud, rainfall and rainy days, and the results are a valuable contribution to the climatology of the British Isles.—A paper by Mr. W. L. Dallas on earth temperature observations recorded in Upper India was also read, in which the author discussed the observations made on the temperature of the soil at three stations, viz. Lahore, the capital of the Punjab; Dehra Dun, in the north-west of the North-Western Provinces; and Jaipur, the capital of the native State of that name. The observations, which were made at depths varying from 4 inches to 4½ feet below the surface, extended from 1884 to 1899.

PARIS.

Academy of Sciences, June 16.—M. Bouquet de la Grye in the chair.—On anomalous dispersion in correlation with the absorbing power of bodies for radiations of a determined period, by M. J. Bousinesq.—Arsenic as a normal constituent of animals, and its localisation especially in their ectodermic organs, by M. Armand Gautier. Remarks on a note of M. Gabriel Bertrand, and replies to the criticisms of Hödmoser, Cerny and Zienke. The author points out that his positive results for certain parts of the body were always accompanied by parallel experiments with the same reagents upon other portions of the body in which negative results were obtained. The fact that under proper conditions arsenic is only normally found in the skin, nails, thymus and thyroid gland is of the highest importance in toxicological researches. Stress is laid upon the attention to detail necessary to secure trustworthy results.—Dissociation of the elements of the energy expenditure of motors employed in overcoming frictional resistances, by M. A. Chauveau.—On the mode of multiplication of *Trypanosoma* in fishes, by MM. A. Laveran and F. Mesnil. *Trypanosoma Kenabi* and *Trypanoplasma Borreli* both multiply by binary division similarly to *Tr. Brucei* previously described. A fish carrying these parasites can easily inoculate another of the same species. The parasites do not appear to have any pathogenic action on the fish.—On a hypothesis concerning the origin of satellites, by M. L. Picart. A consideration of the question as to the possibility of small planets or comets being converted into satellites of a larger planet. None of the satellites of the known planets correspond to the conditions necessary for this view.—On certain couples of applicable surfaces, by M. Maurice Fouché.—On the integration of differential systems which are completely integrable, by M. E. Cartan.—On the displacement and disturbance of equilibrium, by M. Jouget.—The electric discharge in flame, by M. Jules Semenov.—On the electrostatic effects of a magnetic variation, by M. V. Crémieu. In reply to the criticisms of M. Carvallo, the author describes the latest form of apparatus used by him. Although, according to the Maxwell theory, the effects produced should have been quite appreciable, the results have been uniformly negative. The conclusions arrived at in the earlier work of the author on the non-existence of electric forces created in dielectrics by magnetic variations are completely confirmed by the later work.—On a magnetic disturbance observed at Athens on May 8, by M. D. Egnitins. The magnetic disturbance coincided with the eruption of Mont Pelée. From the fact that the seismograph showed absolutely no disturbance, and that a similar phenomenon was simultaneously observed at Paris, it is concluded that the disturbance must have been of a magnetic or electric nature.—The polymerisation and heat of formation of oxide of zinc, by M. de Forcrand. On ignition, zinc oxide undergoes a change into a polymeric modification with the evolution of heat.—Combinations of hydrogen sulphide with anhydrous aluminium chloride, by M. E. Baud. By the action of liquid sulphuretted hydrogen upon anhydrous chloride of aluminium, two compounds are formed, one, $Al_2Cl_6 \cdot H_2S$, stable at the ordinary temperature, the other, $Al_2Cl_6 \cdot 2H_2S$, dissociable at about $-45^\circ C$.—On the alloys of cadmium and magnesium, by M. O. Boudouard. Two definite alloys of these two metals have been isolated, CdMg and CdMg₂. The study of the fusibility curves pointed to the existence of a third, CdMg₃, but this could not be definitely isolated.—On the existence of arsenic in the organism, by M. Gabriel Bertrand. The author has elaborated the method of M. Gautier for the determination of minute quantities of arsenic in organic material, and is able to detect with certainty as little as 1/1000th of a milligram. The results of M. Gautier are generally confirmed. A point of especial interest was the proof of arsenic in the thyroid glands of *Phoca barbata*, captured near Spitzbergen, a case to which the theory of industrial contamination could not possibly be applied.—On isomerism in the benzylidene-methones and on the preparation of an α -methyl- α -isopropylalidic acid identical with dihydrocamphoric acid, by M. G. Martine. The identity of the acid obtained by the oxidation of benzylidene-menthone with potassium permanganate with the dihydrocamphoric acid of Crossley and Perkin has been completely proved.—Pyromucic and isopyromucic acids. The action of phosphoryl chloride and phosphorus pentachloride, by M. G. Chavanne. Isopyromucic

acid differs from the isomeric pyromucic acid in not being a true acid, and is apparently a phenol.—On a new glucoside, aucubine, extracted from the seeds of *Aucuba japonica*, by MM. Em. Bourquelot and H. Hérissey. The new glucoside occurs in the seeds mixed with a large quantity of cane sugar, from which it can be separated by fermentation of the sugar by yeast. Dextrose is one of the products of hydrolysis of the glucoside.—On the production of glycose by the muscles, by MM. Cadéac and Maignon. The muscles resemble the liver in producing sugar after death, the amount produced being a function of the temperature to which the muscle is exposed. This action is in no way connected with putrefaction.—On the hæmolytic action of cobra poison, by M. A. Calmette.—Permanent contraction in the pigoon, by M. Louis Boutan.—On the aerobic fermentation of manure, by M. C. Dupont. The aerobic fermentation of farm manure is due to two bacteria, *Bacillus mesentericus ruber* and *Bacillus thermophilus Grignoni*; these bacteria burn the nitrogenous materials, sugars, starches and gums.—On the internal morphology of the genus *Thylacoplectus*, a parasite of the Alpheidae, by M. H. Coutière.—On the impressions produced under the influence of certain gases, by M. A. J. J. Vandeveldt. The author has produced images similar to those described by MM. Vignon and Colson, making use for this purpose of hydrogen sulphide, ammonia, hydrochloric acid and iodine.—On the subterranean river of Trépaill, Marne, by M. E. A. Martel.—Physiological photometry, by M. G. M. Stanoieitch.—A new method of measuring muscular sensibility, by MM. Toulouse and Vaschide.—On a vertical series of densities of sea water of the Mediterranean, by M. J. Thoulet.

CONTENTS.

	PAGE
Biblical Criticism at its Best and Worst	193
The Foraminifera. By J. J. L.	196
Unorganised Ferments. By Dr. F. Mollwo Perkin	197
Our Book Shelf :—	
Wislicenus: "Astronomischer Jahresbericht." —	
Dr. W. J. S. Lockyer	198
Mackenzie: "Elements of Metaphysics."—A. E. T.	198
Zeuthen: "Histoire des Mathématiques dans l'Anti-	
quité et le Moyen Age."—M.	199
"A la Conquête du Ciel! Contributions Astro-	
nomiques de F. C. de Nascius, en Quinze Livres"	199
Letters to the Editor:—	
Mr. Marconi's Results in Day and Night Wireless	
Telegraphy.—Prof. J. Joly, F.R.S.	199
Remarkable Sunsets at Madeira.—F. W. T. Krohn	199
The Institution of Electrical Engineers' Deputa-	
tion on Electrical Legislation	199
Report on the Teaching of Geometry. By C. G.	201
Seismic Frequency in Japan. By Prof. J. Milne,	
F.R.S.	202
The West Indian Volcanic Eruptions	203
The Royal Society Soiree	204
Notes	205
Our Astronomical Column :—	
Astronomical Occurrences in July	208
The Annus Bredikhine Astronomical Prize	208
Occultation of W Leonis	208
A Remarkable Bolidé Observed at Lyons on March 19	208
Notation of Variable Stars	208
Study of Bright Points and Curves. (Illustrated)	208
Variation—Germinal and Environmental. By	
F. A. D.	209
Rust-Fungus. (Illustrated)	210
University and Educational Intelligence	212
Scientific Serials	212
Societies and Academies. (Illustrated)	213

THURSDAY, JULY 3, 1902.

THE NEW INTERNATIONAL CATALOGUE.

The International Catalogue of Scientific Literature.
M. Botany, part i. (Published for the International Council by the Royal Society of London, 1902.)

WHEN the idea of a complete index of scientific literature was first seriously put forward, it was thought by not a few persons that the magnitude of the task would prove of so overwhelming a nature that its promoters seemed to be courting almost certain failure.

The older "Catalogue of Scientific Papers" published by the Royal Society, although of considerable value, cannot in any sense be called a complete record of the hordes of papers which were pouring forth in ever-increasing volume from the pens of useful and useless writers alike. Moreover, the publication of this catalogue has been in abeyance since 1883.

It is obvious to anyone reflecting on the matter that it was no longer possible for any single scientific society, unless extraordinary funds were placed at its disposal, adequately to continue the work. For apart from the cost of actual production, the catalogue itself, unless rapidly brought up to date by the publication of complete bibliographies at short intervals, must inevitably lose much of its value to those actively engaged in work. And thus on grounds of convenience and utility, as well as of policy, it was decided that endeavours should be made to place the undertaking on an international basis. A considerable number of leading foreign societies and individuals were approached with the view of ascertaining the possibility of evolving a satisfactory scheme which should at the same time be a practicable one. On the whole the replies were so favourable that it became a plain duty to push forward an enterprise from which, if successful, would accrue results of inestimable value to science and hence of immense importance to the world at large.

A conference was held in London during the summer of 1896, and it was attended by representatives of more than twenty different countries. At that meeting the preliminary steps were taken towards the inauguration of a catalogue of which the volume before us comes as the first instalment. A committee of the Royal Society appointed to investigate the working details of the scheme reported to a second representative conference in the autumn of 1898, and at this meeting the general lines on which the work was to proceed were drawn up. A subsequent international conference was held in 1900 to consider the more detailed schemes which had been drafted as the coordinated results of very extensive inquiries and investigations by the Royal Society. Furthermore, inasmuch as in a costly undertaking of this nature financial as well as other kinds of cooperation forms an essential factor of success, this aspect of the matter also received the full consideration of the delegates, and a satisfactory conclusion was arrived at.

As a result of the deliberations, the Royal Society agreed to act as the publishers of the catalogue and to advance the initial capital required, on the understanding that the latter be repaid during the ensuing five

years. The ultimate control of the whole undertaking is vested in an international council, a convention of which is to be held in London in 1905 and thenceforth at ten-yearly intervals. It has been also agreed, and very wisely, that the scheme of the catalogue as now finally approved is to be given a fair trial of at least five years' duration before any serious modification may be introduced.

The first convention was held in December 1900, when it was resolved that the work should begin forthwith and that the contents of the catalogue should be compiled as from January 1, 1901. It is, however, satisfactory to know that the gap existing between the catalogue of 1800-1883 and that of 1901 now incepted is about to be filled up, and that a list of papers published during this interval, together with a subject-index for the whole period, is in actual course of preparation.

Much of what has here been said will doubtless be already familiar to many readers of NATURE. But only those who have watched the untiring activity of the leaders of this enterprise who have thereby succeeded in doing so much for the organisation of science, can at all adequately estimate the continuous strain and effort required to cause it to take a tangible shape.

As at present determined, the main branches of science are treated separately and are arranged under seventeen heads, each being indicated by a letter of the alphabet. The further ramifications of each branch are grouped according to authors and subjects. The classification of the latter (printed in English, French, German and Italian) is based on convenient subdivisions of the particular science concerned, and the respective headings are denoted, for purposes of index and cross-reference, by numbers. The final units are also arranged in alphabetical order.

The first volume of the catalogue which has just made its appearance deals with the literature of botany, and it is stated to be a first instalment of the entire volume due for the year 1901, and it is promised that a second part shall be forthcoming in the near future. As soon as the difficulties inseparable from the commencement of such a work have been overcome, it is intended that an entire volume shall be published in each year. We venture to think that it might have been well to have waited in the present instance until the volume could have been completed, or else that part i. should have been confined to the literature of a stated portion of the year.

The appearance on the title-page of Mr. Daydon Jackson's name is of itself a guarantee as to the care with which the compilation has been effected. The slips actually detected are few, but we confess that we have not been able to ascertain on what principle some of the omissions are to be accounted for. Thus, to take the case of the *Annals of Botany*, there appeared in the June and September issues two papers, both by M. C. Ferguson, dealing with the reproduction processes in pines, and yet, so far as we can discover, only the second one is quoted. We have also noted other omissions from the *Annals*, to confine ourselves to the case of one periodical alone.

Nevertheless, making due allowance for anomalies which experience will soon correct, the volume deserves

the highest praise, for it possesses in a large degree just those qualities that one specially seeks in a work of this nature—qualities that will render it an indispensable addition to the library of every serious student of botany. Papers that have appeared in comparatively inaccessible or little-known periodicals are duly recorded in their places, whilst owing to the clearness of the main subdivisions and the excellence of the system of cross-reference, it is usually easy to search out all the literature cognate to any given subject.

The translation of titles originally printed in unfamiliar languages is a useful feature that this volume will share with those dealing with other branches of science.

Another character of special utility lies in the enumeration, under their appropriate subject-headings, of the new genera and species that have been published during the period covered by the volume. It is sincerely to be hoped that it will always be found practicable to continue to give such *complete* lists, although their preparation must necessarily involve no small amount of labour.

It remains to be said that the typographical arrangements are clear and good, and the few printer's errors on which we have lighted are so trifling as to be almost negligible. Those who have been concerned in its production are to be congratulated on the appearance of this, the first instalment of a great work the value and importance of which it would be impossible to overrate.

J. B. FARMER.

THE GEOMETRY OF COG-WHEELS.

La Costruzione degli Ingranaggi. By Prof. D. Tessari. Pp. xvi + 226; with eight lithographed plates. (Turin: Fratelli Bocca, 1902.)

THE study of the proper forms to assign to the teeth of cog-wheels in order that they may run smoothly affords such simple and useful illustrations of the principles of geometry of roulettes that it seems a pity that few mathematical students have time to interest themselves in the matter. In regard to the assertion of certain empiricists that even if the teeth are not constructed on mathematical principles they will adjust themselves in the course of wear, it is pointed out that an immense amount of power will be wasted in wearing the wheels down, and instead of the teeth becoming adjusted they will run loose.

Whatever form is assigned to the profile of the teeth of one wheel, it is possible to construct a suitable profile for the teeth of the second wheel, and the two profiles are said to be *conjugate*. The condition that two profiles may be conjugate is that they must both be roulettes traced by the same rolling curve on the so-called "primitive" circles of the two wheels. If, however, a number of wheels are to be mutually interchangeable, the profiles of any two must be conjugate, and it is necessary that the generating rolling curve or "epicycle" should be the same for every wheel, and the most convenient form is the so-called epi-hypocycloidal form, in which the portion of the profile outside the primitive circle is an epicycloid and that inside the primitive circle a hypocycloid.

An inferior limit to the number of teeth is determined by the condition that contact between one pair must not cease until contact has taken place between the succeeding

pair, and for smooth running it is further desirable for at least two pairs of teeth to be simultaneously in contact. To make the number of teeth a minimum, it is necessary to make the generating "epicycle" as large as possible, in which case the hypocycloidal form becomes a straight line; and it is shown by a diagram that the minimum number of teeth possible is nine for a pair of equal wheels, or six for a rack and pinion arrangement.

Now if the teeth are cut radially down to the base, the narrowness of the base is a source of weakness, especially when the number of teeth is small and their height consequently considerable; moreover, wheels of different sizes constructed in this way are not interchangeable. For such reasons as these another form is frequently adopted in which the profile is an involute of a circle, which is in this case of smaller radius than the primitive circle and is called the "base circle."

We are next introduced to another form of gearing, in which the teeth of one wheel are replaced by circular cylindrical spindles, an arrangement which, by the way, was some years ago tried in the gearing of tricycles for the purpose of reducing friction, and is still illustrated by chain wheels. In this case the conjugate profile is a curve parallel to an epicycloid, or in the case of interior cogs, a parallel to a hypocycloid. A particular case is that in which the ratio of angular velocities is as 1 to 2, when the spindles on the smaller wheel may be reduced to three or even two in number, and these work in rectilinear slots, an arrangement familiar in connection with the so-called "oval chuck" and the "trammel" methods for describing ellipses.

Hitherto the teeth considered have been of cylindrical form, with axes parallel to those of the wheels. We are now led to consider wheels with spiral teeth, an arrangement due originally to Hooke and White, and which is well illustrated by the diagonal rack and pinion coarse adjustment of the modern microscope. This arrangement has been supposed by some writers to eliminate nearly or quite all friction. Prof. Tessari, however, considers that this view is due to an erroneous opinion as to the nature of the contact existing between the surfaces, and, moreover, that further investigation from an experimental standpoint is desirable on the subject of whether any saving of friction is effected by helicoidal cogs as against cylindrical ones. Here is an important subject for researches which might well be carried out in a modern laboratory of experimental mechanics.

In the eighth chapter a new subject is introduced, namely, gears for converting uniform into variable angular velocity, and the first point is the determination of the primitive lines of wheels adapted for the required purpose. In other words, we have to find the form of two perfectly rough curves which by rolling on each other about parallel axes will effect the required transformation. If we assume that the angular coordinates of the two wheels are θ and θ' , and h is the distance apart of the axes, the polar equations of the primitive lines for any given relation between θ and θ' are determined from the equations $r + r' = h$ and $r\theta = r'd\theta'$. Among the possible arrangements we note a pair of ellipses rotating about their foci, and combinations of elliptic, parabolic or hyperbolic arcs, also arcs of equiangular spirals; many of these arrangements are illustrated by elegant

diagrams. The arrangement here called the "Maltese cross," in which the driving wheel moves the following wheel through a given angle once in every revolution, is interesting in connection with machines for counting revolutions. When a pair of conjugate primitive curves have been constructed, the form of the teeth is determined by the condition that in order to be conjugate they must be roulettes traced on the primitives by the same rolling curve.

From wheels rotating about parallel axes, Prof. Tessari passes on to bevelled cog-wheels, giving both uniform and variable ratios of velocities, and finally to the case where the shafts of the driving and following wheels are neither parallel nor concurrent, but are disposed in any positions in space. A simple application is the well-known modification in which the cogs on the driving shaft are replaced by a spiral thread.

While the present work contains no difficult mathematical formulæ, it places the theory of cog-wheels on a perfectly rigorous and logical basis, and the exposition appears remarkably simple and lucid. There are two lessons to be learnt from the perusal of such a book by those who will learn them. The "practical man" has to learn that a study of the why and wherefore of such matters as the shape of cog-wheels is not very difficult, and will help him a great deal more than merely learning up empirical rules. The mathematician, on the other hand, should see that if he will only make his knowledge of the geometry of conics, equiangular spirals, epicycloids and other curves sufficiently accessible to the practical man he will be doing good work, and by such means as this he may succeed in stimulating a much greater demand for his abilities than exists at present. Here we have a subject for the proper understanding of which a connected knowledge of certain geometrical facts is indispensable. But the average mathematician is somewhat apt to discourage the learner from acquiring a mere connected knowledge of facts; in the early stages by the importance he attaches to the performance of what we may call the scales and five-finger exercises of mathematics, and in the later stages by the stress he lays on the solution in the examination room of questions the meaning of which is often difficult even for a skilled mathematician to interpret when reading the paper at his leisure. Consequently, when the student of applied mechanics wants to learn about epicycloids and hypocycloids for the purposes of better understanding such a book as the present, there is great fear that he may not, as he certainly ought, employ the services of the mathematician.

G. H. B.

EVOLUTION AND DESIGN.

The Lesson of Evolution. By Frederick Wollaston Hutton, F.R.S., Curator of the Museum, Christchurch, New Zealand. Pp. 100. (London: Duckworth and Co., 1902.) Price 2s.

OF the two essays composing this little book, the first formed the inaugural address to the Australian Association for the Advancement of Science at the Hobart meeting in January, 1902. Part of the second essay formed the presidential address to the Geological Section of the same Association at the Sydney meeting

in 1898, while the second part of this essay, dealing with "Later Life on the Earth," has been written for the present work. The second essay may be at once dismissed with the remark that it is a tolerably well-digested statement of the facts of biological evolution as revealed by palæontological succession. The first essay, which embodies the "lesson" which the author desires to impress upon a wider public than the audience assembled to hear the address at Hobart, is the one which claims the most critical attention, because the author most unhesitatingly and boldly declares that he has discovered the aim and object of evolution—that the purpose for which this process was designed and set going on this earth is "the development of man's moral nature."

In order to appreciate Captain Hutton's position, it may be as well to state at once that he is a thorough evolutionist. He begins from the very beginning of the process, and devotes some pages to the subject of inorganic evolution, in the course of which he advocates the meteoritic origin of the solar and other systems as expounded by Lockyer and supported by Prof. G. H. Darwin. The motive powers of evolution are gravitation (Newton), the dissipation of energy (Kelvin), and selection (Darwin). But granting all this and accepting to the full extent the teachings of modern science so far as concerns the mechanism of the process, there has hitherto been no attempt outside the theistic pulpit to introduce the doctrine of special design into the philosophy of evolution to the same intimate degree that is attempted in the present work. It is not going too far to say that we have here the ancient teleology, which Huxley used to declare had been killed by the establishment of the doctrine of evolution, revived and amended in terms of evolution. The author's views are anthropocentric in the extreme. Not only is the development of man's moral nature the goal towards which evolution is directed, but every step in the process has been regulated so as to lead to this end. Thus with respect to the distribution of the metals:—

"Also if man was ever to become civilised, gold, copper and other metals in accessible positions were necessary, although they are of no use in the economy of animals and plants. Gold, however, would be almost useless to man if it was abundant, while iron would be equally useless if it was as rare as gold. But we know that these, as well as the other substances, exist in their right proportions" (pp. 24-25).

"We have therefore in the composition, size and position of the earth overwhelming evidence of design. And as we can prove that carbon existed in the Archæan era before life appeared, and that gold, iron and copper existed long before man, we must also allow that the results of evolution had been foreseen and provided for" (p. 27).

If we ask further why this admirable distribution of the metals has been necessitated, we find in a note (p. 25) that it is because gold is the most suitable metal for coinage, copper and iron for weapons. It would perhaps be unkind to inquire further why, after the right proportions had been provided for, the subsequent distribution of one of these metals had been left to take care of itself, as judged by the extraordinary disparity in the quantities possessed by individual members of that most highly civilised human community for which the original

distribution was planned! Also it is rather a matter of surprise that the author should not have made use of the opportunity of pointing out how the sponges and organisms of the Cretaceous seas had been endowed with the power of accumulating silica so that when man was evolved he might find flints ready to hand for the purpose of making his weapons. This suggestion is offered for a future edition.

Speaking frankly, and with all respect for Captain Hutton's beliefs and his perfectly honest and straightforward attempt to square them with the teachings of the modern doctrine of evolution, we cannot admit that the new teleology as thus presented is in any way preferable to the old teleology of the Bridgewater Treatise school. It leads us by a very circuitous track into precisely the same *cul de sac* into which the authors of those famous volumes led us. The argument in favour of design, for example, as drawn from the distribution of the metals, is very suggestive of the well-known story of the providential location of towns so as always to be on the banks of rivers!

In order to avoid misapprehension, let it be stated here that the author's position *may be* perfectly sound. There is nothing in the doctrine of evolution in the abstract which antecedently excludes the possibility of the whole process being the result of design. In calling attention to this point the present work may be regarded as useful. But there is much more of faith than of reasoning in the pages before us, and where belief is substituted for scientific argument—as is the case, for example, in the treatment of the immortality of the "spiritual" part of man (p. 45)—we are afraid that Captain Hutton's address will fall flat upon the world of science. The work which shall bring the doctrine of evolution into absolute harmony with the theory of design in nature has yet to be written.

R. MELDOLA.

A NEW TEXT-BOOK OF PHYSICAL CHEMISTRY.

The Elements of Physical Chemistry. By Harry C. Jones. Pp. xi + 565. (New York: The Macmillan Company; London: Macmillan and Co., Ltd., 1902.) Price 17s. net.

THIS very readable book differs in many respects from recent text-books treating of physical chemistry; it resembles more closely a modern version of Lothar Meyer's treatise, but contains, at the same time, the more recent views, the introduction of which dates from van 't Hoff's memorable paper in 1887. It is non-mathematical; indeed, the treatment of the subject might have often been more methodical and clear if symbols had been more freely employed.

Beginning with Dalton's laws, Avogadro's hypothesis, and Dulong and Petit's law, methods of determining atomic and molecular weights are briefly described; too briefly, indeed, unless the student studies the original memoirs, to which copious reference is made in the footnotes. A general sketch of the periodic arrangement of the elements follows, and some pages are devoted to J. J. Thomson's, to Lord Kelvin's and to Clerk Maxwell's deductions regarding the magnitude and structure

of molecules. The normal gas-laws are next treated of, with the deviations, explicable on the theory of dissociation. After some pages on the kinetic theory of gases, their specific heats are dealt with. Passing on to the spectra of gases, a sketch of Balmer's law is given, and, as usual, reference to some of the most recent literature is appended in the foot-notes.

The liquefaction of gases forms the next section, but here some of the facts stated are incorrect; they will doubtless be rectified in a second edition. This gives a natural transition to van der Waals's theory, and the well-known form of the Andrews diagram suggested by the late Prof. James Thomson is reproduced. It is a pity that this diagram, which shows curves greatly differing in form from those calculable by van der Waals's equation, or from those representing deductions from direct measurement, should have ingrained itself in all text-books.

Kopp's classical researches on the boiling points of liquids are next considered; but Walker's later researches, in which the boiling points of the members of certain homologous series are connected by a simple expression, find no mention. Again, while Rowland's results bearing on the specific heat of water at different temperatures are alluded to, those of Griffiths are omitted.

The next section is devoted to the refractive indices of liquids and their rotatory powers. But here the matter is too condensed; in many cases the important points are merely touched, and a beginner would find it difficult, without much fuller explanation, to form correct views regarding the subjects treated.

The same fault must be found with Prof. Jones's synopsis of Kopp's work on molecular volumes; it is really impossible in a single page to give any idea of the nature of the problem to be attacked, the method of attacking it, and the results obtained. On the other hand, methods of determining molecular weights of liquids by their capillary rise receive five pages, although here, too, the arrangement of matter might have been improved.

In all, 165 pages are devoted to what may be termed the older aspects of physical chemistry, and the rest of the book, comprising 383 pages, deals with the more modern developments of the subject, solutions, thermochemistry, electrochemistry, photochemistry, and finally chemical dynamics and equilibrium.

There are a good many inaccuracies in the work; it would have been considerably improved by careful revision. For example, on p. 223, where a proof is given of the relation between osmotic pressure and lowering of freezing point, the symbol M stands for both molecular weight of solvent and of dissolved substance, and β has two meanings—percentage composition and pressure. Such oversights are very apt to confuse the mind of a beginner.

The writer's style is, on the whole, clear; but throughout the work there are careless expressions. For example, "heat is either evolved or consumed." Such *lapsus calami* will doubtless, however, be corrected in subsequent editions.

The reviewer's verdict is that the author has, on the whole, given a fairly comprehensive and reasonably exact sketch of the modern aspects of physical chemistry in a

comparatively small number of pages. The book gives a better bird's-eye view of the whole subject than most recent works, and it has the great advantage that copious references make it possible for the student to consult the literature of the subject and supplement from original sources any lacunæ in Prof. Jones's presentation of facts and theories.

W. R.

OUR BOOK SHELF.

Other Worlds. By Garrett P. Serviss. Pp. xv + 282. (London: Hirschfeld Bros., Ltd., 1902.) Price 6s. net.

WHO amongst us has not, at some time or other, considered the question of the possibility or probability of the habitability of the planets that pass across the face of our sky, and wondered whether any of these worlds is an "earth" with all her attendant phenomena? A very excellent account of our neighbours from this point of view will be found in the book before us, which, although it hails from the other side of the Atlantic, yet will nevertheless be welcomed, as it comes from the land where the most recent and very valuable work on the observations of the surface markings of the planets has been done. As has often been pointed out, it is not the large telescope that is necessary for planetary observation, but clear and still air, a comparatively small telescope, and an intelligent eye. In Arequipa the Americans have such a condition of atmosphere, and it is there that important observations of some of the planets have been made.

In the present volume the author gives the reader a very clear insight into the present condition, so far as can be gathered from observation, of each of the planets, and the information is conveyed in such an enticing manner that the book should be interesting reading to everyone. Besides being accurate, the contents are well up to date, as shown by references to Pickering's work on the observations, and deductions from them, of the lunar surface.

The concluding chapter gives a brief but sufficient account of the means of finding and recognising the planets when they are visible in the sky, and in this is included a set of charts of the zodiacal constellations to facilitate the work of a beginner.

Numerous well-reproduced illustrations, many from photographs and drawings made at the Lick Observatory, accompany the text, and the frontispiece shows the Martian surface as charted by Schiaparelli.

As a popular exposition of the degree of habitability of the planets the book is to be recommended, and the clear large print adds to the comfort of the reader.

The Basis of Social Relations. By D. G. Brinton. Pp. xvi + 204. (London: John Murray, 1902.) Price 8s. net.

The Criterion of Scientific Truth. By G. Shann. Pp. 51. (London: Cassell and Co., Ltd., 1902.) Price 1s. 6d.

THE persons responsible for the publication of the posthumous work of Dr. Brinton, described above, would have done better if they had taken a more comprehensive view of their editorial duties. As we are told in the preface, no attempt has been made at verifying references; so that we have highly debatable statements constantly made on such vague general authorisation as "Plato," "Wundt," "Quetelet," "an American scientist," and so forth. Curious inaccuracies in matters of fact have likewise been allowed to stand in various places, e.g. at p. 44, where we read that Crete was the source of "Greek law" (whatever that vague expression may mean), and a well-known citation from the famous

Hymn of Cleanthes, occurring in the "Acts of the Apostles," is said to be from "a Cretan poet," and at p. 13, where it is asserted of Jevons's "logical machine" that it "worked as well as the human brain," the truth being, as all logicians know, that that ingenious invention requires all but the purely mechanical part of the inferential process to be performed for it by the operator.

Some of these statements would possibly have been removed by the author had he lived to give the book his final revision, but others are such as could hardly have been made by a writer really acquainted with many of the subjects upon which Dr. Brinton expressed himself with confidence. No serious student of ancient history would subscribe to the assertion that the early Romans were dominated *exclusively* by the lust of conquest, or the Greeks by the love of art (p. 111), nor does a study of the erotic poetry of the Christian Middle Ages lend much support to the notion that "chivalry" was the expression of profound respect for woman as a sex, and devotion to a high ideal of monogamy (p. 173).

As a whole, the book is somewhat disappointing. It is rather a series of *obiter dicta* on the conditions of social development than a connected study. It is hard to understand the author's exact conception of the "ethnic mind." Sometimes (e.g. p. 25) we are told that the "group" is a "generic concept" with no "objective existence," yet again (e.g. p. 28) that its "actual existence" cannot be denied, and that it is related to the individual mind as the building to its component stones. Dr. Brinton held very strong opinions on some subjects of current controversy. He was, for instance, confident that monogamy was not primitive in the species, and again, that "acquired characters" are transmissible. It is a pity he—or his representatives—should have seen fit to abstain from all citation of evidence or references in dealing with such important questions.

Mr. Shann's little work is a pleasantly written and fairly thoughtful essay in support of the view which sees in scientific truth simply a set of convenient descriptive hypotheses. The "criterion" of truth he adopts is the simplicity and adequacy with which our formulæ enable us to picture a connected train of sensational experiences. Hence he lays great stress upon two points; the origin of all knowledge must be sensational, and no knowledge can be absolute or final. From the standpoint adopted he discusses various cases of the supersession of inadequate by more adequate scientific formulæ intelligently and readably, but he seems not to have realised the grounds on which many able thinkers would dissent from the empirical phenomenalism he advocates. Has he ever asked himself whether his general philosophical theories would enable him to give a reasonable account of mathematical truth? If he will reflect, for instance, on the nature of number, and the difficulties involved in the assumptions that numerical truths are of sensational origin and only relative validity, he will probably discover that there are serious gaps in the phenomenalist theory of knowledge which he advocates. There is no doubt that he has something on this point to learn from Kant, whom he does not mention at all in his historical synopsis, and possibly even more from Plato, whom he dismisses with a sentence or two of vague generality.

A. E. T.

Opere matematiche di Francesco Brioschi. Pp. 416. (Milano: Ulrico Hoepli, 1901.)

THERE could not have been a more fitting tribute to the memory of Francesco Brioschi than the publication of his collected papers in quarto form. In order to carry out such an undertaking, a committee was formed shortly after his death consisting of Profs. G. Ascoli, E. Beltrami, G. Colombo, L. Cremona, G. Negri and

G. Schiaparelli, and the result is a work of which the present is the first volume. It contains fifty-four of Brioschi's papers, of which forty were originally published during the period 1851-1857 in the *Annali di Scienze matematiche e fisiche* under the editorship of Barnaba Tortolini, and the remainder appeared in the *Annali di matematica pura ed applicata*, which formed a continuation of the previous journal, during the years 1858-1861. The last of the series is Brioschi's classical monograph on the theory of covariants and invariants of binary forms and their principal applications. The arrangement adopted has thus been to classify Brioschi's papers according to the journals in which they are published and not according to date or subject-matter.

The committee placed the principal work of editing the volumes in the hands of Profs. Beltrami and Cremona, and on the death of the former the task was continued by Prof. Valentino Cerruti, the papers in the present volume being revised in addition by Profs. Pascal, Gerbaldi, Loria, Pittarelli, Reina and Tonelli. To these names must be added those of Profs. Bianchi and Capelli in connection with the revision of material for succeeding volumes.

A photogravure portrait of Brioschi forms a frontispiece, and a short history of his life will appear at the end of the complete work, forming a lasting monument to the great Italian mathematician.

Webster's International Dictionary of the English Language. To which is now added a Supplement of 25,000 Words and Phrases. Edited by W. T. Harris, Ph.D., LL.D., Editor-in-Chief. (London: George Bell and Sons.) Price 2 guineas net.

No more convincing proof of the extent to which the English language has been enriched as a result of the wonderful activity in scientific circles during recent years could be found than this new edition of the world-renowned "Webster." The supplement, which distinguishes this from the last edition of the dictionary, is largely composed of scientific terms and technical expressions which have come into existence during the last decade. It is only necessary to glance down a list of the names of the men of science who have assisted Dr. Harris in the preparation of this substantial addendum to satisfy oneself that the definitions will prove clear, accurate and complete. Repeated tests have shown that such anticipations are well founded, a conclusion that will not seem surprising when it is stated that among the assistants on whose services the Editor-in-Chief has been able to rely are such scientific experts as Prof. E. S. Dana, Prof. G. K. Gilbert, Dr. E. S. Holden, Dr. T. C. Mendenhall, Prof. E. L. Nichols, Prof. I. Remsen, Prof. A. E. Verrill, Prof. L. F. Ward, and many others of equal authority. The dictionary will continue to merit the confidence with which it has long been regarded.

Education and Empire. Addresses on certain Topics of the Day. By Richard Burdon Haldane, M.P., LL.D., K.C. Pp. xvi + 195. (London: John Murray.) Price 5s. net.

IN the first two addresses in this volume Mr. Haldane is concerned entirely with educational problems, and in both of them pleads in a convincing manner for more earnest attention to the great need of increased facilities for higher technical instruction and for scientific research in this country. The comparisons which are here instituted between what is done in the United Kingdom and in Germany and the United States of North America in the matter of providing technical colleges and laboratories for scientific research should, if anything will, explain to our manufacturers and merchants the reason for the phenomenal success of our trade rivals.

NO. 1705, VOL. 66.]

LETTERS TO THE EDITOR.

The Editor does not hold himself responsible for opinions expressed by his correspondents. Neither can he undertake to return, or to correspond with the writers of, rejected manuscripts intended for this or any other part of NATURE. No notice is taken of anonymous communications.

Mr. Marconi's Results in Day and Night Wireless Telegraphy.

I CAN assure Prof. Joly that his explanation (p. 199) will not do.

The observed effect, which if confirmed is very interesting, seems to me to be due to the conductivity, and consequent partial opacity, of air, under the influence of ultra-violet solar radiation.

No doubt electrons must be given off from matter (dust as well as other matter) in the solar beams; and the presence of these will convert the atmosphere into a feeble conductor. Conducting power in the sea-water surface assists and guides the waves, retaining them in two dimensions after the same fashion as a telegraph wire retains them in one; but conductivity in the dielectric itself will tend to dissipate and enfeeble the waves, by a process of reflection resulting in some amount of distortion.

OLIVER LODGE.

June 27.

Kinetic Theory of Planetary Atmospheres.

IN the *Astrophysical Journal* for November, 1901, is printed a paper of mine in the first part of which a method is proposed for determining the mean temperatures of the atmospheres of the planets and those of their surfaces. In the second part of the paper an attempt was made with the use of these temperatures to determine the composition of the atmospheres of the planets by the "empiric" method proposed by Dr. Johnstone Stoney and based on the supposition that helium escapes from the earth's atmosphere. The most probable velocity of the molecules of helium is 1093 metres per second at 15°C. (the mean temperature of the earth's surface), and the velocity sufficient to overcome the earth's attraction is 11,170 metres per second. Hence it has been inferred that a gas escapes from the surface of the planet, if the most probable velocity of its molecules is 10.22 times less than that required to overcome the planet's attraction.

Prof. G. H. Bryan (NATURE, No. 1698, p. 54) has remarked that according to his and Mr. Cook's calculations, founded on the kinetic theory of gases, helium cannot escape to any sensible extent from the earth's atmosphere by the motion of its molecules among themselves. But the assumption that helium cannot be retained by the earth's attraction is arbitrary. It is possible that helium exists in our atmosphere in only a very small quantity, because it is contained in the interplanetary medium in very insignificant proportions; its escaping, if it occurs, is effected, perhaps, by ordinary diffusion. We know several substances, as thorium, osmium, &c., which are very rare minerals, though their atomic weight is great. It is possible, moreover, that even hydrogen can be retained by the earth; it seems to be confirmed by the observations of M. Gautier (*Bulletin de la Soc. chim. de Paris*, December 5, 1900, p. 884) and Lord Rayleigh (*Phil. Mag.*, vol. iii., pp. 416-422, 1902), who have found free hydrogen in atmospheric air.

Assuming the last supposition, we must substitute for the number 10.22 some other less than 7.42 ($=\sqrt{\frac{11,170}{1500}}$), where 1500 is the most probable molecular velocity of hydrogen at 15°C., for instance, 7, 6, or 5, in order that an appreciable number of molecules may attain the speed sufficient to carry them to infinity; and consequently table iii. in my paper must be changed correspondingly.

E. ROGOVSKY.

The Coloured Sunsets.

THE recent fine weather has enabled one to observe the sunsets and after-glows under very favourable circumstances, and the most striking feature observed was the predominance of the beautiful salmon-colour tinge, which became most intense when the after-glow was brightest.

Practically none of the sunsets observed were strikingly red,

but the yellow, purple and pinkish tinges were most general. The sunsets of the 22nd and 26th and the sunrises of the 27th, 28th and 29th were those which showed the salmon tint to the greatest advantage.

In a letter to NATURE of last week, Mr. Krohn recorded some remarkable sunsets at Madeira, while a *Daily Mail* correspondent at Bombay (June 29) writes:—"The extraordinary red sunsets which have been witnessed for several days past are believed to be due to Martinique dust in the upper atmosphere."

There is little doubt, therefore, that the dust is on the move, being carried by the upper air currents, and perhaps we may yet observe more brilliant effects.

WILLIAM J. S. LOCKYER.

Solar Physics-Observatory, June 30.

As one of the first, in your pages, to call attention to the import of the sunset glows in 1853, I have additional interest in noting the recurrence of similar glows during the past few days. On three nights, at least, they have been more marked than any seen by me since the eighties.

I observed the glow first on June 26, at Croydon, but it was noted at Street, Somerset, on the 24th (Tuesday last). I was there from the 27th to 29th, and saw glows each evening. On the 27th it was brighter, though less widely spread, than at Croydon on the 26th. But at Street, on the 26th, I am informed by my cousin, Mr. Joseph Clark, that it was brighter than on the 27th.

The following resemblances to the glows in 1853 may be noted:—

(a) The distinct interval between the sunset itself, with illuminated lower clouds, and the glow. The latter began 20 to 30 minutes after sunset.

(b) The detachment from the horizon.

(c) The shade, pink, ranging from salmon tinges (26th, due perhaps to London smoke-haze) to almost purple.

(d) The clear interval between a "glow" and "after-glow" about half an hour after sunset (noted on 28th and 29th).

(e) The "after-glow" growing as brilliant as the glow. Indeed, on the 29th it was more brilliant, and alone attracted attention from the ordinary observer.

(f) The strong and prolonged "counter glow" above the earth-shadow (specially noted on 28th, up to 8.50, or half an hour after sunset).

(g) The prolonged ruddiness along the horizon, signs still remaining on 29th at 11 o'clock.

On June 26 (Croydon) the glow arose to at least 75°; otherwise 55° or so was the extreme limit. So far the pink glows have not been observed later than about 9.10, or, say, 50 minutes after sunset. In brilliancy they cannot compare with those of 1853, but perhaps with the glows two years later.

June 30.

J. EDMUND CLARK.

The Halos of May 1, 8 and 22.

SINCE the publication in NATURE of the letters on these three phenomena, my attention has been directed by Prof. S. P. Thompson to the "Memoire sur les Halos," by M. A. Bravais. The first of the above three halos, recorded by Prof. E. E. Barnard, is apparently new, unless the radius of one of the two circles was in reality considerably smaller than that of the other; if this was the case (which from the account seems scarcely likely) this halo might be part of the halo depicted on Plate iii. Fig. 98, and described on pp. 87, 83 and following, and of which Bravais says that the different parts are by no means always visible together.

There is no doubt that the halo described by me is substantially the same as that depicted on Plate iii. Fig. 101, though it will be seen that mine has a cusp not previously described, whilst one of the mock suns given by Bravais is altogether wanting.

Lastly, the halo described by Prof. Grenville A. J. Cole will be found in the same work (Plate iii. Fig. 101), where it is interesting to note that only one parheliion is drawn, and that is the one given by Prof. Cole on the left of the horizontal diameter of the smaller circle.

T. C. PORTER.

Eton, Bucks, June 30.

NO. 1705, VOL. 66]

Matter and Motion in Space.

MR. WILLIAM STANLEY, an American philosopher and engineer, said a few days ago that the grandest words ever uttered by any man on this planet were spoken by Lord Kelvin when he said that if all the matter in the universe were reduced to its ultimate atoms and equally divided through all space, the disturbance caused by the beating of the wing of one mosquito would bring about everything that we find in the material universe to-day. I have written to Lord Kelvin asking him where I can find some account of this, but he denies that he ever said anything of the kind. However, as Mr. Stanley declares that it appeared in NATURE, perhaps you can put me in the way of getting a copy of the paper which contains this remarkable utterance, which, by the way, is quite true, and if Lord Kelvin did not say it, I only have to say that he might well have been the author.

HIRAM S. MAXIM.

18 Queen's Gate Place, London, S.W., June 25.

A Method of Treating Parallels.

MAY I venture to suggest through your columns a method of dealing with the theory of parallels which seems to me to possess some advantages?

Since a philosophically rigid proof of their properties may be regarded as out of the question in the present state of our knowledge, the only desideratum in laying the foundation of this important section of geometry is an axiom the truth of which shall be apparent to the mind of a beginner.

I propose that the following should be adopted, as being the property of parallels which is most prominent in matters of ordinary life, and hence to those who have not made a special study of geometry the most obvious:—"A straight line which is perpendicular to one of two parallel straight lines is perpendicular to the other."

The more general property, that parallels are equally inclined to any straight line which cuts them, follows immediately:—

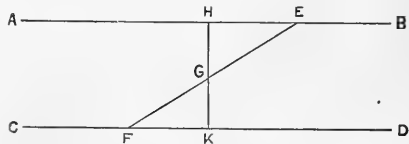

Let AB and CD be two parallels met by a third line at E and F. Bisect EF at G, and draw GH perpendicular to AB and produce HG to meet CD at K. Then HK is perpendicular to AB and CD. Then in the two triangles GEH, GFK,

angle EHG = FKG (right angles),

angle EGH = FKG (I. 15),

EG = GF (construction).

∴ HEG = KFG (I. 26).

Hartley College, Southampton.

S. W. RICHARDSON.

THE FIRST FRUITS OF THE GERMAN ANTARCTIC EXPEDITION.

THE protracted voyage of the *Gauss* from the Elbe to Cape Town excited some anxiety at the time, and called forth a few comments unfavourable to the sailing power of the ship. It appears, however, that the delay was due mainly to the fact that many days were spent in carrying on oceanographical and magnetic work, although the change of programme which led to the abandonment of a visit to Ascension shows that the duration of the passage did to some extent exceed anticipations. The *Gauss*, we may recall, left the Elbe on August 15, 1901, passed the Lizard on the 20th, called at St. Vincent in the Cape Verde Islands on September 11, and reached Cape Town on November 23. The work done in various branches of science was discussed in a preliminary manner on board, and an account of it was issued in March in a paper of

108 pages, with numerous maps and diagrams, by the new Oceanographical Institute in Berlin and the Geographical Institute of the University of Berlin, under the direction of the head of both institutions, Baron F. von Richthofen.¹ The work, though mainly of value in the instruction it afforded the workers, still constitutes a contribution to our knowledge of the Atlantic, and promises well for the scientific harvest which we hope the *Gauss* has by this time begun to reap in less known waters.

The memoir consists of four parts—a general report of the expedition by the leader, Prof. E. von Drygalski, seven reports on the scientific work by the various specialists on board, technical reports by the chief engineer and the captain of the ship, and finally a special report on the establishment of the auxiliary station at Kerguelen.

As the investigators on the *Discovery* brought themselves into working order by monographing the island of South Trinidad, those on the *Gauss* set about the general description of St. Vincent in the Cape Verde group as their first exercise. Dr. Emil Werth describes the topography and types of vegetation of the island, and Dr. Philipp gives a brief account of the geology. The island is described as an ancient volcano, the central plain corresponding to the crater, the rim of which survives in parts as a peripheral mountain-chain.

The more systematic work of the expedition commences with Prof. von Drygalski's report on the oceanographical observations which were his special care. As far as the equator these were confined to the surface, but from the equator southwards deep-sea observations were added at regular intervals, along the course which lay alternately a little to the west and a little to the east of the meridian of 20° E. The superficial conditions are very ingeniously shown by means of curves drawn on the map of the route, the abscissæ being the projection of the track on the meridian and the ordinates the values of temperature, salinity and density *in situ*. The surface temperature, closely following that of the air, rose steadily from 17° C. at the mouth of the English Channel to an average of 27° in the Doldrums (16° N. to 5° N.), then fell to 24° at the equator and remained steady to 15° S., after which it fell steadily, reaching 18° C. in 30° S. The salinity curve showed maxima in the tropics both north and south, separated by a minimum in the belt of calms at 7° N. The density of surface-water *in situ* remained constant between the temperate zone and the tropics in both hemispheres, but fell to a single minimum in the equatorial belt of calms, where the maximum temperature met the minimum salinity. Samples for the determination of density and chlorine were collected every four hours and a number of different methods were employed for making the determinations. Titrations of chlorine were controlled by Knudsen's standard samples of sea-water, which were supplied to the expedition for the purpose. In addition to two patterns of direct-reading hydrometers, a set of Nansen's total-immersion hydrometers by the use of which the troublesome factor of surface-tension is eliminated were utilised, and a refractometer was also employed for the optical determination of the density of the sea-water. The value of the salinity deduced by Knudsen's tables from the chlorine determinations was always found a little lower than when deduced from hydrometer or refractometer observations; the mean error of the determinations was found to be least for titration of chlorine and greatest for the refractometer. The chief difficulty with regard to that instrument was found to be the temperature correction; but Prof. v. Drygalski points out the very decided advantage of the immersion refractometer with which the *Gauss* is provided over the differential refractometer formerly used.

The colour of the sea-water was systematically observed, but the range of Forel's xanthometer being found insufficient, the more extensive scale of colours used by Luksch on the *Pola* expedition was adopted instead.

Deep-sea soundings were made with a modified Sigsbee machine. Using a detaching weight of 35 kilogrammes as a sinker, soundings were completed in 5000 metres (2770 fathoms) in seventy minutes in calm weather. Prof. v. Drygalski found the Negretti and Zambra reversing thermometer unsatisfactory for deep soundings, on account of the shaking of mercury out of the inverted bulb in hauling up through the hot tropical surface-water. The Miller-Casella thermometers, on the other hand, acted admirably, and he regretted not having taken a larger supply. We think, however, that in the very different conditions of the polar seas this opinion of the relative utility of the two types of instrument will very likely be reversed.

On the voyage between 37° N. and 34° S. no fewer than thirty successful deep-sea soundings were taken, of which nine gave depths exceeding 5000 metres (2770 fathoms), and the deepest as much as 7230 metres (3950 fathoms). The positions of the soundings were chosen so as to throw light on special problems of suboceanic configuration.

Opportunity was taken to test the Pettersson-Nansen insulating water-bottle in these depths, and the result was to show that the great contrast of temperature between the bottom and surface in the tropical seas was too much for the power of insulation, and that the inner cylinder of water altered its temperature somewhat before a reading could be made. This difficulty will, of course, not be experienced in the more uniform temperatures of polar seas.

An interesting fact brought out by the determination of salinity as well as temperature at each point of observation was that about the depth of 800 metres, where the sudden change in the temperature curve occurs between the warm upper and the cold lower waters, there occurs an actual inversion of the salinity curve, showing that a stratum of minimum salinity is interposed between the two saltier layers.

The study of oceanic deposits brought out some new facts, and suggests problems not very easy of solution. By using sounding tubes of 2 or 3 centimetres diameter and 200 centimetres long some very long cores were obtained. One of these, from the depth of 7230 metres (3950 fathoms), in 0° 11' S., 18° 15' W., showed distinct stratification. The core was 46 centimetres long; the uppermost 13 centimetres consisted of red clay containing numerous fragments of volcanic rock, then followed in order four bands of different colour, passing from brownish-grey to dark and then light grey. The dark grey layer distinctly resembled a terrigenous deposit, and the light grey layer, the lowest of all, was the only one containing a perceptible proportion of calcium carbonate. The bearing of this observation on past changes in the configuration of the ocean and the distribution of land is pointed out. A still more curious specimen was a core 69 centimetres (say 2 feet) long, obtained in 35° 52' S., 13° 8' E., from a depth of 4957 metres (2750 fathoms). The uppermost 11 centimetres consisted of a brown clayey quartz sand with very little volcanic or calcareous material, while the next 12 centimetres were almost pure globigerina ooze with fragments of the upper layer, and the greater mass of the section consisted of material similar to the upper layer, but with the clayey material predominating over the sand. Dr. Philipp could not account for this appearance of sand in a pelagic deposit by considerations of the prevailing wind (which blows towards, not from, the South African deserts), or by currents, so he is driven to suggest that the material is ice-borne, though he acknowledges the

¹ Bericht über die wissenschaftlichen Arbeiten auf der Fahrt von Kiel bis Kapstadt und die Errichtung der Kerguelen Station.

difficulty of icebergs in sufficient numbers reaching so low a latitude.

The biological work was very fully developed on the voyage, and in addition to a close watch being kept on the changes in the surface plankton by continuous tow-netting, attention was devoted to the use of very large wide-meshed nets (one was of 7 metres diameter) for horizontal towing, and to a vertical net of 2 metres diameter. A somewhat unexpected result of the latter was the discovery that very young fishes increased in number with the depth. Thus in a vertical draught from 500 metres twelve "fischchen" were found, in one from 800 metres fifteen, from 1000 metres thirty-two, from 1200 metres thirty-six, from 2000 metres forty-three and from 3000 metres no fewer than ninety-six. Most of them belonged to the genus *Cyclothone*.

Dr. Bidlingmaier enters very fully into the methods and difficulties of magnetic work at sea. The two principal instruments in use are a Bamberg's deviation magnetometer and a Lloyd-Creak inclination instrument identical with that supplied to the *Discovery*. The results are not yet ready for publication, but a number of observations were made both at the ports of call and at sea. At Cape Town Profs. Beattie and Morrison repeated the comparison of their own instruments with those of the expedition which they had made a short time previously with the *Discovery's*, thus enabling a comparison of the instruments of the two exploring vessels to be made.

The report concludes with a letter from the auxiliary station at Kerguelen which was established by Herr Enzensperger on the shores of Royal Sound in November, and was visited by the *Gauss* on her way southward in January, 1902; but the letter had been dispatched some weeks before the ship arrived.

We miss any detailed account of the meteorological work of the expedition, or particulars as to the placing and working of the various self-recording instruments on board.

It is impossible to overrate the importance of preliminary work in comparatively easy conditions before grappling with the manifold difficulties of the polar seas. Indeed, we believe that those who organise polar expeditions for scientific work would be well advised to insist on a preliminary trip of at least three months' duration before the final plans and equipment are settled. The result would not be waste of time; it would render fruitful a vast amount of work, which without preliminary experience is sure to be wasted. In this respect Antarctic expeditions are more advantageously situated than those to the Arctic regions, where the ship is in the midst of its field of work before the men have settled down to life on board and to work under the countless limitations which harass the man of science at sea.

H. R. M.

RURAL EDUCATION IN FRANCE.¹

ONE is always being reminded afresh of the essential solidarity of the thought of civilised man; no movement seems to begin with one man or in one place; the tide rises, and though this or that first receives the impulse and takes credit for being the creator, yet the wave has already reached many a distant creek and inlet. In two or three years the idea of giving an agricultural colouring to the work of the rural elementary schools of England has been getting itself translated into codes and circulars and syllabuses; the Agricultural Education Committee gave the needful push, but if anything else were wanted to prove that it only supplied the "starter" to a medium already prepared to react, it would be a consideration of the work done in the same direction in

France, as set out in the report before us. And the United States, our Australian Colonies and Canada, to name no more cases, would all report similarly—their educators have begun to realise that primary education has been systematised on bookish and artificial lines, which can nowhere be more pernicious or more easily avoided than in the purely country school, with trees and fields around it.

Unfortunately, the pioneers of any movement, just because they are pioneers and have brought a certain amount of original thought to the work, are apt to forget that there must be other people progressing on the same lines; they shut themselves up in their own schemes, and bit by bit work through the same mistakes which everyone else has previously made.

Here comes the special value of such reports as the one we are now considering, and had this account of the attempt in France to impart an agricultural bias to the rural primary school been available a year or two earlier, many experiments destined to failure might have been avoided, and much well-meant effort directed into more fruitful channels.

The problem in France is like that of England, there is the same depression in agriculture, the same dominance of the town in the organisation of the State, the same increasing distaste for a farming life—in a word, the same impossibility of the primitive industry, with its toil, its small returns, its isolation, competing either for men or capital with the specialised affairs of the town. But as Mr. Brereton reminds us, France is more of an agricultural country than we are, so the problem was taken in hand earlier there; the economic difficulties were palliated by protection, and the primary education of the country was overhauled to ensure that it should stimulate, rather than divert, the child's desire to live on the land.

The volume before us consists of two reports; the first is a very detailed account by Mr. Cloudesley Brereton on the organisation of rural education in the Departments of Calvados, Orne, Sarthe, Indre et Loire, Loir et Cher. Here the machinery for the education both of child and teacher; the relations, financial and administrative, between the central authority, the department and the commune; the status of the teachers, the inspectorate, the departmental professors, &c., are set out at length, together with the personal impressions of the author while visiting typical schools in the district indicated. Mr. J. C. Medd, the author of the second report, deals with the country bordering Mr. Brereton's on the north and east; he is, perhaps, more specially concerned with "l'enseignement agricole" than with the general machinery of education. The first thing that strikes us is the predominance given in both reports, and indeed in the French system, to the programme. Most new movements in education narrowly escape being choked in their early days by a programme, and as we in England are still struggling to free ourselves from the wrappings of syllabuses, it is interesting to read how the vastness of the schemes framed by the departments in response to the law of 1879, resulted in practically no teaching except by a few enthusiasts. This was realised, and the Ministry issued in 1897 a well-reasoned scheme "on the teaching of elementary notions of agriculture in rural schools,"¹ which forms the basis of the work that is proceeding to-day. Even this circular seems to err in attempting instruction which is too definitely technical for the primary school, and so degenerates into text-book repetitions. The study of manures and artificial fertilisers has an extraordinary attraction for the sort of man who teaches in a primary school; he needs to be warned that they do not constitute the whole of agriculture, rather than encouraged to devote his "champs

¹ Vol. vii. of "Special Reports on Educational Subjects," published by the Board of Education.

² A translation appears in the Report of the Irish Commission on Primary Schools [c. 892s].

d'expérience" and his pot cultures to demonstrating the effect of nitrogen, phosphoric acid, potash, &c. Whatever happens to this sort of teaching in England, we hope the primary school will be left uninvaded by theories of manuring. Practical farmers have sometimes denounced the whole race of agricultural teachers as advertising agents for the artificial manure makers, and if when they happen to visit the village school, they hear little lads of twelve and thirteen glibly reciting scraps about nitrates, kainit and the like, there will only be one strong prejudice the more against "education."

All the programmes set out by Mr. Brereton and Mr. Medd are based too much on chemistry, which in an elementary school is necessarily academic instruction, and too little on botany and zoology, which can be made real, and interwoven with the child's daily experience of field and garden. Nor is there any indication of work done by the children themselves; the instruction seems wholly didactic.

But after all a syllabus should only be regarded as a series of boundary walls; it should say, "do what you like within these limits, but don't think yourself called upon to do it all." It does harm when it becomes a stereotyped substitute for the teacher's judgment. On the teacher the whole thing depends, and this is thoroughly recognised in both reports. It is because the current generation of teachers is not prepared for the work, either in England or France, that the work of vitalising the instruction of the village school must proceed slowly. France has the advantage of a properly organised system of training colleges through which all their teachers pass, and in them a course of agriculture is given by the departmental professor. In Mr. Brereton's opinion he has so many more pressing duties that this part of his work is performed in a somewhat perfunctory fashion; the teaching is too academic, and not enough use is made of the garden for practical instruction. It is difficult to see the value of "a lot of hard digging" for students when the gardener is left with the more ticklish operations that follow. We do not gather that the training colleges have arrived at any conception of a "normal" course in these studies bearing on agriculture and horticulture, which would practice the teacher in the very experiments, indoors and out, that he will want to pass on to his scholars. No one is in more need of this kind of drilling, for the primary teacher's training is always disposing him to think that if he knows how to describe an experiment he knows how to do it. Mr. Medd found a teacher who was afraid to do experiments lest his boys should meet with accidents and he himself be involved in claims for compensation; and Mr. Brereton records how unsuccessful the manure experiments, either in the open or in plots, were apt to be, which indeed is only "pretty Fanny's way."

However it is clear that the crux of the whole problem, lies with the teacher. Turn him out with an adequate preparation, keep him encouraged on the right lines by the inspectorate, and let him work out his own salvation. Uniformity is the least of virtues in this matter; the spirit the teacher puts into the task alone tells, and his individuality ought to be reflected in the instruction he gives, until each school has a special character of its own.

We trust these reports will be widely circulated and widely read; they will show what can be done, and may save us from expecting too rapid a progress. Mr. Medd speaks, perhaps, with more knowledge of country life, more experience of the same kind of thing at home, even if his enthusiasm does lead him to see things rather as they are meant to be than as they are. Mr. Brereton has the keener pedagogic eye for the place where the organisation becomes paper only. But both reports are eminently readable. Mr. Brereton is not afraid of letting his own personality appear, and if the final homilies which he addresses to the farmer, parson and squire sug-

gest that Mr. Brereton is young, and knows the country chiefly *en bicyclette*, those poor sinners are too chastened already to take his advice otherwise than with a smile.

A. D. H.

THE SMITHSONIAN INSTITUTION: ITS DOCUMENTARY HISTORY.¹

THE Smithsonian Institution, the great scientific establishment at Washington, which, in many respects, is to the United States of America what the Royal Society is to this country, was founded under the will of James Smithson (b. 1765), a son of Hugh Smithson, afterwards Duke of Northumberland, by Elizabeth Macie, a cousin of the Percys. The story of how it came to be founded, and of its great work for the United States and for the world, has been more than once recounted in this Journal. An article contributed by the late Dr. G. Brown Goode (*NATURE*, vol. liii. pp. 257, 281) in January, 1896, contained a very full account of the origin of the Institution and of the system of its administration; and, when the same writer edited, under the auspices of the Institution itself, a work on the "History of its First Half-Century," we took occasion in reviewing it to give a comprehensive outline of the rise and progress of this great centre of scientific energy (*NATURE*, vol. lviii. p. 271).

The work at present under review does not perform the same function as that of Dr. Goode. It is not a history of the Smithsonian Institution, but, as the title-page declares, it is a collection of "documents relative to its origin and history." In fact, it brings down to date a volume with the same title which was published in 1879. In the latter volume the documents relative to the inception and organisation of "the Smithsonian" from 1835 to 1837 were printed, and the present volumes cover the whole period from 1835 to 1899.

In compiling and editing these documents, Mr. William Jones Rhees, the keeper of the archives of the Smithsonian Institution, has very admirably performed a most arduous task. A compiler is not called upon to produce a work of high literary art, but he is called upon to give with faithfulness and accuracy all that comes strictly within the scope of his compilation, and this Mr. Rhees appears to have done. He has given us two classes of documents: first, the will of James Smithson, with correspondence, &c., relative to the bequest, and, secondly, a full reprint of those congressional proceedings which contain legislation relative to the establishment of the Smithsonian Institution. The extraordinary minuteness of the information preserved in these documents, especially of the first class, is sometimes almost amusing. Not only have we the will of James Smithson and the documents in the Chancery suit brought by the U.S. Government against the British Government, but we have the lawyers' bill for costs of the suit and the full account of the expenses of Richard Rush, who came over to fetch the money. We not only have a list of the stocks transferred by decree of the High Court of Chancery and a schedule of the personal effects of James Smithson, but we have all the details of Smithson's tea-service—12 cups and saucers, 6 coffee cups, teapot, sloop basin, sugar basin and lid, &c. Indeed, such a mass of material, important and unimportant, as is printed in these two volumes would be overwhelming were it not accompanied by a good index. But this, by the editor's care, has been given, and those who have had experience of biographical or historical authorship and who have sighed over the lack of particulars which so often belongs to the early stages of a history will not quarrel with a minuteness of detail

¹ The Smithsonian Institution: Documents relative to its Origin and History, 1835-1899. Compiled and edited by William Jones Rhees. 2 vols. (Tp. liii. + 7044 and xvi. + 7045 to 1935.) (Washington, 1901.)

which is thus made readily available. Mr. Rhee's volumes will doubtless become for the future historian a storehouse of information great and small, and for the official a book of reference of permanent value.

In the voluminous reports of congressional proceedings which are here reprinted, many things will be found which are of special interest to English readers. There are numerous allusions to our own institutions, such as the Royal Society and the British Museum. Among other matters of the kind we note, in the proceedings of the thirty-third congress (1853-55), a letter of Prof. Agassiz, in which he mentions that Smithson's magnificent bequest of 105,000*l.* sterling was originally intended for our own Royal Society, but that certain scientific papers which that gentleman offered for publication in the *Philosophical Transactions* were declined, "upon which he changed his will and made his bequest to the United States." One can scarcely, however, grudge the loss to our own country in view of the liberal spirit and the enlightened policy which have always ruled the affairs of "the Smithsonian," and have done so much to advance the cause of science.

That policy has not been maintained without many a struggle. It took, to begin with, eight years to decide what form the establishment for "increase and diffusion of knowledge" was to take. Schemes for "a library, a botanical garden, an observatory, a chemical laboratory, a popular publishing house, a lecture lyceum, an art museum," all fought together and killed each other, and when this consummation was reached and the Smithsonian Institution was erected upon the battlefield, the ghosts of two at least of the old schemes—the library and the college—continued to haunt the proceedings of congress and cause endless trouble. It was in the course of one of these after-battles—a battle with those who desired to divert the funds of the Institution from scientific work to the foundation of a great library—that a letter from Prof. Benjamin Peirce was read which makes honourable mention of the scientific work both of the foundation and the founder, an extract from which may serve as an appropriate conclusion to this notice:—

"The valuable contributions to knowledge which have already been made by the Smithsonian Institution are a living proof that vast libraries are not necessary to the development of new thoughts. If you will compare these memoirs with the scientific productions of the same period in Europe you may find them, perchance, inferior in erudition, but not in profundity and originality of thought. Do you believe that Smithson, who was himself engaged in chemical investigations, could have intended a library by his words 'an institution for the increase and diffusion of knowledge among men'? If you will examine his nine memoirs to the Royal Society, of which he was an active member, and his eighteen other contributions to science, you will not find one of them which required a library for its production. Each was the natural growth of a deeply thinking mind. Smithson was emphatically a maker, not a collector of books; and, in the scientific circle to which he belonged, the ordinary use of language would have totally precluded the interpretation which some men of quite a different cast of mind have presumed to impose upon his words" (p. 557).

H. R.

ARCTIC MAGNETIC OBSERVATIONS.

A SYSTEMATIC series of observations on terrestrial magnetism, atmospheric electricity and aurora was commenced by Prof. Birkeland and his assistants in 1899-1900, and a report upon some of the results was published last year.¹ The first observations were made at

¹ "Expédition Norvégienne de 1899-1900 pour l'étude des aurores boréales. Résultats des recherches magnétiques." Par Kr. Birkeland. Pp. 80; with 12 plates. (Christiania, 1901.)

Bossekop (Finmarken), in the north of Norway. For magnetic observation, self-recording photographic apparatus was employed of the Eschenhagen pattern, the drums carrying the paper being capable of rotation at two speeds, the faster supplying a very open time scale. Fast runs were made simultaneously on certain prearranged days at Bossekop and Potsdam. A comparison of the records showed the simultaneous, or practically simultaneous, occurrence on several occasions of small regular magnetic waves at the two stations. Similar previous comparisons by Eschenhagen and others have led to similar results, but the comparatively great distance—some 2000 kilometres—between the two stations in the present case makes the results of special interest.

Only a portion of the report mentioned in the foot-note is devoted to the work at Bossekop. A considerable part is occupied with the description of experiments with electric discharges in vacuum tubes, in which Prof. Birkeland has succeeded in producing phenomena having a close resemblance to some of the more prominent features of aurora. Reference is also made to work by Prof. J. J. Thomson and other recent investigators in vacuum-tube discharges. There is also a discussion of the bearing of the observations and experiments on Prof. Birkeland's theory of the cause of aurora and magnetic storms. This he believes to be electric currents in the upper atmosphere, the ultimate source of which he ascribes to cathode rays or other electrical emanations from the sun. The observations and experiments are illustrated in the text and in various plates at the end of the book.

This work is to be regarded only as introductory to a larger scheme in which Prof. Birkeland is about to embark, and in which he desires the cooperation of magnetic and meteorological observatories. The further scheme is described in two circulars which have recently been widely distributed.

The Norwegian Government is to maintain four stations in operation from August 1, 1902, to June 30, 1903. They are situated at Bossekop and in Iceland, Spitzbergen and Nova Zembla. At each of the stations there will be continuous photographic registration of the horizontal and vertical components of magnetic force and of the declination. The instruments are of the latest Eschenhagen pattern, similar to those supplied to the German and British Antarctic expeditions, with arrangements for running at ordinary or at rapid rates. Rapid runs are to be made on certain specified days and times, mainly during the 'term' hours on the 1st and 15th of each month, according to the scheme agreed on between the British and German Antarctic expeditions.

In addition there are to be rapid runs from 9 to 11 p.m., G.M.T., on December 2 to 8, 1902, January 2 to 8 and February 3 to 9, 1903. Prof. Birkeland is anxious that as many magnetic observatories as possible should participate in this scheme of rapid registration. He also asks for the cooperation of meteorologists in observing cirrus clouds, and especially in recording the direction of cirrus bands when such exist. This information is more particularly desired during the days of special magnetic observations referred to above. Prof. Birkeland thinks it probable that high cirrus may be influenced by the electric currents which he believes to exist in the upper atmosphere, and to which, as already stated, he ascribes a principal, if not an exclusive, part in the production of aurora and magnetic disturbances.

One of the principal objects of having four stations in Arctic regions is to obtain data from which calculations can be made as to the direction, altitude and intensity of atmospheric electric currents, if such exist. Prof. Birkeland hopes to obtain quantitative results sufficiently definite to put his theory to the test. The completeness of the test will, however, be much enhanced by the

cooperation of existing magnetic observatories in Europe and other parts of the world.

As one of the principal desiderata is magnetic curves with very open time scale, it may not be out of place to explain that it is not necessary for this purpose to have a specially constructed magnetograph of the Eschenhagen or any similar pattern with small magnets. The ordinary Kew pattern magnetograph, with the usual damping arrangements, requires only a simple addition to the clock to work admirably as a rapid-motion instrument. Additions of this kind have been made to the Mauritius magnetograph by Mr. Claxton, the Director of the Royal Alfred Observatory, and a similar arrangement has been made at Kew itself at a trifling cost. The objection has, indeed, been raised to the use of ordinary magnetographs for this purpose, that the natural period of vibration of the magnets may coincide with that of the short magnetic waves which it is especially desired to investigate. When Eschenhagen described his early observations he apparently believed that the earth magnetic waves were restricted to one or two definite short periods, notably one of about thirty seconds; and he approved a short period of vibration for the magnet system so as to avoid possible synchronism. The records at Potsdam and Bossekop, however, discussed by Prof. Birkeland, and those taken elsewhere, show waves of all periods from eight or ten seconds up to several minutes, the longer-period waves being identical with those long familiar to all concerned with the records of the older types of magnetographs run at the ordinary slow rate. It would thus appear that synchronism is likely to happen very rarely, whatever type of magnetograph is employed. In some respects, of course, a very short period in the magnet system has its advantages, but it is not without its drawbacks. It means small magnets, entailing the use of small mirrors, and so necessitating a more intense light or more sensitive paper than is requisite when heavier magnet systems and larger mirrors are used. The greater robustness of the large-magnet systems is also a recommendation to those responsible for obtaining the records, especially at stations which do not possess a skilled mechanic and are not situated near large towns, a situation which the spread of electric tramways is fast rendering impossible.

C. CHREE.

CORONATION HONOURS TO MEN OF SCIENCE.

AS we went to press last week, news of the King's serious illness was published, and national rejoicing at the anticipated Coronation ceremonies was suddenly changed to sorrow and deep anxiety. Since then, the nation has been slowly recovering from the shock, and the favourable bulletins which the King's physicians have issued this week encourage the hope that the crisis has been successfully passed and that His Majesty's convalescence is assured.

The operation for perityphlitis, from which the King has been suffering, was decided upon by Lord Lister, Sir Thomas Smith, Sir Francis Laking, Sir Thomas Barlow and Sir Frederick Treves, who are in attendance upon the Sovereign. It is beyond our province to describe the medical history of the illness or the nature of the operation performed by Sir Frederick Treves; but we are glad to know that scientific knowledge renders it possible to give relief to the sufferer without the fear of complications which made the surgeon's work almost hopeless before the introduction of antiseptic methods. Remembering this, we trust that the dark days have been passed and that progress towards recovery will be uninterrupted.

When the illness of the King became known, it was scarcely expected that the honours to be conferred in

connection with the Coronation would be announced. But by His Majesty's express wish the list was published on Thursday last, and we give below the names of men of science included in it. The new Order of Merit which has been created by the King is of particular interest. We have applied to the Lord Chamberlain for a copy of the Warrant of the Order, but so far have not received one; the general principles upon which the Order is founded will, however, be gathered from the following information given to and by the *Times* :—

The new Order is clearly founded on the lines of the well-known Prussian "Ordre pour le Mérite." It will have the same comprehensive range and character, including, besides British subjects who have won conspicuous distinction in the naval and military services, those who are exceptionally eminent as men of letters and in the fields of art and science. The number of its members will be, as is right, very restricted. It is, of course, primarily and essentially a British Order, but provision will be made for taking into its ranks distinguished foreign personages as honorary members. The badge of the Order, to be worn by its members, will consist of a cross of red and blue enamel of eight points, having the words "For Merit" (the motto of the Order) in gold letters within a laurel wreath on a blue enamel centre. The reverse of the badge will show the King's Royal and Imperial cipher in gold (two silver swords with gold hilts, placed saltirewise between the angles of the cross, being added in the case of members chosen for military or naval distinction) also within a laurel wreath, on a blue enamel centre; and the whole will be surmounted by the Imperial Crown enamelled in colour, and suspended by a parti-coloured ribbon of Garter blue and crimson, two inches broad. The Sovereign's insignia, except, of course, for the modifications necessary to distinguish the Royal dignity of the wearer, will be similar to the insignia worn by the ordinary members of the Order. The ceremony of the investiture will be from time to time conducted by the Sovereign as in the case of any other Order, the members designate being introduced by the officer of the Order in attendance. Members of the Order will be entitled to attach a facsimile of its badge and ribbon to their arms. The Seal of the Order will show a facsimile of the badge, impaled with the Royal Arms, on a white ground, with the legend "The Seal of the Order of Merit." June 26, as the day originally fixed for the Coronation ceremony, will be observed as the anniversary of the Order.

The Order only comprises one class of ordinary members, and of the twelve eminent men chosen as the first to be admitted, four are men whose names are familiar throughout the world of science.

Among the new Privy Counsellors are Lord Kelvin and Lord Lister.

The new Baronets include Sir Andrew Noble, K.C.B., Sir Francis Laking and Sir Frederick Treves.

The honour of Knighthood has been conferred upon Dr. J. W. Collins, F.R.C.S., Mr. A. Cooper, F.R.C.S., Mr. H. Croom, president of the Royal College of Surgeons (Edinburgh); Dr. T. Fraser, F.R.S., president of the Royal College of Physicians of Edinburgh; Mr. Victor Horsley, F.R.S., Mr. H. G. Howse, president of the Royal College of Surgeons; Principal Oliver Lodge, F.R.S., Prof. W. Macewen, F.R.S., Principal Rucker, F.R.S., and Mr. J. Thornycroft, F.R.S.

In the Order of the Bath (Civil Division) Sir William Church, Bart., president of the Royal College of Physicians, and Prof. W. Ramsay, F.R.S., have been appointed Knight Commanders. Major Ronald Ross, F.R.S., and Prof. A. M. Worthington, F.R.S., have been appointed Companions of the same Order.

In the Military Division of the Order of the Bath, Admiral Sir Erasmus Ommanney, F.R.S., has been appointed Knight Commander.

The Kaiser-I-Hind medal for public service in India has been granted to Mr. Edgar Thurston, superintendent, Government Central Museum, Madras.

Finally, the new Order of Merit includes the names of four distinguished men of science, namely, Lord Rayleigh, Lord Kelvin, Lord Lister and Sir William Huggins.

NOTES.

It is announced that Signor Schiaparelli has been elected an associate of the Paris Academy of Sciences in succession to the late Baron Nordenskiöld.

THE Albert medal of the Society of Arts for the present year has, with the approval of H.R.H. the Prince of Wales, president of the Society, been awarded to Prof. Alexander Graham Bell, "for his invention of the telephone."

THE Panama Canal Bill, which was adopted by the United States Senate a few days ago (p. 205), has been accepted by the House of Representatives and signed by President Roosevelt, so that it has now become law.

THE summer excursion of the Geologists' Association this year will be to the Ipswich and Norwich districts, the directors being Mr. W. Whitaker, F.R.S., and Mr. F. W. Harmer. The party will leave London on Saturday, July 26, for Ipswich, which will be the headquarters until July 31. Norwich will then be the centre until August 5, when the party will return to London.

THE council of the Society of Arts offers the Fothergill prize of 50*l.* and a silver medal for a paper on "Existing Laws, By-laws and Regulations relating to Protection from Fire, with Criticisms and Suggestions." The paper should consist of about eight to ten thousand words, and be written with a view to its being read and discussed at an ordinary meeting of the Society. Papers submitted for the prize must be sent to the secretary on or before October 1. Each paper must be typewritten, and bear a motto, the name of the writer being enclosed in a sealed envelope with a similar motto. The judges will be appointed by the council.

REPORTS of recent volcanic disturbances and related effects continue to be published. A despatch from Honolulu says that a violent eruption from the Kilauea volcano took place on June 3. It is further stated that when the Mont Pelée eruption was at its height, and during the six hours St. Pierre was overwhelmed, there were marked magnetic disturbances in the observatory on Oahu Island. A telegram from Fort de France to the French Minister of the Colonies, dated June 26, says that the scientific expedition which was sent to Martinique considers that the destruction of St. Pierre was caused by a rush of gas at a very high temperature, travelling from north to south. The destruction of Le Prêcheur and Ste. Philomène is attributed to torrents of mud, which overwhelmed them. No appreciable sinking of the sea bottom near the coast has been found.

EVIDENCE of the assistance given to agriculture by the Technical Instruction Committee of the Essex County Council is afforded by the report just published on the various branches of work carried on. Farmers within the administrative County of Essex can obtain from the County Laboratories, for a nominal fee, reports upon chemical, botanical and entomological specimens and materials. Thus, for the fee of one shilling for each subject, reports can be obtained upon the germinating power and purity of seed; the species of a weed or other plant, with a report on its nature and habits and any means of checking or destroying its growth; any disease affecting farm or garden crops; any insect or other pest affecting farm or garden crops, or stock, with advice as to its prevention or destruction. Work of this kind forms a very valuable part of the functions of Technical Instruction Committees in agricultural districts. The biological work carried on under the auspices of the committee has been of a very helpful character. To enable teachers in rural schools to obtain a knowledge of natural history sufficient to inspire interest in it in their pupils, class and field meetings were held during the year and proved very successful. The subject

selected for systematic treatment was plant-life, considered in its broadest sense, so as to give the teacher-students a fairly interesting introduction to the wider subject of nature-study.

AT the meeting of the French Society for the Encouragement of National Industry held on June 13, the Minister of Marine announced that, following the recommendation made at the congress held at Zurich in October, 1900, as to the adoption of an international system of screw gauges, he had, with the concurrence of his technical advisers, decided to render the new system a service regulation so far as it concerned the heads and worms of screws. He had accordingly given instructions that for all sizes used in the French navy the length should be made equal to 1.4 diameters plus 4 millimetres ($L = 1.4d + 4\text{mm.}$); so that from any one part every bolt could be distinguished at first sight from the bolts of other dimensions, either by the head or by the body of the screw; and that, leaving out exceptional cases, the sizes should be determined by the above simple formula.

THE twelfth international congress of the International Tramways Union and the second International Tramways and Light Railways Exhibition were opened at the Agricultural Hall, Islington, on Monday, by Mr. Gerald Balfour, President of the Board of Trade. Mr. Gerald Balfour, in proposing "The Union Internationale Permanente de Tramways," at the subsequent luncheon, remarked that in the industry represented by their own international union, he was afraid that this country had probably more to learn from distinguished friends who had come from the other side of the Channel than they had to learn from us. He hoped that this inferiority, of which he was painfully conscious, was not going to last for ever. In this country we had been taking a nap, but he thought he saw some signs of an awakening. It was with the introduction of the overhead trolley system that the supremacy of electric traction and light railways was established. He believed that this system was not so quickly appreciated in the United Kingdom as it was by our neighbours. The consequence was that we had undoubtedly got a little behind.

THE annual general meeting of the Marine Biological Association of the United Kingdom was held in the rooms of the Royal Society on June 25. The officers and council elected for the year 1902-3 were as follows:—President, Prof. E. Ray Lankester, F.R.S.; hon. treasurer, Mr. J. A. Travers; hon. secretary, Dr. E. J. Allen; council, Mr. G. P. Bidder, Mr. G. C. Bourne, Mr. Francis Darwin, Prof. J. B. Farmer, Dr. G. H. Fowler, Dr. S. F. Harmer, Prof. W. A. Herdman, Prof. G. B. Howes, Mr. J. J. Lister, Prof. E. A. Minchin, Prof. C. Stewart, Prof. D'Arcy W. Thompson and Dr. R. N. Wolfenden. The following governors are also members of council:—Mr. J. P. Thomasson (the prime warden of the Fishmongers' Company), Mr. E. L. Beckwith (Fishmongers' Company), Sir J. Burdon Sanderson, Bart. (University of Oxford), Mr. A. E. Shipley (University of Cambridge), Prof. W. F. R. Weldon (British Association for the Advancement of Science). Special reference was made in the report of the council to the loss sustained by the Association through the death of Mr. Robert Bayly, one of the governors of the Association, whose generous support and valued assistance contributed very largely to the successful establishment of the laboratory at Plymouth.

DEAN HOLE presided at the conference on roses organised by the Royal Horticultural Society in connection with the Coronation Show at Holland House on Tuesday, June 24. He had much to say in praise of the blossoms with which his name is associated, and having commented on the value of the papers to be read, called upon Mr. J. G. Baker, F.R.S., to give an

account of *Rosa stellata* and *R. minutifolia*, recently discovered in New Mexico and California respectively. These roses are characteristic, the first having its leaves, or rather the three terminal leaflets, arranged like those of a *Potentilla* and unlike any other allied species. *R. minutifolia*, as its name implies, has very small leaves which are deeply toothed. These forms are alike in having red flowers, and in habit they resemble the Scotch rose, *Rosa spinosissima*. Only the second species has as yet been grown in this country, and that with little success. The question of the origin of the hybrid tea rose was touched upon by the Rev. J. H. Pemberton in his general paper on this form. Mr. Alexander Dickson stated that as a result of almost a life's work in the hybridisation of roses he had not been able to reduce a single theory to a certainty, and not one feature as regards colour, shape or fragrance could the experimenter ensure in an artificial hybrid. The need for a strain of roses that will stand the English climate was emphasised by Mr. Edward Mawley. Many points of cultural interest were raised, and many papers will appear in the report which time did not permit of being read, such as those on "The Production of New Hybrid Roses," by M. Vivian-Morel, "Wild Asiatic Roses," by M. Maurice de Vilmorin, and "Recently Discovered Chinese Roses," by Mr. George Nicholson.

A PECULIAR appearance at and after sunset was noticed by a number of observers several evenings last week. Dr. C. B. Plowright, of King's Lynn, and some friends with him, observed after sunset a number of rose-red beams of light radiating upward in the western sky, with the sun as the centre. These beams were not of long duration, and changed in position and brilliancy in the course of a few minutes. Sometimes they extended 30° or 40° upwards towards the zenith. On Wednesday, June 25, the beams were brightest about 9.10 p.m. On Friday, June 27th, the phenomenon lasted from about 8.50 to 9.10 p.m. After the beams died away, the upper part of the western sky was tinged by a delicate pink haze. Mr. A. J. R. Jenkin sends a similar account of the beams as seen by him at Trewirgie, Redruth, on June 27, at 8.45 p.m. He noticed at first "a pink glow low down in the south-east, exactly opposite the sun; this soon sent out streamers. Meanwhile, a pink patch of considerable extent had appeared about midway between the horizon and the zenith in the north-west above the sun, and this also quickly resolved itself into rays converging towards the sun corresponding to those in the east, so that at one time they could almost be traced right through the zenith, and one of the rays lower down to the north could be plainly seen right across from west to east. As the western glow increased so the eastern diminished, until at 9 p.m. there was nothing to be seen in the east, but in the west the rays were most striking. Appearing to rise out of a clear belt of lemon-yellow colour along the horizon, they extended high up into the sky. As the sun got further north below the horizon the rays rotated on their axis (the sun) in the opposite direction. They could be distinctly seen up to 9.20 p.m., when they had almost sunk into the belt on the horizon, which by this time was of a similar pink colour."

It is officially declared that the statement recently made to the effect that the Meteorological Department in India has indicated the probability of a deficiency of rain, more especially in Gujerat, is incorrect. The Government of India have, however, decided not to make public the forecasts which the department submit to them from time to time, on account of the imperfect data on which such forecasts are necessarily based. The weekly reports which are sent home by the Government of India, and published in this country, give the most trustworthy indications that can be obtained, both of the actual facts and of the prospects for the future. The last of these reports, for the week ended June 22, stated that the monsoon had given heavy

rain in the west coast districts, light rain in the Deccan and Sindh, and showers in Gujerat. Good rain has also fallen in Burma, Assam and Lower Bengal, and agricultural prospects up to the present are on the whole satisfactory.

THE discussion of the origin of eskers has led to a large amount of literature. Many geologists now believe that these winding ridges of glacial gravel are the product chiefly of the subglacial drainage of an ice-sheet. Mr. W. O. Crosby (*Proc. Boston Soc. Nat. Hist.*, vol. xxx. May, 1902) seeks to show that under normal conditions the deposits of gravel and sand formed in a superglacial channel may be let down upon *terra firma* without obliteration and without loss of the distinctive features of an esker.

DR. S. HEPITES has recently issued the fifteenth volume (for 1899) of the *Annales* of the Meteorological Institute of Roumania. One of the most valuable memoirs contained in it deals with the rainfall of the kingdom, and is illustrated by a map drawn to the scale 1 : 1,000,000 and based on observations made during the fifteen years 1884-1898. Dr. Hepites also describes briefly six slight earthquakes felt during 1899.

EARLY last month the *Standard* and other newspapers contained reports of tremors and rumbling sounds observed on the night of June 3 chiefly in the west of Essex. The times given are not very exact, but were roughly about 11.15 and 11.45 p.m. The resemblance to earthquakes must have been somewhat close, several persons accustomed to earthquakes in other countries being convinced that the disturbances were of seismic origin. The long duration of the vibrations, however, and their apparent transmission through the air, point to an artificial origin, and there can be no doubt that they were caused by the firing of heavy guns that took place at the mouth of the Medway at about the times mentioned. The tremors were noticed and were attributed to earthquakes at places as far as North Mimms and Elstree in Hertfordshire, which are 46 miles from the mouth of the Medway, and at Little Shelford, near Cambridge, distant 55 miles.

THE third volume of the *Annales* of the National Observatory of Athens has been published recently. Besides the usual meteorological tables, it contains two memoirs by the director, Dr. D. Eginitis, one on the observation of shooting-stars at Athens during the years 1897-1899, and the other on the earthquakes felt in Greece during the year 1899. From the latter we learn that 567 earthquakes were recorded, the mean annual number for the six preceding years being 531. Of this large number, 421 were felt in Zante, though some were not entirely confined to that island. The most important earthquake was one that occurred on January 22 in the province of Triphylie on the west coast of the Peloponnesus. This was strong enough to throw down houses over a district 18½ miles long and 10 miles wide, though the total area disturbed was less than 15,000 square miles. It was recorded at Shide, in the Isle of Wight, the mean velocity to that station being 21 km. per second.

PHYSIOLOGISTS have during late years regarded hemoglobin and its derivatives in the animal organism as occupying a somewhat analogous position to that of chlorophyll and its derivatives in the vegetable kingdom, a view which may be said to be the outcome of recent chemical and spectroscopic research. It is well known, for example, that these complex organic pigments produce characteristic absorption bands in the ultra-violet part of the spectrum. Just lately, however, it has been shown by MM. L. Bier and L. Marchlewski (*Bulletin International de l'Académie des Sciences de Cracovie*, April, 1902) that this fact is not apparent in the spectra of all the derivatives of the colouring matter of the blood (hemoglobin); for these observers

have demonstrated by photographs of the spectra of bilirubin, biliverdin, urobilin and proteinchrom that the characteristic bands in the violet part are absent. But from this observation we must not necessarily infer that these organic pigments are not derivatives of hemoglobin, for, as these investigators point out, the characteristic absorption bands in the violet area of the spectrum produced by the complex molecule of hemoglobin may not depend on the constitution of the nucleus forming the basis of this complicated mother substance, but may arise from certain atomic groups which may not appear in some of its derivatives.

A CORRESPONDENT directs attention to the absence of any reference to Dr. Gaskell's work in the note in our issue of June 19 (p. 184) on Prof. Patten's account of the affinities of Tremataspis. The same absence characterises Prof. Patten's paper, to which our remarks were restricted.

In the geological series of publications issued by the Field Columbian Museum, Mr. E. S. Riggs describes the Triassic and Jurassic of the Rio Grande, Colorado, which have yielded so many remarkable dinosaurian remains. The paper is illustrated with some excellent photographic reproductions of the striking scenery of the district.

In describing a species of "sand-fly" allied to *Ceratopogon albopunctatus*, Mr. W. R. College, in vol. xvii. part i. of the *Proceedings* of the Royal Society of Queensland, states that it is probably only the females of these irritating insects which attack human beings. Out of fifty specimens caught on the author's own hands, only one was a male. The sexes are readily distinguishable by the antennæ, which are plumose in the female and filiform in the male.

We have received from the authors, Messrs. Eckel and Paulmier, a copy of a synopsis of the snakes of the north-eastern United States published in the *Bulletin* of the New York State Museum and forming the first instalment of a complete catalogue of the reptiles and amphibians of New York. In the present part the distinctions between venomous and harmless serpents are indicated in a clear manner, while the various species are well described and in many cases illustrated by figures of the head.

We have received from the authors copies of two papers relating to the iguanodons of Bernissart, in Belgium, and the nature of the country at the time of the entombment of their remains. The one, by Mr. L. F. de Pauw, who restored the skeletons, appears in vol. iv. of the *Memoires* of the Hainaut Scientific Society, while the other, by Prof. van den Broeck, is issued in the *Bulletin* of the Belgian Geological Society for the present year. Both writers support the view of Messrs. Cornet and Schmitz that the Bernissart iguanodons inhabited the margins of a lake, and not, as has been supposed, a narrow gorge cut in Carboniferous rocks and filled up by deposits of Wealden age. The features in the section which led to the promulgation of the latter view may be explained by earth-movements of post-Wealden age. Mr. Pauw has made an interesting restoration of a group of iguanodons round the old Bernissart lake, a photographic reproduction from which accompanies the memoir. The author believes that these reptiles often walked on all fours, especially when leaving the lake.

AMERICAN naturalists are devoting more and more attention to the mammals and other vertebrates of the Old World, and by means of vigorous collecting are adding largely to the list of species and races. In the *Proceedings* of the U.S. Museum, for instance, Mr. G. S. Miller describes a large collection of mammals from the Andaman and Nicobar Islands, in the course of which he names a number of mice, as well as other

forms. No less than thirty-five species of mammals are definitely recognised from these islands. Another paper by the same author, dealing with oriental mammals, based on specimens collected by Dr. W. L. Abbott on the islands of the Malay and China seas, appears in the *Proceedings* of the Philadelphia Academy for March, and likewise contains descriptions of a number of forms regarded as new. In a third contribution, published in the journal last mentioned, Mr. A. E. Brown describes a collection of reptiles and amphibians from Borneo and the Liu-kiu Islands, in the course of which a few new names are proposed. In the case of mammals, forms inhabiting different islands, no matter how closely related, are regarded as distinct.

THE *Lancet* of June 21 publishes the report of a lecture delivered by Dr. Rose Bradford before the University College Medical Society on the relation of biology to medicine. After remarking that the subject may be regarded from three points of view—from its educational value, from its relation to practice, and the influence which it has exerted, and probably will exert, on the progress of medical research—the lecturer calls attention to the value of biological study, and more especially to the work of the field-naturalist, as a means of promoting accurate observation. Biological studies, both anatomical and physiological, have a further great advantage to the medical student in giving him a broader conception of the complexity of living matter than if he confines his studies to the human subject. In regard to the relation of biological study to medical practice and research, Dr. Bradford emphatically urges its importance, pointing out the number of diseases now definitely known to be due to animal or vegetable organisms, such as malaria and other blood-affections, and the morbid processes originated by the presence of funguses. It is further suggested that the true nature of cancer may be discovered by biological rather than by purely pathological researches. The lecture concludes by emphasising the importance of a careful study of variation and heredity to the medical practitioner who hopes to advance his profession.

THE Report of the Field Columbian Museum of Chicago for 1900-1901 indicates a continued and rapid progress of this institution. "Inappropriate and undesirable material," writes the director, "is constantly disappearing, to be supplanted by that which is nearer the standard, and the Museum is doing museum work; while the laboratory and the study are not neglected, yet the fact that the Museum is dedicated to the enlightenment, instruction and in a measure to the entertainment of the public is not ignored, and those things calculated to advance this policy are those that most engage the attention of the officers of the institution. As a natural consequence, the general appearance of the Museum is never the same, constant additions, changes and renewals, &c., making the exhibition halls always fresh and inviting." The Field Museum was one of the first to adopt the system of mounting the larger mammals on artificial groundwork in imitation of their natural surroundings, and the Report before us contains a photograph of a big-horn sheep and another of a "sounder" of wart-hogs taken from groups in the Museum, which serve to show the careful and realistic manner in which the plan is carried out. An exhibit of much interest is a model of a limestone cave, with natural stalactites and stalagmite, and specimens of the animals which inhabit such situations. This model is lit up by electricity. The idea is so excellent that it might be adopted by other museums.

THE Hull coins and tokens in the Hull Museum have been described by Mr. William Sykes, an authority on the subject, and issued as one of the illustrated penny guides to the

collections of the Museum. We have previously drawn attention to this excellent series of museum publications, which is due to the energy of the curator, Mr. T. Sheppard.

THE sixth annual report of the New York Zoological Society gives a very favourable account of the progress of the "zoological park" now established on the northern confines of New York, so far as the plans of the Society have yet been carried out. The objects in contemplation by the founders of the association were the creation of a zoological garden with a special view to the preservation of the larger native animals of North America (now, alas! fast becoming extinct) and the



FIG. 1.—Primates' House.

general promotion of the science of zoology. Although the Society is of a private nature, its relations to the city authorities are of the closest kind, and are pronounced in the report on the whole to be in an extremely satisfactory condition. The various buildings in the park are making good progress. One of the chief of them, the "Primates' house," was completed and opened in December last with a series of 114 living specimens of the order Quadrumana, amongst which were two large examples of the rare Gelada baboon of Abyssinia, besides oranges, chimpanzees and gibbons. Of the collections of bears and the herds of prongbucks and other animals, good reports are also given, but as the new "park" contains an area of some 260 acres, it will take some time to fill it. We are glad to see



FIG. 2.—Prong-horned Antelope Herd in 1902.

that the scientific element is well represented on the council of the Society, as is testified by the names of Dr. Allen and Mr. Chapman, of the American Museum of Natural History, and of Mr. H. F. Osborn, of Columbia University. Besides these authorities, the director, Mr. W. T. Hornaday, is well known in zoological circles. The report is illustrated by a front view of the new Primates' house (Fig. 1), a sketch of the herd of prongbucks (Fig. 2) and other good plates. The present number of members of the Zoological Society of New York is stated to be 1182, which in such a populous and wealthy city might well, we think, be considerably increased if such a valuable institution were supported as it ought to be.

THE harpoon is the most complicated of the devices invented by uncivilised peoples. The harpoon is the climax of piercing inventions, and may be held in the hand or hurled from it with or without the aid of devices for propulsion. It has no limits in its application, being equally efficient on the land, in the air, in the water or through the ice, at long range or short range, with short shaft or long shaft, some examples being known in which the shaft is 100 feet in length. The simplest forms have three rude parts; the most highly developed have a score or more. With characteristic detailed description and wealth of illustration, Dr. Otis T. Mason has published a monograph on "Aboriginal American Harpoons: a Study of Ethnic Distribution and Invention," in the Report of the U.S. National Museum for 1900 (1902, p. 189). As the old whaleship has been replaced by the ship driven by steam, so the Eskimo at present kills the seal, the walrus, the whale and the Arctic land mammals with a rifle and explosive bullets instead of the ancient harpoon. Should the Eskimo use his great weapon at all it will be to retrieve his game on the edge of the ice after it is shot, and not as a killing device.

An industry that promises to make progress in Russia consists in the manufacture of oil cakes from the seeds of the sun-flower, and (says the *Engineer*, June 20) good results have already been obtained. The seed with a proper crushing and treatment yields, roughly, 23 per cent. oil, 40 per cent. oil cake and 37 per cent. stalk; the stalk is also used for driving the machinery of the mill, and the ash by being further treated produces 25 to 30 per cent. of potash.

"THE Niagara Falls Power Plant as a Factor in Engineering Development" forms the subject of an instructive and impressive article in the editorial columns of the *Engineer* (Cleveland, June 2). The power of the Falls is practically unlimited, for the amount of falling water has been estimated by Prof. Unwin at 300,000 cubic feet per second, and this amount at a head of 165 feet would generate 10,000,000 horse-power. The plant as put down eleven years ago consisted of two-phase alternating current dynamos of 5000 horse-power (250 revolutions per minute), with a voltage of 2200 and a "frequency" of 25 cycles per second; these were coupled to vertical turbines placed in the wheel pit by shafting 136 feet long. The turbines were of double design, whereby at normal load the lifting action of the escaping water would balance the weight of the revolving parts of the machine. This plant, after eleven years' running, is about to be enlarged and a considerable increase of power derived from the falling waters, and thus we find record again broken at Niagara, where three generators (each of 10,000 horse-power) will be placed in the power house on the Canadian side and will form the nucleus of a plant with a 100,000 horse-power capacity. These generators will be double the size of the old ones and three phase instead of two phase, with a voltage of 12,000 as against the 2200 used before, and the "frequency" and speed will be the same, namely, 25 cycles per second of the former and 250 revolutions per minute of the latter. The transmission voltage in all probability will be fixed at 60,000, which, if adopted, will be 10,000 volts higher than that used in California by the Standard Electric Company on their famous long-distance line.

BOTANISTS who are desirous of filling gaps in their herbaria of cryptogamic plants will be interested to know that Mr. J. Brunthaler's of Johann Straussgasse, Vienna, has published a list of these plants which are for exchange or for sale. The series of Pteridophyta is exceedingly meagre, but the remaining groups are fairly well represented.

A BIBLIOGRAPHY of the analytical chemistry of manganese from 1785 to 1900 has just been published by Messrs. H. P.

Talbot and J. W. Brown, and forms part of vol. xli. of Smithsonian Miscellaneous Collections. The same volume contains a compilation of the statistics of the chemical societies of the world for the year 1900, by Dr. H. C. Bolton.

ACCORDING to a new patent of the Chemische Fabrik Griesheim-Elektron, lead dioxide is now produced electrolytically from a solution of an alkali chloride in which litharge is suspended. The dioxide is formed at the anode by the action of nascent chlorine and sodium hypochlorite on the sodium plumbite produced from the litharge and the sodium hydroxide set free at the cathode. No loss of chlorine takes place at the anode during this electrolytic process.

VOL. xxxvii. of the *Proceedings of the American Academy of Arts and Sciences* contains the results of an investigation of the decomposition of mercurous chloride by dissolved chlorides, by Messrs. T. W. Richards and E. H. Archibald. It is shown that this decomposition is quite considerable if the chloride solutions are fairly concentrated, a point of considerable importance in the analytical determination of mercury as mercurous chloride. The action is not of a catalytic nature, but a definite condition of equilibrium is set up, the dissolved mercury existing probably in the form of a complex ion represented by the formula $HgCl_4$ in the solution.

WHILE admitting that the evidences of embryology, vestigial traces, and geographical distribution have rendered it indisputable that species have arisen in our world, not through creation in each fresh case, but through descent from other kindred species with variation, Mr. James B. Johnston maintains, in an article "What About Natural Selection?" in the *Contemporary Review* for July, that the proved influence of natural selection is being written down as less and less every day. The article is concerned only with the evidence of palæontology.

THE additions to the Zoological Society's Gardens during the past week include a Vervet Monkey (*Cercopithecus islandii*) from South Africa, presented by Mr. J. M. Hemingway; an African Tantalus (*Pseudotantalus ibisi*) from West Africa, presented by Mr. C. T. Reaney; two Black Salamanders (*Salamandra atra*), an Alpine Newt (*Molge alpestris*) from the Alps, presented by the Rev. J. W. Horsley; a Common Viper (*Vipera berus*) British, presented by Mr. E. Ball; a Chacma Baboon (*Cynocephalus porcaricus*), a Natal Sternother (*Sternotherus sinuatus*), from South Africa, a Ludio Monkey (*Cercopithecus indio*) from West Africa, two Grey Lemurs (*Hapalenur griseus*) from Madagascar, two Azara's Opossums (*Didelphys azarae*) from La Plata, a Botta's Snake (*Charina bottae*) from North America, deposited.

OUR ASTRONOMICAL COLUMN.

CHANGES ON THE MOON.—The June number of the *Century Magazine* contains a popular account of the observations of the moon made by Prof. W. H. Pickering at Flagstaff, Arizona, and Jamaica, illustrated with pictures from drawings and photographs. Previous workers have already shown that some markings on the lunar surface were in all probability of a variable nature, but the new observations demonstrate beyond doubt that the surface of the moon is subject to distinct changes, and Prof. Pickering gives some very decisive instances where radical alterations have actually been observed. Attention also is drawn to the existence of seas, canals and lakes on our satellite's surface, terms which have very generally been adopted with reference to the planet Mars, but which are employed here with the full understanding that they do not imply in any way the existence of water in the liquid form. These canals are described as being smaller than those on Mars, but broader in proportion to their length; in colour they are grey and yellowish-white. Many of the changes on the lunar surface are caused by the growth, as Prof. Pickering states, of the lunar vegetation itself, and he quotes a particular

region situated just to the right of the central peaks of Eratosthenes where he observed the most marked change; reference is further made in some detail to the changes observed in some of the canals and lakes. The importance of these observations to geology and the great interest attaching to them should undoubtedly stir up a new desire in many workers to follow and continue these researches, which require no very great instrumental equipment.

REMARKABLE NAKED EYE NEBULOSITY.—MR. W. II. Robinson, writing from the Radcliffe Observatory, Oxford, sends us a description of a curious object observed by him on May 28. Whilst observing with the Radcliffe transit circle at 11h. 19m. G.M.T., his attention was directed to a nebulous object about eight degrees from the zenith. "It was small, but bright and well defined, elliptic in form (major axis 2', minor axis 1'·5), and situated about half-way between η Ursæ Majoris and α Lyre, but a few degrees south. The object very much resembled the Presepe when that cluster is visible in a somewhat hazy sky, an atmospheric condition which prevailed at this time. At first I supposed the object to be a comet, but was soon disillusioned on this point, for in a few minutes its evanescent character was revealed, and, gradually fading, by 11.30 G.M.T. it had entirely disappeared."

The position of the nebosity was found by means of a star atlas to be

R.A. 16h. 15m.
Decl. + 44°.

The sky was watched until midnight for any return of the phenomenon, but nothing was seen except at about 11h. 42m., when a faint patch of light appeared for a few seconds only, about two degrees east of the above position. The luminosity was apparently not of an auroral nature, and Mr. Robinson suggests that it may have been the trail of a meteor, several instances of meteor clouds of this character having been recorded.

Other observations of the object observed on May 28, if forthcoming, would probably enable a determination to be made of its distance and nature.

A THEORY OF VOLCANOES.—In a forcible exposition of a theory which supposes high-tension terrestrial electricity to be the immediate cause of volcanic eruptions, M. A. Taquin, in the *Revue Scientifique* for June 14, brings together some remarkable observations of the connections between volcanic, solar, magnetic, and terrestrial electrical phenomena. The author provides for the disruptive forces and the heat which attend volcanic actions, by the discharge of this high-tension electricity, and then connects this electricity with the previously observed relations between solar, and terrestrial electrical and magnetic phenomena.

M. Taquin accounts for the remarkably sudden deaths of the inhabitants of St. Pierre by supposing that they were electrocuted, and proceeds to urge, in the following words, the establishment of observatories in volcanic districts:—"I am convinced that the study of the manifestations of terrestrial electricity in such districts will give us the means of foreseeing these volcanic eruptions."

THE FRENCH GEODETIC MISSION TO THE EQUATOR.—Commandant Bourgeois gives an interesting and detailed account of the first year's work of the French geodetic expedition in the *Bulletin de la Société Astronomique* (June, 1902). M. Bourgeois first explains that the *raison d'être* of the mission is "to determine certain elements by which to calculate the dimensions of the earth," and he then proceeds to answer the following self-imposed questions:—(1) What are these elements? (2) How are they to be determined? (3) Why is it necessary to make the observations in a place which is so distant and so difficult to reach? In answering these questions the author describes the inauguration, the organisation, and the journey of the mission to Riobamba, Ecuador, S.A., and also explains why Riobamba was fixed upon as the centre of operations. The whole report, which was communicated to the Société Astronomique, gives an instructive account of the work already achieved, and is illustrated by photographs which give the reader a clear idea of the methods pursued by the mission.

OBSERVATIONS OF NOVA PERSEI.—In No. 3796 of the *Astronomische Nachrichten*, Prof. E. E. Barnard gives a brief résumé of the various observations of the Nova which were made at Lick subsequent to July, 1901.

The spectrum of the Nova suggested that it might display the same peculiarity of focus that we find in regard to planetary nebulae, but a series of observations made between August, 1901, and January, 1902, failed to give any indications of this phenomenon.

The determined position of the Nova with regard to fourteen stars in its immediate vicinity—of which Prof. Barnard gives a chart—agrees fairly well with that already published by Prof. Aitken (Lick Observatory Bulletin, No. 8), and a comparison of the two sets of observations confirms no real motion of the Nova.

The observations of brightness, which extend from July 30, 1901, to April 15, 1902, show a gradual decrease in the magnitude of the Nova, with occasional brightenings in which, however, there appears to be no definite periodicity. After special measurements, Prof. Barnard disagrees with the Potsdam magnitude of the reference star B. D. 43° 270 and uses his own estimated value, which is about 0.2m. fainter than that of Potsdam, i.e. it is 7.56m.

Careful observations with the great telescope have failed to reveal, visually, the nebulosity surrounding the Nova, the light of which is probably mainly photographic, nor has Prof. Barnard been able to discover the 12.0m. star recorded by Prof. Cerassi as being 0.31s. following and 7" south of the present position of the Nova (*Astronomische Nachrichten*, No. 3755).

NEW VARIABLE STARS.—The two new variables, as given below, are recorded in No. 3796 of the *Astronomische Nachrichten*.

11, 1902, *Lyrae*.—Mr. Stanley Williams reports the variability of the star, the position of which, as measured on various negatives, is 19h. 7m. 37s. 4 + 41° 3' 7" (1855); its magnitude ranges from 11.10 to 12.20. Examination of the various records shows that the brightness of this star was approximately the same, in September, in 1899, 1900 and 1901, so that its period is probably exactly one year, or possibly one half-year.

12, 1902, *Pegasi*.—Herr K. Graf reports the variability of the star, the position of which is 22h. 7m. 30s. 15 + 14° 4' 10" (1902), its range of variability being from 8.7m. to 9.4m.

DELAY OF THE MINIMUM OF U CEPHEI.—In No. 3796 of the *Astronomische Nachrichten*, Mr. J. Plassman records a delay of about 2h. 27m. in the minimum of U Cephei, on April 27, after the time of minimum recorded at Münster.

EARTHQUAKE NOTES.

THE seventh and eighth numbers of the new series of publications issued by the Earthquake Commission of the Kaiserlichen Akademie der Wissenschaften in Wien respectively refer to earthquakes which have been noted in certain parts of the Austrian Alps and in the Carpathians. The first of these, by Dr. R. Hoernes, is a register of 208 shocks observed in Styria between the years 1000 and 1870. Many of these disturbances are described in detail, and to each description there is appended a criticism of the various sources from which the author has derived his information. To complete this work, earthquakes which shook Styria, but originated beyond its borders, have to be considered, and, lastly, the districts shaken and the lines along which shocks have been distributed have yet to be determined. In short, what E. Suess has done for lower Austria and H. Hofer for Carinthia is to be done for Styria. The second publication, by Prof. W. Laska, is an historical account of the earthquakes of Poland. It refers to a period practically identical with that considered by Dr. Hoernes. The author commences by saying that "earthquakes in Poland are rare," but as reference is made to earthquakes of distant countries which were synchronous with observations made in Poland, the description of Galician shocks extends over thirty-six pages. As an example of these references we read that the first earthquake in 1834 occurred on January 23 at 8h. 45m. and was observed in Tarnopol. On the same day there was an earthquake in England, the epicentrum of which was five miles north of Chichester, and it is worthy of note that there was a similar coincidence in 1666. The probability, however, is that if we had before us a register of all the earthquakes of the world, a coincidence might be found for each of the Carpathian records. In the general remarks attached to these registers we find several interesting notes on the emotional effects produced by those who have predicted the occurrence of earthquakes on

specified dates. An accidental realisation of a widely published prediction took place on February 27, 1876, with the result that processions were organised and prayers were offered that earthquakes should not only shake Poland, but that a few should be arranged for Prussia.

In November, 1900, Prof. E. Odone gave an account in the *Bollettino della Società Sismologica Italiana* (vol. vi.) of forms of apparatus he proposed to introduce into seismometry which did not have the character of pendulums. The object of the first piece of apparatus was to measure the relative motion of two points of ground separated by a short distance. A seismographic arrangement identical with that proposed by Prof. Odone was used in Japan in the years 1884 and 1885. It showed that for fourteen earthquakes the relative motion of the heads of two stakes 3 feet from each other varied between 1 mm. and .08 mm. (*Trans. Seis. Soc.*, vol. xii. pp. 63-66). The second piece of apparatus has the character of a manometer, and in its improved form as now constructed is described in the *Rivista di Fisica* (Pavia), December, 1901. It consists of a chamber about 2 m. in height and holding 200 l. of water, embedded in the foundations of a wall. At the upper and lower ends of this chamber are two passages closed by sheets of iron. On one side these sheets are in contact with the soil in which the foundations are buried and on the other side with the water of the manometer. Should a shock be transmitted through the soil, these metal diaphragms are deflected, with the result that the water from the chamber rises in a small tube 0.85 cm. in diameter, which is attached to the upper end of the manometer. The effect of vibrations due to explosions of powder in mines—in one instance amounting to 10,000 kgr., the apparatus being at a distance of 1 km.—have been studied, and it is seen that the changes of level in the manometric gauge are such as can be easily measured. From this apparatus it is expected to obtain certain direct measurements of earthquake energy, and from a manuscript note attached to the copy of the paper describing the same it is also anticipated that it may record volcanic sounds.

STATISTICAL METHODS IN BIOLOGY.

THE third part of *Biometrika*, published in April, contains several important contributions, the first of which is by Prof. Karl Pearson, who describes "a systematic method of curve-fitting by moments." For practical purposes it is found that if good quadrature formulae are used this method is as good as the well-known method of least squares, and in some cases is applicable where the older method fails. Examples of the application of the new method are given. A communication on the sources of apparent polymorphism in plants comprises an editorial introduction and four papers by Messrs. G. Udny Yule, W. L. Tower, Dr. Alice Lee and Prof. Karl Pearson, and Mr. Yule respectively. Those who have considered the "multimodal" character of many botanical distributions as furnishing evidence of the existence of subspecies or local races will find reasons for reconsidering their views in these papers. In this part also Prof. Pearson contributes a controversial paper under the title "On the Fundamental Conceptions of Biology," in which he deals with discontinuity, differentiation and variation, and replies to Mr. Bateson's criticism of his memoir on the principle of homotopy published in the *Philosophical Transactions* (vol. xcvi. pp. 285-379). Another controversial paper by Prof. Weldon deals with Prof. De Vries's first volume on the theory of the mutation of species ("Die Mutationstheorie," &c., Bd. 1, 1901). The facts adduced by De Vries in favour of this intermittent and apparently anomalous mode of evolution are considered by Prof. Weldon to be inconclusive, and he comes to the conclusion that the evidence is insufficient to warrant the acceptance of this theory in preference to the selection theory of Darwin.

Among other contributions we may call attention to Mr. Blanchard's paper on "grandparental inheritance," in which he emphasises the need for further experimental work on "blending" as distinguished from "alternative" inheritance, and suggests for this purpose insects and some of the smaller mammals. Miss Lewenz publishes the completion of an investigation first started by Miss Whiteley and Prof. Pearson on the variation and correlation of the bones of the hand in woman. The conclusion is suggested "that if efficiency depends on high correlation, it is not to external measurements of the skull that

we must look for tests of intellectual efficiency." Not the least interesting paper at the present time is Dr. W. R. Macdonell's note on the result of previous vaccination on the effect of small-pox when incurred. According to the abstract "he shows that the correlation of foveation and size of scar with severity of attack is only moderate, but that there is very considerable correlation indeed in all the recent epidemics, not only between recovery from, but between the severity of the attack and the existence of the scar." It has not hitherto been found possible to obtain statistical data for deducing the correlation between the presence of the scar and the habit of life of the persons attacked. To the miscellanea Mr. Yule contributes a note on local death rates. It is evident from this synopsis that the standard of the publication is being well maintained and that the new biometric methods are capable of extension over the most diverse fields of biological science.

AVIAN ORGANOGENY.¹

DR. MITCHELL has already devoted considerable attention to the study of the intestinal tract of birds, and in the present contribution he gives us the results of his latest researches, which have embraced all orders of birds and many of the smaller groups.

Adopting the method of investigation pursued by Cuvier, the intestinal tract is removed from the body by severance at the pylorus and the cloaca, and along the mesentery close to the body-wall. Next, the cut ends of the gut are pinned down and its coils unravelled, until they stand revealed as a corrugated tube suspended by the ventral edge of the mesentery.

In tracts so displayed, Dr. Mitchell recognises three distinct loops, a duodenal, a rectal, and a large loop lying between these two which he calls Meckel's tract. The comparison of the varied forms which these loops take constitutes the subject of Dr. Mitchell's researches.

Evolution is rightly the key-note of this work, and accordingly the author starts with a detailed description of what he regards as the most primitive type of gut, from which all others have been derived. This type—found not, as one might have expected, in one of the Ratites, but in the ancient goose-like bird, Palamedea—he calls the archecentric type, whilst modified conditions thereof are distinguished as apocentric. Three kinds of apocentricity are recognised—multiradial, uniradial and pseudocentric. Multiradial apocentricities are those which are purely adaptive or homoplastic, and accordingly are of no value as indications of kinship, since they may, and do, occur repeatedly and independently in different groups. Uniradial apocentricities, on the other hand, Dr. Mitchell defines as complex modifications "of a kind that we cannot well expect to be repeated independently, and . . . must be the most certain guides to affinity."

Not seldom a uniradial apocentricity will form a new centre around which new diverging modifications are produced, and such centres he proposes to call metacentric.

Pseudocentric apocentricity appears to be extremely common and very difficult to distinguish from the archecentric condition. Generally, however, its secondary nature is revealed by some small and apparently meaningless complexity.

The valuation and nomenclature of these characters form a special section of Dr. Mitchell's paper. It is extremely suggestive, and will be read with interest by many who are not directly interested in avian morphology.

The systematic description, which follows this discussion, occupies the bulk of the paper, the intestinal tract of every order of birds being reviewed, copious illustrations serving to bring out, not only the very striking modifications which have taken place, but also the difficulty of the work undertaken.

Space forbids us dwelling, as we would fain do, on this section and the summary thereof at greater length. Suffice it to say that the very remarkable modifications of these loops, which Dr. Mitchell has brought to light, are extremely interesting and very suggestive. We venture to doubt whether a good case has been made out for the position, near the Ralline forms, which has been assigned to the Tinamous. Markedly apocentric though they may be in the matter of their intestinal

coils, yet we see no reason why they should not be allowed to remain among or very near the Ratites.

The concluding section, on "Characters and Classification," forms a most admirable summary. "In the systematic descriptive part," the author writes, "my task was to treat the characters of the patterns displayed by different birds as nearly as possible as if the gut were the whole animal, and the various phylogenetic figures and the three plates display what I take to be the relations of the intestinal tracts, and not necessarily the relations of the possessors of these tracts. I have been taking, in fact, the anatomical structure as the unit, and not the individual or the species. . . . Granting that the plates attached to this paper represent with approximate accuracy the phylogeny of the intestinal tract in birds, we have yet to learn the relation of the phylogenetic tree of this structure to the phylogenetic trees of other structures, and the relation of all these to the phylogenetic trees of those impermanent combinations of characters which we call species."

We would fain quote more of this interesting section, but enough has, we trust, been set down here to draw the attention of morphologists generally to a contribution which is at once valuable and suggestive, and likely to remain the standard work of reference on this subject for some years to come.

W. P. P.

PHOTOGRAPHY AS APPLIED TO ARCHITECTURAL MEASUREMENT AND SURVEYING.¹

WHILE the impressions which a photographic picture yields to a casual observer may or may not be correct, the relationship which exists between a photograph and the objects the images of which are depicted is always definite, and a little careful attention in arranging the conditions under which a picture is taken will suffice to make easy the correct interpretation of it.

To understand the geometric nature of a photograph it must be noted and always remembered that for practical purposes a photograph is a surface of two dimensions, which for choice should be a plane surface, and it is only possible to obtain by photography exact copies of similar object surfaces, and these only when the surfaces to be copied are exactly parallel to the picture surface.

Under these conditions written or printed documents or drawings can be, and often are, copied by photography, so as to be practically exact copies of the originals. The copies may be the same size, or larger or smaller, but all proportionate dimensions will be the same, whatever the relative sizes of object and image may be.

To illustrate the first elementary principles of the subject a photographic picture of straight lines and right angles, arranged to form a set of regular squares, was projected on a movable screen. It was shown how, when the screen was parallel to the lantern slide, there was no perceptible bending of the lines and no perceptible enlargement or diminution of any of the angles, from which it might be concluded that there could have been no perceptible distortion in any part of the picture. By moving the screen nearer to, and further from, the lantern, it could be seen that while the forms of the squares remained constant their areas varied with the distance, in obedience to the ordinary laws of rectilinear radiation, from a point, and it was shown how a photographic picture may be legitimately regarded as being made up of a number of points, each one of which is at the picture end of a straight line, which may be taken for practical purposes to have travelled from a corresponding object point through a station point at the apex of a cone of rays radiating towards the picture.

The geometric relationship between distant objects and photographic images of those objects can be most easily appreciated if the lens is supposed to be replaced by a pinhole at the station point, when it is evident that a straight line from any point of the image to the pinhole will, if prolonged, pass through the corresponding object point, and *vice versa*. Thus any number of true direction lines can be obtained at will.

For making plans, these direction lines can be projected as horizontal rays on a ground plane as in plane table surveying, and positions can be fixed on the plan by the intersection of

¹ "On the Intestinal Tract of Birds: with Remarks on the Valuation and Nomenclature of Zoological Characters." By P. Chalmers Mitchell, M.A., D.Sc. (*Trans. Linn. Soc.*, vol. viii. part vii. 1901.)

¹ Abstract of a paper, by Mr. J. Bridges Lee, read before the Society of Arts on April 16.

such rays from two stations, and checked by rays from photographs taken at a third station when the original intersections are not good or the identification of points doubtful.

When the positions on a ground plan have been fixed and horizontal distances from the different stations have become known, altitudes of points above or below the station can be ascertained by observing the position of the points on the picture and substituting values in a simple formula $h = d \tan \alpha$, where h is the height required, d is distance from the station



FIG. 1.—View from roof of Drummond's Bank overlooking Trafalgar Square.

point for the particular photograph under observation and $\tan \alpha$ is $\frac{y}{x + \sqrt{x^2 + y^2}}$, where x and y are abscissæ on the principal horizontal and vertical lines as rectangular coordinate axes and f is focal distance for the picture. The practical working of this method of plotting horizontal intersections for obtaining a ground plan and then computing altitudes was illustrated by reference to a series of survey photographs from the south and



FIG. 2.—View from corner of roof of Union Club overlooking Trafalgar Square.

west sides of Trafalgar Square, looking north-east and east, and a plan of the square and neighbourhood on which horizontal traces of the picture planes were drawn. It was explained how in practice the horizontal distances of points from the principal vertical line of a photograph are first set off on narrow strips of paper, which are then transferred to the picture traces on the plan and direction lines set off from the station points through the selected points on the strips, when in all cases the direction

lines would pass through the corresponding points on the ground plan of Trafalgar Square and the visible region round. It was also explained how to compute the height of St. Martin's Church from the pictures.

Two of the pictures used for illustration are here reproduced. It will be seen that these pictures bear some markings on their faces which are not usually found on ordinary photographic pictures.

(1) The horizontal line right across the picture is the horizon line, which marks the trace of the horizon plane of the lens (or station). It contains the principal axis of the lens.

(2) The vertical line is the trace of the principal vertical plane, which also contains the principal axis of the lens and the station point.

(3) The intersection of (1) and (2) is the centre or principal point of the picture perspective.

(4) The scale at the top is part of a compass scale, and serves to show the magnetic orientation of the principal axis of the view, the vertical line serving as index.

(5) The scale immediately below, which stretches as a band across the picture, is a scale of reduced horizontal angles (a tangent scale to a great circle of a sphere of radius equal to the exact working focal length).

The MS. notes in the corners are memoranda originally noted on slips of celluloid by the photographer and put in place in special carriers before each picture was taken. All these markings were printed as latent images at the same time exactly and by the same exposure as the picture.

It was explained how all these markings were accurately obtained by aid of a simple mechanism specially designed by the author, who is responsible for introducing the system of recording automatically on the picture face information necessary for interpreting the picture, and how by aid of this information practical photo-surveying, which used to be often difficult, has become very easy and much more certain and accurate than formerly. The apparatus specially designed by the author and used for obtaining these pictures was shown and explained in some detail.

The lecturer concluded by expressing a hope that in due time a simple standard type of working camera, fitted with a good lens and accurate recording mechanism (which could be easily removed and replaced at will), would find its way into general favour, and that regular libraries of standard readable pictures of interesting objects would come into existence.

UNIVERSITY AND EDUCATIONAL INTELLIGENCE.

OXFORD.—The following is the text of the speeches delivered by Prof. Love in presenting Dr. W. H. M. Christie, C.B., F.R.S., Astronomer Royal, and Dr. A. W. Rücker, F.R.S., Principal of the University of London, for the Degrees of D.Sc. *honoris causa*, at the Eneenia, on June 24.

Inter mathematicos, qui Cantabrigiæ quattuor et triginta abhinc annos graduati sunt, clarum erat nomen Willelmi Henrici Mahoney Christie, nunc inter omnes omnium gentium astronomos clarissimum. Astronomorum profecto ille annus magno proventus floruit cum in eodem Tripode Georgii Darwin nomen contineatur. Ambo hi viri Collegii Sanctæ Trinitatis socii creati sunt, sed in astrorum scientia alter alteram instebet viam. Ille solis stellarumque solis parentium ultimam vetustatem investigabat: hic noster se negotio utiliori dedit ut solis stellarum siderumque omnium et locos qui nunc sunt et motus accuratissime notaret. In hoc opere tantam peritiam adeptus est ut iam viginti abhinc annos et Astronomus Regius et Societatis Regalis Sodalis crearetur. Hoc gubernante fere omnia in Observatorio Regio maximo vel novata vel in melius mutata: neque enim id solum curavit ut nova instrumentis cedent vetera, sed ut eadem paulo immutata idonea fierent ad sidera observanda observationesque ita factas memorie tradendas quemadmodum iubent astronomi recentiores. Ita vir peritissimus et rem felicissime navavit et rerario publico pepercit. Summa eius in rem publicam merita agnovit Regina nostra Victoria quæ eum titulo Comitiss de Balneo ornavit: insigni honore prosecutus sunt Academiæ Parisiensis Petropolitana aliæque complures quæ eum inter externos litterarum commercio sibi adiunctos receperunt. Huius nomine inter Doctores nostros inscripto monstrabit profecto Academia nostra se

memorem esse quantum et doctrinæ et hominum utilitatibus Astronomie scientia profuerit.

In Arturo Willemo Rücker orando Academia nostra hominem prosequitur alumnus suum, virum in docendo in rebus administrandis in rerum natura cognoscenda præclarissimum. Huius laudes agnovit Collegium Aenei Nasi, cuius olim scholaris erat, cum eum inter Socios honoris causa adscisceret: agnovit etiam Societas Regalis que duodeviginti abhinc annos Sodalem creatum numismate etiam regis pro singularibus meritis donavit. Huic de tenuissimarum bullarum natura subtiliter quaerenti contigit ut de magnitudine et ratione primarum illarum atomorum e quibus, ut antiquitus docuit Lucretius, omnis materia rerum constat, ipse multa reperiret, res altissimis tenebris alditas luce quadam scientiæ patefaceret et illustraret. Hic etiam de vi magnetica qua orbis terræ animatur peritissimè disseruit, et insularum Britanniarum descriptionem magneticam denuo faciendam curavit. Neque ei satis erat ut Naturæ arcana ipse reseraret; idem, cum Britannicæ Societatis conventui præset, contionem habuit luculentissimam de ratione quæ intercedat inter sententias philosophorum et physicorum de materia rerum doctentium, quæ effecit ut multi de hac re loquerentur, plures cogitarent: idem in Regio Scientiæ Collegio Professor physicorum et in docendo et in rerum gubernatione summa laude inlucuit: eodem denique Secretario Societas ipsa Regalis tanquam in dapem omnium virorum doctorum naturam rerum ubique indagantium symbolam maiorem contulit. Hic vir impiger tamque ingeniosus qui omni hominum societati, quæ eo duce et auctore usa est, laudem et felicitatem semper attulit, nunc Academicæ Londinensium denuo constitutæ primus Præfectus latiore profecto campum inventurus est in quo virtutes eius excurrant et cognoscantur.

CAMBRIDGE.—Prof. A. R. Forsyth, F.R.S., has been appointed a governor of University College, Liverpool, and will represent the University of Cambridge at the Abel Centenary to be celebrated in Christiania next September.

Mr. G. B. Mathews, F.R.S., senior wrangler 1883, has been re-elected to fellowship at St. John's College. At the same college Mr. J. H. Vincent, D.Sc. London, has been elected to a Hutchinson studentship for research in physics.

Mr. W. N. Shaw, F.R.S., secretary of the Meteorological Council, has been admitted to the degree of Doctor of Science.

The late Rev. Henry Latham, master of Trinity Hall, is succeeded in the mastership by Mr. E. A. Beck, senior tutor. The late master has left some 17,000*l.* to the University to form a benevolent fund, from which grants, annual or occasional, may be made to members of the University who are incapacitated for their academic duties by age or infirmity, and to their widows and families when these have been left inadequately provided for.

The complete degree of M.A. *honoris causa* has been conferred on Mr. T. H. Middleton, the new professor of agriculture. In presenting him the public orator referred to the short stay of Prof. Somerville, his predecessor in office, and added "Studiorum academicorum in provincia tam nova occupanda, speramus professorem nostrum novum inventus nostræ ingenis excolendis multo plus quam biennium esse impensurum."

MR. G. W. RUNDALL, head master of the High School, Newcastle-under-Lyme, Staffs., from 1891 to 1900, has been appointed Registrar of the Teachers' Registration Council, Board of Education.

Mr. M. J. R. DUNSTAN, director of the Midland Agricultural and Dairy Institute, and director of technical instruction to the Notts County Council, has been appointed principal of the South-Eastern Agricultural College, Wye, in succession to Mr. A. D. Hall, who was recently appointed director of the Rothamsted Experiment Station.

THE Storey Institute of Science and Art at Lancaster was given to the town by the late Sir Thomas Storey to commemorate the jubilee of Queen Victoria. But though excellent work has been done in the Institute it has been handicapped in recent years by the want of accommodation for the technical and secondary departments. The handsome coronation gift of 10,000*l.* which Mr. Herbert L. Storey has just placed at the disposal of the Corporation of Lancaster, for the purpose of

erecting a technical school on a site adjoining the Institute, will make a desirable educational development possible. Wealthy men in other centres should emulate Mr. Storey's public-spirited action.

THE Hartley Institution, Southampton, which has just been added to the list of University Colleges, and will in future be styled the Hartley University College, was founded in 1850, and has in recent years been greatly improved as a centre of scientific influence. The Institution is at present regulated by a scheme established by the High Court of Chancery in 1850 as altered or supplemented by eight schemes of the Charity Commissioners. The movement for the formation of a University College has been enthusiastically supported locally, and as soon as it became known that H.M. University Commissioners had pronounced the local University income to be 600*l.* short of the required 4000*l.* per annum, three gentlemen, interested in the College, combined together to supply the deficiency for this year, and the governing body was assured that the income should be maintained at the required sum in the future if a portion of the Treasury grant to University College was allotted to the Hartley University College. The College is primarily intended to provide the residents in the counties of Hampshire and the Isle of Wight, Dorset and Wilts with higher education, and is admirably situated geographically for that purpose. The south of England is generally supposed to be deficient in educational enterprise, and this is an additional reason why the activity which is being displayed by Southampton in the formation of this College should be welcomed by all those interested in education. It is felt that the present buildings of the Institution are inadequate for the growing number of students, and a movement is on foot for raising a sum of 100,000*l.* to enable the University College to be suitably housed. It is hoped that a beneficent millionaire will be found willing to interest himself in the scheme, and help in supplying a great deficiency in the educational equipment of the south coast. The principal of the college is Dr. S. H. Richardson.

ON June 25, in the House of Commons, the consideration of the Education Bill in Committee was resumed on the second clause, which empowers the new authorities to make provision for higher education. From the *Times* report, we learn that an amendment was moved with the object of introducing words defining the duties of the education authorities, and directing them to supply secondary, technical and higher education, and to provide for the organisation and coordination of all forms of education, including the training of teachers. It was not accepted by the Government, but a compromise was arrived at; and it was agreed that the authorities should take such steps, after consultation with the Board of Education, as might seem desirable to secure the training of teachers and the general coordination of education. An amendment was carried providing that the funds colloquially known as whisky money should be used without deduction by the county councils in promoting higher education. On Monday the Bill was again before Committee of the House. A proposal that the county boroughs should be exempted from the operation of the provision which restricts to 2*d.* the amount of the rate leviable for higher education was accepted by the Government. An amendment was brought forward empowering the Board of Education to authorise the county councils to strike a rate exceeding 2*d.* The clause gives the Local Government Board the right to increase the rate by provisional order on the application of a county council. Objection was made to this clause, and after discussion it was decided to dispense with the elaborate machinery of provisional orders and to substitute for it the simple assent of the Local Government Board to a proposed extension of the 2*d.* rate. The limit to the rating power for secondary education has thus been abolished entirely for county boroughs and conditionally for rural counties. Passing to the third clause, which proposed to give to the councils of boroughs with a population of more than 10,000 and to the councils of urban districts with a population of more than 20,000 the right to levy a penny rate for the purpose of supplying higher education, an amendment was agreed to on Tuesday conferring the same right on all non-county boroughs and urban districts. Another amendment which would have given non-county boroughs and urban districts unlimited rating power was negatived. After further discussion it was agreed that the clause as amended should stand part of the Bill.

SOCIETIES AND ACADEMIES.

LONDON.

Royal Society, June 12.—"On the Parasitism of *Pseudomonas destructans* (Potter)." By M. C. Potter, M.A. F.L.S., Professor of Botany in the University of Durham College of Science, Newcastle-upon-Tyne. Communicated by Sir Michael Foster, K.C.B., Sec.R.S.

The author gives an account of his further study of the action of the cytase and toxin, secreted by this bacterium, upon the living turnip cell; and he has succeeded in tracing the passage of the bacterium into the cells, through the cell-wall. The observations were made from pure cultures, under the most rigid sterile conditions, by means of the hanging drop. The action of the cytase and toxin was surprisingly rapid; the swelling of the cell-wall and contraction of the protoplasm could be observed almost immediately, upon the introduction of the *Pseudomonas*. Within an hour and a half the cell was dead and its walls in an advanced stage of disintegration. The original cell was kept under observation for some days, and after patient and continuous watching certain of the bacteria were observed slowly forcing their way through the wall, until finally they emerged into the cell-cavity. The penetration of the wall was observed on several occasions, and numerous individuals could be seen in all stages of the process. The time required varied with the thickness of the wall, but on an average occupied about three hours.

Important evidence of the perforation of the cell-wall by *P. destructans* was also afforded by the method of paraffin sections; by fixing and double staining, the cell-wall and bacteria were distinctly differentiated, the latter being shown fixed in the actual process of perforating the wall, and various stages of penetration could be distinguished.

Experiments showed that the old and fully developed cuticle is apparently proof against the action of the enzymes excreted by *P. destructans*, but this parasite can readily effect an entrance into its host through the undeveloped epidermis of young and tender structures.

A comparison of the parasitism of *Botrytis cinerea*, as demonstrated by Nordhausen, presented an exact parallel. The point was established that this bacterium has the power of destroying the living cells of the turnip, and, subsisting upon their dead contents, continues to work its way through the host, and it thus acts in precisely the same manner as one acknowledged parasitic fungus.

Chemical Society, June 18.—Elimination of a nitro-group on diazotisation. Dinitro- β -anisidine, by Prof. Meldola and Mr. J. V. Eyre. When dinitro- β -anisidine is diazotised in presence of hydrochloric acid the 3-nitro-group is replaced by chlorine. —Preliminary notice of some new derivatives of pinene and other terpenes, by Prof. Tilden and Dr. H. Burrows. Pinene nitroschloride, when treated with potassium cyanide in alcohol, is converted into pinene nitrosocyanide, a colourless crystalline substance melting at 171°. The latter reacts readily with various reagents, furnishing well-crystallised reaction products. —The colour-changes exhibited by the chlorides of cobalt and some other metals from the standpoint of the theory of electro-affinity, by Messrs. Donnan and Basset. These colour-changes are shown to be due to the gradual dissociation of the complex molecules of the salts. —The stereochemical formula of benzene, by Mr. Marsh. A discussion of the various possible space formulae of benzene and a reply to Graeb's objections to the stereocentric representation. —An accurate method of determining the compressibility of vapours, by Dr. Steele. A description of a special apparatus devised for this purpose. —A new type of substituted nitrogen chlorides, by Dr. Chattaway. The author describes a group of these substances containing three negative radicles directly attached to the nitrogen atom, such as dibenzoyl nitrogen chloride, $(C_6H_5CO)_3N.Cl$. —The preparation of pure chlorine and its behaviour towards hydrogen, by Messrs. J. W. Mellor and E. J. Russell. The chlorine was prepared by electrolysis of fused silver chloride, and the hydrogen by the action of steam on sodium. Mixtures of these gases were found to be exploded by electric sparks even after several months' drying over phosphorus pentoxide. —Derivates of dibenzoyl mesitylene, by Mr. W. H. Mills and Dr. Easterfield. —The molecular condition of borax in solution, by Mr. H. S. Shelton. The author, from a series of measurements of electric conductivity of borax solution of diminishing concentrations, shows that hydrolysis into boric acid and sodium hydroxide occurs to the

extent of 4 per cent. at 25°. —On the union of hydrogen and chlorine, v. and vi., by Dr. Mellor. The author concludes that the chemical change occurring when moist chlorine is exposed to sunlight is due to interaction between the chlorine and the moisture contained in it. No intermediate compound, such as hypochlorous acid or chlorine monoxide, seems to be formed. —On some hydroxy-pyrene derivatives, by Messrs. Tickle and Collie. A description of hydroxydimethylpyrene and hydroxy-comenic acid obtained by oxidising dimethylpyrene and meconic acid respectively with hydrogen peroxide. —The absorption spectra of phloroglucinol and some of its derivatives, by Messrs. Hartley, Dobbie and Lauder. The absorption spectra of phloroglucinol and its trimethyl ester are almost identical, whence it follows that the parent substance possesses an enolic structure. —Solubility of mannitol, picric acid and anthracene, by Dr. Findlay. An investigation of the general applicability of the rule recently observed by the author connecting the solubilities of substances. —Menthyl formylphenylacetate, by Messrs. Cohen and Briggs. A description of the principal properties of this substance is given differing in some points from those assigned to it by Lapworth and Hann. —Transformation of diacetanilide into aceto- β -aminoacetophenone, by Dr. Chattaway. —Nitrogen chlorides and bromides derived from *ortho*-substituted anilides, by Dr. Chattaway and Mr. Wadmore. A description of several members of this class obtained by the interaction of hypochlorous and hypobromous acids with the corresponding anilides. —Substituted nitrogen chlorides containing the azo-group, by Dr. Chattaway. —The action of chlorine and bromine on nitroaminobenzenes, by Dr. Orton. A description of *sym*-trisubstituted chloro- and bromonitroaminobenzenes obtained by the interaction of the above substances. —The transformation of diazoamide- into aminoazo-compounds and of hydrazobenzene into benzidine, by Dr. Chattaway. A new method of formulating these changes is suggested. —Tribromophenolbromide, by Mr. E. W. Lewis. The melting point of this substance when pure is 148°, not, as generally stated, 118°.

Royal Astronomical Society, June 13.—Dr. J. W. L. Glaisher, president, in the chair. —M. Bigourdan gave an account of the long series of observations of nebulae which he is making at the Paris Observatory, his aim being to obtain accurate micrometric measures of a large number of nebulae. M. Bigourdan presented to the Society two volumes of his observations, and also the volume of Pongré's "Annales Célestes," which the author had left in MS., and which M. Bigourdan had now edited and published. —Dr. Downing read a paper on the distribution of the stars in the Cape Photographic Durchmusterung. He had reduced the places of the stars to galactic coordinates, to investigate their distribution with reference to the Galaxy. The results showed a ring of bright stars nearly in the Galactic plane, stars in the groups mag. 6.5 to 7.0 being more uniformly distributed. After magnitude 8.0 there is a greater difference between the density of the polar and equatorial zones of the Galaxy. The Cape Durchmusterung agrees with the Bonn Survey in assigning an ellipsoidal form to the visible universe. —Mr. Thackeray read a paper on a comparison of Groombridge's and Struve's right ascensions of close circumpolar stars, pre-facing it with an account of the life of Stephen Groombridge. The paper was accompanied by a table showing, from an independent comparison of a certain number of Groombridge's stars, that the probable error of an observation is about 0.53". —Mr. Filon read a paper on reduction of measures of Swift's comet (α 1899) from photographs taken with a portrait lens of 30-inch focus and 5-inch aperture. Apart from the intrinsic value of the comet places, it appeared of interest to determine the degree of accuracy obtainable from measures of stars on plates taken with an ordinary portrait lens, and to find if photographs thus taken would repay the labour of measurement and reduction. The author concluded that such plates can give star places accurate to about 0.83" of arc. —Mr. Hinks read a paper on the reduction of photographs of Eros for the determination of solar parallax. He concluded that the direct comparison of simultaneous photographs by linear reductions is the most convenient method. He desired to propose that seven or eight observatories, spread over as long an arc of longitude as possible, should agree upon a common list of comparison stars, and measure all their plates taken within a period of nine days. It might then be possible to find out in two or three years whether Eros will give as good results for parallax as other less favourably situated minor planets. —A paper by Mr. H. C. Plummer, on the principle of the arithmetic mean, and other papers, were taken as read.

Geological Society, June 11.—Prof. C. Lapworth, F.R.S., in the chair.—A descriptive outline of the plutonic complex of Central Anglesey, by Dr. Charles Callaway. The central complex of Anglesey was originally composed of diorite, felsite and granite. The gneiss and granitoid rock of the area, formerly regarded as sedimentary in origin, are now known to be plutonic masses.—Alpine valleys in relation to glaciers, by Prof. T. G. Bonney, F.R.S. The author discusses some hypotheses about the formation of Alpine valleys which have been advanced by Prof. W. M. Davis, but has left the Ticino Valley, on which the latter lays much stress, to Prof. Garwood, who has very lately visited it. Prof. Davis maintains that the upper and wider parts of Alpine valleys were excavated in pre-Glacial times, the lower and narrower portions during the Great Ice Age. The author tests this hypothesis by applying it first to the valley of the Visp, of the eastern arm of which, and of the "hanging valley" like a gigantic corrie, where Saas Fee is situated, he gives a description, pointing out that all parts are so connected that any separate explanation of their form is impossible. To obtain an idea of the condition of the Alps in Middle and Later Tertiary times, we may consider the effect of alterations of temperature, on the assumption (which, as he shows, is not likely to be seriously incorrect) that the altitude of the Alps during the greater part of their existence has remained unchanged. A rise of temperature of from 6° to 7° F. would have the same effect as lowering the district by 2000 feet; a rise of 10° would correspond with 3000 feet. In the latter case the Pennine chain about the headwaters of the Visp would be comparable with the range from Monte Leone to the Olenhorn. With a rise of 14° glaciers would almost vanish from the Alps, for the snow-line would then be at 12,000 feet above sea-level. Thus glacial action in the Oligocene and Miocene ages would be a negligible quantity, and it would gradually become sensible during the Pliocene; but glaciers would not invade valleys now free from them until the temperature was some degrees lower than it is at present—in other words, can have only occupied these during a small portion of their existence. The author passes in review a number of other Alpine valleys, which lead to the same conclusion. He calls attention once more to the connection of cirques with valleys, to the impossibility of referring the former to glacial action, and to the unity exhibited by all parts of the Alpine valleys, touching upon some structural difficulties which Prof. Davis has been content to meet with hypotheses. Alpine valleys in all parts, as the author shows, indicate by their forms meteoric agencies other than glaciers, which can only have acted for a comparatively short time and have produced little more than superficial effects.—The origin of some "hanging valleys" in the Alps and Himalaya, by Prof. E. J. Garwood. Lateral valleys which enter the main valley marked by discordant grades in the Jongri district of the Sikkim Himalaya have been attributed by the author to Pleistocene elevation and super-erosion of the main valley by water. Similar valleys in the Val Ticino have recently been attributed to overdeepening of the main valley by ice. The author shows that there is no real proof of this, in fact the evidence seems strongly to point to fluvialite and not glacial erosion of the main valley. This is shown by the overlapping profiles and river-gorges situated both above and below some of these "hanging valleys," and by the fact that a greater relative amount of erosion has taken place towards the upper end of the main valley than at the lower, where the mouths of the "hanging valleys" are less elevated.

Zoological Society, June 3.—Dr. Henry Woodward, F.R.S., vice-president, in the chair.—Mr. Lydekker exhibited the mounted head of a male Siberian wapiti, and made remarks on the various forms of the wapiti met with in northern Asia.—Mr. G. A. Boulenger, F.R.S., exhibited a strap made of the skin of the okapi (*Okapia johnstoni*), which had been received in Belgium from the Mangbetta country (lat. 30° N., long. 28° E.) in December, 1899, a year previous to the arrival in this country of the two bandoliers upon which the name *Equus johnstoni* had been founded.—Dr. Forsyth Major exhibited a reduced photograph of the skin of a female okapi (*Okapia johnstoni*), recently received by the Congo State Museum at Brussels, together with the skeleton of a male. Dr. Forsyth Major also made some remarks on this material, which had been handed over to him for publication.—Mr. E. J. Bles exhibited and made remarks upon some living tadpoles of the Cape clawed frog (*Xenopus laevis*). This species had bred in the Society's Gardens, and the event had formed the subject

of a paper in the Society's *Proceedings* by Mr. F. E. Beddard (cf. *P.Z.S.* 1894, p. 101), but Mr. Bles was able to supply some additional particulars.—Mr. Lydekker described the head and skin of a wild sheep from the Thian Shan, recently presented by Mr. St. George Littledale to the British Museum, as belonging to a new subspecies, which he proposed to call *Ovis sairensis littledalei*. He also exhibited and described a specimen of the sheep named by Severtzoff *Ovis borealis*, which had been brought home by Mr. Talbot Clifton from the Yana Valley.—A communication was read from Dr. R. Broom containing an account of the differences exhibited in the skulls of Dicotyles from the Karroo deposits of South Africa. The author was of opinion that these differences, in many cases, were not specific, but were due to sex, and, consequently, that many of the specimens which had received specific rank really belonged to the same form.—Mr. F. E. Beddard, F.R.S., read a paper on the gonad ducts and nephridia of the annelid worm *Eudrilus*, in which supplementary facts to those already ascertained by previous authors concerning these organs were adduced.—Dr. C. I. Forsyth Major read a paper on the pigmy hippopotamus from the Pleistocene of Cyprus, in which he described the fossil remains of *Hippopotamus minutus*, Blainv., exhibited by the author at the meeting of the Society on April 15. The characteristic features of this primitive hippopotamus were pointed out, and reasons were given for the assumption that the type-specimens of the species, Cuvier's *Petit Hippopotame fossile*, supposed to have been found near Dax in the Landes, had been brought over from Cyprus.—Mr. Hamilton H. Druce contributed a paper containing remarks on several species of butterflies of the family Lycaenidae from Australia, especially in reference to those described by Herr Semper. He also read descriptions of several apparently new species of the same family from the Eastern Islands and from Africa.—Mr. R. I. Pocock read a paper which dealt with the habits of the littoral spiders belonging to the genus *Desis*. The seven known species were enumerated, and one of them was described as new, under the name *Desis kenyonae*.—Mr. H. R. Hogg contributed a paper which contained additional information concerning the Australian spiders of the suborder Mygalomorphae. Out of a collection of forty specimens (comprising examples of eleven species and nine genera) received by the author, no less than nine species and five genera had proved to be new, and were described in this paper.

EDINBURGH.

Royal Society, June 2.—Dr. Ferguson in the chair.—Prof. Metzler communicated a paper on some identities connected with alternants and with elliptic functions, in which it was shown that an identity established by Cayley and discussed by Muir, and believed by them to be of general validity, was not true in a particular set of cases.—Prof. A. Smith read a paper on amorphous sulphur and its relation to the freezing point of liquid sulphur. He showed that the freezing point, which in books is stated to be very variable within certain limits, was determined by the amount of amorphous sulphur present. When the amount of amorphous sulphur present was plotted against the freezing point an almost perfect straight line was obtained, indicating 119.25 as the freezing point of liquid sulphur quite free from the amorphous form, although practically that had never been obtained. Taking this value and estimating the depressions of the freezing point due to the presence of the amorphous sulphur, he calculated the molecular depression by means of van't Hoff's formula and finally found 7.6 as the estimated molecular weight of amorphous sulphur—a value which under the difficulties of the experiment was a good approximation to 8.—Dr. W. Peddie, in a paper on the use of quaternions in the theory of screws, &c., showed how by a new interpretation of the scalar and vector parts of a quaternion a screw could be completely symbolised, and the whole theory developed in a compact and systematic way. The direction of the axis of the screw was determined by the direction of the vector part of the quaternion, and the scalar part of the quaternion represented the associated translation, the pitch being the ratio of the scalar to the tensor of the vector part. Any quaternion so regarded represented a screw through the origin; but the same quaternion could be made to represent a screw with axis not passing through the origin by breaking up the vector part into two portions, one of which represented the displacement, while the other represented the axis and with the scalar gave the pitch.—Dr. Hugh Marshall contributed a short paper on the dissociation of the compound of iodine and

(thioura, in which it was shown that in aqueous solutions of the compound there appears to be a complex balanced action of the kind represented by the equations



The addition, to such a solution, of any substance which diminishes the ionisation results in increased dissociation, as shown by the increased intensity of the colour of the solution.

PARIS.

Academy of Sciences, June 23.—M. Bouquet de la Grye in the chair.—New researches on batteries founded on the reciprocal action of two liquids, by M. Berthelot. The smallest amount of hydrogen visible in a voltmeter of special form after one minute was determined for pressures of 760 and 5 mm., in the latter case 0.000014 mgr. This sensitive voltmeter was then applied to the determination of the minimum electromotive force required to produce visible decomposition, and to measure the effects produced by liquid batteries.—The properties of a certain anomaly which is capable of replacing the anomalies already known in the calculation of the disturbances of the minor planets, by M. O. Callandreau.—The influence of the photographic magnitude of stars upon the scale of reduction of a negative, by M. Prosper Henry. Instead of comparing the results obtained by eye and photographically as has been proposed by Gill, a purely photographic method is here suggested. A portion of the sky is photographed upon a given plate first with a short exposure and then with prolonged exposure, the pointer micrometer having been slightly displaced between the two exposures. The results of the application of this method with the large objective of the Paris Observatory are now given.—The extension of the kathode hypothesis to nebulae, by M. H. Deslandres. The light emitted by nebulae has been attributed by Arrhenius to electrified particles, by Nordman to Hertzian waves, but the author regards both these explanations as inadmissible, since, for the same reason, the earth's atmosphere at night should glow with an equal lustre. The cathodic hypothesis appears to offer a better explanation.—On algebraic continued fractions, by M. R. de Montessus de Ballore.—Researches on actino-electric phenomena, by M. Albert Nodon. When light rays or ultra-violet rays are thrown upon a thin conducting plate they give rise, on the dark face of this plate, to radiations analogous to X-rays. They differ from kathode rays, since they easily pass through metals and black paper, and appear to possess properties intermediate between X-rays and radium rays.—On a phenomenon observed on an excitor, the spheres of which are connected to a Ruhmkorff coil, by M. H. Bordier.—The effect of self-induction on the ultra-violet portion of spark spectra, by M. Eugène Néculca.—On the heats of dilution of sodium sulphate, by M. Albert Colson.—The chlorinating properties of a mixture of hydrochloric acid and oxygen, by M. Camille Matignon. Gold, tellurium and platinum are attacked by a mixture of oxygen and pyrochloric acid at temperatures much below the temperature of reaction between hydrogen chloride and oxygen. The mixture may in certain cases replace chlorine.—On the acidity of pyrophosphoric acid, by M. H. Giran. By a study of the heats of neutralisation and heats of solution of the sodium pyrophosphates, the conclusion is drawn that pyrophosphoric acid is a tetrabasic acid, the acid value of each of the hydroxyl groups being identical.—The displacement of strong bases by ammoniacal copper oxide, by M. Bouzat.—On the phenyl migration of phenylethylene and its derivatives, by M. M. Tiffeneau. Evidence is given showing that in several instances the migration of the phenyl group is probable.—Study of the action of selenyl chloride upon erythritol, by MM. C. Chabrié and K. Jacob.—On dibenzoyl-hydrazobenzene, by M. P. Freundler. MM. Biehrieger and Busch have recently described a new mode of decomposition of diazo-compounds by means of copper powder, in which dibenzoyl-hydrazobenzene is stated to be formed. It is here shown that the compound really formed in this reaction is benzaniide, the benzoyl derivative of hydrazobenzene possessing entirely different properties.—Acyl derivatives of isopropionic acid; the acetate, benzoate and propionate of isopropionucyl, by M. G. Chavanne.—Chemical analysis of *Piper Fumechont* or Kissi pepper, by M. A. Barillé.—On the phenomena of migration in ligneous plants, by M. G. André.—On the composition of ewe's milk, by MM. Trillat and Forestier.—On the estimation of organic nitrogen in water, by M. H. Causse.—Analysis of the mode of action of lecithins upon the animal organism, by MM. A. Desgrez and Aly Zaky,

—Orthogonal skiagrams of the thorax; their use for the localisation of anomalies and for the measurement of organs, by M. H. Guillaumin.—The physiological secretion of the pancreas, by MM. C. Delezenne and A. Frouin.—Physiology of the heart in some colonies of compound Ascidians, by M. Antoine Pizon.—On the idea of depth applied to African metalliferous layers, by M. L. de Launay.—On the presence of Carboniferous strata in Tidikelt, Sahara, by M. G. B. M. Flamand.—Reproduction of some Palaeolithic figures drawn on the walls of the grotto of Font-de-Gaume (Dordogne), by MM. Capitan and Breuil. Four reproductions are given, three of the bison and one of reindeer.—On the colouring matter used in the figures described in the previous paper, by M. Henri Moissan. The colours are ochres formed of the oxides of iron and manganese.—The cyclone at Javagnas (Haute-Loire), on June 3, 1902, by M. Bernard Brives.

CONTENTS.

PAGE

The New International Catalogue. By Prof. J. B. Farmer, F.R.S.	217
The Geometry of Cog-Wheels. By G. H. B.	218
Evolution and Design. By Prof. R. Meldola, F.R.S.	219
A New Text-Book of Physical Chemistry. By W. R.	220
Our Book Shelf:—	
Serviss: "Other Worlds"	221
Brinton: "The Basis of Social Relations;" Shann: "The Criterion of Scientific Truth."—A. E. T.	221
"Opere matematiche di Francesco Brioschi"	221
"Webster's International Dictionary of the English Language. To which is now added a Supplement of 25,000 Words and Phrases"	222
Haldane: "Education and Empire. Addresses on Certain Topics of the Day"	222
Letters to the Editor:—	
Mr. Marconi's Results in Day and Night Wireless Telegraphy.—Sir Oliver Lodge, F.R.S.	222
Kinetic Theory of Planetary Atmospheres.—Dr. E. Rogovsky	222
The Coloured Sunsets.—Dr. William J. S. Lockyer; J. Edmund Clark	222
The Halos of May 1, 8 and 22.—Rev. T. C. Porter	223
Matter and Motion in Space.—Sir Hiram S. Maxim	223
A Method of Treating Parallels. (<i>With Diagram.</i>)—Dr. S. W. Richardson	223
The First Fruits of the German Antarctic Expedition. By H. R. M.	223
Rural Education in France. By A. D. H.	225
The Smithsonian Institution: its Documentary History. By H. R.	226
Arctic Magnetic Observations. By Dr. C. Chree, F.R.S.	227
Coronation Honours to Men of Science	228
Notes. (<i>Illustrated.</i>)	229
Our Astronomical Column:—	
Changes on the Moon	233
Remarkable Naked-eye Nebulosity	233
A Theory of Volcanoes	233
The French Geodetic Mission to the Equator	233
Observations of Nova Persei	233
New Variable Stars	234
Delay of the Minimum of U Cephei	234
Earthquake Notes	234
Statistical Methods in Biology	234
Avian Organogeny. By W. P. P.	235
Photography as Applied to Architectural Measurement and Surveying. (<i>Illustrated.</i>)	235
University and Educational Intelligence	236
Societies and Academies	238

THURSDAY, JULY 10, 1902.

THE RECORD OF HUXLEY'S SCIENTIFIC WORK.

The Scientific Memoirs of Thomas Henry Huxley.
Vol. iv. Edited by Sir Michael Foster and Prof.
E. Ray Lankester. Pp. 689; pls. 28. (London:
Macmillan and Co., Ltd., 1902.) Price 30s. net.

THE present volume is the fourth of the promised series, and contains a collection of the scientific memoirs, addresses, and reviews, by Huxley, published throughout the period ranging from the early part of the year 1874 until his death. The first item reproduced is that on the skull and heart of *Menobranchus*, the last the masterly addendum to the life of Richard Owen, with the tenour of which our readers have long been familiar (*NATURE*, vol. li., p. 169). When it is said that the intervening memoirs include those on "*Ceratodus* and the Classification of Fishes"; on "*The Craniofacial Apparatus of the Lamprey*"; on "*The Classification and Distribution of the Cray Fishes*"; on "*The Cranial and Dental Characters of the Canidae*" (with its prophetic passage on the future of the systematist); on "*The Application of the Laws of Evolution to the Vertebrata*" (than which Huxley never wrote a finer philosophic treatise); on "*The Gentians*" (which to the systematic botanists, headed by Hooker and the late Prof. Baillon, who heard it read, came as a surprise); and, finally, the last zoological paper which Huxley wrote, "*Some further Observations on the Genus Hyperodapedon*," it is evident that some of his very best work is in this volume brought before the reader.

By way of general comment, we need only say that the standard of the former volumes, upon which we have more than once passed favourable judgment, has been maintained, except, perhaps, that plates 1 to 3 have suffered somewhat, from the lack of blue-grey colour bestowed upon their originals.

In reviewing the volume which preceded the present one, we took occasion (*NATURE*, vol. lxiv., p. 76) to comment on the imperfection of the published list which the editors originally caused to be circulated in making their intentions known. We are pleased to find that of the three omissions to which we then more particularly drew attention, two have been made good, chief among them being the Survey memoir on "*The Crocodylians of the Elgin Sandstones*," which in the present volume monopolises seventeen of the twenty-eight plates provided. One omission upon which we dwelt they have passed over, viz. the Rede lecture on "*Animal Forms*," delivered at Cambridge in 1883 and duly reported in these columns (*NATURE*, vol. xxviii. p. 187); and we would remark that, if only on account of the absence of this, the words "*THE END*" with which the present volume closes cannot mark the completion of the editors' task, if justice is to be done to the life's record in science of the great man whose teachings the memorialists have decided to perpetuate.

To proceed, let it be said that, in addition to the omission just named there are at least six other of Huxley's scientific writings which we consider should

have found recognition in the present volume. In seeking comparison with other published works dealing with Huxley's career, we naturally turn to the bibliographic record given in the "*Life and Letters*" by his son; and there we find duly listed addresses on "*The Hypothesis that Animals are Automata and its History*" and on "*The Geological History of Birds*," which our editors have either overlooked or withheld. The latter, a Royal Institution lecture, was first delivered in America and published in full in "*American Addresses*"; and it is significant that of the five addresses this book contains, the only one the present volume bears (*i.e.* that on "*The Study of Biology*") was reprinted elsewhere. The address on "*Animals as Automata*" was reported in *NATURE* (vol. iv. p. 362), and with elaboration was printed in "*Science and Culture*," side by side with the article on "*Sensation and the Unity of Structure of the Sensiferous Organs*," which our editors reproduce. We submit that both it and the three American addresses on "*Evolution*" should have been included in the present volume, since they give expression to the working of Huxley's mind on the realisation of a complete evolutionary series—*i.e.* the equine. About the Baltimore address, which the "*American Addresses*" volume also contains, opinions may differ.

Far more serious, however, is the omission, both from its proper place in vol. ii. and from the present volume, of the great Geological Survey memoir (decade xii.) bearing title "*Illustrations of the Structure of the Crossopterygian Ganoids*," which, with the Rede lecture aforementioned, is not listed in even the "*Life and Letters*"; and we are at a loss to conceive by what process other than a too exclusive reliance upon the Royal Society Catalogue of Scientific Papers (which for the period concerned is defective) this oversight, resulting in the omission of one of the most important and far-reaching memoirs Huxley ever wrote, can be explained, especially when it is seen that the editors have duly incorporated its preliminary correlate in its proper place.

Nor is this all. Huxley's lecture before the Fisheries Exhibition at Norwich in 1881 is duly reproduced, but why not that of 1883, which marked the opening of the congresses of the Exhibition at South Kensington, perhaps the more important of the two? This omission is the more unfortunate, since, in the hands of Prof. McIntosh, the chief conclusion reached has but lately become the leading theme in rival controversy among fishery experts. And it is pertinent to this to remark that the memoir on the *Belemnitidae*, to which we alluded in reviewing vol. iii., and which at the outset escaped recognition, similarly contains the striking observation that the genus *Belemnites*, if a *Decapod*, is numerically deficient in "*arms*," and that this but a month or so ago, in the hands of Huxley's pupil Crick, has led to a startling generalisation, which we can personally confirm.

The editors announced in their original prospectus 151 contributions in all—they have printed 163. In doing so they have shown themselves to have been originally lacking by twelve. We have shown that others have yet to be reprinted, if the work is to be "*complete*" as was originally resolved, and to depict worthily the scientific labours of the great man whose reputation in the domain

of "exact science" is (according to our editors' preface) in danger of being underrated.

Moreover, it becomes a question whether the memoir on the "Oceanic Hydrozoa" should not be incorporated, to ensure absolute completeness. We are quite aware that the editors, in their preface, give reasons for excluding this; but we venture to think that if, when they took this step, they had realised the extent of the Survey memoir on the Elgin Crocodiles, and had reflected that the memoir on "The Development of the Elasmobranch Fishes," despite its bulk, was incorporated in the volumes memorialising the late Francis Maitland Balfour, they might perhaps have acted otherwise.

There are thus a possible series of six or seven important scientific communications to be yet reprinted, in order to justify the fulfilment of the memorial. As the matter stands a supplementary volume is imperative, and we leave the plea for it, with respect and full assurance, in the publishers' hands.

The frontispiece to the present volume is a highly successful photographic reproduction of the obverse of the Huxley Memorial Medal. As a likeness it transcends the statue; and it affords us pleasure to remark that the artist (Mr. F. Bowcher) who produced the model is at present engaged upon an enlargement of it, which promises to be even more true to life, and is to be mounted in the Town Hall at Ealing, the place of Huxley's birth. G. B. H.

GEOLOGICAL HISTORY.

History of Geology and Palaeontology to the End of the Nineteenth Century. By Karl Alfred von Zittel. Translated by Maria M. Ogilvie-Gordon., D.Sc. London, Ph.D. Munich. Pp. xiii + 562. (London: Walter Scott, Ltd., 1901.) Price 6s.

WHAT may be called the archæological side of the history of this science has been often treated; but what has long been needed is such a history that the serious student can ascertain exactly the position of any branch at the present day, and the more important steps in the advance towards its position. For a task requiring such a wide range of knowledge and such a well-balanced and unbiassed mind there is probably no one better fitted than Prof. von Zittel, while to translate, condense and adapt the work to the needs of British readers has been a congenial duty to one of Zittel's own talented pupils, Mrs. Ogilvie-Gordon.

The author, judging from his preface, is himself in doubt as to the possibility of combining the difficult task of writing a work which will satisfy the specialist and also commend itself to every man of culture. Frankly we think that to do this is impossible; the needs of the two types of readers are so wholly distinct. For even the best class of popular readers something different from the steady and level plod through division after division of the subject is required. There must be what might be called "picture-writing," colour, shading, prominence, gradation, grouping, and above all perspective. Without these the non-technical reader cannot see wood for trees; he has no landings on which to pause for

breath, and, worst of all, he hardly realises when he has attained a summit and obtained a view.

But, cutting adrift the man of general culture, what is there here for the specialist? There is a most conscientious, concise, complete, and well-balanced record of the chief steps forward in each of the numerous branches of a complex subject, perfect fairness in the treatment of the different workers and of the claims of various nationalities, a remarkable clearness in indicating the general advance of the science as a whole while treating of its many subdivisions, and a powerful presentment of the significance of the inauguration and final proofs of the chief principles of geology.

About a quarter of the whole work is devoted to geological knowledge in the ages of antiquity, the beginnings of palaeontology and geology, and the "heroic age" of geology (1790-1820). Under the first head we read that "fanciful hypotheses and disconnected observations cannot be acknowledged as scientific beginnings of research"; the next stage brings us to the first mineral maps and sections, the earliest ideas of mineral succession, and to primitive opinions about fossils and volcanoes. The "heroic age" was the time of Werner and Hutton, von Buch and Humboldt, Kant and Laplace, Cuvier and Buckland, and above all of William Smith. We are thus brought to the beginning of the nineteenth century, and henceforward we follow the development of the science under the following heads:—Cosmical Geology, Physiographical Geology, Dynamical Geology, Petrography, Palaeontology, and Stratigraphical Geology.

The treatment of these branches is singularly even, the weakest, perhaps, being the first and last, while for the strongest it is difficult to choose between the dynamical, petrographic and palaeontological sections. The translator has shifted the position of the stratigraphical section and omitted that on topographical geology, we think wisely; and she has also shortened the work, partly by abridgment and partly by omission. This difficult task has been discharged with considerable skill and discretion, though we might, perhaps, be inclined to cavil at some of the omissions; for instance, the suppression of the "kern theory" of Rosenbusch and the rock-formule of Michel-Lévy, to note only two examples.

One characteristic of some of the heroes of geology seems not to have died out at the present day. We read that

"It was the spoken word of Werner that carried. Of written words no man of genius could have been more chary. His dislike of writing increased as he grew older, . . ."

Again,

"Hutton's thoughts had been borne in upon him direct from nature; for the best part of his life he had conned them, tossed them in his mind, tested them, and sought repeated confirmation in nature before he had even begun to fix them in written words, or cared to think of anything but his own enjoyment of them."

And once again,

"a dinner was arranged . . . and William Smith consented to dictate a table of the British strata from the Carboniferous to the Cretaceous formation."

Zittel is seen at his best when dealing with the classical works of those masters of the science who have given us

its greater principles. The laws enunciated by such men as Suess, Heim, Richthofen, Sorby, Brögger, Lehmann, Smith, Sedgwick and Darwin are given with genuine appreciation and generally illuminated by a brief but telling thumb-nail picture of their lives and achievements.

The translator, while suppressing too great detail in foreign work, has helped English readers by fitting into its place the occasionally omitted work of English-speaking geologists (see pp. 358, 360, &c.). This plan might with advantage have been extended; for instance, the work of Milne and Davison on earthquakes, of Allport, Bonney and Phillips on petrology, and of Ramsay and Topley in the connexion of geology and geography, might well have received fuller notice; and the application of geology to economic questions still demands its historian, who would have many a strange tale of failure and success to tell.

While the chapter on petrography gives the reader a good summary of the chief theories enunciated, the stages of their proof and their significance in the progress of the science, the palæontological section, probably from the magnitude of the subject, is not so instructive, and does not succeed in giving the reader a clear picture of the real meaning of the successive discoveries made.

Again, the stratigraphical chapter is at the same time one of the most difficult to treat fairly, and the one which is least balanced in its treatment. The introductory part, while giving considerable weight to discoveries in palæophytology, is admirable in picking out the chief contributions to palæontology as applied to stratigraphy, and in its pronouncement upon such subjects as the Sedgwick-Murchison controversy. But the detailed portion gives less than three pages to the Devonian system, omits all account of the zoning of the earlier Palæozoic rocks, and then proceeds to devote almost forty pages to the Trias.

The translator's work has been carefully and conscientiously done, and the book reads far better than is usually the case with translations. A few slips or misprints are unavoidable, and here and there an ambiguity of expression has crept in. We read *Jorulla* (66), physician (77), Linnæus (for *linnaea*, 104), on the age of the human race (the antiquity of man, 195), Davis (David, 253), Euganian Isles (255), microscopic (macroscopic, 369), and aquo-igneous, for which we would venture to suggest the less cacophonous hydrothermal.

The publisher is evidently under the impression that the severer form of the German original requires tempering to that shorn lamb the British reader. The translation has been alleviated by portraits of eminent geologists, many of them admirable and some new. Those of Suess and of Zittel are excellent, but we can hardly bring ourselves to believe that that of Hutton is lifelike. Then, in addition to the shortening of some of the drier details, we have the wholesale omission of the bibliographies which accompany each chapter and many sections of the original. We hope and believe that this is a mistake. It is the serious student who will consult this work; to him the bibliographies are essential, and this will drive him to the original. In some future edition we hope to see these restored, and when this is done we would suggest that even the

NO. 1706, VOL. 66.]

specialist is deserving of, and will certainly be grateful for, anything which helps to pilot him quickly and safely to the haven of his inquiries. Such aid as author and printer can give are his right. The solid mass of print should be broken up by the use of more sections and headings, italics and black-faced type, and above all good headlines to the pages (as in the original), so that a man in search of particular information may find it with the least possible expenditure of time and temper.

But all geologists are grateful to Prof. Zittel for his thorough and painstaking labour, for his fairness and breadth of view, and for his wonderful grasp of the whole of his science; and English-speaking geologists are under an especial debt of gratitude to Mrs. Ogilvie-Gordon for her timely, accurate, and well-written translation.

PLANE SURVEYING.

Plane Surveying. A Text and Reference Book for the Use of Students in Engineering and for Engineers Generally. By Paul C. Nugent, A.M., C.E., Associate Professor of Civil Engineering, Syracuse University. Pp. xvi + 577. (New York: John Wiley and Sons; London: Chapman and Hall, Ltd., 1902.) Price 14s. 6d.

THIS book treats of that elementary part of the subject of surveying, especially useful to engineers, which deals generally with surveys of small areas on large scales. Any book on the subject which comes from America is worthy of attention, since American practice differs in many respects from ours, and this text-book is useful for the purpose of comparative study.

Amongst the subjects dealt with are linear measuring instruments and the measurement of lines, chain surveying, compass surveying, levelling, transit surveying (*i.e.* the use of the theodolite), topographical, hydrographic and mine surveying, and U.S. Government large-scale surveys and resurveys. There are also chapters on the theory of telescope construction, the planimeter, the slide rule and the solar instrument (sun compass), and an appendix on photo-topographic methods.

We have a good deal to learn from America in the use of steel tapes, which for many surveying purposes should supersede the chain, and some useful information on the question will be found at the beginning of the book. The method here described of cutting up the ground in a chain (or tape) survey differs from the English system, and the latter is preferable. A great deal of space is given to surveying with the compass; indeed too much space considering the essential inaccuracy of all compass methods; and on the other hand but little is said about triangulation with a theodolite or traversing with the same instrument, subjects which each deserve a chapter to themselves.

In the chapter on topographical surveying we have topographical methods described from the engineering surveyor's point of view, and for certain large-scale engineering topographical surveys the methods mentioned are useful. But they are not generally the methods used by surveyors on regular topographical surveys, such as the topographical branches of the Survey of India or the U.S. Geological Survey, and the description given of the

use of the plane-table as a topographical instrument is inadequate.

About a dozen pages are devoted to hydrographic surveying, and it is no doubt desirable that the engineer should have a bowing acquaintance with the subject, mainly to enable him to carry out the survey of small inland waters. If he had a larger task on hand, he should consult one of the recognised treatises on the subject.

In a book on surveying written by a professor of engineering it is remarkable that there is so little mention of the execution of special surveys for engineering purposes, such as railway and canal surveys. The whole theory of plane surveying is so simple that the engineer is far more likely to look up a text-book to discover what is the practical method adopted than to discover the solution of some theoretical problem, and the ideal text-book should largely quote examples of practical methods and expedients. The chapter on mine surveying contributed by Mr. W. S. Hall is, however, an example of the brief discussion of the survey methods used for a special engineering purpose, and appears to be useful and clear.

There is a long appendix of some fifty pages on phototopographic methods and instruments, being a paper by Mr. J. A. Flemer in the Report of the U.S. Coast and Geodetic Survey for 1897. Such a system has been much advocated in various quarters during the last few years, and it is interesting and ingenious. Under certain special conditions, such as those in the Canadian North-West, where the features are bold and open and where the field season is short, and where sometimes only occasional glimpses through the clouds can be had of the higher peaks, the method is efficient and economical. But under ordinary conditions it is neither, and as a method it cannot be said to be established, nor is it likely to be; and the inclusion of a detailed report on a tentative topographic method in a book devoted to large-scale engineering survey increases the size of the book, but not its value.

As regards the nomenclature of the book, we do not like the author's division of surveying into plane surveying and geodesy, although authorities can be found in favour of it. The term geodesy should be reserved for those scientific operations of which the object is the determination of the form and size of the earth. Some of the words used are new, e.g. "declinator," meaning the box containing the compass. The northings and southings of a traverse are here called "latitudes," and the eastings and westings "longitudes." We are glad to see that the author uses the word "plotting" and not "plating." The latter is sometimes found in American technical works and is objectionable in spite of its greater antiquity.

C. F. CLOSE.

INSPECTION OF RAILWAY MATERIALS.

The Inspection of Railway Materials. By G. R. Bodmer, A.M.Inst.C.E. Pp. ix + 154. (London: Whittaker and Co., 1902.) Price 5s.

THE inspection of their products has long been a source of worry to the manufacturers of railway material, be it locomotives, bridges or rails. Consulting engineers have their own ideas as to what the tests

should be; few specify alike, with the result that manufacturers have to make various qualities of material for the same purpose—a state of affairs not conducive to economy of manufacture.

The question of material is not the only trouble. Consulting engineers very often specify methods of manufacture for their material. Interference of this kind in works management is most expensive to the manufacturer; it upsets the sequence of the work, delays progress, and in the end has to be paid for by the railway shareholders.

A third complaint might be made by manufacturers, and one which very largely adds to the cost of work in many cases, and that is, what kind of man is the inspector? It is on this point the author of this book commences. He says:—

"The inspection of railway material is a class of work for which every inexperienced neophyte devoted to the engineering profession imagines himself to be qualified."

The author goes on to say that

"in reality, however, many qualifications are required to make a good inspector, and chief among these is experience, the one most likely to be wanting in a young engineer."

With this we thoroughly agree. In certain specifications the general clauses are such that the contractor is entirely in the inspector's hands, and if the inspector does not know his work the result is disastrous. Much has been written lately on the standardisation of locomotives, for instance, as a means of shortening the time of delivery; but given standard tests, non-interference in works practice and a practical man as resident inspector, there is no necessity to crystallise any design, for when all is said and done a thing of yesterday is old.

This book has evidently been written by one who has been through the "inspection mill." There is much evidence of this in the various chapters. Chapter ii. deals with rails, ordinary and tramway, fish plates, &c. We are told that in the case of fairly heavy rails it is possible to inspect four or five at a time. The reviewer could never do more than three continuously.

Steel sleepers are dealt with in chapter iii. The information is well up to date, although we cannot agree that the Indian sleeper fitted with punched up lugs cannot be gauged for gauge unless fitted with a length of rail, &c. The author might have explained that with this type of sleeper the position of the keys for normal gauge is outside the rail, for a medium curve one is moved inside, and for a very sharp curve both are placed inside.

On tyres and axles we find much useful information, and further on rolled material generally is very fully gone into, the tests being carefully explained. Chapter vii. deals very thoroughly with the condition governing the specifications for steel rails, more particularly discussing the mechanical tests, which vary very largely in present-day practice. The work concludes with a short account of the inspection of finished work dealing with various parts of rolling stock, and fulfils the intention of the author in being a brief guide to the inspection of railway material for the use of engineers.

N. J. L.

OUR BOOK SHELF.

The Watkins Manual of (Photographic) Exposure and Development. By Alfred Watkins. Pp. 124. (Hereford: The Watkins Meter Co.; London: George Houghton and Son, 1902.) Price 1s. net.

THE author is universally known among photographers as the inventor of the Watkins exposure meters and as having devised methods of exposure and development whereby the results are rendered more certain than by the older "rule of thumb" procedure. In this manual Mr. Watkins has systematically set forth his methods of timing exposure and development, and as these methods are sound in principle and useful in practice, a complete and orderly presentation of them as is here given results in a handbook that must be of great value to all serious students of the subject. It is the most welcome photographic manual that we have received for a long time.

We should have much preferred it if the author had remained true to his title and not endeavoured to provide a book suitable for two distinct purposes, namely, as an exposition of the procedures that he has introduced and popularised, and also as a guide for the beginner. Anyone who will be instructed by the statements that the lens forms the image and that the plate receives the "lens image," that a box of plates must be opened only in the dark room, and so on, will be quite unable to appreciate the bulk of the volume. Moreover, the author's heart is evidently in those sections of the subject that he has made peculiarly his own. In these he is full and clear, and probably no one, however much he may have studied the matter before, will read these parts without learning a good deal. The other chapters appear to have been written unwillingly, for in them accuracy is sacrificed for the sake of an apparent simplicity, and the subjects they represent cannot be said to be treated of, they are little more than referred to. In learning to photograph, as in learning to speak, the natural method is first to learn to do what it is desired to do, and finally to learn the grammar or the theory. No one tackles a subject in the opposite direction except under the compulsion of a schoolmaster, and then generally he learns the subject badly.

In dealing with chemical and physical changes, one must have a mechanical conception of the process, and Mr. Watkins is generally happy in his illustrations. But when he represents the course of development as a simultaneous reduction to the metallic state of all the particles of silver salt made amenable to the action of the developer by the exposure, so that as the image gradually grows in density these particles are at one stage each one-quarter reduced, later one-half, while finally the whole of each particle is completely reduced, he selects an illustration that is not true to fact. But this is a mere detail. We heartily commend the book to those who know how to photograph and wish to increase their knowledge and improve their practice. C. J.

Nature Study and Life. By C. F. Hodge. Pp. xv + 514; illustrated. (Boston, U.S.A., and London: Ginn and Co., 1902.) Price 7s.

THE author of this little volume is convinced that the only true method of nature-study is by making children thoroughly acquainted with living animals and their ways, both in the wild state and in confinement. He will have nothing to do with technicalities as to their structure and classification, leaving these, if they are ever to be taught at all, for older pupils. The keeping of tame animals as pets, and the history of domesticated animals, so far as known, are regarded as important factors in the scheme. A similar mode of study is pursued in the case of plants, where the pupil is not bothered with a long string of technical names or wearied with details as to their

structure. Their life and their relations to inanimate surroundings are the only things it is sought to teach. The author's mode of procedure is to induce the members of the class to write down the names of all the animals—both wild and domesticated—with which they are acquainted, to classify them roughly, and then to discuss some of the more important types at length.

That the author's method is not a mere empirical suggestion, which may or may not prove successful in the class-room and in the field, is evident from the introduction to the volume by Prof. Stanley Hall, of Worcester, Mass., who writes as follows:—"New as his method essentially is, it is now made public only after years of careful trial in the public school grades in Worcester, until its success and effective working in detail is well assured. Thus it has passed the stage of experiment, and is so matured and approved that, with slight local adjustments, it can be applied almost anywhere for children of from six or seven to thirteen or fourteen years of age."

In the United States the success of the method seems indeed to be assured, and there is accordingly every inducement to give it a fair trial in this country. The book is brightly and pleasantly written and well illustrated. Whether the author is altogether correct in the statement on p. 8, that the mammoth was a third taller and more than twice the weight of "our elephant," and that "the mastodon" was larger still, we may be permitted to doubt. We are also at a loss to know the particular kind of fossil deer indicated by the name *Cervus americanus*, a title properly belonging to the existing Virginian white-tailed deer. R. L.

Manual of Agricultural Chemistry. By Herbert Ingle. Pp. 412. (London: Scott, Greenwood and Co., 1902.) Price 7s. 6d. net.

AGRICULTURAL chemistry deals with a very extensive range of subjects, including the whole of the materials and operations with which agriculture is concerned. The plant, the soil and the animal are each of them subjects sufficient to satisfy a whole generation of workers; but agricultural chemistry includes all these and much more besides. No book ever has been written, and none probably ever will be, attempting to deal with the entire subject; the student must, therefore, fill his shelves with a great variety of books, by many writers, if he would have at command the information available on the subjects of agricultural chemistry.

The present manual represents the course of instruction in agricultural chemistry given at the Yorkshire College, Leeds. The course of instruction is a full one, and the matter has been carefully written out by the lecturer, Mr. H. Ingle. The book thus produced will be heartily welcomed by all students of agricultural chemistry; it brings together clearly and correctly a great mass of facts which can be found in no other single volume. Especial attention is given to questions connected with pure chemistry, organic and inorganic, and with physiological and analytical chemistry; less prominence is given to the problems of practical agriculture. Thus we have the percentage composition of crops, but not the composition of average crops per acre; the subject of rotations is also omitted. Again, under animal chemistry, we have no discussion of the relation of food to animal maintenance, or to the production of work or animal increase. The values of foods for the production of heat are given, but the extent to which these potential values are utilised for animal requirements is not discussed. The epoch-making researches of Kellner and Zuntz on this subject are not referred to.

The author describes Grandeaue's method for the determination of humus in soil, based on the solubility of this substance in alkalis. As a good deal of work is being done with this method both in America and in this

country, it may be worth while noting that it does not show the total humus, but only the humic acids. Berthelot has, in fact, shown that even boiling with potash leaves a considerable part of the organic carbon and nitrogen of a soil undissolved.

English agricultural writers employ two names for *Beta vulgaris*—"mangel" and "mangold"; Mr. Ingle employs the latter. The former spelling is, however, more correct. The word comes from the German description "Mangel-Wurzel," or scarcity root, alluding to its resistance to drought. The spelling has probably drifted into mangold from the golden colour common to the roots. R. W.

Ueber Aehnlichkeiten im Pflanzenreich. By F. Hildebrand. Pp. iv + 66. (Leipzig: W. Engelmann, 1902.) Price 1s. 9d. net.

PROF. HILDEBRAND, in his introductory remarks, takes exception to the use of the term "mimicry." He states that it is applied by zoologists when two very different animals show similar appearances which are of apparent benefit to one, and that the explanation of zoologists infers that these similarities are developed in the struggle for existence. The latter part of this statement is distinctly misleading, as it is doubtful if any zoologists regard such similarities as being developmental. The object of the book is to show that in the plantworld mimicry rarely if ever occurs, and that similarities in plants or plant forms are mainly due to environment or ecological factors. The series of comparative sketches which Prof. Hildebrand has published form light reading, but they might with advantage have been worked up in greater detail.

Index to the Literature of the Spectroscope (1887-1900, both inclusive). By Alfred Tuckermann. Pp. 373. Continuation of the previous index by the same author published in 1888. (Published by the Smithsonian Institution, 1902.)

IN the previous index, extending from the dawn of spectroscopy (or even earlier, for references are made to papers published in the seventeenth century) to 1886, the author arranged the books and papers under 320 different sections, placed alphabetically. In each section the titles of the papers, the authors' names, and references to the original papers and abstracts are arranged in the alphabetical order of the authors' names. The present contribution is divided into two parts, part i. being an authors' index extending to 188 pages, in which the authors' names are placed alphabetically and the full title, year of publication and references to the papers and abstracts are given; and part ii. a subject-index beginning with history, books, spectroscopy in general, followed by nearly 300 divisions arranged alphabetically. In these divisions the authors' names are first given alphabetically, followed by the references to the papers with the year of publication, but without any reference to the titles or to contents of the papers which are not given in the titles. Thus under titanium there are five references; the first is in the *Wiener Anzeiger*, and does not appear in the author-index, the second is an ultra-violet spark spectra, the third on titanium as a comparison spectrum, the fourth on the arc spectrum, and the fifth on the shifting of the arc spectrum lines under the influence of pressure. The value of the index would have been enormously increased if the papers had been arranged alphabetically according to the subjects, and with the papers on the same subject placed in order of date instead of according to the authors' names. Such a system would have entailed more printing, but it would not have caused very much more work in preparation and would certainly have been worth the additional trouble.

The list appears to be very complete; it may be said to be more than complete, for some of the papers in-

dexed do not deal with spectroscopy. Thus five papers on meteors which we have examined do not contain any reference to spectra, and one on the yellow variety of arsenic does not deal with spectroscopy; several papers are indexed which contain only micrometric measurements of the diameters of planets. It is perhaps ungracious to criticise in this manner a work which must have been very arduous to the author, but the inclusion of papers that do not refer to the use of the spectroscope may be the cause of much loss of time and trouble to workers, and this would not have happened if the subject-index had been prepared in the way above suggested.

Dr. Tuckermann must be congratulated on the conclusion of his work, which, notwithstanding the defects which we have mentioned, cannot fail to be of service to many investigators in this important branch of science. H. M.

LETTERS TO THE EDITOR.

[The Editor does not hold himself responsible for opinions expressed by his correspondents. Neither can he undertake to return, or to correspond with the writers of, rejected manuscripts intended for this or any other part of NATURE. No notice is taken of anonymous communications.]

Misuse of Coal.

NATURE of March 20, containing a most interesting communication by Prof. John Perry on the "Misuse of Coal," has reached me lately. Surely Prof. Perry takes an insular view of the matter. Like so many Englishmen, alas! he knows not the forest! The greater portion of the world cooks its food and makes itself comfortable on wood fuel, and though all the forests in the world would, according to European ideas, be inadequate to supply by their growth the present expenditure of coal (their fossilised remains), to overlook altogether the sun power which we can fix by growing wood fuel is surely, from even a European point of view, an oversight. Helmholtz compared the number of thermal units received by an acre of land in Germany during a year with the number of thermal units produced by burning the vegetable matter elaborated during a year. His calculation was that only the 1/1477th part of the sun's heat was thus rendered available.

On this basis it is possible roughly to calculate the maximum thermal efficiency as firewood of the wattle or Eucalyptus vegetation on the coast of Australia or South Africa. (Insolation is for the latitude somewhere about one-sixth greater at Cape Town than in mid-Germany; practically it is more on account of the clearer atmosphere.) The production of firewood is about five times as much; thus, taking Crotondorf as an example of a European forest giving one of the largest yields in timber, we have:—

Crotondorf spruce, mean yearly yield 143 cubic feet.
Quick-growing Eucalypts, S. Africa, do. 700 "

Or the maximum South African yield is five times the maximum European yield. But since the average weight of eucalypt wood is three times that of spruce, the heating power produced on an acre of Eucalypts must be set at about fifteen times that produced on an acre of northern and mid-European forest. Thus on the basis of Helmholtz's calculation a eucalypt plantation can, with the most favourable circumstances, in South Africa or on tropical mountains, store up, say, 15/1500 = 1 per cent. of the solar energy received on the unit of area.

The position in Cape Town to-day is that it is cheaper to plough the ground and plant a forest of quick-growing trees than to import coal from over the sea or by a long and expensive land journey. Firewood in Cape Town is worth nearly 1s. per cubic foot, and before the railway was extended to the diamond fields firewood there has fetched 1d. per lb., the price at which sugar has been retailed in England. No doubt from a British insular point of view coal at 2l. or 3l. per ton is a terrible misfortune. It certainly increases the cost of running machinery; but if this does not take place to a prohibitive extent, and if it makes the user of power careful not to waste it, it is not an unmixed evil. And if thereby afforesting is made a paying operation, it is at least open to discussion whether dear coal and good forests would not be better for England than an expenditure of 23,000,000l. sterling on

imported timber, and the evils, including physical degeneration of the race, and coal fogs in the big cities, which have been shown elsewhere to result from England's neglect of its forests. The reference to De Wet in Prof. Perry's communication is unfortunate: a small quick-moving army would probably have caught him. And surely cheap coal and luxury is not the *summum bonum*. Rather let us have hamlets of strong forest workers than the luxurious town dwellers of to-day with their decayed muscle and cheap mechanical power! Compare a European engine-driver with the runner castes of India and Japan. The engine-driver shows us perhaps fine inherited muscle, but going to decay for want of use; the Eastern runners show the development of muscle by both use and inheritance. Which would have the best chance of catching De Wet a hundred years hence?

As far back as 1882 the discovery was made by Sir D. Brandis and myself that Eucalypts planted on tropical mountains will produce wood fuel at the rate of 20 tons (dry weight at 60 lbs. per cubic foot) per acre per year in perpetuity. The eucalypt plantation reproduces itself when cut, without further expense, and its dry timber, heavier than coal (which, as met with commercially, weighs 50 lbs. to 52 lbs. the cubic foot) has an equal or a higher thermal power, bulk for bulk, than coal. We obtained this result as the maximum yield of *Eucalyptus globulus* on the Nilgiris, Southern India. No doubt there are other instances where higher yields are produced now, and no doubt also when the coal supply is exhausted, selection and experiment will produce a forest vegetation that will produce more than 20 tons per acre per year. The sugar beet and all the fruits and vegetables of civilisation show how the vegetable kingdom can be moulded to suit man's wants. If a chance tree on a chance mountain in a chance soil can produce the equivalent of 20 tons of coal per acre per year, it seems not unreasonable to suppose that by selection we can produce, say, double this, or 40 tons. To produce this in perpetuity we should probably have to find a tree with the moderate soil requirements of the Conifers. A powerful sun, a heavy rainfall, and a very rapid forced growth would be the essentials of such a production of wood fuel.

Looking at a rainfall map of the world, one sees that these conditions are fulfilled over about 8000 million acres of its surface (which is between one-fourth and one-fifth of the total land surface of 35,200 million acres). I take latitudes below 40° and rainfalls above 40 inches. One-half of this area under forest might thus yield the equivalent of 161,000 million tons of coal yearly. This is more than 288 times the world's present consumption of coal, assuming that coal and eucalypt timber are of approximately equal heating power. On the basis of the actual forest yields of to-day we have half this, or 80,500 million tons. In Germany, one-fourth of the total area is under forest, and this is held on the highest authority to be the suitable proportion for a thickly-peopled civilised country such as Germany. The forest should properly occupy a higher proportion in countries where large areas are pestilential and unsuited for human habitation. Putting this, however, aside, and taking the German standard of one-fourth forest, then on the basis of to-day's maximum yields we should obtain a yearly output of 40,250 million tons. And if to convert the maximum forest yield to an average forest yield we again divide by two, we obtain 20,125 million tons. Lower than this I do not think we can reasonably go for the class of forest under consideration. It is a little more than thirty times the world's present consumption of coal. The world's yearly output of coal recently was 663 million tons, says Prof. Perry.

Thus we see that the yield of firewood from the world's tropical and extra-tropical forests, whenever they are fully stocked and scientifically worked, will yield the equivalent of from thirty times to 122 times the present consumption of coal, or even up to 243 times the present consumption of coal if we succeed by cultivation in doubling present timber yield figures.

It may be objected that my figures are far in excess of those representing the yield of European forests and that they require confirmation. No doubt they are far in excess of European figures; but so also is the intensity of the vegetative process in these latitudes, and so also is the stature of the Sequoias of California, and the Eucalypts of Australia and South Africa above the stature of the biggest spruces and silver-firs of Europe. The Nilgiri figures I have quoted above were formally recorded in two official reports printed and published by the

Madras Government in 1882.¹ They have since been confirmed by the measurements of forest officers who have subsequently had charge of the Nilgiri plantations. Similar figures have been obtained by myself and other forest officers in South Africa. They have been exceeded in several plantations in Natal, while at Johannesburg they have not been confined to Eucalypts, but have been obtained from *Acacia decurrens*, or black wattle, as well as from some other trees.

Therefore, "when our coal supply is exhausted, when all the races of the world have fought for the waterfalls and places of high tide," there will still remain that which Englishmen of all the civilised races of the world do most neglect—the forest.

D. E. HUTCHINS.
Grootvadersbosch, Swellendam, Cape Colony, May 14.

Cold Weather in South Africa.

WE have been getting exceptional weather here of late. General French was actually snowed up at Middelburg. A good general idea of the circumstances will be obtained from the telegrams abridged below from the *Diamond Fields Advertiser* of June 14.

Middelburg (Cape), June 11.—For the first time for sixteen years the town is covered to a great depth with snow. King-williamstown, June 11.—A fierce thunderstorm occurred last night, accompanied by heavy rain. Port Elizabeth, June 11.—The train service between Graaff-Reinet and Rosmead is to-day stopped temporarily owing to heavy snowstorms—an unusual experience for South Africa. Cradock, June 12.—An exceptionally heavy fall of snow occurred in the Midlands on Tuesday night and yesterday. Queenstown, June 12.—The rainfall reported during the first five months of the year is the lowest recorded for the same period for the past thirty years. The drought has, however, been broken. Rain started on June 10, and during the night there was a heavy fall of snow. Koikstad, June 12.—There was a heavy snowstorm last night, accompanied by a heavy gale. The snow is several inches deep in the streets. Bloemfontein, June 12.—The weather is unprecedentedly cold. The hills round Thaba N'chu are covered with snow. Last night snow fell in Bloemfontein.

At Kimberley it has been intensely cold, with a low barometer, wind, rain and sleet, and afterwards heavy frost. With the one exception of July 12, 1886 (when Kimberley is said to have been under snow for the whole day), the maximum shade temperature registered is the lowest on record. For the eight days ending Sunday, June 15, the temperatures have been:—

	Observatory Screen.		Stevenson Screen.	
	Max.	Min.	Max.	Min.
June 8 ...	72° 0	34° 0	73° 7	33° 0
" 9 ...	59° 0	39° 0	59° 8	38° 1
" 10 ...	46° 2	38° 0	45° 9	37° 3
" 11 ...	45° 4	36° 9	44° 9	36° 1
" 12 ...	48° 3	31° 6	46° 8	31° 2
" 13 ...	52° 1	25° 2	53° 7	24° 2
" 14 ...	57° 0	26° 9	58° 0	26° 0
" 15 ...	62° 0	29° 0	63° 2	28° 0

The maximum temperatures registered on June 10 and 11 are the lowest on record for any June. The maximum registered on July 12, 1886, was 35° 8: There was also a maximum temperature of 45° in July 1891. Both, however, were obtained under a Glaisher screen and are probably a little too low. Minimum temperatures lower than 25° have been registered perhaps three times; the lowest known is probably 20° in July 1888. All these previous instances have been quite transitory, the temperatures in each case being much higher both the day before and the day after. There seems to be no record of a cold spell having the duration of the one in question.

Kenilworth, Kimberley, June 16. J. R. SUTTON.

¹ "Suggestions regarding Forest Administration in the Madras Presidency," by D. Brandis, C.I.E., Inspector-General to the Government of India (Madras, 1882).

² Report on Measurements of the Growth of Australian Trees on the Nilgiris, by D. E. Hutchins, Dep. Cons. Forests, Mysore (Government Press, Madras, 1883).

A SHORT PERIOD OF SOLAR AND METEOROLOGICAL CHANGES.¹

IN continuation of the inquiries referred to in a former paper on Indian rainfall and solar activity,² attention has more recently been devoted to an examination of the variations of pressure over the Indian and other areas.

(1) It is well known that in India during the summer months (April to September) and during the winter months (October to March) low and high pressures respectively prevail. In the case of the latter, the pressure is found to exhibit very remarkable and definite variations, and is in excess every three and a half years on the average, while at these times of excess of high pressure the low pressure during the other six months of the year is deficient; so that every three and a half years or so the high pressure becomes higher and the low pressure is not so low as usual.

(2) Further, this short-period variation which appears in the mean variation of pressure over the whole of India is as well defined in the mean values for individual

Indian area would appear to lower the mean value of high-pressure months at Cordoba simultaneously. In fact we have a see-saw.

(4) Further investigation shows that not only do the pressures of practically the whole Indian area exhibit variations from year to year which present very similar features, but that this is the case with other large areas.

Thus, for instance, it is found that the yearly mean pressures for Brussels, Bremen, Oxford, Valencia and Aberdeen (the only pressures that have been at present examined) are all remarkably similar in their variations from year to year; and it might almost be said that one curve representing the variations from the normal would approximately define the pressures at all these places.

The probable extra-terrestrial origin of these short-period variations led to a detailed examination of the records of the phenomena connected with solar spots and prominences, with a view of seeing whether similar variations, indicating changes in the solar activity, could be detected.

(5) A preliminary reduction of the Italian observations

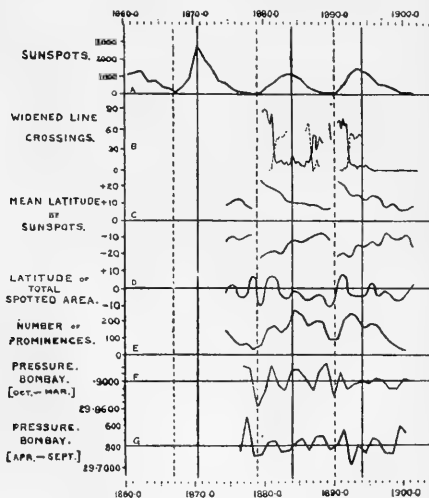

FIG. 1.

stations such as Bombay (Fig. 1, Curve F), Calcutta, Madras, Nagpur, &c.

(3) The view that the variation of pressure in question over India and its neighbourhood is not due to local causes, but is produced by some external, or extra-terrestrial action, is considerably strengthened by an examination of the pressure curve of a very distant station such as Cordoba. Dealing with the pressures at Cordoba during the high-pressure six months, April to September, the curve (Fig. 2, Curves F and E) representing the variation from the mean from year to year is exactly the *inverse* of the curve representing the Bombay and other Indian pressures for the same months over the same period of time. The cause, therefore, which raises the mean value for the low-pressure months over the

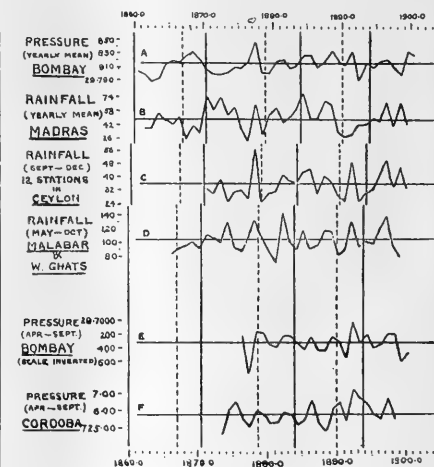

FIG. 2.

of prominences observed on the sun's limb since 1871 was first undertaken. The result of this inquiry indicates that, in addition to the main epochs of maximum and minimum of prominences which coincide in time with those of maximum and minimum of the total spotted area, there are prominent subsidiary maxima and minima having a similar short period, and also coinciding in time (Fig. 1, Curve E).

(6) Although these subsidiary prominence pulses are not distinctly duplicated in the curve representing the spotted area of the solar surface, it is to be noted that corresponding pulses are indicated in the curves which represent the change of latitude of spotted area from year to year; and in each case an increase in prominence activity is associated with a decrease of latitude of the spotted area (Fig. 1, Curves C and D).

(7) A comparison of these solar data with those already referred to relating to terrestrial pressures suggests that these simultaneous outbursts of prominences and changes of the latitudes in which the spots occur about

¹ "On Some Phenomena which Suggest a Short Period of Solar and Meteorological Changes," by Sir Norman Lockyer, K.C.B., F.R.S., and William J. S. Lockyer, M.A., Ph.D., F.R.A.S. (Read before the Royal Society, June 12.)

² "On Solar Changes of Temperature and Variations in Rainfall in the Region Surrounding the Indian Ocean" (*Roy. Soc. Proc.* vol. lxvii. p. 409).

every three and a half years are the true cause of the pressure changes; and that the varying intensity of solar activity within the sunspot period of eleven years produces an effect on the pressure and circulation of our atmosphere, thus affecting the whole globe meteorologically.

(8) The close correspondence between the epochs of these subsidiary pressure variations and those representing prominence frequency suggests, not only their very close relationship, but that the terrestrial pressure quickly answers to the solar changes, while so far as the work has gone it would appear that rainfall (Fig. 2, Curves A, B, C, D) and snowfall are subsequent effects.

(9) It may be remarked that we have already obtained evidence showing that this short-period variation is not the only one acting, but that the eleven-year and thirty-five-year periods apparently influence the short-period variations. But even this does not explain some anomalies already met with, and should the solar origin of these short-period pressure changes be subsequently confirmed, some of them not constant in all localities will have to be explained: and it is possible we may obtain in this way some new knowledge on the atmospheric circulation.

(10) The period of time included in this survey begins generally with the establishment of the full records of the Indian Meteorological Department in 1875 and extends to 1895, when the regularity of the widened-line phenomena was broken, as stated in a previous communication.

Addendum, dated June 26.

In continuing the above researches we have plotted the percentage frequency of the solar prominences derived from the Italian observations for each 10° of solar latitude N. and S. of the equator.

We find that the epochs of maximum prominence disturbance in the higher latitudes are widely different from those near the equator. The latter are closely associated with the epochs of maximum spotted area, the former occur both N. and S. at intervening times.

We have, then, two sets of strongly marked prominence outbursts occurring at intervals of between three and four years.

Both sets are represented closely in the Indian pressure curves.

Solar Physics Observatory.

THE FIRST MAGNETICIAN.¹

"THIS booke is not for every rude and unconnyng man to see, but for clerkyis and very gentylmen that understand gentylness and scyence."

This quotation from Caxton is prefixed by Prof. Thompson to his notes to the new edition of the "De Magnete."

Most students of electricity know that William Gilbert of Colchester is the father of the sciences of magnetism and electricity. They may have some idea of the extent of his discoveries and the general character of his work, but few who have not seen the celebrated book in which he recorded his results can have really grasped how much Gilbert knew and how thorough and complete were his investigations.

"He practised the experimental method of observation before Bacon wrote about it; his methods and discoveries excited the sneers of Bacon, the praises of Galileo and Kepler."

The book justifies the high claim put forward on its behalf by its latest editor, and the thanks of men of

¹ William Gilbert of Colchester, Physician of London, on the Magnet, Magnetic Bodies also, and on the Great Magnet the Earth." Pp. 246. Published in Latin, 1600. Translated and edited for the Gilbert Club, 1900, with notes by Prof. S. P. Thompson, F.R.S.

science are due to him and to all who have helped him for enabling them to learn what Gilbert did.

It was a happy thought to found the Gilbert Club, and the members of the club who have the chance of possessing this splendid volume, the outcome of many years of patient research and loving labour, are greatly to be envied.

The club was founded in 1889 to commemorate Gilbert's work and to issue a translation in English; at that date there was none, though one was published in America in 1893. The original edition was issued in 1600, and it was at first hoped that the translation might be ready in time for the centenary celebration at Colchester in 1900. This proved impossible, but the work is now complete and the result is admirable.

It will be of interest here to give a brief account of the work itself. Starting with the early history of the loadstone, its power of attracting iron known to the ancients and its property of setting in a definite direction discovered in the tenth or twelfth century, Gilbert in the first book of his treatise sets forth the various fundamental properties of a magnet and of magnetised iron, illustrating them by the experiments now familiar to all, and describing almost in every chapter some new discovery or some important law. He is continually appealing to experiment and accurate observation. "Deplorable is man's ignorance in natural science," he writes, "and modern philosophers like those who dream in darkness need to be aroused and taught the uses of things and how to deal with them, and to be induced to leave the learning sought at leisure from books alone and that is supported only by unrealities of arguments and by conjectures." But Gilbert lived too early; it was more than 200 years before the truth of his maxim was realised.

He was quick to appreciate at their true value the inaccurate observations of some who had gone before him.

"Albertus Magnus writes," we are told, "that a loadstone had been found in his day which with one part drew to itself iron and repelled it with the other end; but Albertus observed the facts badly; for every loadstone attracts with one end iron that has been touched by a loadstone and drives it away with the other."

Among other things, we may note his observation that "a long piece of iron (even though not excited by a magnet) settles itself toward north and south"; but perhaps the greatest discovery in this book is contained in the last chapter, "That the globe of the earth is magnetick and a magnet," our "New and unheard of doctrine about the earth" he calls it. The doctrine is proved by the observations and experiments which are the subject of the rest of the treatise.

Book ii. deals with a number of examples of magnetic attraction, and in chapter ii., "On the magnetic coition, and first on the attraction of amber, or more truly on the attaching of bodies to amber," we find the beginnings of the theory of electricity. "For in other bodies," he writes, "a conspicuous force of attraction manifests itself otherwise than in loadstone; like as in amber, concerning which some things must first be said that it may appear what is that attaching of bodies and how it is different from and foreign to the magnetical actions, those mortals being still ignorant who think that inclination to be an attraction and compare it with the magnetic coitions," and so to illustrate electric actions he invents the straw electroscope. He divides bodies into "electricks," which are electrified by friction and attract light bodies, and "non-electricks," the metals and other conductors as we now call them. The effect of heat and moisture is studied and described, and the distinction between electrical and magnetic attraction fully made out.

With amber or other "electricks," "if indeed either a sheet of paper or a piece of linen be interposed there will be no movement. But a loadstone without friction

or heat whether dry or suffused with moisture invites magneticks, even with the most solid bodies interposed, even planks of wood or pretty thick slabs of stone or sheets of metal. A loadstone appeals to magneticks only, towards electricks all things move."

He has no mercy on those who would make a perpetual-motion machine by means of the attraction of a loadstone.

"But they have been little practised in magnetick experiments who forge such things as that. . . . Oh that the gods would at length bring to a miserable end such fictitious, crazy, deformed labours with which the minds of the studious are blinded."

Book iii. is on Direction, the property of the magnet to point north and south. At the outset Gilbert recognises that the compass needle deviates from the true North Pole by an amount which varies at different points on the

the name given to the property of pointing north and south.

Book iv. deals with "Variation," the angle between the true and magnetic meridian at any point, and though we cannot agree with Gilbert that "the variation is caused by the inequality of the projecting parts of the earth," or that "the variation in any one place is constant," we can admire his skill and resource in utilising the scanty material at his disposal and in devising methods to measure the amount of the variation.

In Book v. the action of a dipping needle is described and explained, while Book vi. treats of the "Globe of the Earth the Great Magnet."

Any notice of this edition of the "De Magnete" would be incomplete without some reference to the notes contributed by the editor.

During the work of revising and editing the English



FIG. 1.—The Blacksmith making a Magnet.

earth. "But it must be understood," he says, "on the threshold of the argument (before we proceed further) that these pointings of the loadstone or of iron are not perpetually made toward the true poles of the world, do not always seek those fixed and definite points or remain on the line of the true meridian, but usually diverge some distance to the east or west."

The fundamental laws of the magnetisation of iron by contact with another magnet by induction either from a loadstone or in the earth's field are clearly set out. Gilbert knew, too, how to demagnetise a magnet. "Putting the whole iron in the fire," he writes, "blow the fire with the bellows so that it may be all aglow and let it remain a little longer time red hot. When cooled (so, however, that while it is cooling it does not rest in one position) . . . you will see that it has lost the verticity it had acquired from the stone." Verticity is

translation of "De Magnete," many points, as Prof. Thompson writes, came up for discussion requiring critical consideration and the examination of the writings of contemporary or earlier authorities. The results of some portion of this labour have been collected in the form of notes. The text has with great judgment been printed just as Gilbert left it; in fact, comparison shows that throughout the English and the original Latin versions run page for page. The notes cover some seventy pages, and are replete with curious and interesting information. Take, for example, that relating to the picture of the blacksmith striking the iron while it lies north and south, given on p. 139, which we have reproduced. It appears that woodcuts containing human figures are rare in the art of the sixteenth century, and Prof. Thompson traces Gilbert's picture to a book of fables by Cornelius van Kiel, published at Cologne in 1594,

where it is used to illustrate a fable of the blacksmith and his dog. The dog has been omitted in the Gilbert picture, the words Septentrio and Auster have been added and some other details modified, but there is no doubt where the picture came from.

Another note of interest is that to p. 165, dealing with the discovery of the mariner's compass, its construction, and the wind-rose or chart of the winds marked on the card of the compass. The earliest known examples of the wind-rose are on certain Venetian charts dating back to 1426 or 1436. Not less interesting is the paper which some five years since Prof. Thompson read before the Bibliographical Society on "Peter Short, Printer, and his Marks." This, however, is not in this volume. Peter Short, the hitherto unknown printer of the book, used as his mark the device of a serpent entwined round a T-shaped support, and the investigation as to why this mark was used has led to an interesting chapter in the history of the printers of the sixteenth century.

But enough has probably been said to convince even an unwilling reader of the value of the book "De Magnete" and of the services which the editor and his colleagues have rendered to science by the issue of this English edition. They are to be congratulated on the results of their labour of love, which, though it has cost them many hours of toil, has had so successful an issue.

R. T. G.

RECENT HISTORY OF THE ROYAL SOCIETY.¹

WHEN the "Record of the Royal Society" was first issued in 1897, further editions of that interesting compilation were promised, and the Society has considered the opening of the new century an appropriate time for fulfilling that promise. Although there is not much of especial importance in the history of the Society to chronicle during the four years which have elapsed since the issue of the first edition, no one will quarrel with the Council for having taken this opportunity of issuing a work which contains additions of so much interest as does the "Record" before us.

The first edition was noticed in our columns in 1897 (see vol. lvi. p. 343), and the present volume gives us, with but slight modification, the historical material contained in the first edition. The work, however, has extended from a manual of 224 pages to a substantial volume of 427 pages, and this increase in bulk is almost entirely due to the valuable list of the Fellows of the Society elected since its foundation, arranged in chronological order of election, with an alphabetical index.

While the main portion of the contents of the first edition remains unchanged, the short period which has elapsed between the two issues of the "Record" has seen modifications in some old associations of the Society. The Botanic Gardens, Chelsea, formerly known as "The Physick Garden," established in 1721, after enduring various encroachments upon its boundaries and sundry risks of absorption into the maw of the London builder, has found salvation in that essentially modern sanctuary for neglected charities, a scheme of the Charity Commissioners. This garden was granted by Sir Hans Sloane to the Society of Apothecaries in February, 1721, on conditions mentioned in the notice in NATURE already mentioned. In the event of the Society of Apothecaries at any time failing to fulfil these conditions, or converting the garden into buildings for habitations or any other uses save as a physic garden, the premises were to be held in trust for the Royal Society, by which it was to be held under like conditions, the obligations in this case being to the Royal College of Physicians. The Society of

Apothecaries appears to have carried out the prescribed terms, but in 1861 evinced a desire to be relieved of its charge, which, however, the Royal Society showed no anxiety to assume, and the garden, suffering in the meantime some curtailment on the building of the Chelsea Embankment, remained under its original tenure until 1898, when the Society of Apothecaries, anxious to be rid of the burden of its maintenance, applied to the Charity Commissioners to draw up a scheme for the administration of the garden. Under this scheme, which was drawn up in consultation with the Council of the Royal Society, the management of the garden is placed in the hands of the trustees of the London Parochial Charities, with a committee of management of seventeen, upon which each of the bodies named in Sir Hans Sloane's original deed, viz. the Society of Apothecaries, the Royal Society and the Royal College of Physicians, has one representative; there are also representatives of certain educational authorities, and nine nominees of the trustees above mentioned. The committee is to provide for the maintenance of botanical specimens of living plants for teaching purposes and for the supply of botanical specimens for external instruction, and may also provide instruction, by means of lectures or otherwise, in botany with especial reference to the requirements of elementary education.

Another and more familiar name has disappeared from the list of institutions carried on under the ægis of the Royal Society. The Kew Observatory, built by King George III. on the site of an old monastery in 1769, for observing the transit of Venus which occurred in that year, was handed over by the Government in 1842 to the British Association, who maintained it until 1871. In that year Mr. J. P. Gassiot, F.R.S., executed a deed of trust for the endowment of the Observatory with a sum of 10,000*l.*, the income to be administered by a committee of the Royal Society for the purposes of the Observatory. Such a committee was duly appointed, and assumed control of the Observatory, being subsequently incorporated under the title of the Kew Observatory Committee.

Under the scheme for the establishment of the National Physical Laboratory, the Kew Observatory Committee has been wound up, and the Observatory has become incorporated in the larger institution, of which it forms a department. The conditions of Mr. Gassiot's endowment are, however, observed by the retention, as a body independent of the governing body of the Laboratory, of the Gassiot Committee of the Royal Society, composed of those Fellows of the Society who are members for the time being of the executive committee of the Laboratory.

So much has been written lately in these columns and elsewhere about the National Physical Laboratory that there is no occasion to enlarge upon this subject further than to say that its scheme of management and organization is set out in full in the volume before us, which also contains the full text of the Gassiot declaration of trust.

Another interesting document published in the "Record" is the royal warrant for the board of visitors of the Royal Observatory, Greenwich, granted by His Gracious Majesty the King on May 23, 1901.

The list of benefactions is extended by the addition of two bequests received since 1897—the bequest of Sir William Mackinnon, who left to the Society the residue of his estate, upon trust, for the foundation and endowment of prizes or scholarships for the special purpose of furthering natural and physical science and of furthering original research and investigation in pathology. The first award under this bequest was made last year to Mr. J. J. R. Macleod, M.B., for researches in pathological chemistry. The other bequest is one made by the late Prof. David Edward Hughes, the income "to be annually awarded either in money or in the form of a

¹ "The Record of the Royal Society of London." Second edition, 1901. Pp. vi + 427. "Year-Book of the Royal Society of London, 1902." Pp. 265. (London: Harrison and Sons.)

medal, or partly one and partly the other, for the reward of original discovery in the physical sciences, particularly electricity and magnetism, or their applications." A gold medal, to be called the "Hughes" medal, will be awarded for the first time this year.

These bequests involve corresponding obligations, as may be seen under the heading of "The Trusts of the Royal Society," and the multiplicity and variety of these and similar responsibilities, duly recorded in the volume under review, appear to have stimulated the Council to something in the nature of a protest and an appeal; for, by a memorandum facing the first page of the "Record," we learn that the Council has arrived at the conclusion that it is neither to the advantage of the Society nor in the interests of the advancement of natural knowledge that the already long list of medals should be added to, and the Council expresses the opinion that no further bequests for awards or prizes for past achievements should be accepted by the Society. The memorandum then proceeds to direct attention to the fact that the funds being lost absolutely to the Society and available without restrictions for its general purposes are very few indeed, and that the usefulness of the Society has been greatly hampered by the lack of such funds.

These facts are familiar to those acquainted with the working of the Society, but outside this circle there seems to exist a general impression, whether it be due to the Royal Society's ancient and honourable association with the throne, or to its occupying handsome premises in Burlington House, or to its entertainments in the London season, that it is a wealthy body, able to dispense material assistance to all and sundry undertakings in the wide field of natural knowledge. How far this is from the truth may be seen from the statement of the Society's income published in the "Year-Book." In this we see that the total regular income of the Society, apart from funds which it administers in a fiduciary character, amounts only to about 5000*l.*, and out of this, supplemented by various small miscellaneous, and vicarious, receipts and a portion of the Government publication grant, provision has to be found for an expenditure which last year amounted to 2572*l.* on its publications alone, and 1300*l.* for its "Catalogue of Scientific Papers," in addition to all the expenses of establishment and library. Such a condition of affairs, hampering, as we are told it does, the usefulness of the Society, which has been aptly described by a distinguished foreign savant as "the mother of learned societies," and renders almost daily to the nation important services in matters of deep concern to the people in all parts of the Empire, is testimony only too eloquent to the indifference with which the pursuit of science is regarded in this country.

Space forbids us to refer at length to other undertakings in which advance is recorded in this volume. One of the most important is the completion of the "Supplementary Volume of the Catalogue of Scientific Papers," a volume of 807 quarto pages containing a list of the papers not previously catalogued in the volumes already published, for the period ending with 1835. The Society has already embarked upon the compilation of a similar catalogue for the period 1883-1900. With the completion of this work, however, the Royal Society's direct responsibilities in this matter will cease, the task being taken up from that point by the organisation, to which attention has more than once been called in these columns, of the "International Catalogue of Scientific Literature."

Other matters of more strictly domestic interest are duly recorded. The Society's collection of portraits and medals has received some notable additions. The lists of presidents and other officers, and of the recipients of the Society's medals, are brought up to date.

But perhaps the most interesting part of the volume is the list of Fellows of the Society from its foundation up to the present time. Such a roll of worthies furnishes a

wealth of suggestion to the student of natural knowledge, and their biographies, if they could be presented to us in due sequence, would form an epitome of the history of scientific advance during the past 240 years which might almost be said to be synonymous with the history of the development of modern England. A word must be added in praise of the interesting series of portraits which is begun in the "Record," reproduced from photographs made by Sir William Abney from pictures in the possession of the Society. The present volume contains portraits of Sir Isaac Newton, Henry Oldenburg, Lord John Somers and Sir James Burrow, and we are promised a continuation of the series in future editions of the work.

The principal new feature in this year's "Year-Book," now in its sixth issue, is the incorporation of the complete official list of Fellows of the Society living on January 1, 1902, in place of the abbreviated list which has hitherto done duty in this work. This expanded list has added twenty pages to the size of the handbook, which contains besides, among other current information, the statutes and standing orders of the Society, lists of its Council and its twenty-six standing committees, the regulations for the administration of the Government grant for scientific investigations, the president's anniversary address and the annual report of the Council, with a statement of accounts and obituary notices of Fellows deceased. Appended to the Council's report is the report of a committee of the Society upon the vexed question of the organisation of philosophico-historical studies, a subject which has been already much discussed in the Press. Altogether the "Year-Book" indicates clearly enough how multifarious and important are the activities of the Royal Society.

THE FUTURE OF THE VICTORIA UNIVERSITY.

DURING the next few months the Privy Council will be called upon to come to a decision on a matter vitally affecting higher education in the north of England. The Victoria University, which has been in existence for twenty-three years, has come to a stage in its career when its future must be definitely settled. Liverpool has applied for a separate charter, and Owens College gives its hearty support to the establishment of three distinct and independent universities in place of the present federation.

The ambition of Manchester to have an independent university is not of recent growth. In the year 1641 a petition was presented to Parliament asking for a charter, but rival claims were brought forward by the town of York and nothing came of the effort. A fresh start in the same direction was made in 1836, but only resulted in the affiliation of the Manchester Academy to the London University. The more recent attempts of Owens College to establish a university in the city of Manchester will be in the recollection of many readers of NATURE. The opposition of Yorkshire (history repeats itself) was again successful, and led to the foundation of the Victoria University, which has, on the whole, worked well. What, then, are the reasons for its proposed dissolution?

The functions of a university are threefold—to teach, to advance knowledge and to examine. The more intimately these three functions are interwoven, the more effectively will the university fulfil its purpose. Their separation has been the great impediment to the progress of university education in this country. This is beginning to be recognised, and the recent efforts of Wales, of Birmingham and of London all tend in the direction of subordinating examination to teaching and of giving a proper place in the university ideal to research and advance of knowledge.

The Victoria University was founded in order to establish a greater harmony between teaching and examining

than was possible under the old system, which gave the London University control of the examinations. This worked well for a time, but owing to the growth in the number of students, owing also to the different directions in which the three colleges are developing, we are rapidly drifting back to the old state. Victoria University is now practically an examining body, which unites all disadvantages, for while on the one hand it controls the teaching too much in some directions, it is unable to secure uniformity of standard in others. This is a fundamental defect of the federal system, which can only work well during the early growth of the federated colleges, and will always break down as soon as some of the colleges are strong enough to stand alone.

As a mere piece of administrative machinery, the federal university must always be clumsy and wasteful. Its statutes and regulations must be framed to satisfy the various and sometimes diverging requirements of the different colleges. This can only be done by means of endless meetings and constant compromises. It is the duty of every teacher to give up a portion of his time to administrative work, and he will be glad to do so if satisfactory results may be arrived at without a wasteful expenditure. Every man has only a certain amount of strength and energy, and every hour spent in the committee room is so much taken away from his power of promoting knowledge. Simplicity of machinery is a matter of primary importance in university organisation, and it is not too much to assert that whatever success the Victoria University has achieved, it has done at the expense of taking away a very substantial and unnecessary amount of time, which its teachers might more profitably have spent in their studies or laboratories.

The objections to the splitting of the Victoria University are chiefly based on the assumption that a multiplication of universities is bad in itself. "Union is strength" is a good party cry, but the saying is not true when the union is of the kind one gets in a three-legged race. If there are universities in Manchester, Liverpool and Leeds, it is further asked, why not one in Sheffield or in Oldham, Rochdale or Burnley? Such objections are not serious, and savour too much of the political platform. We might as well argue that we should not eat and drink enough because we might possibly eat and drink too much. Surely, if a town possesses a college of sufficient standing to supply the highest teaching in its various faculties, if it is established on such financial basis as will secure its permanence and its capability of attracting teachers of eminence in the future, and if there is a sufficient supply of students, no reason can be urged against the creation of a fresh university.

Competition and rivalry, it is argued, will lower the standard of a degree. This objection springs from that distrust of the teaching profession which has been one of the chief causes of the backward state of education in this country, and is only now being slowly overcome. Because it is believed that a teacher, if left to himself, will neglect his duties, all kinds of safeguards, external examinations and inspections are invented, which may be excellent if intended to help the teacher, but are bound to break down if used to overlook and correct him. The three Dutch universities of Amsterdam, Leyden and Utrecht are nearer to each other than Liverpool, Leeds and Manchester. Though subject to certain State regulations as regards curricula, the teachers are entirely free to fix their own standard of examination. Any of these universities could, if it wished, lower its standards and give its degrees on easier terms than the other two. If they do not do so, it is because they are not foolish enough to commit suicide, but desire to attract the best students, and keep them for post-graduate and research work. Rivalry will be found to act as a healthy stimulant and not as a temptation.

America is sometimes pointedly referred to as an ex-

ample of the evil effects of the multiplication of universities, and of the danger which accompanies the complete freedom of power to confer degrees. This freedom has apparently led to the depreciation of degrees in the case of a few institutions which abuse their privilege. But the standard of university education in a country should be judged by its highest and not by its lowest work, and when we think of university education in America we think of Harvard, of Yale, of Cornell and other places of high reputation, and do not trouble about a few insignificant places, which after all do very little harm.

If we could secure another half-dozen efficient and progressive universities in England, they would not be too dearly purchased, even if by some mischance one or two were established which did not justify their existence. But there is no fear as regards the immediate question at issue that any lowering of standard will result from the separation of the three northern colleges. In this country it is the old and not the new universities which are tempted to give degrees on insufficient attainments, and can do so without loss of prestige.

There are, of course, matters in which cooperation is desirable. Different entrance or preliminary examinations would obviously be objectionable and complicate the work of the schoolmaster who prepares boys for the university. Unification is here called for, not only as between the three colleges of the Victoria University, but throughout the country. The question of separation should not be mixed up with the no doubt very important question of admission to a university course.

A plausible argument against the multiplication of degree-giving bodies is found in the case of medicine, where the degree carries a qualification with it. The fact that this objection has been very strongly urged shows that our present system is not understood, and that separation is called for in the interest of a clearer definition of the meaning of our degrees. Efficiency is most easily secured if the burden of responsibility is placed on the right shoulders. Let each college give its own stamp to its own graduates, and the college will take better care to secure good teaching than while it can shelter itself behind the nondescript "Victoria University." This holds with special force where the examination, as in medical subjects, is to a great extent of a practical character. It is impossible in these cases to secure equality, and if the public is induced to think that the training or even the examination test is necessarily identical the public is deceived. If separation means the clearer realisation of the nature of the training received, separation is an advantage.

It will be to the ultimate good of each institution, if it feels the weight of its responsibility, and is more immediately made to suffer in public estimation for deficiencies in any of its departments. The effect of this feeling of responsibility is very real and swift. Liverpool has already raised a large sum of money conditionally on a charter being granted, and Leeds has put down its wants at a high figure. What is all this money wanted for except to make the teaching more efficient? It is wanted just as much whether the Victoria University remains as it is or divides; but the probable establishment of separate universities has roused the feeling of responsibility, and brought the gaps and deficiencies home to the governing bodies and to the public.

One further and very cogent argument must be brought forward. University education is often looked upon too much as a matter standing by itself, and without relationship to the previous training of the boys at school, or the parallel training in technical colleges. If a coordination of education is desirable, a federal university of colleges situated in three large cities becomes an impossibility. It is not necessary to argue this point in detail. Those who know the conditions of educational facilities in the north of England, will realise that the great diversity

which exists in the three towns is bound to render one common organisation so cumbersome that it would necessarily check the freedom of development which is essential to success. Speaking for Manchester alone, does it need further argument that a more effective university may be formed by a close cooperation between Owens College, the Municipal School of Technology, the School of Art, the College of Music, and the various theological colleges, than is possible with the present federation, which is confined to Owens College alone? And is it not obvious that the interest in higher education which would be roused by the common feeling of the governing bodies of all these institutions for a great university in Manchester will more effectively secure a high standard of work and a progressive spirit, than the artificial union of three colleges in different towns? In our effort to secure educational freedom we count on the sympathy of all who are truly anxious for educational progress, and we count more especially on the help of those who are now working out a similar problem in the University of London.

ARTHUR SCHUSTER.

NOTES.

WE regret to see the announcement of the death of M. II. Faye, the eminent French astronomer, at the age of eighty-eight years.

DR. J. G. GARSON has been appointed assistant general secretary of the British Association, in succession to the late Mr. G. Griffith.

SPECIMENS of volcanic dust collected in St. Vincent and Martinique, during the recent eruptions, which have been placed by the Colonial Office at the disposal of the Board of Education, are exhibited in the Western Galleries of the Victoria and Albert Museum. To this exhibit there has been added some dust which fell in Barbados, with chemical analyses of the same, and drawings of the minerals which it contains.

THE United States Congress has amended the law which provided for the opening of the Universal Exposition at St. Louis, May 1, 1903, by deferring it for one year. This has been done for many reasons, the principal being that, since its inception, the scope of the exhibition has enlarged. Up to the middle of June the money available for the exhibition, including State and national appropriations, amounted to more than 4,000,000.

A CORRESPONDENT sends us a cutting from the *Manchester Guardian*, announcing that Mr. Assheton Smith has consented to present to the University College of North Wales a site on the Menai Straits for the erection of a marine zoological station. A special fund for the erection of this station is being started, and already Mr. H. R. Davies, of Treborth, who has acted as treasurer of the Puffin Island station since 1892, has led off with a handsome subscription.

WITH respect to the recent coloured sunsets that have been and are being seen in this country, it is interesting to note that similar phenomena are being observed in Germany. Thus the Berlin correspondent of the *Standard* writes (July 7):—"For some time past, both at sunrise and towards dusk, there has been visible here a remarkable glow of colour on the horizon, the sky exhibiting an appearance of unusual beauty. Men of science put forth the theory that this phenomenon is caused by particles in the air emanating from the fiery mass ejected by Mont Pelée." The coloured sunsets referred to last week (pp. 222, 230) were noticed at Lewisham on the evening of June 26. Mr. R. McLachlan, F.R.S., writes to say that when facing nearly due east his attention was attracted by a peculiar

tint in the sky. On proceeding to the front of the house the effect was extremely brilliant, the red predominating. Mr. McLachlan thinks the tint in the eastern sky was probably due to reflection. Mr. A. R. Tankard writes to confirm the observations of remarkable sunsets at Madeira, described by Mr. F. W. T. Krohn in *NATURE* of June 26. He says that the peculiar sunset effects were not visible in the district of the Canary Isles and Madeira during April. As the chief eruptions in Martinique and St. Vincent took place in the first two weeks of May, and the curious effects described made their appearance subsequently, namely, in the early days of June, their connection with the eruptions is rendered probable.

A NOTE in a recent number of the *British Journal of Photography* (July 4) gives a brief account of a balloon voyage of a very uncomfortable nature that was made by Dr. Miethé in company with Lieutenant Hildebrandt. The account, which is taken from the *Photographisches Wochenblatt*, states that the ascent was made at Tegel in the afternoon at three o'clock, and the balloon came to earth at half-past six between Nicker-Finow and Liepe. At the ascent the balloon passed first through a mist, and then suddenly into a thunder cloud. After attaining a height of 200 metres, the balloon was suddenly carried to an altitude of 2000 metres, and then as suddenly fell half that distance. Meanwhile the storm was proceeding, but although the travellers did not see the lightning they were deafened with the thunder, and pelted with rain, hail and sleet. In their rapid leaps and plunges the car was frequently on a level with the balloon, and the tow-rope above their heads. The violent rocking of the car also added to the danger. Watches were not thought of, but according to the barograph this frightful experience must have lasted half-an-hour, when, through loss of gas by pressure, the balloon fell from a height of 2200 metres upon a dense wood of beeches, but for which the travellers would probably have lost their lives. One of them descended by the rope, and obtained help from the villagers at Liepe.

WE have to record the death by drowning, on Tuesday, July 1, of Mr. A. D. Hogg, a student of the Royal College of Science, London. Mr. Hogg, who had been a botanical assistant to Prof. Bayley Balfour in the University of Edinburgh, his native place, came to London and the Royal College of Science as a National Scholar in the autumn of 1901. Having obtained high qualification in botany, zoology and geology, he recently proceeded to St. Andrew's, at the suggestion of Prof. Howes, to study under Prof. McIntosh, in preparation for his return to South Kensington and zoology in the coming autumn. On the evening of his first day in the Gatty Marine Laboratory, seeking quietude and respite from the western sands, which were crowded at the time, he wandered to the mouth of the river to bathe. Not knowing the dangers of the spot, he swam out and was overcome, and in his loss science has become the poorer by an earnest and promising student.

REPORTS from Vienna, published in the *Daily Mail*, state that a severe earthquake lasting twenty seconds occurred at Salonica at 4.20 p.m. on Saturday, July 5. Before the news reached Vienna the instruments at the Laibach Seismological Observatory registered a great disturbance towards the south-east at an estimated distance of 600 miles. Later telegrams state that the earthquake was felt right across the Balkan peninsula. The shocks began on Saturday afternoon, and continued with frequent intervals until midday on Monday. A very cold wind is said to have accompanied the earthquake. More than 200 houses were wrecked at the village of Bani, three miles from Salonica.

It is reported that two slight shocks of earthquake occurred in the neighbourhood of Cheadle, Cheshire, on July 8.

WE regret to learn of the death of the Abbé Maze, on June 17, at the age of sixty-six years. He had been for many years one of the editors of our contemporary, *Cosmos*; his first connection with that journal was as meteorologist after the Franco-Prussian War of 1870-1, and he was for some time secretary of the French Meteorological Society. About twenty years ago he undertook a laborious investigation into the periodicity of rainfall, which he has left uncompleted; it is said that he had established a double period of 6, and 6×7 , or 42 years, for the recurrence of similar general phenomena. He was also engaged for many years on a history of the thermometer, and has left in manuscript a large amount of valuable information upon this subject, collected from every available source, and which we hope will eventually be brought to light.

THE *Morning*, the auxiliary ship of the National Antarctic Expedition, sailed yesterday for Lyttelton, New Zealand, en route to the Antarctic regions, where it is intended to meet the *Discovery* with supplies, and to render any other services which may be required. From an article in the *Times* we learn that while the main object of the *Morning* is to act as tender to the *Discovery*, still she is well equipped with scientific instruments of various kinds, some of which have been supplied by the Admiralty, including survey instruments, a large photographic equipment, sounding gear, and apparatus for collecting at least the surface fauna of the ocean. Constant meteorological observations will be taken, and in other respects as far as possible the staff on board the *Morning* will do its best to supplement the work of the *Discovery*. The captain of the *Morning* and commander of the relief expedition is Mr. William Colbeck, who was one of the staff of the *Southern Cross* Antarctic Expedition, on which he took the observations and drew the charts.

ACCORDING to a recent paragraph in the *Times*, the arrangements for the Scottish National Antarctic Expedition, under the leadership of Mr. W. S. Bruce, are making satisfactory progress. The Norwegian whaler *Hekla*, which Mr. Bruce recently purchased for the expedition, is to be renamed the *Scotia*. The ship is now being reconstructed on the Clyde, at Troon, by the Ailsa Shipbuilding Company, under the guidance of Mr. G. L. Watson, the well-known yacht designer. The *Scotia* is a barque-rigged auxiliary screw steamer of about 400 tons register. New deckhouses are being built, a larger one aft and a smaller one forward divided into a laboratory and cook's galley. A second laboratory and dark room is to be fitted between decks. The ship is being specially fitted to carry on oceanographical research, both physical and biological. Two drums, each containing 6000 fathoms of cable, for trawling in the deepest parts of the Southern and Antarctic Oceans, are being taken. Mr. Bruce intends to follow the track of Weddell and to explore the Ross deep, working eastwards from the Falkland Islands.

A NUMBER of papers dealing with various aspects of the recent eruptions in the West Indies appear in the current issues of the geographical and other scientific journals. A short article on "Martinique und sein Vulkanismus," in the June number of *Petermann's Mitteilungen*, by Dr. Emil Deckert, is accompanied by an excellent map of the island. Dr. Michel-Levy, director of the geological survey of France, contributes a paper on the Mont Pelée eruptions, with some admirable geomorphological diagrams, to the *Revue générale des Sciences*. In the *Geographical Journal* for July Mr. E. André describes a visit to St. Vincent, and some excellent photographs are reproduced, while Mr. H. N. Dickson gives a narrative of events, advancing the view that the destruction of St. Pierre was caused by a tornado originating in the hot gases issuing from the crater of Mont Pelée. A paper on the Windward Isles, by Dr. J. W.

Spencer, appears opportunely in the *Transactions* of the Canadian Institute; it is illustrated by a number of plates and six valuable charts showing the contour of the sea-bottom.

THE fate of M. Andrée is still a subject of speculation. A Renter telegram from Winnipeg states that the Rev. Mr. Fairies, an Anglican missionary among the Eskimos within the Arctic Circle, has arrived there and repeats the story, which was brought two years ago by an Eskimo to Port Churchill, that a band of natives found M. Andrée and party 300 miles to the north of Port Churchill. On approaching them M. Andrée fired a gun. The natives interpreted this as a hostile act and set upon the explorers and killed them. The Hudson Bay Company offered a large reward to the messenger to bring some relic. He departed, but never returned. Mr. Fairies described an instrument resembling a telescope, which was taken from the outfit and carried with other loot to the Arctic Circle by the Eskimos.

THE seventeenth annual meeting of the Photographic Convention of Great Britain was opened at Cambridge on Monday, when Sir Robert Ball, the new president, delivered an address on astronomical photography.

THE Brazilian Minister and the staff of the Brazilian Legation will attend the meeting of the Aeronautical Society to be held on Thursday next, July 17. The following papers will be read:—"The 'Peace' Balloon of the late Senhor Augusto Severo," by Dr. Carlos Sampaio and Mr. Eric Stuart Bruce; "Balloon Ascents in Thunderstorms," by the Rev. J. M. Bacon; "A Performance of the Bristol War Balloon during the South African War," by Captain H. B. Jones, R.E.; and "The Cycala Flying Machine," by Dr. Charles Zimmerman.

THE Sydney correspondent of the *Daily Mail* reports that the drought has become intensified in Queensland and in parts of New South Wales, while there has been rain elsewhere. The New South Wales rainfall for June on the coast to the south of Sydney is 95 per cent. below the average of the corresponding month in past years. In the immediate neighbourhood of Sydney the deficiency is 91 per cent., on the Hunter River 85 per cent., on the North Coast 93 per cent., on the Darling River 84 per cent., and between the Darling, the Lachlan and the Bogan Rivers 87 per cent.

A FEW examples of the practical application of scientific education in Germany are given in the *Journal* of the Society of Arts. The sugar industry is the first illustration of the progress of industry through science. In 1840, 154,000 tons of beet-root were crushed, from which 8000 tons of raw sugar were produced, showing about 5½ per cent. of raw sugar extracted from the root. Twenty years later, 1,500,000 tons were treated, which produced 128,000 tons of sugar, or about 8 per cent. Last year about 12,000,000 tons were crushed, which produced 1,500,000 tons of raw sugar, raising the percentage to 13. This advance is due entirely to scientific treatment. The production of dry colours, chemicals and dyes in Germany shows a corresponding increase in production and dividend-paying capacity. The great increase of earning capacity is due largely to the constant labour of trained men, who by application of their technical knowledge have so cheapened production that they have succeeded in getting this trade out of the hands which previously controlled it. A great advance has also been made in the scientific instrument industry. The value of the exports from Germany of scientific instruments in the year 1898 was about 250,000l.—three times what it was in 1888—and the work gave employment to 14,000 people. These are a few of the many instances showing the close connection between the scientific education of the German people and their commercial prosperity.

THE United States Weather Bureau has just issued a paper by Prof. Alfred J. Henry on wind velocity and fluctuations of water level on Lake Erie. Continuous automatic records of the variations of level at Amherstburg and Buffalo for December, 1899, to November, 1900, are correlated with wind records at Buffalo for the same period, and the material applied to analysis of seiches of different types, including the "fair weather" seiches and those accompanying storms. The period of the smaller seiches is about fourteen hours, that of the larger about sixteen hours. The occurrence of a severe seiche at Buffalo cannot be foretold many hours in advance, but sufficient time could generally be given to warn property interests along the wharves.

THE report of the Californian section of the climate and crop service of the Weather Bureau, for April, contains an interesting note on a statement in the article on Francis Drake in the "Dictionary of National Biography." Referring to the position of Drake's anchorage near the Golden Gate in June, 1579, the article says:—"The one doubtful point is the account of the climate, which is described with much detail as excessively cold and foggy. (Vaux, pp. 113-118). This is now said to be an exaggeration, but to speak of the climate near San Francisco or anywhere on that coast in July in these terms is not exaggeration, but a positive and evidently wilful falsehood (Greenhow, 'History of Oregon and California,' 1845), credulously inserted by the original compiler of the 'World Encompassed.'" The Weather Bureau station at Point Reyes Light, probably not more than three miles from Drake's anchorage, amply confirms the correctness of Drake's description. Fog is specially prevalent during the months June, July and August, and it is generally accompanied by strong north-westerly winds, often reaching a velocity of fifty miles an hour; a comparison of the records with those from the stations at San Francisco and on Mount Tamalpais shows an astonishing contrast as regards temperature, relative humidity and duration of sunshine. Prof. George Davidson, who was in charge of the work of the Coast Survey in this region, and has published a paper on the "Identification of Sir Francis Drake's Anchorage on the Coast of California," says "that from July 2, 1859, the fog hung over the promontory of Point Reyes for thirty-nine consecutive days and nights."

IN an article in NATURE of April 18, 1901, attention was directed to the commercial uses made of peat in Sweden, where it is coming largely into use as a substitute for coal for steam engines. In a recent number of the *Engineer* (June 27) an account is given, with illustrations, of the peat fuel works at Stangfjorden, in Norway, where electricity generated by water power has been in use since 1898 for the manufacture of peat for fuel, which is of the more interest because it is reported that negotiations are now in progress for the introduction of this system for the development of one of the water powers on the west coast of Ireland. So far peat fuel and moss litter are the only two products that have been obtained from a very limited number out of the numerous peat bogs to be found in this and other countries. The chief difficulty in manufacturing peat fuel is the extraction of the water, which comprises about 85 per cent. of the whole bulk, and which must be removed before the remaining carbonaceous matter can be rendered available for fuel. At Stangfjorden the wet peat is brought direct from the bog to the factory in boats of 100 tons capacity; the material is removed from these by electric agency and submitted to a preliminary operation of drying and pressing. The briquettes thus formed are then transported on small iron trolleys with shelves to the interior of the drying chamber. Warm air is driven through this by electric fans. From the drying chamber the blocks are taken on the same trolley to the retorts, where they are packed round spiral resistance coils and the electric

heating agent set in operation. The peat yields—besides the fuel briquettes, which form 33 per cent. of the whole—tar, charcoal, creosote, sulphate of ammonia and other bye-products. The electric power is derived from five 80-kilowatt dynamos coupled direct to five turbines of 128 H.P. The plant is capable of turning out 1000 centers of air-dried peat a day. The fuel burns well, yields little soot or ash, and is readily disposed of in Bergen and other towns.

FROM a paper communicated by Prof. Höfer to the Vienna Academy of Sciences it appears that spring waters from a large number of different petroleum districts either contain no sulphates or at most a minimal quantity of these salts. Under the influence of the petroleum and marsh gas, the sulphates have probably undergone reduction. It is pointed out that the absence of sulphuric acid in waters from petroleum provinces may be advantageously made use of in a practical way for ascertaining the whereabouts of petroleum deposits or inversely for determining the source of the waters in question.

MESSRS. SANDERS AND CROWHURST have sent us a catalogue of the photographic apparatus which is made and sold by them. The list contains almost everything that a photographer can desire; many useful novelties are included.

MESSRS. A. W. PENROSE AND CO. are making Mr. Alex. Tallent's diffraction spectroscope camera, an account of which instrument is given in a small pamphlet published by Messrs. Penrose. The main feature of this camera is that we have in a small compass a light, compact, handy and inexpensive spectroscope, ready for use at any moment. Such an instrument is rendered possible only by the introduction of the Thorp diffraction prism-grating, which does away with the necessity of a train of prisms to obtain large dispersion and what is also an important item, the outlay of considerable expense. The compactness of the instrument is due chiefly to the fact that the prism-grating forms a direct vision system. The instrument, a full account of which is given in the pamphlet, only costs from forty-five to sixty-three shillings, according to the requirements of the user, and will be found very serviceable in many directions, such as the composition of various light sources, colour sensitiveness of plates, examination of dark-room filters, &c. The plate which accompanies the text describes better than words the different uses to which the instrument can be applied, and the scale on which the spectra are obtained.

A COMPARATIVE study of the permeability of living and dead animal membranes by measurement of the electrolytic resistance has recently been made by Mr. G. Galeotti, and the results are published in *Lo Sperimentali, Archivio di Biologia norm. e patol.*, vol. lvi. The living membranes were first investigated, and then after remaining in chloroform vapour for some time were again placed in the electrolytic cell and the resistance of the solution measured as before. Various salt solutions were employed, the strengths of these being in the majority of cases one-tenth normal. The author finds that the resistance of membranes, which in the animal body separate solutions of different nature and concentration from one another, is ten to forty times greater in the living condition than when the membranes are dead. The resistance of membranes, which have no functions of this character in the animal system, is, on the other hand, unaltered by the action of chloroform vapour. The conclusion is drawn that membranes of the first class, for example, from the *cæcum* of the rabbit and the bladder of the turtle, behave as semipermeable membranes in the living condition, but this semipermeability is lost when the cells are dead. Membranes of the second class, on the other hand, act simply as diffusion membranes, and the permeability of these is the same whether living or dead.

ALTHOUGH the question as to whether the nitrogen of the albuminates present in the animal body is partly set free in the form of free gaseous nitrogen has been experimentally studied on several occasions, yet the conclusions drawn by different investigators working under different conditions are by no means concordant. The first series of such investigations was carried out by Regnault and Reiset, who found, in the great majority of their experiments, a considerable increase in the quantity of nitrogen in the respired air. About one hundred experiments were made and animals of totally different classes were subjected to investigation. Seegen and Nowak, with an improved apparatus which permitted of the experiments being continued over much longer periods of time, obtained results which agreed with those of the first observers. Hans Leo, working under different conditions, concluded, on the other hand, that nitrogen, as a product of the decomposition of albuminates, is not set free from the animal system. In Leo's latest experiments, the bodies of the animals under investigation were immersed in water, and under these conditions it was found that the alteration in the amount of nitrogen of the air was scarcely perceptible. To promote the further investigation of this subject, Prof. J. Seegen has placed 6000 kronen at the disposal of the Vienna Academy of Sciences, which sum is offered by the Academy as a prize for the solution of the question. The formulation of the problem reads:—"Es ist festzustellen, ob ein Bruchtheil des Stickstoffes der im thierischen Körper umgesetzten Albuminate als freier Stickstoff in Gasform, sei es durch die Lunge, sei es durch die Haut ausgeschieden wird." Papers sent in for competition are to be written in German, French or English, and should be sent to the office of the Academy before February 1, 1904.

THE *American Naturalist* for June contains an article, by Mr. W. R. Coe, on the Nemertean worms parasitically infesting certain crabs, in the course of which the new genus *Carcinomertes* is described.

MODERN refinements of description render it of the utmost importance that skins of small mammals should be made up on one uniform plan. Mr. G. S. Miller has accordingly published in the *Bulletins of the U.S. Museum* a revised edition of directions for making such preparations, with abstracts in German, French and Spanish.

AMONG other articles, part 4 of vol. lxxi. of the *Zeitschrift für wissenschaftliche Zoologie* contains one by Dr. K. Escherich on the development of the nervous system in flies, and a second, by Prof. P. Bachmetjew, on the effects of heat on the development of the pupæ of butterflies and moths. The nerves of the skin form the subject of a third communication, by Dr. Tretjakoff.

THE thoroughness of American methods is well exemplified in a review of the horned larks (*Otocoris*), by Mr. H. C. Oberholser, forming No. 1271 of the *Proceedings of the U.S. Museum*. In addition to four maps illustrating the distribution and breeding areas of these larks, this memoir contains photographs showing the different kinds of country inhabited by the various local races of certain species. These birds vary so much according to environment that their classification and identification are the despair of the systematist. The manner and degree of this variation—and not the mere identification of specimens—should be the aim of the investigator.

IN the June issue of the *American Naturalist* Mr. J. F. McClendon describes the life-history of the insect commonly known as *Utula hyalina*, a near relative of the so-called antlion of Europe. The larva "hides in some slight depression or under the edge of a stone, with its body covered with sand and its mandibles widely extended so as to touch the fringe of

hair on each side of the head. Its brown colour simulates the colour of the sand. Its body is hidden by the covering of sand, and the head is somewhat concealed by its peculiar covering of hairs, so that small insects may crawl, unawares, too near the extended mandibles. In this case the larva thrusts out its head and snaps the mandibles together, pinioning the victim on the curved points. It then proceeds to suck out the juices of its prey like an ant-lion."

AN appendix to the twentieth annual *Report of the Scotch Fishery Board* contains notes on the digestive tract of salmon and sea-trout kelts from the Tweed by Mr. J. K. Barton, illustrated with some beautiful reproductions from photographs of microscopic preparations. The author is of opinion that sea-trout continue to feed to within a shorter interval of their entering fresh-water than is the case with salmon, although when in the rivers both fishes are equally abstemious. No trace of the desquamative catarrh of the mucous coat which has been supposed to characterise the intestines of river fish was observed. It must be left for subsequent examinations to determine whether salmon-disease is due to the fungus *Saprolegnia*, or whether the presence of that fungus is merely the precursor of death owing to other diseased conditions.

MUCH interest attaches to an article in the *American Naturalist* for June on aggregated colonies in madreporiform corals, by Dr. J. E. Duerden. The fact that coral larvæ will occasionally attach themselves to the cups of adult corals of the same species has been noticed by previous observers. The author finds, however, that in certain West Indian corals an analogous process is quite a common method of formation of composite corals, the larvæ of *Siderastræa* frequently fixing themselves close together in small groups upon some convenient base. In course of time they grow together to form a colony, which thus differs from an ordinary colony in consisting of several individuals. Such an aggregate colony may be distinguished, for a time at least, from one of the ordinary type, by the fact that the component items are not in communication at the base.

THE search for the missing link forms the subject of an article, by Mr. R. S. Baker, in this month's *Idler*, mainly based on the discovery of "Pithecanthropus" and Prof. Haeckel's expedition to Java in search of further remains of that mysterious creature. The author traces the gradual "evolution" of the conception of the origin of one group of animals from another, and illustrates his subject with excellent portraits of Darwin, Haeckel, Huxley and Wallace. We are afraid that the illustrated table of man's descent will be apt to prove a stumbling-block to the uninitiated, and that the gorilla, gibbon, opossum, iguana, &c., will be regarded as among man's direct ancestors. The inclusion of marsupials in man's genealogical tree is, we fear, an error which it will take some time to eradicate from popular writings. The author would have done well to have shown his proof to some zoological friend, which would have resulted in the elimination of the sentence as to the association of *Pithecanthropus* with the elephant, rhinoceros, hyæna, &c. What may be the animal designated in the same sentence as "the gigantic pangolin" we are at a loss to conceive.

A BRIEF summary of progress in archeological and ethnological research in the United States during last year is given by Prof. F. W. Putnam in a reprint from vol. xiv. of the *Proceedings of the American Antiquarian Society* (1901, pp. 461-470). Since the paper was read at the annual meeting of the Society in October 1901, the Carnegie Institute has been founded at Washington, and the broad spirit in which it has been organised gives satisfaction to all who are anxious to extend

the boundaries of scientific knowledge. Referring to the Institute, Prof. Putnam remarks: "The scope of this foundation embraces all the sciences, and its purpose is the encouragement and patronage of research. Such an institution will have the power to render incalculable service to American archeology and ethnology, where so much needs to be done without loss of time."

WE have received the first two numbers of a series of occasional reports on the agriculture and forest culture of German East Africa, issued by the Central Government at Dar-es-Salam, and published by Carl Winter at Heidelberg. These reports, which are to be continued as occasion requires, contain the results of valuable scientific investigations by officials, dealing with such matters as the tse-tse fly, analyses of soils, climatology, &c. Extracts of reports from numerous civil and military stations are given, and accounts of exploring journeys into less-known regions of the colony.

THE current issue of the *British Medical Journal* (July 5) is a special vaccination number, and contains several interesting contributions on Jenner's life and works, and on small-pox and vaccination. Much valuable material—scientific, clinical and administrative—connected with the disease and its remedy, is described by writers of recognised authority.

MESSRS. DUCKWORTH AND Co. will publish immediately a book on "European Fungus-Flora," by Mr. George Masee, principal assistant at the Royal Herbarium, Kew. The work will be a synopsis of the European Agaricaceae, giving the specific characteristics of 2750 European species, of which 1553 are British.

MESSRS. DAWBARN AND WARD have commenced the publication of a series of practical handbooks designed to be of service to dwellers in the country. The first book of the series, on "Outdoor Carpentry," by Mr. S. Walter Newcomb, gives brief instructions, with plans, sketches and details, for constructing rustic work of many kinds. Among the subjects of future volumes will be water-supply and distribution, sanitation and drainage, and planning gardens, grounds and outbuildings.

THE *English Illustrated Magazine* for July contains an article upon the supposed portrait of Christ on the Holy Shroud of Turin, translated from the French, and based upon Dr. Vignon's work on "Le Linceul du Christ." The article leaves the question whether the markings upon the shroud were really produced by the body of Christ undecided, but it is held that there is sufficient evidence for the belief that the image was naturally imprinted upon the shroud by the action of vapours arising from a human body. Another article in the magazine, by Mr. J. J. Ward, gives an instructive illustrated account of May-flies and related insects.

THE "Technolexicon," or technical dictionary, to be published by the Society of German Engineers, has previously been referred to in these columns. The editor, Dr. Hubert Jansen, Berlin (N.W. 7), Dorotheenstr. 49, is anxious to include in the dictionary all technical terms used by French, German and English engineers, so that the dictionary shall contain equivalent words and expressions in each of the three languages. Collaboration is invited from societies, individuals and engineering works. The editor would be glad to receive technical catalogues, price lists, hand-books, or lists of words and terms for which correct renderings cannot be found in ordinary dictionaries. The work will be so useful when ready that all who are able to contribute to its completeness should do so.

THE additions to the Zoological Society's Gardens during the past week include two White-eared Conures (*Pyrrhura leucotis*) from Brazil, presented by Lady Lindsay; two Peregrine Falcons (*Falco peregrinus*), European, presented by Dr. R. Lawton Roberts; a European Pond Tortoise (*Emys orbicularis*),

European, presented by the Earl of Dudley; a Common Viper (*Vipera berus*), British, presented by Mr. E. Ball; two Snowy Egrets (*Ardea candidissima*) from America, two Vinaceous Amazons (*Chrysotis vinacea*), two Red-tailed Amazons (*Chrysotis brasiliensis*) from Brazil, seven Roofed Terrapins (*Kachuga tectum*) from India, a Black Sternotherpe (*Sternotherus niger*) from West Africa, a Wrinkled Terrapin (*Chrysemys scripta rugosa*) from the West Indies, a Blue-tongued Lizard (*Tiliqua scincoides*) from Australia, a Madagascar Tree Boa (*Corallus madagascariensis*) from Madagascar, deposited; a Proboscis Monkey (*Nasalis larvatus*) from Borneo, two White Storks (*Ciconia alba*), European, purchased.

OUR ASTRONOMICAL COLUMN.

THE PERIODICAL COMET OF TEMPEL-SWIFT (1869-1880).—This object is one of the most interesting of the somewhat numerous class of comets which at aphelion pass just outside the orbit of Jupiter and perform their revolutions in periods ranging from about 5 to 9 years. First seen by Tempel in 1869 November 27, the character of the orbit was not determined until its independent discovery by Lewis Swift in 1880 October 10. It was then found to be moving in an orbit of short period for the elements deduced by Bruhns, for the apparition of 1869 very closely resembled those obtained by Chandler for the return of 1880, and the latter pointed out the true character of the orbit early in 1880 November. Messrs. Schulhof and Bossert, of Paris, also published elements indicating a periodic time of 5½ years.

The average period for the four returns which occurred between 1869 and 1891 was 20.9 days, or 5 years and 183 days. At every alternate return, however, the comet is invisible. The perihelion is reached at a distance of about 10,000,000 miles outside the earth's orbit, and the three previously observed perihelion passages having occurred between November 6 and 18, the conditions were extremely favourable, the longitude of the comet's perihelion being 43° and the longitude of the earth on November 6 being 43°. The comet and earth were, in fact, mutually situated in or near those parts of their orbits which make the nearest approach to each other. At alternate returns such as in 1875, 1886, 1897, 1908 and 1919, the earth is on the opposite side of the sun to the comet when the latter passes through perihelion. In such circumstances the object is altogether beyond reach, for at one of these unfavourable returns it is placed nearly 200,000,000 miles from the earth, whereas under the best conditions, similar to those which prevailed during the apparition in 1880, the distance may be less than one-tenth of that mentioned.

As in 1869, 1880 and 1891, so in 1902, the comet will be very favourably visible in the autumn and winter months, and it will probably be re-detected in one of our large telescopes in about September next. The object will be by no means conspicuous, nor is it likely to display any attractive variety of aspect, but any moderately good telescope will show it as a large faint nebulosity. One of the best known of the ever-increasing group of Jovian comets, it will be sure to attract considerable attention during its forthcoming return, not so much, perhaps, on account of its visible characteristics as from the example it affords of a numerous class of bodies and from the interesting history attached to its previous appearances.

MR. TEBBUTT'S OBSERVATORY AT WINDSOR, N.S.W.—The annual report of this observatory for 1901 shows that much useful work was done last year. Measures of the positions of Venus, Ceres, Parthenope, Melpomene and Diana were made and the results forwarded to the *Astronomische Nachrichten* (Band clvi, p. 105).

Under "Comet Observations" we find that 273 determinations of the position of Comet I. 1901 were made between May 3 and June 13, 1901, and the full results were published in the *Astronomische Nachrichten* (Band clvi, p. 95 and Band clvii, p. 187). Encke's comet was fruitlessly sought on the evenings of October 2 and 8.

During twenty evenings the measures of twenty-eight double stars were made and the results published in the *Monthly Notices R.A.S.* (vol. lxi, p. 51).

The tables of meteorological observations show a temperature above, and a rainfall below the average, the year 1901 being the driest year recorded (excepting 1888) since 1862.

Many astronomers will regret the necessity for the inclusion of the following paragraph in the report, for it announces a great loss to observational astronomy generally, and especially to that of the southern hemisphere:—"In consequence of the author's advancing years, it is probable that there will be a considerable relaxation in his efforts for the year 1902."

EXTENSION OF THE KATHODE RADIATION HYPOTHESIS TO NEBULE.—At the meeting of the Académie des Sciences held on June 23, M. Janssen presented a note from M. Deslandres, in which the latter extends the kathode ray hypothesis, which he had already proposed in order to explain solar phenomena, to nebule.

The author says that the hypothesis of Arrhenius which attributes the light emitted by nebule to electrified particles, and also that of Nordman which attributes it to Hertzian rays gathered from space, are both wrong, for if they were true, the terrestrial atmosphere itself would, at night-time, display similar light; therefore, he adds, the light must be in the nebule themselves.

PERSONAL EQUATION IN THE MEASUREMENT OF SPECTROSCOPIC NEGATIVES.—In a note to the *Memorie della Società degli Spettroscopisti Italiani*, M. Hasselberg makes some interesting statements on the part that the personal equation of the observer plays in the measurement of photographic spectra. Quoting the note on this subject, by Mr. Reese, in *The Lick Observatory Bulletin*, No. 15, wherein it was demonstrated that the tendency in the case of Mr. Reese was to place the dark lines of the spectrum negative, as contrasted with the bright lines, a little too much to the right of the field of the microscope, M. Hasselberg goes on to demonstrate that in his own case the tendency is exactly opposite. Consequently, he finds that, in general, his personal equation makes his wavelengths come out systematically less than those published by Rowland for the same lines.

The author gives three sets of measurements of metallic spectra which he has observed, compares them with the analogous values obtained by Rowland, and, after meaning the differences to eliminate accidental errors, he finds that there remains a systematic difference of ± 0.007 Angström units, and this he ascribes to purely physiological causes.

In the third table given by M. Hasselberg he compares his measurements of the lines in the tungsten spectrum: (1) when the lines are brought to the centre of the field from the left to the right, and (2) when they are brought to the centre from the right to the left, and here he finds that in the first case his values are too great, whilst in the second case they are too small.

The author concludes by pointing out that, although these errors are very small, yet they are too pronounced to be neglected, and shows that by a curious coincidence his personal error would, if introduced into the determination of radial velocities, produce a difference of exactly 1 kilometre per second from the true velocity.

APPARENT DEFORMATIONS OF THE SUN'S DISC NEAR THE HORIZON.

ALTHOUGH curious deformations of the apparent shape of the sun and moon near the horizon have been noticed from the earliest times, observations are not very frequently made, and the apparent changes of the appearances of these bodies when near the horizon cannot be said to be very commonly known. Among the earliest descriptions of this phenomenon may be mentioned one during "The strange and dangerous voyage of Capitaine Thomas James, in his intended Discovery of the Northwest Passage into the South Sea," London, 1633. He states:—"I observed the Sunne to rise like an Ouall, amongst the Horizon: I cald three or foure to see it, the better to confirme my Judgement: and we all agreed, that it was twice as long as it was broad." On March 26, 1632, James observed the same phenomenon at the time of the rising of the moon. Biot, in his "Traité élémentaire d'Astronomie physique," writes:—"C'est encore par un effet de la réfraction atmosphérique que le Soleil à l'horizon paraît ovale et aplati dans le sens vertical, même dans les temps les plus calmes et les plus serens. Tous les points de son disque sont alors élevés par l'effet de la réfraction, mais ils le sont inégalement: les points inférieurs le sont plus que les supérieurs, parce qu'ils sont plus près de l'horizon, où la réfraction est plus forte. Le disque du Soleil doit donc alors sembler aplati, dans le sens vertical."

Among more recent papers upon this phenomenon may be mentioned one by Lieut. F. Křifka, entitled, "Refraktionserscheinungen der aufgehenden Sonne" (*Meteorologische Zeitschrift*, 1891, p. 101). During the trigonometrical survey of Brno in Bohemia, Colonel von Sterneek directed attention to the remarkable shape of the rising sun, and careful observations were taken by himself with a telescope, and by Lieut. Křifka with the naked eye, until the sun rose above the horizon. Illustrations are given of the shape and colour of the sun during fifteen phases; the colour was first a deep red and gradually faded into yellow as the sun regained its globular appearance. The forms were very curious, some resembling a basin with a projecting lid; others appeared very much like the shape of a mushroom, with its stalk; later, an oval shape was assumed.

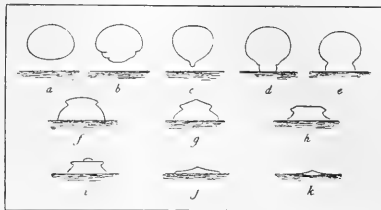

FIG. 1.

During the voyage of the Belgian Antarctic ship *Belgica*, M. H. Arctowski, a member of the scientific staff, made frequent observations of the phenomenon in question between Rio de la Plata and the Straits of Magellan, both when the sun was rising and setting, and he has communicated the results in an interesting paper published in the *Bulletin de la Société belge d'Astronomie*, accompanied by outline sketches. The description given of the phenomenon seen on November 23, 1897 (Fig. 1), of the coast of Patagonia is typical of other observations. On approaching the horizon the lower portion of the sun became flattened, and continued to become more deformed as it descended. At about 3° above the horizon there was a thin film of cloud, and the part of the sun which was still above the level of this little cloud preserved its regular shape. Gradually the lower part assumed a triangular shape, a little point or stem appeared, and became enlarged as it touched the horizon. The sketches show that all the zone comprised between the fine belt of cloud and the horizon possessed the property of deforming the sun's disc, and that in every case the cloud was the principal seat of the deformations. After the sun had set it was scarcely possible to see the cloud. The sketches very closely resemble the Bohemian illustrations already mentioned.

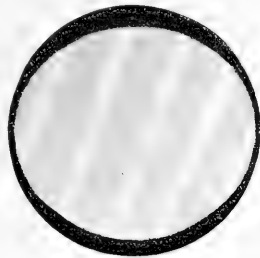

FIG. 2.

The accompanying figure (Fig. 2) is a reproduction of a photograph showing deformation of the setting sun, taken by Prof. W. Prinz, of the Royal Observatory of Belgium, at Uccle, near Brussels, and communicated to the *Memorie della Società degli Spettroscopisti Italiani*, by Prof. A. Riccò. The dark background is drawn exactly circular, in order that the deformation of the sun's disc may be seen more clearly. In this case the ratio of the vertical to the horizontal diameter is 75 : 84 mm. = 0.893.

OCEANOGRAPHICAL INVESTIGATIONS IN SOUTH AFRICAN WATERS.¹

THE observations published in the pamphlet of which the title is given below are the first of a series undertaken in connection with the fishery investigations recently inaugurated at the Cape. They include observations made in March and April, 1900, by the Government steamer *Pieter Faure*, consisting of temperatures and analyses of water samples from points to the west of the Cape Peninsula; observations of surface temperature made on February 11 to 18 and March 3, 1898, at intervals of about five miles, to a distance of fifty miles west of Cape Town, and on a voyage to St. Helena Bay; daily records of air and sea temperatures taken at Robben Island in Table Bay, and at Roman Rock in Simon's Bay during the three years 1898-1900; temperatures and analyses of water samples taken at intervals on passages of the Government trawler between Table Bay and Simon's Bay, and of mail steamers between Table Bay and Cape Hangklip. An extended series of observations is now in progress over the whole of the South African coast.

The investigation of which this forms the beginning is, without doubt, one of the most valuable and important of its kind ever attempted. The preliminary international work which has been carried on in the North Sea and the Baltic during the last nine years, and is now about to take definite shape as an organised system of research, has shown that adequate hydrographical observations are of the utmost value, not only in themselves as determining the circulation of waters, but in their relation to climatology and to fishery work of all kinds. Similar research in South African waters has the additional interest of dealing with a region where the current system is not only unusually complex, but is very strongly and clearly developed; and the fact that the services of a special ship are available renders the opportunity of studying the relations existing amongst the different current elements unique.

Unfortunately, however, the methods employed in the present series of observations seem to leave much to be desired. Nothing is said about the thermometers employed in taking temperatures, or about their corrections, and the observations at different depths are made with little reference to the changes of temperature; many of them are unnecessary, and there are frequent gaps which leave the true form of the temperature curve undetermined. The curves and sections shown suggest that the boundaries between masses of water are often very sharply defined, and that a high degree of accuracy, in the instruments employed, in their working, and in the determinations of ship's position, is essential. The laboratory analyses of the samples of water collected are still more unsatisfactory. In most cases the chlorines have been determined, by a method not stated, and the results are, for a reason left unexplained, expressed in grains per gallon, thereby rendering them incomparable with any other determinations except those of county analysts. A study of the chlorine values in relation to their geographical distribution does not inspire confidence in the accuracy of the determinations, and the uncertainty increases on comparison with the values in columns headed "specific gravity" and "sulphuric oxide." No account is given of the methods by which the specific gravity determinations have been made, nor is there any statement as to the temperatures to which they are referred, and we find, for example, such records as the following:—

Temp. °F.	Specific gravity.	Chlorine in grains per gallon.
63° 0	1'02712	1412'0
63° 0	1'02696	1414'5
63° 0	1'02700	1409'5
63° 0	1'02700	1422'0
63° 0	1'02696	1402'0
63° 0	1'02723	1414'5

The determinations of sulphuric oxide, which are, presumably, also stated in grains per gallon, give, on a series of averages (p. 215), values of the chlorine ratio ranging from 11'8 to 12'2, and on a single set (p. 213) from 10'4 to 13'1. Such determinations fall distinctly short of the standard required for work of the kind, and as there is no continuity in the variations, we must regard the whole of the tabular matter in the paper

¹ Cape of Good Hope, Department of Agriculture. Marine Investigations in South Africa. Observations on the Temperature and Salinity of the Sea around the Cape Peninsula. By J. D. F. Gilchrist, M.A., B.Sc., Ph.D.

with considerable suspicion. Finally, we note that in a region where meteorological observations are of the greatest interest and value, a specially equipped scientific expedition makes its barometer readings "direct from Aneroid."

We direct attention to these points because the importance of the work imperatively requires that it should be thoroughly well done when there is an opportunity of doing it at all. The detailed reports on methods, published by participants in the international work already mentioned, and the tables produced by Knudsen under the direction of the International Committee, leave no excuse for doing it otherwise.

A NEW FORM OF SEISMOGRAPH.

IN the *Bollettino della Societa Sismologica Italiana* (vol. vii. No. 7), Dr. G. Agamennone gives a detailed description of a seismograph, consisting of two horizontal pendulums each of which carries a mass of 1½ kg. and a vertical spring seismograph with a mass of 2 kg., which write their records side by side on a band of smoked paper 25 cm. broad.

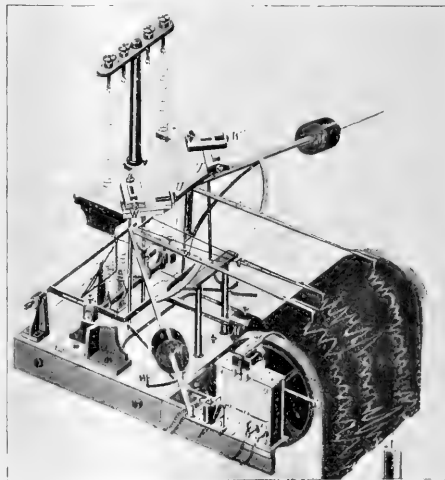

A reference to the accompanying figure shows the manner in which these three well known pieces of apparatus, which stand on a bed plate 55 cm. square, are arranged. The screws *v* alter the inclination of the vertical axes of the horizontal pendulums and hence their period. The screws *u* are to give horizontal adjustment for the same. By shifting the position of the weights *MM*, assuming the same to coincide with centres of oscillation, the multiplication of the writing pointers, which are at the extremities of arms attached at 45° to those carrying the weights, may be made twice that of the movement of the ground. It is almost needless to remark that with so small an amplification the instrument is only intended to record earthquakes which can be felt and are severe. When such an earthquake occurs, the electromagnet *F* is brought into action to release the clock-work, and the smoked paper then moves beneath the writing pointers at a rate of 25 metres per hour—a speed sufficiently high to give an open diagram of vibrations with periods of 1/10th second. But is it not desirable to record vibrations with a frequency greater than 10 per second, and in addition to obtain a trace of the preliminary tremors? Dr. A. Canciani, who uses films which move continuously at a rate of 6 metres per hour, obtains something to show the latter, but the rate is not sufficiently high to give open records of movements the period of which is very short. Then again, it must not be overlooked that the large movements of severe earthquakes are undulatory in character, and both horizontal pendulums and vertical spring

seismographs are simply swung from side to side or up and down under the influence of the tilting of their supporting bed plate.

Dr. Agamennone's new arrangement will no doubt give records which are valuable, but the seismograph which is suitable to record all forms of earthquake motion has yet to be designed. J. M.

UNIVERSITY AND EDUCATIONAL INTELLIGENCE.

CAMBRIDGE.—During the long vacation, beginning on July 7, courses of lectures will be given as follows:—Mathematics and astronomy, by Sir Robert Ball, Mr. Richmond, and Mr. Coates; practical histology, by Dr. Hill and Dr. Barclay-Smith; pharmacology, by Prof. Bradbury and Dr. Dixon; osteology, by Dr. Barclay-Smith; geology, by Mr. Marr; crystallography, by Mr. Hutchinson; chemistry, by Mr. Fenton; metallurgy, by Mr. Dootson; analysis of foods, &c., by Mr. Purvis; practical physics, by demonstrators in the Cavendish Laboratory; pathology and morbid histology, by Prof. Woodhead and Mr. Strangeways-Pigg; bacteriology and preventive medicine, by Dr. Nuttall; animal parasites, by Mr. Shipley; medicine, by Dr. Humphry and Dr. Lloyd-Jones; surgery, by Dr. Griffiths and Mr. Wherry; hygiene, by Dr. Anningson.

THE Nature-Study Exhibition to be held at the Royal Botanic Gardens will be opened on July 23 by the Duchess of Devonshire, the Duke of Devonshire being in the chair. A number of interesting conferences have been arranged in connection with the exhibition. Among the subjects to be brought forward in addresses and short papers are:—"The Study of Nature," by Lord Avebury, F.R.S.; "Seasonal Studies in Natural History," by Prof. J. Arthur Thomson; "Nature-Study in Elementary Schools," by Prof. C. Lloyd-Morgan, F.R.S.; "Visual Instruction," by Prof. Bickmore; "Nature-Study in Colleges and Higher Schools," by Prof. Miall, F.R.S.; "Plant-Life as Nature-Study," by Mr. Scott Elliott; "School Gardens," by Mr. T. G. Rooper; "Geology as a Branch of Nature-Study," by Prof. Grenville Cole; "The Training of Teachers in Nature-Study," by the Rev. Canon Steward; and "The Relation of Nature-Study to School Work and to the Home," by Sir Joshua Fitch.

MANUFACTURERS and others interested in paper-making have been invited to give their support to a scheme for the establishment of special scientific and technical instruction in connection with this industry at the Battersea Polytechnic. It is suggested that the scheme should provide for both day courses (extending over two or three years) and evening classes for employes who cannot be spared during the day; and that it should include thorough and systematic scientific and technical instruction (theoretical and practical) in chemistry and engineering so far as is necessary for the science of the subject and helpful for its practical carrying out, combined with experimental work in a laboratory or workshop specially fitted up for the actual manufacture of paper and complete testing of the finished product. Such a department when organised would naturally become a centre of research in questions connected with the paper-making and cellulose industries. The circular states that the paper-makers in the North of England have taken up the question in a very practical way and are supporting one of the large technical colleges, where they have put down a small model paper machine, which has been made in Germany, no English manufacturer being found willing to undertake the making of it.

THE Calendar of the Tokyo Imperial University for 1901-1902 shows that provision is made for the study of many branches of pure and applied science. In the College of Engineering, practical work and excursions are arranged outside the College, in addition to the laboratory work. In connection with the College of Science there are museums of zoology, geology and anthropology, and a herbarium. At the Astronomical Observatory the principal work carried on consists of observations of position and the compilation of almanacs. The director of the Botanic Garden is prepared to exchange seeds with foreign botanists or institutions. Earth-movements are continually studied at the seismological observatory, and on the occurrence of a great earthquake an expedition is at once sent to make all possible investigations. The Marine Biological Station is situated on the extremity of the peninsula jutting out between the Bay of Sagami and the Gulf of Tokyo; it thus has access to localities

rich in remarkable animal forms. Though the station is primarily intended for the use of instructors and students of the University, its facilities are extended to other persons who are qualified to avail themselves of the opportunities of research there afforded. The College of Agriculture is a very active part of the University, and the numerous investigations carried on in the experimental farm have often been noticed in NATURE. Connected with the zoological laboratory of this department are four buildings for the study of silk-worm culture, containing all the apparatus required for experiment and research. Rooms are also provided for special work in the study of the pebrine disease—the most formidable obstacle to silk-worm culture.

SEVERAL matters of interest are mentioned in the report of the Council of the City and Guilds of London Institute, a copy of which has been received. Important extensions have been made at the Central Technical College, among them being additions to the electrical department in order to bring it up to the present requirements of the electrical industry. The total cost of the extension of the College, including equipment and all structural additions and alterations, both for the College and for the department of technology, is estimated at 10,000*l.*, and the additional annual cost at about 1000*l.* The Institute has recently received from the University of London an offer to devote 125*l.* a year to the department of engineering in the Central Technical College, subject to certain conditions. This amount is the larger part of a grant made to the University by the Technical Education Board of the London County Council for improving and extending the teaching of engineering in the metropolis. It involves the appointment of the professor of engineering of the College as a "transferred teacher" of the University, and it is a recognition by the University that the College occupies the foremost position among engineering colleges in the metropolis. The organisation and work of the College have not otherwise been affected by reason of its inclusion as a school of the University. At the Technical College, Finsbury, the only change recorded in the educational scheme is the addition of a laboratory class in electrochemistry for second-year chemical students. The development of the use of electricity in the chemical industries has shown the necessity of making more complete the training which has been given to chemical students in this branch of physics.

A COPY of an address on the University of London, delivered by Dr. E. H. Starling, F.R.S., at University College, London, on June 5, has been received. Some of the prominent points brought forward in the address have already been described (p. 164), and are the same as those stated in these columns on more than one occasion. What are wanted in London are great University centres, adequate to the higher intellectual needs of the seven million inhabitants. The main features of the University of London sketched by Prof. Starling are as follows:—"Under the control of the Senate, but administered by local councils appointed by the Senate, would be these four or more centres, by which the main teaching and research of the University in all Faculties would be carried out. In addition to these centres there would be a number of schools of the University which would preserve their autonomy, but would direct their teaching according to the requirements of the University. Such schools would be essentially post-graduate in character, in that it would be their office to grant on the general training in method, acquired within the walls of the University itself, the special professional training necessary to fit the man for the pursuit of medicine, law, commerce, administration, &c. The relation of the Polytechnics to the University will require careful consideration. In any policy decided upon, it must be remembered that the whole object is the improvement of the mental training of our fellow citizens and not the distribution of degrees. It is vital to the welfare of the country that as many as possible of its inhabitants should have received a thorough university training, and be competent to use their brains in solution of the new problems which must continually meet them, whatever their trade or profession. The whole progress of the nation depends on the mental equipment of its members. At no time more than the present have the words of Bacon on this subject been so full of counsel: 'If any man thinks philosophy and universality to be idle studies, he doth not consider that all professions are from thence served and supplied. . . . For if you will have a tree bear more fruit than it used to do, it is not anything you can do to the boughs, but it is the stirring of the earth and putting new mould about the roots that must work it.'"

SOCIETIES AND ACADEMIES.

LONDON.

Royal Society, May 15.—"A Note on the Recrystallisation of Platinum." By Walter Rosenhain, B.A. (Cantab.), B.C.E. (Melbourne). Communicated by Prof. Ewing, F.R.S.

The author has observed phenomena in platinum analogous to those of recrystallisation in other metals previously described by Prof. Ewing and himself (*Phil. Trans.* A, 1900, vol. cxv.). It is well known that platinum which has received a prolonged exposure to high temperature becomes brittle and that its surface, if it has been exposed to flame, shows crystalline markings. This has been ascribed to the action of carbon, but the author ascribes it to a process of recrystallisation and subsequent surface etching by the flame. Evidence in favour of this view is drawn from the micro-structure of this "brittle" platinum, from its behaviour on etching with aqua-regia, and from its mode of fracture when hot. The micro-structure is shown to be that characteristic of recrystallised metals, the action of aqua-regia is found to brighten the flame-etched surface, and the fracture follows lines characteristic of the surface crystals, thus proving that the surface pattern truly represents the structure of the whole thickness of metal. The author points out that cold-worked metal is very apt to undergo recrystallisation at high temperatures, and that in several well-known cases brittleness results from such a process; he believes, therefore, that recrystallisation accounts for all the phenomena except the surface markings, and these he ascribes to an etching action of the flame in which the temporary formation of a carbide may play a part.

June 19.—"On an Approximate Solution for the Bending of a Beam of Rectangular Cross-section under any System of Load, with Special Reference to Points of Concentrated or Discontinuous Loading." By L. N. G. Filon, B.A. (Cantab.), M.A., B.Sc. (Lond.), King's College, Cambridge, Fellow of University College, London, and 1885 Exhibition Science Research Scholar. Communicated by Prof. G. H. Darwin, F.R.S.

The paper investigates the elastic equilibrium of a long bar of rectangular cross-section in cases where the problem may be treated as one of two dimensions, the plane of the strain being the vertical plane through the axis of the bar.

General solutions in arbitrary functions are first obtained. These, on being applied to the particular case, lead to series involving hyperbolic sines and cosines. These series, when the length of the bar is made infinite, degenerate into integrals which can be expanded in ascending powers of the radius vector from any point, within a certain circle of convergence. The properties of these series and integrals in the neighbourhood of points of concentrated or discontinuous load are specially considered.

By means of these solutions, arbitrary conditions of stress over the top and bottom faces of the beam can be satisfied.

Various cases, including those of a doubly supported beam carrying a central isolated load, of a block resting upon a smooth rigid plane and pressed by a knife edge on its upper surface, of a beam under two equal opposite loads not in the same straight line, and of a bar under tension produced by knife-edge "grips" on either side, are considered.

The corrections that must be applied to the expressions given by de Saint Venant for stresses in the free parts of long bars, when we approach the points of application of concentrated loads, are investigated at length. It is found that, at distances from the sections where such load is applied of the order of the larger diameter of the cross-section, these corrections, *i.e.* the local perturbations, become insensible.

Finally, solutions in finite terms are discussed, and such a solution is obtained for a beam carrying a uniform load.

Physical Society, June 20.—Prof. S. P. Thompson, president, in the chair.—Mr. G. F. Herbert-Smith exhibited the three-circle goniometer recently constructed for the British Museum from his designs. In this form of goniometer the advantages of the earlier forms are combined: as with the two-circle or theodolite goniometer, a crystal is only once adjusted during the whole of the observations, and as with the one-circle goniometer observations are made in zones, and full advantage may be taken of the zonal characters of crystals and of the simple formulae depending thereon.—A paper on the heat evolved or absorbed when a liquid is brought in contact with a finely

divided solid, was read by Mr. G. J. Parks. Pouillet discovered the fact that when a powder is put into a liquid which does not exert any solvent or chemical action upon it, there is, in general, a rise of temperature. The objects of the present investigation were to obtain a relation between the quantity of heat evolved and the area of the surface exposed, to find the rate of variation of heat evolved with temperature, and to apply to the results the laws of thermodynamics. From the results of his experiments the author states that when silica, sand or glass is brought into contact with water at approximately constant temperature, the heat evolved is proportional to the area of the surface exposed by the solid, and the amount of heat developed per square centimetre is approximately '00105 calorie when the temperature is near 7° C. Assuming that the phenomenon of Pouillet is reversible and that it is due to a pressure at the surface of the powder, the author has, by the application of the laws of thermodynamics and the results of his experiments, arrived at the conclusion that at 7° C. the surface-pressure of water and silica diminishes at the rate of 157 dynes per centimetre for an increase of temperature of 1° C. Experiments made at different temperatures indicate that the heat evolved is roughly proportional to the absolute temperature. Experiments were also made which showed a fall of temperature on putting a finely divided solid into mercury.—A paper by Prof. R. W. Wood, on a remarkable case of uneven distribution of light in a diffraction grating spectrum, was read by the Secretary. It is a well-known fact that in the spectra formed by diffraction-gratings the light is unevenly distributed, that is, the total light in any one spectrum will not recombine to form white light. The author has been examining a most remarkable grating in which the drop from maximum illumination to minimum occurs within a range of wave-lengths not greater than the distance between the sodium-lines. In other words, the grating at a certain angle of incidence will show one of the D lines, and not the other. Experiments with polarised light have proved that these anomalies are only exhibited when the direction of vibration (electric vector) is at right angles to the ruling. The paper gives a detailed account of the appearance of the spectra at different angles of incidence when the grating is in air and when it is immersed in different liquids. It is shown that the phenomena are not due to interference between disturbances coming from widely separated lines, and the author suggests that the matter must be referred to the form of the groove.—A paper by Prof. R. W. Wood, on the electrical resonance of metal particles for light waves (second communication), was read by the Secretary. In a previous paper the author has shown that granular deposits of the alkali metals exhibit brilliant colours by transmitted light. These colours were referred provisionally to the electrical resonance of the minute particles for light waves. The present paper gives an account of experiments made with gold and silver films to determine whether the resonance is molecular, or whether it is an electrical vibration of metallic masses, smaller than the light waves, though of the same order of magnitude. Further investigations on the dispersion of the films and a more careful study with polarised light will doubtless throw light on the matter.—Prof. H. L. Callendar showed a simple apparatus for measuring the mechanical equivalent of heat.

Royal Microscopical Society, June 18.—Dr. Henry Woodward, F.R.S., president, in the chair.—The secretary read a note from Mr. Nelson on some high-power photomicrographs of *Pleurosigma angulatum*, *Savirella genoma* and *Coccinodiscus asteronophatus*, taken by Mr. F. E. Ives.—Mr. A. Hilger exhibited a new photo-measuring micrometer attached to a microscope designed specially for accurately measuring the distances between the lines of the spectrum, but it could also be used for various laboratory purposes.—Messrs. Watson and Sons exhibited and described a new two-speed fine adjustment for microscopes. They also exhibited a microscope fitted with a new holder by which metallurgical specimens could be held in any position while under examination.—Messrs. Carl Zeiss exhibited their epidiascope, a projection apparatus by means of which large brilliantly illuminated pictures of objects can be shown on a screen. Objects such as ordinary lantern slides and transparencies up to 9 inches square, opaque objects, such as photographs, drawings, prints, bones, medals, butterflies in their natural colours, &c., were shown in illustration of its capabilities. A simplified form of microscope was then attached to the instrument, and micro-slides were projected on the screen, giving pictures about 6 feet diameter, with great brilliancy and sharpness of definition.—Prof. Marcus Haartog gave a short

account of the structure of Acinetines, from observations on a species (*Chaoiphya infundibulifera*) epizoic on Cyclops. He demonstrated that the spiral marking of the tentacles was due to a double-threaded constriction, that in protrusion and retraction there was no torsion, but only an opening and closing of the spiral, and that the tentacles were continued deep into the endosarc of the creature.—Mr. C. F. Rousselet read his paper on the genus *Synchaeta*, with a description of five new species.—Mr. Walter Weschke gave a brief résumé of his paper on undescribed palpi on the proboscis of some dipterous flies, with remarks on the mouth-parts in several families. Specimens showing the palpi on several species were exhibited under microscopes.

Zoological Society, June 17.—Prof. G. B. Howes, F.R.S., vice-president, in the chair.—Mr. R. I. Pocock exhibited and made remarks upon the nest of a gregarious spider (*Stegodyphus dumicola*) sent home by Captain Barrett-Hamilton from Vredfort Road, Orange River Colony, South Africa.—Mr. Oscar Neumann exhibited specimens of some new and interesting mammals which he had discovered during his recent journey through Eastern Africa, and called special attention to some monkeys of the genus *Cercopithecus*, and to various species of hyraxes (*Procavia*).—Dr. Walter Kidd read a paper on certain habits of animals as traced in the arrangement of their hair. It was an attempt to interpret, in terms of certain characteristic habits, the departures from a primitive type of hair-arrangement. Short-haired mammals, chiefly ungulates and carnivores, were considered. The habits referred to were divided into passive (those of sitting and recumbent postures) and active (chiefly those of locomotion), and these were shown to match closely the variations observed in the direction of hair in the animals concerned.—Mr. F. E. Beddard, F.R.S., described the carpal organ which he had observed in a female specimen of *Hapalennur griseus* that had lately died in the Society's Gardens. He pointed out that this organ in the female differed in some details from that in the male.—Mr. R. I. Pocock read a paper on some points in the anatomy of the alimentary and nervous systems of the false scorpions of the order Pedipalpi.—A communication from Mr. H. J. Elwes, F.R.S., called attention to Mr. Lydekker's recently published description of a new elk, *Alces bedfordiae*, based on some unpalmed antlers and a skull of an elk from Siberia, and offered a remark that he thought it inadvisable to found a new species, or even a subspecies, on the material. Mr. F. E. Beddard, F.R.S., read a paper, prepared by himself and Miss Fedarb, descriptive of a new coelomic organ in the earthworm, *Pheretima (Perichaeta) posthumus*, which consisted of a series of sac-like structures on the floor of certain segments in the middle of the body.—Mr. Beddard also described some new species of earthworms belonging to the genus *Polytoreutus*, and made some remarks on the spermatophores of that genus.—A communication from Miss Igera B. J. Sallas contained an account of the Sponges obtained during the "Skeat Expedition" to the Malay Peninsula in 1899-1900. The collection contained examples of twenty-nine species, eleven of which had proved to be new and were described in the paper.—Mr. G. A. Boulenger, F.R.S., enumerated the eight species of fishes of which specimens were contained in a collection made Mr. S. L. Hinde in the Kenya district of East Africa. Four of them were new and were described by the author.—A communication from Mr. A. L. Butler contained a list of the species of batrachians—thirteen in number—that had been added to the Malayan fauna since the publication, in the Society's *Proceedings* in 1899, of Captain Flower's paper on the reptiles and batrachians of the Malay Peninsula.

Geological Society, June 18.—Prof. Charles Lapworth, F.R.S., president, in the chair.—The Great Saint-Lawrence-Champplain Appalachian fault of America, and some of the geological problems connected with it, by Dr. Henry M. Ami. The extent, earth-movements and striking characteristics of this fault-line and of the geological formations which occur along this line of weakness in the earth's crust, with special reference to the formations in British North America, were discussed.—At this stage of the proceedings, Mr. E. T. Newton, F.R.S., took the chair at the president's request.—The Point-de-Galle Group (Ceylon): Wollastonite-Scapolite-Gneisses, by Mr. A. K. Coomaraswamy. The chief rock-types vary from basic pyroxene-sphene-scapolite-rock, through intermediate rocks composed of pyroxene, scapolite and wollastonite, with felspar and quartz subordinate or abundant, to acid types made up of orthoclase-

microperthite or coarse-grained quartz-felspathic rocks. They differ in several respects from the normal types belonging to the Charnockite series.—On the Jurassic strata cut through by the South Wales direct line between Filton and Wootton Bassett, by Prof. S. H. Reynolds, and Mr. Arthur Vaughan. In this section a thin bed of typical Cotnam Marble is followed by the "White Lias," and that by the Lower Lias, which in this district attains a thickness of about 200 feet.

Linnean Society, June 19.—Mr. W. Carruthers, F.R.S., vice-president, in the chair.—Dr. W. G. Ridewood described a new genus of Copepoda occurring parasitically in the suprabranchial cavity of the lamellibranch *Lyonsiella*, and for which, on account of the great inflation of the thorax, he proposed the name *Obesiella*. He showed that the systematic position of *Obesiella* was next to *Ascomyzon*, in the family *Ascomyzontidae*.—Mr. George Masee described some of the results of modern methods of investigation in mycology, illustrating his remarks by means of lantern slides. He pointed out the errors of some observers who urged the suppression of genera wholesale on the evidence of a few species, and pleaded for the retention of familiar names until a clear case for their suppression had been established on evidence furnished by pure cultures.—Mr. W. P. Pyrcraft read the second part of his contribution towards our knowledge of the morphology of the owls. This dealt with the osteology. After drawing attention to the close resemblances between the skeleton of the striges and that of the accipitres among the falconiformes, and pointing out the homoplastic character of these resemblances, he proceeded to discuss briefly the more important characters of the several genera, and of the nestling skull, which exhibited some curious relations between the squamosal, parietal and alisphenoid bones. The modifications referred to appear to fall under two heads. Especial stress was laid upon the relations of the squamosal. In some forms this bone was barely visible in the inside of the skull, whilst in others almost its entire inner surface was exposed, thus taking a prominent part in the formation of the cranial cavity.

PARIS.

Academy of Sciences, June 30.—M. Albert Gaudry in the chair.—On the structure and history of the lunar crust, remarks suggested by the fifth and sixth numbers of the photographic atlas of the moon, published by the Observatory of Paris, by MM. Loewy and P. Puiseux.—New researches on the liquid hydride of silicon, Si_2H_6 , by MM. H. Moissan and S. Smiles. The vapour density of this liquid silicon hydride has been determined at 100° C. by Gay Lussac's method, and has been found to be 2.37. The formula Si_2H_6 requires 2.14. The compound is not decomposed on heating to 100° C.; it is very soluble in ethyl silicate, but is only slightly soluble in water. The compound possesses very strong reducing properties, acting instantly on solutions of mercury perchloride, silver nitrate and gold chloride. The most remarkable property of this new hydride is its action on saturated compounds rich in chlorine or fluorine. An attempt to determine its solubility in carbon tetrachloride gave rise to a violent explosion immediately the two liquids came into contact, and the very stable sulphur hexafluoride gave rise to a similar reaction with detonation.—On some new properties of amorphous silicon, by MM. H. Moissan and S. Smiles. When liquid silicon hydride is decomposed by a series of electric sparks, amorphous silicon is obtained in a new form. It differs from the amorphous silicon prepared by the method of Vigouroux in possessing reducing properties towards potassium permanganate, sulphate of copper, mercury perchloride, and chloride of gold. These differences are attributed by the authors to the different state of division.—On appendicitis and its causes, by M. Lannelongue. A discussion of the history of appendicitis and its relations to other diseases of the intestines and peritoneum. Appendicitis is a microbial enteritis, rarely associated with a single micro-organism, several species usually being found in association.—The action of the X-rays on very small electric sparks, by M. R. Blondlot. It was discovered some years ago that the sparking distance for a given potential is increased under the influence of the X-rays; in the present paper a new action is described. Two pieces of metal are placed a small fraction of a millimetre apart, and kept at a potential difference slightly greater than that necessary to produce a spark in the absence of the X-rays. If this spark interval is now exposed to these rays, the spark becomes distinctly brighter. Suppress the X-rays, and the

spark returns to its original condition.—Signor Schiaparelli was elected a Foreign Associate in the place of the late Baron Nordenskiöld.—On a class of functional equations, by M. Ivar Fredholm.—On the integration of differential systems which are completely integrable, by M. E. Cartan.—On injection motors, by M. L. Lecornu. A thermodynamical analysis of the Diesel petroleum motor.—On the liquefaction of air, by M. Georges Claude. A description of an improved machine for the economical production of liquid air. Worked by an engine of 30 B.H.P. about 20 litres of liquid air per hour is produced, and from a second engine worked by the escaping gases about 6 B.H.P. is obtained, thus producing about 1 litre of liquid air per 1 B.H.P.—Remarks on the above paper, by M. d'Arsonval. It is pointed out that, although the theoretical possibility of the method used by M. Claude has always been conceded, the attempts of Siemens and Solvay were failures, and Linde, in fact, definitely stated that such an arrangement could not possibly work. The results obtained after two years' work are very promising.—Remarks by M. Caillaet on the same subject.—The precautions necessary in the use of Ruhmkorff coils in radiography, by MM. Infort and Gaiffe. It was noticed in comparing radiographs taken by the aid of induction coils with those taken by the use of static machines that the latter were always perfectly sharp whilst the former were often wanting in clearness. This effect has been traced to the action of the magnetic field of the coil on the kathode flux of the bulb. On removing the Crookes tube to a sufficient distance from the coil, this effect was obviated.—The action of self-induction in the extreme ultra-violet portion of spark spectra, by M. Eugène Néculcéa. Details are given of the measurements with lead and zinc.—On the speed of the ions in a salt flame, by M. Georges Moreau.—On the magnetic properties of the ferrosilicons, by M. Ad. Jouve. The points of inflection on the curves given point to the existence of two definite compounds of iron and silicon in the alloys studied and no more, Fe_2Si and $FeSi$.—The centre of gravity of binary accords, by M. A. Guillemin.—On the double nitrites of iridium, by M. E. Leidié. The preparation and properties of the double nitrites of iridium with potassium, sodium and ammonium are described.—On the constitution of the aloins; comparison with the glucosides, by N. E. Léger. The aloins appear to belong to a new class of compounds, glucosides not split up by dilute acids.—On two new sugars extracted from manna, mannctetrose and mannintriose, by M. C. Tanret.—The action of carbon bisulphide on the polyvalent amino-alcohols, by MM. L. Maquenne and E. Roux. The polyoxamines are attacked on warming with carbon bisulphide, giving cyclic combinations containing only a single atom of sulphur, probably oxazolones.—On the estimation of lecithin in milk, by MM. F. Bordas and Sig. de Raczowski.—The mechanism of the synthesis of leucine, by MM. A. Vila and E. Vallée.—On the application of hot air as a method of heating non-volatile liquids in the form of spray, by M. J. Glover.—Variations in the state of refraction of the human eye according to the illumination, by M. Auguste Charpentier.—On the effects produced by the section of the semi-circular canals from the point of view of their stimulation and their paralysis, by M. Louis Boutan.—On the brain of the Phascosolome, by M. Marcel A. Hébrubel.—On the existence of elements corresponding to a primitive form of the sieve tubes in Gymnosperms, by M. G. Chauveaud.—On the density of sea-water, by MM. Thoulet and Chevallier.

NEW SOUTH WALES.

Linnean Society, April 30.—Mr. J. H. Maiden, president, in the chair.—The gummosis of the sugar-cane, by Mr. R. Greig Smith. From the gum of diseased stalks, *Bacterium vascularium*, Cobb, was isolated and purified. Under suitable conditions of nutrition, temperature and acidity, the bacterium produces, in the laboratory, a gum or slime which is chemically identical with the gum obtained from diseased canes. The gum is therefore not a pathological secretion of the plant, but is undoubtedly of microbial origin. For the formation of gum, saccharose or levulose is necessary; dextrose is not so useful, and the other commonly occurring sugars and carbohydrates are useless. Of the saline nutrients, phosphate is essential, and potash can be replaced by calcium or magnesium; sodium salts act as decided poisons to the microbe. The specific characters of the bacterium are described.—On a Gyrocotyle from *Chamaera Ogilbyi*, and on Gyrocotyle in general, by Prof. W. A. Haswell, F.R.S.—Notes from the Botanic Gardens, Sydney, No. 8, by Mr. J. H. Maiden

and Mr. E. Bette.—Further remarks upon the mechanism of agglutination, by Mr. R. Greig Smith, Macleay bacteriologist to the Society.

GÖTTINGEN.

Royal Society of Sciences.—The *Nachrichten* (physico-mathematical section), parts ii. and iii. for 1902, contain the following memoirs communicated to the Society:—

February 8.—Lothar Heffter: On the theory of real curve-integrals. Walther Borsche: Xanthene derivatives from β -nitrophenol. O. Kellogg: On the theory of the integral equation $A(x, t) - A(x, t) = \mu \int_0^1 A(x, r) A(r, t) dr$.

February 22.—W. Ernst and A. Lessing: On the migration of galvanic polarisation through platinum and palladium plates. R. Straubel: Experiments on thermoelectric effects in tourmaline.

March 8.—J. O. Müller: On the minimal property of the sphere. E. Wiechert: Observations at Göttingen of the polar light. A. Schoenflies: On a fundamental theorem of the analysis of position. J. Elster: Dr. V. Cuomo's measurements of the distribution of atmospheric electricity in the open air at Capri.

May 3.—H. Ebert: Report of observations on atmospheric electricity at Munich in the year 1901-2. F. Exner: Report of observations on atmospheric electricity at the stations of the Vienna Academy.

CONTENTS.

PAGE

The Record of Huxley's Scientific Work. By G. B. H.	241
Geological History	242
Plane Surveying. By Major C. F. Close	243
Inspection of Railway Materials. By N. J. L.	244
Our Book Shelf:—	
Watkins: "The Watkins Manual of (Photographic) Exposure and Development."—C. J.	245
Hodge: "Nature Study and Life."—R. L.	245
Ingle: "Manual of Agricultural Chemistry."—R. W.	245
Hildebrand: "Ueber Aehnlichkeiten im Pflanzenreich"	246
Tuckermann: "Index to the Literature of the Spectroscope (1887-1900, both inclusive)."—H. M.	246
Letters to the Editor:—	
Misuse of Coal.—D. E. Hutchins	246
Cold Weather in South Africa.—J. R. Sutton	247
A Short Period of Solar and Meteorological Changes. (With Diagrams.)—Sir Norman Lockyer, K.C.B., F.R.S., and Dr. William J. S. Lockyer	248
The First Magician. (Illustrated.) By R. T. G.	249
Recent History of the Royal Society	251
The Future of the Victoria University. By Prof. Arthur Schuster, F.R.S.	252
Notes	254
Our Astronomical Column:—	
The Periodical Comet of Tempel-Swift (1869-1880)	258
Mr. Tebbutt's Observatory at Windsor, N.S.W.	258
Extension of the Kathode Radiation Hypothesis to Nebule	259
Personal Equation in the Measurement of Spectroscopic Negatives	259
Apparent Deformations of the Sun's Disc near the Horizon. (Illustrated.)	259
Oceanographical Investigations in South African Waters	260
A New Form of Seismograph. (Illustrated.) By J. M.	260
University and Educational Intelligence	261
Societies and Academies	262

THURSDAY, JULY 17, 1902.

MECHANICS OF ENGINEERING.

The Mechanics of Engineering. By Prof. A. Jay DuBois, C.E., Ph.D., Yale University. Vol. i., Kinematics, Statics, Kinetics, Statics of Rigid Bodies and of Elastic Solids. Pp. xxxiv + 634. Price 31s. 6d. Vol. ii. Stresses in Framed Structures and Designing. Pp. xxiii + 609. Price £2 2s. (New York: Wiley and Sons; London: Chapman and Hall, Ltd., 1902.)

THIS manual forms one of a number of publications which are being prepared by professors and instructors of Yale University and issued in connection with the Bicentennial Anniversary.

Dealing first with vol. i., the first 400 pages of the book, about two-thirds of the whole, are devoted to what may be considered as the preliminary work of developing the principles of the mechanics of solids. In substance this part corresponds with the author's treatise on the "Elementary Principles of Mechanics," published in three volumes, entitled "Kinematics," "Statics" and "Kinetics." The treatment is mainly analytical, graphical methods being reserved for the later chapters, in which the practical application of the principles is dealt with, and for the second volume.

In the section dealing with the fundamental and derived units of measurement, the author rightly insists on the importance of constantly keeping in mind the dimensions of the various quantities, and of checking equations from time to time by inserting the dimensions and applying the principle of homogeneity.

The old difficulty as to the use of the same word *pound* to denote both mass and force is partially overcome by writing lb. when mass is referred to, and pound when force is meant. There is thus a distinction to the eye if not to the ear. This convention, however, is not adhered to in the latter parts of the work.

In the development of the subject the reader is constantly reminded of the very useful fact that the various directed quantities which appear are vectors, and follow the vector law. But we think it would have tended to increased clearness of view if the author had brought into greater prominence the distinction between vectors the representative lines of which have different degrees of freedom, or, as they have been named, between unlocalised vectors, vectors localised in lines, and vectors which are localised at points.

The author's fundamental definition of a vector as a directed quantity merely, with the frequent inference that any quantity which has magnitude and direction is a vector and therefore obeys the vector laws, is open to criticism. The reader will find that its application to the resolution and composition of angular displacements on pp. 58 to 60 is not very clear or convincing. Stated in this form it is liable to lead to slips like the one we notice on p. 186:—

"If a rigid body has angular acceleration about an axis through its centre of mass, the resultant is a force couple in a plane at right angles to this axis. And conversely," &c.

In the chapter on central forces the author touches on planetary motions and on harmonic motion. The latter

might with advantage be treated more fully in any subsequent edition, considered from the vector point of view, and with some reference to Fourier's theorem.

In treating of friction, only the simple approximate laws of solid friction are considered. Academic calculations are made as to the action and efficiencies of machines like the wheel and axle, the different systems of pulleys, the screw, &c. Some useful lessons, not revealed in the treatise under review, would be learnt by any student who had the opportunity of putting the results of these calculations to the test by actual experiments in a laboratory.

In the chapter on impact there are some practical observations on pile driving and on the limiting pressures which may be put on pile and earth foundations.

The section on the development of principles is brought to a close by a discussion of the action of the gyroscope and spinning top, and the statement of the equations of motion of a rigid body in their general form.

In the part dealing with the practical applications of principles, the subject-matter treats mainly of questions specially interesting to the civil engineer. This is naturally to be expected, having regard to the position and qualifications of the author.

There are two short chapters relating to framed structures and bending moments, evidently curtailed in anticipation of vol. ii. Then follows an interesting discussion on masonry structures, dealing with earth and water pressures, and including the design of masonry dams and retaining walls.

The closing section of the volume, comprising about 150 pages, relates to the "Statics of Elastic Solids," and deals with the design of such details as ties, riveted joints, pins and eye-bars, shafts, beams, springs and long columns; and the first volume concludes with an application of the principle of least work to the swing bridge, the metal arch, the stone arch and the suspension bridge.

The discussion of the theory of elasticity is meagre and disappointing. The various formulæ are established without giving the reader any clear insight with regard to the assumptions made and to the consequent limitations to the practical applications of the formulæ that are obtained. Consequently there is a tendency to interpret the results of the calculations as if they had the same certainty as demonstrations in geometry, and sometimes the proof given is quite illusory. For instance, the investigations on pp. 509 to 511 on the strengths of shafts need thorough revision. The work of St. Venant in regard to the torsion of shafts of other than circular section is entirely ignored. The formula $\frac{M}{I} = \frac{f}{\rho}$, applicable to circular shafts only, is taken as if it were true for all forms of section, and is actually applied to square and rectangular shafts. As another example of misleading theory, we think the working of example 3, p. 491, relating to a plate girder, should be entirely recast.

In other portions of the subject the author is more happy. He applies the method of strain energy and the principle of least work to framed metal arches, in a manner readily lending itself to cases of travelling loads. He also investigates temperature stresses in the two-hinged and the continuous arch. We think he is right

in also applying the same methods and principles to stone arches and to stiffened suspension bridges, and that the results so obtained are probably more to be depended on than corresponding results by older writers based on other assumptions. However, in structures of this class, liable to be self-strained, and with important factors necessarily omitted or only roughly guessed at in any estimate of the straining actions, we should not be inclined to set the same value on the results of the calculations that the author seems to attach to them. The remarks made on p. 519, in reference to calculations for a four-leg table, probably apply largely to this case, and indicate the more appropriate attitude of mind in regard to the value to be assigned to the results.

Whilst pointing out that much of vol. i. will seem inadequate to an English engineer, we are glad to draw attention to the large number of practical examples scattered throughout its pages, and in many cases fully worked out. In fact, many students might refer to these with advantage, although they will have to look elsewhere for a more thorough discussion of the principles involved.

The second volume consists of the author's well-known treatise on "Stresses in Framed Structures," eleven editions of which have already appeared, the present revised edition being the first under the new title. Some of the subject-matter of vol. i. is repeated in vol. ii., so as to make the latter complete in itself.

Students and engineers on this side of the Atlantic who are interested in bridge building will wish to possess this volume, in which modern American practice is very fully dealt with. In developing the subject, the author gives numerous examples of the design and construction of details, worked out numerically and profusely illustrated by diagrams and drawings. Towards the end, the author quotes a standard specification for bridge work, in compliance with which he works out in detail a complete design of a typical structure, giving all the calculations, and accompanying the discussion by plates comprising a full set of working drawings.

The volume concludes with special chapters by experts on shop drawings, office work and inspection; on the erection of bridges; and on lofty commercial buildings, in the construction of which steel enters largely.

SURFACE-FEEDING DUCKS.

The Natural History of the British Surface-feeding Ducks. By J. G. Millais, F.Z.S. Pp. xiv + 107. With 6 Photogravures, 41 Coloured Plates, and 25 other illustrations. (London: Longmans, Green and Co., 1902.) Price 6 guineas net.

THE first feeling of a reader on closing Mr. Millais's "Natural History of the Surface-feeding Ducks" will be surprise that one individual—though naturalist, sportsman and artist in one, and blessed, as the author has been from boyhood, with exceptional opportunities—should have been able single-handed to collect direct from Nature so much new and interesting information about familiar birds.

The next will be, perhaps, a touch of regret that it should have been given to the public in a form and at a NO. 1707, VOL. 66]

price (six guineas net) which must limit its readers to the favoured few who have broad bookshelves and substantial balances at their bankers, or who may be living within reach of rich libraries.

But the tyranny of custom has decreed that a monograph of bird or beast, if it is to take rank as a serious contribution to scientific literature, must dress up to the part, and appear in the form and type of a family Bible; and Mr. Millais, prudently no doubt, has judged it wise not to fly in the face of the conventionalities.

The result is a richly illustrated and beautifully got-up quarto volume weighing nearly nine pounds—about as much as a couple and a half of well-fed mallard—describing the life and changes of plumage of seven species of ducks more or less common in England, with pictures and shorter notices of three others which, as rare occasional visitors, have been admitted to the list of British birds. Mr. Millais has much that is interesting to tell of the courtships and varying habits of feeding of the ducks he writes about; of their contrivances for escaping the notice of birds of prey; and of their every-day life.

But it is to the wonderful plumage changes during the period of the drake's "eclipse," when at a time of helplessness he assumes the inconspicuous dress of his mate, that he has more especially devoted his attention. The conclusions he has arrived at add another to the marvels which every fresh discovery in natural history has revealed.

Birds, as everyone knows, periodically renew their feathers, some oftener than others; but all, or nearly all, probably at least once a year. As a rule—though often when undergoing the change they mope and show other-wise signs of the need of a tonic—the moult is effected without seriously incapacitating them. Geese and most kinds of ducks are an exception, and, at least in the case of the males, for a time commonly completely lose the power of flight. Why this should be so, science has never yet been able to suggest. But it is, incidentally, where the birds most congregate, of immense advantage to human beings. It is during the moult that the Samoyedes, without much more exertion than is involved in driving sheep into a pen, lay in their most important winter stores.

The most interesting chapters in Mr. Trevor Battye's "Icebound in Kolguev" are those in which he describes the great autumn goose drives in which he took part, when the birds, unapproachable at any other time, were knocked on the head by thousands to be salted down for future consumption.

Nature has been a little more pitiful to the ducks than to the geese, and for their protection has arranged that, during the week or two that the duck is practically flightless, he shall doff his conspicuous colouring, and masquerade in the unobtrusive dress of the female. In the case of the mallard, the colour even of the legs and beak is changed.

Nature in most of her processes works economically. In the matter of the drake's "eclipse" she is reckless. The strain put on the bird's system, for no other apparent reason than to avoid startling contrasts and produce the desired results gradually, is almost incredible.

Two-thirds of the mallard's feathers (viz. those of the head, neck, breast and parts of the back and scapulars),

writes Mr. Millais, as the results of close observation, "between June 15 and October 10, undergo a *double moult*, that is to say, the feathers are actually shed twice, whilst one-third (*viz.* the long scapulars, wings, tail and back feathers) are renewed only once, and during all the time, both in the shedding of the old feathers and the assumption of the new, there is a process of constant sympathetic change of colour."

Mr. Millais has something even more strange to tell.

"I am convinced," he writes, "that a bird has full power to command the moult as it will, and also"—stranger still—"to infuse or withhold colouring matter as it thinks necessary."

The Lord of creation "cannot make one hair black or white."

His conclusions, startling as they may be, are those of a thoughtful and observant man who has conscientiously devoted many years to a close study of a fascinating subject.

It is not, as a rule, until the drake has completely assumed the duck's brown dress, harmonising as it does with the colour of the dying reeds, that the quills are shed. The operation is got through without an hour's waste of time. "I have known them" (Mr. Millais must speak for himself again) "all come out together in one day, the new flush starting at once."

The duck has others to think of besides herself. If she, like her mate, were to be deprived of flight-power, it would often be at the risk of her brood, and so her wing feathers are shed, like those of most birds, gradually, and she seldom, if ever, quite loses the use of her wings. If she has a second brood to look after, and is thus occupied later than usual with family cares, even this comparatively harmless moult is postponed for a more convenient season—as Mr. Millais believes, if we read him rightly—by a direct action of will on her part.

It is a wonderful story, but nothing in Nature is incredible merely because incomprehensible.

Mr. Millais has a very simple answer to a question which has puzzled many others than scientific naturalists. When ducks and other birds which usually nest on the ground change their habits, as they often do, and lay in trees, how do the young ones—*nidifugae* who leave the nest as soon as they are hatched—manage to get down?

At the mother's call, he says, they throw themselves down and alight unhurt. The explanation is good so far as it goes, and may, not improbably, be in most cases true. But it would be rash to accept it as of universal application.

Three young birds found dead at the foot of a tree in a park in Sussex led this spring to the discovery of a moorhen's nest at a very considerable height from the ground. The young birds were all well nourished and had been apparently killed by the fall.

Woodcocks have been more than once seen by trustworthy witnesses in the act of carrying their young, and there is no reason to suppose that ducks and other birds cannot on occasion as easily do the same.

There are many other directions in which, if space permitted, it would be pleasant to follow Mr. Millais's lead. But enough has, perhaps, been said already to show that his book is original and very interesting. The pictures are all excellent. Among the most interesting

is the pencil sketch by the author, facing p. 60, of the beak of a shoveller, with its strange spoonbill tip and the hanging bristles, in which—as in a sieve, or in the great mouth-fringes of the whalebone whale, to compare small things with large—dainty morsels are trapped as the bird skims the water as he paddles about with extended neck.

"Here" (the quotation is from the note attached to the sketch) "we see a wonderful provision of Nature. The comb-like teeth or *laminae* of the surface-feeding ducks are developed in proportion to the extent to which the particular species feed on the surface or otherwise. An omnivorous and somewhat coarse feeder like the mallard only possesses them in a very rudimentary form, whereas the shoveller, which is constantly skimming the surface for fine substances, has them greatly developed in both upper and lower mandibles."

Mr. Thorburn contributes eight full-sized coloured plates. He is still, among English bird-artists, an easy first. But in some of his pictures, notably Plates xxx. and xxxvii., garganeys chasing water-beetles, and the pintails, Mr. Millais has run him close.

The only fault to be found with a beautiful book is that in choosing his subjects for illustration the author has, perhaps, ridden his hobby "Eclipse" a little too hard.

The best work, excepting in the case of the few rare visitors figured, which are, strictly speaking, scarcely British, is confined almost entirely to birds in immature or transitional plumage. In a book of natural history, destined to take a well-earned place for some years to come as the standard work on our surface-feeding ducks, a few plates might with advantage have been spared, if only as a sop to unscientific bird-lovers, for ducks and drakes at their best.

T. DIGBY PIGOTT.

A FRENCH TEXT-BOOK OF ZOOLOGY.

Traité de Zoologie Concrète. Par Yves Delage et Edgard Hérouard. Tome II., 2^{me} Partie, Les Cœlentérés. Pp. x + 848. (Paris: Libraire C. Reinwald, 1901.)

THE volumes of the "Traité de Zoologie Concrète" already published are so well known and have been so acceptable to zoologists that the present volume, dealing with the Cœlentérata, scarcely requires any recommendation. While it leaves little to be desired in such important matters as abundance and excellence of illustrations, bibliography, index and glossary, the chief merit of the "Traité de Zoologie Concrète" must be attributed to the logical and systematic method of exposition adopted by its authors. The majority of zoological textbooks, following the German model, give a brief and insufficient definition of each class or order of the animal kingdom, and this is succeeded by a discussion of the organology and embryology of the class or order that is generally so diffuse as to leave the student in a state of hopeless uncertainty as to what are the characteristic structural features of the group in question. Recognising the importance of fixing clear and definite ideas of structural relations in the student's mind, M.M. Yves Delage and Hérouard have adopted the time-honoured plan of illustrating the anatomy of each important group of animals by a description of a morphological type, which

serves as a standard to which all the other members of the group may be referred. The method is familiar enough, but has fallen into discredit because previous authors have made too little use of it and have confined themselves to the description of one or two animals as examples of a large class, whence it has resulted that students have too frequently formed narrow conceptions of animal structure and have underestimated the wide range of variation of which animals belonging to the same class are capable. The "Traité de Zoologie Concrète" has the merit of having avoided this error by describing a morphological type, not only for each class or subclass, but also for each order, suborder, and even for each tribe. Thus a general description is given of the morphological type of the order Octanthida (Alcyonaria); Kophobelemnon is taken as a type of the suborder Pennatulidæ; Renilla, Umbellula, Kophobelemnon, Pennatula and Gœndul are taken as the morphological types of the five tribes into which the Pennatulidæ are divided, and a sufficient description of the families and genera included in the tribe follows the description of each type. This system is consistently adopted throughout the work, and as the types are illustrated by well-designed schematic drawings, the essential characters of all the subgroups are brought in the clearest possible manner before the mind.

The book gives evidence of a minute acquaintance with zoological literature, and the numerous illustrations are largely copied from treatises of a recent date. In the latter respect, the volume on the Cœlenterata is considerably in advance of other text-books, for it is only too frequently the case that old and sometimes obsolete illustrations are copied from book to book, while more recent work is ignored.

The classification adopted does not depart widely from accepted lines. The Cœlenterata are divided into two branches, Cnidarea and Ctenarea, the latter being co-extensive with the Ctenophora. Though some authors would separate the Ctenophora from the Cœlenterata on the ground that they have an embryonic mesoblast, M. M. Delage and Hérouard give sufficient reasons for retaining them in the phylum in which they have so long been classed.

The Cnidarea are divided into two classes, Hydrozoaria and Scyphozoa, the former including all the forms usually classed under Hydrozoa, except the Scyphozoa, which have been placed along with the Anthozoa in the class Scyphozoa. The union of these two groups is a step in advance, abundantly justified by recent anatomical and embryological researches. In the class Hydrozoa it is noticeable that the Siphonophora are raised to the rank of a subclass, the other subclass, Hydrophora, including the Hydridæ, the Hydro-medusæ, the Trachymedusæ and Narcomedusæ. The grounds for this distinction are probably sufficient, but it is open to question whether the classification of the Siphonophora adopted in this work is an improvement on that of Hæckel, and one cannot but regret that the authors' love of symmetry or their anxiety to satisfy the claims of priority should have led them to abandon well-known and generally accepted names for others which are unfamiliar. For example, the order Chondrophorida sounds strange to most ears; the name is due to

Chamisso, but has never come into general use, and that of Disconectæ is preferable because better known. Again, in the Scyphozoa the name Octanthidæ, derived from the Octactinia of Ehrenberg, is preferred to Alcyonaria, though the latter is in general use and there is no good reason for abandoning it. The name Actinanthidæ, again, is substituted for Zoantharia, without sufficient reason, and the classification of the order is open to many objections. It scarcely seems consistent to class Edwardsia and Tealia under the Hexactinidæ, though the authors justify the inclusion of the former genus because of Faurot's discovery of micromesenteries completing the first cycle of six pairs in certain species. The division of madreporarian corals into Hexacorallidæ and Tetracorallidæ is quite unjustifiable in the present state of our knowledge, and in spite of their sharp criticism of Miss Ogilvie's work on the microscopic characters of the corallum (p. 602), the authors might have given her the credit of having demonstrated the unity of structure in recent and so-called rugose or tetracorallid corals. Indeed, they are open to the charge of inconsistency in this respect, for they have borrowed largely from her figures and adopted her possibly erroneous views on the mode of formation of the corallum, but have refused to accept some of her most important and well-grounded conclusions. It is scarcely possible, at the present time, to retain the groups Aporina and Porina (Aporosa and Perforata of Milne-Edwards), though it must be confessed that no acceptable alternative has been offered, and M. M. Delage and Hérouard, while retaining a discredited classification, give a very good summary of the various schemes that have been proposed by different authors.

Knowing the previous writings of M. Delage, one is not surprised to find that, in discussing the origin of atolls and barrier-reefs, he takes the opportunity of making a double attack on the Darwinian theories of the formation of coral reefs and natural selection. It is to be regretted that he allows himself to write so dogmatically on these subjects, for it is by no means the case that the theory of natural selection has been abandoned by zoologists in general as a "hypothèse séduisante," attractive but inadmissible. He would seem to have overlooked the school of statistical zoologists, whose work, so far as it has gone, has done much to strengthen the opinion that natural selection is by far the most potent factor in the evolution of species. Finally, when the complete results of the boring at Funafuti are published, M. Delage will probably be obliged to admit that the great English naturalist was not far wrong also in his speculations on the origin of atolls and barrier reefs.

G. C. BOURNE.

WAVES AND SOUND.

Wellenlehre und Schall. Von W. C. L. van Schaik.

Translated into German by Dr. Hugo Fenkner. Pp. xi+358. (Brunswick: F. Vieweg and Sohn, 1902.) Price Mk. 8.

NO portion of physics is more difficult to treat in an elementary way than that of sound; the consequence is that though advanced treatises of magnificent quality exist, an elementary text-book in English which

is less severe than these, but which is something more than a mere description of acoustic phenomena, is still a desideratum. Where attempts have been made to supply the want the result is not successful, owing chiefly to the clumsy methods employed in "getting round" the calculus. We are not upholders of the doctrine that the calculus should be "got round"; it is much better, we think, to "get through" it. Experience in teaching others has taught us that pupils find no difficulty in grasping its elements, and this is the case whether they are taught analytically or geometrically. Why then should we seek to devise elaborate methods of eluding the calculus—methods which in most cases we would never think of employing ourselves, and which, moreover, are usually only adapted to the particular problem for which they are devised—when a straightforward introduction to the methods we use ourselves would clear the ground and render the student's progress easy, and enable him the sooner to be his own path-finder instead of needing to rely on the guidance of others?

The book under review cannot supply this want in England, for it is a translation into German (from the Dutch); the substance of the book is in the above respect, however, entirely to our mind.

No calculus is employed in name; but the notion of it is everywhere. Velocity is the limiting value of a ratio and so is acceleration, and their values are found by the usual direct methods employed in proving the initial theorems of the calculus. We would have gone a step further and given the process a name, in order to suggest to the student to what branch of mathematics these and similar theorems belong. But the notion is the main thing. There is nothing here which a man will discard at a future time, having learnt a better way; though he will, of course, learn to abbreviate the logical statements of the process into the mere symbols dx/dt and d^2x/dt^2 .

Without making a full analysis, the following subjects dealt with may be briefly stated:—In the mathematical treatment: simple harmonic motion—waves and their composition, with a proof of all the simple theorems.

Fourier's theorem is given, but not proved; it is illustrated, however. The dynamical equation to simple harmonic motion is given, and the motion deduced by showing that it satisfies the equation. Even the case of a restoring force involving second as well as first power of displacement is given, on account of its importance in connection with the Helmholtz theory of the production of combination tones. The equation to damped motion is treated as an article for faith; its properties, however, are lucidly described.

Although the experimental phenomena are mainly collected together, the mathematical portion is not wholly free from experimental illustration. For example, we specially note a device which should be found useful for illustrating the behaviour of forced oscillations with different degrees of damping.

Perhaps the most interesting section is that dealing with the interference and diffraction of waves. This might be amplified by an account of recent experiments imitative of Lloyd's mirror and diffraction from two apertures (Young's experiment); and, in particular, an account of Rayleigh's brilliant application of the principles of diffraction in *restricting* the spreading of sound to one

plane by suitably shaping the aperture of the fog horns employed in coast signals would form an excellent additional illustration.

The last chapter is concerned with movements of air in pipes, concluding with an account of the secondary motions usually developed, such as the small striations in the cork figures in a Kundt's tube, which were investigated by Walther König and others (König is mentioned without being discriminated from R. König). These are highly interesting, though many will no doubt consider them rather out of place in an elementary book.

There is no mention of Rücker's important experiments in connection with combination tones.

OUR BOOK SHELF.

Malarial Fever, its Cause, Prevention and Treatment. Containing full Details for the use of Travellers, Sportsmen, Soldiers, and Residents in Malarious Places. By Ronald Ross, F.R.S., Walter Myers Lecturer in the Liverpool School of Tropical Medicine. Ninth edition, revised and enlarged. Pp. 68. (London: Published for the University Press of Liverpool by Longmans, Green and Co., 1902.) Price 2s. 6d.

THIS little book is an enlargement of a previous work by the same author, and should prove of the utmost use to those for whom it is written. The exact knowledge concerning the epidemiology of malaria which has been attained during the last six or seven years has made clear the principles upon which the disease may be prevented in the individual and perhaps exterminated in the locality. The wide dissemination of these principles and of the facts upon which they are based is the next obvious step in the campaign against malaria, and the Liverpool School of Tropical Medicine has done good service in the publication of this work. Within the short compass of some seventy pages we find a lucid and succinct account of the nature and life-history of the malarial parasite, of the habits and life-histories of the gnats which serve as its definitive hosts, of the precautions to be taken to avoid infection, and of the elementary treatment of the disease should it be acquired. In short, nothing is wanting that should enable an intelligent man, even if devoid of any scientific training, to escape malaria, even where it is most virulently endemic. The writer's wide experience, and the important share which he has taken in building up our knowledge of the disease and its propagation, are a sufficient guarantee of the accuracy of his information and of the practical value of his rules for guidance. There is a consensus of practical experience that, by attention to the rules here set forth, a man may safely pass through countries where malaria of the most dangerous type prevails. We recommend the book heartily to all who have occasion to sojourn in such lands.

Velocity Diagrams. Their Construction and Uses. Intended for all who are interested in Mechanical Movements. By Prof. C. W. MacCord, A.M., Sc.D. Pp. iii + 116; 83 figures. (New York: John Wiley and Sons; London: Chapman and Hall, Ltd., 1902.) Price 1.50 dollars.

IN this book some examples of plane motions of machines are worked out. The title well describes the scope and contents of the work and the very modest aims of the author.

The main problem to which the discussion is directed is:—Given a skeleton drawing of a mechanism and the speed of the driving point, to find graphically the corresponding speed of the driven point, and to show the latter all throughout the cycle by means of a rectangular

curve of speed plotted on a time base. The author believes that this curve exhibits the kinematic action of the machine more clearly and directly than any other form of diagram.

Beginning with the composition and resolution of velocities, it is shown how the constraints of slides, pivots and rigidly connected points affect the ordinary rules for vectors, and one or two simple special rules are established. These are applied systematically to selected mechanisms such as pruning shears, quick return motions, direct-acting and oscillating cylinder engines, epicyclic trains of wheels, the pilgrim-step motion, &c., until the reader becomes quite familiar with the process.

No attempt is made to give more than a cursory and very limited account of the plane motions of mechanisms, consequently many important theorems and constructions of a general nature find no place. Simple harmonic motions, and harmonic analysis, often so useful, are not considered. Acceleration is only incidentally referred to in showing how an acceleration-time curve can be determined graphically from a velocity-time curve. The author has evidently imposed severe restrictions as to the amount of ground to be covered. But so far as the subject is dealt with, the methods and demonstrations are very clear and convincing, and the diagrams are well drawn and beautifully printed.

Spiderland. By Rose Haig Thomas. Pp. viii + 227. (London: Grant Richards, 1902.) Price 5s.

THIS is a charming little book, based on the authoress's original observations on a variety of animals and plants, and cast into a poetic form likely to interest children in natural history. It is dedicated as follows:—"To my Son, whose wondering child-eyes first taught me to look deeper into the workings of Nature, and to all the Children I know and shall never know, I dedicate these simple tales." As we remarked when reviewing elsewhere the first edition, printed for the author in 1898, which comprised only the first twelve tales, whereas twelve more are added in the present edition, the book reminds us of the "Episodes of Insect Life," on the one hand, and Mrs. Gatty's "Parables from Nature?" on the other. The mode of treatment resembles that of the former book, and the general style the latter. A great variety of subjects are dealt with, and only one or two of the stories relate to spiders; among others, we note such titles as "The Tree Frogs," "Pistol the Peace-maker" (a more elegant setting of the old fable of the "Stomach and the Limbs"); "Thomisa Citrina, the Robber-Mother"; "The Wedding of the Fly Ophrys"; "The Green Caterpillar" (a study somewhat resembling one of Mrs. Gatty's, but dealing with a more mournful phase of caterpillar life, an ichneumonid caterpillar); "Hymen, the Worker Ant"; "Nimble Nat, the Gay Grasshopper"; "Cocky: a London Love-Tale" (sparrows); "The Romance of the Water Beetle"; "The Lemming," &c. The remarks on the lemming are interesting, and will be new to many readers. Here and there we meet with a trifling oversight; the authoress has travelled in France and Norway, and has forgotten to note that processionary caterpillars are not British; and the auditory organs (hardly "ears") of grasshoppers are situated, not in the hind legs, but in the front legs.

Children are easily interested in natural history and insect life; and a poetical view of some of its phases, such as Mrs. Thomas has here given, is likely to prove more attractive to them than a purely didactic book, like "Uncle Philip's Conversations with Children," which was almost the first book on natural history read to the present writer in his childhood. Naturally, the stories written by Mrs. Thomas are not all of equal merit; but most of them are excellent, and we regret that our space will not allow us to give a sufficiently long quotation to afford a fair idea of the style of her book. W. F. K.

Tuberculosis as a Disease of the Masses, and How to Combat It. By S. A. Knopf, M.D., of New York. Adapted for English use by J. M. Barbour, M.D. Pp. 76; 25 figures. (London: Rebman, Ltd., 1902.) Price 1s. net.

IN plain, simple language, devoid of technicalities, Dr. Knopf presents an accurate account of the causes of tuberculosis, some details of the symptoms of a few of its many phases, and indicates the chief hygienic principles which underlie the present-day methods of treatment.

He emphasises the fact that tuberculosis is a contagious and therefore a preventable disease, that the child of a tuberculous mother is not itself necessarily tuberculous, although it frequently acquires the disease—the maternal kisses often being the channel of infection—that man may derive the infection from animals and that he may in turn transmit the disease to them, and above all that *tuberculosis is a curable disease*.

The author fully explains the duty of the consumptive to himself and to his fellows, and points out in no uncertain manner the real danger attendant upon the habit of spitting elsewhere than in a proper receptacle by the subjects of this disease. He also gives much excellent and useful advice with regard to the practice of calisthenics by, and the inculcation of habits of cleanliness in, the young, and the value of fresh air and sunshine as factors in the prevention and cure of tuberculosis, as well as many suggestive hints on the home care of consumptives.

We are not surprised to learn that this essay was awarded the first prize (200*l.*) offered by the "International Congress for the Study of the Best Way to Combat Tuberculosis as a Disease of the Masses," which met at Berlin, and that it has already been published in five languages besides English. It is an excellent treatise, and should be in the hands of every individual, sick or well, who has at heart the physical welfare of his fellow mortals.

The Teacher's Manual of Object Lessons in Geography. By Vincent T. Murché. Pp. xvi + 334. (London: Macmillan and Co., Ltd.) Price 3s. 6*d.*

HOW great has been the improvement in methods of teaching during recent years can be measured to some extent by a comparison of newly published books intended for use in public elementary schools with those in circulation twenty years ago. The old implicit reliance on the child's faculty for memorising is fortunately giving place to an appeal to his observation and incipient reasoning powers. Mr. Murché's latest addition to his already extensive series of books on elementary science is marked by his usual clearness of exposition and by that helpfulness for which he is justly highly esteemed by teachers in elementary schools. But the bewildering miscellany of type, with its frequent transitions from Roman to italics and from these to Clarendon and capitals, makes the volume a trying one to read and raises the question of the possibility of such over-emphasis defeating the object in view. It is unfortunate that in explaining volcanic activity the author speaks of "dense volumes of flame and smoke" which "burst out from the crater," and that he instructs the teacher to explain "that ages ago this earth on which we live was a burning mass like the sun." This seems to indicate a want of clearness as to the nature of smoke and burning; it will certainly give the child a wrong idea. But the book should do a great deal to improve the teaching of geography.

William Gilbert of Colchester: a Sketch of his Magnetic Philosophy. By Charles E. Benham. Pp. 96. (Colchester: Benham and Co., 1902.) Price 2s. net.

THE immediate occasion of the appearance of this little book is the issue to the subscribers of the Gilbert Club of the English translation of "De Magnete." The author

has attempted, and with real success, to show what manner of man Gilbert was, wherein lay his genius, what were his merits, and what also were his faults and failings. Mr. Benham dwells on the circumstance that, although Gilbert's actual discoveries were few and crude, he must be judged rather by the spirit of his work. "He was not the builder of sciences, but the architect of a truly scientific spirit; and his life-work consisted in the doctrine, new to England, that all scientific knowledge must be founded on practical experiment and observation alone, instead of upon speculations and theories evolved out of inner consciousness." The successive chapters of the book deal with the old magnetic philosophies, magnetic motions and electric force, the magnet's "directive virtue," the variation of the compass, the dip and "orbes of virtue" of the magnet, the life of the Universe (in which Gilbert, although no Manichean, was clearly a believer) and the Copernican theory. The author is particularly happy in his treatment of this last topic; but throughout the analysis of Gilbert's work is accurate and discriminating. The book is illustrated with a picture of Gilbert's terrella, and another of his tombstone in the church of Holy Trinity, Colchester. S. P. T.

The Vocal System based on the Fundamental Laws of Language. By G. Lionel Wright. Pp. 20. (Published by the Author, Upper Belgrave Road, Clifton, Bristol.) Price 1s. net.

It is now recognised that teaching to read is not the simple matter which it was once thought to be. In recent years one system has followed another in rapid succession, and each has claimed in turn that by its introduction the time taken by the child to learn to read the mother tongue was much reduced. There seems to be a chance that these experiments may eventually reduce the difficulty of this first step in human education to a minimum. Mr. Wright proposes to make extensive use of the blackboard and of *visuâ voce* methods of instruction, and to start teaching the child to read by making him learn the five vowels. When this has been accomplished, the learner is introduced, by carefully graduated steps, to certain combinations of vowels and consonants, which are clearly indicated in this brochure, and by following which Mr. Wright claims that children may read at the age of six. A somewhat minute examination of the contents of the pamphlet leads us to think that Mr. Wright would be well advised in making his instructions to the teacher much more detailed and explicit if he is anxious that his system should become widely adopted, for at present the teacher will be, at several points, at a loss to know the next step in the course of work.

The Lake Counties. By W. G. Collingwood. (Dent's County Guides.) Pp. xii + 392; illustrated. (London: J. M. Dent and Co.) Price 4s. 6d. net.

This little volume—the fourth of the series to which it belongs—will be found invaluable to all who visit the Lake District. In addition to being an excellent guide, with a number of itineraries and many maps, it contains four chapters on the natural history of the district, the birds being described by Miss Armit, the butterflies and moths by Canon Crewdson, the flora by Mr. S. L. Petty, and the geology by Prof. Hull. In the chapters on fox-hunting, angling and shooting, the sportsman will find abundant matter for interest, according to his particular taste. This volume fully maintains the high reputation of its predecessors, and is, in fact, all that a guide should be. Those tourists who wish to go more deeply into the natural history of one of the most interesting and beautiful districts in England will find all they want in the more pretentious volume by the late Mr. Macpherson entitled "Lakeland." R. L.

LETTERS TO THE EDITOR.

[The Editor does not hold himself responsible for opinions expressed by his correspondents. Neither can he undertake to return, or to correspond with the writers of, rejected manuscripts intended for this or any other part of NATURE. No notice is taken of anonymous communications.]

Symbol for Partial Differentiation.

PROF. PERRY'S difficulty (NATURE, May 15, p. 53) is without doubt a real one, and is deserving of serious consideration. In connection therewith the following extract from a paper at present passing through the press may be found interesting, at least on the historical side. It is in reference to a memoir of Jacobi's published in the year 1841 in the twenty-second volume of *Crelle's Journal*:—

"The subject of the notation of differential-quotients is then entered on at some length (pp. 320-323), and the decision made to use ∂ in the manner which soon afterwards came to be familiar. The insufficiency of this notation is not forgotten, however, although its advantages over the different devices of Euler and Lagrange are recognised, his illustrative example being the case of $\partial z / \partial x$ where z is a function of x and u , and u is a function of x and y . He puts the whole matter in a nutshell when he says that it is not enough to specify the function to be operated on and the particular independent variable with respect to which the differentiation is to be performed, but that it is equally necessary to indicate the involved quantities which are to be viewed as constants during the operation."

To this the following footnote is added:—

"I may state in passing that in 1869 when lecturing on the subject I found it very useful to write

$$\phi_x, y, z, f_x, t, u, v, \dots$$

in place of

$$\phi(x, y, z), f(s, t, u, v), \dots$$

and then indicate the number of times the function had to be differentiated with respect to any one of the variables by writing that number on the opposite side of the vinculum from the said variable; thus

$$\overset{1}{\phi}_x, \overset{2}{y}, \overset{3}{z}$$

meant the result of differentiating once with respect to x , thrice with respect to y , and twice with respect to z .

"Using this notation to illustrate Jacobi's example, we see that if it were given that

$$z = \phi_x, u$$

we should have

$$\partial z / \partial x = \phi_x, u$$

but that if it were given that

$$z = \phi_x, u \quad \text{and} \quad u = \psi_x, y$$

then we should not be certain as to the meaning of $\partial z / \partial x$, as it would stand for

$$\overset{1}{\phi}_x, u \quad \text{or} \quad \overset{1}{\phi}_x, u + \overset{1}{\phi}_x, u \cdot \overset{1}{\psi}_x, y$$

according as u or y was to be considered constant."

Cape Town, S.A., June 5. THOMAS MUIR.

I AM glad to think that a pure mathematician sees the difficulty met with by users of mathematics. I wish that men who write to me privately would publish their remarks. One correspondent says: "I think 'the mathematicians' made a rather stupid blunder when they introduced ∂ for partial differentiation. This way: nearly all differential coefficients are partial; even a complete one (assumed complete) may become partial by extension of the field of operation. So an old investigation of Kelvin's, for example, using d throughout, is, by 'the mathematicians,' replaced by the same using ∂ throughout, except one or two here and there! What is the use? It gives a lot of trouble, and as printers haven't always ∂ 's, or proper sized ∂ 's, it makes bad work. It should have been ∂ itself that was introduced for the exceptional use, thus making next to no alteration in the classical investigations." These are, indeed, my own views, but as my pupils go forward to University examinations I

advise them to adopt the fashion which is likely to please the examiners.

In thermodynamics we cannot easily adopt Mr. Muir's suggestion. Take the simplest case of unit quantity of mere fluid. v , p , t , E and ϕ are such that they are all known if any two (except in certain cases) are known. Any one may be expressed as a function of any other two. My symbol $\left(\frac{dE}{dv}\right)_p$ is quite definite. But to adopt Mr. Muir's suggestion I must say:—

Let $E = f(v)$, p then $f(v)$, p is what my symbol means. Inasmuch as my letters stand for the same quantities irrespective of the letters of which they are functions, I use one letter E where on Mr. Muir's suggestion I must use E as $f(v)$, p or $F(v)$, t or $\Psi(v)$, ϕ or $\chi(p)$, t or $\theta(p)$, ϕ or $\xi(t)$, ϕ or six distinct symbols if I have to express any differential coefficient of E , and if I have to express all the differential coefficients of v I must use other six symbols; altogether I must use thirty of these curious symbols instead of five common letters, and, furthermore, I must keep them all in my head. JOHN PERRY.

The First Magnetician.

WHILE thanking you and "R. T. G." for the exceedingly kind appreciation of the Gilbert Club's English translation of "De Magnete" (p. 249), I write to express the wish that the notice had mentioned the names of those who have collaborated in the production of this version. They are the late Mr. Latimer Clark, the late Sir B. W. Richardson, Rev. A. S. R. Howard, Prof. R. A. Sampson, Dr. Joseph Larmor, Sec. R.S., Prof. Meldola, F.R.S., Mr. Edward Little, Mr. G. T. Dickinson and Rev. W. C. Howell. To the last-named a special recognition is due for indefatigable and critical care during the long final revision and press correction.

July 14.

SILVANUS P. THOMPSON.

"Fox-shark" or "Thrasher" (*Alopias vulpes*) in the English Channel.

ON July 2 a fine specimen of this shark was captured several miles south of the Eddystone Lighthouse by fishermen in search of mackerel. The fish was taken at a depth of about 40 fathoms, and did a large amount of damage to the mackerel nets before it could be hauled on board and killed. The shark was brought to the Plymouth Museum and purchased for the collection.

It may be worth while to state that the spiracles, which Couch says he was unable to detect, are distinctly visible in this specimen. It is scarcely surprising that they should be sometimes overlooked, for though our fish is 13 ft. (thirteen feet) 7 in. (seven inches) long (of which the tail occupies seven feet), the spiracles are only $1/12$ th (one-twelfth) of an inch long by $1/16$ th (one-sixteenth) of an inch wide. Each is situated exactly $2\frac{1}{2}$ (two and a half) inches behind the eye, and a line from the spiracle to the tip of the snout passes just above the centre of the pupil. E. ERNEST LOWE.

Plymouth Museum, Plymouth.

THE TRAMWAYS EXHIBITION AT THE AGRICULTURAL HALL.

THE International Tramways and Light Railways Exhibition which came to an end on Saturday last must be regarded as having been very successful from all points of view. The opening ceremony was performed by Mr. Gerald Balfour on July 1, and was accompanied by the usual luncheon and speeches. Mr. Gerald Balfour alluded, as might have been expected, to the recent deputation to his Department on the subject of electrical legislation, but he did not evince any sign of having become convinced of the necessity for speedy reform. In other respects the speeches were not of much interest; the same may be said to be true to a certain extent of the proceedings of the International Tramways and Light Railways Congress, which held its meetings on July 1 and 2. The Congress, which was the

twelfth held by the Union internationale permanente de Tramways, was the first to be held in London; the papers read and discussed dealt with the management and technical details of tramway schemes, and were most of them contributed by the engineers or managers of continental tramways. Many of them were very valuable, especially as they were based on the results of wide practical experience, but we doubt if they would prove of great interest to the readers of NATURE.

The exhibition itself contained a number of very attractive exhibits. Although primarily a general exhibition of all things pertaining to tramways, there was much on view which was of the greatest interest to those having nothing to do with traction. It was also very noticeable that the exhibition resolved itself practically into one of electric tramways. Of course, there was much that was not electrical—such, for example, as rails, points, &c.—but these are all part of the equipment of an electrical system. And perhaps the general impression with which one left the hall, that a "tramway" was necessarily the same thing as an "electric tramway" was of more interest, as a sign of the times, than were any of the individual exhibits.

Several different types of car were on view; the one which, not unnaturally, attracted the most attention was that constructed by Messrs. Dick, Kerr and Co. for the London County Council. This is the first of one hundred cars being built for the Council's South London Tramways. The car is double-decked, and has a total seating capacity of sixty-six (twenty-eight inside and thirty-eight outside), and is equipped for the conduit system to be used on the South London lines. The Westinghouse Company exhibited a car which ran over a fully equipped trolley line laid along the total length of the hall, a distance of more than 300 feet. Power was obtained for running this from a 75 kw. direct-current generator (500 volts), driven by a Westinghouse three-cylinder gas engine. The car was fitted with the Westinghouse magnetic brake. This brake has a triple action, acting as a wheel-brake, a track-brake and an axle-brake; it is energised by current derived from the car motors, which work as generators whilst the car slows down, the necessary energy being derived from the momentum of the car. The action of the brake is therefore independent of the main current supply.

A notable feature of the exhibition was the Bremer arc lamp, exhibited by the Westinghouse Company. This lamp was used for part of the lighting at the Natural History Museum on the occasion of the Institution of Electrical Engineers' conversation. Unfortunately, it did not create a very favourable impression there, as the lamps kept flickering; those at the Agricultural Hall seemed to be burning much better. The carbons used in the Bremer lamp are saturated with certain minerals which volatilise and become incandescent in the arc; they are, moreover, arranged nearly parallel to one another instead of vertically one above the other; the ends project a little below a protecting hood, meeting at an angle of about 20°, and the arc is kept at the tips by means of a magnetic deflecting device. The position of the arc, the materials used in the composition of the carbons, and the reflecting power of the conical hood, combine to produce a highly efficient light. It is said that the lamp is three times as efficient as an ordinary arc. The colour of the light is also much pleasanter and warmer than that of the ordinary arc, and the light appears to fill the globe much better, with the result that it produces somewhat the effect of a golden ball of light.

Another similar arc lamp exhibited was that of the Union Electric Company. This, which is called the "Flame" arc lamp, has vertical carbons like an ordinary lamp; the carbons are, however, cored with a mixture of certain fluorides, and the upper one passes through a

dome-shaped hood, which is fixed a little above the arc itself. A rather long arc is burnt, and the effect is very similar to that produced by the Bremer lamp, only the light is of a slightly different colour. This lamp is also said to be three times as efficient as an ordinary arc.

We have not space at our disposal to describe the exhibits fully. There is one other, however, which deserves special comment on account of its ingenuity and possibly great importance. This is the Partridge "Sparklet" fuse, exhibited by Messrs. Elliott Brothers. This fuse is designed more especially for high-tension circuits carrying heavy currents. When the fuse in such a circuit goes an arc forms, and in order to prevent this burning, either a very long fuse or some form of oil fuse is used. In Mr. Partridge's "Sparklet" fuse a short length only is used, and the terminals of the fuse wire are connected to an ordinary sparklet such as is now a familiar article for making soda-water. The arc when it forms burns between the two sparklets, and in a very few seconds one or other of these is burnt through; the carbon dioxide immediately rushes out through the hole and blows out the arc. It will readily be understood that the more current the circuit is carrying, and the more power there is in the arc, the sooner will the sparklet burn through, and also the hole being larger the more certain it will be in its action. At the Agricultural Hall a model fuse was shown working a circuit of 2500 volts. The current was small, only about 6 amperes, the power being therefore about 15 kilowatts; yet the arc was blown out in less than three seconds. Two sparklets are used, one at each end of the fuse, in case one should be defective; but this precaution has never been found necessary during all the experiments and trials that have been carried out. For the past eighteen months the apparatus has been in practical use, and has proved, it is said, thoroughly satisfactory. Mr. Partridge is certainly to be congratulated on a very ingenious idea; it remains to be seen whether it will prove a sufficient cure for all the troubles that are likely to be met with now that large-power high-tension circuits are becoming common.

M. S.

THE ASTROGRAPHIC CHART.

IT is probably well known, even to those who are not astronomers, that an astronomical enterprise of considerable magnitude was initiated fifteen years ago, and is steadily, although somewhat slowly, progressing towards completion. In the year 1887 a conference of astronomers met at Paris to consider the best means of cooperating to make a complete map of the heavens on a large scale, and with all possible attention to accuracy, by photography. As the outcome of this conference, eighteen observatories of various nationalities undertook the work, the whole sky being divided up into eighteen zones; a zone assigned to each observatory with due regard to its geographical position. A standard pattern of photographic telescope was chosen, and all the eighteen observatories obtained instruments of the required type and set to work. The enterprise being in several respects entirely new, it has been necessary to guide the procedure in the light of experience acquired; and conferences assembled at Paris in the years 1889, 1891, 1896 and 1900 to report progress and compare notes. At the last of these conferences a second enterprise was undertaken. The small planet Eros, discovered in 1898, was to make a particularly close approach to the earth in the winter of 1900-1, thus affording an opportunity, the like of which would not recur for thirty years, of determining the solar parallax; it was felt that, although the main object of the association of observatories (viz. the formation of the Astrographic Chart) was not yet attained, still the advantages to astronomy which would result from utilising this exceptional opportunity were too great to be neg-

lected, and it was resolved that the cooperating observatories should add to their programme the photographic observation of the little planet during the months October 1900 to February or March 1901. In connection with this second enterprise it has been found necessary to circulate a large amount of statistical material, such as approximate positions of the planet on different dates and of all the well-known stars lying near his path in the heavens, lists of the observations made at the different observatories, so that one might know how to match plates with another, and so on. The energy of the director of the Paris Observatory (who has from the first acted as director of the whole work) in printing and circulating this material has been most noteworthy. We have recently received the *ninth* circular relating to Eros, which is itself a pamphlet of 200 pages quarto, and represents a vast amount of work. In the first place, M. Lœwy discusses, in two long memoirs (supplementing a former one already published), what accuracy is obtainable from measures of photographic plates and what precautions are necessary to obtain that accuracy. The discussion is concerned with a number of minute details, and involves the adjustment of conflicting advantages, so that there is room for difference of opinion in the conclusions; but there can be but one opinion of the value of the material patiently collected and tabulated by M. Lœwy, which can be examined in the light of any hypothesis preferred. The second part of the ninth circular gives, among other useful information, ephemerides of the planet Eros and of the sun, calculated to eight significant figures for every six hours—almost a new departure in such work, the only precedent being afforded by the investigations of Sir David Gill on the planets Victoria, Iris and Sappho, whereby he clearly showed that eight figures were necessary to represent the accuracy of heliometer measures. To advance one decimal place is of course a step of the gravest importance, and to Mr. Hinks, of the Cambridge Observatory, belongs the credit of being the first to show that an accuracy can be obtained from photographic measures of the Eros plates of the same order as that which led Sir David Gill to ask for an eight-figure ephemeris.

The appearance of so much important literature in connection with this second enterprise, the photographic observation of the planet Eros, naturally suggests a glance at the state of affairs with regard to the main work, the Astrographic Chart itself. It is, as remarked in the first sentence of this article, some fifteen years since the work was initiated, and it should by this time be possible to form an estimate of the probable outcome and the approximate date of completion. It must be confessed that the original estimate of the time required has already been seriously exceeded. In the letter which summoned the conference of 1887 it is stated that:—

"Ce grand travail . . . pourrait être facilement exécuté en quelques années si dix ou douze observatoires bien répartis sur le globe pouvaient se partager convenablement la tâche."

The phrase "quelques années" is somewhat indefinite, but it may be assumed that those who assembled in 1887 would have been shocked to learn that after a lapse of a dozen years scarcely one-fifth of the work projected had been accomplished. Indeed, many who are tolerably familiar with the general course of events may be startled to hear this statement made; and yet a glance at the last comprehensive report available (see R.A.S. *Monthly Notices*, vol. lxi. p. 280) shows it to be only too true. It was decided to work on such a scale that 11,000 plates would be required to cover the sky, and this number was to be repeated four times, twice with short exposures (of 6 minutes, 3 minutes and 20 seconds), and twice with long exposures (40 minutes). The plates of the first series (catalogue plates) were to be measured, and the measures printed and published; those of the second series

(chart plates proper) to be reproduced in facsimile. In June, 1900, the state of affairs was as follows:—15,000 of the 22,000 catalogue plates had been taken, but only 4000 had been measured; and the measurement is of course by far the most serious part of the work. Of the 22,000 chart plates required, less than 4000 had been taken, and only a small portion of these had been reproduced and published. So that the fraction of the whole programme accomplished in a dozen years can certainly not be put higher than one-fifth.

Does this mean, then, that it will take sixty years to finish the whole? It is earnestly to be hoped that this would not be a legitimate inference, and fortunately there are good sound reasons why it should not be. The years immediately succeeding 1887 were naturally devoted to experimental work, of which a large amount has been necessary. This was foreseen at the outset; witness, for instance, the words of the veteran Otto Struve in his opening address:—

“En effet, l’Astronomie pratique possède aujourd’hui, dans la Photographie, un instrument de la plus haute valeur et qui, probablement avec le temps, facilitera énormément nos études épineuses. Mais restons sobres dans nos prévisions. Pour le moment, nous ne devons regarder la Photographie que comme un instrument très précieux, mais dont l’étude reste encore à compléter.”

But it will probably be agreed that the amount of work necessary to “complete the study” has exceeded expectation.

Beyond the preliminary experiments which might have been foreseen by an individual worker, much time has been spent in a well-meant endeavour to secure uniformity in the work, which has, after all, not been very successful. Thus a large part of one year was lost in attempts to devise an obscuring screen which should diminish the light received from the stars in a known ratio, and ultimately secure uniformity in the limiting brightness (or rather faintness) of the stars charted; but this attempt was at last abandoned in favour of the simpler method of fixing a definite time of exposure, which might have been adopted from the first. Or going further back in the history, it must be remembered that although a standard pattern of telescope was adopted in 1887, it took a considerable time, not only to make the eighteen instruments required, but for the makers to find out how to make them. Thus it would be fair to estimate that in 1900 the work had been in actual progress, not for a dozen years, but for less than half that period; so we need not fear that the completion of the work is still half a century off. Nevertheless, he would be sanguine who should reduce this prospective limit below twenty years, unless some very drastic measure is adopted in the near future. Some of the cooperating observatories are well advanced with their work, but others are far behind. In 1900 there were actually three which had not started at all, and these have been struck off the list and replaced by three new ones. We have good reason for anticipating energetic action from these new comers, but it must be remembered that they start a dozen years at least behind their colleagues.

This great delay in the execution of the work has been prominently mentioned because it demands most serious attention if the original scheme is to be carried out in any real manner. Even without the addition of the Eros work there was sufficient cause for anxiety; with that important and unforeseen addition there is reason for alarm. It is to be hoped that the dangers may be realised and obviated within the next few years.

But when we turn to the contemplation of what has been accomplished, there is good reason for satisfaction. To take first the series of catalogue plates, with short exposures of a few minutes only. Each observatory has to take about 1200 of these, and the area of the

sky covered by each is a square of two degrees in the side, so that sixteen full moons arranged in solid square formation would just about cover this area. On each plate there are some 300 or 400 star-images on the average; but this is an average from which the deviations are large. A plate exposed near the Milky Way, even for a few minutes only, shows thousands of stars, whereas if the telescope be pointed to a region distant from the Milky Way, the number may fall below 100. Taking the average as 350, there are on the 1200 plates which form the share of one observatory some 400,000 star-images; and it is the business of that observatory, after taking the plates, to measure carefully the relative positions of all these images and publish the results. Moreover, it has been found advisable to make these measures at least twice over, so that we may put the total number at something like a million. It will readily be conceded that this is a gigantic piece of work for a single observatory to carry out, and it is a great thing to be able to say that some of the observatories are already in sight of its accomplishment. Others, as has been admitted, have not yet commenced the work, but they will enter upon it with all the advantages of following an example already set, and we may consider that the greatest difficulties have been overcome.

This portion of the work affords another reason for satisfaction. Mention has been made of some preliminary experimental work which produced no positive result, but other such investigations have had more fortunate issues, especially the research on the best method of measuring the plates. In 1887 there were at least three different methods which might be adopted, and corresponding to each of these there was a choice of patterns for the instrument to carry it out. The proper method for measuring stellar photographs has now been practically settled, and though there is diversity of opinion as to the best actual instrument, the relative advantages of the different forms are becoming tolerably well known. It will be realised how definite an advance has here been made when it is remembered that an eminent astronomer, in reviewing the possibilities in 1887, dismissed the method which has since been universally adopted as obviously inferior to the others and not worthy of consideration. The test of experience had, in fact, not been applied, and the result of its application may be regarded as a valuable scientific asset.

Let us turn now to the other set of plates, the chart plates as they are called, similar in every way to the catalogue plates, except that they are exposed to the sky for a much longer time (forty minutes at least, instead of three or six), and hence contain thousands of stars instead of hundreds. It is proposed that these plates shall be reproduced on paper by some process which depends on the automatic action of light only, and is thus free from the imperfections incidental to human agency. The exact process has not been formally specified, and it is open to any observatory to circulate ordinary contact prints, for instance, if such can be made without losing too many of the fainter star-images. Up to the present time, however, the only reproductions of chart plates which have been published are in heliogravure. The French observatories (Paris, Algiers, Toulouse, Bordeaux) and the Observatory of San Fernando, in Spain, have produced and circulated most beautiful enlargements (twice the linear dimensions) of some of their chart plates made by heliogravure, and there are many reasons why we may hope that their example will be universally followed. To begin with, the charts are really beautiful to look at—as might be expected from the French, they have produced something æsthetically satisfactory. Secondly—a matter of infinitely more importance astronomically—the charts

are wonderfully accurate. It has been shown that the places of stars can be measured from them with an accuracy almost equal to that obtainable from the original glass negatives. Finally, they are presumably permanent—far more so than the glass negatives, unless the toning process recently suggested by Sir William Crookes is adopted and found as successful as is expected. Against these manifest advantages is, unfortunately, to be set the costliness of the process. It is estimated that to reproduce its 1200 plates in this way each observatory must have a sum of about 10,000*l.* at command, independently of the actual time spent in the work. This sum is large, but not prohibitive. Five observatories are apparently already provided with it; in the interests of uniformity in a magnificent piece of work, may it be hoped that in some way or other the remaining shares will be taken up? If the paper reproductions were (as it was at one time supposed they would be) mere playthings of no scientific value, such expenditure might have been deprecated. But it has been demonstrated that they are accurate beyond expectation, that, in fact, an observatory provided with copies of this kind for the whole sky could in a few minutes obtain the place of any star down to the 14th magnitude with an accuracy equal to that with which the best meridian observations can be made. It seems probable that the outlay is as good a one as can be made with our present imperfect knowledge of the requirements of the future.

The consideration of what this means in actual weight of paper brings home to us in a striking manner the magnitude of the whole enterprise. If the 22,000 maps are completed in the style adopted by the French, the sheets when piled one on the other would form a column thirty feet high and weighing nearly two tons! The most elaborate star atlas which has been produced up to the present time can be bound as a single, though rather large, volume, which could be added to any library without sensible disturbance. But not so with a copy of the Astrogographic Chart; it is a matter for the serious consideration of each fortunate possessor where and how he shall store the sheets and ensure their preservation. There is not likely, of course, to be any real difficulty in doing this, the point is only mentioned here to illustrate the novelty of the departure rendered possible by photography.

As there is an obvious danger of not being able to carry out this vast programme (for which, it will be remarked, not only scientific labour, but much hard cash is required, and the latter may not be easy to extract from reluctant Governments), it is reassuring to know that there is at least one good alternative. We might carry out the work much more economically with a different type of instrument, though at the cost of some obvious advantages. The type selected in 1887, a refracting telescope of 11½ feet focal length, allows us to photograph an area of the sky at one exposure limited to two degrees square, and 11,000 plates are required to cover the whole sky. Two other types were considered and rejected. The first was the reflecting telescope, with a concave mirror in place of a lens. The area satisfactorily photographed at one exposure with a reflector is even smaller, and the number of plates required for the whole sky consequently greater. Though the reflector has distinct advantages in cheapness and in light-grasping power which have recommended it for other classes of work, there is no doubt that it was rightly rejected for the Astrogographic Chart; all our experience subsequent to 1887 has tended to confirm this view. The third possibility open to the conference of 1887 was the use of a doublet lens, such as is familiar in an ordinary camera. The lens of a camera is made up of two lenses (each of which is itself double) separated

by a definite interval, where a "stop" may be inserted. A photograph could be taken with one of these lenses alone, but only a comparatively small portion of the picture near the centre would be in good focus; the combination is made to give a larger "field." If such a doublet lens is used to photograph the sky, we get a much larger field at one exposure, and can cover the sky with fewer plates. The claim has recently been made that twenty or thirty plates would suffice to cover the sky instead of 11,000! Of course the results would be on a correspondingly smaller scale, and this extreme procedure is not to be contemplated as an alternative to the large and accurate charts with which a start has already been made. But if we could reduce the 10,000*l.* required to (say) 1000*l.*, we are in the region of the possible or even the probable, and this only means reducing the number of plates required in the ratio of one to ten, or increasing the area covered by each in the same ratio. We may take it as fairly well established that a doublet will satisfactorily cover a field at least ten times as large, in area of the sky, as the single lens at present in use for the work of the chart.

The question naturally arises whether these facts were realised in 1887, and if so, how the single lens came to be preferred to the doublet. The discussion on the type of instrument to select took place on April 18, 1887, and the *procès-verbaux* are given on pp. 36-43 of the official account of the conference. Twenty-six distinguished astronomers were present, and eighteen of them took part in the debate. *The photographic doublet was not even mentioned.* At the present time this circumstance is almost bewildering. At the end of the volume a letter is printed from Prof. E. C. Pickering (who most unfortunately was not able to attend the conference) advocating the use of the doublet, and giving detailed suggestions for the whole work which commend themselves, in the light of subsequent experience, as admirable. But his views received no attention; the debate was confined almost entirely to the relative advantages of reflectors and refractors, and the proper size to be adopted for the latter, and it must be confessed that an opportunity was lost. Since that time Prof. Pickering, using doublets, has charted the whole sky himself many times over, while the associated observatories have not yet accomplished a third of their programme. It must not be forgotten that their programme includes much more than the mere charting of the sky, viz. the measurement of some plates and the reproduction of others; but even making this allowance, the discrepancy between what he has done single-handed and what has been done on the plan preferred at Paris in 1887 is sufficiently serious.

The fact is that astronomers generally were afraid of the doublet in 1887, and some of them have not yet lost their mistrust. They were afraid that so fair a promise was too specious; that, in fact, the gain in extent of field over the refractor must be accompanied by a corresponding loss in accuracy. At the time no definite information was forthcoming on this point, and it must be admitted that even now our knowledge is far from complete. It is not so easy as it might seem to test pictures of the stars for the minute accuracy necessary to an astronomer, and it may still be proved that the choice of the refractor in 1887 was, from the point of view of getting the greatest attainable accuracy, a wise one. But, on the other hand, it has been shown that the mistrust of the doublet was largely unjustifiable; its accuracy is of a high, if not of the very highest, order. It is not even now too late to follow the excellent advice which was offered in 1887 only to be ignored. By adopting the doublet the chart plates might be completed in a reasonable time and at a reasonable cost, though on a smaller scale.

H. H. TURNER.

SOME NEW FORMS OF GEODETICAL INSTRUMENTS.

THE optical principles involved in gun-sighting apparatus, described in the issue of NATURE for January 9, 1902 (p. 226, vol. lxx.), have been further developed by Sir Howard Grubb, F.R.S., and applied to some new forms of geodetical instruments. In the gun-sighting apparatus alluded to, a virtual image of an illuminated cross is optically projected on to the object aimed at, and both the cross and the object are easily seen without any refocussing or straining of the eyes. In the case of the gun sights and also the present instruments, light traverses a plate of glass coated with a very thin film of galena; by this means reflection of light from the surface of the glass is greatly increased, while but little transmitted light is shut off. The process of depositing galena is due in the first instance to Prof. J. Emerson Reynolds, F.R.S.; it is described in the *Proc. Chem. Soc.* for 1884, under the heading "The Synthesis of Galena by means of Thiocarbamide."

The process has been modified by Mr. G. Rudolf Grubb and applied with great success to some new forms of surveying instruments. These instruments have not

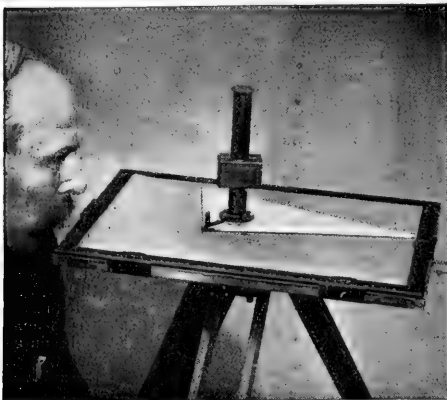

FIG. 1.

been designed to take the place of the standard instruments of the engineer, namely the level and the theodolite, but to place in the hands of comparatively inexperienced observers, a ready means of making a rapid survey with an accuracy as great as can be attained in plotting a survey on paper. In the case of ordinary surveying, for example, in road making and in the conveyancing of property, the accuracy of the survey is limited by the degree of precision with which it can be actually plotted on paper with a pencil giving fine lines. When the theodolite is used, the readings are first entered in the field book and then afterwards plotted on paper, the angles being set off with a protractor. By means of the new instrument, the survey is continuously plotted as the instrument is being used. In Fig. 1 the new form of plane table is shown. The central pillar, through which the successive bearings are taken, is shown in section in Fig. 2; it is mounted on a triangular base, or set square, which can be rotated about a point situated in the centre of the paper on the plane table. The instrument is used thus. The sight tube is rotated until its fixed line coincides with a given object, a line is then ruled, it is again moved through some angle till the line coincides with a second fixed object, and another line is ruled along the

edge of the set square, the process being repeated until the position of the last fixed object is recorded. Then the whole plane table is moved to a fresh station at a measured distance from the first station, and similar observations are made on the same fixed objects; the intersections of the two sets of bearings give the points

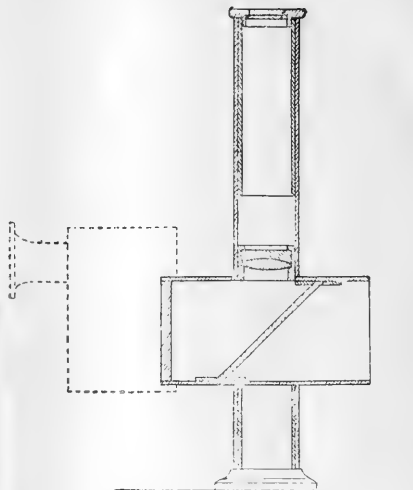

FIG. 2.

required for the survey. In the case of the survey of a small area, the instrument is not shifted to a new station, but the distances corresponding to the ruled lines are determined by reading the number of divisions which appear in the field of the instrument between two marks



FIG. 3.

of known distance apart on a staff held at a fixed point. The instrument thus becomes a telemeter, and by means of a suitable scale the distance along any given direction is found and marked on the paper. The actual method of using the instrument is as follows:—The staff man

walks round a field and successively plants his staff upright where a change in the directions of the boundary occurs; at each point the observer at the plane table rules the direction line and marks the distance, repeating the operation for each successive point, so that the survey of the field is made during the time taken by the staff man in walking round the field and making the necessary halts at each point for the observation to be recorded. The scale and view photographed through the plane table instrument is shown in Fig. 3.

The same optical principle has also been employed by Sir Howard Grubb in the construction of a level to be used in making rapid estimates of gradients in road making and laying out property.

The observer sees at the same instant a fiducial mark, the bubble of the level, and an arc marked with degrees projected on to the field of view.

The excellent optical device has also been utilised in the construction of a prismatic compass and a clinometer.

M. HERVÉ FAYE.

ALL who have taken any interest in the advance of science, more particularly in the direction of astronomy and meteorology, will hear with regret of the death of M. Hervé Faye, which sad event was announced last week. A long course of scientific industry has marked his career, and a great distance seems to separate the workers of to-day from the epoch when Faye and many others, whose names are now but a matter of history, laboured strenuously and successfully to make the paths for their successors more easy and of more rapid attainment. Nearly sixty years have passed since M. Faye first came prominently before the world as the discoverer of a comet, to which his name has always been attached, and it will serve to make us appreciate the advance accomplished in one lifetime if we recall the fact that this was the first elliptic comet the period of which was determined by calculation alone, without any assistance drawn from observations made at previous returns. Faye, at that time an assistant in the Paris Observatory, recognised the necessity of computing an elliptic orbit, but the credit of determining the first orbit of considerable eccentricity from a few days' observations belongs to Goldschmidt, who was stimulated to the task by Gauss. Then the information and the methods of the *Theoria Motus* had not filtered through a score of text-books and come into the hands of numberless computers, whose deftness of calculation had been whetted by the discovery of hundreds of asteroids, the orbits of which stood in need of determination.

But it will be rather on his philosophical writings than his scientific observations that the reputation of Faye will rest and be honoured by his countrymen. It may be that to some of his theories a general assent has not been given, and that in some cases later discoveries have modified the views the distinguished physicist expressed, but no doubt will be entertained concerning the clearness and ability with which those views have been uttered, or of the influence they have had on French thought. Ever since the time that Laplace in a few pregnant sentences sketched the plan on which the solar system might have been constructed, the subject has been a favourite speculation among French physicists. M. Faye has not been able to resist the temptation to attack this subject, and though, like all attempts at universe construction, the scheme of M. Faye fails to meet all the difficulties which beset the problem, yet it is a most suggestive contribution to the subject, and should prove an incentive to further inquiry. In some respects this cosmogonic theory contrasts very favourably with that of Laplace, and in others, as was natural, it falls behind that of his great predecessor; but this is

not the place to enter into any details or criticisms of the argument developed. In recalling, however, the services which M. Faye rendered, one would not willingly forget this finished essay ("Sur l'Origine du Monde"), in which is given, with much that is suggestive, a lucid explanation of the state of our knowledge of the solar and stellar systems.

Similarly, it would be out of place to discuss here the views he expressed on the constitution of the sun, the causes of sun-spots, the behaviour of solar prominences or the chemistry of the sun generally. All these are subjects that fell under Faye's notice and which he treated broadly and philosophically, but necessarily without the facts and knowledge that later observations have brought to light. In cosmical physics and chemistry he was to a great extent a pioneer, and if his theories are in some cases for this reason insufficiently supported by exact observation, they are generally characterised by a breadth of view and thoroughness of conception that contrasts favourably with contemporary opinion. In the discussion of problems connected with cosmical meteorology, or with the motions of our own atmosphere, he was, perhaps not so happy, and his writings on cyclonic motions, the laws of storms, the behaviour of tornadoes, and the exceptional phenomena which we occasionally experience will probably be soon forgotten. Not so, however, with such works as the "Cours d'Astronomie nautique" and other mathematical books with which he has enriched French literature, and which are models of arrangement and of clearness of expression.

One could with difficulty recall the numerous services which M. Faye rendered to his Government or the acknowledgments that he received from foreign scientific bodies. He was, of course, Membre de l'Institut and besides a seat at the Bureau des Longitudes which he had occupied since 1862, in succession to Biot, he was called by Marshal MacMahon to fill in his Cabinet the office of Minister of Instruction, at a time when it was thought not impossible that M. Faye might have become Director of the Paris Observatory in succession to Le Verrier. He was elected a Foreign Associate of the Royal Astronomical Society so long ago as 1848, while Belgium, Venice, the United States of America enrolled him among the members of their scientific societies. Full of years and distinction he is removed from us, and with him another link that connects the science of to-day with the science of the past.

W. E. P.

NOTES.

THE new botanical laboratories of the Chelsea Physic Garden are to be opened by Earl Cadogan at a garden party there on Friday, July 25.

A REUTER telegram from Kronstadt in yesterday's *Times* reports that on July 14 the Italian cruiser *Carlo Alberto* received, for the first time, messages by wireless telegraphy from the Poldhu station in Cornwall. These are the first experiments in wireless telegraphy over a distance of 1600 English miles in a straight line by land, and the results are said to have been most successful, the messages received having been very distinct.

AMONG the Civil List Pensions announced in a Parliamentary Paper just issued are the following:—Mr. W. H. Hudson, in recognition of the originality of his writings on natural history, 150*l.*; the Rev. Dr. John Kerr, F.R.S., in recognition of his valuable discoveries in physical science, 100*l.*; Mrs. S. C. Jones, in recognition of the services rendered by her late husband, Principal John Viriamu Jones, to the cause of higher education in Wales, 75*l.*; and Mr. H. Ling Roth in consideration of his services to anthropology, 70*l.*

THOUGH the damage done in Salonica by the earthquake which occurred there on the afternoon of July 5 (see p. 254) was not great, some of the surrounding villages suffered considerably. At Guvezno 150 houses were wrecked and at Karajere fifty houses were destroyed. A new spring burst out at the mineral baths of Langaza. The shock was recorded at the observatory of Laibach, which is about 560 miles north-west of Salonica, and also in Birmingham, about 1440 miles in the same direction.

THE current number of the *Bulletin de la Société d'Encouragement pour l'Industrie Nationale* contains the programme of prizes proposed by the Society for the present year. Among these may be noticed a prize of 2000 francs for the invention of a cement capable of agglomerating diamond dust for mechanical purposes, another of 3000 francs for a steam superheater fulfilling certain conditions, and one of 2000 francs for any important progress in the mechanical transmission of work. In chemistry a prize of 1000 francs is offered for the utilisation of a bye-product, and medals for publications useful to chemical industry or metallurgy. A prize of 2000 francs is offered for an apparatus suitable for domestic use capable of sterilising drinking water by boiling, one of 2000 francs for a study of the alcoholic ferments and diastases, and one of 1000 francs for freeing the vine from an insect parasite. In political economy, a prize of 3000 francs is offered for a study of the effects of trusts and industrial syndicates generally upon production and sale.

SEVERAL eruptions of Mont Pelée occurred last week. On July 9 a disturbance began at 7.30 p.m. and continued until midnight. From the *Times* we learn that a column of black smoke streaked with lightning was first observed, and that this was apparently followed by flame, which set fire to the ruins of St. Pierre. Stones and ashes fell for 25 minutes on Morne Rouge and Fonds St. Denis. Drs. Anderson and Fledd were thought to have been overwhelmed by the ejected matter, but they arrived safely at Fort de France on July 11. They were on board a sloop which was lying off St. Pierre when the eruption occurred. A message from St. Thomas states that three loud detonations were heard from the Soufrière, St. Vincent, between 8 p.m. and 9 p.m. on July 9. Advices from Barbados state that loud detonations were also heard there on the night of July 9, in a westerly direction. A telegram from Fort de France states that about midnight on July 12 there was a third violent eruption of Mont Pelée. Large quantities of stones and ash fell on Morne Rouge, Macouba and Ajouba Bouillon. The French scientific mission, which arrived the day before from Guadeloupe, whence it had been recalled by the Governor, left on July 13 for St. Pierre.

M. F. A. FOREL describes, in the *Journal Suisse* of July 10, some brilliant sky effects observed by him at Morges on July 5 directly after sunset. A brilliant disc of light of a whitish-yellow colour appeared thirty degrees above the sunset point a quarter of an hour after the sun had set, and lasted for a quarter of an hour. Ten minutes later a purple circle sixty degrees in diameter appeared, and sunk lower and lower as the sun increased its distance below the horizon. While this circle was visible the sky was brightened by an after-glow. The red sunset effects observed at Jamaica on May 25, Madeira on June 10, and Bombay about June 25 had not been seen at Morges on July 8.

In the July number of the *Bulletin de la Société Astronomique de France*, M. Flammarion gives the first instalment of a history of the West Indian volcanoes, with special reference to Mont Pelée and the recent eruptions. The article is illustrated by photographs and charts, and contains letters of pathetic interest written a day or two before the great eruption, which show

that at least some of the inhabitants of St. Pierre, including several members of the Société Astronomique, feared the possibility of a disaster several days before the final catastrophe occurred.

MR. PIERPONT MORGAN has bought and presented to the Paris Museum of Natural History the collection of precious stones formed by Mr. Kunz, of New York, for the Buffalo Exhibition of last year. He has also sent to the American Museum of Natural History in New York a large star sapphire and a beautiful yellow sapphire. These gems will be added to the collection of precious stones previously presented by Mr. Pierpont Morgan to the Museum.

THE expedition to the Malay Peninsula undertaken by Mr. N. Annandale and Mr. H. C. Robinson with the aid of grants from the Government Grant Fund and Edinburgh University, has now concluded its field work, and it is hoped that a preliminary notice of its more important results may be presented to the British Association at Belfast. A complete series of anthropometrical measurements, representing more than 300 individuals of the various races "wild" and "civilised" inhabiting the Siamese Malay States and Perak, has been obtained, with numerous photographs and about thirty authenticated skeletons and skulls, nearly two-thirds of which belong to the primitive peoples known as "Sakais," "Semangs," and "Orang Laut" respectively. Studies have been made of the religions, burial customs, and sociology of these races, and collections of their clothing, weapons, utensils, and magical and musical implements made. The zoological results comprise extensive notes on mimicry and kindred phenomena and a series of photographs of insects and other animals in their natural surroundings as well as general collections from both high and low levels.

IT was recently reported that Dr. Doberck was retiring from the directorship of the Hong Kong Observatory; but we understand this is not the case and that he is merely home on sick leave.

A TELEGRAM from the Viceroy of India, dated July 12, reports:—"Good rain has fallen over the greater part of India, but fall light in Burma, in Southern India, Southern Punjab, in parts of Rajputana and Sind."

A BRITISH and Colonial Industrial Exhibition will be held at Cape Town for a period of four months from November 1903. All the necessary funds have been guaranteed, and a site adjoining the Botanic Gardens has been chosen. It is important that British manufacturers should participate in a scheme which offers a good opportunity of bringing their products and wares before the South African public, especially in view of the inroads made by foreign competitors in the South African market. When the exhibition is open the industries of farming, dairying, and wine growing will be busy in schemes for a fresh start. The exhibition of the latest and most up-to-date appliances, tools, mechanism and machinery should, therefore, lead to very extensive business, and the opening of new and permanent trade outlets for Imperial manufactures.

THE preliminary programme of the nineteenth congress of the Sanitary Institute, to be held in Manchester on September 9-13, has now been issued. The president of the congress is Earl Egerton of Tatton. Dr. W. N. Shaw, F.R.S., will deliver the lecture to the congress and Sir W. J. Collins will deliver the popular address. The three sections and their presidents will be:—(1) Sanitary science and preventive medicine, Sir James Crichton-Browne, F.R.S.; (2) engineering and architecture, Sir Alexander Binnie; (3) physics, chemistry and biology, Prof. A. Sheridan Delépine. There will be eight special conferences of municipal representatives,

port sanitary authorities, medical officers of health, engineers and surveyors to county and other sanitary authorities, veterinary inspectors, sanitary inspectors, domestic hygiene, and hygiene of school life. In connection with the congress, a health exhibition of apparatus and appliances relating to health and domestic use will be held, as a practical illustration of the application and carrying out of the principles and methods discussed at the meetings.

THE announcement that the meteorological observatories on Ben Nevis and in Fort-William will have to be closed at the beginning of October next, in consequence of the want of funds to keep them in operation, will be received with regret by many meteorologists and other men of science. During the last four years the liberality of Mr. Mackay Bernard, of Dunsinnan, made the continuation of the work at the observatories possible, but there is no hope, in the opinion of the directors, that the observatories can be continued as permanent institutions except by assistance from the State. From the commencement of the work, in 1883, until now, the total cost has been fully 24,000*l.* Of this sum nearly 17,000*l.* has been received by the directors in the form of subscriptions. The balance of the expenditure has been met by a payment of 100*l.* a year, since 1883, from the Meteorological Council for the Ben Nevis Observatory, and of 250*l.* a year from the same body, since 1890, for the Fort-William Observatory. These two contributions constitute all that can be regarded as State aid. The directors have received definite intimation that, whether the observatories are continued or not, the latter sum—250*l.*—is to cease to be paid at the end of this year. In connection with this subject we notice that Sir John Stirling-Maxwell has notified the Lord Advocate that he will put a question this week in the House of Commons as to whether any application has been made through the Scottish Office for assistance for the observatory from the public purse, and whether, if such application has been refused, he will state the grounds of refusal.

AT the Aeronautical Congress held recently at Berlin it was concluded that no ascent should take place at a higher level than 7 or 8 kilometres without placing the observers within a closed car, "nacelleclose," as was suggested, in 1871, by Mr. Louis Tridon. At that time a motion to this effect was rejected on account of the faith it places in the life-sustaining properties of pure oxygen. The scientific committee of the Aéro Club discussed this same subject on June 30 and came to the same conclusions. Dr. Henoque, professor of physiology at the Collège de France, said that the foregoing principles will be observed in the ascents now in preparation by the French Society of Physiology. He held that the atmosphere should be divided into three zones; that in the first, up to 4 or 5 kilometres above the sea-level, life was possible without the use of additional gas. For the third zone, at a level less than 10,000 metres, it would be necessary to resort to the closed car, or to an aerial diving suit. The ascents which Dr. Henoque arranged to take place on July 15, were to be executed entirely in the first zone. Investigation was to be made of the effects of the ascents within the limits of a depression consistent with life, or not ruinous to health, and in accordance with a series of observations made at the Eiffel Tower. Dr. Henoque hopes to show that in this zone the ascents may be considered as beneficial to the general health, invigorating the lungs and likely to afford a remedy against some pulmonary affections. The conditions of life are not the same as when mountaineering, owing to the greater velocity due to the elevation and the absence of all muscular fatigue when the aerial traveller is comfortably seated in the car of a balloon.

ACCORDING to the *Times*, there is likelihood of large supplies of electrical and mining machinery being required shortly for

Johannesburg, where an extensive electric tramway system is to be built. There is a desire to place orders as far as possible with British firms, but freights are very heavy, and British machinery requires therefore to be made lighter. Prompt delivery and lower prices are also needed to meet American and German competition; it is said that several orders have recently been secured by foreign firms at very low prices in order to secure a firm footing in the market.

A NEW oxygen-acetylene burner has been devised by M. Fouche (says the *Engineer*, July 11) which not only has a much higher temperature, but also the admixture of ether vapour is prevented. The ratio of the mixture [is 1 volume of acetylene to 1.8 volumes of oxygen, and the flame, which is 6 mm. long, has a greenish dart in the centre with a point at a very high temperature. Iron and steel, it is claimed, can be easily welded without either oxidising or carburising the iron.

In an Appendix iii. to the Weekly Weather Report for the year 1901, the Meteorological Council has recently issued a very useful set of tables showing for the stations which furnish returns for that Report and the monthly summaries, (1) the average maximum, minimum and mean temperatures for each month, and for the whole year for thirty years (1871-1900); (2) the average monthly rainfall and number of rain-days for thirty-five years (1866-1900); and (3) the average number of hours of bright sunshine and percentages of possible duration for twenty years (1881-1900). These tables are in continuation of those issued in the preface to the Weekly Weather Report for 1895, and furnish at a glance valuable information on the climatology of each of the districts into which the British Islands have been divided for the purpose of weather forecasts.

MR. W. E. COOKE'S report on meteorological observations made under his direction at the Perth Observatory and other places in Western Australia during the year 1900 contains an excellent collection of monthly and yearly climate and rain maps referring to the colony. One series of the maps shows for every month the mean pressures and temperatures and the mean maximum temperatures at day and minimum temperatures at night; also the annual means of the same records. In another series the amount of rainfall for every month of the year is shown graphically in each square degree of the colony, with the average rainfall for that district; and the distribution of the rainfall for the whole year is shown in the same way in a separate map. Mr. Cooke reports that the astronomical buildings of the Perth Observatory are now finished and the instruments in adjustment. The observatory is pledged to take a share in the preparation of the International Photographic Catalogue of Stars, but owing to want of assistants, it is difficult to obtain time for the work. The meteorological observations are, however, kept up at a fair number of stations, and the results for various localities throughout the State obtained since 1875 have been examined, tabulated and discussed, and will shortly be available in a volume entitled "The Climate of Western Australia."

MR. KUMAGUSU MINAKATA sends us from Japan two specimens, mounted as microscopic slides, of a fresh-water alga which he collected in a pond at Wakayama Shi, Japan. He desired to obtain an opinion as to the species, which he believed to be *Pithophora Oedogonia*, Wittrock, var. *vaucherioides*, Wille, of which he possessed a quantity of specimens personally collected near Jacksonville, Florida, between 1891-92, well agreeing in detail with those submitted. He also remarked:—"Since the publication of Wittrock's elaborate monograph of the Pithophoraceæ, 1877, has any species, besides *P. Kewensis*, been ever reported from any other part of the Old World?" Prof. Howes, to whom we submitted the specimens, says in reply:—"I have no doubt that the Japanese identification is

correct. Mr. Rendle, with a former pupil of mine, Mr. W. West, jun., has described as new for Britain a variety of the genus from a canal in Manchester, where it was assuredly introduced (see *Journal of Botany*, vol. xxxvii., 1899, p. 289). I take his word as final. Mr. Minakata may be referred to the above-cited paper for the answer to his second question. *P. Kewensis* must have also been introduced, as it has never been found again.¹⁷

PROF. T. LEVI CIVITA has contributed to the *Annales* of the Faculty of Sciences of Toulouse a paper having an important bearing on the recent discussions as to the production of a magnetic field by moving charges. In a previous paper on that subject, Prof. Righi had examined the possible sources of error in various experiments, from those of Rowland down to the recent observations of Cremieu and Adams, and had pointed out that some uncertainty was introduced by the presence of the conductor used to shield the magnetic needle from electrostatic action. This remark has led Prof. Levi Civita to undertake a mathematical investigation of the effect of an infinite plane-conducting screen on the magnetic field produced by an electrostatic charge moving uniformly parallel to the plane. The results which are embodied in the present paper show that if a is the ratio of the velocity of translation to that of light, then up to the order of a^2 , the electric and magnetic forces on the side of the screen opposite to the moving charge are derivable from a potential. The electric force is negligible, while the magnetic force is reduced to a certain fraction, less than one-half, of what it would be at the same point if the conductor were removed. The magnetic force is not, however, entirely screened by the conductor except in the limiting case when the sheet has infinite conductivity.

THE unique construction of the "Cooke" photographic lenses, made by Messrs. Taylor, Taylor and Hobson of Leicester, has given rise to possibilities of variation of their focal lengths by the user, that are both interesting and useful. The replacement of the back component by a lens of greater focal length, increasing the focal length of the objective by about 50 per cent. we referred to some time ago, the alternative back lens being known as an "extension lens." Messrs. Taylor, Taylor and Hobson have now formulated a method by which the focal length may be reduced. This is effected by unscrewing the front component. One complete turn shortens the focal distance of a five-inch lens by nearly half an inch. Such a difference is of little use with reference to the resulting alteration in the scale of the image, though it may sometimes be convenient. But when applied as an alternative to the use of rack-work and other devices for increasing the distance between the lens and the plate for focussing purposes, as in the use of hand-cameras for comparatively near objects, this range is ample. Without moving either the objective as a whole or the plate, less than half a rotation of the front component of an objective of five inches focal length will alter the distance of the object that is in focus from infinity to three yards. The makers take advantage of this fact in a new issue of their lenses, in which a scale is engraved on the mount so that objects at infinity, ten, six, four and three yards' distance may be brought into focus by this simple means. Within this range the defining power of the objective from corner to corner of a quarter plate, using the full aperture of $f/6.5$, is so little affected that the deterioration of the image at the edges of the plate can only be detected by means of a magnifier. The advantages of this method of focussing are that it is more simple from a constructional point of view than others now in use, saving the weight of those parts hitherto necessary simply for focussing purposes, and that as the lens and plate may be rigidly fixed in their relative positions, there is less risk of instability or misplacement with the con-

sequent deterioration of definition. The same principle is applicable when the "extension lens" is employed, thus further increasing the range of adjustment possible.

MESSRS. R. FRIEDLANDER UND SOHN, of Berlin, have issued two catalogues of floras, one of European, the other of exotic plants.

ACCORDING to the Report for 1901, the Manchester Microscopical Society continues to do excellent work, although the hon. secretary has to deplore a diminished attendance at the meetings.

Nature Notes for July contains a notice of Mr. E. N. Buxton's efforts for the re-afforestation of a large part of the old Hainault Forest, which was deforested about 1850. The cost will be about 20,000*l.* for the Lambourne and Hainault lands, and 7000*l.* for the Grange Hill Forest. It is proposed to ask the great City Corporations and the Essex County Council to bear the main cost, although much financial help is expected from private beneficence and local bodies.

IN a paper published in vol. lxxi. of the *Journal* of the Asiatic Society of Bengal Mr. F. Finn notices certain instances of what he terms "abrupt variation" in Indian birds. Among them he notices a not uncommon colour-phase in the ruff, and for the birds displaying this peculiarity he proposes the name *Pavonella pugnax leucoprora*; this, it may be mentioned, is not in accordance with modern practice, which restricts subspecific titles to local geographical forms. The author also calls attention to a domesticated cock in the Indian Museum, described many years ago by Blyth, which has partially assumed the female plumage, and appears to be the only known example, at least in India, of such an abnormality.

THE failure of pea crops forms one of the more important items in the *Bulletin* issued this year by the authorities of the agricultural experiment station at Fort Collins, Colorado. It was discovered that the soil was permeated with the hyphae of a Rhizoctonia, similar to, if not identical with, that which is destructive to potatoes. Peas are more resistant to the attacks of this fungus than potatoes, but under certain conditions, such as in a heavy soil which holds the water and while the plants are young, the fungus gets the better of the struggle. In the case of seeds taken from diseased potato plants, treatment with solutions of corrosive sublimate or formalin has been found to prove efficacious, and probably this will also hold good for peas. A Rhizoctonia was also found to be the cause of disease on blackberries. Injurious effects of spraying apple trees with Bordeaux mixture are reported, causing malformation of the fruit. These and other pathological effects are illustrated by excellent plates produced from photographs.

CAPTAIN STANLEY S. FLOWER has issued his Report, for 1901, on the Zoological Gardens at Ghizeh, near Cairo, which are now placed under the Public Works Department of the Government of Egypt. The Report gives an excellent account of the condition and progress of this institution, which seems to have prospered greatly under Captain Flower's directorship. The Gardens, which extend over about 50 acres, are beautifully treed and kept up; they are situated at Ghizeh on the left bank of the Nile, and are connected with Cairo by tramway. They contain living examples of about 700 species of mammals, birds and reptiles, and a great variety of plants. The number of visitors increases every year, and was 52,711 in 1901. The lion additions to the buildings are an elephant house, a lion house and a large aviary, besides other smaller structures. It is stated that examples of forty-five different species of wild birds were observed within the Gardens in 1901.

USEFUL suggestions for laying out, planting and cultivating a garden and grounds are given by Mr. T. W. Sanders in the second number of the series of rural handbooks in course of publication by Messrs. Dawbarn and Ward. Seven plans are given for laying out plots varying in area from a quarter of an acre to ten acres; and anyone free to follow the designs set forth, and capable of waiting patiently for the trees and shrubs to develop, may act with advantage upon the concise instructions which Mr. Sanders gives.

A CHEAP edition (price 6s.) of Laing's "Modern Science and Modern Thought," revised and brought up to date, with a biographical note by Mr. Edward Clodd, has been issued for the Rationalist Press Association by Messrs. Watts and Co. With reference to the revision which the advance of knowledge during the last seventeen years has rendered necessary, Mr. Clodd remarks:—"The portions thus affected are those dealing with the continuity of Palæolithic and Neolithic man in Continental Europe; with the recent discovery of remains, probably of an intermediate form between man and ape, in Java; and with the remarkable discoveries in Babylonia, which appear to accord to that empire on earlier civilisation than that of Egypt."

MR. BENJAMIN KIDD is leaving England shortly for South Africa, in connection with studies on which he is engaged. Since the publication of "Principles of Western Civilisation" he has been occupied with articles of some length for the "Encyclopædia Britannica." One of these deals with the application of the doctrine of evolution to society. The article on sociology in the new edition will be contributed by Mr. Kidd.

THE question as to whether tellurium or iodine possesses the larger atomic weight has given rise to many researches since Mendeléeff pointed out that the conclusion drawn from the periodic system was opposed to the experimentally determined facts. This work has hitherto been principally devoted to tellurium, partly because as the rarer and lesser known element tellurium might possibly contain elements of higher atomic weight, but chiefly because the work of Stas in regard to iodine appeared so convincing that further determinations of this constant for iodine would be superfluous. Since all the work done on tellurium tends to show that its atomic weight is decidedly higher than that of iodine, Prof. Ladenburg has attacked the question from the other side, and has redetermined the atomic weight of iodine, using methods of purification differing from those adopted by Stas; the result is in almost absolute agreement with the usually accepted figure, so that the discrepancy between the conclusions of the periodic law and the results of experiment still remains unexplained.

THE current number of the *Berichte* contains a paper by Dr. W. Marckwald on polonium, the radioactive constituent of bismuth. The discoverers of these radioactive elements, M. and Mme. Curie, after numerous attempts to isolate this element, concluded that polonium is a species of active bismuth, and that there is as yet no proof that it contains a new element. Dr. Marckwald, after numerous fruitless experiments, has succeeded in obtaining a minute amount of polonium in a manner which would appear to exclude the possibility of its identity with bismuth. Starting with some kilograms of residues from pitchblende, about 1 per cent. of strongly radioactive bismuth oxychloride was obtained, and it was proved that this activity remained unchanged after several months. The acid solution of this was then treated with a stick of pure metallic bismuth, the metal becoming after some time coated with a black deposit. It was found that the activity of this deposit, as measured by the electroscope, far exceeded that of the original solution, the residual solution having lost its activity during the deposition. No deposit was seen when a second stick of bismuth was

placed in this exhausted solution. The total weight of polonium obtained was only 5 milligrams, corresponding to an amount not exceeding 1 gram per ton of pitchblende. The author hopes to be able to obtain sufficient material to carry out an atomic weight determination.

ALTHOUGH the fact of the existence of a gaseous antimony hydride has been known for many years, it is only comparatively recently that it has been obtained in the pure state, and the accounts of the stability of the pure hydride differ considerably. Thus, according to Olszewski, who first succeeded in solidifying the gas, decomposition with separation of antimony occurs readily even at -90°C . The current number of the *Berichte* contains a paper on this subject by A. Stock and W. Dohr. In order to obtain as rich a gas as possible, they made a careful study of the composition of the gas evolved from a series of alloys of antimony with zinc, sodium, calcium and magnesium, and they found that the magnesium alloy was much the best for the purpose. Thus, whilst the zinc-antimony alloys never yielded a gas containing more than 1 per cent. of the hydride, an alloy of one part of antimony with two of magnesium gave hydrogen containing from 10.4 to 14 per cent. of the antimony hydride. From this mixture the pure gas was easily solidified out with liquid air, melting at -88°C . and boiling at -17°C . The solid melts to a clear liquid, and evaporates without leaving any trace of antimony, and, in fact, the gas may be kept at the ordinary temperature for some hours before decomposition sets in.

THE additions to the Zoological Society's Gardens during the past week include a Brown Capuchin (*Cebus fatuellus*) from Guiana, presented by Madame Delmas; two Ocelots (*Felis pardalis*), two Common Boas (*Boa constrictor*) from South America, presented by Captain W. H. Lacy; two Giraffes (*Giraffa camelopardalis*, ♂ ♀) from Kordofan, two Cheetahs (*Cynoleurus jubatus*), three Secretary Vultures (*Serpentarius reptiliivorus*) from Africa, presented by Colonel Mahon; a Green Woodpecker (*Geococcyx viridis*) British, presented by Mr. J. T. Jones; a Roseate Cockatoo (*Cacatua roseicapilla*) from Australia, presented by Miss Ina King; five Lions (young) (*Felis leo*), two Grévy's Zebras (*Equus grevyi*, ♀ ♀) from Southern Abyssinia, a Campbell's Monkey (*Cercopithecus campbelli*) from West Africa, five Pratincocks (*Glareola pratincola*), European, two Lesueur's Terrapins (*Malacoclemmys lesueuri*), two prickly Trionyx (*Trionyx spinifer*), an Alligator Terrapin (*Chelydra serpentina*) from North America, two Striated Snake-head Fish (*Ophiocephalus striatus*) from India, two Egyptian Geese (*Chenalopex aegyptiacus*) from Africa, deposited; an Orang-Outang (*Simia satyrus*) from Borneo, two Golden-backed Woodpeckers (*Brachypternus aurantius*), an Indian Roller (*Coracias indica*) from India, two White-eyebrowed Gulls (*Ponolepe superciliosus*) from South-east Brazil, purchased; a Duke of Bedford's Deer (*Cervus xanthopygius*) born in the Gardens.

OUR ASTRONOMICAL COLUMN.

BRIGHT METEOR OF JULY 13.—Several correspondents send particulars of a brilliant meteor observed over a wide area last Sunday evening, July 13, about 10.30. According to charts sent by Prof. F. J. Allen from Cambridge, and Mr. A. Macrae from Crouch End, the meteor, which was probably sporadic, first appeared at an altitude of about 40° , and travelling in a N.E.—S.W. direction crossed a line joining Jupiter and Markab at right angles, at about 25° from the former. The meteor travelled very quickly and was intensely bright. Prof. Allen says:—"It illuminated the landscape like a considerable flash of lightning, though the moon shone and incandescent lights were near." Its colour is given as "violet-white." Mr. C. Waterer, of Margate, also remarks:—"It lighted up the whole

landscape in a remarkable manner, and seemed to glow with a peculiarly steady light." Mr. C. G. Osborne, who saw the meteor at Godalming, says that the light was so brilliant that people in a large hall thought a flash of lightning had occurred.

The trail, which was about 10' long and lasted for 15-20 seconds, is described as being of a violet and blue colour, and before extinction it became quite sinuous.

The Rev. F. J. Jervis-Smith, who observed the meteor at Ilfley, near Oxford, sends the following notes of his observation:—"Time, 10.30 p.m., July 13. Approximate angle subtended by total length of luminous path about 15°. Line of flight downwards and nearly vertical. Bearing E.S.E. Angle between its highest point and the horizon about 45°. Time of duration about 2½ seconds."

Mr. Walter E. Besley, director of the meteoric section of the British Astronomical Association, states in the *Times* that the course of the meteor was from R.A. 311° and north declination 21° to R.A. 310½° and north declination 16½°.

DISCOVERER OF NOVA PERSEI.—At a meeting of the Société Astronomique held on July 4, M. Flammarion informed the members that it was one of their number, M. A. de Borissiak, a student at Kieff, who first observed Nova Persei. This observer recorded the Nova as being equal in magnitude to β Geminorum at 8 p.m. February 21, 1901 (Pulkowa time), and, taking into account the difference of longitude, this was about 8h. 40m. before Mr. Anderson discovered it.

The Russian Government has presented M. Borissiak with a special medal for this discovery (*Bulletin de la Société Astronomique de France*, July).

NOVA PERSEI.—The fourth report (June 1902) of the Variable Star Section of the British Astronomical Association, is devoted to a memoir in which Colonel Markwick has gathered together all the observations of the members on the magnitude, colour, light curve and spectrum of Nova Persei. The memoir contains several maps and charts of the region about the Nova, some very good light curves compiled, from many observations, by Mr. J. E. Gore and a series of excellent photographs of the Nova itself obtained by Mr. Alex. Smith at Dalbeattie, using a 5½-inch doublet at various foci, sometimes with full aperture and sometimes with only half (*i.e.* a semicircular) aperture.

HONG KONG DOUBLE STAR OBSERVATIONS.—Nos. 3798-99 of the *Astronomische Nachrichten* are mainly devoted to the observations of 200 double stars made by Mr. W. Doberck at Hong Kong.

Mr. Doberck describes his instrument, which seems to be an ancient one, and shows how the somewhat necessarily large errors have been eliminated. He insists that observations of the same double star should be separated by fairly long intervals in order to render them quite independent of each other, and contends that stellar objects should always be designated by the initial and number of the discoverer, and not by any reference to a general catalogue.

OBSERVATIONS OF THE VARIABLE STAR χ^2 CYGNI DURING 1899.—M. Blum publishes in the *Bulletin de la Société Astronomique de France* an account of the observations of this star made during 1899 by MM. Ed. de Perrot and P. Sella.

The two sets of results and the curves plotted therefrom show very fair agreement, and M. Sella deduces the following conclusions from them:—

- (1) The star is visible to the naked eye 3 days before and 30 days after the theoretical times.
- (2) It increases to maximum (4.7) very rapidly, viz. in 17 days, but decreases very slowly.
- (3) There exists a second maximum (4.8) about 28 days after the first, a third maximum (5.0) 16 days later than the second, and a fourth maximum about 18 or 19 days later than the third. The respective dates of observation were May 10, June 7, June 23 and July 11-12. The complete range of variability of this star is about 8 magnitudes.

ROTATION OF THE BRIGHTER FIXED STARS, AS A WHOLE, WITH RESPECT TO THE FAINTER STARS.—In No. 3800 of the *Astronomische Nachrichten*, Sir David Gill communicates a preliminary note on the apparent rotation of the brighter fixed stars, taken as a whole, in regard to the fainter fixed stars, taken as a whole.

After comparing the common data given in the Cape Catalogues of 1880 and 1900, Newcomb's Fundamental Catalogue

for 1900, Taylor's and other catalogues, and carefully correlating and eliminating the personal errors therein, the author arrives at the conclusion that the remaining discrepancies can only be accounted for by supposing the above-mentioned rotation.

The author urges that the greatest care should be taken to eliminate all the errors in reducing plates for the Astrographic Chart, and suggests that the Repsold-Struve method for magnitude correction, described by Cohn in the *Astronomische Nachrichten*, No. 3766, should be used.

PHOTOGRAPHIC MAGNITUDE OF STARS.—In a note to the Paris Académie des Sciences, M. Prosper Henry points out the effect of the influence of magnitude in causing errors, small but effective, in the reduction of stellar negatives.

Dissatisfied with the final utility of the method proposed by Sir David Gill in the *Bulletin du Comité de la Carte du Ciel*, he proposes a method where duplicate images of the same region are obtained very near together on the same negative, the one with a very short exposure, the other with a long exposure, and then by means of a formula in which the only variables are n , g' and g , he finds the quantity $\frac{n}{g' - g}$, which is the variation of the scale for a difference of one magnitude in the scale of magnitudes adopted, $g' - g$ being the difference in magnitude between the images obtained by the two different exposures. One advantage of this method is that it is not necessary to reduce the coordinates of the plate to right ascension and declination, neither is it necessary to correct for refraction unless the two exposures were made very far apart, and at some distance from the meridian.

MARINE BIOLOGY IN WALES.

AS announced last week, Mr. G. W. Duff Assheton-Smith, of Vaynol Park, Bangor, who has for many years taken a warm interest in the zoological department of the University College of North Wales, has offered a site to the College for a marine zoological station, on condition that the maintenance of the station when erected is assured. The fine zoological collection at the College bears ample testimony to Mr. Assheton-Smith's interest, as he has frequently enriched it with valuable specimens from his menagerie at Vaynol. The site spoken of is on the Menai Straits, about midway between Bangor and the suspension bridge. Sheltered and beautifully situated, it is from every point of view the best site in the locality on which to place such an institution. Besides giving the site with his rights to the foreshore, Mr. Assheton-Smith will also give the necessary facilities of access through his property. In the laboratory, aquarium and enclosures, which will be features of the station, investigations and experiments in connection with our fisheries will be instituted and carried out. The Menai Straits possess a peculiarly rich fauna, and material is always available for investigation and experimental purposes.

A brief note on the steps which have led up to this development may not be out of place. When, in 1892, the Liverpool Marine Biological Committee decided to vacate the station on Puffin Island and to take up its headquarters at Port Erin, Prof. Herdman offered, on behalf of his committee, to dispose of the Puffin Island station to Prof. White. Being unwilling to allow an institution of this nature so near to his college to lapse, and at the same time being desirous of continuing the work of the station as far as possible, Prof. White, with the cooperation of some of his colleagues, provided the money to acquire it. With the assistance of friends he also raised a small income for the maintenance of the building, for carrying on the work and for the publication of reports. A committee for investigating the fauna and flora of the coast of North Wales, and for promoting the sea fisheries, was formed and the work began. An account of the work accomplished is given in the various reports which have been issued.

The inaccessibility of the island, and other obvious difficulties connected with an isolated position, frequently presented themselves, and these led Prof. White to cast round for a more suitable situation, with the result as noted.

In addition to the promise of a site, the College obtains the professional services of an accomplished architect—Mr. Harold Hughes, of Bangor—free. Mr. Hughes took much interest in the Puffin Island station, and both he and Prof. White made some interesting excavations to elucidate the past history

of the island. A start has been made in raising the building fund, and Mr. Henry R. Davis, of Treborth, who acted as hon. treasurer of the Puffin Island station since 1892, has made a handsome contribution. It is hoped that his example will be largely followed.

With regard to maintenance, hopes are entertained that some money from Government sources will be available. A year ago the College approached the Board of Trade with a view of obtaining a grant to enable it to undertake systematic investigations in connection with fisheries, and recently the College put forward its claims for support before the Ichthyological Committee of the Board.

FORESTRY.

THE opening paper in the *Transactions* of the Royal Scottish Arboricultural Society, 1901 (vol. xvi. part iii.), is by Mr. J. S. Gamble, C.I.E., F.R.S., and gives a full account of the Forestry Exhibition in Paris in 1900, in the "Palais de Forêts, de la Chasse et des Cueilletes," the latter term practically meaning productions of various kinds, from baskets and fishing-rods to sponges and Russian caviare. The chief exhibit by the French Government was a series of models, photographs, pamphlets, &c., on the reclamation of mountain sides, including a large diorama representing a hill-side before—and several years after—reclamation. All these illustrate the magnificent work done by France in the last forty years, during which nearly 640 square miles of country have been reafforested at a cost of about two and a half million pounds. Mr. Gamble refers to the necessity of such work being undertaken in the Himalayas, where landslips due to forest denudation have wrought wholesale destruction. He instances hill-slopes which he once knew as covered with fine forests, but which are now bare and scored with landslips, while their gentle streams have been converted into torrents. The "sufficient for the day" policy of Indian administrators constantly neglects the work of preserving mountain forests, which is done seriously and systematically and with the best results in France, Austria and Hungary. The possession of a world-wide empire should induce us also to undertake such an obvious duty. More has been done in India to fix shifting sands, chiefly by means of casuarina plantations along the Coromandel coast, here also following the great French work in Gascony, where 260 square miles have been reclaimed and planted with maritime pine. The Germans have also afforested nearly the whole North German coast with *Pinus sylvestris*.

A great feature of the International Sylvicultural Congress held at Paris during the progress of the Exhibition was M. Mélard's paper on the world's annual excess of imports over exports of timber, which he estimated at 3,437,115*l.* in 1898, the chief importing countries being Britain, showing an annual excess of imports over exports of 20,523,758*l.*, and Germany, 13,741,240*l.*, and the chief exporting ones Austria-Hungary, having an excess of exports over imports of 7,941,422*l.*, Sweden, 7,927,080*l.*, Russia, 5,361,285*l.*, and Canada, 5,077,756*l.* Alluding to the enormous imports of timber into the British Isles, M. Mélard notes that we have annually to build houses, factories and workshops for an increased population of 300,000, more than equal to that of Bordeaux, the third town in France. The large imports of timber into Germany, where 26 per cent. of the country is forest, much of which is scientifically managed, is a remarkable proof of the recent great economic development of that country.

The second paper in the *Transactions* is a reprint of Dr. Schlich's lecture at the Society of Arts, London, on February 27, 1901, on the world's timber supply, which gives more recent figures than M. Mélard's. Dr. Schlich had broken ground on this subject in March, 1897, in a lecture at the Imperial Institute; in the present paper he gives very full statistics, and sums up with the statement that plenty of hardwood is still available, but that coniferous wood (soft-wood), which forms 85 per cent. of the total demand, can be continuously provided only by Sweden, Russia and Canada. Sweden, where the forests are well managed, may be able to increase its yield to 1,500,000 tons, out of a total demand of about 9,000,000 tons of coniferous timber, but the Russian supply is precarious; the great stand-by for coniferous timber will be Canada, if the Dominion Government does not lose time in introducing a rational management of the Canadian forests.

There are two useful papers by Mr. R. C. Munro Ferguson, M.P., the first on the arboricultural adornment of towns, with a list, by Prof. Bayley Balfour, of the shrubs and trees flourishing in the Royal Botanic Garden, Edinburgh. It is not, says Prof. Balfour, the low temperature of Edinburgh that retards the growth of woody plants, but winds blowing during cold weather deprive the plants of their water, so that given shelter, a large number of trees and shrubs may be grown. Mr. Ferguson's second paper is entitled "Hints on the Training of Foresters." The advice given is excellent, and should be read by all young woodmen. Schools for woodmen might with advantage be established in the Crown woodlands adjoining the Forest of Dean and the New Forest, as well as near Edinburgh, but the great requisite for this country in forestry education is that it should be available at our universities, so that land owners, land agents and future colonial administrators may be taught the importance of forestry. At present it takes several years to teach a new colonial governor not to devastate woodlands, and as soon as he has learned the lesson and prepared a useful forest scheme he has to go, and his successor frequently upsets all he has done.

Several useful papers follow by different authors, chiefly estate woodmen, and in one of these, by Mr. D. A. Glen, on "Forestry in Kent and Sussex," the following passage occurs:—"In many of these woods, not only the dead leaves, but every bit of herbage and vegetable undergrowth is carefully raked together and carted away to make litter, which, after it has been well rotted in the cattle-sheds, is utilised as manure for the hop-fields." This practice is apparently also followed in Hampshire, and the future ruin of these impoverished woodlands is as certain as those treated similarly near Nuremberg, where the Scotch pine has become a dwarf tree rarely exceeding 12 feet in height.

Paper No. 41 of the *Transactions* is an account of a deputation last October to the President of the Board of Agriculture. This has been followed by the appointment by Mr. Hanbury of a Departmental Committee, "to inquire into and report as to the present position and future prospects of forestry, and the planting and management of woodlands in the United Kingdom, and to consider whether any further measures might with advantage be taken, either by the provision of further educational facilities, or otherwise, for their promotion and encouragement." Mr. Hanbury's committee is admirably selected, and the best results may be anticipated from its deliberations if only money is forthcoming to carry them out.

Colonel Bailey, R.E., the Instructor in Forestry at Edinburgh, gives some "Notes on the Forests of Norway," chiefly compiled from an official publication, which will be very useful to the members of the Royal Scottish Arboricultural Society in their proposed excursion to Norway this year. Last year's excursion was to woodlands near Glasgow, an account of which and several useful notes and queries on forest questions close this volume. The Society is to be congratulated on the excellent work done under its auspices.

While the Royal Scottish Arboricultural Society has been in existence for forty-eight years and contains more than 900 members, the English sister society is twenty years old and contained 513 members when the last volume of its transactions was published.

These transactions, in the first place, deal with last year's excursion to some interesting woodlands within easy reach of Peterborough. Then follow the two prize essays, to each of which a silver medal was awarded, the former by Mr. J. Price, on forest roads, with diagrams, a most useful paper, and the latter by Mr. A. Deane, of the Warrington Museum, giving descriptions of the structure of British woods, with beautiful reproductions of photographs of transverse sections of each species. Other interesting papers follow: "Arboreal Tunnelers" (leopard moth, hornet clearing, goat moth and wood wasp), by Mr. C. Morley; and on an oak canker due to a species of Stereum, which the author considers to be new, and proposes to call *Stereum quercinum*, by Mr. M. C. Potter, Professor of Botany at the College of Science, Newcastle.

Sir Hugh Beevor contributes the financial history of a four-acre mixed plantation, calculating the rate of interest at 4 per cent., which Sir J. Hooker considers forestry should pay before it will attract attention from investors. The financial history of this plantation is summarised in the following statement, which is of sufficient general interest for reproduction in the pages of NATURE.

(1)		INCOME.	
Annual recurrent Income per acre:—			
Spotting Rent	£0 7 0
			£0 7 0

(2)		FELLING RECEIPTS—4 ACRES.				
Date.	Age.	Trees Felled.	Total Receipts including underwood.	Expenses of Extraction.	Expenses of Sale.	Net Receipts.
1861	15	1059 Larch at 9d.	40	£ 8 0 ¹	£ 3	£ 29
1872	26	251 Larch at 2/4 200 Oak at 7d. 56 Spruce at 1/3	42	8 0 ¹	3	31
1880	34	162 Larch at 6/8 174 Oak at 2/5 40 Spruce at 2/2	85	{ Felling 9 10 Clearing	7	63
1892	46	143 Larch at 6/6 100 Oak at 4/4 8 Spruce at 3/2	76	{ Felling 8 10 Clearing 4 10	6	57
1901	55	35 Larch, 735 c. ft. 268 Oak, 4000 ,, 10 Spruce, 200 ,,	240 ¹	48 0 ¹	22 ¹	170 ¹

¹ Items where estimate only was available. Such estimate must be considered approximate only.

An account follows of some French forests near Valenciennes and Compiègne, the latter having been selected for this year's excursion of the Society. It is shown that the French coppice-with-standards of St. Amand, with a rotation of twenty-five years, produces a net annual revenue of £1 2s. 8d. per acre, and that the splendid State forest of Retz, with an area of 32,550 acres under beech and oak, produces a net annual revenue of 17s. 7d. per acre, with a rotation of 150 years. Dr. Somerville, of the Board of Agriculture, the President of the English Arboricultural Society, contributes a notice on Prof. Schwappach's report on Prussian experiments with forest trees. The results most interesting to us are those obtained with *Fraxinus americana*, which withstands inundations better than *Fraxinus excelsior*, and develops its foliage fourteen days later than the latter, thus escaping ordinary spring frosts. *Larix leptolepis*, the Japanese larch, is also said to resist insects and fungi better than the European larch, while it easily reproduces injured leaders.

A Forestry Society has just been started in Ireland, so that all parts of the British Isles are now enlisted in the cause.

W. R. FISHER.

RECENT DISCOVERIES IN CHINESE TURKESTAN.

DURING the last twelve years or so, the attention of scholars has been repeatedly arrested by remarkable discoveries of ancient Hindu manuscripts in Central Asia. In 1889, Lieutenant Bower found an ancient birch-bark manuscript in Kuchâr, in the northern portion of Chinese Turkestan. This "Bower Manuscript" was at once recognised as the oldest Indian manuscript extant. In 1891 and 1892, M. Petrovsky, Imperial Consul-General of Russia at Kashgar, and the Rev. F. Weber, missionary in Leh, Ladakh, made no less important finds of old manuscripts in the region of Kashgar. Again, in 1897, the French traveller M. Duteuil de Rhins found, in the vicinity of Khotan, some leaves of a very ancient birch-bark manuscript, in which M. Senart recognised fragments of a Prakrit version of the well-known Buddhist text, the Dhammapadam. Meanwhile Dr. Hoernle, then principal of the Calcutta Madrasah, to whom we are indebted for a splendid edition of the "Bower Manuscript," had drawn the attention of the Government of India to the remarkable records of ancient Hindu civilisation to be found in Central Asia, and on his recommendation in-

NO. 1707, VOL. 66]

(1)		EXPENDITURE.	
Annual recurrent Expenditure per acre:—			
Tithe Rent Charge	£0 2 1
Land Tax	0 0 5
Fencing and Draining	0 1 4
Rates	0 0 8
Property Tax	0 0 4
Mole Catching	0 0 2
Bailiff Wage	0 2 0
			£0 7 0

(2)		MONEYS DUE AT EACH FELL.				
Date.	Cost and 4 per cent. Interest.	Rent and 4 per cent. Interest.	Total due.	Balance due.		
1846-61	£ 72	20	92	63		
1861-72	97	13	110			
...	97		
1872-80	118	9	127	64		
...		
1880-92	102	15	117	60		
...		
1892-1901	85	10	95			
1901	Estimated Profit after paying balance due, £75 = £19 per acre.					

PLANTING COST, £40; RENT, £1.

structions were issued to the British officials in Kashgar and Ladakh concerning the acquisition of antiquities from Chinese Turkestan, and a "British Collection of Central-Asian Antiquities" was gradually formed at Calcutta.

But all these had been more or less casual discoveries, and as soon as it became known that European officials were ready to pay high prices for such antiquities, native "treasure-seekers" made it their business to ransack the ancient sites in the desert, not without damaging them, for manuscripts and other remains, and some of them were even unscrupulous enough to manufacture "old books" and sell them to Europeans as "antiquities" unearthed in the desert. In these circumstances it became really a matter of urgency that systematic explorations, by some competent scholar, should at once be undertaken in these parts, all the more so as no part of Chinese Turkestan had ever been explored from an archeological point of view. No man could have been better fitted for this task than Dr. M. A. Stein, who, by his excellent topographical and archeological work in Kashmir and other parts of India, as well as by his scholarly edition and translation of the "Chronicles of the Kings of Kashmir," has shown that he combines the thoroughness and profound knowledge of the true scholar with the energy and hardiness, the practical experience and tact of the explorer. All students of India must feel thankful to the Indian Government for securing the services of such a man for the archeological and topographical exploration of Chinese Turkestan.

In June, 1900, Dr. Stein was placed by the Government of India on a year's special duty, for the purpose of exploring the southern portion of Chinese Turkestan and more especially the region of Khotan. A Chinese passport from the Tsung-li-Yamen was obtained, authorising him to travel and make excavations in Chinese territory. The Survey of India Department rendered material assistance by deputation one of the surveyors, Babu Raim Singh, to accompany Dr. Stein on his travels, and by providing the necessary equipment of surveying instruments. Thus Dr. Stein was enabled, throughout the whole of his journey, to carry on geographical work along with his most interesting archeological researches.

A "Preliminary Report,"¹ published by Dr. Stein shortly after the completion of his journey, gives information about the character and scope of his explorations and their principal

¹ "Preliminary Report on a Journey of Archeological and Topographical Exploration in Chinese Turkestan." By M. A. Stein, Indian Educational Service. Published under the authority of H.M.'s Secretary of State for India in Council. (London, 1901.)

results. As to the intrinsic historical value of the discoveries made there can be only one opinion. It is true their full import will only be realised after the publication of the detailed report to be expected from Dr. Stein himself, and after a thorough examination of the archeological specimens, photographs, coins and manuscripts which will occupy scholars for many years to come; but even a perusal of the "Preliminary Report," and a glance at the illustrations and plates added to it, suffice to show that they will shed a flood of light on the history of an important period, and on the manifold relations between India and Central Asia during the first centuries of our era.

Dr. Stein left Srinagar on May 29. He travelled by the Gilgit-Hunza route, and on June 28 crossed the Kilik Pass and entered Chinese territory on the Tāghdumbāsh Pāmīr. A five days' journey down the valley of this Pāmīr brought him to Tāshkurgān, the chief place of the Sarikol mountain tract. Marching down the plains of Kashgar, he arrived, on July 29, safely at the capital of Chinese Turkestan. In Kashgar he made the necessary preparations for his travels in the desert, not only by organising a fresh caravan, but also by making efforts to secure the good-will of the Chinese authorities for the intended explorations. In these efforts he was assisted, not only by Mr. Macartney, the diplomatic agent of the Government of India at Kashgar, but also by—the famous Chinese pilgrim of the seventh century, Hiuen-Tsiang. "All educated Chinese officials," writes Dr. Stein, "seem to have read or heard legendary accounts of the famous Chinese pilgrim's visit to the Buddhist kingdoms of the 'Western countries.' In my intercourse with them I never appealed in vain to the memory of the 'great monk of the T'ang dynasty' (T'ang-Sên), whose footsteps I was now endeavouring to trace in Turkestan, as I had done before in more than one part of India."

On September 11, Dr. Stein left Kashgar and started on his journey to Khotan, choosing for his march to Yarkand, not the ordinary caravan route, but a track leading through the desert. After a short halt in Yarkand, he proceeded on the caravan route leading to Khotan along the southern edge of the desert, following "the same great thoroughfare by which in earlier times the trade from the Oxus region and the far West passed to Khotan and to China." A peculiar feature of this route and of the desert around Khotan are the "Tatis," as the natives call the "extensive patches of ground where the eroded loess is thickly strewn with fragments of coarse pottery, bricks, slag, and similar refuse marking the sites of villages and hamlets long ago abandoned"—an ideal marching ground for the archeological explorer. He reached Khotan town on October 12. The next four weeks were devoted to geographical work in the Kuen-luen range and Khotan mountains, whereupon he turned again to archeological interests, paying a visit to the Kohmārī ridge opposite to the village of Ūjat, and examining old sites in the Khotan oasis, more especially those near the village of Yōtkan, where "treasure-seeking" has long been carried on along with jade-digging and gold-washing. Having finished the survey of ancient localities within the oasis, he started on December 7 on his way to Dandān-Uiliq, the site chosen for the first excavations in the Taklamākān desert. Marching through the desert, the small caravan, including a party of thirty labourers for the excavation work, found itself on December 18 in the midst of the scattered ruins of Dandān-Uiliq. This ruined site had been seen by Dr. Sven Hedin on his march to the Kerīya Daryā, and is spoken of in the narrative of his travels as "the ancient city of Taklamākān." For fully three weeks most successful excavations were carried on by Dr. Stein amongst these ruins. On January 6, 1901, he left this neighbourhood, and marched across sand dunes, rising to a height of about 200 feet, to the Kerīya Daryā, and along the hard frozen river to the oasis and town of Kerīya, in order to secure the assistance of the Amban (the Chinese district magistrate) for his further explorations. Making inquiries at Kerīya about old localities, he heard of an "old town" in the desert north of the Muhammadan pilgrimage place of Imām Jafar Sādik. He set out in search of this ancient site, and reached Niya—the Ni-jang town of Hiuen-Tsiang—on January 21. Six days later he was among the ruins of the Niya River site, as Dr. Stein, in absence of any special local designation, calls this site, where the excavations, carried on for nearly three weeks, yielded the most important results of the whole journey. At Niya he had heard of old remains to be found in the desert to the east towards Cherchen, and he set out in search of them. Marching more than a hundred miles to the east from Imām

Jafar Sādik, he reached the point where the Endere stream is lost in the sands. A day's march further to the south-east brought him to the "old town of Endere," which was next explored. Interesting archeological remains and manuscripts were brought to light by the excavations. Some Tibetan manuscripts found here showed that the easternmost point of the exploration area had been reached. Hence Dr. Stein began to march back to Kerīya and Khotan. Some 150 miles north of Kerīya the ruins of Karadong—as they are called by the nomadic shepherds grazing along the Kerīya Daryā—were visited and explored by Dr. Stein, before he continued his march to Khotan. The sand-storms and increasing heat warned him that work in the desert would soon become impossible. He hastened, therefore, to visit the ancient sites to the north-east of Khotan which had still to be explored. After examining the scanty ruins of Ak-sipil, some fifteen miles from the right bank of the Yurung-Kāsh opposite Khotan, he marched due north through the sands for about fourteen miles, when he reached the ancient site called Rawak by native "treasure-seekers." Here the last, but by no means the least interesting, excavations were carried on for a whole week. On April 18 the work was finished, and, having completed the programme of his explorations in the desert, Dr. Stein could return to the town of Khotan, where he arranged and carefully repacked his archeological finds. On May 1 he set out for Kashgar, where he made arrangements for his journey to Europe. He left Kashgar on May 29, and travelling through Russian Turkestan he reached, at Andijan, the terminus of the Transcasian Railway. By it he travelled to Krasnovodsk, crossed the Caspian to Baku, and finally, on July 2, arrived in London, where he was able to deposit his important collection—twelve large boxes, containing numerous reliefs, frescoes, painted tablets, and other specimens of Central Asian art, coins, manuscripts, and more than 800 negatives on glass plates, the photographic results of his journey—in the British Museum. A three months' period of deputation in London had to suffice for the provisional arrangement and cataloguing of his precious finds and for preparing the "Preliminary Report."

It would require far more space than I could be allowed in these columns to mention only the most important results of Dr. Stein's explorations. I must content myself with just pointing out the most striking features of the discoveries recorded in the "Preliminary Report." Though archeology and historical topography were the chief interests, and the desert around Khotan was the principal area of the explorations made by Dr. Stein, he missed no opportunity, throughout the whole of his journey, to attend to general geographical work as well and to make valuable anthropological and ethnographical observations.

Thus, in the interests of geography, he superintended the survey on the Tāghdumbāsh Pāmīr and in the Sarikol mountain tract; and by choosing for his march to Kashgar the route which passes through the valleys between the Russian Pāmīrs and the western slopes of the Muziāgh-Āta range, he was able to extend this survey to the Muziāgh-Āta and the mountain ranges overlooking the Little Karakul Lake. Again, on his march from Kashgar to Yarkand he succeeded in fixing the position of Ordām Pādshāh more accurately than is done on the existing maps. After his arrival in Khotan he devoted a whole month to survey operations in the Kuen-luen mountain range, especially in that portion of it which contains the head-waters of the Yurung-Kāsh River. He also explored the hitherto unknown mountain tract towards the Karakāsh River and was able to complete the triangulation of the Khotan Mountains.

Anthropometric observations were made by Dr. Stein in all regions offering any anthropo-geographical interest, for instance among the Iranian hillmen in the Sarikol settlements. Nor did he omit to make notes of any popular legends and folklore connected with interesting localities, and often he found "old stories" which Hiuen-Tsiang had heard and recorded in the account of his travels, still alive among the population. The tenacity with which local legends survive proved often very useful in the identification of old sites. Thus, near the frontier of the Khotan district, there is a Muhammadan shrine known as Kaptar-Mazar, *i.e.* "the pigeon's shrine," at which thousands of pigeons are kept and propitiated by food offerings, and a legend is told of a great victory won with the help of pigeons by some Muhammadan hero over a host of Khotan unbelievers. Now Hiuen-Tsiang tells us that some thirty miles to the west of the capital of Khotan there was a range of hills supposed to have been formed by the burrowing of rats, the rats having been

worshipped there owing to the popular belief that in ancient Buddhist times they had saved the land by destroying the leather of the harness and armour of some hostile army. The locality indicated by the Chinese pilgrim corresponds exactly to Kaptar-Mazar, and Dr. Stein has no doubts that the pigeons of the Muhammadan legend have taken the place of the rats of the legend as related by Hiuen-Tsiang.

During the whole of his journey, Dr. Stein paid the greatest attention to historical topography. Everywhere he tried to trace and identify ancient sites mentioned by Hiuen-Tsiang and other Chinese travellers. Thus—to mention only some of the more important results—Paloyo, the Dard designation of the people of Baltistan, was identified with the term Po-liu, as used in the Chinese Annals and in the narratives of the Chinese pilgrims. Sir Henry Yule's identification of Sarikol with the K'ie-p'an-to territory of Hiuen-Tsiang was fully confirmed by Dr. Stein's investigations. On his march to Khotan he was able to identify the small oasis of Mōji with the town of Po-Kia-i, where a famous Buddha statue brought from Kashmir was worshipped in the times of Hiuen-Tsiang. Following the road once used by the Chinese pilgrim, he traced other ancient sites near the oasis of Zangtiya, and close to the frontier of the Khotan district. Two identifications, previously made by M. Grenard, were fully borne out by the evidence found by Dr. Stein—that of the Kohmāri ridge and cave with the ancient Gōsringa mountain and the cave where the popular legend of Hiuen-Tsiang's time supposed a Buddhist saint to reside "plunged in ecstasy and awaiting the coming of Maitreya Buddha"; and that of the village of Yōtkan with the ancient capital of Khotan. Among the many proofs for the latter identification, the most convincing was that, from this starting point, Dr. Stein was able to identify the positions of the most important Buddhist shrines visited by Hiuen-Tsiang, the places of which are generally occupied now by Muhammadan Zārats. Thus, the small hamlet of Somiya was found to correspond exactly to the Buddhist convent described by the Chinese pilgrim under the name of Sa-mo-joh. Finally, we may mention that on his march from the Karadong ruins to Keriya, Dr. Stein identified the position of the town of Pi-mo, described by Hiuen-Tsiang, in the neighbourhood of Lachim-Ata Mazar.

But it is chiefly for his archaeological discoveries and his manuscript finds that Dr. Stein's journey of exploration will ever be memorable. We cannot enter here into details about the many interesting Buddhist monuments examined by Dr. Stein in the course of his travels in Gilgit, Hunza, Sarikol and Kashgar, and the antiquities collected by him on the Yarkand-Khotan route, in Khotan town and in the village of Yōtkan. Also for the excavations made at the Ender site, at Karadong and at Ak-sipil we must refer the reader to Dr. Stein's "Preliminary Report." But a word or two must be said about the most important results of the excavations carried on among the ruins of Dandān-Uiliq, the Niya River site and of Rawak.

No less than fourteen detached temples and dwelling-houses were excavated in Dandān-Uiliq. First of all two temple cells were brought to light, richly decorated with wall paintings and stucco images. The interior of the larger cella was occupied by a colossal stucco statue, probably representing a Buddha. Each of the four corners of the same cella was occupied by a draped stucco figure standing on a lotus-shaped pedestal. The cella walls were decorated, inside with frescoes showing figures of Buddhas or Buddhist saints, and outside with fresco bands containing small representations of saints, seated in an attitude of meditation. In style of composition and the drawing of figures, these wall decorations are similar to the later of the Ajanta frescoes. But as we possess only very few specimens of old Indian painting, the study of the Dandān-Uiliq frescoes will prove of particular interest. For the same reason, the small painted tablets which Dr. Stein discovered on excavating the temple cellas are of importance. They were probably votive offerings from worshippers who had come to visit the shrines in ancient times. A figure represented on one of these tablets shows the head of a rat—which is interesting in view of the legend of sacred rats mentioned above. Near the excavated buildings Dr. Stein generally found groups of shrivelled and bleached trunks of poplar and fruit trees, the remains of ancient orchards or avenues. Also traces of old irrigation channels were recognisable in the sand.

Of the manuscripts excavated at Dandān-Uiliq, the most important are some oblong leaves of paper inscribed with old

Indian Brāhmī characters (*i.e.* the alphabet which is written from left to right, and used in the edicts of King Asoka, and similar epigraphic documents), and belonging to five different manuscripts, three of which are in Sanskrit and contain Buddhist texts. From their palaeographic peculiarities Dr. Stein concludes that they cannot be later than the seventh, and may belong even to the sixth or fifth, century. Moreover, there were found single leaves of thin, coarse paper, inscribed with cursive Indian characters, but showing a non-Indian language, and some Chinese documents of similar material and appearance. Two of the latter bear dates, according to which they must have been written between 763–805 A.D. Dr. Stein thinks that these dates indicate about the time when the dwellings were abandoned. The evidence of numerous coins found in the course of excavations supports this dating of the Dandān-Uiliq ruins.

Among the most interesting discoveries in the ruins at the Niya River site, there are remains of two large dwelling-houses, excavated by Dr. Stein. In one of them some specimens of household furniture, illustrating the industrial arts of the period, were found, amongst others a wooden chair with ornamental wood carving, the decorative motives of which closely resemble those of the relievo sculptures of the Buddhist monasteries of Yuzufai and Swat (the ancient Gandhāra). In one room, the stuccoed walls of which showed a carefully executed fresco decoration, the pieces of a coloured rug—an interesting specimen of ancient textile industry—were brought to light. Again, in another of the excavated houses there were found the legs and arm-rests of a wooden chair, representing lions and human-headed monsters, and still retaining traces of colour, and also the broken end of a kind of guitar, resembling the popular "Rahāb" of modern Turkestan.

But most important of all are the manuscripts unearthed at the Niya River site. More than 500 wooden tablets inscribed with ancient Kharosthī characters (*i.e.* the alphabet written from right to left, and known chiefly from Indo-Scythian and Indo-Greek coins, found in the north-west of India) were found among the ruins of this site. Most of them are wedge-shaped, from 7 to 15 inches long, and arranged in pairs; and some of them still retained their string and clay sealing intact, thus illustrating the ingenious manner adopted for the fastening and sealing of these documents. Other tablets were oblong, some of considerable length (up to 30 inches), resembling the Indian palm-leaf manuscripts. An ancient pen, made of tamarisk wood, with a bone knob, was found, and gives us some idea of clerical work in this remote period. A considerable number of these tablets were found in an ancient rubbish heap, and there were also some narrow pieces of wood inscribed with Chinese characters. The same rubbish heap yielded another very rare, and in a Buddhist country particularly surprising, writing material, namely, about two dozen documents written in Indian Kharosthī characters on leather. A thorough examination of all these documents as to their contents will take much more time than Dr. Stein was able to bestow on them during his short deputation. But he could make out that most of them were written in an old Prakrit dialect with an admixture of Sanskrit terms, and the wedge-shaped tablets seem to contain correspondence, records of agreement, bonds, memoranda and the like, while religious texts, votive records, &c., will probably be found to form the contents of the longer tablets. As to the date of these documents, palaeographical evidence proves them to belong to the first centuries of our era. For the writing resembles closely that on the inscriptions of the Indo-Scythian kings who ruled over the Punjab and the Kabul region during the first two centuries, and the Kharosthī alphabet soon ceased to be used after that period. These wooden tablets must, therefore, be considered at present as the oldest Indian manuscripts extant. The use of wood as writing material is also a proof of considerable antiquity. From the fourth century onward, the use of paper as writing material is attested for Turkestan. Yet not the smallest scrap of paper was discovered in the ruins of the Niya River site. Numismatic finds, as well as the influence of classical art shown on some of the clay seals attached to the tablets, confirm this dating.

The last excavations were those made at Rawak, where Dr. Stein found an imposing Stūpa surrounded by a court forming a quadrangle 164 feet long and 143 feet broad. Both inside and outside, the walls of this Stūpa court were decorated with rows of colossal statues in stucco, representing Buddhas or Bodhisattvas, and between them at frequent intervals with smaller reliefs

representing deities and saints. The whole of the relief work had originally been coloured, and there were fresco paintings besides. The excavations of these reliefs proved no easy task, as the structures threatened to collapse when the sand was removed. Yet Dr. Stein succeeded in clearing ninety-one large and numerous small reliefs. Photos were taken of the larger reliefs, while the smaller ones were taken to England. In style and details of execution the Rawak sculptures resemble the Græco-Buddhist sculptures of the Peshawar Valley and the neighbouring regions. Chinese copper coins, found among the ruins, proved to be coins of the Han dynasty. As the rule of the kings of this dynasty covers the period of 25-220 A.D., and some of their coins are known to have been current until the close of the fourth century, we have thus a chronological limit, to which the Rawak sculptures may safely be referred.

Finally, we must at least touch upon one negative, though none the less important, result of Dr. Stein's journey of exploration. During his last eight days' stay at Khotan he succeeded in clearing up the doubts he had long entertained concerning the genuineness of certain very puzzling manuscripts and blockprints "in unknown characters" which had for some years past been purchased from Khotan and added to the "British Collection of Central-Asian Antiquities" in Calcutta. With the help of the Chinese authorities he got hold of the very man—one Islam Akhün—from whom most of these documents had been bought. The man was brought before Dr. Stein, who forced from him, in the course of a prolonged cross-examination, an open confession of his manufacture of "old books." Dr. Stein has shown that it is easy to distinguish the forgeries from genuine old manuscripts, and there is no fear that any scholar will, in future, be deceived into trying to decipher the "unknown characters" of Khotan manuscripts.

This brief sketch will suffice to give an idea of the singular importance of the discoveries made by Dr. Stein. But the costly treasures brought by him from Chinese Turkestan will require the most careful examination and study to be made fruitful for further research, and who could be better fitted for this task than the happy discoverer himself? While congratulating both the Indian Government and Dr. Stein on the brilliant discoveries made in Central Asia, we can only express our sincerest hope that the authorities of the India Office may see their way to grant Dr. Stein the leisure required for completing the work so happily begun, in order that the present "Preliminary Report" may soon be followed by a Detailed Report of Dr. Stein's tried workmanship.

M. WINTERNITZ.

UNIVERSITY AND EDUCATIONAL INTELLIGENCE.

The authorities of Reading College have received an intimation that the Treasury recommends the advancement of the College to the list of University Colleges, with a Government grant of 1000*l.* a year for five years. The grant will be subject to the Treasury audit, but local subscribers have assured the necessary income.

PROF. HEWLETT, director of the Department of General Pathology and Bacteriology at King's College, London, has arranged a vacation course in practical and clinical bacteriology to commence Wednesday, August 6, and end Saturday, August 16. The course will consist of lectures, demonstrations and practical work; in the latter, the members of the class will make for themselves permanent preparations of the chief pathogenic micro-organisms and will carry out the principal manipulations employed in bacteriological investigations.

A MEETING of numerous representatives of primary, secondary (including technical) and other branches of education was recently held at the Municipal School of Technology, Manchester, to consider whether arrangements should be made for a conference of science teachers in the north of England on the lines of those established by the Technical Education Board of the London County Council, which have been held in London during the Christmas vacation for some years past. The proposal to hold similar conferences in the north of England was unanimously adopted, and a committee formed to make the necessary arrangements. The first conference will be held on Friday and Saturday, January 2 and 3, 1903, at Manchester.

A LIST of requirements and courses at the Clarkson Memorial School of Technology, Potsdam, New York State, has been received. The institution was founded in 1895 to provide technological education of college standard, and is a constituent college of the University of the State of New York. It is of interest to note that the regular courses of work extend over four years and that satisfactory evidence of thorough preparation must be given by students who wish to enter the college. Now that the London polytechnics are part of the University of London, efforts should be made to introduce or extend the same kind of regulations as to systematic work and preliminary studies.

HERETO none of the technical institutes has been specially organised for the optical trades, though optical classes have been held in several of them, notably in the Northampton Institute in Clerkenwell. But the optical trades appear to have awakened to the need of specialised instruction of the highest kind for the young men in their industry, and a movement to create a real Optical Institute is on foot. The Optical Society has approached the Technical Education Board of the London County Council to urge upon it the creation of such an establishment. If the Technical Education Board could see its way to organise and equip a special technical school in optics, and endow it with a grant of 3000*l.* or 4000*l.* a year, we might expect great things for the future of the optical trades. When it is remembered how greatly the electrical industries of Great Britain have benefited by the electrical teaching and the electrical laboratories established twenty years ago by the City and Guilds Institute, one wonders why similar optical laboratories, properly equipped for the teaching of technical optics, have not been long ago organised. The present movement is a sign that England is waking up.

SOCIETIES AND ACADEMIES.

LONDON.

Royal Society, February 13.—"The Refractive Indices of Fluorite, Quartz and Calcite." By J. William Gifford. Communicated by Prof. Silvanus P. Thompson, F.R.S.

Tables are given of the refractive indices of the above substances for twenty-six wave-lengths, from wave-length 7950 Rb to wave-length 1852 Å inclusive at 15° C., and of the temperature refraction coefficients. To ensure accuracy a new method of observation was adopted. The prisms were polished on three sides, and deviations were measured at each of the three angles. The indices were calculated by the formula

$$\mu = \sin^2 (D + 60^\circ) / \sin^2 30^\circ$$

The difference of the angles of the prisms from 60° were in each case less than 4 seconds of arc. When this is the case the error introduced is less than 0.000001 in the index. It is not, therefore, necessary to measure the angles with accuracy. Some of the rays from the collimator are reflected from the base of the prism and enter the telescope. The image of the slit thus obtained coincides with the refracted image only when minimum deviation is reached. In cutting the goniometer circle a burr is thrown up by the engraving tool on each side of every division. By two small electric lamps behind the reading microscope either or both burrs are made to appear as fine white lines. With the help of quartz fibres measurements are made on these and the mean taken. A correction is made for the error of the reading microscope, and special precautions have been taken to ensure the optical correctness of the prisms. An exact copy of the original measurements for line C fluoride is given. An approximate estimate of the total error gave for the 119 indices in the table,

33 less than...	...	0.0000023
39 "	...	0.0000034
31 "	...	0.0000084
15 more than	...	0.0000084
1 only as great as but	}	0.0000150
not more than		

Some indices for left-handed quartz are given, and a rough determination of the specific gravities of right and left quartz. The partial and proportional dispersions of fluorite, quartz and calcite for the visual spectrum and their lens combinations are also given, together with a list of focal lengths for unity and a table of curves for the whole spectrum with ordinates for a mean focal length of six thousand nine hundred and eighty-five millimetres.

PARIS.

Academy of Sciences, July 7.—M. Bouquet de la Grye in the chair.—The president announced to the Academy the loss it had sustained by the death of M. Faye, member of the Section of Astronomy.—On the relation between the intensity of the voltaic current and the amount of electrolytic action, by M. Berthelot.—The properties of a certain anomaly capable of replacing the anomalies already known in the calculation of the disturbances of the smaller planets, by M. O. Callandreau.—On the development of analytical functions in a series of polynomials, by M. Paul Painlevé.—The local treatment of the localisations of rheumatism, by M. Ch. Bouchard. From the experimental results quoted, the superiority of local treatment by injection over general treatment by the same drug (sodium salicylate) is well marked. The author concludes that in general it is better to apply the drug only at the place where it is useful, by injection.—M. Bouvier was nominated a member of the Section of Anatomy and Zoology in the place of the late M. Filhol.—On a new linear group of four variables, of finite order, by M. Léon Autonne.—On the electrolysis of silver nitrate, by M. A. Leduc. It is generally stated that the bath of nitrate of silver becomes more and more acid after prolonged electrolysis; the contrary effect was, however, observed by Rodger and Watson. It is shown how either result may be obtained by varying the conditions in a definite manner. It is noted incidentally that the counter electromotive force of a silver nitrate voltammeter, which has been usually assumed to be zero or extremely small, is in reality by no means negligible, amounting to about 0.03 volt.—On the action of self-induction in the ultra-violet portion of spark spectra, by M. Eugène Néculec. A continuation of previous papers, the present instalment giving a study of tin.—New researches on open currents, by M. V. Crémieu.—On the nature of the coherer, by M. J. Fényi. A coherer formed of four steel needles in parallel is no more sensitive than a single needle, but if the four are placed in series a greater electromotive force can be placed in the circuit, and the sensibility is accordingly increased.—The dissociating action of the divers regions of the spectrum on matter, by M. Gustave le Bon.—Dark light and actinoelectric phenomena, by M. Gustave le Bon.—On the hydration of zinc oxide, by M. de Forcrand. A thermochemical study of the solution of zinc oxide.—The oxidising properties of a pyranol, by M. R. Fosse. Dinaphthopyranol possesses an oxidising action towards hydroiodic acid, an attempt to prepare the hypiodite resulting in the formation of the tri-iodide of the oxonium compound.—The condensation of nitromethane with aromatic aldehydes, by MM. L. Bouveault and A. Wahl. The best condensing agent for the reaction between the nitromethane and the aromatic aldehyde is sodium methylate; the sodium salt which separates is then treated with zinc chloride. The reaction has been applied to anisic, piperonylic and ortho-nitrobenzoic aldehydes and to furfural.—The action of diazoic salts on desmotroposantonine and desmotroposantonous acid, by MM. E. Wedekind and Oscar Schmidt.—On a new proof of the cellular resistance of the saccharomycetes and on a new application of this property to industry and the distillery, by M. Henri Alliot. The method which is usual in distilleries for removing nitric acid and other volatile acids prejudicial to the development of the yeast is to add sulphuric acid to the molasses, heat to boiling and force through a current of air. To avoid this, the author takes some of these volatile compounds and grows an acclimatised yeast by gradually adding increasing quantities of these antiseptic compounds to the cultures. The properties thus acquired by the yeast are sufficiently permanent for industrial use in the distillery.—On the active principles of the poison of the toad, *Bufo vulgaris*, by MM. C. Phisalix and Gab. Bertrand. Toad poison owes its activity to two principal substances—bufotaline, of a resinoid nature, and bufonine.—On the nature of bufonine, by M. Gabriel Bertrand. The bufonine described by Faust does not exist in toad poison directly extracted from the glands, but has its origin in other parts of the skin. It appears to be an impure cholesterol.—The influence of sulphocyanic acid on the growth of *Aspergillus niger*, by M. A. Fernbach. The sulphocyanide does not appear to interfere with the growth of the mycelium, but arrests fructification.—On the influence of choline on the glandular secretions, by M. A. Desgrez. Although an advanced decomposition product of albumin, choline is not without use to the organism in which it is produced, it exerts a favourable influence on the nutritive exchanges and contributes especially to the retention of phosphorus.—The disappearance of ethers in the

blood *in vitro*, by MM. Maurice Doyon and Albert Morel.—Inhibition produced by interference on the retina, by M. Aug. Charpentier.—On the autoregulation by carbonic acid of the energetic working of organisms, by M. Raphael Dubois.—The influence of temperature on the parthenogenetic development, by M. C. Viguer.—On the evolution of the branchial formations in the lizard and slow-worm, by MM. Prenant and Saint-Remy.—Contributions to the anatomical study of *Rhabdopleura Normani*, by MM. A. Conte and C. Vaney.—On the cause of the changing colours of teguments, by M. H. Mandoul.—On a new method for the destruction of the pyralis and other noxious insects, by MM. Vermorel and Gastine. The use of liquid insecticides having proved non-efficacious, recourse was had to gaseous poisons, hydrocyanic and sulphurous acids, sulphuretted hydrogen, &c., but without effect. By means of a special apparatus, steam at 50° C. was then applied to the leaves, and this mechanical method, which used with due care proved to be without injurious effects on the vines, was found to be very serviceable.—On the presence of the Aptian stage in south-east Africa, by M. W. Kilian.—On the volcanic eruption of May 8 at Martinique, by M. Thierry.

CONTENTS.

	PAGE
Mechanics of Engineering	265
Surface-Feeding Ducks. By T. Digby Pigott, C.B.	266
A French Text-Book of Zoology. By Dr. G. C. Bourne	267
Waves and Sound	268
Our Book Shelf:—	
Ross: "Malarial Fever, its Cause, Prevention and Treatment"	269
MacCand: "Velocity Diagrams. Their Construction and Uses. Intended for all who are interested in Mechanical Movements"	269
Thomas: "Spiderland."—W. F. K.	270
Knopf: "Tuberculosis as a Disease of the Masses, and how to Combat It"	270
Murch: "The Teacher's Manual of Object Lessons in Geography"	270
Benham: "William Gilbert of Colchester: a Sketch of his Magnetic Philosophy."—S. P. T.	270
Wright: "The Vocal System based on the Fundamental Laws of Language"	271
Collingwood: "The Lake Counties."—R. L.	271
Letters to the Editor:—	
Symbol for Partial Differentiation.—Dr. Thomas Muir, C.M.G., F.R.S.; Prof. John Perry, F.R.S.	271
The First Magnetician.—Prof. Silvanus P. Thompson, F.R.S.	272
"Fox Shark" or "Thrasher" (<i>Alopias vulpes</i>) in the English Channel.—E. Ernest Lowe	272
The Tramways Exhibition at the Agricultural Hall. By M. S.	272
The Astrogaphic Chart. By Prof. H. H. Turner, F.R.S.	273
Some new Forms of Geodetical Instruments. (Illustrated.)	276
M. Hervé Faye. By W. E. P.	277
Notes	277
Our Astronomical Column:—	
Bright Meteor of July 13	281
Discoverer of Nova Persei	282
Nova Persei	282
Hong Kong Double Star Observations	282
Observations of the Variable Star χ^2 Cygni during 1899	282
Rotation of the Brighter Fixed Stars, as a whole, with respect to the Fainter Stars	282
Photographic Magnitude of Stars	282
Marine Biology in Wales	282
Forestry. By Prof. W. R. Fisher	283
Recent Discoveries in Chinese Turkestan. By Prof. M. Winternitz	284
University and Educational Intelligence	287
Societies and Academies	287

THURSDAY, JULY 24, 1902.

THE ENCYCLOPEDIA BRITANNICA.

The Encyclopædia Britannica. Vol. xxvi. Aus.-Chi. (Vol. ii. of the tenth edition). Pp. xxii + 763. (London and Edinburgh: Adam and Charles Black; and The Times, Printing House Square, London, 1902.)

SEVERAL articles of scientific interest are contained in this volume, but limitations of space will only permit us to refer to a few of them. Among the subjects of contributions, in addition to those mentioned below, are Balanoglossus, by Dr. A. Willey; George Bentham, by Sir William T. Thiselton-Dyer; Birds, by Dr. H. Gadow; Brachiopoda, by Mr. A. E. Shipley; Calibration and Calorimetry, by Prof. H. L. Callendar; and the Channel Tunnel, by Prof. Boyd Dawkins. There are also articles on all geographical divisions having names between Austria and Chicacole.

The subject-matter of the article on "Bacteriology" has been divided into two sections, general and pathological, the former of which has been contributed by Prof. Marshall Ward. Commencing with a brief introduction upon the botanical position and affinities of the Schizomycetes, their general morphology, structure, flagellation and sporulation are then considered, the difficulties of classifying them discussed, and an outline of Fischer's system of classification detailed. The life and functions of the various classes of bacteria are next dealt with, and a brief, but sufficient, account is given of their growth, action of physical agents upon them, and of the nitrifying, cellulose, sulphur, pigment, phosphorescent and other forms, of the various fermentations, and of symbiosis. The effects of light upon bacteria are described, but we are inclined to think that the author lays too much stress upon this agent as a factor in the bacterial purification of streams, &c.; nor is it at all certain that the cure of lupus effected by the "light" treatment is due to the bactericidal action of the light rays.

In dealing with the bacteriosis of plants, it is pointed out that the evidence of the bacterial invasion of vegetable tissues must be accepted with caution and be carefully controlled, as in the majority of instances the bacteria are secondary, and have gained access along the dead hyphæ of an invading fungus or through the punctures due to aphides or other insects.

Not the least interesting and instructive portion of this article is the brief discussion of the possible sources of energy which contribute to the wonderful activities exhibited by these minute organisms.

The whole of this section, while showing a wide and comprehensive grasp of the subject, is a model of conciseness, and its value is enhanced by several original illustrations.

The pathological section is from the pen of Prof. Muir, and, after an historical introduction, the methods employed for the study of the bacteria are summarised. The general features of infection are then considered, and the nature of toxins, disease-production, susceptibility and immunity are briefly, but sufficiently, discussed; in fact, we have been unable to note any omission of importance.

The formation of antitoxin and the nature of the antagonism between antitoxin and toxin are next considered, and this leads naturally to an exposition of Ehrlich's "side-chain" theory, which is clearly described. Lastly, the nature of anti-microbial sera and the phenomena of bacteriolysis, of agglutination and of phagocytosis are considered, and another admirable survey is concluded with a few critical remarks upon natural immunity.

In the article upon "Brewing," by Dr. Schidrowitz, the reader is presented with an able summary of modern practice in this important industry, and much additional information is given, statistical and legal, and upon such subjects as the cultivation of barley for malt, malt and malting, hops, and malt and hop substitutes. The process of mashing and the changes which ensue, fermentation and the practical application of Hansen's discoveries, and brewing with pure cultures are briefly described. The article seems to be well up to date; for example, Buchner's yeast-cell extract or "zymase" and the theories respecting its nature are mentioned.

Beri-beri, that remarkable disease having the characters of a multiple peripheral neuritis, is described by Dr. Shadwell, his description, however, being mainly based upon Manson's writings (referred to, by the way, as Sir Patrick; may it be an omen). Ross's suggestion that beri-beri is a form of arsenical poisoning is alluded to, but is not considered probable. The micro-organisms of Pekelharing and Winkler and of Rost are not mentioned, and the absence of fever in the disease does not necessarily exclude a micro-parasite, as is suggested.

The article on cancer, also from the pen of Dr. Shadwell, deals mainly with the statistical problems presented by this dread disease; the pathological ones, we understand, will be discussed in another place. With regard to the alleged increase of cancer, it is considered that "on the whole it must be held that though there has probably been some increase, it has not been satisfactorily proved and is certainly less than is supposed."

R. T. H.

The supplementary article on chemistry contributed by Prof. Armstrong fills thirty-eight pages and surveys almost the whole field of scientific chemistry. The task of reviewing the article is such that I have felt inclined to shirk it altogether; for the article proves to be, not so much a record of recent advances in chemistry as a manifesto of Prof. Armstrong's own views on the chief phenomena and problems of modern chemistry. With these views I am entirely out of sympathy. I should be willing enough to say why, but I should want nearly as many pages to traverse Prof. Armstrong's statements as he has occupied in making them. I can do no more than give one or two examples of my meaning.

At the outset of the article we have a reproduction of the table of the elements which Prof. Armstrong recently brought before the Royal Society. In this table all atomic weights have to be whole numbers, and argon and its companions have to form diatomic molecules; these and other things *have* to be what they have been demonstrated *not* to be, so far as the most careful, accurate and trusted work of a generation of chemists can be said to have afforded any demonstration at all.

One would expect some compensation for this; but in exchange for our most precious experimental data I can

find nothing more substantial than a number of integers which mutely stand and wait for elements not yet discovered, or not yet isolated in as pure a state as may be possible.

I suppose we must view this table, and in fact the whole article, in the light of Prof. Armstrong's dictum,

"that imagination and even sentiment play an important part in chemistry, and that if too narrowly and rigidly interpreted, facts may become very misleading factors."

I do not know that this is true, but I feel convinced that the ruthless treatment which facts receive in this new table is not calculated to further exact science.

I must pass over the doctrine of residual affinity and the view of chemical combination as reversed electrolysis which figure so largely in the article. Their application to facts involves a most intricate discussion. These views have been before the chemical world for many years, and I do not think the measure of acceptance which they have gained warrants the prominence which Prof. Armstrong gives them in a general article.

Lastly, in dealing with the ionic theory Prof. Armstrong begins, it is only fair to say, by giving an impartial account of it, with illustrations of its application to chemical phenomena. He adds to this a reiteration of his own objections to the theory and an exposition of possible alternatives which he thinks preferable. This may be allowable, but I cannot pass over the serious charge which is made, that

"the advocates of the dissociation hypothesis have declined even to consider the objections which may be raised to it from the chemist's side."

I am aware of the historic fact on which this statement is based, but I consider it most unfair to leave the reader of the Encyclopædia article under the impression that the ionic theory is entertained as a dogma by the large number of eminent chemists in whose hands it has been the means of effecting such remarkable advances of knowledge.

I do not wish, of course, to imply that in this article Prof. Armstrong has done otherwise than give an honest account of the state of chemistry as it appears to him, and I affect no claim to compete with him in dictating the true faith. But I do say that the whole article is so imbued with the peculiar opinions of the author as to be the polemic of an individual rather than a description of the state of chemistry as it appears to the vast majority of those who follow the craft. For this reason it does not appear to me to be well suited for an encyclopædia.

ARTHUR SMITHELLS.

SUBMARINES.

Les Bateaux Sous-Marins et les Submersibles. Par R. D'Equelley, Ingénieur Civil des Constructions Navales, Ancien Ingénieur aux Forges et Chautiers de la Méditerranée. (Paris: Gauthier-Villars, 1901.)

IT is curious to note the difference in the general appreciation of the submarine in England and in France. Here until recently these engines of destruction do not appear to have been taken seriously by our professional guides, and, so far as the public know, but

little has been done to prove their value, whereas in France, not only are there many already belonging to the Navy, but public appreciation of their utility is such that engineers will have to make themselves familiar with their history and their present lines of development. A handy little book such as this at three francs is likely, therefore, to find a ready sale.

The first chapter relates to the history of the subject under the heads of the different countries. It is interesting to us to note that the earliest submarine mentioned, *La Hollande*, was constructed on the Thames in 1620 and was worked in some way by oars, greatly to the delight of James I. The English have not done much in this line, nor have they been greatly encouraged by the authorities, for we are told that Johnson, early in the nineteenth century, navigated under the Thames in a submarine, which was confiscated by the Government on the pretext that he was going to deliver Napoleon. The builder of the submarine and of the motor-car seem to have been about equally stimulated.

It is surprising to see how, in almost every country but England, the problem has been attacked by many inventors, France apparently taking the lead.

The conclusion of the second chapter, that "habitability" is the most easy thing to attain, is not what would be expected, nor does it seem quite to agree with the accounts of the exhaustion of the men that have appeared at times in the newspapers.

The description of the view obtained from a submarine is interesting. At the depth of only a few metres it appears as if the boat is at the centre of a great circular hall without a roof, as refraction prevents skylight from penetrating beyond the critical angle. It is interesting to contrast this with the appearance of the earth seen from a balloon. Here the observer, as the effect of perspective, seems to be in the centre of a vast concave bowl. The colour of the water is described as favourable for lighting by the electric arc, as the course can be seen for 50 metres ahead.

Under the head of security, the author offers some rather chilly comfort, for he explains that as the submarine is of necessity of about the same density as the water, if you chance to run on a rock there is very little to prevent your glancing off, whereas with a surface-boat the weight at once prevents its rising in a similar way. It must, however, be remembered that if a liner merely scrapes laterally against quite an insignificant iceberg the plating is ripped off as long as the contact lasts. Of course, in consequence of the higher speed and greater dimensions, inertia is far more formidable in this case, but it is difficult to believe that even a submarine could do much rock scratching with impunity. Lest, however, anyone should become too confident, the author points out that one danger always exists—that of not being able to go up, up, up. For this reason the system always employed in French submarines has much to recommend it. These, even when they descend, retain a considerable buoyancy tending to make them rise, but they only actually descend by the action of horizontal rudders or aqua planes corresponding to the acroplane of a flying machine. Such an arrangement will not permit of remaining below the surface voluntarily when at rest.

The chapter on the discharge of torpedoes is necessarily disappointing, as the author is unable to disclose information of a confidential nature.

The most interesting chapter is that which deals with the different stabilities on which the successful navigation depends. There can be no stability of buoyancy when totally immersed; the vessel either rises to the surface, or if it is ever so little heavier than the surrounding water it descends with ever-increasing velocity as the shell becomes compressed until the bottom is reached. When, however, the ship is moving longitudinally, the horizontal rudders determine the rise or fall. The author has no word of commendation for the method of rising or sinking by means of vertical screws.

After discussing shortly the interesting question of lateral stability when floating and when immersed, the author proceeds to the explanation of the effect of the position of the horizontal rudder on the good behaviour of the ship when diving. It seems that the old contest between rear and front steering wheels in tricycles has its counterpart here, and that the front steering, as in the other case, leads to more steady and certain results. The stability of direction depends upon there being plenty of length with fine lines aft. We are told that the submarine of the French Navy, after a run under water of several miles, can come to the surface again on exactly the same course as that which was followed at first.

A series of chapters on motors—steam, electric, petrol—and on tactics bring the author to his conclusion, which shows that he and the French Navy are in grim earnest, and that in his opinion so powerful and insidious a weapon will make naval warfare too terrible to be tolerated any longer. However confident the author may be, and whatever the truth may be, there is in this country much scepticism as to the power of the submarine, as will be gathered from an excellent article in the current number of *Whitaker*, p. 694. C. V. B.

THE DYNAMICAL FOUNDATIONS OF THERMODYNAMICS.

Elementary Principles in Statistical Mechanics. By J. Willard Gibbs, Ph.D., LL.D. Pp. xviii + 207. (New York: Charles Scribner's Sons; London: Arnold, 1902.) Price 10s. 6d. net.

WHERE a branch of science has been approached exclusively from the deductive side or exclusively from the experimental side, it is far easier to form a correct estimate of our state of knowledge in it than is the case where experimental and deductive methods have been continuously worked side by side. The study of rational dynamics has afforded excellent mental training for those who have made the greatest marks in the world as physicists, notwithstanding the fact that the conclusions arrived at in rational dynamics are in direct contradiction to ordinary experience. Thus it is impossible to verify experimentally that the times taken by particles to slide down perfectly smooth chords of a vertical circle are equal, and the phenomena of Nature are far too complicated to allow of an experimental test of the velocity with which a boy would have to throw

a cricket ball *in vacuo* in order to give it a horizontal range of 200 yards. In the study of thermodynamics, on the other hand, where the experimental has preceded the deductive treatment, as has been the case ever since Joule discovered the so-called mechanical equivalent of heat, much confusion and failure to appreciate correctly our state of knowledge have necessarily resulted, and the only way of evolving order out of chaos is to formulate a theory on a purely deductive basis founded on certain hypotheses. The interest of the theory from a physical standpoint will then depend in the agreement or want of agreement between the conclusions of the theory and the results of observation.

In his study of the equilibrium of heterogeneous systems, Prof. Willard Gibbs, starting from the deductive side, gained a point of vantage which has proved of the greatest possible value to the experimental physical chemist. In his present work the same author is to a large extent following in the footsteps of Boltzmann, Watson and other writers, but at the same time he is imparting a great amount of his own originality, both in form and in treatment, to their work. It is impossible to read this volume without feeling that Prof. Gibbs has been to a great extent imbued with the same spirit which led Dr. Watson to produce the second edition of his excellent treatise on the "Kinetic Theory of Gases." This is a valuable feature, for it would be difficult to produce in a small compass a better introduction to the purely deductive study of the kinetic theory than has been given us by Dr. Watson. But Prof. Gibbs has gone further, and has not only discussed the subject at somewhat greater length, but by clothing the investigation in new language, under the title of "Statistical Dynamics," has presented it in a form in which it can be studied quite independently of any molecular hypothesis as a purely mathematical deduction from the fundamental principles of dynamics.

The study of statistical dynamics is based on the consideration, not of a single body or system, but of a very large number of such systems, and such a collection Prof. Gibbs calls an *ensemble*; moreover, in the course of the work it is found necessary to distinguish between *grands ensembles* and *petits ensembles*. The principle underlying the whole investigation is the well-known determinantal relation (corresponding to § 8 of Watson's book) connecting the initial and final values of the multiple differentials of the coordinates and momenta of an *ensemble*. The precise meaning of this relation has always been exceedingly difficult to grasp. It surely adds considerably to our clear understanding of the property to have it now enunciated as the "principle of conservation of extension in phase." A slightly modified form of enunciation gives the principles of conservation of density in phase, and of probability of phase. A further property is that extension in phase is an invariant in that it is independent of the choice of coordinates.

The most interesting distribution of the coordinates and momenta of an *ensemble* is that determined by a probability coefficient of the form e^{-hE} which is commonly known as the Boltzmann-Maxwell distribution. Prof. Gibbs calls this the *canonical* distribution, and the limiting case of $h=0$ where the coefficient of probability is unity is called the *micro-canonical* distribution. The

discussion of certain maximum and minimum properties leads to considerations of the changes which take place in an *ensemble* of system both when left to itself and when subjected to external influence, also of the results obtained by bringing two canonically distributed *ensembles* within influence of each other. The general conclusion is that there exist in statistical mechanics processes strictly analogous to many of those occurring in thermodynamics. Thus equations may be formulated closely resembling those which represent the irreversible heat-changes between two bodies of unequal temperature. When it comes to choosing a pair of conjugate variables to represent temperature and entropy, it is found that these are not uniquely determined, but that several systems are possible, a fact previously brought out, indeed, by von Helmholtz in his "Statics of Monocyclic Systems."

The last chapter deals with *ensembles* analogous to mixtures of different kinds of molecules, and these the author calls *grands ensembles*. They differ from the *petits ensembles* previously considered in the fact that they contain particles or systems of different kinds which may be present in different numbers.

Prof. Gibbs's work is not very easy to read, and it hardly seems appropriate to apply the title "elementary" to it; but the difficulties are no doubt inherent in the subject. It does much to elucidate the conditions under which a body composed of molecules obeying the equations of rational dynamics presents to beings of comparative dimensions similar to those of the human race attributes which may be summed up in the single word "temperature." G. H. BRYAN.

AN ATTEMPT AT ORIGINALITY IN THE TEACHING OF ZOOLOGY.

A Course in Invertebrate Zoology. By Henry Sherring Pratt, Ph.D. Pp. xii + 210. (Boston, U.S.A., and London: Ginn and Co., the Athenaeum Press, 1902.)

DR. PRATT'S book, defined on its title-page as a guide to the dissection and comparative study of invertebrate animals, is the latest of the many novelties which aim at effecting an improvement on the world-famous Huxleyan system, to which acknowledgment is made. The author sets out with the intention of enabling the student to study the larger groups as a whole, instead of detached types of different groups, as he claims is now generally done. In order to achieve this end, he deals in 174 pp. with no fewer than thirty-four representative animals, and the headlines of some of his chapters even bear the names of two alternative genera, for which a single description is made to suffice. Although this gives an average of little more than five pages for each animal, it must be admitted that, so far as they go, the descriptions and instructions, of necessity of a very elementary form, are lucid and correct.

Without going into further detail concerning the body of the book, it may be said that the essence of its novelty lies rather in the appendix and its associated classificatory scheme. This leads off with a copy of Claus's 1887 system, in which, as an all-conspicuous

feature, the Sponges were classed as Cœlenterates, the Enteropneusta as Echinoderms. Then follows a short, but withal a useful, historical sketch of the growth of classificatory systems, from Cuvier to Hatschek, whose scheme of 1888 is given in tabular form, with a succeeding list of "short definitions" which are supposed to be *en suite*, and of which it is remarked that while not exhaustive they "are intended but simply to characterise the various groups in the fewest possible words." The first great subdivision is into subkingdoms (Protozoa and Metazoa), divisions follow, then types, classes, and orders. When, however, on comparison, one finds that while the table provides for five types (Spongiaria, Cnidaria, Trochozoa, Echinodermata, and Chordata), the three first-named are for the definitions numbered in order, and the two last-named are numbered five and six, one is led to seek for number four. The search is vain, since table and definitions do not agree. Most of the descriptions, moreover, in their would-be conciseness, are inadequate. And when with this it is said that, under type Trochozoa, defined as "Metagastrozoans whose common descent and relationship are shown by their possession in some form of a trochophore larva or of an embryonic form allied to it," there are included as subtypes Vermes, Articulata, and Mollusca, further comment becomes unnecessary, except to give it as our opinion that whatever the future of the zoological training of the young, it will not develop on these lines.

The above analysis might be extended with even humorous results; but whatever the good points the book may possess, failure appears to us certain in the attempt to do too much. The would-be new departure is foreign to the best traditions of the Huxleyan system. In the later development of this, the thorough mastery of type-structure has come to be regarded as an alphabet, by which the student learns to read, and the broadest possible survey of the structural limitations of the several groups of which the types are members, as a reading lesson to follow, under the special guidance of the teacher.

OUR BOOK SHELF.

Slide Rule Notes. By Lieut.-Colonel H. C. Dunlop, R.F.A., Professor of Artillery at the Ordnance College, and C. S. Jackson, M.A. (Barrister-at-Law), Instructor in Mathematics R.M. Academy, late Scholar Trinity College, Cambridge. Pp. 66. (London: Simpkin, Marshall, Hamilton, Kent and Co., Ltd., 1901.)

THE slide rule is one of those things which can be less readily explained in writing than verbally. A few words explaining the principle so as to develop the slide rule sense is all that is required to put anyone of reasonable quickness in the way of becoming an adept. On the other hand, the full exposition of the logarithmic theory of the mode of setting for each class of operation, which is essential where the art is to be taught from a book, makes the thing seem so complicated and difficult to remember, that many who would find no difficulty in being taught by the first method might well give it up in despair at the very outset when taught only by the second method. However, it is not given to everyone to be able to find an adept with a power of exposition, and so the book becomes a necessity.

In the writer's opinion, the introductory chapter on the properties of logarithms does not furnish the most practical method, though of course it is eminently scientific, of showing the way to the use of the slide rule. But given that it is to be taught as school subjects are taught, *i.e.* so that the learner cannot see what the object is until he has arrived there, there is nothing but commendation for these notes, as they are called. Many as the books are on the slide rule, the writer of this notice has never seen one so complete and so logical. In addition to the regular uses which are always explained, though many who are familiar with the A, B, C and D lines fight shy of the trigonometrical lines, the solution of quadratic and cubic equations, exponentials and the plotting of curves are illustrated by many examples. Dr. Roget's log. log. line is shortly described, but no reference is made to Lancheater's radial cursor, which makes thermodynamical calculations with γ -wise exponents almost as direct as plain multiplications, and far more convenient than with the log. log. line.

One unfortunate misprint occurs near the beginning, where the construction of the rule is being explained, and the distance from 1 to 2 or log 2 is stated to be 3.03 instead of 3.01. C. V. B.

Injurious and Useful Insects: an Introduction to the Study of Economic Entomology. By L. C. Miall, F.R.S. Pp. viii+256. (London: George Bell and Sons, 1902.) Price 3s. 6d.

THIS little book is unfortunate in its title. One would expect to find all its pages given up to economic entomology; instead we find much valuable space taken up with long accounts of a carnivorous water beetle (*Dytiscus marginalis*), pp. 32 to 37; the tiger moth (*Arctia caja*), pp. 58 to 62; the harlequin fly (*Chironomus*), pp. 100 to 125. What such subjects have to do with economic entomology it is difficult to understand. At the same time, some interesting accounts of various economic species and groups are given, such, for instance, as the cockchafer, wireworm, turnip-beetle, the gooseberry saw-fly, the hive bee, the silkworm, aphides and scale insects, &c. The accounts of the life-histories of these are all interestingly and accurately compiled, but when the practical part comes the work fails; compilation mainly from foreign sources, unless backed up by practical experience of such matters, is usually fatal.

For instance, no mention is made of trapping the adult click-beetles, the parents of the ravenous wireworm, yet it is the only way any good is done; nor is the practice of growing a crop of mustard on wirewormy land mentioned, and what is the use of advising the American remedy for the ground form of woolly aphis—tobacco-dust dug into the soil—in this country? The work is divided into four parts, dealing with the following subjects:—Part i., preliminary lessons, giving an excellent account of the structure of an insect; part ii., lessons on common insects, chiefly such as are either useful or injurious to man.

Part iii. deals with classification, and gives a concise outline of the different groups of insects; this is the most useful portion of the book. The names given to a good many insects in this part are, however, unfortunately not quite accurate; for instance, on p. 192 all the aphides, *rosae*, *humuli*, *mali*, &c., are put as belonging to the genus *Aphis*, which is not the case; nor is the name of the diamond-back moth *Plutella cruciferarum*, nor is that of the wheat midge *Cecidomyia tritici*; there may be an excuse for specific names being inaccurate, but surely not for generic ones.

Part iv. deals with the destruction and mitigation of insect pests; this is mainly compiled from American sources, the writer evidently being unacquainted with any work done in this country. Certainly here no one

would dream of following [the advice given on p. 246, "Paris green may be applied without danger at the strength of 1 lb. to 150 gallons of water." No mention is made of quassa wash or caustic alkali wash, so largely used in this country. The whole chapter is, in fact, but a poor account of the subject.

The work is illustrated with 103 figures, the majority good, but the reproductions of Bracy Clarke's bot-flies (Figs. 81 and 82) are scarcely recognisable; nor would anyone recognise the larva of the gooseberry saw-fly (Fig. 56), or the goat moth and its larva (Figs. 48 and 49).

To the pure entomologist the work will prove interesting and instructive reading, but it cannot be recommended to those who wish to study the economic side of the subject.

Chloroform: a Manual for Students and Practitioners.

By Edward Lawrie, Lieut.-Colonel I.M.S., &c. Pp. 120. (London: J. and A. Churchill, 1901.) Price 5s. net.

THE book before us will be read with interest by those in whose memory the chloroform polemic is still green. It consists essentially of a physiological and clinical part. With regard to the former, Dr. Lawrie gives a history of the polemic between Drs. Gaskell and Shore and himself, extending from the first publication of the Cambridge physiologists upon this subject to the discussion at Toronto in 1894, in which, in the author's words, "the victory, which was decisive and permanent, rested with us." In addition to this historical sketch, the author gives certain experiments from the report of the Hyderabad Commission, some experiments made subsequently at Hyderabad, and some made by Prof. Rutherford upon the effect of stimulation of the vagus nerve during the inhalation of chloroform. These experiments are all illustrative of the action of chloroform upon the circulation, and are adduced by the author in support of the thesis that chloroform has no direct paralytic action upon the heart. The rest of the book is devoted mainly to the clinical aspect of the subject, the author entering fully into the technique of chloroform administration. Here he maintains strongly that the entire attention of the anaesthetist should be devoted to the respiration, and that no chloroform should be administered during struggling. The last chapter is devoted to the question of the statistics of chloroform and ether administrations. The author's statistics of chloroform show one death in 17,300 administrations; those of Mr. Roger Williams one death in 1236 chloroform and one in 4860 ether administrations.

Les Limites de la Biologie. Par J. Grasset. Pp. iv + 188. (Paris: Felix Alcan.) Price 2f. 50c.

PROF. GRASSET'S book is based upon a lecture he delivered at Marseilles in April of last year; we have here, however, not only the substance of that discourse, but numerous extracts from the writings of philosophers and men of science of many countries in support of the author's thesis. It is urged that biology is not the universal and unique science which some of its exponents claim it to be; and an attempt is made to describe its limitations. In separate chapters of his book, M. Grasset considers biology in its relation to the physicochemical sciences, to morality, psychology, aesthetics, sociology, mathematics, logic, metaphysics and theology. Whether the reader agrees with the conclusions or not, he will be interested in this exposition of the views of a medical man who believes there are parallel lines of progress along which human knowledge will continue to grow, and that these lines cannot from the nature of things intersect.

LETTERS TO THE EDITOR.

{The Editor does not hold himself responsible for opinions expressed by his correspondents. Neither can he undertake to return, or to correspond with the writers of, rejected manuscripts intended for this or any other part of NATURE. No notice is taken of anonymous communications.}

Heights of Sunset After-glows in June, 1902

THERE was a very fine example of red sunset after-glow visible here on the evening of the 26th ult., which presented with rather remarkable appropriateness to the date of its appearance, as immediately occurred to me while watching the impressive sight, a scene of transcending splendour of nature's own elaboration which could hardly have been much surpassed in grandeur by what England's great display of rare illuminations on that night would undoubtedly have been, if a check most sorely sad and grievous had not interposed a throb of deep sorrow on the nation, eliciting good proofs of its heartfelt sympathy and loyalty so universally and strongly as to prevent those sumptuous light displays from being used as auspiciously as they were hoped to be to celebrate the joyfully expected Coronation-day of 1902. The sun set at about 8h. 25m. with its orange-yellow disc unhazed, and only shorn of rays by a few faint cirrus cloud-streaks close to the horizon, the sky being elsewhere apparently quite free from clouds. At about 8h. 40m. a long low belt of sky extending 70° or 80° along the north-west horizon had grown orange-yellow, streaked with a few faint lines of red and gradually diluted upwards at a height of 15° or 20° into pale shades of light yellow. A ruddiness of the sky in the east had at the same time risen nearly to the zenith, and through its natural blue tint there the sky passed gradually to white about half-way from the zenith to the west horizon, while under this white tract (about 30° in width) lay the bright belt of orange light with its shades of yellow gradually deepening downwards. But at about 8h. 45-50m. the pure white interval between the ordinary blue and the yellow-tinted regions was gradually invaded, and at last quite occupied, by the advancing ruddy colour from the east; and until about 8h. 55m. a space from 30° of altitude in north-west to near and somewhat beyond the zenith, and for 40° or 50° to either side of a vertical line through the place of sunset, presented a broad expanse of rich rose-coloured, lake-red light pervading all the sky's north-western quarter with a fine wide blaze, against the purple glare of which tall trees and houses all looked sharply silhouetted, and for a short space of about ten minutes that the rose-red colour lasted, all objects of the landscape facing towards the west looked conspicuously crimsoned. The ruby-tinted glow sank rather rapidly in height, and by 9 p.m. it had subsided into the summit of a lower and far brighter pinkish-orange bank of light about 30° high, the lower layers of which formed a belt 12° or 15° in height stretching for about 90° along the west-to-north horizon in a blaze of yellow amber or of ochre-yellow colour. No radiating streamers or shadow-beams crossed either the previous purple glow or this orange-reddish, dome-like bank of light; but the latter light-field's splendid flood of unfecked, evenly-spread colour sank very gradually, preserving its length, to 12° or 15° in altitude by 9h. 15m., growing less ruddy, and assuming pretty uniformly then throughout the horizon layer's yellow-ochre colour. As its brightness had then very sensibly diminished, no further watch was kept on its later changes of appearance.

The time of occurrence of the true rose-tinted glow, when the white space's illumination was replaced, and then swept down into the sunset-glow, by a westward coursing wave apparently, of rose-tinted light, was about 8h. 50-55m. when at its brightest, or about 25-30m. after sunset, when the sun was therefore about 3° below the horizon here, and when the earth's shadow-surface cast by the sun through the air above this point of view was about five miles from the earth's surface. The finely divided matter which by a red-bordered coronal or "Bishop's ring" effect¹ of diffraction, probably, on an exceedingly wide-

circle scale, bent downwards into view from nearly overhead the sun's parting rays in the westward coursing way which seems to be quite general in these dust-caused colour-glows, and with red colour made rosy, probably, by mixture with the sky's ordinary blue, must thus, it appears, have been at no very considerably greater height in the atmosphere than about five miles; or at about the ordinary floating level of cirrocumulus and cirrostratus clouds.

A few less radiant after-glows of rosy tinge appeared here when the sky was clear, on June 17 and 21; but no perceptible traces of rose colour occurred in the pallid sunsets of June 23 and 25, although the sun went down on the latter date behind a faint low bank of cirrus cloud, surrounded by a splendid orange-yellow "glory" about 10° wide, very suggestive of "Bishop's ring," as it was shaded off by redder colour at its borders. As the last visible spark of the sun's bright orange body disappeared in a little cleft, apparently (for it lingered there for a second or two), of a tree-clad hill horizon four or five miles distant, it was white (and the same was noted on the 26th), and showed no greenish coloration.¹ Under the north-western edge of a thick cloud-veil which overspread the sky on Sunday evening, June 22, a belt of sky about 40° long and about 10°-15° high was brilliantly ablaze, from 9h. to 9h. 15m., with light of orange-yellow colour slightly streaked with red, and presented, among fragments of dark cloud dispersed across it, an almost terrifying resemblance to reflection in the sky of an immense distant conflagration. On June 24 a ruddy yellow glare widely pervaded the clear sky to a high altitude in N.W. from 8h. to 8h. 30m., but I was not fortunate enough among obstructions of its view in London to obtain any observations of its changes. On two other evenings, however, Friday and Saturday, June 27 and 28, sufficiently clear views of the rose-tint were seen, the times of apparition of which were recorded, to afford additional determinations of the real height of its appearance; and the following are some details of the pink glow's aspect on the three or four dates besides June 26 when with its successive changes here were pretty clearly recognised and were approximately noted.

On June 17, the first clear evening after a cold, rainy fortnight, a pale cochineal tint, in the north-west, of the beautifully transparent sky was first quite plainly noticed, at 9h. 10-15m., of some width and at an altitude of about 10°-30°; although a similar, but rather weaker, pink glow had already before been seen with rather less distinctness on the last two nights of May; and on this evening it faded out by 9h. 15m., sinking down into a brick-red light-glare 5°-10° high, which by about 9h. 20-25m. grew dull orange-yellow and then faded. The first commencement of the glow was not seen, but as it was probably near its inwards of this distinct red bordered ring from nearly overhead towards the west as the remaining upper levels of the atmosphere still lit by the sun's rays grew every moment loftier, must pretty surely indicate that the first red light to fade away, or that beginning nearly overhead and further from the sun, belongs at once to both the lowest and the finest-grained dust-layers of the corona-forming haze; a conclusion nowise inconsistent with a usually experienced property of mists that they most commonly become corona-grained in retreating inwards from their borders.

¹ The earliest mention that I have seen of the "green-flash" at sunset, as having been sometimes observed on the sea horizon from Bude, in Cornwall, by the Rev. G. H. Hopkins (NATURE, vol. xxix. p. 7, 1883, November 1), concludes with a remark that the effect was not produced when the sun set behind a distant cloud, and this effect was probably also seen at sunrise. This last conjecture was immediately confirmed (*ibid.*, p. 76) by Prof. W. Swan, who wrote from Edinburgh that when watching for sunrise on the Rigi, on the very clear morning of September 13, 1865, he saw the sun appear with a dazzling blaze, for the first instant, of superb emerald green colour, from behind the sharp outline of a distant mountain. It may be interesting to add here, with respect to the other condition noticed by Mr. Hopkins, of the green flash not being apparently produced by the sun's descent behind a cloud, that having been myself, with three others (two of us using binocular field-glasses), well placed on April 22 last for trying to observe the totally eclipsed moon in the east and the setting sun in the west above the horizon together, the sun at least, after a cloudy and rather stormy day, set in an opening of clear sky, behind a low bank about 2° or 3° high of sharply edged, opaque and solid-looking cumulus which, judging from the ten miles distant ridge of hills at Cookham, very far behind me, which the cloud-bank seemed to lie upon, could hardly have been less than 20 or 30 miles from our position. Passing the word to "look out for colour," when the sun's upper limb was nearly disappearing, we all exclaimed "green!" together, as the last and most northerly light-spect of three bright beads into which the sun's upper limb broke up at last disappeared, not much more than half a second after the other two, both of which looked rather whiter than the last, when fading, and then vanished. Of the last spark's distinctly green colour there could be no doubt, and it incited rather to a yellowish than to a blue shade of green. A thin thread of yellowish light, like a slender, slender, short, and horizontal lightning flash, fringed the dark cloud's upper edge for a few minutes, behind which, at about 7h. 15m., the sun had descended; and beyond that the clear sky was nearly grey, and until about 7h. 30m., like the sun's disc itself, very free from yellow and orange sunset colours.

¹ The ring was thus described by Mr. S. E. Bishop, at Honolulu, in NATURE (vol. xxix. p. 266, 1884, January 17).—As "a very peculiar corona or halo extending from 20° to 30° from the sun, which has been visible every day with us, and all day, of whitish haze with pinkish tint shading off into lilac or purple against the blue. . . It is hardly a conspicuous object." In the growing dusk, however, of an hour after sunset, the ring of pinkish white and purple, probably produced by admixture of the sky's ordinary blue with the yellow, orange and red parts of a pure corona, however weakly visible in full daylight, might yet in twilight look bright enough to be easily distinguishable; and the gradual shrinking

brightest at 9h. 10m., 45 or 50m. after sunset, when the sun would be $5\frac{1}{2}^\circ$ below the horizon, its real height above the earth, making proper allowance for its low altitude of 20° and for the sunlight's refraction, was about 13 miles; while its low angular distance from the sun probably denoted a not very excessive fineness of the sunlit haze material.

On June 21, at 8h. 53-56m., or about 30m. after sunset, a wide expanse of pink glow was seen in the upper parts of three broad streamers radiating not far from vertically upwards, to altitudes of about 30° , from the sun's place. The streamers sank in altitude to about 20° by 9h., and subsided gradually by about 9h. 5m. into the summit of a ruddy yellow light belt extending about 90° along the horizon in the sunset quarter to altitudes of 8° - 15° . This bright tract grew duller yellow and orange at its base and borders, until about 9h. 20-25m., when it had nearly faded out. At 30-35m. after sunset, when the streamers' crests at an altitude of 20-30° glowed visibly with rosy light, the sun was $3\frac{1}{2}^\circ$ or 4° below the horizon here, and the height of the red coronal glow produced there by the sun's parting rays must have been about $6\frac{1}{2}$ -8 $\frac{1}{2}$ miles above the earth.

For nearly half an hour after sunset on June 27, the clear north-western sky showed only weak dull shades of yellow, but a long low belt of this at the horizon attained some intensity at 8h. 45-50m., when a short arched band of level cloud streaks grew pink at first and then bright crimson on their lower edges, and from 8h. 50m. to 9h. presented there a splendid interlacing network of red stripes about 35° long and 4° high. At the latter hour pink streamers radiating from the hidden sun as centre and springing chiefly from the northern upper portion of the yellow light belt began to be visible, two immensely long and very narrow straight ones leaving it at about N.N.W., altitude 8° , with slopes of 15° - 20° from horizontal, and reaching out, 3° or 4° apart, through 53° or 60° to somewhat beyond N.N.E., ending at altitudes there of 15° - 20° . The upper and stronger one was pink towards its end, but where they joined the light belt most brightly, and passed through north at altitudes of about 10° - 12° , they partook of the light belt's reddish yellow colour; above them some much shorter and weaker pinkish streamers soon appeared, and at about 9h. 15m. two rather tall wide patches of faint rosy pink were formed at an altitude of 25° or 30° above the sunset place, by two nearly vertical wide streamers, and remained visible with pink colour for some minutes. While travelling here by train from London during its appearance, I could not note the early stages of this glow's commencement, and my whole view of it was very partial; but from the pink tint's visibility from 9h. to 9h. 15m. at an altitude of about 20° - 30° , at about 4 or 50m. after sunset here, when the sun was $4\frac{1}{2}^\circ$ - 6° below the horizon, the heights of the pink crests of the radiating streamers would seem to have been, not very accurately, about 12 $\frac{1}{2}$ -20 miles above the earth.

A most complete view, however, of the successive features of the purple glow was obtained here on the evening of Saturday, June 28, when the concluded height of its appearance so surprised me by its unexpected lowness as to lead me to examine also the foregoing observations with a view to a general comparison together of the glow's real heights that would be found to be derived from my notes of it on different evenings. The sky was then streaked with cirrostratus cloud-screens ruling it with fan-like convergence towards about the sunset quarter; but except in that direction those fleecy stripes dispersed by about 8h. 40m., and the nearly clear north-western sky half-way to the zenith was pale yellow, passing above about that altitude into greyish white, and beyond the zenith into blue. At 8h. 50-53m., the yellow sky-zone's colour having deepened and the grey-white tract above having descended to about altitude 40° - 45° , the latter space grew rapidly rose-pink and round its centre a nearly circular field about 40° in diameter displayed pale pink oleander-flower or almond-blossom colour. Ending upwards, under this, in light straw-yellow, lay the wide-arched summit of a pretty strong horizon glow about 20° high over the sun's place and about 30° long in span to either side of it, of ochre-tinted yellow. The rose-pink coloured space sank gradually, or died out from above, between 8h. 55m. and 9h., replaced from behind by greyish and blue sky and invading the pale straw-yellow summit of the arched horizon-glow, which together with that whole glow, by about 9h. 5m., grew orange-red throughout. This litharge-red, and a little while later faint-looking, glow contracted slowly downwards until 9h. 15m.,

when as it was growing dim and inconspicuous I ceased to watch it. But in the last 10m. its upper border had in its usual way, when beginning to grow red, broken up into bright radial streamers crossing what remained visible of the cirrus streaks at such appreciable angles as to show them to be true solar light-beams quite unconnected with the wind-imparted radiation of those cloud-streaks from a near neighbouring but different focal centre. Where a long and well-defined straight radial streamer shooting up obliquely southwards crossed some of those faint cloud-streaks' strongest ripples, their gauzy cloud materials certainly did not add to its brightness; but at the same time, they diminished the streamer's light so much less than that of the grey sky immediately adjoining it, that they could hardly be said to have very distinctly screened and darkened it.

As the sun's parting illumination of the sky with rosy colour, from altitude about 50° - 60° , downwards, in this sunset, occurred (at about 8h. 55m.) not much more than 30m. after sunset here, when the sun was $3\frac{1}{2}^\circ$ below the horizon, it would follow that this red illumination by direct sunbeams, of microscopically fine haze matter took place at about $7\frac{1}{2}$ miles above the earth, or apparently not far from about the probable real heights of the simultaneously noticed cirrostratus cloud-streaks.

The chief features of these recent after-glows having been just the same as those which were generally noticed during the gradual subsidence of the volcanic after-glow appearances in 1883-4, since it was then pointed out by some investigators of their real heights that some white cloud-whips looking phosphorescently bright long after dark, and even sometimes, near the horizon in the north, throughout the night, must have been floating far above the ordinary height limits of rain and snow clouds produced by aqueous vapour, I was led by the comparative lowness of these few new height conclusions to consult the original accounts given in NATURE by many good observers of the sky-glows in 1883-4, to recall more exactly than I could certainly remember what real heights had then been actually assigned to them. In such letters as Mr. F. A. R. Russell's, at Haslemere (NATURE, vol. xxix. p. 55), describing the evening sky-glow on November 9, 1883, as having twice pervaded the sky with rosy red, beginning from overhead, first at 5h. and again at 5h. 40m. (or at 42m. and at 1h. 22m. after sunset at 4h. 18m.), and as having gradually settled down into the greenish-yellow glare at the horizon in about 20-25m., it is quite evident that much loftier heights of the pink glow were then indicated than those which have just now again been essayed to be determined. The sun, at these two glows' commences, would be about $5\frac{1}{2}^\circ$ and $11\frac{1}{2}^\circ$ below the Haslemere horizon, and the corresponding vertical heights over Haslemere of its earth-grazing beams would, allowing about $\frac{1}{2}^\circ$ for their downward deflection by refraction, be about 17 and 75 miles above the earth.

In letters from Mr. J. E. Clark at York and from Mr. J. LL. Bozward at Worcester (*ibid.*, pp. 130-131), the sky-glows from November 27 to December 4, 1883, were similarly described, in general, as usually attaining their strongest and brightest redness about one hour after the time of sunset, with durations afterwards of the fiery-looking dying-out phase of the glow for nearly an hour longer. Although these observations were not made with certain enough discrimination of the exact times of the rose-red tints' commencements to afford very definite determinations of their real heights, yet in their records of about one hour after sunset, at which the whole height and width of the sky assumed an especially imposing kind of red magnificence, they were for the most part pretty perfectly accordant. At an hour after sunset on December 1, the sun would have sunk about 7° below the horizons of York and Worcester, and the height above the earth of fine dust-haze beginning to shine then overhead with red illumination would be about 25 miles. But determinations of the pink glow's real height by the method which has here been used, and of the warrantableness of which the roseate displays' frequent collection into tufted heads of real sheaf-like sunbeam radiations is itself a sufficient proof to afford us full assurance, were in fact actually obtained on November 25-26 and 29, 1883, and were communicated in letters (*ibid.*, p. 103 and p. 130) by Annie Ley, at Ashby Parva, Leicestershire, and by R. von Helmholtz, in Berlin, who concluded it to have been at upwards of 13 and at about 40 (7 more nearly 30) miles high respectively. The intervals after sunset when the wide red glow began in these two latter cases were about 50-60m. and a little more than one hour, resembling the generality of other observers' records, in those

most gorgeously coloured, long-enduring sunsets, of the times of the conspicuous red glows' commencements; but this average interval appreciably surpassed the shorter space of 25-50m. (as did also the fading-out duration of nearly an hour exceed that of only 20-25m.) observed in last month's displays; and the computed heights accordingly of the glow-producing matter ranged considerably lower (from 5 or 8 to 13 or 20 miles) in these latter than in the memorable sunset glows which followed the great eruption in Java on August 27, 1883, when heights appear to have been found of 13 or 17 to 25 or 30, or even possibly of 40 or 70 miles, for the strata of the atmosphere contaminated with volcanic dust.

The relative height results and the comparative intensities of the present and of the former glow displays seem, however, to have been in quite naturally comprehensible agreement with the lower height of projection, and with the generally lesser magnitude of the recent fearfully destructive outburst on the islands of Martinique and St. Vincent, when compared with the terrifically violent and immense volcanic explosion of Krakatoa in August, 1883, which is generally admitted to have had no previous parallel, in respect of scale and violence of mountain-mass ejection, in the history of such terrestrial convulsions. It will be interesting to notice on future nights if more examples of rose-red coloration should occur, when the times of the white and yellow sky-tracts becoming pink and ruddy should be noted, as the past month's rosy and fire-tinted sunsets were perhaps not quite sufficiently conspicuous to establish their certain connection with the terrible volcanic catastrophe of May 7-8 last in the West Indies. But considering the low temperature and continued cold soaking rainfall during all the early part of last month, until Sunday, June 22, it seems far from easy to conceive that the strikingly fine sunset display of Thursday, June 26, and the conspicuously rosy colorations of the sunset sky on June 27 and 28 can by any possibility have been merely sunset glares produced by ordinary floating dust raised locally from parched or arid tracts of land by the heat and fresh east wind of those few days of the first short interval of summer warmth and sunshine in last month, on which they were observed.

Observatory House, Slough, July 10. A. S. HERSCHEL.

P.S.—July 16.—A very fine display of orange-reddish streamers diverging in an open fan of six or seven steady light-beams from a similarly coloured horizon glow, 6° or 8° high at their common base where the sun had set (at about Sh. 15m.), was seen here on Monday evening, July 7. From Sh. 50-55m., when these fiery-looking beams began to appear, up to altitudes of about 35°, across a rosy tract of sky which had sunk to the elevation of their growing crests from a higher region of pink colour first distinctly well perceived at Sh. 42-44m., their radiant light-sheaves shortened gradually without change of place or brightness; and they lasted thus quite 20m., retreating slowly into the decreasing glow at the horizon until that glow itself, at last, grew quite low and dull at 9h. 15m. The pink glow's lower border, when the first bands of streamers crossed it, was not more than 10° or 12° from the horizon, and the glow's red hue soon permeated all the yellow belt of sky which lay below it, while the streamers, at their heads, grew orange-red in place of pink, and thus from Sh. 50-55m. onwards, the whole display, until it subsided, was of one bright pinkish-orange tint in all its features. The new moon's very slender crescent, at Sh. 55m., lay less than 1° from the horizon, under the end part of the most southern streamer, looking pure yellow, and showed by its clear visibility how free from mist and smoky haze the sky was on that evening quite close to the horizon.

From the pink glow's first appearance at Sh. 43m. with an altitude of about 35°, at about 28m. after sunset, the resulting real height of the layer of dusty air which was thus lit up by the sun's departing rays, could not much exceed 5 miles above the earth's surface. On other dates in July before and since that notable appearance, the observed occurrences of a pink tinge in the sunset sky were scarcely noticeable, and the estimated time of its first appearance was only once thought to be pretty certainly trustworthy, on Sunday, July 13. A rosy tinge then first presented itself pretty brightly at Sh. 41m., about 33m. after sunset, at about altitude 40°, sinking down along the heads of some nearly vertical wide streamers, in three or four minutes to altitude 15°-20°, where it soon died away. The height of the mauve-coloured haze-stratum in the atmosphere which this observation pretty nearly indicated would seem to have been about 7 or 8 miles.

NO. 1708, VOL. 66]

In addition to the above short notes of some particular accounts contained in NATURE of the bright sky-glow of November and December, 1883, it was observed, I find also, by Mr. E. Douglas Archibald, at Rusthall, near Tunbridge Wells (NATURE, vol. xxix. p. 176), that after sunset (at about 3h. 51m.) on December 6, a bright silky-looking white space in the clear sunset sky changed to pink at 4h. 25m. (34m. after) and to red at 4h. 45m. (54m. after sunset), which would imply heights of the pink and red glows of about 8 and 21 miles above the earth. But from the appearance of the glow on December 7 and of its reflection on low clouds, Mr. E. D. Archibald remarked that the red light's long continuance after the pink glow's departure was mainly attributable to cloud or haze reflections of true red coronal glares about the sun; and the conspicuous tinging of the white space with pink or rosy iridescence he concluded, from the interval between the concluding glow of ordinary cirrus and the commencing glow of the loftier dust stratum, corresponded more nearly with a height of from 10 to 13 miles, than with the great height of 40 miles assigned to the glow (probably from long-lasting reflection of red glows in the west on low-lying clouds, or perhaps even on the high dust stratum itself) by Prof. von Helmholtz.

Distribution of Pithophora.

In your Notes of July 17 you state that Mr. Kumagusu Minakata wishes to know if any species of the genus *Pithophora* besides *P. Kewensis* has been reported from any part of the Old World except Japan since 1877.

P. radians, West and G. S. West, was described from Loanda, on the west coast of Africa, in *Journ. Bot.* (January, 1897, p. 36), and has more recently been found in Ceylon (*cf. Trans. Linn. Soc.*, bot. ser. 2, vol. v., 1902, p. 132). *P. Keinechii*, Schimide, was described from Samoa in Engler's *Bot. Jahrb.* (xviii., 1896). Schimide has also described at least one other species from the Old World, but I have not the reference to hand. It will be found within the last five years either in Engler's *Bot. Jahrb.* or in "Hedwigia." G. S. WEST.

Royal Agricultural College, Cirencester, July 18.

Saturn Visible through the Cassini Division.

IN NATURE of May 22 you were good enough to publish my prediction that, on July 17, the Cassini division of Saturn's ring would be invisible where it crossed the planet.

On July 15, Mr. Townshend, president of the Leeds Astronomical Society, reports that he saw the division throughout the ring and crossing the globe, but that on the 17th the portion crossing the globe was invisible. Mr. Townshend observed with a 10-inch reflector, and is a very competent observer.

On July 17 I was observing with a 9-inch refractor, and the Cassini division, clearly seen in the ansæ of the ring, was quite invisible in that part of the ring which crossed the globe.

I shall be very glad to receive notes of other observations of Saturn made on July 17, and shortly before and after that date. Invermay, Leeds, July 21. C. T. WHITMELL.

THE ELECTRIFICATION OF LONDON.

THE various electric railway Bills which have already passed through the House of Lords came up for second reading in the House of Commons last week. In spite of some attempts to reject several of these Bills they all successfully passed the second reading and have been referred to two Select Committees of the House of Commons. These Committees, each of which will deal with about half-a-dozen Bills, are to hold their first meetings at once, the one under the chairmanship of Sir L. M'Ever, the chairman of the other being Mr. Seale-Hayne.

The Bills have already been thoroughly investigated by the Select Committees of the House of Lords presided over by Lord Windsor and Lord Ribblesdale during April and May. These two Committees had much the more arduous task, as they had to deal with a larger number of Bills, several of which they rejected. It is possible, as a result of their work, to form some idea of

the probable effect of the proposed new railways in relieving the congested London traffic. It will be understood that it is assumed in the following article that the Bills which have passed the House of Lords will also pass through the Commons without any modifications of the first importance. In all, no less than twenty-four different Bills have come before Parliament this session relating to electric railways in London; of these eighteen were for new railways or extensions of authorised routes, one was for power to run an existing steam railway electrically, and the remaining five for extension of time for construction. The extension of time was in all cases granted, but it seems that the

which proposed to run the new line as a "circle" in conjunction with their existing route. This Bill was, however, rejected, the successful competitor being the London United Tramways, which, working with the London United Tramways and the Piccadilly and City and North-East London Railways, will provide a through route from the extreme west to the north-east of London. From the map which we publish in illustration of this article, the references to different railways will be easily understood. For the data for this map we are largely indebted to the excellent maps published from time to time in the *Electrician*. It shows only those lines the construction of which has been authorised (or which are

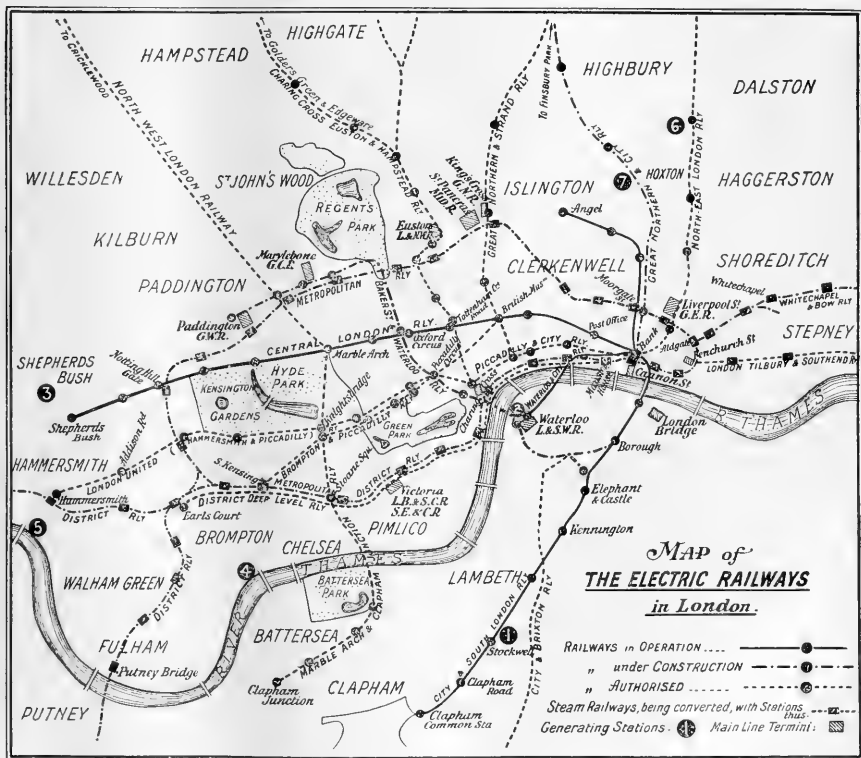

number of instances in which it was applied for had a notable effect on the decisions of the Committees with regard to other schemes. For it was the difficulty in raising the necessary capital which made application for extension of time necessary, and, as a result, where new railways were promoted the Committees required evidence that the promotion was financially well backed before sanctioning the lines. Of the eighteen Bills for new railways, many were directly in competition for the same route, so that it was inevitable that some should be rejected. Thus there were three different companies promoting Bills for a railway connecting Hammersmith with the city, one of these being the Central London Railway,

in operation), and a different system of drawing has been adopted to indicate which railways are working, which under construction and which merely authorised. The engineering details, so far as they are yet decided, show a remarkable uniformity, resulting partly from the decisions of the Board of Trade, the Vibration Committee, &c., which have recently been given in connection with different difficulties arising in the construction and working of "tube" railways. Most of the new railways will be "tubes". The Hampstead-Edgware line, which is to be about 6 miles long, is to run in the open; it forms a continuation of the Charing Cross, Euston and Hampstead Railway shown on the map; so also will a few miles of

the northern end of the North-East London Railway which runs past Tottenham to Palmer's Green. Of course, also the Metropolitan and District Railways and the London, Tilbury and Southend Railway (which is authorised to convert to electric traction) will not run in tubes. In some of the railways the proposed diameter of the tube is 11 feet 6 inches, and in the others two feet larger than this, Mr. Yerkes favouring the smaller diameter for the railways under his control. The larger diameter allows of the construction of two platforms, one on either side of the train, for the use of passengers in case of an accident. These, with the electric lighting of the tunnel which it is proposed to carry out, will afford an easy means of getting to the nearest station should a train be stopped in the tube. With the smaller tubes it will not be possible to have these platforms, and passengers will have to use the permanent way as a means of escape. The smaller tunnels will also involve slightly raising the floor level of the motor carriages to allow room for the motor equipment, which will involve possibly slight inconvenience to passengers. Against these disadvantages must be set the diminished cost of construction. It is also claimed by Mr. Yerkes that the side platforms are really more dangerous than a platform along the permanent way, and would, moreover, be destroyed in case of a derailment.

The electrical details of all the schemes are very similar. Current will be generated as high-pressure alternating current, and transformed to continuous current at 500 volts for working the trains. The multiple-unit system has been adopted—that is to say, the trains will consist of two or three motor cars with three or four trailers, and will not be entirely of trailer cars drawn by a single locomotive. It is also noteworthy that both the conductors are to be insulated, the rails not being used as a return; in the case of the tubes of larger diameter, both conductors will be underneath and protected by one of the side platforms, whereas with the smaller tubes, one conductor, the positive, will be at the side of the track and adequately shielded and the return negative conductor will be between the rails.

The District Railway, including the deep-level line from Earl's Court to the Mansion House, the Brompton and Piccadilly, the Great Northern and Strand, and the Charing Cross, Euston and Hampstead Railways, all of which are under the control of Mr. Yerkes, are to be supplied with power from a generating station by the riverside at Chelsea (4). The generating pressure is to be 11,000 volts and the output 50,000 kw., the station being the largest for traction purposes in the world. The railways under Mr. Morgan's control are the Piccadilly and City, and the North-East London. These, with the two railways belonging to the London United Railways, viz. the Hammersmith and Piccadilly and the Marble Arch and Clapham Junction, in the former of which Mr. Morgan owns a half share, will be supplied with power from two generating stations, one in Fulham (5) having a capacity of 12,000 kw., and the other in the Kingsland Road (6) having a capacity also of 12,000 kw.; it is proposed to use three-phase transmission at 10,000 volts.

It will be seen from the map that although, on the whole, London will be very well supplied with rapid transit facilities when all the new railways are working, there are still some districts inadequately catered for. It must, however, be remembered that in many of these districts there are good tramways either running, or to be run, electrically. Thus, in the south-east corner of the map, the network of tramways is fairly comprehensive. In the north-west the Middlesex county light railways will help to bring traffic to the city. A tube railway for the north-east, connecting Waltham Abbey and Walthamstow with the city, was withdrawn owing to certain alterations in the city end of the route, but it is understood that a similar line will be promoted next

session. Indeed, one cannot help feeling that there are for the present a sufficient number of railways in hand, especially when it is considered how many are being financed by the same people; it will be time enough when these are either running or well advanced in construction to promote other Bills for the more complete electrification of London.

The question of fares and through booking is likely to become of importance when all the railways are at work. At present opinion seems divided between the system of the Central London Railway and the more usual booking system. It would certainly seem that when the whole network is complete a through booking arrangement would be a great convenience to the travelling public. At present, whilst the railways are few and the number of cross connections still fewer, the matter is not one of much importance; but once it becomes possible to travel from almost any part of London to any other by electric railway, the journey necessitating possibly two or three changes of line by the way, the question is put on another level. This is, however, a consideration which may well be left for time and circumstances to settle.

We may conclude by a brief summary of the route and principal points of interest of the different lines.

(1) *City and South London Railway*.—This, the first electric railway in London, was opened in 1890. It has since been extended, and now runs from Clapham Common through the City to Islington. The original electrical equipment of the power station was replaced in 1900; the line is remarkable, as it is run on a three-wire system. The power station is at Stockwell (1), and has a capacity of 3000 kw. The train voltage is 500, and the rails are used as return conductors. Length of line 6½ miles, and scheduled speed 15 miles an hour. The trains are drawn by locomotives.

(2) *Waterloo and City Railway*.—This railway was opened in 1898 to connect the L. and S.W.R. with the City. It has no stations beyond those at Waterloo and the Bank. Length of line 3 miles, speed 18 miles an hour. Multiple unit system used, 500 volts pressure, and rails as return conductors. Generating station at Waterloo (2), capacity 1300 kw.

(3) *Central London Railway*.—The railway was opened in 1900, and runs from Shepherd's Bush to the Bank. The western end is fed by the London United Tramways coming from Hounslow and Southall. The length of line is 6 miles and the speed 14½ miles an hour. Locomotives were originally used, but experiments with the multiple unit system have recently been tried on account of the vibration troubles, and the Company has just closed a contract with the British Thomson Houston Co. for 64 motor-car and 160 trailer-car equipments. The rails are used as return conductors. Power is generated at Shepherd's Bush (3) at 5000 volts; capacity of station 5100 kw.

(4) *Metropolitan and District Railways*.—The lines to be electrically equipped include the Inner Circle and the Hammersmith and Putney branches. They afford a means of approach to the City from the south-west, and also communication through various districts by means of the "Circle." The electrification will be completed in eighteen months or two years.

(5) *District Deep Level*.—This is to provide an express route from Earl's Court to the Mansion House running under the existing line. The line is authorised, but construction work is not yet begun.

(6) *Whitechapel and Bow Railway*.—This branch of the District Railways will be electrified with the rest; it affords connection with the London, Tilbury and Southend Railway at Bow.

(7) *Brompton and Piccadilly Railway*.—The line will run from South Kensington Station (District Railway) *via* Knightsbridge to Piccadilly Circus; the construction

work has just started. An extension to Holborn has been granted, where (besides connecting with the Central London Railway) it will form a junction with the

(8) *Great Northern and Strand Railway*.—This will run from Finsbury Park (G.N.R.) past King's Cross and Holborn to the Strand.

(9) *Charing Cross, Euston and Hampstead Railway*.—Starting at the Charing Cross end, the line runs to Tottenham Court Road, where it gives a cross connection with the Central London, thence *via* Euston to Hampstead (Golder's Green) and Highgate. At the Golder's Green end there is to be a junction with the

(10) *Hampstead and Edgware Railway*.—This is to run in the open to Edgware. The line, which is outside the limits of the map, is to be controlled by the Charing Cross, Euston and Hampstead Railway.

(11) *Baker Street and Waterloo Railway*.—This railway was authorised in 1893. Construction work is now considerably advanced. The line with the extensions granted runs from Paddington (G.W.R.) *via* Marylebone (G.C.R.), Baker Street, Oxford Circus, Piccadilly Circus, Charing Cross and Waterloo to the Elephant and Castle, where it connects with the City and South London Railway.

Mr. Yerkes holds a large interest in all the above railways (4-11). Power will be supplied to all (except possibly the two last) from the generating station in Lots Road, Chelsea (4), particulars of which have already been given. The Metropolitan Railway has, however, a separate power station at Neasden.

(12) *London United Railways (Hammersmith and Piccadilly)*.—This line, which is promoted by the London United Tramways and half owned by Mr. Morgan, will run under Hammersmith Road, Kensington High Street and Piccadilly to the Circus. At the Hammersmith end it is fed by the tramways. At the Piccadilly end it forms an end-on junction with the

(13) *Piccadilly and City Railway*.—This line is to run from Piccadilly Circus to Charing Cross, and thence under the Strand and Fleet Street to the Bank. At the Bank there is an end-on junction with the

(14) *North-East London Railway*.—This railway runs from the Bank through Highbury and Tottenham to Palmer's Green (near Southgate). The last few miles are to run in the open. This, with the two above lines and the London United Tramways, will give a through route from the extreme west to the north-east of London. Through booking is to be adopted, the proposed fares being extremely small. The group is known as the "Morgan" group, and will be supplied with power from the stations at Fulham (5) and Kingsland (6).

(15) *London United Railways (Marble Arch and Clapham Junction)*.—This line gives a south and north connection running from Clapham Junction *via* Sloane Street under Hyde Park to Marble Arch. It is promoted by the London United Tramways Company, and will obtain power from the same station as their other railway. At Marble Arch there is connection with the Central London Railway and an end-on junction with the

(16) *North-West London Railway*.—This railway is to run under the Edgware Road to Cricklewood. The line was authorised in 1899, but construction work has not yet started. There are to be stations every half mile.

(17) *Great Northern and City Railway*.—An extension of this railway (which starts at Finsbury Park) to the Bank has been granted. The construction work is nearly completed. The generating station is to be on the Regent's Canal (7).

(18) *City and Brixton Railway*.—This line, which has been leased to the City and South London Railway, runs under the Brixton Road and connects Brixton with the City. Construction work has not yet commenced and details are not available.

(19) *London, Tilbury and Southend Railway*.—Powers have been granted to run the whole of this line electrically, but it is not proposed to do so until necessary. At first only such portions will be converted as are considered necessary to work in with the District Railway electrification. A site, large enough for a generating station for the whole line, has been acquired on the River Roding (a little beyond the limit of the map).

M. S.

THE PITTSBURG MEETING OF THE AMERICAN ASSOCIATION.

THE fifty-first annual meeting of the American Association for the Advancement of Science was held at Pittsburg, Pa., June 28-July 3, 1902, under the presidency of Prof. Asaph Hall, formerly of the United States Naval Observatory, and Harvard University.

The meeting was not a large one, but was attended by many of the leading men of science in the United States. The total registration was 436, and the majority of those in attendance were Fellows. A number of affiliated societies met at the same time and place in connection with the Association. These societies were the Geological Society of America, the American Chemical Society, the Society for the Promotion of Agricultural Science, the Botanical Society of America, the American Microscopical Society, the American Folk-Lore Society, the Association of Economic Entomologists, the Society for the Promotion of Engineering Education, the American Physical Society, the American Anthropological Association and the National Geographic Society. The meetings of these societies were all largely attended and their registration was not included in that of the Association, so that the Pittsburg meeting was practically a gathering of about one thousand scientific men.

As is quite natural, on account of its great mining and manufacturing interests, Pittsburg proved to be an especially attractive meeting-place for the engineers and geologists. The botanical and chemical sections and their affiliated societies were also represented with especial strength.

The address of the retiring president, Dr. Charles Sedgwick Minot, of the Harvard Medical School, was delivered on the evening of July 1 and is printed in full in this number. The other evening functions of the meeting were:—(1) A popular lecture by Dr. Leonard P. Kinnicutt, of the Worcester Polytechnic Institute, on "The Prevention of the Pollution of Streams by Modern Methods of Sewage Treatment." Dr. Kinnicutt is a well-known American expert in this line of work, and has been a careful observer of the experiments which have been and are being made in England, many of his lantern slides referring to English work. (2) On July 3 Mr. Robert T. Hill, of the U.S. Geological Survey, gave an illustrated lecture on the recent volcanic eruptions in Martinique. Mr. Hill was leader of an expedition to Martinique a few days after the eruption of Mont Pelée, other members being Prof. I. C. Russell, of Ann Arbor, Mich., and Commander Borchgrevink. The expedition was sent out by the National Geographic Society.

The vice-presidential addresses were as follows:—Prof. James McMahon, of Cornell University, before the Section of Mathematics and Astronomy, on the subject "Some Recent Applications of the Function Theory to Physical Problems." Prof. D. B. Brace, of the University of Nebraska, before the Section of Physics, on the subject "The Group Velocity and the Wave Velocity of Light." Prof. H. S. Jacoby, of Cornell University, before the Section of Mechanical Science and Engineering, on the subject "Recent Progress in American Bridge Construction." Dr. B. T. Galloway, of the U.S. Department of Agriculture, before the Section of Botany, on

the subject "Applied Botany—Retrospective and Prospective." Prof. C. R. Van Hise, of the University of Wisconsin, before the Section of Geology and Geography, on the subject "The Training and Work of a Geologist." Prof. David Starr Jordan, of Stanford University, before the Section of Zoology, on the subject "The History of Ichthyology." Dr. J. Walter Fewkes, of the Bureau of American Ethnology, before the Section of Anthropology, on the subject "Prehistoric Porto Rico." Mr. John Hyde, of the U. S. Department of Agriculture, before the Section of Social and Economic Science, on the subject "Some Statistical and Economic Aspects of Preventable Diseases."

Certain important amendments to the constitution were made. The terms of office of secretaries of sections were lengthened from one year to five years. The council was given the power to add to its number nine Fellows whose terms of office shall be three years. The sectional committees were given greater permanency by provision for the election of one member each year who shall serve five years. All the recent changes in the constitution have aimed towards a greater permanency in the executive officers of the Association, of the council and of the sectional committees, and have increased the powers of the council.

The report of the treasurer and the financial report of the permanent secretary show the finances of the Association to be in a prosperous condition, and although they have by no means reached the standing of those of the British Association, the American Association is able this year to devote more funds to research grants. This year grants were made to committees on anthropometric measurements, the study of blind vertebrates, the relations of plants and climate, the atomic weight of thorium, and the determination of the velocity of light.

The next meeting of the Association will be held at Washington, from December 29, 1902, to January 3, 1903. The change in the time of meeting is a very important one and was made only after the most careful consideration. American universities and colleges have lengthened their Christmas holidays so as to enable the members of the scientific faculties to attend such winter meetings, and the week which contains the first day of January each year has been designated as "Convocation Week." Not only will the national scientific societies of the United States meet during this week under the auspices of the American Association, but the other learned societies of the country will also adopt this plan.

The president elected for the Washington meeting is Prof. Ira Remsen, the well-known chemist, recently made president of Johns Hopkins University. The vice-presidents of the different sections will be as follows:—Mathematics and Astronomy, Prof. George Bruce Halsted, of the University of Texas; Physics, Prof. E. F. Nichols, of Dartmouth College; Chemistry, Prof. Charles Baskerville, of the University of North Carolina; Mechanical Science and Engineering, Prof. C. A. Waldo, of Purdue University; Geology and Geography, Prof. W. M. Davis, of Harvard University; Zoology, Prof. C. W. Hargitt, of Syracuse University; Botany, Mr. F. V. Coville, of the U. S. Department of Agriculture; Anthropology, Mr. G. M. Dorsey, of the Field Columbian Museum, Chicago; Social and Economic Science, Mr. H. T. Newcomb, of Philadelphia, editor of *The Railway World*.

At the Washington meeting many additional societies will come into affiliation with the American Association, notably the American Society of Naturalists, with its group of special societies which have always held a mid-winter meeting, namely, the Society of Morphologists, the Society of Anatomists, the Society of Physiologists, the Society of Psychologists, the Society of Bacteriologists, the Society of Plant Morphologists, and others.

ADDRESS BY PROF. C. S. MINOT, PRESIDENT OF THE ASSOCIATION.

The Problem of Consciousness in its Biological Aspects.

OUR Association meets in Pittsburg for the first time. We are glad to indicate by our assembling here our appreciation of the immense work for the promotion of education and science which has been begun in this city and already is of national value. It has been initiated with so great wisdom and zeal that we expect it to render services to knowledge of the highest character, and we are glad to be the guests of a city and of institutions which are contributing so nobly to the cause of science.

We may congratulate ourselves on the bright prospects of the Association. Our membership has grown rapidly, and ought soon to exceed four thousand. Every member should endeavor to secure new adherents. For our next meeting we are to break with the long tradition of summer gatherings and assemble instead at New Year's time, presumably at Washington. To render this possible it was necessary to secure the cooperation of our universities, colleges and technical schools to set aside the week in which the first of January falls as "Convocation Week" for the meetings of learned societies. The plan, owing to the cordial and almost universal support given by the higher educational institutions, has been successfully carried through. For the winter meetings we have, further, succeeded in securing the cooperation of numerous national societies. The change in our time of meeting is an experiment, which we venture upon with the greater confidence because of the success of our present meeting in Pittsburg.

For my address this evening I have chosen the theme, "The Problem of Consciousness in its Biological Aspects." I hope both to convince you that the time has come to take up consciousness as a strictly biological problem, and also to indicate the nature of that problem and some of the actual opportunities for investigating it. It is necessary to begin with a few words on the philosophical interpretation. We shall then describe the function of consciousness in animal life, and consider its part in the evolution of animals and of man. The views to be stated suggest certain practical recommendations, after presenting which I shall conclude by offering an hypothesis of the relation of consciousness to matter and force.

Consciousness is at once the oldest problem of philosophy and one of the youngest problems of science. The time is not yet for giving a satisfactory definition of consciousness, and we must first content ourselves with the decision of the metaphysician, who postulates consciousness as an ultimate datum or concept of thought, making the brief dictum *cogito, ergo sum* the pivot about which his system revolves. I have endeavored vainly to discover, by reading and by questioning those philosophers and psychologists whom I know, some deeper analysis of consciousness, if possible, resolving it into something more ultimate.

Opinions concerning consciousness are many, and often so diverse as to be mutually exclusive, but they may be divided into two principal classes. The first class includes all those views which make of consciousness a real phenomenon, the second those views which interpret it as an epiphenomenon. We are, I think, practically all agreed that the fundamental question is, Does or does not consciousness affect directly the course of events? Or stated in other words, Is consciousness a true cause? In short, we encounter at the outset the problem of free-will, of which more later.

The opinion that consciousness is an epiphenomenon has gained renewed prominence in recent times, for it is, so to speak, a collateral result of that great movement of European thought which has culminated in the development of the doctrine of monism. Monism itself is postulated chiefly upon the two greatest discoveries of the nineteenth century, the law of the conservation of energy and the law of the evolution of species. Both laws establish a greater unity in the phenomena of the universe than mankind had previously been able to accept. In the physical world, instead of many forces we now recognise only one force,¹ which assumes various forms of energy, and in the living world it recognises one life, which manifests itself in many types of form. With these two unities in mind, what could be nearer than the thought that the unity goes still deeper,

¹ Force is used throughout this address as more likely to be understood by a general audience. It would be more correct to use "energy" in the sense in which the word is now applied technically in physics.

and that the phenomena of the inanimate or physical and of the living world are fundamentally identical? The progress of physiological science has greatly increased the impetus towards the adoption of this thought as the cardinal dogma of the new faith, because the work of physiologists has been so devoted to the physical and chemical phenomena of life that the conviction is widespread that all vital phenomena are capable of a physical explanation. Assuming that conviction to be correct, it is easy to draw the final conclusion that the physical explanation suffices for the entire universe. As to what is, or may be, behind the physical explanation, complete agnosticism is, of course, the only possible attitude. Such in barest, but I believe correct, outline is the history of modern monism, the doctrine that there is but one kind of power in the universe.

It is evident that monism involves the elimination of two concepts, God and consciousness. It is true that monists sometimes use these words, but it is mere jugglery, for they deny the concepts for which the words actually stand. Now consciousness is too familiar to all men to be summarily cast aside and dismissed. Some way must be found to account for it. From the monistic standpoint there is a choice between two possible alternatives, either consciousness is a form of energy, like heat, &c., or it is merely a so-called epiphenomenon. As there is no evidence that consciousness is a form of energy, only the second alternative is in reality available, and in fact has been adopted by the monists.

It is essential to have a clear notion of what is meant by an epiphenomenon. Etymologically the word indicates something which is superimposed upon the actual phenomenon. It designates an accompanying incident of a process, which is assumed to have no causal relation to the further development of the process. In practice it is used chiefly in regard to the relation of the mind or consciousness to the body, and is commonly employed by those philosophers who believe that consciousness has no causal relation to any subsequent physiological process.

For many years I have tried to recognise some actual idea underneath the epiphenomenon hypothesis of consciousness, but it more and more seems clear to me that there is no idea at all, and that the hypothesis is an empty phrase, a subterfuge, which really amounts only to this: we can explain consciousness very easily by merely assuming that it does not require to be explained at all. Is not that really the confession made by the famous assertion that the consciousness of the brain no more requires explanation than the aequosity of water?

Monism is not a strong system of philosophy, for it is not so much the product of deep and original thinking as the result of a contemporary tendency. It is not the inevitable end of a logical process, because it omits consciousness, but rather an incidental result of an intellectual impulse. Its very popularity betokens its lack of profundity, and its delight in simple formulae is characteristic of that mediocrity of thought which has much more ambition than real power and accepts simplicity of formulae as equivalent to evidence. It would seem stronger, too, if it were less defended as a faith. Strong partisans make feeble philosophers.

Consciousness ought to be regarded as a biological phenomenon, which the biologist has to investigate in order to increase the number of verifiable data concerning it. In that way rather than by speculative thought is the problem of consciousness to be solved, and it is precisely because biologists are beginning to study consciousness that it is becoming, as I said in opening, the newest problem of science.

The biologist must necessarily become more and more the supreme arbiter of all science and philosophy, for human knowledge is itself a biological function, which will become comprehensible just in the measure that biology progresses and brings knowledge of man, both by himself and through comparison with all other living things. We must look to biologists for the mighty generalisations to come rather than to the philosophers, because great new thoughts are generated more by the accumulation of observations than by deep meditation. To know, observe. Observe more and more, and in the end you will know. A generalisation is a mountain of observations; from the summit the outlook is broad; the great observer climbs to the outlook while the mere thinker struggles to imagine it. The best that can be achieved by sheer thinking on the data of ordinary human experience we have already as our glorious inheritance. The principal contribution of science to human progress is the recognition of the value of accumulating data, which are found outside of ordinary human experience.

Twenty-three years ago, at Saratoga, I presented before the meeting of this Association—which I then attended for the first time—a paper "On the Conditions to be Filled by a Theory of Life," in which I maintained that before we can form a theory of life we must settle what are the phenomena to be explained by it. So now, in regard to consciousness, it may be maintained that for the present it is more important to seek additional positive knowledge than to hunt for ultimate interpretations. We welcome, therefore, especially the young science of experimental psychology, which, it is gratifying to note, has made a more auspicious start in America than in any other country. It completes the circle of the biological sciences. It is the department of biology to which properly belongs the problem of consciousness. The results of experimental psychology are still for the most part future. But I shall endeavour to show that we may obtain some valuable preliminary notions concerning consciousness from our present biological knowledge.

We must begin by accepting the direct evidence of our own consciousness as furnishing the basis. We must, further, accept the evidence that consciousness exists in other men essentially identical with the consciousness in each of us. The anatomical, physiological and psychological evidence of the identity of the phenomena in different human individuals is to a scientific mind absolutely conclusive, even though we continue to admit cheerfully that the epistemologist rightly asserts that no knowledge is absolute, and that the metaphysician rightly claims that *ego* is the only reality and everything else exists only as *ego's* idea, because in science, as in practical life, we assume that our knowledge is real and is objective in source.

For the purposes of the following discussion we must define certain qualities or characteristics of consciousness. The most striking distinction of the processes in living bodies, as compared with those in inanimate bodies, is that the living processes have an object—they are teleological. The distinction is so conspicuous that the biologist can very often say *why* a given structure exists or *why* a given function is performed, but *how* the structure exists or *how* the function is performed he can tell very imperfectly—more often not at all. Consciousness is only a particular example, though an excellent one, of this peculiarity of biological knowledge; we do not know what it is; we do not know how it functions; but we do know why it exists. Those who are baffled by the elusiveness of consciousness, when we attempt to analyse it, will do well to remember that all other vital phenomena are in the last instance equally and similarly elusive.

In order to determine the teleological value of consciousness we must endeavour to make clear to ourselves what the essential function is which it performs. As I have found no description or statement of that function which satisfied me, I have ventured, perhaps rashly, to draw up the following new description:—

The function of consciousness is to dislocate in time the reactions from sensations.

In one sense this may be called a definition of consciousness, but inasmuch as it does not tell what consciousness is, but only what it does, we have not a true definition, but a description of a function. The description itself calls for a brief explanation. We receive constantly numerous sensations, and in response to these we do many things. These doings are, comprehensively speaking, our reactions to our sensations. When the response to a stimulus is obviously direct and immediate, we call the response a reflex action; but a very large share of our actions are not reflex, but are determined in a far more complicated manner by the intervention of consciousness, which may do one of two things, first, stop a reaction, as, for example, when something occurs calling, as it were, for our attention and we do not give our attention to it; this we call conscious inhibition; it plays a great *role* in our lives, but it does not mean necessarily that inhibited impressions may not survive in memory and at a later time determine the action taken; in such cases the potential reaction is stored up. Second, consciousness may evoke a reaction from a remembered sensation and combine it with sensations received at other times. In other words, consciousness has a selective power, manifest both in choosing from sensations received at the same time and in combining sensations received at different times. It can make synchronous impressions dyssynchronous in their effects, and dyssynchronous impressions synchronous. But this somewhat formidable sentence merely paraphrases our original description:—The function of consciousness is to dislocate in time the reactions from sensations.

This disarrangement and constant rearrangement of the sensations, or impressions from sensations, which we gather, so that their connections in time are altered, seems to me the most fundamental and essential characteristic of consciousness which we know. It is not improbable that hereafter it will become possible to give a better characterisation of consciousness. In that case the opinion just given may become unsatisfactory and have to yield to one based on greater knowledge. The characteristic we are considering is certainly important, and so far as the available evidence goes it belongs exclusively to consciousness. Without it life would have no interest, for there would be no possibility of experience, no possibility of education.

Now the more we have learned about animals, the better have we appreciated the fact that in them only such structures and functions are preserved as are useful or have a teleological value. Formerly a good many organs were called rudimentary or vestigial, and were supposed to be useless survivals because they had no known function. But in many cases the functions have since been discovered. Such, for example, were the pineal gland, the pituitary body, the suprarenal capsules and the Wolffian body of man, all of which are now recognised to be functionally important structures. Useless structures are so rare that one questions whether any exist at all, except on an almost insignificant scale. It has accordingly become well-nigh impossible for us to imagine consciousness to have been evolved, as it has been, unless it had been biologically useful. Let us, therefore, next consider the value of consciousness from the standpoint of bionomics.¹

We must begin with a consideration of the nature of sensations and the object of the reactions which they cause. In the simpler forms of nervous action a force, usually, but not necessarily, external to the organism, acts as a stimulus, which causes an irritation; the irritation produces a reaction. Within the ordinary range of the stimuli to which an organism is subjected the reaction is teleological—that is, it tends to the benefit of the organism. A familiar illustration is the presence of food in the stomach, which produces a stimulus, the reaction to which is manifested by the secretion of the digestive fluid for the purpose of digesting the food. An organism might conceivably be maintained solely by this mechanism, in cooperation with the physical laws, which govern all matter. Life in such an organism would be a succession of teleological processes, essentially mechanical and regulated automatically by the organism. By far the majority of biologists regard plants as essentially conforming to this type of life. Whether they absolutely so conform we do not, of course, yet know.

A sensation involves the interpolation of consciousness between the stimulation and the reaction, and in consequence there is established the possibility of a higher order of adjustment to the external world than can be attained through the teleological reaction to a stimulus. This possibility depends upon the fact that the intervention of consciousness permits an adjustment in accordance, not merely with the immediate sensation, but also and at the same time in accordance with earlier sensations. Thus, for example, the child sees an object, and its reaction is to take hold of the object, which is hot and hurts the child. Later the child sees the object again, and its natural reaction is to take hold of it again; but the child now reacts differently because its consciousness utilises the earlier as well as the present sensation; the previous sensation is dislocated in time and fused with the present sensation, and a new reaction follows. No argument is necessary to establish the obvious conclusion that an organism which has consciousness has an immensely increased scope for its adjustments to the external conditions; in other words, consciousness has a very high value for the organism. It is unnecessary to dwell upon this conclusion, for it will be admitted by everyone, except, perhaps, those who start with the *a priori* conviction that consciousness is an epiphenomenon.

A sensation gives information concerning the external world. Perhaps science has achieved nothing else which has done so much to clarify philosophy as the demonstration that the objective phenomena are wholly unlike the subjective sensations. Light is a series of undulations, but we do not perceive the undulations as such, but as red, yellow and green, or, as we say, colours; the colours give us available information, and we use them as so many labels, and we learn that reactions to these labels may be

helpful or hurtful, and so we regulate our conduct. Objectively red, yellow and green do not exist. Similarly with the vibrations of the air, certain of which cause the sensation of sound, which is purely subjective. But the sound gives us information concerning our surroundings which we utilise for our teleological needs, although in nature, external to us, there is no sound at all. Similarly, all our other senses report to us circumstances and conditions, but always the report is unlike the external reality. Our sensations are symbols merely, not images. They are, however, biologically sufficient because they are constant. They are useful, not because they copy the external reality or represent it, but because, being constant results of external causes, they enable consciousness to prophesy or foresee the results of the reactions of the organism, and to maintain and improve the continual adjustment to the external reality.

The metaphysicians have for centuries debated whether there is any external objective reality. Is it too much to say that the biological study of consciousness settles the debate in favour of the view that the objective world is real?

Consciousness is not only screened from the objective world from which it receives all its sensations, but also equally from immediate knowledge of the body, through which it acts. As I write this sentence I utilise vaso-motor nerves, regulating the cerebral blood currents, and other nerves, which make my hand muscles contract and relax, but of all this physiological work my consciousness knows nothing, though it commands the work to be done. The contents of consciousness are as unlike what is borne out from it as they are unlike what is borne in to it.

The peculiar untruthfulness to the objective, which consciousness exhibits in what it gets and gives, would be perplexing were it not that we have learned to recognise in consciousness a device to secure better adjustment to external reality. For this service the system of symbols is successful, and we have no ground for supposing that the service would be better if consciousness possessed direct images or copies instead of symbols of the objective world.

Our sensory and motor organs are the servants of consciousness, its messengers or scouts, its agents or labourers, and the nervous system is its administrative office. A large part of our anatomical characteristics exists for the purpose of increasing the resources of consciousness, so that it may do its bionomic function with greater efficiency. Our eyes, ears, taste, &c., are valuable because they supply consciousness with data; our nerves, muscles, bones, &c., are valuable because they enable consciousness to effect the needed reactions.

Let us now turn our attention to the problem of consciousness in animals. The comparative method has an importance in biology which it has in no other science, for life exists in many forms, which we commonly call species. Species, as I once heard it stated, differ from one another with resemblance. The difference which resembles we term an homology. Our arm, the bird's wing, the lizard's front leg are homologous. The conception of homology, both of structure and of function, lies at the basis of all biological science, which must be and remain incomprehensible to any mind not thoroughly imbued with this conception. Only those who are deficient in this respect can fail to understand that the evidence is overwhelming that animals have a consciousness homologous with the human consciousness. The proof is conclusive. As regards at least mammals, I think we could safely say as regards vertebrates, the proof is the whole sum of our knowledge of the structure, functions and life of these animals.

As we descend the animal scale to lower forms there is no break, and therefore no point, in the descent where we can say, here animal consciousness ends and animals below are without it. It seems inevitable, therefore, to admit that consciousness extends far down through the animal kingdom, certainly at least as far down as there are animals with sense organs or even the most rudimentary nervous system. It is unsatisfactory to rely chiefly on the anatomical evidence for the answer to our query. We await eagerly results from psychological experiments on the lower invertebrates. A sense organ, however, implies consciousness, and since such organs occur among coelenterates we are led to assign consciousness to these animals.

The series of considerations which we have had before us lead directly to the conclusion that the development and improvement of consciousness has been the most important—really the dominant—factor in the evolution of the animal series. The

¹ And other organs in efferent relations to consciousness.

¹ A convenient term, recently gaining favour, for what might otherwise be called the economics of the living organism. Bionomics seems preferable to *ecology*, which some writers are adopting from the German.

sense organs have been multiplied and perfected in order to supply consciousness with a richer, more varied and more trustworthy store of symbols, corresponding to external conditions. The nervous system has grown vastly in complexity in order to permit a constantly increasing variety in the time dislocations of sensations. The motor and allied apparatus have been multiplied and perfected in order to supply consciousness with more possibilities of adjustment to external reality, which might be advantageous.

If we thus assign to consciousness the leading rôle in animal evolution we must supplement our hypothesis by another, namely, that conscious actions are primary, reflex and instinctive actions secondary; or in other words, that for the benefit of the organism conscious actions have been transformed into reflexes and instincts. Unfortunately, we must rely chiefly on future physiological and psychological experiments to determine the truth of this hypothesis. Its verification, however, is suggested by certain facts in the comparative physiology of the vertebrate nervous system, which tend to show that in the lower forms (amphibia) a certain degree of consciousness presides over the functions of the spinal cord which in mammals is devoted to reflex actions. Its verification is further suggested by the natural history of habits. As we all know, new actions are performed with difficulty, and slowly, but if often repeated they are soon easier and more rapid. If a given reaction to a sensation or group of sensations through consciousness is advantageous to the organism, and the environment is such that the sensation is often repeated, then a habit is formed, and the response becomes more rapid; and often in ourselves we see habits, which arose from conscious action, working almost without the participation of consciousness, and moreover working usefully, because rapidly. The usefulness of conscious reactions is that they are determined, not merely by the present sensation, but also by past sensations; but they have the defect that they are slow. We can readily understand that it would aid an organism to have the quicker reaction substituted, and we thus recognise a valid teleological reason for the replacement of conscious action by habits in the individual, by instincts in the race. The investigation of the evolution of reflexes and instincts is one of the important and most promising tasks of comparative psychology.

A frank, unbiased study of consciousness must convince every biologist that it is one of the fundamental phenomena of at least animal life, if not, as is quite possible, of all life. Nevertheless its consideration has barely a place in biological science, although it has long occupied a vast place in philosophy and metaphysics. If this address should contribute to a clearer appreciation of the necessity of treating consciousness as primarily a problem for biological research to solve, my purpose will be achieved. In an ideal world philosophers and men of science would be identical; in the actual world there are philosophical men of science and scientific philosophers; but in the main the followers of the two disciplines pursue paths which are, unfortunately, distinct. The philosophical mind is of a type unlike the scientific mind. The former tries to progress primarily by thought based on the data available, the latter seeks to advance primarily by collecting additional data. The consequence of this difference is that philosophy is dependent upon the progress of science, but we who pursue the scientific way can make no greater mistake than to underestimate philosophy. The warning is needed. Data of observation are a treasure and very precious. They are the foundation of our mental wealth, but that wealth consists of the thought into which the data are transmuted. In pleading, therefore, for an increased observational study of consciousness we plead, not merely for science, but equally for philosophy. The scientific progress must come first. Hence we urge the advantage of investigating consciousness in its immediate revelations, which are accessible now. Let us give up the ineffectual struggle to discover the essential nature of consciousness until we can renew it with much larger resources of knowledge.

The psychologists ought now to apply the comparative method on a grand scale. They are just beginning to use it. Years of patient labour must pass by, but the reward will be very great. The psychic life of animals must be minutely observed, the conditions of observation carefully regulated, and the results recorded item by item. The time has passed by for making generalisations on the basis of our common, vague and often inexact notions concerning the habits of animals. Exact experimental evidence will furnish a rich crop of psychological discovery. Scientific psychology is the most backward in its development of all the great divisions of biology. It needs,

however, little courage to prophesy that it will bring forth results of momentous importance to mankind. After data have been gathered, generalisations will follow which, it may be hoped, will lead us on to the understanding of even consciousness itself.

The teleological impress is stamped on all life. Vital functions have a purpose. The purpose is always the maintenance of the individual or of the race in its environment. The entire evolution of plants and animals is essentially the evolution of the means of adjustment of the organism to external conditions. According to the views I have laid before you, consciousness is a conspicuous, a commanding factor of adjustment in animals. Its superiority is so great that it has been, so to speak, eagerly seized upon by natural selection and provided with constantly improved instruments to work with. A concrete illustration will render the conception clearer. In the lowest animals, the cœlenterates, in which we can recognise sense organs, the structure of them is very simple, and they serve as organs of touch and of chemical sensation resembling taste. In certain jelly fishes we find added special organs of orientation and pigmented spots for the perception of light. In worms we have true eyes and vision. In vertebrates we encounter the true sense of smell. Fishes cannot hear, but in the higher vertebrates, that is from the amphibians up, there are true auditory organs. In short, both the senses once evolved are improved and also new senses are added. It is perfectly conceivable that there should be yet other senses, radically different from any we know. Another illustration, and equally forcible, of the evolution of aids to consciousness might be drawn from the comparative history of the motor systems, passing from the simple contractile thread to the striated muscle fibre, from the primitive diffuse nunculation of a hydroid to the highly specialised and correlated muscles of a mammal.

It is interesting to consider the evolution of adjustment to external reality in its broadest features. In the lowest animals the range of the possible adjustment is very limited. In them, not only is the variety of possible actions small, but they cover also a small period of time. In animals which have acquired a higher organisation, the adjustments are more complex both because the reactions are more varied and because they cover a longer period of time. Thus the jelly fish depends upon such food as happens to come within its reach, seizing from moment to moment that which it encounters; but a lobster pursues its food, making complicated movements in order to reach and seize it. One can trap lobsters easily; I doubt if one could trap a jelly fish at all. The next great advance is marked by the establishment of communication between individuals of the same species. About this phenomenon we know exceedingly little; the investigation of it is one of the most important duties of the comparative physiologist. Its bionomic value is obviously great, for it allows an individual to utilise the experience of another as well as its own. We might, indeed, compare it with the addition of a new sense, so greatly does it extend the sources of information. The communication between individuals is especially characteristic of vertebrates, and in the higher members of that subkingdom it plays a very great rôle in aiding the work of consciousness. In man, owing to articulate speech, the factor of communication has acquired a maximum importance. The value of language, our principal medium of communication, lies in its aiding the adjustment of the individual and the race to external reality. Human evolution is the continuation of animal evolution, and in both the dominant factor has been the increase of the resources available for consciousness.

In practical life it is convenient to distinguish the works of nature from the works of man, the "natural" from the "artificial." The biologist, on the contrary, must never allow himself to forget that man is a part of nature and that all his works are natural works. This is especially important for the present discussion, for otherwise we are likely to forget also that man is as completely subject to the necessity of adjustment to external reality as any other organism. From the biological standpoint, all the work of agriculture, of manufactures, of commerce and of government is a part of the work of consciousness to secure the needed adjustments. All science belongs to the same category as the teleological efforts of a jelly fish or lobster. It is work done at the command of consciousness to satisfy the needs of existence. The lesson of all this to us is that we should accustom ourselves to profit by our understanding of the trend of evolution, which, in the progress humanity makes, obeys the

same law of adaptation to objective reality which has controlled the history of animals. This view of the conditions of our existence puts science in its right place. As all sensations are symbols of external reality useful to guide organisms to teleological reactions, so is all science symbolic and similarly useful.

Nature never produces what to us seems a perfect organism, but only organisms which are provided with means of adjustment sufficient to accomplish the survival and perpetuation of the species. Man also is imperfect, but in the struggle for existence wins his way because his consciousness has greater resources than that of any other organism. His great power arises from his appreciation of evolution. His highest duty is to advance evolution, and this duty must be most strongly felt by those who accept the religious interpretation of life. The advancement of science is an obligation. To this view of the work of our Association I may safely claim the assent of all present.

The function of science is to extend our acquaintance with the objective world. The purpose of the American Association is not alone to increase the sum total of science, but equally also to preach by word and precept the value of truth, truth being the correct conscious symbol of the objective, by utilising which our purposeful reactions are improved. The most serious obstacle truth encounters is the prevalence of what I may call "doll ideas," by analogy with the material dolls with which children play. The child "makes believe" with the doll, knowing all the time its unreality, assigns to it hopes, passions, appetites; the child may feel the intensest sympathy with its doll, weep at its sorrows, laugh over its joys, yet know always that it is a mere inanimate, senseless doll. Adult men and women have ideas, with which they play make-believe; doll ideas, which they know are unreal, and yet they mourn sincerely over the adversities of their mental dolls, rejoice over their successes and fight for them with passion. Such doll ideas become mingled with the real and inextricably woven into the fabric of life. They are treated with the most earnest seriousness. Men will fight for them as a child will fight for its doll, not because it is property, but because it is sacred personality. So are doll ideas often made sacred and defended with fanaticism. Yet behind, in consciousness, is the sense of unreality, the disregarded admission of "making believe." Do not doll-ideas—pseudo-opinions—play a great rôle in human life? I think they do, and thinking so, deem it all the more imperative that you and others should teach the people the standard of science, the humble acknowledgment of reality. I wish an impulse towards this goal from our Association could be imparted to every man and woman in the country, and I hope the Association may continue to grow in number and power for long years to come, as it has grown in the last few years, so that it shall be a national, all-pervading influence serving the truth.

It seems to me inconceivable that the evolution of animals should have taken place as it actually has taken place, unless consciousness is a real factor and dominant. Accordingly, I hold that it actually affects the vital processes. There is, in my opinion, no possibility of avoiding the conclusion that consciousness stands in immediate causal relations with physiological processes. To say this is to abide by the facts, as at present known to us, and with the facts our conceptions must be made to accord.

The thought which I wish to emphasise is the importance for the future investigation of consciousness of separating the study of what it does from the study of what it is. The latter study is recondit, metaphysical, and carries us far beyond the limits of verifiable human knowledge. The former study is open to us and offers opportunities to science, but it has hitherto been almost completely neglected. Biology has now to redeem itself by effectual researches on consciousness. On the adequate prosecution of such researches we base great hopes.

Before I close, permit me a few words concerning the relations of consciousness to the body, to the living substance through which it manifests itself. It is intimately linked to protoplasm. Probably no question is so profoundly interesting to all mankind as the old question, What is the relation of the mind to the body? It is a question which has been stated in many forms and from many points of view, but the essential object of the question is always the same, to ask whether consciousness is a function of living matter or something discrete and not physical or material.

Throughout this address consciousness has been viewed as a device to regulate the actions of the organism so as to accomplish

purposes which on the whole are useful to the organism, and accordingly we have termed its function teleological. If this view is correct, it accounts for the limitations of consciousness, its mechanical mode of work, its precision and definiteness of action, for, of course, unless consciousness is orderly and obeys laws it cannot be of use to the organism, but, on the contrary, it would be harmful, and conscious animals would have ceased long ago to survive. The very fact that consciousness is of such high value in the bionomy of an animal renders it obvious that it must be subject to law. Accordingly it appears to us regulated as do the functions of protoplasm, hence to certain modern thinkers it presents itself as a function of protoplasm, or, as it may be better stated, as a state or condition of protoplasm.

The internal evidence of consciousness, however, is against this view and presents to us conscious actions as depending upon the consciousness. As before stated, I believe this evidence must be accepted. Now all the sensations of consciousness are derived from physical force, and all the acts of consciousness are manifested through physical force, hence if it has any real power consciousness must be able to change the form of energy. Unless we accept this doctrine we must give up all belief in free-will and adopt the automaton theory of life. Is not the more reasonable explanation that which is based upon all the contents of our consciousness rather than that which we can draw only by discarding the internal evidence which consciousness brings us? The hypothesis which I offer for your consideration is this:—

Consciousness has the power to change the form of energy, and is neither a form of energy nor a state of protoplasm.

By this hypothesis there are two fundamentally different things in the universe—force and consciousness. You ask why I do not say three, and add matter? My answer is that we do not have, and never have had, any evidence whatever that matter exists. All our sensations are caused by force, and by force only, so that the biologist can say that our senses bring no evidence of matter. The concept "matter" is an irrational transfer of notions derived from the gross molar world of the senses to the molecular world. Faraday long ago pointed out that nothing was gained and much lost by the hypothesis of material atoms, and his position seems to me impregnable. It would be a great contribution to science to kill off the hypothesis of matter as distinct from force.

To conclude, the universe consists of force and consciousness. As consciousness by our hypothesis can initiate the change of the form of energy, it may be that without consciousness the universe would come to absolute rest. Since I close with a bold speculation, let my last words recall to you that my text is:— Investigate consciousness by comparative observation. Only from observation can we know. Correct, intelligent, exhaustive observation is our goal. When we reach it, human science will be completed.

NOTES.

WE understand from recent Queensland newspapers that it has been determined to abolish the Weather Bureau of that colony as from the 30th ult., and that the services of Mr. C. L. Wiagge and his special staff have been dispensed with. In a letter addressed by the Premier of Queensland to the Federal Prime Minister it is pointed out that this apparently retrograde step is owing to the urgent necessity for reducing in every branch of the public service the estimates of expenditure of the State, and that it is one of the "most unfortunate" results of the large deficit in the revenue, brought about by drought and other causes. Prior to federation, the Weather Bureau formed part of the Post and Telegraph Department of Queensland, and all telegrams and correspondence passed free. But during the last fifteen months the Federal Government has charged for these communications at the rate of about 4000*l.* a year, which expense cannot be borne any longer by the Queensland Government. The Premier writes that he feels sure the States in general will welcome any reasonable suggestions for a continuance of the work of the Bureau under federal control; we may therefore hope that the existing instruments and stations will be utilised, as far as practicable, in the interest of meteor-

logical science. Truly the Colonies are in this respect following the mother country, and we may soon expect the Empire, so active in neglecting science, to be the laughing stock of civilised peoples.

THE Copenhagen correspondent of the *Times* reports that the International Conference for Biological and Hydrographical Research, the object of which is to promote ocean research for fishery purposes, was opened there on July 22. Dr. Deutzer, Danish Foreign Minister, welcomed the delegates, who represented Great Britain, Sweden, Norway, Finland, Russia, Holland, Germany and Denmark. In reply to Dr. Deutzer's welcome, the British delegate, Sir Colin Scott-Moncrieff, expressed the thanks of the delegates, who, he declared, earnestly hoped that their labours would have fruitful results. Herr Herwig, the German delegate, was elected president of the conference.

It is stated that Prof. Virchow, who is now staying at Harzburg, is obliged to keep to his room owing to general weakness. His condition is causing uneasiness among his friends.

THE *British Medical Journal* announces that the King of Italy has given 10,000 lire to the Italian Red Cross Society in aid of the campaign against malaria in the Campagna this season. Prof. Postempski will, as formerly, act as director of the medical service organised under the auspices of the Society.

MR. E. B. BAILEY has been appointed a geologist on the Geological Survey of Scotland.

THE death is announced of Prof. Gerhardt, the well-known authority on diseases of the lungs and children's diseases, at his estate of Damberg, in Baden. Prof. Gerhardt, who was born in 1833, held professorships at Jena, Würzburg and Berlin, and was the author of several important medical works.

MR. BENJAMIN MARTELL, whose death we regret to see announced, for more than thirty years played a prominent part in the many important changes which have taken place during that period in connection with the development of ship construction in this country. He was born in 1825, and trained at Portsmouth Dockyard, where he served his time as an apprentice. He joined Lloyd's Register Society in 1856, and in sixteen years, after serving the Society at several of the important ship-building centres in the country, was called to the position of chief surveyor, which he held until his retirement in 1899. The tables of freeboard prepared by Mr. Martell, and afterwards placed upon the Statute Book, represent the results of one of the many pieces of work which he successfully carried out for the good of the shipping community.

WE regret to announce the death of Prof. V. Safarik (Schafarik) at the mature age of seventy-three, which took place at Prague on July 2. Prof. Safarik became professor of chemistry in the Bohemian Polytechnicum in 1868. In 1882 he was appointed professor of chemistry in the Bohemian University and in 1892 professor of descriptive astronomy, from which post he retired in 1896. In the fifties and sixties of last century he published several papers in organic chemistry (specific volumes, vanadium, platino-cyanides, &c.), and his last chemical paper was on the constitution of natural silicates, in 1872. Later on he devoted himself to astronomical investigations, which he carried out in his private observatory, and his work on the surfaces of planets, variable stars, &c., is well known to astronomers. He was an adept at grinding and polishing metallic and glass mirrors for reflectors and in silvering the latter. He attended the Bradford meeting of the British Association in 1873, and from that time was often in communication with several leading

British astronomers. Those who knew Prof. Safarik personally could not but admire his very wide, almost universal knowledge; indeed, he was one of the last polyhistorians of the Alexander Humboldt school, whose work he translated into the Bohemian language. He has left behind a long series of astronomical observations, which he was prevented by ill-health from publishing.

At the meeting of the London County Council on Tuesday, the Technical Education Board reported the result of the inquiry by a special subcommittee of the Board as to the need and present provision for special training of an advanced kind in connection with the application of science (especially chemistry and electricity) to industry, and as to what, if any, developments are needed to secure efficient training in these subjects for senior county scholars and other advanced students who desire to qualify themselves to take leading positions in scientific industries. The report of the special subcommittee deals with matters which the Board points out are of great importance to the present and future prosperity of various English industries, notably some connected with London. The members of the special committee came, without a dissentient voice, to the conclusions (1) that England (and London in particular) has suffered the loss of certain industries and that others are in danger; (2) that this loss has been largely due to defective education, especially in the higher grades; and (3) that London is still seriously behind other cities, notably Berlin, in the provision for the higher grades of scientific training and research. The report was accepted, with the addition of the recommendation "that the Technical Education Board be instructed to report as to the steps it proposes to take in order to give practical effect to the suggestions contained in the report."

GRANTS in aid of the following researches were made at a recent meeting of the Board of Trustees of the Elizabeth Thompson Science Fund:—150 dollars to Prof. H. E. Crampton, Columbia University, New York, for experiments on variation and selection in Lepidoptera. 100 dollars to Dr. F. W. Bancroft, University of California, Berkeley, Cal., for experiments on the inheritance of acquired characters. 125 dollars to Dr. J. Weinzirl, University of New Mexico, Albuquerque, N. Mex., for investigation of the relation of climate to the cure of tuberculosis, it being agreed that if the work justifies it the same amount will be granted next year. 300 dollars to Prof. H. S. Grindley, University of Illinois, Urbana, Ill., for investigation of the proteids of flesh. 300 dollars to Dr. H. H. Field, Zürich, Switzerland, to aid the work of the concilium bibliographicum. 250 dollars to Prof. T. A. Jagger, Harvard University, Cambridge, Mass., for experiments in dynamical geology, provided the secretary receives the necessary assurance that the work can be undertaken with reasonable promptitude. 50 dollars to Dr. E. O. Jordan, University of Chicago, Chicago, Ill., for the study of the bionomics of *Anopheles*. 300 dollars to Dr. E. Anding, München, Bavaria, to assist the publication of his work "Ueber die Bewegung der Sonne durch den Weltraum," but the grant is conditional upon other means being also secured by the author sufficient to accomplish the publication. 300 dollars to Prof. W. P. Bradley, Wesleyan University, Middletown, Conn., for investigations on matter in the critical state. 300 dollars to Prof. Hugo Knoecker, Bern, Switzerland, for assistance in preparing his physiological researches for publication. 300 dollars to Prof. W. Valentiner, Grossh, Sternwarte, Heidelberg, Germany, to continue the work of Grant No. 93 (observations on variable stars).

It is reported that a storm of unusual violence, accompanied by torrential rain and a heavy hail shower, broke over the city of Kieff on July 20. A violent cyclone passed over Chalon-sur-Saône on July 15 between 6 p.m. and 7 p.m., blowing down

chimneys and trees and sinking several vessels on the River Saône.

We learn from the *Times* that news has been received of a severe earthquake shock at Bandar Abbas on July 9. It commenced at half-past seven in the morning and lasted three or four minutes. All the chief buildings suffered. The Governor's house partly collapsed, while the Customs office was destroyed. The shocks continued in the Persian Gulf on July 9 and 10, and apparently proceeded from Kishm Island. Loud noises at Kishm were distinctly audible at Bandar Abbas. It is feared that the destruction at Kishm is considerable. No further information is available. A few years ago an earthquake at Kishm destroyed hundreds of people. The whole population of Bandar Abbas has flocked to the sea-beach for safety.

A MESSAGE from the Geneva correspondent of the *Daily Chronicle*, dated July 14, says:—A luminous haze has attended the sunsets lately, as if the whole of the west of Switzerland was on fire and the flames reflected in the sky. Swiss men of science attribute this to the presence of fine dust or ashes in the upper currents of air, and are of opinion that this dust has been carried across the Atlantic from Mont Pelée by air currents. This supposition is given support by the news that after a shower of rain at Frauenfeld, in Canton Thurgau, the ground was covered with a thin layer of ashes of greyish-blue colour.

A TELEGRAM from Kingstown, St. Vincent, states that on Thursday last, July 17, several shocks of earthquake were felt there, a terrific shock being experienced at a quarter to ten in the morning, accompanied by a loud rumbling explosive sound like thunder. The worst shock lasted only ten seconds. The shocks were probably caused by explosions of subterranean gas or steam. A few days ago it was reported that the saddle between the two craters of the Soufrière had collapsed, throwing thousands of cubic feet of sand, scorée and rock into the funnel of the Soufrière, thus blocking the throat of the crater. In consequence of this, it is suggested that the gas and steam, failing to find any outlet by the throat or funnel of the mountain, caused internal explosions and severe concussions. A *Times* message from St. Thomas states that a severe earthquake was felt in St. Vincent on July 22 at 1.15 in the morning. The shocks were local, and seem to have been confined to a certain area of which Kingstown and its vicinity were apparently the centre.

It would seem to be the universal belief that volcanic ash has very fertilising qualities, and Prof. d'Albuquerque's contrary view, as a result of the first examination of the St. Vincent ash which fell at Barbados early in May last, was generally regarded with suspicion. The latest number of the *West Indian Agricultural News* contains an interesting paragraph on the subject. Analyses by different authorities in the West Indies and in England showed conclusively, as Prof. Harrison said, "that the volcanic dust was quite valueless as a manure—the value of the soluble constituents being about three cents." Owing to the copious rains that fell in Barbados immediately after the dust, causing a sudden bursting of leaf and flower on plants that had previously been parched by drought, a popular idea was fostered that the dust was, more or less, of a fertilising character. It is believed, probably on good grounds, that it was useful in destroying the small black ants common in the island, and in drying up the egg-clusters of the moth-borer then on the leaves of the sugar-cane.

MR. H. HESKETH BELL, Administrator of Dominica, has a long letter in Tuesday's *Times*, in which he shows that the effects of the recent volcanic eruptions in Martinique and St. Vincent have been greatly exaggerated in many reports. No attempt is made to minimise the disaster, but only to show that the area involved in it is comparatively small. Even estimating the devastated

area in Martinique at fifty square miles, there still remain more than 300 square miles in that island that are practically in exactly the same condition as they were in the day before the eruption. With the exception of the blasted triangle on the western slope of Pelée, the whole colony is still dotted with plantations, homesteads and villages. St. Vincent has also suffered, but there are still 43,000 colonists in the island. No other islands have been affected. Although, as has correctly been stated, many of the Leeward and Windward Islands possess craters and volcanic cones, there has so far not been in any of them the slightest sympathetic activity with the outbursts in Martinique and St. Vincent. The fall of volcanic dust that has been noticed in many of the islands has simply been a harmless phenomenon, and, so far as sympathetic volcanic agency may be concerned, it is said that the islands might just as well have been thousands of miles away from the affected craters. Dominica is in precisely the same prosperous condition that it was in the day before the eruptions at Martinique and St. Vincent. Although barely forty miles distant from Pelée and near enough for the inhabitants to hear the detonations, Mr. Bell says the island has been absolutely unaffected by the recent outburst. The hot springs and geysers have remained in their normal condition, and, with the exception of one slight shock of earthquake felt by a few persons, there has not been any seismic disturbance. Even the shower of powdered scorée that fell on May 11 was so slight that its presence could only be detected on the surface of palm-leaves and other large foliage.

A CORRESPONDENT sends us from Bath a drawing of a rather curious development of a foxglove (*digitalis*). The plant represented was similar to any ordinary foxglove, with the exception that the terminal flower of each inflorescence was not a foxglove blossom, but a Canterbury bell (*campanula*). This flower, from an external view, looked like any normal Canterbury bell; the stamens, however, were eight in number and similar to those of the foxglove, while the pistil was somewhat like that common to the foxglove. A botanist to whom we submitted the drawing and description tells us he obtained a photograph of the same kind of flower some years ago, and upon inquiry he found that the anomaly is fairly frequent and well known. The combination of two flowers other than the foxglove and *campanula*, if it occurs, would, however, be worth recording. The specimen from which the photograph mentioned was taken grew in a semi-wild garden in Surrey not far from London.

THE use of oxygen inhalers in connection with high balloon ascents was mentioned last week (p. 279). On the occasion of the last Aeronautical Congress held at Berlin, a report on the inhalation of oxygen was presented, and the subject has also occupied the attention of the *Société française de Navigation aérienne*. The July number of the *Aeronautical Journal* contains a report of a lecture delivered by Dr. Siring before this Society upon his ascent with Dr. Berson on July 31, 1901, when the height of 10,500 metres was reached. It was pointed out that as to the physiological side of the question, on closely studying foreign and German ascents, three stages may be distinguished. During the first of these stages the excitement exceeds considerably the phenomena of height-sickness proper, resulting from want of oxygen. In such a state of excitement, one does not know, perhaps, the real state of the height-sickness, and this naturally becomes an exceedingly critical matter when the dangers of a mishap become imminent. The regrettable issue of the *Zenith* expedition in the year 1874 is no doubt to be traced to this, to a large extent at any rate. The second and more dangerous stage is that of confusion. By systematically inhaling oxygen, this state of excitement leading to confusion and imminently dangerous conduct can be warded off by

astronauts of ordinarily cool disposition; whereas it is evident that a state of enervation with signs of relaxation cannot be completely prevented. Notes are illegibly written in the wrong place, the eyes refuse their services, the slightest exertion results in a dangerous weakness, and, finally, the whole organism falls a victim to an inevitable need for sleep. But, also these illnesses may yet be overcome to a certain extent if greater precautions are taken in future ascents, if the astronaut avoids all exertions, all excitement, sleeps sufficiently, undergoes a still more systematic inhaling of oxygen, begins earlier with it and protects himself sufficiently against cold.

PERHAPS the most singular statement in the Meteorological Office pilot chart for the month of August is that relating to the appearance, early in July, of a fairly large ice floe, 40 feet by 15 feet and a foot out of water, off the west of Scotland, close inshore on the Treshnish Islands, on the west side of Mull, and only a few miles from Tobermory. From other sources it appears that the fishermen who saw it could not be mistaken, as they sailed within 20 feet of the floe. It was reported by independent observers on two days. There can be little doubt that it was the remains of one of the icebergs which had for some time been infesting the coast of Iceland, but it would be interesting to trace its movements southward. Off Mull it was travelling in a north-easterly direction, so it is reasonable to suppose that it had at first drifted southward outside the Hebrides before the northerly winds which prevailed so long earlier in the season. While we have had this quite exceptional circumstance on our side of the Atlantic, the ice record about the Newfoundland banks remains almost blank. Three or four observers report a berg in about 45° N., 49° W., and there was one in 42° 40' N., 47° 30' W. The strait of Belle Isle had been clear of ice until about the end of June, but early in July several bergs had drifted in past Belle Isle. There was, however, nothing like the usual quantity at this time of the year, and shipmasters appear to have seen nothing of the heavy ice of a month earlier, which was reported to block the approaches to the strait. This freedom from ice probably explains the excess in the temperature of the sea surface on the banks and over an extensive region eastward and westward during the month of May last, the results of which, derived from 4400 observations, are shown on an inset chart.

AN interesting review of recent work in wireless telegraphy is commenced in *L'Eclairage Électrique* for July 5. The article is by M. Turpain, himself a worker in this field. It is noteworthy that the author is unable to credit Mr. Marconi's having succeeded in signalling across the Atlantic, and attributes the signals received at Newfoundland to atmospheric effects. No reference to the later experiments on the *Philadelphia* is made. M. Turpain also quotes evidence to show that the successful solution of the syntony problem has not as yet been found by Mr. Marconi. Prof. Slaby's system and the experiments with a repeater made by M. Guarini are also described in this instalment.

THE *Journal de Physique* for June contains an article by M. Armagnat on the study of resonance by means of oscillographs. The paper deals with the subject both theoretically and experimentally. The method has been devised because the wave forms obtained by means of an oscillograph, or other wavetracing instrument, are not accurate enough to allow of the harmonics being found by means of graphical analysis. Two oscillographs are used, one in series with a non-inductive resistance tracing the wave-form under examination; the other is in series with a variable self-induction and capacity which are altered until the different harmonics are resonated and traced on the screen. The paper is illustrated by some interesting curves

obtained in this manner, one of which shows how the method may be used to measure the irregularities in the speed of an alternator.

In the "Verhandelingen der Koninklijke Akademie van Wetenschappen te Amsterdam (Tweede Sectie)," Deel ix. pp. 1-12, Dr. P. H. Eykman has published an interesting paper describing a method for obtaining a Röntgen photograph of an internal part of the living body during the performance of a definite functional movement. The author applies the method to the investigation of the motion of the tongue, pharynx and larynx in swallowing. He fixes a contact on the Adam's apple, the motion of which closes the current which feeds the Röntgen tube at a perfectly definite moment during the motion. The motion has to be repeated 120 or 130 times with the contact in exactly the same position in order to obtain a distinct photograph. Other photographs of different phases of the motion are obtained by altering the position of the contact. The photographs are good considering the difficulties of the experiment and throw a welcome light on the position of the epiglottis and on the condition of the upper opening of the larynx during the act of deglutition.

ALCOHOL as a motive power has formed an interesting set of experiments in France at the present time, the object being to produce a home-made substitute for petrol, which all has to be imported. According to *Feilden's Magazine* for July the results obtained are of a satisfactory nature, both for the heavier and lighter types of cars, and it is stated that passenger cars driven by alcoholic traction have been proved to hold their own against those with petrol as a motive power. The price of alcohol at present is higher, but by the use of beet-root in its manufacture its market value has been greatly reduced. The experiments showed that the amount of alcohol consumed by the engines (which were designed to burn petrol) was 50 per cent. higher than that of petrol, but it is stated that with engines properly constructed to use the new motive power this difference would be greatly reduced, and should this be the case it will form a home-made motor-car spirit to replace the imported article. Attention is also directed to the ease with which it can be prepared from potatoes, and consequently, on account of its general utility for heating, lighting, &c., it would seem that an opportunity is open for Ireland to create a most important industry.

MR. M. L. SYKES has favoured us with a copy of his paper on the evolution of butterfly-scales, published in the *Report and Transactions of the Manchester Microscopical Society for 1901*. The illustrations show that the scales of butterflies which mimic other species are generally quite different in form from those of the species mimicked.

ACCORDING to a photograph, taken from a living example, of which a reproduction is given by Dr. Jentink in *Notes from the Leyden Museum for July*, the form given to the nose in mounted specimens and figures of the proboscis-monkey of Borneo is quite incorrect. Instead of being sharply pointed, compressed, and projecting straight forwards, this appendage is expanded and depressed at the extremity, which hangs down in front of the upper jaw so as to conceal the greater part of the mouth in a full-face view.

MARINE fish-destroyers form the subject of an article by Prof. W. C. McIntosh in the May number of *Harper's Magazine*, in the course of which the chief types of extinct and living marine monsters destructive to sea-fish are described and illustrated. The author considers that such destroyers have done much more harm than man to food-fishes, and suggests that little good is done by regulations for controlling sea-fisheries.

Whether he is justified in classing the freshwater labyrinthodonts as marine fish-destroyers may be open to question; and his statement that the American Devonian fish *Dinichthys* occurs in the English "Old Red" does not appear to rest on good foundation. Why he should say that plesiosaurs "continued to the Mesozoic" is hard to understand; and his estimate of the size of the dinosaurian *Atlantosaurus* (100 feet long and 30 feet high) appears a gross exaggeration.

To the *Notes* from the Leyden Museum Dr. R. Horst contributes some remarks on the habits of the coconut-crab, based upon observations made on captive specimens at Batavia and living examples near Bantam by Mr. C. P. Sluiter. Recently some doubts have been expressed as to whether it is in the habit of ascending palm-trees. Mr. Sluiter has, however, seen these crabs climb to the top of mangrove-trees and palms fully 60 feet in height. What they did when at the top he was unable to ascertain, but, from observations made on captive specimens, he considers it probable that they were engaged in opening young coconut-nuts and devouring their contents. Whether they have the power of opening ripe cocoanuts could not be determined, the specimens under observation merely fumbling such as were given them without attempting to penetrate the shell.

At the conclusion of a memoir on the structure of the retina of the eye, published in the *Quarterly Journal of Microscopical Science* for July, Mr. H. M. Bernard states that this structure can no longer be regarded as being built up of a number of distinct cells, each of which possesses distinct and definite functions. On the contrary, if distinct cells ever exist, their walls must be broken down at a very early stage of development. In technical terms, the retina is a continuous cytoplasmic reticulum containing non-stationary embedded nuclei. The other papers in the same serial include one by Mr. H. J. Fleure on the relations of the kidneys in *Haliotis*, and a second, by Miss I. Drummond, on the development of *Paludina*.

In most seismographs, the records are made on a sheet of glass or strip of paper which is either set in motion by an earthquake or has an ordinarily slow velocity increased at a somewhat advanced phase of the shock. In either case the interesting preliminary tremors are more or less completely lost. During the last three years, however, Dr. Cancani has avoided this loss by keeping the strip of paper continuously moving at the rate of six metres an hour. This velocity he has shown to be sufficient to decipher vibrations with a period of one-twentieth of a second and therefore above the lower limit of audibility. In a paper recently published (*Boll. Soc. Scivol. Ital.*, vol. vii. pp. 292-298), he maintains that even this velocity may be conveniently increased to one ten times as great and therefore capable, so far as speed is concerned, of registering the vibrations of earthquake-sounds occurring at the rate of 200 per second.

A WORTHY notice of the life and scientific work of the late Prof. P. G. Tait is contributed to the *Physical Review* (July) by Mr. A. Macfarlane, and is accompanied by a portrait of Tait printed in photogravure on plate paper.

MESSRS. CROSBY LOCKWOOD AND SON have ready for publication a volume entitled "Aerial Navigation," by Mr. Frederick Walker, dealing with the construction of dirigible balloons and other flying-machines; and another on the "Elements of Agricultural Geology," by Mr. P. McConnell.

In the abstract of the paper on refractive indices by Mr. J. W. Gifford, published in *NATURE* of July 17 (p. 287), line 12 reads, "The difference of the angles of the prisms from 60° were in each case less than 4 seconds of arc." Mr. Gifford informs us he should have said, "less than 4 minutes of arc."

An interesting essay on "Clouds and Weather Signs," by Commander D. Wilson-Barker, has been reprinted from *Knowledge* and issued as an illustrated brochure. The pictures of clouds which the publication contains are exceptionally fine, and the descriptions of them should be the means of increasing the number of scientific observers of cloud phenomena.

In the article on "Some New Forms of Geodetical Instruments" which appeared in last week's *NATURE*, it should have been mentioned that the illustrations of the instruments were from Sir Howard Grubb's paper in the *Transactions* of the Royal Dublin Society (vol. vii. No. 15). We are indebted to the Society for the use of the illustrations.

THE firm of Gustav Fischer, Jena, has begun the publication, in parts, of a new edition of the attractive work on deep-sea exploration entitled "Aus den Tiefen des Weltmeeres," by Prof. C. Chun. Although the original volume was remarkable for the large number of interesting and beautiful pictures, the second edition will contain many new illustrations. The work is one of five which are used as the text for an interesting essay on the methods and results of deep-sea investigations, in the current number of the *Quarterly Review*.

AN excellent series of lecture experiments illustrating different types of catalytic reactions is described by Messrs. Noyes and Sammet in vol. xli. of the *Zeitschrift für physikalische Chemie* (pp. 11-27). For convenience, catalysators are divided into seven classes, namely, carriers, absorbent contact-substances, electrolytic contact-substances, water, dissolved electrolytes, enzymes and inorganic colloid substances, and by means of the simple experiments described, the catalytic function of substances belonging to any one of these classes in increasing the velocity of chemical change can be demonstrated to an audience in a very satisfactory manner.

AN investigation of the rate of hydrolysis of sulphonic acid esters, published by R. Wegscheider in vol. xli. of the *Zeitschrift für physikalische Chemie*, has shown that this phenomenon is very different in character from that observed with the ordinary carboxylic esters. Whilst the latter are hydrolysed much more rapidly by solutions of acids than by pure water, the hydrogen ion of the acids being supposed to act as a catalytic agent, the hydrolysis of sulphonic acid esters is scarcely accelerated at all by acids. A further study of this subject would no doubt afford valuable information with regard to the essential difference between these two classes of acids.

TO the numerous syntheses effected by means of the magnesium alkyl halogen compounds it is to be added an extremely elegant method of passing up the series of carboxylic acids. Messrs. Houben and Kesselkaul, in the current number of the *Berichte*, describe the synthesis of carboxylic acids by means of the action of carbon dioxide upon these magnesium compounds. Thus, as an example, ethyl bromide is treated with magnesium in the usual way and a slow stream of carbon dioxide passed in; propionic acid is easily isolated from the product in a yield corresponding to 50 per cent. of the theoretical. Acetic, propionic, benzoic and phenylacetic acids have been synthesised in this way, so that the generality of the method is well established.

AT the Municipal Observatory of Montsouris the quantitative examination of atmospheric air has been carried out for a period of twenty-five years. About six years ago some special researches were commenced, under the direction of M. Albert Lévy, by MM. Henriet and Pécoul, the first results of which were presented to the Academy of Sciences in 1898. The fact was announced that atmospheric air which had been perfectly freed from carbon dioxide by an exhaustive treatment with potash and

baryta, on circulating repeatedly by means of a mercury circulator through a fresh quantity of baryta, gave appreciable amounts of barium carbonate corresponding to the production of amounts of carbon dioxide of an order nearly approaching, in some cases, the amount of carbon dioxide originally in the air. These facts were so extraordinary that the Academy appointed a commission, consisting of MM. Armand Gautier, Haller and Ad. Carnot, to repeat and report on this work. Their report is published in the current number of the *Comptes rendus*, and they confirm in every particular the views originally stated by MM. Henriet and Pécou. M. Henriet also publishes in the same number an account of an attempt made to determine the nature of the gaseous substance present in the air capable of giving these results, and comes to the conclusion that there is present in the air of Paris the vapour of a substituted formamide, the slow hydrolysis of which by the baryta furnishes the carbon dioxide originally found.

THE additions to the Zoological Society's Gardens during the past week include a Black Lemur (*Lemur macaco*) from Madagascar, presented by Mr. Thomas Watson; a Hybrid Zebra (between *Equus burchelli* and *E. caballus*) from South Africa, presented by H.M. The King; a Caracal (*Felis caracal*) from South Africa, presented by Regimental Quartermaster-Sergeant Glenton, L.R.; two Javan Peafowls (*Pavo spicifer*) from Burma, presented by Mr. O. F. Wheeler Cuffe; a — Ouzel (*Merula*, sp. inc.) from India, presented by Miss Porter; thirteen Slow-worms (*Anguis fragilis*) British, presented by Mr. C. J. Frielander; a Mongooz Lemur (*Lemur mongooz*) from Madagascar, seven Cunningham's Skinks (*Egernia cunninghami*) from Australia, four Amphiumas (*Amphiuma means*), a Corn Snake (*Coluber guttatus*) from North America, two Ruddy Sheldrakes (*Tadorna casarca*) European, deposited; a Wapiti Deer (*Cervus canadensis*, ♂) from North America, purchased.

OUR ASTRONOMICAL COLUMN.

BRIGHT METEOR OF JULY 13.—Several letters referring to observations of the bright meteor of July 13 have been received, in addition to those mentioned last week (p. 281).

Mr. O. J. R. Howarth observed the meteor at Chelsea, his attention being attracted by a flash resembling a very powerful searchlight, of a bluish hue, which lit up the sky and street brightly for an instant. "On turning to discover the cause a trail of light of considerable breadth (perhaps 1°) was observed. It was of serpentine form, about 10° in length, of a granulated appearance, and gradually faded from a bright golden colour, remaining visible from eight to ten seconds. Its elevation was estimated at 60°, and its direction was about S.E. from Chelsea."

Mr. W. Gilles, observing at Deal, says:—"The meteor became visible about 10° S. of the zenith and left a luminous trail of a remarkably sinuous character at its commencement, which was visible for about one minute afterwards."

RADIAL VELOCITY OF THE ORION NEBULA.—In No. 5, vol. xv. of the *Astrophysical Journal*, Prof. H. C. Vogel gives an interesting description of the methods employed, and the results obtained, by Dr. Eberhard and himself in determining the radial velocity of the Orion nebula.

The spectrograms were obtained by Dr. Eberhard with a photographic refractor of the Potsdam Observatory, which has an aperture of 32.5 cm. and a focal length of 343 cm. Owing to the lens not being fully corrected it was impossible to photograph lines of greater wave-length than H γ . An exposure of 180 minutes, using a three-prism spectrograph, gave a spectrum in which, at H γ , 0.25 m. corresponds to a difference of 0.42 μ , whilst an electrical heating apparatus enables the observer to maintain a constant temperature in the prism box within a tenth of a degree for several hours.

Seven spectrograms, taken between November 22, 1901, and February 22, 1902, each showing two iron comparison spectra in addition to the nebula spectrum, gave very uniform results, the mean of which, as measured by both observers, indicates a

velocity of recession, relative to the sun, of 17.4 ± 1 km., and this agrees very well with the 17.7 ± 1.28 km. obtained by Keeler as the velocity of this object in his classical researches on the velocities of nebulae.

Several drawings of the H γ line which are given plainly indicate the existence of differential velocities in various parts of the nebula.

MOTION OF THE POLE.—In No. 523 of the *Astronomical Journal*, Dr. J. C. Chandler directs attention to the apparent existence of a fifteen months' periodical motion of the pole, which has not yet been identified. This apparent motion is so minute (0".05) that Dr. Chandler hesitates to assert its real existence, but at the same time he cannot account for the constant differences in the coordinates by any other supposition, and he summarises his article with the following statement:—"In dealing with a phenomenon so obviously complex as these motions of the earth's axis are, and until we are certain of the superior limit of precision in astronomical measurement, it would be unphilosophical to ignore without examination such indications as these."

PHOTOGRAPHS OF THE PERSEIDS IN 1901.—Mr. J. Sykora communicates to the current number of the *Memorie della Societa degli Spettroscopisti Italiani* the results obtained by the staff of the Jorjuev Observatory (Dorpat) in photographing the Perseid trails in August, 1901.

Seven meteor trails were found on the negatives obtained, but of these two were evidently not due to Perseids. Of the remaining five, two were remarkable, inasmuch as they show the explosion of meteors, one in the middle of its trail, the other at the end of its trail; drawings of these accompany the article.

Measurements of the trails in regard to the coordinates obtained from stellar images on the same negatives give the radiant point for August 11 as

$$\alpha = 4^{\circ} 55' 8'' \quad \delta = 57^{\circ} 10' 3''$$

whilst the radiant point for August 12 is evidently slightly east of this position.

VARIABLE STARS.—2815 U *Geminorum*.—Mr. J. A. Parkhurst has observed the latest maximum of 2815 U *Geminorum* with the 12-inch and 40-inch refractors of the Yerkes Observatory, and finds a range of 3.04 magnitudes between April 3 and May 8, the maximum (9.76 m.) being attained at 13.9 h. on April 14.

Mr. Paul A. Yendell, of Dorchester, U.S.A., has made observations of the four following variable stars:—

2279 T *Monocerotis*.—Eleven observations of this star in 1900, and forty-six from December 1, 1901, to April 24, 1902, show four minima and five maxima.

2335 W *Geminorum*.—Fifty-one observations extending from November 24, 1901, to April 28, 1902, indicate five maxima and one minimum.

2509 ζ *Geminorum*.—Four maxima and three minima are deduced from thirty-two observations of this star made between December 27, 1901, and May 2, 1902.

2676 V *Monocerotis*.—Twenty observations from January 13 to April 14, 1902, include a minimum of 7.1 m. on January 30 and a maximum of 6.2 m. on February 12. (*Astronomical Journal*, No. 523).

THE AUGUST METEORIC SHOWER.

LIKE the great majority of meteoric streams, the Perseids return every year, and if they do not compose a really brilliant display they form a very noteworthy shower. An observer attentively watching the firmament on about August 11 may sometimes count 100 meteors in an hour, but the moon must be absent and the atmosphere very clear. In those years when it is most conspicuously exhibited it well repays observation even by those persons who do not specially apply themselves to this department of astronomy. At the close of July and opening of August there are comparatively few Perseids visible, but there is a rich shower of Aquarids at that particular epoch, so that meteors are generally pretty numerous, and occasionally surprisingly so.

Watching for these objects on ordinary nights is sometimes apt to prove tedious even to enthusiasts, but the Perseids are always sufficiently frequent and brilliant on about August 10, 11 and 12 to attract the interested attention of the most casual

stargazers. There are few more alluring spectacles than that afforded by the prolific fall of meteors on a genial August night, and we need not wonder that in the past few years observers of these phenomena have greatly increased, and that a more general interest than formerly is taken in recording apparitions of shooting stars.

This year the conditions will be favourable, for the moon will not offer any serious impediment to observation between about July 28 and August 12. It will be possible, therefore, to watch the progress of the shower through the fortnight comprising its more active stages. The weather is often a great drawback to investigations of this character (and this particularly applies to the English climate), for cloudy skies destroy the continuity of the work and occasion breaks which materially affect the value of the results. In watching a display similar to that of the Perseid stream, which is presented over a comparatively lengthy period, it is most essential to secure observations on many successive nights, so that the relative strength of the shower and the position of its radiant point may be determined at short and regular intervals. This is, however, not often practicable in England, though in exceptional cases there is little to take exception to in regard to prevalent weather. For instance, in August, 1901, thirteen of the fifteen nights from the 10th to 24th inclusive were clear, or partly so, and enabled observations to be obtained.

Everyone who views a meteoric shower would do well to record some of its leading features. One of the most important requirements is that the apparent paths of the meteors amongst the stars be registered. The fainter class of objects may be disregarded, but the lines of flight of the brighter meteors should be marked upon a celestial globe or star chart, and the right ascension and declination of the beginning and end points read off and entered into a book suitably ruled for the purpose. Such records, if carefully and accurately acquired, possess considerable value, as they furnish the materials from which the real paths and radiants of the individual meteors may be ascertained. Even those observers who have had no previous experience in work of this kind should make an effort to record the Perseid shower, for it will furnish an entertaining and instructive employment, and probably intensify their interest in the subject. In spite of the oft-repeated observation of the August display in past years, we have by no means completed our knowledge of its visible behaviour, and it should be further watched for data to enable us to more fully comprehend its various observational and theoretical aspects.

W. F. DENNING.

UNIVERSITY AND EDUCATIONAL INTELLIGENCE.

It is announced from Berlin that the Academy of Münster has been raised to the status of a University.

At University College, London, on July 14, Mr. H. E. H. Smedley gave a demonstration of his methods of wax-modelling as applied to plant structures, more particularly with a view to elucidating complex anatomical relations.

At Bedford College for Women (University of London), Dr. W. H. Wilcox has been appointed lecturer in hygiene. The Pfeiffer scholarship in science has been awarded to Miss E. A. Bridger. Six open Pfeiffer scholarships of the value of 15 guineas will be awarded to the best candidates holding a degree, or equivalent, in arts or science wishing to train as secondary teachers. Application should be made to Miss H. Robertson, the head of the training department, not later than December 13, 1902.

AMONG the examiners for the London Matriculation Examinations of September, 1902, and June, 1903, we notice the following—Mathematics, Mr. W. D. Eggar and Prof. G. B. Mathews, F.R.S.; physics, Dr. A. H. Fison and Mr. D. Rintoul, M.A.; chemistry, Mr. H. B. Baker, F.R.S., and Dr. G. S. Turpin; botany, Mr. H. Richardson and Mr. V. H. Blackman; zoology, Dr. G. Herbert Fowler and Mr. O. Latta; geography, Mr. G. G. Chisholm and Prof. W. W. Watts; geometrical and mechanical drawing, Mr. Walter Hewson and Mr. H. G. Christ.

It will be remembered that in January last the Drapers' Company offered to devote the sum of 30,000*l.* to the extinction of the debt on University College, "provided that the Senate of

the University of London and the Corporation of University College can, before February 28, 1903, agree upon a scheme for the incorporation of the college in the University, and such scheme be approved by the Company." The *University Gazette* of July 19 announces that the Senate has considered the proposal in all its bearings, both administrative and financial, and has approved the outlines of a scheme which had been drafted in conference with the council of the college as a preliminary step towards its realisation. Further negotiations are in progress between the University and the college with respect to certain details, and it is hoped that by the date specified a complete scheme for the incorporation of the college in the University may be agreed upon by both parties. The realisation of the scheme will depend upon whether it is possible to raise the necessary funds.

The Directory of the Board of Education, South Kensington, has been superseded by "Supplementary Regulations for Secondary Day Schools and for Evening Schools," a copy of which has just been received. The greater part of the volume (pp. 42 to 241) consists of syllabuses of the subjects in which the Board of Education holds examinations. There are, in addition, syllabuses of certain subjects in which the Board does not hold examinations and lists of apparatus suitable for use in science classes. Some of the syllabuses contain very helpful instructions for experiments and other practical work. For instance, the syllabus of practical plane and solid geometry gives outlines and hints for a course of construction and measurement of an original character, much in advance of the traditional plane and solid geometry and geometrical drawing. The syllabuses which were formerly given in the Code for Evening Continuation Schools are now included in the volume before us, among the subjects being general rudimentary science and elementary rural science.

SCIENTIFIC SERIALS.

The *Journal of Botany* for July opens with an account by Mr. G. S. West of algae obtained from hot springs. One collection from Iceland consisted mainly of filamentous Myxophyceæ and small Diatoms. A new species of the genus *Aulosira* was found in considerable abundance, also *Mastigocladus laminosus*, which is commonly found in all hot springs. Twelve genera of green and blue-green algae are represented. A second collection from Sira Ramau in the Malay Peninsula produced two new species, a *Symploca* and a *Phormidium*. Figures of the more important species are given on an accompanying plate.—Mr. Spencer le Moore describes five new species of Rubiaceæ, and three belonging to the Asclepiadaceæ, occurring in Dr. Rand's Rhodesian collections which are incorporated in the National Herbarium.—In the list of Glamorganshire plants observed by the Rev. E. S. Marshall and W. A. Shoobred in June last year, several new records are given.—A note by Mr. F. A. Williams.—Mr. E. F. Linton contributes an appreciative biography of the late Mr. J. C. Mansel-Pleydell.

American Journal of Science, July.—On spectra arising from the dissociation of water vapour, and the presence of dark lines in these spectra, by John Trowbridge. With powerful discharges in hydrogen, oxygen and rarefied air the same spectrum is obtained, and this is regarded as arising from the dissociation of rarefied water vapour. From a study of the spectrum of powerful spark discharges under water the author concludes that dissociation of water vapour takes place in the atmosphere of the sun; oxygen must therefore be present. The dissociation of water vapour, under the effect of powerful electrical discharges in the presence of small amounts of atmospheric air, results in the production of argon, even in tubes presumably filled with dry hydrogen. The great brilliancy of the dissociation spectrum of water vapour, which obscures the spectra of metallic vapours, and the presence of dark lines due to photochemical reversals, show the need of caution in accepting photographic evidence in regard to the states of development of stars.—The occurrence of Greenockite on calcite from Joplin, Missouri, by H. B. Cornwall. The Greenockite occurs as a bright yellow, dust-like coating on the calcite, which can be easily rubbed off with the finger. Beneath this coating is a thin layer of sphalerite.—A quantitative study of variation in the fossil brachiopod *Platystrophia luyx*, by E. R. Cumings and A. V. Mauck.—Studies of Eocene Mammalia in the Marsh

collection, Peabody Museum, by J. L. Wortman. The present instalment contains details of *Sinopa minor*, *Sinopa major*, together with observations upon the marsupial or metatherian relationships of the Creodonts. A summary of the results obtained for the whole series of Eocene Carnivora in the Marsh collection is appended.—New exposures of eruptive dikes in Syracuse, by P. L. Schneider.—Petrography of recently discovered dikes in Syracuse, N.Y., with note on the presence of melilite in the Green Street dike, by C. H. Smyth, jun.—The significance of certain Cretaceous outliers in the Klamath region, California, by O. H. Hershey.—The action of copper sulphate upon iron meteorites, by O. C. Farrington.—The classification of meteorites as active and passive towards solutions of copper sulphate, as given by Wöhler, is shown to be untenable. The rapidity with which the copper is deposited upon a thoroughly cleaned surface appears to decrease with the increase of the percentage of nickel, the temperature remaining constant, and hence meteoric iron, which always contains nickel, may be readily distinguished from terrestrial iron by this reason.—A petrographical contribution to the geology of the eastern townships of the province of Quebec, by J. A. Dresser.—The action of carbon dioxide upon the borates of barium, by L. C. Jones. A criticism of the method for estimating boric acid of Morse and Burton.—Studies in the Cyperaceæ, by T. Holm.

SOCIETIES AND ACADEMIES.

LONDON.

Royal Society, June 19.—"On the Correlation between the Barometric Height at Stations on the Eastern Side of the Atlantic." By Miss F. E. Cave-Brown-Cave, Research Student of Girton College, Cambridge, with some assistance from Karl Pearson, F.R.S., University College, London.

In a memoir on the correlation and variation of the barometric height at divers stations in the British Isles by Prof. Karl Pearson and Dr. Alice Lee, it is suggested (i.) that interesting results might be obtained by correlating the barometer at stations on the east and west sides of the Atlantic, allowing an interval of time between the observations (see *Phil. Trans.* vol. cxc. A, p. 459); and (ii.) that with a certain distance between stations, the correlation would be found to be negative, i.e. a high barometer at the one station corresponding to a low barometer at the second (see p. 467).

In order to deal with these points, steps were taken in 1897 to collect the necessary material. Twenty years, 1879-1893 inclusive, were selected for consideration, and the early morning barometric observations for these years, copied from material provided by the kindness of the British and other Meteorological Offices.

A preliminary study has been made of the East Atlantic stations, and this has impressed us with the desirability of continuing, if possible, our chain of stations right down the west coast of Africa, even to the Cape. The great mass of material to be dealt with, and the many new problems which arise in an almost entirely novel investigation of this kind, have meant, of course, very slow progress, and while publication of the final conclusions must be delayed for some time yet, it seems desirable to draw attention to a few of the results already reached for the East Atlantic stations.

In the first place it was soon discovered that the winter and summer months (equinox to equinox) must be treated separately. It was already known that the average height varied considerably in the summer and winter months, but there are also very significant differences in the variability, and, in what we are most concerned with, the correlation. For example, there is hardly any correlation (0.04) between Lisbon and Valencia in the summer, but in the winter it is quite considerable (0.22). Further, the results worked out in two groups of ten years each, show that very sensible differences in mean, variation, and correlation can exist between one decade and the next, so that at least twenty and probably more years are desirable if we are to obtain steady values for the barometric constants. In the next place, while we have found a small but sensible cross Atlantic barometric correlation after a definite interval of time, we must wait for more complete American data, and for still closer investigation of the best interval for different stations

before results on this point are published. The second suggestion, however, has been amply verified, and to draw attention to this is the principal object of the present preliminary notice.

As we go generally south from any station, we reach a point at which for readings on the same day there is no correlation at all. For stations beyond this point the correlation becomes negative, reaches a negative maximum, and then begins to decrease. Clearly it must reach a second zero. What happens after this? Does the correlation remain zero for all greater distances? To fully answer this problem we must obtain data south of Sierra Leone—in fact, we want data for St. Helena, Ascension, and the Cape, and have taken steps to obtain them.

Thus Valencia is positively correlated with Bôdj, Lisbon, however, is negatively correlated with Bôdj, but positively with Valencia. We require to go as far south as Funchal to find a negative correlation with Valencia. To get a negative correlation with Lisbon we must go as far as Sierra Leone, which has become positive again for both Bôdj and Valencia. At St. Helena we have our second negative correlation zone for both Bôdj and Valencia, while we are only in the second positive zone for Lisbon. In other words, the curve of barometric correlation with distance from a station appears to give roughly the form:—

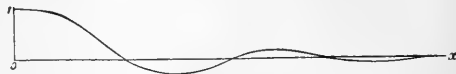

We do not find with increasing distance a diminishing correlation, as of a curve rapidly asymptoting to $0 \cdot x$, but as it were a wave-curve of diminishing amplitude. There is not apparently an area of positive correlation surrounded by a field of zero correlation, but going south there are only points of zero correlation, not regions of zero correlation. Probably if the area of investigation can be extended we shall find lines not zones of zero correlation round each station, separating districts of positive and negative correlation. What we are certain about is, that a zone of positive correlation is followed by a zone of negative correlation. What we are less sure about is, that this negative zone is again followed by a positive zone of much less intensity, but our rather meagre results certainly suggest it.

Full numerical data are given in the paper for Bôdj, Skudesnes, Valencia, Lisbon and Funchal, and less complete data for Sierra Leone and St. Helena.

We hope shortly to complete our calculations to the Cape, and then to finish the work already begun on the American stations. Meanwhile, we think that the correlation of a series of stations following roughly a parallel of latitude across Europe and Russian Asia would throw a flood of light on whether a chain of roughly north and south stations differs wholly in character from a chain of east and west stations. The magnitude of the computations, however, almost precludes the idea that any individual worker or workers can hope to complete such a task within a reasonable period.

DUBLIN.

Royal Dublin Society, June 18.—The Right Rev. Monsignor Molloy in the chair.—Prof. J. Joly, F.R.S., communicated a paper by Mr. W. B. Wright, of the Geological Survey, on some results of glacial drainage round Montpellier Hill, co. Dublin. At the lowest point of the ridge which connects the outstanding hill of Montpellier with the main mass of the Dublin Mountains to the south is a dry, transverse gap, connecting the valleys on either side; this gap cuts directly across the junction of the granite and slate, and has apparently no reference to the structure of the rock in which it is excavated. The occurrence in one of the side valleys of a thick deposit of gravels, ending in a fairly straight line on the Boulder Clay plain, which stretches up to its mouth, is suggestive of the occurrence in this valley, during the later stages of the decay of the ice sheet, of an ice-dammed lake which had its overflow channel through the gap. The gravel is composed for the most part of limestone and other material foreign to the ice sheet, indicating that the depositing waters flowed mainly from the ice sheet. At the other end of the gap are some mounds of granite and slaty material, probably the debris from it. At a subsequent period the drainage appears

to have been directed round the north side of Montpelier Hill, and has left its traces here in a series of terraces and incipient channels.—Dr. E. J. McWeeny made some remarks on a bacteriological method of air examination.—Mr. H. J. Seymour, of the Geological Survey, gave a short note on the occurrence of cassiterite in the Tertiary granite of the Mourne Mountains, co. Down.—Monsieur Molloy described and demonstrated working models of a three-phase generator and a three-phase motor, suitable for lecture purposes.

PARIS.

Academy of Sciences, July 15.—M. Bouquet de la Grye in the chair.—On the structure and history of the lunar crust: observations suggested by the fifth and sixth numbers of the "Photographic Atlas of the Moon," published by the University of Paris, by MM. Lecwy and P. Puiseux.—Preparation and properties of a silicide of vanadium, by MM. H. Moissan and Holt. A mixture of vanadium oxide, V_2O_5 , with about five times its weight of pure silicon is heated in the electric furnace for four or five minutes. The compound VSi_3 is formed; it can also be prepared by the action of magnesium powder upon a mixture of silicon and vanadic acid. Heated in a current of hydrochloric acid gives silicochloroform and a mixture of chlorides of vanadium.—On the coccidia found in the kidney of *Rana esculenta* and on the general infection which it produces, by MM. A. Laveran and F. Mesnil. It is shown that this organism, *Hyaloklossia Lieberkühni* of Labbé, is really an Isospora, and is renamed by the author *Isospora Lieberkühni*. Diagrams are given showing its different stages of growth; it causes an acute mixed nephritis in the frog.—The direct hydrogenation of acetylenic hydrocarbons by the method of contact, by MM. Paul Sabatier and J. B. Senderens. The method of direct hydrogenation by contact with nickel or copper has been applied to acetylenylidene and phenyl-acetylene. With nickel the chief product in the first case is normal heptane; with copper a heptene together with a small amount of heptane. With phenyl-acetylene nickel gives chiefly ethylcyclohexane; with copper ethylbenzene, with small quantities of diphenyl-butane and metastyrolene.—Report on the experiments made at the Observatory of Montsouris relating to the composition of atmospheric air, by MM. Armand Gautier, Hialler and Ad. Carnot. The experiments of MM. Lévy, Henriot and Pécol on the existence of an easily oxidisable gaseous compound in the air of Paris have been repeated and confirmed (see p. 308).—The use of hail rockets, by M. E. Vidal. Evidences are given of the power possessed by the rockets of breaking up storm clouds, and especially of preventing damage to vines by hail.—Application of the method of the arithmetical mean to the surfaces of Riemann, by M. A. Korn.—On the formation of liquid drops and the law of Tate, by MM. Leduc and Sacerdote. The law of Tate states that the weight of the drops of a given liquid falling from the extremity of a tube is proportional to the radius of the end of this tube. It is shown that this is only approximately true and that the usual reasoning establishing this law is incorrect. A new expression is deduced which is submitted to an experimental study.—On binary accords, by M. A. Guillemin.—On a new organic vapour in atmospheric air, by M. H. Henriot. Filtered air is mixed with steam and this is then condensed. The condensed water was then examined and found to contain a minute amount of what would appear to be a substituted formamide.—On the properties and constitution of the peroxides of zinc, by M. de Forcrand.—On oxyisopropylphosphinic acid, by M. C. Marie.—On a new method of preparation of α -substituted β -ketoic esters, by M. René Locquin.—The electric resistivities of pathological blood serums and serous effusions in man, by MM. Lesage and Dongier.—The zymase from *Eurotiopsis Gayoni*, by M. Mazé. It has been found that the zymase is present in considerable quantity in the developing mycelium, but that with aerobic cultures the quantity of the zymase present in unit weight of mycelium diminishes rapidly with the age of the cultures.—On the cure of "la casse" in wines by the addition of sulphurous acid, by M. J. Laborde. The author criticises the views of MM. Bouffard and Diener, and gives fresh experimental evidence in favour of the hypothesis originally advanced by him.—Researches on the Culicidæ of Algeria, by M. H. Soutié.—On the treatment of black rot, by M. A. Prunet. Mildew and black rot being different diseases the same remedies should not be applied to both. The

maximum interval which should be allowed to elapse between two successive treatments with the copper sulphate solution has been determined experimentally.—On the lower Gothlandian of the Armoisian massifs, by M. F. Kerforné.—Some facts, new or little known, concerning the Glacial period, by M. David Martin.

NEW SOUTH WALES.

Linnean Society, May 28.—Mr. J. H. Maiden, president, in the chair.—Descriptions of new genera and species of Lepidoptera (Fam. Noctuidæ), by Dr. A. Jefferis Turner.—An ascobacterium from the sugar cane, by Mr. R. Greig Smith.—Preliminary note on the geology of the Queensland coast, with references to the geography of the Queensland and New South Wales plateau, by Mr. E. C. Andrews. An attempt is here made to refer the origin of the present coastal configuration of Queensland and Northern New South Wales primarily to a recent variable crustal movement. The topography of the Cordillera and the continental shelf is found to throw light on Barrier Reef problems.—Notes on the botany of the interior of New South Wales (part vi.), by Mr. R. H. Cambage. The conspicuous botany of the country between Camden, near Lake Cowal, and Narrandera is described. Mention is made of the damage done to certain trees, notably dogwood (*Myoporum deserti*), by the rabbits.

CONTENTS.

PAGE

The Encyclopædia Britannica. By R. T. H.;	
Prof. Arthur Smithells, F.R.S.	289
Submarines. By C. V. B.	290
The Dynamical Foundations of Thermodynamics.	
By Prof. G. H. Bryan, F.R.S.	291
An Attempt at Originality in the Teaching of	
Zoology	292
Our Book Shelf:—	
Dunlop and Jackson: "Slide Rule Notes."—	
C. V. B.	292
Miall: "Injurious and Useful Insects: an Introduc-	
tion to the Study of Economic Entomology"	293
Lawrie: "Chloroform: a Manual for Students and	
Practitioners"	293
Grasset: "Les Limites de la Biologie"	293
Letters to the Editor:—	
Heights of Sunset After-gloves in June, 1902.—Prof.	
A. S. Herschel, F.R.S.	294
Distribution of Pithophora.—Prof. G. S. West	296
Saturn Visible through the Cassini Division.—C. T.	
Whitcomb	296
The Electrification of London. (With Map.) By	
M. S.	296
The Pittsburg Meeting of the American Association	
.	299
Address by Prof. C. S. Minot, President of the	
Association	300
Notes	304
Our Astronomical Column:—	
Bright Meteor of July 13	309
Radial Velocity of the Orion Nebula	309
Motion of the Pole	309
Photographs of the Perseids in 1901	309
Variable Stars	309
The August Meteoric Shower. By W. F. Den-	
ning	309
University and Educational Intelligence	310
Scientific Serials	310
Societies and Academies. (With Diagram)	311

THURSDAY, JULY 31, 1902.

AUTOMOBILES.

Schule des automobil Fahrers. By Wolfgang Vogel. Pp. viii + 189. (Berlin: Schmidt, 1902.) Price m. 2'60.

MR. WOLFGANG VOGEL has moved about on his motor cars with such pleasure to himself that it has resulted in a desire to share that pleasure with others, and he addresses his book chiefly to those who are unlearned, not only in motor cars, but even in the rudiments of the usage of machines. He is right in this, for they are numerous.

Probably the largest percentage of persons who are quite ignorant of mechanical matters exists among the upper classes. The millions who work in factories, delve in mines, and direct some one or other of the innumerable agricultural appliances have had an acquaintance with machinery forced upon them. Few of these would require a diagram and many words to indicate the use of a sight feed oiler or a Stauffer lubricator, by whatever name they might distinguish them.

But among those who can buy motor cars these things are still a mystery, and it is likely that the automobile movement will cause a very important alteration in the mental attitude of the so-called cultivated classes towards machines, and thence towards mathematics and science. At present, therefore, it is reasonable that a book such as Herr Vogel's should give elementary diagrams of the Otto cycle and obvious sketches of the much-sketched induction coil.

Chapter ii. shows how explosive gas is made by spray or vapour from the liquid petrol mixed with air, how it is controlled in amount, ignited electrically, and voided noiselessly after it is burnt.

A very justifiable preference is shown for the secondary over the primary battery and for the dynamo over either for the purpose of making sparks to fire the charge; but it is remarkable how much less perfect is the electrical part of automobiles than might have been expected. Instead of working fervently in this new field, the electrician has evidently settled down to making money in his other dearly earned preserves.

If we compare the amount of energy utilised in igniting the charge in an explosion engine with the bulk and weight of the usual ignition equipment we shall feel some surprise. If we further consider how easy it is to make an electrical instrument "fool proof," especially when it is devoid of moving parts, we shall be astonished at the numbers of electrical breakdowns—the loose wires, oily contacts, broken terminals, which characterise every beginner's early motor-car runs.

It has been noted in various automobile competitions that electrical troubles were prominent in cars entered by manufacturers and agents, and almost absent from cars entered and owned by private persons, the differences being ascribed to the superior electrical knowledge of most of the amateurs who had sufficient mechanical tendencies to tempt them to what then was, in its early days, an odious sport.

There still remains much to be done to diminish the

high cost, high weight, large bulk and frequent opportunities of breakdown which characterise even the most modern motor cars, but these questions of design and improvement do not exercise our author, who contents himself with instructions how to use cars as they are.

It may be mentioned that the book contains many tabulated forms, which give, in order, the necessary operations for getting the machine ready before running, for starting up, and in case of breakdown. Copies of these tables should be of great value to the beginner, and he is intended to use them until thoroughly familiar with his machine.

The "self-mover" which is more likely than any other to create a stir in the world, and which, until he is educated up to it, the pedestrian and carriage person hates, the motorist despises, and the ordinary cyclist is jealous of, is the motor bicycle. This most useful machine by no means receives its proper share of attention at the hands of our author, who ascribes to it only two pages. It will be avenged on him some day, even if it be only in the matter of the sale of his book.

In chapter iii., Herr Wolfgang Vogel divides automobiles into cycles, voiturettes and motor cars, without showing any very good reason for so doing, though he incidentally points out that the driving of a motor tricycle will probably come more easily to one who has never been accustomed to ride a bicycle. In chapter iv. he deals with brakes, and explains simply and clearly the necessity for differential gear which so often puzzles the tyro. The subsequent chapters are given over to trailers and the like. Possible breakdowns and their remedies are dealt with.

Part ii. begins by dealing with minor accessories and the repairs of pneumatic tubes. Hints are given for lengthened tours, and a table is appended which includes all the hundred and one articles which are so apt to be left behind. The reader may gather several wrinkles from this chapter; they all deserve the description of "praktisch."

Chapters iii. and iv., which are devoted to the description of tours from Berlin to the Rhine, Switzerland and Italy, made by the author, are lightly and interestingly written, and give the reader an excellent idea of the pleasures and difficulties incidental to such tours. The run over the Stifler Joch, the highest bit of road in Europe, seems likely to provide as much excitement as modern man could desire.

The necessity for being provided with enough money of the various countries passed through and an ample number of spare parts is pointed out, with illustrations from the author's own experience of delays at an exacting Customs Office. A knowledge of languages is, of course, desirable.

The author proffers an admirable suggestion that continental automobile clubs should compile a register of the hotels which have suitable "stabling" for motor cars, and not confine their attention to the places where petrol can be procured. He is, of course, not cognisant of the good work done by the English Automobile Club both in this and in every other direction for road and route improvement.

The author favours petrol cars, and, according to him, the purchase of a motor cycle only engenders the

desire for a voiturette, which had better have been satisfied from the first. If he were to sit on one or two committees of the English club above named, he would learn to his astonishment that a number of members who already possess a luxurious car are adding a motor cycle to their "stable," a fact which is hardly in accord with his opinion.

From the brevity of part iii., which deals with electro-motors, and of part iv., which devotes to steam cars the short space of four pages, he would appear to be less than kind to the formidable competitors of his favourite petrol explosion engine.

On the whole, the book gives in a very simple and interesting manner a large amount of information which must prove invaluable to the beginner, and may with advantage be studied even by those who are more conversant with the vagaries of the motor car.

The author's style is unusually understandable to English readers, and with a little judicious "skipping" the sense can easily be followed, owing to the number and clearness of the illustrations, without the laborious necessity of using a dictionary.

MERVYN O'GORMAN.

COMPARATIVE ANATOMY OF ANIMALS.

An Introduction to the Study of the Comparative Anatomy of Animals. Vol. ii. By G. C. Bourne, M.A., D.Sc. Pp. xv + 321. (London: G. Bell and Sons, 1902.) Price 4s. 6d.

DR. BOURNE'S work is divided into thirteen chapters, which, though serial with those of the preceding volume, are separately pagged. In addition, there is a short "conclusions" chapter—in reality a concise summary of the contents of the book, with some good advice to the student—and also an excellent index.

The text treats of the cœlomate Metazoa, with a special leaning to the developmental side, which the author regards as indispensable to "a just appreciation of the problems of comparative anatomy." Of the thirteen chapters, the first is restricted to the Platyhelminia, with especial reference to the liver fluke; the second and third to the earthworm alone; the fifth mainly to the mussel; the sixth to the snail; the eighth to the crayfish; the ninth to the cockroach; and the eleventh to the dogfish. The two concluding chapters are devoted respectively to the development of the frog and a very general survey of the field of mammalian morphology; while the three which remain are in turn given to the Annelida, Crustacea, and Cephalochorda in general, to Apus and Amphioxus in particular.

In the selection of material, the author has been guided by the requirements of the "preliminary and intermediate science examinations in the universities of Great Britain." By way of illustration he gives us seventy-seven text figures, many of which are new and meritorious. The researches of Benham, von Boutin, Ehlers, Fraipoint, Hatschek, Kowalevsky, Lacaze-Duthiers, Reichenbach, Vejdovsky, Wilson, and others, have been duly laid to account, with acknowledgment, such as might well have been similarly accorded to certain English workers upon whose labours the author has drawn. Of the author's

own diagrams, those illustrating the development of the mammal may be cited as excellent; but even here clearness might well have been further ensured, had the alimentary canal been delineated in outline, as giving rise to the allantois and yolk-sac.

The book is fully up to date and well worthy its predecessor and its author's reputation, and one of its chief attractions is its literary style. Such criticism as we offer must needs be detailed. For example, in defining the urinogenital organs of the mammal, the uterus masculinus is regarded as the persistent lower end of the Müllerian duct, with an accompanying illustration which most nearly recalls the condition in the rabbit. It might have been advantageous to point out that in this animal the organ generally thus named has been proved, by von Kolliker, Pallin, and others, to be a product of fusion of the vesiculae seminales, and no uterus masculinus at all. Similarly, a little more precision might well have been given to both description and figure of the crayfish nervous system, by directing attention to the approximation of ganglia about the sternal artery, which this genus so instructively exhibits, as a determining feature of the decapod type. With the crayfish, again, the statement that the "gastrolith" "is supposed to form a reserve of calcareous matter to supply material for the new armour formed after ecdysis" is most certainly erroneous, and mention might rather have been made of the evidence for its association with this very function. Nor is the author more fortunate in his treatment of the decapod mandible, the wholly endopoditic nature of the "palp" of which cannot be maintained in knowledge of the facts recorded by Boas. And when we come to questions of doubt, we cannot accept the declaration of the supposed composite nature of the "cerebral ganglion-pair" in Anodon, deduced, as it would seem to be, by analogy from Pelseneer's statements for Nucula.

As to terminology, while the author is at most points sound, we consider him in error in the term "demibranch" as defining the gills of sharks; *hemibranch* it should surely be, since the root noun is Greek. Again, we much prefer the term *thoracic* to dorsal, as applied to the mid-trunk vertebræ of the mammal; and while we consider the description of the mammalian coracoid inadequate, we can only refer to the statement that the corpus callosum is characteristic of the mammalian brain as misleading, since the Eutheria alone possess it as now defined, viz. as a tract of neopallial commissural fibres invading the alveus.

The foregoing amounts almost to hypercriticism, where all else is so well done; and we would rather congratulate the author on the production of a book which, while professedly written up to the requirements of an examination system, is thoroughly trustworthy and eminently readable and instructive. It fully realises our expectations, expressed on reviewing its companion volume (*NATURE*, vol. lxii. p. 364); and, as an additional recommendation, it may be said that, in order to ensure clearness and continuity, details are in places suppressed, reference being given to authoritative sources whence they may be found already described.

There is an interesting erratum of a page and a quarter which calls for special comment, viz. a corrected figure and description of the syngangium of the frog,

which, as now described, is in line with previous knowledge and most recent investigation. The figure in the first volume which it is to replace, incomprehensible as it stands, is now admitted by the author to have been due to confusion, in the attempt to reconstruct his own rough drawings during the intervals of military duty. If only for this we forgive him, despite his somewhat emphatic contentment with the original, now condemned. An attractive elegance is a leading feature of this book, and by this it is calculated to draw the reader to its subject. In this respect it contrasts both forcibly and favourably with the baldness of expression and lack of culture which characterise many of its would-be competitors.

THE CLASSICS OF PHYSICAL SCIENCE.

Scientific Memoirs. Edited by J. S. Ames, Ph.D. Fifteen volumes, prices varying from .60 to 1.00 dollar each. (New York: American Book Company, 1898 to 1902.)

IT is refreshing to meet with this series. Not that the contents are novel, though recent things are not lacking. It is the aim of the series which is stimulating. Our students are gradually being degraded into a reliance upon text-books for nourishment instead of being brought up on a study of scientific classics. It was not ever thus. Time was when text-books were almost unknown, and knowledge of science had to be acquired by a study of original sources. The more modern craze for, and reliance upon, examination tests has altered all that. Nowadays a man must know a little bit of every branch of the rapidly extending circle of sciences in order to take a county scholarship or a degree. And text-books spring up by the dozen to supply the very special wants of any newly created examination. It is possible, and it is to be hoped, that the new regulations in the University of London will tend to remedy this state of affairs. Much greater stress is to be laid upon a knowledge of recently published work, and the habit of mind that is so induced is bound to be a healthy one. We wish, too, that for the less recent work men were more encouraged to put text-books on one side and study some one branch at least in the original memoirs.

This handy series in fifteen volumes is a move in the right direction. It consists of translations or reprints (in English) of memoirs dating from the rise of physical science to the present day. Each volume is confined to one subject, has a separate editor, who writes a very short preface—in part historical, in part elucidatory—and also a brief biographical sketch of each of the writers whose memoirs are selected from. The first volume consists of papers by Gay-Lussac, Joule, and Wm. Thomson and Joule on the "Free Expansion of Gases." In the brief introductory sketch it might have been well if the editor had pointed out the essential distinction between the earlier and the later experiments. Thus, while the absence of a fall of temperature in Gay-Lussac's experiments is so far a proof of Mayer's hypothesis, its absence in Joule and Thomson's experiments would not have proved it. In fact, the editor is labouring under a very common mistake in thinking that the

experiments all satisfy the condition of zero performance of external work; this is the case in the first but not in the last. It is a pity that the expression "free expansion" is not reserved for cases which satisfy the above condition, and some other term (*e.g.* throttle expansion—the term of the refrigerating engineer) be employed where the conditions are those which obtain in porous plug experiments or the "wire drawing" of steam.

The other volumes are as follows:—

Vol. ii. "Prismatic and Diffraction Spectra." Papers by Fraunhofer and Wollaston.

Vol. iii. "Röntgen Rays." The now historical papers of Röntgen and Stokes (the Wilde Lecture) and J. J. Thomson.

Vol. iv. "The Modern Theory of Solutions." Pfeffer, van 't Hoff, Arrhenius and Raoult.

Vol. v. "The Laws of Gases." Robert Boyle and Amagat.

Vol. vi. "The Second Law of Thermodynamics." Carnot, Clausius and Thomson.

Vol. vii. "The Fundamental Laws of Electrolytic Conduction." Faraday, Hittorf and Kohlrausch.

Vol. viii. "The Effects of a Magnetic Field on Radiation." Faraday, Kerr and Zeeman.

Is it a fact, as stated by the editor, that in the Hall effect "the stream lines of an electric current flowing through a thin conducting sheet transverse to a magnetic field are deflected"? That the lines of electric force are deflected is, of course, certain; but the two statements are not equivalent.

Vol. ix. "The Laws of Gravitation." Newton, Bouguer, Cavendish, with abstracts from others.

Vol. x. "The Wave Theory of Light." Huygens, Young and Fresnel.

Vol. xi. and xii. "The Discovery of Induced Electric Currents." Joseph Henry and Faraday.

Vol. xiii. "The Foundations of Stereo-chemistry." Pasteur, van 't Hoff, Le Bel and Wislicenus.

Vol. xiv. "The Expansion of Gases by Heat." Dalton, Gay-Lussac, Regnault and Chappuis.

Vol. xv. "The Laws of Radiation and Absorption." Prévost, Stewart, Kirchhoff, and Kirchhoff and Bunsen.

The editor attributes to Kirchhoff the first rigorous proofs of the celebrated law connecting emission and absorption. This is the common view; but in the light of Rayleigh's recent vindication of Stewart in the *Philosophical Magazine* this attribution is inadmissible.

It will be seen from the above very brief summary what the kind of selection has been. Other editors might very well have selected differently without effecting any improvement.

If a criticism may be attempted, it is that objection may be easily raised to the abridgment which several of the papers have undergone. Much may, of course, be urged in favour of this pruning when carefully done; but the necessity for it is certainly to be regretted. It recalls the similar process which novels have been obliged to submit to—a process which suggested to *Punch* the brilliant idea of republishing pictures with parts deleted. The editors carefully point out, however, when they have applied the knife, and they appear to have used it with care.

At the end of each volume is a bibliography, in which reference to allied papers is made.

With this our task is done. This is not the time to discuss the matter of the papers themselves. Let it only

be said that they are all classics, and we ask the student to decide in favour of reading them in preference to some brief text-book summary. He will find no great mathematical difficulty in any of them which would make it impossible for him to understand them thoroughly without being otherwise helped.

PURE AND APPLIED BACTERIOLOGY.

Traité de Bactériologie pure et appliquée à la Médecine et à l'Hygiène. Par MM. P. Miquel et R. Cambier. Pp. xv + 1059. (Paris: C. Naud, 1902.) Price fr. 45.

THIS work, comprising more than one thousand pages and a comprehensive index, is a valuable addition to the already extensive literature of the subject of bacteriology. As the title of the work indicates, it deals with bacteriology, not only from the purely scientific point of view, but also from the technical and applied, inasmuch as its application to industry and to sanitation forms an important part of the work. The book is divided into four principal divisions. The first division treats of the morphology, the chemical, physical and other conditions concerning the composition, growth and reproduction of bacteria, and capable of affecting them favourably or unfavourably. It deals, further, with the methods used in cultivation, the culture media, their preparation and their physiological action in the human and animal body. In the same division is found an account of the methods of staining bacteria, their spores and cilia, both from cultures and from animal tissues. And lastly, the optical instruments used in the study of bacteria (microscopes, photomicrographs, magnifying glasses, &c.) are treated in chapter ix.

All these subjects are treated in a clear and comprehensive manner, very useful and sufficient for the student of bacteriology, and in many instances brought up to the most recent times, so that both student and original worker have the advantage of the most recent improvements in the methods of the study of bacteria. While, therefore, the reader has in the 236 pages constituting this first part all that it is of real importance to know concerning the most modern methods in bacteriology, he misses a good deal concerning some modern views of the morphology and classification (Migula, Meyer).

The second part, comprising in five chapters about 325 pages, is the one which for the student of medicine and hygiene is the most important, since it describes the different species of pathogenic bacteria of diseases of man and animals.

This part of the book will be found less satisfactory than the first, because in our opinion it is in several respects somewhat imperfect; the descriptions of the different species, their characters and actions might be more detailed; it is deficient in the theories of immunity, and notably in regard to suitable and representative illustrations. The absence of proper and accurate illustrations, not only in this, but in other portions of the book, seems inexplicable. The authors devote time and trouble to teaching photomicrography, yet there is not in the whole book a single photomicrograph to illustrate a single species of the many hundreds described. We have no fault to find with the use of schematic drawings, such as occur

in this book, when it is a question merely to illustrate general characters as to the aspect and morphology of the bacteria, but we fail to understand the value of such illustrations as occur in this second portion of the work ("Pathogenic Bacteria"), where, in total disregard of all natural conditions, a few tinted dots or a few tinted lines are here produced to represent cocci or bacilli. Another subject in this section seems to us deserving of explanation. It is this. All text-books, all writers and all those who have contributed to their discovery have recognised and described as "bacilli" the various species that cause "hæmorrhagic septicæmia" in different animals, yet here in this book we are suddenly brought to a full stop, and for no adequate reason, by having all these different bacilli (fowl cholera, swine plague, swine fever, wildseuche, duck cholera, grouse disease, &c.) grouped amongst "Micrococques Pathogènes."

The third and fourth portions of the work (pp. 568-888 and 888-1038 respectively) in our opinion are excellent, both as regards treatment and arrangement, and denote the hand of the master; and considering the known works and reputation of M. Miquel, this is quite what was to be expected. The third part deals with the important processes of fermentations caused by bacteria, as lactic, acetic, butyric, pectic, &c.; with the production of pigment; with the bacteria of air, water and soil; with putrefaction; with the bacteria occurring in the different parts of human and animal bodies, and with phosphorescent bacteria.

The fourth and last part deals with the principal methods of analysis of air, water and soil as practised and applied by the authors and others in their own systematic work; further, with the purification of potable waters; and last, but not least, with the most efficient means of disinfection.

As stated already, these two sections of the book form, by their clear and concise descriptions and by their complete treatment, an advance over all existing books, and we venture to say that the book on this account alone deserves to be, and will doubtless become, of universal use.

There is one further merit in this book not to be taken lightly, and that is the copious references to the original works of other authors, notably French and German. There are references also to English and American workers, but, as is usual with most German and French writers, to which we in England have become by this time well accustomed, references to English and American literature occur rather sparingly and are treated in a somewhat stepmotherly fashion.

E. KLEIN.

OUR BOOK SHELF.

General Investigations of Curved Surfaces of 1827 and 1825. By Karl Friedrich Gauss. Translated with Notes and a Bibliography by James Caddall Morehead, A.M., M.S., and Adam Miller Hildebeitel, A.M. Pp. viii + 127. (Princeton, N.J., U.S.A.: The Princeton Library Publishing Association, 1902.) Price 175 dollars.

THIS is an English translation of the classic memoirs of Gauss on the theory of surfaces. The first paper is that which was presented to the Royal Society of Göttingen in

1827, and is still regarded as the most finished and useful introduction to the study of infinitesimal geometry. The translation is based on a copy of the original paper, but in the work of preparing it and the present notes all the other editions were consulted. This is followed by a translation of the abstract presented by Gauss to the Royal Society of Göttingen. Under the title of "*New General Investigations of Curved Surfaces*," the translators next give a paper really written by Gauss at an earlier date (1825), but which was not published until the eighth volume of Gauss's works appeared in 1900. Both papers contain the fundamental properties of what is now known as Gauss's measure of curvature, the theorem that the spherical excess of a geodesic polygon is proportional to the corresponding area on the auxiliary sphere, and the proof that the locus of points the geodesic distances of which from a fixed point are equal cuts these geodesics orthogonally. The paper of 1825, however, contains introductory matter on curvature in a plane which was omitted by Gauss from his 1827 paper, and while, in 1825, Gauss used geodesic polar coordinates only, in 1827 he introduced the notion of generalised coordinates ρ and g . It will thus be seen that the order in which the papers have been printed is the reverse of chronological order.

A large number of notes have been inserted by the translators, those on the 1827 paper occupying twenty-eight pages. Many of these notes contain proofs of results merely stated by Gauss; others consist of explanatory matter, restatements of Gauss's conclusions, or simple corollaries. The "bibliography" contains a list of 343 papers dealing chiefly with the following subjects:—Curvilinear coordinates, geodesic and isometric lines, curvature of surfaces, deformation of surfaces, orthogonal systems and the general theory of surfaces. A large proportion of the papers listed are of comparatively recent date, thus affording a guide to the literature about curved surfaces which has grown up in the development of methods first laid down by Gauss.

The Elements of Mind. By H. J. Brooks. Pp. xviii + 312. (London: Longmans, Green and Co., 1902.) Price 10s. 6d. net.

THE author claims to have made the correlation of chemistry physiology and psychology possible by the discovery of the "simple elementary substances of mind" which, according to him, "when compounded with those of force and matter, constitute the mysterious substance we call life." It is not easy to gather his exact meaning, as his definitions of his fundamental terms are partly defective, partly circular. Matter and force he leaves undefined; of life he simply says that he "uses it in its ordinary sense." Mind—when not further defined by a restricting adjective—is "everything that is not matter," a definition which would include, e.g., space, time and the series of natural logarithms. As an instance of a definition which is circular as well as obscure, "By Ego I mean that which is known as the personality of the brain. . . . Personality I employ in the ordinary sense of a person's physical and mental characteristics." Substance, again, should have been defined with special accuracy by a writer who attaches so much importance to his professed discovery of the "elementary substances" of mind. Yet all that Mr. Brooks has to say of it is that "substance is philosophically described as that which exists and remains." Now space and time may be said to "exist and remain"; are they substances or are they not? Mr. Brooks, of course, knows whether he means to say that they are, but a reader is nonplussed. And finally, what exactly does Mr. Brooks mean by an "element"? By "elements of matter," as his examples show, he means chemically undecomposable constituent parts; but what exactly are meant by the "elements" of force, which "scientists with somewhat less success have de-

scribed"? So far as the absence of precise definition permits us to form a judgment, Mr. Brooks's doctrine seems to agree with the "mind-stuff" theory of W. K. Clifford. He quotes Prof. James's trenchant refutation of this theory of the composition of a unitary consciousness out of atomic constituents and attempts to turn its edge. He does not, however, seem to realise its full force. The case of "light" is no exception to James's contention that "all the combinations which we know are effects wrought by the units said to be combined" upon something other than themselves. Still less is the relation between an organism and its members the same as that between an aggregate and its parts. I confess that I have been unable to discover in Mr. Brooks's book any one consistent theory of the relation between his elements and the single whole which he calls the "greater Ego." Sometimes this whole is spoken of as controlling, dominating and using the elements, sometimes as built up by their mechanical interaction. So with his general metaphysical theory. He appears sometimes to hold that "mind," "force" and "matter" are things which can compound quasi-chemically, sometimes that they are different "aspects" of a single reality. Where I do understand him, he appears to be expounding in novel language a psychology of the extreme associationist type, though not without moments of deeper insight in which he seems to uphold the ultimate identity of mind and body.

A. E. T.
A Graduated Collection of Problems in Electricity. By Prof. Robert Weber, D.Sc. Translated from the third French edition by E. A. O'Keefe, B.E., M.I.E.E. Pp. xv + 351. (London: E. and F. N. Spon, Ltd.; New York: Spon and Chamberlain, 1902.) Price 7s. 6d. net.

THIS book is intended to be a help to the teacher of physics, and consists of a collection of problems of varying difficulty in almost all the branches of electrical work. The third edition differs chiefly from the previous ones in the inclusion of some fresh problems and in the careful revision and correction of errors which has been made. The author has adopted the plan of giving the solution immediately after each problem, and though objections may be urged against this method, we think on the whole it is the most satisfactory for a book of this kind. Those interested in electricity from its practical side will regret that most of the problems are of an academic character. Thus, to quote one example, the section on glow lamps gives the impression that lamps are usually made for 40 or 50 volts and that lighting is carried out by means of primary batteries. Occasionally one comes across a problem in which the data are not sufficient in reality. Apart from a few minor defects of this sort, the book is a very useful one, as the questions are well calculated to show whether or not the student has really grasped the meaning of the work he is doing, which should be the principal aim of a teacher. The addition of a short section on units and a number of tables enhances the value of the work.

M. S.
Junior Chemistry and Physics. By W. Jerome Harrison. Pp. vi + 224. (London: Blackie and Son, Ltd, 1902.) Price 1s. 6d.

SOME of the fundamental principles of physics and chemistry are simply described in this book. Common objects are used as subjects of observation and experiment, and an attempt is made to show the scientific aspects of familiar things. The first few pages seem out of place in a book of this character. Pupils beginning the study of science ought not to be troubled with such statements as "The universe is composed of matter, "We have given the name of ether to an extremely rare kind of matter," "Matter has extension," "Matter is indestructible," &c. These subjects belong to the later stages of natural philosophy.

LETTERS TO THE EDITOR.

(The Editor does not hold himself responsible for opinions expressed by his correspondents. Neither can he undertake to return, or to correspond with the writers of, rejected manuscripts intended for this or any other part of NATURE. No notice is taken of anonymous communications.)

Penetrating Rays from Radio-active Substances.

THE permanent radio-active substances uranium, thorium and radium all give out two types of rays, one easily absorbed and non-deviable by a magnetic field and the other more penetrating in character and deviated by a magnetic field. In addition to these rays, Villard, using the photographic method, first drew attention to the existence of some very penetrating rays from radium non-deviable by a magnetic field. This result was confirmed by Becquerel.

I have recently examined all these radio-active substances by the electrical method, and have found that thorium, and also the excited radio-activity produced by thorium and radium, emit some rays as penetrating in character as those from radium. Uranium, in comparison with thorium and radium, emits little, if any, of this radiation.

These rays are extraordinarily penetrating in character, and pass readily through great thicknesses of matter. They are certainly as penetrating as the most penetrating rays given out by a hard X-ray tube. The amount of ionisation produced by them is only a very small fraction of that produced by the other two types of radiation. Using testing vessels of ordinary size, the ionisation due to the penetrating rays is of the order of 1 part in 100 of that due to the deviable rays and 1 part in 10,000 of that due to the easily absorbed rays.

In the experiments on radium, 0.7 gram of radium chloride, of activity 1000 times that of uranium, was used. The radiation from this, after its passage through 1 cm. of lead, caused a rapid movement of the needle in the sensitive electrometer employed. The radium was placed in a thick-walled lead vessel and a piece of aluminium waxed tightly over the top to prevent the escape of the emanation. The following numbers illustrate the diminution of the rate of leak in a testing vessel, placed above the radium, with the thickness of the lead traversed by the radiation:—

Thickness of lead.	Current.
.72 cm. 60
.72 + .62 cm. 37
.. + 1.24 25
.. + 1.86 16
.. + 2.50

The current with .72 cm. of lead over the radium is taken as unity. It will thus be seen that the current falls off approximately in a geometrical progression with the thickness traversed, and that after passing through 1.86 cm. of lead the intensity is reduced to about one-quarter.

The following table shows the thickness of different metals traversed before the intensity is reduced to one-half:—

Metal.	Thickness in cm.
Mercury75
Lead9
Tin 1.8
Copper 2.2
Zinc 2.5
Iron 2.5

Assuming this law of absorption to hold, the rays would pass through a thickness of about 7 cm. of lead, 19 cm. of iron and about 150 cm. of water before the intensity would be reduced by absorption to one per cent. of its original value.

The amount of the penetrating radiation from thorium is about the same as for radium, taking into account the ratio of their radio-activities. As the radium employed was about 1000 times as active as thorium, it was necessary to work with a kilogram of thorium nitrate to obtain about the same amount of rays as from the .7 g. of radium.

Experiments were also made to see if the excited radio-activity, due to thorium and radium, which gives out deviable and non-deviable rays, also emits these penetrating rays. In order to get measurable effects, it was necessary to obtain intense excited activity. For this purpose a zinc plate was exposed as kathode in a closed vessel containing 300 g. of thoria. A lead wire was also made very active by exposure as kathode for six hours in a

vessel containing a large amount of radium emanation, obtained by bubbling air through a solution of radium chloride. The excited radiation from these two sources was found to include rays about as penetrating in character as those from radium and thorium. The intensity of these rays diminished with the time, rapidly for radium and more slowly for thorium excited radiation. This diminution with time is probably directly connected with the rate of decay of the other known types of radiation from excited bodies.

Since the penetrating rays are present in thorium and radium, and also in the excited radiations due to these bodies, and are absent in uranium, it seems probable that the penetrating rays in both radium and thorium are due to the excited radio-activity, produced in the mass of the compound by the emanations which are unable to escape into the air. According to this view, the production of penetrating rays is a function of that portion of radio-active matter which causes excited radio-activity.

Connection between Absorption and Density.—Some experiments were made to see how the absorption of the rays by matter varied with the density. The coefficient of absorption λ was determined by noting the ratio of the intensities of the rays after passing through a known thickness of matter. The following table illustrates the results:—

Substance.	Penetrating rays.		Deviable rays from uranium.	
	λ	λ density	λ	λ density
Water033	.033	—	—
Glass086	.035	14.0	5.7
Iron28	.036	44	5.6
Zinc28	.039	—	—
Copper31	.035	60	7.7
Tin38	.052	96	13.2
Lead77	.068	122	10.8
Mercury92	.068	—	—

A comparison table on the right is added for the deviable rays given out by uranium. It will be seen that the quotient of absorption by density is in neither case a constant, but the differences are no greater for the non-deviable penetrating rays than for the deviable rays of uranium. It is interesting to observe that the value of λ divided by the density is for both types of rays twice as great for lead as for glass or iron. It will be seen from the above table that the penetrating rays from radium, compared with the deviable rays of uranium, pass through a thickness of glass about 160 times greater for the same reduction of intensity.

Comparison of penetrating Rays with Röntgen and Kathode Rays.—The question at once arises as to whether these very penetrating rays are projected particles like kathode rays or a type of Röntgen rays. The fact that the penetrating rays are not deviable by a magnetic field seems, at first sight, to show that they cannot be kathode rays. I have repeated the experiments of Villard, and have been unable to obtain any appreciable deviation of the rays, which had passed through .6 cm. of lead, even in a very strong magnetic field. The photographic method was used, and four days' exposure of the plate was necessary to get an appreciable impression. In some other respects, however, the rays seem more closely allied to kathode than to Röntgen rays. It is well known that Röntgen rays produce much greater ionisation in gases like sulphuretted hydrogen and hydrochloric acid gas than in air, although the differences in density are not large. For example, sulphuretted hydrogen gives six times and hydrochloric acid gas nine times the conductivity of air. On the other hand, with kathode rays the conductivity observed is only slightly greater than for air.

The experiment was made of filling the testing vessel with sulphuretted hydrogen, when it was found that the current for the penetrating rays from radium was only slightly greater than for air. Both this experiment and the results for the variation of absorption of the rays with the density of matter seem to show that the penetrating rays have a closer resemblance to kathode than to Röntgen rays.

It must, however, be remembered that the observations on the relative conductivity of gases and the relative absorption of

metals for Röntgen rays have only been determined for rays far less penetrating in character than these rays from thorium and radium. Benoit has shown that the relative absorption of Röntgen rays by matter depends to a large extent on the kind of rays employed. "Hard" rays give quite different ratios from "soft" rays. For penetrating Röntgen rays the absorption of the rays by a given weight of the elements is a continuous and increasing function of their atomic weights. From the curve of absorption, given in his paper, the variations of absorption with density are much greater for Röntgen rays than for the penetrating rays from radio-active substances.

A very important question arises in discussing the character of these penetrating rays. According to the electromagnetic theory, developed by J. J. Thomson and Heaviside, the apparent mass of an electron increases with the speed, and when the velocity of the electron is equal to the velocity of light its apparent mass is infinite. An electron moving with the velocity of light would be unaffected by a magnetic field.

It does not seem at all improbable that some of the electrons from thorium and radium are travelling with a velocity very nearly equal to that of light, for Kaufmann has recently determined the velocity of the most penetrating deviable rays from radium and found it to be about 95 per cent. of the velocity of light.

The power of these rapidly moving electrons of penetrating through solid matter increases very rapidly with the speed. From general theoretical considerations of the rapid increase of mass with speed, it is to be expected that the penetrating power would increase very rapidly as the speed of light was approached. Now we have already shown that these penetrating rays have very similar properties, as regards absorption and ionisation, to rapidly moving electrons. In addition, they possess the properties of great penetrative power and of non-deviation by a magnetic field, which, according to theory, belong to electrons moving with a velocity very nearly equal to that of light. It is thus possible that these rays are made up of electrons projected with a speed of about 186,000 miles per second.

An interesting speculation arises from the experimental observation that the excited radiations from bodies include these very penetrating rays. Elster and Geitel have recently shown that excited radio-activity can be produced from the atmosphere by exposing a negatively charged wire in the open air. This excited activity is very similar in properties to that produced by thorium and radium. Since the earth is negative with regard to the upper atmosphere, the surface of the earth is itself made radioactive. From the nature of the phenomenon, it necessarily follows that, not only the surface of the earth, but also the whole interior surface of buildings is covered with an invisible deposit of radioactive matter. From the close similarity in the nature of this excited activity from the air with that from radio-active bodies, it is not improbable that the excited radiations from the air include also some of the penetrating rays. If this is the case, our bodies must be continually subject in a small degree to something very like the Röntgen ray treatment, which is now so popular in medical circles. It would also follow that the "spontaneous" ionisation of air, observed in closed vessels by Elster and Geitel and C. T. R. Wilson, may be due, in part at least, to the presence of these rays, which so readily pass through the walls of the containing vessels. E. RUTHERFORD.

McGill University, Montreal, July 6.

The Future of the Victoria University.

THE interesting contribution on the subject of the Victoria University which Prof. Schuster has made to your columns (July 19, p. 252) invites a few words of reply from one who does not regard the possible disruption of the University with the same complacency.

It may be unknown to many readers of NATURE that the proposals which would disband the University arose in such a way as to preclude that close and careful deliberation on the future of the University and its colleges which would have resulted in a peaceful maintenance of the *status quo* or in a harmonious process of separation. We should otherwise have been saved from the unfortunate situation in which the University is now placed, when one of the colleges and its county is left standing alone for the maintenance of the University.

I refer to this because it might be supposed that the existing state of affairs was the outcome of something like a quarrel. There has been no quarrel; the three colleges of the Victoria

University have worked together with a degree of smoothness and good feeling that might seem hardly possible to those who know the strong local sentiment of the two counties and the three towns. There have indeed been many controverted questions in the University history, but the lines of party have, I think, been usually independent of the colleges.

The question of disruption having been raised in such a way that the University itself could not consider it by means of an unpledged tribunal, the Yorkshire College, believing the movement to be detrimental to the interests of education, desired that there should be a Government inquiry by means of a Royal Commission or other body of high authority. This proposal has not been accepted by the majority of the University Court, and as the matter rests now we have the application of Liverpool for a university formally opposed by Yorkshire and formally approved by Owens College, subject to Manchester being also allowed an independent university.

I have no wish to enter here upon the general question of the relative merits of single college and federal universities, but I think there is something to be said on another question of more immediate practical importance, and that is, whether an action so grave as the disestablishment of a university should not be the subject of a strict and impartial public inquiry.

It is true, no doubt, that the Privy Council may be trusted to give a careful and impartial consideration to the question before it, but in the ordinary course of things that would not involve a public inquiry, and the grounds on which any decision was reached would not be made known.

I believe that the future of the Victoria University is a question not affecting that University alone. It raises the much greater issue of the future of university organisation in England, and it seems to me to be of the first importance that the real grounds, if there are any, for the disruption of the federal Victoria University should be clearly set forth in evidence and endorsed by competent authority.

Prof. Schuster says that "the Victoria University is now practically an examining body, which unites all disadvantages." That is just the sort of statement I wish to see sifted by an impartial tribunal. Many of us would say that such a statement cannot be serious; it seems so exaggerated.

It is proposed to dissolve a great educational corporation which after twenty-three years of hard work has acquired real momentum and has come to be recognised as a factor in educational affairs not inconsiderable when compared even with the older universities. I am one of those who believe that a factor of this particular kind has been and is one of the most urgent needs of our time. I believe also that the defects of the Victoria University, which are undoubted, might be largely rectified by a less drastic process than disruption, and that with a revised constitution the University might continue to exist with greater freedom and ease for its constituent colleges and with undiminished effect in their collective action as an enlightened "modern" force on English education.

Surely at least the question is worthy of the most careful consideration and is one that calls for an open inquiry.

In conclusion, I deplore the haste which has been made by advocates of disruption to convince the public of the defects of a University which after all may be obliged to continue its existence.

ARTHUR SMITHELLS.

July 14.

IN writing about the future of the Victoria University in a scientific journal I was anxious to avoid all questions which are immaterial to the main point. Prof. SmitHELLS's letter deals mainly with side issues. The lines of cleavage at our board meetings interest no one but ourselves, and it does not matter now whether Liverpool might or might not have preceded in a more academic manner.

The position at present is this:—The two senior colleges, representing about three-quarters of the University, believe that independent universities will in future be able to carry out their educational work better than the present federation. Prof. SmitHELLS thinks that we ought to have accepted the proposal of the Yorkshire College to have the whole question referred to a Royal Commission. But surely the only course likely to be followed by men who know their own minds is to ask for what they want; at any rate, it is the only way to get it. It is fortunate, however, that Prof. SmitHELLS's predilection in favour of a federal university may yet be satisfied. Yorkshire is quite large enough to supply the material for a federation, and as an

experimental philosopher he ought to rejoice at the possibility of having two rival systems put to the test in two neighbouring counties. Prof. Smithells's reference to the momentum acquired by the Victoria University is not a happy one, as he ought to know that if a moving body separates under the action of internal forces, momentum is conserved, while kinetic energy is increased.

As regards the concluding sentence of his letter, it seems to me that while advocating public inquiry by Royal Commission he deprecates public discussion before the only tribunal which is competent to deal with this question. It is to men who have had practical experience of university teaching, or who by helping to advance knowledge have acquired a right to speak with authority on the organisation of a teaching university, that I addressed myself in writing to you on the subject.

ARTHUR SCHUSTER.

Science and the London Matriculation Examination.

THE late June matriculation examination of the University of London being the last general examination for all candidates under the old regulations, it may be worth while to note one or two things revealed by it.

(1) Out of just under 3000 candidates, fifteen only gained a place in the honours division, but none of these were from what we should recognise (in the accepted parlance) as "public schools," and no female name appears in that division.

(2) The great public schools are represented only by Harrow, Westminster and Shrewsbury (with five names between them); and if we extend the connotation of the term "public school" to include such schools as the great day-schools of the metropolis, such semi-day-schools as Dulwich and Highgate and such public schools of the second rank as Felsted, Repton and Epsom, we can only (with a liberal interpretation of the term) credit them with somewhat less than sixty names in the whole list. More exactly, the number one counts is fifty-seven, of whom only four represent an "optional science," the remaining fifty-three having offered an "optional language."

These facts seem to represent a poor return for all the talk we have heard of late in connection with scientific education. The fair inferences from them seem to be, (1) that the teaching of languages is immensely stronger in this country than the teaching of science; (2) that the University of London as yet scarcely touches the education of the country as represented by the great public schools of England; (3) that, so far as the public schools generally are concerned, science is regarded still as a *παράρτημα* (with the exception of Epsom, and to a less extent the City of London School, St. Paul's School and Clifton College). In some cases, perhaps, it may be inefficiently taught, but in many more it is handicapped by the biased autocracy of the classical headmaster. Gentlemen of that type even with the best intentions lack real sympathy; and the responsibility for the results (little short of disastrous) must ultimately rest with the governing bodies of the great schools of the country. While this condition of things remains, can we wonder at the death of brain-power exhibited by our officers as a body in the late war, or at that development of mere loquacity which so often characterises the utterances of our public men and puts the thinker entirely into the shade? One is inclined to ask the question whether present attempts at educational legislation are likely to prove other than abortive when our legislators for the most part need to be educated to a true appreciation of science, its nature, its aims and its methods. A. IRVING.

Bishop's Stortford, July 21.

The Recent Fireball.

THE very brilliant meteor which made its appearance about 10h. 30m. on Sunday night, July 13, is on record, so far as is known at present (July 26), as having been seen from 106 places. A large proportion of these are in the counties of Middlesex, Surrey, Kent and Essex, while isolated accounts come from as far away as Devon, Wales, Lancashire, Lincolnshire and Norfolk. Many reports of the phenomenon give no details whatever; very few give trustworthy data concerning its path in the heavens. The meteor was fortunately seen by Mr. Denning at Bristol, and from descriptions by him and a few other observers who carefully noted the position of the meteor its approximate real path in the air has been computed. At its first appearance the object seems to have been at an elevation of 86½ miles, the place of its final extinction being 52½ miles over the Straits of Dover. The course of 45 miles was over a line 11 miles to the west of one joining St. Omer and

Cape Gris Nez. The fireball must have presented a splendid sight to the inhabitants of the district of France over which it passed, and it is greatly to be hoped that some descriptions will be available from there in order that the above result may be confirmed or corrected.

The radiant-point was probably at $316^{\circ} + 30^{\circ}$, which, though a well-known shower-centre in July, does not seem to have provided such a similarly brilliant member during recent years.

The features of the fireball may be gathered from an inspection of some of the descriptions. The brightness was at least as great as that of the moon, this great light being due to the bursting of the meteor, which then gradually faded. A serpentine streak was afterwards visible, fading away in turn. Some portions of this were traced by some observers for a few minutes afterwards. The duration of flight was variously estimated. If an average of two seconds be taken, as seems permissible, the speed would be $22\frac{1}{2}$ miles per second.

WALTER E. BESLEY.

75 The Chase, Clapham Common, S.W.

Sunspots and Wind.

THE Greenwich tables of wind-direction contain much, I think, that is suggestive of sunspot influence. Take, e.g., the days of northerly wind in the first quarter of the year (according to the classification N., E., S., W.).

Curve A shows how their number has varied since 1841. In B, each year-point represents an average of five values (on an enlarged scale). D is a curve for the whole year, similarly obtained. C is the inverted sunspot curve.

(It should be stated that the values prior to 1860 are a little by defect, owing to the manner of dealing with calms, in the earlier table used.)

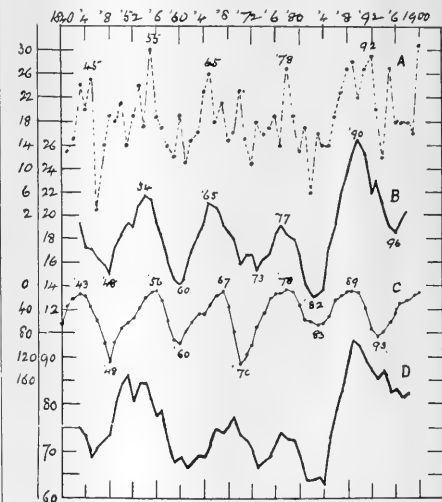

FIG. 1.—A. Days of northerly wind (Greenwich) in first quarter of year (actual variations). B. Result of smoothing A with averages of five. C. Inverted sunspot curve. D. Days of northerly wind (Greenwich) in year, smoothed.

Regarding curve B (especially), are we obliged to think that this consistent correspondence through sixty years, showing always less northerly wind about maxima than about the adjoining minima, is a matter of chance? If we are to accept the views given in a recent presidential address (from which, I think, there must be considerable dissent), that is how it is to be interpreted.

A systematic inquiry into the configuration of high-pressure systems in Europe about sunspot maxima and minima, especially in the winter half, would, I believe, be fruitful in results.

ALEX. B. MACDOWALL.

THE CHELSEA PHYSIC GARDEN.

MANY of the readers of NATURE will be aware that the Physic Garden at Chelsea has for some time past been undergoing numerous alterations and improvements in order to enable it once more to take up its old position as a centre of botanical instruction and research. New laboratories and plant-houses have been erected, and on Friday, July 25, these were opened by Earl Cadogan, K.G., who expressed the hope that a long career of usefulness now lay before them. Mr. Hayes-Fisher, M.P., who presided on the occasion of the ceremony and who has throughout the reorganisation taken a most active part in the matter, gave a sketch of the history of the Garden and an outline of the purposes to which it is henceforth to be devoted.

Since its foundation by the Society of Apothecaries some 220 years ago, the Physic Garden has passed through many vicissitudes of fame and fortune, and its history is full of interest to the antiquary and the botanist alike. It has numbered many eminent men amongst its past curators, and as Sir W. Thiselton-Dyer remarked, it gave a curator to that younger physic garden which has since developed into the magnificent institution at Kew. Although it was primarily designed to provide for the proper study of medicinal plants, it soon began to serve as a channel through which new foreign plants became introduced into this country, and it is said (though not without contradiction) that the first cedars of Lebanon to be grown in Britain were the four trees planted in 1683 and formerly thriving in the Garden, of which the last only finally succumbed some two or three years ago.

It seems to have excited some surprise even in those early years to discover how well plants were found to succeed in the Garden, and Evelyn, who visited it in 1685, remarks on the excellent condition of the collections as a whole, and he also incidentally refers to the then novel method of heating the conservatory by heat conveyed subterraneously from a stove situated under the building.

Some fifty years later, Linnaeus in 1736 visited the Garden, and he records in his diary that Millar (the gardener) allowed him to collect a number of plants and also gave him some dried specimens. The note is of interest as illustrating the importance which at that time attached to the place. For many years it continued to be more or less used, chiefly by medical students, but its maintenance proved a heavy tax on the somewhat narrow resources of the Society of Apothecaries, and as neither the Royal Society nor the College of Physicians, both of which had an interest in it under the terms of the original conveyance, in accordance with the intentions and wishes of Sir Hans Sloane, would accept the responsibility, the Charity Commissioners were approached with the view of devising a scheme which would provide for the relinquishing of the trust whilst at the same time securing its continuance as a scientific institution. The late Sir Henry Longley became interested in the matter, and a departmental committee, consisting of Sir Henry Longley, Sir W. Thiselton-Dyer and Mr. Spring-Rice, was appointed by the Treasury to inquire into the matter.

The outcome of the various deliberations and negotiations has been the passing of a Scheme in 1899 whereby was ensured the preservation for the practical study of botany in London of a venerable institution and an excellent garden. The Trustees of the London Parochial Charities, subject to certain conditions, provide an annual income of 800*l.*, whilst the Treasury, through the Board of Education, subsidises it by a further amount of 150*l.* per annum in consideration of certain rights and privileges thereby attaching to the Royal College of Science. The Garden is administered by the Trustees of the London Parochial Charities, and by a Committee of Management, the seven-

teen members of which are appointed in accordance with definite regulations laid down in the scheme.

In adapting the Garden to its new purposes various necessary changes have been effected in connection both with the buildings and also with the outdoor department. A strip of land required for the purpose of widening Queen's Road was sold to the Chelsea Borough Council, and this involved the demolition of the old lecture-rooms and curator's house, together with two lean-to greenhouses. Moreover, the main range of plant-houses had fallen into a hopelessly ruinous condition, and their removal was decided upon, the intention being to erect a new range of plant-houses, together with laboratories and a curator's residence, along the revised north-western boundary of the Garden. This has now been done, and it was to witness the opening of these new buildings that the gathering assembled on Friday last.

The laboratories and curator's house have been designed by Mr. G. E. Rivers, of H.M. Office of Works. The laboratories are comprised in a two-storied building which contains on the ground floor a large main classroom, to be fitted up with working tables; out of this open a greenhouse, to be used for physiological purposes, and also two smaller rooms and a convenient dark-room. Upstairs there is a large laboratory which will also be available for lecture purposes, and there are three other smaller rooms, one of which will be appropriated to contain the library and working garden herbarium. The basement of the building has ample convenience for storing and other purposes.

The plant-houses, built by Messrs. Foster and Pearson, are arranged on the corridor system that experience shows to be both economical and easily worked. A single corridor runs along inside the boundary wall, and out of this open three houses designed for stove, intermediate and cool plants respectively. Two excellent pits are connected with the range and are heated by the same boilers. The houses, taken as a whole, are not large, but they will suffice for the practical requirements of the Garden.

Only one of the old glass-houses—a large lean-to on the south-western wall—has been retained. It is an unheated structure, and it was here that Moore, the well-known authority on ferns, grew the greater part of his collection. The rest of the old plant-houses have now, as has already been said, disappeared. The place where they formerly stood is marked by the three small tanks formerly built into them, but which are now situated in the grass in front of the laboratories.

Doubts have often been expressed as to whether it would be possible to grow the plants necessary to enable the Garden to discharge its new functions. A visit to the place would soon dispel any such fears, for it may be at once seen that a very large proportion of the herbaceous species flourish luxuriantly under cultivation there. The fine aspect, with the river frontage, is partly responsible for this, and it is fortunate that for educational uses the greater part of the needed specimens can be provided in the form of herbaceous species. Some of these are of course more difficult to manage than others, but experience shows that by the exercise of discretion in the selection of appropriate material, the obstacles imposed by climate and environment in the way of forming a representative collection such as is needed by students can for the most part be easily surmounted.

In the Garden, as in the laboratories, it is intended that provision shall be made for experimental and other investigations, and certain plots of ground will be set aside for these purposes as occasion may arise. And in order that effect may be given to these intentions, general regulations under which the various resources of the Garden may be made as widely available as practicable will be issued early in the ensuing autumn.

A QUARTETTE OF MUSEUM
PUBLICATIONS.¹

BY the issue of the handsome and beautifully illustrated volume standing first on our list, the Trustees of the British Museum have followed the lead set a couple of years ago by the appearance of the "Monograph of Christmas Island," and have thus added a second work describing the fauna of a definite area to the long list of publications bearing their name on the title-page. And there can be little doubt that this new departure will be welcomed by naturalists and by the public at large. In the present instance it has afforded a means of commemorating in a graceful and fitting manner the munificence and generosity of the originator of the *Southern Cross* expedition, and has likewise furnished zoological science with a valuable memoir on the fauna, flora and petrology of the Antarctic. How valuable such a publication is at the present time needs no comment here; and it will accordingly suffice to say that with the "Antarctic Manual" and the present volume

the specimens, more especially in correlating the skulls with the skins of the fine series of Antarctic seals, which formed, perhaps, the gem of the entire collection. Moreover, the loss of an important memoir on the white seal which had been drawn up with great care by Mr. Hanson was an irretrievable misfortune.

The task of describing the different portions of the collection was divided among a large number of specialists, the editorship of the memoirs relating to vertebrates being assigned by the Director of the Natural History Branch of the Museum to Dr. Bowdler Sharpe, while Mr. F. J. Bell prepared for press the invertebrate section of the work. Altogether the work comprises twenty-two separate memoirs, for which the services of as many specialists were secured.

The new forms described in the volume are not very numerous. They include, however, three genera of fishes, each represented by one or more new species, and two specific representatives of a previously named genus. The other new forms are all invertebrates. In this connection it may be observed that there is a want of uniformity between the plans followed by the two editors. In the vertebrate section each new form is indicated as such in the heading, but this is not so in the invertebrate part. It is not a matter of much importance, but still uniformity would have been advisable.

The most generally interesting sections of the book are undoubtedly those treating of the seals and the penguins. The description of the seals was originally undertaken by Captain Barrett-Hamilton, who, we believe, had to leave for South Africa before the volume was finished. Owing to the destruction of the labels, this gentleman was unable to correlate the skins with the skulls, and it was consequently only the latter that could be specifically identified with certainty; his descriptions are, therefore, chiefly limited to the skull and dentition. At a later period it was, however, found possible to assign the skins to their respective species, and their description was undertaken by Mr. E. A. Wilson, now serving on board the *Discovery*. When this identification was made, that eminent artist Mr. H. Grönvold was commissioned to draw the five plates of seals, which were coloured by Mr. Wilson himself and form one of the most striking features of the book. The exclusively Antarctic seals are four in number, namely Weddell's seal (*Leptonychotes weddellii*), the leopard-seal (*Ogmorhinus leptonyx*), the white seal (*Lobodon carcinophagus*) and Ross's seal (*Ommatophoca rossii*), each the sole representative of its genus. Ross's seal, previously known only by the skull, is a most extraordinary-looking creature, recalling, in the curious inflation of the throat, a pouter-pigeon. Captain Barrett-Hamilton comments on the remarkable dissimilarity presented by the dentition of the four species and correlates this with the nature of their food. Specimens of three of the species are exhibited in the Natural History Museum.

The penguins, together with the other birds, are described by Dr. Bowdler Sharpe. They include three species, of which two, the emperor-penguin (*Aptenodytes forsteri*) and the Adelia penguin (*Pygoscelis adeliae*) receive the largest share of attention. Two coloured plates are devoted to the latter, while numerous text-figures (two of which we are enabled to reproduce) illustrate the haunts and habits of both species. The Adelia penguin is a migratory species, which congregates during



FIG. 1.—Adelia Penguins on their Nests. (By permission of Sir George Newnes, Bart.)

the scientific staff of the *Discovery* will, on their return, have an excellent basis for the commencement of their work.

The *Southern Cross* expedition, we may remind our readers, was fitted out in 1898 by Sir George Newnes, regardless of expense, the zoological staff consisting of Messrs. N. Hanson and H. Evans. On the return of the vessel, Sir G. Newnes, with characteristic generosity, presented the British Museum with the first "pick" of the natural history collections, desiring that the duplicates should be distributed among other museums, both British and foreign. Unhappily, Mr. Hanson did not survive to superintend the sorting and description of the extensive collections formed during the voyage, and there was consequently considerable difficulty in identifying some of

¹ (a) "Report on the Collections of Natural History made in the Antarctic Regions during the Voyage of the *Southern Cross*." Edited by R. B. Sharpe and F. J. Bell. Pp. ix + 344; illustrated.

(b) "Catalogue of the Collection of Birds' Eggs in the British Museum (Natural History)," vol. ii. By E. W. Oates. Pp. xx + 400; illustrated.

(c) "Guide to the Galleries of Mammalia in the British Museum (Natural History)." Pp. v + 120; illustrated.

(d) "Guide to the Coral Gallery in the British Museum (Natural History)." By R. Kirkpatrick and F. J. Bell. Pp. v + 73; illustrated. London: Published for the Trustees of the British Museum, 1902.

the breeding season in enormous rookeries, and special interest attaches to a photograph of the arrival of a party of these birds on the Antarctic land. The curious discovery that these birds as they ascend the cliffs make deep groovings in the solid rocks with their claws was not announced in time to be mentioned in the volume. The eighth and last coloured plate represents the remarkable colour-phases presented by the eggs of MacCormick's skua (*Megalestria maccormicki*).

All concerned in this important contribution to natural history are to be congratulated on the successful completion of a by no means easy task.

Our congratulations must likewise be offered to the author of the second work on our list, the first volume of which has been already noticed in these columns. Since the appearance of the first volume the Museum collection of eggs has received a most important addition by the bequest of the Crowley collection, noted on account of its richness in the eggs of Australian birds. The registration of this vast collection was not completed when the MS. of a large portion of the second volume went to press, so that Mr. Oates has been compelled to add an appendix. The collection will also, we presume, render necessary an appendix to the first volume, if only to include the great auk's egg which forms one of its treasures. Previously the Museum possessed only two bleached eggs of that species, which are entered in the catalogue as valueless.

Even with the addition of the Crowley bequest, the Museum collection is by no means so extensive as is desirable, although it is probably far ahead of any other. To say nothing of many species totally unrepresented, there are many birds—among them such well-known forms as the secretary-bird, the bay vulture and the South African griffon vulture—of which there are not more than two or three eggs in the collection.

Among the special rarities recorded in the volume before us, mention may be made of two eggs of the sanderling (*Calliiris arenaria*)—the one from Grinnell-land and the other from Iceland—and three assigned to the knot (*Tringa canutus*). Two of these latter (belonging to the Crowley bequest) were taken in Iceland, while the third is one of a clutch of four, said to have been taken with the hen-bird, sent to the late Mr. H. Seebohm from Disco Island. All three specimens are alike; but, according to Mr. Oates, "they bear an exact resemblance in size, shape and colour to some of the eggs of the common snipe. The genuineness of these eggs therefore requires confirmation, but they are probably correctly identified." Here we may call attention to what, in our opinion, is an imperfection in the indexing of the volume. Species of which there is a supplemental notice in the appendix are duly recorded in the index, but this is not the case with genera. It is true that such genera do not receive a separate heading in the appendix, but we nevertheless think they should have been indexed as occurring there; it would have made reference easier.

Other rarities catalogued include eggs of the American noble snipe (*Gallinago nobilis*), two; the Malagasy snipe (*G. macrodactyla*), three; the black jacana (*Jacana nigra*), two; the black-winged courser (*Rhinopterus chalcopertus*), three; the African wattled crane (*Bucgeranus carunculatus*), three; the white-winged trumpeter (*Psophia carinata*), two; and the seriema (*Cariama cristata*), three. Of the two species last mentioned, all the eggs in the collection were laid in confinement, those of the trumpeter in Mr. Blauw's aviary in Holland and those of the seriema in the London Zoological Society's menagerie.

The volume is illustrated by fourteen beautifully coloured plates of eggs, drawn and coloured by Mr. H. Cronvold. Apart from their special interest to oologists, these figures are of great value to the general naturalist as giving him a much better idea of the prevalent type

of coloration characterising the eggs of different groups of birds than can be obtained from the figures of exclusively British species. Both author and editor appear to have executed their tasks carefully and conscientiously, and when the remaining volumes are issued the work will not only be invaluable, but absolutely unique.

The works standing third and fourth in our list are of a totally different type from those already noticed, and are intended for the general public rather than for scientific naturalists, although even the latter class of readers may perhaps gain some information from them in regard to those sections of zoology of which they have not made a special study. Before proceeding further we may say a word with regard to the covers and title-pages of these two little works. In the "Mammal Guide" the words "British Museum" are printed in large type and "Department of Zoology" in smaller type, whereas just the reverse of this occurs in the "Coral Guide." Apart from the question of uniformity (which we consider by no means an unimportant one), there seems no doubt that the former style is far the most preferable. It may be added that the address "Cromwell Road, London, S.W.," which appears on the cover of the "Coral Guide" is, in our opinion, quite unnecessary, and not suitable to the dignity and importance of a great public institution.



FIG. 2.—Adelia Penguins Paired. (By permission of Sir George Nevins Bart.)

If, however, it is required in the one "Guide," it is also necessary in the other.

The two "Guides" differ in that the one devoted to the mammal galleries is the seventh edition, while the other is the first issue; a further difference is to be found in the fact that whereas the names of the authors appear in the second, no such information is afforded in the first. Another point of distinction is the greater prominence given to popular names and the smaller amount of technical detail given in the former than in the latter. In the "Mammal Guide," for instance, the English names of the animals are alone placed under the figures, whereas many of the figures in the "Coral Guide" have only the scientific names, and when English names are given they occupy the second instead of the first place. It is true, as stated in the preface, that it is less easy to avoid the use of technical terms in dealing with the lower invertebrates than when treating of mammals or birds, and popular names are not so readily at hand. We venture to think, however, that more might have been done in this direction than the authors have thought fit to attempt. In any case, the substitution of terms like "hairs" for "cilia," "feathery" for "plumose" and "horny" for "chitinous" could be made without any loss of accuracy

and with advantage to the public. It is extraordinary how limited is the vocabulary of a large portion of even the well-educated section of the public; and it is the too free use of technical terms in the better class of popular natural histories which drives people to those of an altogether inferior description. Another point to which we would draw attention in connection with the "Coral Guide" (which, by the way, includes sponges and various other low invertebrates) is the advisability of omitting the names of describers of particular species or structures. Such names as Wyville Thompson, Hickson, Duerden and Shipley are familiar enough to zoological students, but they are quite unknown to the outside public for whom the book is intended.

A feature of the "Coral Guide" is the wealth and beauty of the illustrations, which render it a most wonderful shillingsworth, altogether apart from its high value as an excellent introduction to the groups of animals of which it treats. A number of new illustrations also characterise the seventh edition of the "Mammal Guide," which, for reasons apparent to those in the "know," the present writer is debarred from either criticising or commending.

R. L.

TERRESTRIAL MAGNETISM.

AN interesting paper describing the results of an investigation to determine to what extent magnetic disturbances of the needle are connected with the geological conformation of a selected mountainous district has recently been published.¹

The well-known inquiry into the relation between the magnetic and geological constitution of Great Britain and Ireland conducted by Rücker and Thorpe has been before us for some six years, and in the present paper we have the report of results obtained in another country and in later years having the same object in view.

The region selected for the observations was the Kaiserstuhl, a mountainous district in the neighbourhood of Freiburg in Baden, of which exact topographical and geological surveys had been made, and it is from this source that the maps accompanying the paper and upon which the results of the observations are exhibited were obtained.

The base station was at Freiburg on the spot occupied by Lamont in 1852, but the several observations were compared with a station nearly in the centre of the Kaiserstuhl, at which the magnetic elements were considered normal. In all, 382 determinations of the horizontal force, 140 of the inclination and 137 of the declination were made, and the epoch assigned is 1898.7, but no corrections for diurnal inequality were made. The resulting disturbances from these observations are shown on a special map of "Isanomalen."

The author arrives at the following conclusions:—(a) That wherever the geological conformation is of basalt, there he experiences disturbance of the needle partly due to permanent magnetisation of the basalt; (b) that the principal disturbances are caused by compact masses of basalt with a North Pole acting vertically upwards—or nearly so—on the north-seeking end of the needle, and the magnetism of these masses is not due to induction from the earth.

With (a) we may concur as to a connection being frequently found between the geological formation of basalt and magnetic disturbance of the needle, but it has been also shown that basalt may be present in large masses and certain forms without causing any such disturbance. The conclusion in (b) can hardly be accepted, for it is well known that in the northern hemisphere

¹ "Erdmagnetische Untersuchungen im Kaiserstuhl," von G. Meyer. Published in the *Berichte der Naturforschenden Gesellschaft zu Freiburg* i. B. Band xii., 1902.

sphere the north-seeking end of the needle is generally attracted downwards by locally disturbing rocks, pointing rather to induction from the earth as the cause of the magnetisation of basalt.

In order to find an explanation of the causes of the observed disturbances of the needle, pieces of basalt were taken from the surface and from a working quarry, and their several effects upon a compass observed, but no information of importance was obtained from the experiments. The question of the effects of lightning on the magnetism of rocks is also discussed, but dismissed as untenable.

It should, however, be remarked that the author does not look for more than general results from the observations as carried out, but they certainly form the nucleus of a further survey from which more definite results might be obtained as to the connection between geological conformation and magnetic disturbances.

Having considered some of the effects of local magnetic disturbance in Germany, we may now turn to the remarkable effects of such disturbance on the magnetic declination in the United States as shown in the latest chart¹ of lines of equal value of that element for 1902.

This chart is a continuation of the series published by the United States Coast and Geodetic Survey, and gives true isogonals for every degree. An examination of the lines shows that some of the most remarkable disturbances occur in mountainous districts, especially in the State of California. With its lines of equal annual change of the declination this chart is decidedly valuable, both from the practical and scientific points of view.

The values of the magnetic dip and declination given in Father Doyle's pamphlet² are the result of eight years' photographic record taken at the Manila Central Observatory during the period January 1, 1890, to December 31, 1897. The position of this observatory has been specially selected with a view to avoiding magnetic disturbances either in the locality or the materials of the building. Curves of the mean hourly variation of the declination for each month of the eight years are given, and also curves of the mean annual and mean semi-annual variation of the dip and declination. The chief interest, however, of the data recorded lies in the values of the secular variation of both elements for the epoch 1887-99. In these we have corroborative evidence of the small secular change of the declination, and the large change which is so marked in the dip, which has taken place during the epoch 1880-1900 at the observatories of Bombay, Batavia, Manila and Hong Kong. A chart of the isogonic and isoclinic lines corresponding to the epoch January 1892 for the region comprised between the Philippine Islands and Southern Japan is appended.

THE "NATURE-STUDY" EXHIBITION.

THROUGH the courtesy of the Royal Botanic Society, the aims of which are by no means so purely social as some of its present interests might suggest, a "Nature-Study" Exhibition is now being held in Regent's Park. Never has there been a better undertaking, nor could one be set on foot, which would do more to bring about a rational system of teaching such as is now looked forward to, whereby the pupils may be keenly interested instead of bored and their work made a labour of love instead of a dreary task.

There have long been in this country those who appre-

¹ "Chart of Lines of Equal Magnetic Declination and Annual Change for 1902." (Published by the United States Coast and Geodetic Survey, February, 1902.)

² "Magnetic Dip and Declination in the Philippine Islands." Brief notice of the same by Rev. John Doyle, S.J., of the Manila Central Observatory (1901).

ciate the emotional delights and the intellectual pleasures accruing from a first-hand acquaintance with nature, but the magnitude and success of the present exhibition go to show how widely and how well the value of the study which this demands is becoming recognised as a branch of all general education by those more nearly concerned with it than the naturalist.

THE OPENING CEREMONY.

In the first place, the Duke of Devonshire, who presided at the opening ceremony, which was performed by the Duchess of Devonshire on July 23, said that "the new educational departure," as he termed it, had the "very warmest sympathy" of the Board of Education, of which he is the President. In the case of rural education, he continued, the Board had met with a serious difficulty, for if the agricultural labourer does value education at all, it is only too often merely because it enables him to escape from the drudgery of his existence in the country into the more exciting atmosphere of the towns. In these circumstances it is not surprising that country gentlemen and many farmers have not viewed education and educational progress with any great enthusiasm. The Board of Education was consequently very desirous of finding some means by which education, and more especially elementary education, should be brought into closer relation with rural life and with the occupations connected with the cultivation of the land. It also felt the necessity of making all classes connected with the land feel that education is a thing which is not necessarily antagonistic to, but which ought to be conducive to, their interests.

Within the last three years, the Duke went on to say, the Board received the external assistance which they required by the formation of a very influential committee (the 'Agricultural Education Committee,' of which Mr. Henry Hobhouse, M.P., is the secretary) of members of Parliament and county councils, which drew up certain resolutions which were formally laid before the Board of Education and accepted with much pleasure and satisfaction. The Duke of Devonshire then briefly indicated the changes in the elementary education code and in the directory for scientific education which had been made in accordance with the suggestions thus received. He alluded to the publications impressing upon the managers of schools the importance of making education in the village more consonant with the environment of the scholars, and more especially of encouraging children to gain an intelligent knowledge of the common things which surround them in the country. The lack of teachers is being met by the requirement of the Department that "nature-study" from a practical and experimental point of view shall be taken as one of the subjects for the certificate examination. The Duke also referred to the valuable assistance afforded by county councils, and gave it as the opinion of his Board that "nature-study" may with advantage be introduced into all schools, urban as well as rural. In conclusion, although the value of books as representing accumulated knowledge was ungrudgingly allowed, yet in the opinion of the Duke of Devonshire the study of them may too often be only an exercise of memory and may leave almost untouched the other faculties of the mind, while the intelligent observation and study of the facts of nature is a mental discipline which cannot fail to develop those powers of the mind which it is the object of all true education to discover, to cultivate and to strengthen.

THE EXHIBITION.

The number of the exhibits and the fact that all classes of educational establishments have contributed them is another argument in favour of the contention

that the appreciation of "nature-study" as a factor in education is no longer confined to a few enthusiasts. The time has passed when one could only say what might be attempted, now one can point to this training college or to that school and say what has been done. The main object of the Association was to bring the movement to this stage and to collect together as many examples as possible of "nature-study" work or of what goes by this name. Teachers who have taken up such teaching would then be able to improve their methods after an examination of others' endeavours, while those in ignorance of how to proceed or apathetic could obtain the information they required or be spurred on to attack a subject so well worthy of attention.

In order that nothing of value might be excluded, the committee admitted anything connected with natural history teaching, and contented itself with making general suggestions as to how this might be represented at the exhibition. It must be said that the immediate results have far exceeded all anticipation. A more detailed consideration of these may be considered in connection with the chief awards that have been made, and this after a third point showing the importance attached to the "nature-study" movement has been dwelt upon. The judges whose names are given below without hesitation signified their willingness to undertake what has proved an arduous task—Prof. Hall, Miall, Lloyd Morgan, Arthur Thomson and Wallace.

In Group A the Boards of Education and Agriculture are exhibiting their leaflets, and most of the agricultural colleges are represented. Seeing how much work has been done by county councils in the training of teachers, but few of them have sent exhibits; Cheshire, Hampshire and Surrey contribute collective exhibits showing the whole educational scheme of each county, and of these Surrey has received one medal for the general exhibit and another for the individual work exhibited by Tiffin's Boys' School Natural History Society properly coming into Group B (secondary schools). A large number of the latter schools of all grades have sent exhibits. Medals have been awarded to the High School, Arbroath, for drawings illustrating natural history; to St. Paul's School, for the work of the School Field Club; to Streatham High School, of the Church School Company, for a nature-study calendar; to James Allen's Girls' School, Dulwich, for the general exhibit, which contains many interesting water cultures of plants; to Bedale's School, Hants, for its scheme of nature-study; and to the Friends' School at Bootham, York, for its general exhibit, which was chiefly that of the Boys' Natural History Society.

Among the numerous elementary schools, the Chislehurst Road Board School, Orpington, Kent, received a medal for its general exhibit, as did the Arnot Street Board School, Liverpool, for its excursion scheme. The only training college similarly recognised was the House of Education, Ambleside, while among the exhibits of private persons and institutions a medal was given to the Stepney Borough Museum. Two American exhibits, namely, those of the New York Natural History Museum and Philadelphia Training College, also received the highest possible award.

A most important result which will possibly accrue from the exhibition will be the determination of what kind of nature-study teaching is to be recognised as such; for this one must look to the report of the Association after receiving the collective and individual expressions of opinion from the judges. Looking, however, at the exhibits which have received medals, it will be seen that they have in nearly all cases shown evidences of outdoor work or practical dealing with living things upon the part of pupils themselves. The fourth piece of evidence as to the value of the exhibition as promoting nature-study is afforded by the position and standing of

those who have taken part in the conferences or have promised to do so. A short account of some of the addresses and papers is given below.

THE CONFERENCES.

Mr. Hianbury, President of the Board of Agriculture, presided at the first of the meetings on July 24 and spoke of the general educational value of nature-study and of the special dependence of agricultural industry upon habits of careful observation. He further pointed out how his Board and that of Education were working in harmony together, and said with regard to those agricultural colleges which have been undertaking the training of teachers that their work ought to be recognised by the bestowal of extra grants by the Board of Agriculture.

Lord Aveybury took as the subject of the first address "The Study of Nature." He attributed a most curious ignorance of common things to the fact that great public schools omit the subject altogether, or devote to it only an hour or two in the week snatched from the insatiable demands of Latin and Greek. Oxford and Cambridge have most excellent science schools, but prizes and fellowships are still mainly given to classics and mathematics; degrees are given there, and now, alas! even at the University of London, without requiring any knowledge of the world in which we live. Our universities give excellent teaching, they prepare learned specialists, but are places of instruction rather than of education. Lord Aveybury touched also on early specialisation; on the use and abuse of collections; and the various lines along which nature may be studied.

Mr. Henry Hobhouse, M.P., read a paper on "How County Councils may encourage Nature-Study." Their chief work, he said, lies in the direction of training teachers, and this training, though not necessarily a thoroughly scientific one, should impart the elements of certain sciences, and more particularly a knowledge of the best methods of inculcating habits of observation. Mr. Hobhouse summarised what the county councils had already done, and said that much more still remained to be accomplished. As it was not to be expected that every village schoolmistress would be able to teach nature-study, an arrangement would have to be made for peripatetic teachers to visit groups of small schools: school gardens and school museums would also have to be organised. Useful work in the protection of wild birds might be done by holding classes to which gamekeepers might be specially asked to attend, and much economic nature-study could be taken up.

Prof. Geddes was unable to be present, and his paper was taken as read; its vital points are (1) that nature is a moving unity or pageant of the seasons, not an abstract syllabus of "object lessons" or even dissected "types"; (2) that the essential strategic point for the nature teacher is to give the pupil the joy of nature before the intellectual analysis of it; (3) among immediate practical possibilities, and taking excursions for granted, the essential desideratum to be secured for country and suburban schools without delay and for town schools so far as possible is the school garden, always provided this is designed to show to the full, the living seasonal beauty of its chosen plants and be not a cats' graveyard of labels, however orderly. The introduction of a flower border, however small, into the present desert playground is pleaded for on all grounds, moral as well as intellectual and æsthetic.

Prof. J. Arthur Thomson began his most interesting and suggestive paper by quoting the definition of nature-study given by his friend Prof. Geddes, it is "the habit of observing and thinking for oneself and at one's best, without books or helps, in the presence of the facts and in the open air." Prof. Thomson had next a word to say on the danger of doing nature-study teaching badly and distorting the child's outlook on the world. Given a man or woman with the mood of the naturalist, the country schoolmaster who knows and loves the birds, or the country schoolmistress who knows and loves the flowers, then the course of nature-study—now compulsory—is sure to be healthful. Given, however, a teacher who, through overwork, or preoccupation with other disciplines, or lack of early training, is only coercively, not organically, interested in nature-love, then Prof. Thomson feared that the result would be very bad indeed. The title of the paper was the "Seasonal Study of Natural History," and a sketch of a seasonal course was given, arranged so that the scholars faced appropriate problems at appropriate times.

It was argued that the seasonal order and method of study, though not the easiest, was the most natural. It was the most primitive method, yet the exhibits seemed to show that it was capable of being the most evolved. It followed up the pre-school education of the child, and was justified by physiological and psychological facts. Furthermore, the seasonal method worked exceedingly well in practice, being always relevant to what the pupils are seeing and feeling out of school, facilitating the desirable cooperation of the class in securing the specimens for the actual work, and being readily correlated with other school studies.

Mr. H. Coates illustrated the subject of local museums as aids in the teaching of nature with reference to Perth Museum, in connection with which children's essay competitions are most successfully held.

Lord Strathcona, as chairman at the second conference on July 28, gave an account of work in Canada carried out by the generosity of Sir William McDonald, who has given three-quarters of a million of money. Model farms were touched upon, and Lord Strathcona gave a particularly interesting account of his own work in introducing vegetable culture into Labrador, which had previously been unknown.

Prof. Lloyd Morgan had also a definition to give when dealing with nature-study in elementary education. He said that it was "a means by which simple natural objects and processes acquire meaning." Like Prof. Thomson's paper, the whole question is so carefully considered that no brief notice could do it justice. The movement which the meeting was to foster and develop, according to the speaker, is part of that reform of educational procedure which has been in progress for many years. One of the points to be regarded is the patchiness of a child's mind, to whom even the beginnings of science are impossible. The teacher, say a scientific botanist, must not, therefore, get tired of fostering the powers of observation and affording facilities for simple investigation, and instead endeavour to inculcate general laws and principles beyond the comprehension of the child. Technical terms where they are simple nouns and not descriptions are allowable, but after reading a long description of the dandelion taken from a nature-study book Prof. Morgan begged his hearers to stop before they got to "anthers syngenesous."

Mr. Franklin dealt with how to bring children into touch with nature, and the work of the Leicester School Board was described by Mr. Major. Miss Mary Simpson, in speaking of the teacher as an observer, suggested that if the teacher had reached that stage most of the difficulties would be gone. Finally, at this meeting, which during the latter half was presided over by Sir Joshua Fitch, Mr. John Evans urged the advantages of using trees as a means of nature-study.

On Tuesday, July 29, the chair was taken by the Lord Balfour of Burleigh, K.T., Secretary for Scotland. He gave an account of the excellent progress of the "nature-study" movement started several years ago across the border. "Nature-study," he said, must be rather looked upon by the children as recreation; their minds must not be filled with facts, but must be taught to make observations and to investigate. If this were done it would redound to the credit of education in all countries.

Mr. Choate, the American Ambassador, in introducing Prof. Albert Bickmore, of the Natural History Museum, New York, added the weight of his testimony to the value of the work in hand. After this Prof. Bickmore briefly explained his methods of visual instruction, at first geographical and now combined with nature-study; and after the conference in the club-room the audience adjourned to the museum in the gardens to see a series of views thrown upon the screen with the lantern to illustrate further Prof. Bickmore's methods, with children, older scholars, university students and teachers. He began his work with a class of 28, and last winter the attendance at his lectures was 26,910.

Mr. Herbert Morrell, M.P., brought forward many trenchant and amusing examples of the value of "Nature-Study in relation to Rural Pursuits."

Prof. Hall, of Wye College, in defining the "Proper Attitude of the Teacher," had some excellent points to lay before his hearers. He appeared, however, to think, contrary to others interested in the subject, that "facts" must be accompanied by "ideas" which brings it near to elementary science teaching. The subject taken from the standpoint of a teacher in an elementary school and considered in a paper by Mr. G. H.

Rose, headmaster of Caterham Board School, has much in it that others less nearly connected with the work might fail to recognise, and will prove well worthy of careful examination when it is printed.

The remainder of the programme is as follows:—

Thursday, July 31, chairman, Sir George Kekewich, K.C.B., Secretary to the Board of Education. Address on "Nature-Study in Colleges and Higher Schools," by Prof. Mall, F.R.S. Selected speakers:—"Nature-Study in Girls' Secondary Schools," Miss Mary Gurney; "Plant Life as Nature-Study," Mr. Scott Elliott; "School Gardens," Mr. T. G. Rooper; "Geology as a Branch of Nature-Study," Prof. Grenville Cole.

Friday, August 1, chairman, the Right Hon. Sir W. Hart-Dyke, Bart., M.P. Address on "The Training of Teachers in Nature-Study" by the Rev. Canon Steward. Selected speakers:—"The Relation of Nature-Study to School Work and to the Home," Sir Joshua Fitch; "Nature-Study as an Element of Culture," Mr. M. E. Sadler; "School Rambles and the Training of Teachers," Mr. J. H. Cowham; "The Present Work of the County Councils," Mr. H. Macan.

In conclusion, it must be said that the work of bringing the undertaking to such a successful issue has taken the whole time and energy of Mr. J. C. Medd, the honorary secretary, who has had at his disposal the great experience and the marvellous tact of Sir John Cockburn, the chairman of the Association; Mr. Cundall, of the Victoria and Albert Museum, Mr. A. T. Simmons and Mr. A. Taylor, I.I.M. sub-inspector, to whom the task of arranging the exhibits was allotted, must also be given a full measure of praise. WILFRED MARK WEBB.

NOTES.

THE members of the new Order of Merit were entertained at dinner by the Athenaeum Club on Friday last. Science was represented by four of the twelve members of the Order—Lord Rayleigh, Lord Kelvin, Lord Lister and Sir William Huggins. Lord Avebury (trustee of the club) presided, and among other members present were many leaders of science, art and literature.

A NEW laboratory for the study of experimental psychology has been instituted at King's College, London. The laboratory will be in charge of Dr. W. G. Smith, under Prof. Halliburton's general supervision.

THE *Times* states that during her passage from Kronstadt to Kiel the Italian cruiser *Carlo Alberto* carried out some important experiments in wireless telegraphy under the personal direction of Mr. Marconi. Signals were exchanged with stations 2000 kilometres distant, 1000 kilometres by sea and 1000 kilometres by land.

PROF. F. A. FOREL writes from Morges to say that he has made inquiries into the report that after a shower of rain at Frauenfeld, Canton Thurgau, Switzerland, the ground was covered with a thin layer of ashes of greyish-blue colour (p. 306). A teacher of natural history at Frauenfeld has informed him that the news was misleading and that the dust was not of volcanic origin.

A TELEGRAM from Kingstown, St. Vincent, states that there have been two slight eruptions of the Soufrière volcano since July 21, and an earthquake in the north-eastern part of the island. The cable steamer *Newington*, which is working eighteen miles to the north, reports that the depth of the sea has increased in that locality to a mile and a quarter.

THE *Daily Mail* correspondent at Madrid reports that two large cliffs near the town of Calatayud, in Aragon, have fallen down, destroying several houses and injuring many people. A crater has opened in the Pico de Europa mountains, which

separate the provinces of Santander and Asturias. A great column of vapour is issuing therefrom, and the people are in a state of alarm, fearing a volcanic eruption. A Central News despatch from the Azores states that there has just been a terrific submarine volcanic eruption off Horta. Masses of rock in a state of incandescence were thrown up, and the people became panic-stricken. A Reuter despatch from San José, Costa Rica, states that there has lately been unusual activity among the Costa Rican volcanoes, considerably affecting the land in the neighbourhood of Terraba. From New York another Reuter despatch records that an earthquake shock was felt shortly after midday on Monday, July 28, in parts of Nebraska, Iowa and South Dakota, but no damage was done. Three shocks have also occurred in the Pomoc Valley, California, since Sunday evening, July 27. Cracks appeared in the earth and there was widespread panic among the inhabitants. Vibrations have also been felt at other places in California.

THE *Westminster Gazette* on Saturday last devoted a column and a half to the Armstrong-Orling system of wireless telegraphy. We have referred on two or three occasions to this system, the receiving apparatus of which was described in these columns last December. We now understand that a company is about to be registered to manufacture and supply the transmitters and receivers. It is stated that apparatus has been worked out suitable for wireless signalling up to a distance of twenty miles, the ground being used as a conductor, and that it will be sold, at a very cheap rate, for private installations. Details of a technical nature are, however, entirely wanting, and without these it is impossible to form any opinion of the system. So far as we know no description of the transmitter has been published, although we were told eight months ago that it was proposed to read a paper upon it before one of the scientific societies. We have also consulted the patent files, but there is nothing in Mr. Orling's name as yet printed which is specially novel or remarkable. It is therefore advisable to wait until further particulars are available before deciding whether the "programme of amazing promise" sketched in the *Westminster Gazette* is likely to be realised.

WE regret to see the announcement of the death of the Rev. Charles E. Searle, master of Pembroke College, Cambridge, and formerly college lecturer in mathematics.

IN the House of Commons on Monday, Mr. J. A. Dewar asked whether it could be made a condition of the annual grant of 15,300*l.* to the Meteorological Council that the high-level and low-level observatories at Fort William should be kept in a state of efficiency, or whether an additional contribution towards the expenses of properly maintaining these observatories would be considered. In reply, Mr. Balfour said he had been advised it would not be desirable to impose conditions on the Meteorological Council or to inquire into this or that particular observatory. He was not prepared to give an answer to the last part of the question.

THE decision to close the observatory on Ben Nevis was discussed at the general meeting of the Scottish Meteorological Society, held in Edinburgh last week. Lord Maclaren, who presided, said that the observatory would have to be closed because there were no funds available for carrying on the work. He thought it was a case for inquiry, and if the Government appointed a committee to take evidence, probably the difficulties would be overcome. Sir John Murray, as one of the original directors, said it was not their intention to found a permanent institution, but only to make an experiment of high-level observations. The experiment had been most satisfactory in every respect. But the observatory must now be closed unless one of two things happened; either the State must take over

the observatory, or the directors must be put in possession of 12,000*l.* worth of consols to enable them to carry it on for another meteorological cycle.

PRINCE AUGUSTE D'ARENBERG, president of the Suez Canal Company, has sent a letter to the president of the Liverpool School of Tropical Medicine asking for the cooperation of the school in a concerted effort to cope with the prevalence of malaria in Ismailia, and making a formal request for the services of Major Ronald Ross, C.B., F.R.S., to start operations there against mosquitoes. The committee of the school has acceded to the request, and is making arrangements to enable Major Ross to proceed to Ismailia in September next, when malaria is especially prevalent. Major Ross will begin by starting an organised campaign against malaria, and will go out again later in the year to carry it through.

THE Prince of Wales has consented to act as president of the fund which has been established for the purpose of conducting research into the nature, causes and cure of cancer. The vice-presidents of the fund are the Lords Lister and Strathcona, the Right Hon. Arthur Balfour, Sir Frederick Bramwell, Sir William Broadbent and Mr. Bischoffshelm. The executive committee is composed of Sir W. Broadbent, Sir W. Church, Sir H. Howse, Drs. Sydney Martin, Pye-Smith and Rose Bradford, Prof. Sims Woodhead, and Messrs. Langton, Henry Morris, Butlin, McFadyean and Watson Cheyne. The money contributions actually paid amount to 32,391*l.*, and promises of 4100*l.* more have been received, making a total of 36,491*l.* towards the full amount of 100,000*l.* originally asked for. Work will be commenced with the sum in hand, but it is hoped that the full capital required will be subscribed.

NATURAL science in Ceylon has sustained a severe loss by the untimely death of Mr. Oliver Collett, F.R.M.S., who, while carrying on actively his vocation as a tea planter, found time for excellent original work both in the field and laboratory. He devoted himself especially to the Mollusca; and a genus and several species of land shells bear his name. As a member of the Ceylon branch of the Royal Asiatic Society he contributed various papers on zoological questions. He also brought his scientific knowledge to bear on some economic questions in connection with the cultivation of tea, and was much esteemed by his fellow planters, being at the time of his death chairman of the local Planters' Association. Mr. Collett, who was thirty-five years of age, possessed a very attractive personality, and many, both at home and in Ceylon, who were brought in contact with him by common interests, deplore the loss of a charming friend and an enthusiastic naturalist. He died on June 13 somewhat suddenly at Colombo, from an attack of dysentery.

A MEETING of the Institution of Mechanical Engineers was held at Newcastle on Tuesday and Wednesday, July 29 and 30. Among the papers down to be read were:—"Liquid Fuel for Steamers," by Mr. E. L. Orde; "Some Experiments on Steam-Engine Economy," by Prof. R. L. Weighton; "Pumping Plant for Condensing Water," by Mr. Charles Hopkinson; "Mechanical Appliances in Mines (Drilling and Coal Cutting)," by Mr. R. H. Wainford; "Recent Developments in Pneumatic Tools and Appliances," by Mr. Ewart C. Amos; and "Motor Cars of 1902," by Captain C. C. Longridge.

A FEW weeks ago (July 3, p. 227) we gave a short account of the investigations into the connection between the magnetic currents in the earth and the Aurora Borealis, which Prof. Kr. Birkeland conducted in the winter of 1899-1900 at two stations Talvik and Halde, on the summits of two mountains to the west of Bossekop, Altenfjord, in Lapland. Prof. Birkeland

recently left Christiania for Archangel in order to start from there on July 23 and proceed to Matoschkin Strait, Nova Zemba, to organise and set in working order a similar station and leave it in the hands of four observers before returning to Norway. At Bossekop, where observations will also be made, the observatory is admirably situated on the summit of Halde Mountain; for at the base a tunnel belonging to a copper-mine runs for 250 metres into the mountain, and registering apparatus can be set up in it. Simultaneous observations can thus be made on the electrical currents in the atmosphere and in the earth. The third station will be on Axel island, Spitsbergen. A fourth station, with two observers, will be at Dyrafjord, Iceland, and researches will be carried on for about a year at all of them. In order to supplement his own observations and compare them with others, Prof. Birkeland has invited more than a hundred magnetic and meteorological observatories to make simultaneous observations, and has received promises of cooperation from many of them.

WRITING from St. Petersburg on July 22, Mr. J. F. Baddeley gives in the *Times* a few details of a serious glacier disaster in the Caucasus, news of which has been received from Vladikavkaz. Between Mont Karbek and Ghimari Khokh a glacier descends into the narrow wedge-shaped valley of the Ghenal Don, which, after a course of about thirteen miles, nearly due north, joins the Ghizel Don, a tributary of the Terek. Like most of the glaciers in the Caucasus, that of the Ghenal Don has of late years receded considerably, and some thirty years ago copious springs of hot sulphur water were uncovered, which had formerly made their presence known by the steam that forced its way through the ice. About the middle of July the end of the glacier suddenly broke off and slid down the valley, causing the loss of thirty-two lives. On July 19 another huge block of ice broke off and followed the first with terrible rapidity for eight miles down the Ghenal Don. Similar catastrophes have frequently occurred on the Georgian Road, in the valley of the Terek, owing to icefalls from the Devdoraki Glacier, north and slightly east of Kazbek; but Mr. Baddeley says he has not met with any mention of previous cases in connection with the Ghenal Don.

EVIDENCE that the competition of the electrical tramway is making itself seriously felt is afforded by the fact that the North-Eastern Railway Company has decided to start working some of its local lines near Newcastle-on-Tyne electrically, and has already invited tenders for the electrical equipment of the substations, permanent way and coaches. It is also reported that the Lancashire and Yorkshire Railway Company is about to make a practical test of electrical running on one of its branch lines near Manchester.

A RECTIFIER for alternating currents devised by Messrs. G. H. Morse and C. R. Cushman is described by the former in the *New York Electrical World and Engineer* for July 19. An electric arc is burnt between three carbon points which are placed in a strong magnetic field; the arc burns between the upper carbon and one or other of the lower carbons, according to the direction of the current. The alternating current is thus divided into two pulsating direct currents, and experiments have shown that, with a proper adjustment of the strength of the magnetic field, the length of arc, &c., the rectification can be made practically complete; that is to say, two direct currents can be obtained each equal to half the alternating current.

ELECTROCHEMISTRY has made enormous strides on the continent and in America. But chemists and electricians in this country have, for some reason best known to themselves, shown a want of interest which is absolutely astonishing. Almost every university and technical institute in Germany has

an electrochemical laboratory, or if there is no special laboratory at least the subject is taught, and the same may be said of America. France also is making considerable headway in the teaching of electrochemistry. Here in this country the whole subject has been practically ignored. In order to try to bring the claims of this very important science before the scientific world and to interest manufacturers in electrochemistry, a small committee of electricians and chemists has been sitting since March in order to see whether it would not be possible to form a British Electrochemical Society. A fair amount of support has been promised, and the committee is now sending out circulars inviting cooperation in the formation of the proposed society. It is to be hoped that there will be a ready response to the invitation, so that all who are interested in electrochemistry may combine their efforts to promote its advancement in this country.

INTERNATIONAL balloon ascents were made on the morning of March 6 in France, Germany, Austria and Russia, and kites were also sent up by Mr. Rotch at Blue Hill, Boston, U.S.A., on the previous evening. The following are some of the preliminary results of the highest unmanned ascents:—Itteville (near Paris), temperature at starting, $2^{\circ}8\text{C}$.; greatest height reached, 14,000 metres; lowest temperature recorded, -67°o . Strasburg, temperature on ground, $-0^{\circ}4$; at 9300 metres, -54°o . At Blue Hill the kites ascended through a thick snowcloud; the lowest temperature, -7°o , was recorded at a height of 1658 metres; above this the temperature rose, and at a height of 2000 metres it reached $-2^{\circ}4$. Over Europe an area of high barometric pressure prevailed, while at Blue Hill the kite rose on the north-west side of a deep depression, the centre of which lay over the Atlantic.

THE results of the meteorological observations made at the Rousdon Observatory, Devon, during the year 1901 have been published by the Hon. Lady Peek. The observations have been regularly made, as hitherto, by Mr. C. Grover, and the tables have been prepared for publication under the supervision of Mr. W. Marriott, assistant secretary of the Royal Meteorological Society. The volume also contains an account of damage done by lightning to a room occupied by two persons on the night of June 29-30. The results of this valuable series of observations for the years 1884-1900 are discussed by Dr. J. Hann in the current number of the *Meteorologische Zeitschrift*, chiefly from tables given in the previous volume (1900). In this discussion Dr. Hann lays stress on the advantage of calculating the mean monthly and yearly extremes of temperature and pressure instead of merely quoting the absolute extreme readings, because the latter may only refer to any one of the years under discussion, and are not comparable with the results of a series of years.

AN interesting instance of that adaptability to changing tastes and conditions which is the mainspring of progress in industry as well as in science is afforded by a note in the *Journal of the Society of Arts* (July 18). For some years the demand for claret has greatly diminished in favour of the wines of Champagne, and has seriously affected the wine industry in the Bordeaux district. Several proprietors in the Médoc have, however, now commenced the production of sparkling wines by the same process as champagne is made, and their action has been the means of developing practically a new industry. It may at first seem strange that white wine should be able to be made in the Médoc, where only black grapes are grown, but as a matter of fact champagne is almost entirely made from black grapes, and the most celebrated vineyards in the Champagne district are all planted with them. The colour of the wine depends only on the way in which the wine is made. All the colouring matter is in the skin, while the fruit itself is colourless, or nearly so. If the

whole of the grape, skin and all, be allowed to ferment together, the colouring matter in the skin will be dissolved in the juice of the grape, and the wine produced will be red. If, on the contrary, the skin be removed before the fermentation begins, the wine will be white. Sparkling wines require much more working and preparation than still wines, and a second fermentation has to take place when the wine is in bottle, and it is this which gives the gas. The wine has to pass through a long series of operations, which have to be carried out, from first to last, under a perfectly even temperature. For this reason, the cellars in the Champagne district are dug out often to a great depth in the chalk. It would have been impossible to find such cellars in the Médoc, where the soil is of a gravelly nature, but at Bourg, on the right bank of the Gironde, opposite the Médoc vineyards, there are cliffs of Oolitic limestone, whence the stone has for centuries been quarried. The stone has been quarried out in long galleries, which are now adapted for cool cellars, with a perfectly even temperature all the year round, and in these the sparkling médoc is made in identically similar circumstances to the wines of Rheims or Epernay. It is stated that to the ordinary taster there is nothing but the label to distinguish the sparkling médoc from the best brands of champagne. Another white sparkling wine is made at St. Emilion, and the cellars are in the caves below the ruins of an old monastery, from which the wine takes its name.

In a note contributed to the *Atti dei Lincei*, xi. (1) 10, by Signor E. Daniele, dealing with certain particular cases of motion of a point in a plane, we notice the following interesting conclusion:—"In the motion of a point under a central force, the trajectories can be divided into an infinity of isothermal orthogonal systems, when the force is proportional to any power of the distance."

THE theory according to which the properties of colloidal substances are attributed to particles in a fine state of suspension is advanced by Dr. J. Billitzer in a recent communication to the Vienna Academy (*Sitzungsberichte*, No. 9). The author starts with the assumptions that we have to deal with a fine suspension and that the particles of this are oppositely electrified to the fluid. From these hypotheses numerous important conclusions are derived, and an attempt has been made to answer the principal objections to the theory.

A MATHEMATICAL investigation of the principles of the seismograph is given by Dr. M. Contarini in the *Atti dei Lincei*, xi. (1) 10. In this paper the author passes from the problem of the motion of a chain of rigid bodies, the first of which is fixed to the ground by at least one point, to the special case of two bodies only. It is shown how with such a system it is possible to determine four out of the six components of the seismic disturbance. For the other two components an instrument resembling the Vicentini microseismograph may be used.

THE question as to whether bats are capable of transmitting bubonic plague is discussed by Dr. B. Gosio in the *Atti dei Lincei*, xi. (1) 10. During a recent small epidemic at Naples it was suspected that the disease emanated from a building completely isolated by walls from the town, and with separate drainage, and the idea suggested itself that the infection must have been carried by the numerous bats that were constantly flying around the building. Dr. Gosio accordingly made experiments by inoculating specimens of *Vespertilio noctula* with doses of the virus varying from 0.5 c.c. to 0.05 c.c. of cultures developed for twenty-four hours. The result was that in every case the bats contracted the disease and died in a comparatively short interval, and on examination all the organs of the dead animals were seen to be rich in germs. It is suggested that the

numerous parasites with which the bat is commonly affected may be the means of propagating the germs, and this view is confirmed by experiments previously made in the author's laboratory on the common flea. A further confirmation is afforded by the observation that subcutaneous injections of infected matter, even in small quantities, are sufficient to transmit the disease to bats.

THE *Zoologist* for July contains but two papers, the one, by Dr. A. G. Butler, on birds in captivity, the other, by the Messrs. Ticehurst, on birds met with in Finmark.

THE "corallines," or calcareous algae, of Japan form the subject of a memoir by Mr. K. Yendo in the second part of vol. xvi. of the *Journal of the College of Science of Tokyo*, the other two articles in the same issue being also devoted to botanical subjects.

IN the first part of vol. lxxii. of the *Zeitschrift für wissenschaftliche Zoologie*, Herr E. Schultz continues his studies in "regeneration," taking as his text the turbellarian worms. The superficial nerve-cells in the spinal chord of birds and reptiles form the subject of an article in the same journal by Herr A. Kükliker.

To the *Aarborg* of the Bergen Museum for 1902, Mr. J. A. Grieg contributes a review of the echinoderms of northern Norway; while Mr. H. Friele describes the molluscs obtained during the cruise of the fishery steamer *Michael Sars* in the North Sea during the summer and autumn of 1900. In the latter paper several new forms are named. A third article, by Mr. H. H. Gran, forms the continuation of a memoir on marine bacteria.

IN a memoir on a new generic type (*Gephyrocrinus*) of crinoid dredged by the Prince of Monaco at a great depth in the Atlantic, the authors, Messrs. Koehler and Bather, state that it is allied to *Hyocrinus*, represented by a single species obtained by the *Challenger*. Only one specimen, and that imperfect, of the new form was obtained. The paper is published in vol. xv. of the *Mémoires of the French Zoological Society*.

FROM an article in the *Egyptian Gazette* we learn that the additions to the Zoological Gardens at Ghizeh during May and June were seventy-six in number, and include many very valuable and rare animals. Nearly all are natives of the Nile Valley except four Capuchin monkeys from South America, received in exchange, and a specimen of the two-humped Bactrian camel, which has been purchased and delivered in Egypt through the assistance of Dr. Büttikofer, the well-known Swiss naturalist, now Director of the Rotterdam Zoological Gardens, where this species of camel is bred with success. In Egypt, where the one-humped camel is so well known, it is especially interesting to be able to see a specimen of the two-humped camel, and to the native visitor it is perhaps the most astonishing animal in the menagerie.

AT a special memorial meeting held on April 25 of this year under the joint auspices of the Natural History Society, the Teachers' School of Science and the University of Boston (of which an account appears in vol. xxx. No. 4 of the *Proceedings of the first-named society*), addresses were delivered in commemoration of the work of the late Prof. A. Hyatt. According to the inaugural address, Hyatt was born at Washington in 1838 and died suddenly at Cambridge, Mass., in January of the present year on his way to attend a meeting of the Boston Natural History Society, of the museum of which he was so long curator. Hyatt "was professor of zoology and paleontology at the Massachusetts Institute of Technology from 1870 to 1888, and professor of biology at Boston University from 1877. He

was the founder of the seaside laboratory at Annisquam, and took the leading part in the foundation of the Teachers' School of Science and of the American Society of Naturalists."

ONE evening in the autumn of last year, while strolling on the beach of a small watering-place near Christchurch, New Zealand, Dr. A. Dendy picked up a small gelatinous object thrown up by the tide. On examination this object turned out to be a relatively large pelagic hydroid polyp. When found it was in a moribund condition, and the body was seen to be covered with a number of medusae in various stages of development. A full account of this remarkable organism is given by its discoverer in the July issue of the *Quarterly Journal of Microscopical Science*. The organism, which is endowed with free-swimming power, indicates an entirely new type of hydroid, for which the name *Pelagohydra mirabilis* is proposed. Structurally it comes nearest to the aberrant *Corymorpha*. "It is a very curious fact," remarks the describer, "that two distinct genera of tubularian hydroids agreeing in such striking anatomical peculiarities should have become adapted to two such different modes of life, the one (*Pelagohydra*) swimming freely in the open ocean, and the other (*Corymorpha*) rooting itself in the sand at the bottom. . . . So far as I am aware, there is no other hydroid yet known which has become specially adapted to a pelagic mode of life."

A NEW popular edition of Mr. Oliver G. Pike's pleasantly written book entitled "In Bird-Land with Field-Glass and Camera" has been published by Mr. T. Fisher Unwin. The book is illustrated by eighty-three reproductions of photographs of birds and nests taken direct from nature by the author. A notice of the original edition, with one of the illustrations, appeared in NATURE two years ago (vol. lxiii. p. 418).

MR. HENRY FROWDE will publish shortly the first instalment of the "Tebunis Papyri" found by Dr. B. P. Grenfell and Dr. A. S. Hunt at Umm el Baragât in the south of the Fayum and edited by them, with the assistance of Mr. J. Gilbert Smyly. This volume deals with the papyri in which the mummies of crocodiles were wrapped, and they date from the end of the second or the early part of the first century B.C. Mrs. Hearst supplied the funds for the excavations on behalf of the University of California, and this volume inaugurates a series of publications by the University dealing with Egyptian archaeology. The book is being issued conjointly by the Egypt Exploration Fund to subscribers to the Græco-Roman branch.

IN the July number of the *Moniteur Scientifique*, Prof. Zinno describes a synthesis of tartaric acid suitable for the production of this substance on the large scale. The method consists in passing a current of carbonic acid gas under a pressure of about three atmospheres over potassium glycerate, the reaction being very similar to that of Kolbe by which sodium salicylate is produced. Potassium glycerate is easily obtained by oxidising glycerin by means of lead dioxide or minium and nitric acid, and then adding to the boiling solution of the lead salt potassium carbonate. Numbers are given in the paper which show that cream of tartar can be produced by this method at a cost which should justify the commercial development of the process.

THOSE who are interested in the sulphuric acid industry will find a noteworthy series of articles bearing upon the subject in the July number of the *Moniteur Scientifique* under the title "Grande Industrie Chimique." The first of these, by Messrs. Nidensfuhr and Luty, is entitled "A comparative economic study of the manufacture of sulphuric acid by the anhydride and the modern lead chamber processes." Much interesting matter is contained in the paper, and the authors arrive at the conclusion that at the present time the lead chamber processes, when conducted properly, are considerably more economical than the

contact processes, so far as the production of acids which are not very concentrated is concerned. For the manufacture of the strongest acids, however, numbers are given which indicate that the contact process is considerably superior to the older process from the commercial point of view. The other articles on the subject deal with more recent alterations which have been made in the lead chamber process, the theory and practice of sulphuric acid manufacture and the treatment of platinum residues.

THE additions to the Zoological Society's Gardens during the past week include a Side-striped Jackal (*Canis lateralis*), a Young Leopard (*Felis pardus*), a Spotted Hyæna (*Hyæna crocuta*), a Harnessed Antelope (*Tragelaphus scriptus*), a Nagor Antelope (*Cercicapra redunca*), a Marabou Stork (*Leptoptilus crumeniferus*), a White-necked Crow (*Corvus capulatus*), a Spur-winged Goose (*Plectropterus gambensis*), two Red-backed Pelicans (*Pelecanus rufescens*) from Gambia, West Africa, presented by Captain Sir George C. Denton, K.C.M.G.; a Striped Hyæna (*Hyæna striata*) from Gambia, West Africa, presented by Captain MacCarthy Morrogh; a Black-eared Marmoset (*Hapale penicillata*) from South-east Brazil, presented by Mrs. Armynt Thornton; a Yellow-fronted Amazon (*Chrysotis ochrocephala*) from Guiana, presented by Miss Ellen Cull; a Red-winged Parakeet (*Ptilites erythropterus*) from Australia, presented by Miss E. P. France; a Pale-headed Parakeet (*Platyercus pallidiceps*) from Australia, presented by Mr. Thomas Morson; a West African Python (*Python sebae*) from West Africa, presented by the Rev. H. Ross Phillips; two European Tree Frogs (*Hyla arborea*), European, presented by Mrs. Sidney Wolton; a Thar (*Hemitragus jemlaica*), a Yak (*Poepagus grunniens*) born in the Gardens.

OUR ASTRONOMICAL COLUMN.

ASTRONOMICAL OCCURRENCES IN AUGUST:—

- August 1. 15h. 25m. to 19h. 8m. Transit of Jupiter's Sat. III.
4. 11h. 34m. to 16h. 29m. Transit of Jupiter's Sat. IV.
5. 5h. Jupiter in opposition to the sun.
8. 12h. 38m. Minimum of Algol (β Persei).
10. 8h. 29m. to 9h. 32m. Moon occults 8 Librae (mag. 5.3).
10. 8h. 41m. to 9h. 35m. Moon occults a Librae (mag. 3.0).
11. 9h. 27m. Minimum of Algol (β Persei).
- 11-12. Maximum of the Perseid meteoric shower.
15. Venus. Illuminated portion of disc = 0.886. Mars = 0.965.
18. 17h. 1m. to 17h. 22m. Moon occults ϵ^1 Capricorni (mag. 5.2).
28. Saturn. Outer minor axis of outer ring = $16''\cdot48$.
30. 4h. 37m. to 8h. 20m. Transit of Jupiter's Sat. III.
31. 11h. 10m. Minimum of Algol (β Persei).

A NEW ALGOL VARIABLE.—Prof. Pickering announces the discovery of a new Algol variable ($+43^{\circ}4101$) by Mrs. Fleming, at the Harvard College Observatory.

Two plates, taken with the 8-inch Draper telescope on March 7, 1900, and April 3, 1902, respectively, were being examined in order to discover, if possible, a trace of the image of Comet 1902 a on the latter plate. This search was unsuccessful in its immediate object, but Mrs. Fleming noticed that the image of a faint star, the position of which for 1900 was R.A. = $21^{\text{h}}\ 55^{\text{m}}\ 21^{\text{s}}$, Dec. = $+43^{\circ}\ 52'$, showed a variation in magnitude during the interval between the taking of these two plates, and on examining more plates it was found that generally the light was bright and constant, thus showing the star to be of the Algol type.

The period is about 31.4 days, and the star retains its maximum brightness (photographic magnitude = 8.9) for twenty-eight days and then decreases to minimum by the following steps:—9.0 m. at 1.05 d. before minimum, 9.5 at 0.94 d., 10.0 at 0.84 d., 10.5 at 0.71 d., 11.0 at 0.58 d., and 11.5 at 0.43 d.

NO. 1709, VOL. 66]

The light then remains constant at 11.6 m. for more than half a day. The times of increase are apparently the same as those of decrease, but this is not conclusively indicated. (*Astrophysical Journal*, No. 5, vol. xv.)

SPECTROSCOPY OF THE SOLAR ECLIPSE OF MAY 18, 1901.—In No. 5, vol. xv. of the *Astrophysical Journal*, Mr. W. J. Humphreys gives an account of the United States Naval Observatory Eclipse Expedition to Sumatra last year, and a reduction of the spectrograms obtained.

Excellent photographs of the corona were obtained, the celostat used having a mirror at either end of its heavy polar axis, one supplying the light to the coronagraph, the other to the spectroscope.

The concave grating used was of 30 feet focal length and had a diffracting surface 8 inches long and 5 inches wide; the whole of this area was not used, however. To obtain good uniform focus heavy celluloid films were used, and these were 2½ inches wide and 36 inches long.

Six films were exposed, and the reductions of the spectra are set out in tabular form, 330 lines between $\lambda\ 3118$ and $\lambda\ 5204$ having been measured. Neglecting those due to hydrogen and helium, the lines are chiefly those belonging to the Mendeleeff series which terminates with the Fe, Ni, and Co groups.

Incidentally observing the shadow bands, Mr. Humphreys found that they were stationary at first, but another observer noted that afterwards they widened out and then attained an increasing velocity.

Mr. Humphreys concludes his report with some useful suggestions which might be profitably considered by future eclipse observers.

REPORT OF THE CAPE OBSERVATORY FOR 1901.—Sir David Gill, in this report, announces the completion and official inauguration of the 24-inch "Victoria" telescope presented to the observatory by Dr. Frank McClean.

The transit circle has been completed and effectively mounted, the house being of a semi-cylindrical form, of which the two halves may be drawn aside at right angles to the axis when observations are to be taken. Owing to the loose nature of the upper rocks, the standard azimuth marks have had to be placed on the surface of the solid rock at the bottom of shafts some 30 feet deep, from which the marks are reflected to the instrument. The heliometer has been cleaned and repaired, and observations of the oppositions of Mars, Jupiter and Saturn have been made. Some thirty observations of the distances and position angles of Jupiter's satellites have also been completed.

The equatorials have been used for observing the phenomena attending ninety-seven separate occultations, to observe Giacobini's comet and the great comet of 1901, and to seek, without success however, for Encke's comet. Thirteen previously unrecorded double stars have been detected by Mr. Innes, the most interesting of them being τ_2 Lupi, $h\ 4625$ (chief star) and C.G.A. 2861. The 7-inch equatorial has been used for the revision of the C.P.D., and incidentally the unsuspected variability of the following stars has been detected:—C.P.D. = $51^{\circ}\ 22'75$, anonymous, Cor. D.M. = $22^{\circ}\ 14789$, the ranges of variability being from 8.6 m., 9.8 m. and 9.4 m. to invisibility respectively. The character of the second star is not completely known yet, but it is suggested that it may be a Nova, R.A. = $11^{\text{h}}\ 14^{\text{m}}\ 14^{\text{s}}$, Dec. = $61^{\circ}\ 10'\ S$. (1875).

The geodetic work has been actively prosecuted throughout the year, the geodetic arc of meridian having now been carried to the Zambesi, and an effective service of time signals has been distributed throughout the Colony.

WORK AT THE ATHENS OBSERVATORY.¹

YEARS ago, under the vigorous direction of the late Prof. Schmidt, the Athens Observatory acquired a distinction that was denied to some kindred institutions more favoured with instrumental equipment and substantial endowment. Since that time evil days have fallen on the National Observatory of Greece and its record of useful work has been broken; but it is now a pleasant task to record that a period of renewed activity appears likely to make itself felt in the future conduct of this ancient centre of scientific work. The third volume of the

¹ "Annales de l'Observatoire National d'Athènes." Publiées par Démétrius Eginitis, Directeur de l'Observatoire. Tome iii. Pp. 376. (Athènes: Imprimerie Royale Raftanis-Papageorgiou, 1901.)

"Annales," which has just appeared, devoted mainly to meteorological and climatic inquiries, is perhaps of a modest character viewed from a scientific standpoint; but it shows that the present director, M. Egnitis, is alive to the importance of creating a broader scientific interest throughout the country, which may be productive of greater energy and lead to the establishment of a well-supported institution. If this be the intention of the director, the means he has employed are excellent. For M. Egnitis has endeavoured to interest a number of the better instructed class, such as civil engineers, professors of mathematics in the colleges and schoolmasters, in meteorological and seismological inquiries, and has induced the Government to provide a simple instrumental equipment at stations where it could be properly employed. The result is that he has distributed throughout Greece and the Ionian Isles a number of centres whence climatic observations are regularly forwarded to the central observatory at Athens and there reduced.

The results for the years 1894-9 are printed in this volume, and we regard the fact that the dormant energies of a large number of people are interested, and the habit of continuous observation encouraged, as of greater importance than the actual observations collected. The public is being trained to expect a certain amount of scientific work from the Government officials, and demands for a further advance will be made and will be granted, when urged by competent observers backed by a growing scientific opinion. We would urge M. Egnitis steadily to pursue the methods which he has introduced, and which cannot but be productive of a lasting and beneficial result.

Two memoirs from the director accompany the volume, one a discussion of the observations of meteors made at the observatory, the other on the distribution of earthquakes throughout the day and year as recorded at the Grecian stations. In 1899, M. Egnitis reports 567 earthquake shocks, of which 271 occurred in the spring against 62 in the summer months, and this peculiarity is in general agreement with a more extended inquiry embracing the period 1803-8. With regard to the relative position of the earth and moon; in which the latter might be presumed to have some slight effect in displacing the arrangement of internal rocks as the consequence of a tidal flow, M. Egnitis finds that there is no noticeable connection between the frequency of seismic disturbance and the position of the moon in its orbit. A description of the effects experienced on the occasion of the earthquake at Triphylie on January 22, 1899, concludes this section.

VIBRATIONS OF BRIDGES.

THE last volume issued by the Earthquake Investigation Committee of Japan published in a foreign language is "On the Deflection and Vibration of Railway Bridges"—a subject which, although not seismological, is an excellent illustration of investigations which seismologists have been tempted to pursue.

The author, Dr. F. Omori, experimented on twelve railway bridge girders, the spans of which varied between 20 and 200 feet. The instruments used to record the bridge vibrations were a pair of seismographs such as are used for recording horizontal motion, and a horizontal lever seismograph for vertical motion. This latter instrument is here called a *deflectometer*. The quantities measured were the *deflection* of girders, or the total amount of bending caused by the passage of rolling stock, and the vertical transverse and longitudinal *vibrations*, which latter are almost *nil* when the speed of a passing train is either very slow or at a maximum, when the speed has a certain value. The incentive to this work was a question respecting the stability of the Rokugo-gawa Bridge, which was the first large bridge built in Japan. It was put up in 1875, a time when the rolling stock was somewhat lighter than that now in use. Oddly enough, the vibrations and deflections of this same bridge, and also others, were investigated in 1895 with apparatus similar to that now employed, and had Dr. Omori known this, it is possible that he would have compared the apparent state of the bridge at that date with what it was found to be five years later.

An account of this earlier work, with reference to that of others, as, for example, the seismometric measurements made by Prof. J. A. Ewing on the new Tay Bridge, will be found in *Engineering*, January 24, 1896.

The mechanical time marker used to determine the speed at which the record-receiving surface was moved, which is a determination of great importance when estimating vibrational periodicities, is apparently very similar to a contrivance largely used in seismometry in 1882 (see *Trans. Seis. Soc.*, vol. iv. p. 97, Fig. 8).

A point not touched upon is a comparison between values given to displacements as measured by seismographs and as determined by the direct methods employed by engineers. Previous investigators have done a little in this direction, but before the confidence of the practical man can be obtained it is clearly necessary that this work should be extended. The results which, however, have been arrived at respecting the strength and rigidity of various types of iron girders by this neglected method of investigation appear to be worthy of consideration by the builders of bridges. In the *Erdbebenwarte* of last year there are three notices of Dr. Omori's important and carefully conducted investigations, which are now followed by the advertisement of an instrument maker who is prepared to supply engineers with apparatus designed for this particular class of work. J. M.

REPORT ON UNIVERSITY COLLEGES.

A REPORT upon the work of university colleges has been issued as a Blue-book and contains much information as to the provision for higher education in various parts of the country. An annual grant of 25,000*l.* is made by the Government in aid of certain university colleges, and the character and quality of the work done, with special reference to the difference between work of an elementary character and that of a more advanced nature, is tested by occasional inspection.

A visit of inspection was held in 1896 by Mr. T. H. Warren and Prof. G. D. Living, and another was made last year by Dr. H. G. Woods and Dr. Alex. Hill. The colleges visited were:—University College, London, King's College, London, Bedford College for Women (University of London), the Owens College, Manchester, University College, Liverpool, Yorkshire College, Leeds, the University of Birmingham, University College, Bristol, Durham College of Science, Newcastle-on-Tyne, University College, Nottingham, Firth College, Sheffield, University College, Dundee, Reading College, the Royal Albert Memorial College, Exeter, and Hartley College, Southampton. As has already been announced, the Reading College and the Hartley College, Southampton, have only recently been added to the list of university colleges, of which there are now fifteen which participate in the Government grant.

The present report is almost entirely made up of descriptions of the buildings and laboratories of each of the colleges, main lists of work, organisation, and position of various departments of arts and sciences. Preceding this is a general statement by Drs. Wood and Hill, and following it a report by Mr. H. Higgs upon the financial position of the colleges. A few of the points touched upon by Drs. Wood and Hill are mentioned below.

Plan of Buildings.—Anyone who makes the round of the university colleges is certain to develop in his own mind an ideal scheme of college buildings. Our own observations have led us to the conclusion that it is a mistake for a college to invest a large portion of its capital in buildings which cannot readily be adapted and extended to meet changing needs. We could cite cases in which much money has been spent upon the material fabric of a laboratory, whereas the want of funds to provide an adequate modern equipment seriously reduces the effectiveness of its work. The demands of science are constantly changing. It is therefore desirable that funds should be so husbanded as to allow of the provision of new apparatus and appliances of all kinds as they are called for. In this connection we feel that it is not too much to say that we have seen no single college in which adequate funds were available for departmental expenditure. A few departments of particular colleges which have been housed and equipped by private munificence are notable exceptions, but in the large majority of cases the funds assigned to departmental libraries, apparatus, lecture illustrations, &c., are altogether insufficient.

Statistics of Progress.—The general result of our observations and inquiries is to show that very remarkable progress has been made by the university colleges during the last five years. The great, we might almost say immense, growth is proved by the following statistics:—(1) The total amount of the benefactions

received during the last five years by the twelve colleges which participate in the grant amounts to close upon one million sterling. (2) The total number of day students attending the colleges during the session ending in July, 1901, was 7825, as against 7186 attending during the session ending July, 1896. (3) The advance in the standard of work is more striking than the advance in numbers. This advance is best shown by the larger number of university degrees obtained by students. The aggregate figures for the two periods are as follows:—1891-6, 1437 degrees; 1896-1901, 2186 degrees.

Position of Teachers.—Nothing has impressed us more than the enormous amount of routine work which the majority of university colleges exact from their teachers. There are, it is true, several exceptions. In certain colleges and in particular departments in which the number of students is small, the professors and their assistants have a good deal of leisure, and are able to undertake literary and scientific work with the support, in some cases, of fairly satisfactory libraries and laboratory appliances. In the larger and more successful colleges and departments the pressure upon the time and thought of the teachers is unduly great. If the head of a department is to maintain a high standard of teaching and to ensure a creditable list of examination successes he has little leisure for private work, and especially is he obliged to be assiduous in his duties because the students of the university colleges belong, for the most part, to a social class which exacts the maximum return in results for the fees paid. As to the effect of too much work upon the teacher there is no room for doubt. It tends to sap his intellectual vitality by leaving him neither time nor energy to draw fresh inspiration from the study of the work of others or from his own investigations. A fresh and unharassed mind is, above all things, necessary for research.

There is another respect in which, as it appears to us, the colleges are not serving their own best interests by overworking their teachers. The stipends which they offer are, for the most part, distinctly moderate. The opportunities for continued study and research are, except in London, inferior to those which Oxford and Cambridge afford. It can hardly be expected, nor is it to be desired, that a man of real capacity should look upon an appointment at a provincial college as a settlement for life. Rather should he regard it as a stepping-stone to preferment. If the colleges were to realise that the smallness of the stipend which they offer would be more than compensated in the eyes of an ambitious man by larger opportunities of qualifying for preferment, they would attract to their service young men of the greatest promise. If the probability of the advancement of its professors and lecturers to more lucrative and important posts is kept in view and their duties so arranged as to allow them leisure to display their capacity for original work, the colleges may count upon a supply of young men of the greatest ability who will occupy their chairs for a certain number of years while waiting to be called to a wider sphere.

Research.—We have found it difficult to give any adequate idea of the amount of original research in science which has been carried out by the teachers and students of the several colleges during the quinquennium under review. The greater part of the research work carried out at provincial colleges is done by heads of departments, and we recognise that a summary of each professor's own work would have greatly increased the value of our report. For several reasons, however, we have not felt ourselves at liberty to attempt this. In the first place, the leisure and, therefore, the opportunities for research, which the professors enjoy vary immensely. In the majority of cases we should say that the professor's duties are far too arduous and incessant to allow him to do much work of this kind. In the second place, we find that certain professors hold that it is the duty of the head of a department to work through his students. To them he conveys his ideas and affords constant assistance in carrying them out. A teacher who adopts this point of view may publish nothing under his own name, although all the work which emanates from his laboratory is really inspired by him.

Students and Original Research.—With regard to the question of the desirability of encouraging students to undertake original investigations, we find that teachers hold diametrically opposed views. Some consider that to set a student to such work is to rob him of the opportunity which his student days afford of acquiring information. Others look upon experience in research as the best training which any student can receive. The amount of research work done by students depends, therefore, to a certain extent upon the position which professors take with regard to

this question. It may also be noted that the effort and originality required to produce "a paper" in some subjects is very different from that required in others. Probably the scope for original work in science is greatest in chemistry and least in physiology. In chemistry, too, the making of new substances and the investigation of interactions is a training in the science to a much greater extent than is similar work in any biological subject.

University Colleges and Secondary Schools.—We find that the relations of the more important provincial colleges to the secondary schools of their districts have become distinctly closer in the last five years. Not merely do more pupils pass from the secondary schools to the colleges, but reciprocity of representation on the governing bodies of schools and colleges is becoming more frequent, and there has been a certain amount of inspection of secondary schools carried out by members of the staff of several of the colleges. Another significant fact is that there have been of late several instances of denominational colleges, especially training colleges for the Nonconformist ministry, settling near university colleges in order that their students may attend university courses in arts and science. These facts point to the increasing importance of university colleges as educational centres.

University Colleges and Technical Education.—In an ever-increasing degree the university colleges are serving to co-ordinate the various agencies for higher education into an effective whole. They serve to focus educational forces. Particularly is their integrating action noticeable on the technological side, and although their results in this direction are not the phases of their activity which we were commissioned to investigate, they are, in our opinion, so desirable that we venture to call attention to them. Technical institutes are growing up in all large towns. When they are not in direct connection with the university colleges, where such exist, there is inevitably a certain amount of rivalry, with consequent friction, overlapping and waste of energy. The scientific direction of technological studies is a matter of national importance. In the technical departments of a university college, technical education is lifted to a higher plane. The head of a technical department, who is also a member of a college staff, and in close touch with the heads of departments of pure science, takes a higher and wider view of his own work, and inspires a more scientific spirit in his pupils. Further than this, the more capable of his pupils have the opportunity of prosecuting the study of the pure sciences as far as their inclination or financial resources allow. Not infrequently they discover in themselves an aptitude for science which would never have been suspected had they not joined a technical department for the purpose of acquiring instruction which would enable them to earn a living. In departments which would at first sight appear to be the most distinctly technical, we found that researches were being prosecuted which were helping to solve questions of general interest to men of science, the results reaching far beyond the interest of the particular industry to which the department belonged. Every year the boundaries which separate pure science from applied science become more indistinct. The physicist, the chemist and biologist make discoveries which prove to be unexpectedly useful in their application, while the technologist, going farther and farther afield, undertakes researches, the applications of which he cannot foresee, in the hope that he may light upon results which commerce can turn to account.

UNIVERSITY AND EDUCATIONAL INTELLIGENCE.

THE pass list of the D.Sc. examination of the University of London contains the following names:—Mixed mathematics, Louis N. G. Filon (Granville scholarship); experimental physics, G. J. Parks, W. Watson; chemistry, R. H. Aders, R. M. Caven, C. H. Desch, E. J. Russell, J. Wade, Martha Annie Whiteley; botany, F. E. Weiss; zoology, H. S. Harrison (Sherbrooke scholarship), H. H. Swinnerton; physiology, Florence Buchanan, F. G. Hopkins; geology, C. A. Matley, E. W. Skeats.

The Annual Calendar of the McGill College and University, Montreal, for the session 1902-1903 is a volume of more than four hundred pages filled with details of the buildings and equipment of the various departments, and the courses of work

carried on in them. The three buildings endowed and equipped by Sir William C. Macdonald for engineering, chemistry and mining, and physics, afford excellent facilities for study and research. There are special laboratories and workshops in which machinery of full size has been erected, so that all investigations can be carried on in all respects under working conditions.

THE tenth report of the Technical Instruction Committee of the County Borough of Plymouth has been received. The concluding words of the report show that the committee realises that fundamental principles rather than technical details should be the object of the work in such municipal science, art and technical schools as that at Plymouth. The committee remarks:—"It must not be assumed that the work of the schools is intended to embrace what are commonly called technical subjects only. Their object is to give such higher education and training, combined with manual and technical skill, as may enable their students to perform their work in life with greater intelligence, ability and success."

SINCE Prof. Perry brought forward the subject of "The Teaching of Mathematics" at the meeting of the British Association last September, several associations of teachers have discussed the reforms suggested or appointed committees to report upon the matter. A committee of the Assistant Masters' Association has had the subject under consideration, and a preliminary report has been drawn up, from which it appears that masters in secondary schools are in favour of most of the reforms advocated by speakers at the British Association meeting. The report is as follows:—I. *Arithmetic*. (1) The method of teaching in the early stages should be inductive and concrete. Actual measuring and weighing should be introduced as early as possible. (2) Decimals should be treated as an extension of the ordinary notation, their nature being illustrated by actual metric weights and measures. Multiplication and division of a decimal by a decimal would, we think, have to follow vulgar fractions. (3) The decimalisation of English money and English weights and measures should be practised frequently. (4) Approximate methods should be gradually introduced after the treatment of finite decimals. They should be taught with due regard to rigidity of proof. Appreciation of the degree of approximation should be continually insisted upon. (5) If "commercial arithmetic" is to be taught at all, the subject-matter should receive more adequate and correct treatment, and the examples should be drawn from transactions as they actually occur.—II. *Algebra*. (1) The foundation of algebra should be "literal arithmetic," i.e. algebra should at first be arithmetic generalised. (2) The minus sign should receive its extended meaning from copious illustrations; and illustrations, not rigid proof, should also be resorted to for the purpose of the "rule of signs." (3) Algebra should often be applied to geometry. (4) Logarithms should form an important section of the subject. We believe that the graphic method could be very usefully employed in this connection. (5) We desire to deprecate the waste of time so commonly practised in mere manipulation of symbols.—III. *Geometry*. (1) We are strongly of opinion that the ordinary deductive geometry should be preceded and continually supplemented by concrete and inductive work. (2) Whilst "mensuration" might possibly be taught in connection with physics and arithmetic, we believe that the value of geometry would be enhanced by practical applications of the propositions as they occur. (3) We feel very strongly that Euclid's text is very unsuitable for teaching geometry. But we are impressed with the difficulty of abolishing its use in the face of external examinations. In the circumstances, we can only hope that examining bodies, even if they insist on Euclid's sequence, will allow greater latitude in methods of proof, and give greater prominence to easy "riders" and applications of geometry.

SOCIETIES AND ACADEMIES.

LONDON.

Royal Society, June 12.—"The Dissipation of Energy by Electric Currents induced in an Iron Cylinder when rotated in a Magnetic Field." By Ernest Wilson, Professor of Electrical Engineering, King's College, London.

The effect which induced currents have upon the distribution of magnetism in an iron cylinder, when rotated about its longitudinal axis with uniform angular velocity in a magnetic field, has already formed the subject of a communication (Wilson,

Roy. Soc. *Proc.*, vol. lxi. p. 435, also *NATURE*, vol. lxx. p. 502). The present paper deals with the energy dissipated by these electric currents, and a comparison is made between the results of experiment and theory. In connection with the theory of the subject a contribution by Mr. J. B. Dale is made use of. The cylinder experimented upon has diameter and length each 10 inches (25.4 cm.), and is rotated between the poles of a magnet weighing some tons. It is supplied with exploring coils, threaded through holes drilled in a plane containing its longitudinal axis, by the aid of which the electromotive forces due to rotation in a magnetic field have been observed. The results of experiment have been obtained graphically by a process of double integration. The distribution which has to be assumed in connection with the experiments is that the induced currents distribute themselves on the surfaces of cylinders similar to and concentric with the cylinder experimented upon. Two other distributions are also discussed, namely, the distribution assumed by Baily (*Phil. Trans. Roy. Soc. A*, vol. clxxvii., 1896, pp. 715-746), that in any section the electric currents flow in rectangular paths similar to the boundary of the section, and the distribution in which the current density in any path is constant throughout the path.

Dealing with the distribution assumed in connection with the experiments, both graphical treatment and theory agree in giving the formula $3.95B^2f^2/10^{10}\rho$ for the watts dissipated per cubic centimetre, where B is the intensity of magnetic induction assumed constant, f is the frequency, l is the length of the cylinder assumed equal to its diameter, and ρ is its specific resistance. In the experiments the frequency was varied from 1/45 to 1/360, and for each the average intensity of induction was varied from 1000 to 20,000. In each case the watts per cubic centimetre are less than would be dictated by the above formula. The ratio of the results is 1.3 at frequency 1/360, and is substantially constant for all values of the induction density. At frequency 1/45 this ratio varies from 1.4 to 1.7 for high and low values of the induction density, but it is 3.1 for an intermediate value. A similar, though less marked, effect is observed at frequency 1/90. The explanation given is that with these intermediate forces at these frequencies very great crowding of the induction to the surface occurs; and, moreover, since the wave-form of the electromotive force near the surface of the cylinder in all the experiments is more rectangular, the dissipation of energy per cubic centimetre is less than the formula above would give, since *there* the wave-form is assumed to be a sine-curve. On the assumption that the electromotive force at the surface is truly rectangular, the formula obtained by graphical treatment is $2.08B^2f^2/10^{10}\rho$.

Having reconciled the results of experiment with those of theory, the author compares the dissipation of energy in rotating and alternating magnetic fields. It is pointed out that in the case of circular plates in which the diameter is very great as compared with the thickness, and in which the lines of force are uniformly distributed in the plane of the plate, the rotating field would dissipate about 1.7 times as much energy as an alternating magnetic field in the same time. The results are, however, greatly influenced by variation in wave-form, and even when the lines of force are confined to the plane of the plate, a condition not always met with in practice, the rate of dissipation of energy for a given average induction density may be considerably reduced if the distribution of magnetic induction is such as to give a more rectangular wave-form to the induced electromotive force.

"Note on a Magnetic Detector of Electric Waves, which can be Employed as a Receiver for Space Telephony." By G. Marconi, M.I.E.E. Communicated by Dr. J. A. Fleming, F.R.S.

The detector is based, in the author's opinion, on the decrease of magnetic hysteresis which takes place in iron when, under certain conditions, it is exposed to the effects of Hertzian waves. On a core of thin iron wires is wound a coil consisting of one or two layers of insulated copper wire, and over this and separated from it by insulating material is wound a second longer coil. The ends of the inner coil are connected to earth and the aerial conductor, and the ends of the outer coil to a telephone. The iron core is magnetised by a permanent magnet at one end, which is rotated by clockwork so as to cause a continual slow change in the magnetisation. The magnetisation, however, lags behind the magnetic force owing to the hysteresis of the iron, but when a high-frequency current passes through the inner winding there is a decrease in the hysteresis, due

apparently to the iron molecules being momentarily released from constraint. A sudden variation in the magnetisation of the iron results, and this induces a current in the outer copper winding connected to the telephone. The author finds that the telephone reproduces very accurately the transmitted signals, and that the receiver is more sensitive than the coherer and more suitable for use with a syntonic system of wireless telegraphy. Experiments with the receiver have been carried out between St. Catherine's Point and North Haven, the distance between these points being 152 miles; the length of the electric waves used was 200 metres.

"A Note on the Effect of Daylight upon the Propagation of Electromagnetic Impulses over Long Distances." By G. Marconi, M.I.E.E. Communicated by Dr. J. A. Fleming, F.R.S.

During the experiments carried on between Poldhu, Cornwall, and the U.S. s.s. *Philadelphia* it was observed that the signals transmitted at night had a greater carrying power than those transmitted by day. The transmitting conductor consisted of fifty bare copper wires suspended from a wire stretching between two poles 48 metres high. On board ship the receiving conductor was suspended from the mast and was composed of four wires the tops of which were 60 metres above the sea level. Signals were sent from Poldhu at stated intervals from 12 to 1 a.m., from 6 to 7 a.m., from 12 to 1 p.m., and from 6 to 7 p.m. Until the *Philadelphia* was 500 miles from Poldhu no differences were observed; at distances of more than 700 miles signals transmitted during the day failed entirely, whereas those sent at night remained quite strong up to 1551 miles and were decipherable up to 2099 miles. Daylight at Poldhu was rapidly increasing from 6 to 7 a.m., and it was observed that on the *Philadelphia* the signals which were quite clear at 6 a.m. had almost disappeared by 7 a.m. Confirmatory tests were carried out between Poldhu and North Haven, and it was found that receiving wires 12.1 metres high could be used at night, but that, other things being equal, the height had to be increased to 18.5 metres for the daylight signals to be equally clear. The author suggests that the effect may be due to the diselectrification of the transmitting elevated conductor by daylight, the electrical oscillations being thereby prevented from acquiring so great an amplitude as they attain during darkness. That the effect has not been previously noticed may be due to the extra high potential to which the aerial wires at Poldhu were charged for this long-distance work. This potential was sufficient to cause sparking between the tops of the wires and an earthed conductor 30 cm. distant.

EDINBURGH.

Royal Society, June 16.—The Hon. Lord M'Laren in the chair.—Prof. C. G. Knott read a paper on the change of resistance of nickel due to magnetisation at various temperatures. The apparatus used had been constructed twelve years ago in Japan, but other work had prevented anything like a thorough investigation being made with it. Two exactly equal pieces of nickel wire were coiled so as to form anchoring cores to magnetising coils of copper wire coiled round them. Round each nickel wire were coiled two distinct coils with exactly the same number of turns. Thus by joining up the coils in different ways the experimenter was able to subject the enclosed nickel to a strong magnetic field or to no field, without in any way altering the strength of current circulating in the coils. The nickel coils were balanced on a Wheatstone bridge. The magnetising current was passed round the pairs of coils on the nickel cores, so as to magnetise the one nickel but not the other. In this way the heating effect was practically the same in both coils and the change of resistance due to heating very nearly compensated. The coils were heated up to various temperatures in an air bath and the resistance change was measured by deflection after a balance was nearly adjusted. The galvanometer was gauged by means of the deflection produced when a definite change of resistance was made in one arm of the bridge. The first series of experiments indicated that there was a decrease in the proportional change at higher temperatures; but this showed that the total amount of change estimated in ohms for any given wire was very nearly the same at all temperatures between the limits of 10° and 170° C. The bearing of this result upon Prof. J. J. Thomson's theory of corpuscles was pointed out; but further results were held over for another communication.—Prof. Knott also gave an account of the last piece of quaternion work which Prof. Tait had jotted down on July 2, 1901, just two days before his death. The

notes bore upon the properties of the linear vector function and were a following up of previous work published in the *Proceedings*.—Dr. Hugh Marshall described the results obtained by him in the first part of an investigation of the thallic sulphates and double sulphates. From these it would appear that it is largely a matter of solubility whether normal or basic salts are obtained, rather than a matter of sulphuric acid concentration. Thus, potassium thallic sulphate, $K_2(SO_4)_2 \cdot 4H_2O$, when treated with dilute sulphuric acid gives a sparingly soluble basic salt; $K_2TiOH(SO_4)_2$; the latter dissolves easily in dilute nitric acid and this solution gives crystals of the first-mentioned normal salt. No thallic alums could be obtained.

July 7.—Sir William Turner in the chair.—An obituary notice of Lieut.-Colonel J. H. B. Hallen, C.I.E., F.R.C.S.E., was communicated by Principal W. Owen Williams.—Mr. J. G. Goodchild contributed a paper on Scottish mineralogy, based upon a study of the specimens under his charge in the Edinburgh Museum of Science and Art. It dealt chiefly with the developmental history of albite studied in relation to crystal genesis in general. The paper also dealt with the crystallography of Scottish cerussite, analcime, forsterite and some others. Drawings of a large number of crystals were exhibited.—Mr. James N. Miller demonstrated the mode of applying his mechanical trisector to the quinquesection of an angle. It was an ingenious extension of the properties of the trisector.—In a paper on experimental observations on leucolysis, by Drs. A. Goodall and E. Ewart, the following conclusions were arrived at:—(1) Necrobiotic changes occur in the circulatory leucocytes in health; (2) these changes are much more evident in conditions of impaired nutrition and toxæmia, notably in cancerous cachexia; (3) in toxic conditions usually associated with leucocytosis the extent of the necrobiotic changes in the white cells varies in inverse ratio to the number of leucocytes in the circulating blood; (4) these necrobiotic changes can be rapidly induced "in vitro" by the action of certain organisms or other products; (5) the rapidity and extent of the changes depend on the kind of organisms, the virulence of the culture and the number of organisms employed.—In a paper on cross-magnetisation in iron, Mr. James Russell described a large number of experiments showing how the induction, either longitudinal or circular, was affected by cross fields and how the effects of these cross fields were themselves reacted upon. As one among many results, consider the case of a steady longitudinal field with a cyclically changing circular field superposed. The induction due to the longitudinal field went through a corresponding cycle with its maximum points occurring at the instants of greatest change in the cyclic circular field. The cyclic change in the longitudinal field was very similar in form to the change accompanying twisting.—In a note on a suggested improved method of measuring deep-sea temperatures, Prof. Knott called attention to the unsatisfactory character of the methods at present in use, and advocated the use of the platinum thermometer, with which the temperature must be taken *in situ*. Various obvious difficulties in the way of applying the platinum thermometer to deep-sea work were considered, also the manner of measuring the depth at the instant of taking the reading. For experiments down to moderate depths there was no special difficulty in using these electric resistance thermometers, and by such rapidly acting apparatus important problems connected with the penetration of solar radiation through surface waters could be readily solved.

PARIS.

Academy of Sciences, July 24.—M. Bouquet de la Grye in the chair.—On electrolytic actions developed by batteries consisting of two liquids, one being an acid, the other an alkali, by M. Berthelot.—On the existence in the albumin of birds' eggs of a fibrogen substance capable of being transformed, *in vitro*, into pseudo-organised membranes, by M. Armand Gautier. Fresh white of egg, after filtration through paper, was diluted with water and treated with a current of an indifferent gas, such as nitrogen or carbon dioxide. A substance is precipitated in the form of white transparent membranes, possessing a rudimentary organisation, and approximating in composition to the fibrin of human blood and to myosin, but differing considerably from egg-albumin.—On the glycyonic acid in the blood of the dog, by MM. Lépine and Bould.—Report on a memoir of M. Torres concerning a scheme for a steerable balloon presented to the Academy on May 26. The committee regards the work of M. Torres as constituting a very interesting contribution to the theory of steerable balloons, and considers it desirable that

experiments on the subject should be made.—The mission to Martinique; extract from a letter of M. Lacroix to M. Michel Lévy. A short account of the experiences of the exploring party. Stress is laid on the fact that no heavy masses appear to have fallen upon St. Pierre; the destruction must have therefore been due to the effects of masses of incandescent gases. The torrential rains have caused great ravages, and in some cases have changed the hydrography of the coast. Soundings show that the sea bottom near the coast line has not undergone any appreciable alteration.—On the generalisation of the analytical prolongation, by M. Emile Borel.—Observations on the preceding communication, by M. P. Painlevé.—Anomalies presented by the charge of isolated conductors on solid dielectrics. Particular magnetic phenomena proved in the neighbourhood of the nodes of electric oscillations, by M. V. Crémieu.—On the mechanical phenomena of the electric discharge, by M. Jules Semenov. It has been generally supposed that when a spark passes between two conductors material particles are torn off each pole and carried to the opposite pole. The author describes experiments which show that no particles are removed from the positive pole and that the material carried by the spark towards the negative pole arises exclusively from the gas or vapour in the immediate neighbourhood of the positive pole.—Photograph of a multiple lightning flash, by M. Piltschnikoff.—On magnetic double refraction, by M. Quirino Majorana. The study of magnetic double refraction in solutions of ferrous chloride and of dialysed ferric oxide has led to the deduction of the following laws: the double refraction is proportional to the thickness of the liquid normal to the lines of force, to the concentration of the liquid, to the square of the field strength and to the reciprocal of the square of the wavelength.—On the atomic weight of radium, by Mme. Curie. By concentrating by fractional crystallisation a large quantity of radioactive barium chloride, about 0.1 gram of radium chloride has been obtained, the atomic weight of which, on the assumption that radium is a divalent metal, is 225. According to its chemical properties radium belongs to the series of the alkaline earths. The anhydrous chloride is spontaneously luminous.—The action of hydrochloric acid upon the sulphates of aluminium, chromium and iron, by M. A. Recoura. By the action of hydrochloric acid upon chromium sulphate a chromium chlorosulphate is obtained, $\text{CrSO}_4\text{Cl}_2\text{H}_2\text{O}$, the chlorine of which is not precipitated from its aqueous solution by silver nitrate. Freezing-point determinations showed that this compound is not dissociated in aqueous solution.—On the mixtures formed by sulphur and phosphorus at temperatures below 100°C ., by M. K. Boulouch. No definite chemical combination of sulphur and phosphorus appears to be formed below 100°C . A eutectic mixture which melts sharply at 9.8°C . simulates a definite compound.—On the precipitation of copper bromide and chloride by sulphuric acid, by M. Georges Viard.—Study of cerium silicide, by M. Sterba. A well-defined crystallised silicide of cerium is obtained by heating together cerium oxide and silicon in the electric furnace. Its composition is CeSi_2 , and it possesses great stability. Its properties are different from those of calcium silicide and approximate rather to those of the silicides of the heavy metals.—The action of alcohols upon the sodium derivatives of other alcohols, by M. Marcel Guerbet. A mixture of *o*-naphthyl alcohol, ethyl alcohol and sodium heated in sealed tubes to 230°C . gives some normal nonyl alcohol. The method appears to be a general one for obtaining higher homologues of the higher alcohols.—Study of the simultaneous distillation of two non-miscible substances, by MM. Eug. Charabot and J. Rocherolles. The ratio between the weight of a substance not miscible with water and the weight of water which distils simultaneously varies in the direction approaching unity when the temperature increases short of the critical temperature of one of the liquids.—On a new di-iodophenol, by M. P. Brenans.—The action of nitrous acid in acid solution on the α -substituted β -ketoic esters; the synthesis of homologues of pyruvic acid, by MM. L. Bouveault and R. Locquin.—On a method permitting of the separation from complex animal or vegetable liquids of the greater part of the ternary substances and several of the bases which may accompany them, by M. S. Dombrowski.—The variations of the iodine in the blood, by MM. E. Gley and P. Bourcet.—The pharmacodynamic properties of some aromatic semicarbazides, by MM. Auguste Lumière, Louis Lumière and J. Chevrotier.—The experimental transmission to descendants of lesions developed in the ancestors, by MM. A. Charin, A.

Delamare and Moussu.—On the evolution of the cranial ring detached by trepanning and immediately transplanted, by MM. V. Cornil and Paul Coudray.—Mosquitoes and yellow fever in Havana, by M. André Pocy.—The elaboration of zymogen in the gastric glands of the snake *Berus*, by M. L. Launoy.—On artificial parthenogenesis, by M. C. Viguière.—The production of sleep and local and general anaesthesia by electric currents, by M. Stéphane Leduc. With electric currents the complete inhibition of the cerebral centres can be instantly obtained and without apparent pain, leaving intact the centres of respiration and circulation. A complete general anaesthesia can thus be obtained which is without any after action.—Spermatogenesis in *Cybister Roesslii*, by M. D. N. Voinov.—On the rôle of the spleen in the hematolytic function, by M. Louis Lapique.—On the presence of lecithin in plants, by MM. Schlagdenhauffen and Reeb.—On the conservation of the germinating power in seeds, by M. L. Maquenne.—On the specialisation of parasitism in *Erysiptæ graninis*, by M. Ém. Marchal.—On the hydrography of Tidikelt in the Central Sahara, by M. G. B. M. Flamand.—On the constitution of the sea floor, by M. J. Thoulet.

CONTENTS.

	PAGE
Automobiles. By Mervyn O'Gorman	313
Comparative Anatomy of Animals	314
The Classics of Physical Science	315
Pure and Applied Bacteriology. By Dr. E. Klein, F.R.S.	316
Our Book Shelf:—	
Gauss: "General Investigations of Curved Surfaces of 1827 and 1825"	316
Brooks: "The Elements of Mind."—A. E. T.	317
Weber: "A Graduated Collection of Problems in Electricity."—M. S.	317
Harrison: "Junior Chemistry and Physics"	317
Letters to the Editor:—	
Penetrating Rays from Radio-active Substances.—Prof. E. Rutherford	318
The Future of the Victoria University.—Prof. Arthur Smithells, F.R.S.; Prof. Arthur Schuster, F.R.S.	319
Science and the London Matriculation Examination.—A. Irving	320
The Recent Fireball.—Walter E. Besley	320
Sunspots and Wind. (With Diagram.)—Alex. B. MacDowall	320
The Chelsea Physic Garden	321
A Quartette of Museum Publications. (Illustrated.)	
By R. L.	322
Terrestrial Magnetism	324
The "Nature-Study" Exhibition. By Wilfred Mark Webb	324
Notes	327
Our Astronomical Column:—	
Astronomical Occurrences in August	331
A New Algal Variable	331
Spectroscopy of the Solar Eclipse of May 18, 1901	331
Report of the Cape Observatory for 1901	331
Work at the Athens Observatory	331
Vibrations of Bridges. By J. M.	332
Report on University Colleges	332
University and Educational Intelligence	333
Societies and Academies.	334

THURSDAY, AUGUST 7, 1902.

HANN'S METEOROLOGIE.

Lehrbuch der Meteorologie. Von Dr. Julius Hann, Professor an der Universität in Wien. Mit 111 abbildungen im text, 8 tafeln in lichtdruck und autotypie, sowie 15 karten. (Leipzig: Chr. Herm. Tauchnitz, 1901.)

THIS remarkable book had its origin in a suggestion by the publishers that Dr. Hann should write a textbook of meteorology for students. As the author himself points out, it has travelled far beyond its original object, and as it stands it constitutes substantial ground for increased gratitude to Dr. Hann from meteorologists of all countries, by whom he has long been recognised as a master in the subject. The book is a veritable encyclopædia of meteorological science. It consists of 792 pages of text, and each page is made up of small type, smaller type and smallest type. The small type gives the professor's current narrative; the smaller type gives a large number of technical details; the smallest type embodies a most valuable series of references with critical notes; and the whole constitutes a complete representation of the present position of meteorological science apart from those climatological details which are given in Dr. Hann's well-known "Climatologie."

The arrangement of the book is on physical lines. After a general introduction, temperature in all its relations, pressure, moisture, wind phenomena and dynamical meteorology, *i.e.* the meteorology of atmospheric disturbances, are successively treated, while an appendix gives some of the most important of the mathematico-physical theories of meteorology.

One striking feature which illustrates the wide range of the book is the number of distinguished physicists and chemists whose researches have contributed to the development of meteorological science and whose papers are quoted or referred to. Among English physicists the names of J. W. Strutt, Lord Rayleigh, Lord Kelvin, Stokes, Osborne Reynolds, Shelford Bidwell, W. Ramsay, J. J. Thomson, Abney, Schuster, Oliver Lodge, Poynting, all appear as responsible for various meteorological contributions, and a similar list of names might be adduced for other countries. It may surprise physicists generally to learn how many of their distinguished colleagues are referred to in a work which deals with the present state of meteorology adequately. It is satisfactory evidence that meteorology has not yet drifted out of touch with modern physics.

The arrangement is so skilful that every page of the book is full of interest. It takes a thoroughly rational and impartial view of all meteorological theories and speculations, gives an account of the results derived from the discussion of most voluminous meteorological observations, and in spite of the huge mass of material with which it deals it manages to keep the reader's attention. It is, indeed, difficult to read because it is so full of matter and so skilfully arranged that the reader is hardly willing to regard one page as exhausted and to go on to the next. The illustrations are all most carefully selected, excellently reproduced, and some of them are impressive examples of the possibilities of photographic reproduction

NO. 1710, VOL. 66]

in what may be called the department of the natural history of the atmosphere. They make one wonder whether it is not really an advantage for other departments of natural history and for the public that their specimens are so unwieldy that they must be broadly displayed in a suitable museum instead of being neatly folded away in books and stored on the upper floors of an office. No doubt Dr. Hann, who for so many years has been in touch with meteorologists of all countries, is in a position of special advantage in regard to the work of compiling such a book, but when all his advantages are taken into account the reader cannot help being amazed at the skill and judgment with which the organisation of the facts has been carried out. Whether one deals with the variation of meteorological elements from hour to hour, from day to day, from month to month or from year to year, the statistical results are so clearly and concisely expressed and the salient features so well marked by special type or other devices that the reader can draw his own conclusions with ease. To take a trivial example, on p. 335 we find statistics of the diurnal distribution of rain. Those who are interested in such matters may see at a glance that at Kew in summer the most unfavourable hours for a garden party are from 2 to 4 in the afternoon, and next to those from 4 to 6, when the frequency of rain is about half as much again as it is between 6 and 8 a.m., whereas in winter from 4 to 6 is the best time of the day from the point of view indicated. On the other hand, at Valencia the frequency of rain from 4 to 6 in the afternoon in summer is not much more than half the frequency at the corresponding morning hours.

The work is brought very closely up to date. The most recent developments of the study of the upper atmosphere by means of kites, balloons and clouds are noted, and some of the results of the simultaneous balloon ascents under the auspices of the International Aeronautical Committee are included.

In dealing with the physical aspects of meteorology the author exhibits the same comprehensive grasp of the subject and the same conciseness of style as when dealing with the direct results of observation, but here the reader may find himself at fault. The science requires a knowledge, not only of meteorological facts, but of the physical and chemical theory which is necessary for the appropriate coordination of the facts. The author briefly incorporates all contributions to the science, and naturally when he makes use of physics or chemistry or mathematics he does not stay to develop the necessary introductory study of those sciences. The consequence is that many concise and comprehensive sentences require a considerable amount of antecedent knowledge for their full appreciation. As an example of the rapidity with which subjects are passed under review, I quote the paragraph which deals with the selection of the thermometric scale, as follows:—

"Die Fahrenheitsskala ist noch in allen Ländern englischer Zunge, selbst in wissenschaftlichen Werken üblich. Als ein Vorteil derselben wird angeführt dass man weniger mit negativen Graden zu rechnen hat und dass der Grad kleiner ist, weshalb es vielfach genügt die Temperatur nur in ganzen Graden anzugeben."

with the footnote,

"Sehr auffallend muss es erscheinen dass die namentlich für physikalische Formeln ganz unbehilfliche Fahrenheit'sche Skala noch jetzt bei Männern der Wissenschaft Verteidiger findet. M. S. z. B." Buchanan, in NATURE, August 17, 1899. "Auch Sir John Murray ist für die Fahrenheit'sche Skala."

The words are few, but they give a remarkably vivid picture of the present position of a very important question, and the example is quite typical of the author's style.

When an author with this power of concise representation deals with the present state of our knowledge of the composition of the atmosphere, solar radiation and its measurement, the general circulation of the atmosphere, the thermodynamics of the atmosphere and the modern developments of atmospheric electricity, it will be evident that he has gone far beyond the limitations of an introductory text-book and addresses himself to mature students.

In order to deal more completely with the theoretical side of the subject, an appendix of sixty-eight pages is devoted to the exposition of some of the most important mathematico-physical theories of meteorology and their applications. In this are included (1) the calculus of periodic phenomena; (2) the distribution of heat in the ground; (3) thermal distribution in the atmosphere; (4) nocturnal changes of temperature and the coefficient of radiation of atmospheric air; (5) the vertical distribution of pressure and its relation to temperature and moisture; (6) measurement of height by the barometer. These involve an adequate knowledge of mathematical processes and may be found difficult by those who are not familiar with mathematical physics.

For this reason the book must be regarded as encyclopaedic rather than didactic. The beginner who reads it will be conscious that he has much to learn, and even the expert will realise that there are many things he would like to pursue further. Yet the style is happily chosen. It will be recognised that means of obtaining the necessary information are everywhere available for students who desire it, and to have amplified the work by including instruction in the indispensable preliminary knowledge would have spoilt it. Dr. Hann is entitled to the sincerest congratulations on the rapid completion of so thoroughly comprehensive a treatise. There can be no question that the publication of so complete a summary of meteorological knowledge must lead to important developments from the many points of scientific and practical interest which are exhibited. It is indeed fortunate for the science that the University of Vienna is able to afford to so distinguished a meteorologist opportunity for the prosecution of this important work.

W. N. SHAW.

THE FIBRE INDUSTRIES.

The Textile Fibres of Commerce. By William S. Hannan. Pp. x + 236. (London: Charles Griffin and Co., Ltd., 1902.) Price 9s. net.

THE title of this work raised a hope that the author had seized the opportunity open to any specialist of carrying on the critical labours of Vetillard, Wiesnet, Hugo Müller, J. Christie, Otto Witt, and the experts of

the Colonial and Indian Exhibition, now almost of ancient history. The opportunity is a great one; for the subject-matter is vast, the interests involved are stupendous, while the first principles of the subject are few, very few, and so are they who recognise them. The opportunity is one, not merely for a book enunciating in one comprehensive view the relationships of our highly developed textile methods to one another and to the properties of the ultimate spinning units, but for a definite forecast of the progressive future, which is of obvious commercial moment.

The book before us, however, neither aims at nor claims to reach the pioneer standard of technical literature, and must be judged accordingly. The author's labours have no doubt been exhaustive and minute. But the failure to attain to the ideal standard is self-predicted by the opening sentence of the introduction:—

"The vegetable and mineral fibres of commerce may be arranged in four groups, viz. (1) plumose fibres; (2) stem and leaf fibres; (3) fruit fibres (all derived from plants); and (4) mineral fibres. These groups are represented by the fibres used in various important industries, and by other vegetable fibres which at present are of special interest from a scientific point of view only."

This classification has no morphological basis and is devoid of technical significance. The sentence stands immediately beneath the title "The Textile Fibres of Commerce," and the reference to these "other fibres," which are, in fact, from the point of view of commerce or industry, mere lumber, introduces us to the supposed antithesis of science to commerce, which is archaic, but in these days misleading, and were better left out. The introduction, in short, prepares us for the plan actually followed in the book, which is that of alphabetical sequence of the conventional or trivial names of the fibres; perhaps the best in the absence of a positive, critical basis and consequent classification. The reader is thus prepared to find the book a non-critical compilation, and although the title suggests the subordination of the matter to commercial, that is industrial, proportions, the expert will be disappointed and the lay reader will get little instruction in the *practical science* of the subject.

Of course, be it understood, a book of 230 pages, upon such a subject, and containing 150 illustrations, mostly the original work of the author and friends, affords much interesting reading. This interest belongs to the subject, which is fascinating from whatever point of view it may be handled. We have no wish to depreciate the author's evident aim to popularise the subject; on the contrary, we wish for the book a successful run, and that a second edition may see a considerable improvement in the matter. But as we take the request in the preface for "any suggestions that will enable me to add to the utility of this work" as an honest invitation to the critic, we feel we should be wanting in honesty and in a duty to the technical public if we shirked the task of pointing out by a few examples the author's want of precision in handling fundamental questions. We cite first the introductory sentence of the section "Vegetable Fibres," p. 3, "Physical and Chemical Properties," which reads, "The principal vegetable fibres are plumose and

bast. Both are used for spinning and weaving, and their prices fluctuate in accordance with the quality and quantity of the annual crops. The plumose fibres are composed of cellulose."

Plumose and bast should not be coupled with the same term "fibre" unless the author intends "ultimate fibre." We take it that the spinning unit is intended, and in the case of the bast fibres the unit is a more or less complex filament. Fibres are not used for spinning and weaving; the fibres or filaments are spun into yarns and the yarns woven. It is fairly obvious that prices vary with supply and quality, but there is something to be said for demand. Why, however, interject this superficial reference to the important question of value under the heading of "Physical and Chemical Properties"?

Lastly, to describe the plumose fibres as "composed of cellulose" is misleading. In the cotton substance the non-cellulose, it is true, is small in proportion, but the composition of the *eriodendron floss*, as of other seed hairs, is widely divergent.

Later in the section we find the bast fibres described as made up of cells of which the "walls are composed of more or less thickened lignin or woody material." This is quite inaccurate in regard to the most important of them, viz. flax, hemp and rhea.

Again, the "good commercial qualities" of the fibrovascular bundles of monocotyledons "depends upon their moderate length, strength, flexibility, and the number of fibre cells in each bundle." Without reference to the grammatical slip, we will fix the looseness of the phraseology by transposing the terms to another case. "The good commercial qualities of gold depend upon its moderately yellow colour, specific gravity, ductility, and the number of silver coins of equivalent value!"

We have dealt with this section on "Physical and Chemical Properties" at disproportionate length, for the author exhausts it in a single page of matter. The failure to lay a solid critical foundation by an adequate treatment of the section, of obviously fundamental import, measures the failure of the work to contribute to the systematic development of the subject.

We are bound, further, to particularise some strange inaccuracies in the information conveyed to the perhaps unsuspecting reader. Jute is described under the heading "Jute, Common," and the description contains many curious statements. Thus:—

"The fibres are several feet in length, have a satiny lustre on account of which they are sometimes used in the manufacture of the cheaper silks."

There is a popular confusion, we presume, between jute and "jute"; there is also a slang word "water" well known "in the city," but we suggest that only in the official mind of a judge of the High Court would there be any possible confusion of the material with the immaterial "water." So we venture to think that the author has served up a popular error in relation to "jute" as an industrial fact in relation to jute.

In particularising the applications of jute yarns we find,

"the backing of hearthrugs, the lining of ladies' slippers, the collars of gentlemen's coats and burlaps for bales of jute or hemp coverings."

NO. 1710, VOL. 66]

We refer the author to Dundee for information.

Lastly, "the jute fibre readily dissolves in alkalis and mineral acids at a low temperature." The reader may correct this statement by reference to any of the standard works on cellulose chemistry.

The chemistry of the fibre substances is dealt with generally in a superficial way. The author should have been careful to avoid such statements as the following in reference to cotton (p. 91):—

"Acids have so destructive an effect upon cotton that their use in the cotton industry ought generally to be dispensed with, since alkalis such as soap . . . can be employed for scouring and cleaning cotton fibres without materially injuring them."

And again (p. 97),

"Cotton fibres have some affinity for vegetable dye stuffs such as indigo . . . but little or none for coal-tar dyes."

The section on "Cotton" otherwise contains useful information of a conventional commercial order, and as it comprises some forty-five pages is clearly the most important of the book. In the categorical description of the various cottons, the dimensions are given in inches and fractions of an inch. This in a scientific text-book is a gratuitous concession to the rigid conservatism of our industrial system. We should like to ask if the expression 1/1180 inch conveys any definite mental impression to the reader?

We briefly notice the section "Paper Fibre Plants." We all know that paper can be made from an endless variety of fibrous materials, and the author is evidently more impressed with the fact than with the advantage of using the qualifying term "commercial" as a winnow for separating the grain from the chaff. The paper-maker will find the section of little practical importance. The subsection "Woodpulp" opens with the curious sentence, "This is rather confused and mixed up with paper-making." The remainder of the section may be similarly described.

A subsection on "Woodpulp Silk" is rather out of place at the conclusion of the section on "Silk." The treatment of this highly important industry indicates that it lies outside the author's range of experience and does not invite serious criticism.

The author is entitled to the credit of having produced an interesting book on a universally attractive subject. That it does not take the place of a standard text-book of critical importance is due to the fact that he has not sufficiently grasped the trend of the progressive scientific movement which underlies the many-sided "commercial" developments of the fibre industries.

THE FISHES OF THE CONGO BASIN.

Les Poissons du Bassin du Congo. Par G. A. Boulenger. Pp. lxii + 532. (Bruxelles: Publication de l'État Indépendant du Congo, 1901.)

IT is a striking proof of the high estimation in which science is held by the authorities of the Congo Free State that they have devoted so much expense to the publication of the beautiful volume now before us, and it is also fortunate for science that the material was placed in the hands of so highly competent an ichthyologist as

Mr. Boulenger. Already a lavishly illustrated quarto volume ("Annales du Musée du Congo") had been issued containing descriptions and figures, by the same author, of new genera and species of fishes recently discovered in the Congo, and now comes the present work, the twenty-five plates of which are "half-tone" reproductions of the lithographs illustrating the descriptions in the "Annales."

This is the first work dealing with a group of animals over the whole extent of the Congo Basin, *i.e.* including Lake Tanganyika. It commences with an introduction divided into six parts, namely, (1) general characters of the fresh-water fishes of Africa, (2) distribution of fishes in the Congo Basin, (3) fisheries and methods of capture, (4) methods of preservation and transport of fishes for scientific purposes, (5) terminology used in scientific descriptions of fishes, (6) list of previous writings specially dealing with the fishes of the Congo Basin.

A few years ago, about 90 species of fishes were known from the Congo Basin, but in the present work the list is swelled to no less than 320, 78 of which are confined to Lake Tanganyika. The families most abundantly represented are Mormyridæ, Characinaidæ, Siluridæ and Cichlidæ, the name for the last-mentioned family being for good reasons adopted in place of the better-known "Chromidæ."

I am glad to see that, in spite of Cope's dictum, Mr. Boulenger still considers the Lampreys to be "fishes," as he divides the class into three subclasses—Cyclostomi, Chondropterygii and Teleostomi. Only the last is represented in the fish-fauna of the Congo Basin.

The Teleostomi include here the Crossopterygii, the Dipneusti (the usual name "Dipnoi" is rejected on account of its having been originally used to designate the Batrachia) and the Teleostei. Our author seems inclined to retain the "Ganoids" (= Acipenseroides and Lepidosteoides) as a distinct order, but as none of these inhabit the basin of the Congo, the question is not gone into in a detailed manner. As to the Crossopterygii, Mr. Boulenger admits only two primary divisions, the extinct Osteolepida and the modern Cladistia, represented in African rivers by the singular though well-known family Polypteridæ, of which five species of Polypterus, three being new additions, and one of Calamichthys are here chronicled. As regards the Dipneusti, in the course of some interesting remarks on vertebrate limb theories, the author adopts Dollo's view as to their probable derivation from the Crossopterygii, the corollary to which, as the present writer has also pointed out, is that the "archipterygial" form of limb must have been diphyletically realised, on the one hand, by the Pleuracanthid Selachii, and on the other by the Holoptychii and the lung-fishes. An interesting new species of Protopterus (*P. Dolloi*) is here described and figured.

Proceeding to the ordinary bony fishes or "Teleostei," we may note in the first suborder, that of the Malacopterygii, the extraordinary variety of form among the Mormyridæ, even within the limits of one genus, as in the case of *Mormyrops curtus* and *M. attenuatus* (plate iii). Sagemahl is followed in the association of the four families of Characinaidæ, Cyprinidæ, Siluridæ and Gymnotidæ in one group or suborder of Ostariophysii, the essential characteristic of which is the presence of the Weberian ossicles, by which the swim bladder is brought

into relation with the ear. The Cyprinodonts, of which the region produces four species all belonging to the genus *Haplochilus*, are included with the Esocidæ, Dalliidæ and Amblyopsidæ in a third suborder, that of the Haplomi. A fourth is formed by the Percesoces (the Müllerian "Pharyngognathi" being entirely abandoned), and which includes, not merely the Scomberesocidæ, but also the Ammodytidæ, Atherinidæ, Mugilidæ, Polyneimidæ, Sphyrænidæ, Ophiocephalidæ and Anabantidæ. Coming now to the fifth suborder of Teleostei, that of the Acanthopterygii, we find that, with the exception of a few Serranidæ, Scænidæ and Pristipomatidæ, it is entirely represented by twenty-four genera and eighty-seven species of one family, that of the Cichlidæ (= Chromidæ of Günther). This family, which was also included in the "Pharyngognathi" of the Müllerian system, is here considered as closely allied to the Perches, in spite of the fusion of the inferior pharyngeal bones. The diversity of genera of this family in Lake Tanganyika is worthy of notice. The volume finishes with a description of eleven species of *Mastacembelus* (suborder Opisthomi) and one of *Tetrodon* (suborder Plectognathi).

In conclusion, it may be said that the talented author is to be congratulated on the interesting work he has produced, and the zoological public in having, in so compact a form, a guide to a general knowledge of the fresh-water fish-fauna of so large a portion of the African continent, interspersed with many valuable remarks bearing on the subject from a morphological as well as systematic standpoint.

R. H. T.

APPLIED MECHANICS.

The Rookee Manual of Applied Mechanics, Stability of Structures, and the Graphic Determination of Lines of Resistance. Vol. ii. By Lieut.-Colonel J. H. C. Harrison, C.E., late Assistant Principal, Thomason Civil Engineering College, Rookee. Pp. viii+318+70. (Rookee: Printed at Thomason Civil Engineering College Press.)

THIS "Manual of Applied Mechanics" is primarily intended for the use of students of the Thomason Civil Engineering College, Rookee, North-West Provinces, India. It forms an extension of vol. i.; the latter was originally prepared by Lieut.-Colonel A. Cunningham, R.E., and was revised by the present author in 1895.

Vol. i. does not include important subjects such as the stability of block-work, the design of retaining walls, abutments, masonry arches, earthwork, foundations, &c. These omissions have been met by the issue of vol. ii. Moreover, the treatment in vol. i. is mainly analytical, whereas in vol. ii. graphical methods have been developed and largely employed; so that the two volumes together now form a very complete treatise on the principles of mechanics as applied to roofs, girders, bridges, foundations and allied structures.

In the first part of the volume under review the author describes the plotting of vector and link polygons for a general system of forces in one plane. Then, in reference to various types of structures, such as beams, cantilevers, block-work, suspension chains, and arches he develops

the properties of these polygons and shows how, by their use, the shearing and bending actions, lines of resistance, &c., due to given loads may be determined. The drawing of link polygons so as to lie within given loaded arch rings is explained, and applied to the determination of the so-called line of least resistance of a masonry arch. The deflections of beams are next considered, and the link polygon method is extended and applied to the plotting of the elastic curves of loaded beams, including continuous beams. The latter were treated in vol. i. by the aid of the theorem of three moments. The student has thus the advantage of a comparison of the two methods.

Nearly a fourth part of the text is thus occupied in establishing the fundamental properties of the link and vector polygons, and then the author, in the second part, which comprises the remainder of the work, and is divided into three sections, proceeds to the practical applications.

Section i. deals with the stability and design of tall chimneys, buttresses, and various forms of cranes.

In Section ii. the subject of earth pressure is very fully considered, and examples are given of the design of retaining walls to resist the pressure of earth, and of masonry dams for reservoirs.

"Structures that span an interval" is the heading to the concluding Section iii.; and here the author treats very fully of masonry arches, fixed and continuous girders, cantilever bridges, stiffened suspension bridges, hinged metal arches, &c.

In an appendix a partial reprint is given of a paper by Colonel A. Cunningham on well foundations, which should prove of special interest to students and engineers in India, where, in spanning many of the rivers, the foundations have to be laid in quicksand.

It seems an unfortunate omission that in so excellent a treatise no reference is made to the application of the strain-energy method and the principle of least work to calculations on the deflections and stresses in braced frames, structures with redundant members, arched ribs, &c.; but otherwise the treatment is quite up to date. As regards practical construction, information is given as to the design of many details; and some examples of complete designs are fully worked out, and illustrated by drawings, taken principally, by permission, from Colonels Wray and Seddon's "Instruction in Construction." There are numerous folding plates, facilitating reference and allowing the figures to be drawn to a large scale.

The treatise can be recommended as a useful book of reference for engineers in the pursuit of their profession. Students who master the details of both volumes should, in the subjects of which they treat, be well equipped for their duties of after life.

OUR BOOK SHELF.

Ordnance Survey of England and Wales. Scale $\frac{1}{162500}$, or 1 inch, or 1:253,440. Sheet iv. Price 1s. 6d.

THIS sheet is a specimen of the new quarter-inch map of the British Isles which is being issued by the Ordnance Survey at Southampton, and we have pleasure in recognising in it many marks of the vitality of the Survey and of its power of employing the most modern methods to meet new requirements. The old quarter-inch map of

Ireland in four huge sheets was a masterpiece of engraving and of printing directly from the plate; the old quarter-inch map of Scotland was a somewhat hapless attempt to show rivers in blue on an outline very sketchily printed from transfers in black, while the old quarter-inch map of England was a clear outline with fine lettering but little detail, the antiquity of which was thrown into painful relief by the insertion of railways up to a modern date. The new quarter-inch map of Great Britain, now in course of publication, is up to date in all particulars, and beautiful as well as accurate. The sheets are of convenient size (2.4 in. \times 16 in.), the edges graduated to single minutes of latitude and longitude, with the meridians and parallels for each 20' drawn clearly across the map, thus greatly facilitating the plotting of any distribution which has been worked out on maps of a larger scale, an advantage which will appeal to every geographical worker. The names and general detail are printed in black, the size of the lettering nicely graduated to show relative importance, and the style of execution is worthy of the best traditions of the old one-inch map. Railways are shown in a strong black line, county boundaries in a distinct dotted line, and roads of three classes are distinguished, the first class having the usual indication as to fencing and being coloured solid brown. Rivers and other water surfaces are given in blue, and when the altitudes marked on in bold black figures are considered the surface would appear to be so fully occupied that nothing could be added. Here, however, the chief novelty and beauty of the map appears. The configuration of the country is shown by a hill shading so expressive and unobtrusive that it actually seems to make more room for the other features, by throwing each into its own proper place and fixing it there. The blue threads of the water-courses accentuate the valleys of the high moorlands, the roads and railways are fitted with a pictorial commentary explanatory of every curve; even the county boundaries, so arbitrary on common maps, are seen to be natural lines, now a main watershed, again a powerful river. Colonel Johnston deserves the utmost credit for his bold and successful experiment in expressing relief without the use of contours or of hachures by the half-tone photographic reproduction of washes of colour. The hill-work is printed in brown, with which the blue of the water and the black of the names and railways contrast equally, and even the green with which extensive woodlands are shown stands out well.

The technical production leaves nothing to be desired, and we confidently place this map before any other in the world on the same scale for beauty of finish, accuracy of execution and sound judgment in the selection of features and names. It will be invaluable for mapping the distribution of phenomena in many branches of science, and welcome also to the tourist and motorist.

A Manual of Elementary Practical Physics. By Julius Hortvet, B.S. Second edition. (Minneapolis: H. W. Wilson, 1902.)

"LIFE is not long enough to admit of a *rediscovery* of the fundamental laws of physics. Besides . . . some of the laws were not discovered through experiment at all, but, on the contrary, were obtained by pure reasoning and afterwards verified by experiment."

This quotation will show that the author is not an adherent of the out-and-out heuristic school. But while it is not expected that a pupil shall go through the necessarily slow process of acquiring *all* his knowledge by his own investigations, he is expected to think for himself while the chain of reasoning to be followed and the conclusions to be drawn are indicated by questions which the pupil has to answer. While in sympathy, in the main, with this method, we do not think that the questions are always very happily chosen. Thus after experiments on the bending of a lath and the stretching

of a spiral spring occur the following:—"What quantities included among the above results are stresses and what are strains? State the relation between the elongation of the spiral and the stretching force. Does it appear that the elasticity of the spiral is perfect? State the relation between the force of elasticity and the elongation; also the relation between the elasticity of the spiral and the stretching force. State the relation between the strain and the stress."

We like better the instruction given in regard to the performance of the selected experiments, much of which appears excellent and should prove very useful to the teacher. It is a school-book, and we therefore notice with pleasure an adequate paragraph on "significant figures" and another on the plotting of curves. The book, although a second edition, is by no means free from mistakes and obscurities, some of which will be briefly mentioned. The standard metre is not the one preserved in the Archives of Paris, but one of those at the International Bureau at Sèvres. In connection with the barometer, "The same rise in temperature has caused the metal scale and tube to expand so that the observed height is too small." The expansion of the tube does not matter. On p. 136 we find, "Heat is a physical quantity in the same sense that force is a quantity," while on p. 73 it is stated that "force is not in itself a physical entity." In the former, did the author mean "energy" instead of force? The signs in the formulae for lenses on p. 185 are very confused. "It is important that the principal axis of the lens should lie parallel with the line joining the centres of object and image, and be as near to that line as possible" (p. 186). Page 193, explanatory of electric capacity, is bad; while in the same chapter the phrase "touch B to bring its charge to zero" occurs twice, when potential, not charge, is meant. Lines of magnetic force are said on p. 197 to form closed circuits through a magnet, although such a line has been defined as giving the direction in which a north pole would be urged.

Such statements as these will mislead a teacher who is not very clear himself, and work the usual havoc. But a good man will receive a large number of useful hints from the book, and to such we commend it.

A. W. P.

The Journal of the Iron and Steel Institute General Index. Vols. xxxvi.-lviii., 1890-1900. Edited by Bennett H. Brough, Secretary. Pp. 511. (London: E. and F. N. Spon, Ltd., 1902.)

IT is impossible to over-estimate the value of collective indexes to the transactions of scientific societies as an aid to research. The new general index to the twenty-three octavo volumes of the *Journal of the Iron and Steel Institute* published during the years 1890 to 1900 inclusive is of special value, inasmuch as it contains references, not only to the authors and subjects of papers contributed to the Institute, but also to those of papers relating to iron and steel and cognate subjects published in other journals at home and abroad of which abstracts have been printed by the Institute. These abstracts are systematically arranged and constitute a valuable feature of the Institute's *Journal*. They indicate the great amount of activity at present exhibited in research and investigation connected with iron and steel. In 1900 no less than 1507 papers dealing with iron and steel, written in various languages, were abstracted. The general index furnishes, therefore, a useful means of reference to the whole field of recent literature of iron and steel. The volume also contains an interesting introduction tracing the history of the development of the Institute. From its foundation in 1869 to the end of 1900 it had published 581 original memoirs, and its *Journal* had covered 29,105 pages, with 1124 plates. This introduc-

tion is illustrated by full-page portraits of the sixteen past presidents, the seventh Duke of Devonshire, Sir H. Bessemer, Sir Lowthian Bell, W. Menelaus, Sir W. Siemens, E. Williams, J. T. Smith, Sir B. Samuelson, Dr. Percy, D. Adamson, Sir J. Kitson, Sir F. A. Abel, E. Windsor Richards, Sir David Dale, E. P. Martin and Sir W. Roberts-Austen.

Zur Metaphysik des Tragischer. By L. Ziegler. Pp. ix + 104. (Leipzig: Dürrschen Buchhandlung.) Price Mk. 1'60.

A PLEASANTLY written little pamphlet on the spirit of tragedy and its philosophical implications. Mr. Ziegler's main contention is that the object of tragedy is to exhibit the absolute domination of the whole personality of the tragic hero by a single impulse or purpose. The tragic catastrophe affords, as it were, an ocular demonstration of the "illogicality" or "guilt" of any finite purpose which sets itself up against the totality of the world-process. This thought is then affiliated by the writer to the central idea of von Hartmann's doctrine of the unconscious, the "redemption" of the "cosmos" from itself. As in duty bound, Mr. Ziegler exhibits all the intellectual prejudices of the sentimental-romantic school to which he belongs. He is, of course, anti-semitic, and is quite sure that "we Germans" are the metaphysical salt of a degenerate world. Also he prefers Richard Wagner to Shakespeare as an exponent of the tragic idea. From his somewhat sentimental point of view he has some interesting criticisms of ancient and modern tragedy. This is not the place to discuss his theory in detail, but one question may perhaps be put to him. On his view, so long as the tragic hero wills something passionately, it must be a matter of indifference what he wills. Richard III. or, for the matter of that, Bluebeard is as good a hero as Antigone or Othello. Now does not this position, to say the least of it, require some substantiation? With more reverent study of the great masters of tragedy and less rhetoric about the defects of the Jews and the superhuman excellences of the German genius, he may in future make a more valuable contribution to æsthetic theory.

A. E. T.

Hygiene for Students. By Edward F. Willoughby, M.D. Lond. Pp. xx + 563. (London: Macmillan and Co., 1901.) Price 4s. 6d.

THIS book, which is a fourth edition of the "Principles of Hygiene," although designed for the examinations of the Board of Education, covers a wide field, and should be of considerable value to medical practitioners and others who wish to gain a general knowledge of, without going deeply into, the subject. An excellent account is given of various dietetic substances, wines, tea, coffee, bread, meat, butter, &c., their actions, uses and adulterations. Some good advice is given respecting sleep and its attainment, but the suggestion that 5-10 grains of chloral may be taken in extreme cases of insomnia is decidedly one that should have been omitted. Ventilation and heating are dealt with more fully than is usual in books of the size; and there is a good account of drainage and sanitary appliances. Chemical methods for the disposal of sewage are condemned, while a concise account of the various bacterial systems is given. The author adopts a classification of his own of the specific infective diseases, which has many points to recommend it; and the information given seems to be well up to date, e.g. the transmission of malaria and of yellow fever by the mosquito. Altogether, the book is one which may be recommended, not only to the beginner, but also to the advanced student, for much information is introduced which is usually only met with in the larger text-books.

R. T. H.

LETTERS TO THE EDITOR.

(The Editor does not hold himself responsible for opinions expressed by his correspondents. Neither can he undertake to return, or to correspond with the writers of, rejected manuscripts intended for this or any other part of NATURE. No notice is taken of anonymous communications.)

A Simple Telephonic Receiver for Wireless Telegraphy.

WHILE engaged in some testing experiments with an installation for wireless telegraphy (Popoff system) between the Hook of Holland and the Government lightship, lying at a distance of 16 km. from shore, it occurred to me to try telephonic communication. As the necessary apparatus, now constructed by different companies, could not be procured without much delay, I made myself a most simple arrangement, yet yielding excellent results, an account of which may interest those occupied in similar experiments.

I fixed two parallel pieces of carbon (as used in an ordinary arc lamp) having a length of 5 cm. on a square piece of wood, and made with it a circuit including a couple of dry elements (small size) and an Ader telephone; the circuit was completed by placing three or four common sewing needles loosely in transversal direction on the carbon rods. The apparatus is ready for use when the insulated wire of the signal mast (antenna) is joined to one carbon and the other is connected to the earth conductor. The letters from the Morse alphabet are very distinctly heard by this most simple device as shorter and longer taps in the telephone, and at the given distance the telegrams were easily read by sound, by a trained operator, as they were sent from the ship, and more quickly, of course, than they could be delivered by the usual coherer arrangement combined to the Morse writer; besides, it does not require special care to keep it in working condition. Yet it is sensitive enough to make audible the peculiar noise which accompanies the motion of the interrupter combined with the induction coil when it is operated by hand to produce the spark.

I believe that such a receiver may prove very useful for temporary installations of wireless telegraphy, as any one may carry it, along with all its accessories, in his pocket and put it at once in action when an insulated wire can be fixed to some elevated post, earth connections being always at hand.

I also investigated this arrangement in my laboratory with the view to ascertain whether it is really auto-decohering, as has been claimed recently for circuits where a telephone is used and carbon as coherer substance. Indeed, it seems that no tapping or any other arrangement is required to keep the telephone in good receiving condition. But when I substituted a sensible aperiodic galvanometer (Weston's construction) for the telephone, and operated with a small induction coil and Leyden jar (spark 3 mm.) in an adjacent room, every discharge produced a deflection of the needle, which did not return to its former position, unless a slight tapping was applied near the carbons, otherwise each new spark increased the deflection obtained by the former. It may be that the self-induction of the coil of the telephone is sufficient for decohering, which factor is not so active when a galvanometer is substituted.

I examined other substances than the steel needles, namely, copper, nickel, platinum, carbon, this also in powder (as used in the Mixand Genest telephone), and they all gave the same result, and this was obtained in the best way when, before the sparking of the coil, the transverse wire, by slightly tapping, had obtained a contact sufficient to transmit a small portion of the circuit current. But I observed that sometimes with platinum, and also with carbon, the deflection was reduced to zero, when the sparks set in, indicating that the resistance was increased by the electric waves, instead of diminishing, as was usually the case.

I found that a certain pressure exerted on the transverse wire, lying on the carbons, did not prevent the influence of the electric waves on the contact surfaces. When a load of 15 kg. and even of 5 kg. was placed on the needles (protected from immediately touching them by a glass plate), the deflection of the galvanometer set as well in and the telephone answered as distinctly to the sparks, produced in another room, as before.

It is obvious that the described arrangement proves also to be a very delicate microphone, but a slight pressure applied in the same way on the transverse wires makes it directly insensible to sound impulses, as was to be expected.

The Hague, July.

L. BLEEKRODE.

NO. 1710, VOL. 66]

The Future of the Victoria University.

PROF. SCHUSTER (p. 319) does not challenge the accuracy of my statements and I have nothing to alter in them. I have enjoyed reading his playful comments, but I have no desire to enter upon a mere dialectic contest with him, especially if it is to be fought with dynamical metaphors. I only wish now to disavow the predilection for federal universities, which Prof. Schuster artfully attributes to me. I have certainly acquired belief in one existing federal university which includes Lancashire and Yorkshire, but if that "experiment" is to fail, I do not see that I should necessarily favour another of the same kind. I must therefore decline with thanks the consolation that is offered me in the contingent possibility of my being able to take part in a federal university for Yorkshire. The immediate need of those who are or may be charged with university organisation seems to me to be an authoritative and impartial pronouncement on the causes which are alleged to warrant the disruption of the Victoria University. This is what I await before agreeing to any fresh experiment.

ARTHUR SMITHELLS.

August 1.

M. Faye and the Paris Observatory.

I THINK the addition of the following to the excellent article on Hervé Faye in NATURE of July 17 (p. 277) is of interest. I had the facts from Le Verrier and Faye; they have not been reported in the speeches delivered, and should not be lost to history.

It is known that one of the great things done by Le Verrier was the creation of the Central Bureau of Meteorology, as part of the Paris Observatory. When the celebrated astronomer was dismissed, in 1870, by the Emperor, no change took place in the organisation of this establishment. When Le Verrier was recalled, in 1872, after Delaunay's accidental death, he filled, as in former times, the double position of head of French astronomy and of meteorology. But he was told that steps were being taken by the Administration to form a Central Bureau, independent of the Observatory, when he should have breathed his last. This idea grieved Le Verrier; he complained bitterly of it to his friends and to the Academy.

When Le Verrier died, M. Yvon Villarceau was appointed intermediate director, and filled this office for some months. M. Bardoux, a member of the Senate, sent a message to the Academy of Sciences asking its opinion on the idea of creating an independent "Météorologie." The question was warmly discussed in secret session, and M. Faye, like many others, raised objections. The Academy accepted their opinion, and answered in the negative to the official proposition. As the advice of the Academy was not binding, M. Bardoux had a right to disregard it, which he did. The reputation of M. Faye was such that he was generally considered as being the only possible successor of Le Verrier. M. Bardoux advised M. Faye to accept the directorship of French astronomy, as meteorology would henceforth form a separate department. M. Faye thanked M. Bardoux, but declined under such conditions.

WILFRED DE FONVILLE.

Electrical Resistance of Iron at very Low Temperatures.

OWING to the kindness of Dr. M. W. Travers in providing me with some liquid hydrogen, I have recently been able to observe the resistance of a specimen of iron wire at a temperature of about 20° absolute. The specimen was the same that had been used in previous experiments on resistance between 1100° and -200°, and the result of continuing the resistance-temperature curve is of considerable interest. In two papers on this subject Prof. Fleming and Dewar reach the conclusion that the resistance of pure metals tends to vanish at the absolute zero, but that the presence of impurity in the specimen reduces the rate of decrease of resistance with temperature, and that this behaviour may even afford a test of the purity of a conductor. This bears out a remark made by M. Edmond Van Aubel (*Annales de Chimie et de Physique*, 1899) that the purity of bismuth can be gauged by the variation of its electrical resistance between 0° and 30°.

The temperature coefficient of bismuth is abnormal when the element is in certain physical conditions, its resistance increasing with fall of temperature in more than one position over the range indicated, a behaviour which is less surprising if bismuth really contains a small percentage of polonium. An observation

of resistance at the temperature of liquid hydrogen was made by Dewar on platinum, and he found that the resistance decreased to a certain value and then became constant. Thus from this result and from the behaviour of bismuth it is not altogether unexpected that a rather impure specimen of iron should show a definite turning power.

The present experiments, so far as they go, show that the resistance of iron at the temperature of -253° is actually greater than that at -191° (liquid air), a turning point on the curve occurring just below -200° . Several readings were taken of the resistance of the iron spiral when immersed in liquid hydrogen, and the readings in liquid air were consistent with my previous results. But the observations lack confirmation, and I am induced to publish them owing to the small chance of getting any more liquid hydrogen until next year. E. PHILIP HARRISON.
University College, London, July 31.

Retention of Leaves by Deciduous Trees.

I HAVE read with much interest the various communications in NATURE on this subject, as the phenomenon was the subject of much conjecture to me last winter in Northumberland. In one particular instance which I had constant opportunity of observing, the cause of the retention of the leaves could hardly have been "protection," as the beech hedge in question was in a very exposed, though by no means an elevated, situation. The hedge was a high one, probably 12 or 15 feet high, and formed a protection to the garden to the south or south-east of it, and in spite of the severe winds to which it was exposed it retained its leaves long after those of the beech trees of the neighbourhood had fallen.

I am inclined to think that it is much more probable that the frost theory brought forward by "P. T." in NATURE of May 15 is the true solution of the phenomenon than that the retention is a "protective device."

It would be interesting to know whether "P. T." or any other readers of NATURE can produce any further proof of early frosts causing the premature drying up of the leaves in the case of beech hedges and young small trees. If, as "P. T." suggests, the early freezing prevents the formation of the abscission layer of cork at the base of the petiole, it should also cause the leaves of hedges and small trees to display their autumn tints, or at least to show signs of drying up earlier than the leaves of the larger trees.

If this can be shown to be generally the case where the leaves are retained, I think "P. T.'s" theory would be considerably strengthened. A. F. G.

Henzada, July 1.

Campanulate Foxgloves.

IN the issue of NATURE for July 24 (p. 306) is a paragraph which is somewhat misleading. It is distinctly stated therein that "the terminal flower of each inflorescence was not a foxglove blossom, but a Canterbury bell (Campanula)," and again, "the combination of two flowers other than the foxglove and Campanula, if it occurs, would, however, be worth recording." There is no telling what hybridisers may do in the future, but it is quite certain they have not yet succeeded in crossing the foxglove with a Campanula, nor does it seem likely they will ever accomplish such a feat. Bigenic hybrids (if they are really bigenic) are not uncommon nowadays, but the union is always between nearly allied genera, not between groups so widely different one from the other as the foxglove and the Canterbury bell. The confluence of several of the uppermost flowers of the foxglove into a large cup-shaped blossom is not uncommon. Indeed, the peculiarity is so far "fixed" that a large percentage of the seeds from this form may now be relied on to "come true." Is this a case of the inheritance of an acquired character?

The syanthic condition of the foxglove flowers is mentioned in my "Vegetable Teratology," p. 40, or p. 59 of the German editions, and has repeatedly been recorded, but I am not aware that the cause of the deviation has been ascertained.

MAXWELL T. MASTERS.

Forestry.

IN my paper on forestry which appeared in NATURE of July 17 (p. 283) I was wrong in stating that *cuculletes* means "production of all kinds from baskets and fishing rods to sponges

and caviare." The term means articles of forest produce, collected and utilised, though not specially made the object of the working of the forest.

Fruits and seeds, grasses, flowers, bark, medicinal products, and so on, all belong to *cuculletes*.

This correction is due to Mr. J. S. Gamble, F.R.S., who wrote the article in the Royal Scottish Arboricultural Society *Proceedings*, which I noticed in the paper referred to.

Coopers Hill, Englefield Green, Surrey. W. R. FISHER.

THE FORTHCOMING MEETING OF THE BRITISH ASSOCIATION AT BELFAST.

SECTIONAL ARRANGEMENTS.

THOUGH several of the sections of the British Association have not completed their programmes, it is possible to make a preliminary statement of some of the subjects to be brought before the Belfast meeting. Up to the time of going to press, the following particulars of sectional arrangements have reached us.

In Section A (Physics) there is to be a department in astronomy and cosmical physics, to be presided over by Prof. Schuster. To this department papers on the work on Eros, on the Moon and on Nova Persei will be presented, and some discussion on points connected with the nebular theory will, it is hoped, take place. Photographs from Yerkes Observatory will probably be shown, and several seismological communications will be made. In the section itself, Lord Rayleigh will probably raise the question of the conservation of weight in chemical reactions; Prof. Trouton will describe his experiments to detect the rotation of the ether with the earth, and Dr. Larmor will have something to say on the temperature of radiant energy. Belfast will be represented in the programme, Profs. Everett, Morton and Dixon having several communications to make.

The presidential address in Section C (Geology), by General C. A. McMahon, F.R.S., will deal with the general principles of rock metamorphism. Among the papers received or promised for the section are the following:—(1) "The Geology of the District around Belfast, including the Mourne Mountains"; (2) lecture on "The Structure of Ireland," by Prof. Grenville A. J. Cole; on "The Viscous Fusion of Rock-forming Minerals," by Prof. J. Joly, F.R.S.; "List of Minerals known to occur in Ireland," by Mr. H. J. Seymour; note on "The Scenery of Ceylon," by Mr. A. K. Coomaraswamy; on "A Lower Carboniferous Fish-fauna from Victoria, Australia," by Dr. A. Smith Woodward, F.R.S.; on "The Graptolites of the Belfast District," by Mr. R. Clark; on "The Valleys at the Head of the Hardanger Fjord, Norway," by Mr. H. W. Monckton; on "The Marine Fauna of the Boulder Clay," by Mr. Joseph Wright; on "The Original Form of Sedimentary Deposits," by Rev. J. F. Blake; on "A Stage in the Evolution of the Brittle Stars," by Prof. W. J. Sollas, F.R.S.; on "The Fishes of the Lower Devonian 'Roofing Slate' of Gemünden, Germany," by Dr. R. H. Traquair, F.R.S.

Prof. Howes is president of Section D (Zoology) this year, and it is believed that he will devote his address to a general consideration of the importance of the morphological method in zoology. As regards the subsequent work of the section, several papers of a morphological and more or less technical character have already been promised. The president will show, on behalf of Dr. Hill, an interesting series of photographs of segmenting eggs and other early stages in the development of *Dasyurus*. Prof. Johnson Symington will read a paper on the "Cetacean Larynx." Prof. MacBride will describe the development of Echinus, and Mr. Bles, whose exhibit of living larvæ of *Xenopus* (*Dactylethra*) excited so much interest at the Royal Society's soirée

recently, will give a general account of the development of this interesting frog. Mr. Graham Kerr will describe the result of his investigations on the early development of nerve and muscle in Lepidosaurs.

It is hoped that Prof. Herdman will be able to contribute accounts illustrated by lantern of his recent experiences of "Dredging in the Indian Ocean" and "Life and Work on the Pearl-oyster Banks of the Gulf of Manaar." Several other papers from the Liverpool School are expected—by Mr. A. T. Watson, on a very interesting defensive mechanism which he has discovered in certain Onuphid worms; by Mr. I. C. Thompson, on Indian Ocean Copepods collected by Prof. Herdman; and by Mr. H. C. Robinson, on his recent journeys in the East. Mr. J. Stanley Gardiner will read a paper on the "Bionomics of a Coral Reef."

The International Fisheries Investigation scheme, the inauguration of which is exciting so much interest at present, will form the subject of papers by Prof. McIntosh and Mr. Garstang. Of similarly economic interest will be Dr. J. L. Jameson's account of his reinvestigation of the problem of pearl formation. Mr. J. Stuart Thomson will give an account of his recent researches on the scales of marine fishes as an index of age.

Prof. Cossar Ewart will communicate the results of his recent experiments upon intercrossing of dogs. Prof. Weldon, in one of the evening lectures, will deal with heredity. This subject is so much "in the air" at present that it is to be hoped that some further communications dealing with it may be presented to the section. In regard to faunological matters, Dr. Scharff will read a paper on the "Atlantis Problem," Mr. Carpenter on the "Insect Fauna of Irish Caves," and Mr. Steel will make an interesting exhibit of Australian specimens.

Among the papers which, it has been arranged, will be read in Section E (Geography) are the following:—Dr. H. R. Mill, on "Antarctic Expeditions"; Dr. J. Milne, F.R.S., on "World-shaking Earthquakes in relation to Volcanic Eruptions in the West Indies"; on "The Jordan Valley" and on "Petra," by Prof. Libbey, of Princeton University, N.J.; Prof. Johnson, Dublin, on "Peat"; Mr. C. R. Beazley, on "Mythical Islands to the West of Ireland"; Mr. R. L. Praeger, of the National Library of Ireland, on "Geographical Plant Groups in the Irish Flora"; the Rev. W. S. Green, on "Rockall and Porcupine Bank off the West of Ireland"; Mr. J. Porter, on "The Cork Valleys"; Mr. R. B. Buckley, C.S.I., on "Colonisation and Irrigation in Uganda and the British East Africa Protectorate"; Captain Ryder, R.E., on "Surveys in Yunnan"; and Mr. C. H. Hawes, on "The Island of Sakhalin and its Inhabitants." The general subject of the presidential address by Sir Thomas H. Holdich will be "The Necessity for the Application of more Scientific Methods to Geographical Exploration."

The president of the Engineering Section is Prof. John Perry, F.R.S., whose presidential address is looked forward to with interest. In this section it is expected that an important report will be presented by the Committee on Road Traction. The committee, the secretary of which is Prof. H. S. Hele Shaw, was appointed two years ago to investigate certain questions connected with the propulsion of vehicles on roads. The introduction of motor cars has made these problems of great importance, and one easily realises that much has to be done, remembering that scientific engineering was born long after the railways had absorbed all important traffic from the roads. The Screw Gauge Committee reported last year that it was transferring its work to the National Physical Laboratory, and the progress of this will probably be reported this year. Among the papers to be read are several on Irish water questions, on problems connected with steam raising, on electrical and

surveying apparatus and on some subjects of mechanical detail.

The president of Section K (Botany), Prof. J. R. Green, F.R.S., will deal in his address with the present position of research in vegetable physiology and its importance in connection with agriculture. He will give a general account of some of the more important problems in this department of botany, and will endeavour to indicate certain lines of research which may be expected to have important developments in the future. The work of the section will include papers on "The Morphology and Past History of the Aracaceae," by Mr. A. C. Seward, F.R.S., and Miss Sybille Ford; on "Internodes and their relation to Morphological Problems," by Prof. Percy Groom; on "The Dorsoventrality of the Podostomaceae," by Mr. J. C. Willis; on "The Function of the Nucleolus" and on "The Nucleus of the Cyanophyceae," by Mr. Harold Wager; on "Sex in the Genus *Diospyros*" and on "Foliar Periodicity in Ceylon Trees," by Mr. H. Wright; and on "Fossil Nipa Seeds from Belgium," by Mr. Seward and Mr. Arber. Papers will also be read by Prof. Oliver and Miss Chick, Dr. Dixon, Miss Matthaei, Miss Bateson, Mr. Worsdell, Prof. Bottomley and others, and Mr. Thomas Steel will exhibit some characteristic Australian plants.

The president of Section L (Educational Science), Prof. Henry E. Armstrong, F.R.S., will deliver an address on the morning of Thursday, September 11. The subjects to be brought forward in papers, addresses or reports with a view to discussion are:—"Recent Reforms in Irish Education, Primary and Secondary, with a view to their Coordination," by Dr. W. J. M. Starkie; "Report on the Teaching of Mathematics"; Irish Educational Work: (1) "Intermediate Education in Ireland," by Mr. R. M. Jones; (2) "The Introduction of Practical Instruction into Irish National Schools," by Mr. W. Mayhowe Heller; "Technical Instruction in Relation to Industrial Development in Ireland," by the Right Hon. Horace Plunket; "Report on Teaching of Science in Elementary Schools"; "The Training of Teachers," by Prof. Withers, Miss Walter and others; "Report on the Conditions of Health essential to the carrying on of the Work of Instruction in Schools"; "The Subjects to be Taught as 'Science' in Schools and the Order in which they should be Taken," by Dr. C. W. Kimmins; papers on "Educational Experiments"; "The Teaching of English," by Mr. P. J. Hartog, Canon Lyttelton and others; joint discussion with Section G on "The Training of Engineers"; and "Interim Report on Examinations."

The Belfast Harbour Commissioners have offered to lend their steamer *Musgrave* to the local committee for the use of members of the Association for Harbour and Lough trips on three days during the meeting, and it was suggested that on one of these days a special visit of the Engineering Section might be made to the Harbour Works. Supplementary excursions are being arranged by the Belfast Naturalists' Field Club, consisting of short trips in the neighbourhood in the afternoons during the meeting, and also longer excursions for the Thursday after the meeting. Ample information respecting all these will be obtainable in the reception room. On Thursday, September 11, the Lord Mayor of Belfast, Sir Daniel Dixon, D.L., will invite members, associates and holders of ladies' tickets to a reception in the exhibition hall near Queen's College. On Friday, September 12, the Earl of Shaftesbury invites members, associates and holders of ladies' tickets to a garden party in the grounds of Belfast Castle at the foot of Cave Hill at three p.m. (limited to 600). On Saturday evening, September 13, Major Ritchie and Miss Ritchie will invite 150 members to a reception at the Grove, at nine p.m. A list of lodgings and hotel accommodation has been prepared and may be obtained on application.

THE FIRST MEETING OF THE INTERNATIONAL COUNCIL FOR THE EXPLORATION OF THE SEA.

AT the conference which was held at Stockholm in June, 1899, having for its object the promotion of international cooperation in studying the physical and biological conditions of the seas bordering Europe, programmes were discussed and formulated, which were revised at the second conference, held in Christiania, in May, 1901, when a scheme for the coordination of the proposed work was provisionally agreed to. This scheme contemplated the creation of an International Council nominated by the Governments of the countries interested, which should meet periodically and organise and direct the proposed work, utilising for this purpose funds to be placed at its disposal by the Governments in question.

The question having been considered by all the maritime countries of northern Europe, all except France decided to participate, in most cases, however, for a few years only, and with conditions limiting the application of the funds which were voted to researches likely to produce practical results beneficial to fisheries at an early date.

The first meeting of the International Council took place in Copenhagen on July 22, when the following delegates and experts took part:—Great Britain, Sir Colin Scott Moncrieff and Prof. D'Arcy Thompson, with Dr. H. R. Mill and Mr. W. Garstang as experts; Denmark, Captain Drechsel and Dr. M. Knudsen, with Dr. C. G. J. Petersen and Dr. Ostenfeld as experts; Holland, Dr. P. P. C. Hoek; Finland, Prof. Hömön and Dr. Nordqvist; Germany, Dr. Herwig and Prof. Krümmel; Norway, Prof. F. Nansen and Dr. J. Hjort, with Mr. Schweigaard as secretary; Russia, Dr. Knipovich; Sweden, Prof. O. Pettersson and Dr. Trybom, with Prof. P. T. Cleve as expert. The Council was received at the opening meeting by the Prime Minister, M. Deutzer, who welcomed the delegates to Copenhagen and explained that the Belgian Government, while not sending a delegate on this occasion, had not dissociated itself from the work. The King of Denmark received the delegates on a later occasion, and the Prime Minister and the Minister of Agriculture gave dinners in their honour. The meetings took place in the Foreign Office, and every possible facility was afforded for carrying out the work for which the Council had assembled.

At the first sitting the Council was constituted. Dr. Herwig, of Hanover, the head of the German Sea-Fisheries Association, was elected president; Dr. Otto Pettersson, of Stockholm, vice-president; and Dr. P. P. C. Hoek, of The Helder, in Holland, was appointed general secretary, in accordance with the suggestions of the Christiania conference.

The second sitting was occupied in discussions as to the management of the business of the Council, and two committees, each consisting of one delegate from each country represented, were appointed to draw up definite proposals as to the oceanographical and biological work of the Council. The third sitting received the reports of these committees and adopted them after discussion.

The scheme of biological work has been considerably modified on account of the conditions imposed by most of the Governments in giving funds for the international cooperation. Practical results of direct value to the fisheries are sought for, and the money has been given definitely for that purpose, thus preventing the institution of researches of a purely scientific aim the results from which might not directly and rapidly lead to the benefit of fisheries.

It was decided to undertake at once the systematic study of two problems of immediate practical importance—the migrations of the most important food-fishes of the North Sea, especially the cod and herring; and the

question of over-fishing in those parts of the North Sea, Skagerrak and Kattegat most frequented by trawlers, with special reference to the plaice, the sole and other flatfish, and to the haddock. Each problem is to be studied by international observations directed by an international committee under a chairman or convener nominated by the Council. The committee on fish migration consists of one representative each of Germany, Denmark, Norway, Sweden, Finland and Russia, and two of Great Britain (for England and Scotland); the convener of this committee is Dr. Johan Hjort, of the Norwegian Fisheries Department. The committee on over-fishing consists of one representative each of Germany, Denmark, Sweden and the Netherlands, and two of Great Britain (for England and Scotland), to whom will be added eventually one of Belgium. The convener of this committee is Mr. W. Garstang, of the Marine Biological Association.

A third committee for the investigation of the Baltic was also appointed, consisting of one representative each of Germany, Denmark, Sweden and Finland, with Dr. Nordqvist as convener.

The "hydrographical," or, as we would rather term it, the purely oceanographical work of the international cooperation is to be carried out by means of the steamers provided by the participating States in accordance with the provisions of the Christiania programme. The representatives of the various countries handed in provisional schemes authorised by their Governments, the British scheme including two areas for research—the English Channel west of the Isle of Wight and the Færoe-Shetland Channel. The Dutch area includes the southern and the German area the northern half of the North Sea; the Danes undertake observations between Færoe and Iceland, the Norwegians observations in the western North Atlantic off the coast of Norway, and the Russians in the Arctic Sea. It is hoped that Belgium may undertake the eastern part of the English Channel. The countries possessing a coast-line on the Baltic divide that sea between them. The essential feature of the physical work consists of a simultaneous quarterly cruise by all the ships, employing instruments and methods of higher precision than have hitherto been thought necessary, and determining the horizontal and vertical distribution of temperature, salinity, dissolved gases and also of plankton. This does not, however, exhaust the programme, which provides for securing an extensive series of surface observations, and samples from regular liners crossing the North Sea and the Atlantic, and also aims at utilising lightships and coast-stations for regular observations at frequent intervals, in order to connect the various periodical cruises and so enable a continuous record of the march of seasonal change to be kept.

The International Council will conduct its work through the Central Bureau, which has now been established in Copenhagen, and the International Laboratory, to be opened in Christiania. The Bureau consists of the president, vice-president and general secretary of the Council, with the addition of Captain Drechsel, one of the Danish delegates, as an honorary member. It will exercise the executive authority of the Council, calling the annual or extraordinary meetings when required and keeping up communication with the various national organisations through the secretary, Dr. Hoek. The chief assistant in the Bureau is Dr. Martin Knudsen, lecturer on physics in the Polytechnic Institute of Copenhagen.

The International Laboratory at Christiania will be opened under Dr. Nansen, as honorary director, in the month of October, and Dr. Walfrid Ekman, of Stockholm, has been appointed first assistant, specially charged with the purely physical work; a second assistant for chemical work will be selected by Dr. Nansen at an early date. The work of the Laboratory, as defined in the Chris-

tania programme, includes the instruction of observers, the verification of instruments, the preparation and distribution of standard sea-water for controlling analyses, and experiments with new apparatus.

As in all international undertakings, concessions have had to be made on all sides; but the proceedings at the Council were always harmonious, and there is good reason to expect that the various national organisations will cooperate heartily to obtain results which at the end of a few years may justify the experiment to the practical man engaged in fisheries as well as to the man of science.

H. R. M.

POLYNESIAN POLITICS AND ANTHROPOLOGY.¹

IN the course of a long residence in the South Pacific as a British official, Mr. Basil Thomson has from time to time published several amusing and instructive works, illustrative of native life and thought and the

book, however, and, to those who are interested in the well-being of the Pacific Islanders, the more pleasant part, is that which concerns the visit to Savage Island. The sovereignty of that island had been offered to Queen Victoria in 1887, and a protectorate so long ago as 1859. The island had been Christianised by the London Missionary Society, of whose missionaries, and particularly of Mr. Lawes, the resident missionary at the time of the proclamation, Mr. Thomson speaks in the highest terms. The natives were accordingly well-disposed towards the object of the visit; and the ceremony of proclamation of British supremacy was performed, and the protectorate flag hoisted, after the signature of a formal treaty, in the presence of a general assembly of the people, with their full assent.

Mr. Thomson took the opportunity of his visit to make inquiries into the history, customs and racial affinities of the natives. This was partly a business inquiry, for on coming under British rule certain changes in the law, particularly in the penal code, were requisite. It is only

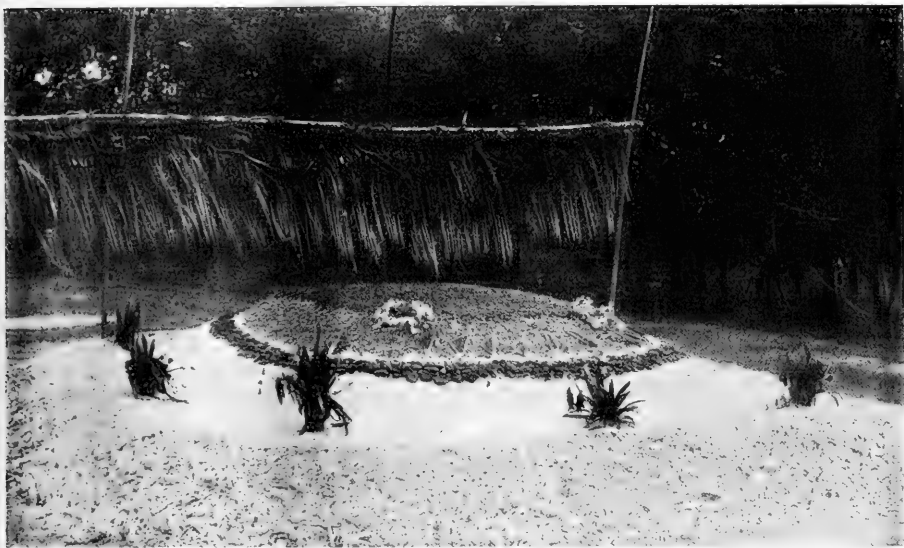

FIG. 1.—A grave in Tonga.

problems with which a civilised Government has to deal. Not the least instructive, or the least amusing, of these was "The Diversions of a Prime Minister," issued in 1894. There the author recounted the difficulties which beset him in repairing the evils of the misgovernment of the Tonga Islands by Mr. Baker, formerly a Wesleyan missionary, and afterwards, as prime minister of the king, practically despot of the islands. The present volume narrates his experiences as commissioner for the purpose of taking over the suzerainty of Savage Island and Tonga consequent on the Samoa Convention with Germany, whereby these islands were assigned to Great Britain. So far as regards Tonga, therefore, it is a sort of sequel to the former work. The more important part of the

one example of the intimate connection between anthropological study and the practical politics of the widely extended British Empire. Fortunate it was for the Savage Islanders that an official so experienced in the ways of the Polynesian and Melanesian races, and so sympathetic, was found to undertake these delicate duties.

To enumerate the various subjects of scientific interest briefly discussed by Mr. Thomson would be to make a pretty long list. It must suffice to mention only three or four. The first is the physical and mental characteristics of the Niueans. Polynesians they are, but Polynesians with a dash of alien blood which has rendered them less indolent, more alert and enterprising, than others of Polynesian race. Another subject is that of the historical value of tradition. The author cites a Niuean tradition of a Tongan invasion, and sets beside it the Tongan account of apparently the same event, as well as an

¹ "Savage Island: an Account of a Sojourn in Niue and Tonga." By Basil Thomson. Pp. viii + 234. Illustrated. 7s. 6d. net. (London: John Murray.)

independent tradition of the Futuna islanders of an incident said by the Tongans to have occurred on that island during the same expedition. Whatever a critical examination of these traditions may yield, there is one caution to be observed. The Polynesians have an unusual facility for the preservation of quasi-historical memories. Their genealogies go back for many more generations than those of most other savages; and it is impossible to generalise from their example as to the historical value of the traditions of other races. Even their retention of the memory of events is capricious. The Niueans have preserved a mimicry of the rite of circumcision, which renders it obvious that they once practised the rite in real earnest, like other South Sea islanders; but they have no tradition of how, or why, or when they abandoned it. The ceremony in question is curious, and, as Mr. Thomson says, probably unique. It is worth further inquiry. Lastly, the sacredness of animals, which is here noticed as a suggestion of totemism, is a clue to be followed up. There is nothing in the information given by Mr. Thomson pointing directly to totemism. But the wish, at which he hints, that Polynesian folklore should be systematically collected in all the islands, and compared, is one that every anthropologist will echo. If this were done, whether totemism were discovered or not, much would be discovered of importance to science, and something perhaps of not a little utility for the administration by European Powers of those outlying portions of their Empires.

The book is written with Mr. Thomson's accustomed gaiety. It contains a number of plates from photographs, of which the one here reproduced, by the courtesy of the publisher, shows a Tongan grave-mound of coral, white sand and polished black pebbles, together with the garlands worn by friends and suspended above it as a mark of their affection. Is the word "surplus" on p. 163 a misprint, or a joke?

E. SIDNEY HARTLAND.

KEW MICROMETER.

ALL botanists, entomologists and others who have to deal frequently with the minute measurements of parts of the object they examine must have felt the inconvenience of the double measurement involved in the use

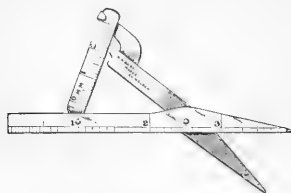

of compasses and measuring rule. The instrument of which we give a figure has been named the Kew micrometer, and has been devised by Sir Joseph Hooker to remove this inconvenience.

The construction will be evident on reference to the figure. By a simple adjustment of a scale to one arm of the micrometer, the length of an object is recorded up to a fraction and can be read off at leisure. One side of the scale is graduated to millimetres, the other to inches. For work under a microscope there is great advantage in the use of an instrument of this kind, for a measurement may be recorded and a dissection proceeded with without lifting the eye from the eyepiece of the instrument. Another useful feature of the micrometer is that the graduation to inches and millimetres on opposite sides of

the scale furnishes a ready means of turning the one scale into the other without calculation, and this is a matter of some moment at the present time, when the two scales are in use in several countries. The length of the arm of the micrometer is exactly four inches, and this is graduated to tenths of inches and can therefore be used for larger measurements.

The instrument is a small and handy one, and can be easily carried in a sheath in the waistcoat pocket; it supplies a real want. Mr. Baird, scientific instrument maker in Edinburgh, is the maker of the instrument.

NOTES.

THE preliminary programme of the meeting of the German Association of Naturalists and Physicians to be held at Carlsbad in September has been prepared. On Sunday, September 21, the various committees will meet to transact the preliminary business in the forenoon, and the rest of the day will be devoted to social gatherings. Of the seventy-four meetings this will be the second visit paid to Carlsbad, the first occasion having been forty years ago. Prof. Dr. Heubner, of Berlin, is the president for this year, with Prof. Dr. van 't Hoff, of Charlottenburg, and Prof. Dr. Chiari, of Prague, as vice-presidents. On September 22 the work of the meeting will commence after an address of welcome to the general body, when Hoffmeister, of Strasburg, will deliver an address "On the Molecular Construction of White of Egg"; Weber, of Amsterdam, on "The Early History of the Malay Archipelago"; and Voller, of Hamburg, on "The Origin and System of Wireless Telegraphy." In connection with the last-mentioned, there will be during the week opportunities for the members to study the Slaby and Braun system, practical illustrations of which will be supplied by the General Electrical Co., of Berlin, and the Wireless Telegraphy Co. (Braun and Siemens-Halske system), of Berlin. On Wednesday morning the sections again unite to be addressed by Suess, of Vienna, "On the Nature of Hot Springs"; by Meyerhoffer, of Berlin, on "The Chemo-physical Constituents of Medical Springs"; and by Ruff, of Carlsbad, on "David Becher, the 'Carlsbad Hippocrates,' 1725-1792." At another general meeting on Friday morning lectures will be delivered by Baron von Eiselsberg on "The Importance of the Thyroid Gland in the Economy of Nature"; by von Wettstein on "Neo-Lamarckisms"; and by von Miller on "The Forces of Nature in the Service of Electricity." At the meetings of the 28 sections, the communications promised cover every field of investigation in natural science and medical and surgical practice, some hundreds of papers in all. On the scientific side they range up to 18 in the mathematical, astronomical and geodesy section, and 29 in the chemistry section, while on the medical side they range up to 60 in the surgical section. The closing meeting will be on Friday, September 25. Everything is being done by the ten local sub-committees to render the week a pleasant one for visitors, the Entertainments Committee having made a complete arrangement of concerts, theatricals, dinners and excursions to occupy the whole of the spare time.

PROF. D. J. CUNNINGHAM, F.R.S., has accepted the invitation of the Anthropological Institute of Great Britain and Ireland to deliver the third annual Huxley memorial lecture, the date fixed being October 21. He has chosen for his subject "Right-Handedness and Left-Brainedness."

THE San Francisco correspondent of the *Daily Mail* reports that the people of Santa Barbara, a county of southern California, are terror-stricken owing to the increasing frequency and severity of the earthquake shocks, of which there were seventy-

five from July 27-31. The most destructive was that at the town of Los Alamos, at 1.20 a.m. on July 31. All the brick buildings were thrown to the ground, but the frame buildings generally escaped serious injury except to their windows. Not a chimney has been left standing. The shock lasted thirty seconds, and seems to have had a spiral motion. Goods were hurled from the shelves of the stores and piled in the middle of the rooms; even heavy desks were tossed about. The inhabitants ran into the streets in a panic, for in the morning between 7.25 and 7.30 there were three additional shocks, and just before nine two more. It is also reported that there were four severe shocks of earthquake in Los Alamos Valley on August 1. Several buildings which had survived the earlier shocks were badly cracked, and an immense structure near Los Alamos was turned partly round on its foundations. The earth continues to tremble at intervals, and the countryside is said to be changing appearance. A Reuter telegram from Leiria, Portugal, states that a violent earthquake shock was felt there at midnight on August 3 and was renewed at 6.45 a.m. on August 4. One shock was felt throughout the centre of Portugal and on the seaboard. The Central Meteorological Bureau of Italy announces that a severe earthquake shock was felt at Carrara at 11.35 p.m. on Monday, August 4. It was followed by two more shocks. Another earthquake shock is reported from Massa. The seismographs at Siena, Florence, Padua, Rome and Rocca di Papa also registered disturbances.

In the House of Commons on Monday, the decision to close the observatories at Ben Nevis and Fort William was again brought forward, and the First Lord of the Treasury was asked whether he would order an inquiry to be made into the distribution by the Meteorological Council of the annual grant of 15,300*l.*, so as to secure that an adequate allowance be made to these observatories. In his reply, Mr. Balfour referred to an inquiry held about twenty years ago, at the close of which the committee recommended that the inquiry should be repeated from time to time, a recommendation that has not been followed. In the circumstances he thought it would be right to have an investigation and to repeat it from time to time. This would involve no slur or slight on the scientific committee which allocates the funds.

A COPY of the remarks made upon the subject of the Ben Nevis observatories by Sir Arthur Mitchell, honorary secretary of the Scottish Meteorological Society and of the directors of the Ben Nevis observatories, at the meeting of the Society on July 23, has been received. It is pointed out in this statement that the importance of observations at a high level is emphatically and increasingly recognised in the countries of Europe and in the United States of America. Both the high- and low-level observatories at Ben Nevis have been, all through their existence, under the sole management and control of the directors, by whom they were erected and to whom they belong. Having high-level observations to compare with suitably associated observations at sea level has a direct bearing on the study of meteorology broadly; but it is also and everywhere held that the possession of such observations may be reasonably expected to assist directly in weather forecasting. The directors started in 1883 with the intention of performing a big and costly experiment in atmospheric physics, which, in their opinion, ought to cover a sun-spot period, that is, from eleven to twelve years. This experiment they have been able to complete by the aid of public generosity. For the first seven years after 1883, when the observatory at the top of Ben Nevis was opened, there were no hourly observations at sea level for purposes of comparison, so that the experiment began in a complete form only twelve years ago, in 1890, when the low-level observatory at Fort-William was also opened.

THE Museum of Practical Geology, Jermyn Street, will be closed as usual from to-morrow evening, August 8, until the morning of September 10.

THE Reale Accademia dei Lincei has conferred on Mr. Marconi a special prize of ten thousand francs under the Santoro foundation in recognition of his work in connection with wireless telegraphy.

THE Bisset Hawkins gold medal of the Royal College of Physicians of London has been awarded to Dr. W. H. Power, F.R.S., principal medical officer to the Local Government Board. The medal was instituted in 1896 with the object of perpetuating the memory of the late Dr. Francis Bisset Hawkins, and is bestowed triennially on some duly qualified medical practitioner who has, during the preceding ten years, done good work in advancing sanitary science or in promoting public health. Dr. David Ferrier, F.R.S., will deliver the Harveian oration of the College on St. Luke's day, October 18. The Bradshaw lecture will be delivered in November by Dr. C. J. Cullingworth. Dr. A. S. F. Grünbaum has been appointed Goulstonian Lecturer and Dr. T. R. Glynn Lumlaine lecturer for 1903, and Dr. J. R. Bradford the Croonian lecturer for 1904.

ON Friday last Sir Alfred Jones, chairman of the Liverpool School of Tropical Medicine, entertained at dinner the Duke of Northumberland and the Tropical Diseases Section of the British Medical Association, at the Adelphi Hotel, Liverpool. In proposing the health of the Duke of Northumberland, Sir Alfred Jones mentioned that a friend had given a donation of 25,000*l.* for the study of tropical medicine at the Liverpool School, and through the energy and perseverance of Prof. Boyce the School was being endowed with 10,000*l.* The Duke of Northumberland, in replying, said that he had been impressed with the importance of the efforts which were being made in the direction of ameliorating the conditions of tropical existence. In responding to the toast "Tropical Medicine," Sir W. Kynsey said it seemed extraordinary that in a wealthy country like England it was impossible to get a penny from Government for these schools, which had been entirely dependent upon private benevolence.

THE steamer *America*, with the whole of the Baldwin-Ziegler Arctic expedition, arrived on August 1 at Honningsvåg, in Northern Norway, and then proceeded to Tromsø. Mr. Evelyn B. Baldwin, the leader of the expedition, reports as follows to Reuter's Agency:—"This year's work has been successful. An enormous depot of condensed foods has been established by sledge on Rudolf Land within sight of the Italian expedition's headquarters. A second depot has been formed in lat. 81 33, and a third depot at Kane Lodge, Greely Island, which has been newly charted as near the 81st degree of latitude. These large depots, together with the houses and stores left at Camp Ziegler, as well as provisions for the five ponies and 150 good dogs now on board, besides the pack itself, will afford means for a large Polar dash next year. The fact that all the channels through Franz Josef Land remained blocked by ice during the autumn of 1901 prevented the establishment of depots by steamer last year. The breaking up of the ice early in June compelled us to use our reserve supply of coal, and hence our departure from Camp Ziegler on July 1 in order not to imperil the expedition. We dispatched 15 balloons with 300 messages in June. We have obtained the first moving pictures of Arctic life. We discovered Nansen's hut, recovering the original document left there and securing paintings of the hut. We have also secured marine collections for the National Museum, new charts, &c. Thirty men, with 13 ponies, 170 dogs and 60 sledges, were employed in field work from January 21 to May 21, this severe work resulting in the destruction of the sledges; this and the depletion of the food for the ponies and the dogs rendered a return imperative."

In a paper read at the International Navigation Congress recently held at Dusseldorf, Mr. Gordon C. Thomas, C.E., gives a description of a novel kind of canal lift which he has recently constructed at Foxton, on the Grand Junction Canal, one of the most important arterial waterways in this country. At Foxton there is a rise of 75 feet, which used to be overcome by a flight of 10 locks, which could only take barges carrying 33 tons. The time occupied in passing a boat through these locks was 75 minutes, and 30,000 gallons of water were used for the purpose at each lockage. The increasing traffic necessitated some better means of raising and lowering the barges and decreasing the quantity of water required. For this purpose Mr. Thomas has recently constructed for the Canal Company a new system of elevation at a cost of 40,000*l.*, by means of which the time occupied in raising and lowering the boats has been decreased to twelve minutes for one boat ascending and another descending as compared with an hour and a quarter for the passage of a single boat, the quantity of water used being only one-tenth of that required when the locks are used. The lift consists of an inclined plane connected with the higher and lower levels of the canal at an angle of 1 in 4. On this incline two docks, or iron troughs, 80 feet long, 15 feet wide and 5 feet deep are hauled up and down, the barges being first floated into or out of the docks from the canal, the ends of which are closed by gates made watertight. The troughs are hauled up sideways and the wheels on which they rest are so adjusted that the water in them always remains level. As one trough is drawn up, either loaded with a boat or empty, except as to the water, the other descends. This lift is capable of passing 200 canal boats in twelve hours, and can be managed by three men.

SIGNOR FILIPPO EREDIA has published in the *Atti* of the Royal Academy of Scienze some interesting statistics in regard to the rainfall of Sicily during the period 1880-1900. Considering the following ten stations, Palermo, Termini, Messina, Riposto, Catania, Syracuse, Mineo, Girgenti, Caltanissetta and Trapani, it is found that if the twelve months of the year be arranged in descending order of their average rainfalls, the five least rainy months at each station occur in the order September, May, August, June, July. The most rainy month is November for Messina, Riposto, Catania and Trapani, and December for the other stations. The next in order is December for Messina and Trapani, November for Syracuse, Termini and Girgenti, and January for the other stations. October occurs fourth on the list for Palermo, Termini, Girgenti and Syracuse; it is the third for Messina and Trapani, fifth for Riposto and Catania, and still lower down for Mineo and Caltanissetta. February is fifth on the list for Palermo, Termini, Messina, Trapani and Syracuse, fourth for Catania, Mineo and Caltanissetta and third for Riposto. Finally, March and April occupy the sixth and seventh places at all stations except Girgenti, Mineo and Caltanissetta.

THE director of the International Bureau of Weights and Measures, at Paris, has recently issued a further volume of the *Travaux et Mémoires* of the Bureau (vol. xii., 338 pp.; Paris: Gauthier-Villars.) This volume deals with (1) the determination in 1894-5 of the length of the yard in terms of the metre; (2) with the verification in 1890-7 of standard end-measures (mètres à bouts); and (3) with a comparison of platinum and gas thermometers. The volume also contains a reprint of the "Compte rendu des Séances" of the three general conferences on weights and measures which were held at Paris in 1889, 1895 and 1901, to the last of which reference has been recently made in our columns. The comparisons of the yard and metre, and the verification of the end-measures (1) (2), are now almost ancient history, and the important results obtained in 1895 and 1897 have been duly recognised in this country. A full and interesting report

is made on the comparisons of platinum, gas and mercurial thermometers by Dr. J. A. Harker and Dr. P. Chappuis (3). The results of their researches have, however, been already published in London (*Phil. Trans. Roy. Soc.*, vol. xciv. pp. 37-134, 1900). Prof. Callendar's method of measuring temperatures based on the determination of the electrical resistance of a platinum wire, has been extended to a comparison at the Bureau of the platinum thermometer with the nitrogen thermometer (now adopted as the international standard thermometer) at temperatures varying from 50° to 460° C. A comparison was also made between the platinum and the mercurial thermometers at lower temperatures, all the comparisons having been made under the direction of Dr. Benoit. These comparisons were originally proposed by the Kew Observatory Committee, and the numerous formulæ as well as the results are clearly set out in appendices to the report.

THE explosion of a charge of about ten tons of gunpowder in connection with blasting operations in the granite quarries near Baveno (Lago Maggiore) has afforded Dr. Emilio Oddone an opportunity for making a series of observations of interest in connection with seismology, and the results are described in a paper communicated to the Istituto Lombardo in May last. The charge was fired on October 30, 1901, and Dr. Oddone made observations in a hut distant about 13 kilometres to the north of the mines, using a seismometer for horizontal motions, an apparatus for determining the relative motion in a radial direction of two points three metres distant, a variometer for the aerial disturbances, an aneroid and a chronometer. To calculate the velocity of propagation, observations were made at 7, 10 and 20 kilometres, and also with the instruments at Pavia, Milan, Turin and Padua. The indications of the seismograph showed initially a solitary wave of amplitude 0.1 millimetre, but in consequence of the rock subsequently breaking off in five pieces this was followed by subsidiary waves. The variometer indicated an instantaneous variation of atmospheric pressure of about 1/24 millimetre of mercury. The distant observations gave negative results; at Baveno, 7 kilometres distant, no earth tremors were noticed, and even the sound of the explosion hardly reached 15 kilometres. A calculation of the total energy dissipated by the waves across a hemispherical surface of radius 1500 metres about the hypocentre gives 1.4×10^7 kilogrammetres, the total energy set free by the combustion of the powder being 2.584×10^9 kilogrammetres. It appears, however, probable that about 92 per cent. of the elastic energy was absorbed at a distance of 1500 metres, and this absorption Dr. Oddone attributes to the viscosity of the granite. The same cause accounts for the absence of any observed earth tremors at the distant stations, which made it impossible to calculate the velocity of wave propagation. At the same time, an explosion high up on a mountain at the side of a deep lake hardly appears to be favourably placed for sending earth-tremors to a long distance.

A BEAUTIFULLY illustrated pamphlet, by Mr. C. Dixon, issued by Ross, Ltd., of New Bond Street, describes the advantages of Ross's prism field-glasses to the out-of-doors naturalist.

NUMBER ix. of the L.M.B.C. *Memoirs*, by Mr. O. V. Darbishire, is devoted to a full account of the natural history of Chondrus, or "Irish moss." At the conclusion of his memoir the author deplors the want of a thoroughly trustworthy and up-to-date work on British sea-weeds.

THE August number of the *Contemporary Review* contains an interesting article on bird-life by Mr. Digby Pigott, in which the author draws special attention to the beautiful preparations in the Natural History Museum illustrative of the arrangement of the feathers in the wing.

THE *Journal* of the Straits Branch of the Royal Asiatic Society for January contains a long paper on Sarawak Hymenoptera, by Mr. P. Cameron, largely based on the collection made by Mr. R. Shelford. Since the report in 1857 on Dr. Wallace's collection very little work has been done on this subject, and the author is enabled to record a number of new generic and specific types.

THE contents of the July number of the *American Naturalist* include a paper on the gastrulation of the egg of the toad *Bufo lentiginosus*, by Miss H. D. King, and another, by Mr. W. A. Hilton, on the sense-hairs of caterpillars. In the latter the author states that the majority of the body-hairs of these larvae are sensory, and that almost the only mode in which sensory nerves terminate on the bodies of insects is by means of hairs.

IN the July issue of the *Journal of Anatomy and Physiology*, Dr. H. W. M. Tims discusses the intricate question of the homology of certain deciduous and permanent cheek-teeth in mammals, in the course of which he disputes the view that the functional teeth of marsupials belong to the deciduous series. In the same number Mr. Elliot Smith describes the manner in which the desiccated brain is preserved in many Egyptian human skulls, other than those of mummies, and Prof. F. G. Parsons figures some of the leading modifications of the aortic arch in mammals.

THREE interesting instances of abnormality in mammals are recorded in journals received during the past week. In the *American Naturalist* for July Mr. F. Howe discusses the nature of the polydactylism in a breed of cats kept at Cambridge, Mass. It is concluded that the polydactylism lends no support to the theory of reversion to a six- or seven-toed ancestral type, the only definite statement possible being that three digits are developed where there are normally but two. In the *Journal of Anatomy and Physiology* for the same month Prof. O. C. Bradley records the occurrence of seven cheek-teeth, exclusive of the deciduous first premolar, in a horse, while Mr. Elliot Smith mentions an ancient Egyptian skull with an additional incisor. Mr. Smith, from his specimen, suggests that the missing incisor in man is *i*. 1, and not *i*. 2, as Tomes believes to be the case. It may be pointed out that Lydekker suggested the missing tooth to be *i*. 2 in 1884, or fourteen years earlier than the work of Tomes cited by the author.

AT the conclusion of some notes in the *Proceedings* of the Philadelphia Academy on the so-called flying-lemur (*Galeopithecus volans*), a creature usually regarded by naturalists as an aberrant member of the Insectivora, Dr. H. C. Chapman sums up as follows:—"It appears, at least in the judgment of the author, that Galeopithecus cannot be regarded as being either a lemur, or insectivore or bat, but that it stands alone, the sole representative of an ancient order, Galeopithecidae, as Hyrax does of Hyracoidea. While Galeopithecus is but remotely related to the Lemuroidea and Insectivora, it is so closely related to Chiroptera, more particularly in regard to the structure of its patagium, brain, alimentary canal, genito-urinal apparatus, &c., that there can be but little doubt that the Chiroptera are the descendants of Galeopithecus, or more probable that both are the descendants of a Galeopithecus-like ancestor."

IN a valuable series of observations on living brachiopods contributed to the *Memoirs* of the Boston Natural History Society (vol. v. No. 8), Prof. E. S. Morse quotes with approbation a note from NATURE of July 13, 1899, based on Prof. J. A. Thomson's inaugural address at Aberdeen, on the importance of "nature-study," and he gives as one of the reasons for publishing his observations, which were made twenty years ago, our lack of knowledge of the habits of living brachiopods. It is not that these animals cannot be easily kept in con-

finement, as Prof. Morse states that in the middle of summer he transported a series of specimens a distance of 700 miles in a small bowl. In this connection it is interesting to note that from its vitality in such unfavourable circumstances Prof. Morse was led to suggest that the long persistence of Lingula might be accounted for. A few weeks ago we chronicled the very same suggestion made by Mr. N. Yatsu, of Tokio. The memoir is illustrated by twenty beautifully executed plates, of which the first is coloured.

WE have received the Report of the American Museum of Natural History for 1901, containing a full account of the rapid progress made by that institution and of the various expeditions which have been equipped by private persons for its enrichment. Among the latter is the Jesup expedition to the North Pacific, which has resulted in the acquisition of a mass of material illustrating the life of the Chukchi's of the extreme north-east of Siberia. The cost of publishing the results of this and other expeditions has become a somewhat serious difficulty. "It does not seem proper," says the Report, "to ask those who have generously placed parties in the field also to provide the funds for publishing the scientific results of their investigations; on the other hand, the general funds of the Museum are not sufficient to meet the obligation." As usual, the Report is well illustrated. A plate of the new "auditorium," with its benches crowded with attentive listeners, illustrates a phase of museum development unknown in our own metropolis. Among other illustrations is one of a group of gullems and gulls mounted in the Museum in imitation of their natural surroundings. A second displays a remarkably fine skeleton of a fish-lizard (Ichthyosaurus) containing numerous young skeletons within the ribs, recently acquired by exchange with the Stuttgart Museum. Other plates are devoted to ethnographical specimens.

A FORTNIGHT'S cruise in the North Sea was made recently by the Norwegian Government's research steamer *Michael Sars*. The first week was spent in a series of studies on the distribution of animal life at various depths on "Storeggen" and "Shetlandseggen," which are great submarine ridges with sloping sides. With a 50-foot trawl dredgings were made down to a depth of 600 fathoms to ascertain the distribution at various depths of the fishes used for food. A sharply defined boundary manifested itself between the distribution of the food-fishes and the deep-sea forms of life, and this boundary coincides with a rapid transition from water of a higher temperature to water just above or at the freezing point. This boundary occurs on the slope of the Shetland ridge, at a depth of between 275 and 300 fathoms. A series of studies was next undertaken on the steep north-east slope of the Faero bank. Here, so far as is known, no accurate soundings had been previously taken and no fishing carried on either here or upon the great ridge or upon the Shetland ridge. A series of soundings was made, which do not correspond with those given on the British charts. Experimental fishings were carried on for three days with most satisfactory results; nine lines were cast, with a total of 5500 hooks attached to them, of which 660 were halibut hooks; and the catches consisted of 117 halibut weighing more than 5000 kilos., 300 large cod, 500 brosmie, 10 common ling and 80 blue ling. This result is of interest, as it points to a new and important area for sea-fishery and to the existence of large quantities of halibut at a time of the year when it is not to be found on the great bank or ridge on the coast of Norway, and the same applies to the cod also. Both cod and halibut had herrings in their stomachs, although the catch was made at a depth of 200 fathoms. The work was carried out under the personal supervision of Dr. Johan Hjort.

ATTENTION was directed in NATURE for April 3 to a memoir by Prof. Yoshiwara on the geology of the Japanese islands which form the "Riukiū Curve." We have since received a report on the fossils of these islands and of Formosa, by Mr. R. B. Newton and Mr. R. Holland (*Journ. Coll. Science, Tokyo, Japan*, vol. xvii. 1902). The specimens comprise many examples of Orbitoides and other foraminifera, together with one or two species of Cellepora and one nullipore. They occur in the Orbitoidal-limestone of Miocene age, and in the raised coral-reef formations which belong to some part of the post-Pliocene series.

A SECOND and enlarged edition of the "Hand-List of Herbaceous Plants" cultivated in the Royal Botanic Gardens at Kew has been issued. In the preface it is pointed out that no substitute for the "Students' Garden"—the site of which was required for the new wing of the herbarium—is contemplated, more especially since the Botanic Gardens at Chelsea have been reconstituted under the auspices of the Charity Commissioners to serve a similar purpose. A new feature in this edition is a reference to works in which figures of the species may be found.

OF the various subjects reviewed by Mr. J. H. Maiden in his presidential address to the Linnean Society of New South Wales, the forestry question and a botanical survey of the country are topics on which the opinion expressed is that of an indefatigable worker and a practical expert. In connection with the State management of forests, Mr. Maiden directs attention to the importance of conserving areas which are not suited to agriculture, and to the necessity for planting trees to check the sand-drifts and to provide shade on the arid western plains. The object of the botanical survey would be to summarise existing records and extend them. In order to institute a survey which shall be carried on by independent workers, the delimitation of the country into areas, whether known as *domains* or *counties*, is essential; otherwise a definite basis for concerted action is wanting. A tentative scheme of botanical counties is outlined in a chart which accompanies the paper.

We have received two papers dealing with insects harmful to agriculture, horticulture, &c., the one, by Mr. G. H. Carpenter, on injurious insects observed in Ireland in 1901 (*Economic Proceedings of the Royal Dublin Society*, vol. i. part 3, No. 5), the other by Signor A. Berlese, entitled "Importanza nella Economia Agraria degli Insetti Endofagi," published in *Bollettino* No. 4 of the Royal College of Agriculture of Portici, Sicily. In the former Mr. Carpenter states that entomologists appear to have paid scarcely any attention to the maggots of flies which infest the bodies of live sheep, and he has therefore considered it advisable to describe in some detail the life-history of the sheep-fly (*Lucilia sericata*). It is somewhat remarkable that this infestation seems to be mainly confined to Great Britain and Ireland, having been recognised on the continent only in France and Holland; in the latter case, at any rate, there is good reason to believe that it was introduced from England. The author also records the occurrence of a "plague" of black ants of the Tropical American species *Iridomyrmex humilis* near Belfast in 1900. In the second communication Signor Berlese describes, with figures, the life-history of a number of deleterious insects met with in Sicily.

THE Maidu stock of north-eastern California contains some very primitive tribes, who, in their lack of clan organisation or totemic grouping, practical absence of clothing and other negative characteristics, recall the Seri Indians of the Gulf of California as set forth in the elaborate study by Dr. W. J.

McGee (Seventh Annual Report of the Bureau of American Ethnology). Mr. Rowland B. Dixon, when on the Huntingdon California Expedition, made a large collection of Maidu myths, which he has recently published in the *Bulletin of the American Museum of Natural History* (vol. xvii. 1902, p. 33). The time has not yet come when these myths can be made to yield general conclusions, more field-work being necessary in other districts. When such material is available it will probably enable us to trace more accurately the lines of migration and the mutual relationships of the great mass of stocks scattered along the Pacific coast from the Columbia River to Mexico. These myths are beast-tales with, or without, a human element. The coyote is very prominent; he seems to be generally inimical to mankind, and appears often as a buffoon and trickster, who comes out of his adventures in a sorry plight.

GERMAN translations of Faraday's papers on experimental investigations in electricity, from the *Philosophical Transactions* of 1835 and 1838, are given in Nos. 126 and 128 of Ostwald's admirable series of scientific classics published by Mr. W. Engelmann, Leipzig. Dr. A. J. v. Oettingen is the editor of the volumes, and contributes a few remarks upon them. No. 125 of the same series, edited by Dr. F. G. Donnan, contains translations of John Mayow's papers on nitre, combustion and respiration, and No. 124 papers on thermodynamics by von Helmholtz, edited by Prof. Max Planck.

THE additions to the Zoological Society's Gardens during the past week include two Green Monkeys (*Cercopithecus callitrichus*) from West Africa, presented by Captain Hugo B. Burnaby; a Common Otter (*Lutra vulgaris*) British, presented by Mr. W. Radcliffe Saunders; a Common Seal (*Phoca vitulina*) from British Seas, presented by Mr. H. C. Rouch; three Mauge's Dasyures (*Dasyurus viverrinus*) from Australia, presented by Mr. Paris K. S. Foot; eight Rufous Tinamous (*Rhynchotus rufescens*) from Brazil, presented by Colonel Sir Thomas Hungerford Holdich; a Common Mynah (*Acridotheres tristis*) from India, presented by Mrs. Hope Robinson; a Greater Black-backed Gull (*Larus marinus*) European, presented by Mrs. V. H. Veley; a Yellow-eyed Babbler (*Pyctorhis sinensis*), two Striated Babblers (*Arreya carlii*), two Himalayan Black Bulbuls (*Hypsiops psaroides*), three Rufous-bellied Bulbuls (*Hypsiops maclellandi*), a Verditer Flycatcher (*Stoerhola melanops*) from British India, presented by Mr. E. W. Harper; a Rough-scaled Lizard (*Zonurus oryzius*), a Spotted Gecko (*Pachydactylus maculatus*) from South Africa, presented by Mr. R. Broome; six Menopomas (*Cryptobranchius alleghaniensis*), four Menobranths (*Necturus maculatus*), a Blue Lizard (*Gerrhonotus coeruleus*), a Spiny-tailed Mastigure (*Uromastix acanthinurus*), four Horned Lizards (*Phrynosoma cornutum*) from North America, deposited; a Bennett's Wallaby (*Macropus bennetti*), three Glossy Ibises (*Plegadis falcinellus*), three Jameson's Gulls (*Larus novaehollandiae*), a Herring Gull (*Larus argentatus*) bred in the Gardens.

OUR ASTRONOMICAL COLUMN.

THE SPECTROSCOPIC BINARY β CEPHEI.—In No. 5, vol. xv. of the *Astrophysical Journal*, Prof. Frost gives the results of his own and Mr. W. S. Adams's estimations of the radial velocity of β Cephei, reduced from ten spectrograms which these observers obtained between December 18, 1901, and May 24, 1902, with the Bruce spectrograph.

The results obtained by the two observers agree very well and indicate a radial velocity which varies from -20.3 to $+11.3$ km. It was expected that the period of variation would be found to be a long one, but two spectrograms obtained with an

interval of five and a half hours show a variation in velocity of about 14 km., or nearly half of the whole range yet observed.

DOUBLE STARS.—As an extract from the *Monthly Notices R.A.S.* for May, 1902, the Rev. T. E. Espin publishes his micrometrical measures of double stars made at the Wolsingham Observatory with a 17½-inch reflector.

The catalogue contains several records of new components, such as in $\Sigma 59$, where two new components, C and D, have been observed, and $\Sigma 3010$, where a third component has been observed for the first time. There are also several variations of distance and position angle noted, and new values given to them, e.g. in $\Sigma 2708$ the measures made by Mr. Espin vary considerably from those made by the discoverer of this system, Prof. Hall, but this discrepancy is accounted for by a movement of $0^{\circ}26'$ towards $137^{\circ}7'$ which has been observed at Wolsingham. In regard to θ Persei ($\Sigma 296$) it is stated that the proper motion during the last 116 years has been perfectly rectilinear, all the observations being well represented by

$$\Delta = 16'' \cdot 363 + 0'' \cdot 029 (t - 1866 \cdot 0).$$

$$T = 297'' \cdot 162 + 0'' \cdot 075 (t - 1866 \cdot 0).$$

It has been observed that $\Sigma 1321$ is a similar system to 61 Cygni, P.M., the two components A and B both being of a reddish-yellow colour, whilst a third component, too faint to measure, was discovered on January 22, 1901.

LIGHT OF THE GALAXY AND BRIGHT STARS.—In No. 3803 of the *Astronomische Nachrichten*, Mr. C. Easton gives the results of his researches in comparing the light of the Galaxy to that of the comparatively bright stars of the Milky Way of the Northern Hemisphere.

Mr. Easton divided the galactic zone between -15° galactic latitude and $+18^{\circ}$ galactic latitude into 108 rectangles, and then, by an ingenious method, compared the light emitted from the area of each rectangle with the light emitted by the stars of the Northern Milky Way. The results show that there is a correlation and parallelism between the distribution of the galactic light and the stars of Argelander. On this basis Mr. Easton deduces that the stars in general may not simply be isolated units, but they may all belong to such agglomerations as we believe make up the Milky Way, the only real difference being in their relative distances from us; he suggests that the apparently crowded parts of the heavens, such as occur in the region of Cygnus, are parts where we get two such agglomerations at different distances, overlapping at the edges, and supports this theory by noting the fact that in such regions, both the galactic light and the brighter stars increase in density together.

PERIODICITY OF VOLCANIC ERUPTIONS AND EARTHQUAKES.—Circular No. 49 of the Wolsingham Observations contains a summary, by the Rev. T. E. Espin, of the results obtained by arranging and charting the data which he has collected in regard to the times of volcanic eruptions and earthquakes.

These results point to a period of between eight and nine years in the phenomena of which Mr. Espin has received the records.

This period agrees with the period of revolution of the moon's perigee, and further investigation indicates that the greatest volcanic activity takes place when the perigee occurs at its maximum northerly declination.

MINOR PLANETS.—Prof. Max Wolf records the observations, during July, of six minor planets, giving their R.A., declination and magnitude. Amongst them is a new minor planet 1902 JL, the position of which on July 9, 1902, at 12h. 13^m.7m. (Heidelberg mean time) was R.A. = 20h. 25^m.9m., Decl. = $-19^{\circ} 58'$, and the daily movement of which is $-0^{\circ} \cdot 8$, $-6'$ (*Astronomische Nachrichten*, No. 3803).

PHARMACOLOGY AT THE BRITISH MEDICAL ASSOCIATION.

THE section of pharmacology at the British Medical Association at Manchester this year was distinctly active, and many interesting discussions were held and papers read. The first day's discussion was devoted to a subject of great practical value to physicians, viz. the unexpected and undesired effects of medicines. Sir Lauder Brunton introduced the discussion

and his paper was full of interest. He treated at length the various factors which tend to render medicines either ineffective or productive of unusual effects. Speaking of tolerance, he instanced a case in which as much as 24 grains of morphine was used by a patient as a hypodermic injection, the ordinary dose being one-third of a grain. Taking arsenic as an example, he showed how the form in which this was given greatly influenced the results produced by it. The influence of certain remedies in producing skin rashes, especially those of the anti-pyrene series, was also referred to, and finally the occasionally extraordinary effects of some of the antitoxin sera; especially in this connection antistreptococcal serum was referred to as having in a few minutes produced in a patient an almost universal swelling of the subcutaneous tissues (general oedema). The varying effects of opium were, according to the lecturer, most probably to be explained by the inconstant chemical composition of this substance and its preparations.

Subsequently several papers were read. One which aroused great interest was communicated by Prof. Liebreich, of Berlin, upon the therapeutic value of alkaline waters of the Vichy type. The lecturer refused to believe that waters artificially made from the data of chemical analysis were of the same therapeutic value as the naturally occurring waters. Especially in this connection was the presence in natural waters of a substance of colloidal nature, known as glairin, of importance. In continuation, the lecturer indicated the special conditions for which Vichy waters were to be recommended. In the discussion which ensued, Prof. Tunncliffe drew attention to the work of Nageli, Locke and others upon the physiological action of chemically unrecognisable quantities of certain substances, especially, for instance, copper, and thought that for this reason the chemical analysis of natural waters afforded, although perhaps the best available, nevertheless not entirely trustworthy data for the artificial manufacture of medicinal waters. Papers were subsequently read by Prof. Marshall, upon the action of heroine and dionine upon the circulation, and by Dr. Dixon, upon the question of injectable purgatives.

An interesting paper upon synthetic purgatives was communicated by Prof. Tunncliffe. It appears from recent researches into the chemistry of the vegetable purgatives, especially of the rhubarb group, that the active purgative group of these substances is an anthraquinone derivative. Starting from this fact, certain artificial anthraquinone derivatives have been made in the laboratory, and one anthrapurpurin acetate has been introduced into therapeutics as a purgative. This substance is very interesting and marks a decided advance in pharmacology, since it must be regarded as the first synthetic vegetable purgative. According to Prof. Tunncliffe, however, the phthaleins exert a purgative action, and have certain advantages over both the natural purgatives and also the artificially prepared anthraquinone derivatives. The substance of especial interest in this connection is the chemical indicator phenolphthalein, a dihydroxyphthalophenone. This substance is now to be introduced under the name pargen, and the lecturer gave an account of the results of its administration as a purgative in 1000 cases.

On Thursday the section was devoted to a discussion upon the therapeutic value of arsenic. The discussion was introduced by Dr. Ralph Stodman. The author gave the result of certain observations he had made upon the action of arsenic upon the bone marrow. These researches included microscopic examinations of the bone marrow of patients who had died in the Manchester beer-poisoning epidemic. The discussion was followed by a paper by Prof. Liebreich upon the therapeutic value of cantharidin. In this paper the author discussed the rôle played by the capillaries in the absorption and elimination of poisons. He ascribed to each capillary area a specific irritability. Dr. Pope subsequently read a paper upon arsenic in the treatment of chorea.

Friday was occupied by a discussion on the treatment of diphtheria. Subsequently several papers were read of considerable pharmacological interest.

In reviewing the proceedings of the section we may certainly say that it evinced a healthy activity; the material to be dealt with was in excess of the available time. The meetings were well attended by pharmacologists from England, Scotland, Ireland and Wales, and it is certainly to be expected that they will perform the true function of such assemblies and act as a healthy stimulant to further research work in this important subject.

PHOTOGRAPHY OF DIFFRACTION AND
POLARISATION EFFECTS.

IT was natural that such a subject as physical optics should call forth the best skill of mechanics, and science owes a debt to their beautiful instruments; but the very excellence of these has perhaps filled the worker with too much awe and made him feel that wave interference can only be observed in a great laboratory. The present object is to give details of simple arrangements which enable all such phenomena to be seen and photographed.

Diffraction.—The general appearance of the apparatus is shown in Fig. 1. It may be seen at the Victoria and Albert Museum. The middle stand carries a square piece of soft wood blackened, 3 inches square, $\frac{1}{16}$ inch thick, with a $\frac{3}{4}$ inch square cut out of the centre. A dozen or more of these wooden squares should be made, as holders for the various objects which cause diffraction. It is desirable to have some sheet aluminium and rolled brass, the thickness in each case about No. 30 standard wire gauge. Several objects can be made of aluminium and attached with pins to the centre of the wooden squares: a single edge; a rectangular edge for Grimaldi's crested fringes; two straight edges with adjustable distance, the adjusting edge of aluminium being made to slip under two clips of aluminium pinned down, one on either side. The pins should be cut short to about the thickness of the wood; a slight tap with a hammer rivets them. Let three of the 3-inch squares have the central

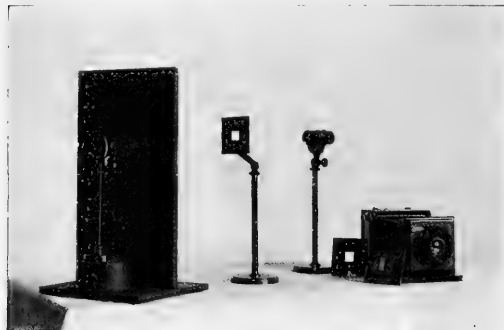

FIG. 1.

hole covered over with aluminium and let pinholes of various sizes be made; the aluminium is easily cut with scissors and pierced with a needle; when the hole is less than $\frac{1}{4}$ mm. the phenomenon is different from that given by larger holes.

Put thin microscope cover glass on the aperture of two or three wooden squares, and with the smallest speck of liquid glue attach shot of various sizes to the glass. This affords the easiest means of seeing Arago's famous experiment, a bright centre in the shadow of an opaque circular disc.

Other suitable objects are needles of various sizes, needle eyes and needle points. Fig. 2 shows diffraction by a fine and a thick needle. The centre of the shadow is a line of light in both cases; it is the finer needle which has the broader central line. For the same cause the central light broadens towards the points, and the centre of the shadow of a quartz fibre is very broad indeed. On one side of a needle place a strip of aluminium; this causes the interior bands to disappear at this position. To one side of a needle, along half its length, apply a piece of microscope cover glass; this shows Arago's crucial experiment to prove that the velocity is less in glass than in air. It is imperfectly described by saying that the fringes are shifted towards the glass side. There is another system of fringes, narrower and more in number as if from a broader needle; the central line of these is shifted towards the glass. The experiment is rather difficult; the edge of the glass gives trouble; it must be placed just over the thickness of the needle, and the needle had better be thin.

Perforated zinc and wire gauze easily give good effects; the former has series of rings in the spaces, and the centre can be made white or any colour with a small movement of the object;



FIG. 2.

also there are fine hexagonal rulings all over the geometrical shadow. The wire gauze gives bright Scotch plaids of any clan, when moved over a range of about two inches.

Some of the most beautiful effects which can be produced are shown in Fig. 3. The diffracting objects were small groups of four and five circles, circular lines of light photographed on glass, each group being $\frac{1}{16}$ inch diameter. They were made years ago for another species of diffraction, that as studied by Fraunhofer, Schwersd and Herschel, in which a telescope is focussed on to a distant point of light and various screens are placed on the object glass. Our present view is that of Fresnel, in which waves starting from a point, almost mathematical, of light are diffracted or broken by an interposing body.

A word more as to the holder of the objects. In the bottom of the 3-inch squares of wood, Fig. 1, is a slot; this slot is placed over a screw fixed in the top of the oblique bar in the middle stand; a nut on the screw clamps the square and allows adjustment in a vertical plane. The lower end of the oblique bar, which is 3 inches long, has a stiff joint on to the upright, which is 9 inches high; the stiff joint makes an easy adjustment for height.

On the left of Fig. 1 is a wooden screen 16 inches high, 9 inches broad. At a height of 10 inches is a hole $\frac{1}{2}$ inch in diameter; on either side of this let there be a brass spring which will allow one of the 3-inch squares to be slipped under it. The square should have a sliding strip of aluminium, with three pin-holes ranging in size from the smallest that can be made. Sometimes an adjustable slit should be placed here. A convex lens condenses lamplight or sunlight on to this aperture, whether pinhole or slit; this is the source of light.

Towards the right hand in Fig. 1 may be seen an eye-piece for

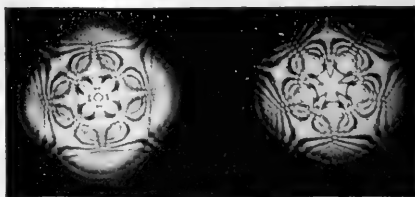

FIG. 3.

direct observation or a camera for photographing the effects. The distance for either of these is about 2 feet from the wooden screen which carries the source of light. The eye-piece is Beck's B microscope Huyghen's eye-piece. Any simple holder

can be made to serve, but it is useful to have a sliding tube in a brass upright and at the top a V which is above a stiff joint. On this V the eye-piece can be held with an elastic band; or an eye-piece of different breadth, or a Nicol's prism may be so fixed. Most of the effects may be well seen if a lamp is used for the source of light. It is easier to observe in a room which is rather dark, for then the space between screen and eye-piece need not be

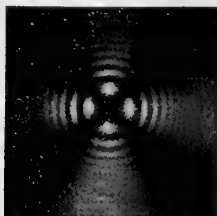

FIG. 4.

covered up. Sunlight may be reflected by a hand-mirror into a darkroom through an open door. The lens which condenses on to the pinhole can be moved a little until it is seen that a pencil of light is just covering the lens of the eye-piece; then the object can be adjusted so as to be also covered by this pencil. Of course, the effects as seen directly by the eye are far more beautiful than the photographs. The object is about 18 inches from the pinhole. With good sunlight there are often groups of brilliant jewels, in which the emeralds and the rubies are made to change places by a small movement of the object. For producing Arago's bright spot with an object so broad as a threepenny piece, the distance from the pinhole to the eyepiece must be about 36 feet.

In photographing the phenomena the same eye-piece is fitted on to the front of a camera, instead of the usual lens; the camera can be placed on a box and adjusted to the right height with books or paper. If there is good sunlight, about 30 seconds' exposure is suitable for an Ilford ordinary plate. There is no question of focus; to whatever position the back of the camera is drawn out the figures are equally in focus. There is a series of folds or zones of light and shade, and prismatic colours which are often crossing one another and suffering interaction of their waves, so that if these zones are cut at various positions there is infinite change of form and colour. If the same eye-piece is used in a telescope or a microscope it will focus the sun or a diatom on to a screen; and when the screen is moved back the image is still in focus; but in these cases the reason is different, for the pencils of light emerge in parallel rays and make clear images at all positions.

Some of us who are fortunate have been inspired in early life at some well-known school of optics where there was the best



FIG. 5.

teaching and the best instruments; then we descend to our own rough contrivances. There is a third stage, when we watch for examples of wave interference with no apparatus at all. In looking at distant lamps at night-time several forms of Grimaldi's fringes can be seen by moving the eyelids over the eye; with care it is possible to see interference from the light reflected along the eyelashes, and there are fine figures of endless variety

which can be produced by slowly lifting the eyelid so as to draw a film of moisture across the eye. Some are similar to the figures of Michelson's refractometer, and all these are probably of the character of thick plates.

Polarisation.—It has often been considered that the rings and brushes made by oblique pencils through crystals can only be seen with elaborate instruments; but according to the method here described all polarisation effects of which the writer has any cognisance have been photographed. It is convenient to cut the cork mounts of the crystals so as to be round, about $\frac{1}{4}$ inch diameter. Place one of these on the top of the same microscope eye-piece, from which the cap has been removed; if the microscope is at hand, it forms a convenient holder. No objective is put on. A Nicol's prism may be inserted at the bottom of the tube. This, however, is not necessary, for the reflection from the plane mirror under the stage polarises almost as well. A cardboard tube, which fits the eye-piece, may be used instead of the microscope. In this case, cut a hole in the side of the tube at the further end and reflect up polarised light by a piece of microscope cover glass fixed on cork with black sealing-wax. A long pin run through the tube and the cork makes easy adjustment for this reflector.

For an analyser a tourmaline is desirable, as light in colour as possible. The artificial tourmalines are best, but they are now difficult to procure. The tourmaline is placed above the crystal section which is already on the top of the eye-piece. Perhaps the cap of the eye-piece will hold these two steady when they are turned to the right position. It is safer to twist thin copper wire round the top of the tube so as to have a small hook on either side; a thin india-rubber band from hook to hook over

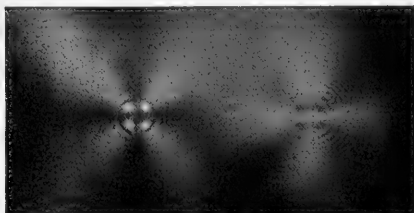

FIG. 6.

the tourmaline holds them securely. It is only necessary to place the tube through the front of a camera from which the lens is removed so as to have the figures projected on the photographic plate. Sunlight is best to work with. Sodium light gives a field covered with fine detail, but does not make effective lantern slides.

Fig. 4 shows the calcite cross; Fig. 5 shows calcite circularly polarised and circularly analysed, or circularly polarised and plane analysed. One of the most attractive of polarisation crystals is Bertrand's prism. It is so cut that light entering directly through one side is internally reflected along the optic axis; it then emerges owing to a similar internal reflection. These reflections polarise and analyse; moreover, the first reflection preserves both the ordinary and extraordinary rays. The result is that by placing this one crystal without polariser and analyser on the eye-piece the black-cross and the white-cross systems both appear at once, as seen in Fig. 6. The interest does not end here; with a slight tilt, made by a shaving of cork under one side of the prism, the white and black crosses change places, with certain other changes of detail in the figures; and there is another tilt which will give two white-cross systems.

If Fig. 6 is to be projected on to a screen on a large scale, the crystal is placed at the focus of a convex lens on to which sunlight is turned, or else at the focus made by the condensers of a lantern when the light is drawn back; this is sufficient without a focussing lens. In both cases the heat may injure the crystal unless about $\frac{1}{4}$ inch of water is placed between the lens and the crystal. The ordinary crystals of calcite and nitre must have a Nicol on one side and a tourmaline on the other, and be placed at the focus as before. W. B. CROFT.

THEORY OF THE MOTION OF THE MOON.¹

DR. BROWN, in the first two parts of his work, has explained his methods. The third part contains little more than tables of results. Our review, therefore, must be necessarily confined to an extension of the tables that

have appeared in NATURE on November 25, 1897, and July 13, 1899. It will be seen that the high order of accuracy to which the computations have been pushed has been maintained, and that most of the latest series of terms are very small and, with a few exceptions, below the limits of observation.

Reference Number.	Characteristic.	Argument.	Number of Terms.	Approximate value in arc of the largest coefficient.	Value of unity in the millions of a second of arc.	Reference Number.	Characteristic.	Argument.	Number of Terms.	Approximate value in arc of the largest coefficient.	Value of unity in the last figure given in millions of a second of arc.
1	1	0	13	206265	0.0002	61	ka	l + F + D	10	0.1	0.2
2	e	l	18	17000	2	62	ka	l - F + D	10	0.2	0.2
3	l	l	21	350	0.4	63	ka	l' + F + D	10	0.2	0.003
4	a	D	9	80	0.05	64	ka	l - F + D	10	0.5	0.003
5	e ²	F	11	9000	0.01	65	ka ²	F	8	0.004	0.06
6	e ²	0	21	240	3	66	e ⁴	4l	13	0.6	32
7	e ²	0	11	340	3	67	e ⁴	2l	15	0.6	32
8	ee'	l + l'	21	140	4	68	e ⁴	0	9	0.5	32
9	ee'	l - l'	22	100	4	69	e ³ e'	3l + l'	14	0.3	5
10	e ²	2l'	18	6	0.6	70	e ³ e'	3l - l'	14	0.3	5
11	e ²	0	10	2	0.6	71	e ³ e'	l + l'	16	0.4	5
12	l ²	2F	20	400	0.4	72	e ³ e'	l - l'	17	0.5	5
13	l ²	0	11	400	0.4	73	e ² e ²	2l + 2l'	15	0.2	0.7
14	ea	l + D	19	12	0.6	74	e ² e ²	2l - 2l'	15	0.1	7
15	e'a	l' + D	20	14	0.1	75	e ² e ²	2l	15	0.04	7
16	a ²	0	9	0.01	0.1	76	e ² e ²	2l'	14	0.2	7
17	le	l + F	10	15	0.06	77	e ² e ²	0	9	0.07	0.7
18	ke	l - F	11	45	0.06	78	e ² e ²	l + 3l'	13	0.2	1
19	ke'	l' + F	10	1	0.01	79	e ² e ²	l - 3l'	14	0.03	1
20	ke'	l' - F	11	0.4	0.01	80	e ² e ²	l + l'	15	0.05	1
21	ka	F + D	10	4	0.02	81	e ² e ²	l - l'	14	0.07	1
22	e ³	3l	17	11	27	82	e ⁴	4l	11	0.01	0.16
23	e ³	l	18	11	27	83	e ⁴	2l	11	0.04	0.16
24	e ³ e'	2l + l'	17	6	4	84	e ⁴	0	7	0.001	0.02
25	e ³ e'	2l - l'	18	3	4	85	e ³ k ²	2l + 2F	13	0.5	5
26	e ³ e'	l	19	8	4	86	e ³ k ²	2l - 2F	14	1.7	50
27	ee' ³	l + 2l'	16	5	0.6	87	e ³ k ²	2l	16	1	50
28	ee' ³	l - 2l'	15	2	0.6	88	e ³ k ²	2F	15	2	50
29	ee' ³	l	17	1	0.6	89	e ³ k ²	0	9	2	5
30	e ³	3l'	13	0.3	0.01	90	ee' ² k ²	l + l' + 2F	13	0.1	7
31	e ³	l'	16	0.1	0.1	91	ee' ² k ²	l + l' - 2F	14	0.1	7
32	ek ²	l + 2F	15	11	4	92	ee' ² k ²	l - l' + 2F	15	0.06	7
33	ek ²	l - 2F	17	30	4	93	ee' ² k ²	l - l' - 2F	14	0.4	7
34	l	l	16	14	0.4	94	ee' ² k ²	l + l'	16	0.6	7
35	e'l ²	l' + 2F	15	2	0.07	95	ee' ² k ²	l - l'	15	0.8	7
36	e'l ²	l' - 2F	16	1	0.7	96	e ² k ²	2l + 2F	11	0.04	0.1
37	e'l ²	l'	16	4	0.7	97	e ² k ²	2l - 2F	13	0.01	1
38	e ² a	2l + D	18	0.8	0.6	98	e ² k ²	2l	13	0.06	1
39	e ² a	D	7	1.3	6	99	e ² k ²	2F	13	0.03	1
40	ee'a	l + l' + D	16	0.4	1	100	e ² k ²	0	7	0.03	0.1
41	ee'a	l - l' + D	16	0.8	1	101	k ⁴	4F	9	0.04	0.8
42	e'l ² a	2l + D	15	0.3	0.02	102	k ⁴	2F	11	0.8	8
43	e'l ² a	D	8	0.4	0.2	103	k ⁴	0	7	0.8	0.8
44	ka	2F + D	16	0.5	0.1	104	e ³ a	3l + D	15	0.06	7
45	ka	D	8	3	0.1	105	e ³ a	l + D	16	0.13	7
46	ea ²	l	16	0.03	0.1	106	e ² e'a	2l + l' + D	12	0.05	10
47	ea ²	l'	16	0.002	0.02	107	e ² e'a	2l - l' + D	12	0.2	10
48	a ³	D	8	0.001	0.03	108	e ² e'a	l + D	12	0.4	10
49	k ³	3F	9	1	0.2	109	ee' ² a	l + 2l' + D	10	0.06	1.4
50	k ³	F	8	0.2	0.2	110	ee' ² a	l - 2l' + D	11	0.03	1.4
51	ke ²	2l + F	10	10	1	111	ee' ² a	l + D	12	0.06	1.4
52	ke ²	2l - F	10	9	1	112	e ³ a	3l + D	11	0.001	0.2
53	ke ²	F	10	4	1	113	e ³ a	l + D	12	0.002	0.2
54	ke'e'	l + l' + F	10	5	0.2	114	ek ³ a	l + 2F + D	12	0.02	0.1
55	ke'e'	l - l' - F	10	3	0.2	115	ek ³ a	l - 2F + D	15	0.02	1
56	ke'e'	l - l' + F	11	2	0.2	116	ek ³ a	l + D	15	0.2	1
57	ke'e'	l - l' - F	11	4	0.2	117	e'l ³ a	l' + 2F + D	13	0.01	0.2
58	ke' ²	2l + F	10	0.8	0.03	118	e'l ³ a	l' - 2F + D	14	0.01	0.2
59	ke' ²	2l - F	10	0.08	0.3	119	e'l ³ a	l' + D	15	0.2	0.2
60	ke' ²	F	10	0.4	0.03	120	e'a ²	2l	12	0.002	20

¹ "Theory of the Motion of the Moon"; containing a New Calculation of the Expressions for the Coordinates of the Moon in Terms of the Time." By Ernest W. Brown, M.A., Sc.D., F.R.S. (From the *Memoirs* of the Royal Astronomical Society, vol. liii.)

Reference Number.	Characteristic.	Argument.	Number of Terms.	Approximate value in arc of the largest coefficient.	Value of unity in the last figure given in millionths of an arc.
121	$e^2 a^2$	0	7	0'002	20
122	$ee a^2$	$l+l'$	13	0'0006	0'2
123	$ee a^2$	$l-l'$	14	0'001	0'2
124	$k^2 a^2$	$2F$	11	0'001	2
125	$k^2 a^2$	0	7	0'001	0'2
126	ke^2	$3l+F$	8	0'5	1
127	ke^2	$3l-F$	8	0'3	1
128	ke^2	$l+F$	9	0'7	1
129	ke^2	$l-F$	9	0'7	1
130	$ke^2 l'$	$2l+l'+F$	8	0'2	0'2
131	$ke^2 l'$	$2l-l'-F$	8	0'1	2
132	$ke^2 l'$	$2l-l'+F$	8	0'1	2
133	$ke^2 l'$	$2l-l'-F$	9	0'1	2
134	$ke^2 l'$	$l'+F$	9	0'3	2
135	$ke^2 l'$	$l'-F$	9	0'2	2
136	kee^2	$l+2l'+F$	8	0'2	0'03
137	kee^2	$l+2l'-F$	8	0'1	0'03
138	kee^2	$l-2l'+F$	8	0'1	0'03
139	kee^2	$l-2l'-F$	8	0'1	0'03
140	kee^2	$l+F$	9	0'02	0'03
141	kee^2	$l'-F$	9	0'02	0'03
142	ke^3	$3l'+F$	6	0'02	0'004
143	ke^3	$3l'-F$	8	0'002	0'04
144	ke^3	$l'+F$	8	0'01	0'04
145	ke^3	$l'-F$	8	0'002	0'04
146	ke^3	$l+3F$	7	0'1	0'2
147	ke^3	$l-3F$	7	1'0	0'2
148	ke^3	$l'+F$	8	0'5	0'2
149	ke^3	$l'-F$	8	4'3	0'2
150	$ke^3 l'$	$l'+3F$	6	0'05	0'03
151	$ke^3 l'$	$l'-3F$	7	0'03	0'3
152	$ke^3 l'$	$l'+F$	8	0'08	0'3
153	$ke^3 l'$	$l'-F$	7	0'08	0'3
154	$ke^2 a$	$2l'+F+D$	8	0'03	0'03
155	$ke^2 a$	$2l'-F+D$	9	0'06	0'03
156	$ke^2 a$	$F+D$	9	0'07	0'03
157	$ke^2 a$	$l+l'+F+D$	7	0'02	0'4
158	$ke^2 a$	$l+l'-F+D$	7	0'005	4
159	$ke^2 a$	$l-l'+F+D$	7	0'007	4
160	$ke^2 a$	$l-l'-F+D$	7	0'017	4
161	$ke^2 a$	$2l'+F+D$	6	0'001	0'006
162	$ke^2 a$	$2l'-F+D$	8	0'001	0'006
163	$ke^2 a$	$F+D$	8	0'004	0'006
164	$ke^2 a$	$3F+D$	7	0'01	0'004
165	$ke^2 a$	$F+D$	8	0'06	0'004
166	$ke^2 a$	$l'+F$	7	0'001	0'006
167	$ke^2 a$	$l'-F$	7	0'0005	0'06
168	$ke^2 a$	$l'+F$	7	0'002	0'01
169	$ke^2 a$	$l'-F$	7	0'0002	0'01

characterising the later forms, the upper tusks were protected by a descending flange at the fore part of each side of the lower jaw. Apparently, however, this was not found to be a satisfactory working arrangement, and it was accordingly discarded in the later forms, the tusks of which became proportionately thicker so as to stand in need of no such protection. At the same time the whole lower jaw became remarkably slender and weak, so much so, indeed, that it is evident it could not have been used in the same manner as the lower jaw of a lion or a tiger. Confirmation of this view is afforded by the circumstance that the lower jaw articulates with the skull in quite a different way from that which occurs in the last-mentioned animals.

Sabre-teeth were distributed over a great portion of the surface of the globe, their remains having been found in England, France, Germany, Hungary, Greece, Persia, India and North and South America. They lived at first at a time when true cats were either very scarce or entirely unknown, and they appear to have survived longest in South America.

A moment's consideration will show that, at any rate in the case of the longest-tusked species, it was quite impossible for these animals to bite in the ordinary manner, as the entrance to the mouth would be barred by the tusks, which must have reached to the sides of the lower jaw if the extent of the gape were only equal to that of a lion or a tiger.

This disability has given rise to several suggestions as to the mode in which the sabre-teeth used their upper tusks. One idea was that they were employed as stabbing weapons, and used while the mouth is closed. With the earlier forms, in which the tusks were shorter and protected by a flange on the lower jaw, this method of use would obviously be an impossibility. Moreover, as is pointed out by a writer whose name will be mentioned later on, it would involve, after long adaptation to striking with the mouth open, a sudden change to attacking with the jaw closed. Perhaps a still more serious objection is the fact that the efficient length of the weapon would be diminished by about a half if the attack were made with the jaw shut, and therefore that the animals might just as well have remained in their primitive form, with comparatively short tusks. Again, the closed mouth would obviously be a very serious disadvantage to an animal which drinks the blood of its victims.

Among other strange suggestions, it has been supposed that the tusks were employed as aids in climbing trees! Apart from other considerations, their brittle structure and finely serrated edges would render them obviously unsuited for this purpose. Another idea is that the sabre-teeth were aquatic in their habits, and that their tusks were used in some respects in the same manner as are those of the walrus. Needless to say, this idea, although difficult to disprove in so many words, may be dismissed without serious comment. It may be added that the long tusks of the later and more specialised sabre-teeth have actually been regarded as the cause of the extinction of the group, the idea being that the creatures, owing to the entrance being barred by the tusks, could not open their mouths sufficiently wide to admit food.

Recently, in the *Memoirs* of the American Museum of Natural History, Mr. W. D. Matthew has suggested an explanation of the puzzle, which, although somewhat startling to preconceived ideas, seems on the whole to be the best solution of the problem hitherto offered. Starting with the indisputable fact that the mode of articulation of the lower jaw to the skull is quite different from that which obtains in the true cats, and also bearing in mind the weakness of the lower jaw itself and the smallness of its tusks, the author suggests that the sabre-teeth dropped the lower jaw into a vertical position, and were thus enabled to use their upper tusks as stabbing weapons. An examination of the skull of the large South American species in the British Museum shows that such a position of the lower jaw is quite possible, the small size of its ascending or coronoid branch allowing the necessary movement to be made without interfering with the cheek-arches.

"Presumably," adds the author, "the ligaments were adjusted to these changes, and if so, there appears to be no reason why the sabre-tooth should not open his mouth far wider than is possible for the cat, laying back the chin against the throat without inconvenience. Along with this change there is a decrease in power of the muscles closing the jaw, due probably to lack of use of the lower canines (used against the upper ones in other Carnivora, but useless in this way to the sabre-tooth)."

HOW THE SABRE-TOOTHED TIGERS KILLED THEIR PREY.

DURING the greater portion of the third or last great geological epoch—the Tertiary period of geologists—there flourished certain very large and powerful members of the cat tribe, commonly known, on account of the inordinate length of their upper tusks, as sabre-toothed tigers, although there is nothing to show that they had any more affinity with the tiger than with the lion. Indeed, they were widely separated structurally from both, as they were from all living cats. In these sabre-teeth the upper tusks were huge, compressed, scimitar-shaped teeth, with the front and back edges generally, if not always, finely serrated. In some of the later species, which existed contemporaneously with man, the upper tusks were eight or nine inches in length, and they were longest of all in a South American species. In the earlier members of the group, before they had attained the inordinate development

It is further urged that the disappearance in the long-tusked species of the flange on the lower jaw which protected the canines in the more primitive forms is correlated with this mode of opening the mouth, as the presence of such a flange would prevent the lower jaw lying close against the throat. Moreover, the anterior cheek-teeth, which are used by modern Carnivora chiefly for bone-crushing, and are most developed in the hyænas, have almost disappeared in the sabre-tooths, while, on the other hand, the shearing carnassial teeth—the sole function of which is flesh-cutting—have been inordinately increased in size and power.

As is well known, a large number of the mammalian contemporaries of the earlier sabre-tooths were short-necked and probably thick-skinned ungulates, some of which were more or less distantly allied to the modern tapirs and others to the pigs. And in the same manner as the long-necked and thin-skinned ruminants of to-day form a large portion of the prey of the modern lion, tiger, leopard, &c., so these early ungulates fell victims to the attack of the sabre-tooths. Now, antelope and deer are killed by the neck being bitten through or broken when attacked by the larger Carnivora; but it seems unlikely that such a method of attack would be successful in the case of short-necked and thick-skinned animals.

Accordingly, it is suggested by Mr. Matthew that in the case of the sabre-tooths "their most advantageous method of attack was to inflict stabbing and ripping cuts at points where an artery could be reached, using their short, broad and powerful fore-teeth as fulcrums, and probably bleeding the animal to death."

It is added that the earlier appearance of true cats in Europe as compared with North America, where they are very rare throughout the Tertiary period, may very probably be correlated with the earlier appearance and greater abundance of the modern type of specialised ruminants in the Old World. Finally, the largest and most specialised member of the group, the great *Machærodus neogans* of the Pleistocene of South America, which the author believes to have been the slowest mover of its kind, may have preyed on the huge thick-skinned and slow-moving ground-sloths which attained such a remarkable development in that continent. In a subsequent section the author hazards the suggestion that the more cat-like Carnivora known as Dinictis, the upper tusks of which were noticeably shorter than those of the sabre-tooths, were creatures with a greater turn of speed and therefore better adapted for preying on the smaller and swifter-footed Herbivora than was the case with their long-tusked relatives.

R. L.

UNIVERSITIES IN RELATION TO RESEARCH.

IT will perhaps be expedient for me at the outset to say that I propose to use the word research in its widest meaning, *i.e.* as indicating those efforts of the human mind which result in the extension of knowledge, whether such efforts are exerted in the field of literature, of science or of art.

The chief agencies of modern organised research are (1) the learned societies and (2) the universities. The former receive and publish research papers; the latter superintend and direct investigators and publish results. To these should properly be added the various journals which have been established and carried on by private effort. It is a significant fact that the establishment of modern learned societies coincides closely in time with the Renaissance movement. Telesio established one of the earliest mathematico-physical societies—the Academy of Cosenza. Other Italian societies of similar scope were founded in Rome in 1603, in Florence in 1657, and the Royal Society of London dates from 1660 or earlier. Organised research in universities was of slower growth. In them the mediæval spirit was tenacious of life, and it was only in the nineteenth century, in Germany, at the close of the Napoleonic wars, that research, not only in natural philosophy, but in the whole field of knowledge, became the basis of the German educational system, and I might remark, without going into details, that the university systems of France and the other principal countries of Europe, with the exception of Great Britain, are in the main parallel with that of Germany, although not so consistently elaborated.

¹ Abridged from the presidential address delivered by Prof. James London before the Royal Society of Canada at the recent annual meeting of the Society at Toronto.

We are so subject to the authority of words that it is difficult for us to realise that the organisation called a university in Germany is almost entirely different in scope and object from the institution which we so designate in this country. Hitherto, at least in England and Canada, the function of the university has mainly been to impart a general and liberal education, continuing and completing the beginning already made in the secondary school. Speaking generally, I may say that under the German system the work of our secondary schools and universities combined is performed by the gymnasium, the nine or ten years' training of which leaves the young man of nineteen or twenty years of age with a much better liberal education than that possessed by the average graduate in arts of an English, Canadian or American university. How this is accomplished it is not my purpose here to explain. There is no doubt, however, as to the fact, which is substantiated both by the nature of the curriculum of the gymnasium and by the testimony of those familiar with both systems.

It is upon this substantial preliminary training that the work of the German university proper is based. Up to this point the young man has been a "learner"; on entering the university he becomes a "student." This distinction, expressed by the German words "lernen" and "studieren," marks the difference between gymnasium and university—the acquisition of knowledge under the teacher in one, the independent research under the guidance of the professor in the other.

The ultimate object of both professors and students is the advancement of knowledge, and the independence with which research is conducted is well expressed by the two words "Lehrfreiheit" "Lernfreiheit"—the freedom of the professor as to what he teaches and the freedom of the student to select his special line of research. Some idea of the extent of this work may be formed from the number of universities in Germany, twenty-one in all, and from the fact that the aggregate number of matriculated students exceeds 12,000, in addition, to non-matriculated students, who are also numbered by thousands, while the philosophical faculty at Berlin and Leipzig in 1901-2 numbered, respectively, 207 and 120. To the twenty-one universities mentioned should be added the nine technische Hochschulen which have now the right to confer the doctor's degree in the applied sciences.

The place and importance of research in the German system is further indicated by the fact that even teachers in the gymnasium devote themselves to such work, their papers being published in the annual reports of their institutions. With such respect is the ability for research regarded that the publication of a paper of this kind may lead directly to a professorship in the university, as was the case, for instance, in the appointment of Weierstrass, the celebrated mathematician.

In the organisation of the German university, research has been shown to be a fundamental principle; in the British university it is as yet incidental or of sporadic manifestation. I do not, of course, ignore the very important contributions which have been made by British scholars to the advancement of learning, but it is worthy of note that the credit for their splendid achievements is rather due to the individuals themselves than to the universities with which many of them were connected. The British university is not primarily an institution for research. In its function of providing the higher grades of a liberal education the proper comparison is with the upper classes of the German gymnasium, not with the German university proper. True, we find in some of the British universities a specialisation in certain subjects, *e.g.* in honour classics and mathematics at Oxford and Cambridge, leading to higher work than that attempted in the gymnasium; but however advanced the studies may be, there is rarely any attempt to guide the English undergraduate in the direction of research. Reading and examinations are the academic watchwords, and to the great mass of students and tutors the field of research is a *terra incognita*.

The attitude of the British nation has been hitherto largely that of indifference towards organised research, and this has been true, not only of the general public, but also of those engaged in academic administration. There has existed a deep-seated conviction, born perhaps of reiterated assertion, that the British university system is superior to that of Germany or any other country, and as near perfection as may well be. We are not concerned just here with the discussion of the merits of the system, which are undoubtedly many and great, but we must admit that the attitude of self-satisfaction which has prevailed, combined with the ignoring of other ideals, is at least unphilosophical. In the

midst of such an atmosphere it is not surprising that the development of a true Renaissance spirit has been somewhat tardy.

But the British nation is on the eve of an awakening, an awakening which has already taken place among certain leaders of thought. The fact is dawning upon the British mind that some vital connection really does exist between national progress and scientific discovery, and that the latter should be fostered in connection with the higher institutions of learning. Under the conviction that British commercial supremacy will be seriously threatened unless foreign, and especially German, scientific methods are adopted, universities of a more modern type than Oxford and Cambridge, and also technical colleges, have been established. Such institutions no doubt fill a long-felt want, but they do not go to the root of the matter. On the academic side they are but a modification of the older type; on the technical side they contemplate, not the discovery of new truth, but the application of what is already known. The spirit of research is lacking, and without it no expenditure of money, no raising of examination standards for mere acquirement, will actually increase the capital account of national knowledge.

The policy of the universities of the United States regarding this matter is in marked contrast with the incision and conservatism which prevail in the mother country. The type of mind which has been developed in the century and a quarter of separate national existence is one of great vigour and originality; but these qualities have for the most part been turned aside by the circumstances of a new country from abstract investigations. Research after the almighty dollar by the nearest short-cut has been, and perhaps still is, regarded as the chief national characteristic of our American cousins, and in this pursuit they have displayed a genius for concrete research in mechanical invention and an ability for commercial and industrial enterprise which have been an object of wonder, and latterly of anxiety, to other nations. During the first hundred years of national existence the university of the gymnasium type which had been inherited from England continued to develop and expand in the United States. Suddenly, however, almost exactly twenty-five years ago, a remarkable modification was introduced.

Since 1877 many universities, including the best of those already in operation, as well as new foundations, have added a graduate department leading to the Ph.D. degree, although none of these, with the exception of Clark University, has made the prosecution of research the sole business of the university. Some idea of the rapid progress of this movement may be gathered from the fact that the numbers pursuing graduate studies in the universities of the United States have increased from 8 in 1850 to 399 in 1875, and to about 6000 in 1902.

I have confined my remarks up to this point almost wholly to the historical aspect of the question, but it will perhaps not be out of place for me to point out in conclusion some of the advantages which in my opinion are connected with the pursuit of university research.

Let us consider first the stimulating effect upon the individuals and institutions concerned. Among those who are affected by this stimulus should first be named the professor. Dr. Samuel Johnson was wont to compare accumulated knowledge to a heap of ice lying exposed to the summer sun, the bulk of which could not be maintained without constant replenishment. Continuing the figure, we can readily imagine that the professor's fund of knowledge which is ample enough for the class-room teaching of immature minds might shrink and trickle away until little is left but the sawdust which we usually associate with the preservation of that commodity. Under the stimulus of research this is impossible, for research into the new implies a full and minute mastery of that branch of knowledge in which the research is being conducted. Hence if no other advantage resulted a good case might be made out along this line of argument.

This stimulus to the professor would react with increased force upon the student. It was a favourite saying of a certain celebrated artist that those who follow after others rarely outstrip them. To hold up before the student either by theory or practice solely the ideal of acquiring what has already been learned is medievalism pure and simple; it is to teach him to creep where he might walk upright and alone; it is to rob him in part of that intellectual birthright of independent thought which is the inheritance of every man, at least since the Renaissance. It is sometimes objected that the results attained by research students are often trivial or futile. I am disposed, however, to agree with a remark made by one of George Eliot's characters:—"Failure after long perseverance is much grander (and I would

say parenthetically more useful) than never to have a striving good enough to be called a failure." It is sometimes also urged that research in the immature student leads to superficiality and conceit. I cannot but think this fear ill-grounded. It has been proved, on the contrary, that nothing will so quickly ripen and enlarge preliminary knowledge and so effectually extinguish presumption as the hand-to-hand struggle with some special problem in the department of study in which the student is already proficient.

Apart from the professor and student, the first effect of the inauguration of research work in our universities, if of the genuine stamp, will be felt upon the teaching profession of the country as a whole. Assuming an educated and interested public opinion, the premium so long placed upon memorised knowledge will disappear, and a change in the principle of selection of teachers both in universities and secondary schools will result.

UNIVERSITY AND EDUCATIONAL INTELLIGENCE.

AFTER consultation with Mr. Astor, and in accordance with his wish, the council of University College, London, has resolved to endow the chair of pure mathematics and to name it the "Astor chair." The staff of the reorganised department of chemistry of the College will be as follows:—General and inorganic chemistry: professor, Sir William Ramsay, K.C.B., F.R.S.; assistant professors: Dr. F. G. Donnan, Dr. Morris Travers and Mr. E. C. C. Baly. Organic chemistry: professor, Dr. J. Norman Collie, F.R.S.; assistant professor, Dr. S. Smiles.

THE Royal Commissioners for the Exhibition of 1885 have made the following appointments to science research scholarships for the year 1902, on the recommendation of the authorities of the several universities and colleges:—University of Edinburgh, J. K. H. Inglis; University of Glasgow, A. Wood; University of St. Andrews, W. Wallace; University of Aberdeen, A. C. Michie; University of Birmingham, J. A. Lloyd; Yorkshire College, Leeds, H. D. Dakin; University College, Liverpool, F. Rogers; University College, London, E. P. Harrison; Owens College, Manchester, G. C. Simpson; Durham College of Science, Newcastle-on-Tyne, C. R. Dow; University College, Sheffield, G. B. Waterhouse; Queen's College, Galway, W. Goodwin; University of Toronto, W. C. Bray; Dalhousie College, Halifax, Nova Scotia, T. C. Hebb; University of Melbourne, K. Hosking; University of Adelaide, W. T. Cooke; University of New Zealand, M. A. Hunter. The following scholars nominated in 1901 have had their scholarships continued for a second year on receipt of a satisfactory report of work done during the first year:—F. Horton, A. Siator, R. B. Denison, G. Owen, G. Senter, F. W. Rixon, T. Baker, S. C. Laws, Alice E. Smith, J. Hawthorne, R. K. McClung, C. W. Dickson, G. Harker. The following scholars nominated in 1900 have had their scholarships exceptionally renewed for a third year:—Dr. W. M. Varley, Dr. S. Smiles, J. A. Cunningham, W. S. Mills, J. Patterson, J. Barnes.

THE Cambridge summer meeting organised by the Local Examinations and Lectures Syndicate was opened on Friday last with an address by the vice-chancellor, Dr. A. W. Ward, master of Peterhouse. Many men of distinction are taking part in the meeting, and the lectures cover a very wide range. The general subject of the meeting is "Some Aspects of Life and Thought in Europe and America in the Nineteenth Century." In the section of physical and natural sciences, the following lectures will be delivered during the meeting, which is divided into two parts, and ends on August 26:—"Some Modern Astronomical Speculations," Prof. G. H. Darwin, F.R.S.; "Sidereal Astronomy," Mr. Arthur Berry; "Meteorology in the Nineteenth Century," Dr. W. N. Shaw, F.R.S.; "Pasteur and his Work," Prof. Sims Woodhead; "An Aspect of the Influence of America on Geology," Dr. R. D. Roberts; "Progress of Geology in the Nineteenth Century as illustrated by modern views on (1) The Structure of the Earth's Crust, (2) The Evolution of the Configuration of the Surface," Mr. J. E. Marr, F.R.S.; "Advances of Botany," Prof. H. Marshall Ward, F.R.S.; "A Great Botanist: Sachs," Prof. W. B. Bottomley; "Colour Photography," Mr. T. B. Wood; "The Rise and Development of Electro-Chemistry," Mr. D. J. Carnegie. Among the subjects in the section of education are:—"Hygiene as a Factor in National Education," Miss A. Ravenhill; "Nature-Study" (Six Lectures), Prof. Patrick Geddes;

and "Illustrative Lectures in Nature-Study," Miss Von Wyss. There will be practical courses in nature-study (chemistry and botany) and in geography in its physical aspects. A conference upon the subject "In what sense can and ought Schools (Primary and Secondary) to prepare Boys and Girls for Life?" was opened by Dr. M. E. Sadler on Saturday last, and one on "Hygiene in Schools" will be opened by Miss Ravenhill on August 14.

SOCIETIES AND ACADEMIES.

PARIS.

Academy of Sciences, July 28.—M. Bouquet de la Grye in the chair.—On a curious property of a class of algebraic surfaces, by M. Émile Picard.—Reflection and refraction by a body transparent undergoing a rapid translation; equations of motion and some general consequences, by M. J. Boussinesq.—The reduction of nitric-derivatives by the method of direct hydrogenation in contact with finely divided metals, by MM. Paul Sabatier and J. B. Senderens. Nitronaphthalene is readily reduced to naphthylamine by hydrogen in presence of reduced copper at 350° C. With nickel the reduction goes further, ammonia and naphthalene tetrahydride being formed. Nitromethane and nitroethane are reduced completely to the corresponding amines.—A method of spectrum analysis capable of furnishing the still unknown law of rotation of planets of feeble brightness. Verification of the method, with preliminary results, by M. H. Deslandres. This method, which was applied with success in 1895 to the measurement of the rotation of the bright planets, has now been extended to those of lesser magnitude, including Uranus and Neptune.—The entire image of the planet submitted to spectrum analysis undergoes deformations from which the sense of the rotation can be determined, and to a certain extent its velocity. The rotation of Uranus has been found to be retrograde.—On the problem of Dirichlet for domains limited by several contours or surfaces, by M. A. Korn.—On one of the causes of the explosion of steam boilers and on a means of preventing it, by M. J. Fournier. It is shown that with the ordinary form of safety valve the release may take place in the normal way, and yet an insufficient amount of steam may escape to prevent the pressure rising to a dangerous extent. A modification of the ordinary safety valve is described in which this difficulty is overcome.—On magnetic dichroism, by M. Quirino Majorana. Active liquids behave in a magnetic field like uniaxial crystals possessing dichroism.—On the electrochemical equivalent of silver, by M. A. Leduc. A short account of researches the complete description of which will be published shortly in the *Journal de Physique*, in which the effect of temperature changes, current density, and acidity of the bath upon the value of the electrochemical equivalent of silver has been determined.—The silvering of glass and daguerreotype, by M. Izarn. A minute description of the method of silvering glass by means of ammoniacal silver nitrate and solutions of formaldehyde.—On the precipitation of the chlorides and bromides of cadmium, mercury and tin by sulphuric acid, by M. Georges Viard.—On mannite, the nitrates and the alkaloids of normal urine, by M. S. Dombrowski. By applying the method of separation described in a previous note the author has succeeded in isolating from urine sodium nitrate, cadaverine, mannite and a new alkaloid.—An attempt at an immediate analysis of nerve-tissue, by M. N. Alberto Barbieri.—On the ligature of the appendicular extremity of the oecum in *Cercothicus cephus*, by M. Jean Maumus.—The internal secretion of the testicle in the embryo and in the adult, by M. Gustave Loisel.—The microbial kinases; their action on the digestive power of the pancreatic juice together with albumin, by M. C. Delezenne.—The parasitic nature of certain calcareous degenerations, of some inflammatory tumours and of special lesions of the skeleton, by MM. A. Charin and G. Delamare.—A comparative study of hemolysis by poisons in the dog and rabbit, by M. C. Phisalix.—On a new form of tactile sensibility, trichesthesia, by MM. N. Vaschide and P. Rousseau.—On the possibility of combating mildew and oidium of the vine by a liquid treatment, by M. J. Guillon.—On a method of concentrating wine, by MM. Eudoin and Schibaux. The method which was found to give the best practical results consisted in first partially distilling the wine at a low temperature and then removing some water from the distillate by freezing.—The prehistoric drawings in the grotto of La Mouthe, Dordogne, by M. Émile Rivière. Facsimiles of drawings of a reindeer and of a horse are given.

NEW SOUTH WALES.

Royal Society, Sydney 4.—Prof. Warren, president, in the chair.—The parks of June; or some of the problems of control and management, by Mr. J. H. Maiden.—A possible connection between volcanic eruption and sunspot phenomena, by Mr. H. I. Jensen. The author of this paper mentions that the idea of the existence of such a connection was suggested to him by the fact that Vesuvius was in violent eruption in the years 1813, 1822, 1855, 1867, 1891 and 1900, all of which were minimum years. By means of a chart he shows that earthquakes and eruptions are most violent, numerous and extensive when there is least sunspot activity. Though seismic disturbances do occur at all times, they seem for the last hundred and twenty years to have been most severe around the minimum years—1811, 1822, 1833-4, 1844, 1855-6, 1867-8, 1878-9, 1888-9 and 1900-2—large groups of great earthquakes and eruptions having taken place in and about these years. On the other hand, the chart also shows that in years of maximum, like 1893-8, 1884-5, 1869-71, 1858-65, and so on, these phenomena have been comparatively few and unimportant. The author thinks that the cause of this connection between solar and seismic disturbances is that in years of sunspot minimum there is less heat, and other energy, received from the sun, and consequently there is more rapid radiation from the earth, causing quicker cooling, hence more cracking of the earth's crust. He also suggests that the earth's atmosphere exerts a greater squeeze on the crust in years of minimum, thus forcing lava out of fissures.

CONTENTS.

PAGE

Hann's Meteorologie. By Dr. W. N. Shaw, F.R.S.	337
The Fibre Industries	338
The Fishes of the Congo Basin. By R. H. T.	339
Applied Mechanics	340
Our Book Shelf:—	
"Ordnance Survey of England and Wales"	341
Hortvet: "A Manual of Elementary Practical Physics."—A. W. P.	341
"The Journal of the Iron and Steel Institute General Index"	342
Ziegler: "Zur Metaphysik des Tragischer."—A. E. T.	342
Willoughby: "Hygiene for Students."—R. T. H.	342
Letters to the Editor:—	
A Simple Telephonic Receiver for Wireless Telegraphy.—Dr. L. Bleekrode	343
The Future of the Victoria University.—Prof. Arthur Smithells, F.R.S.	343
M. Faye and the Paris Observatory.—Wilfred de Fonvieille	343
Electrical Resistance of Iron at very Low Temperatures.—E. Philip Harrison	343
Retention of Leaves by Deciduous Trees.—A. F. G. Campanulate Foxgloves.—Dr. Maxwell T. Masters, F.R.S.	344
Forestry.—Prof. W. R. Fisher	344
The Forthcoming Meeting of the British Association at Belfast	344
The First Meeting of the International Council for the Exploration of the Sea. By H. R. M.	346
Polynesian Politics and Anthropology. (<i>Illustrated</i> .) By E. Sidney Hartland	347
Kew Micrometer. (<i>Illustrated</i> .)	348
Notes	348
Our Astronomical Column:—	
The Spectroscopic Binary β Cephei	352
Double Stars	353
Light of the Galaxy and Bright Stars	353
Periodicity of Volcanic Eruptions and Earthquakes	353
Minor Planets	353
Pharmacology at the British Medical Association.	
Photography of Diffraction and Polarisation Effects. (<i>Illustrated</i> .) By W. B. Croft	354
Theory of the Motion of the Moon	356
How the Sabre-Toothed Tigers Killed their Prey. By R. L.	357
Universities in Relation to Research	358
University and Educational Intelligence	359
Societies and Academies.	360

THURSDAY, AUGUST 14, 1902.

THE ENCYCLOPÆDIA BRITANNICA.

The Encyclopædia Britannica. The Third of the New Volumes, being vol. xxvii. of the Complete Work. Chi-Eld. Pp. xx + 744. (London: A. and C. Black, and *The Times*, 1902.)

IT is impossible within the limits of a short notice to describe even briefly more than a few of the scientific articles in this new volume of the "Encyclopædia Britannica." Many subjects of interest to men of science are dealt with, the following being among the contributions:—Cholera, Dr. A. Shadwell; chronograph, Rev. F. J. Jervis-Smith; biblical chronology, Prof. S. R. Driver and Mr. C. H. Turner; coal, Mr. H. Bauerman; Cœlentera, Dr. G. H. Fowler; colours of animals, Prof. E. B. Poulton, F.R.S.; combinatorial analysis, Major P. A. MacMahon, F.R.S.; comets, Dr. E. S. Holden; compass, Captain E. W. Creak; condensation of gases, Prof. J. D. van der Waals; conduction of heat, Prof. H. L. Callendar, F.R.S.; copper, Dr. J. Douglas; cremation, Sir Henry Thompson, Bart.; Crustacea, Rev. T. R. Stebbing, F.R.S.; Ctenophora, Dr. G. H. Fowler; cuttlefish, Rev. J. F. Blake; cytology, Mr. Harold W. T. Wager; dairy, Dr. W. Fream; Darwin, Prof. E. B. Poulton, F.R.S.; dietics, Dr. W. O. Atwater; differential equations, Mr. H. F. Baker, F.R.S.; diffraction gratings, the late Prof. H. A. Rowland; diffusion of gases, Prof. G. H. Bryan, F.R.S.; dimensions of units, Dr. J. Larmor, F.R.S.; diphtheria, Dr. A. Shadwell; du Bois-Reymond, Sir Michael Foster, K.C.B., F.R.S.; du Bois, Prof. J. J. Hummel; dynamo, Mr. C. C. Hawkins; analytical dynamics, Prof. Horace Lamb, F.R.S.; dynamometer, Prof. W. E. Dalby; figure of the earth, M. R. Radau; earthquakes, Prof. J. Milne, F.R.S.; Echinodermata, Dr. F. A. Bather; Echiuroidea, Mr. A. E. Shipley; eclipse, Prof. Simon Newcomb; economic entomology, Prof. F. V. Theobald; education, Sir Joshua Fitch and Dr. N. M. Butler; eel, Mr. J. T. Cunningham; Egypt (physical geography), Major H. G. Lyons; and Egyptology, Prof. W. M. Flinders Petrie, F.R.S., and Mr. F. L. Griffith; and elastic systems, Prof. A. E. H. Love, F.R.S.

It will be evident from this selected list of subjects and authors that science is well represented in the volume, and that the editors have endeavoured to secure authoritative statements of the position of knowledge of many departments of scientific study. In general, the articles contain good accounts of advances in the departments of intellectual activity with which the writers deal, but there are some in which the view described is not so comprehensive as it might have been.

Take, for instance, the article on eclipse, which is supposed to bring the information up to the present position of knowledge of the subject as regards eclipses of the sun. We find various details referring to the extent and structure of the corona, and the number of lines photographed during various eclipses, but there is no clear view of the subject as a whole. Significant observations are overlooked, while others are catalogued without any attempt at analysis of the material. The article

on comets is just as unsatisfactory, and the only value it has to a student of the subject lies in the catalogues of elements of these bodies. Nothing is said about such important points as the distribution of orbits, the origin of comets or their spectroscopic history.

The article on education, by Sir J. G. Fitch, is worthy of the "Encyclopædia." Its main purpose is

"to trace the gradual growth of what may be called the English system, the forces which have controlled it, and the results it effected during the last quarter of the nineteenth century."

For purposes of comparison, a brief account is also given of the provision made for education in three or four nations of Europe in which the people are less hampered by tradition and the leaders are animated by a progressive spirit. Towards the close of his valuable paper, Sir Joshua Fitch points out some of the problems of the future.

"The motive force which we need," he remarks, "must be found in a higher and truer popular conception of a liberal education, and of its relation to the formation of character and to the duties of industrial, civic and family life. That the acquisition of knowledge, though obviously the prominent business of a school, is not the whole of education, and that knowledge consciously directed to the special professional and industrial needs of life is of far less real value than the knowledge which helps to bring out the best powers of the reflective and accomplished man, are truths which are yet imperfectly recognised."

The scientific study of Egyptian antiquities is reviewed in the article "Egyptology" by Prof. W. M. Flinders Petrie and Mr. F. L. Griffith. The latter confines his attention to the ancient language.

Egyptology is a science in the making, and as yet no general scientific systems of Egyptian archaeological or linguistic study which command the allegiance of all Egyptologists have been worked out, although in the archaeological field great progress has been made in this direction, owing chiefly to the work of Prof. Petrie. Any general article dealing with Egyptological study must, therefore, be in great measure a statement of personal opinion on the subject. So in these two articles by Messrs. Petrie and Griffith we have not so much general reviews of Egyptian archaeological and linguistic study as *ex-cathedra* statements of the opinions held by two distinguished Egyptologists. These, however, are stated without any hint being given to the reader that many other equally distinguished Egyptologists disagree with them. For instance, Prof. Petrie's whole reconstruction of the first two Egyptian dynasties, based on the results of his excavations at Abydos, has recently been challenged in almost every point by Prof. Naville, the distinguished Egyptologist of Geneva, in the *Recueil de Travaux*.

Now we do not think that the Genevan professor's challenge is by any means altogether successful, but the fact that it could be made at all is a proof of the uncertainty of the whole matter. But no hint of uncertainty is given by Prof. Petrie on pp. 720, 722 of the "Encyclopædia" where he deals with it.¹ Similarly, the description of the

¹ Prof. Petrie's article was no doubt already set up in type before the publication of that of Prof. Naville, but this makes no difference to the argument; the uncertainty existed from the first.

language given by Mr. Griffith on pp. 726-731, while it contains much matter on which all scholars are agreed, and have been agreed since the time of De Rougé, nay, since the time of Champollion, is, in the main, as he himself makes quite clear, a statement of the views of a particular school of German Egyptologists, led by Dr. Erman, to which Mr. Griffith has attached himself.

Now, leaving English Egyptologists out of account, we find that these views are more or less shared by Prof. Sethe, Prof. Steindorff, Prof. Spiegelberg, Prof. Breasted, Dr. Schäfer, and a few others of less note. They are not only not shared, but are constantly criticised, by Prof. Maspero, Prof. Naville and Prof. Piehl, while Profs. Wiedemann, Lieblein and Schiaparelli, MM. Revillout, Lefébure and others, have not shown the slightest disposition to accept them. In England, Prof. Petrie himself has, so far as we are aware, never yet signified his adhesion to the views which Mr. Griffith expounds. Certainly Prof. Petrie never uses the hideous transliteration of the hieroglyphs, without conventional vowels, which is the shibboleth of the Berlin school. Mr. Griffith does, and he is justified in using it in scientific work, but we regret his use of it in a popular encyclopædia, for no person ignorant of the hieroglyphs can possibly comprehend it, and words written according to its rules cannot be pronounced without the insertion of the necessary conventional vowels, which might just as well be inserted in print. Mr. Griffith uses a transcription which is intelligible to the layman in the publications of the Egypt Exploration Fund; why not in the "Encyclopædia Britannica"?

Scientific opinion is therefore sharply divided on the subject of the language, and, this being so, we are of opinion that Mr. Griffith should not have stated the Ermanian theory without giving his readers any hint of the existence of this division of opinion.

Prof. Petrie's historical summary is, after the debatable period of the earliest dynasties is passed, naturally no longer so much an exposition of his own personal views, although on one or two points (*e.g.* the date of the Antef kings) he seems to differ from the opinion of the majority nowadays. His section dealing with archaeology generally is of great interest and value. Fig. 10, giving the principal types of Egyptian pottery from the early pre-dynastic period to the twenty-sixth dynasty, is very appropriate to an encyclopædia.

The existence of differences of opinion on important matters among Egyptologists in no way points to any condition of chaos in Egyptology; on the contrary, it rather indicates the energy and vigour of the study, to the furtherance of which men like Prof. Naville and Prof. Maspero are, no less than Prof. Erman, Prof. Petrie and Mr. Griffith, devoting the best energies of their lives.

In Prof. Driver's article on "Old Testament Chronology," which is, generally speaking, very learned and comprehensive, we have one fault to find. At the beginning of the chronological table (p. 77), the professor, after giving Ussher's date for the Creation, proceeds in a most absurd manner to give the "probable real date" for the creation of man, which date, he opines, is "indeterminable, but much before 7000 B.C." (!) Why 7000 B.C. in particular? Because, in the column "Events in Con-

temporary History" (*sic*), given parallel to the Creation, we find under "Babylonia" the statement "7-6000. Temple of Bel at Nippur founded." So that the Creation Week must have been in a year somewhat anterior to the foundation of the Temple of Bel. Indubitably, but surely in the present year of grace this sort of thing is somewhat ridiculous, and worthier of a theological text-book for the use of Boer predikants (who are credited with also believing that the world is flat and that the sun goes round it) than of the "Encyclopædia Britannica!"

The article on "Earthquakes" contains some valuable sections. Within the compass of two and a half pages, we have accounts of most of the best instruments that have been constructed for the registration of earthquakes, whether of near or of very distant origin. These should be read in conjunction with the article on "Seismometers" in the ninth edition, which as yet is far from obsolete. Following the section referred to are paragraphs in which the results obtained from instrumental records are pithily described, those on velocity being an admirable summary of the important work of recent years. The practical applications of seismometry in the regulations to be observed by builders and engineers in earthquake countries will be read with no less interest than profit. These are all subjects on which the writer of the article is a recognised authority. Other branches of the science are treated in less detail. The sections on the origin and on the frequency and periodicity of earthquakes are hardly representative of our present knowledge on these subjects. Nor are there more than bare allusions to seismic sea waves, earthquake sounds and the changes of surface features produced by earthquakes. In particular, we miss a consecutive account of the phenomena of a typical earthquake. The progress of seismology, however, has been so rapid since the issue of the corresponding article in the ninth edition that to treat all branches in their due proportion within the limits of eight pages would be a difficult task and one requiring very extensive reading.

With the exception of the article "Dynamo," by Mr. C. C. Hawkins, the volume does not contain much of special interest to the electrical engineer. The article on the "Compass," by Captain E. W. Creak, is a useful addition to that in the ninth edition, and that on "Copper" contains a brief summary of the growth and importance of the electrolytic refining industry.

Mr. Hawkins's contribution deserves fuller mention, not only on account of its intrinsic merit, but because it fills a gap more keenly felt, since the references to the dynamo in the ninth edition are very meagre. The present article, however, brings the subject quite up to date. It opens with a brief discussion of the general theory of the induction of electric currents and an account of the development of a practical machine from Faraday's revolving copper disc. The different methods of field and armature winding for continuous-current machines and alternators are then considered more in detail, but not too elaborately. A general summary of the leading types of machine and a consideration of the suitability of each for different classes of work are also given. As a whole, the article forms a valuable contribution to the literature of the subject, and, without going into the matter very deeply, gives an interesting survey of the

present position of the dynamo from both a theoretical and a practical point of view.

The first of the more important biological articles included in the volume is one on *Celentera*, by Dr. G. H. Fowler, in which it is shown how much our conception of this group has altered since the date of the previous issue. The colours of animals are treated of by Prof. E. B. Poulton, who lays emphasis on the advance of our knowledge with regard to the object of the general coloration of mammals and birds. Crustacea are described by the Rev. T. R. Stebbing, *Ctenophora* by Dr. Fowler, and cuttlefish by the Rev. J. F. Blake. In the general table accompanying the latter article it is noticeable that *Octopus* (or rather *Polypus*) is regarded as the descendant of an ammonite of the *Hoplites* group, and also that the author accepts the view of one or two German writers as to the homology of the argonaut shell with that of an ammonite. The *Echinodermata* (called *Echinoderma* in the table of contents) are elaborately treated by Dr. F. A. Bather, while Mr. A. E. Shipley is responsible for that small marine group known as *Echiurids*, and, from the presence of segmentation in larval life, sometimes classed as *Annelids*.

The very important subject of economic insects falls to the lot of Prof. F. V. Theobald, but limitations of space render his article all too short. Recent investigations into the breeding-habits of the eel and the discovery of the real nature of "leptocephali" have enabled Mr. J. T. Cunningham to render the article "Eel" one of especial interest. The only botanical subject is cytology (vegetable), for which Mr. H. W. T. Wager is responsible.

ASPECTS OF MEDICAL SCIENCE.

Pathologie générale et expérimentale. Les Processus généraux. Par A. Chantemesse and W. W. Podwysotsky. Pp. xiv + 428; 162 figures. (Paris: G. Naud, 1901.)

Matière médicale zoologique, Histoire des Drogues d'Origine animale. Par H. Beauregard, Professeur à l'École supérieure de Pharmacie de Paris. Révisé par M. Coutière, with a preface by M. D'Arsonval. Pp. xxxi + 396; numerous plates and illustrations. (Paris: G. Naud, 1901.) Price fr. 12.

Chemische und medicinische Untersuchungen. Festschrift zur des sechzigsten Geburtstages von Max Jaffé. Pp. 472; 7 plates. (Braunschweig: Vieweg u. Sohn, 1901.)

Das Wirbeltierblut in mikrokristallographischer Hinsicht. Von Dr. med. H. U. Kobert. Mit einem Vorworte von Prof. R. Kobert. Pp. 108; 26 figures. (Stuttgart: Ferdinand Enke, 1901.)

THE first book before us is the first volume of a system of general and experimental pathology. In an academically written preface of ten pages, the authors explain the object of the book, pointing out the extreme value of comparative experimental pathology in elucidating the prime problems of morbid processes in the human subject. In especial the authors cite the work of Pasteur on silkworm parasites, and that also of Metchnikoff on the effects of irritants upon low forms of life. Equally well might the recent researches upon

the causation of malaria have found a mention in this connection. M. Chantemesse's Russian collaborator, M. Podwysotsky, has already published in Russian a general experimental pathology covering similar ground to the volume under consideration. The present work, however, is much more extensive, both with regard to the letterpress and figures, and can in no sense be regarded as a translation from the Russian.

It is impossible in a short review to enter adequately into the subject-matter of so compendious a volume, and little more than a table of contents can be given. More than half the space is devoted to the degenerations, which are treated very fully, each having appended to it a copious, we were going to say appalling, bibliography. These huge lists of papers bearing on the corresponding subject are really the more appalling in that upon glancing through them it at once becomes evident that they are more complete with regard to French and Russian workers than with regard to German and English ones. Judging from them and the text, it appears that the authors are not well acquainted with current English scientific literature, as the number of English authors quoted is very small, and the same cannot be said of the English work done upon the subject in question. Certainly one, and in the reviewer's opinion not the least, of the advantages of the book is that it makes accessible to a cosmopolitan public a mass of Russian work, evidently of great value, which otherwise, on account either of its language or its inaccessibility, might have easily escaped the observation of workers in the field of experimental pathology, to their and their readers' detriment.

Under the degenerations are included goitre and cretinism, the authors giving, concerning these affections, an interesting series of experiments upon the effect of the water of the district upon endemic goitre. Saint Jean de Maurienne is apparently one of the most goitrous districts of France, and the waters here have actually the reputation of producing goitre, and are resorted to with success by certain individuals anxious to avoid compulsory military service. Glycosuria is discussed under glycolytic degeneration. An interesting section is devoted to watery and vacuolar degeneration, which includes a detailed description, with very beautiful illustrations, of the vacuolisation of the cells of the central nervous system under the influence of certain toxins and drugs.

The book throughout is written in a most lucid and attractive style, and in a distinctly philosophical manner. The amount of subject-matter treated is very great, and even subjects having little more than an indirect bearing upon the main theme of the book are exhaustively discussed. Some idea of the extent to which this is done may perhaps be formed in noting that no less than fifty pages are devoted to the subject of heredity, and that under this division of their subject the authors include a lengthy discussion of the views of Weissmann. The subject of argyrosis, or general pigmentation following the administration of silver salts, occupies six pages, and has appended to it a copious bibliography.

The reviewer regrets that the references in the bibliographies are not numbered, even when quoted in the text; reference to any given paper is by this fact

rendered very difficult. This difficulty is exaggerated since the position of any given name in the bibliography quoted in the text is not determined alphabetically, but by the date of the corresponding paper. This chronological arrangement of the bibliographies may possibly render them more valuable as entities, but certainly renders them more unwieldy for the purpose of their true function, viz. their reference to the text.

The volume is exceedingly well printed and provided amply with illustrations, often of preparations made by the authors, the execution of which leaves little to be desired. The book will certainly rank as a standard work of reference, and if the high efficiency of the present volume be maintained by its successors will certainly be accorded an emphatic welcome by all pathologists. The authors and the publishers are distinctly to be congratulated upon what can only be the result of labour at once skilful and unremitting.

The second work under notice is a posthumous one. As all interested in pharmacy in France know, M. Beauregard died some months before the publication of his "Matière médicale zoologique." Up to the very last, however, he took the keenest interest in it, and it is pathetic to note from the introduction that the proof sheets were corrected by the author upon the sick bed from which he was never to rise. The author is well known for his researches upon pharmaceutical subjects; these have, further, been in large measure directed to products of animal origin. Especially should his work upon the animal vesicants and upon the animal perfumes find mention here.

The volume which is the object of this review is a compendious book of reference upon all substances used, not only in pharmacy, but also in perfumery, which owe their origin to the animal kingdom. It must be at once observed that the information in the book is for the most part zoological, and that the chemistry of the products in question is not entered into at all fully. In many instances there is little to be said from the chemical side, but it is well to remark that from the chemical standpoint the book cannot be considered as comprising all that is known. Cod liver oil and musk are to some extent exceptions. Under cod liver oil the author gives an account of Gautier's work on the alkaloids contained in this substance, but no mention is made of Hegerdahl's researches on the chemical composition of the fatty constituents of the oil. Under musk an interesting paragraph is added upon artificial musks; nine synthetic substances, mostly butyltoluene derivatives, are mentioned which approach more or less closely to musk in smell. These substances, however, all differ from the natural musk (the preputial secretion from a variety of reindeer) in being less lasting. The extraordinary way in which musk keeps its smell renders this substance very valuable. The trade in this commodity is considerable, and in France is certainly increasing; in 1895, 686 cattie (604 grammes) were imported into France and 465 into London. At the present time musk fetches about 100l. a kilogramme.

Amongst other substances which are treated very exhaustively from the zoological side may be mentioned spermaceti, the crystalline fat derived from the head of the sperm whale, and the rare substance ambergris.

The literature of ambergris is very small, and M. Beauregard has certainly added very considerably to it. It appears that this interesting substance is an intestinal concretion occurring in certain whales. Ambergris is not employed in medicine, but is very much prized in perfumery on account of the property it possesses, although itself odourless, of reinforcing the scent of other substances. The chief market for ambergris is apparently at Boston, and some idea of its value may be formed from the fact that it sometimes fetches as much as 280l. the kilogramme.

The vesicant insects, *Cantharis vesicatoria* and its immediate allies, are, as was to be expected, treated very fully. The book concludes with a chapter devoted to the sponges.

From the above somewhat disjointed review it will be seen that M. Beauregard has for his last work produced a valuable addition to the literature of a subject concerning which not much has been written. We are afraid the limited number of readers to which the book will appeal will render the sale of it relatively small; be this as it may, the gratitude of those interested in the subject is due to the author for having collected in a most readable volume the scattered work of many observers, among which must be mentioned his own.

The German custom of celebrating the birthdays of professors by publishing a collection of papers by their collaborators and pupils has many advantages. The collection of monographs published to celebrate the sixtieth birthday of Prof. Max Jaffé by his former collaborators and pupils, although not quite so compendious as many of its forerunners, nevertheless contains an interesting collection of papers. The subject-matter may roughly be divided into three parts. The first series of papers is chiefly devoted to clinical medicine, and is written, for the most part, by old collaborators of Prof. Jaffé who have become famous as clinicians. Amongst these may be mentioned Prof. Leyden, who contributes an article upon the therapeutics of oxygen, and Prof. Nothnagel, from whose pen comes a most useful essay upon intestinal hæmorrhage.

The second series of papers, the shortest in the book, comprises three essays upon pathological, morbid anatomical and embryological subjects.

The third part of the book, occupying more than half its entire bulk, is essentially experimental. The first essay seems to be an entirely chemical one. Dr. Salkowski contributes an article upon the chemical composition of hydrocephalus fluid; he draws attention to the fact that the fluid is different in acute and chronic cases in so far as concerns its content of potash salts. He regards the excess in potash salts of acute hydrocephalus as due to the fever which accompanies the acute variety. Normal urine contains, according to this author, only 21 per cent. of the sum of potash and soda salts as potash salts, whereas in fever urine 87 per cent. of this sum consists of potash salts.

An interesting piece of work by Dr. Rudolf Cohn, on the glyocol-store of the organism, comes from the Laboratory of Experimental Pharmacology and Medical Chemistry at Königsberg. It is a contribution to the study of intermediate tissue change. The work consists essentially of a repetition, by other methods, of that of Hugo

Wiener. The fact that benzoic acid is converted by the organism into hippuric acid, and is poisonous only in so far as it is not so converted, is made use of to estimate the quantity of glycol present in the organism under different conditions at any given time. The result of the researches, in the author's opinion, shows that in rabbits the store of glycol is neither small nor constant, and that it bears a constant relationship to proteid katabolism; further, that this relationship appears to be the same whether the proteid material be katabolised in the animal body or by external chemical means.

Prof. Hans Meyer, conjointly with Dr. J. T. Halsey and Dr. F. Ransom, contributes a paper on tetanus. The stimulus to this research appears to have been the work of Courmont and Doyon upon the influence of temperature upon the development of tetanus after the injection of the tetanus toxin. The results of Meyer and his collaborators are in the main confirmatory of those of the earlier observers, and appear to show distinctly that cold has a marked preventive influence upon the development of tetanus in animals after the injection of tetanus toxin. These results point, according to Ehrlich and his school, to the fact that the "toxophore" group, in the case of tetanus, develops slowly, and only at relatively high temperatures. The nearest poison of known chemical composition to the tetanus toxin is strychnine, and Koeninck has shown that the development of the symptoms of strychnine poisoning in animals is independent of the temperature.

The book contains other interesting essays, which the space at our command does not permit us to review.

Dr. Kobert's pamphlet is intended primarily for those interested in the medico-legal detection of blood, and consists for the most part of a compilation of the facts at present known upon this subject, culled from the appropriate original works. In some respects, however, it is original, especially with regard to the description and figure of haemochromogen crystals, and hence will in this sense be possibly of use to physiological chemists generally. The book apparently owes its origin to a practical course upon the detection of blood stains which Prof. Kobert gave himself, and which in a much less complete form appeared in *Zeitschrift für angewandte Mikroskopie*.

The first few pages of the monograph are devoted to the interesting subject of the mutuality of iron and copper with regard to the blood pigment. It is a known fact that in certain invertebrata the blood performs its respiratory function through a copper compound. This physiological equivalence of copper and iron in this respect is distinctly of interest in connection with the supposed toxic effect of copper.

A considerable space is devoted to the interesting substance hæmatoporphyrin, which occurs in human urine especially after the administration of sulphonal, a very commonly used hypnotic. The relation of hæmopyrrol (methyl propyl pyrrol) to hæmoglobin and chlorophyll is also discussed in the light of the work of Marchlewski and Schunck.

A short section is devoted to blood serum crystals, and the pamphlet concludes with a concise bibliographical and general index.

The booklet is certainly thoroughly written, and will

be found useful by those especially interested in this somewhat limited field, as well as of practical use in guiding the medical jurist with regard to method.

F. W. T.

CHEMICAL ESSAYS.

Essays in Historical Chemistry. By T. E. Thorpe, C.B., LL.D., F.R.S. Pp. xii + 582. (London: Macmillan and Co., Ltd., 1902.) Price 12s. net.

IT is always a pleasure to read any of Dr. Thorpe's essays; in this volume a number of them, delivered on very different occasions, at intervals during the last twenty-five years, have been collected. Some have been published in book form before, but several, which are to be found in the present work, are reprinted from *NATURE* and from the *Transactions* of the Chemical Society.

The first essay—that on Robert Boyle, "the father of modern chemistry"—displays Dr. Thorpe's admirable style at its best. One is struck by the great wealth of allusion to contemporary events, touched lightly, it is true, but none the less giving a clear impression of the times in which the subject of the essay lived, and of the surroundings in which he carried on his work. Dr. Thorpe possesses, too, a happy knack of apt quotation; the particular passage from a writer of prose or poetry which best illustrates the point which he wishes to make flows easily from his pen, and gives much interest and spice to his narratives. The essay on Boyle is a sketch; much that is interesting is omitted, and there is plenty of room for other essays on Boyle; but what is told is written in such an attractive style, and gives such a perfect picture of the quiet, meditative philosopher—*philareticus*, or the friend of virtue, as he calls himself in a passage which might with advantage have been quoted—that to complain of a lack of completeness would be to appear to undervalue what is given.

Dr. Priestley is the subject of the next sketch. Again the same careful delineation of character is to be noted; but perhaps in the life of Scheele, the subject of the third essay, Dr. Thorpe is at his best. It is hardly fair, however, to the shades of Mayow to credit Dr. Priestley with the invention of the pneumatic trough, although the name, doubtless, is due to him; for Mayow's *Tractatus quinque* contain many illustrations of that convenient appliance.

In the essay on Cavendish, a delightful picture is given of an imaginary soirée at the house of Sir Joseph Banks:—

"The portly visitor, with the large frill, makes his way upstairs, to the evident embarrassment of a thin middle-aged gentleman in an old-fashioned Court-dress of faded violet, and a knocker-tailed periwig, who is moving uneasily about on the landing, evidently afraid to face the assembly. The approach of the gentleman on the stairs, however, drives him into the room. He shuffles quickly from place to place, his manner is awkward; his face betrays a nervous irritation of mind, and he appears annoyed if looked at. It is the Honourable Mr. Cavendish. Finding himself close to a group, evidently, from the appearance which their faces wear, speaking of a deeply important matter, he draws near to listen. They are talking of a rumour of some grave disaster which has befallen my Lord Cornwallis and his troops, who it

would seem have been circumvented in some unexpected manner by the machinations of that arch-rebel Washington. Mr. Cavendish is scarcely interested, and he moves aside to catch something concerning, it may be, some fresh eccentricity of poor Lord George Gordon, or perhaps some account of the troubles of the unhappy Mr. Watt, the engineer, who, it is said, is fighting tooth and nail to defend his just rights from a set of unprincipled rogues who pirate his inventions. None of these matters is sufficiently moving to detain him. But his manner quickly alters when he overhears the mention of the name of Mr. Herschel. Mr. Herschel is a musician at Bath, who employs his leisure in constructing big telescopes, with one of which he has just discovered a new planet. Mr. Cavendish is greatly interested; he listens with marked attention; he is even about to put a question, and begins in a nervous, hesitating manner, and in a thin, shrill voice, when his eye catches that of a stranger; he is instantly silent, and retires in great haste, for he has a horror of a strange face. The portly gentleman with the large frill spies him, and comes up with a foreign gentleman, who is formally introduced to Mr. Cavendish. Mr. Cavendish is assured by the portly gentleman that his foreign friend is particularly anxious to make the acquaintance of a philosopher so profound and so universally celebrated—all of which is confirmed by the foreign gentleman, who adds that it was, indeed, his chief reason for coming to London, that he might see and converse with one of the most illustrious philosophers of that or any other age. Mr. Cavendish is speechless; he is overwhelmed with confusion, until seeing an opening in the crowd, he darts through it with all possible speed, and reaching his carriage, is driven home."

This it must be acknowledged is a most graphic piece of descriptive narration; it conveys the man and the age like a living picture. The author would have made a thrilling novel-writer, at all events on the descriptive side.

The sketch of Lavoisier, although giving a fair account of his life and works, possibly treats at too great a length with his tragic death; but this error (if it be one) is partly atoned for in the next essay, in which the rights (and wrongs) of the dispute regarding the share of Priestley, Cavendish and Lavoisier in the discovery of the nature of combustion and of the composition of water are fully discussed. No English chemist will dispute that while Priestley and Cavendish, personally, and through Blagden, furnished Lavoisier with the facts relating to the preparation of oxygen and the composition of water, it was Lavoisier who interpreted them correctly. It is strange that Priestley (in a passage quoted on p. 153) and Cavendish, in his paper in the *Phil. Trans.* for 1784, p. 150, both consider the advantages and disadvantages of using the conceptions given to the world by Lavoisier; and both, after stating arguments on both sides, prefer the method of statement in terms of phlogiston. It is a pity that such international disputes should arise; would that scientific men of all nations would take to heart the words of Pasteur:—

"I find myself deeply impressed by two propositions: first, that science is of no nationality; and secondly, in apparent but only apparent contradiction, that science is the highest personification of nationality. Science has no nationality, because knowledge is the patrimony of humanity, the torch which gives light to the world. Science should be the highest personification of nationality, because, of all nations, that one will be the foremost which shall be the first to progress by exerting

thought and intelligence. Let us strive, for strife is effort, strife is life, when progress is the goal."

The strife should consist in trying to raise one's own nation to the highest pinnacle of intellectual and industrial greatness, and not in disputes as to priority of discovery and invention.

A full analysis is given of Graham's work, and his biography is pleasant reading. The genial, kindly nature of the man is well brought out. The remaining essays, on Wöhler and Liebig, founded on Hoffmann's charming biography; of Kopp and of Victor Meyer, both old friends; and of Mendeléeff and Cannizzaro, enter more into the details of their chemical work, and may therefore prove of less interest to the general reader; but they are fairly exhaustive, and produce the effect which they were intended to produce—a high estimate of the genius and hard work of the subjects of biography.

The progress of chemistry in this country during the nineteenth century was the subject of Dr. Thorpe's presidential address to the Chemical Society in 1900; it is conceived in his best style, and presents a life-like picture of the progress of the science in the early part of the century. A continuation of this sketch is promised, but up to now has not appeared. But it is acknowledged to be easier to paint a distant landscape than a near one; the numberless details, which produce somewhat of confusion when close, merge into broad masses of colour when sufficiently far away.

One conclusion, among many, stands out conspicuous from Dr. Thorpe's pages. It is the enormous influence of the teacher on the taught; how potent is the effect of personal contact with the experienced investigator on the future career of the young student! Scheele with Retzius and Bergmann, Watt with Black, Lavoisier with Rouelle, Faraday with Davy, Graham with Thomson, Wöhler with Gmelin and Berzelius, Liebig with Gay-Lussac, Dumas with De Saussure and De Candolle, Kopp with Gmelin, Victor Meyer with Bunsen. It is rare that a young man has, like Boyle and Cavendish, sufficient initiative and perseverance to forge a way for himself. As Prof. von Baeyer once remarked to the writer of this notice:—"I care not what a young man knows; if he can only *think*, after he has left my laboratory, I feel that I have done my duty by him." When will this elementary view of education influence the action of those who legislate on the training of our youth? W. R.

AN ASSISTANT MASTER, AND HIS WORK.

The Schoolmaster: a Commentary upon the Aims and Methods of an Assistant Master in a Public School.
By Arthur Christopher Benson, of Eton College.
Pp. vi + 173. (London: John Murray, 1902.) Price 5s. net.

THIS book is not, and does not profess to be, a manual of pedagogy. The reader in search of help in regard to school organisation, to the allocation of time and subjects, to the methods of teaching generally, the bearing of Herbartian or other philosophical theories on practical problems, or educational politics in any sense, will probably find the book disappointing. The author has little or nothing to say on the relation of

Government or public authorities to the school and its teachers, the influence of external examinations, the place of science in the curriculum of a school, the professional training of school masters, or any of the numerous subjects which form the staple of newspaper controversy or Royal Commissioners' reports in relation to school policy and work. His point of view is simply that of a classical master, whose work has been done only with scholars drawn from the upper ranks of society, whose educational ideals have been formed by Eton traditions and by the requirements of the universities, and who discusses with his readers in an informal and conversational fashion the question how, under the exceptional conditions of a boarding-house at a great public school, the utmost can be done to foster manliness, good scholarship and the characteristics of a Christian gentleman.

But within this limited range of observation and experience Mr. Benson has acquired much valuable knowledge, and his book shows him to be distinguished, not only by literary skill, but also by a genuine love for his profession and by a keen and sympathetic insight into the nature and the needs of boyhood. His view of the spiritual and mental relationship which should be established between a wise teacher and his pupil, his large tolerance for differences in the character and tastes, the virtues and the faults of boys, his belief in Thring's well-known *dictum* that there is no such thing in the world as a good-for-nothing boy, and his insistence on the value of an atmosphere of cheerfulness and intelligence as distinguished from the mere learning of lessons—all give a special charm to the book and will serve to make it peculiarly attractive to young teachers who are not pedants, but who seek to achieve the highest and truest kind of professional success.

The discussion on the prospects of the teaching profession and its disadvantages is marked by much candour:

"No enthusiasm will ever quite succeed in gilding a trade which consists in part of providing food and lodging for a large number of people and charging them rather more than they cost."

On the other hand, to one who is drawn to the profession by a sense of personal fitness and by a liking for the work,

"there is a certain attractiveness about the perpetual exercise of minute control, there is a sense very strong in the British character of pleasure in exercising discipline and showing power"; "there is no profession which is so apt, if exercised faithfully, sympathetically and tenderly, to broaden the character and enlarge the spirit,"

and it often happens that the man who begins as the careless, self-regarding practitioner of a not very dignified

"trade discovers that he is in the thick of a very real and vivid life which stirs all sorts of interests and emotions and brings home to him some of the deep realities of life."

The writer of such passages is under no illusions and has no temptation to magnify his office unduly; but he is deeply impressed with its seriousness, and he believes that a young teacher will find, as he acquires new power and stronger sympathy, increased delight in his work.

As to specific training for that work, Mr. Benson is somewhat sceptical. Apparently he is not speaking from any experience of trained as compared with untrained colleagues: but because his own success has been attained by other means than formal preparation, he pronounces boldly that training can never make a man an effective teacher. He thinks that

"a sensible man may learn more in a week from teaching a division of his own when he has no one to depend on but himself than in months spent in a training college."

His plan appears to be to treat a class of boys as the *corpus vile* on whom pedagogic experiments may be tried, and he adds with charming *naïveté*,

"As far as mere methods are concerned, I am sure I could tell a young man in half an hour the simple dodges which have proved in my own case useful and effective."

The author fails to see that while a man endowed with natural gifts such as insight into character and professional enthusiasm may become a valuable teacher without training, it is evident that the rank and file of the teaching profession will find themselves at least helped by some knowledge of the philosophy of the art they profess and by some acquaintance with the methods and performances of famous teachers, and of the reasons for their success or failure.

The best chapters in the book are those in which the author discusses the means by which school lessons may be made interesting and attractive to boys.

"A school lesson," he says, "should be of the nature of a dramatic performance from which some interest and amusement may be expected, while at the same time there must be solid and business-like work done. The aim ought not to be to turn everybody into a literary personage. Literature is only one province of the intellectual life. . . . An intellectual person is one whose mind is alive to ideas, who is interested in politics, religion, science, history, literature, who knows enough to wish to know more and to listen if he cannot talk."

But no man is capable of generating in his pupils a real love for knowledge unless he himself cultivates some intellectual interests apart from the obvious routine of school work.

"The master, out of school, should live in the company of good books and big ideas. Everyone cannot be interested in everything, but everyone is capable of being interested in something, and I do not care very much what the subject is, provided only that there is a little glow, a little enthusiasm in it."

On the well-worn topics of athletics, on holidays, on prizes, on the right use of chapel services and on moral teaching, Mr. Benson speaks with strong conviction and good sense. His aims are high, but he is afraid to set up impossible ideals or to forget that, while temptation is often strong and boys are weak, they

"are in their better moments earnestly and pathetically desirous to be kept from evil, and that no help which the schoolmaster can give them is ever thrown away."

The book abounds with obvious truisms, but they are rendered attractive by the freshness with which they are stated, and by the fact that they are the product of actual experience and of the serious devotion of a life to

duties which the author has learned to enjoy as well as to fulfil. In the midst of much that he and others regard as revolutionary in educational theory, and of many important claims on the part of "modern subjects" in schools, it is useful for us all to be reminded, as in this book, of what may be done in connection with the traditional discipline of the great public schools, when the work is undertaken by men who, though standing honestly *super vias antiquas* in regard to the staple of school teaching, are nevertheless profoundly conscious of the needs of our own time, and who look on scholarship, not as an end in itself, but mainly as a means to the higher end of Christian manhood and honourable citizenship.

OUR BOOK SHELF.

The Dictionary of Photography. By E. J. Wall, F.R.P.S. Revised and brought up to date by T. Bolas, F.C.S., F.I.C. 8th edition. Pp. iv + 656. (London: Hazell, Watson and Viney, Ltd., 1902.) Price 7s. 6d. net.

THE fact that the eighth edition of this dictionary is now published is the best of all evidence of the appreciation that it continues to receive. And this appreciation is deserved, whether one regards the work of the author or the reviser. So far as we have been able to examine the work, the information it gives is sound and useful. Mr. Bolas states that he has added nearly a hundred new pages of subject-matter, as many fresh headings and many new diagrams, but by a process of concentration and elimination has not increased the bulk of the volume so far as to render it unwieldy.

The great difficulty in compiling a book that aims at being something more than a simple guide for beginners and something more handy and less costly than a treatise that aims at approximate completeness, is to satisfactorily apportion the available space to the various subjects. As the needs of no two readers are exactly alike, a very wide margin must be allowed for the discretion of the compiler, but we notice a few cases in which the reviser might with advantage have extended his work of adding to the original, even if it necessitated still more "concentration and elimination." The page and a third devoted to "amphitype," for example, might well have been spared, while the six or seven lines devoted to "hypo-eliminators" might profitably have been expanded to a couple of pages. The getting rid of sodium hyposulphite is a problem that has to be attended to in the production of every negative and silver print, and even if all "eliminators" are regarded as useless, some are still on the market, and every thinking photographer wants to know something as to their mode of action, advantages and drawbacks.

Acetylene is very unfairly treated. After it has been in use for so many years as it has, and has proved to be so convenient, effective and safe, it must be a prejudiced view of it that leads to its consideration in less than a page, half of which is devoted to its endothermic and consequently supposed dangerous character, and the other half to its history and a statement that the "great hopes" concerning it have not been realised!

In the selected bibliography of photography some hundred and twenty books are mentioned, ranging from apparatus makers' pamphlets and beginners' guides to the most comprehensive works; but of the few books recommended for students by the City and Guilds examiners, presumably because of their educational value, we have counted nine in English, including three on general photography, that are not mentioned. This

difference can hardly be dismissed as due to the exercise of a wise discretion.

These are examples of the cases in which the reviser might have gone even further than he has in his additions, concentrations and eliminations. Doubtless he will do so when the next edition is called for.

Die Entwicklung des Gesichtes: Tafeln zur Entwicklungsgeschichte der ausseren Koerperform der Wirbelthiere. By Carl Rabl. Part i., *Das Gesicht der Saeugethiere.* With 8 plates. (Leipzig: Engelmann, 1902.) Price 12s.

THIS, the first of four parts of a comprehensive work, deals with the development of the external form of the head-region in rabbit, pig and human embryo. How many different vertebrate animals the author proposes to make use of for the purposes of the research is not stated, but it may be recognised that the net is cast widely enough when within its meshes so lowly an animal as the lamprey is to be contained. The figures of the eight folio plates, drawn by the author, are certainly exquisite, quite unique, indeed, of their kind. From others previously published they differ in two important respects. While the former rarely exceed a magnification of five diameters, the present ones possess three times this, and—a very important point—they are the first series of the kind to be lithographed by the firm of Werner and Winter. This is a sufficient guarantee that full justice has been done to the originals by the lithographer's art.

In fundamental features the drawings, perhaps, hardly reveal anything not already visible in the well-known pictures of pig and human embryos published by His and Keibel. Possibly novelties may be looked for in subsequent parts of the work. To the figures extant of normal human embryos, those here given will form additions welcome to the anatomist and the embryologist alike. As to the others, the one noticeable deficiency is that they stop short of and do not at all cover the period when, for instance, the pig-embryo first becomes unmistakably a member of the genus *Sus*, a representative of the species *Sus scrofa*, and a pig with a particular individuality of its own. That is to say, the author ignores what His has termed the period of the passage of the embryo into the fetus, the point when the unfolding of the embryo is about finished.

The work, which with so large a number of fine plates is remarkably cheap, is being published by the aid of the Imperial Academy of Sciences, Vienna.

Les Fleurs du Midi. By P. Granger. Pp. viii + 371. (Paris: J. B. Baillière et Fils, 1902.)

THE vast quantity of early flowers which reaches this country in the early spring from the Mediterranean region might lead one to suppose that the conditions of the climate there are entirely favourable to the forcing and rapid development of plants. A perusal of this book indicates that the gardeners of the littoral do not find circumstances by any means so propitious, for the east wind causes drooping of the leaves and withering of the flowers, while the mistral coming from the north-west at times blows with such force that trees are uprooted and shelters overturned.

The various protective devices, whether hedges or trees, glass frames, straw mats, &c., are fully described and illustrated, together with the conditions under which they may advantageously be employed. Then follows a discussion of various details, such as manures, insecticides, the best methods of gathering and packing, and the cost of freight. The main bulk of the book treats of the plants which lend themselves to cultivation during the winter, with an enumeration of species and varieties which are suitable to the climate and likely to yield a remunerative return for time and money expended in their production. The book is essentially practical and represents the outcome of several years' experience. The

type is good and the illustrations form an important feature, being artistic and at the same time expressive and useful.

Physiology for Beginners. By Leonard Hill, M.B., F.R.S. Pp. xvii + 124. (London: Edward Arnold, 1902.) Price 1s.

In this tiny volume the author has set himself the difficult task, as he describes it in his preface, of putting in simple language the essential facts concerning the structure and functions of the human body.

The book is intended for junior students who have no previous knowledge of the subject, and it may be said that the author has put forward the main essentials of the subject in an attractive way such as ought to engage the interest of school children, for whom the book is obviously intended. The author clothes his subject in the homeliest possible phraseology, avoiding technical terms and hard names so far as can be done in dealing with such an abstruse subject, and instead of giving dull definitions he suggests and then answers questions which must arouse interest in the juvenile mind.

Although mainly written for use as an elementary school book, the volume may be recommended to anyone who wishes to obtain some knowledge of the functions of the different organs of the body without the trouble of a detailed or technical study of the subject.

The book is artistically got up and adorned with many clear and well-drawn illustrations of the subject-matter.

B. MOORE.

Die Philosophie August Comte's. By L. Lévy-Bruhl. German translation by H. Molenaar. Pp. 286. (Leipzig: Dürr'schen Buchhandlung, 1902.) Price Mk. 6.

THIS is a careful translation into German of a full and sympathetic study of Comte's positivist philosophy in all its aspects. M. Lévy-Bruhl is not one of those more cautious disciples who, like Littré, rejected Comte's religion in the name of his philosophy. He boldly defends the whole later development with its curious substitute for Catholicism as a necessary consequence of the original Comtian conception of a reform of society operating by means of a reform of philosophy. The actual subject of his book is, however, the philosophy apart from the subsequent developments. He treats with lucidity and knowledge in his first book of the foundations of the positivist doctrine, the alleged "law of the three stages," the classification of the sciences and the concept of law. In books ii. and iii. he presents a sketch of the natural and social sciences, exhibiting their interrelation. The concluding book is devoted to an exposition of the positivist ethics. The translation reads well and pleasantly, and makes one wish that we in England, where Comte is more talked about than studied, possessed a statement of his doctrine in a once so lucid and so concise.

A. E. T.

Elementary Coal Mining. By George L. Kerr. Pp. 225. (London: Charles Griffin and Co., Ltd. 1902.) Price 3s. 6d.

THIS volume "is meant as an introductory manual to the larger and more advanced text-books." The subject-matter is dealt with in fourteen chapters, at the end of each of which there are examination questions. The information is given concisely and in a form adapted for easy assimilation by students preparing for the examinations held under the Education Department and the County Councils and under the Home Office for under-managers' certificates. There is no striking novelty in arrangement or in the matter dealt with. The 200 illustrations are good and clear. Several of them appear to have been borrowed from Mr. Herbert W. Hughes's well-known text-book, with no mention of the source.

LETTERS TO THE EDITOR.

[The Editor does not hold himself responsible for opinions expressed by his correspondents. Neither can he undertake to return, or to correspond with the writers of, rejected manuscripts intended for this or any other part of NATURE. No notice is taken of anonymous communications.]

Earthquake of May 28 at the Cape, and Coincident Meteorological Effects.

As certain peculiar meteorological phenomena seem to have been closely associated with the earthquake felt in the Cape Peninsula on May 28, the following particulars of this occurrence seem to deserve notice.

After being practically calm all day, a loud sound resembling a clap of thunder or the rumbling of approaching heavy waggons was heard about 11.45 p.m. (Cape mean time of 22½° east), followed in Cape Town and Green Point by a heavy downpour of rain, and in the suburbs by a severe squall of wind and rain; practically simultaneous with the sound there occurred a shaking and rattling of windows and doors; some state they felt also a distinct shock, others that their beds rocked, while information was received of the cracking of the walls of at least two dwelling houses. The wind-squall was strong enough to uproot or blow down trees in some of the eastern suburbs. One gentleman, whose written account is in our possession, states that "it fairly shook the room and its contents which I occupy at Rosebank; shortly afterwards a similar sound (tremor?) was felt; it lasted only a few seconds and died away." Dogs were apparently conscious of the occurrence, one which was never known to be affected by thunder or lightning moving about and whining in a peculiar manner, while a parrot indicated by its screeching that it was sensible of something unusual happening.

Our meteorological records show that rain fell (except on May 19) every day from May 17 to May 24, amounting to 3.10 inches at the Royal Observatory and to 7.45 inches at Newlands. Between the 24th and 28th, although no rain fell, there was almost an entire absence of drying winds, being chiefly light from the N.W., from which direction comes the bulk of the Cape Peninsula rainfall.

Barometric pressure was high, 30.071 inches at 8 a.m. on May 27, but fell steadily to 29.775 inches at 6 p.m. on May 28, after which it remained stationary, so far as hourly eye-readings showed, until 11 p.m.; between 11 p.m. and midnight it fell to 29.717 inches, and rose rapidly to 29.771 inches at 12.15 a.m. on May 29, to 29.809 inches at 12.25 a.m., and to 29.817 at 12.30 a.m., unusually large and rapid fluctuations for the Cape Peninsula, and suggesting at once the presence of thunderstorms in the neighbourhood. These rapid variations in pressure might account for the rumbling sound, on the supposition of it being thunder, also for the wind-squall, and even for the rattling of doors and windows (not affected by ordinary winds), but fails to account for the "rocking" of the beds, the cracking of walls and the unusual behaviour of the dog already mentioned, all these inducing the belief that an actual "earthquake" was experienced.

No record of any seismic disturbance was, however, shown on the seismometer at the Royal Observatory.

The lightkeeper at Cape Point makes these remarks on his meteorological schedule for May—"28th: wind S.E. to S.W., light; silent lightning from N. to N.W. at 8 p.m., then thick fog from 10.30 p.m., and a light drizzling shower at 11.45 p.m. Fog and rain till midnight, then thunder and lightning at midnight; again rain off and on from 1.40 a.m. till 8 a.m. on May 29."

Through the courtesy of Mr. D. E. Hutchins, Conservator o. Forests, the writer has been enabled to examine his barogram obtained at Cape Town for the period between Tuesday, May 27, and Sunday, June 1. This record shows a dip in the curve occurring after 11 p.m. on May 28. Similar irregularities are recorded for the early mornings of May 29 and 31; these too were associated with thunderstorms, but may be connected with the West Indian eruptions of about the same date, an account of which is given in your issue of June 5.

In the absence of fuller information than is in our possession at present, no definite connection can be traced, but these phenomena seem to be closely related one to the other. At least, it will be admitted that a comparison of this barographic curve with the diary of events in the West Indies shows some

¹ Corrected to 32° Fahr., but not to sea-level; approximate height of barometer, 40 feet.

most peculiar coincidences:—(1) Renewal of eruption of Mont Pelée on morning of May 28; peculiar atmospheric disturbance at the Cape, simultaneous with earthquake shock there. (2) Renewal of irregularities in pressure curve on May 29 and 31 and early morning of June 1, there being renewed volcanic disturbances in West Indies on or about these same dates. The curve for these last two days is remarkable, resembling closely a series of ripples and suggesting "interference" effects.

Which was cause and which effect, or is there any correlation whatever? CHARLES STEWART.
Meteorological Commission, Cape Town, July 16.

A Tripartite Stroke of Lightning.

AT about 6.50 p.m. on August 7, after two or three preliminary low thunder rumblings, which by no means prepared us for what was to come, a most tremendous crash of combined thunder, lightning and electric discharge burst right over my residence here.

My butler, who was looking in the direction of our front gate, 80 yards to the north of our front door, saw a burst of smoke, mingled with a shower of leaves, rise into the air out of the adjoining shrubbery.

My coachman, who was sitting just within the open door of the lodge, close to the front gate, was dazed by a vivid burst of flame at his feet which seemed to leap into the doorway.

My neighbour's gardener, looking out of the lodge opposite, saw a nearly horizontal flash of fire enter the shrubbery close to my front gate.

A subsequent examination of the surroundings of the front gate and my coachman's lodge has revealed:—

(1) A tearing up of the ground close to the massive iron post of the front gate, the splitting of a large flint at its foot, and a litter of ivy leaves on the gravel.

(2) The clean cutting in two of an oak post, 35 yards distant to the north-east, from which an iron hand-gate was hanging.

(3) The scorching of the outside foliage of a horse-chestnut some 15 yards still further off, in a direct line with the other two objects struck.

In thirty years' experience of thunderstorms, which are rather frequent here, I have never observed the simultaneous striking of three different points by the electric discharge. A death-like stillness succeeded the crash, the storm appearing to have exhausted itself in a single tremendous explosion. Heavy rain was falling when the crash occurred. I have measured an inch and a half of rain-fall within the last three days.

Six Mile Bottom, Cambs., August 8. W. H. HALL.

Colours between Clouds at Sunset.

ABOUT sunset on the evening of Sunday, July 13, being at Ripon with my son, our attention was arrested by an unusual appearance, which I will briefly describe. Two large clouds, covering a considerable portion of the western sky, and separated by an interval leading generally towards the west, were each bordered along this interval by a bright and well-marked double spectrum. The two spectra forming this were together of the width of about one and a half times the diameter of the sun; they followed the foldings of the edge of the clouds, and, which suggests a partial explanation, were at right angles to a fringe of nebulous striae, which bordered the clouds, so that, except that the spectral colours were parallel instead of consecutive, the phenomenon had in some degree the appearance of the reflection from a grating.

Our observation lasted about twenty minutes, and it was especially noticeable that when, through the fading light, the more refrangible colours had disappeared, the two red lines on the rim of each cloud remained clearly marked to the last.

Never having previously seen or even heard of such an appearance, any information on the subject would be much appreciated. I might also report that on the evening of July 17 the pink streamers mentioned by some of your correspondents could be well observed, and had they been less stable, and had they radiated from the north instead of from the position of the setting sun, the appearance would have much resembled the Aurora Borealis.

JOHN BADDELEY.

Adswold, Bury New Road, Higher Broughton,
Manchester.

Retention of Leaves by Deciduous Trees.

ONE of the proofs in favour of this being caused by early frost is that frequently on exposed beech and other deciduous trees only the leaves near the ground are affected and remain brown on the trees until the spring. Leaves higher up escape the frost and fall normally, as these early frosts are usually confined to the strata of air near the ground. W. R. FISHER.
Coopers Hill, Englefield Green, Surrey, August 8.

THE WEST INDIAN ERUPTIONS.

AMONGST the last contributions to our knowledge of the eruptions which so recently devastated portions of the West Indies are five preliminary reports to the National Geographic Society. These, with excellent illustrations, appear in the July magazine of the Society.

In the following notes upon these reports attention is drawn to those portions of their contents which are not generally known, and to these are added a few observations made by witnesses, particularly those made by Captain E. W. Freeman, of the s.s. *Roddam*, whose experiences, although he was interviewed by members of the American expedition, have as yet received but slight consideration.

The first report is by Mr. Robert T. Hill, of the U.S. Geological Survey, who, with other scientific investigators, accompanied a relief expedition in the U.S. steamer *Dixie*, which sailed from Brooklyn Dock on May 14.

Notwithstanding the ill-advised introduction of matters foreign to the object of a scientific expedition, the bulk of Mr. Hill's report is well worth consideration. La Montagne Pelée, which has been introduced to our notice as the goddess of Hawaii and as the mountain which is bare or "naked," is now referred to as the "shovelfull," an allusion possibly to its form. In May, 1901, we are told that a picnic party discovered on its summit a small fume rising at one corner of its crater lake. On April 23 three distinct shocks were felt in St. Pierre, and everybody saw a great cloud of smoke rising from the summit crater. Two days later the lower Soufrière was in eruption, and from this date until May 5 the showers of ashes steadily increased. The succeeding sequence of events has already been published in these columns, whilst the observations of April 23 bring us nearer to the seismic disturbances of April 19, which, although they originated in Central America, there are strong reasons to suspect were the primary cause of disturbances in the Antillean fold.

As the introduction to the account of the catastrophe Mr. Hill mentions his witnesses, and here we find for the first and last time in these reports the name of Captain Freeman. Certainly there is a reference to his vessel. According to engineer Evans, of the *Roraima*, which was burned, the *Roddam* was lifted on a wave "so that her anchor chain broke and she was enabled to escape," which is not correct. Now at the time the great and fatal blast swept across St. Pierre and its roadstead, Captain Freeman was on the deck of his vessel—then about three ships' lengths from the shore—and for some time at least could see what occurred, whilst other witnesses whose testimony is referred to had sought refuge in engine-rooms or down below. Captain Freeman says that although there were many minor puffs of clouds from Pelée there was only one great eruption, and this came from the side of the mountain. There were no detonations or loud reports, and from his point of view there was no sheet of flame accompanying or following the blast. The force of this, which came with the wind, was so great that he believes it was the cause of the s.s. *Grappler* turning turtle. There was no return blast, neither was there any absence of air. The difficulty in breathing was due to the quantity of fine ash with which the atmosphere was charged and the fetid gases with which it was mixed.

The *Roddam* was not saved by being lifted on a wave, neither was it saved by knocking out shackle pins and slipping the cables. What Freeman did was to free his windlass and then run full speed astern until the cable parted. After that, the steering gear being jammed with ash, he steamed ahead and then astern, close to burning ships, seeing and hearing the cries of those on board and also of those who were running to and fro along the shore. From this it is certain that many of the people in St. Pierre did not die suddenly. Twenty-six of his own men also died, and for the most part they died slowly. At the end of an hour and a half the gear was cleared and he escaped. Then came a shower, not of mud, but of rain. About eight hours later, with 120 tons of fine sand-like ash upon its deck, the *Roddam* steamed into St. Lucia. Notwithstanding the fact that possibly 2 or 3 per cent. of this material consisted of grains of magnetite, and the quantity of ash containing this material above and around his vessel was so great that daylight was replaced by a darkness that could be felt, such compasses as were left in the *Roddam* were serviceable for navigation and did not show any irregularity in behaviour. Before the eruption nothing unusual was observed in the barometer.

These few notes, which bear upon the reports we are considering, but, as will be seen, are not entirely in harmony with the same, come from a man who saw the great explosion, was in the midst of its blast and saw what could be seen from the sea of the events which closely followed its occurrence.

That Captain Freeman, whilst on a burning ship, where he was more than half suffocated with hot ashes, when the boots were burned from his feet, his face seared and his hands so scorched and welted that he worked with his elbows, had the presence of mind to do what he did and the physical and mental power to carry out his intentions under these trying conditions is one of those instances of will-power and endurance possessed by few so well worthy of record. Let it be repeated, the *Roddam* was not saved by accident, but it was saved as Captain Freeman saved it once before whilst eleven other steamers foundered, by good judgment and courage, and it is to be hoped that before long he will receive from underwriters or others substantial recognition, not only for his services on the *Roddam*, but for the example he has placed before the world.

To return to Mr. Hill's report, at 7 o'clock on the morning of May 8 Mr. Ferdinand Clerc observed the needle of a large aneroid barometer pulsating violently, and it was in consequence of this fact that he left the city and escaped. It is, of course, possible that these movements were due to the air disturbances accompanying the outbursts of "smoke" which preceded the great eruption. This eruption, which took the form of a big black cloud, no doubt made up of ash, steam and other gases, issued from "a point fully 1000 metres below the summit" and travelled at the rate of a mile a minute downwards over the surface of the earth upon St. Pierre and its harbour. The ashes which fell upon the deck of the *Roddam* were found still to be warm thirteen days after the eruption.

At the time they fell on the *Roraima* they were hot enough to ignite rope and bedding, but not to ignite wood. This statement, according to Captain Freeman, means that the level surface of a deck would not be fired by a thick layer of such ashes, whilst woodwork round the edges of such a layer might be ignited. At all events the *Roraima* and other vessels were destroyed by fire, whilst the cloud as it passed over St. Pierre set fire to buildings. The *Dominica Guardian*, of June 25 writes on this subject as follows:—

"It would appear that a sudden fissure was opened on the side of the mountain overlooking the city; and, near to the Étang Sec on this flank of the volcano, a large

vent belched out lava, superheated steam and acid gases downwards on to St. Pierre and the roadstead. The flashing off into steam of the water imprisoned in the incandescent lava converted that lava into sand and dust before it reached the city, and the radiation of heat from molten rock at a temperature of more than 1000° C. caused an incredibly hot blast that would create a red hot hurricane—if I may employ such a term—that would kill people and animals instantly, and that would cause all inflammable matter to burst into flame. This from what I gather is what really happened, and I do not think that poisonous gases or electrical phenomena are accountable for the destruction of life."

The steam, hot air or gas penetrated clothing without firing the same, but it burned the skin beneath. This seems to have been true for those who were on the seaward side of St. Pierre, but it hardly appears to have been the case with those who were on the side nearest to the eruption.

Those who saw the cloud from the front, Mr. Hill tells us, say that it was not accompanied by incandescence, whilst those who were at the side or behind the same testify to seeing a flash-like flame suggestive of the ignition of a gas. It is quite conceivable that those behind the cloud might see that which was invisible to those in front, but the nuns at Morne Rouge do not appear to have seen the alleged flame.

The total quantity of ash that fell in St. Pierre was less than 1 foot in thickness, and it was piled highest against the northern walls, that is, on the side facing Mont Pelée.

In the blackening of silver and other metal objects picked up in the ruins, Mr. Hill sees evidence of the presence of vapours which were sulphurous. That silver should have been blackened within a burning house is what might be expected, but it does not follow that this blackening was due to sulphur from Mont Pelée. That there were small quantities of sulphurous vapour escaping before the great eruption is exceedingly likely, but when the latter took place it is more likely that the gas which accompanied the steam blast was hydrochloric rather than sulphurous. Since the days of Sodom and Gomorrah sulphur has been associated with volcanic action, and in the popular mind a volcano must always be accompanied by the combustion of this element.

The force of this blast may be judged by the photographs, the most striking of which is that of the monument of Our Lady of the Watch, which, although it weighed several tons, was hurled 50 feet. The blast caused vessels to turn turtle, walls were blown down and almost every standing object was levelled with the ground.

After the first blast, which pulverised buildings on the north side of St. Pierre, there was a return blast to blow over the south end of buildings, and lastly there came what appears to have been a vacuum—witnesses say that they "could get no air to breathe."

The fact that in the clouds which were thrown out in subsequent eruptions there were "tremendous displays of bolts and flashes" suggests that the flash which is said to have accompanied the primary outburst may have been a phenomenon akin to sheet lightning, which could only be seen on one side of the cloud which covered St. Pierre.

With this blast there was practically no noise of a great explosion, neither was there any evidence of marked seismic activity.

People were killed by inhaling hot ashes, some were burned by ashes or steam or flames, and by no means did all die instantly. With the exception of a few trees and plants protected in deep ravines, the country around St. Pierre was denuded of vegetation, but it is satisfactory to read that "nineteen-twentieths of the area of Martinique is as green and beautiful to-day as ever it was." Out of an area of 380 square miles only 12½

square miles have been devastated. No lava flowed, but only streams of mud, and to this it is added that neither the land nor the sea bottom has subsided or been uplifted—a statement in which we cannot concur.



[Photo by Israel C. Russell.]

FIG. 1.—Mud-plastered landscape, south end of Morne d'Orange.

Evidences of lightning strokes have been found in St. Pierre by Prof. Heilprin, but they are not numerous. The time at which the city was overwhelmed was at 7.50 a.m. (local time). At 7.53 and 7.55 magnetic disturbances commenced at Cheltenham, near Washington, and at Baldwin, in Kansas, and disturbances were also recorded in Paris and Hawaii.

In the *résumé* of the report Mr. Hill tells us that the fatal explosions were not from the old crater of Mont Pelée, which is 5 miles from St. Pierre, but from a lower vent about $2\frac{1}{2}$ miles distant, and it is therefore a Soufrière which has created destruction both in Martinique and in St. Vincent.

The report furnished by Prof. Israel C. Russell refers to both of these islands. It commences with a list of those who were fortunate in obtaining berths on board the *Dixie*, amongst whom was Mr. Borchgrevink, who conversed on "the desolate wilds of the Antarctic Con-

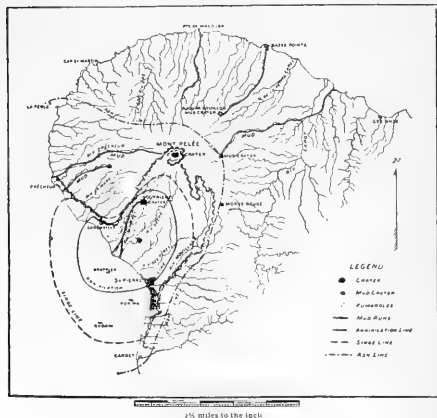

FIG. 2.—Map prepared by Mr. Robert T. Hill showing zones of devastation in Martinique.

inent," but whose report is held back for a future publication. Mr. Russell's photographs are excellent, and without these the instructiveness of his and other reports would have lost much in value. The material

ejected in Martinique was much finer than that thrown out in St. Vincent, where stones 5 and 6 inches in diameter fell at a distance of about 5 miles from their origin.

Mr. J. S. Diller describes the rocks of Mont Pelée as hypersthene and hornblende hypersthene andesites. The material forming the peak of Mont Carbet is a dacite or quartz andesite. The pumice from the recent eruption is hypersthene andesite. Eight chemical analyses show differences in ejectamenta from different eruptions and in the character of the materials which fell near and at a distance from the craters from which they originated.

The lavas from St. Vincent are also hypersthene andesites, but are peculiar in the fact that they contain olivine. In the ejecta from St. Vincent sulphur, which is absent in that from Mont Pelée, is a marked constituent. In a separate report Mr. W. F. Hillebrand points out other differences between the lavas and lapilli from these two islands which are sufficiently marked that the product of Pelée can be easily distinguished from that of La Soufrière. In referring to Dr. Pollard's analyses (see



[Photo by Israel C. Russell.]

FIG. 3.—A river of mud pouring from La Soufrière.

NATURE, vol. lxxvi, p. 130) indicating the presence of nickel and cobalt, Mr. Hillebrand remarks:—"Either we of the Survey have overlooked traces of nickel . . . or Dr. Pollard has counted as nickel something which was not that element."

Although we have here and there ventured a few critical remarks upon these reports, we cannot but regard them as a valuable contribution to vulcanology, and anticipate pleasure in the perusal of their continuation.

In the August number of the *Century Magazine* we have read with interest two articles on "The Last Days of St. Pierre," each of which is founded upon documentary evidences. The first of these is a letter written in the form of a journal by the Very Rev. G. Parel, vicar-general of Martinique, to his Bishop, and the second a series of extracts contained in *Les Colonies*, a daily paper published in St. Pierre. Although, as might be anticipated, a large portion of these documents refer to the attitude taken by the inhabitants of the stricken districts, and furnish details of local rather than of general interest, much may be extracted from them of scientific value.

Now we learn that Mont Pelée showed its cap of white vapours as early as April 25, and that excursionists who were attracted by the spectacle reported that the Etang Sec, "which has the shape of an immense basin inclined towards St. Pierre," was filling up with boiling water.

Prior to the eruption of 1852 this cirque was also filled

with water, but subsequently it dried up. Although sulphurous vapours escaped from its bed, which led to its being named La Soufrière, we read that it was more or less covered with vegetation.

On May 2, in addition to vapours, Pelée erupted ashes to cover Le Précheur. At 11.30 that night there were terrifying detonations, and "cinders" covered the country as far as Fort de France. These detonations, but varying in intensity, were continuous. With these sounds were mixed those of thunder, which followed the flashes of lightning in the dust cloud, the general rumbling in the crater, and the roar of many torrents. Thirty streams round Mont Pelée rose at once, and yet not a drop of rain had fallen on the coast. On May 5 the Rivière Blanche became a threatening and muddy torrent. Suddenly a column of vapour was seen to rise from the valley that expands below the crater of Mont Pelée, following which a "boiling water-spout" burst in the mountain, and this, laden with rocks and earth, buried the Guérin Sugar Works and rushed seawards, to founder two yachts, one of which was 150 metres off the shore, and to sink eight lighters.

Near the site of the factory this mud is at least 6 metres in depth. It appeared to Prof. Landes, who contributed to the last issue of *Les Colonies*, that the contents of the Étang Sec had broken their barrier and avalanche-like had rolled 700 metres downwards to the sea. The origin of this disaster, like that which on May 8 destroyed St. Pierre, is therefore to be found on the flanks of Pelée rather than at its crater.

Those who on April 27 visited the Étang Sec describe the same as a bowl 300 metres in diameter at the bottom and 800 metres at the top. The surface of the lake within this bowl was covered with black cinders, whilst the trees round the crater were covered with a "metallic black coating."

On the eastern side of the basin there was a cone 10 metres high and about 15 metres in diameter at its summit. From this new crater "smoke" rose in great puffs, water spouted from the borders of the basin and poured downwards to the lake, and there was a sound of boiling. The temperature of the water in the lake was that of the body, but where it entered it was probably very much higher. It deposited a fine slate-coloured powder, and contained sulphurous gas which blackened silver. Here and there green leaves could be seen in the lake, which the guides affirmed were on the upper branches of trees probably 20 metres in height.

The vicar-general says that about 4 a.m. on May 7 he saw on the flanks of Pelée two red craters, and these were visible for half an hour. On May 8, about 4 a.m., there was a violent thunderstorm, and torrents of rain fell in Fort de France.

At about 8 o'clock there was a hail of stones and hot cinders, and the sea retreated three times a distance of several hundred metres. Whilst this fiery tornado was obliterating St. Pierre, two atmospheric currents—one from the south-east and the other from the north—showered rain upon its flanks.

On May 1 *Les Colonies* told its readers that on April 29, between 3 and 5 p.m., there had been several shocks of earthquakes, but nothing is said about volcanic eruptions.

On May 2 it advertises an excursion to Mont Pelée, but it is not until after the eruption which took place the same night that any serious reference is made to the volcano. Next day (Saturday, May 3) *Les Colonies* is filled with details relating to a cinder rain that never ceases, the closing of houses, the difficulty of obtaining vegetables, the obliteration of roads, the muddy rivers, the dead birds and dying animals, and the flight on the steamers of the Compagnie Girard.

Great fear seems to have existed lest an earthquake should occur. The issues of May 6 and 7 continue the

gruesome story. In his last issue the editor inserts a note that Thursday, May 8, being the Feast of the Ascension, his offices would be closed, and the next number of *Les Colonies* would appear on Friday. But for St. Pierre Friday never came.

A second paper in the *Century Magazine* gives the narratives of two eye-witnesses of the eruption in St. Vincent. The first of these is from Captain Calder, chief of the police in that island. From his account it appears that La Soufrière showed signs of eruption on May 5. On May 6, at 8.30 p.m., Captain Calder left Kingstown by boat for Chateau Belair, and about midnight he saw the whole top of the mountain burst into "flame." This was followed by a heavy explosion.

At 2.30 a.m. (May 7) there were similar explosions, with but little "flame." About 10 a.m. there was a terrific explosion, and in the "smoke" cloud there was a little pale flame. At 1.30 p.m. this cloud had reached a height of at least two miles. Next he describes the flight of the population holding boards above their heads to prevent injury from falling stones, following which are detailed accounts of the varying phases of the volcanic activity and the destruction which it wrought.

The second personal narrative is from Mr. T. McGregor McDonald. From this it appears that at Chateau Belair the first notice of an eruption was at 2.40 p.m. on May 6. At first the Soufrière erupted columns of white vapour without explosions. At 7.30 p.m. the vapour was accompanied with flame, and explosions took place at intervals of about two hours.

On May 7, at 6 a.m., black "stuff" was erupted. About 7.45 columns of vapour rose to a height of 30,000 feet in one minute. From 11.10, when there were thunder and lightning, Mr. McDonald made entries in his notebook of what was occurring almost every five minutes. This he did until 2 p.m., when beneath a rain of stones he escaped to Walliabu, where the diary was recommenced and continued up to 9.30 p.m. on May 14.

J. MILNE.

A TEXT-BOOK OF MAMMALS.¹

FEW branches of zoological science have made greater advances during the last ten or a dozen years than has the study of mammals. Investigations with the microscope and the section-cutter have revolutionised our ideas as to the homology and succession of the dentition of the marsupials, while our conception of the relationship of that group to the monotremes on the one hand, and to the typical placentals on the other, has been totally altered by the discovery of a vestigial placenta in the bandicoots, and also by the apparent evidence of a connection with the creodonts afforded by certain extinct types from the South American Tertiaries. Then, again, the systematic part of the subject has been enriched by the discovery of a number of totally new and unexpected living generic types, such as *Notoryctes* and *Cænolestes* among the marsupials, *Zenkerella* and *Idiurus* among the scaly-tailed African squirrels, and *Ocapia* among the ungulates. Our conceptions of species and local races have undergone an equally profound change in the group under consideration, and the number of such new forms—some good and some bad—which have been added to our lists during the last few years is little short of astonishing. Moreover, trinomialism has been introduced into the science, and is largely adopted by a considerable number of eminent writers; and nomenclature itself has undergone a change which, while in many respects regrettable, could scarcely have been avoided, at least to a certain degree, if zoology is to maintain any

¹ "The Cambridge Natural History." Vol. x. Mammalia. By F. E. Beddard. Pp. xii+605. Illustrated. (London: Macmillan and Co., Ltd., 1902.) Price 17s. net.

semblance of consistency. Neither have the palæontologists been idle during the period referred to, the wonderful extinct mammalian fauna of Patagonia—inclusive of the ground-sloth, whose skin was recently found in a cave at Ultima Esperanza—having been to a large extent described during the last decade, while many interesting forms of extinct mammalian life have been made known from other parts of the world. If to the above be added the change of view with regard to the limits of zoological regions and the extent to which lands now widely sundered have been connected in past epochs of the world's history, there is little cause for wonder if the majority, or all, of the standard text-books dealing with mammals are more or less completely out of date.

Accordingly, it may be taken for granted that a trustworthy and up-to-date technical text-book on the study of mammals is a desideratum at the present time, and that the author has thus an unusually favourable opportunity before him. But this is not all that may be said in his favour, apart from the contents of the work itself. Mr. Beddard, from his official position at the Zoological Society's Gardens in the Regent's Park, has special, and probably unrivalled, opportunities of making himself acquainted with the anatomy of the soft parts of mammals—a subject too often neglected, or treated in insufficient detail in works of this nature. In addition to devoting a large amount of attention to the external glands of mammals, as well as to their internal anatomy in general, Mr. Beddard has made a special study of the mammalian brain, the results of which are incorporated in the volume before us. On this, if on no other, account his work must have an exceptionally high value for the students of mammals, as containing an enormous amount of information on this branch of the subject which can be obtained elsewhere only by laboriously searching through a long series of original memoirs.

A special feature of the volume is the large amount of space devoted to the consideration of extinct forms of mammalian life; and this is the more to the author's credit since, we believe, he is not himself a student of the palæontological aspect of the subject. He has, however, doubtless realised that the extinct forms afford the only key to the true relationship of their modern descendants; and he is to be congratulated that his work stands apart from all text-books on the same subject published in this country on account of the large amount of detailed information concerning extinct types. For one who is not himself a palæontologist, the author appears to have succeeded remarkably well in the treatment of this portion of the subject. He has, however, unfortunately quite failed to realise the nature of the dental succession in elephants and mastodons. Otherwise we should not have met with the statement on p. 220 that *Elephas planifrons* is the only member of its kind in which milk-molars are developed, and that in mastodons these teeth are more common; or the further and contradictory statement on p. 230 that these teeth occasionally persist throughout life. He should, of course, have known that milk-molars are always present, and that in one elephant and several mastodons they are succeeded by pre-molars.

As regards zoological regions, it is satisfactory to find that Mr. Beddard has adopted the view that the land surface of the globe is divisible, from this point of view, into three primary divisions, or realms, at least one of which is capable of being split up into regions. The division of the northern part of Arctogæa into a palæarctic and a nearctic region is, however, retained; and it is somewhat regrettable to find that the author is unable to convince himself of the necessity of a Sonoran region. Even greater matter for regret is his refusal to allow the rank of a region to Madagascar. Still, of course, the author has a perfect right to his own opinion,

and cannot be condemned for following the same. In the introductory chapters a noticeable feature is the large amount of space allotted to the consideration of the structure and development of the milk-glands of mammals, in the course of which the author takes occasion to refer to the remarkable circumstance that the egg-pouch of the monotremes does not appear to be homologous with the nursing-pouch of the marsupials. Hair-glands are likewise discussed at some length, some countenance being given by the author to Dr. Weber's theory that the ancestral mammals were scaly creatures.

Teeth, as might have been expected, receive a large share of attention in the same section of the work, their cusps being named on the American system based on "trituberculism." Speaking generally, the author's treatment of the difficult subject of dentition is decidedly good; we believe, however, that on p. 48 he has written fifty-four in place of forty-four as the normal maximum number of mammalian teeth, while he has omitted to mention that the replaced tooth in marsupials, which he identifies with the last premolar, has been regarded by at least one recent writer as corresponding with the



FIG. 1.—A Flying Fox (*Pteropus poliocephalus*). From Beddard's "Mammalia."

third of that series. Allusion is made to the mammalian resemblances of the dentition of the African *Anomodontia* (a group-name which, by the way, the author, on p. 48, credits to Huxley instead of Owen), but the question whether the one type is directly derived from the other is not discussed.

Passing from the introductory to the systematic portion of the work, we find Mr. Beddard differing from the majority of his predecessors in dividing the Mammalia into two, in place of three, primary groups—namely, the Prototheria, now represented only by the monotremes, and the Eutheria, including both marsupials and the true placentals. In view of the discovery of a vestigial placenta in marsupials, to which allusion has been already made, as well as from other considerations, we are inclined to think that the author is fully justified in the innovation, and hope to see the new departure followed by other writers. The absence of a corpus callosum in the brain of monotremes is regarded by the

author as important, in spite of the reduced size, or even absence, of that structure in marsupials.

The author's classification of the latter calls for no special comment, although attention may be directed to certain remarks on p. 128 as to the origin of the two chief groups, in which the view of the northern origin of the entire order is adopted without hesitation. As to whether diprotodonts came into existence as early as the Jurassic or the Cretaceous, Mr. Beddard maintains a cautious reserve, although we think he might have expressed a definite opinion on this point without undue risk. It is, perhaps, a pity, in the light of modern discoveries, that Owen's footless figure of the skeleton of Diprotodon is reproduced; and it rather puzzles us to reconcile the statement on p. 146, as to the close affinity of this creature to the kangaroos, with the assertion on the opposite page that its hind-foot could not be more unlike that of a kangaroo than it actually is.

But Mr. Beddard seems to take a delight in puzzling his readers by statements that to the average mind appear absolutely contradictory. For instance, on p. 160, after stating that the extinct Patagonian Prothylacynus and Amphiproverra "are not merely polyprotodonts, but definitely dasyures," in the very next paragraph it is suggested that they are not marsupials at all.

The Edentate order is taken to include the pangolins and aard-varks as well as the typical American forms, although it is stated that the aard-varks do not show marked signs of affinity with the pangolins. A strong point in favour of the author's system is that the pangolins are stated to possess a muscle found elsewhere only in the American edentates. Fossil forms are treated at some length, but it would have been better had the author reproduced one of the figures of Glyptodon published by the La Plata Museum instead of the cut of an imperfect example from one of Owen's works. The inclusion of the North American Eocene ganodonts among the edentates is, we believe, a feature which appears for the first time in an English text-book.

The chapter on ungulates commences with a well-written description of the foot-structure of the different groups, followed by an interesting discussion on horns and antlers. Mr. Beddard was fortunately able to introduce a brief account of the okapi, although he was, of course, unacquainted with the fact that the adults are horned. This being so, it is somewhat curious to find no mention of Dr. Andrews's description of ancestral Proboscidea from Egypt, which was published about the same time as the announcement of the discovery of the okapi. We have already had occasion to allude to the author's unfortunate error in regard to the nature of the dentition of fossil elephants, and we are obliged to say that the whole chapter on ungulates, especially as regards recent forms, is far from being as satisfactory as it ought to be. In pointing out certain deficiencies and errors in this and other parts of the work, it may be well to state that it would be scarcely worth while to allude to these, were we not impressed with the high value and importance of the work as a whole, which makes it the more to be regretted that such blemishes should occur.

As regards the Equidae and Tapiridae, we have little or no fault to find, but when treating of the rhinoceroses, the author should have been aware that the white species has been recorded from Central Africa, while the affinity to this species of the extinct so-called *Rhinoceros tichorhinus* should have been indicated. More severe criticism is called for with regard to the chapters on the deer and hollow-horned ruminants, which are everywhere "scrappy" and in many cases absolutely misleading. To include among the typical deer such a widely different animal as Père David's deer is at the present day little short of absurd. But, unfortunately, the author appears quite unable to recognise the essential difference between the "brow-tined" and the "forked"

types of antlers, otherwise we should not have, on p. 301, the absurd statement that the antlers of the extinct *Cervus* (properly *Anaglochis sedgwicki*) are "like those of a red deer exaggerated." It would be just as true to say that a leopard is coloured exactly like a tiger! The account of the species rightly included in the genus *Cervus* is, moreover, altogether inadequate, the reader not even being informed that the species incorrectly called *C. lueddorfi* is one of several Asiatic representatives of the wapiti. The treatment of the antelopes, although brief, is fairly satisfactory, but in describing the wild oxen the author states that the gaur and the gayal have a white rump-patch, whereas that feature is distinctive of the banting alone; and he aids in perpetuating the error that the British white park-cattle are the nearest relatives of the extinct wild ox of Europe.

The sheep and goats are very unsatisfactorily treated, both as regards description and illustration, some of the figures being those of immature animals, while the distribution and nomenclature are in several instances incorrect. As an example, it will suffice to mention that (on p. 324) one and the same sheep is stated, under the name of *Ovis nahura*, to be Tibetan, and, as *O. burriel*, Indian. Again, in the description of the goats, after stating that the horns are never spirally curved, Mr. Beddard writes that the markhor (the horns of which are spirally twisted) is confined to certain parts of Afghanistan!

Little need be said with regard to the treatment of the other mammalian orders, which follows to a great extent the usual lines, and is generally satisfactory. Details connected with the characters or distribution of species are, however, in several instances not altogether correct. For instance (p. 418), it is altogether misleading to write of the South American *Canis jubatus* as the red wolf of America; while *Enhydriodon* (p. 440)—of which, by the way, the name is misspelt—has nothing to do with the sea-otter. Again, the statement on p. 569, that the monkeys of the genus *Rhinopithecus* have "also a long, but more definitely upturned nose," seems to suggest that in certain instances the author has no practical acquaintance with the animals of which he is writing. Probably the recent transference of the Tibetan *Eluropus* from the bears to the raccoons was not published soon enough to allow of the animal finding a place among the latter in Mr. Beddard's volume.

To turn to another consideration, even careless readers will scarcely fail to notice that while the figure of the polecat (on p. 436) is lettered *Mustela putorius*, the animal is alluded to in the text as *Putorius foetidus*. Whether this is due to carelessness, or whether it is an instance of a remarkable hesitation displayed by the author as to which name to adopt for certain genera, it is not for us to say. Such hesitation is, however, very noticeable throughout the book, the author frequently using one name, although stating that an alternative title is the proper one. It is, indeed, very difficult to decide what has been his guide in this matter. Sometimes he follows modern ruling, as in the substitution of *Microtus* for *Arvicola*, while in other cases he retains discredited names, such as *Cariacus* for the American deer. In regard to the wide sense in which generic terms are for the most part used, we are in full accord with Mr. Beddard.

As the result of a somewhat lengthened perusal of his work, we are glad to be able to say that the author has succeeded in producing a volume which cannot fail to be of very high value to all students of the Mammalia, especially from the standpoints of morphology and palæontology. It has failings (many of which might have been remedied by the exercise of a little more care on the part of the author and his editors), but these occupy a very subordinate position in comparison to its merits; and, with this reservation, the work may be said to maintain the high standard of excellence of the series of which it forms a part.

R. L.

HYDROGRAPHICAL OBSERVATIONS ON THE
"PRINCESSE ALICE."

THE yacht *Princesse Alice*, with the Prince of Monaco on board, left Monaco on July 18 and arrived at Gibraltar on the evening of July 22, having been detained some hours by the pursuit of a school of *Orca gladiator* and the capture of one of them. The whale hunt took place within sight of the rock. Having coaled, the ship left Gibraltar on the evening of July 23, and shaped a course for the Azores. On July 24 an interesting sounding was made in lat. $36^{\circ} 6' N.$, long. $10^{\circ} 16' W.$ (Paris). The depth was 1473 metres, and the temperature of the bottom water was $9^{\circ} 4 C.$ As this thermometer was mounted so as to be overturned by the motion of a small screw propeller, its indication was not entitled to complete confidence; but when the dredge, coming from the same depth, brought a quantity of mud which had a temperature of about $8^{\circ} 75 C.$, it was evident that the conditions as regards temperature were very different from those which obtain in the open waters of the North Atlantic. At the above depth the temperature could not be expected to be above $4^{\circ} 5 C.$ It is evident that this sounding struck one of the main drains out of the abysmal regions of the Mediterranean, and furnishes evidence of the *brining down*, to use a stoker's expression, of the waters of that sea, of which a more particular description can be found in the article "Mediterranean" of the "Encyclopædia Britannica."

Unfortunately, no sample of the bottom water was procured, and confirmatory evidence of its salinity is lacking, but the excess of temperature is so great that we may use it with perfect confidence in estimating the composition of the water, considered as a mixture of the deep water of the Mediterranean with that of the neighbouring regions of the North Atlantic.

If we take the original temperature of the Mediterranean water in the mixture to be $13^{\circ} C.$ and that of the Atlantic water to be $4^{\circ} 5 C.$, it consists of 50 per cent. of Mediterranean and 50 per cent. of Atlantic water. This is a spot where, with adequate means, with the necessary skill and experience, and, above all, with sufficient patience, a very fine piece of oceanographical work can be done.

Continuing westwards, the ship's course passed close to the Gorringe or Getsyburg bank. As the former *Princesse Alice* spent July 25, 1894, on this bank, when enormous quantities of fish were taken with the line, the Prince decided to spend July 25, 1902, on the same spot. The fishing was about equally successful, but there was not the same surprise or novelty about the experience. The depth of water on the bank is very uneven and the surface of the bottom very rough. The following soundings, taken when searching for the shallowest part, are given in the order in which they were made: 192, 146, 200, 122, 83, 177 metres. In the evening the westward course was resumed, and it was shaped so as to pass over the position of the Josephine bank. This bank was discovered a short time before the *Challenger* sailed, and at the beginning of the cruise it was a question whether she should not make a station on it; but, on the one hand, it was felt that the ship had been fitted out for the investigation of deep and not of shoal waters, and on the other the bank did not lie in her route either from the Channel to Gibraltar or on that from Gibraltar to Madeira. Moreover, the interest which attaches to oceanic shoals and to their study was not, and could not be, at that time recognised.

On July 26 soundings were obtained, gradually shoaling to 1038 metres with hard bottom. This was taken to be on the eastern escarpment of the bank, and one of the Prince's latest *nasses* or traps, made of wicker-work, was sent down and buoyed, with lights. The ship was kept near during the night, and early in the morning the pro-

cess of heaving up was begun. It was continued with much patience, but the cable had evidently hooked on the rocky bottom, and it finally carried away. Had it been the *nasse* which had got fixed, it would have come away quite easily, because it would have been torn to pieces. The remainder of the day was spent in sounding over the bank, in so far as time permitted, and the results are rather remarkable.

In sharp contrast with the Gorringe bank, the depths on which are so uneven, the soundings made on the Josephine bank revealed a uniformity of depth which is astonishing. The superficial area of the bank is evidently very considerable, but in the time at disposal it was impossible even roughly to delineate it. An area of about three miles square was sounded over, and the depths are here given in the order in which they were obtained: 218, 230, 220, 219, 211, 216, 218, 215, 212, 215, 189, 190, 204, 208 metres. The descriptive value of these figures cannot be excelled. A successful, but in no way very remarkable, dredging was made in this water. In the evening the route was continued in the direction of Ponta Delgada, in the island of St. Michael. Soundings were obtained in 4275 and in 2589 metres, and the writer was enabled to attach to the sounding lines piezometers of two different and rather novel patterns, and thus to resume the experiments on compressibility at great pressures which he began on the *Challenger*. The instruments acted quite satisfactorily, and it is hoped that useful results will be obtained with them. On the morning of July 31, when only a few miles off the coast of St. Michael, the dredge was put over in 1189 metres, and a very rich haul was obtained.

Although no very definite or detailed programme exists, it is the Prince's intention to work among the islands for a week or two, then to make an excursion southwards to the very deep water which lies between this archipelago and the Canary Islands, and thence to work homewards so as to arrive at an European port by the middle of September. Up to the present date the weather has been everything that could be desired, and the bright, bracing climate of these islands is invigorating and refreshing.

J. Y. BUCHANAN.

Yacht *Princesse Alice*, August 1.

NOTES.

THE impressive rite of the coronation of King Edward was performed on Saturday last in circumstances of unequalled splendour. All who witnessed the spectacle must have been moved by feelings of loyalty and love for their Sovereign and country, and of pride in the history of the British race. Few men of science appear to have been invited to the function, though the nation owes so much to them. Scientific knowledge combined with medical skill has brought the King safely through a period of great danger and suffering, and given us all cause for thankfulness at our monarch's return to health. The modern science of electricity contributed as much as the mediæval pageantry to make the day memorable. But the ceremony belongs more to the past than to the future; it is the symbol of unity between the King and his people, and it shows the basis of liberty of thought and action which is our national heritage, and without which progress is impossible. The past has truly been glorious, but the future needs the development of new attributes of national character if we are to maintain our position among the peoples of the world. We trust that the reign of King Edward VII. will not only be long and happy, but that it will be characterised by the cultivation of the scientific spirit which will promote its prosperity.

A SPECIAL number of the *Atti* is devoted to the anniversary meeting of the Reale Accademia dei Lincei, held at Rome on June 1 under the patronage of the King and Queen of Italy.

Prof. Pasquale Villari has been recently elected president of the Academy. The report of the vice-president, Signor Blaserna, shows that in the past year the Academy has issued three volumes of *Proceedings*, containing 192 pages and notes, a volume containing memoirs relating to moral sciences, and notices of excavations, brought out under the auspices of the Minister of Public Instruction, and four parts, with 160 plates, of the "Codex Atlanticus" of Leonardo da Vinci. The Academy has taken part in the meetings of the International Association of Academies, and in work connected with the Royal Society's "International Catalogue of Scientific Literature." The observatory on Monte Rosa has been considerably enlarged, a fund for this purpose having been founded by Queen Margherita, whose name the edifice bears; it is now available for researches in meteorology, physics and physiology. A fresh field of study has been opened up in the island of Crete, and an expedition, presided over by Prof. Halbherr, has taken a prominent part in the excavations proceeding in that island.

OF the three royal prizes offered by the Reale Accademia dei Lincei for the year, that for physics has been awarded to Prof. Cantone, of Pavia, for his researches in the phenomena of elastic equilibrium outside the limits of Hooke's Law. Prof. Cantone has obtained phenomena in elasticity closely resembling the phenomena of magnetic hysteresis, which are appropriately described as "elastic hysteresis," and the laws of which account for a large number of observed facts. The prize for archaeology has been conferred on Prof. Gherardo Ghirardine, of Padua, whose work, while covering an extensive range, has been of especial interest in connection with the antiquities of the Veneti. The prize for history is unawarded. Under the Santoro foundation, an extraordinary prize has been awarded to Mr. Marconi, who, Signor Blaserna remarks, "is generally recognised as the first who had the fertile idea of making use of Hertzian waves, not for sending signals to a distance of a few metres, as had already been done by Righi, Lodge and other investigators, who deserve the credit for having first started in this direction, but for making them the basis of a system of telegraphy properly so-called." Of the two prizes offered by the Minister of Public Instruction, that for history has been divided, awards of 700 lire being made to Profs. Cogo (Genoa), Segre (Massa) and Sorbelli (Bologna), and premiums of 400 lire to Profs. Luiso (Lucca), Santini (Florence) and Strazulla (Messina). The Ministerial prize for mathematics has been divided into two prizes of 1300 lire, awarded to Profs. Giuseppe Bagnera (Messina) and Domenico de Francesco (Naples), and a premium of 700 lire has been assigned to Prof. Michele de Franchis (Melfi). The division of these prizes affords ample evidence of the activity of members of the Italian teaching profession in the matter of research. The proceedings of the meeting concluded with an address by Prof. G. Gloria on "The Position of the World in Modern Astronomy."

THE Advisory Committee appointed by the King in connection with the erection of a sanatorium for tuberculosis in England announces that 180 essays were sent in in competition for the three prizes. The Advisory Committee consists of Sir William Broadbent, Sir R. Douglas Powell, Sir Felix Semon, Sir Hermann Weber and Dr. Theodore Williams. The prizes have been awarded as follows:—First prize, value 500*l.*, Dr. Arthur Latham, with whom is associated as architect Mr. W. West (London). Second prize, value 200*l.*, Dr. F. J. Wethered, with whom are associated as architects Messrs. Law and Allen (London). Third prize, value 100*l.*, Dr. E. C. Morland, with whom is associated as architect Mr. G. Morland.

GILBERT WHITE'S house at Selborne is again for sale, and the suggestion is made by Mr. E. A. Martin, member of the council of the Selborne Society, that it should be purchased as

a permanent memorial of the father of British naturalists. The house, known as The Wakes, is situated in the main street of the village of Selborne, and is in much the same condition as it was in White's time.

THE British Pharmaceutical Conference is being held at Dundee as we go to press. The members were formally received by the Lord Provost of Dundee on Monday, and on Tuesday the opening meeting was held at the University College, when an address was delivered by the president.

REUTER'S AGENCY is informed that the Prince of Monaco has presented a quantity of deep-sea apparatus to Mr. W. S. Bruce for the Scottish Antarctic Expedition, including trawls, nets, water-bottles for obtaining samples of water from great depths for physical examination, thermometers and other similar apparatus.

THE annual meeting of the French Association for the Advancement of Science was held last week at Montauban, in the South of France, when an address on the development of wireless telegraphy was delivered by M. Carpentier, president of the Association. Electric traction was the chief subject of discussion at one of the general meetings. Since the last meeting the Association has received a legacy of two thousand francs from M. E. Lumy, and one of thirty thousand francs from M. Guilleminet.

THE following papers will be brought before the Section of Physiology at the Belfast meeting of the British Association:— "The Estimation of Small Quantities of Urea," Mr. Barcroft; "Nerve-Regeneration," Prof. W. D. Halliburton, F.R.S., and Dr. F. W. Mott, F.R.S.; "The Morphology of the Camel's Brain," Dr. W. Page May; "The Hydrolysis of Glycogen," Dr. W. A. Osborne and Mr. S. Zobel; "Some New Features in the Intimate Structure of the Human Cerebral Cortex," Dr. John Turner; (1) "The Paths of Conduction for Volitional Impulses," (2) "The Functions of the Pituitary Body," Prof. E. A. Schäfer, F.R.S.

THE committee entrusted by the Society of Arts to award the Shaw prize for industrial hygiene has awarded a gold medal, or a prize of 20*l.* to Mr. James Tonge, jun., of Westhoughton, Lancashire, or his hydraulic mining cartridge—an appliance for breaking down coal in mines without the use of explosives. The prize, under the conditions laid down by the testator (Mr. Benjamin Shaw), is given "For any discovery, invention, or newly-devised method for obviating or materially diminishing any risk to life, limb or health, incidental to any industrial occupation, and not previously capable of being so obviated or diminished by any known and practically available means."

ON August 5 a statue erected to the memory of Pasteur was unveiled at Dôle, the birthplace of the great chemist. The following account of the ceremony is given by the French correspondent of the *Chemist and Druggist*:—Nineteen years ago, on July 14, 1883, the Doloise municipality commemorated the fact by placing a marble slab on the modest house where he was born on December 27, 1822, in the Rue des Tanneurs, now called Rue Pasteur. For the inauguration of the statue the townspeople had made extensive preparations, and all the local notabilities, including the members of Parliament, were present. The Government was represented by M. Trouillot, Minister of Commerce, who made the distribution of medals and decorations that is customary here on such occasions. He afterwards proceeded to the ceremony of unveiling the monument, and made an interesting speech, in which he traced the life of Pasteur. The Minister referred to it as an incessant struggle against death and suffering, which ended in victory for the *savant*. He also spoke of the advantages suffering humanity

al over the world had derived from Pasteur's discoveries. Never has the saying "genius is patience" been so truly proved as in the case of his life. In concluding, M. Trouillot said: "Pasteur's native place shows itself worthy of his memory and faithful to his teachings when it affirms its faith in the definite triumph of the ideas of peace, unity and justice." The Dôle statue of Pasteur is by the well-known sculptor M. Carls, and was shown at the Paris Salon of the Artistes Français this spring. Mme. Pasteur and various members of her family attended the ceremony, and in the evening they were present at a banquet given in honour of the event.

A REUTER telegram from New York reports that a severe earthquake shock was felt at Skagway on Sunday last, August 10.

LLOYD'S agent at Havre states that the steamer *Homer*, on arrival at that port, reported that on July 20, in latitude $0^{\circ} 30'$ north, longitude $29^{\circ} 36'$ west, she spoke the German four-master *Christine*. Whilst speaking this vessel she felt a severe earthquake shock. The compasses all oscillated violently. This lasted about 40 seconds. The German vessel also signalled the same experience.

ON October 30, 1901, a strong earthquake felt in the neighbourhood of Lake Garda and especially at Salò gave an interesting record on the photographic tromometer at the Collegio della Quercia in Florence. From the two component traces Father Melzi has drawn a diagram representing the resultant movement of the ground during the first forty seconds. For twenty-one seconds the oscillations took place chiefly along a line directed E. $37^{\circ} 34'$ N. and W. $37^{\circ} 34'$ S. At the end of this time the direction suddenly changed, through very nearly a right angle, to N. $54^{\circ} 22'$ W. and S. $54^{\circ} 22'$ E. The cause of the change is unknown, but, from the long interval that elapsed, it was clearly unconnected with the arrival of transverse vibrations.

DR. HANS REUSCH, director of the Geological Survey of Norway, has sent us a letter received by him from Dr. W. J. Branch, of Basse-Terre, St. Kitts, one of the Leeward Islands, containing an account of the effects observed there during the recent volcanic eruptions in Martinique and St. Vincent. The volcano Mount Misery, the highest point of the island, exhibited a few indications of sympathy with Mont Pelée and the Soufrière, but no remarkable effects were noticed at the time of the eruptions of these volcanoes. A fortnight after the destruction of St. Pierre, however, a loud explosion was heard by labourers working on the side of Mount Misery; flames seemed to leap out of the ground, and a strong wind swept by, overturning two small houses. At the same time a heavy thunderstorm occurred, with vivid lightning flashes. Though the actions of Mont Pelée and the Soufrière are apparently in sympathy, Dr. Branch's idea is "that Mount Misery is more in league with the volcanoes of Guadeloupe, Montserrat, Dominica and St. Lucia. Their history in the past as well as in the present time seems to me to favour this idea."

IT has long been known that unhygienic conditions favour the occurrence of the disease known as beri-beri, and it has been surmised that it is dependent upon defective food. Major Rost, I.M.S., claims to have discovered a bacillus in fermenting rice and rice-liquor which he believes to be the specific organism of this disease. It produces in fowls many of the symptoms resembling beri-beri in man. Moreover, fowls feeding upon fermenting rice develop similar symptoms. The disease is therefore ascribed to the use of fermenting rice and especially rice-liquor, to which beverage the coolies, who are the main sufferers, are much addicted. Children never, and women rarely, drink the rice-water liquor, and hence the in-

frequency of the disease in these subjects. Interesting as Major Rost's observations are, they do not throw much light on the remarkable outbreak of disease, believed to be beri-beri, at the Richmond Asylum, Dublin, some years ago, the cause of which has never been explained. (See *Ind. Med. Gazette*, July 1901 and 1902).

AIDS to practical navigation, however small they may be, should always be welcome. In the "single-handed dividers" patented by Mr. F. Howard Collins and sold by Mr. J. D. Potter, an improvement has been made on the dividers ordinarily in use for measuring distances on a chart. These new dividers are provided with two finger-holes, into which the thumb and forefinger can be inserted in a manner similar to that of using an ordinary pair of scissors, thus enabling the navigator to open and close them readily with one hand and giving a greater command over the instrument. The joint, which is made a round ball, is also of a very good form for handling. This instrument is strongly made in German silver and is suitable for the ordinary service of a sea-going vessel.

PROF. G. HELLMANN has published the fourteenth volume of his remarkable reproductions of notable old papers and charts relating to meteorology and terrestrial magnetism. The present work deals with meteorological optics during the years 1000 to 1836, and is, as usual, accompanied by valuable bibliographical notes, the result of laborious researches which we think we may safely say have never been excelled and are possibly unequalled. Meteorological optics may be said to be a somewhat neglected branch of the science, and this renders the investigation the more welcome. The work contains four important papers on the rainbow and allied phenomena, including the classical treatise of the late Sir G. B. Airy "On the Intensity of Light in the Neighbourhood of a Caustic," three papers on halo phenomena, with others on mirage, twilight, &c. For readers wishing to study the early history of the subject, the author gives references to the works of Kämtz, Clausius and the recent important contributions of Dr. Pernter. As one instance of Prof. Hellmann's persistent researches, we may refer to the first of the papers now described, "De Radialibus impressionibus" (1311), by Theodorich, a remarkable work on atmospheric phenomena, which was supposed to have been buried for 500 years and lost to science until it was published by Venturi, at Basle, in 1814; but Dr. Hellmann discovered that Theodorich's theory was taught at the Erfurt University up to the beginning of the sixteenth century. At the present time only two copies of the original manuscript are known to exist, one at Basle and the other at Leipzig (the latter being not quite perfect).

THE Imperial Department of Agriculture for the West Indies has just issued the following reports:—On the Botanic Station, Dominica, for the twenty months to the close of November, 1900; and on the Agricultural School, for the year 1901. On the Experiment Stations at Montserrat, for the fourteen months to the close of March, 1901; and on the Botanic Station, Agricultural School and Land Settlement Scheme, St. Vincent, for the year 1901. The reports are generally of a favourable character, and show that much useful work was accomplished in the distribution of plants and seeds, in experimenting with new plants, &c., which may be introduced for profitable cultivation, and so on. Details are given of the courses of practical instruction in the agricultural schools. The 1900 season in Dominica was a dry one, the rainfall of 57.75 inches being 23.95 inches less than the average. In St. Vincent, 1901 was fairly wet, the rainfall of 125.69 inches being 12.43 inches above the average. It would considerably enhance the value of these West Indian reports if the Imperial Commissioner could arrange for each series issued to cover the same period throughout

the islands, instead of, as indicated above, each island adopting its own and often very irregular period.

THE question of the existence of a portrait of Gilbert White is discussed by Mr. R. Holt-White in a letter to the August number of *Nature Notes*, with the result that there is no good reason to believe that any such picture is known.

WE have received from Prof. H. F. Osborn a budget of papers on vertebrate paleontology and kindred subjects, two of which, "The Law of Adaptive Radiation" and "Homoplasy as a Law of Latent Homology," were mentioned in this Journal as they appeared in the *American Naturalist*. Special interest attaches to a communication on the Eocene Primates and rodents of North America (*Bull. Amer. Mus.*, vol. xvi. art. 17), in which it is stated that presumed representatives of the former group from the basal Puerco Eocene bear no sort of ancestral relationship to the undoubted Primates of the overlying Wasatch beds. Whether the latter forms are anthropoids or lemuroids, or whether they include members of both groups, or, finally, whether they constitute a primitive group by themselves, is left undecided. Three American families are recognised, the first of which (*Ilyopsodontidae*) is believed to be nearly related to the Hampshire *Microcherus*. Of even greater importance, if well founded, is the author's recognition of a group of primitive rodents in the Bridger and Wasatch Eocene, for which the name "Proglirines" is suggested. These forms had canines and rooted incisors, and their lower jaws lacked the backward-and-forward motion characteristic of their supposed descendants. They are typified by Cope's genus *Mixodectes*.

IN the autumn of 1900 a gardener of Hundsheim, in German Altenburg, Lower Austria, brought to the high school at Vienna part of the lower jaw and an upper cheek-tooth of a rhinoceros which he said had been found in the vineyard where he worked, in association with other remains, not improbably including the entire skeleton. Recognising from the structure of the teeth that the remains did not belong to the ordinary woolly rhinoceros, Prof. F. Toulou, to whom they were submitted, proceeded to Hundsheim, and was fortunate enough to disinter the almost complete skeleton of the animal, which has now been mounted. Unfortunately, the terminal third of the skull is missing, but sufficient remains to show that the animal was a two-horned species belonging to the same group as the living Sumatran rhinoceros. In a preliminary notice Prof. Toulou proposed the name *Rhinoceros (Ceratorhinus) sumatrensis* for the new species, and in a recent issue (vol. xix. pt. 1) of the *Abhandlungen* of the Austrian Geological Survey he describes the skeleton in detail, figuring the various bones in no less than twelve plates. The breccia at Hundsheim in which the skeleton was found is of Pleistocene age, and is notable for containing the remains of a goat allied to the tahr (*Hemitragus*). Rhinoceroses of the *R. sumatrensis* group were previously unknown from the European Pleistocene.

A BRIEF report on the disintegration of building stones in Egypt, by Mr. A. Lucas, has been issued by the Survey Department, Public Works Ministry, Cairo (1902). The decay of the building stones, which consist of limestone and sometimes of calcareous sandstone, appears mainly at or near the surface of the ground, and is often accompanied by an incrustation or efflorescence of sodium chloride. The cause of the disintegration is the entry into the stone of moisture and soluble salts, chiefly from the soil, which is always in a more or less saturated state.

THE coal, lignite and asphalt rocks of Texas are dealt with in a *Bulletin* published by the University of Texas (1902), the Mineral Survey being under the direction of Mr. W. B. Phillips. The Eocene lignites, the Cretaceous and Carboniferous coals are

described, mainly from an economic point of view. The lignite industry has felt the competition of fuel oil more keenly than that of the bituminous coal, but as there is a marked tendency to increase the price of oil, there is hope for the lignite miners. The asphalt rocks comprise sandstones, alternating sands and clays, and limestones impregnated with bitumen, and they occur in the Cretaceous formation sometimes where it impinges upon the Carboniferous, and also in the Tertiary strata.

WITH a view to stimulate planters in New South Wales to undertake the cultivation of the cork oak, the director of the Sydney Botanic Gardens has issued a pamphlet in which are embodied notes on the economic value, suitable soil and position for growing, and other details of management of this tree.

IN the recently published "die Organographie der Pflanzen," want of space prevented Prof. Goebel from treating at any length the question of "regeneration in plants." A series of articles on this subject is now appearing in the *Biologisches Centralblatt*. The discussion is limited to regeneration in so far as it relates to the development of new parts or latent rudiments, and illustrations are taken from the ferns *Anemia rotundifolia*, *Asplenium obtusifolium*, from the genus *Bryophyllum* of the Crassulaceae, and from *Nymphaea stellata*, var. *bulbillifera*. In the case of the ferns, it will be noticed that the tendency is to push the formation of buds towards the apex, while in *Bryophyllum* the cutting off of supplies from the apex stimulates the growth of lateral buds. *Cyclamen persicum* affords an instance of the formation of new members induced by the stimulus caused by mutilation. If in the young seedling the stem apex is cut off just at the junction with the single cotyledon, one or more leaves are developed in various positions, perhaps more generally from the base of the petiole.

A POPULAR paper on thunderstorms and lightning discharges, by Mr. A. H. Bell, and one on minute marvels of nature, by Mr. J. G. Ward, illustrated by photo-micrographs, appear in the August number of *Good Words*. The latter article contains several good reproductions of photographs showing internal structures of leaves.

THE Royal Agricultural Society of England has issued a sixpenny pamphlet, written by the Society's zoologist, Mr. Cecil Warburton, with the title "Orchard and Bush-Fruit Pests and how to combat them." After giving the ingredients and the methods of preparation of a few of the most useful and readily mixed insecticides, the pamphlet describes a number of commonly occurring insects affecting the leaves, blossoms, fruits or wood of orchard trees, with the best methods of preventing their attacks, of checking their depredations, or of destroying them altogether, where possible. The same kind of information is given with regard to various insects infesting currants, gooseberries and raspberries. The pamphlet is illustrated with twelve original wood cuts and is published for the Society by Mr. Murray.

A LECTURE on "The Relation of Science to Art: in reference to Taste and Beauty," delivered before the Hampstead Scientific Society by Sir Samuel Wilks, Bart., F.R.S., on May 12, has been published by the Society. The scientific attitude of mind is so often considered to be opposed to artistic feeling that this analysis of the relationships between the two temperaments is of wide interest. The artist admires the form, and the man of science seeks to discover the cause which produces it. The two-fold characters of an object are closely associated and dependent on one another, but few individuals are able to appreciate them both fully. A large part of Sir Samuel Wilks's address is devoted to the consideration as to "whether beauty depends in any way upon fitness or utility, or whether the feeling is not an inherent faculty of the mind"; and the general conclusion arrived at is

in favour of the former view. As regards people who are able to contemplate with admiration the world around them, the belief is expressed that "much of their appreciation of beauty or aversion to the ugly is obtained from the necessary physical laws governing all objects, although they themselves may be unconscious of the fact."

The additions to the Zoological Society's Gardens during the past week include a Bonnet Monkey (*Macacus sinicus*) from India, presented by Mr. H. G. B. Whitehead; a Lesser White-nosed Monkey (*Ceropithecus fetaurista*) from West Africa, presented by Mr. J. Hoatson; two Chinchillas (*Chinchilla lanigera*) from Chili, presented by Captain B. Dixon, R.A.; two Kinkajous (*Crotophaga caudivolutus*), two Cooi Herons (*Ardea cooi*), four American Jabirus (*Mycteria americana*), an Anaconda (*Eunectes murinus*) from Brazil, presented by Dr. E. A. Goeldi; a Common Squirrel (*Sciurus vulgaris*) British, presented by Miss Rice; two Graceful Ground Doves (*Geopelia cuneata*) from Australia, presented by Mrs. C. A. Thompson; a White Stork (*Ciconia alba*) European, presented by Mrs. A. Gregory; a Bennett's Tree Kangaroo (*Dendrolagus bennettianus*) from Queensland, presented by Mr. Winkley Smith; a Cooi Heron (*Ardea cooi*) from Brazil, presented by Mr. W. A. Churchill, H.B.M. Consul, Pará; two Coquerel's Mouse Lemurs (*Chirogaleus coquereli*) from Madagascar, two Red-masked Conures (*Conurus rubrolarvatus*) from Ecuador, a Blue-winged Siva (*Siva cyanoptera*) from India, deposited; two Graceful Ground Doves (*Geopelia cuneata*) bred in the Gardens.

OUR ASTRONOMICAL COLUMN.

ROTATION PERIODS OF THE SUPERIOR PLANETS.—In the *Comptes rendus* of the Paris Academy of Sciences for July 28, M. Deslandres gives the results of his experiments in determining the rotation of superior planets by means of the spectroscopic method based on the Fizeau-Doppler principle.

The method, which was described in detail in *Comptes rendus*, vol. cxx. p. 417, depends upon the differential displacement of the opposite ends of the equatorial diameter, which causes this diameter to appear inclined to its normal direction, and thereby gives, instead of a circular image of the planet in the spectrum, an inclined ellipse, the axis of which is inclined more or less depending upon the speed of the planet's rotation; the relative direction of the major axis of the ellipse depends upon the direction of the planet's rotation.

M. Deslandres uses a spectroscope of moderate dispersion and a wide slit, and emphasises the fact that the entire light of the planet may thus be used, and still very useful, though less accurate, results may be obtained. He points out that one advantage of this method is that the apparent displacement is double the real displacement due to the rotary motion, for, of course, both ends of the diameter are equally displaced, therefore a high degree of accuracy may be obtained. Experimenting on the rotation of Jupiter, two forms of instrument were used, first a small spectroscope with a wide slit and then a 30° prism mounted in front of the object-glass of a telescope of om. 55 aperture. In each case three exposures were made, the first with the slit, or the edge of the prism, parallel to the equator of Jupiter, and the second and third after having turned the complete apparatus through 90° and 180° respectively; thus the displacement of the equatorial extremities was made evident on both sides of their normal position, thereby giving greater accuracy to the measurements, and in the case of Jupiter indicating for the linear equatorial velocity of 12 km. an equatorial velocity, according to the displacement, of 48 km. The results obtained show very good accordance, and M. Deslandres claims a greater degree of accuracy for this method than is obtainable by the ordinary method. During this year the method has been applied to the determination of the rotation of Uranus, and it has already been shown that the planet rotates in a retrograde direction, but the detailed results will be given in a later communication.

THE DUTCH ECLIPSE EXPEDITION OF 1901.—In a preliminary report published by the Eclipse Committee of the Royal Academy of Sciences, Amsterdam, Profs. Julius, Wilter-

dink and Nijland give an account of the proceedings of the expedition which was sent out to Sumatra, by the Dutch Academy, to observe the total solar eclipse of May, 1901.

Elaborate preparations were made. Government help in the matters of transport and manual labour was obtained, and a number of officers and men belonging to the Dutch ironclad *Sumatra* was told off to assist in making the observations.

The programme of the expedition was divided into four parts: (1) the coronagraphs, (2) the spectrographs, (3) the physical observations, and (4) the collection of amateur observations, and the results of the observations made in each section are treated separately in the report.

The coronagraph negatives were mostly spoiled by cloud-fog, only those obtained by short exposures and on slow plates giving good results. Using the 40-foot coronagraph, kindly lent by the U.S. Naval Observatory, and a "Lumiere jaune" plate measuring 24 × 30 inches, some very fine prominences and details of the inner corona were obtained on the negative.

Of the five spectrographs used, only one gave results which are of any use, and in the negatives obtained Prof. Julius makes a special point of the doubling of all the chromospheric crescents, which he assigns to the phenomenon of anomalous dispersion of the chromospheric light, afterwards pointing out the improbability of the doubling being of instrumental origin.

In the physical observations the clouds interfered seriously, so that little weight may be attached to the heat-radiation observations, but in the observations of the polarisation of the coronal light it is shown that the light at some distance from the sun's limb is more strongly polarised than that which is near to that limb, whilst the polarisation decreases again as the distance from the limb is increased.

The results of the amateur observations are various; 39 drawings and 69 photographs of the corona have been secured, and 37 of the latter are described as "good," "very good," or "excellent." Reports on the observations of the shadow-bands were received from seventeen stations.

THE SATELLITES OF SATURN AND URANUS.—Dr. J. J. See gives the results of his observations of the satellites of Saturn and Uranus, made with the 26 inch refractor of the U.S. Naval Observatory, Washington, in No. 3806 of the *Astronomische Nachrichten*.

The "Clark Micrometer II.," with magnifying powers of 388 for the satellites of Saturn and 606 for those of Uranus, was used, and the observations are based on the method of relative measures adopted by Prof. H. Struve at Pulkowa. The micrometer is so constructed that in measuring the position of *Japetus* it can be directly referred to Titan by means of a sliding eyepiece, thus probably giving more correct results than by the usual method.

Dr. See points out that the statement in his paper on the satellites of Uranus, *A.N.* 3676, that the places given in the American ephemeris are 37" in advance of the observed places, is an error due to the ambiguous wording of the ephemeris.

AUSTRALIAN CHILDREN'S GAMES.¹

A certain amount of attention has been paid of late years to the subject of the games of primitive peoples, but so far we are only in the preliminary stage of the inquiry; indeed, a vast deal more evidence must be collected before sound generalisations can be made. A few suggestions have been thrown out by various students which must be regarded more as trial hypotheses than as definite conclusions, indeed they should be looked upon rather as "kites."

So few travellers think it worth their while to mention games and toys, especially those played by children, that the record for any country is imperfect, and for most peoples there is no information to hand. When there is any information it is nearly always simply a bare enumeration of the games played or of the toys employed; very rarely is a description given of the method of playing.

We are slowly learning the lesson that many of those activities which appear to be merely trivial have, or have had, an important significance in the evolution of human culture. The physiological, psychological and sociological aspects of playing have been dealt with by Karl Groos in his book "The Play of

¹ North Queensland Ethnography: Bulletin No. 4, March, 1902, "Games, Sports and Amusements." By Walter E. Roth, Home Secretary's Department, Brisbane, C.A. 8-1902.

Man," but it is not yet possible to map the distribution of most of the toys and games, to trace their origin, or to indicate the meaning that in many cases was primitively attached to their exercise.

Thanks to the investigations of Messrs. A. MacFarland Davis, F. Cushing, Stewart Culin, G. A. Dorsey and others, we have some indication concerning the variations, distribution and significance of the principal games of the North American Indians. Some hundred or so of these games are known, which can, however, be reduced to six main groups. These are derived from the employment of the shield and spear, marked arrows, shields on which were painted the four world quarters, and balls. Some of these games may have been originally merely games of skill, others were divinatory, while others, again, were doubtless magical.

In that vague region known as the Far East, the fragmentary evidence points to similar conclusions as the researches, amongst others, of Messrs. Stewart Culin, G. von Schlegel, R. Andree and E. B. Tylor. The same, too, appears to hold good for Oceania.

These general remarks will show how important it is that further evidence should be collected, and will indicate the welcome that will be given to the last of Dr. Walter E. Roth's studies in the ethnography of North Queensland. The following is Dr. Roth's classification of games, sports and amusements:—(1) Imaginative games, such as tales, of which nine are given. (2) Realistic games, playing with pets, playing with plants, making smoke spirals, bathing, &c. (3) Imitative games, objects and phenomena of nature imitated by attitudes, movements and paintings; the author figures seventy-four

a duck flying (Fig. 1), is similar to a string figure in Torres Straits which is called "throwing the fish spear," but this is a very simple figure to make. In this category are placed all those games in which children imitate their elders. Several round games are described in which "collecting honey,"



FIG. 2.

"catching cockatoos" and similar operations are represented; one of them, "playing bean tree" (Fig. 2), resembles a game I have described as played by Papuan children ("Head-Hunters, Black, White and Brown," 1901, chap. xv.). There are other analogies between the games of the aborigines of North Queensland and those of the Papuans. (4) Discriminative games, hide and seek and a guessing game. (5) Disputative games, wrestling, tug-of-war. (6) Propulsive games, ball games, tops, stick-throwing games, &c.; amongst the latter are certain methods of casting petioles of grass blades similar in principle to what is done by certain Papuan children. Of special interest is the hurling of a toy spear by means of a knotted string; a similar device was used by the men of the Southern New Hebrides, New Caledonia and the Loyalty Islands, and the present writer has recorded it as a child's plaything at Delena, Hall Sound, British New Guinea, and now it has turned up amongst the coastal blacks of North Queensland. (7) Exultative games, songs, dances, music. This little memoir, which is illustrated by thirty-nine plates, is full of valuable information, as it opens up a new field to the student.

A. C. H.

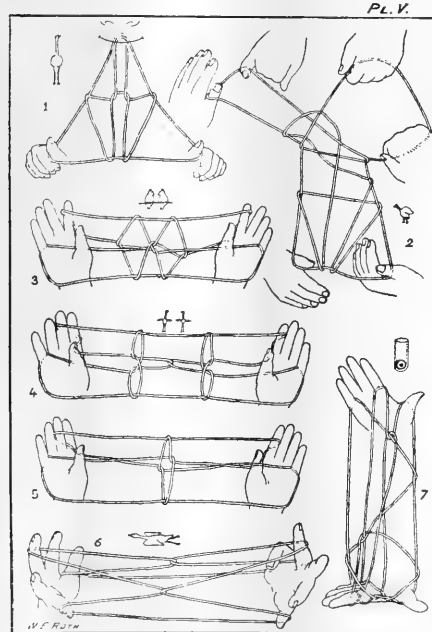

FIG. 1.

examples of those ingenious string figures in which so many primitive peoples excel. Very few illustrations of "cat's cradles" have ever been published, so that we cannot at present say how far particular devices are common to different peoples. One at all events (Plate v., Fig. 6), which represents

UNIVERSITY AND EDUCATIONAL INTELLIGENCE.

SIR GEORGE G. STOKES, Bart., F.R.S., senior fellow and president of Pembroke College, Cambridge, has been elected master of the College, in succession to the late Dr. Searle.

DR. W. PALMER WYNNE, F.R.S., assistant professor of chemistry in the Royal College of Science, South Kensington, has been appointed to the chair of chemistry in the School of Pharmacy of the Pharmaceutical Society of Great Britain in succession to Dr. J. Norman Collie, F.R.S., who was recently appointed to the chair of organic chemistry in University College, London.

THE council of University College, Liverpool, has unanimously agreed to invite Dr. Benjamin Moore to accept the chair of biochemistry recently founded in University College by Mr. William Johnston. Dr. Moore is now lecturer on physiology in the Charing Cross Medical School, and has made himself widely known among men of science as a successful teacher and an original investigator.

MR. J. QUICK has been appointed principal of the Technical Institute, Limerick.

AFTER a discussion extending over several sittings, the seventh clause of the Education Bill has passed Committee of the House of Commons in an amended form. The clause refers to the management of elementary schools, and it raised the

question as to the proportion of popularly elected managers which should act as bodies controlling the work of voluntary and denominational schools. The clause as amended provides that the management board of every public elementary school not provided by the local educational authority shall consist of four foundation or trust managers and two managers appointed by elected bodies. This principle has been accepted as part of the Bill. The discussion of the whole question of the machinery by which the managers of voluntary schools are to be elected has been postponed until the autumn session.

THE Ministerial changes consequent upon the resignation of Lord Salisbury, and the appointment of Mr. Balfour as Premier, involve a reconstitution of the representatives of the Board of Education in Parliament. Sir John Gorst, who has been Vice-President of the Committee of Council for Education since 1895, has resigned, and his office becomes extinct. The Duke of Devonshire remains Lord President of the Council, but ceases to preside over the Education Department. The newly constituted Board of Education has for its President the Marquis of Londonderry, who was chairman of the London School Board some years ago, and as Parliamentary Secretary Sir William Anson, member for the University of Oxford and a leading authority upon educational matters. The Duke of Devonshire will therefore no longer be directly concerned with departmental work in education, though he will have charge of the Education Bill when it reaches the House of Lords.

THERE is a feminine and a masculine type of mind. The former depends chiefly on memory and being reproductive; the other relies upon reasoning and being creative. The mind of the man of science is masculine, that of the clergyman is feminine. Not every woman possesses a feminine mind, though many men have little else. The whole of our education from top to bottom is essentially feminine, chiefly because in its origin and continuance it is clerical. Such are but a few of the opinions expressed by Mr. James Swinburne in an article on "Feminine Mind Worship" in the current number of the *Westminster Review*. The whole article is a powerful appeal for a fuller recognition of the value in education of a rational training in the methods of science, so that boys may obtain at school such a practical acquaintance with experimental physics and chemistry as will lead them to develop their reasoning faculties and endow them with those powers of initiative which are essential, since the whole welfare and existence of a commercial country like ours depends on the application of science and the work of the despised masculine mind. Mr. Swinburne's essay deserves to be widely read.

SCIENTIFIC SERIALS.

Bulletin of the American Mathematical Society (2) viii. No. 9, June.—T. J. I'An. Bromwich, on the infinitesimal generators of parameter groups. The author gives a simplified method of calculating the generators of a group of known structure, and compares his results with those of Slocum (*Bulletin* for January).—E. V. Huntington, a second definition of a group. The definition is reduced to four independent postulates, to which a fifth must be added if a distinction is to be made between finite and infinite groups.—G. A. Miller, determination of all the groups of order p^m , p being any prime, which contain the Abelian group of order p^{m-1} and of type $(1, 1, \dots)$.—L. E. Dickson, a class of simply transitive linear groups.—D. N. Lehmer, errors in Legendre's tables of linear divisors.—Reviews of Gray's "Treatise on Physics," vol. i., Cellérier's "Cours de Mécanique" (E. B. Wilson), and Kiepert's "Grundriss der Differential- und Integral-Rechnung" (E. W. Davis).

Annals of Mathematics (2) iii. No. 4, July.—H. S. White, note on a twisted curve connected with an involution of pairs of points in a plane.—R. E. Allardice, on some curves connected with a system of similar conics.—J. Westlund, note on multiply perfect numbers.—W. R. Ransom, a mechanical construction of confocal conics.—P. F. Smith, on Sophus Lie's representation of imaginaries in plane geometry. This is an interesting commentary on Lie's first paper, published in the *Transactions* of the Academy of Christiania in 1869.—G. A. Miller, note on the group of isomorphism of a group of order p^m .—L. D. Ames, evaluation of slowly convergent series.

SOCIETIES AND ACADEMIES.

LONDON.

Royal Society, June 19.—"On the Measurement of Temperature." Part i.—On the Pressure Coefficients of Hydrogen and Helium at Constant Volume and at different Initial Pressures. Part ii.—On the Vapour Pressures of Liquid Oxygen at Temperatures below its Boiling Point on the Constant Volume Hydrogen and Helium Scales. Part iii.—On the Vapour Pressures of Liquid Hydrogen at Temperatures below its Boiling Point on the Constant Volume Hydrogen and Helium Scales. By Morris W. Travers, D.Sc., Fellow of University College, London, George Senter, B.Sc., and Adrien Jaquerod, D.Sc. Communicated by Prof. William Ramsay, F.R.S.

Part i. (M. W. T. and A. J.).—The pressure coefficients were determined by measuring the pressure which the gases exerted when the bulb of the constant-volume thermometer was surrounded with melting ice, or with steam at the boiling point. The apparatus employed cannot be described in this abstract; it was completely constructed of soda-glass, and as all junctions were sealed in the blowpipe, flame, leakage of the gas was impossible. By enclosing the manometer column and dead space between parallel glass plates in a water jacket, it was possible to measure the temperature of these parts of the apparatus to ± 0.02 C. and thus eliminate errors which might seriously affect the results.

The pressure coefficient at an initial pressure of 700 millimetres in the case of either gas appears to have the value 0.00366255, which does not differ appreciably from that obtained by Chappuis for hydrogen at an initial pressure of 1000 millimetres of mercury. At a pressure of 520 millimetres no appreciable decrease in the value of the coefficient could be detected. As has hitherto been assumed, the pressure coefficient for hydrogen, and also for helium, appears to be independent of the pressure, so far as thermometric observations are concerned.

Part ii. (M. W. T., G. S. and A. J.).—Previous investigators have measured the boiling point and vapour pressures of liquid oxygen by immersing the thermometer in a mass of the liquid and measuring the pressure under which it was evaporating. This method is unsatisfactory on account of the difficulty of obtaining pure oxygen in sufficient quantity, and of the tendency of the liquid to become superheated.

In the experiments described in this paper, a bulb in which a small quantity of pure oxygen could be liquefied was immersed, together with the bulb of the thermometer, in a vacuum vessel containing liquid air or oxygen, through which a rapid current of air was passed. The bulb containing the pure oxygen communicated with the lower chamber of a barometer, so that measurements of the vapour pressures were quite independent of the atmospheric pressure.

Four thermometers were employed in these experiments, the capacities of the bulbs being approximately 90 c.c., 12 c.c., 26 c.c. and 27 c.c. The large thermometer was employed in one series of measurements only, as it was found to be difficult to maintain so large a bulb at a constant and definite temperature without employing very large quantities of liquid air. The temperatures obtained by means of the three smaller thermometers rarely differed by more than ± 0.3 from the temperature, corresponding to the same pressure, taken from the smoothed vapour-pressure curve. The pressure on the gas at the ice point was in every case about 1000 mm. of mercury.

The thermometers were so constructed that the pressure on the gas could be measured independently of the atmospheric pressure. The temperature of the dead space was determined by means of a mercury thermometer, and the temperature of the vertical portion of the stem above the thermometer bulb was measured by means of an auxiliary gas thermometer, of similar construction, with a narrow cylindrical bulb of the same length as the stem. The coefficient of expansion of the glass was found to be 0.0000284; between 0° and 100° C., and 0.0000218 between 0° and -190° C.

Pressure in millimetres.	Vapour Pressures of Liquid Oxygen.	
	Temperature on hydrogen scale.	Temperature on helium scale.
800	90.60	90.70
760	90.10	90.20
700	89.33	89.43
600	87.91	88.01
500	86.29	86.39
400	84.39	84.49
300	82.09	82.19
200	79.07	79.17

Part iii. (M. W. T. and A. J.).—The three small thermometers used to measure the vapour pressures of liquid oxygen were also employed in the case of liquid hydrogen. The small bulb, which in the previous experiments had contained pure oxygen, now contained pure hydrogen. The agreement between the results obtained with different thermometers is indicated in the following table:—

I.—Hydrogen Scale.

Thermometer.	Vapour pressure of liquid hydrogen.		Temperature.	
	mm.	Found.	From curve.	
A (12 c.c.)	757.2	20.17	20.21	
B (26 c.c.)	766.6	20.28	20.25	

II.—Helium Scale.

Thermometer.	Vapour pressure of liquid hydrogen.		Temperature.	
	mm.	Found.	From curve.	
A (12 c.c.)	765.0	20.42	20.44	
B (26 c.c.)	759.2	20.41	20.41	
C (27 c.c.)	770.0	20.43	20.46	
	749.0	20.36	20.36	

The vapour pressures were measured between the boiling and melting points. The results are as follows:—

Vapour Pressures of Liquid Hydrogen.

Pressure in millimetres.	Temperature on the hydrogen scale.		Temperature on the helium scale.	
	Found.	From curve.	Found.	From curve.
800	20.41	20.60	20.60	20.60
760	20.22	20.41	20.41	20.41
700	19.93	20.12	20.12	20.12
600	19.41	19.61	19.61	19.61
500	18.82	19.03	19.03	19.03
400	18.15	18.35	18.35	18.35
300	17.30	17.57	17.57	17.57
200	16.37	16.57	16.57	16.57
100	14.93	15.13	15.13	15.13
50	—	14.11	14.11	14.11

Though the pressure coefficients of hydrogen and helium between 0° and 100° C. show no appreciable difference, measurements of low temperatures on the scales of the two thermometers are not identical. It is probable that at the normal temperature both gases may be considered as so nearly perfect that the difference between the gas scale and the absolute scale is insignificant. As the critical point of helium lies much lower than that of hydrogen, measurements of low temperatures on the helium scale should approach more closely to absolute temperatures than measurements on the hydrogen scale. It is pointed out that helium should replace hydrogen as the normal thermometric substance.

The melting point of hydrogen was found to be 14° to on the helium scale.

The pure helium used in the thermometric measurements was obtained by passing purified cleveite gas through a coil cooled to 15° in liquid hydrogen boiling *in vacuo*. An unsuccessful attempt was made to liquefy this gas, which could not be condensed at 13° under a pressure of 60 atmospheres.

The vapour pressures of solid neon were measured at temperatures corresponding to 20.74 (12.8 mm.) and 15.65 (24 mm.). It was shown that the vapour pressure did not change as the solid evaporated, proving that neon is a homogeneous substance.

EDINBURGH.

Royal Society, July 21.—Prof. Geikie in the chair.—The Neill prize for 1898–1901 having been awarded to Dr. J. S. Flett for his papers entitled "The Old Red Sandstone of the Orkneys" and "The Trap Dykes of the Orkneys," Prof. Geikie, in making the award, recalled the important work which Dr. Flett had done in searching for and finding organic remains in rocks hitherto supposed to be unfossiliferous, and then in proving that these strata were divisible into definite zones, each characterised by its own particular fish fauna. The paper on the trap dykes could have been written only by one who was at once a skilled field geologist, a thoroughly equipped petrologist, an expert microscopist and a facile chemist.—In a further communication on magnetic shielding in hollow iron

cylinders and superposed magnetic inductions in iron, Mr. James Russell discussed in particular the superposition of two magnetising forces at right angles to one another, and the magnetic æolotropy of demagnetised iron. Thus, if H_1 represent the field first acting and H_2 the field superposed at right angles to the first, and if B_1 and B_2 represent the resultant inductions in the directions of H_1 and H_2 respectively, then the general result was that with H_2 superposed on H_1 the B_1 component always lay above the B_2 component. For low fields the B_1 component is greater than in the normal case when no H_2 acts, but as the field is taken stronger the B_2 component approaches the normal value, and finally in high enough fields falls below it. The B_2 component lies below the normal value with this exception, that with low values of H_1 there is a slight excess of the B_2 component over the normal value. Then again, as regards æolotropy the following result was established. During the early stages of induction, iron is more permeable to a force in the same direction as that used in the immediately preceding process of demagnetising by reversals than it is to one at right angles to it. The results were discussed in terms of the recognised theories of molecular magnetism.—Dr. W. Peddie, in an additional note on the use of quaternions in the theory of screws, applied his method of interpretation to the case of a rigid body moving with two degrees of freedom, and was led to the investigation of the elliptic cylinder, which differs from the ordinary cylinder by being referred to an elliptic cylinder instead of to a right cylinder. Further developments were also given.—Prof. C. G. Knott read the second part of a paper on change of resistance of nickel due to magnetisation at different temperatures. The apparatus was the same as that already described, but by a modification in the method of experimenting more precise results had been obtained. The rate of change of resistance per unit increase of field at constant temperature and the rate of change per unit increase of temperature of this magnetic rate of change in a given field being distinguished as the magnetic change rate and the thermal variation respectively, the general conclusions were: (1) the magnetic change rate of resistance of a given nickel wire increases steadily with increase of field, but at a somewhat slower rate as the field increases; (2) the magnetic change rate increases slightly but unmistakably with rise of temperature up to 100° C. and probably higher; (3) the thermal variation of this change rate is greater at 40° than at 75° in fields higher than about 40, but tends to be less at the lower temperature in fields smaller than 35 or 40 C.G.S. units; (4) the change of resistance due to a field applied in a given direction is greater when the immediately preceding field has had the same direction than when it has had the opposite direction. The results were discussed along the lines of Prof. J. J. Thomson's theory of electrified corpuscles.—Prof. Alexander Smith, in continuation of a previous paper on the freezing point of sulphur, communicated a note on causes which determine the formation of amorphous sulphur. The proportion of amorphous sulphur formed in a mass of sulphur purified by crystallisation and kept heated at 448° C. was found to increase with the time which elapsed between the purification and the heating, and to decrease as the heating was greatly prolonged. Passing certain gases such as air, dry sulphur dioxide and dry hydrogen chloride through the sulphur during the heating increased the yield of amorphous sulphur; and under these conditions long continuation of the treatment did not cause any reduction in the yield. On the other hand, nitrogen, carbon dioxide, hydrogen sulphide and ammonia, used similarly from the beginning of the heating, seemed to prevent the formation of the amorphous form. It was not advisable to offer any theory until further work had been done.

PARIS.

Academy of Sciences, August 4.—M. Bouquet de la Grye in the chair.—Reflection and refraction as regards transparent bodies in rapid motion; reflected and refracted waves; amplitude of vibrations, by M. J. Boussinesq.—Experimental demonstration of the decomposition of carbon dioxide by leaves exposed to light, by MM. P. P. Dehérain and E. Demoussy. The authors point out that when the ordinary method of immersing leaves in a saturated solution of carbon dioxide is followed, the results are invariably successful with normally submerged aquatic plants like *Ceratophyllum submersum*, but vary greatly with plants the leaves of which normally decompose carbon dioxide in air. The results are satisfactory if the leaves

are placed in air above a saturated solution of carbon dioxide. The volume of oxygen liberated was invariably found to be exactly equal to that of the carbon dioxide decomposed, and no appreciable quantities of carbon monoxide, hydrogen, or gaseous hydrocarbons were formed.—The fruits of *Rosellinia necatrix*, by M. Ed. Prillieux. One of the common parasites which destroy the roots of fruit trees and vines was named *Dematophora necatrix* by Hartig, although he pointed out that it seemed to be closely allied to the group *Rosellinia*. The author has for the first time been able to study thoroughly the fruits, and as the parasite without doubt belongs to that group suggests a change of name.—Direct reduction of oxides of nitrogen by the contact method, by MM. Paul Sabatier and J. B. Senderens. A study has been made of the action of reduced nickel and reduced copper on the oxides of nitrogen. The results obtained are shown to be similar to those produced by spongy platinum, and it is pointed out that nickel or copper might with advantage replace platinum for such reactions.—Measurement of the limit of elasticity of metals, by M. Ch. Fremont.—On a new method of optically measuring the thickness of plates, by MM. J. Macé de Lepinay and H. Buisson (*cf. C. R.*, April 21). Results are given for a plate of quartz showing the great accuracy of the method.—Reflection of light from an iron mirror magnetised perpendicularly to the plane of incidence, by M. P. Camman. The author confirms experimentally the theory of M. C. H. Wind (*Archives néerlandaises*, 2^e série, t. i. 1897) regarding the reflection of light from magnetised mirrors, viz., if the incident light is polarised in the plane of incidence, the magnetisation has no effect upon the reflection, but if the incident ray is polarised perpendicularly to the plane of incidence, the time, the phase and the amplitude of reflected rays are changed.—Method of regulating resonators for high-frequency discharges with a view to their use in medicine, by M. H. Guilleminot.—On gentiobiose: preparation and properties of crystallised gentiobiose, by MM. Em. Bouquelot and H. Hérissey (*cf. C. R.*, cxxiii., March 4, 1901, p. 571).—Ammoniacal anhydrous copper chlorides: cupro-ammoniacal radicles, by M. Bouzat. The author finds that besides the compounds (a) $\text{CuCl}_2 \cdot 6\text{NH}_3$ and (c) $\text{CuCl}_2 \cdot 2\text{NH}_3$ described by Rose and Graham respectively, there is a third intermediate compound, (b) $\text{CuCl}_2 \cdot 4\text{NH}_3$. He assigns to them the constitutional formulæ

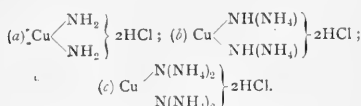

—Action of nitrous acid in alkaline solution on α -substituted β -ketonic esters, by MM. Bouveault and René Loquin. The conclusion arrived at is that if the reaction is carried out under such conditions that the ester group is not saponified, or if it be saponified in acid solution, there results an acid and an oxime of a substituted glyoxylic ester; but if, during the reaction, the ester group is saponified in such a manner as to give the salt $\text{R}-\text{CO}-\text{CH} \begin{array}{l} \left\langle \begin{array}{l} \text{COOMe} \\ \text{R}' \end{array} \right\rangle$, one obtains a monoxime of an α -diketone and carbonic anhydride.—Antiparameccious serum, by M. Ledoux-Lebard. The author finds that the serum of rabbits and guinea-pigs which have been several times injected with cultures of *Paramecium caudatum* is much more toxic towards this species of *Paramecium* than normal serum. The toxic effect is less towards other species of *Paramecium* (e.g. *P. aurelia*).—Action of alcoholic fermentation on the *Bacillus typhosus* and the *Bacillus Coli*, by MM. E. Bodin and F. Pailheret. Alcoholic fermentation does not seem of itself to destroy these bacilli.—Variation of the phosphoric acid in cow's milk with time after calving, by MM. F. Bordes and Sig. de Raczkowski. The phosphoric acid diminishes steadily from the time of calving.—Researches on the assimilation of leaves, influenced by chlorophyll, of which the upper or lower surfaces may be exposed to light, by M. Ed. Griffon.—On the cavern of Höll-Loch (Hell's Cavern) and the Scheidechen Brunnen (Creeping Springs), Switzerland, by M. E. A. Martel. This cavern, discovered in 1880, is one of the most remarkable in Europe. It lies near Stalden. A description is given.

NEW SOUTH WALES.

Linnean Society, June 25.—Mr. J. H. Maiden, president, in the chair.—By the wish of the council, the president explained to the meeting that, in consequence of the retrenchment policy which untoward circumstances had forced upon the neighbouring State of Queensland, it was to be feared that Mr. F. M. Bailey's "Queensland Flora," now in course of publication, would be brought to an abrupt termination in the middle of the sixth or concluding part. An expression of the views of scientific men in other States would perhaps help to justify the Queensland Government in making some special effort to utilise to the full Mr. Bailey's experience and unrivalled knowledge of the flora of Queensland in completing the important publication in question. On the motion of the president it was unanimously resolved, "That this meeting desires respectfully to give expression to the hope that, in the interests of science, the Queensland Government may see its way to allow Mr. F. M. Bailey to take the steps necessary to complete the 'Queensland Flora.'"—Notes on *Juncus holoschanus*, R.Br., and *J. prismatocarpus*, R.Br., and on certain other New South Wales plants, by Mr. E. Cheel.—(1) On *Eucalyptus Bauieriana*, Schau; (2) on *Eucalyptus calyogona*, Turcz, by Mr. J. H. Maiden.—A new gum (Levan) bacterium from a saccharose exudate of *Eucalyptus Stuartiana*, by Mr. R. Greig Smith.—*Eucalyptus melanophlora*, F.v.M., and its cognate species, by Mr. R. T. Baker. The object of the paper is to show that previous descriptions of this species must now be modified, as the foliage has not that constancy of form that has up to the present time been attributed to it.

CONTENTS.

	PAGE
The Encyclopædia Britannica	361
Aspects of Medical Science. By F. W. T.	363
Chemical Essays. By W. R.	365
An Assistant Master, and his Work	366
Our Book Shelf:—	
Wall: "The Dictionary of Photography"	368
Rabl: "Die Entwicklung des Gesichtes: Tafeln zur Entwicklungsgeschichte der äusseren Körperperform der Wirbelthiere"	368
Granger: "Les Fleurs du Midi"	368
Hill: "Physiology for Beginners."—Dr. B. Moore	369
Lévy-Bruhl: "Die Philosophie August Comte's."—	
A. E. T.	369
Kerr: "Elementary Coal Mining"	369
Letters to the Editor:—	
Earthquake of May 28 at the Cape, and Coincident Meteorological Effects.—Charles Stewart	370
A Tripartite Stroke of Lightning.—W. H. Hall	370
Colours between Clouds at Sunset.—John Baddeley	370
Retention of Leaves by Deciduous Trees.—Prof. W. R. Fisher	370
The West Indian Eruptions. (Illustrated.) By Prof. J. Milne, F.R.S.	370
A Text-Book of Mammals. (Illustrated.) By R. L.	373
Hydrographical Observations on the "Princesse Alice." By J. Y. Buchanan, F.R.S.	376
Notes	376
Our Astronomical Column:—	
Rotation Periods of the Superior Planets	380
The Dutch Eclipse Expedition of 1901	380
The Satellites of Saturn and Uranus	380
Australian Children's Games. (Illustrated.) By A. C. H.	380
University and Educational Intelligence	381
Scientific Serials	382
Societies and Academies.	382

THURSDAY, AUGUST 21, 1902.

A MONOGRAPH OF THE BRITISH
LIVERWORTS.

The Hepaticae of the British Isles, being Figures and Descriptions of all Known British Species. By William Henry Pearson. Vol. i. text, vol. ii. plates. Pp. vi + 520, and vii + plates 218. (London: Lovell Reeve and Co., Ltd., 1902.) Price 7*l.* 10*s.* net.

A TRUSTWORTHY work on the British Hepaticae has long been needed by those who are interested in this somewhat difficult group of plants. Since the appearance of Sir W. J. Hooker's "British Jungermanniæ" in 1816, we have had no treatise on our native species that can be regarded as either up-to-date or as of much use to the student. A beginning was made some years ago by Dr. Carrington in cooperation with the author of the volumes before us, but, unfortunately, the attempt was not destined to meet with success, and the enterprise was abandoned at an early stage of its publication.

So many new forms have been added to the British flora since Hooker's time, partly as the result of revisions of older species and genera and partly owing to the discovery of new ones, that the whole subject has come to present a very different aspect from that which it wore ninety years ago. The vast majority of hepatics were then included in the single genus *Jungermannia*, whereas only comparatively few species are now retained in it. A more extensive study has gradually rendered it possible to segregate the species into smaller and more natural groups, such as are familiar to those who have been accustomed to use the well-known "Synopsis Hepaticarum" of Gottsche, Lindenburg, and Nees v. Esenbeck.

It is pleasing to remember that our own countryman Spruce, who added so much to our knowledge of liverworts, was one of the foremost to discriminate between, and give expression to, the affinities existing between the species of the larger and more complex genera. He was thus able to break up these unwieldy collocations of species into smaller and more manageable subgenera.

Mr. Pearson, in the fine work before us, has adhered to the general arrangement of Spruce as laid down by him in his "Hepaticæ Amazonicæ" and elsewhere, which has, with more or less modification, served as the basis for most of the modern forms of classification. The first volume is devoted to the text, and opens with an introductory chapter in which organography and other preliminary matters are very briefly dealt with. It is in connection with this chapter that we would express regret that Mr. Pearson should have allowed to slip by the opportunity of attempting some reform in the esoteric terminology that has grown up in association with this group of plants. Many terms possessing a perfectly well-known meaning in connection with the rest of the vegetable kingdom are, in the systematic literature of Hepaticæ, habitually distorted so as to imply something totally different from what they mean elsewhere. Thus the so-called stipules are not in the least degree comparable with stipules as generally understood, and the

word ought to be altogether dropped in favour of *amphigastria*, a neutral term that may well be retained to designate the ventral leaves of these, usually dorso-ventral, plants. The radially constructed species prove clearly enough that the amphigastria have nothing to do with true-stipules, but are merely special leaves which owe their particular (often reduced) form to the dorso-ventral habit of the stems. To continue to apply the older and misleading term of stipules to these structures is clearly an unjustified anachronism. Similarly, the expressions "Postal" and "Antical" might with advantage be replaced by the words Dorsal and Ventral, as universally used elsewhere. And once more, why continue to speak of "Pistillidia" instead of Archegonia, the word invariably employed in modern botanical works to designate these structures? Of course, Mr. Pearson is not to be held responsible for the introduction of these terms; they are of hoary, and we had hoped of senile, antiquity. And though he has probably retained them purposely, we could have wished that he had otherwise decided.

As regards the rest of the work, there is much deserving of praise. The descriptions of the species are clear and full, and the shorter notes that accompany many of them are interesting and often of critical value. Especially is this the case with species likely to be easily confounded. The special diagnostic characters are then discussed and emphasised, as, for example, in the two common species of *Pellia*, *P. calycina* and *P. epiphylla*. Curiously enough, however, no reference is made to the anatomical differences, pointed out by Leitgeb, between the cells of the thallus in these two plants. The geographical distribution of each species is mentioned, and frequently the actual localities also. Naturally these are not exhaustive, and those especially who have collected the plants in the more southern parts of England will be able readily to supplement them. Some species that are described as rather rare, e.g. *Reboulia hemispherica*, would probably not be so regarded by many people. A glossary, table of literature and a good index complete the volume. A chapter on the interesting biological features in which the liverworts are so exceptionally rich would have been a welcome addition to the book. There is hardly another family of plants that displays so manifold a variety of form or such a remarkable series of structural modification in relation to the environment as does that of the hepatics, and these fascinating adaptations deserve far more attention than they commonly receive.

The second volume is devoted to the figures, and it contains no fewer than 228 plates. These form a splendid adjunct to the text, and will prove of material service in the proper identification of the various species. The plates are in nearly all cases excellent, and each generally includes a life-size representation of the species, as well as drawings, on a large scale, of dissections, fructifications, &c. The cellular structure of the leaves is also depicted, and this will often be found of much value in deciding between doubtful cases. In the genus *Fossombronina* the spores are carefully drawn, as furnishing perhaps the most easily recognised characters by which the species of this somewhat difficult genus can be identified.

Although we have freely criticised certain features in the book wherein our own judgment happens not

altogether to have coincided with that of the author, we have done so feeling that to pass over these points of difference would be to pay Mr. Pearson but a poor compliment. For we fully recognise the great value of the work in all essential matters, and we cannot but admire the energy with which a task of no ordinary difficulty has been carried to completion. Mr. Pearson has laid British botanists under great obligations, and has succeeded in producing a book that ought to serve to rescue from comparative though altogether unmerited oblivion a family, by no means the least interesting, of the vegetable kingdom.

J. B. FARMER.

STRUCTURALLY ACTIVE MEDIA.

De la Double Refraction elliptique et de la Tétrard-fringence du Quartz dans le Voisinage de l'Axis. Par G. Quesneville. Pp. xiv + 361; avec 4 planches. (Paris : Gauthier-Villars et Fils, 1898.)

THE peculiar phenomena exhibited by quartz in directions slightly inclined to the optic axis were explained by Airy in 1831 on the hypothesis that in any such direction two streams of permanent type can be propagated, these streams being oppositely and elliptically polarised with their planes of maximum polarisation respectively parallel and perpendicular to the principal section. With the aid of these assumptions, he calculated the forms of the interference patterns displayed in plane and circularly polarised light by plates of quartz perpendicular to the optic axis, and also discussed the remarkable phenomena that are observed when two such plates of equal thickness but of opposite rotations are superposed and traversed by a convergent stream of polarised light that is subsequently analysed. The close agreement between these calculated results and the experimental forms of the curves led to a general acceptance of Airy's views, and the conviction of their correctness has since been strengthened by experimental investigations of a more direct character.

This theory M. Quesneville, without disguising the magnitude of the task, has undertaken to refute, replacing it by a new one devised by himself. He maintains that the interference exhibited by plates of quartz in polarised light is in at least one important particular at variance with the results calculated by Airy, and claims that Jamin's investigations (the only experiments that he discusses), so far from confirming the accepted theory, actually lend support to that which he himself enunciates. Further, he alleges a theoretical objection to Airy's hypotheses. According to these there is, of course, a continuous change in the polarisation of the waves of permanent type as the position of their normal changes from a direction inclined to the optic axis to that of the axis itself, while it is the circular polarisation, and not the rotary phenomenon, that is the fundamental property of an active crystal in this latter direction. M. Quesneville, however, contends that Airy's formulæ involve a discontinuity in the phenomenon, inasmuch as a rotation of the primitive plane of polarisation nowhere occurs therein, for "s'il existe suivant l'axe, il est inadmissible que tout près l'axe, alors que les ellipses sont presque des cercles, elle ait disparu."

NO. 1712, VOL. 66]

This idea is the key-note of his own theory, according to which the streams in an active crystal, propagated in a direction slightly inclined to the optic axis, only become of permanent type after a certain zone has been traversed within which a rotation of the plane of polarisation is "le phénomène primordial." On entry into the crystal, a beam of plane polarised light is supposed to be resolved into two elliptically polarised streams of opposite sign with their planes of maximum polarisation respectively parallel and perpendicular to the primitive plane of polarisation; after a small distance has been traversed, these are regarded as having for their resultant a stream that is plane polarised in a new azimuth, while this is, again, equivalent to two fresh elliptically polarised streams; this process is supposed to continue during passage through the first zone, within which the elliptic vibrations change both in form and in orientation. It is not clear what circumstances determine the limitation of the zone, but it is assumed that after a certain length of path, that diminishes as its inclination to the axis increases, the two elliptically polarised streams cease to occasion a rotation of the last plane of polarisation, and that they then enter the second zone, where each gives rise to two streams of the permanent type assumed by Airy. In this manner the four-fold refraction of quartz in the vicinity of the axis is arrived at; there is, however, no assumption of more than two wave-velocities corresponding to a given direction, neither is there any recognition of a separation of the streams by refraction, so that the four elliptically polarised waves may be grouped together in pairs, the constituents of each group travelling with the same speed in the same direction, and there consequently is no question of a four-fold refraction, even if the author's contention be correct.

The limitation of this review precludes a discussion of the physical and mechanical difficulties involved in these ideas; they are, however, sufficiently obvious. It is claimed that the theory is not merely kinematical, but that it represents the actual state of things that occurs during the passage of light through a plate of quartz, though its author confesses his inability to formulate any hypothesis respecting the distribution of the ether round the axis of an active crystal from which it could be deduced.

The book in which this theory is expounded is divided into three sections, preceded by an introduction giving a sketch of the plan and scope of the work. In the first section the author discusses some investigations prior to his own. MacCullagh, in 1836, showed that the addition of certain terms to the differential equations of motion for inactive uniaxial crystals would lead to the elliptic polarisation assumed by Airy. Starting from a mistaken conception of the significance of these equations, M. Quesneville professes to show that "Convenablement interprétées," they prove that

"Il existe dans le quartz une première zone pendant laquelle les rayons dès l'entrée donnent lieu à la rotation du plan primitif de polarisation, non seulement suivant l'axe, mais obliquement à l'axe jusqu'à la périphérie."

He then proceeds to a discussion of Jamin's experiments, deducing therefrom the result that in calculating the difference of phase between the two oppositely polarised

streams, introduced by passage through a plate of quartz, only the distance travelled in the second zone is to be taken into account. It may at once be conceded that Jamin's results do not afford a very striking confirmation of Airy's theory, which may in great measure be attributed to the experimental methods that he employed; but M. Quesneville in his criticism does not appear to have sufficiently recognised the distinction between the phase-difference of the streams on emergence into air and that of the rectangular plane polarised components of the resultant elliptically polarised train of waves.

In the second section we have the author's own experimental investigations, that were made with double prisms of quartz cut in different directions with respect to the optic axis and arranged in the shape of rectangular parallelepipeds. When the primitive polarisation is circular, M. Quesneville's theory leads to the same final results as that of Airy, but a divergence occurs when the initial polarisation is plane. Consequently it is found in accordance with both theories that if the light traverse the first prism along the optic axis and its path in the second be inclined to this direction, the emergent pencils can be completely quenched by means of a quarter-wave plate and an analyser; on the other hand, with a pair of prisms, such that the direction of propagation of the light was in the first perpendicular to the optic axis and in the second inclined to it at an angle varying from 5° to 9° , M. Quesneville was unable to obtain complete extinction of the emergent streams either with an analyser alone or with a quarter-wave plate and analyser, whatever might be their orientations. He thence deduced the inference that each pencil is formed of two elliptically polarised streams of opposite rotations that, having traversed the quartz with the same velocity, remain superposed on emergence, and on this experiment he relies for his proof of the four-fold refraction of quartz near the axis. It is noteworthy that this result was only obtained with small prisms, a fact for which a very inadequate explanation is offered.

The last section is devoted to a discussion of the rings produced by plates of quartz in polarised light. Two instances must suffice to show the manner in which Airy's formulæ are treated. On p. 280 it is argued that these would give the so-called quadratic curves even when the initial and final planes of polarisation are parallel, the fact being overlooked that the term that introduces this form of the curves has a factor that is then equal to zero; and on p. 341 the result that in the same circumstances the circles in white light would be black instead of coloured is deduced by equating to zero a sum of essentially positive terms. This section, however, contains several points of interest, the most important being the question whether or no circles exist in conjunction with the phenomenon known as Airy's spirals. In the photographs published in the book these circles do not appear, though they are present in those given by other authors. A question therefore arises as to the accuracy of the plates employed by M. Quesneville, but if his contention be proved it must be recollected that Airy's result, is confessedly only approximate, and it is possible that a more complete investigation would lead to a formula giving spiral curves alone.

The book is wanting in the clearness of exposition that

we are accustomed to expect from a French writer on a physical subject, and it is a matter for regret that the author, in his anxiety to make a strong case for his own views, should have permitted himself to repeatedly accuse Verdet and other physicists of "prudently passing over in silence" facts that tell against the theory that he is attacking.

ELEMENTARY PHYSICS.

A Text-book of Physics, with Sections on the Applications of Physics to Physiology and Medicine. By R. A. Lehfeldt, D.Sc. Pp. 304; 112 figures. (London: Edward Arnold, 1902.) Price 6s.

A COMPLETELY new arrangement has been adopted in this book in the order in which subjects are presented to the student. The traditional order of the text-book of physics has been abandoned, in many cases with advantage, but often a student will be sadly at loss in consequence. He will find it hard to fathom the object of proving (p. 81) that the elasticity of a gas is equal to its pressure before he is familiar with the idea of the elasticity of liquids (p. 85) or of solids (p. 130), and he can derive little help in his efforts by being given for the time being the definition of "constant ratio of stress to strain" when the immediate object is to prove that it is not constant, but equal to the variable β . The study of gases alone would never have suggested attaching importance to the ratio of stress to strain.

Again, to take another example, the subject order adopted involved introducing in connection with conductivity of heat (p. 72) the question of the anomalous expansion of water described later (p. 90).

Likewise, in treating of electrolysis (p. 188), the term electrical charge is used without explanation. In the order adopted this does not appear until p. 249.

Of course, it is not always possible to avoid such anticipations. Students often, however, in consequence fancy they do not understand the point in hand, when it is really the anticipation which is troubling them.

In the order of the chapters, "Heat" comes before "Properties of Fluids," and next comes "Properties of Solids." Sometimes the analogies adopted in consequence come quaintly to one accustomed to the old traditional order of things, and are apt to appear upside down, as the analogy taken from conductivity of heat to help the reader to grasp the idea of flow in liquids.

The work contains a vast number of distinct things for its size. Scarcely any branch of physics is omitted, but it is a question whether there is not too much in the book and whether less matter more carefully arranged would not have better chance of sticking. We must avoid giving our students mental indigestion from overloading. There is an unpleasant feeling throughout of being rather rushed, and that nothing must be left out which the external examiner may perchance alight on in setting the paper. Perhaps the fault, if it be one, may not lie with the book.

The attractions and repulsions of currents appear to be no further alluded to than in the statement describing the Kelvin current balances, that "of the two fixed coils on the right, one attracts the movable coil

near it, the other repels," leaving the reader to wonder why they do not both attract or do not both repel, or, indeed, why on earth they do either.

The plan of describing instruments and their working instead of the principles involved is to be deprecated in elementary text-books. At the very outset (p. 5) a description of how a tuning-fork is run by an electric current is given, with an explanation of the mode of action which, were it true, would mean that the vibration of the fork could not be kept up by the current. It seems unnecessary at the start to introduce the question at all, but if it must be so, the student should certainly be warned of the necessity of supposing some lag in the current.

One or two serious errors have crept in and must be altered in any future edition. In describing rigidity, the ordinary definition of a simple shear is given, but what follows will certainly bewilder the student.

"When a pair of steel shears or scissors is used, the force applied is distributed over a very small area, the area of the 'edge' of the shears, so that the shearing stress (per sq. cm.) is great, and the finer the edge the greater the stress becomes; consequently the material so stressed can be cut."

The area here spoken of is at right angles to the area meant in the definition, and in fact has nothing to do with the simple shear. Besides, the action in question is in reality anything but a simple shear.

Another passage requires rewriting. The air supplied to an organ pipe is spoken of as

"setting in motion a reed fixed in the end, or if there be none, the 'lip' or thin lamina of wood or metal near the front aperture of the pipe."

One misses the old familiar fundamental experiments of the text-books, and in many cases this absence is to be regretted. Thus, at p. 251, the attractions and repulsions of electrified bodies are not described as fundamental observations, but follow as corollaries in rather a cart before the horse fashion from the assumed shortening and swelling of things called lines of force. The student is given a picture of lines of force, and is told that it is "evident that positive and negative charges attract each other."

On p. 233 the metals have got evidently inverted, when it is said that "both soft iron and steel show retentivity, the former to even the greater extent of the two."

It is errors such as these which are just the ones which trouble the student.

From what has been said it might be inferred that the book was found to be without interest; such is not the case. With some alteration it is easy to imagine it made into a thoroughly useful one, especially for medical students, for whom it was more particularly written. The chapter on chemical physics is splendid and forms a most excellent introduction to the subject. The chapter on light is also good. Here the dioptric system is introduced with effect; the parts touching on geometrical optics are simply described, no proofs being given. This has much to commend itself in a book of this scope, but at the same time the average student must not be asked to draw conclusions without being carefully given the premisses, as at p. 281, where he is told without

further ado that "the distance BF is called the focal length and in case of a mirror is *clearly* half the radius of curvature." A first-class student will see there is something to prove and will prove it; others will not do either. This sort of thing tends in the long run to woolliness in thinking.

The book is well printed and the diagrams are good. There are few misprints; the following, however, were noticed and are given with the view of correction in a future edition. On p. 41, $l. 32$, heads should be altered to beads; p. 60, $l. 21$, $19^{\circ}57'$ to $195^{\circ}7'$; p. 78, $l. 17$, T to P ; p. 141, $l. 35$, $0^{\circ}93'$ to $0^{\circ}93$; p. 267, $l. 5$, E to F .

On p. 180, $l. 11$, 48 watts per hour are spoken of; "per hour" should be omitted.

On p. 240 we find it stated that if a wire of length l be moved across a field of strength H , "the electromotive force due to a motion of 1 cm. will be proportional to lH "; "per sec." has dropped out.

THE VOICE AND RESPIRATION.

Health, Speech and Song: a Practical Guide to Voice-production. By Jutta Bell-Ranske. Pp. 158. (London: Swan Sonnenschein and Co., Ltd.; New York: E. P. Dutton and Co.) Price 4s. 6d. net.

ALTHOUGH the subtitle of this book is "A Practical guide to Voice-production," the space is chiefly occupied by a description of the organs of voice and respiration, accompanied by statements of the somewhat peculiar views of the author as to the anatomy and physiology of these organs, and criticisms of the views of the many schools of voice-production. There are but a few pages devoted to giving practical instructions on the training of the voice, and what little is said upon this subject is too vague and general to be of much service.

The book throughout is written in a very rhapsodical fashion, so much so that it becomes exceedingly difficult to trace out any meaning in some of its passages, while in other cases the effect produced can only be described as ludicrous.

The following passage may be cited as illustrating this:—

"Since I have stated that the vocal instrument consists of three elements, it might at first appear that each element must be of equal importance. And if the motor element which drives the organ were given us for the sole purpose of creating song, it would be so, but this element has a far more important function, being the element of life itself; hence song becomes only an overflow of life. Life is breath."

The author repeatedly deplors the ignorance of physiology shown by voice trainers, but the physiological statements made in the book are often very peculiar and occasionally erroneous. Thus it is stated on p. 27 that

"The diaphragm flattens, that is, is drawn down. The chest is expanded upwards, downwards and outwards, at the expense of the abdomen. The floating ribs, which are attached to the outer rim of the diaphragm, are pressed forward and outwards, thereby greatly expanding the bases of the lungs, an act which constitutes rib or costal breathing."

Other statements in the book (p. 28, *et seq.*) clearly show that the author confuses costal and diaphragmatic breathing, regarding these as identical and to be care-

fully distinguished from abdominal breathing, which is stigmatised as an exceedingly vicious process.

The description of the larynx and its muscles given in chapter iv. is very amusing to a person who is only acquainted with that organ as usually described. Thus, on p. 44, we are gravely told, though certain important intrinsic muscles of the larynx have been passed over without a word, that

"The only muscle that remains to be mentioned is the epiglottis, which is a thin, leaf-shaped cartilage that covers the aperture of the larynx when we eat, so as to prevent anything entering the voice-tube when food passes into the gullet (œsophagus)."

Many of the chapters in this novel scientific treatise are headed by beautiful quotations, such as

"He likened her voice to a string of pearls."

"And pure the pearls of matchless beauty they,
Yet purer still her song, for there was soul therein."

It may have been these quotations which suggested the statement to the author that song when not improved by development of the psychological side is a "pearl of value, but a *dead* jewel for all that."

The author deprecates the misunderstanding of psychology as it is used in voice-production; this arises, it is stated, from confusing its component parts, which are:—(1) Cognition—knowing; (2) volition—will; (3) feeling—affective states. Certainly there seems to us to be some ground for confusion here, especially as the author explains the matter no further, but simply leaves it thus.

In a chapter on deportment we are told that more than half the trouble existing around us springs from neglect of the diaphragm, and in this chapter also is found the remarkable statement that

"The contraction of the diaphragm flattens the abdomen, and invigorates all the various muscles that influence the liver and kidneys."

A very short chapter follows on "Advice to Singers," and the book then concludes with a recapitulation of the views of various authors as to the musical instrument which the voice most closely resembles.

B. MOORE.

OUR BOOK SHELF.

The Principles of Simple Photography. By F. W. Sparrow, R.N. Pp. 130. (London: Hazell, Watson and Viney, Ltd., 1902.) Price 1s. net.

THERE are now so many guides for beginners in photography that the first question with regard to a new one is as to the reason for its production. It is fitting that the author, who dates from H.M.S. *Royal Oak*, Mediterranean, should give a chapter on shipboard photography and hints for work abroad. This is evidently a description of the results of experience, and as such is a valuable record. It is, however, rather straining matters to suggest that differences of exposures of six, or even twenty, per cent. would make an appreciable difference in the result, even if it were possible to obtain plates of a uniformity of sensitiveness that would render such variations possible. The desirability of carrying plates rather than films is insisted on "for several reasons"; they can be obtained at almost any port of call, and on the whole are more trustworthy and more easy to work. The methods of extemporising a dark room on board ship are clearly described, and the apparatus in general and water supply are practically considered.

The other part of the book deals with apparatus,

plates, exposure, development, printing, picture composition, &c., in very much the old-fashioned way. For development, pyro. and ammonia are prescribed, and the operation is either "normal," that is, rapid and risky, or "tentative," that is, slow, with the gradual addition of the accelerator. So long as the author follows the usual lines his information is trustworthy and useful, if not quite up to date; but when he departs therefrom he is not always a safe guide. The idea that "the perspective of a picture depends entirely on the focal length of the lens" is erroneous, though perhaps not original. There is confusion in the statement that a "very high tower with parallel sides" will show a convergence towards the top. We do not remember any guide to photography before this which states that the diaphragm cuts off the light that passes through the circumferential portions of the lens and thus gives the equivalent of a lens of smaller diameter; or that "chemical fog" (produced by unwise development) may be removed by an acidified alum clearing bath; that in fixing "the emulsion is eaten away from . . . the plate"; that a perfectly trustworthy method of intensification still remains to be discovered; that when varnishing, if the negative is made too warm the film will melt; that in modern printing out papers "the emulsion is composed of nitrate of silver—replaced by a chloride in toning—which is borne on a gelatine solution: hence the term gelatino-chloride paper"; that in many cases "hypo. is used to bleach the pulp" of which paper and mounting boards are made. Blemishes such as these enforce the opinion that, although this is one of the newest elementary guides for beginners in photography, it is not one of the best.

Philosophy of Conduct. By G. T. Ladd. Pp. xxii + 663. (London: Longmans, Green and Co., 1902.) Price 21s.

PROF. LADD'S remarkable industry is once more evinced by this bulky and comprehensive work on ethics. The general standpoint adopted, which will be already familiar to readers of other books by the same author, is that of idealist philosophy tempered by a strong interest in the facts and methods of psychology and anthropology. Prof. Ladd's latest work, while presenting a fairly complete survey of the facts of morality from this point of view, can hardly be said to add anything fresh to our comprehension of the theoretical and practical problems raised by the moral life. The author's arrangement of the subject-matter is perhaps adapted to be of service to students beginning a course in moral philosophy, though the connection he seeks to establish for it with the fundamental factors in psychological analysis seems forced. He treats first of the psychology of the moral life, the nature of the feelings of obligation and approbation, the origin and meaning of moral personality and moral freedom; next of the different types of action esteemed as virtuous or right by the moral judgment; and finally of the metaphysical implications of ethics and religion as held by believers in a personal absolute being. His treatment of the psychology of ethics, though largely acceptable to thinkers of all schools, suffers from a certain want of thoroughness and tendency to dogmatise. This is partly due to his habit of presupposing the results of his previous works on psychology. Now this would be a defensible plan of procedure if systematically followed, but it is at least tantalising to be offered lengthy disquisitions upon such all-important topics as moral freedom and personality, in which all the crucial positions are simply taken for granted. Prof. Ladd should either have dispensed with discussion at all or have made his discussions more thorough. Incidentally I may remark that the professor shows some acrimony in his treatment of opponents, frequently hinting that their opinions on the psychology and metaphysics of ethics are morally "dangerous," and now and then descending to the calling of names. There is a

particularly deplorable personal reference at p. 417 which might well have been spared.

The fundamental difficulty in the author's psychological theory is his ambiguous treatment of the self. He speaks of it, now as a product and process of development, in terms which seem to identify it with the moral character, again as a mysterious something behind character and acting causally upon it. The discussions of particular virtues in part ii., if somewhat too diffuse, are, to my mind, the most suggestive things in the whole book. In part iii. the attack on "utilitarianism" is too bitter to be discriminating. Egoistic Hedonism may be an illogical theory, but an egoistic Hedonist need not in practice be a worse man than his neighbours; it is mere vituperation to assert that "few prostitutes are so vile" as to be egoistic Hedonists.

The religious problems raised and in part treated by Prof. Ladd are too grave to be dealt with in a summary note like the present. A. E. T.

The Thompson Yates Laboratories Report. Edited by Robert Boyce and C. S. Sherrington. Vol. iv., part i., 1901, and vol. iv., part ii., 1902. Pp. 563. (London: Longmans and Co.)

THE first ninety pages of part i. of this Report are occupied by a description of the filarix or blood-worms obtained by the Liverpool Expedition to Nigeria. This practically constitutes a monograph upon this important group of parasites, is from the pen of Messrs. Annett, Dutton and Elliott, and a number of new species are described and illustrated. Dealing with human filarix, the opinion is expressed that, notwithstanding certain differences between them, the weight of evidence is on the side of the identity of *Filaria nocturna* and *F. diurna*. The bibliography accompanying this paper should prove of the greatest value to future workers in the subject. The other important papers in part i. are the "Flora of the Conjunctiva in Health and Disease," by Dr. Griffith, and the use of bile-salt broth as a test for faecal contamination, by Drs. MacConkey and Hill. The former gives a very complete account of the bacteriology of the conjunctival sac, and, like Lawson, Griffith has found the Xerosis bacillus to be a common inhabitant of the normal sac. In MacConkey and Hill's bile-salt broth we have a very useful medium for the detection of the *Bacillus coli* and allied species in water, but the procedure recommended, viz. to add 1 c.c. of the water to each of three tubes, would detect, in all probability, only a highly polluted water, not one in which the *B. coli* was present in small amount, in which case it is essential to concentrate the water by filtration through a porcelain filter and to examine the deposit. The same remarks apply to the examination of samples of the Liverpool water supply; the quantity of water examined (1 c.c.) is far too little to give a trustworthy negative result.

In part ii., Mr. Macdonald contributes an exhaustive paper upon the "Injury Current of Nerve," and Dr. Grünbaum and Prof. Sherrington make an important contribution to the physiology of the cerebral cortex in the higher apes. Dr. Annett produces some startling figures relative to the frequency of expectoration in public thoroughfares and the risk of infection with tuberculosis therefrom. The volume contains several other papers of minor importance upon various points of bacteriological, pathological and clinical interest, and concludes with the Report of the Liverpool Expedition to Brazil to study yellow fever, by Dr. Durham and the late Dr. Myers. The latter is somewhat disappointing, the ætiology of yellow fever being left very much where it was, save that a fine bacillus, difficult to stain and impossible to cultivate, was detected in the tissues.

In conclusion, it may be said that these volumes maintain in every respect the standard of their predecessors.

R. T. H.

LETTERS TO THE EDITOR.

[The Editor does not hold himself responsible for opinions expressed by his correspondents. Neither can he undertake to return, or to correspond with the writers of, rejected manuscripts intended for this or any other part of NATURE. No notice is taken of anonymous communications.]

Sunset Effects.

AT Baveno (Lago Maggiore) on the evening of July 10, when the sun was setting behind the mountains in the north-western quarter of the horizon, a number of bright streaks of light appeared to radiate from behind a bank of clouds in exactly the opposite quarter of the sky. As these streaks were very bright near the point from which they apparently emanated and gradually faded away with increasing distance from that point, the effect was to produce the impression that the sun had set in the south-east instead of in the north-west. The explanation of the phenomenon is perfectly simple, being that the beams of sunlight, cut off by clouds and mountains, had travelled overhead through a clear atmosphere and, reaching the hazy air over the plains of Lombardy, had illuminated this air, which was especially thick at a point opposite the sun, the streaks appearing to converge to a vanishing point by the laws of perspective. The effect no doubt occurs whenever the necessary conditions prevail, viz., banks of clouds or mountains in the direction of the setting sun, a clear sky overhead and a thick atmosphere in the quarter opposite the sun.

G. H. BRYAN.

THE letter on iridescent sunset effects in the current number of NATURE (p. 370), and the correspondence now going on in the columns of *Science*, prompt me to send the following extract from my journal which was made on board the barquentine *Dayspring* while lying at anchor in Friday Island Passage, Torres Straits, on November 29, 1897:—

"The sun was setting behind cumulostratus clouds, while a little to the southward the horizon was occupied by a large storm cloud through which lightning was constantly playing, and other clouds of various types were scattered over the sky. Behind the storm cloud and between it and the sun were several very fine even-textured cirrostratus patches; these assumed prismatic coloration. The colours were very vivid and included the blues and greens as well as those of the red end of the spectrum; and they appeared to be arranged in the sequence of Newton's rings. The appearance of the clouds reminded me of a polarisation phenomenon. The colours were disposed in broad concentric bands shading into one another; they appeared to be dependent upon the thickness of the cloud mass, and were most brilliant at its thinner parts. The colours changed but slightly as the sun sank behind the horizon, but after a time the prismatic effect gave place to the ordinary sunset glow."

The phenomenon thus described made a great impression upon me at the time, and I am quite convinced that it had nothing in common with the normal "glow" reflected by the setting sun.

Hounslow, August 18.

S. PAGE.

THE OLDER CIVILISATION OF GREECE: FURTHER DISCOVERIES IN CRETE.¹

IN a review of No. VI. of "The Annual of the British School at Athens," published last year (vol. lxi. p. 11), the great importance of the discoveries of Mr. A. J. Evans at Knossos in Crete was pointed out, and the opinion was expressed that that volume contained "matter of extraordinary interest to students of the history, not only of Greece, of Egypt, and Western Asia, but also of mankind in general," for, since "the culture which now dominates the world is the child of the civilisation of Ancient Greece, . . . any archaeological discovery which tends to increase our knowledge of the beginnings of Greek civilisation possesses an importance and an

¹ "The Annual of the British School at Athens." Part vii. Session 1900-1901. Pp. vii + 191. (London: Macmillan and Co., Ltd.)

interest far greater than that of any other possible discovery whatever in the archaeological field." The writer then proceeded to sketch briefly the position of Mycenaean civilisation in history, insisting more especially upon what is now a commonplace of archaeological knowledge—the fact that "the culture of classical Greece, as we know it, is but the second epoch of Greek civilisation. Classical Greece had a past, the true history of which had been half forgotten, had been preserved in confused and contradictory legends. The culture of the past had bloomed from end to end of the Greek world, in cities, some, like Athens or Knossos, of renown in classical as well as pre-classical days, others, like Mycenae and Tiryns, cities whose fame ceased to be when the Dorians entered Greece. This culture was bronze-using, and was, in fact, the Greek phase of the European culture of the Bronze Age, a phase earlier in date than the phases of Central and Northern Europe, and in all probability not only their forerunner, but to a great extent their forebear."

In Mycenaean discovery progress is swift, and the ideas of one year are never precisely those of the year before; and since these lines were penned the appearance of Prof. Ridgeway's "Early Age of Greece" has caused many defenders of the usual view to look well to their armour. For many weighty reasons which cannot be discussed here, it does not, however, seem probable that the view that the Mycenaean culture was not only the forerunner, but the forebear of the European culture of the Bronze Age, will be hastily abandoned in favour of the interesting theory propounded by Prof. Ridgeway. The discoveries of the last two years have pushed back the existence of human civilisation of the highest and most developed type in the Aegean basin to so remote a date B.C. that the possibility of this culture having derived its origin from Central Europe is fast fading away; it is to Egypt, if anywhere, that we must look for the first impulses of Aegean culture, and it is to this Aegean culture that we must look for the origins of the European civilisation of the Bronze Age. So that while it may be an exaggeration to say that the relation of the prehistoric civilisation of Greece to this general European culture is quite clear, it is none the less a mere affectation of reserve to imply that the nature of this relation is not, generally speaking, pretty clearly indicated by what evidence we have. The evidence points to the Aegean culture having been the forebear of the general European civilisation of the Bronze Age, of which it itself may be regarded as the Greek phase.

No dogma can be proclaimed as to the ethnic affinities of the people to whom this Aegean culture belonged. In "The Oldest Civilization of Greece," pp. 105, 202, the present writer has essayed the opinion that "the Mycenaean culture had well begun before the arrival of the Aryan Hellenes"; and we may, in fact, well hold that its originators belonged to that "Mediterranean Race" of Sergi, which extended from Armenia to Spain. When, however, the fair-haired invaders from the north—the "Celts" of Prof. Ridgeway—descended upon the Aegean world, it would seem that they took over the civilisation of their predecessors, over whom they henceforth ruled and with whom they mingled, while giving them their Aryan language. So it is that "the whole of Greek culture from the solid rock of the Athenian acropolis up" is indeed one, for the civilisation of the Aryanised "Hellene" was directly descended from that of the un-Aryan "Pelagian" of Knossos or Phaistos without any very violent break." Thus it is possible, without inconsistency, to write also that "the Mycenaean culture belonged primarily . . . to Hellenes" when one is not using the word "primarily" in the sense of time at all, and when, too, one has expressly, in order to make one's meaning clear even to the most careless critic, inserted between the words "primarily" and "to Hellenes" the sentence (in brackets) "*not entirely or*

necessarily originally" ("Oldest Civilization of Greece," p. 104; not in italics in original). The sentence, "the Mycenaean culture belonged primarily (but not entirely or necessarily originally) to Hellenes" cannot be made to disagree with that previously quoted to the effect that "the Mycenaean culture had well begun before the arrival of the Aryan Hellenes," without suppressing the words within brackets, and thus suggesting a meaning for "primarily" not intended by the author.

The present writer holds, therefore, to his opinion, as expressed in "The Oldest Civilization of Greece," that the Aegean culture belonged originally to the pre-Hellenic race or races, but that in all probability some of its most important developments took place among populations already "Hellenised," e.g. in Argolis; i.e. it "belonged primarily to Hellenes." How far Cretan discovery may modify this position it is impossible as yet to say; in all probability, however, the modification will be in the direction of considerably reducing the probable connection of the Aryanised "Hellenes" (Achaïans) with, at any rate, the Cretan monuments of the "Aegean" or early Mycenaean age, and in bringing the pre-Aryan, pre-Achaïan population into greater prominence. Such a development has long been foretold by Prof. Ridgeway; but it is not probable that his drastic proposition "No 'Mycenaean' were Achaïans" will ever be accepted in its entirety. To him, however, the inception of the idea is due; the point on which one would be inclined to criticise him is his proposition that the Pelasgians were Aryans, which, since the work of Kretschmer and Sergi has appeared, seems an old-fashioned view. Following Kretschmer, the present writer has maintained the view that the primitive population of the Aegean basin was of "kleinasiatisch" race, and that this race was not Aryan, since Lycian, the typical "kleinasiatisch" language, and its cognate idioms, Carian, &c., are obviously not Aryan, *pace* Prof. Bugge and one or two other Scandinavian philologists who still maintain the opposite view. In *Sphinx*, vol. ii. p. 120, the well-known veteran archaeologist, Prof. Piel, of Upsala, still holds the Scandinavian view, saying:

"Nous savons, grâce à Bugge, à Thomsen et à Torp, que cette langue [Lycian], très-voisiblement, est d'origine aryenne bien authentique."

With all respect to Prof. Piel, it, however, must be recorded that, except in Scandinavia, Kretschmer's view seems to be now generally accepted, more especially since his philological results agree so remarkably well with those obtained by Sergi from craniological study.

We shall return to the question of race later; the above preliminary remarks are necessitated by the progress which has been made in Mycenaean study during the past year.

In the present number of the "Annual of the British School at Athens" Mr. Evans proceeds to describe the results of his further excavations at Knossos in 1901, when he was assisted by Dr. Duncan Mackenzie as excavator, and by Mr. D. T. Fyfe as architect. Mr. Fyfe has prepared the very clear and intelligible ground-plan of the palace which accompanies the memoir, and his services have no doubt been, generally speaking, of the greatest use to Mr. Evans, since nobody who has not visited Knossos can have much idea of the great amount of regular architectural, not to say engineering, work which has had to be carried out during the course of the excavations, consisting not only in the housing-over of the Throne Room (illustrated in *NATURE*, lxxiv. p. 14, Fig. 4), but in excavating, shoring-up and underpinning staircases, remains of upper stories, &c., especially in the vicinity of the Hall of the Colonnades (Plan, G 10). Mr. Hogarth, who in 1900 excavated the town-ruins, did not work at Knossos in 1901, but transferred himself to the eastern end of Crete, where he worked on the

Mycenæan site at Zakro; his results are described in the present number of the "Annual."

The operations carried on at Knossos in 1901 are summarised by Mr. Evans on pp. 1, 2. Space forbids us to do more than select for description and discussion some of the more important results of his excavations.

The underlying Neolithic settlement was further investigated, and a report of the results obtained was made by Mr. Evans to the Anthropological Section of the British Association (Glasgow meeting, September, 1901; see NATURE, lxiv. p. 615).

The "Kaselles" (*κασέλλαι*), stone cists or receptacles beneath the floors of the Magazines (see NATURE, lxiv. p. 13, Fig. 2), have been proved to be chiefly safes for the keeping of treasure ("Annual," pp. 44-5).

The housing-over of the Throne Room has already been referred to. This work was urgently needed to protect the throne, &c., from the weather.

"In order to support the roof it was necessary to place some kind of pillars in the position formerly occu-

soon to acquire some idea of what the palace may have looked like when seen from the opposite eastern downs or from the way leading up from the sea. Mr. Fyfe's restored longitudinal section and plan (Fig. 33) give a very good idea of how the palace descended the eastern slope. On the left is seen one of the most sensational of Knossian discoveries, the quadruple staircase which descended from the Central Court to the Hall of the Colonnades, a hall which reminds one more of a court with *loggia* in an Italian palace than anything else! At the point of the staircase the palace was certainly three and probably four stories high; in fact, three flights of steps still remain. Originally the staircase "consisted of fifty-two stone steps, of which thirty-eight, and the indications of five more, are preserved." The excavation of the lowest flight "was of extraordinary difficulty, owing to the constant danger of bringing down the stairway above. It was altogether miner's work, necessitating a constant succession of wooden arches;" (p. 104).

Down the greater part of this staircase it is now possible to walk, and in doing so the visitor gets a very good idea of the difficulties, already alluded to, which have beset Mr. Evans's work at Knossos, and of the successful way in which he has overcome them. But this heavy kind of work needs money, if it is to be properly carried out: the reader of NATURE who has a guinea or two to spare for archeological purposes could hardly do better than devote them to the Cretan Exploration Fund.

Mr. Evans is of opinion that "the whole result of the most recent excavations has been more and more to bring out the fact that, vast as is the area it embraces, the Palace of Knossos was originally devised on a single comprehensive plan. The ground scheme of a square building, with a central court approached at right angles by four main avenues, dividing the surrounding buildings into four quarters, is a simple conception which, as we now know, long before the days of the later Roman *Castra*, was carried out in the *Terromare* of Northern Italy. . . . The Minoan architect may claim the credit of adapting the same root idea to an organic whole, and fitting it in to a complicated arrangement of halls, chambers, galleries, and magazines, forming parts of a single building" (p. 100).

Further confirmation of the generally accepted date for the earlier parts of the palace, c. 1700 B.C. and later, was found in 1901 by the discovery in the "early Palace stratum," a deposit "containing a large proportion of charcoal, and representing the burnt remains of an earlier structure," and situated "immediately under the Mycenaean wall-foundations, at a depth of 40 centimetres below the later floor-level," of "the lid of an Egyptian alabastron, upon the upper face of which was finely engraved a cartouche containing the name and divine titles of the Hyksôs King Khyan" (see Fig. 1), who reigned somewhere about 1800 to 1700 B.C. The style of the hieroglyphs and phraseology of the inscription show us that this object is contemporary with the king whose name it bears. Therefore the discovery of this object of c. 1800-1700 B.C. may be taken to confirm the weaker evidence of the thirteenth dynasty statuette of Abnub, son of Sebek-user (date c. 2000 B.C.), which was discovered in the course of the excavations of 1900, and with this to indicate roughly the date of the beginnings of the great Palace of Knossos, which is undoubtedly, as its excavator maintains, the veritable Labyrinth of Minos.

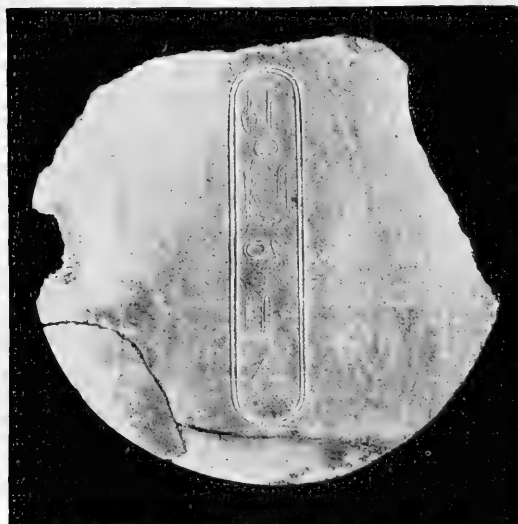

FIG. 1.—Egyptian alabastron-lid, inscribed with the name of the Hyksôs King Khyan (c. B.C. 1800). Found at Knossos.

ried by the Mycenaean columns, the burnt remains of which were found fixed in the sockets of the stone bench opposite the throne."

Accordingly pillars of Mycenaean design were erected, and the whole roofed over. This necessary work of conservation is analogous to that at Dér el-Bâheri: no attempt at "restoration," as it is understood on the Continent, has been made. All who have seen the result can testify that it is entirely successful.

One of the chief results of the excavation is the inking it gives of the great extent of the palace, which seems, in fact, to have not only covered the whole of the knoll on which it stands, but to have descended in a series of several-storied halls and towers down the eastern side of the hill to the bank of the stream which runs below. And now that Mr. Evans has announced the discovery at Knossos this year of contemporary representations of Mycenaean houses we may perhaps be able

The store of Knossian inscribed tablets has been largely increased during the course of the excavations; it is much to be regretted that the Cretan Assembly seems unable to see its way to allow any of these tablets to leave Crete for the purpose of study and possible interpretation.

Our knowledge of Mycenaean life has been increased in a rather startling way by the discovery of a fresco-painting depicting, side by side with the well-known "cowboys" of the common Mycenaean scenes of *ταυροκαθάψια*, of female toreadors in the act of tackling infuriated bulls. Mr. Evans remarks (p. 95):—

"The episode is sensational in the highest degree, but we have here nothing of the mere catching of bulls, wild or otherwise, as seen on the Vaphio Cups. The graceful forms and elegant attire of these female performers would be quite out of place in rock-set glens or woodland glades. They belong to the arena, and afford the clearest evidence that the lords of Mycenaean Knossos glutted their eyes with shows in which maidens as well as youths were trained to grapple with what was then regarded as the king of animals. The sports of the amphitheatre, which have never lost their hold on the Mediterranean world, may thus, in Crete at least, be traced back to prehistoric times. It may well be that, long before the days when enslaved barbarians were 'butchered to make a Roman holiday,' captives, perhaps of gentle blood, shared the same fate within sight of the 'House of Minos,' and that the legends of Athenian prisoners devoured by the Minotaur preserve a real tradition of these cruel sports."

The sinister impression which is given by this discovery is not dispelled by the sight of the deep walled pits, described by Mr. Evans on pp. 35, 36, which are, no doubt, as he says, the dungeons of the palace.

"In these deep pits with their slippery cemented sides above, the captives would be as secure as those 'beneath the leads' of Venice. The groans of these Minoan dungeons may well have found an echo in the tale of Theseus."

One is irresistibly reminded of Watts's picture in the Tate Gallery of the horrible Minotaur leaning over the high battlements of Knossos, looking out to sea, awaiting the bringing of his prey. The civilisation of Knossos was probably by no means Arcadian, even if it was Pelasgic!

The artistic triumphs of this Minoan civilisation are further established by the discoveries of 1901: e.g. the splendid vase illustrated on p. 91 (Fig. 30), the high reliefs in painted *gesso duro* (Figs. 6, 29, pp. 17, 89) which are so characteristic of Knossian art, the carved stone weight (Fig. 12, p. 42), &c.; an interesting hint of costume is given us in Fig. 17, a fresco-painting, presumably of a girl, whose coiffure is exactly parallel to that of the men from *Keftiu*, who are depicted in the Eighteenth Dynasty tomb of Rekhmara at Thebes in Egypt; while the wonderful gaming-board of gold, ivory, crystal, and *kyanos* (Fig. 25, p. 79) tells us something of the minor amusements of the princes of Knossos. A curious find, "which strongly suggests a more seamy side of the high civilisation here represented," is that of "a clay matrix formed by making a stamp from the impression of an actual seal, and which could thus be itself used as a signet for making counterfeit impressions of the same kind. The original of this was evidently a large gold signet-ring of a kind resembling, both in its form and the character of its subject, that found in the Akropolis Treasure of Mycenae. That this, like the other, was a royal signet is highly probable, and what adds to the interest of the matrix is that several clay impressions taken from the original ring were subsequently found in association with a very important deposit of inscribed clay tablets. . . . It would seem that the [counterfeit] clay matrix was actually used for forging the royal signature" (p. 19).

A rather startling discovery was that of a quantity of small bone objects, perhaps for inlay, many of which are inscribed with signs, among which occur most of the letters of the later Greek alphabet, though "the Mycenaean date of these bone pieces is as well ascertained as anything found within the walls of the palace" (p. 119). Here is an enigma.

It is a strange thing, this Cretan civilisation of perhaps the eighteenth to the fourteenth centuries B.C. Mycenaean we know, but this is not Mycenae, though it is "Mycenaean." Knossos is older, and Knossos is more civilised. Knossos is no hill fort, *ἐν μυχῷ*, "Αργεος, like Mycene or Midea; Tiryns is more like it. But Tiryns itself is strongly fortified with galleries and casemates, which even now are wonderful; Knossos, however, seems open to the attack of any enemy. It seems a palace of secure peace, apparently undefended by walls, a palace of luxurious baths and polished dancing-floors, inhabited by princes who seem to have taken their pleasure in the leading of a life of luxurious ease, surrounded by a court of ladies in most amazingly modern low-necked dresses and coiffures like the triumphs of a Regent Street window, and men with hair as long as the women's and almost as elaborately dressed, served by crowds of slaves and tribute bearers, and diverted by the witnessing of brutal sports of the arena, in which women figured as well as men, sports connected possibly with the worship of a cruel deity to whom human sacrifice was not unknown, for whom, perhaps, were incarcerated the victims in the oubliettes, like the holes of the trap-door spider, which exist within the palace walls. Knossos was the seat of the just and mighty Minos: it was also the Labyrinth of the Minotaur.

This is conjecture, but it conveys the impression which Knossos, and also Phaistos and Gournia, give: an impression of an ancient culture, highly developed, peaceful, art-loving and luxurious, effeminate if you will; but brutal withal and possessing sinister traits which oppress the mind.

What overthrew it? What overwhelmed the City of Live-at-Ease with a storm of long-forgotten war, and burnt its halls and towers with fire? The conquering Aryan from the north, probably; but we do not know. Who the Minoans themselves were we hardly know. Dark Pelasgians, of Sergi's "Stirpe Mediterranea," speaking a language akin to that of the Lycians, most probably; identical with the *Keftiu* of the Egyptian tombs, there is no doubt. To one who has not made himself fully acquainted with the details of the subject the thought may occur that these *Keftiu* and the famous Youth with the Vase, or Cupbearer, from Knossos perhaps belonged to some intermediate race (in Northern Palestine, perhaps), which sent tribute on the one side to the dynasts of Knossos, on the other to Pharaoh of Egypt. Such an opinion is easily refuted, as follows:—The Cupbearer is Mycenaean in costume; so are all the other male figures at Knossos; Mycenaean like the men of the Vaphio Cups. And since Knossos was a "Mycenaean" town inhabited by Mycenaean, the probability is that the representations of Mycenaean upon its walls are representations of Cretan Mycenaean. And since it is not "alleged," but is a *fact* well known to all who have eyes to see, that the eighteenth dynasty representations of the *Keftiu* at Thebes are practically identical, even down to minute details of costume, with the Knossian Cupbearer, the natural conclusion is that these *Keftiu* were Cretan Mycenaean. The date thus indicated for the coming of Cretan ambassadors to Egypt is c. 1550 B.C. That they may have come from Knossos or Phaistos is by no means impossible.

The excavations of Mr. Hogarth in a Mycenaean town

¹In "The Oldest Civilization of Greece" the present writer has expressed the view that these *Keftiu* were more probably Cyprian than Cretan Mycenaean. The progress of discovery in Crete has, however, now convinced him that they were more probably Cretan.

at Zakro, on the eastern coast of Crete, identified by Spratt with the site of Itanos, described by him in pp. 121-149 of the "Annual," are of great importance, not only as giving us much new knowledge of Mycenaean house-building, but as throwing light upon the question of Mycenaean connections with Libya. The use of bricks for the upper courses of house-walls is now proved. The bricks were large and flat, the largest measuring $24 \times 16 \times 4$ inches, and "well and squarely laid" (p. 130). In the houses, besides vases; bronze implements, &c., was found a large number (nearly 800) of clay sealings, bearing impressions of intaglios, three of which are figured by Mr. Hogarth (Fig. 45; see Fig. 2 below). These "Minotaur" types are in the highest degree curious. This female figure with a bull's head; this bull-headed woman with a bird's wings and tail—are they mere fanciful designs, or do they point to the veneration of some strange androgynous deity?

However late in the Mycenaean age the existing remains of the settlement may be placed, "these were still anterior to the Age of Iron," says Mr. Hogarth (italics in original). . . . "Nor were any fragments observed of distinctly geometric vases. . . . The fact that the remains . . . come to a clean and abrupt finish with" the close of the Bronze Age, "showing no admixture of remains of the succeeding epoch, is in favour of those who hold that the use of iron and the



FIG. 2.—Clay Seal. Impression from Zakro.

inception of the geometric style resulted from some violent and radical social change in the Ægean, such as conquest by a distinct race" (p. 146). Whether this was an Achaian or a Dorian conquest, Prof. Ridgeway and his critics must settle: personally, we still prefer the second alternative.

The settlement is regarded by Mr. Hogarth as a trading outpost of Knossos, and in view of the objects of Knossian type discovered, this view seems a very probable one.

"Its position," he says (p. 147), "indicates that Zakro traded with Libya direct, and not (as has been supposed) by a circuitous route through Rhodes and Cyprus." While still holding to his view that the circuitous route, by which we know came the great armament which attacked Egypt in Rameses III.'s time, in which it is possible that Cretan Axians were included,¹ was the most likely one for primitive navigators to follow, the present writer is inclined to think that he has, in "The Oldest Civilization of Greece," to some extent underestimated the possibility of direct communication in Mycenaean times between Crete and Libya. The bay of Zakro, remarks Mr. Hogarth (p. 123), "is the best known rendezvous and port of call for the fishing fleets of the eastern islands, which sail annually to the sponge-grounds off the Libyan shore. . . . For sailing craft the bay of Zakro is still the principal station on the road from the Ægean to Libya."

¹ It is true that Axos was an inland town but this was no bar to its having taken part in an over-sea expedition: see also Herodotus, iv. 154, which should not be forgotten.

The argument is a fair one, but we have no certainty that Mycenaean sailors were as familiar with the direct route to Africa as the modern sponge-fishers. The geographical objection to the theory of direct connection, which has been stated to be non-existent, is simply the absence of any coast leading the primitive voyager from Crete to Libya; he would naturally follow the coast round, as the later Greeks went from Greece to Sicily, and not sail south into an open and unknown sea. However this may be, space forbids the further discussion of the point here.

Mr. Hogarth appends a description by Dr. Boyd-Dawkins of proto-Mycenaean dolichocephalic skulls found by him, which the distinguished craniologist pronounces to possess characters which "point unmistakably to the fact that the possessors of the skulls . . . led the artificial life of highly civilised peoples" (p. 151). These skulls are regarded by him as belonging to the long-headed Pelagic or Mediterranean stock of Sergi, which is what we should have expected.

The review of last year's "Annual" spoke of it as "the most important contribution to our knowledge of the early history of mankind that has appeared for many years" (NATURE, lxi. p. 15). It can only be said of this year's number that in interest and importance it suffers very little by comparison with No. VI. H. H.

ALEXANDER KOWALEVSKY.

THE illustrious Russian embryologist and student of the anatomy of lower animal forms, Kowalevsky, died, to the great grief of the whole zoological world, on November 22, 1901, of an attack of apoplexy.

Kowalevsky was one of those rare men whose name is associated by all his contemporaries with a new departure in the branch of science which he cultivated. Albert Kölliker, still alive and well, had as long ago as 1844 followed with his microscope and drawn the division of the single cell constituting the egg of the cuttlefish, and had traced the process of the formation of the mass of embryo-cells by division of the cells resulting from the cleavage of the first or primary egg-cell. Remak, in 1850-58, had traced the evolution of definite tissues from the embryonic cells, and later students of the embryo chick had followed out the earlier indications of von Baer and were busy with the discussion of the origin and outcome of the embryonic layers of cells. But Kowalevsky went further than this, and in small transparent embryos (such as those of Ascidia, Amphioxus, Sagitta and Argiope) traced the history of adult organs cell by cell to the original egg-cell. It is this procedure which must immortalise Kowalevsky. Ten years after his first papers were published, the aim which he had given to embryological science became the definite and recognised purpose of successive generations of embryologists in England, Germany and the United States. Before Kowalevsky's work on the development of Amphioxus, carried out in 1864-65, and on Ascidia in 1866, zoologists were content to regard the cell-masses resulting from the first cell-divisions of the animal egg-cell as intricate heaps of units which no one could expect to analyse. Some way was made in the direction of their comprehension by the application to invertebrate embryos of the doctrine of cell-layers, but it was not until the avowed purpose of the embryologist became the definite tracing of the genesis of the cells of cell-layers one by one from pre-existing cells and finally from the first cell-divisions of the egg-cell that Kowalevsky's work bore its full fruit, and a thorough-going cellular embryology was established. Much still remains to be done on this basis, but we see it clearly foreshadowed in Kowalevsky's great memoirs on the development of Amphioxus and of Ascidia, wherein the identity of the nervous system, the

notochord, the alimentary canal and the primitive branchial slits of those two apparently unrelated animals is shown by the method of tracing the exact derivation of the cells constituting those organs in the two cases.

Kowalevsky published several embryological memoirs on Sagitta, Alcyonians, Holothurians, Argiope, Hydrophilus, Chiton and other forms, in which exact observation of the cell-lineage was his purpose and his result. His writings are singularly free from generalising theory; his delight and his power lay in the making and recording of exact observations destined to build up our understanding of animal structure on a sound basis. His later zoological researches included some minute studies on the anatomy of the vascular system in insects and some novel and important researches on the phagocytes of lower animals. He collaborated for a time with Marion, of Marseilles, and wrote with him on the Neomemans (Solenogastres). He was the discoverer of the planarian dwarf male of Bonellia, and was the first to describe the anatomy of the Balanoglossus of Della Chiaje and to demonstrate its perforate pharynx. In his last years he was occupied with researches on the structure of the leeches (especially the rare and extremely interesting setigerous leeches of the genus *Acanthobdella*) from Russian fresh waters, and on some other strange worm-like forms (the Hedyliidae) from the Sea of Marmora.

Alexander Onufrievitch Kowalevsky was born on November 20, 1840, in a country house situated not far from Witebsk, in the north-west of Russia. His father was a Pole and his mother a Russian. After his early education at home he was placed at the Engineering School of Roads and Highways at St. Petersburg. But he preferred the study of science to a practical career, and entered the faculty of natural sciences of the University. The University disturbances of 1861 obliged Alexander Kowalevsky to quit Russia and pursue his studies abroad. He went in the first instance to Heidelberg, where he was for some time a pupil of Bunsen. He actually published two small memoirs of a purely chemical nature under the guidance of the great German chemist. But very soon Kowalevsky's taste for zoology and comparative anatomy declared itself. After studying with Bronn and with Pagenstecker, Kowalevsky passed on to Tübingen, where he became the assiduous pupil of Leydig (still living and honoured in his old age). It is there that the young Russian learnt histological methods and prepared himself for his delicate researches on the anatomy and embryology of the lower animals. In 1864 he published in Russian his first zoological work, which was entitled "The Anatomy of *Idothea*." The paper contains anatomical details as to this Isopod, which is very common in the Bay of Finland. After having "passed his licentiate" (the equivalent of a bachelor's degree in England) at St. Petersburg, Kowalevsky went in 1864 to Naples with a definitely-thought-out programme of researches on the lower animals. He spent about eighteen months there (there was no Stazione Zoologica in those days), and it is there that he carried out his beautiful researches on the embryology of Amphioxus and of many other marine forms (*Argiope*, *Sagitta*, *Holothurians*, &c.), and also made his important discoveries as to the anatomy of *Balanoglossus* (revealing for the first time its curious branchial structure), which he subsequently published. In 1865 he had to return to St. Petersburg to pass his examination for the degree of "magister zoologiae," and presented his memoir on Amphioxus as his inaugural thesis. He then returned to Naples, and at Ischia in 1866 he made his researches on the development of Ascidia, which he published in the course of the same year. It was this memoir, taken in conjunction with his similar discoveries with regard to Amphioxus, which startled the zoological

world, led to the recognition of the Ascidians as Vertebrata, gave a new impulse and direction to embryological research, and among other things led to the development of the important doctrine of degeneration as applied to other than parasitic animals.

An epitome of Kowalevsky's researches on Ascidia and Amphioxus was written by Prof. Michael Foster at the request of the editors of the *Quarterly Journal of Microscopical Science* in 1870, and zoologists were divided into those who had and those who had not "bowed the knee to Kowalevsky." Kowalevsky, after being for a time "privat docent" at the University of St. Petersburg, was appointed professor extraordinarius at Kazan in 1868, professor ordinarius at Kiev in 1869, and at Odessa in 1874. He remained at Odessa until 1890, when he was made "titular member" of the Academy of Sciences of St. Petersburg. He was professor of histology during two years at the University of St. Petersburg, but later concentrated his activity on the Academy of Sciences and occupied himself much with the biological station at Sebastopol, of which he was director. Besides being a foreign member of the Royal Society, Kowalevsky was a member and correspondent of a great number of scientific academies, and was decorated by the Emperor of Germany with the order "pour le mérite." He was married in 1868 and was the father of one son and two daughters. His son is a chemist, and one of his daughters (Madame Tchistovitch) is a doctor of medicine; the other is married to M. Cheviakoff. The celebrated mathematician Sophie Kowalevsky was the wife of a younger brother of Alexander Kowalevsky, the same who published some valuable work on mammalian paleontology about thirty years ago and died a few years later.

Personally Kowalevsky was a man of retiring disposition, devoted to his microscopic work, and of the most gentle and courteous address. He visited England with one of his daughters in October, 1895, for a few days, but took alarm at the dangers of the London streets and left somewhat abruptly.

The writer is indebted to his and Kowalevsky's friend, Prof. Elias Metschnikoff, of the Institut Pasteur, Paris, for the biographical details above given. Prof. Metschnikoff is preparing a biography of Kowalevsky for publication. A list of Kowalevsky's publications is given below.

E. RAY LANKESTER.

List of Papers by Alexander Onufrievitch Kowalevsky.

- (1) Anatomy of the marine cockroach *Idothea entomon*, and list of the Crustacea which are met with in the freshwaters of the St. Petersburg Government. [In Russian.] (*Estest. Izzlyed. St. Petersburg. zhurn. (Russ. Entomol. Obshchest. S. Petersburg.)*, 1864, Tom. 1.)
- (2) Le développement de *V. Amphioxus lanceolatus*. (*Archives Sci. Phys. Nat.*, xxvii. 1866, pp. 193-195; *Ann. Mag. Nat. Hist.*, xix. 1867, pp. 69-70; *St. Petersburg. Acad. Sci. Mém.*, xi. 1868, No. 4.)
- (3) Beiträge zur Anatomie und Entwicklungsgeschichte des *Loxosoma Neapolitanum*, sp. n. [1865.] (*St. Petersburg. Acad. Sci. Mém.*, x. 1867, No. 2.)
- (4) Anatomie des *Balanoglossus*, Delle Chiaje. [1866.] (*St. Petersburg. Acad. Sci. Mém.*, x. 1867, No. 3; *Ann. Mag. Nat. Hist.* xx. 1867, pp. 230-232.)
- (5) Entwicklungsgeschichte der Rippenquallen. [1865.] (*St. Petersburg. Acad. Sci. Mém.*, x. 1867, No. 4; *Ann. Mag. Nat. Hist.*, xx. 1867, pp. 228-229.)
- (6) Entwicklungsgeschichte der einfachen Ascidien. [1866.] (*St. Petersburg. Acad. Sci. Mém.*, x. 1867, No. 15; *Quarterly Journ. Microsc. Sci.*, x. 1870, pp. 59-69.)
- (7) Untersuchungen über die Entwicklung der Coelenteraten. (Göttingen, *Nachrichten*, 1868, pp. 154-159.)
- (8) Beitrag zur Entwicklungsgeschichte der Tunicaten. (Göttingen, *Nachrichten*, 1868, pp. 401-415; Halle, *Zeitschr. Gesamm. Naturwiss.*, xxxii. 1868, pp. 343-344.)
- (9) Beiträge zur Entwicklungsgeschichte der Holothurien. [1866.] (*St. Petersburg. Acad. Sci. Mém.*, xi. 1868, No. 6.)

(10) Die Entwickelungsgeschichte der Störe. [1869.] (*St. Petersb. Acad. Sci. Bull.*, xiv. 1870, col. 317-325; *Rev. Sci. Nat.*, 4, 1875-76, pp. 146-151).

(11) Weitere Studien über die Entwickelung der einfachen Ascidien. [1870.] (*Archiv. Mikrosk. Anat.*, vii. 1871, pp. 101-130).

(12) Embryologische Studien an Würmern und Arthropoden. [1869.] (*St. Petersb. Acad. Sci. Mém.*, xvi. 1871, No. 12).

(13) Ueber die Vermehrung der Seesterne durch Theilung und Knospung. (*Zeitschr. Wissensch. Zool.*, xxii. 1872, pp. 283-284).

(14) Zur Anatomie und Entwickelung von Thalassema. (*Zeitschr. Wissensch. Zool.*, xxii. 1872, p. 284).

(15) Ueber die geschlechtslose Fortpflanzung des *Amarocidium*. (*Zeitschr. Wissensch. Zool.*, xv. 1872, p. 285).

(16) Ueber die Knospung der Ascidien. (*Archiv. Mikrosk. Anat.*, x. 1874, pp. 441-470).

(17) Sur le bourgeonnement du *Perophora lysteri*, Wieg. [Trad.] [1874.] (*Rev. Sci. Nat.*, iii. 1874-75, pp. 213-235).

(18) Ueber die Entwickelungsgeschichte der Pyrosoma. (*Archiv. Mikrosk. Anat.*, xi. 1875, pp. 597-635).

(19) Du développement des Actinies. [Trad.] [1875.] (*Rev. Sci. Nat.*, iv. 1875-76, pp. 15-26).

(20) Du mâle planariiforme de la Bonélie. (*Rev. Sci. Nat.*, iv. 1875-76, pp. 313-320).

(21) Weitere Studien über die Entwickelungsgeschichte des *Amphioxus lanceolatus*, nebst einem Beiträge zur Homologie des Nervensystems der Würmer und Wirbelthiere. (*Archiv. Mikrosk. Anat.*, xiii. 1877, pp. 181-204).

(22) Ueber die Entwickelung der Chitonen. Vorläufige Mittheilung. (Carus, *Zool. Anzeiger*, ii. 1879, pp. 469-473).

(23) Zur Entwickelungsgeschichte der Alcyoniden *Symphodium coralloides*, M.-Edw., und *Clavularia crassa*, M.-Edw. (Carus, *Zool. Anzeiger*, ii. 1879, pp. 491-493).

(24) Weitere Studien über die Entwickelung der Chitonen. (Carus, *Zool. Anzeiger*, v. 1882, pp. 307-310).

(25) Observations on the Development of Brachiopods. [In Russian.] (Moscow, *Soc. Sci. Bull.*, xiv. 1874, pp. 1 (bis)-40 (bis)).—[Abstract.] (*Archives Zool. Exper.*, i. 1883, pp. 57-76).

(26) Note on the author's journey to the Caspian Sea. [In Russian, 1869.] (*Kiev Soc. Nat. Mém.*, i. 1870, pp. 19-20).

(27) Note on the structure of the alimentary canal in the *Dendrocoela*. [In Russian, 1869.] (*Kiev. Soc. Nat. Mém.*, i. 1870, pp. 109-110).

(28) Contribution to the embryology of the shark, from observations on *Mustelus laevis* and *Acanthias vulgaris*. [In Russian.] (*Kiev Soc. Nat. Mém.*, i. 1870, pp. 163-187).

(29) Development of the ova in *Sterna-pis thalassenoidea*, Otto. [In Russian.] (*Kiev Soc. Nat. Mém.*, i. 1870, pp. 287-290).

(30) Contribution to the embryology of *Amphioxus lanceolatus*. [In Russian.] (*Kiev Soc. Nat. Mém.*, i. 1870, pp. 327-338).

(31) Contribution to the embryology of the tortoise *Emys europaea*. [In Russian.] (*Kiev Soc. Nat. Mém.*, i. 1870, pp. 378-385).

(32) Preliminary report to the Society of Naturalists of the Vladimir University on measurements in the Black Sea. [In Russian.] (*Kiev Soc. Nat. Mém.*, iii. 1873; *Proc.*, pp. 33-37).

(33) Observations on the development of the Coelenterata. [In Russian.] (Moscow, *Soc. Sci. Bull.*, x. No. 2, 1874, pp. 1 (bis)-38 (bis)).

(34) *Neomenia gorgonophila*. [In Russian, 1880.] (Moscow, *Soc. Sci. Bull.*, xxxvii. No. 1, 1881, pp. 181-186).

(35) Embryogénie du *Chiton politii*, Philippi, avec quelques remarques sur le développement des autres chitons. (*Marseille Mus. Ann.*, i. 1883, No. 5, 46 pp.).

(36) Etude sur l'embryogénie du Dentale. (*Marseille Mus. Ann.*, i. 1883, No. 7, 54 pp.).

(37) On the history of the development of the Chitons. Preliminary communication. [In Russian.] (*Zapiski Novoross. Obshchest. Estest. Odessa*, Tom. viii. pt. 1, 1882).

(38) On the preparation of the organs of some insects, spiders and centipedes. [In Russian.] (*Zapiski Novoross. Obshchest. Estest. Odessa*, xiv. pt. 2, 1889).

(39) Observations sur les organes excréteurs des animaux invertébrés. (*Zapiski Novoross. Obshchest. Estest. Odessa*, xiv. pt. 1, 1889).

(40) On the spleen of Mollusca. [In Russian.] (*Zapiski Novoross. Obshchest. Estest. Odessa*, xv. pt. 2, 1890).

(41) Ein Beitrag zur Kenntniss der excretionsorgane der Pantopoden. (*St. Petersb. Acad. Sci. Mém.* xxxviii. 1892, No. 12).

(42) Einige Beiträge zur Bildung des Mantels der Ascidien. (*St. Petersb. Acad. Sci. Mém.*, xxxviii. 1892, No. 10).

(43) Une nouvelle Glande lymphatique chez le Scorpion de l'Europe. (*St. Petersb. Acad. Sci. Mém.*, v. 1897, No. 10).

(44) Etudes anatomiques sur le genre *Pseudovermis*. (*St. Petersb. Acad. Sci. Mém.*, xii. 1901, No. 4).

(45) Phénomènes de la fécondation chez l'*Haementeria costata*, Müller. [In Russian.] (*St. Petersb. Acad. Sci. Mém.*, xi. 1901, No. 10).

(46) With Barris (Jules), Matériaux pour servir à l'histoire de l'Anchinie. (Robin, *Journ. Anat.*, xix. 1883, pp. 1-23; *Ann. Mag. Nat. Hist.* xii. 1883, pp. 1-20).

(47) With Marion (A. F.), Etudes sur les Neomenia. [1881.] (Carus, *Zool. Anzeiger*, v. 1882, pp. 61-64).

(48) With Marion (A. F.), Sur le développement des Alcyonaires. (Paris, *Acad. Sci. Compt. rend.*, xcv. 1882, pp. 562-565).

(49) With Marion (A. F.), Documents pour l'histoire embryogénique des Alcyonaires. (*Marseille Mus. Ann.*, i. 1883, No. 4, 50 pp.).

(50) With Marion (A. F.), Contributions à l'histoire des Solenogastres, ou Aplacophores. (*Marseille Mus. Ann.*, iii. 1887, No. 1, pp. 76, 7 pls.).

(51) With Ovsyannikov (F. V.), Ueber das Centralnervensystem und das Gehörorgan der Cephalopoden. [1866.] (*St. Petersb. Acad. Sci. Mém.*, xi. 1868, No. 3).

(52) With Shulghin (M. A.), Zur Entwickelungsgeschichte des Kaukasischen Scorpions, *Androctonus ornatus*. Preliminary communication. [In Russian.] (*Zapiski Novoross. Obshchest. Estest. Odessa*, xi. pt. 1, 1866, pp. 39-55).

And quite recent papers on leeches (*Acanthobdellidae*) and on the curious worm-like Gastropods, the *Hedyllidae* of the Sea of Marmora and Black Sea, published in the *Transactions* of the Imperial Academy of Sciences of St. Petersburg (the latter since his death).

NOTES.

THE Berlin official *Keichsanzeiger* announces that the order "Pour le Mérite" has been conferred upon Lord Avebury and Prof. A. Agassiz, of Harvard University.

THE Hugh Miller centenary will be celebrated at Cromarty to-morrow, August 22. At the public meeting addresses will be given by Mr. Arthur Bignold, M.P. (chairman), Sir Archibald Geikie, F.R.S., the Right Hon. James Bryce, M.P., Principal Rainy, D.D., and Prof. J. M. Clarke, of Albany, New York.

THE *Daily Mail* reports that millions of winged ants descended on the Bohemian watering-place of Tepitz in a dense cloud on Saturday, August 16. At Brussels also there were swarms of ants, and the streets in some places were so thickly strewn with their bodies that the firemen had to be called out to wash them away.

A REUTER message from Yokohama states that the small island of Tori Shima, which is one of a chain extending between the Bonin Islands and the main island of Japan, was overwhelmed by a volcanic eruption between August 13 and August 15. There were about 150 inhabitants, and the whole of them appear to have perished. The island is covered with volcanic débris and all the houses have disappeared. The eruption was still proceeding on August 18, together with a submarine eruption in the vicinity of the island, and passing vessels report that the place is dangerous of approach.

THE manager of the Eastern Extension, Australasia and China Telegraph Company sends us the following extract from a letter received from the superintendent at Banyuwangi, Java, dated July 6:—"The Roaang volcano, which is about thirty-five miles from

Banyuvangi to the west, and has the appearance of being much closer, is, as a rule, very quiescent, only a very slight column of smoke being visible. On May 1 it commenced to throw up large columns alternately of black and white cloud, the whole mountain being at times quite hidden with the cloud. This continued until May 4, when it again assumed its usual peaceful appearance. It is curious that this should have occurred about the same time as the big affair in the West Indies." Since about the end of April, reports of volcanic eruptions, earthquakes and other disturbances apparently connected with them have been received almost every day. It is suggested by the *Newcastle Daily Chronicle* that the numerous colliery explosions which have recently been recorded may have some relationship with the seismic disturbances, and that a commission should be appointed to bring together the records of eruptions and earthquakes with a view to determine whether they have any connection with the occurrence of explosions in coal mines. Whatever may be the result of such an inquiry, there are many indications that the present year is an abnormal one in several respects.

The death is announced, from Vienna, of Dr. Leopold Schenk, formerly professor of embryology and author of a work on the artificial determination of sex by means of diet.

A REUTER message from Bulawayo states that further discoveries have been made in the great ruins at Zimbabwe. Two ancient ascents leading up to the citadel have been found, and the citadel itself has been cleared. An old stairway was also discovered, and various objects, including gold bangles and pieces of pottery, were found. One of the passages which was penetrated for the first time is 994 feet in length.

We learn from the *Times* that Prof. Barbosa Rodrigues, director of the Botanical Garden of Rio de Janeiro, has arrived in England on a short visit. The Brazilian Congress has voted a considerable sum for the printing of his work "*Sertum Palmarum*," in which he describes 160 species of palm trees, entirely new and discovered by himself in his journeys in the interior of Brazil for more than thirty years, the letterpress to be accompanied by large coloured plates drawn in the places where each species grows spontaneously.

SOME time ago it was decided by some of Mr. Nicholson's friends and colleagues to offer him, privately, on the occasion of his retirement from the Curatorship of the Royal Gardens, Kew, some tangible evidence of the high regard in which he is held. We now learn from the *Gardeners' Chronicle* that the committee formed to carry out the proposal received contributions sufficient to purchase several articles to remind Mr. Nicholson of his old friends, among them being a salver bearing this inscription:—"Presented to George Nicholson, V.M.H., late Curator of the Royal Gardens, Kew, by his friends and colleagues, who, while admiring his qualifications as a man of science and a gardener, have a warm appreciation of his worth as a friend. 1902."

The *Times* announces that the following prizes have been awarded for essays on subjects connected with tropical diseases:—

- (1) A prize of the value of 10*l.*, entitled the Sivewright prize, presented by Sir James Sivewright for the best article on "The Duration of the Latency of Malaria after Primary Infection, as proved by Tertian or Quartan Periodicity or Demonstration of the Parasite in the Blood," awarded to Dr. Attilio Caccini, assistant physician, Hospital of Santo Spirito in Sassia, Rome.
- (2) A prize of the value of 10*l.*, entitled the Bellios prize, presented by the Hon. E. R. Bellios, C.M.G., for the best article on "The Spread of Plague from Rat to Rat, and from Rat to Man by the Rat-flea," awarded to Dr. Bruno Galli-Valerio, professor in the University of Lausanne, Switzerland. The

prize of the value of 10*l.* entitled the Lady Macgregor prize, presented by Lady Macgregor for the best article on "The best Method of the Administration of Quinine as a Preventive of Malarial Fever," was not awarded. The judges were Surgeon-General Rose Hooper, president Medical Board, India Office, Colonel Kenneth MacLeod and Mr. Patrick Manson, F.R.S.

AT the forthcoming meeting of the British Association the address of the president of the Section of Anthropology, Dr. A. C. Haddon, F.R.S., will deal with the wide subject of totemism, and may be expected to lead to discussion; other folklore papers are offered by Mr. T. N. Annandale, on the popular religion of the Malays of Patani; by Rev. J. H. Holmes, on the religious ideas and initiation ceremonies of the natives of the Papuan Gulf; by Mr. E. S. Hartland, on the stone of destiny at Jara, and the appointment of a king by augury; and by Mr. F. T. Elworthy, on perforated amulets. Archaeology, especially British, will be well represented. Mr. W. J. Knowles has a paper on plateau-impliments from interglacial gravels, and a series of exhibits illustrating the manufacture of stone implements; Miss Layard describes a new Paleolithic site at Ipswich; Messrs. Clinch, Fennell and MacRitchie discuss the significance of British underground dwellings of Neolithic and later periods; and Mr. Coffey describes the Irish equivalents of the Hallstatt period of culture, in relation to the introduction of iron in western Europe. There is an important paper on the types of British Neolithic pottery by the Hon. John Abercromby, and a full report of this year's excavations at Silchester and in Crete. Physical anthropology will be represented only by Prof. D. J. Cunningham's paper on the Irish giant, whose skeleton will be present, and by a few minor exhibits of an anatomical kind; but there will be several important papers in descriptive ethnography; on the Lolos of Szechuan, by Mr. Augustine Henry; on the Nagas, by Dr. Furness, of Philadelphia; and on the races of the Malay Peninsula, by Messrs. Annandale and Robinson. A paper by Dr. Graham on the mental and moral characteristics of the people of Ulster is likely to lead to some discussion. Important reports will be presented by the committees on the age of stone circles, on Canadian ethnography, and on the teaching of anthropology in Great Britain and elsewhere.

We are glad to note the formation of an Imperial Vaccination League. The Vaccination Act of 1898 will expire at the end of 1903, and from this it follows that legislation of some kind will be necessary next year. The League desires mainly to assist the community to study carefully certain possible amendments of the 1898 Act. Foremost of these is the necessity for obligatory revaccination of school children at a specified age. This practice is universal in Germany, and to it the freedom of that country in recent years from epidemic small-pox must be assigned. The League will also consider the question whether the entire supply of glycerinated calf-lymph should not be guaranteed and regulated by some public authority. In Germany fifty-five millions of people are supplied by twenty-two State laboratories; Great Britain and Ireland, with forty millions of people, have but one. The League intends to put its views upon these subjects before members of both Houses of Parliament and to circulate literature. For this purpose it appeals for funds, which may be sent *inter alia* to Dr. Edwardes, at the offices, 53 Berners Street, W.

AN interesting address was given by Sir James Crichton Brown, the president of the Sanitary Inspectors' Association assembled last week at Middlesbrough. Sir James referred to the rôle played by flies in the propagation of disease. Leaving aside the researches concerning the part played by the Anopheles in malarial infection, he confined his attention to the common house-fly. "This most fearless and audacious of all creatures" is probably the carrier of many varieties of bacterial infection.

It appears that cultures of many pathogenic organisms have been obtained recently from the excreta of the common house-fly, *Musca domestica*. The rôle played by these insects in the dissemination of enteric fever in South Africa was referred to, and Sir James remarked that one of the collateral advantages of our campaign in South Africa might prove to be the opening of our eyes to the part played by flies as disease mongers. The enormous fertility of the ordinary fly forms one of the chief obstacles to its extermination; it has been calculated that one female fly may have 25,000,000 descendants during one season.

MESSERS. COOK, the tourist agents, have put forward a proposal to run an electric railway to the crater of Vesuvius from the Naval Arsenal in Naples to take the place of the funicular railway now used. The Faculty of Science in the University of Naples has forwarded a strong protest against the scheme to the Italian Government, on the grounds that it would interfere with the seismic and magnetic observations and records which are made at the University.

The lecture delivered by Mr. J. Swinburne before the Incorporated Gas Institute, on the electrolysis of gas mains, is a valuable and impartial *résumé* of the whole subject. Few will disagree with the conclusion that the question is not really settled, and that although electrolysis undoubtedly takes place it is hardly possible at present to say whether it is serious or not. Mr. Swinburne urges the gas and water companies to watch carefully; should serious corrosion be observed some means must be found of making those who are responsible pay for the damage, though it is to be feared there will be difficulty in fixing the responsibility in towns, such as London, where there are a number of electric tramways and railways. The lecture is reprinted in the last two issues of the *Electrician*.

It is proposed to work electrically that part of the New York Central Railway which runs through the city, the principal motive for the conversion lying in the fact that two miles of the track are in a tunnel. The scheme involves the electrification of thirty miles of track, at a cost of nearly three million pounds, and requires a power station with an output of 100,000 h.p. As a result of tests with a dynamometer car on a portion of the lines, estimates of the cost of working with different electrical systems have been prepared. These are embodied in a paper read by Mr. D. J. Arnold before the American Institution of Electrical Engineers. Local conditions have largely determined what system should be recommended, and that which works out cheapest has in consequence not been chosen. The one selected comprises a combined alternating- and direct-current generating station near the outer end of the line and a substation at the other end, with batteries in both. The alternate-current transmission is at 11,000 volts and the direct-current working pressure is 600 volts. The total cost with this system is estimated at 23'63 cents per locomotive-mile as against 24'18 cents with steam. The economy is little enough, and would not be sufficient to justify the conversion unless there were other considerations. The *Electrician* justly points out that the scheme, if adopted, can hardly fail to be merely the stepping-stone to the complete conversion of the whole railway.

A PAPER has been contributed to the *Lombardy Rendiconti*, xxxv. 15, by Dr. Edoardo Bonardi, in which the author asserts his disbelief in the existence of specific characters in bacteria, and considers that a curative serum has no rigorously specific action, but that its action in curing infectious diseases consists in its strengthening the animal organism against the attacks of disease germs.

FROM Prof. Garbasso we have received the reprint of a note communicated to the *Atti* of the Italian Electrotechnical Asso-

ciation on the condition under which two conductors arranged in multiple arc are equivalent to a single conductor when self- and mutual-induction are taken into account. A more general discussion of the discharge of a condenser by n wires arranged in parallel is given by the same author in the *Annalen der Physik*, 8.

In acoustics it is common to measure large intervals of pitch in octaves and smaller ones in "commas," M. A. Guillemin proposes to adopt instead of these units the *savart* and the *millisavart*. By the savart is meant an interval of ten to one, which equals three octaves plus a major third. The millisavart, which is the thousandth part of the savart, represents the interval between two French standard diapasons giving one beat per second.

WE have received a reprint from the *Astronomical Journal*, for January, of Dr. G. Johnstone Stoney's paper on the effect of meteoric deposits on the length of the terrestrial day. It deals exclusively with the effects so far as they are due to an alteration of the moment of inertia of the earth, the object being to show that when the earth's compressibility is taken into account the increase in the moment of inertia is much smaller than would appear from calculations in which this influence is omitted.

In a preliminary note contributed to the *Atti dei Lincei*, 9, Dr. Quirino Majorana describes certain novel magneto-optic phenomena. The analogy of Kerr's phenomenon has suggested that when a substance possessing magnetic properties is placed in a field of force, the state of strain set up should give rise to double refraction. Dr. Majorana has investigated this magnetic double refraction, which he finds exists in a small degree in ferrous chloride and to a greater extent in dialysed iron or ferric oxide in colloidal suspension. But another phenomenon was observed, particularly in solutions of ferric chloride that had acted on hydrates of iron. This phenomenon consisted in a rotation of the plane of polarisation when this plane was neither parallel nor normal to the lines of force. In each case the direction of the incident light was perpendicular to the lines of force, and if the direction of polarisation was either parallel to or perpendicular to the lines of force, no phenomenon of the kind considered was observed, while, on the other hand, the effect was a maximum when the direction of polarisation made an angle of 45° with these lines, and it consisted in a rotation of the plane of polarisation which the author describes as positive when its direction is towards the lines of force. For this phenomenon the name of bimagnetic rotation is proposed.

THE report of the director of the Liverpool Observatory for the year 1901 has been published, by order of the Mersey Docks and Harbour Board, and contains the usual daily results of meteorological and other observations, which are the more valuable from the fact that they have been continued and carefully prepared for a long series of years. The Observatory lies within the area of the usual tracks of our prevalent westerly gales, and this is doubtless one reason for the special attention that is given to wind observations; these embrace anemometrical records of the horizontal motion of the air and the extreme pressure on the square foot. In addition, the tables show the maximum daily velocities recorded on a Dines's pressure-tube anemometer, and thus afford a valuable check on the registrations of the ordinary instruments. In addition, to the regular work of a first-class observatory we observe that telegrams are forwarded daily to the Meteorological Office for use in the preparation of weather-forecasts and storm-warnings, and that special observations of clouds are supplied in connection with the monthly international balloon ascents, which are frequently noticed in our columns. The earth disturbances that have been registered during the year have also been carefully collated.

WE have received vol. xliii. part 2 of the *Annals of the Astronomical Observatory of Harvard College*, containing observations and investigations made at the Blue Hill Meteorological Observatory at Massachusetts in the years 1899 and 1900 under the direction of Dr. A. Lawrence Rotch. The first five tables include the observations made twice daily, together with summaries of them both at the base and valley stations, and a summary of visibility of objects in different azimuths; all these refer to the year 1899, while similar information is brought together in tables vi. to x. for the year 1900. Tables xi. to xiii. give general summaries for the lustrum 1896-1900, and table xiv. is devoted to phenomena which show the advance of the seasons for the 15 years 1886-1900. Appendix A. contains a very interesting study of the visibility of distant objects 18 to 40 miles away in different azimuths, based on observations made during the years 1896-1900. A very valuable series (1851-1900) of temperature observations made at Milton is discussed in Appendix B.

IN No. 3 of vol. ii. of the *Journal of Hygiene*, Dr. Ritchie continues his interesting *résumé* of "Current Theories on Immunity." Mr. Irons discusses the value of neutral-red in water-examination, and concludes that used alone this method is likely to give misleading results. Dr. Savage, in an interesting paper on the presence of the *Bacillus coli* in drinking waters, gives some useful data for estimating the significance to be attached to this organism. Post-scarlatinal diphtheria is dealt with by Dr. Pugh in an exhaustive paper; vital statistics are represented by Dr. Hayward, who writes on the construction and use of life-tables; and the diseases of tropical countries are dealt with by Major Aldridge, R.A.M.C., and Dr. Stanley, who contribute papers on "Enteric Fever and Sewage Disposal" and on "Beriberi" respectively, and the number concludes with an obituary notice on Dr. Thurburn Manson. Every number of this comparatively young journal hitherto published covers a wide field and contains many valuable contributions.

HAVING regard to the varied opinions that have been expressed relative to the thermal death point of the tubercle bacillus in milk (see NATURE, vol. lxiii. pp. 166, 205 and 353), a paper by Mr. H. L. Russell (*Philad. Med. Journ.*, November 16, 1901) on bovine tuberculosis and milk supplies is worthy of note. Milk was infected with tubercle bacilli from cultures and was then pasteurised in a rotating commercial pasteuriser, and after treatment the milk was tested by inoculation. It was found that even a ten-minutes' exposure at 60° C. was sufficient to destroy the vitality of the tubercle bacillus so thoroughly that no trace of disease developed in the inoculated animals. In an open vessel, however, a fifteen minutes' exposure had no effect. This difference seems to be due to the film which is formed when milk is heated in an open vessel. Provided the pasteuriser be closed so that no film forms, a temperature of 60° C. acting for not less than ten minutes, preferably for 20-30 minutes, is sufficient to destroy the infective properties of tuberculous milk, while such treatment hardly alters the flavour and nutritive qualities.

THE voluminous reports annually issued by the various experimental stations as well as by the central Government are proofs of the fostering care exercised by the State for agriculture in the United States. In an excerpt from the "Eighteenth Annual Report of the Wisconsin Agricultural Experimental Station," 1901, which has recently reached us, among other valuable papers is one by Messrs. Babcock and Russell upon the "Causes Operative in the Formation of Silage," and the view is expressed that the changes which lead to silage production are hardly explicable on the theory that these are caused by the growth of micro-organisms, but rather that the internal processes

of the living plant cells themselves are the factors which inaugurate the series of changes that result in the formation of typical silage.

TO the July number of the *New Phytologist*, Prof. F. W. Oliver contributes an article on "Gymnospermous Seeds," in which he traces a suggestive connection, possibly phylogenetic, between the fossil types Lagenostoma and Pachytesta and the existing genus Torreya. The examination of rhizomic material of the unique fern *Matonia pectinata* collected by Mr. Tansley on Mount Ophir forms the subject of some notes by Miss G. Wigglesworth. The arrangement of concentric steles differs in some respects from the specimen collected in Borneo and described by Mr. Seward. The notice by Mr. V. H. Blackman of a recently published monograph, by Mr. H. Lohmann, on Coccoliths will be useful to those botanists to whom the original memoir is not available. The revised classification of the green Algae undertaken by Mr. F. F. Blackman and the editor is continued. It was the expressed desire of the editor that the correspondence columns should form a medium for the communication and discussion of educational matters. The attention of teachers may well be directed to the account of a trial of the heuristic method in a secondary school, as well as to a letter which points out the adaptability of systematic botany to meet the requirements of instruction for children.

WE regret that in our last week's issue the name of the fossil Austrian rhinoceros described by Prof. Toulou was given as *Rhinoceros sumatrensis* instead of *R. hundsheimensis*.

WE have received a useful paper on American insects injurious to agriculture and horticulture and insecticides, by Mr. C. P. Gillette, forming *Bulletin* No. 71 of the experiment station of the Agricultural College of Colorado.

IN a paper published in the *Mémoires* of the Royal Institute of Lombardy (vol. xix. part 7) Dr. A. Negri claims to have discovered in the red blood-corpuscles of mammals a special substance which is abundant during foetal life and gradually diminishes with advancing age.

THOSE remarkable horned ungulates the titanotheres, of the Oligocene of North America and Eastern Europe, are shown by Prof. Osborn (*Bull. Amer. Mus.*, vol. xvi. art. 81) to be divisible into four branches, or "phyla," characterised by the proportion of the length to the breadth of the skull, and in some cases by the relative length of the limbs. In this respect they resemble the rhinoceroses, the various "phyla," as in the case of the latter, being regarded by the author as representing as many genera.

PROF. OSBORN'S studies of the groups just referred to have led him to take into consideration (*Bull. Amer. Mus.*, vol. xvi. art. 7) the morphological importance of length or shortness in the skulls of mammals—dolichocephalism and brachycephalism—and he concludes that both these features are characteristic of specialised types, the former condition being (as in the horse) often, although not invariably, connected with length of limb and neck, and adaptation to speed, while brachycephalism may be correlated with short limbs and an abbreviated neck. Exceptions to this rule, as exemplified by the cats, are due to special adaptive causes. It may be added that, in a paper published in the *Comptes rendus* of the late Geological Congress at Paris, Prof. Osborn figures a restoration of an American ancestral form of the horse nearly related to the English Eocene Hyracotherium; the animal is represented as fully striped.

IN their recently issued Report the Royal Commissioners strongly urge the necessity for a central authority to have control of the whole of the salmon fisheries of Great Britain, or even of the United Kingdom. As a temporary measure a

controlling authority of sufficient independence might be obtained by a modification of the present departmental arrangements in each of the three countries of the kingdom; but a single department to have charge of all questions connected with salmon-fishing in both seas and rivers is what is really wanted. Whether, however, the control be triple, dual, or single, it is essential that the holder of the office should himself be an expert on matters connected with salmon and salmon-fishing, and that his time should not be frittered away by attention to official details. The second section of the report deals with the life-history of the salmon, which is set forth in considerable detail. The Commissioners point out many deficiencies in our knowledge of this subject, such as whether fish entering rivers at different seasons of the year frequent particular branches or parts of the main river at spawning time. Information is likewise much needed with regard to the migration of kelts, and still more so concerning the history of the fish, both in its immature and adult condition, during its sojourn in the ocean. Experiments have shown that while a certain number of fish return to the rivers they left, others seek fresh spawning-grounds; and it will be obvious that fuller information on this point is of prime importance before steps are taken for the improvement of the fishery in any given district. In regard to the general idea of the deterioration of salmon-fisheries, the Commissioners are extremely cautious, stating that "it is useless to attempt to submit the popular belief that there has been a deterioration to any severe test. We can only accept the fact that such belief exists."

THE parliamentary Blue-book just issued on the working and expenditure of the British Museum for the past year shows that important additions have been made to the natural history collections at South Kensington, and considerable improvements effected in regard to the arrangement of the specimens exhibited to the public at that branch. It is satisfactory to learn that, in cooperation with the Trustees, the Egyptian Government vigorously carried on the survey of the fishes of the Nile during the year, nearly 700 miles of the river having been examined, resulting in the acquisition of several new generic and specific types. In the spring of 1901 Dr. Smith Woodward was dispatched by the Trustees to explore the well-known mammaliferous beds of Pikermi, Attica, with the result that a fine series of remains from this horizon (previously very poorly represented in the collection) was acquired for the Museum. During a visit made to the Fayum district of Egypt in company with Mr. Beadnell, of the Geological Survey of Egypt, Dr. Andrews was fortunate enough to be the joint-discoverer of a hitherto unknown Tertiary vertebrate fauna of remarkable interest. Collections were also made under the auspices of the Trustees in Tripoli. In the Museum itself a section of economic zoology has been established. Among other acquisitions, the collection has been enriched by the magnificent series of birds' eggs bequeathed by the late Mr. Crowley, as well as by the gift of Lord Walsingham's unrivalled cabinet of micro-Lepidoptera and library pertaining to the same. The elephant-seal presented by Mr. Walter Rothschild is likewise a notable addition, which is exhibited in a case (also the gift of the same benefactor) with the Antarctic seals presented by Sir G. Newnes. The series of domesticated animals has been largely increased; and much progress has been made in arranging and mounting the collection of recent mammals and birds according to modern ideas. The insect collection—both in the public galleries and in the study rooms—has likewise claimed a large share of attention on the part of the staff. Indeed, the whole Natural History Branch of the Museum is to be congratulated on a good record of progress.

THREE pamphlets for the information of the islanders have recently been published by the Imperial Department of Agri-

culture for the West Indies. No. 14, by Mr. Maxwell-Lefroy, deals with "Screw Worm in Cattle at St. Lucia." In October last it was reported to the Department that a "fly maggot" was causing injury to cattle in the island. Mr. Hudson, the agricultural instructor, made careful observations of the habits of the fly and the extent of the injuries it inflicted, and Mr. Maxwell-Lefroy, on the suggestion of the administrator, visited St. Lucia to investigate the matter personally. The fly proved to be the "screw worm" of the southern United States, and also widely distributed in the West Indies. The pamphlet is devoted to the life-history of the worm, its mode of attack, the treatment of the wounds, prevention, &c. No. 15 is entitled "Plain Talk to Small Owners at Montserrat," being the substance of an address to the small cultivators in the island by Mr. Watkins, the Commissioner of Montserrat. In a small compass much information is conveyed in simple language on the value of the soil, manuring, the cultivation of foodstuffs for home consumption and for export, the regulation of the quality of fruit for exportation, bee-keeping and other subjects. No. 16 is by the same authority, "Hints on Onion Cultivation," also an address to the small cultivators of Montserrat. Based on experiments carried on during the past two years on the island, the prospects of the onion industry are considered to be distinctly promising, and this little brochure of twenty-five pages, which gives the essential particulars at every stage, from the selection of soil and seed to harvesting, packing and shipping, should prove invaluable, not only to the onion growers of Montserrat, but also to those of the other islands where the industry is being introduced.

FOR several years past explorations have been carried on by the Geological Survey of Canada in the North-West Territory, chiefly in the Belly River formation of Assiniboia and Alberta. This formation underlies the Fox Hills-Ft. Pierre Group, and is, therefore, Mid-Cretaceous, as distinguished from the Upper Cretaceous Laramie of Wyoming and Colorado, which overlies these marine beds. It thus enables an examination to be made of the characters of the Mid-Cretaceous land fauna of North America. The fossils have been collected by Mr. Lawrence M. Lambe, who has also prepared and figured them. The manuscript report upon this collection, entitled "On Vertebrata of the Mid-Cretaceous of the North-West Territory," has just been completed under the direction of Prof. Osborn. It includes two parts, the first a general introduction entitled "Distinctive Characters of the Mid-Cretaceous Fauna," by Prof. Osborn, the second entitled "New Genera and Species from the Belly River Series, Mid-Cretaceous," by Mr. Lambe. It will be illustrated by twenty-one plates and a large number of text figures, and will appear from the press of the Canadian Geological Survey early in the autumn. The comparison of these Belly River Dinosaurs, especially the Iguanodonts and horned Dinosaurs or Ceratopsia, with those of Montana appears to demonstrate that a part at least of the Montana fauna is contemporaneous with the Belly River and represents an older horizon than the Laramie of Wyoming described by Marsh. The Belly River contains some of the older Jurassic families, which, so far as known, are wanting in the Laramie. The Montana fauna has hitherto been regarded as contemporaneous with the Wyoming and Colorado Laramie fauna, but there do not appear to be adequate grounds for this opinion in the vertebrates now known.

In the April number of the *Journal of Physical Chemistry* is a paper by Mr. J. E. Mills in which several interesting applications of the kinetic theory of gases are made. By considering the transition from the liquid to the gaseous state in a particular way, an equation is obtained in which all the quantities are measurable, and it affords an experimental test of the

assumption that the molecular attraction varies inversely as the square of the distance from the molecule and does not vary with the temperature. This assumption is found to be in agreement with the experimental data as tested by the equation. It is further shown in the paper that the molecular attraction differs from the attraction of gravity in being determined primarily by the chemical constitution of the molecule and not by its mass.

In the July number of the *American Chemical Journal*, Messrs. Morse and Frazer give an account of their experiments on the preparation of cells for the measurement of high osmotic pressures. Osmotic-pressure determinations are well known to be attended with considerable difficulties, and the number of experimenters who have succeeded in carrying out the measurement of even low osmotic pressures is comparatively small. Specially constructed porous cells made of fine materials, very uniformly mixed and hard burned, were employed, and the semipermeable membranes were produced in these by electrolysis. The electrical resistance of the membranes so obtained varied very considerably, the lowest resistance being about 3000 ohms and the highest more than 200,000 ohms. From the observations made by the authors it appears that high-resistance membranes are those which are requisite for successful osmotic-pressure measurements, but no certain method of obtaining such membranes has been discovered. Experiments were carried out with half-normal and normal cane-sugar solutions. For the former the osmotic pressure was found to be about 1375 atmospheres, and for the latter a lower limit of 314 atmospheres was determined. It is extremely interesting to note that this osmotic pressure of more than thirty atmospheres was developed within two hours of commencing the experiment, and that the membrane within the cell had a resistance of more than 200,000 ohms.

ALTHOUGH the electrochemical equivalent of silver has been the subject of several very careful investigations, the results obtained by different experimenters indicate that the quantity of silver deposited by a given quantity of electricity is dependent to a certain small extent on the form of voltmeter and on the conditions under which this is employed. Messrs. Richards and Heimrod (*Zeitschrift für physikalische Chemie*, vol. xii. p. 302) have investigated minutely the cause of these differences, and find that the most important disturbing factor in the ordinary silver voltmeter is the formation of a complex silver ion at the anode which diffuses towards the cathode, and by its decomposition increases the quantity of silver deposited at the cathode. An improved form of silver voltmeter is described in which the anode and cathode are separated by a porous cell which prevents the diffusion of the anode solution to the cathode, and the accuracy of the results obtained by the use of this instrument is demonstrated by several series of experiments. As a result of this investigation it appears that the electrochemical equivalent of silver as determined by Lord Rayleigh's voltmeter is at least '05 per cent. too high, and that the quantity of electricity associated with one gram equivalent must now be taken as 95,580 coulombs.

The additions to the Zoological Society's Gardens during the past week include a Geoffroy's Cat (*Felis geoffroyi*) from Paraguay, presented by Dr. Jose Carlos Rodriguez; a Somali Ostrich (*Struthio molydophanes*) from East Africa, presented by Mr. A. Marsden; two Lion Marmosets (*Midas rosalia*) presented by Miss E. M. Unwin; a Syke's Monkey (*Cercopithecus albicularis*) from East Africa, a Macaque Monkey (*Macacus cynomolgus*), a Roofed Terrapin (*Kachuga tectum*), a Hamilton's Terrapin (*Damonia hamiltoni*), four Bungama River Turtle (*Emyda granosa*) from India, a Moustache Tamarin (*Midas mystax*) from the Upper Amazons, four Long-necked Chelodines (*Chelodina longicollis*), two Valpine P. lalangers (*Trichosurus vulpecula*) from Australia, nine Tigris Frogs (*Rana tigrina*)

from the East Indies, a Californian Toad (*Bufo boreas*), four Pennsylvanian Mud Terrapins (*Cinosternon pennsylvanicum*) from North America, two Blackish Sternotheres (*Sternotherus nigricans*) from Madagascar, a Lesueur's Water-Lizard (*Physignathus lesueurii*) from Queensland, two Black-pointed Teguxins (*Tupinambis micropanctatus*) from South America, deposited; a Hoolock Gibbon (*Hylobates hoolock*) from Assam, purchased; a Crested Porcupine (*Hystrix cristata*) born in the Gardens.

OUR ASTRONOMICAL COLUMN.

A NEW REGISTERING ACTINOMETER.—M. G. de Fontenoy, of Paris, communicates to the *Bulletin de la Société Astronomique de France*, of August, a description of a novel registering actinometer which he has made and has found to act consistently.

The record is produced by the sunlight acting on a sensitised roll of paper fastened to an inner cylinder in the usual way, but in order to differentiate the varying intensities of the actinic effect, the light is allowed to act on the sensitised surface through a series of small windows, pierced in an outside cylinder of thin brass, which are equal in area and equidistant, but have different degrees of transparency. The whole instrument is rotated so that the common axis of the cylinders is always at right angles to the path of the sun's rays, and the inside cylinder is rotated by clockwork once in every twenty-four hours.

The paper is divided into equal spaces, representing hours, by a series of lines drawn on its surface perpendicular to the direction of its rotation, and a reproduction of one of the charts resulting from the exposure and working during one day in June plainly shows the traces made by the light which passed through the various windows; the longest trace (*i.e.* the one which is shown for the greatest number of hours) is the one which was formed by the light which passed through the most transparent window, the shortest is the one due to the light which passed through the most opaque window. By joining the ends of these traces one gets a curve, the integration of which gives the total amount of light registered during the twenty-four hours if one has previously determined the actinic constant for each window by submitting the instrument to the action of a standard light.

SOLAR PHENOMENA DURING 1901.—The "Commission Solaire" of the Société Astronomique de France has published the observations of sun spots and facule during 1901.

Numerous observers scattered all over the globe make these observations and then submit them to the commission. Observations were made on 357 days during the year 1901, and it is hoped that, with the assistance of several recently enlisted volunteers, a complete record will be obtained for this and future years.

During 1901 twelve separate groups of spots, including 392 individual spots, were observed, the sun presenting a spotted surface on sixty days out of the 357 days of observation.

It is recommended by the secretary, M. F. Boué, that members should also record the barometric pressure, the temperature, and the state of the surrounding atmosphere at the same time that they record the numbers of solar spots and facule.

A DARK SPOT ON JUPITER.—In a letter to the *Observatory* Mr. Theodore Phillips describes the movements of the dark spot which was observed in the neighbourhood of the red spot last year. On June 19 this year it was observed that an enormous area of dark material, extending for 35", followed the "shoulder" of the red spot, and on June 26 a dark spot was observed close to the "shoulder," or west, of the red-spot hollow.

Mr. Phillips asks, "How did it arrive at its present position?" and then discusses the various solutions to the question, finally arriving at the conclusion that the dark material must have been diverted to the south by the red spot, and, after passing that obstruction, have regained its former latitude. As there is still a portion of the dark area to the east of the red spot, it would be advisable for observers to pay special attention thereto, as valuable additions to our knowledge of Jovian phenomena may thereby be secured.

Mr. Phillips also records an apparent acceleration, of late, in the velocity of the red spot.

ROYAL SOCIETY REPORT ON THE WEST INDIAN ERUPTIONS.¹

THE Soufrière mountain forms the northern extremity of St. Vincent, and its general form at once suggests a comparison with Vesuvius. It is a simple cone without lateral or parasitic craters. The one at its summit is surrounded on the north side by the remains of a gigantic crater ring, which has the same relation to the present crater as Somma has to Vesuvius. On the north-east lip of the main crater there is a smaller one known as the New Crater, as it is believed to have originated in the eruption of 1812. It is only one-third of a mile in diameter. It is doubtful whether the New Crater was active during the late eruption, and there can be no doubt that it was from the principal crater, or "Old Crater," that the materials mostly were emitted. Deep valleys, often with precipitous sides, have been cut in the slopes of the mountain, especially on its southern side, and it is in these—and particularly in the Wallibu, Rozeau and Rabaca Dry River—that the greater part of the ejecta of the recent eruption have collected.

Premontory Signs of Activity.

The eruption of May, 1902, though sudden in its outburst and disastrous in its effects, was far from unexpected. In the north of St. Vincent there were two settlements of the Aboriginal Caribs, and these had been so startled by the frequent violent earthquakes, that in February of last year they were considering the advisability of deserting the district. But the first signs of actual volcanic activity were on Tuesday, May 6. The inhabitants of the leeward side were fortunate in having a clear view of the crater, and warned by the outbursts of steam they fled to Chateaubelair, and other places along the coast-line to the south, so that few lives were lost in this quarter. But, on the windward side, the summit of the mountain, as is frequently the case, was wrapped in cloud. Here, at the base of the mountain, there is an extensive stretch of flat land, known as the Carib country, on which were situated some of the largest and richest estates in the island, with a dense population, mostly black or coloured. So little alarm was felt here, that even on the morning of Wednesday, May 7, when the leeward side was practically deserted, sugar-making was in progress on several estates, and all the operations of tropical agriculture were being conducted as usual. From Kingstown, telephonic messages were sent to Georgetown, which is not far from the base of the hill, stating that the Soufrière was in eruption, but they appear to have occasioned little anxiety. And when, about mid-day on Wednesday, the danger was too obvious to be overlooked, the Rabaca Dry River, and some of the streams on the windward side, usually dry except after rains, were running boiling hot, and could not be crossed. Many fugitives in this way found their escape cut off. It was here that the loss of life was greatest, which, though many escaped, is estimated to have amounted to 2000, including about a dozen white men—the overseers of the plantations. The exact number will never be known, as many were entombed in the ashes where they fell.

Progress of the Eruption.

About mid-day on May 6 the first signs of the eruption were observed by those dwelling on the south-western side of the mountain. At 2.40 that afternoon there was a considerable explosion, and a large cloud of steam ascended into the air. By 5 o'clock a red glare was visible in the steam cloud on the summit. Activity continued during the evening, and at midnight there was a great outburst, and red flames were noticed on the lip of the crater. Next morning from Chateaubelair a splendid view could be obtained of gigantic mushroom-shaped clouds rising to a great height in the air—estimated at 30,000 feet—and drifting away before the north-east trade wind. As the day advanced the eruption increased in violence; by 10.30 a.m. enormous clouds of vapour were being emitted with loud noises, accompanied by much lightning. It is remarkable that at that time the inhabitants of the windward side were still in doubt about the reality of the eruption, since they mistook the dark cloud covering the mountain for a thunder cloud. The mountain was now in a state of continuous activity, and from Chateaubelair it could be seen that the materials were mostly discharged from the old or principal crater. Vast clouds of steam, showers of

dark matter (probably mud), and of stones, could be seen projected from it, partly on the leeward, but mostly on the windward side. At mid-day the slopes of the mountain were still green, and the rich mantle of tropical vegetation had not yet been destroyed. A thin layer of fine ash had fallen over the lower ground, only sufficient to give the leaves a greyish colour. The enormous columns of vapour continued to ascend from the crater, with frequent violent outbursts, projecting showers of stones and mud.

About this time it was noticed that steam was rising from some of the valleys on the south side of the hill, and this increased until at 12.50 the whole mountain was suddenly enveloped in a dense cloud of vapour. Just before this the rivers Wallibu and Rabaca had been seen rushing down in raging floods of boiling water. It is most probable that these phenomena were due to the escape of the crater lake, which was driven over the lower or south lip of the crater between 12 o'clock and 1 o'clock on the Wednesday afternoon, and poured down the valleys to the sea. So far as we know there were no mud lavas, in the ordinary sense, flowing down these valleys, but only a tremendous rush of boiling water, which left no traces which we could recognise when we visited the district.

By 1 o'clock the roaring of the volcano was tremendous. Showers of stones were being projected both to windward and to leeward. The enormous columns of steam continued to ascend from the crater. The lightnings were terrific, and after the large outbursts, which took place every few minutes, volumes of vapour might be seen covering the whole area. Hitherto the eruption had been of a type with which geologists are familiar, and the destruction done was confined to the higher parts of the mountain in the close vicinity of the crater.

But about 2 o'clock—to quote the words of an eye-witness (Mr. T. M. McDonald, of Richmond Vale Estate)—"there was a rumbling and a large black outburst with showers of stones, all to windward, and enormously increased activity over the whole area. A terrific huge reddish and purplish curtain advanced to and over Richmond Estate." This was the strange black cloud which, laden with hot dust, swept with terrific velocity down the mountain-side, burying the country in hot sand, suffocating and burning all living creatures in its path, and devouring the rich vegetation of the hill with one burning blast.

The Hot Gases and Dust.

On the leeward coast few were overtaken by the black cloud, as the inhabitants had fled and taken refuge in the villages south of Chateaubelair. Those who were caught were killed or badly burned. One boat was near Richmond at the time the blast swept down. The occupants describe the heat as fearful. Hot sand rained into the boat, and the sea around was hissing with its heat. The darkness was so complete that a man could not see his hand. They saved their lives by diving into the water; when they returned to the surface the air was suffocating, but they continued to dive again and again, and when at their last gasp, they found that the air cleared, and they could breathe again. This occupied only a few minutes—probably much less in reality than it appeared to them. One man was too exhausted to continue diving; he clung to the gunwale of the boat, and the tops of his ears were severely scorched.

On the windward side of the island an uninterrupted view of the progress of the eruption could not be obtained, owing to the veil of cloud which obscured the summit. By mid-day on Wednesday even the most sceptical were convinced that the Soufrière was in eruption, and that the noises heard continuously were not due to a thunderstorm. Before mid-day there had been very heavy rain-showers, and it was noticed that the raindrops carried down fine particles of ash. Work ceased on the plantations, and those labourers who still remained endeavoured to escape to Georgetown or shut themselves up in their houses. By 2 o'clock fine ashes, with occasional larger stones, were falling steadily, but, as yet, little damage had been done, and no one had been injured. Then came the climax of the eruption, and those who were in the open air saw a dense black cloud rolling with terrific velocity down the mountain. They took refuge in their houses and in the plantation works, where they crowded together in such numbers that in one small room 87 were killed. The cloud was seen to roll down upon the sea, and was described to us as flashing with lightning, especially when it touched the water. All state that it was intensely hot, smelt strongly of sulphur, and was suffocating. They felt as if something was compressing their throats, and as if there was no

¹ Abridged from a preliminary report by Dr. Tempest Anderson and Dr. J. S. Flett, just published in the *Proceedings of the Royal Society*, vol. lxx. pp. 423-445.

air to breathe. There was no fire in the ordinary sense of the word, only the air was itself intensely hot and was charged with hot dust. The suffocating cloud only lasted a few minutes. Those who survived this ordeal mostly escaped, though many died within a few hours from shock, or from the severity of their injuries. In some cases a few survived, entirely or almost entirely uninjured, in a room in which many others died. Most of those who escaped had shut themselves up in the rum cellars or in substantially built houses, and had firmly closed all doors and windows. By the time the hot blast had reached the coast the sand it contained was no longer incandescent, and though still at a very high temperature it did not set fire to wood or burn the clothes of those exposed to it. The burns on the survivors were chiefly on the outer aspect of the arms and legs, and on the faces, and confined to parts not protected by their clothes.

The Rain of Dust.

Complete darkness now covered the whole north end of St. Vincent—a darkness more intense than any the inhabitants had ever before experienced. The fugitives had to creep along the roads or feel their way along the roadsides. The roaring of the mountain was terrible—a long, drawn-out, continuous sound resembling the roar of a gigantic animal in great pain. Fine ash and sand rained down over the whole country with occasional showers of large stones. Some of these were so hot as to set fire to the trash roofs of huts in the south-end of Georgetown, at a distance of 7 miles from the crater. In Kingstown, 12 miles from the Soufrière, the ash was at first moist, but afterwards dry. It had a strong sulphurous smell, and pattered on the roofs like a heavy shower of tropical rain. Around the volcano the earth shook and trembled continuously, and the motion was described to us as undulating rather than resembling the sharp shock of an earthquake. Only in one or two cases were the walls of houses injured. What was taking place on the summit of the mountain no one can tell, but all who passed that night in the vicinity of the Soufrière agree that there was one black suffocating cloud, and only one. In all probability the eruption had reassumed the ordinary phase, and the showers of ash and stones were produced by violent upward explosions of steam. By half-past 5 o'clock the ash was falling in Barbadoes, 100 miles to the eastward, whither it had been carried by the upper currents of air in a direction opposite to that of the trade winds. In St. Vincent the darkness lessened slightly before nightfall, but the rain of dust and the noises lasted until early in the ensuing morning.

When day broke it was seen that in St. Vincent, and even in Barbadoes, everything was covered with fine grey ash resembling a fall of snow. The dust had penetrated into the interior of the houses, where it lay in a thin film on walls and furniture. In Kingstown there were stones as large as a hen's egg; in Georgetown and Chateaubelair some had fallen as much as 1 foot in diameter. Little damage, however, appears to have been done to growing crops, except in the north-end of the island. In fact, many believe that the sulphurous ash had insecticidal properties, and benefited the vegetation. From Chateaubelair it could be seen that the volcano was still emitting puffs of slaty-coloured steam, and showers of fine dust were falling on the leeward side of the mountain. For several days these discharges of vapours continued, but a new phenomenon now attracted more attention. The ravines which furrow the south side of the mountain were found to be discharging clouds of vapour, and this gave rise to reports of fissures having opened on the flanks of the Soufrière, of subsidiary eruptions arising from these fissures, and of streams of lava flowing down the valleys. As a matter of fact, they were really due to the action of water flowing through the hot sand, which in some places had almost obliterated the old stream courses, as will be explained more fully later on. By May 15 the volcanic activity had apparently subsided, and the mountain remained clear and unclouded. The explosions of steam in the valleys continued and are probably still going on.

The state of quiescence continued until Sunday, May 18. Confidence was being restored, and the inhabitants of those districts near the mountain which had not suffered severely were returning to their homes. On the windward side the work of burying the bodies had been completed and things were resuming their normal course. But about 8 o'clock that evening an ominous sound was heard from the crater. Its nature was at once recognised and struck the black population with terror. The

noises were as loud as those of the first eruption, and the lightning was very vivid. On the leeward side complete darkness prevailed, and ashes and sand fell freely for some hours. In Georgetown the fall of ashes was quite inconsiderable, not exceeding a thin film on the roofs of the houses. Gradually the noises lessened, the darkness lifted, and the moon appeared again. No lives were lost and practically no damage was done, but exactly what happened on those parts of the mountain nearest the crater it is, in the circumstances, impossible to say. This second eruption was the last which proceeded from the main crater. Clouds of steam were sometimes seen gently rising for some days later, but nothing of the nature of a volcanic outburst has since taken place.

Products of the Eruption.

We arrived at Kingstown on Tuesday, June 10, and proceeded at once to Chateaubelair, where Mr. Jas. E. Richards, of Kingstown, kindly placed a house at our disposal. The geological products of this eruption proved to be of very simple character. The Soufrière and the surrounding country were covered with a layer of ashes mostly in the form of fine dark-coloured sand, but mixed with spongy bombs of various sizes and many ejected blocks composed of fragments of the old rocks of the hill. Lapilli and scoria are there in plenty, as is obvious where the heavy rains have washed away the finer material, but the greater part of the ejecta consists of fine sand which, when dry, is hot and yellowish-grey in colour, but when wet becomes almost black. This sand, as has already been noted by many observers, contains plagioclase feldspar, hypersthene, augite, magnetite and fragments of glass, and represents a fairly well-crystallised hypersthene-andesite magma which has been blown to powder by the expansion of occluded steam.

The coarser material is mostly a slaggy andesite with crystals of plagioclase and pyroxene. There is little pumice, though we obtained a few fragments which floated on water and contained but few crystals visible to the naked eye. The larger bombs are often black, highly lustrous and glassy when broken across. Some were seen at Wallibu (4 miles from the crater) 3 feet in diameter. The ejected blocks consist of weathered andesites and andesitic tuffs such as can be seen in the walls of the crater. They are very numerous, and some are more than 5 feet across. In addition to these, fine-grained dark green banded rocks occur, which appear to be baked and indurated sediments, probably the mud from the bottom of the crater lake, or the finer beds intercalated in the older volcanic series. Another type of ejected block which is very common in some parts of the hill is a coarse-grained aggregate of feldspar, hornblende (brown under the microscope), and perhaps olivine. It is not vesicular and contains little or no glass, being apparently holocrystalline. These rocks are very friable, and the crystals are loosely aggregated together. They seemed to us to be comparable to the sandinites of the Eifel and many other modern volcanic districts. They are certainly quite unlike true plutonic diorites, both in their structure and in the character of their minerals.

It may be noted that none of these rocks are characteristic of this eruption, but all can be found among the older materials of the hill. The hardened, baked sediments were well known to the Caribs, who have long used them for the manufacture of their finer stone implements. The feldspar-hornblende blocks were found by us among the older rocks, and in some places even as rounded masses enveloped in the old lavas. Some of the fresher bombs in the river beds and the seashore can hardly be distinguished from those which were the product of this eruption, though undoubtedly of much older date.

The conclusion was forced upon our minds that immense quantities of hot sand had rushed down the hill into these valleys in an avalanche which carried with it a terrific blast, and piled the ashes deep in the sheltered ravines, at the same time sweeping everything of the exposed ridges which lay between. The rain of volcanic material, which lasted for hours after the hot blast had passed, then covered the surface of the country with a final sheeting of fine dust and scoriae.

Effects produced by the Hot Blast.

When we ascended the Soufrière, the evidence of the passage of a hot blast laden with sand was overwhelmingly clear. The various stages of its action, and its varying intensity at different spots, are most easily observed on the windward side, where the country is more flat and open, and there are fewer ravines and

spurs to modify the course of its operations than in the Wallibu Valley.

The track to the summit passes across the Rabaca Dry Valley near the shore, then turns upwards through the sugar-cane fields of Rabaca and Lot 14. These were covered with 3 or 4 feet of sand and scorific; the trees all bare, their leaves stripped by the falling cinders; but few branches were broken, and no trees had been uprooted or cast down. The woodwork of the houses was unburnt, though the roofs of some of the verandahs, and of the labourers' huts, had collapsed from the weight of ashes that had fallen on them. Many people were killed on these estates. The survivors described to us how the dark cloud had rolled down from the mountain, and how hot and suffocating the air had been when it enveloped them. But it was evident that the velocity of the blast was not above that of an ordinary gale, and the dust it carried, though hot, was not incandescent.

At Lot 14 it was seen that many trees had their limbs twisted off and broken, and some of the negroes' houses had taken fire (probably mostly from hot falling bombs). The blast was more violent here, but not hot enough to set fire to the wood-work or char the green wood of the standing timber.

On the flat ground above the plantation buildings (at an elevation of about 1000 feet), a further stage of devastation was encountered. The fields were here swept bare, the trees broken down, though not as a rule uprooted, their smaller branches swept away; a deep layer of black sand covered the crops of sugar-cane. The blast was here a violent gale.

A little further up the effects of the blast were remarkable. Enormous trees had been uprooted and cast down. Their leaves and finer branches, of course, had disappeared. In every case the fallen trunks pointed directly away from the crater. Even the great cotton-trees, 10 feet or more in diameter, were broken off or uprooted. The smaller trees had in a few cases been swept away like straws. The larger were merely cast down, and lay side by side, their tops directed down the valley, their roots towards the summit of the mountain. Most were charred, some deeply, but, as the wood was green, only the smaller branches had been consumed. The effect was like that produced by a violent hurricane, only more complete, for many of these trees had withstood the hurricane which ruined St. Vincent in 1898. At the lower limit of this region some curious effects of the hot sand blast could be seen. Where any branches or trunks were still standing, they invariably showed themselves to be burnt and eroded on one side—that next the crater—the wood having been charred and the charred material removed by the action of a hot sand blast. On the side away from the crater, the original bark was still left, unburnt, but dry and peeling off; that is, there had been no erosion on the sheltered or lee side of the stems. The wood was too green to take fire, but the sand had been sufficiently hot to char the surfaces which were exposed to it.

Further up the hill—that is to say, above the 1500-foot level, there was little left of the rich tropical vegetation which had covered it from summit to base. Blackened remains of tree-trunks were to be seen, overturned or broken off near the ground, and buried in dark sand. The highest parts of the mountain are as bare and desolate a scene as could be imagined. The ash is 5 to 12 feet deep, and though full of large blocks and spongy bombs, is mostly so fine that when thoroughly wet it becomes a fine mud, very tenacious and slippery, in which one sinks to the knee. In it there is a good deal of burnt timber, utterly blackened and converted into charcoal. Everything has been mown down, and at the same time the intense heat has consumed all the smaller fragments and charred the larger. There is nothing to show what was the velocity of the blast when it left the crater. After a couple of miles it was that of a hurricane or tornado. The limit between the zone of uprooted trees and that of trees still standing, but broken and much damaged, is surprisingly sharp. At 4 miles from the crater the blast was travelling at 20 to 40 miles an hour, and rapidly slowing down. This agrees with the evidence of an eye-witness who saw it when it reached the sea near Chateaubelair. It came over the water with a wave before it, but it did not overturn the small boats which lay in its course.

Another peculiar feature of this blast is the manner in which its course was modified by irregularities in the configuration of the ground over which it passed. To the north of the crater stands the encircling crater wall, already referred to as the *Somma*. There can be no doubt that a black cloud descended

over this side of the mountain, though here the devastation is comparatively slight, and it is inferred that the high intervening ridge overlooking the crater served as a rampart and helped to protect the country behind it from the effects of the blast. The southern lip of the crater, on the other hand, is the lower, and the avalanche of hot sand seems to have poured over this lip almost like a fluid. Down the deep open valley between the *Soufrière* and the *Morne Garu* Mountain it rushed, ever following the steepest descent. It clung to the valley bottoms and coursed along them in a manner which somewhat recalls a raging torrent in a river. The streams in these valleys after descending the first part of the hill turn sharply at a right angle towards the coast, deflected by the opposing mass of the *Morne Garu*. The hot blast mostly followed these valleys, and in them it piled up enormous deposits of sand, but part of it swept up the shoulders of *Morne Garu*, and tore up the heavy timber which was growing there. The direction in which the fallen trunks point shows that the blast was split into two parts—one taking the east and one the west side of the mountain, rushing upwards obliquely from below. The mountain protected the country behind, and the line of demarcation between the burnt and the green forest almost corresponds with the dividing ridge. The south side is green; the north side towards the *Soufrière* is devastated and burnt.

Geological Modifications.

Apart from the changes which have taken place within the crater, and the deposits of ash which have formed in the river valleys, and on the surface of the hill, the only other important geological modification of the country has been the disappearance of a narrow strip of coast along the leeward side of the island. Near the mouth of the Wallibu and from thence northward to *Morne Ronde*, the sea has encroached on the land for perhaps 200 yards. Below Wallibu plantation there stood a village of labourers' huts on a low flat beach with a bluff behind. Here the sea now washes the foot of a cliff some 30 feet high. This cliff consists of soft tuffs covered with several feet of new hot ashes, and is in an unstable condition, as masses are constantly falling down from its face. In this way a new beach is now forming in front of it. It is agreed by those who knew the district before the eruption that not only has the old beach disappeared, which carried the village and the public road, but that part of the bluff behind has also subsided. We were informed by Mr. T. M. McDonald, who is intimately acquainted with this coastline, that similar subsidences had also taken place, though on a much smaller scale, at several places further north. There is no evidence elsewhere of any changes of level of land and sea. The tide-marks on the rocks and the landing-stages at the villages enabled us to ascertain that the level of high-water was at any rate within a few inches of what it had been before. It was clear that the alterations in the coast-line were due to local subsidence of the foreshores, and that they had mostly affected loose and ill-consolidated deposits, such as beach gravels and the fans of alluvium which had formed at the mouths of the streams. The submarine slopes on the leeward side of St. Vincent are very steep, averaging about 1 in 4. Within half a mile of the shore the depth is often more than 100 fathoms.

It seems most probable that owing to the concussions and earthquakes produced by the explosions, some of the less coherent accumulations on these steep slopes slipped bodily into the deep. On this supposition most of the facts would be explained, but at the same time it is possible that at Wallibu the inner margin of the depressed tract may be a fault line. It has a very straight trend, and it is a curious fact that this shore was formerly known as *Hot Waters*. This might indicate the existence of a fissure up which hot springs were rising.

Comparison of the Soufrière with Mont Pelée.

When we arrived at Martinique, we had the pleasure of meeting Prof. Lacroix, the head of the French Scientific Commission, which had spent some time in making a preliminary survey of *Mont Pelée*, and the north-end of the island, and from him we obtained much valuable information regarding the sequence of events and the geological consequences of the eruptions in that quarter. It was our intention to make merely such reconnaissances as would enable us in a general way to ascertain the points of difference and of similarity between the outburst of *Mont Pelée* and that of the *Soufrière*, and to see what light the phenomena in Martinique threw on the events which had happened in St. Vincent.

Both volcanoes are of the same type, simple cones with a large vent near the summit and without parasitic craters. They are both deeply scored with ravines, and on their south-west sides there is a broad valley—occupied at Martinique by St. Pierre City, at St. Vincent by the Wallibu. It is in these valleys that the destruction has been most pronounced. In both, the recent eruptions have been characterised by paroxysmal discharges of incandescent ashes, and a complete absence of lava streams.

In St. Vincent, however, the mass of material ejected has been much greater, and a considerably larger area of country has been devastated than in Martinique. That the loss of life was not so large can be accounted for by the absence of a populous city at the foot of the mountain. Had the city of St. Pierre been planted at the mouth of the Wallibu, there can be no doubt it would have been equally completely destroyed.

On Mont Pelée, we understand that a fissure has opened on the south side of the mountain between the summit and St. Pierre, from which the blast was emitted which overwhelmed the city. But on the Soufrière the old orifices have been made use of. The eruption of Pelée began with the flow of mud lavas, but none such were seen in St. Vincent. On the other hand, the hot blast which swept down on the doomed city was essentially similar to that which we have described as having taken place at the Soufrière. Both eruptions produced principally hot sand and dust, with a small proportion of bombs and ejected blocks.

Observations of an Eruption of Mont Pelée.

We were fortunate in having an opportunity to witness one of the more important eruptions of Mont Pelée before we left Martinique, and this enabled us to see how far the actual phenomena corresponded with the ideas we had been led to form from an inspection of the effects of the earlier outbursts. On July 9 we were in a small sloop of 10 tons, the *Minerva*, of Grenada, which we had hired to act as a convenient base for our expeditions on the mountain. The morning was spent in St. Pierre City, and on the sugar-cane plantations on the lower slopes of the mountain on the banks of the Rivière des Péres. The volcano was beautifully clear. Every ravine and furrow, every ridge and crag, on its gaunt naked surface stood out clearly in the sunlight. Thin clouds veiled the summit, but now and then the mist would lift sufficiently to show us the jagged broken cliff which overlooks the cleft. From the triangular fissure which serves as the crater hardly a whiff of steam was seen to rise, and the great heap of hot boulders which lies on the north side of and above this fissure could be perfectly made out. Small land-slides took place in it occasionally, and small jets of steam rose now and again from between the stones.

A little after mid-day large steam clouds began to rise, one every 10 or 20 minutes, with a low rumble. As they rose they expanded, becoming club-shaped and consisting of many globular rolling masses, constantly increasing in number and in size as they ascended in the air. They might be compared to a bunch of grapes, large and small, or to a gigantic cauliflower. When their upward velocity diminished they floated away to leeward, and fine ash rained down in a dense mist as they drifted over the western side of the mountain. They occasioned no anxiety in our minds, as we had found that the mountain was never long without exhibiting these discharges, and they were due merely to an escape of steam carrying with it fine dust. They rose, as a rule, to heights of 5000 or 6000 feet above the sea.

That afternoon as the sun was getting lower in the heavens and the details of ravine and spur showed a contrast of light and shadow which was absent at mid-day, we sailed along from St. Pierre to Précheur, intention obtaining a series of general photographs of the hill. The steam puffs continued, and, about 6 o'clock, as we were standing back across the bay of St. Pierre, they became more numerous, though not much larger in size. We ran down to Carbet, a village $\frac{1}{2}$ miles south of St. Pierre, where there is a supply of excellent water and good anchorage. About half-past six it was obvious that the activity of the mountain was increasing. The cauliflower clouds were no longer distinct and separate, each following the other after an interval, but arose in such rapid succession that they were blended in a continuous emission. A thick cloud of steam streamed away before the wind so laden with dust that all the leeward side of the hill, and the sea for 6 miles from the shore, was covered with a dense pall of fine falling ash. The sun setting behind this cloud lost all its brightness, and became a

pale yellowish-green disc, easily observable with the naked eye. Darkness followed the short twilight of the tropics, but a day's old moon shed sufficient light to enable us to see what was happening on the hill-side.

An Incandescent Avalanche.

Just before darkness closed in, we noticed a cloud which had in it something peculiar, hanging over the lip of the fissure. At first glance it resembled the globular cauliflower masses of steam. It was, however, darker in colour, and did not ascend in the air or float away, but retained its shape, and slowly got larger and larger. After observing it for a short time, we concluded that it was travelling straight down the hill towards us, expanding somewhat as it came, but not rising in the air, only rolling over the surface of the ground. It was so totally distinct in its behaviour from the ascending steam clouds that our attention was riveted on it, and we were not without apprehension as to its character. It seemed to take some time to reach the sea (several minutes at least), and as it rolled over the bay we could see that through it there played innumerable lightnings. We weighed anchor and hoisted the sails, and in a few minutes were slipping southward along the coast with a slight easterly wind and a favourable tide. We had, however, scarcely got under way when it became clear that an eruption was impending. As the darkness deepened, a dull red reflection was seen in the trade-wind cloud which covered the mountain summit. This became brighter and brighter, and soon we saw red-hot stones projected from the crater, bowling down the mountain slopes, and giving off glowing sparks. Suddenly the whole cloud was brightly illuminated, and the sailors cried, "the mountain bursts!" In an incredibly short space of time a red-hot avalanche swept down to the sea. We could not see it start from the crater owing to the intervening veil of cloud, but the lower parts of the mountain were clear, and the glowing cataract poured over them right down to the shores of the bay. It was dull red, with a billowy surface, reminding one of a snow avalanche. In it there were larger stones which stood out as streaks of bright red, tumbling down and emitting showers of sparks. In a few seconds it was over. A loud angry growl had burst from the mountain at the moment when this avalanche was launched from the crater. It is difficult to say how long an interval elapsed between the time when the great glare burst on the summit and the incandescent avalanche reached the sea. Possibly it occupied a couple of minutes: it could hardly have been more. Undoubtedly the velocity was terrific. Had any buildings stood in its path they would have been utterly wiped out, and no living creature could have survived that blast.

The Lightning Discharges.

Hardly had its red light faded when a rounded black cloud began to shape itself against the starlit sky, exactly where the avalanche had been. The pale moonlight shining on it showed us that it was globular, with a bulging surface, covered with rounded protuberant masses, which swelled and multiplied with a terrible energy. It rushed forward over the waters, directly towards us, boiling, and changing its form every instant. In its face there sparkled innumerable lightnings, short, and many of them horizontal. Especially at its base there was a continuous scintillation. The cloud itself was black as night, dense and solid, and the flickering lightnings gave it an indescribably venomous appearance. It moved with great velocity, and as it approached it got larger and larger, but retained its rounded form. It did not spread out laterally, neither did it rise into the air, but swept on over the sea in surging globular masses, consorting with lightnings. When about a mile from us it was perceptibly slowing down. We then estimated that it was 2 miles broad and about 1 mile high. It began to change its form; fresh protuberances ceased to shoot out or grew but slowly. They were less globular, and the face of the cloud more nearly resembled a black curtain draped in folds. At the same time it became paler and more grey in colour, and for a time the surface shimmered in the moonlight like a piece of silk. The particles of ash were now settling down, and the white steam, freed from entangled dust, was beginning to rise in the air.

The cloud still travelled forward, but now was mostly steam, and rose from the surface of the sea, passing over our heads in a great tongue-shaped mass, which in a few minutes was directly above us. Then stones, some as large as a chestnut, began to

fall on the boat. They were followed by small pellets, which rattled on the deck like a shower of peas. In a minute or two fine grey ash, moist and clinging together in small globules, poured down upon us. After that for some time there was a rain of dry grey ashes. But the cloud had lost most of its solid matter, and as it shot forwards over our heads it left us in a stratum of clear pure air. When the fine ash began to fall there was a smell of sulphurous acid, but not very marked. There was no rain.

The volume of steam discharged must have been enormous, for the tongue-shaped cloud broadening as it passed southwards covered the whole sky except a thin rim on the extreme horizon. Dust fell on Fort de France and the whole south-end of Martinique. The display of lightning was magnificent. It threaded the cloud in every direction in irregular branching lines. At the same time there was a continuous low rumble overhead.

What happened on Mont Pelée after this discharge cannot be definitely ascertained. For some hours afterwards there were brilliant lightnings and loud noises which we took for thunder. That night there was a heavy thunderstorm over the north-end of Martinique, and much of the lightning was atmospheric, but probably the eruption had something to do with it, and the noises may have been in part of volcanic origin.

Characteristics of the Eruptions.

There can be no doubt that the eruption we witnessed was a counterpart of that which destroyed St. Pierre. The mechanism of these discharges is obscure, and many interesting problems are involved. But we are convinced that the glowing avalanche consisted of hot sand and gases—principally steam; and when we passed the hill in R.M.S. *Wear* a few days later, we had, by the kindness of the captain, an excellent opportunity of making a close examination of the shore from the bridge of the steamboat. The south-west side of the hill along the course of the Rivière Seche was covered with a thin coating of freshly fallen fine grey ashes, which appeared to be thickest in the stream valleys. The water of the rivers flowing down this part of the hill was steaming hot. This was undoubtedly the material emitted from the crater on the night of the eruption. There was no lava. We saw no explosions of combustible gases, and nothing like a sheet of flame. We were agreed that the scintillations in the cloud were ordinary lightnings which shot from one part of its mass to another, and partly also struck the sea beneath.

The most peculiar feature of these eruptions is the avalanche of incandescent sand and the great black cloud which accompanies it. The preliminary stages of the eruption, which may occupy a few days or only a few hours, consist of outbursts of steam, fine dust and stones, and the discharge of the crater lakes as torrents of water or of mud. In them there is nothing unusual, but as soon as the throat of the crater is thoroughly cleared, and the climax of the eruption is reached, a mass of incandescent lava rises and wells over the lip of the crater in the form of an avalanche of red-hot dust. It is a lava blown to pieces by the expansion of the gases it contains. It rushes down the slopes of the hill, carrying with it a terrific blast, which mows down everything in its path. The mixture of dust and gas behaves in many ways like a fluid. The exact chemical composition of these gases remains unsettled. They apparently consist principally of steam and sulphurous acid. There are many reasons which make it unlikely that they contain much oxygen, and they do not support respiration.

THE PERSEID METEORIC SHOWER OF 1902.

THE display of Perseid meteors was fairly abundant this year, though somewhat marred, and only partially observed, in consequence of the unsettled weather which prevailed. In the west of England the first half of August proved an exceptionally cloudy period, and comparatively few observations could be secured. In the eastern counties atmospheric conditions appear to have been decidedly more favourable, for while at Bristol only meagre results could be gathered from skies wholly or partially veiled with clouds, observers in metropolitan suburbs reported clear weather and collected a plentiful harvest of meteor flights. At Hampstead Mr. G. M. Knight counted 500 meteors during the first fortnight of August. Between August 1 and 5, 167 were recorded, and on August 10, from

11h. 30m. to 15h. 15m., 239 were seen. The majority of them were Perseids of the usual swift, streak-leaving type, and there were minor showers in Cassiopeia, Andromeda, Cepheus and other regions. Mr. Knight has forwarded the writer some charts containing projections of his recorded paths, and the place of the Perseid radiant appeared to be indicated as under. The ephemeris positions given in the *Monthly Notices*, December, 1901, p. 169, are also added for comparison:—

1902.	Radiant.	No. of meteors.	Ephemeris.
August 1-3 ...	37 + 55 ...	12 ...	33°9 + 55°0
" 4 5 ...	40 + 55½ ...	26 ...	37°0 + 55°6
" 10 ...	44½ + 57 ...	43 ...	44°3 + 50°9

The agreement is fairly good, though the places observed this year in the early part of August are somewhat east of the predicted centres. A certain allowance has, however, to be made for errors of observation.

At Bristol the writer watched for the Perseids on parts of the nights of August 2, 6, 10, 12 and 14, but clouds prevented anything like a thorough investigation of the progress of the display. The Perseids were fairly numerous, and shot from the radiants given below, but very few meteors were seen on August 6 and 14 owing to the clouds, so that the points of emanation on those nights were merely suspected:—

1902.	Radiant.	Ephemeris.
August 6 ...	39 + 57 ...	38°9 + 50°0
10 ...	45 + 58½ ...	44°3 + 56°9
12 ...	47 + 58½ ...	47°1 + 57°3
14 ...	50 + 57 ...	50°0 + 57°7

The year 1900 not having been a leap-year, the maximum was expected on either August 11 or 12. There was an unusually bright exhibition of these meteors on August 11, 1898. It seems that the maximum intensity was well defined this year, for "a magnificent shower of Perseids" is reported to have been witnessed at Odessa on Tuesday night, August 12. The chief radiating point is said to have been at an altitude of 45° or 50° in the north-east firmament. The latter position corresponds approximately with the normal place of the Perseid centre. But, unfortunately, the report mentions no details as to the number of meteors observed or the duration of the observations, and it is impossible, therefore, to form any exact conclusion as to the character of the display witnessed. It will probably be found, however, when particulars come to hand, that it represented nothing more than a tolerably plentiful return of the stream. There are no other descriptions favouring the inference that a strikingly brilliant shower was witnessed. In and since 1898 the Perseids appear to have been richer than usual, though it is extremely difficult to ascertain the relative strength of the shower from year to year owing to the variable conditions affecting the visibility of the meteors. W. F. DENNING.

THE ZOOLOGICAL SOCIETY'S NEW APE-HOUSE.

THE ordinary plan of keeping monkeys in zoological gardens is to house them in cages which, while closed in winter, can be opened to playing-places in the external air in summer. The objection to this course is that, though it gives the great advantage of fresh air, the monkeys emerging from a heated chamber into a cooler atmosphere are very liable to catch cold and suffer from pulmonary complaints. In the case of some of the harder Quadrumana (such as the Tchei monkey of Manchuria and the Cape baboon), there can be no doubt that such animals will thrive best without artificial warmth of any kind beyond the protection of a dry roof, and may be kept in the open air all the year round. This plan, however, would hardly answer in the case of the anthropoid apes, which live in hot, moist climates and are accustomed all their lives to a high and uniform temperature. In constructing the new ape-house for the special accommodation of these animals, the Zoological Society has adopted the plan, which has been tried with some success on the continent, of separating the animals entirely from the evils of a changeable climate by an air-tight glass screen through which only they can be seen by the public. The

further advantage of this plan is that the apes can receive no germs of disease from the visitors, and can be kept behind the screen in a higher temperature than is maintained in the portion of the building allotted to the spectators.

The new ape-house, for which there was much difficulty in finding a convenient site in the already crowded Gardens in the Regent's Park, is nearly square in shape, being about 70 feet in length and breadth. The principal floor is raised some 5 or 6 feet above the level of the ground, in order to secure the animals from the damp of the stiff clay soil upon which the house is built; and the chambers below the principal floor are devoted to the keeper's apartments and to feeding and heating purposes. On entering the spectators' portion, which occupies the north side of the building, by one of the flights of steps which ascend to the outside platform, the apes will be found occupying four large and roomy chambers on the south side. They are entirely separated from the spectators by the glass screen which runs across the building and corresponds to the windows of a fashionable shop in Regent Street. The spectators are on the outside of the screen and the objects to be inspected on the inside. They are in a good light because the interior is made bright and clear by skylights and by four large windows which occupy the south aspect of the building, while the spectators stand in a darker light. The screen has the further advantage that the animals cannot be improperly fed or unnecessarily stirred up with sticks and umbrellas, as is too often the case in the ordinary monkey-house. The apes themselves can hardly be said to be in cages, but live in large rooms some 16 feet square, which are fitted up with tree-branches, swings, and other contrivances for their amusement and exercise. All round these four rooms runs a narrow passage by which the keepers can gain access to any part of them. The temperature of the rooms for the animals is kept at from 80° to 85° F., while that of the portion of the house devoted to the spectators is usually from 10° to 15° less.

The apes that at present tenant the new ape-house are some seven or eight in number, and consist of chimpanzees, orangs and gibbons, representing all the three usually distinguished genera of the anthropoid apes. Besides these, one of the compartments is occupied by a small individual of the very curious proboscis monkey of Borneo (*Nasalis larvata*), one of the most peculiar forms of Old-World monkeys. This has always been found to be a most delicate animal in captivity, and very few specimens of it have ever reached Europe alive. When adult the proboscis monkey is rather a large animal, measuring, perhaps, some 30 inches in the length of its body, while the tail is nearly as long. It is remarkable for its large and elongated nose, of which, however, there is comparatively little appearance in the present young specimen. The young animal is also much more simple in coloration, being of a nearly uniform pale rufous above and grey below, while the adult is brightly and mostly distinctly coloured with yellow and chestnut. The proboscis monkey is an inhabitant of Borneo, and was made known to European science by Wurm, the Dutch Governor of Batavia about 1780. Preserved specimens of it were first brought to Europe by Sir Stamford Raffles. Captain Stanley Flower received some living examples of it at the Ghizeh Gardens, Cairo, in 1899 (see *P.Z.S.*, 1899, p. 785), but they did not last long even in the favourable climate of Egypt.

THE HABITS OF THE LARVÆ AND ADULTS OF SIREX AND THALESSA.

WE have received from Mr. E. P. Stebbing, of Dehra Dun, India, an account of the habits of the larva of a Himalayan species of sawfly (*Sirex*) and its parasite, an ichneumon allied to *Thalessa*, of which the following is an epitome. The adult sawfly deposits its eggs in the wood of dead spruce-trees (*Picea morinda*). When hatched, the grubs bore horizontally into the wood for a short distance and then drive a tunnel vertically upwards or downwards after the manner of the European *S. augur*. The debris, after passing through the body of the grub, is so closely jammed in the tunnel that no holes are visible in the wood when sawn through. The pupa is formed at the end of the tunnel, where it lies naked at an angle to the axis of the stem at a variable distance from the exterior. In place of following the old, tortuous track of the grub—for several reasons a matter of difficulty—the adult insect cuts its way to the exterior by the nearest route, which, unlike that of the European species, is not, as a rule, at right angles to the larval tunnel.

The mature insect never seems to have the slightest hesitation in determining the direct route to the outer world. It may be added that the larval state seems to last for several years, as grubs of different ages occur in the same trunk.

With regard to the parasitic ichneumon-fly allied to or identical with *Thalessa*, Mr. Stebbing is of opinion that it never makes the mistake of attacking wood in which pupæ of the sawfly *Sirex* are not entombed. As to the statement that the ichneumon-fly frequently dies from its ovipositor becoming inextricably fixed in the wood, he suggests that the insect, after depositing its last egg, dies in the position then assumed, as is certainly the case with many of the bark-boring beetles of the family Scolytidæ. As the ovipositor of the ichneumon does not exceed an inch and a half in length, while the spruce-bark may be fully an inch thick, it is considered that the *Thalessa* must have some means of fixing the position of the *Sirex* eggs and of the tunnels of the young grubs in the wood underlying the bark. Without such knowledge it would seem an impossibility for the parasite, the ovipositor of which appears of inadequate length for its task, to reach the larval tunnels. Numbers of dead ichneumons were observed in partially bored galleries, this being apparently due to the circumstance that the *Sirex* larvæ often travel with their parasites to such a depth in the trunk that the adults of the latter are unable to cut their way out. The numbers of the ichneumon are thus, involuntarily, kept down by the sawfly larvæ.

UNIVERSITY AND EDUCATIONAL INTELLIGENCE.

MR. J. GRAHAM KERR, of Christ's College, Cambridge, has been appointed professor of natural history in the University of Glasgow, in succession to Prof. John Young, who has resigned.

THE Martell scholarship in naval architecture, offered for competition for the first time this year, has been awarded by the council of the Institution of Naval Architects to Mr. L. Woolard, of the Thames Ironworks, Blackwall. The scholarship is of the annual value of 50*l.* and is tenable for three years.

AN exhibit to illustrate the state of education in the British Empire will be sent by the Government to the Universal Exposition to be held in St. Louis in 1904. The official exhibits will be limited to education and the fine arts, but facilities will be afforded to trade and individual exhibitors to show products representing British industries.

THE last annual report of the Technical Instruction Committee recently presented to the Oxfordshire County Council supplies further evidence of the serious deficiency in the supply of secondary education in many parts of the country, which it is hoped the passing of the Education Bill, now before Parliament, will do much to remedy. The Committee again directs attention to the lack of secondary schools for girls throughout Oxfordshire, and for boys in the district between Chipping Norton and Bicester. In other directions favourable conditions mark the educational activity of the Committee; there has been a general improvement in the agricultural instruction in the rural centres, and good work has been done in supplementing the training of elementary school teachers.

In accordance with the action of the Board of Trustees and the provisions of the will of the late Jonas G. Clark, the founder, the collegiate department of the Clark University, Worcester, Massachusetts, will be opened on October 1. There is to be no charge for tuition for the year ending 1903; for the next year the charge is to be twenty-five, and for the third year fifty dollars. After the third year, the charge per student in all classes will be at a rate to be fixed by the Board of Trustees. The preliminary announcement issued by the president of the college, Dr. Carroll D. Wright, shows, amongst other provisions, that mathematics will be taught as the groundwork of the college education and that sports will be permitted solely "for the development of physical and moral conditions." Special attention is in the future to be given to the "new" psychology, to economics and to sociology.

THE Volta Bureau of Washington, U.S.A., for the increase and diffusion of knowledge relating to the deaf, has issued its second international report of schools for the deaf. The data brought together from all parts of the world give a gratifying assurance that a marked improvement has taken place since

1895, the date of the last report issued by the Bureau, in the provisions made in all countries for the education of this unfortunate class. Not only are the charitably disposed of European and American countries fully alive to the possibilities of assisting the deaf by suitable methods of instruction, but, as the report shows, there are schools in good working order in China, Japan, Algiers and other places not often associated with educational progress. It is interesting, too, to learn that upwards of thirty periodicals for the deaf are issued in Europe, and nearly sixty in America.

The following list of successful candidates for Royal Exhibitions, National Scholarships and Free Studentships (science) has been issued by the Board of Education, South Kensington:—Royal Exhibitions: Charles Cook, Landport, Portsmouth; Gilmour E. Brown, Balloch, Dumbartonshire, N.B.; Charles J. Stewart, Fratton, Portsmouth; George H. Childs, Portsmouth; William Welch, Fratton, Portsmouth; Edward L. Macklin, Buckland, Portsmouth; Alfred Jones, Crewe. National Scholarships for Mechanics: Herbert G. Tisdall, Beeding, Sussex; Joseph J. Holloway, Saltley, Birmingham; George H. Andrews, Sherness; John Alexander, Glasgow; Christopher J. Lees, Oldham; Robert Roys, Oldham. Free Studentships for Mechanics: William E. Gardner, Edgbaston, Birmingham; Harold Fowler, Urmston, Manchester; Leonard E. B. Pearce, London. National Scholarships for Physics: Ambrose E. Woodall, Swinton, Lancs.; James H. Brinkworth, Chippenham; Herbert Moss, Leeds; Thomas F. Connolly, St. Albans; A. Henderson McKenzie, Salford, Manchester. Free Studentships for Physics: Evan J. Evans, Llanely; Wilfrid M. Hooton, Sutton Bridge, Lincs. National Scholarships for Chemistry: Alfred F. Joseph, London; Alexander McDonald, Middlesbrough; Donald F. Blyther, London; James M. Hird, South Woodford, Essex; Howard H. Morgan, Rhayader, Wales; John W. Birkby, Leeds. Free Studentship for Chemistry: Robert G. Kirkby, Whitstable. National Scholarships for Biology: William F. Collins, London; Thomas Southwell, Todmorden; Arthur E. Pratt, London. National Scholarships for Geology: George Haworth, Burnley; Thomas Dewhurst, Burnley.

SCIENTIFIC SERIAL.

American Journal of Science, August.—The terraces of the Westfield River, Mass., by W. M. Davis. Miller's theory of defending ledges gives a better explanation of these terraces than any other, the normal action of a meandering and swinging river sufficing to account for nearly all the details of terrace form.—Notes on the Cretaceous turtles, *Toxochelys* and *Archelon*, with a classification of the marine Testudinata, by G. R. Wieland.—The magnetic effect of electric displacement, by J. B. Whitehead, jun. After a short historical account and criticism of the previous work done in this field, new experiments are described, the net result of which is against the presence of the magnetic effect of electric displacement in an amount given by Maxwell's expression. Only once was a positive result obtained, and this is regarded as being liable to question.—Certain relations of plant growth to ionisation of the soil, by A. B. Plowman. The experiments described show that negative charges stimulate and positive charges paralyse the embryonic protoplasm of plants.—The demagnetising effects of electromagnetically compensated alternating currents, by Z. E. Crook. An experimental study of the effects of the alternating current on the magnetic properties of iron and steel, with special reference to the effect due to the current independently of that produced by the circular magnetism.—Nepheline and other syenites near Port Coldwell, Ontario, by A. P. Coleman.—The double ammonium phosphates in analysis, by M. Austin. A study of the best conditions for the determination of zinc and manganese as double ammonium phosphates.—On the electrical resistance of glass, quartz, mica, ebonite and gutta-percha, by O. N. Rood.

SOCIETIES AND ACADEMIES.

PARIS.

Academy of Sciences, August 11.—M. Bouquet de la Grye in the chair.—Reflection and refraction by a body undergoing a rapid translation, by M. J. Boussinesq.—On the law of pressures in cannon, by M. E. Vallier. As the expression originally proposed by the author necessitates complicated inte-

polations, an empirical formula of a simpler nature is suggested which is sufficiently exact.—On entire functions of finite order, by M. Ernst Lindelöf.—On the mode of formation of kathode and Röntgen rays, by M. Th. Tommasina. The study of the unipolar production of the X-rays by M. Jules Semenov led him to the conclusion that the antikathode gives off rays only if it carries an electric charge, and if connected to the earth it gives off practically no rays. Having regard to the theoretical importance of this fact, the author has submitted it to further experimental study. The following conclusions are stated:—The diffuse reflection of the anode flux alone is sufficient to give rise to kathode rays and to Röntgen rays; the phenomenon takes place even when the antikathode is connected to the earth, and the multiple reflection by the walls of a vacuum tube suffices to produce the partial transformation of the anode flux into both kathode and Röntgen rays.—Phenomena observed at Zi-Ka-Wei, China, during the Martinique eruption, by M. de Moiré. A magnetic disturbance was observed, as at Paris and at Lyons, at a time corresponding with the explosion of Mont Pelée, together with an earth tremor which lasted about eight hours.—New contributions to the physiology of the leucocytes, by MM. H. Stassano and F. Billon.—Haemoglobinuria of muscular origin, by MM. Jean Camus and P. Pagniez.—On the existence of a kinase in snake poison, by M. C. Delzenne. Snake poison contains a diastase possessing the same properties as enterokinase, or the microbial kinases. It has not yet been determined whether it is distinct from the poisonous principle of the snake venom.—The toxin of tetanus. Observations of the electrical resistance and of the index of refraction, by MM. Dongier and Lesage.—The distribution of the suprarenal bodies of the Plagiostomes, by M. Ed. Grynfeldt.—Observations on the germinative duration of seeds, by M. Jules Poisson. The seeds of plants growing in moist soils preserve their vitality longer than others provided that they do not leave their moist situation.—The verification of the law of barometric heights, by M. W. de Fonvielle.

CONTENTS.

PAGE

A Monograph of the British Liverworts. By Prof. J. B. Farmer, F.R.S.	385
Structurally Active Media	386
Elementary Physics	387
The Voice and Respiration. By Dr. B. Moore	388
Our Book Shelf:—	
Sparrow: "The Principles of Simple Photography"	389
Ladd: "Philosophy of Conduct."—A. E. T.	389
"The Thompson Yates Laboratories Report."—R. T. H.	390
Letters to the Editor:—	
Sunset Effects.—Prof. G. H. Bryan, F.R.S.; S. Pace	390
The Older Civilisation of Greece: Further Discoveries in Crete. (Illustrated.) By H. H.	390
Alexander Kowalevsky. By Prof. E. Ray Lankester, F.R.S.	394
Notes	396
Our Astronomical Column:—	
A New Registering Actinometer	401
Solar Phenomena during 1901	401
A Dark Spot on Jupiter	401
Royal Society Report on the West Indian Eruptions	402
The Perseid Meteoric Shower of 1902. By W. F. Denning	406
The Zoological Society's new Ape-House	406
The Habits of the Larvæ and Adults of <i>Sirex</i> and <i>Thalassa</i>	407
University and Educational Intelligence	407
Scientific Serial	408
Societies and Academies	408

THURSDAY, AUGUST 28, 1902.

A FIELD NATURALIST'S SCIENCE.

The Primrose and Darwinism. By a Field Naturalist, M.A. Camb. Pp. xiii + 233. (London: Grant Richards, 1902.) Price 6s. net.

IT is hard to tell why this book was written. The preface alone is enough to condemn it, for in the preface we have in miniature the chief defects of the book—inaccuracy and want of scientific method.

At the foot of p. vi. the author makes the astonishing statement that Darwin's predecessors are to be

“commended for strictly subordinating theory to natural facts. They thus happily avoided the error into which Darwin, in this instance at least, most assuredly and most conspicuously fell.”

On p. vii. the author continues,

“We consider that it was most unfortunate for Natural Science that Darwin relied almost so exclusively on artificial observation, or, in other terms, on experiment, for the investigation and interpretation of natural laws in facts connected with the fertilisation of flowers.”

That is to say, the botanists are to be commended for not having attempted to solve the problem of the sexual relation between the two forms of dimorphic flowers in the only possible way in which that question can be attacked.

The preface is followed by a chapter of three pages in which some technical terms are defined, and an incomplete account of dimorphism is given. This, we gather, is intended for the general reader, but it is useless for the purpose; indeed, we fail to see what interest such a reader can find in the book. If he is convinced by the Field Naturalist, and consequently gives up his belief in Darwin's work on the fertilisation of flowers, what does he gain? He has lost a coherent and interesting doctrine which, whatever may be its faults, is undoubtedly in agreement with an enormous range of authentic observation and experiment, and one that has stood the test of time, having been before the world in its modern shape since 1862. The reader is told by the Field Naturalist that *Arum maculatum* is a “purely self-fertilised flower”; if his faith endures up to this part of the book, and if he accordingly swallows the statement, he must for the future give up all attempt to find a function for floral structures, the whole build and habit of reproductive mechanism having become meaningless. It is the same throughout the book; we have pages of weak argument directed against well-authenticated conclusions—arguments which, if accepted, would leave floral structures unexplained and inexplicable. And when the author ventures on suggesting a function, we are liable to come across such a theory as that the orifice in the carina of *Lotus* (through which pollen is obviously and visibly pumped out) is to serve for the ventilation of the pollen stored within the carina!

If the general reader desires to read this book, let him prepare himself by reading a discussion on floral biology by some candid and competent person. And if, after he has seen how the subject can be treated by a rational writer, he still insists on reading “The Primrose

and Darwinism,” we must leave him to his fate, though we shall continue to be sorry for him.

We do not propose to go through the whole book, but to discuss one or two points and to leave our readers to judge of the remainder; we must indeed confess that we have found it impossible to read the whole.

The author's principal objection to Darwin's experiments is that in order to exclude insects he made use of a covering of netting. This treatment the author assumes, without any evidence, to be injurious to the pollen. He gives (p. 8) his general reasons for believing in this astonishing conclusion.

(1) “The influence of the solar rays would be greatly diminished,” and “would be much debarred from exercising their full maturing power on the anthers. . . .”

This may or may not be the case; but what botanist would make such a statement, unsupported by a single experiment?

(2) “Radiation would likewise be almost entirely prevented by the net, and the dew would consequently fail to fall on the anthers. . . . In the mornings of early spring, . . . we have frequently found the flowers of the primrose bedrenched with dew.”

The general reader would naturally assume that pollen is known to be improved in quality by being wetted. No botanist would have been likely to frame such a hypothesis, for it is well known that pollen is injured by water. And when a Field Naturalist theorises in this way, without giving a shred of experimental evidence, he must be plainly told that he gives up all claims to be considered a man of science.

(3) “In calm weather” the net would prevent “the free access of the wind, and would prevent it from shaking, and so from freely disturbing and distributing the pollen.”

Here again not a particle of evidence is given for his point of view.

In Chapter iv. the author gives instances intended to prove the injurious effect of the net. They are quoted from Darwin's “Cross and Self-Fertilisation.” One is the case of *Salvia tenori*, which when protected by a net was quite sterile except for two or three flowers on the summit of the spikes which touched the net when the wind blew.

The Field Naturalist (p. 11) says:—

“To attribute the capacity for fertilisation” in the unprotected “flowers to the bees is perfectly gratuitous, as the flowers under the net (when bees were excluded), ‘when they touched the net and the wind blew,’¹ produced seeds without any cross-fertilisation.”

How the Field Naturalist accounts for the flowers which touched the net when the wind blew being in a more natural condition than those which did not touch it we are unable to guess. He does not show that they were more wetted with dew, and gives, in fact, nothing that can be called a reason for his conclusion. Yet he has to account for a striking difference, since those flowers that did not touch the net were quite sterile. How Darwin accounts for the fertility of the flowers is not clear. They may have been visited by bees. Why does not the Field Naturalist go into this point, which would

¹ An incorrect quotation.

probably entail a discussion of the several types of floral structure found in the genus *Salvia*? We also look for a discussion of the question whether or no the fact that the flowers were pressed against the netting could so far disturb the mutual relations of the parts as to bring about self-fertilisation.

The same want of full discussion is felt in his critique on Darwin's observation on the broom (*Sarothamnus scoparius*). Darwin says the flowers were

"extremely sterile when the flowers are neither visited by bees, nor disturbed by being beaten by the wind against the surrounding net."

The Field Naturalist quotes this passage incorrectly, omitting "when the flowers are neither visited by bees"—and these words are of some importance, for they show that the disturbance by the wind was believed to have an effect analogous to that produced by insects. In another passage ("Cross and Self-Fertilisation," edit. ii. p. 164) Darwin states that "if the flowers are not dashed by the wind against any object, the keel never opens." If the flower is not opened the style remains in the keel surrounded, but either not fertilised or imperfectly fertilised by its own pollen. But if the style and stamens are freely exposed, as would be the case in the flowers opened by the wind's action, the flowers may conceivably be "dashed against" each other and fertilised, even if they cannot be visited by insects. The whole economy of the broom flower should be thoroughly known, and, indeed, fresh observations should be made, before it is possible to draw the conclusion of the Field Naturalist, that the sterilising action of the net accounts for the results.

The same sort of thing is put forward in the case of *Reseda lutea*. Here Darwin says,

"The bees were able to suck the flowers through the meshes, and brought pollen to them from the neighbouring plants."

The Field Naturalist says (p. 13),

"The bees could not possibly reach with their proboscis the side or inside flowers, yet the branches were loaded with capsules."

As the Field Naturalist was not present when the bees brought pollen to the mignonettes, and as one of the best observers in the world was present, we need not waste more time over this case.

In "Cross and Self-Fertilisation," from which the Field Naturalist takes his cases, he might have found, if he had looked for them, facts which he will find difficult to fit to his theory of the "denaturalising" effect of the net. Darwin gives ("Cross and Self-Fertilisation," edit. ii. p. 357-369) two lists:—(1) Containing plants which, when insects are excluded, are quite sterile, or produce, as far as he could judge, less than half the normal number of seeds. (2) Containing those which, when protected from insects, are either quite fertile or yield more than half the normal number of seeds. The Field Naturalist is bound to account for the fact that many plants are extremely fertile under the net, and he must account, too, for the fact that, broadly speaking, there is a difference between the type of flower found in the two classes. Or, to put it more accurately, in the first or sterile lot 65 per cent. of the genera have asym-

metrical or otherwise specialised flowers, while in the fertile lot the specialised genera are 43 per cent.

Why, according to the Field Naturalist's view, should the net be less hurtful to the simple unspecialised flowers? According to the rational view of the matter taken by most botanists, it was to be expected that specialised flowers would be more highly sterile, when insects are excluded, than simple unspecialised flowers. But it is useless to argue thus, for if a female dioecious plant were placed under a net, and were found to be sterile, the Field Naturalist would doubtless account for its sterility by the denaturalising influence of the net, not by the fact that pollen could not reach its stigmas.

Chapter xiii., on "The So-called Dichogamous Plants," may be taken as another instance of the Field Naturalist's method of treating a scientific problem. His notions on this subject seem to be taken from Lord Avebury and Dr. Wallace, neither of whom can rank as original authorities on the question, while we look in vain for references to Sprengel, Delpino and Hildebrand. This is only one instance of the author's ignorance of the literature of his subject. It is probably in consequence of want of knowledge that he sets up an incorrect definition of dichogamy against which to direct his arguments. He ought to be aware that dichogamy does not necessarily mean a complete separation in time of the staminal and stigmatic functions. However, allowing this serious flaw in his point of view to pass, let us see how he deals with a strongly dichogamous species, *Arum maculatum*. He tells us that no flower gives clearer evidence of its own self-fertilisation than the *Arum*. Yet he quotes an observation of Darwin, who saw minute flies emerge from an *Arum*, dusted with pollen, and subsequently visit a neighbouring plant. Here Darwin found pollen within the spathe, though the stamens had not burst. No one will pretend that this one observation is conclusive, but it points clearly to the view accepted by botanists that flies carry pollen from the older to the younger spathes, thus fertilising the female flowers¹ before the pollen in the spathe is ripe.

The Field Naturalist principally devotes himself to trying to prove that the *Arum* does not imprison flies with sufficient regularity and in sufficient numbers to be of any use. He writes (p. 80):—

"About the forced imprisonment of small flies, Darwin says, 'this statement has [now] been shown by Hildebrand to be erroneous,' and Darwin proves that it is incorrect, and that the small flies can escape before the hairs above wither, by his own experiment" ("Cross and Self-Fertilisation," edit. ii. p. 420).

It so happens that Hildebrand's statement (according to Darwin) refers to *Aristolochia*, not to *Arum*. But even if it had referred to *Arum* it would only have illustrated another piece of inaccuracy of the Field Naturalist. What was shown by Hildebrand (as quoted by Darwin) to be incorrect was the old statement that flies which enter the flowers *never escape*, whereas the Field Naturalist seems to consider it an argument against imprisonment occurring at all. His own observations are on a level with this loose treatment of the problem, for he does not say in which of Delpino's stages were the

¹ Often described as ovaries.

Arums in which he failed to find imprisoned flies. He is clearly ignorant of Knuth's and Müller's positive statements as to the presence of imprisoned insects, and of Müller's description of the flies flying vainly against the imprisoning hairs. He describes the stigmas as covered with pollen after the anthers of the same spadix have burst—which is by no means surprising since the stigmas secrete nectar after they have ceased to function.

He throws in the gratuitous guess that the dead flies sometimes found at the bottom of the prison are killed by feeding "on the intensely acrid juice which, as is well known, is secreted by the tissues of the flower." As a matter of fact, precisely the opposite is known, namely, that "juice" of the plant is not acrid, the irritating effect of the tissues as a whole being due to minute pointed crystals. He concludes that Arum is "a purely self-fertilised flower." To one with any knowledge of the subject this statement, appended as a justifiable conclusion from such an array of arguments, is enough by itself to condemn the author.

Chapter xxiii., p. 190, is headed "Trimorphic Flowers. The cleistogamic flowers directly disprove the theory."¹ The hasty reader might suppose that the theory in question is the Field Naturalist's own hypothesis that nets are a cause of sterility. For if sterility can be produced by keeping the pollen from sun, rain, wind, &c., as the Field Naturalist states to be the case, then surely a cleistogamic flower, in which the andrœcium is shut up within the corolla (a covering much more impervious than a net), must be completely sterile, more especially as the reproductive parts are more or less in the dark, a condition known to produce sterility in chasmogamic flowers. This does not occur to our author, who calls the cleistogamic flower Nature's "own natural net."

The Field Naturalist completely misunderstands Darwin's point of view about cleistogamy, which, by the way, is also the view of biologists generally. Cleistogamy is an economical arrangement for securing fertilisation at any price; it is important that cross-fertilisation shall take place, but it is still more important that seedlings of any parentage should be produced. Floral structures are compromises between the two extreme forms, cleistogamy and diœciousness, in one of which offspring is assured, in the other the offspring, if any, is cross-fertilised. The existence of cleistogamy, instead of being fatal to "the theory," is a most instructive part of the body of facts on which the modern view is founded. Why the Field Naturalist supposes that "cleistogamic flowers directly disprove the theory," especially in the case of trimorphic plants, is not obvious, for the meaning of cleistogamy is the same in any class of flowers. We fail to see that his discussion throws any light on the subject. The only point which is worthy of notice is a quotation (p. 191) from Darwin's "Forms of Flowers," which has several copyist's mistakes, and, moreover, contains interpolated words which do not occur in the original, the whole being within inverted commas. It is this sort of treatment of Darwin's text that makes it almost impossible to read the Field Naturalist. We can never know whether the quotations are correctly given, and life is not long enough for the

verification of his innumerable citations. There is, however, little in the book but quotations and criticism, and when the reader distrusts the quotations and can see no value in the criticisms, the task of getting through the book becomes unbearable.

We would urge the author to give up his barren attempt to discredit work of such perennial value as Darwin's by niggling bookish methods. Let him rather imitate Darwin's life-long habit of absolutely honest experiment, coupled with broad-minded discussions in which all facts and considerations which oppose his views are brought into full prominence. Then, and not until then, can we take his writings seriously.

CHRONOMETRY.

Exposition universelle de 1900. Congrès international de Chronométrie. Comptes rendus des Travaux, Procès-verbaux, Rapports et Mémoires. Pp. xl + 254. (Paris: Gauthier-Villars, 1902.)

AMONGST the numerous congresses at Paris in 1900 was one on chronometry, of which the work under review is the official publication. In addition to the "minutes" of the meetings, which include abstracts of the communications, it gives the full text of more than thirty papers and reports. These deal with such subjects as the testing of watches and chronometers, the decimalisation of time, questions of units and standards, topics of historical or current interest in horology, the description of novel instruments or materials, and mathematical and physical investigations bearing on chronometry.

M. de Vanssay, one of the secretaries to the Congress, gives an account, pp. 5-12, of the tests applied to watches and chronometers at the chief testing observatories. On pp. 153-156 is the report of a commission appointed to consider the question of watch tests, with a view to securing uniformity at different places. The commission confined its attention to the regulations in vogue at Geneva, Kew and Besançon, which are similar in general character, and to new regulations proposed for Neuchâtel. While generally favourable to the Geneva-Kew-Besançon rules, the majority of the commission preferred the Neuchâtel method of dealing with the results obtained at different temperatures. The commission recommends the addition of a two days' test with the watch vertical pendant down, excessive difference between the rate in this position and in the other vertical position pendant up to be a cause for rejection. It makes other recommendations tending to increase the severity of the tests. It recommends that the marks obtained by a watch be given only in the official list of the testing institution, and expresses a wish that all observatories should assign marks according to some common scheme.

A second subject considerably discussed was the decimalisation of time, papers on this topic occupying pp. 116-145. M. Guyou would accept the existing hour and subdivide it decimally; but he would do so only in the case of clocks or chronometers, "tropomètres," used for astronomical or nautical work, whilst the general public would be left to the existing clock or "garde-temps." M. de Rey-Pailhade is more advanced, though his argument that the metre is "admirablement proportionnée à la taille de l'homme" rather savours of

¹ We have omitted the letter "D" which forms part of the title, and shows that the chapter continues the previous section C.

antiquity. He proposes a unit the "cé" or 1/100th of the day, subdividing it into the "décicé" and "millicé." In the meantime, he would confine the system to men of science, but would teach it in the schools as soon as it meets with international approval. M. Goedseels considers the greatest obstacle to progress to be the existence of numerous tables and costly instruments based on the sexagesimal system. To help to remove this obstacle, he contributes seven pages of tables for converting time and angles to a decimal system. He takes the hour and the degree as units for one system; for a second he supposes the day divided into forty hours, the circumference into 400 grades. Dr. F. Jaja advocates a system similar to that of M. de Rey-Pailhade; but instead of "cé" he calls his unit "degré," its multiples "décagrade," "hectograde," its submultiples "décigrade," &c., down to "décimilligrade." For use by the public, he suggests for the subdivisions the titles "minute première," "minute seconde," "moment" and "instant."

The English equivalent of a "minute seconde" would be found rather awkward, and why should an "instant" be shorter than a "moment"? In England decimalisation of time may appear rather a remote topic, but it seems to have met with considerable favour at the Congress. The fact that a standing committee was appointed on the subject may not mean rapid progress, but M. Guyot mentions that his system has had a nine months' trial on five French cruisers.

Units form the subject of short papers by M. Lippmann, pp. 175-6, and Dr. Guillaume, pp. 179-183, and of a report by a special commission, pp. 184-6. M. Lippmann's paper is theoretical, treating of various alternatives to the present second as unit of time. One is based on the Newtonian constant of gravity, a second is a submultiple of the sidereal year, a third is the time of vibration of a simple pendulum the length of which (at a given place presumably) would subtend a certain angle at the earth's centre, a fourth is based on the oscillation period of a condenser. Dr. Guillaume's paper is practical. He suggests the classification of watch movements according to diameter. Taking 2 cm. as point of departure, he suggests that the interval between successive classes should be 2 mm. above this point and 1 mm. below. For balances he takes the formula $T = \pi \sqrt{I/M}$ for a French (or half) vibration, where I is the moment of inertia, and M is the "moment elastique" (stiffness) of the spiral spring. He suggests that the number of the *balance* be the value of $\pi \sqrt{I}$ and the number of the *spring* be \sqrt{M} , both expressed in C.G.S. measure. These suggestions meet with considerable favour in the report of the special commission. The institution of definite types, with the elimination of intermediate sizes, is, of course, an important one for watchmakers.

Amongst the papers bearing on topics of historical or current horological interest may be mentioned those by Rodanet on the proper definition of a chronometer, by Ditisheim on the classification of escapements, by Kaiser on the price and scientific value of chronometers, and by Caspari on the chronometers of the French navy. In the paper by Ditisheim, pp. 40-46, there are a number of interesting data bearing on the

comparative merits of different escapements. We have also a paper by A. Cornu, pp. 55-59, on the phenomena observed in magnetised watches, with a full discussion of the effect of changing the position of a magnetised watch relative to the earth's field; while Brillouin, pp. 164-174, treats experimentally of rapid variations in the amplitude of oscillation of balances, with special reference to the question of the shape and finish of the teeth of wheels.

Amongst the papers dealing with instruments may be mentioned those by A. Cornu, pp. 47-54, on the clock at Nice, by Maillard Salin, pp. 63-5, on "montres-a-billes," by Féry, pp. 69-72, and Thury, pp. 146-152, on applications of electricity, by Borrel, pp. 204-7, on a kind of Venetian blind semaphore for signalling time to ships, and by C. W. Schmidt, pp. 113-5, on his chronograph. This last instrument appears to be employed in France for measuring the velocity of projectiles, and is said to give velocities up to 700 metres a second correct to about 1 part in 500. A specially important paper is that by Dr. Guillaume, pp. 90-112, on nickel steels and their applications to horology. The substance of this paper has mainly been published elsewhere, but it is presented here in a convenient form and it attracted considerable attention at the Congress. Dr. Guillaume has yet another interesting communication, pp. 195-7, on an instrument for drawing the terminal curves of spiral springs in accordance with the results of Phillips's well-known application of the mathematical theory of elasticity.

The mathematical papers, though mentioned last, are by no means least in evidence. M. Faddegon, pp. 13-33, treats of the effects of changes of temperature on ordinary and on compensated pendulums. The formulæ he arrives at for the "grid-iron" pendulum are complicated and those for the mercury pendulum still more so. In the latter case we encounter on p. 27 a determinant with ten rows and columns, and the mere look of the formulæ on pp. 32 and 33 will probably suffice to damp the ardour of anyone anxious to combat the author's conclusion, on p. 31, that it would be well for scientific purposes to give up attempts at compensation and revert to homogeneous pendulums.

M. Goedseels, pp. 73-89, treats of mathematical processes, less exhausting than least squares, for determining constants in linear formulæ containing a considerable number of terms. Comparing the methods of Cauchy and of Tobie Mayer, he concludes that in point of simplicity the advantage rests sometimes with the one, sometimes with the other, according to the circumstances of the problem. But in the case of the ordinary 6-term formula for the rate of chronometers he decides in favour of Mayer.

The final mathematical memoir, pp. 217-252, consists apparently of a collection of already published papers by M. E. Caspari, the acting president, which the Congress decided to reprint. The common subject is the isochronism of helical springs. Calculations are made, after the methods of Phillips, Resal and Yvon Villarceau, of the influence of the "centrifugal force" acting on the balance through its own motion, of the inertia of the spring, and of air resistance, friction, &c. There is also an investigation into the possibility of obtaining isochronism by varying

the length of the spring without having its terminal portion shaped after one of Phillips's curves. On p. 240 it is concluded that, provided the windings are numerous enough, there are in each turn two points diametrically opposite, the attachment of which to the balance would procure isochronism. The paper contains also references to some experiments, and certain mathematical functions are tabulated. The memoir is one which only an expert elastician can follow, while an unprejudiced technical expert could alone judge of its practical value. This implies a combination doubtfully existent in England.

The book as a whole is full of ideas, and contains in addition many valuable facts. It is well worth the attention of horologists, whether practical or theoretical. In some of the papers, however, there are indications of a little haste, or of careless proof-reading. M. de Vanssay's description of the Kew watch trials seems to be founded on a set of regulations superseded in 1890. He specifies different rejection limits as applying to ordinary class A watches and to those obtaining the distinction "especially good." This is not now the case, the distinction denoting simply the attainment of at least 80 per cent. of the total possible marks. In some of M. Faddegon's mathematical expressions there are a few rather obvious misprints, and the paging is wrong in the few cross-references in the text of his paper.

In M. Féry's description of a pendulum with electric "restitution" the letters employed in the text are omitted in Figs. 1 and 2 on p. 70, rendering the description difficult to follow. There are a good many slight errata in intermediate steps in M. Caspari's memoir. Thus on p. 234 the sign of equation (7) is wrong, and the term containing b in the line above is also given incorrectly. The suffix in a is omitted somewhat arbitrarily on pp. 239 and 244, and on the latter page its factor $\sin \phi$ is omitted several times. The errata, however, are seldom of a kind likely to cause serious trouble.

C. C.

TRADES' WASTE AND RIVER POLLUTION.

Trades' Waste: its Treatment and Utilisation. By W. Naylor. (London: Charles Griffin and Co., Ltd., 1902.)

IN this volume the author, who is the chief inspector of rivers of the Ribble Joint Committee and consulting engineer on sanitation and rivers' pollution to the Somerset County Council and other public bodies, has put together the results of his experience and observation, as to the causes of the pollution of rivers and as to the best known practical means of preventing it. The subject, it need hardly be said, is of the greatest importance, but it is also one of ever-increasing difficulty and perplexity. It has been forced upon public attention with more or less insistence at irregular intervals during the last half century. In 1867 the whole question was relegated to a Royal Commission, the reports of which are justly styled by the author as by far the best production on the subject hitherto published in any country. The labours of this Commission paved the way for the Rivers' Pollution Act of 1876, but this, as administered by the various local sanitary authorities, proved to be of little practical good. There can be no question that if it had been

efficiently administered much might have been accomplished, and by simple means, and we should not have had to wait for the more costly operations which have resulted from the Local Government Act of 1888. Had the local authorities put the Act in operation with the vigour which they showed in the case of the Alkali Works Regulation Act a great public benefit might have been effected with comparatively little friction or irksomeness. The author points out how the opportunity was allowed to slip.

"Land on which to instal plant might have been obtained which cannot now be procured, and machinery might have been put down, and drains laid at levels which would have permitted the interception of the drainage without the resort to pumping now in many cases necessary. But this was not done. Manufacturers are just as much to blame themselves as anybody. In many cases it was due to their opposition as large ratepayers or to their personal influence on the local governing authorities, that the Act remained a dead-letter."

Whether the larger powers vested in such bodies as the two boards of the Mersey and Irwell Joint Committee and the Ribble Joint Committee, some of which have also been acquired, or sought to be acquired, by county councils, will result in a larger measure of good remains to be seen. But it is evident from the manner in which various trade associations, as, for example, the Paper Makers' Association, have been moved that a more stringent administration of the Act throughout the country is in contemplation, and that the opposition, overt or covert, of many of the manufacturers has still to be reckoned with.

In a chapter on chemical engineering the author deals with the general principles underlying the treatment of trades' waste, either as liquid or semi-solid products. He discusses the "laws" regulating the subsidence of solid particles floating in liquids, the conditions determining their aggregation and the various modes in which precipitants are manufactured. He then gives typical illustrations of the application of these principles as carried out in actual practice, as in the Mather and Platt system and in the continental tank systems. He gives details of the mode of construction of precipitation tanks, together with a design of retaining walls for resisting hydraulic pressures, &c. This chapter is illustrated by diagrams and plans, together with a number of well-executed "process" reproductions of photographs of installations in actual use. It is not, however, very obvious why it should be headed "Chemical Engineering," since it is mainly concerned with the application of physical and mechanical principles to the filtration and clarification of more or less turbid liquids.

The remaining chapters, seven in number, deal with some of the special industries which produce waste in notable amounts, such as woollen mills, tanneries and fell-mongeries, breweries and distilleries, bleach and dye works, calico printing works, paper making and chemical works. As a matter of fact, however, the author treats only comparatively few of the waste-producing industries.

The various industries, adopting the classification of the Society of Chemical Industry, may be grouped into twenty-two classes. According to the author, only five of these may be said to have no liquid waste of consequence as regards volume, whereas the remaining

seventeen have both liquid and solid waste, and in the greater number of these the liquid waste preponderates.

But those industries selected by the author for special treatment are undoubtedly among the greatest sinners as regards possible river pollution. Their waste is, as a rule, particularly difficult to deal with, and a study of the means adopted in the several instances presents many features of interest to the sanitary and municipal engineer.

The work has been judiciously put together, and the examples of plant selected for special description are in all cases typical examples of their class. It is admirably printed and illustrated, and the diagrams and drawings are such as will commend themselves to the practical man. The work is specially addressed to borough engineers and surveyors, and we trust that it will be as widely read and studied by them as it deserves to be.

OUR BOOK SHELF.

Die Weltherrin und ihr Schatten. Ein Vortrag über Energie und Entropie. Von Dr. Felix Auerbach, Prof. a. d. Universität Jena. Pp. 56. (Jena: Gustav Fischer, 1902.) Price Mk. 1.20.

DR. AUERBACH no doubt undertook a very difficult task when he endeavoured to popularise the exact significance underlying the expressions "energy" and "entropy," and the relations subsisting between them, and it is not easy to say how far he has succeeded in making himself intelligible to an unscientific audience. Doubtless, of energy everyone believes himself to be more or less well informed, but of entropy, though perhaps not really more difficult of apprehension, yet from its less familiar use very great perplexity and uncertainty seem to exist. We can only hope that the author dissipated some of the clouds which hover around this intricate subject. The somewhat fanciful title of "The Mistress of the World and her Shadow" which is attached to the address leads one to expect a more picturesque and imaginative treatment than the subject receives. One looks naturally for a new set of metaphors and illustrations by which a rather dry subject may be illuminated and its treatment rendered more entertaining, but one does not find much that is new or very appropriate, though of course the matter is sound, and doubtless as a popular address the lecture was very effective.

We are glad to see that it has since been published in *Himmel und Erde*, where it is likely to meet with many and appreciative readers, and thus reach a wider audience than is possible in a lecture theatre. The authoritative version is accompanied by a short list of works connected with the general subject, and also some pages of explanatory notes from the professor addressed to those who are supposed to have some slight previous knowledge of the subject. Notes attached in this way are usually a tacit admission on the part of the author that he has failed to accomplish the task that he has undertaken. We see no reason to view these notes in a different light.

Chemisch-Analytisches Praktikum. Von Dr. Karl Anton Henniger. Pp. viii + 127. (Brunswick: F. Vieweg und Sohn, 1902.) Price Mk. 1.50.

The chief interest of this book lies in the fact that the author is head-master of the Charlottenburg Real Gymnasium, and that the course which he describes is the one adopted in that institution. We have thus an opportunity of seeing what kind of practical chemistry is cultivated in one of the first-class German schools. According to the author, the goal to be reached by the

great majority of his pupils is a knowledge of the chief reactions of the non-metals and metals, as well as sureness and clearness concerning the procedure of analysis and the use of the distinguishing reagents. This is to be effected by exercising in simple analysis.

If this be the case, it may be said that the book is well calculated to fulfil its purpose, for it is substantially a treatise on qualitative analysis prefaced by some useful exercises on different types of chemical action. Descriptions and equations are given for all the tests that are to be performed, and the pupil is, in fact, put through a regular analytical drill. The amount of detail is surprising considering that we are concerned with school-work, and it is difficult to see what would be left for the university to teach in the way of qualitative analysis if the students came with a mastery of this book.

It is remarkable that the course of chemistry here prescribed for school purposes is of the kind that, with pretty general approval, has been steadily disappearing from English schools during the past fifteen years. In this corner of education Germany can hardly be said to show the way. A. S.

La Protezione degli Animali. By N. Licò. Pp. viii + 64. (Milan: U. Hoepli, 1902.)

THE appearance of this "booklet" may be taken as an indication that the proper treatment by man of the inferior animals and the avoidance of unnecessary and wilful cruelty are attracting attention in countries other than our own. Indeed, Turin, like Paris, possesses its own Society for the Protection of Animals, and the crusade against bearing-reins and other forms of minor torture is carried on as vigorously (and, shall we say, as vainly) as in London.

The author commences with a chapter on the duty of humanity to animals in general, and then proceeds to discuss the various groups of animals brought more especially into contact with man, and the cases where amendment in their treatment is most urgently required. In general, the arguments appear to be put temperately and moderately, even in regard to that thorny subject vivisection. Such sports as dog-racing (under the conditions in which it is conducted in some continental countries), cock-fighting and bull-fights the author unhesitatingly condemns. He is likewise averse to all mutilations of animals, whether to "improve" their appearance or for other reasons. But minor matters, such as the treatment of horses by cavalry soldiers and coachmen, and the nature and fitting of their accoutrements and harness, claim a share of attention. Whether the author will succeed in convincing the world that a vegetarian is preferable to an animal diet may be more than doubtful, but if the book leads to a diminution in any degree of certain forms of cruelty to animals from which this country at any rate is free, its publication will not have been in vain. R. L.

Coal Cutting by Machinery in the United Kingdom. By Sydney F. Walker. Pp. 144. (London: The Colliery Guardian Co., Ltd., 1902.)

THE complaint has frequently been made against mine owners in this country that they are not availing themselves of coal-cutting machinery to anything like the same extent as mine owners in the United States. The complaint is justifiable, inasmuch as any methods by which labour and capital can economise are now absolutely necessary. In his excellent monograph on coal cutting by machinery, Mr. Walker shows that the question is by no means new to this country. The history of the coal cutter in Great Britain is an ancient one. Indeed, the earliest proposal to substitute the labour of a machine for that of a collier appears to have been made by Michael Menzies, of Newcastle-on-Tyne,

towards the end of the eighteenth century. The historical portion of the work shows the evolution of mechanical coal cutting in Great Britain since that date. Descriptions are given of every machine that has been put to practical use, as well as detailed particulars of those that are now in successful operation. The conclusions drawn by the author from his elaborate investigations are that the whole of the coal of Great Britain must be cut by machines, or the industry will find itself in much the same condition as the corn-growing industry, swamped by American production. The pillar and stall method of mining should be replaced by the long wall method, and coal-cutting machines would render blasting unnecessary. The most serious problem to be dealt with is that of cutting coal under a weak roof. The difficulties are perhaps hardly sufficiently emphasised by the author. In a tender coal the roof is crushed down on the machines, or supports have to be set near the faces. These get in the way of a machine. Moreover, machines are so noisy when at work that it is impossible to hear the preliminary warning sounds that the roof generally gives before it breaks down. Eventually, no doubt, it will be ascertained which machine can best be adapted to these conditions, or how the conditions can be modified to suit the machine that promises best.

The author's lucidly written and well illustrated volume cannot fail to prove of great value in directing the attention of mine owners to problems that, at the present time, are of the utmost importance.

Metallography: an Introduction to the Study of the Structure of Metals, chiefly by the Aid of the Microscope. By Arthur H. Hiorns. Pp. xiv + 158; with ninety-six illustrations. (London: Macmillan and Co., Ltd.; New York: The Macmillan Company, 1902.) Price 6s.

THE study of the properties and constitution of metals and alloys has made great progress during the last few years, and has reached a point when it can no longer be neglected by engineers. Steel workers have already received some guidance from the labours of metallurgists, chiefly, perhaps, from investigations on what Osmond called the "pathology of metals," and the time may not be far distant when the microscope and the pyrometer will form part of the outfit required in the ordinary testing of materials. Metallography has been regularly taught for some time at many of the technical schools both in this country and in America, and it is remarkable that no text-book on the subject existed in the English language before the publication of the work under review. The researches on which Mr. Hiorns has based his book are scattered and highly specialised, and the acquirement of a general elementary knowledge of the subject has been a difficult matter for the student. The appearance of this book is, therefore, particularly well timed, and it will be eagerly read by many, who will not be disappointed by what they find.

The author has carefully collected most of the important results which have recently been obtained, and has given a terse and lucid summary of them which is surprisingly complete, considering the modest dimensions of the book. He has not devoted much effort to the philosophic aspect of the subject, but that is, perhaps, just as well, inasmuch as the science is in its infancy. With regard to the illustrations, exception may be taken to many of the photomicrographs, which appear to have been taken from a set of poor negatives. On the other hand, they have been beautifully reproduced on special paper. In the study of steel, the author has handicapped himself unnecessarily by using such low powers of magnification that some of the structures of which he speaks cannot be seen at all. Nevertheless, taking the book as a whole, Mr. Hiorns deserves the thanks of his fellow workers and teachers for the useful aid he has given them.

LETTERS TO THE EDITOR.

[The Editor does not hold himself responsible for opinions expressed by his correspondents. Neither can he undertake to return, or to correspond with the writers of, rejected manuscripts intended for this or any other part of NATURE. No notice is taken of anonymous communications.]

Notes on Young Gulls.

IN northern Bohemia there is a large pond or artificial lake—the Hirschberger Grossteich—with a small, rocky island. This is a favourite breeding-place of gulls. Most of these are *Larus ridibundus*, but some *Sterna hirundo* also breed on the rock. For the purpose of studying its plankton I have repeatedly visited this pond, and have thus had occasion also to make some observations on the gulls which may perhaps be of interest to readers of NATURE.

The rock island which forms the breeding-place is some 400 square metres in extent, and rises in ledges to a height of 15 metres. It is composed of the Cretaceous "Quadersandstein" of those parts, partly bare and partly covered with patches of tough, greenish-brown grass and brighter green thistles. The *Larus ridibundus* nests on this rock are pretty carefully built and entirely composed of dry leaves of bulrushes. There are generally three eggs in each nest. At the height of the breeding season there are about 200 such nests on the rock, besides the much less numerous *Sterna* nests. The nests usually lie on the bare rock close to the margin of a patch of vegetation. The dirty brownish-yellow and black-spotted, mimetic colouring of the down-covering of the young is very effective. When from two to ten days old these young crouch, on being disturbed, against the half-dry grass-tufts and thistles close to their nest, and are then by no means easy to detect. It seems to me that the colouring of these young gulls is not quite the same as that in young of the same species breeding in different environments. It is quite likely that we have here a case of adaptation of the colour of the young to different surroundings, unaccompanied by any difference in the colouring of the adult into which they develop. Older ones, which are already beginning to replace the down with feathers, but in which the head is still entirely covered by the primitive yellowish-brown and black down, do not, as a rule, try to hide themselves in this way, but hurl themselves into the water and swim away rapidly when the boat approaches the rock. The old birds scream loudly and try, first, to entice the intruder away in the usual manner by slowly swimming and flying about near the boat and pretending to be wounded and lame. Besides this, however, they also swoop down on the swimming young, sometimes pushing them right under the water. The first of these actions clearly tends to draw the attention of the intruder away from the young; the second has the very opposite effect. Perhaps it may be accounted for in this way. The young have—this can be observed clearly enough—no idea of the nature of the movements of a boat, and often try to escape it by swimming straight ahead in front of the bow. It gives the impression that the old birds try by their screams to convey instructions to the young about the direction in which they should swim so as better to escape the boat. The young, however, often appear not to understand or to heed these "words of advice," whereupon the old birds pounce down on them and give them one or two good slaps with their wings so as to make them understand and obey. These sharp lessons do not seem to be of much good, however. After being thus slapped, the young continue to swim straight ahead of the boat as stupidly as before.

One of the eggs I brought home and hatched artificially. The bird began to chirp in the egg a few days after I had placed it in the oven, upon which I cut away the blunt end of the eggshell and found, as was natural after hearing the bird give voice, the beak protruding into the air-chamber. On the fourth day after this the young gull left the egg-shell. It then weighed 22.7 gr. We weighed it daily for a fortnight. The average daily gain of weight during this time was 8.5 gr.

The daily increments were quite irregular, varying between 1.6 and 3.2 gr. the first four days, and between 5 and 27.5 gr. the latter ten days. These irregularities were, of course, due to differences in the quantity of the contents of the intestine. One day—not three, as has been stated by Prof. Thomson (NATURE, vol. lxiv. p. 588)—after birth the young bird swam about when placed in water just as well as a young duck. For

the first six or seven days it preferred to stand on its heels, and usually rose to its toes, that is, the normal position of the adult, only when walking.

The bird often ate indigestible things, little stones, &c., not, as it appeared to me, altogether accidentally, but chiefly and purposely, after it had made a good meal off some living food—*Tenebrio* larvae, *Limnaeus*, or the like. Smaller edible things like ants' chrysalids it picked off the ground itself very early, but larger morsels, bits of fish, mice, &c., it only takes when held in the hand and presented to it even now, when it is eight weeks old. The stones, &c., it occasionally eats, and the hair and larger bones it has swallowed it brings up and vomits in a mass. It lost the thorn of the beak on the fourth day and began to fly a little after four weeks; when seven weeks old it began to make longer excursions, and flew—without precept or example—very well. It has, however, not yet attained to anything like the elegant flight of full-grown gulls, and occasionally makes an involuntary somersault in the air when trying to soar or rest on the wind without flapping its wings.

R. V. LENDENFELD.

Prague.

The Effect of Light on Cyanin.

WHILE working on the reflective power of cyanin mirrors I have noticed some very interesting effects of light on that substance. Freshly fused cyanin is of a deep metallic bronze colour, but exposure to light turns it plum colour and finally a steely blue-black. In the moderate light of a cloudy day the change is perceptible in half an hour, in direct sunlight in less than a minute. The complete change to blue-black requires an exposure of about twenty hours to diffuse daylight or half an hour to direct sunlight. It has long been known that cyanin is unsuitable for use as a cloth dye on account of its rapid fading in sunlight, but recent investigators of the optical properties of this substance appear to have overlooked this light effect. That the effect is purely photographic and not due to any rise in temperature is shown by the fact that long-continued heating in the dark produces no trace of discoloration. On the contrary, the effect of heating is to reverse the effect produced by the light, for a thin coating of cyanin, exposed until blue-black throughout, returns nearly to its original bronze colour on fusion or long-continued heating in the dark. By an exposure of thirty hours I have obtained on cyanin easily recognisable photographs of small, well-illuminated objects. A cyanin mirror, or better yet a piece of ground glass washed over with fused cyanin, exposed for ten hours to the spectrum of a Nernst lamp shows the effect to be very strong in the yellow, just perceptible in the adjacent red and green, and imperceptible in the blue and ultra-violet. It appears to correspond with the absorptive index as determined by Pfleger in various parts of the spectrum. At the same time, the exposure to light greatly decreases the absorbing power where it was originally large, as may be easily seen on looking at a sodium flame or a spectrum through an exposed coating of cyanin. It is as though the absorption were due to molecular resonance and the light produced a fatigue or destruction of this resonating power.

A most noteworthy change in the refractive index accompanies this change in the absorptive index, and is shown by the alteration in the reflecting power. The reflecting power of fresh cyanin is roughly 20 per cent. in the yellow, 2 per cent. in the blue-green and 6.5 per cent. in the ultra-violet. After exposure to light the reflecting power is nearly constant, 6.5 per cent., from the red out to 250μ in the ultra-violet. Now in the blue-green the absorptive index is so small as not to affect the reflecting power sensibly, so that the refractive index varies from about 1.1 to 1.6. Evidently work on the optical constants of cyanin is of little value unless carried on without exposure of the cyanin to daylight. A decrease in the absorptive index from 0.75 to nearly zero is indicated by the decrease in the reflecting power in the middle of the yellow, where exposure to light does not greatly affect the refractive index. The general effect of exposure to light is, then, to remove the absorption band and to destroy the characteristic anomalous dispersion.

The cyanin used was furnished by Kahlbaum, in Berlin, and is the ordinary diamyl iodide, $C_{25}H_{33}N_2I$, easily soluble in alcohol and ether, but only very slightly soluble in water.

Gottingen, August.

P. G. NUTTING.

Fog Bow at Oxford.

A SOMEWHAT curious phenomenon, presumably an effect caused by the searchlights at Spithead, was visible here in Oxford on the night of Saturday last.

About 11.15 p.m., the night being fine and warm and the sky somewhat overcast, my attention was arrested by the appearance of an arc of whitish light, about 15° above the south horizon, within which the sky appeared of an intense black. The arc rapidly increased in elevation until, in six or seven minutes' time, it had reached the zenith, forming an arch extending, apparently, to the horizon on the east and west; it then declined northwards, and in another four or five minutes had vanished.

In appearance it suggested a brilliant lunar fog bow, but the light was of a more bluish tint, the interior circumference being far brighter than the outer; and the brilliancy did not diminish to any great extent until the bow attained its highest altitude, after which it rapidly became fainter. The distance from Spithead is rather more than seventy miles.

Rawlinson Road, Oxford, August 20.

J. ROSE.

Simple Means of Producing Diffraction Effects.

IN the interesting article on "Photography of Diffraction and Polarisation" published in the issue of NATURE for August 7, the writer describes various means of producing diffraction effects. It may possibly interest some readers of NATURE to know that beautiful fringes may be seen with even simpler apparatus than that described in the article referred to. All that is required is an ordinary folding foot-rule, preferably of ivory. To see diffraction bands by its means, it is only necessary to close the two halves of the rule until they are almost in contact and then to fold them over. On looking at the sun or other bright source of light through both slits, a series of brilliant diffraction bands will be seen.

WILFRED HALL.

Tynemouth, August 20.

Time-Signals by Wireless Telegraphy.

MAY I suggest that the wireless telegraph offers a means of enabling Greenwich or other astronomical time being sent to ships at sea for the correction of their chronometers and the finding of their longitude? Distinct signals have already been transmitted from England to America, and these are all that is necessary for communicating time. At certain hours of the day or night, for example 1 p.m., a series of wireless signals, perhaps ten or twenty, at intervals of one second, might be sent from Greenwich far and wide as an extension of the time-ball signal which now serves for ships in the Thames and the Downs. By international regulation these time-signals could be protected from other wireless signals. I need scarcely add that such time-signals would also be useful inland.

JOHN MUNRO.

Croydon, August 25.

THE BELFAST MEETING OF THE BRITISH ASSOCIATION.

SINCE the publication of our last article on the approaching meeting, the following additional arrangements have been made:—

The local executive committee (chairman, Sir Otto Jaffe) invites members, associates and holders of ladies' tickets to a garden party in Botanic Gardens Park, near Queen's College, on September 15, at 3 to 5.30 p.m.

In connection with this reception, the new fernery recently arranged by Mr. Charles McKim, curator of the Botanic Gardens, will be opened for the first time, and will be found well worth seeing by those interested in ferns and tropical plants.

On September 16, Lord O'Neill gives a garden party at Shane's Castle, picturesquely situated on the shore of Lough Neagh.

The Belfast Harbour Commissioners invite members, associates and holders of ladies' tickets to a reception in the Harbour Office on September 16, at 8 p.m.

Mr. and Mrs. John Brown will give a garden party at Longhurst on September 11 (by invitation). Their guests will be invited by Mr. G. Herbert Brown, J.P., to inspect St. Ellen damask and linen weaving works close by.

Mr. W. S. Bruce, of the Scottish Antarctic Expedition, has arranged that the exploring ship *Scotia*, recently fitted out, shall, before her departure, visit the harbour during the meeting for inspection by those attending it. The ship is elaborately supplied with instruments and apparatus for zoological, oceanographical and other branches of research, which will be in charge of her scientific staff. The inspection of the ship and her outfit will no doubt form a most interesting incident of the meeting.

Under the able management of Prof. Symington, good progress has been made with the loan exhibition, the following contributions to which will be found of special interest:—

From Mr. W. J. Knowles, a collection of specimens illustrating the various stages in the manufacture of stone implements collected from the remains of an ancient flint implement factory at Cushendal.

From Mr. R. Welch, a collection of Irish jaunting cars illustrating the development of that vehicle from a primitive form; also series of photographs illustrative of

Irish ethnology, local geology and of the more special trade processes of the north of Ireland.

Irish ethnographical collections will also be exhibited by Dr. Scharff, Mr. S. F. Milligan, Mr. W. H. Patterson and Miss E. Davis.

The skeleton of the Irish giant is being kindly sent for exhibition from Trinity College, Dublin.

In connection with Section K (Botany), an interesting collection of Australian plants will be exhibited by Mr. Thomas Steel, as the representative of the Linnean Society of New South Wales.

Mr. R. Lloyd Praeger will exhibit a number of rare Irish plants.

The collection of apparatus employed by the late Prof. Andrews in his researches on the continuity of the liquid and gaseous states and on heats of combination, &c., is being carefully arranged by his daughter, Miss Mary Andrews.

Much private hospitality has been offered, but the large number of distinguished members who have signified their intention to attend has thrown considerable strain on the committee having charge of this department.

A forecast of the papers to be brought before most of the sections has already been given (August 7, p. 344; August 14, p. 377; and August 21, p. 397). We have now received the following list of papers arranged for the Section of Chemistry:—The president of the Section, Prof. E. Divers, F.R.S., is expected to take the atomic theory as the subject of his address at Belfast. A paper will be read by Dr. G. T. Morgan "On our Present Knowledge of Aromatic Diazo-compounds," and Dr. A. W. Crossley will give a paper "On Reduced Benzene Derivatives containing a Single Nucleus." The following papers, amongst others, will also be read:—"Present Synthetical Research on the Glucosides" and "The Synthetical Action of

Enzymes," by Dr. E. F. Armstrong; "The Alkylation of the Sugars," by Prof. T. Purdie, F.R.S., and Dr. Irvine; "The Colour of Iodine containing Compounds," by Miss Ida Smedley; "On Zirconium Hydrate and other Colloids from Elements of the Fourth Group," by Dr. J. H. Gladstone, F.R.S., and Mr. W. Hibbert; "On some Optical Properties of Tellurium," by Dr. J. H. Gladstone, F.R.S.; "On the Telluric Distribution of the Elements in Relation to their Atomic Weights," by Mr. W. Ackroyd; "On the Undesirability of Establishing Standard Analytical Methods," by Mr. B. Blount; "On the Corrosion of Copper by Sea Water and on the Detection of Traces of Impurity in the Commercial Metal," by Dr. E. A. Letts; "On Experiments to Ascertain the Amount of Carbonic Anhydride from Sea Water by Air," by Dr. E. A. Letts and Mr. W. Caldwell; "On the Absorption of Ammonia from Water by Algae," by Dr. E. A. Letts and Mr. J. S. Jotson; "On the Action of Distilled Water on Lead," by Dr. F. Clowes; "On the Decomposition of Urea," by Dr. C. E. Fawcitt.

The following description by Mr. R. Welch of the new path along the face of the Goban's Cliffs will be of interest to visitors.



FIG. 1.—The "Goban's Cliffs" path at the Goban's Viaduct over the Man-o'-War Gully under the Gully.

A Path around the Goban's Cliffs.

A fine cliff path along the base of the basaltic marine precipices near Belfast is now rapidly approaching completion; Mr. Wise, the engineer of the railway company—the B. and N. C. R., which is making the path under great difficulties—is putting forth every effort to have it ready before the British Association meets in Belfast. These mural cliffs of Lower Basalt lavas, in part semi-columnar, in part highly vesicular, with their many caves, will now for the first time be accessible to the geologist and the naturalist generally. At low tide many rock pools and natural aquariums will be available; some of these are coated with the pretty pink Lithothamnion, and have, like the pools of the Antrim Coast generally, a very varied fauna and flora. The path is carried over the many ravines at the mouths of caves by steel girder bridges; the troublesome wide gully at the "Man o' War" sea stack has been "negotiated" by a lattice girder, oval in section, 75 feet long, through which the path runs to the stack, thence by a flat girder bridge to the main cliff again.

Owing to the very heavy seas which sometimes break against the cliffs and run far up, the bridges have been set as high as possible; the "Goban's Lattice Bridge" is almost 30 feet above the sea. The path is tunnelled through one projecting spur of the cliff and runs through a long cave at another, while at the

"Seven Sisters" caves it will be carried by a suspension bridge of novel design, 200 feet long. At another place is a swing bridge, suggested by the famous rope bridge of Carrick-a-Kede; here it is no "rock in the road" of the salmon, but a deep gully into a wide cave, "in the road" of the climber. From the path, seals have been seen almost every day in early August; on one day porpoises were rolling about close inshore, and others are known to have haunted the place from time immemorial. Some of the fish bones found in digging out a cave which was hidden by a great slip of basalt about forty years ago may be due to otters. Others of birds and mammals certainly are not, but have the appearance of the broken bones so plentiful in the prehistoric middens of Antrim and Down. These were found under from 400 to 500 tons of boulders, partly consolidated with earthy matrix, taken out of the cave, and are now in the hands of the Cave Fauna Committee investigating the Irish cave-deposits. The northern end of the path may not be completed this season, heavy gales having much delayed the work, and the tunnel which it will be necessary to excavate in hard rock at a place where the cliff overhangs very much will take some months to complete.

The first part of the path, that along the picturesque under-cliff south of the cliffs section, was completed last year; there the Upper Chalk may be seen in large masses, broken up and slipping over the soft underlying Lias Clay, some sections of which are exposed, with, in a few places, good sections of Chloritic Chalk, Yellow Sands and Marls, and Glauconitic Sands. Details of these sections with lists of their fossil fauna will be found in Dr. Hume's classical paper on the Cretaceous strata of co. Antrim (*Q. J. Geol. Soc.*, November, 1897, pp. 557-560, pl. xlv, and xlv.). The Basalts, I am afraid, have not received the attention here which they deserve, but now that these inaccessible cliffs, tier upon tier of thin lava flows weathering in the most varied manner, can by this new path be easily reached from the land, it is to be hoped they will be visited by many geologists in the near future. The *Memoir of the Geological Survey, Ireland*, No. 29, gives a brief description of them, with section at south termination. One may dine in London or Manchester, and by the short sea route *via* Stranraer breakfast in Larne or Whitehead, and be right under these cliffs long before noon. Mr. Wise has kept well in mind the motto of the Belfast Field Club, of which he is a member, "Preservation, not Extinction," and the herring gulls which nest along the cliffs here in large numbers were disturbed as little as possible; some even nested on the partly made path. He has been careful to preserve the natural weathered surface of the rock all along the path; it has only been broken where absolutely necessary for safety, and geologists are kindly requested to follow this example. They will find abundance of good material quarried out at many places quite close to the path, including good samples of the vesicular portions of the flows, with the original vesicles now filled with various zeolites.

R. WELCH.

A GREAT PERSIAN TRAVELLER.¹

THE fascination which countries "old in story" exercise on many minds is more easily recognised than explained. But the existence of this fascination being once admitted, it is not difficult to understand why a peculiar glamour should attach to Persia, a land of which the history extends almost as far back as any authentic record of the human race, other than that derived from fossil bones or implements, can be said to exist. Nor is this the only attraction which Persia possesses, for although it is inhabited by the most civilised people of Asia, the greater portion of the Persian plateau was, until the last thirty years of the nineteenth century, almost unexplored by Europeans, and even at the commencement of the twentieth century no railway has crossed the Persian frontier, and the only road constructed for wheeled carriages, that from Resht to Teheran, is of

no great length and is said to be in bad condition. In many respects the Persia of the present day resembles western Europe three hundred years ago, or perhaps in some respects even earlier. The general mode of travel is on horseback, the traveller's baggage and all merchandise are carried on pack animals, the roads are insecure and robbers abound. Even in the latter half of the nineteenth century, in eastern Persia and Baluchistan, raids by armed bands were of common occurrence, whilst less than thirty years ago Turcoman hordes from the north swept over northern Persia as far as the gates of Yezd and Isfahan, and murdered, plundered or dragged away as slaves the unfortunate inhabitants whom they encountered. Almost to this day the history of the tribal chieftains and of the provincial governors in eastern Persia and Baluchistan resembles that of European princes in the middle ages, when it was a rare exception for any man of note to live or die peaceably.

But a great change is gradually being effected in Persia, as in so many other countries. The Turcoman forays were summarily ended by Skobelev's sweeping destruction of the raiding clans at Gook-tepe, a consummation aptly compared by Major Sykes to the more recent annihilation of the Soudanese slave-drivers at Omdurman. The "chapaos" of the Baluchis have been checked by the division of Baluchistan between Persian and British rule, and the frontiers between Afghanistan, Persia and British Baluchistan have been defined and mapped. The central government in Persia has gained power, and has been able during the last half century, despite many shortcomings, to do something for the protection of the people and the encouragement of agriculture and trade.

The author of "Ten Thousand Miles in Persia" has consequently had the advantage of studying the country at an interesting time. Few of the travellers in Persia since the time of Alexander the Great have had better opportunities or been better qualified than Major Sykes, who is an energetic explorer, a good linguist and a sympathetic student of Persian life and history. Several portions of his travels in eastern Persia and Baluchistan have already been briefly described in the *Geographical Journal*, but fuller accounts are given in the present work, together with numerous notes on the physical geography, history and people of the countries traversed. The various journeys of the author are not confined to eastern Persia. At one time or another he has traversed all the principal routes, including the well-known road from the Persian Gulf to the Caspian by Shiraz, Isfahan and Teheran; but, as he points out in his preface, he has touched but lightly on the provinces and cities of Persia that were fully dealt with in Lord Curzon's work, and has chiefly treated of those parts of the country, in eastern Persia and Baluchistan, that were previously less well known. A very large part of the book treats of journeys and researches of various kinds in the province of Kerman and in Persian Baluchistan, but in the execution of consular duties interesting visits were made to Sistan and Kain in one direction, and to the Persian Gulf, Basra (Bussorah) and Shuster in the other.

The additions made by Major Sykes to our knowledge of the geography of eastern Persia and Baluchistan are numerous, and they have in many cases greatly changed the map. For instance, by ascertaining that the stream flowing past Bampur does not reach the sea by the Rapsb, but is, like so many other Persian rivulets, evaporated in a "kavir," or salt marsh, he has added at least 20,000 square miles to the Persian inland drainage area, from which no water flows to the ocean. He has also aided materially in completing the investigation of the great desert region of Khorassan, called Dasht-i-Kavir or Dasht-i-Lut in maps. He shows that the name

¹ "Ten Thousand Miles in Persia, or Eight Years in Iran." By Major Percy Molesworth Sykes (Queen's Bays), H.M. Consul, Kerman and Persian Baluchistan. Pp. xv + 481; with numerous illustrations and map. (London: John Murray.)

of Lut by itself is that generally used in the region, and that this name is identical with the scriptural Lot. It may be remarked that in some cases the views put forward by Major Sykes as to the origin of geographical terms differ from those of his predecessors. This is especially noteworthy in the case of Makrán, the well-known name for the Baluch seaboard. Instead of adopting Sir T. Holdich's explanation that the term is derived from *Maki-Khuran*, or fish-eaters, the Ichthyophagi, as the inhabitants were called in the days of Alexander the Great, Major Sykes looks upon it as connected with the people once known as Maka, the Mykians or Mycæans of Herodotus.

One of the most interesting tracts examined by Major Sykes is the Sarhad, or cold country, of Persian Baluchistan. A large portion of the population of Persia consists of

ascended and measured both the great peaks south of Kerman, which rise to between 13,000 and 14,000 feet.

Amongst the principal historical questions on which fresh light is thrown by the present work are the travels of Marco Polo and the remarkable march of Alexander the Great, with an army, through Baluchistan, from the Indus to Persepolis. This march, one of the most extraordinary military enterprises ever undertaken, must always remain a puzzle to all who have any acquaintance with the country traversed, for a more hopeless desert than the greater part of Makrán at the present day does not exist. In reference to this march, and to the remains of ancient cities and the evidence of abandoned cultivation in so many parts of Persia, Major Sykes supports the view already adopted by many other travellers in



FIG. 1.—Makrán Scenery.

wandering tribes, who pass the winter in a Garmsir or warm tract, and drive their flocks and herds in summer to a Sarhad or more elevated region. The Baluch Sarhad had only been visited by one traveller before Major Sykes entered it, and it is remarkable for including within its limits two extinct and dormant volcanoes, the Kuh-i-Basmán, 11,000 feet high, and the Kuh-i-Taftán, more than 12,000 feet, both of which were ascended. There is a great area covered by volcanic formations in south-eastern Persia, the lofty peaks of Kuh-i-Hezar and Kuh-i-Shah, south of Kerman, consisting, in part at all events, of basalt and similar rocks, although these mountains are certainly not volcanoes of recent origin, like those of the Baluchistan Sarhad, some 200 miles further west. Major Sykes, however, is not a geologist, and adds but little to our information on this point, although he

Persia and in Central Asia generally, that the whole area is undergoing gradual desiccation, and that the rainfall must have diminished considerably in the course of the last two or three thousand years. This view has recently been strongly enforced by Mr. Vredenberg's interesting observations in Baluchistan, of which an account has appeared in the *Memoirs of the Geological Survey of India* (vol. xxxi. pt. 2). The diminution of the rainfall may be connected with the disappearance of certain great Central Asiatic lakes, of which important remnants exist in the Caspian and Aral Seas. In one passage Major Sykes is inclined to attribute the diminished rainfall to the destruction of forests, and even appears to believe (p. 365) that India, if all the forests were swept away, would become as barren as Persia. This is rather an exaggerated view. The destruction of every tree in

India would not prevent the rain of the south-west monsoon from falling, although it might somewhat diminish the amount, and it would in other ways seriously affect the fertility of the country. It may fairly be doubted whether, at all events within the last three thousand years, anything deserving the name of forest existed in eastern Persia.

The numerous illustrations in the present work, chiefly reproduced from photographs, convey an excellent idea of the barren Persian and Baluchistan hill scenery and of Persian towns and people. On the whole the scenery of Baluchistan, and especially of Makrán, of which two examples are here given, is perhaps better depicted than are the plains of Persia. The enormous distances to which these plains extend probably preclude their effective representation by photographic means, but it is remarkable that none of the views,

Elburz Mountains, to Quetta, where, east of the town, there is a well-marked glacis-like slope on a smaller scale.

Major Sykes is no zoologist, and it is therefore not surprising that some of the names of animals to which he refers require alteration. It is not quite correct to call the Persian wild goat an ibex, a term belonging to goats with very different horns; but a greater mistake is made in the foot-note at p. 47, where it is stated that "the Jabal Bâriz range separates the habitat of the *Gazella Bennetti* (it should be *Bennetti*) from that of the *Gazella fuscifrons* of the plateau of Irân." The gazelle of the "plateau of Irân" is *G. subgutturosa*; *G. fuscifrons* is a variety of *G. Bennetti*. Again, on p. 289 an amusing account is given of the capture of a *hake* at the island of Hormuz, in the Persian Gulf. The *hake* is a fish peculiar to the North Atlantic.

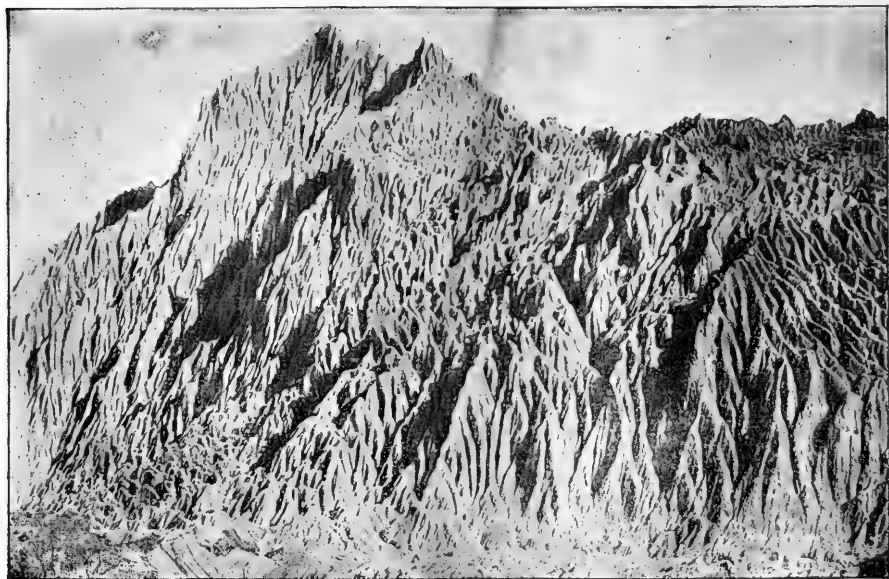

FIG. 2.—Clay Formation, Makrán.

numerous and varied as they are, gives any idea of one of the most striking characteristics of Persian scenery, the gravel slopes, often many miles wide, that surround nearly all the great plains and often occupy the broad valleys that extend from the plains far into the hills. As the waterless plains themselves are often, in parts, occupied by "kavir" or salt marsh and in other parts by drifting sands, whilst the broken hill-ranges that cross the country are only passable in places, it is on the gravel slopes that the principal trade routes run, and it is in them that are tunnelled the "kanauts" or "karez," the artificial subterranean channels from which the water-supply for towns and for irrigation is largely derived. Throughout the Persian plateau these slopes are a most striking feature; they are seen from Teheran, north of which city one, on a large scale, extends to the

But if Major Sykes's pages add but little to our knowledge of geology, botany or zoology, they abound in fresh information concerning the curious mixture of Asiatic races which inhabits the wilds of Baluchistan, on the physical geography of the eastern Persian area and on the history of the towns and provinces. The author's views as to the political relations existing between Persia and our Indian Empire are of importance as expressing the opinions of an officer who has had exceptional opportunities of forming an accurate judgment. In one respect Major Sykes has proved himself a model diplomatist, for he appears to have succeeded in establishing friendly relations with almost all the officers of the Persian Government with whom he came in contact.

W. T. B.

NOTES.

EARLY in this year a petition praying for the incorporation of a British Academy for the Promotion of Historical, Philological and Philological Studies was presented to the King, and referred to a committee of the Privy Council. Acting upon the advice of this committee, His Majesty has granted the Academy a Royal Charter. The Charter has not yet been published, but according to the *Times* it states that the Academy aims at "the promotion of the study of moral and political sciences, including history, philosophy, law, politics and economics, archeology and philology." The forty-nine first fellows of the British Academy include leading representatives of many branches of scholarship, but not of poetry or fiction or other departments of pure literature. The Academy will be an independent body, with a separate organisation of its own; and it will not have any closer relationship to the Royal Society than has the Royal Academy of Arts. Our institutions for the advancement of learning and the development of intellectual activity will not, therefore, be coordinated in the way they are in France and several other countries.

THE following reports of eruptions and earthquake shocks have been published during the past few days:—August 21.—Severe eruption of Mont Pelée reported by the steamer *Dahome* to have occurred at noon. No confirmation of the news has reached the French Colonial Office. August 22.—Mont Almonte in Calabria reported from Rome to be in eruption. Subterranean rumblings have been heard, and showers of rock fragments and vapour have been ejected from the crater. An unusually large earthquake was recorded at Shide, in the Isle of Wight. The movement commenced at 3h. 10^m. a.m. Twenty-five minutes later the amplitude of the large waves exceeded 22 mm. (12"0). The time interval suggests an origin about 62^m distant from the Isle of Wight. Origins for world-shaking earthquakes at this particular distance are Alaska, the West Indies and northern India. Sixty-seven minutes after the maximum movement, but long before its irregular group of followers had ceased to exist, a second group of large waves appeared, the amplitudes of which were 18 mm. (9"0). The seismographic instruments at observatories in Hungary and Alsace registered several earthquake shocks in the direction from east to west in the afternoon. Two violent shocks were felt at Andishan, and one at Pavlovgk, near St. Petersburg. August 25.—Messages from Dominica report that between 10 a.m. and 3 p.m. clouds of dust were seen in the direction of Mont Pelée, while detonations were heard at long intervals until morning. Light showers of volcanic dust fell in Dominica.

DR. L. A. BAUER contributes to *Terrestrial Magnetism and Atmospheric Electricity*, vii. 2, a note on his observations of the magnetic disturbances which occurred during the eruption of Mont Pelée on May 8. At 11h. 59m. a.m., Greenwich mean time, a disturbance occurred which began simultaneously at the two Coast and Geodetic Survey magnetic stations of Cheltenham, Maryland and Baldwin, Kansas. The time of these disturbances was the same as recorded at other observatories, and corresponded to 7h. 54m. of local time at St. Pierre, being about the time at which the principal clock of that town was stopped. The horizontal intensity was the element principally disturbed, and the suddenness with which the disturbance of May 8 began is well illustrated by Dr. Bauer's horizontal intensity curve. Several interesting magnetic disturbances also occurred between April 10 and May 8, possessing striking similarities with each other and with that of May 8, these similarities, both in magnitude and direction, extending to all three elements. During the eruptions, Dr. Bauer observed perturbations of greater or less degree, another striking coincidence occurring on May 20 at the second eruption.

THE nomination of Lord Rayleigh as foreign corresponding member of the Vienna Academy of Sciences has just been confirmed by the Emperor Francis Joseph.

A NUMBER of eminent surgeons representing many countries will be present at the Congress of the Belgian Society of Surgery, to be held at Brussels on September 8-11, when a proposal will be made to found an international society of surgery.

MRS. R. W. LONGFIELD writes from Bandon, co. Cork, Ireland, to say that on August 18 she heard the cuckoo's note distinctly near Bandon. The cry of cuc-koo was repeated several times.

THE address by Sir Archibald Geikie, which we are able to print in full in another part of the present issue, was delivered before a large audience at Cromarty on Friday last, in connection with the celebration of the centenary of Hugh Miller. Many eminent men from America, Canada and Italy, as well as from various parts of the British Isles, assembled to do honour to Miller's memory and to testify to his inspiring influence. The oration delivered by Sir Archibald Geikie was worthy of the occasion, and the eloquent words in which Miller's life and work were described will be read with as much pleasure as they were listened to by the audience privileged to hear them. Among other speakers at the open-air meeting near Hugh Miller's monument, and at the subsequent luncheon, were Principal Rainy, Prof. Clarke, Albany, New York; Sir James Grant, Canada; Dr. Horne, F.R.S., and Prof. Middleton.

If we may judge from the rarity of reports, the sound of the salutes during the naval review on August 16 does not appear to have been heard at any unusual distance. Mr. H. F. Pinder, writing from Blackbourton, near Bampton, informs us that the salute at 2 p.m. was heard by one, but so far as he knows only by one, person. Earlier on the same day, between 11.30 and 12.15, heavy firing was heard, apparently from the south-south-west, the sound being continuous during the first half-hour. The distance of Blackbourton from Spithead is about 70 miles.

WE learn from the Berlin correspondent of the *Times* that the German Sea Fisheries League recently organised a scientific expedition to ascertain the value of deep-sea fishing in the Baltic. The league, with the assistance of the Ministry of the Interior, chartered the Kiel steamer *Holsatia* and fitted her out for trawl fishing and for scientific investigations. It was also intended to experiment with a view to discover how far the type of boat and the methods of fishing at present in use on the Baltic coast would prove suitable in the open sea. The report has not yet been published, but it appears that no large feeding grounds have been found, and that trawl fishing such as that practised in the North Sea would not pay in the Baltic.

THE thirteenth annual general meeting of the Institution of Mining Engineers will be held at Newcastle-upon-Tyne on September 17-19, under the presidency of Mr. J. S. Dixon. Among the papers to be read, or taken as read, are the following:—On the probability of finding workable seams of coal in the Carboniferous Limestone or Bernician formation beneath the regular Coal-measures of Northumberland and Durham, with an account of a recent boring made at Chopwell Woods, near Lintz Green, Mr. J. B. Simpson; notes on the correlation of the beds of the Carboniferous series in the north-east and north-west of England, Mr. David Burns; the Marl-slate division of the Permian, Prof. G. A. Lebour; steam-generation by the gases from Beehive Coke-ovens, Mr. M. R. Kirby; and the Fernie coal dust explosion, British Columbia, Mr. William Blakemore.

A NOTE on the progress of the Swedish South Polar expedition appears in the *Times*. The vessel *Antarctic*, with five scientific members of the expedition, left Port Stanley, in the Falkland Islands, on April 11 for South Georgia, U.S.A. The expedition

stayed in South Georgia from April 22 to June 15, and during this time a detailed survey was made of Cumberland Bay, one of the largest bays in South Georgia. Investigations into the natural history of Cumberland Bay were carried on, and zoological collections brought home from depths as great as 2700 metres. Soundings have given depths up to 5997 metres north-west from South Georgia. The expedition returned to Port Stanley on July 4, and will up to the end of September carry on work around the Falkland Islands and in Tierra del Fuego. In October, the *Antarctic* will start for Graham Land, in the Antarctic Ocean.

THE United States National Museum has just issued a printed list (24 pages) of the meteorites acquired for the Washington collection before January 1, 1902. The list, which is intended mainly to facilitate exchanges and the increase of the collection, is alphabetically arranged, and gives for each of the meteorites the weight in grams, the date of fall or find, and a brief description of the more salient characters. As many as 348 falls are represented, 143 being those of meteoric iron. There are three full-page plates, photographic reproductions; one illustrates the arrangement of the specimens for exhibition, while the two others are pictures of the Allegan and Casas Grandes meteorites. The list has been prepared by Mr. Wirt Tassin, assistant curator in the Division of Mineralogy.

IN vol. xxiv. of the *Proceedings* of the United States National Museum, Mr. G. P. Merrill gives a detailed description of fragments of a meteorite ploughed up some years ago at Admire, Lyon County, Kansas, U.S.A. As the metallic part is much rusted, probably a long interval of time elapsed between the fall and the find of the material. The meteorite, of which about 4 lb. weight is known to have been collected, belongs to the same group as the iron brought by Pallas from Siberia (1749), but approximates more closely in characters to the meteorite found in 1880 at Eagle Station, in Kentucky. It consists of a continuous mass of meteoric iron enclosing angular crystals of olivine (1 to 30 millimetres in diameter), the crystals having been in almost every case broken and afterwards cemented together by metallic material which had flowed into the fissures. Schreibersite, troilite and also small grains of chromite are comparatively abundant as constituents of the metallic portion, which forms about one-third of the whole mass.

ALASKA would seem to offer opportunities to the bryologist as well as to the gold-seeker. Although several collections of mosses have been made in that country from the year 1867 to the present time, Mr. J. Cardot and Mr. I. Thériot have placed on record twenty-nine new species as the result of collections made by the Harriman expedition in 1899. The descriptions of these, together with a general list of all known mosses from Alaska, are given in the *Proceedings* of the Washington Academy of Sciences bearing the date July 31 of this year. This does not, however, include a collection of more than 200 mosses which have been identified and named by Mr. R. S. Williams since this paper was written. The new species, which are given on the authority of the writers, except most of the Bryum species, for which M. Philibert is responsible, are fully diagnosed and illustrated. In addition, seventeen new varieties are recorded, and *Bartramopsis Lescurii* is described in full with figures.

IT is not the happy fate of many botanical gardens to be able to put by a surplus of more than 1000l. in one year. Such is the announcement which appears in the thirteenth annual report of the Missouri Botanical Garden. The director, Dr. Trelease, presents his report, and in addition a memoir on the tribe Yuccaceæ of the order Liliaceæ. The latter is the result of a study extending over sixteen years, during which time large numbers of varieties have been examined in their native habitats

and certain of them have been taken into cultivation. As this tribe is preeminently American, and in fact almost confined to the United States, and as the writer has taken advantage of every available opportunity to examine interesting or critical specimens, the results and opinions here recorded are extremely valuable. Very interesting by reason of the ordinary dependence of these plants upon the *Pronuba* moth for pollination is the reference to hybrids which have been raised. It will be noticed that one of the parents in many cases is *Yucca aloefolia*, this species being unique since it is usually self-pollinated. To the two genera *Yucca* and *Hesperaloe*, which are combined by Engler, is added a third genus, *Samuela*, with two species, instituted by Dr. Trelease; also the genus *Yucca* of Dr. Engler is split into three genera, *Hesperoyucca*, *Chistoyucca* and *Yucca*. The memoir is lavishly illustrated with more than one hundred figures reproduced from photographs.

THE Imperial Engineering Company, of Liverpool, has issued a pamphlet descriptive of apparatus for illustrating Prof. Hele Shaw's experiments on stream-line motions, both for use in schools and colleges and for original research.

A BRIEF account of the bibliography of Gilbert's "De Magnete" is given by Herr G. Hellmann (Berlin) in *Terrestrial Magnetism and Atmospheric Electricity*, vii. 2. It appears that only three editions of this work appeared, namely, Londini 1600, Sedinii 1628, and Sedinii 1633. Of the Sedinii 1628 edition two varieties are known, differing in their title-pages. The rarest edition is the Stettin one of 1628, and of the two varieties that is rarest which has on its title-page the words "Sumptibus [Authoris]".

A NEW journal has been started in Glenville, U.S.A., bearing the title *The Aeronautical World*, and dealing with matters relating to aerial navigation of all kinds. It contains a large number of notes on events of current interest in this connection, lists of patents, and other information of this class. We should like to see rather more attention given to the difficulties which have still to be surmounted in connection with the problem of flight, leaving writers like Mr. H. G. Wells to indulge in "anticipations" of a speculative character as to the future of aerial navigation when these difficulties have been overcome. Still, such speculations have a certain attraction for those who cannot appreciate anything but accomplished results.

THE *Comptes rendus* of the Paris Academy of Sciences (July 21) contains a report on a paper by M. Torres dealing with a project for a navigable balloon with an interior keel. The idea contained in this project is very similar in general principle to that underlying M. Severo's ill-fated machine, namely, to bring all the forces acting on the balloon into the same horizontal line, with a view of minimising pitching. Accordingly M. Torres proposes a balloon with several compartments, containing a central beam suspended in its interior, and forming, with its attachments, a rigid internal keel. The propeller will then be attached at the end of this beam, and the car, which is to be reduced to the smallest possible dimensions, will be close up to the balloon. The fatal *Pax* disaster, however, raises doubts in regard to the last feature.

AN astronomical model called the "Rotaplane," devised by the Rev. C. Thomas and provisionally patented by him, has been submitted to us for examination. The model is intended to show the apparent diurnal motion of the horizon of any latitude with reference to the ecliptic at any time of the year. The direction of the polar axis is represented by an upright rod, to which the horizon can be inclined at an angle equal to the latitude of the desired place of observation. A semi-meridian is fixed to the horizon, and outside the whole is a flat ring to represent the plane of the ecliptic. By turning the polar axis, after

setting the ecliptic at the correct inclination, the diurnal movement of the horizon with reference to the sun or other object in the ecliptic can be made manifest. An objection to the model as an educational instrument is that the horizon is only horizontal when the latitude for which it is set is 90°. The student of astronomy who understands the relationship between the fundamental planes of the horizon, equator and ecliptic might find it an advantage to fix his ideas by means of a model of this kind. But such a student would be in a position to use a celestial globe by which he could see the apparent motions, with reference to the horizon, of objects in any part of the celestial sphere instead of being limited to the ecliptic.

THE twenty-fourth Report of the Deutsche Seewarte, Hamburg, for the year 1901, exhibits the usual activity in the various pursuits in which the institution is engaged. Several meetings have been held at Berlin and Hamburg with the view of improving and expediting the telegraphic weather reports. In this most important object and in the establishment of a 7h. a. m. service, several of the European countries are to some extent participating, but the movement is due mainly to the impulse given to it by the Deutsche Seewarte. The sum of six thousand marks has been placed at the disposal of Dr. von Neumayer for the purpose of establishing special weather forecasts for agriculturists, probably on the same lines as those for the harvest forecasts issued by our own Meteorological Office. The collection of observations made at sea, for the construction of sailing directions and meteorological handbooks of the various oceans, has been vigorously carried on. Complete log-books were received during the year from 60 men of war and 538 merchant vessels, in addition to some 300 short logs from steamers. The majority of the voyages refer to the north and south Atlantic, but also include a considerable number in the Pacific and Indian Oceans. Telegraphic warnings of storms were issued on fifty-nine days; the number of telegrams (including those to lower the signals) exceeded 3000, but the percentage of success is not stated.

EXCLUDING the well-known thermophilic group of bacteria, it has generally been considered that an exposure to a temperature of 65° C., or frequently to a lower temperature than this, is rapidly fatal to all non-sporing forms of bacterial life. Messrs. H. L. Russell and E. G. Hastings, however, describe a micrococcus, isolated from milk, the thermal death point of which is 76° C. for an exposure of ten minutes. Not all the cells of this organism are equally resistant; as the temperature is raised to about 70° C. some of the cells begin to succumb, but a small residuum retain their vitality until 76° C. is reached (*Centr. f. Bakt., Zoologie Abt.*, Bd. viii. p. 339). Using this organism, Messrs. Russell and Hastings have carried out some interesting observations upon the increased resistance of bacteria in milk pasteurised in contact with the air (*ib.*, p. 462). Heated in bouillon and in milk in closed vessels (sealed tubes) the thermal death point is approximately the same, viz. 76° C., but in milk heated in an open vessel the organism survived a temperature of 80° C. It was found that this resistance is due to the protection afforded by the membrane which forms when milk is heated freely exposed to the air, for in samples of sterile milk seeded with the organism and heated in an open beaker to 80° C., on subculturing numerous colonies were obtained from the membrane, while the milk below this was sterile.

SURRA, a disease affecting horses and other animals, and due to a protozoan parasite, the *Trypanosoma Evansi*, has been found to be very prevalent in the Philippines, causing the death of no less than 2000 of the army transport and cavalry horses in a period of six months. This disease, met with also in India and Burma, is now regarded as identical with nagana or the (setsefly disease of Africa. In India, the exact mode of transference

of the disease from one animal to another has not been discovered, though certain "horse-flies" have been surmised to be the intermediaries. In the Philippines, Curry states that the intermediary is a fly, the *Stomoxys calcitrans*. The fly lays its eggs in the excrement of horses and cattle, in which its larvæ and pupæ thrive, and as the disease is almost always fatal, prophylactic measures must be employed, especially the destruction of the larvæ and pupæ in the excrements by treatment with lime or petroleum (*Amer. Med.*, July 19).

THE *Zoologist* for August contains notes on Erasmus as a naturalist, by Mr. G. W. Murdock, and a useful account by Mr. G. Smith, of Prof. Bachmetjew's experiments on the temperature of insects.

WE have received a copy of the first number of the *Rural Studies Series*, which contains the report of a lecture by the Rev. E. A. Woodruffe-Peacock on the manner in which horses—especially thoroughbreds—affect the grass-lands on which they are pastured, and the best manner of improving such pastures.

THE *Memorias* of the Scientific Society Antonio Alzate, vol. xvi., Nos. 5 and 6, contain an account, by Señor A. L. Herrera, of the means recently taken to mitigate the plague of mosquitoes from which the city of Mexico constantly suffers. A couple of men provided with tins of paraffin appear to have done wonders in the way of destroying the larvæ which infest the pools and sheets of water in the suburbs.

IN its report for the year 1901-1902, the committee of the Manchester Museum directs attention to the highly satisfactory and commendatory remarks on that institution and its work which appear in the Blue-book recently issued by the Commissioners on the University Colleges of the country. Among the collections received during the year is a fine series of shells presented by Mr. R. D. Derbyshire, containing a number of rare forms and also examples of the range of variation presented by particular species. The lectures and addresses delivered during the year have proved attractive to the general public, and will be continued during the current session, when Prof. Hickson will discourse on reptiles, Prof. Weiss on club-mosses and ferns, and Prof. Dawkins on caves.

THE geology and petrography of part of the Ural region of Perm, in the upper basin of the Koswa, a tributary of the Kama, has been elaborately dealt with by MM. Louis Duparc and Francis Pearce (*Mém. de la Soc. de Physique de Genève*, xxiv. 1902). In particular, the gabbros and dunites of Koswinsky are described, but there are also full accounts of the orography and hydrography of this region.

IN the *Papers and Proceedings* of the Royal Society of Tasmania for 1900-1901, a great many subjects are dealt with, including some useful general articles on the botany, the birds, the recent Mollusca, the minerals and the geology of Tasmania. In notes on the microscopic structure of some Tasmanian rocks, Mr. W. F. Petter describes some aberrant members of the basalt family. Mr. W. H. Twelvetrees describes a new oxychloride of lead, under the name Petterdite. There are notes also on the discovery of amphibian remains in the permo-Carboniferous rocks.

WE have received the annual report for 1901 of the Geological Survey of New Jersey, by Mr. II. B. Kimmel, acting State Geologist. He refers to the fact that New Jersey is the chief clay-producing State, and that a new and exhaustive memoir of the clay deposits is in preparation. The report is accompanied by a memoir and map of the Green Pond Mountain region, a belt of Cambrian, Silurian and Devonian rocks which rest on an eroded surface of gneisses. There are notes on the

iron, zinc and copper mines, on various artesian wells, and on the presence of chlorine in certain natural waters. It is recommended that the State authorities should conserve all watersheds likely to be drawn upon in future by large towns.

THOSE who attended the meeting of the Geological Society of London on January 8 were impressed with the lucid explanations of Glacial phenomena in the north of England then given by Prof. Percy F. Kendall and Mr. Arthur R. Derreryhouse. Their observations recently published (*Quarterly Journal Geol. Soc.* for August) constitute most valuable contributions to the study of the Great Ice Age in this country. Prof. Kendall deals with the Cleveland Hills, and points out the evidence there existing of the former occurrence of a number of glacier-lakes or "extra-morainic" lakes, such as are produced whenever a glacier or ice-sheet advances against or across the general slope of a country and impounds the natural drainage. Evidence is given of such lakes of large and small dimensions in the Vale of Pickering, in Glaisdale and Eskdale, in Harwood Dale and at Hackness, lakes which must have been formed when the ice occupied the Vale of York and extended along the northern and eastern borders of the Cleveland area. The evidence is furnished by shore scarps, occasional lacustrine deltas with fan-like forms, by laminated lacustrine deposits such as the warp clays of the vales of Pickering and York, by overflow channels whence the impounded water escaped in gorges which trench the main watershed or sever spurs independent of the present natural drainage, and by crescentic valleys excavated in the face of a hill by water flowing round a lobe of ice. The Glacial deposits are, of course, fully considered from sections and from borings, some of which were carried out by Prof. Kendall. The assemblages of boulders and rock fragments lead to the conclusion that three main ice-movements affected the area—a northern from Scotland and Northumberland, a western from Stainmoor Pass and the Tees valley, and an eastern from the North Sea and Scandinavia. The general sequence which may be inferred from a study of the somewhat complicated phenomena is (1) the unobstructed passage of the Teesdale glacier to the coast; (2) the arrival of the Scandinavian ice; and (3) the invasion of the Scottish ice. The author finds no signs of the presence of the sea in the Cleveland area at any time during the Glacial period. Mr. Derreryhouse describes the glaciation of Teesdale, Wear-dale and the Tyne valley, a region in which, like that of Cleveland, the higher tracts stood out as "nunatakkrs," while the grounds beneath were buried by ice. He also points out that at the period of maximum glaciation a number of lakes were formed, owing to the obstruction of the drainage of lateral tributary-valleys by the ice of the main glaciers.

DRS. H. M. HILLER and W. H. FURNESS have privately issued bound copies of the "Notes of a Trip to the Veddahs of Ceylon," which were published in vol. iii. of the *Bulletin of the Free Museum of Science and Art*, Philadelphia (April, 1901). The "Notes" do not contain much that is new, but they are illustrated with several excellent photographs, the most interesting of which are those illustrating a Rock Veddah shooting (standing) with a bow and arrow, and one making fire with a "fire-drill."

THERE is in *The Reliquary and Illustrated Archaeologist* (vol. viii. No. 3) a well-illustrated article, by Mr. R. Quick, on the Carib stone implements in the Horniman Museum. These implements show the technical skill of the aborigines of the West Indies in working hard rock. Some of the implements are really remarkable examples of stone-work. One example which is figured has a most irregular contour; from its high finish it was evidently greatly prized, and was probably a symbolic religious object, of which the significance is at present unknown.

The early Christian monuments of the Isle of Man are becoming well known to students through the enthusiastic labours of Mr. P. M. C. Kermodé. In the July number of *The Reliquary and Illustrated Archaeologist* he gives numerous illustrations of recently discovered crosses and runic and ogam inscriptions. One of the most interesting discoveries is a carved stone with very characteristic Scandinavian interlacing; on one side is seen the figure of Loki in the act of heaving stones at the other which is eating the salmon it has just caught in the foss; above this is the steed Grani with the chest containing the hoard won by Sigurd upon his slaying the dragon Fafni.

MESSRS. PERKEN, SON and Co. have issued a new revised and enlarged edition (the eighth) of their "Beginner's Guide to Photography." The book is now in its seventeenth thousand.

IN the article on "The Older Civilisation of Greece," which appeared in *NATURE* of August 21, the following corrections should be made:—P. 391, col. 1, l. 9 from bottom: for "the un-Aryan 'Pelagian'" read "the probably un-Aryan 'Minoan'"; p. 393, col. 2, l. 12 from top: for "ἐν μυχῷ, 'Apyeos'" read "ἐν μυχῷ 'Apyeos'" *ibid.*, l. 14 from top: for "casemates" read "casemates"; p. 394, col. 1, Fig. 2: for "Clay Seal. Impression" read "Clay Seal-impresion."

A MINUTE investigation of the composition of Pennsylvania petroleum has recently been carried out by Mr. C. F. Mabery, and an account of the hydrocarbons with boiling points above 216° C. is published in the *Proceedings of the American Academy of Arts and Sciences* (vol. xxxvii. p. 565). Hydrocarbons of the methane series from tridecane $C_{13}H_{28}$ to octacosane $C_{28}H_{58}$ have been isolated, and according to the molecular-weight determinations carried out by the freezing-point method the products obtained by the author as the result of repeated fractional distillation under low pressure are almost pure. No account appears to have been taken, however, of the possibility of the occurrence of different isomeric forms. In addition to these saturated compounds the hydrocarbons $C_{27}H_{44}$, $C_{29}H_{48}$, $C_{31}H_{48}$, $C_{26}H_{52}$ and $C_{27}H_{54}$ belonging to the ethylene series and $C_{28}H_{54}$ a homologue of acetylene, have been obtained.

MUCH remains to be learnt about the numerical relationships of the atomic weights of the elements. It has long been realised that when referred to the standard O = 16 many of the atomic weights approach whole numbers to an extent out of all proportion to the probabilities of the case. In the *Chemiker-Zeitung* for July 19, Mr. Arthur Marshall, as well as directing attention to this fact, shows that very remarkable relationships exist in many cases between the atomic weights of allied elements. Taking from the tables of the German Chemical Society the eighteen values given to two places of decimals, the theory of probabilities shows that the chances against their approaching as close as they do to whole numbers are as high as 4120:1. If, on the other hand, the atomic weights are referred to H = 1, there appears to be little or no tendency to become whole numbers. It is, however, only when certain of the atomic weights are referred to entirely different standards that the most striking relationships appear. The weights of the atoms of the halogen elements and silver, for instance, are exactly in the ratio Cl:Br:Ag:I = 90:203:274:322. In the case of the alkali metals the proportions are even simpler, Li:NH₄:Na:K:Rb = 7:18:23:39:85. Again, the horizontal series, V:Cr:Mn:Fe:Ni:Co:Zn = 54:55:58:59:62:67:69. It is yet premature to work out relationships for all the elements, for there is still great uncertainty about most of the atomic weights, but the values for most of the above substances are thoroughly well established.

MESSRS. HABER and GEIPERT have been investigating the conditions under which aluminium is obtained by the electrolytic method, and have published their results in recent issues of the

Zeitschrift f. Elektrochemie. They point out that no trustworthy details of the method employed in the various works where the metal is now produced have hitherto been made public. Using a small experimental fusion cell, and the ordinary lighting supply current of the Karlsruhe Technical Institute, they were able to reduce alumina without difficulty and to obtain as much as 230 grams of the metal in one operation. The metal obtained was remarkably pure, one sample tested containing only .05 per cent. C and .034 per cent. Si. The mechanical tests made with six samples of the aluminium gave an average tensile strength of 21,425 lb. per square inch. The fused mixture used in the carbon cell contained 33 per cent. AlF_3 , 33 per cent. NaF and 33 per cent. Al_2O_3 , the high percentage of aluminium fluoride being conducive to fluidity. The current density employed was about 2800 amperes per square foot, and the E.M.F. varied between 7 and 10 volts. The authors, as the result of their experiments, have come to the conclusion that the steady improvement in the efficiency of the process as carried out in the aluminium works is due, not to secret modifications in the process, but to the more careful attention now given to the purity of the raw materials employed. They also point out that the carbon contained in the aluminium obtained in their experiments was not present in the combined form, and as it was graphic in character they assume that it represented mechanically enclosed particles, due to the disintegration of the anode and kathode carbon. By remelting the aluminium, it was possible to remove a portion of this impurity from the metal. The necessity of employing carbons comparatively free from ash is insisted on, since any impurities of the carbon used will be found in the final product.

The additions to the Zoological Society's Gardens during the past week include a Vervet Monkey (*Cercopithecus lalandi*) from South Africa, presented by Mr. J. S. Sweetman; a Ring-tailed Lemur (*Lemur catta*) from Madagascar, presented by Colonel Ewart; a Tiger (*Felis tigris*) from India, presented by Mr. A. Forbes; two Two-spotted Paradoxoes (*Naninia binotata*) from West Africa, presented respectively by Major D'Arcy Anderson and Mr. Walter O'Brien; two Bank Voles (*Arvicola pratensis*) British, presented by Mr. G. T. Rope; a Broad-fronted Crocodile (*Ostolemus tetraspis*) from West Africa, presented by Dr. W. F. Macfarlane; a White-collared Mangabey (*Cercocebus collaris*) from West Africa, a Black-faced Spider Monkey (*Ateles ater*) from Eastern Peru, a White-fronted Capuchin (*Cebus albifrons*) from South America, a Common Marmoset (*Hapale jacchus*), a Six-banded Armadillo (*Dasypus sexcinctus*) from Brazil, a Vulpine Phalanger (*Trichosurus vulpecula*) from Australia, two Petz's Conures (*Conurus canicularis*) from Mexico, a Western Boa (*Boa occidentalis*) from Argentina, deposited; five American Pochards (*Fuligula americana*) from North America, received in exchange.

OUR ASTRONOMICAL COLUMN.

ASTRONOMICAL OCCURRENCES IN SEPTEMBER.—

- Sept. 3. 7h. 59m. Minimum of Algol (β Persei).
 6. 8h. 1m. to 11h. 43m. Transit of Jupiter's Sat. III.
 13. 11h. 28m. to 15h. 11m. Transit of Jupiter's Sat. III.
 15. Venus. Illuminated portion of disc = 0.945, of Mars = 0.948.
 22. 9h. 2m. to 9h. 25m. Moon occults δ^1 Tauri (mag. 4.0).
 22. 9h. 14m. to 10h. 2m. Moon occults δ^2 Tauri (mag. 4.7).
 23. 8h. 13m. to 13h. 6m. Transit of Jupiter's Sat. IV.
 23. 9h. 41m. Minimum of Algol (β Persei).

NO. 1713. VOL. 66]

- Sept. 23. 10h. 34m. to 11h. 12m. Moon occults 115 Tauri (mag. 5.4).
 23. 12h. 0m. Sun enters Libra. Autumn commences.
 23. 13h. 28m. to 13h. 53m. Moon occults 120 Tauri (mag. 5.3).
 24. 17h. 0m. Mercury at greatest elongation ($26^\circ 11'$ E.).
 24. 17h. 32m. to 18h. 38m. Moon occults 26 Gemini-
 norum (mag. 5.1).
 25. 13h. 40m. to 14h. 40m. Moon occults 68 Gemini-
 norum (mag. 5.0).
 26. 6h. 30m. Minimum of Algol (β Persei).
 27. 15h. 22m. to 15h. 38m. Moon occults α Leonis
 (mag. 5.6).

NEW DISCOVERIES OF VARIABLE VELOCITIES IN LINE OF SIGHT.—In addition to the thirty-two binaries previously announced, Prof. Campbell records the data of six more spectroscopic binaries which have been detected with the Mills spectrograph; they are the following:—

ϕ *Persei*: $a = 1h. 37m.$; $\delta = +50^\circ 11'$. The maximum variation as yet recorded is from +24 km. (December 16, 1900) to -12 km. (November 11, 1901). This star has bright hydrogen lines, $H\gamma$ appearing as a narrow absorption line with very bright borders.

η *Geminorum*: $a = 6h. 09m.$; $\delta = +22^\circ 33'$. Maximum variation as yet recorded is from +14 km. (January 15, 1900) to 25 km. (February 2, 1902).

γ *Canis Minoris*: $a = 7h. 23m.$; $\delta = +9^\circ 08'$. Range of variability as yet detected is from +40 km. (November 6, 1901) to +54 km. (December 22, 1901).

ζ *Herculis*: $a = 16h. 38m.$; $\delta = 31^\circ 47'$. This is a well-known visual binary having a period of about thirty-three years, but the earlier observations of Belopolsky, Campbell and Newall in 1893, 1898 and 1897-99, respectively, did not establish the variability. However, by taking the means of these early observations and comparing them with the mean of the recently observed velocities determined at the Lick Observatory, it is found that the velocity has changed by about 4 km. since 1898.

α *Aquellæ*: $a = 21h. 11m.$; $\delta = +4^\circ 50'$. The velocity of this star varied from -26 km. on June 25, 1900, to -2 km. on June 25, 1901, and then returned to -26 km. on June 2, 1902.

σ *Andromedæ*: $a = 22h. 57m.$; $\delta = +41^\circ 47'$. The range of variability, so far as it is yet known, is from -11 km. (October 9, 1900) to -20 km. (June 25, 1901).

Miss Maury, of the Harvard College Observatory, has discovered the composite character of the spectra of the two last-mentioned stars.

Out of the 350 stars observed up to date, 41 have proved to be spectroscopic binaries, giving a proportion of one binary to every eight stars observed, not taking into account a number of suspected cases which await confirmation.

The variable velocity of the sun has a double amplitude of only a few hundredths of a kilometre, and Prof. Campbell suggests that, with increased accuracy in our methods of observation, we shall probably find that there is a regular gradation from this comparatively minute quantity up to the much greater velocities already recorded, and that it will be found that a star which is not a spectroscopic binary is a rare exception (Lick Observatory Bulletin, No. 20).

THE NAMING OF NEW VARIABLE STARS.—No. 3808 of the *Astronomische Nachrichten* contains a list of the titles which have been assigned to the 24 variables discovered during the years 1900, 1901 and 1902 by the commission appointed to this duty. Among the 24 there are only four variables of the Algol type, one of which has the remarkable period of 31.3 days.

The published table gives the star's number in Chandler's catalogue, its temporary name, the assigned permanent name, the maximum and minimum magnitudes, and the data regarding the position for 1900.

THE SPECTRUM OF NOVA PERSEI.—Prof. Campbell and Mr. Wright subscribe a short note to the Lick Observatory Bulletin, No. 20, on the later spectrum of Nova Persei (1901).

Spectrograms, obtained throughout the autumn and winter, up to January 7, 1902, showed no appreciable difference from the immediately preceding ones, the fine dark H (calcium) line referred to in Bulletin No. 8 still remaining visible. It was suggested that the corresponding K line did not appear because there was no light in that region of the spectrum for the calcium vapour to absorb, but this suggestion has been proved incorrect

by the appearance of the K line on a negative, obtained by Mr. Wright, which was given a very long exposure with the intention of deciding whether this line did, or did not, exist in the Nova spectrum.

The writers suggest that it would now be an exceedingly interesting experiment to test the presence of the absorption lines of calcium, sodium and other elements, in the gaseous nebulae, by giving exposures long enough to record their continuous spectra.

THE CHANGES IN THE NEBULA SURROUNDING NOVA PERSEI.—Prof. Louis Bell, writing in the *Astrophysical Journal* (No. 1, vol. xvi.), discredits the "simple reflection" explanation of the changes which have taken place so rapidly in the nebulous matter surrounding the Nova, for the following reasons:—(1) Reflected light would be more or less polarised, and Perrine reports the total absence of polarisation in the light received from this nebula. (2) Reflection does not satisfactorily explain the persistence of strongly illuminated nebulosity at small angular distances from the Nova. (3) At the enormous distances (210 light days) from the Nova that some of the bright portions are situated, reflection would not account for the brightness of these parts.

Prof. Bell supports the theory of Seeliger, which accounts for the apparent movements of the brightest portions of the nebula, by supposing that the various parts of this highly tenuous matter are successively lighted up by the effects of a travelling electromagnetic wave-front, and shows that this theory agrees entirely with the observed phenomena.

HUGH MILLER: HIS WORK AND INFLUENCE.¹

AMONG the picturesque figures that walked the streets of Edinburgh in the middle of last century, one that often caught the notice of the passer-by was that of a man of good height and broad shoulders, clad in a suit of rough tweed, with a shepherd's plaid across his chest and a stout stick in his hand. His shock of sandy-coloured hair escaped from under a soft felt-hat; his blue eyes, either fixed on the ground or gazing dreamily ahead, seemed to take no heed of their surroundings. His rugged features wore an expression of earnest gravity, softening sometimes into a smile and often suffused with a look of wistful sadness, while the firmly compressed lips betokened strength and determination of character. The springy, elastic step with which he moved swiftly along the crowded pavement was that of the mountaineer rather than of the native of a populous city. A stranger would pause to look after him and to wonder what manner of man this could be. If such a visitor ventured to question one of the passing townsmen, he would be told promptly and with no little pride, "That is Hugh Miller." No further description or explanation would be deemed necessary, for the name had not only grown to be a household word in Edinburgh and over the whole of Scotland, but had now become familiar wherever the English language was spoken, even to the furthest western wilds of Canada and the United States.

A hundred years have passed since this notable man was born, and nearly half that interval has elapsed since he was laid in the grave. The hand of time, that restlessly winnows the wheat from the chaff of human achievement, has been quietly shaping what will remain as the permanent sum of his work and influence. The temporary and transitory events in his career have already, in large measure, receded into the background. The minor contests in which, from his official position, he was so often forced to engage are mostly forgotten; the greater battles that he fought and won are remembered rather for their broad and brilliant results than for the crowded incidents that gave them such vivid interest at the time. His contemporaries who still survive him—every year a sadly diminishing number—can look back across the half century and mark how the active and strenuous nature whose memory they so fondly cherish, now

"Orbs into the perfect star
We saw not when we moved therein."

A juster estimate can doubtless be formed to-day of what we owe to him than was possible in his lifetime. That the debt is great admits of no dispute, and that it is acknowledged to be

due could hardly be more fittingly shown than by the widespread desire which has brought us here to-day from so many distant places in order to raise in the town of his birth, which he made a place of pilgrimage to many a lover of English literature, a visible memorial of him in an institution of which he would himself have heartily approved.

In order adequately to realise the nature and extent of the work achieved by Hugh Miller during his too brief career, we should clearly picture to ourselves the peculiar conditions in which he grew up. Happily he has himself, in one of the most charming pieces of autobiography in the language, told the story of his youth and early manhood. Descended from both a Highland and a Lowland ancestry, he combined in his nature the vivid imagination and poetic impulse of the Celt with the more staid and logical temperament of the Teuton. He was born amidst an English-speaking community, but at a distance of only a few miles from the fringe of the mountainous region within which men use the Gaelic tongue. He knew some survivors of Collodun, and had heard his own grandfather tell how, when a stripling, he watched, from the hills above Cromarty, the smoke wreaths of the battle as they drifted along the ridge on the further side of the Moray Firth. From infancy he was personally familiar with the people of the hills and their traditions, as well as with the ways of the hardy fisher-folk and farmers of the plains. The hereditary predispositions of his mind were in this way fostered by contact with the two races from which they sprang.

Happily in the possession of this racial blending, he was still more fortunate in the place of his birth. He used to remark with satisfaction that both Sir Roderick Murchison and he had been born on the Old Red Sandstone of the Black Isle; but while the career of the author of the "Silurian System" owed practically nothing to his birthplace, which he left while still an infant, Miller's life from beginning to end bore the impress of the surroundings amid which he was born and educated. It would hardly be possible to choose in this country a place of which the varied features are more admirably fitted to stimulate the observing faculties, to foster a love of nature, and to appeal to the poetic imagination than the winding shores, the scarped cliffs, the tangled woods, the wild boulder-strewn moors and distant sweep of blue mountains around Cromarty. And how often and lovingly are these scenes portrayed by him under every varying phase of weather and season! They had stamped themselves into his very soul and had become an integral part of his being.

"The gauding cataract
Haunted him like a passion; the tall rock,
The mountain, and the deep and gloomy wood,
Their colours and their forms were then to him
An appetite, a feeling, and a love."

But while Nature was his first and best teacher, he has told us in grateful words how much he owed to two uncles—hard-working, sagacious and observant men, by whom his young eyes were trained to discriminate flower and tree, bird and insect, together with the teeming organisms of the shore, and whose high moral worth he, even as a boy, could appreciate. Having learnt to read while still of tender years, he developed an insatiable thirst for books. What he acquired in this way for himself seems to have been at least as useful as the training gained during the rather desultory years spent by him at the town grammar-school. He was an intelligent but wayward boy, as much ahead of his schoolmates in general information as in all madcap adventures among the crags and woods. When the time arrived at which he had to choose his calling in life, he selected an occupation that would still enable him to spend his days in the open air and gratify his overmastering propensity for natural history pursuits. Much to the chagrin of his family he determined to be a stone-mason, and at the age of seventeen was apprenticed to that trade. For some fifteen years he continued to work in quarries and in the erection of buildings in various districts of the north country, and even extended his experience for a short time into Midlothian. Deeply interesting and instructive as is the record he has left of these years of mechanical toil. But amidst all the hardships and temptations of the life, the purity and strength of his character bore him nobly through. His keen love of nature and his intense enjoyment of books were a never-failing solace. He continued to gain access to, and even by degrees to possess, a considerable body of the best literature in our language, reading some of his favourite authors over twice in a year. He thus laid up a

¹ An address given at the centenary celebration of the birth of Hugh Miller held in Cromarty on August 22, by Sir Archibald Geikie, D.C.L., F.R.S.

store of information and allusion which his retentive memory enabled him eventually to turn to excellent advantage.

While still at school he had gained some notice for the verses which he wrote. In the intervals of his subsequent labours with mallet and chisel, he continued to amuse himself in giving metrical expression to his feelings and reflections, grave or gay. Conscious of his power, though hardly yet aware in what direction it could best be used, he resolved to collect and publish his verses. At the age of seven-and-twenty he accordingly gave to the world a little volume with the title "Poems written in the leisure hours of a Journeyman Mason." Not without some misgiving, however, did he make this first literary venture. Even before the voices of the "chorus of indolent reviewers" could travel up from the south country, with their sententious judgments of the merits and defects of this new peasant-poet, he set himself to prepare some contributions in prose which might perchance afford a better measure of his quality. Some years before that time he had been out all night with the herring fleet, and he now sent to the *Inverness Courier* some letters descriptive of what he had then seen. These made so favourable an impression that they were soon afterwards reprinted separately. They marked the advent of a writer gifted with no ordinary powers of narration and with the command of a pure, nervous and masculine style. The reception which these letters met with from men in whose judgment and taste he had confidence formed a turning point in his career. He now realised that his true strength lay, not in the writing of verses, but in descriptive prose. Some years, however, still passed before he found the class of subjects on which his pen could most effectively be exercised. In the meantime he began to record the legends and traditions of his native district. Most of these had been familiar to him from childhood, when he heard them from the lips of old grey-headed men and women, but they were dying out of remembrance as the older generations passed away. Part of his leisure for several years was given to this pleasant task, until there grew up under his hand a bulky volume of manuscript. This time he was in no hurry to publish; the book did not make its appearance until 1835, as his charming "Scenes and Legends of the North of Scotland." In this work some of the most striking passages were to be found, not so much in the tales themselves which were narrated as in the local colouring and graphic setting that were given to them. The writer displayed a singularly vivid power in the delineation of scenery, and his allusions to the geology of the district, then almost wholly unknown, attracted attention, since they showed that besides his keen eye for the picturesque above ground, he knew something of the marvels that lay beneath. He was feeling his way to what ultimately became his most cherished and most useful task. He had realised that his main object should be to know what was not generally known, "to stand as an interpreter between nature and the public," and to perform the service of narrating, as pleasingly as he could, the facts which he culled in walks not previously trodden, and of describing, as graphically as might be, the inferences which he drew from them.

Ever after his first day's experience as an apprenticed mason in a stone-quarry, of which he has left more than one impressive account, he was led to interest himself in the diversified characters of the rocks of the district. Even as a boy he had been familiar with the more obvious varieties of stone to be met with in a tract of country wherein the sedimentary formations of the Lowlands and the crystalline masses of the Highlands have been thrown side by side. But he had been attracted to them rather on account of their singular shapes or brilliant colours than from any regard to what might have been their different modes of origin. Now, however, he had discovered that these rocks are really monuments, wherein are recorded portions of the past history of the earth, and he was full of hope that by patient study he might yet be able to decipher them. The supply of elementary treatises and text-books of science, in the present day so abundant, had hardly at that time begun to come into existence. Geology, indeed, had but recently attained a recognised position as a distinct branch of science. And even had the young stone-mason been able to possess himself of the whole of the scanty geological literature of the time, it included no book that would have solved for him the problems that daily confronted him as he pursued his labours in the quarry, or rambled in leisure hours along the shore. The best treatise which could have fallen into his hands and which would have been full of enlightenment and suggestion for him—Playfair's immortal

"Illustrations of the Huttonian Theory"—had appeared seven-teen years before; but we have no evidence that it came in his way. He had laboriously to work out his problems for himself.

Innumerable as are the subjects for geological inquiry offered by the district of Cromarty, it was fortunate for Hugh Miller, and not less so for the cause of science, that chance placed him face to face in the most practical way with the Old Red Sandstone, and that he was, as it were, compelled to attempt to understand its history. While the lessons taught by the strata of the quarry had greatly impressed him, the abundant and well-preserved fossils among the Liass shales of the Eathie shore, which at spare moments he visited, had deepened that impression. It was while endeavouring to find these shales nearer home, on the western side of the Southern Sutor, that he stumbled upon the clays which contain the fish-bearing nodules of the Old Red Sandstone. This happy discovery, which was made in the autumn of 1830, the year after the publication of his "Poems," marks an eventful epoch in his life, as well as an important date in the history of geological investigation.

At that time comparatively little was known of the Old Red Sandstone. Its very existence as a distinct geological system was disputed on the continent, where no equivalent for it had been recognised. It was alleged to be a mere local and accidental accumulation, which could hardly be considered as of much historical importance, seeing that no representative of it had been found beyond the British Islands. Yet within the limits of these islands it was certainly known to bulk in no inconsiderable dimensions, covering many hundreds of square miles and attaining a thickness of more than 10,000 feet. It had been clearly shown by William Smith, the father of English geology, to occupy a definite position beneath the Mountain Limestone and above the ancient "greywacke" which lay at the base of all the sedimentary series, and he had indicated its range over England and Wales on his map published as far back as 1815. In Scotland, too, its existence and importance as a mere mass of rock in the general framework of the country had long been recognised. Ami Boué had published in 1820 an excellent account of its igneous rocks, but without any allusion to the organic wonders for which it was yet to become famous. The extraordinary abundance of its fossil fishes, where it spreads over Caithness, had been made known to the world by Murchison in 1826, and in more detail the following year, when Sedgwick and he read their conjoint paper on the conglomerates and other formations of the north of Scotland. But it may be doubted if any of these publications had found their way to Cromarty when Miller was gathering his first harvest of ichthyolites in the little bay within half a mile of the town. He had passed over that beach many hundreds of times in his boyhood without a suspicion of the treasures wrapped up in the grey concretions that lay tossing in the tideway. On breaking these stones, hoping to meet with a repetition of the Liassic organisms with which he had grown familiar at Eathie, he found a group of forms wholly different. At each interval of leisure he would repair to the spot, and, digging out the nodules from their matrix of clay, would patiently split them open and arrange them along the higher part of the beach, according to what seemed to be the natural affinities of the fossils enclosed within them. Scouring the parish for fresh exposures of the nodule-bearing clay, he was soon rewarded by the discovery of some six or eight additional deposits charged with the same remains. There was a strange fascination in this pursuit. He had, as it were, discovered a new world. No human eye had ever before beheld such strange types of creation. Though he was well acquainted with the marine life of the adjacent firths, he had never seen any creature that in the least resembled them, or served to throw light on their structure.

With no chart or landmark to guide him into this new domain of nature, he continued for years quietly to collect and compare. The first imperfect knowledge which he was able to acquire regarding the few modern representatives of the creatures disinterred by him at Cromarty was derived in 1836 from a perusal of the well-known memoir by Hibbert on the limestone of Burdiehouse. Next year, however, he made the acquaintance of Dr. Malcolmsen, who eventually carried some of his specimens to London and the continent, and was the means of bringing him into correspondence with Murchison and Agassiz. Hugh Miller was thus at last placed in direct communication with the world of science and into relation with the men who were most thoroughly versed in the subjects that had

so long engrossed his thoughts, and most capable of helping him to clear away the difficulties that beset his progress.

Meanwhile an important change had taken place in his condition of life. During the year 1834, after having worked for fifteen years in his calling of stone-mason, he was offered the accountship of the Commercial Bank agency to be opened at Cromarty. This offer, which came to him unasked and unexpected, was a gratifying mark of the esteem and confidence with which his character was regarded. He accepted it, not without some diffidence as to his competence for the duties required. It would, however, retain him in his native town, enable him to marry the accomplished girl to whom he had for years been attached, and afford him opportunity to prosecute the researches in the Old Red Sandstone, of which he had now come to realise the importance. It likewise provided him with leisure to prepare contributions to different periodicals, which, though of no great consequence to his reputation, were of service in adding to an income narrow enough for the support of a wife and family. These writings had this further advantage, that they gave him a readier command of the pen and accustomed him to deal with lighter as well as with graver subjects of discussion, thus furnishing a useful training for what was ultimately to be the main business of his later life.

At this time ecclesiastical questions occupied public attention in Scotland to the exclusion of almost everything else. The Church was entering on that stormy period which culminated in the great Disruption of 1843. Hugh Miller, who was at once an earnest Christian and a devoted son of the Church, watched the march of events with the deepest sympathy. As a thoroughly "Establishment man" he had taken but slender interest in the previous Voluntary controversy, but the larger and more vital conflict now in progress filled him with concern. It was his firm conviction that the country contained "no other institution half so valuable as the Church, or in which the people had so large a stake." The anxiety with which the situation impressed him affected his sleep, and he would ask himself, "Can I do nothing for my Church in her hour of peril?" The answer which he found was to write his famous "Letter from one of the Scotch people to Lord Brougham." This pamphlet was soon after followed by another, entitled "The Whiggism of the Old School, as exemplified in the past history and present position of the Church of Scotland." These writings, so cogent in argument and so vigorous in style, had a wide circulation, and undoubtedly exercised much influence on the progress of the ecclesiastical controversy throughout the country. The leaders of the non-intrusion party, with whose cause he showed such keen and helpful sympathy, soon after the appearance of the first pamphlet invited Miller to confer with them in Edinburgh, and offered him the editorship of their projected newspaper, the *Witness*. With some misgiving as to his competence to meet all the various demands of a journal that was to appear twice a week, he accepted the proposal. Thus, after his five years' experience as a bank-accountant, he became at the beginning of 1840, when he was thirty-seven years of age, the editor of an important newspaper, and he retained that position until his death.

Up to this time the name of Hugh Miller was but little known beyond his native district. His political pamphlets first gave it a wide reputation, and thenceforth his conduct of a journal that represented the interests of one of the great parties into which his country was divided kept him constantly before the eyes of the public. The *Witness* rapidly attained a large circulation. It appealed, not merely to the churchmen whose views it advocated, but to a wide class of readers, who, apart from ecclesiastical polemics, could appreciate its high tone, its sturdy independence, its honesty and candour, and the unusual literary excellence of its leading articles. It not only upheld, but raised the standard of journalism in Scotland. As a great moral force it exercised a healthy influence on the community. There cannot be any doubt that the powerful advocacy of the *Witness* was one of the main agencies in sustaining the energies of the non-intrusion party and in consolidating the position of the young Free Church. It is my own deep conviction that the debt which that Church owes to Hugh Miller has never yet been adequately acknowledged.

Before he had been many months in the editorial chair he began to publish in the columns of his paper the first of that brilliant succession of geological articles which attracted the attention of men of science, as well as of the general public, and which continued to be a characteristic feature of the *Witness* up

to the end of his life. The first articles, describing his discoveries in the Old Red Sandstone of Cromarty, created not a little sensation among the geologists who had gathered in the year 1840 at the memorable meeting of the British Association at Glasgow. It was there that Agassiz, who had come fresh from the study of Swiss glaciers to the Scottish Highlands, announced that he had found clear evidence that the mountains of this country had once also nourished their glaciers and snow-fields. It was then, too, that the same illustrious naturalist gave the first account of the fossils found by Hugh Miller at Cromarty, one of which he named after its discoverer. In that gathering of eminent men, Murchison declared that the articles which had been appearing in the *Witness* were "written in a style so beautiful and poetical as to throw plain geologists like himself into the shade." Buckland, famous for his own eloquent pages in the *Bridgewater Treatise*, expressed his unbounded astonishment and admiration, affirming that "he would give his left hand to possess such powers of description." The articles were next year collected and expanded into his "Old Red Sandstone, or New Walks in an Old Field"—the first and, in some respects, the freshest and most delightful of all his scientific volumes.

In subsequent years there appeared in the same columns his "Cruise of the Betsy"—a series of papers written among the Western Isles, and full of the poetry and geological charm of that marvellous region; his "Rambles of a Geologist," in which he included the results of his wanderings over Scotland between 1840 and 1848, and other essays, the more important of which were collected with pious care by his widow and published in a succession of volumes after his death. His "First Impressions of England and its People" appeared in 1846, and greatly increased the reputation of its writer as an observant traveller, an able critic and an accomplished writer, possessing a wide and sympathetic acquaintance with English literature. The "Footprints of the Creator," which followed in 1847, was of a less popular character. Its detailed account of the structure of some of the fishes of the Old Red Sandstone is, however, of lasting value, though its controversy with the "Vestiges of Creation" has no little more than a historical interest. The "Schools and Schoolmasters," after running as usual through the pages of the newspaper, was issued as a separate volume in 1852, and was everywhere hailed as one of the most delightful and instructive of all his works. The "Testimony of the Rocks," with the final proofs of which he was engaged on the last day of his life, was issued a few months after he had been laid to rest beside his friend Chalmers. Altogether of his collected writings, including those that appeared in his lifetime, a series of twelve volumes has been published, but many hundreds of articles of less permanent interest, yet each marked by the distinctive charm of its writer, remain buried in the files of the *Witness*.

If, from his writings alone, we judge of the extent and value of the work achieved by Hugh Miller, we can have little hesitation in believing that it is mainly his contributions to the literature of science that will hand his name down to future generations. Like so many other men who have attained distinction in the same field, he from the beginning to the end made geology his recreation, in the midst of other paramount preoccupations. It furnished him with solace from the toils of the quarry and the building yard, it supplied him with a healthful relief from the labours of the bank, and when in later years he escaped each autumn for a few weeks of much-needed leisure from the cares and responsibilities of the editor's desk, it led him to ramble at will all over his native country, and brought him into acquaintance with every type of its rocks and its landscapes.

Unquestionably the most original part of his scientific work, that wherein he added most to the sum of acquired knowledge, is to be found in his reconstruction of the extinct types of fishes which he discovered in the Old Red Sandstone. The merit of these labours can hardly be properly appreciated unless it be borne in mind that he came to the study of the subject with no preliminary biological training save what he could pick up for himself from an examination of such denizens of the neighbouring firths as he could meet with. But after prolonged search he could find in these northern seas no living creatures the structure of which afforded him any clue to that of the fossil fishes of Cromarty. Some men had concluded that the organisms were ancient turtles, others that they were crustaceans or even aquatic beetles. He had the sagacity, however, to surmise that they were probably all fishes, and he

enjoyed the satisfaction afterwards of learning that Agassiz pronounced even the most bizarre amongst them to belong to that great division of the animal kingdom. He was guided by his own intuitive conception of what must have been the plan on which these long-vanished types of organic structure had been fashioned. Huxley, who twenty years afterwards had occasion to subject the Old Red Sandstone fishes to critical study, and who brought to the inquiry all the resources of modern biology, has left on record the impression made on his mind by a minute revision of Hugh Miller's work. "The more I study the fishes of the 'Old Red,'" he remarks, "the more am I struck with the patience and sagacity manifested in Hugh Miller's researches, and by the natural insight which in his case seems to have supplied the place of special anatomical knowledge." He refers to the "excellent restoration of Osteolepis," in which even some of the minute peculiarities had not escaped notice, and he declares that Hugh Miller had made known almost the whole organisation of *Dipterus*, and had thus anticipated the most important part of Prof. Pander's labours in the same field, the distinguished Russian palæontologist not having been aware that the work had already been done in Scotland.

But it is not, in my opinion, by the extent or value of his original contributions to geology that the importance of Hugh Miller's scientific labours and writings should be measured. Other men, who have left no conspicuous mark on their time, have surpassed him in these respects. What we more especially owe to him is the awakening of a widespread interest in the methods and results of scientific inquiry. More than any other author of his day, he taught men to recognise that beneath the technicalities and jargon that are too apt to conceal the meaning of the facts and inferences which they express, there lie the most vital truths in regard to the world in which we live. He clothed the dry bones of science with living flesh and blood. He made the aspects of past ages to stand out once more before us, as his vivid imagination conceived that they must once have been. He awakened an enthusiasm for geological questions such as had never before existed, and this wave of popular appreciation which he set in motion has never since ceased to pulsate throughout the English-speaking population of the world. His genial ardour and irresistible eloquence swept away the last remnants of the barrier of orthodox prejudice against geology in this country. The present generation can hardly realise the former strength of that bigotry, or appreciate the merit of the service rendered in the breaking of it down. The well-known satirical criticism of the poet Cowper expressed a prevalent feeling among the orthodox of his day, and this feeling was still far from extinct when Miller began to write. I can recall manifestations of it even within my own experience. No one, however, could doubt his absolute orthodoxy, and when the cause of the science was so vigorously espoused by him, the voices of the objectors were finally silenced. There was another class of cavaliers who looked on geology as a mere collecting of minerals, a kind of laborious trifling concealed under a cover of uncouth technical terms. Their view was well expressed by Wordsworth when he singled out for contemptuous scorn the enthusiast

"Who with pocket hammer smites the edge
Of luckless rock or prominent stone,
Detaching by the stroke
A chip or splinter, to resolve his doubts,
And, with that ready answer satisfied,
The substance classes by some barbarous name
And hurries on;
He thinks himself enriched,
Wealthier, and doubtless wiser, than before."

But a champion had now arisen who, as far as might be, discarding technicalities, made even the duller reader feel that the geologist is the historian of the earth, that he deals with a series of chronicles as real and as decipherable as those that record human events, and that they can be made, not only intelligible, but attractive, as the subjects of simple and eloquent prose.

The absence of technical detail, which makes one of the charms of Hugh Miller's books to the non-scientific reader, may be regarded as a defect by the strict and formal geologist. Like every other branch of science, geology rests on a basis of observation, which frequently depends for its value upon the minuteness and accuracy of its details. To collect these details is often a laborious task, which is seldom undertaken save by those whose department of the science they specially belong. A palæontologist cannot be expected to devote his time to the study of the microscopic characters of minerals and rocks. He leaves that research to the petrographer, who, on the other

hand, will not readily embark on an investigation of the minute anatomy of fossil plants or animals. This specialisation, which has always to some extent existed, necessarily becomes more pronounced as science advances. The days are far past for Admirable Crichtons, and it is no longer possible for any one man to be equally versed in every branch of even a single department of natural knowledge.

Hugh Miller's researches among the Old Red Sandstone fishes showed him to be above all a naturalist and palæontologist, capable of expending any needful amount of patient labour in working out the minutest details of organic structure. In other fields of geological inquiry, while he was far from undervaluing the importance of detail, he avoided the recapitulation of it in his writings. It interested him, indeed, only in so far as it enabled him to reach some broad conclusion or to fill in the canvas of some striking picture of bygone aspects of the earth's surface. Hence he did not apply himself to the minute investigation of problems of geological structure, and when he undertook any inquiry in that direction he was apt to start rather from the palæontological than the physical side. Thus the work of his last years along the shores of the Firth of Forth, wherein he sought to accumulate proofs of the comparatively recent upheaval of the land, was mainly based on the position of shells with reference to their present habitat in the adjacent seas. As a youth enthusiastically geological, I was privileged to enjoy his friendship, sometimes accompanying him on an excursion, and always spending an evening with him after one of his autumn journeys that we might exchange the results of our several peregrinations. Only a week or two before his death, on the last of those memorable evenings, he had his trophy of shells spread on the table, which enabled him to prove that at no very distant date Scotland was cut in two by a sea-strait that connected the Firths of Forth and Clyde. He had found marine shells at Bucklyvie, on the flat ground about midway between the two estuaries. Finding I was not quite clear as to the precise geographical position of his shell-bed, he burst out triumphantly with the lines placed by Scott at the head of the chapter in "Rob Roy," which tells of the journey of Bailie Nicol Jarvie and Osbaldistone into the Highlands:

"Baron of Bucklyvie
May the foul fend drive ye,
And a' to pieces rive ye,
For building sic a town,
Where there's neither horse-meat, nor man's meat, nor a chair
to sit down."

I remember, too, that on that occasion I had brought with me the detailed map of Arthur's Seat at Edinburgh, of which I had just completed the geological survey, and I explained to him in some detail what I had found to be the structure of the hill. Having grasped the main succession of the rocks, he with characteristic rapidity passed from the particulars which I had given him to the events of which they were the record, and turning to his daughter, who was sitting near, he exclaimed to her, "There, Harriet, is material for such an essay as has been prescribed to you at school." Then in a few graphic sentences he drew a picture of what seemed to him to have been the history of the old volcano.

While various causes, no doubt contributed in this country to the remarkable and rapid increase in the general appreciation of the interest of geological investigation, I feel assured that one of the chief of them has been Hugh Miller's imaginative grasp of the subject and his eloquent advocacy. The personal experience of a single individual can count for little in an estimate of this kind; but for what it may be worth, I gladly avail myself of this opportunity to state mine. It was Hugh Miller's "Old Red Sandstone" that first revealed to me the ancient history that might be concealed in the hills around me, and the meanings that might be hidden in the commonest stones beneath my feet. I had been interested in such objects, as boys are apt to be who spend much of their time in the open country. But it was that book which set me on the path of intelligent inquiry. And this experience must doubtless have been shared by many thousands of his readers who never saw his living face and who never became geologists.

I have alluded to the excellence of his literary style—a characteristic which, unfortunately, is only too rare among writers in science. There can be little doubt that this feature of his work will constitute one of its claims to perpetual recognition. His early and wide acquaintance with our literature enabled him to intersperse through his pages many an apposite quotation and

felicitous allusion. He had set before himself as models the best prose writers of the previous century, and the influence of Goldsmith upon him is especially notable. He thus acquired the command of pure, idiomatic and forcible language wherein to clothe the arguments which he wished to enforce, to describe the landscapes which had imprinted themselves like photographs on his memory, and to present restorations of ancient lands and seas which his poetic temperament and powerful imagination called up before his eyes. Moreover, he had a keen sense of humour, which would show itself from time to time, even in the midst of a scientific discussion. He could not bear dullness in others, and strove to avoid it himself. Where his subject might have been apt to grow wearisome, he contrived to lighten it with unexpected flashes of pleasantry or with some pertinent words from a favourite author. This felicitous style seemed so spontaneous, and yet it was in reality the result of the most scrupulous attention. Even in his newspaper articles on the multifarious topics of the passing day, he continued to maintain the same high standard of composition. He has left as his literary monument a series of works that may serve as models of English writing.

In estimating a man's influence on the world we look, not only at his work, but on his character, often the more important and valuable of the two. Judged from this side, Hugh Miller's claims to our regard and admiration are not less strong for what he was than for what he did. Pious and pure-minded, full of generous sympathies, and alive to all that was noblest and best in human life, he was endowed with a manly independence of nature which kept his head erect in every changing phase of his career, and won for him the respect of all, gentle and simple, who came in contact with him. Though naturally robust, his occupation as a mason had left behind some seeds of disease. He was at different times attacked with inflammation of the lungs and other disorders of enfeebled health. His strong sense of duty, however, kept him at his post when prudence earnestly counselled rest. At last the strain became too great, and brought a noble and well-spent life to a sudden and tragic end.

It is to me a valued privilege to take part to-day in the centenary celebration of such a man. The years slip away, and I am probably the only geologist now alive who knew Hugh Miller well. He was my earliest scientific friend. Some boyish articles I had written in an Edinburgh newspaper on a geological excursion to the Isle of Arran had gained me his acquaintance, and ever thereafter I enjoyed his friendship and profited by his encouragement. To his helpful intervention I owed my introduction to Murchison, and thence my entry into the Geological Survey. His death was one of the great bereavements of my youth. It is therefore with heartfelt gratification that here, in his native town, so early familiar to me from his graphic descriptions, I find myself permitted on this public occasion gratefully to express my life-long indebtedness to him for his noble example, for the stimulus of his writings, and for the personal kindness which I received at his hands.

WHAT THE UNITED STATES OF AMERICA IS DOING FOR ANTHROPOLOGY.¹

HAVING recently had the good fortune to pay a somewhat extended visit to the United States of America, I have thought it might not be uninteresting to you to hear what our kinsmen and colleagues across the Atlantic are doing for the furtherance of anthropology.

The means for the advancement of the science of anthropology fall under the following heads 1.—(1) The collection of information in the field; (2) the publication of such information; (3) the collection of specimens; (4) the preservation of specimens; (5) the publication of museum specimens; (6) the instruction of students; (7) independent investigation of collected material.

As no hard and fast line can be drawn between some of these activities, I shall deal first with the museums and with the field work undertaken by the more important institutions in the United States of America, and then very briefly with the teaching of anthropology in the United States.

¹ Abridged from the presidential address delivered by Dr. A. C. Haddon, F.R.S., before the Anthropological Institute on January 23. The address is published in full in the current number of the *Journal of the Institute*.

I. Field Work and Museums.

It is a glory to the nation of the United States that it has recognised the duty of collecting information about the aboriginal Americans. The twenty or more annual reports published by the Bureau of Ethnology constitute a monument to the intelligence of the Government and of its departmental officials of which their country may well feel proud. Nor does the Bureau of Ethnology neglect the collection of specimens, as is evidenced by the very extensive collections transferred to the National Museum. I cannot, however, refrain from remarking that it seems very strange that the anthropology, or physical anthropology, of the native tribes is entirely neglected by the Bureau, and I know that others share with me the hope that this state of affairs will be remedied.

The head curator of the department of anthropology in the National Museum, Dr. W. H. Holmes, is gradually working out his conception of what his museum should be. His object is twofold: (1) to illustrate the cultural history of mankind; (2) to demonstrate the distinctive characteristics of the various races and people.

(1) Numerous series of objects have been installed to illustrate the progress of culture, such, for example, as the various stages of evolution from stone implements, on the one hand, to the most modern steel tools and engineering appliances on the other. In this work the curator has been ably helped by the veteran Dr. Otis T. Mason, whose writings on technology are so well appreciated by students. An admirable land transport series has been got together, and one hall is devoted to a wonderful collection illustrating transport by water. There is also an interesting section devoted to comparative religions, of which Dr. Cyrus Adler is the custodian. No Government in the world does so much for ethnology as does that of the United States.

The Free Museum of Science and Art in Philadelphia contains some very valuable and pleasingly arranged collections of Babylonian, Egyptian and Etruscan antiquities. Good representative collections of American ethnology and archaeology are being got together, owing to the exertions of Mr. Culin, the director. Of the special collections given to the university, mention need be made only of the collection of gems, of musical instruments and the Furness-Hose collection from Sarawak. In the museum is also to be found Mr. Culin's very instructive and almost exhaustive collection of games, but unfortunately it is stored away in drawers. If this collection was adequately exhibited it would give to the museum a unique position among anthropological museums.

It is instructive to note that although this is a university museum, no support is received from the university, all the scientific work being prosecuted by funds raised from private sources, a result largely due to the enthusiasm of Dr. Sara Y. Stevenson, the energetic secretary of the department.

In 1869 a little band of public-spirited men was created by the Legislature "a body corporate by the name of 'the American Museum of Natural History,' to be located in the city of New York, for the purpose of establishing and maintaining in said city, a Museum and Library of Natural History; of encouraging and developing the study of Natural Science; of advancing the general knowledge of kindred subjects, and to that end of furnishing popular instruction and recreation."

A partnership, under sanction of the law, was entered into by the citizens of New York in their corporate capacity with the president and trustees of the museum, it being mutually agreed that the city should pay for the erection of the buildings, their maintenance and protection, while the trustees took upon themselves the responsibility of providing the exhibits, the library, the lectures and other means of instruction and mental recreation. This arrangement is perpetual and irrevocably binding on both parties.

The anthropological department of the museum has accomplished an unprecedented amount of research during the past year, a large sum of money having been received from private sources for the purchase of several important collections of American archaeology and ethnology and for the expenses of many expeditions in the field.

The greater part of the anthropological collections in the Yale University Museum are archaeological in character. The Peabody Museum of Harvard University is already overcrowded and fresh collections are constantly arriving, which the curator, Prof. F. W. Putnam, is forced to keep in boxes in the store rooms. The main collections are the results of the

digging of mounds in the Eastern and Central States; thus the archaeology of that portion of America can be very well studied in the museum. During the years 1887 to 1893 the late Mrs. Mary Hemenway provided funds for archaeological and ethnological expeditions to the Pueblo Indians of Arizona and New Mexico.

The history of the progress of anthropology in Chicago is eminently characteristic of that typical American city.

There is no need to give a detailed history of the anthropological department of this museum, as Dr. Dorsey has already done so in the *American Anthropologist*, n.s., ii, 1890, p. 247; but I will briefly indicate the main collections and their origin.

The anthropological collections which formed the foundation of the department were obtained through special expeditions sent out under the direction of Prof. F. W. Putnam, or by collectors resident in the field, who were commissioned by the department of ethnology to undertake the work. A mass of interesting and valuable material from Alaska to Peru was thus accumulated. A few collections from other quarters of the globe were also obtained. The history of the museum since then has been one of almost unparalleled activity. Expedition after expedition has been sent out to collect ethnological and archaeological material in North and Central America; some of these have been paid for out of the museum funds, while others have been rendered possible by special donations from benefactors, most of whom are Chicago merchants.

The more technical aspect of the museum has been so well described by Dr. A. B. Meyer that I need not dwell upon it.

The most recent inauguration of anthropological activity is that displayed by the University of California. A department of anthropology was established by the Regents of the University in September, 1901.

As an encouragement to others and as an expression of her great interest in the new department, Mrs. Phoebe A. Hearst, who is one of the Regents and a most generous benefactor to the University, has promised 10,000l. (50,000 dollars) a year for five years for anthropological research. In this manner is struck the key-note of the new department. Research first and foremost. We may look forward in the immediate future to the establishment of a really important museum on the Pacific coast which, being under the jurisdiction of the University of California, will be the centre of considerable anthropological research and instruction.

Now that the financial position of the Stanford University at Palo Alto is permanently secured, it is to be hoped that the claims of anthropology will not be overlooked.

This is not the place to describe the points of interest in the various museum buildings, the installation of the collections and the details relating to museum administration and technique. It is the less necessary as Dr. A. B. Meyer, of Dresden, who is a recognised authority on all matters pertaining to museums, travelled in the United States in 1899, and he is publishing a series of well-illustrated reports on the institutions he visited. These reports are invaluable to all those who are interested in the promotion or maintenance of museums and libraries, and it is to be hoped that no architect in the future will attempt to draw up plans for a new museum or library until he has consulted this work.¹

II. *The Teaching of Anthropology in the United States of America.*

In America courses of anthropology were established about fifteen years ago at Harvard University and at the University of Pennsylvania. It was one of the first subjects introduced into the curriculum of the University of Chicago. Seven or eight years ago anthropology was recognised in Columbia University in the city of New York. At the present time some thirty-three universities and colleges offer instruction in anthropology. Limit of space precludes my giving details concerning the instruction in anthropology in these numerous institutions, so I confine myself to a consideration of two of the universities where the teaching is most firmly established. Further information on this subject will be found in Prof. G. G. MacCurdy's report on "The Teaching of Anthropology in the United States" in *Science*, n.s., vol. xv, 1902, p. 211.

It would be impossible to include within the limits of a brief

¹ The two parts already issued are entitled "Ueber Museen des Ostens der Vereinigten Staate von Nord Amerika." Reisenstudien von A. B. Meyer. (Berlin: R. Friedländer und Sohn.)

address an account of all the work that is being done in anthropology by the Government, by public and private institutions, or by individual effort in the United States of America. Much as I should have liked to have emphasised the interest exhibited in the subject and the wonderful activity that is being displayed, the bare enumeration of all this activity would make a very weary chronicle.

I must confess that I felt a not inconsiderable amount of envy when on every hand I witnessed this energy and then recalled the apathy which pervades our own country.

The American public is more intelligently alive to the interest and importance of anthropology than is our public. The exponents of the science are energetic, enthusiastic and competent, and they succeed in gaining the practical sympathy of wealthy merchants, who are not averse to spending money freely when they see that the money will be wisely spent for the good of the State or of the city. One cannot say that the wealthy Americans are more intelligent than are our rich men, but they do seem to appreciate the value of learning to a much greater extent than do ours. At all events, they respond more readily to the very pressing need there is for the endowment of research and of those institutions which bring the knowledge of the expert down to the comprehension of the masses.

I am quite willing to admit that the fault in this country may lie as much with the specialist as with the capitalist. In any case we have an inspiring demonstration in the United States of America of what can and should be done in Great and Greater Britain, and I venture to thank our American colleagues in the name of anthropological science for this good example of strenuous effort and praiseworthy accomplishment.

UNIVERSITY AND EDUCATIONAL INTELLIGENCE.

THE new municipal school of technology in Manchester will be opened by Mr. Balfour on October 15.

DR. W. PALMER WYNNE, F.R.S., professor of chemistry in the School of Pharmacy of the Pharmaceutical Society, will deliver an address at the inauguration of the sixty-first session of the School on October 1.

MR. PARKIN, who has just gone to America to formulate a plan for putting into execution the provisions of Mr. Cecil Rhodes's will, has, a correspondent of the *Times* reports, been trying to interest Mr. Pierpont Morgan in a plan whereby the Rhodes scholarship scheme should be made reciprocal, the same number of young Englishmen being educated at American universities as Americans at Oxford. When he landed at New York on August 20, Mr. Parkin said:—"I think it would be a most splendid thing for some liberal American, or several Americans, to endow in some of your great colleges scholarships for the benefit of English youths similar to those founded by the bequest of Mr. Rhodes for the young men of America at Oxford." The same idea was put forward in several American papers when the terms of Mr. Rhodes's will were announced.

THE Childhood Society was founded some five years ago by the late Sir Douglas Galton, and, as its fifth annual report shows, it continues to grow in importance and usefulness. The objects of the Society are to promote the study of educational methods and of the environment of children during school life, with a view to discover the conditions best suited to ensure the healthy mental and physical development of normal children, and those best adapted to the peculiar needs of the mentally feeble and otherwise abnormal children. For the first time, the council of the Society has printed and issued the lectures and papers delivered at its meetings in book form, under the title of "Volume I. of the Transactions of the Childhood Society." A glance through the list of the Society's officers for the current year reveals a desirable cooperation between medical men and professional educationists which cannot fail to result in an improvement in the structure and equipment of schools as well as in the less material conditions of the class room.

A RECENT return printed by the order of the House of Commons, tabulating the sums applied by local authorities to the purposes of technical education, shows that the total amount expended on technical education in England and Wales during 1900-1 was 1,051,422l., but this does not include sums allocated to intermediate and technical education under the Welsh Intermediate Education Act. The total amount of

money available under the Local Taxation (Customs and Excise) Act for technical education in England (excluding Monmouthshire), or, as the grant is usually called, the "whisky" money, was during the same period 924,360*l.*, but only a part was appropriated to educational purposes, 60,513*l.* going to the relief of rates, the London County Council recognising this unenlightened policy to the extent of 32,711*l.* It is gratifying to find, however, that nine only of the forty-nine county councils included in the return devote part of their funds available for education to the relief of rates, and only six of the sixty-two county borough councils allow any such diversion of funds. More than this, two county councils, twenty-four county borough councils, ninety-nine boroughs and 195 urban districts are making grants out of the rates under the Technical Instruction Acts. In Wales and Monmouth, the whole of the "whisky" money is devoted to education, and in addition to this sum about 24,000*l.* raised by rates was expended for the same purpose during the period under review.

On August 23, Prof. Geddes presided over the Nature-Study Conference organised in connection with the University Extension Meeting at Cambridge, and Mr. Wilfred Mark Webb gave an address on his "Impressions of Nature-Study." Mr. Webb showed the importance of the three branches of nature-study which he recognises with reference to four of its non-utilitarian aims. "Scientific teaching will often provide," he said, "a definite hobby or interest in life." Going to the other extreme, simple "nature-lore"—studied out of doors—may be expected to add to "the mere joy of existence," to produce "an appreciation of the country and its pursuits," and in correlation with "unsystematised nature-knowledge"—acquired in school as part of general education—to cultivate "habits of investigation by directing natural curiosity into rational channels." The necessity of emphasising outdoor work, the ease with which it may be undertaken off-hand by any teacher and the possibility of regarding it as nature-study in a restricted sense were touched upon. Mr. Macan's excellent suggestion that special nature-study training colleges should be inaugurated by groups of county councils was strongly commended. In the interesting discussion which followed, Miss Ravenhill showed how nature-study leads to the necessary consideration of man in his environment. Prof. Haddon hinted that the best naturalists, and therefore teachers of nature-study, were not necessarily those who had passed examinations. Mr. Oldham disagreed with those who would confine nature-study to animate objects and thus exclude the consideration of the earth itself. Miss Von Wyss described the voluntary biological work undertaken by all the students in the Cambridge Training College.

SCIENTIFIC SERIAL.

Journal of Botany, August.—Continuing their descriptions of "Crassulas from South Africa," Mr. S. Schonland and Mr. E. G. Baker introduce twelve new species of the genus.—A bryological article, with illustrative plate, by Mr. E. S. Salmon is mainly concerned with a consideration of the genus *Thiema*, C. Müll, which he is inclined to sink in the genus *Willemsiella* of the same authority, and the description of a variety of *Syrrophodon Gardneri*, Schwaeg.—Other articles are:—Buchanan's *Avan Plants*, J. Britten; *Hieracium mucronum* and *H. caesium*, F. N. Williams; West Lancashire Notes, C. E. Salmon and H. S. Thompson.

SOCIETIES AND ACADEMIES.

PARIS.

Academy of Sciences, August 18.—M. Bouquet de la Grye in the chair.—The resistance to traction of mortar, by M. Considere. The experiments were carried out on prisms strengthened at the angles with iron wires. The results of the traction experiments were automatically recorded by the testing machine, and reduced facsimiles of these curves accompany the paper.—On the year's work at the observatory at the summit of Mont Blanc, by M. J. Janssen. The researches which are proposed for the present year include a study of the modifications which the hæmoglobin of the blood undergoes with muscular effort at varying altitudes, the relations between the altitude

and rarity of the atmosphere, and the richness of the spectrum in violet and ultra-violet rays, studies on atmospheric electricity, and the effect upon the composition of the blood and the respiratory exchanges of altitude alone or combined with muscular effort.—On the assemblage of two bodies, by M. G. Kœnigs.—On some organic addition compounds, by M. P. Lemoult. A description of the preparation and properties of some addition compounds of chlorodinitrobenzene with some diamines.—Experimental researches on the conservation of muscular potential in an atmosphere of carbon dioxide, by M. Lhotak de Lhota. Carbonic anhydride accelerates the fatigue of a muscle by stopping the disengagement of energy. On account of this the muscle cannot be used up; the energy may be given off after the removal of the carbon dioxide, and hence this gas constitutes a favourable factor in preserving muscular energy.—The comparative study of the organic fluids of the sacculina and the crab, by MM. Louis Bruntz and Jean Gautrelet.—On some fossil pollens, male prothallia, pollenic tubes, &c., in the coal-measures, by M. B. Renault. Many pollen grains of the coal epoch contain a perfectly well-marked male prothallus, the compartments of which contain the mother cells of the antherozoids. This prothallus may emit a pollen tube, as in *Stephanospermum*, or allow the antherozoids to escape directly from the pollen chamber, as in *Aethoestea*.—The influence of cream separation on the principal constituents of milk, by MM. F. Bords and Sig. de Raczowski. The removal of the fat to the extent of 98 per cent. takes away at the same time 69 per cent. of the lecithin. In the authors' opinion, this is sufficient to explain the high death-rates through gastro-intestinal troubles in those towns where the sale of skimmed milk is allowed. It also accounts for some diseases in infants fed exclusively on sterilised milk.—On the physical geography of the Western Yaula, Crimea, by M. E. Daniloff.

CONTENTS.

PAGE

A Field Naturalist's Science	409
Chrometry. By C. C.	411
Trades' Waste and River Pollution	413
Our Book Shelf:—	
Auerbach: "Die Weltherin und ihr Schatten. Ein Vortrag über Energie und Entropie"	414
Henniger: "Chemisch-Analytisches Praktikum."—A. S.	414
Lico: "La Protezione degli Animali."—R. L.	414
Walker: "Coal Cutting by Machinery in the United Kingdom"	414
Horns: "Metallography: an Introduction to the Study of the Structure of Metals, chiefly by the Aid of the Microscope"	415
Letters to the Editor:—	
Notes on Young Gulls.—Prof. R. v. Lendenfeld	415
The Effect of Light on Cyanin.—P. G. Nutting	416
Fog Bow at Oxford.—J. Rose	416
Simple Means of Producing Diffraction Effects.—Wilfred Hall	416
Time-Signals by Wireless Telegraphy.—John Munro	416
The Belfast Meeting of the British Association. (Illustrated)	416
A Great Persian Traveller. (Illustrated.) By W. T. B.	418
Notes	421
Our Astronomical Column:—	
Astronomical Occurrences in September	425
New Discoveries of Variable Velocities in Line of Sight	425
The Naming of New Variable Stars	425
The Spectrum of Nova Persei	425
The Changes in the Nebula surrounding Nova Persei	426
Hugh Miller: his Work and Influence. By Sir Archibald Geikie, F.R.S.	426
What the United States of America is doing for Anthropology. By Dr. A. C. Haddon, F.R.S.	430
University and Educational Intelligence	431
Scientific Serial	432
Societies and Academies	432

THURSDAY, SEPTEMBER 4, 1902.

DANGEROUS TRADES.

Dangerous Trades: the Historical, Social, and Legal Aspects of Industrial Occupations as affecting Health.

By a number of Experts. Edited by Thomas Oliver, M.D. (London: John Murray, 1902.)

IT is claimed for this volume of some 900 closely printed pages that it constitutes the first serious attempt in this or indeed any other country to deal comprehensively with the conduct of trades in relation to the life and health of the workers. And there is a certain fitness in the fact that such a book should first be produced here and that its authors should be British, inasmuch as Great Britain has led the van in factory legislation as she has hitherto led it in industrial enterprise. Industrial enterprise and the economic and social amelioration of the worker inevitably go together, for in proportion as each country advances in commercial prosperity and in economic development, higher ideals of comfort and higher standards of industrial hygiene are demanded by its people. Our own legislative attempts to secure these began with the opening years of the last century, and have been made the basis of, and the occasion for, similar attempts abroad. The general result has been that during the last forty or fifty years the lot of the artisan has been everywhere brightened by the improvement of the conditions under which much of his labour has to be performed.

It is hardly necessary to say that such a measure of progress has only been obtained by strenuous and persistent effort, by outside interference, or in other words, by the working of the public conscience and the force of public opinion.

Apathy, callousness, self-interest and an obstinate adherence to the doctrines of a perverted political economy have too frequently stood in the way of well-recognised reforms. It must be admitted that much of the improvement has been contemporaneous with the shifting of political power, but whether as the direct result of it is by no means equally certain. The spread of information, a more enlightened self-interest on the part of the worker, the organisation of labour, a deeper and more active sense of public responsibility in regard to unhealthy trades, together with an intelligent appreciation on the part of employers that what is good for the bee is also good for the bee-hive, have combined to secure the good which has been achieved.

The book before us is made up of sixty chapters—so many separate essays, in fact—contributed by thirty-eight authors, all of whom must be considered specialists on the subjects with which they deal.

It is impossible within the space at our disposal to do more than indicate in the briefest possible way the main features of the mass of material which Dr. Oliver and his coadjutors have brought together. We hope, however, to succeed in showing that the work deserves the careful attention of everyone interested in the hygiene of industrial life—employers of labour, factory inspectors, certifying surgeons, and also of the many members of our Legislature who concern themselves with the well-

being of our artisan population. It is not to be expected that all will give unqualified assent to every expression of opinion to be found within the work. The various questions of public policy which are incidentally raised are necessarily subjects of controversy, and will be viewed very differently by persons of different political proclivities or of different schools of economics. But we think that every dispassionate and impartial reader will admit that, taking it as a whole, it is a conscientious and praiseworthy attempt to deal with matters which lie at the very foundations of our industrial prosperity and happiness.

In an introductory chapter Dr. Oliver traces in a few short paragraphs the main features of the industrial revolution—the change from the domestic system of industry to the modern methods of production by machinery—which constitutes one of the most momentous epochs in the history of our civilisation, and he indicates the changes in the social and intellectual condition of the people to which it has directly and indirectly given rise. He explains how a demand for the State control of our industries so far as relates to the safety, health and moral condition of the workers has arisen, how it has been met, and within what limitations the control has been operative and effective. As regards the economic effect of factory legislation, Dr. Oliver utters no uncertain sound.

“Those who blame State interference as the cause of the doubtful decline of our industrial supremacy, and who believe that it is checking enterprise, are not making a sufficiently serious attempt to grapple with the question by sifting all the facts carefully. It can be demonstrated that legislation has not paralysed but has improved trade as well as the conditions of labour.”

He is no less reassuring as regards the results which have flowed from the Workmen's Compensation Act:—

“The Workmen's Compensation Act,” he says, “which was so strongly opposed by many employers on the supposed ground that it would ruin the industries of this country, has had apparently no effect in that direction. Although it has theoretically increased their financial liability, as a matter of fact many employers have been less out of pocket than formerly. The Act has cleared the industrial atmosphere, made employers more careful in their selection of workmen, more willing to safeguard machinery, and do all they reasonably can to prevent accidents. It pays them to do so.”

Should the Act be extended so as to include a larger number of industries and more particularly those regarded as dangerous trades? On this point opinions may differ, as was shown by the fate of the proposal in Parliament to place industrial diseases on the same footing as accidents.

The main objection would seem to depend upon the difficulty of defining industrial diseases.

“For a disease to be regarded as industrial, and capable, therefore, of being brought within the scope of the Workmen's Compensation Act, it would have to be placed upon the same narrow limit as an accident. It would require to be shown that it was the sole result of the occupation, and that there had been produced a definite pathological lesion of the body. Adopting this view, the maladies that could be included in the category would be, among others, anthrax, poisoning by lead, mercury, phosphorus, and bisulphide of carbon; but with the exception of anthrax, in which the disease is often

suddenly induced, and as rapidly runs to a fatal termination, there is not as a rule the same exactitude in the incidence of disease as is the case in accident. There might be little difficulty in including anthrax under the Act of 1897. The inclusion of some of the other dangerous trades would give rise to frequent litigation, but it would make employers more careful in the selection of their work-people, and in the means adopted to prevent industrial poisoning."

Among the most thoughtful and suggestive of the essays contained in the work are those contributed by the lady inspectors of factories. Miss Anderson's "Historical Sketch of the Development of Legislation for Injurious and Dangerous Industries in England," and her chapter on the "Regulation of Injurious or Dangerous Occupations in Factories and Workshops in Some of the Chief European Countries," are especially noteworthy for their breadth of view, thoroughness and impartiality. The one chapter, in fact, may be regarded as complementary to the other. Comparing what has been done abroad with the position at home, H.M. Principal Lady Inspector comes to the conclusion that England is lagging behind.

"England stands in a special position, with its own qualities and defects. Having entered long before most other European countries on the path of control of employment in factories owing to the earlier need of such regulation, and having admittedly also led the way in the task of building up a complete and precise sanitary code for regulation of public health, England has shown in the later stages of the part of the work which touches industry too little interest in the later efforts, on different lines, of other countries. This slowness is traceable in part to the same causes as those which have retarded in England the general study of comparative legislation and administration, of which foremost, no doubt, stands the necessity of developing on national lines our own safeguards, yet it seems probable that the country which in a singular degree stimulated European progress in public health by the justly famous "Report on the Sanitary Condition of the Labouring Population," 1838, has latterly retarded its own progress in industrial hygiene by too close an adherence to its own methods."

Again:—

"In several of these [foreign] countries, all of which had originally to some extent looked to the far earlier example and experience of England in enforcement of the law, the important step was taken, considerably in advance of England, of bringing into the factory service medical, engineering, and chemical expert knowledge. No doubt in England, the delay in this matter is directly traceable to the character stamped on the institution by the educational, moral and social origin of our Factory Acts, and to the very recent beginnings of development (1883-1891) of a special basis of factory hygiene."

In one respect, however, England compares favourably with continental nations in the completeness of its statistics in regard to industrial poisoning. As Miss Anderson points out,

"In no other country has the step been taken of laying both on the occupier of a factory or workshop and every medical practitioner the duty of reporting to a chief inspector of factories, or the central authority, individual cases of industrial poisoning.

On the other hand, in no other country is there "a power reserved to employers," similar to that which was in force in England until last year, "of compelling such

objections as they can sustain to proposed rules to be settled by arbitration." What Parliament and the country thought of the manner in which arbitration had worked in the past was seen in the practical unanimity with which this form of procedure was swept away in 1901.

In a short chapter on the "Principles of Prospective Legislation for Dangerous Trades," Mr. Tennant, the chairman of the Dangerous Trades Committee, which presented its final report in 1899, deals more especially with the question of the amendment and consolidation of the law relating to factories and workshops, the history of which has this in common with that of the British constitution, that "the structure of each is compounded of small accretions, contributed by what seemed the necessity of the moment." In the present condition of the law there are unquestionably many incongruities and anomalies—exemptions difficult to justify and exceptions incapable of rational explanation. But whilst much of the practical force of Mr. Tennant's contention has been minimised by the transference, above alluded to, of the responsibility for the special rules from an arbitrator or umpire to the Secretary of State, the doubt still remains whether the main defects of the present system are altogether remedied.

Chapter v. deals with the influence of factory labour upon infant mortality, and is made up of two essays, one contributed by Mrs. Tennant, formerly H.M. Principal Lady Inspector of Factories, and the other by Dr. Reid, the Medical Officer of Health of the Staffordshire County Council. Each of these essays tells the same tale, and a sad enough story it is. We heard a good deal some little time since about "the holocaust of babes" in the concentration camps in South Africa, but the waste of infant life there was out of all comparison with that which goes on unchecked as the result of our own factory system. A former Lord Londonderry once railed against the "hypocritical humanity" of Parliament when it sought to protect the lives and limbs of coal-miners. We may hope that Parliament will not continue to turn a blind eye to the large amount of infant suffering and the terrible waste of child-life in our manufacturing towns, but will learn to recognise before it is too late that, as Sir John Simon once said, "a high local mortality of children must almost necessarily denote a high local prevalence of those causes which determine the degeneration of the race."

The exigencies of space only allow of a passing reference to Miss McMillan's essay on "Child Labour" and to that by Mr. Ballantyne on "Home Work." Happily the half-time system is dying out and the age of the full-timer is being steadily raised. The question of home or out-work is one of great difficulty, and there is much in it which calls for State regulation. But it would require a strong Minister with a strong public opinion behind him to deal with it at all adequately.

The editor contributes a short paper on the "Physiology and Pathology of Work and Fatigue," in which he treats of the means of measuring muscular work, the changes which occur in tired muscle and in the blood of fatigued persons, the effect of work on nerve structure, the use of alcohol as a muscle food, &c. Although appealing more particularly to the physiologist, the

article is not too technical, and its style is appropriate to the work in which it appears. It is, perhaps, not undesirable that those who regard men and women as "hands"—that is, as machines for turning out work—should have some knowledge of the pathological consequences of fatigue.

Dr. Tatham's paper on "Mortality of Occupations" deals briefly with matters which have already been more fully treated by him and others in official publications, notably in the successive decennial supplements to the reports of the Registrar-General. In the chapter on "Dust-producing Occupations" he considers more particularly those industries which give rise to the constant inhalation of dust, leading to grave and characteristic lesions resulting in premature breakdown and death among the workers, and in a subsequent section he discusses the effects of the accumulation of respiratory and other impurities in the air breathed, partly from the neglect of suitable methods of ventilation and partly as the result of the cramped position adopted in certain cases of sedentary indoor labour.

Dr. Oliver also contributes a chapter on "Dust as a Cause of Occupation Disease," with special reference to the skin diseases of flax-workers and the diseases of the nails among furriers, lung diseases, and gastro-intestinal lesions attributable to dust.

The chapter on "Dustwomen" is curious and interesting, and serves to show how the dangers due to what is a disagreeable and at times even a disgusting employment may be mitigated by the conditions under which the work is performed if only a little common sense and prudence are exercised.

By far the greater portion of the work is concerned with the effect of particular industries upon the health or longevity of the worker, and it is this section which will appeal most strongly to individual employers, to statisticians and to the practical legislator. Mr. Cunyng-hame contributes an interesting article on the history of the attempts which have been made by the Board of Trade and by Parliament to bring the dangerous operations on railways under regulations analogous to those which can be made by the Home Office in regard to the dangerous processes in factories and mines. Although time can alone show how far Mr. Ritchie's attempt to bring railway labour within the circle of protected industries will actually realise the anticipations held out at the time of the passing of his Act, there can be no question that the position of railway servants as regards immunity from accidents has been thereby greatly ameliorated.

The extraordinary development of the technical applications of electricity has brought a special crop of dangers to the workers in its train, which are dealt with by Commander Hamilton Smith, who also contributes a chapter on acetylene and its dangers.

Lead and its compounds are naturally dealt with by the editor, who also treats of china and earthenware manufacture, and of phosphorus and lucifer matches—subjects with which he has specially concerned himself at the instance of the Home Office. Mr. Malcolm Morris furnishes a short chapter on the industrial employment of arsenic; Dr. Legge contributes one on the dangers in the use of mercury and its salts, and one on the

lesions resulting from the manufacture and uses of the alkaline bichromates. The effects of the dust of basic slag, and that resulting from ganister crushing and from buhrstone chiselling, are also treated in special chapters. Steel grinding is dealt with by Mr. Sinclair White, who, as a lecturer connected with the medical department of University College, Sheffield, has special opportunities of acquiring information; and the subject of "brass ague," which is particularly prevalent in Birmingham, the home of the brass trade, is treated by Dr. Simon, of the General Hospital in that city.

The dangers incidental to the use of bisulphide of carbon and naphtha in the manufacture of indiarubber and of benzene in dry cleaning are considered by the editor, who in this connection might also have had regard to the use of carbon bisulphide as a wool cleansing or degreasing agent. Dr. Prosser White, who is officially connected with the Roburite Explosives Company, contributes a chapter on the effects of dinitrobenzene and other nitro-substitution products on the workmen employed in the manufacture of high explosives. The effects of such explosives on the air of mines, together with the general pathological results of breathing the atmosphere of mines, are considered by Dr. Haldane, who is specially well qualified by experience and observation to deal with the subject. Principal Laurie treats of the health of workers in chemical trades; Drs. Hamer and Bell furnish two essays on anthrax and its relation to the wool industry; and Mr. Stuart, who is the medical officer of health at Batley, contributes chapters on blanket stoving and on rags and their products (shoddy mungo, &c.) in relation to health. The woes of the washerwomen—and they are more grievous than many of us are aware—are sympathetically dealt with by Miss Lucy Deane; whilst Miss Paterson tears aside something of the romance which seems to environ the life of the braw fishwife "bearing with apparent ease the enormous creel of fish and her almost equally surprising burden of petticoats." We do not usually associate much that is unhealthy either with the occupation or the appearance of the stalwart lassies that make such a picturesque congregation on the quays of Stornoway, Peterhead or Lerwick. But that the "kipperer" and the "gutter" have their peculiar troubles, and that these may be avoided by definite enactment and administration, with regulated hours and sanitary work places, are equally certain.

There is much else in the book that we should have liked to indicate and many excellent features upon which we could have wished to dwell at greater length. If we have a fault to find it is that it includes too much. The diseases of soldiers at home and abroad and questions of marine sanitation hardly come within the province of a work entitled "Dangerous Trades." Admirable as the articles relating to these subjects are, we think the editor would have been well advised to keep to subjects which are strictly within the purview of the Home Office. No doubt it is an all-embracing Department, but if the profession of arms is to be regarded as a dangerous trade in the sense that the occupation of the potter or the wool-sorter is considered dangerous, it is not easy to see why that of the medical man, the journalist, or even the legislator should not equally have been included.

We venture to think, too, that the work suffers to some extent by the mode in which its parts have been put together. It is necessarily somewhat mosaic in character, and there is a certain want of harmony and continuity of arrangement. No doubt this is due to the difficulty of dealing with so large a body of contributors, all of whom are working independently. But these, after all, are minor blemishes, and do not seriously detract from the very great value of the compilation. We heartily congratulate Dr. Oliver and his colleagues on the production of a work which will unquestionably take high rank in the literature of sanitary reform.

T. E. THORPE.

THE NEW INTERNATIONAL CATALOGUE.

International Catalogue of Scientific Literature. First Annual Issue. D. Chemistry, Part i. Pp. xiv + 468. (1902.) Price 21s.

THIS is the second instalment of the work of the International Catalogue Bureau, the first (part i. of Botany) having been reviewed in our issue of July 3 (p. 217). In a notice on p. xiv. it is explained that in consequence of the difficulties attending the complete organisation of the work of the regional bureaux some delay has arisen, and it is hoped that the second part of the volume will be published in a few months. In starting a colossal work such as this "International Catalogue," delay was inevitable, and it is to be hoped that when the different bureaux are in working order the volumes will be published more closely to the period to which they refer. On the title-page it is stated that the MS. for this volume was completed in January, 1902, so we presume that both parts i. and ii. will deal with the year 1901 only.

It is reported that although the seventeen annual volumes which constitute the "Catalogue" will, as a rule, contain the work of twelve months, yet they will not all refer to one calendar year; probably it is impossible to avoid this arrangement so as to maintain the work of the Central Bureau at a uniform rate, but it would certainly be convenient to scientific workers if, for each science, all the papers of one calendar year could be collected into one volume. No doubt the title-page of each volume will indicate the period over which the papers indexed extend, but the annual arrangement, if practicable, would appear to be much more convenient.

The authors' catalogue is contained in 111 pages with 2455 entries; in this the authors' surnames are printed in Clarendon type with the Christian names in Roman; when initials only are given in the original paper, the remainder of the name is placed in square brackets; when a paper is by more than one author, only the name of the first is in thick type. The complete title is given, usually in the language in which the paper is written. In the case of languages other than English, French, German and Italian, a translation of the title in one of these four languages follows the original; in some instances, however, translations only are given, the names of the original languages being placed in brackets. Then follow the abbreviated titles of the periodicals, with the complete reference to volume, year and pages of beginning and ending of the paper, the number of the pages being in

NO. 1714. VOL. 66]

parentheses. The registration numbers are placed in square brackets, and when the papers deal with other sciences in addition to chemistry, the letters and registration numbers of these sciences are included. The papers are numbered consecutively, these numbers concluding the entries. At the commencement of the volume, the schedule of chemistry, with registration numbers, is printed in English, French, German and Italian; and at the end there is a list of the periodicals with their full titles and the abbreviations used in the "Catalogue."

The subject catalogue occupies 283 pages, and is arranged in the order of the registration numbers. At the top of each page the registration number is given in thick type and is easily seen. Each division is marked with the registration number and the corresponding subject as a heading. The numbers are here also printed in thick type and the subject in Roman capitals, but they do not catch the eye so well as could be wished; the subsidiary titles are in Clarendon with capital initials, and are more easily seen than the heading of the division; thus on p. 195 the heading "Zinc Oxide" is very visible, whereas the heading "Zinc" at the commencement of the division is not so clearly shown.

In the subject catalogue the entries are, as a rule, reprints of the corresponding entries of the authors' catalogue, commencing with the authors' names in Clarendon and, if the papers belong to more than one division, concluding with the registration numbers other than those of the division under which the entries are made. The entries are repeated under each registration number. As in a subject catalogue the authors' names are not of the first importance, it would be better, if it were possible, to give prominence to the subject. The title of a paper does not always indicate its contents, and we are glad to see that in many of the papers from English serials a title is given in square brackets which shows much more effectually the contents of the papers than the original heading; thus in the authors' catalogue occurs the following entry:—"Frankland, Percy Faraday and Farmer, Robert Crosbie. Liquid Nitrogen Peroxide as a Solvent. London, *J. Chem. Soc.*, 79, 1901 (1356-1373) . . . [0490 7100 7250]" In the subject catalogue under "0490 Nitrogen," subdivision "Nitrogen Oxides," the same entry occurs, with the registration numbers [7100 7250]. Under "7100 Mass Properties," subdivision "Molecular Weights," after the names of the authors there follows "[Molecular weight determinations in liquid nitrogen peroxide by the ebullioscopic method]," with the registration numbers [0490 7250]. Under "7250 Electrical and Magnetic Properties," subdivision "Conductivity," we find the names followed by "[Conductivity of solutions in liquid nitrogen peroxide]," with the numbers [0490 7100]. It will be seen that the last two subjects cannot be inferred from the title of the paper, and there must be many other cases of the same kind. The subject catalogue is much increased in value by this indication of the contents of the papers, for which we are indebted to the activity of the English Bureau, or perhaps more definitely to that of Mr. Ernest Goulding, the referee for this volume. It would be a great boon if the other regional bureaux could be induced to give this partial analysis of the papers. It may be replied that the fact of the reference being placed under

certain subdivisions would sufficiently indicate the contents of the paper, and in the case above cited this is partially true; but take the paper numbered 733 and compare its title with those under the various sections (they are too long to quote), and the value of the additional titles will be at once appreciated.

Of recent years our knowledge of organic chemistry has increased so rapidly that it might be difficult to know under which registration number to look for some of the organic compounds, and chemists will be thankful to the Central Bureau for giving a list of organic bodies and their registration numbers extending over nearly sixteen pages in double columns and containing some 1800 references.

It may be thought that the mode of using the registration numbers would be very difficult to acquire, but it is surprising how rapidly one becomes accustomed to their employment after a little practice. It cannot be said that the schedules as they now stand are perfect, but when they are revised in 1905 many emendations will doubtless be made.

We must be thankful to the Central Bureau for the care and accuracy with which this volume has been compiled, and we must congratulate chemists on having another instrument of research at their disposal.

HERBERT MCLEOD.

ANOTHER THEORY OF SEX.

Qu'est-ce qui détermine le Sexe? Par le Docteur A. Van Lint, Médecin Assistant à l'Hôpital Saint-Pierre, à Bruxelles. Pp. 77. (Paris: Baillière et Fils, 1902.)

DR. A. VAN LINT has convinced himself of the validity of a somewhat extraordinary new theory as to the determination of sex, which is in some measure a rejuvenescence of Starkweather's. If it is true, it should give pause to virile fathers who wish to have sons, for unless they can secure still more vigorous mates they are sure to have daughters only. The theory is, that the offspring follow the sex of the weaker parent, though, as we read on, this turns out to mean the parent whose available germ-cells are relatively less vigorous at the time of fertilisation. But an attempt to estimate the relative vigour of germ-cells leads us into the region of the unverifiable.

To understand the author aright we must note that he does not believe in the concept of the germ-plasm ("pour nous, les cellules génitales se développent tout entières aux dépens des cellules somatiques," p. 34), and that he postulates the origin of the unisexual organism from primitive hermaphroditism, a tendency to which always persists in more or less subtle guise. We cannot within our limits argue about these postulates, but we cannot agree with either. It is very interesting to compare van Lint's views with those stated by Dr. John Beard in his paper on the determination of sex, also published this year.

Van Lint's new theory is a coordination of five hypotheses, which he expounds in a lucid and suggestive manner:—(1) The ovum and the spermatozoon are anti-thetic, expressing opposite extremes of cellular differentiation, and perhaps analogous to right-handed and

left-handed crystals of the same stuff. (2) There is also a somatic antithesis between the masculine body and the feminine body, often conspicuous in the so-called secondary sex-characters, often inconspicuously expressed in minute contrasts which saturate the whole soma. (3) Again, there is an antithesis between the character of the germ-cells borne by an individual and the character of the body of that individual; they are complementary expressions of the primitive hermaphroditic unity of the organism; indeed, the characters of the sex suppressed in the development of the unisexual gonads are expressed, as it were, in pervasive influence on the soma. (4) So strong is this third antithesis that the male's somatic cells—which the author in a question-begging term calls "parovules"—may be regarded as sexually equivalent to ova; while the female's somatic cells—which the author in another question-begging term calls "paraspermatozoides"—may be regarded as sexually equivalent to spermatozoa. This seems an extravagant and unwarranted hypothesis, and we are quite unconvinced by the facts as to effects of castration, &c., adduced in support of it. But to continue. (5) The properties of the "sexualised" body react on the properties of the germ-cells, in embryonic as well as in adult life, and this in such a definite way that they determine the sexual bias, or the sex of the offspring into which the germ-cells will develop. In short, the sex of the offspring depends on the relative bodily vigour of the parents.

Thus, if a relatively feeble ovum be fertilised by a relatively vigorous spermatozoon, the spermatozoon's qualities will be dominant; the embryo will therefore have (by hypothesis) a masculine or "paraspermatozoid" body, and to balance this the gonads will be female. One naturally wishes to know what the relative vigour of a cell means, and this is discussed in chapter v.; one also wishes to know how the vital force of a parent is measured, and chapter vi. gives the six heads of a complete medical examination. We are relieved to find, however, that the certain sign that a man is more vigorous than his wife is his having a daughter. "Le sexe de l'enfant tranchera la question." Could there be a more conclusive criterion?

In the seventh chapter it is shown that the author's theory fits in well with the phenomena of "crossed inheritance." The son is the result of a more vigorous ovum fertilised by a less vigorous spermatozoon; the somatic cells must balance the gonads, therefore they must be feminine, and, of course, the boy is the image of his mother. Could anything be simpler?

In the eighth chapter the author seeks to show with great ingenuity that the available statistical and experimental results on this difficult subject may be harmonised with his views, and concludes by showing that the so-called auto-regulation of the proportions of the sexes is also explicable on his theory, according to which it is always the more feeble that Nature insists on replacing. If we had space at our disposal we should be delighted to disagree with the ingenious author in regard to the detailed facts, but it would be of little avail since we cannot admit his postulates. The moral of the book seems good—that the strong man who wishes to have sons must find a still stronger mate; but it also follows, unfortunately, that the weak woman who does not wish

to have daughters has no resource but to find a still weaker husband. The thesis, if accepted, should beget humility in those male parents who have large families of lusty sons.

J. A. T.

RÖNTGEN RAYS IN MEDICINE AND SURGERY.

The Röntgen Rays in Medicine and Surgery as an Aid in Diagnosis and as a Therapeutic Agent. By Francis H. Williams, M.D. (Harvard). Pp. xxxii+704; 401 illustrations. Second edition, with appendix. (New York: The Macmillan Company; London: Macmillan and Co., Ltd.) Price 25s. net.

THE second edition of this excellent work was called for because the first was unexpectedly exhausted within three months, and we congratulate the author upon his deserved success. Only those acquainted with the subject can appreciate how difficult it is for any author to give a correct view of the progress of such a branch of science as the X-rays, because of the great advances made within a comparatively short period, the number of authors engaged in research and the nature of the subject itself. As might have been expected, Dr. Williams fully understands this, because in his preface he states that the work is rather a report of progress than a final presentation of a growing subject. Further, owing to the short time at his disposal for the preparation of a second edition, he has only been able to add some forty pages, chiefly on apparatus and the therapeutic uses of the X-rays. This will be found in the appendix.

Dr. Williams very properly introduces his subject by reference to the principles of physical science, and, without overburdening the student, he tells what is necessary for their appreciation. Next he deals in the most practical way with the equipment necessary for photographic and therapeutic work. Having thus prepared the way, he enters into a full description of the normal conditions of the cavities of the body so that the observer may be able to appreciate deviations from the normal, a principle which will be thoroughly appreciated by all those who are seeking for information from the clinical aspect. The pathological changes are well described by photographic illustrations, diagrams and histories of selected cases.

A noticeable feature of the work is the amount of attention devoted to what might be called the medical aspect of the subject as opposed to the surgical. This is interesting, because for a long time many who believed in the value of X-rays in the detection of fractures, dislocations of the hard structures and foreign bodies were inclined to think that the use of X-rays would be limited to these. If any are still of this opinion we commend them to a perusal of this work.

The third great step in the development of X-rays in medicine was their application in diseased structures, and the present position of their therapeutic action is frankly and fairly stated in these pages.

While it is true that the work gives a very strong representation of the methods employed in America—indeed, the illustrations themselves show that the work has not been produced in any European laboratory—still

the labours of others have not been neglected. In future editions the work might be enhanced in value by a reference to what has been done in this country and the European schools of medicine, a fact which is admitted by the author in his preface, because he states that he had intended to include as complete a list as possible of the publications on the subject. This was not found possible on account of its extent, so he adds that had he foreseen this he would have referred in the text to many other important papers.

The work is well written by one thoroughly familiar with the subject, is profusely illustrated, and to those who desire a guide to the study of the subject the work may be thoroughly recommended; and this remark applies to students and practitioners.

OUR BOOK SHELF.

Elementary Geometry. By W. C. Fletcher, M.A., Head Master of the Liverpool Institute; late Fellow of St. John's College, Cambridge. Pp. 80. (London: Edward Arnold, n.d.) Price 1s. 6d.

THIS is a very small book and a very good one. Its object is to teach geometry to boys without hindering and wearying them with metaphysical subtleties, or requiring them to express the proofs of propositions with that pedantic recitation of details—that parody of logical accuracy—which has long been identified with the study of Euclid.

The author is perfectly correct when he says that his little book "contains the whole substance of Euclid i.-iv. and vi. except the elegant but unimportant proposition, iv. 10."

The branches of the subject are taken in the following order:—Angles, triangulation (*i.e.* the discussion of the properties of triangles), quadrilaterals, loci, proportionals, circles, tangents, areas, maxima and minima, this last section being very short and merely illustrating what is meant by a maximum or a minimum. There is no formality whatever in the proofs, the most simple propositions being often left to the student with a hint sufficient for the solution. Each section, besides terminating with a number of simple exercises (well within the power of the beginner), contains a number of numerical illustrations to be worked by actual drawing with instruments. This is precisely the kind of teaching which is now being advocated by those who have taken up the question of the reform of mathematical teaching.

In propositions relating to proportion—as, for example, that a line drawn parallel to the base of a triangle divides the sides in the same ratio—the author explicitly states that he assumes two magnitudes to have a common measure, and that the difficulty which arises in the case in which they have not "had better be disregarded for the present." The reason for thus making an *essential* difference between "commensurable" and "incommensurable" quantities of the same kind is not obvious, since any proposition which holds for the former will be admitted, even by the beginner, to hold for the latter when it is pointed out that the unit magnitude may be taken so small that the distinction between commensurable and incommensurable quantities practically disappears. The proposition that the sum of two sides of a triangle is greater than the third is proved by the definition of a right line as the shortest distance between two points. The nature of a tangent as the limiting position of a chord is that which the author adopts. This also is in accordance with modern notions, and it offers no difficulty whatever even to the merest beginner. In p. 42, line 4, for "place them so that two pairs of sides are parallel,"

read "place them so that any two corresponding sides are parallel." In p. 63, ex. 19, for "prove also that OT, ON equal OP²" read "prove also that OT.ON equals OP²."

Diagrams of Mean Velocity of Uniform Motion of Water in open Channels, based on the Formula of Ganguillet and Kutter. By Prof. Irving P. Church. 11 Diagrams + 1 page Text. (New York: Wiley and Sons; London: Chapman and Hall, Ltd., 1902.)

THIS little work, in spite of its ponderous and somewhat ambiguous title, is a useful and workmanlike collection of curves from which may be obtained the value of the mean velocity v in the empirical formula $v = c\sqrt{rs}$, so much used in computing the flow of water in channels.

To the ordinary reader the term "mean velocity of uniform motion" is puzzling; but anyone versed in hydraulics will understand that the author wishes, very properly, to restrict the application of his curves to cases where the rate of flow is constant, *i.e.* where the same number of cubic feet or gallons pass a given section of a channel of uniform cross-section every second.

In the formula the trouble is with the coefficient c , which is not independent of r and s —the hydraulic mean depth or "hydraulic radius" and the slope. The coefficient may be computed, for channels of different materials, from well-planned timber to earth and stones, by the formidable law of Ganguillet and Kutter,

$$c = \frac{1.4866 + 41.65 \frac{0.00281}{s}}{1 + \frac{n}{\sqrt{s}} \left(41.65 + \frac{0.00281}{s} \right)}$$

where n is the arbitrary constant which ranges in value from 0.009 to 0.035 in the two extreme cases cited.

Very few people, we imagine, actually calculate c in this way, as tables by Trautwine and others give its value for all likely values of n , r and s . Prof. Church has, however, gone a step further, and his diagrams give values, *not* of c , but of v , thus avoiding the further calculation usual after c is found from tables.

There are eleven diagrams, each corresponding to a particular value of n , the vertical lines in each diagram showing "slopes," inclined lines "hydraulic radii," and horizontal lines "mean velocity" v . The intersection of any three of these lines satisfies the relations referred to, and shows for the selected values of n , r and s the required mean velocity in feet per second, which, multiplied by the cross-sectional area of the channel in square feet, gives the flow in cubic feet per second.

A test or two, worked out from the formulæ, shows the curves to be accurate enough for practical purposes.

Thus, selecting $n = .01$, $r = 10$, $s = 2.0 \div 1000$, the calculation gives

$$c = \frac{1.4866 + 41.65 \frac{0.00281}{0.002}}{1 + \frac{.01}{\sqrt{10}} \left(41.65 + \frac{0.00281}{0.002} \right)} = \frac{224.155}{1.136} = 197.3$$

and

$$v = 197.3 \sqrt{10 \times .002} = 27.89 \text{ feet per second.}$$

The diagram gives v about 28.

In another test where $n = .03$, $r = 10$, $s = 2.0 \div 1000$, the diagram gives v about 10.5; calculation makes it 10.38.

There is no doubt, therefore, that Prof. Church has compiled a real "labour-saver" for those who have to make numerous calculations of the kind referred to.

Near the end of the author's explanation he mentions the application of the diagrams to cylindrical pipes and sewers "running full or half-full." We would point out that the rule $v = c\sqrt{rs}$ is not applicable with success to pipes running full, though various American writers

attempt to use the law in this sort of universal sense. Much more authentic formulæ are available for calculating the flow in pipes, and the curves given in this little work should not be applied to that purpose. R. G. B.

A First Course of Chemistry (Heuristic). By J. H. Leonard, B.Sc. Pp. vi + 134. (London: John Murray, 1902). Price 1s. 6d.

THIS little work provides a course of elementary chemistry resembling the well-known course which was drawn up some years ago by Prof. Armstrong and endorsed by a British Association committee. Great pains are taken to make the teaching undogmatic and to imbue the pupil with the zeal of a scientific inquirer. The topics include a study of chalk, lime and carbonic acid, air, water, combustion, acids and salts. Though the work cannot be pronounced superior to some that have already been written with the same object, it gives a good representation of what many people now think the right way of approaching elementary chemistry. On any system the teaching of elementary chemistry will for long remain full of difficulties and inconveniences. We notice that on p. 43 there is an instruction to collect oxygen by displacing air in an inverted cylinder, and on the next page an experiment, correctly enough described, perhaps, leading to the conclusion that oxygen is lighter than air. A. S.

An Elementary Book on Electricity and Magnetism and their Applications. By Profs. D. C. Jackson, C.E., and J. P. Jackson, M.E. Pp. xi + 482. (New York: the Macmillan Company; London: Macmillan and Co., Ltd., 1902.) Price 7s. 6d.

THE object of the authors has been to write a book which will serve both as an elementary text-book and as an interesting account of the subject for the general reader who has a taste for the science. With this in view they have naturally taken industrial development as a guide, and wherever possible have shown the connection between the simple principles of the science and their technical applications. As the general reader is usually ill-equipped with mathematics, we find that little more than the simplest equation is used in the book.

Each chapter is followed by questions. Here are some of the questions which come at the end of the first chapter:—

"How much is known about the real constitution of electricity?"

"What is electricity supposed to be by some scientists?"

"What kind of electricity will a positively charged ball induce?"

The book contains twenty-three chapters, and from chapter xv. to the end the subject-matter is principally technical applications. Thus polyphase motors, electric welding, cooking and Röntgen rays, and other new uses are each described in their appropriate chapters. S. S.

The Face of Nature. By the Rev. C. T. Ovenden, D.D. Pp. ix + 188. (London: John Murray.) Price 2s.

IN this little volume we have the material for several "popular readings in elementary science," the subjects of the four chapters being weather forecasting, vegetable life, the record of the rocks, and stones from boulder clay. The village clergyman or teacher who desires to show that there are "sermons in stones" and other natural objects and phenomena will find Canon Ovenden's short addresses of service.

A few points will, we think, lead to misconception if accepted as they now stand. For instance, a barometer is said to weigh the air, whereas it really measures pressure. Again, it is only true in the northern hemisphere that a "cyclone spins always against the hands of a clock, and the anticyclone rotates with the hands of the clock."

In the chapter on plants, roots are said "to suck up water through tiny mouths," "to search for lime salts," and "to pick up compounds of potash." Of some plants we read, "They determined to do by cunning what they could not accomplish by force," "One very clever tree seems to have foreseen this danger and provided a remedy." "The hazel never intended to grow nuts either for boys or squirrels." "The pitcher plant and Venus's fly trap which set most ingenious snares for insects, and devour them when caught."

The point of view of the whole of this chapter is unscientific, for plants do not do any of these things intentionally, and to attribute intelligence to them is misleading.

The illustrations are line drawings enclosed in circles for reproduction as lantern slides. In many cases a scale should have been provided. The diagram of a bean seed (p. 49) is very poor.

Gold Seeking in South Africa: a Handbook of Hints for intending Explorers, Prospectors and Settlers. With a chapter on the Agricultural Prospects of South Africa. By Theo Kassner. Pp. x + 134; with maps and illustrations. (London: Charles Griffin and Co., Ltd., 1902.) Price 4s. 6d.

Now that a new era is opening in South Africa, the appearance of any book giving information likely to be useful to intending immigrants is opportune. It will not be taken for granted by everyone that the last discoveries of gold in the Transvaal have already been made, and the venturesome prospectors who go there should include this little book in their outfit, as it is written by one who knows the country well. It contains some useful notes on the geology and history of the Transvaal goldfields, and a number of sketch maps. The De Kaap goldfield is treated somewhat more at length than the others, although even this account can hardly be called exhaustive. The illustrations are numerous, but a protest must be made against the inclusion of some of them, particularly of Fig. 6, which is said to represent a pestle and mortar.

A Text-Book of Inorganic Chemistry. By Dr. A. F. Holleman. Rendered into English by Hermon C. Cooper. Pp. viii + 458. (New York: John Wiley and Sons; London: Chapman and Hall, Ltd., 1902.) Price 10s. 6d.

THE German edition of this Dutch work was noticed in NATURE, vol. lxxi. p. 598, October 18, 1900. A reperusal shows that considerable improvements have been made in the English version. The translation is entirely satisfactory, and the book may be recommended as a lucid and scientific account of inorganic chemistry. It includes a great deal of well-expounded physical chemistry and also many incidental matters of interest that are not usually found in works on inorganic chemistry. It is likely to prove very acceptable to those who wish to have a moderately advanced book of inorganic chemistry embodying an unaggressive presentation of the most modern discoveries and theories.

The Bernese Oberland. By G. Hasler. Vol. i. From the Gemmi to the Mönchjoch. Pp. xxv + 164. (London: T. Fisher Unwin, 1902.) Price 10s.

THIS is the first volume of a series of four intended to guide climbers to the peaks and passes of the High Alps of the Bernese Oberland. The routes are arranged in chronological order of the conquest of the peaks to which they lead, and are dealt with in six sections referring to the Balmhorn, Breithorn, Blümlisalp, Bietschhorn, Aletschhorn and Jungfrau groups. With this guide in his pocket, a climber will be able to explore districts which, happily, have not been entirely permeated by the show and tourist spirit characteristic of more frequented spots, and are full of interest.

NO. 1714, VOL. 66]

LETTERS TO THE EDITOR.

[The Editor does not hold himself responsible for opinions expressed by his correspondents. Neither can he undertake to return, or to correspond with the writers of, rejected manuscripts intended for this or any other part of NATURE. No notice is taken of anonymous communications.]

Archæological Remains on the Summit of the Nevado de Chañi.

DURING the excursions that were made under my direction in 1901-1902 in the north of Argentina and the south of Bolivia from the Puna de Atacama to Crevaux at Pilcomayo, some of my comrades climbed to the top of Nevado de Chañi about 6100 metres in Puna de Jujuj.

Two ascents were made, the first by Count Eric von Rosen, the second by Dr. R. Fries, Mr. G. von Hofsten and Mr. Wenceslao Mercado. Von Rosen ascended quite near to the top, the others reached it. The summit is of granite; on the north-west side the rock is sandstone.

Dr. Fries made botanical collections. On the top he found lichens. The microscopical life of the snow was poor. The snow line was about 5600 metres. On the side of the mountain there are remains of old houses. On the top there are small walls, and there Hofsten and Fries found pieces of pottery, a little green stone worked by man, a depot of wood of cactus, tola, &c. The walls were built in two small squares with one side open. One of the pieces of pottery was painted with a wedge-shaped (kilformigt) ornament, quite similar to ornaments found by Count von Rosen on pottery from Ojo de Agua, a pre-Columbian "pueblo" in the Quebrada del Toro, some miles to the south. The wood was found both inside and outside of the walls and very well preserved; probably this may be explained from the fact that at this height there are no, or few, microbes. Also in the Puna about 3500 metres above the sea in the pre-Columbian grave-fields, there are still preserved pieces of clothes, skins, instruments of wood, &c.

It seems to me probable that these small walls on the top of the Chañi are the remains of an old sacrifice or signal place from pre-Columbian time.

Dalbyo, August 14.

ERLAND NORDENSKIÖLD.

↓ Radiant Point of the Perseids.

YESTERDAY morning, August 11, I watched the northern sky for shooting stars from a place near Baddeck, Nova Scotia, from oh. 30m. to 2h. 15m. (Atlantic time). During this period I observed forty-nine meteors—mostly faint—forty-one of which appeared to radiate from the constellation Perseus.

While trying to locate the radiant point, I noticed a speck of light flash out in Perseus, which died away without apparent change of position, as though a third-magnitude star had suddenly appeared and disappeared. This was probably due to a meteor advancing directly in the line of sight, in which case the location of the luminous point perceived may be of importance to astronomers, as an indication of the radiant point of the Perseids.

The right ascension was about 2h. 35m., declination +56°, as nearly as I can make out from a star chart. I may say frankly, however, that I am not accustomed to make observations of astronomical positions. I can point out the exact position in the sky, and would be very glad if some of my astronomical friends would care to verify the R.A. and Decl.

I may add that the paths of most of the Perseids observed seemed to intersect at or near the point where the stationary meteor appeared.

Baddeck, N.S., August 12.

ALEXANDER GRAHAM BELL.

Earth Surface Vibrations.

IN NATURE for August 14, Mr. Charles Stewart writes from the Cape stating that exceptionally rapid barometric variations took place there on the morning of May 28. Mr. Hill states in the same number of NATURE that on the morning of May 8, Mr. Ferdinand Clerc, at St. Pierre, "observed the needle of a large aneroid barometer pulsating violently."

The two similar barometric movements at different places suggest that the air disturbances at St. Pierre did not cause the barometric movement there.

Mr. Stewart assumes there was an earthquake at the Cape for the reasons he gives. But the Royal Observatory showed no record of any seismic disturbance.

If the earth movement took place at the Cape as an absolutely perpendicular vibration, would the seismograph have recorded it?

Can sudden and abnormal change in atmospheric pressure cause volcanic or other disturbance on the earth?

August 19. F. C. CONSTABLE.

IN NATURE, August 14, p. 371, it is stated that "at 7 o'clock on the morning of May 8, Mr. Ferdinand Clerc observed the needle of a large aneroid barometer pulsating violently." Above this there is, however, another note which says that "nothing unusual was observed in the barometer." But even supposing barometric perturbations to have taken place on May 8 in St. Pierre, what connection could these have had with phenomena which happened twenty days later at the Cape of Good Hope?

The Milne horizontal pendulum installed at this latter place will record disturbances originating at its antipodes, but will not respond to the rapid elastic vibrations of local shocks. You may hear seismic sounds, windows and doors may rattle, but the instrument in question will remain at rest.

The movement of an earth particle at the time of an earthquake is in all azimuths and at varying angles with the horizon. A strictly perpendicular movement seems an impossibility.

Abnormal changes in atmospheric pressure may act on a region in a state of excessive seismic or volcanic strain much in the same way as the last straw is said to act upon the camel's back; the relationship, however, is far from being pronounced.

This and other questions referred to by Mr. Constable are discussed in the volumes on "Seismology" and "Earthquakes" published in the International Scientific Series.

J. M.

August 26.

Larva Stage of *Heliocoprís* *Isidis*.

IN the month of March last, I discovered at a depth of a few cm., among the roots of the tree *Albizia lebbek*, several large balls of earth, varying in diameter from 5.0 to 8.5 cm. These on being broken open were found to be hollow spheres, the thickness of the wall being about 1.5 cm. This wall was composed of concentric layers of mud and bits of vegetable matter mixed, having the composition and appearance of native unburnt bricks.

Inside the sphere was a coleopterous larva about 2.0 cm. in diameter at its thickest part, about 9.0 cm. in length measured along the dorsal line, and about half that length measured along the ventral line; the larva lay on its side and assumed a curved position. A few days ago, an imago of *Heliocoprís Isidis* emerged from one of the balls by boring a hole in the roof of its cell just large enough for it to pass through.

If any of these facts are new in the life-history of this beetle, they might interest your readers.

FRED. FLETCHER.

School of Agriculture, Ghizeh, Egypt, August 14.

THE LAVA-LAKE OF KILAUEA.

THE recent destructive eruption in Martinique has revived interest in the question of the causes of volcanic action. Only lately have I become sensible of the peculiar value of some observations of my own as evidence of the primary force which impels the ascent of lava from its interior habitat, as distinguished from the explosive violence caused by steam generated by the encounter of the ascending lava with ocean and other surface waters.

I have long believed the primary force to reside in the expansion of the gases originally occluded in the magma, ever since its first condensation from the nebula.

Whenever released from solidifying pressure by disturbances of the superincumbent crust, the intensely hot magma bursts into a viscid foam and pushes upwards. In a quiet volcano like our Kilauea, meeting no water to generate explosive steam, the lava wells up continuously and steadily in a comparatively gentle fountain, which displays effervescence only on the surface.

In support of this opinion I beg to offer positive evidence contained in certain facts observed by myself in Kilauea during April 8-14, 1892, and on August 28, 1894. The volcano had been in very steady and uniform action for nearly two years before the earlier date, and so continued until a short time after the latter date, or nearly five years in all of a quiet, continuous and rather copious welling up of lava, wholly unattended by any explosive action.

On the earlier date I carefully observed the then existing lava-lake during six successive days. This lake occupied the centre of the inner crater, called Hale-a-mau-mau, or Fern-hut. The main crater called Kilauea is nine miles in circumference, averaging 400 feet in depth, and rather unevenly floored with recent lava. South-west of the centre is the inner pit of Hale-a-mau-mau. This pit was at that time nearly circular



FIG. 1.—Fire-lake as seen in 1891-2.

and 2400 feet in diameter, with vertical sides averaging 150 feet down to the talus. Before the welling up of lava began in 1890, the pit had been about 700 feet deep. In two years the lava had risen 400 feet, and stood within 300 feet of the rim and main floor.

A lake of liquid lava, covered by a thin, spongy film, occupied the centre of the pit. This lake was nearly circular, averaging 850 feet in diameter. It was bordered by a low dyke, which partially restrained its frequent overflows. Outside of the dyke, freshly congealed lava sloped away to the talus. By day the crust-film was grey to the eye, but by night a deep red. It was traversed by numerous fissures of white fire. During the whole time three fountains of lava were welling up with somewhat regular intermittence, and three smaller ones at irregular intervals. There was no explosive action whatever.

The largest fountain was about 120 feet south-east of the centre of the lake. It played with great regularity about three times in a minute, rising in a round billow 25 feet high and 50 feet in diameter, bursting at the top and falling back to level, its discharge moving in a broad stream towards the centre of the lake. The fling of spray from its summit rose to 40 or 50 feet above the level.

West of this central fountain were two others of very different character, being more spasmodic in activity, but never long quiet. Occasionally they would unite their forces for half an hour at a time, forming a stationary line of 130 feet of spraying billow much like a surf-comber with flying spray. This stationary surf-wave was 15 feet high, incessantly flinging its spray 10 feet higher along its whole length. In the night, the effect of these fountains was extremely brilliant and was attended by loud metallic crashing.

The other three fountains were smaller, near the borders of the lake, and often quiet for hours together.

During the thirty months' interval between my two visits, the gradual elevation of the fire-lake continued quite uniformly, as attested by occasional photographs. By its frequent overflows it had built itself up to a height of fully 50 feet above the previous main floor of Kilauea, so that it formed an extremely low truncated cone, surmounted by the level lake, to the edge of which visitors daily approached.

About March, 1894, a recession began, which ended in

of supply for these five years' outpour of gently effervescing lava was in an interior magma which itself contained the impelling force in its own originally occluded gases. For its activity this source was wholly independent of any encounter with water to generate steam. Expanding steam evidently had no part in that steady, quiet, persistent activity in the fire-lake of Kilauea.

I would add that the exceptionally quiet and uniform activity of Kilauea seems to render it one of the most important of all volcanoes for study. I regret to say that since the collapse nearly eight years ago no lava has appeared in the crater, except a small quantity last June, which has again gone out of sight.

Having seen no European notice of the fact, I would report that twelve days after the Martinique eruption very vivid afterglows appeared here, about as bright as those seen here after the first two weeks of the Krakatoa glows in September, 1883. They have not yet wholly disappeared. The solar corona, or "Bishop's Ring," is still conspicuous. It is worth stating that the Krakatoa glows reached Honolulu in ten days, coming twice the distance of the Martinique glows in twelve days.

S. E. BISHOP.

Honolulu, July 31.

THE INFLUENCE OF EDUCATION UPON TRADE AND INDUSTRY.

A SHORT time ago the Technical Education Board of the London County Council appointed a sub-committee to report upon the "application of science to industry." The witnesses called before the committee were leaders of science and employers in various branches of industry. Dealing first with the loss of industries to the country, during the last twenty or thirty years, the committee points out that all the witnesses were practically agreed in considering the loss sustained to be due to deficiencies of our educational system. It is not so much the training of the workmen which is at fault; they even con-

sider that the opportunities open to the London workman for obtaining technical education are superior to those enjoyed by workmen abroad. It is the want of highly trained men of science who are able to undertake research work. Prof. Dewar says he knows of no firm in England where chemists are employed in research work, while in Germany a large firm will employ a number of men for research only, who will have no connection with the business or managerial part of the works.

The causes which have operated to keep manufacturers from taking highly trained men into their works are twofold. In the first place, generally speaking, the men who have been employed as scientific experts have had a wholly inadequate training, but have often the idea, as Mr. Beilby says, that they have "nothing to learn and everything to teach." In the second place, the manufacturer is often afraid that they may learn something. He may be willing to take all they can give him, but he will not let them learn the details of the process which he desires to have improved—details which are not to be found in text-books. There is also the lack of scientific training of the manufacturers themselves, and their consequent inability to recognise the importance of scientific assistance.

With reference to our secondary education, Prof. G.



FIG. 2.—Fire-lake as seen in 1892-3. Lake gradually rose so as to overtop the rim of the pit, more than 50 feet in 1894, but all the time keeping its position and limits.

a final collapse of activity. The lake soon sank some hundreds of feet, carrying with it the sides of a circular pit, about 1400 feet in diameter, and central to the original 2400-foot pit. When I saw it in the following September, the fire-lake was not less than 500 feet below the rim. During the evening, masses of rock frequently crashed in, driving heavy surges of fire far up the talus. There was a good deal of steam-cloud slowly rising, charged with sulphur. During my previous visit, all vapour had seemed to be absent, and I made the circuit of the pit without encountering sulphur. Subsequent photographs had also indicated the absence of vapour from the lake.

I now have to add an important observation. To my great surprise, at this last visit, I perceived that the three fountains above described were in full activity and in the same relative position as before, although during the thirty months the level of the lake had risen 350 feet and had then fallen 500 feet. By what system of supply-ducts such fountains had been so long maintained was a mystery concealed in the fire-depths. But the fact of a marvellous steadiness and uniformity of action was obvious. For a long period a uniform and gentle outpour of effervescence had been maintained. It had persisted for two years and a half, throughout all the immense changes.

I submit as the unavoidable conclusion that the source

Lunge observes that in our grammar schools the faculty of observation is too little developed, and that mathematics, drawing and modern languages should be more thoroughly taught. "At present there is no time for this, because far too much time and interest are devoted to athletics. The idea that secondary education should mainly aim at breeding manly characters is very fine, but the hardly veiled contempt of positive knowledge which this implies causes much mischief, and this is, of course, much worse if you substitute 'gentlemanly' for 'manly'." The committee is convinced that scientific industries have suffered, not only through defects in higher scientific education, but to an even greater extent through defects in general secondary education. Mr. Levinstein, in his presidential address to the Society of Chemical Industry at Liverpool, also refers to our want of a sound system of secondary education; he considers that our primary education is fairly good, but what we require is "general non-specialised secondary education." Those engaged in the educational profession must surely have had it forced upon them that the crying need of the country is specialisation; but it is useless, and worse than useless, to attempt to specialise without first having the sound foundation of a thorough general education.

Dr. Merz thinks that science teachers in secondary and public schools are not of a sufficiently high standard as compared with the teachers abroad. They have too little time for improving their knowledge by further study, the result being that they soon become disciplinarians only instead of men of science. Our teachers often seem unable to instil the love of science into their students, who lack the enthusiasm which exists abroad, and may almost be compared to the tradition which is found in our public school life here. How often one hears a graduate say, "Ah! that's finished; I ground up science for my degree, but I shall drop it now." To such men the degree is a qualification and that is all.

In referring to the London polytechnics, the committee recognises the difficulties under which the heads of departments labour if they desire to carry on research. They are understaffed and underpaid, and almost the whole of their time is taken up in teaching or in superintending the teaching of all branches of their subject. It might here be pointed out that in many cases the governors of the institutes, with the exception of those appointed by the Technical Education Board, have absolutely no idea what research means, and strongly object to chemists and others taking up expert work whereby they would obtain an insight into the technical side of their subject, which otherwise it is almost impossible for them to do.

A generation ago the bulk of the manufacture of fine glass for scientific and optical purposes was in English hands. Now it is almost entirely in the hands of Germans. "German chemists have succeeded in introducing such modifications in the manufacture of optical glass that opticians have been enabled to place on the market lenses approaching more closely to mathematical perfection than any previously manufactured in this country." Mr. Conrad Beck says, "there is no place in the whole of England where a man can learn optics in a way that is of any use to him for practical application to optical instrument making. . . . It is a positive fact that if I desire to employ a mathematician to work out my lenses, I cannot find any ready-made man in England." The German Government has not only endowed institutes where optics, among other subjects, is taught in a practical way, but has granted large sums of money "by which costly experiments on a manufacturing scale have been rendered possible."

Mr. Levinstein's presidential address to the Society of Chemical Industry has already been mentioned, and perhaps a short notice of some of the points in it may be of interest.

In directing attention to the unsatisfactory condition of our trade, he points out that in 1890 our total exports amounted to 328 million pounds. The average amount during the decade 1891-1900 was only 300 millions. That is to say, during these ten years we exported 280 million pounds' worth of goods less than we should have done if the figures for 1890 had been maintained. With Germany it is otherwise; in 1890 the total exports amounted to 3,409 million marks, while the average for 1891-1900 was 3688 million marks. Germany has gone forward, we have gone back; this can hardly be called satisfactory. Mr. Levinstein suggests the following as some of the reasons why Germany has advanced so markedly:—

- (1) Superior economy, thoroughness, *attention to detail*.
- (2) The possession of a far larger number of thoroughly and systematically trained men than any other country (not men only trained technically, but with a thorough *general training*).
- (3) A close alliance of legislation and of science with the interests of trade and industry—a result no doubt indirectly due to the high average of general education and training.
- (4) A national system of railways and canals, with a scale of internal and external freights averaging less than one-third of our own.
- (5) Cheaper skilled labour, *with longer hours than our own*.¹
- (6) A large supply of unskilled labourers, trained to habits of punctuality and discipline through a system of universal military service.
- (7) Protective tariffs.
- (8) A system of patent laws which takes the interests of the public as well as those of the inventor into consideration.

Some of these conditions obviously could not be introduced into this country, but Mr. Levinstein suggests the following four measures which he considers require immediate attention:—

- (a) The appointment of a competent and expert Minister of Commerce.
- (b) The nationalisation and extension of our canals and waterways.
- (c) A measure for greatly extending and improving our secondary education.
- (d) A sensible reform of our patent laws.

It does seem an anomaly that a commercial empire such as ours should be without a Minister of Commerce. The Board of Trade is so tied up with red tape and so steeped in routine that deputations upon trade and commerce often receive but scant attention, and have to be content with hazy assurances of good will which are often forgotten almost as soon as uttered.

Mr. Levinstein pays considerable attention to the question of freights. In France and Germany, the combined network of railways and canals enables merchandise to be carried at extremely low rates. Undoubtedly our railway companies might learn a good deal from America as to the handling and haulage of goods, by which means very considerable savings in the cost of transport could be made. But owing to the enormous cost of construction and over-capitalisation of our railways, even if all possible improvements were introduced and the boards of directors were business men and not appointed because of their social position, we could not compete on level terms with other nations. But how about our 4000 miles of canals? For years they have hardly been used at all, and many of them have become antiquated and are almost, if not quite, ruined. In contradistinction to our want of forethought, France, Belgium and Germany have been continually increasing and improving their canal system, and America, that land of restless energy, is building canals. Before the opening of the Erie Canal the cost of moving one ton of freight from Buffalo to Albany was 100 dollars; on the opening of the canal this immediately

¹ The tendency here seems to be a general shortening of hours and extra holidays to watch others playing games.

fell to 10 dollars. At present the cost of moving merchandise by canal from Buffalo to New York, a distance of 500 miles, does not, on the average, exceed one dollar, or four shillings per ton.

European States are devoting millions of money annually to the construction of canals and canalised rivers, with the result that it costs less to-day to bring sugar from Hungary, thousands of miles across Europe, to London than to carry the same sugar on our own railways from London to Manchester. Goods which can be carried from Hamburg to Berlin, a distance of 174 miles, at four shillings per ton cost eight shillings and fourpence per ton from Manchester to Liverpool, a distance of 30 miles. Cattle can be sent at less cost from Chicago to Liverpool (about 4000 miles) than from Northumberland to Liverpool. It costs more to send one ton of goods from London to the west of Ireland than from London to Japan. Denmark can send her dairy and farm produce to London at less cost for transport than can the English farmer living only 30 miles away in the home counties.

Mr. Levinstein calls for a reform of the patent laws. He attributes, as do many of the witnesses examined by the committee of the Technical Education Board, much of the success of the German manufacturer to the excellent and protective patent laws, which have been in operation since 1876. Yet though our patent laws leave very much to be desired, they do not directly, as Prof. Meldola points out, prevent discovery or originality. Indirectly they may do so, because if a man feels that his invention is not properly protected, he may give up working in disgust. In order that a patent may be valid in Germany, it is necessary that the article patented should be manufactured in Germany. We have no similar provision. It pays an inventor to manufacture in Germany and export to England better than to build extra works here, where British labour would be employed.

Admitting, however, that our patent laws are bad, our manufacturers narrow-minded and unscientific and our business methods lacking in enterprise, and that therefore we are, if not absolutely falling behind, barely holding our own in the markets of the world, we always come back to the fact, if we will but admit it, that all these causes may directly or indirectly be traced to our educational system or want of system.

The report of the Technical Education Board is so valuable that I should like to suggest that the County Council publish a digest of it in pamphlet form and circulate it among manufacturers in London. This may seem a rather large order, but how otherwise are these men, upon whom so much depends, to be reached?

F. MOLLWO PERKIN.

BIRD-PHOTOGRAPHY IN THE GARDEN.¹

ALTHOUGH he disclaims the title of naturalist and states that he knows nothing of photography, the author has contrived to produce a very entertaining little work, illustrated by reproductions from photographs which we have seldom seen equalled and rarely surpassed. They are, in fact—especially the full-page plates—ideal representations of the birds they portray, and ought to tempt the amateur photographer to try to do likewise—if he can. The object of the volume, like so many others at the present day, is to show the outdoor naturalist and bird-lover how full an insight he can obtain of the life-history and habits of his feathered favourites by portraying them in their natural haunts and surroundings. And with this end in view, he describes in some detail the type of camera and plates best suited

¹ "Birds in the Garden." By G. Sharp. Pp. xi + 190; illustrated. (London: J. M. Dent and Co., 1902.)

for the purpose, and the mode of using them. His main difficulty appears to be to find a "shutter" which shall be sufficiently rapid in action, and at the same time not frighten the bird as it falls.

As the title implies, the author, in place of wandering far afield, has been content with the birds commonly met with in any English country garden, and he shows how much may be learnt that is more or less new even with regard to familiar species. Perhaps he would have been better advised had he refrained from saying that our knowledge of bird-anatomy is such that work is no longer needed in that branch of ornithology. Indeed, it is a great pity that field-naturalists and museum-workers are constantly in the habit of belittling one another's efforts; each has his appointed place, and the work of the one cannot be completed without that of the other.

The author restricts himself to ten species, five of which are tits, and he has something interesting to say



FIG. 1.—Robin Pausing at Food. (From "Birds in the Garden.")

about each. If we were asked to select the two best illustrations in a work in which all the pictures are charming, we should choose the page-plates of the pied flycatcher and redbreast. We reproduce one of the text-figures.

R. L.

A NEW THEORY OF THE TIDES OF TERRESTRIAL OCEANS.

MR. ROLLIN HARRIS has done so much good work in preparing his "Manual of Tides" for the United States Coast Survey that it is an ungrateful task to find oneself constrained to criticise adversely his recently published part iv. A. of that treatise.¹

I shall pass over many points of interest which occur in the earlier portions of the book, because the discussion of them is apparently designed to lead up to a new theory of oceanic tides. That theory, to which I shall confine my attention, depends on a proposition that it is possible to dissect our oceans into a number of basins in which the oscillations are virtually independent of one another and are almost unaffected by the diurnal rotation of the earth.

We may, then, pass at once to chapter vii., where Mr. Harris considers forced oscillations in tanks, as impeded by friction. The waves are treated as long waves in which the water in any vertical slice always remains vertical, and the friction is assumed to be proportional to the velocity of the slice. These assumptions are open to criticism, but I will follow Mr. Harris in supposing that

¹ Reports of the U.S. Coast Survey. Parts i., ii., Appendices 8, 9, Report for 1867. Part iii., Appendix 7, Report for 1894. Part iv. A., Appendix 7, Report for 1900.

the physical conditions are adequately represented in this way.

He desires to find a solution when the period of the external disturbing force is the same as that of a free standing oscillation of the type of a seiche in a lake. For a seiche with a single central node the length of the tank must be equal to half the distance traversed by a long wave in the period of the external force. Thus the size of the tank is determined by the period of the external force and by the depth of the water. In the detailed treatment of the problem the depth is supposed to be uniform. Mr. Harris writes his equation of motion in the form of an equation of virtual work; he reverses the forces of inertia, adds them to the impressed forces and equates the virtual work to zero. Lagrange made the displacements arbitrary, and thus his equation of virtual work was exactly equivalent to as many differential equations of motion as there were variables; but Mr. Harris takes the displacements as proportional to the actual displacements per unit time and obtains a single equation. This is permissible, but the result cannot be anything but an equation of energy. I am unable to see any advantage in this procedure. He then assumes that the type of oscillation will be the same as in free oscillations, but this is surely a quite unwarrantable assumption. If the periodic forces have the same period as the free oscillation the oscillations will be large, but the type will in general be different. Does not this error vitiate his whole treatment of the problem? However, let us proceed. The type and period being the same as those of a free oscillation in the absence of friction, the periodic sustaining forces must exactly balance the frictions, and the frictional forces are proportional to the velocities. Now the motion being of the same type as in a free oscillation, the displacements are all simple harmonic functions of the time, and at any instant are all in the same phase. Hence the frictional forces, and therefore also the sustaining forces, are all in a phase differing from that of the displacements by a quarter period. Thus all the sustaining forces vanish at the instant when the displacement is a maximum, and we get nothing out of the equation of virtual work but what was put into it by dubious assumptions.¹

As a result of this discussion the following rule (p. 621) is given:—

"Project the force arrow" (of a number of tidal-force diagrams giving the direction and magnitude of the forces at various parts of the basin at successive hours) "belonging to the assumed time in each diagram upon the line of motion passing through it; the aggregate of the elementary masses, each multiplied by the intensity of the tidal force in the direction of the displacement, and again by a quantity proportional to the value of the maximum displacement (since the oscillation is harmonic), must be zero at the time of high and low water. The algebraic sum of these products for any given hour should be plotted as an ordinate at that hour. Where the curve thus constructed crosses the time axis denotes the time of high and low water."

Besides the objection to the proposition raised above in the case of the canal of uniform depth with synchronous disturbing force, I fail to see any adequate consideration of the variability of depth, of the absence of synchronism in the component disturbing force in the direction of the canal, or of the effects of the component transverse to the canal.

But even if it were possible to assent to this rule, it appears to me that there are other still more doubtful assumptions. On p. 624 we read:—

"Considering the actual distribution of land and water,

¹ A considerable portion of this criticism is due to Prof. Love, with whom I have had the advantage of discussing the matter. He points out, further, that Mr. Harris's equation (303), p. 619, which forms the key-note of the whole, is really identically satisfied by the assumptions.

a few computations upon hypothetical cases will suffice to convince one that as a rule the ocean tides, as we know them, are so great that they can be produced only by successive actions of the tidal forces upon oscillatory systems, each having, as free period, approximately the period of the forces, and each perfect enough to preserve the general character of its motion during several such periods were the forces to cease their action. This greatly simplifies matters. . . ." Undoubtedly the simplification is great, but is it true?

Then later:—"The paths of the particles being practically fixed and determined by the boundary conditions, it becomes possible to disregard the forces arising from the earth's rotation."

Now Lord Kelvin has concluded that "the oscillations of water in a rotating rectangular trough are not of the simple harmonic type in respect to form, and the problem of finding them remains unsolved" (*Phil. Mag.*, vol. x., 1880, p. 113). He has, however, solved the case of a rotating endless canal with straight sides, and adduces his results as probably dominating some remarkable characteristics of the tides of the English Channel. It seems to follow that either Lord Kelvin or Mr. Harris is wrong.

I gather that the free period of oscillation in the several basins into which the ocean is partitioned is the same as that of the tidal force. Now it is surely profoundly improbable that any large portion of our curiously shaped oceans should possess even approximately the critical free period, yet unless this is so the theory seems to be inapplicable. Finally, I think that the process of partition should receive an elaborate and critical discussion as to each basin; but I do not find that this is given in the book.

I can, in conclusion, only express a hope that I am not doing an injustice to Mr. Harris in dissenting so absolutely from his views. No one would have welcomed more warmly than I a new clue to our treatment of this difficult problem. I venture to express my admiration at the courage of the attempt, and although, as I think, it is a failure, yet it may inspire others to more successful attacks.

G. H. DARWIN.

NOTES.

THE hundredth anniversary of the birth of Abel, the great Norwegian geometrician, is on the point of being celebrated at Christiania. Representative men of science from many countries are expected to be present. The interest which His Majesty King Oscar II. has manifested in this centenary celebration is another proof of his continued sympathy with mathematical work and scientific research generally. It is announced that the Paris Academy of Sciences will be represented by M. Darboux and the Paris University by M. Émile Picard.

It is announced in *Science* that at a recent meeting of the corporation of the Marine Biological Laboratory at Woods Hole it was voted to transfer the Laboratory and its equipment to the Carnegie Institution. This action was taken after it had been stated to the members of the corporation that the executive committee of the Carnegie Institution would recommend to the trustees that the Laboratory should be accepted, that its debts should be paid, that new buildings should be erected, that 20,000 dollars a year should be allowed for maintenance and that the scientific management should rest as heretofore with the naturalists of the United States.

THE Cape Town correspondent of the *Times* states that great interest is being manifested there in the suggested visit of the British Association in 1905. As a preliminary measure, free passes on all the South African railways are promised for the

delegates, while the Colonial Governments will contribute 7000*l.* towards the expenses of the voyage and of the stay in South Africa.

A REUTER message from Barcelona, dated August 27, states that a severe storm has passed over Felanitx, Majorca, causing great damage in the town and district. The storm was accompanied by a downpour of rain. Several places were flooded and many houses were destroyed by lightning, by which several persons were killed. A south-easterly gale of exceptional violence was experienced on the southern coast of Cape Colony during Sunday evening, August 31, and Monday, September 1, causing much damage and loss of life.

The following reports of eruptions and earthquakes have appeared during the past week:—August 27. A telegram from General Chaffee, the Commander-in-Chief in the Philippines, to the U.S. War Department, states that a series of earthquakes has occurred in Lake Linao country, in the Moro section of the island of Mindanao. The rivers and mountains have been considerably disturbed. Four hundred shocks have been felt since August 21. August 26, *St. Thomas*. A despatch received from Dominica at 6 p.m. reports that since two o'clock rumbling noises in quick succession have been heard from the southward, and that there is every indication that Mont Pelée is in violent eruption. August 30. A violent eruption of Mont Pelée destroyed Morne Rouge and Ajoupa Bouillon. About 1000 persons were killed and several hundred injured. A wave caused much damage at Carbet. A violent earthquake shock was felt at Carupano, on the coast of Venezuela, at 9 p.m. The disturbance was accompanied by a noise which was heard along the whole shore of the Caribbean Sea. September 1. The vessel which was sent to Tori Shima to report on the results of the volcanic disaster in that island in the middle of August has returned to Yokohama, and reports that Tori Shima is in a state of utter ruin. More than 150 lives were lost in the eruption, no one being left alive on the island.—A telegram from Castries states that Mont Pelée has been in constant eruption since August 15. There was an enormous fall of ashes on the night of August 25, and a very severe eruption on the night of August 28. Three eruptions occurred on the night of August 30, and it was impossible to reach St. Pierre from the sea.

At the annual congress of the Royal Institute of Public Health, which concluded its sittings at Exeter last week under the presidency of the Earl of Idlesleigh, the necessity for teaching the principles of public health in rural districts was strongly urged, and the creation of a "Ministry of Public Health" advocated. Prof. Sims Woodhead directed attention to the need for further funds for the investigation of diseases such as cancer and tuberculosis, and pointed out what a good investment such expenditure would be as regards the national welfare. In the veterinary section, the deplorable condition of town and country stables and country cow-sheds and piggeries was alluded to by Mr. Eaton Jones in a paper on the "Veterinary Supervision of Domesticated Animals," and the meeting passed a resolution advocating the abolition of private slaughter houses, the appointment of veterinary inspectors of all animals intended for food, the inspection of dairies and cow-sheds, and the providing of suitable provision for the disposal of the carcasses of animals unfit for food. At a final meeting, Mr. Windley attempted to defend the course pursued by Leicester in its neglect of vaccination, and Dr. Millard suggested that the danger of the spread of small-pox supposed to arise from the presence of a large unvaccinated element in a community had been somewhat overrated. Prof. Smith pointed out that even in Leicester the hospital staff had been vaccinated, and that in the London small-

pox hospitals the staffs were subjected to compulsory vaccination and not a single case of small-pox had occurred among them; he believed that no one would attempt to establish a small-pox hospital and to officer it with an unvaccinated staff. The formation of a national water board, the new pharmacy bill and the construction of sanatoria for consumptives were the subjects of discussion in various sections.

PROF. VIRCHOW, who has been lying extremely ill at Harzburg, has moved to Berlin, where he arrived on Saturday last. His strength is said to be unmistakably failing.

LORD CURZON, the Viceroy of India, has ordered the heads of the Veterinary, Survey, Forest, Meteorological, Geological, Agricultural and Botanical Departments of India to form a board of economic inquiry, which shall meet twice annually to formulate a programme and to review past work. The board is also to act as an advisory committee to the Government. The Royal Society has promised its assistance.

FROM the *Daily Mail* we learn that as a result of the last anti-tuberculosis conference held at Berlin a special organisation called the International Central Committee for the Prevention of Tuberculosis has now been established. The first meeting will be held under the patronage of the German Empress on her birthday, October 22, under the presidency of Prof. Von Leyden. Many prominent physicians from various countries will also be present. The organisation has already 120 members.

THE sixth annual week's fungus foray of the British Mycological Society will be held at Hereford, from Monday to Saturday, September 22-27.

THE following papers will be read in the Section of Physiology at the British Association in Belfast, in addition to those already mentioned (p. 377):—Prof. Symington and Dr. Cecil Shaw will show Edinger's drawing apparatus for higher magnifications and stronger light; the functions of the rods and cones of the retina, Mr. F. W. Edridge-Green; on the movements and innervation of the stomach, Dr. Page May; a new method for demonstrating chlohematin in ox-bile, Dr. W. A. Osborne.

THE *Patent Office Gazette* reports that patents on eleven different parts of wireless telegraphic apparatus have been granted by the U.S. Patent Office to Prof. Reginald A. Fessenden. Among the patents are included a device for signalling by magnetic waves, a current-actuated wave-responsive device, and also a conductor for wireless telegraphy apparatus.

A REUTER message from Ferrol states that on Friday last Mr. Marconi received a number of Spanish telegraphists on board the Italian cruiser *Carlo Alberto*. In the course of conversation, he stated that he was in daily communication with a receiving station near Plymouth and by this means had received news of the arrival of the King of Italy in Berlin. Referring to the prevention of interference of simultaneous messages, Mr. Marconi said that he was able recently to keep constantly in communication with England at the same time that men-of-war were communicating with each other and with the stations situated in the regions of the Hertzian waves.

A NEW YORK contemporary states that the De Forest system of wireless telegraphy has now been in practical operation for some months between New York and Staten Island. In this system, an anticorherer of the electrolytic type is employed, its chief advantage lying in the fact that it requires no tapping back; a telephone is used in conjunction with this instrument, and the Morse signals are read by ear. The induction coil is eliminated from the sending apparatus, the spark being produced

by a pressure of 50,000 volts obtained by transforming up from the street mains. It is said that a speed of 25 to 30 words a minute is easily maintained. An instance is quoted of two messages having been read at the same time from the same receiver, one coming from an "outside" source, probably a Marconi station. This seems a doubtful recommendation for the system, and shows that the time can not be so very far distant when some consolidation of all the competing systems will be essential. It is to be hoped that this may result, not merely in the survival of the fittest, but in the evolution of a system possessing all the special advantages of the various competitors.

A NEWFOUNDLAND correspondent contributes a lucid and interesting article on "This Year's Arctic Work" to a recent issue of the *Times*. The preparations made for Baldwin's expedition northward from Franz Josef land, which has ended unaccountably in failure, are described with considerable detail, and the unusual completeness of Baldwin's equipment makes the return without substantial achievement all the more remarkable, especially in comparison with the results of the Duke of the Abruzzi's expedition. A short account of Peary's twelve years of Arctic work brings the extraordinary sufferings of that indefatigable explorer into strong relief, and the prospects of his success and safe return this year from what is to be his last Arctic journey are discussed. The safety of the expedition led by Sverdrup, captain of Nansen's *Fram*, which started from Jones Sound in 1899 to explore the vast unknown area beyond the Parry Islands and has not been heard of since, is already doubtful, and unless it returns this summer its position must be one of extreme peril, as it was only provisioned for three years. Should Peary and Sverdrup return safely this season, the Arctic regions will next spring be without a single investigator, a circumstance that has not occurred for more than fifteen years.

WE learn from the *Journal of the Society of Arts* that the Association of German Machinery Engineers of Berlin has offered prizes of 5000, 3000 and 2000 marks (250*l.*, 150*l.* and 100*l.*) for a constructive tracing of a locomotive able to pull a train of 180 tons in weight, on a level roadway, at a speed of 120 kilometres per hour (74.5 miles) for a continuous run of at least three miles, the highest rate of speed not to exceed 150 kilometres (93.2 miles) per hour. The close of the competition is fixed for December 1, 1902. Any further particulars may be obtained by applying to the secretary of the above association, Herr Geheimer Kommissionrath, F. C. Glaser, Lindenstrasse 80*l.*, Berlin.

OUR American contemporary *Science* protests strongly against the appointment of Captain Colby M. Chester, a naval officer without special knowledge of astronomy, as superintendent of the U.S. Naval Observatory. The institution is regarded as the national observatory of the United States, and the opinion is expressed that an astronomer should be at its head instead of a naval officer. Our contemporary adds: "The institution has no rational purpose of existence except a desire on the part of the American people that our nation shall, in its public capacity, do its full share in the promotion of those branches of astronomy which have to be pursued under public auspices. The leading position which our country has taken in the extraordinary development of astronomic science during our generation can alone justify the unparalleled expenditure of our Government upon its observatory. The results of this expenditure through the ten years since the completion of the new observatory should have been its general recognition as the leading observatory of the world in at least some important field of the sciences. With its great advantages over old-fashioned Greenwich and Paris, it should have left both these institutions in the rear."

M. DE FONVIELLE informs us that M. Camille Pelletan, Minister of the French Marine and of the Colonies, has placed the *Epte*, a torpedo destroyer, 306 tons, 62 men, at the disposal of Comte de la Vaulx for purposes of aeronautical manoeuvres on the Mediterranean, with a new balloon. It may be remembered that last year Comte de la Vaulx tried to cross the Mediterranean from Toulon with a large balloon made captive by floating pieces of wood. The experiment, although interesting, proved a failure, owing to the wind blowing eastward. This year the experiments are likely to begin from Palavas, a point near the place where, in 1901, the trip ended. The *Epte* is to join the balloon there on September 10. The new balloon will carry in its car a propelling petroleum engine, which, however, will be used only in the second series of manoeuvres. On Sunday, August 24, M. Heureau, a young and promising aeronaut, tried on a smaller scale similar performances in the Channel. He proved by an ascent at Dunquerque that a tug-boat can conduct a balloon against a strong wind. The balloon *Alcor* was sent up in the direction of the sea and for some time was lost to view in the clouds; but, after having run some miles, the valve was opened and the balloon descended close to the waves. M. Heureau dropped his cone-anchor and waited until a tug-boat, sent out especially from Dunquerque, threw a rope to the car, by which the balloon was tugged easily and reached Dunquerque fully inflated.

AT the annual meeting of the Société d'Encouragement pour l'Industrie nationale, the president announced the mode of distribution of the grants at the disposal of the Society for research work bearing upon industry. The gold medal of the Society for work which has exercised the greatest influence on French industry is awarded to M. V. Steinlen for his researches on the invention and construction of machine tools, M. Rabate receiving the Parmentier prize for his original studies on the resin industry. Money grants were also given to M. Fremont (3500 fr.) for his work on the testing of metals, to M. Gutton (3000 fr.) for his work on the fragility of materials, to M. C. Brioux (2000 fr.) for his geological and agricultural study of Basse-Bourgogne, to M. C. Urélin (500 fr.) for his work on the acetylacetates, to M. Guyot (500 fr.) for his researches on colouring matters, and to M. Canovetti (1000 fr.) for his work on air resistance. The total amount of the grants for research made by the Society for the years 1902-1903 is twenty thousand francs. The president expressed the hope that the industries which benefit by this sacrifice will lend assistance in their turn in providing for the commencement of new studies which the Society has not as yet been able to attempt for want of sufficient funds.

ON the occasion of the recent meeting of the members of the British Pharmaceutical Conference at Dundee, the president, Mr. J. C. Druce, summarised in his address the progress of Scottish botany. The review begins with an account of the work of Robert Sibbald, who lived in the latter half of the seventeenth century and compiled the work known as "*Scotia Illustrata*." After him, the more important systematic botanists referred to are Dr. Lightfoot, the author of "*Flora Scotica*" (1777), Sir James E. Smith, whose "*English Botany*" is a standard work, George Don, famous on account of his botanical explorations (1800), Sir W. J. Hooker, who also published a "*Flora Scotica*" (1821), and Mr. H. C. Watson, to whom we are indebted for the "*Cybele Britannica*" (1847-1860). The most impressive part of the address is the vivid sketch of George Don, who, humbly born and poorly educated, devoted himself with untiring energy to scientific, more especially botanical, observations, and was the first to explore many Highland districts now famous, but at that time quite unknown. Owing to unfortunate circumstances, many of Don's discoveries have been called into question,

but later investigations tend to re-establish his reputation. There is no doubt that, owing to the fact that he sent out specimens from his garden, and that his references to localities were at times inaccurate, his records are not always trustworthy; on the other hand, some of his doubted specimens have since been re-affirmed, of which Mr. Druce mentions *Salix doniana*, *Triticum alpinum* and *Carex ustulata*. The concluding part of the address furnishes a list of species peculiar to Scotland, and an account of species characteristic of counties or districts.

Now that autumn is approaching, and it is time to be planting bulbs, those growers who require daffodils will be interested in the catalogue issued by Messrs. Barr and Sons. This firm has for a long time made a speciality of these flowers, and offers all varieties, from the inexpensive kinds suitable for planting in woodlands to the select and rare hybrids which require several years to raise from seed.

THE report on the St. Kitts-Nevis Botanic Station, for the year ending March 31 last, states that in August, 1901, an experiment with tobacco was successfully established on half an acre of ground. Plots were also started on four estates, advice and assistance being constantly given to those in charge, and the planters invited to witness each operation in progress. With seed procured from England, another attempt was made to cultivate potatoes, but the results went to show that instead of producing what we know at home as "new" potatoes, the crop when reaped was found to have precisely the flavour and conditions of old potatoes. For the purpose of destroying grasshoppers, an endeavour was made to acclimatise the Barbadoes blackbird. Several consignments of birds were received, but nearly all disappeared, a few being seen only in one or two places where they are regularly fed.

THE *Journal* of the Royal Microscopical Society for June contains an interesting paper, by Mr. C. F. Rousselet, on the genus *Synchaeta*. Some of the members of this genus are amongst the commonest rotifers inhabiting fresh-water lakes and ponds as well as brackish tide pools and the open sea. Pastor Eichhorn (1761) and F. O. Müller (1786) are probably the earliest authors who have left sketches probably representing species of this genus; but our real knowledge of these rotifers dates from 1831 to 1834, when Prof. Ehrenberg described four species of *Synchaeta*. Mr. Rousselet now records sixteen different species, of which five are new, viz. *S. bitina* (in fresh water), *S. littoralis* (in brackish water), *S. cecilia*, *S. vorax* and *S. neapolitana* (marine).

A NOTE by Prof. Garbasso, of Turin, contributed to the *Nuovo Cimento*, 5, ii., deals with a phenomenon observed by Prof. Manuelli, viz. the action of sunlight in facilitating the passage of electric sparks, an effect closely resembling, if not identical with, Hertz's phenomenon. Prof. Garbasso has made experiments which show that even diffused sunlight has a considerable effect. In one experiment he counted 24 discharges in 30 seconds in the light as against 8.8 in darkness; in another experiment the numbers were 18.1 and 6.3. The effect of the light seems to last for a certain interval after the illumination is cut off. Experiments were made first with a lens and next with a mirror used for concentrating the rays; and it was also found that when the light was brought to a focus on one of the electrodes, an uninterrupted current was obtained even at distances beyond the sparking distance in the dark, but the effect was greatest when the light fell on the negative pole. This influence of solar light is unaffected by the passage of the light through quartz or Iceland spar, but is destroyed by a few films of mica, a thick glass plate, or a vessel of water or alum solution 4 cm. thick. These results point to the view that the effect of Manuelli is due, not to the presence of ultra-violet rays, but rather to the heating of the electrodes.

Bulletin No. 51 of the U.S. National Museum will be exceedingly useful to working naturalists, since it contains a list of the publications of that institution from the year 1875 to 1900, drawn up by Mr. R. L. Geare.

THE last issue of the *Transactions* of the South African Philosophical Society, comprising pp. 561 to 896 of vol. xii., is entirely devoted to a continuation of the valuable descriptive catalogue of the beetles of South Africa. A very large number of new species as well as some new genera are described in this fasciculus, the diagnoses of which appear to be well and carefully drawn up. We think, however, it would have been better had the dates been added in all cases to the references to previously named genera and species.

Science for August 15 contains a full report of a long address on the history of ichthyology, delivered by Prof. Jordan before the zoological section of the recent meeting of the American Association, held at Pittsburg. Commencing with Aristotle, the lecturer gives a full account of the gradual progress of our knowledge of recent and fossil fishes, in the course of which he allows full credit to the efforts of the earlier workers, especially Ardeji, whose list of genera is given at length. The British Museum catalogues of fishes, recent and fossil, receive a large share of commendation. Of one of these the lecturer speaks as follows:—"The chief criticism which one may apply to this work concerns most of the publications of the British Museum. It is the frequent assumption that those species not found in the greatest museum in the world do not really exist at all." We venture to doubt whether this sweeping criticism is deserved. Readers with a knowledge of British fish-literature will not fail to notice that the first appearance of Yarrell's work is misprinted 1859 (in place of 1839) in the report of the address.

In the August (third) number of the *Field Naturalist's Quarterly*, the editor devotes the opening paragraphs to a discussion of the present form of nature-teaching in schools, and the manner in which this may be improved. It is essential that the lessons should be simple and practical, and the author recommends that a child should be encouraged to watch and describe the life-history of a common insect, or the daily development of a flowering plant. Later on in the same number, Mr. R. Haines discusses the difficulties in connection with the establishment of an "Arbor-day" in this country. The main idea of such an institution is that on a certain day each inhabitant of a village or town should plant a tree; and the author very pertinently inquires who is to provide the trees and the land on which they are to be planted, and the kinds of trees to be selected. He might have asked who is to be responsible for the attention and care they will certainly require during the earlier years of their growth.

We have received from Dr. H. Hergesell the year-book of meteorological observations taken in Alsace and Lorraine during 1898. For Strassburg, hourly or two-hourly readings are published, and the usual observations at ten stations of the second order. Rainfall summaries are given for fifty-eight stations.

THE eighteenth volume of observations made at the Hong Kong Observatory for the year 1901 has been published by Dr. Doberck. The comparison of the daily weather forecasts with the weather subsequently experienced shows, as in previous years, a large amount of success, the sum total (including cases of partial success) reaching 93 per cent. The useful work of collecting observations from ships' logs, for the construction of pilot charts for the eastern seas, has been vigorously continued; the number of entries in 10⁷ squares available for each month of the year save two exceeds twenty thousand. The magnetic and astronomical observations have also been regularly carried on. In the year 1901, the number of transits observed was 3349.

We have received from Prof. F. Omori the first portion of a memoir on macro-seismic measurement in Tokyo, containing the analysis of the diagrams of 220 earthquakes observed at three places in that city, mostly between September, 1887, and July, 1889. Prof. Omori defines the macro-seismic motion as that part of the earthquake-motion which consists of vibrations the period of which, except in very strong shocks, does not exceed two or three seconds. A discussion of the analysis will be given in the second portion of the memoir.

DURING the past year, we have received the nine parts forming vol. vii. of the *Bollettino* of the Italian Seismological Society for 1901-1902. The description of new instruments or of modifications of old ones is, as usual, a prominent feature of the volume. We have noticed already several of the papers, and need here only call attention to Prof. Mercalli's studies of Vesuvius from July, 1900, to the end of 1901, Prof. Riccio's paper on the central crater of Etna, and the valuable notices of earthquakes recorded in Italy during the year 1900.

THE Home Office has issued the annual report relating to persons employed and accidents at mines and quarries in the United Kingdom in 1901. It is edited by Prof. C. Le Neve Foster, F.R.S., and contains a large amount of interesting information. The total number of persons employed was 933,366. There were 1075 accidents, causing the loss of 1229 lives. Compared with the previous year, there was a decrease of 48 in the number of fatal accidents, but an increase of 52 in the number of lives lost. The general death-rate was 1.348 per 1000, as compared with 1.408, the average for the past ten years. Of the fatal accidents, 43.7 per cent. were due to falls of ground, 11.0 per cent. to explosions, 13.5 per cent. to surface accidents, 7.0 per cent. to shaft accidents, and 24.8 per cent. to miscellaneous accidents underground. The use of coal-cutting machinery does not appear to be making very rapid progress.

THE School of Mines of the University of Wyoming has issued a series of bulletins on petroleum, and of these No. 5 (June) deals with the Newcastle oilfield. Petroleum occurs in the Dakota shales and sandstones near the base of the Cretaceous, and it proves of value for lubricating and for fuel.

AN interesting account of the Darling Downs district in Queensland is given by the Hon. Arthur Morgan (*Proc. Roy. Geograph. Soc., Australia*, vol. xvii.). He dwells especially on the work of Allan Cunningham, who in 1827 discovered the Darling Downs, now regarded as one of the most fertile and healthful tracts, and also as a region of considerable geological interest, for it has yielded remains of remarkable fossil mammalia, gigantic in size compared with the recent representatives.

DR. HENRY WOODWARD contributes to the *Proceedings of the Bath Natural History and Antiquarian Field Club* (vol. x.) an interesting outline of the life of William Smith, the "father of English geology." It is accompanied by a portrait (reproduced from Phillips's "Life of William Smith"), by a photograph of the bust by Chantry, which stands in St. Peter's Church, Northampton, and by a view of the monument erected by Lord Moreton, at Churchill, in Oxfordshire, the birthplace of Smith.

IN some contributions to South African petrography (*Geol. Mag.*, August), Mr. Frederic P. Mennell, curator of the Rhodesia Museum, refers to the great development of basic lavas and acid plutonic masses. He describes examples of basalt, dolerite, gabbro, syenite, &c., that have been gathered from a wide area in Rhodesia, Betschuanaland and other parts of South Africa. The great granite mass of the Matopos, which forms the backbone of southern Matabeleland, closely resembles

the Dartmoor rock, but near Bulawayo it presents appearances of foliation which may be due to movement before complete consolidation.

SOME interesting details relating to the recovery of tin from tin-scraps have recently been published in the *Zeitschrift f. Elektrochemie*. In Germany, several works have been built and operated for carrying out this procedure, the largest of these being that of Goldschmidt, at Essen, where 50-60 tons of tin-scraps are reported to be treated per day. The difficulty of obtaining an adequate supply of raw material has hindered the development of other works, and the anonymous writer of the article we are discussing hints that the supply of tin-scraps is monopolised by one or two of the larger works. The processes used for recovering the tin are based upon the use of the scraps as anode material, in a bath containing sodium chloride and hydrate, or in one containing hydrochloric acid. The advantage of the former is that less iron goes into solution, but against this there is the lower energy efficiency of the process and the more spongy nature of the deposit obtained at the kathode. The failure to produce directly metallic tin is one of the chief difficulties in the operation of both processes, for considerable losses occur in smelting and refining the spongy deposit obtained at the kathode. Under certain conditions, metallic tin can be obtained in the electrolytic bath, and Pfannhauser, in the issue of the *Zeitschrift f. Elektrochemie* for January 16, has stated his opinion that the avoidance of the formation of spongy deposit is simply a question of maintaining the concentration of the tin salt solution in the neighbourhood of the kathode. This condition would appear to be difficult to attain in the works treating tin-scraps on an industrial scale, and the problem of producing metallic tin at the kathode is complicated further, by the slow but gradual increase of impurities in the electrolyte. A new works for the treatment of tin-scraps has recently been built at Pfaffstätten, near Vienna, and an electrolytic process for recovering tin from slags is also reported to be in operation at Tostedt, in Germany. In this country we are not aware of any similar works in actual operation, but during 1901 a company was formed with a capital of 10,000*l.* to build and operate a works for the treatment of tin-scraps by a new electrolytic process. A plant for dealing with 50 tons of cuttings per month was to be erected, presumably near London.

MESSRS. WHITTAKER AND CO. will shortly publish a work on galvanic batteries, by Mr. S. R. Böttone. The book will deal with the theory, construction and use of electric batteries, comprising primary, single and double fluid cells, secondary and gas batteries.

MESSRS. NEWTON AND CO. have sent us a copy of a useful catalogue of physical apparatus and accessories manufactured by them. In addition to numerous figures in the text, the catalogue has eight plates containing reproductions of photographs of typical instruments used for demonstrations in the lecture room and practical work in the laboratory. Among the apparatus described, we notice a cyanine prism for showing anomalous dispersion, circular diffraction gratings and photographic gratings, zone plates, new contact breaks, localising instruments for Röntgen ray work, apparatus for wireless telegraphy demonstrations, and for experiments with alternating currents of high tension and high frequency.

WE have just received the annual report of the Government Analyst at Trinidad. The report indicates that in addition to the examination of officially submitted samples, of which more than 2000 were received during the year, a considerable amount of valuable work is being done by the head chemist, Prof. Carmody, by investigation of the mineral deposits of the island. Experiments have also been made at the Government farm on the diurnal variation of cow's milk.

ACCORDING to the report of the principal chemist of the Government Laboratory for the year ending March 31, it appears that during the past twelve months the work of the Customs branch of the Laboratory has more than doubled in magnitude, the increase being due chiefly to the imposition by the Budget of April, 1901, of duties on sugar and cognate substances, and on the numerous articles in the manufacture of which these substances are used. More than 64,000 samples were submitted for test as compared with about 34,000 in the preceding year.

A CAREFUL experimental inquiry regarding the nutritive value of alcohol has recently been carried out in the chemical laboratory of Wesleyan University by Messrs. Atwater and Benedict, a report on which forms the sixth memoir of vol. viii., published by the National Academy of Sciences. The main question studied is the value of alcohol as a fuel in the human body and its comparison in this respect with sugar, starch, fats and other nutrients of ordinary food materials. Collaterally, the question of the effect of alcohol upon the proportions of nutrients digested from the food with which it was taken has also been examined. Metabolic experiments on an elaborate scale have been instituted with the view of investigating the problem, and no expense has been spared to obtain complete and accurate results, a large share of the costs having been borne by the Committee of Fifty for the Investigation of the Drink Problem. The results of the inquiry indicate that more than 98 per cent. of the ingested alcohol was oxidised in the body and that the potential energy of the alcohol was transformed into kinetic energy as completely as that of the ordinary nutrients. Alcohol appears to be very efficient in the protection of body fat from consumption, but not quite so efficient as the isodynamic amounts of the ordinary nutrients in the protection of body protein. The conclusion is drawn that so far as the utilisation of the total energy of the diet is concerned, there is a slight advantage in favour of the non-alcoholic diet, especially when the body is subjected to hard muscular exertion, but the difference is so small as to lie almost within the limits of experimental error.

The additions to the Zoological Society's Gardens during the past week include a Purple-faced Monkey (*Sennopithecus cephalopterus*) from Ceylon, presented by Miss M. Wheatcroft; a Bonnet Monkey (*Alouatta sinicus*, ♂) from India, presented by Mr. C. F. Taylor; a Green Monkey (*Cercopithecus callitrichus*) from West Africa; a Bonnet Monkey (*Alouatta sinicus*) from India, presented by Mr. R. M. Drury; an Australian Sheldrake (*Tadorna tadornoides*) from Australia, presented by Mr. W. Jamrach; an Egyptian Monitor (*Varanus niloticus*) from West Africa, presented by Mrs. Mary A. S. Deacon; two Coteau's Skinks (*Macroscoelus coteaui*) from the Cape Verde Islands, presented by Mr. F. Newton; two Axolotls (*Amblystoma tigrinum*) from North America, presented by Mrs. Millicent Summers; a Spotted Salamander (*Salamander maculosa*), European, presented by Mr. R. R. Green; a Common Snake (*Tropidonotus natrix*), British, presented by Mr. E. Crane; a Grand Galago (*Galago crassicauda*, var.) deposited; a Black-necked Swan (*Cygnus nigricollis*, ♀) from Antarctic America, purchased; a Rufous-necked Wallaby (*Macropus ruficollis*), a Common Wallaroo (*Macropus robustus*), born in the Gardens.

OUR ASTRONOMICAL COLUMN.

CATALOGUE OF NEW DOUBLE STARS.—Mr. W. J. Hussey publishes, in No. 21 of the *Lick Observatory Bulletin*, the fifth catalogue of one hundred new double stars which he has discovered with the 12-inch and 36-inch refractors of the Lick Observatory, all these doubles having distances less than 5".

Twenty-five per cent. of the five hundred pairs announced have distances not exceeding 0".50, 48 per cent. not exceeding 1".00, and 72 per cent. not exceeding 2".00. The average distance for the five hundred pairs is 1".52.

NO. 17 14, VOL. 66]

HYPOTHESIS ON THE NATURE OF SOLAR PROMINENCES.—Prof. W. H. Julius has described before the Royal Academy of Sciences (Amsterdam) a theory as to the nature of solar prominences.

It may be remembered that Prof. Julius accounted for the doubling of the arcs in the spectrograms obtained by him during the last total solar eclipse, by saying that it was due to the anomalous dispersion of the chromospheric light, and he now applies this theory of anomalous dispersion to account for solar prominences. He abandons the idea of the existence of various layers of different materials in the solar atmosphere, and suggests that "throughout the gaseous body, as well inside as outside the critical sphere, the various elements are altogether intrinsically mixed (granting that in the mixture the quantity of materials with greater specific gravity must grow with the depth)." It is suggested that, in the whirls formed by the ascent and descent of heated gases combine^d with the rotational velocity of the solar atmosphere, we get anomalous dispersion at the points where two or more of these whirls intersect and break each other; and the author goes on to propose "that the whole chromosphere with all its prominences is nothing but this system of waves and whirls, made visible within shorter or longer distances from the sun's edge by anomalous dispersion of light, coming from deeper layers."

Prof. Julius also points out that this theory abolishes the necessity for supposing the immense velocities which Fenji and others have observed in connection with solar prominences, because it suggests that there is not a transmission of material, but only successive appearances of the same phenomena at various heights. He likens this to the apparent velocity of the line of foam caused by water waves breaking on a coast which is inclined to their wave-fronts (*Proceedings of the Royal Academy of Sciences, Amsterdam*).

VISIT OF THE ENGLISH ARBORICULTURAL SOCIETY TO COMPIÈGNE.

THE English Arboricultural Society held its annual meeting in London on Monday, August 18, and Mr. George Marshall, of Framstone, Liphook, one of the members of the Royal Forestry Commission, was elected president for the year, in succession to Dr. Somerville, of the Board of Agriculture. M. Daubrée, Conseiller d'Etat and Directeur des Eaux et Forêts, was elected honorary vice-president, and four other French officers connected with the forests which were to be visited by the Society were elected honorary members.

On August 19, fifty-three members of the Society proceeded *en* diligence to Compiègne. Among these, besides our president, may be noted Mr. H. J. Elwes, F.R.S., of Colesborne, Gloucestershire; Mr. Coroner Graham, of Durham; Mr. F. W. Beadon, of Longley Hall, Huddersfield; Mr. J. Smith Hill, principal of the Agricultural College, Aspatria; Sir Hugh Beever; Mr. J. Davidson, the secretary, in charge of the forests belonging to Greenwich Hospital; Mr. E. McCa, Mair, late of the Indian Forest Department; Mr. Forrest, agent to the Duke of Bedford at Thorney; Mr. W. Forbes, forester to Lord Masham; Mr. Havelock, forester to Lord Yorborough; Mr. Gillanders, forester to the Duke of Northumberland; Mr. A. C. Forbes, forester to Lord Lansdowne, and many other foresters and nurserymen.

On August 20, the party proceeded to Villers Coterêts (Aisne), the birthplace of Dumas, and spent the morning in inspecting the extensive timber yards of M. Carpentier and of the Chemin de Fer du Nord. The French band saws are the best in existence, and a very large quantity of fine beechwood is now being sawn up. The beech is sawn green during summer and then carefully seasoned, while oakwood is now being collected for autumn and winter sawing, hornbeam wood being sawn up in the spring. M. Carpentier sells much hornbeam wood in England. The system of crosscutting by the Chemin de Fer du Nord is new. It is very effective, and was explained in detail and by practical illustration by the director. Large quantities of beech and oak sleepers are thus prepared, the beech absorbing three times as much creosote as the oak, and, as an experiment, a few maritime pine sleepers were being tried, this species not being yet used by this railway.

After breakfast, the party visited the Forêt de Retz (32,550 acres with a net revenue of 23,698*l.*), an undulating land 200 to 800 feet in altitude, the soil being chiefly a deep and fertile

loam above cerithic limestone, sand and quartzite. It is one of the finest forests in France, containing

Beech	40	per cent.
Hornbeam	40	"
Pedunculate oak	15	"
Sallow, poplar, chestnut and elm	3	"
Conifers	2	"

During the last thirty years, oak has been extensively planted in the young woods, so that it is hoped to raise the percentage of this species to 33 per cent. We inspected some of the regeneration areas and thinnings, under the guidance of M. Cottignies, Inspecteur des Eaux et Forêts, and his assistants, and were greatly pleased with the results, not a single blank existing in the forest.

On August 21, the Society visited the Forêt de Compiègne (36,072 acres with a gross revenue of 33,480*l.*). It is situated on a poorer and drier soil than that of the Forêt de Retz, half the area being flat and on Eocene sands and clay, the rest hilly (117 to 495 feet altitude) and above nummulitic sand and lime-



FIG. 1.—Sessile Oak in the Forêt de Bellême.
Girth at 4 ft. 6 in. = 9 ft. 9 in. Total height 119 ft. 6 in.

stone. M. Peiffer, Inspecteur des Eaux et Forêts, conducted us through the forest, which, when I saw it in 1871, was overstocked with red deer and rabbits, so that natural regeneration was rendered almost impossible. Although game is still important and produces an annual rental of 3880*l.*, yet it is now kept sufficiently in check, and the regeneration of the forest is proceeding satisfactorily, chiefly by natural seed. A practical illustration was given of setting free oak saplings from invasive growth of inferior species. This is done by the forest guards with a crescent-shaped cutting instrument having a handle about 4 feet long, and attracted much attention and commendation.

The party visited the splendid Château de Pierrefonds, which, under Napoleon III., was restored to its former condition in the middle ages by M. Violet le Duc, and from its watch-tower a most extensive forest panorama of the two forests of Retz and Compiègne was seen. We were then joined by M. Daurée, the chief of the French Forest Department, and by the Conservateurs of Paris and Amiens, MM. Récopé and Molleveux,

and inspected the sessile oaks of the Beaux Monts. Such a mass of huge 300-year-old oak trees is to be seen only in France. A photograph of a French sessile oak taken by M. Granger, one of the Compiègne forest officers, is here reproduced.

The Mayor of Compiègne and the French officials dined with the Society in the covered courtyard of the hotel, which was ornamented with flags, creepers and evergreen trees. Besides the usual patriotic speeches by the president and the Mayor of Compiègne, Mr. Elwes, F.R.S., proposed the health of the French Forest Department in an excellent French speech, which was responded to most sympathetically by M. Daurée, who invited the party to visit other French forests on some future occasion, and expressed his thanks for being elected one of our vice-presidents.

On August 22, most of the visitors went to Paris, some of whom visited the Forêt de Fontainebleau, but several proceeded to Valenciennes and spent two days in the splendid coppice-with-standards of the State forests of S. Amand (8290 acres) and the private forest of Raismes (3500 acres) belonging to the Duchesse d'Areberg. These forests are on Tertiary sandy loam above the Coal-measures, and are noticeable for the equable distribution of standards (chiefly oak and ash) from ten to 120 years old. This is less marked in the State Forest,

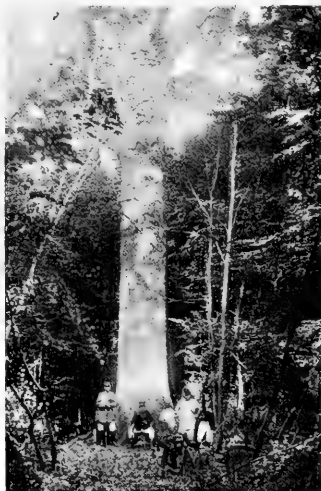

FIG. 2.—Pedunculate Oak in the Forêt de S. Amand.

owing to wholesale felling of old oaks from 1790 to 1815. The ideal to be aimed at is to have 1400 cubic feet of standards per acre when the underwood is twenty-five years old, and to fell half this volume, leaving 700 cubic feet to grow for another twenty-five years, when it should again amount to 1400 cubic feet. A photograph is here given of one of these old standards, the distinctive growth of which, as compared with that of the oak grown in high forest, being noteworthy. During the Napoleonic wars, a large area in the forest of S. Amand had become mere heather and bracken waste; this was sown with Scotch pine about sixty years ago; the oak has sprung up naturally among these pines, which are being gradually removed every six years, and broad-leaved forest, chiefly of birch under oak standards, results. Each of these forests produces a net revenue of about £1 2*s.* 6*d.* per acre.

A full account of the notes taken in this expedition will be published in this year's *Proceedings* of the Society, the chief object gained being the continual discussion in the forest of interesting points of forestry by the members and the French foresters, and the demonstration of the successful following of a continuous plan through many decades for producing fine timber.

W. R. FISHER.

PALÆOLITHIC FRESCOS AND MURAL ENGRAVINGS.¹

ATTENTION has already been drawn in NATURE (vol. lxx, p. 299) to the recent discovery of large mural decorations by Palæolithic artists, and as the subject is of such extraordinary interest we do not hesitate to give a further account of the more recent discoveries of like nature.

MM. Capitan and Breuil presented at the meeting of the Paris Academy of Sciences of June 23 a communication describing some paintings on the wall of the cavern of Font-de-Gaume in Dordogne. Of the eighty figures which are painted in red ochre and manganese black on the walls of the cave, forty nine are of bisons; all are engraved and painted, but sometimes the surface of the rock has also been scraped; a thick layer of stalagmite has covered many of the designs. The original of the figure of the running bison that we reproduce has a length of 1 m. (39½ in.) and a height of 60 cm. (25½ in.); it is entirely painted in a brown colour with a red tint on the forehead. These are the first frescoes recorded for France, as the engraved designs from the cave of La Mouthe, published by M. Émile Rivière in 1895, were rarely and, even so, but partially coloured.

M. Henri Moissan has analysed the colouring matters employed by the Palæolithic mural decorators, and finds that they are ochres composed of oxides of iron and manganese in variable proportions.

At the meeting of the Academy on July 28, M. Émile Rivière drew a distinction between the true frescoes described by the former authors and his own discoveries in the cave of La



FIG. 1.—Fresco of a Bison, Font-de-Gaume.

Mouthe, also in Dordogne. The latter are almost exclusively more or less deep engravings or shallow markings produced by scraping or scratching the rock. Two of the figures present some traces of paint; one of these represents a ruminant, perhaps *Bos priscus*; the contour only of the hind limbs is coloured a blackish red-brown, especially at the level of the joints and hoofs; the left flank of the animal is marked with ten spots of the same blackish-brown colour, extending in a line from the shoulder to the upper portion of the thigh. The other design represents a kind of hut, not engraved by a simple line which indicates the contour as in the numerous animals represented upon the walls of La Mouthe, but by a scraping of the rock. Ochre (possibly mixed with manganese) has been applied superficially to portions of the scratches in such a manner that the colour is much less deep than in the former figure; it is laid on in a series of bands approximately parallel and alternately clear and dark. This is the only known drawing of a habitation of primitive man.

M. Rivière does not commit himself as to the contemporaneity, or otherwise, of the engravings of La Mouthe with the paintings of the Font-de-Gaume; but he reasserts that the figures of La Mouthe are undeniably Palæolithic (Magdalenian), and, geologically speaking, of the Quaternary epoch. The prehistoric

artist who engraved them was the contemporary of the reindeer and of the mammoth the portraits of which he delineated.

In a recent number of *l'Anthropologie* (t. xiii. Mai-Juin, 1902), M. Émile Cartailhac gracefully acknowledges that he was wrong in doubting the genuineness of the pictographs of animals painted on the walls of the cave of Altamira in Spain. He gives two illustrations of these frescoes, one of which (Fig. 1, p. 351) contains a group of seventeen animals, drawn with spirit and with a considerable degree of accuracy. The Altamira artist, or artists, evidently belonged to the same "school" and period as that of the Font-de-Gaume artists. A. C. H.

SEA TEMPERATURE VARIATIONS ON THE BRITISH COASTS.

THE Meteorological Office pilot chart for September contains very interesting information relating to the temperature of the sea water round the coasts of the United Kingdom in the month of June last. Over nearly the whole of the Atlantic between the 30th and 50th parallels the temperature for the month was below the average, in many places the deficiency amounting to 5° and upwards. This fact is clearly shown on the general chart, but two small charts have been added to illustrate a remarkable change experienced close inshore. Daily records at a large number of coastguard stations and lightships disclose the prevalence of very cold water during a considerable part of the month, and a rapid increase of warmth towards the close. The extra sketches exhibit the mean results for June 1 to 24 and June 25 to 30 respectively. Along the western and southern coasts, many of the minimum values during the cold

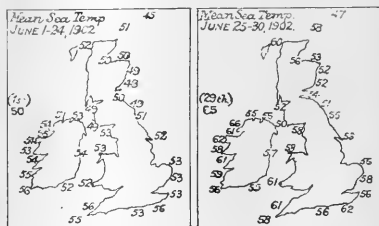

FIG. 1.—Sea Temperature Variations on the British Coasts.

period were as low as 48° to 52°, the lowest in several places occurring as late as the 15th of the month. Off Eastbourne, 54° on the 8th and 9th was the lowest June record in nineteen years. On the east of Britain and west of Scotland the minima were from 42° to 48°. Before the end of the month the west and south coasts were generally above 60°, and the east and north 55° to 60° and upwards. Up the north-western shores the temperatures were higher than in any other neighbourhood, the maxima being registered on the 28th or 29th as a rule. Stornoway and Seaford touched 66°, Ballyglass 67°, Lisacoran 68°, Teelin Head 70°, and Blacksoot Point 72°. Even the Orkneys reached 60°, while Eastbourne did not pass 62°. Confirmation of these very high readings in the north-west is afforded by the records of ships well out in the offing, the observations in about 55° N., 11½° W., showing 50° on the 1st and 65° on the 29th.

Judging by the mean results for the two periods, the greatest change took place off Teelin Head, Donegal, where the closing days averaged 12° warmer than the previous part of the month. Blacksoot, to the south, was 8°, Arran Island 7°, Seaford 5° and Minard 4° warmer, while Ballydonegan, at the south-west extremity of Ireland, showed no change. Northward from Teelin Head we find a rise of 8° at Stornoway, 7° at the Orkneys, and curving southward down the coast of Calthness, 6° at Cromarty. The warmth scarcely affected the Shetlands, where the increase was only 2°. Eastward past the north of Ireland the effect diminished rapidly, the rise at Sheephaven being 4°, at Port Rush and Lamlash 3°, and at Ballantrae 1°. For the warm period the Orkneys equalled and the Hebrides exceeded by 2° the result at Scilly, 55°. It must be remembered

¹ Reproduction des figures paléolithiques peintes sur les parois de la grotte de Font-de-Gaume (Dordogne). By MML. Capitan et Breuil (*Comptes Rendus Acad. Sci., Paris*, t. cxxxiv. p. 1539). ² Sur les matières colorantes des figures de la grotte de Font-de-Gaume. By M. Henri Moissan (*ibid.*, p. 1539). ³ Les figures préhistoriques de la grotte de La Mouthe (Dordogne). By M. Émile Rivière (*ibid.*, t. cxxxiv. p. 265).

in connection with this phenomenon that the country experienced almost the only few days of warm weather of the summer, but while the water was decidedly warmer in the north-west than elsewhere, the air temperature was higher over England than over the south of Ireland, and still higher than in the north of Ireland.

RECENT EDUCATIONAL REPORTS.¹

THE protracted discussions in the House of Commons, the numerous leading articles in the newspapers and the frequent public speeches of politicians, concerned with the subject of education, with which we have been provided during the past six months, are evidence enough that English people are at least beginning to be interested in the important question of the provision made by the State for the education of its citizens. But interest alone is not enough, it must be intelligent; and to ensure this it is important that the instructors of public opinion should themselves be well informed, both as to what is actually happening in the schools and colleges of our own country and as to the systems of education in other lands. For these and similar reasons, the special reports published from time to time by the Board of Education, under the editorship of Mr. Michael E. Sadler, the director of special inquiries, have a peculiar value just now; while the general reports of H.M. Inspectors serve admirably to remind Members of Parliament that despite the changes which may be necessary in our educational administration, good, thorough work is even now being accomplished in most of our State-aided schools, whether elementary or secondary.

The two volumes dealing with education in the United States of America are concerned more with general principles and tendencies than with specific details as to methods of instruction. Though this will detract from their value to practical teachers, it gives greater opportunities to insist upon the necessity for the possession by our legislators of proper, high ideals as to the function of education. As Mr. Sadler says in a paper he contributes to the second volume, "a national system of education which made money-getting its central aim would deserve all the contumely which history in a more enlightened future would be certain to heap upon it." American educators are showing the world that it is possible at the same time to develop the higher faculties, to have a due regard to the pleasures of cultivated leisure, to encourage "sweetness and light," and yet thoroughly to equip their young men with a knowledge of recent advances in pure and applied science, so that without difficulty they may take an honourable part in the production of those material comforts without which the most cultured would find it hard to live.

Two factors, among many others, preeminently contribute to the success of American education. In the first place, there is the munificence of wealthy Americans. Mr. Percy Ashley, at the end of his article on American universities, tabulates the total amount of benefactions reported during the years 1890-1901. During these eleven years, very nearly twenty-three millions of pounds were given to higher educational institutions, not including libraries and museums, and more than two millions went to the Leland Stanford University alone. These princely sums are largely devoted to the encouragement of research; as Mr. Ashley says—"In all the arrangements for research work the United States is much under German influence; and it is greatly to be regretted that England should be so far behind."

In spite of the establishment in recent years of degrees awarded for research by Oxford and Cambridge, there is still no place where organised research work is carried on in England.

It must be said that the research work of the American universities is probably the part of their activity most worthy of study by those interested in academic progress in England. It must be admitted, however, that the material attractions to research and an academic career are far stronger in the United States than here."

¹ "Special Reports on Educational Subjects." Vol. x. "Education in the United States of America." Part I. Pp. 538. Price 2s. 3d. Vol. xi. "Education in the United States of America." Part II. Pp. 624. Price 2s. 6d. (Eyre and Spottiswoode.)

"General Reports of H.M. Inspectors on Elementary Schools and Training Colleges for the year 1901." Pp. 234. (Eyre and Spottiswoode.) Price 1s.

"General Reports of H.M. Inspectors on Science and Art Schools and Classes and Evening Schools." Pp. 93. (Eyre and Spottiswoode.) Price 5s.

The second factor in the success of American education to which reference has been made is the recognition of the existence of a science, as well as an art, of education. Sir Joshua Fitch points out in his introductory paper that "America may be regarded as a laboratory in which educational experiments are being tried on a great scale, under conditions exceptionally favourable to the encouragement of inventiveness and fresh enthusiasm, and to the discovery of new methods and new truths." The experimenters are, moreover, well trained for their work. There is little scepticism as to the value of training for teachers in the minds of American authorities, and some idea of the pains taken to make the training as helpful and practical as possible can be obtained from Dr. Russell's account of the admirable Teacher's College of Columbia University, included in Part I. of the report. Among the numerous proofs, contained in these pages, of the success attained by the teachers proceeding from American training colleges, President Hadley's opinion may be quoted:—"Our best American schools of technology are no longer places for shop work, but places for the training of thinkers—of men who may not know how to do the particular things which will first be wanted of them, but who are in possession of that general knowledge which will enable them to learn more thoroughly the real bearings of any new problem as it arises. They have become less technical and more scientific."

The space available allows only the briefest reference to the general reports of H.M. Inspectors. Attention must, however, be called to the remarks of Mr. Pullinger, Chief Inspector of science and art schools in the northern division of England, on the work of evening continuation schools. He finds that many of the pupils in these schools "come for warmth, for the comforts of an attractive, well-lighted room, for the monthly lantern lectures and for the free trip to Blackpool at the end of the session." The schools have been variously described as "gather-em-in-at-any-price-schools" and as "a sort of shelter for homeless boys and girls." Mr. Pullinger wishes "to state emphatically that the supply of really educational night schools is most inadequate." When it is remembered that the evening classes of our technical schools have largely to rely upon the preliminary training given to their students at these evening continuation schools, the immediate necessity for their improvement becomes evident, and it is to be hoped that the Board of Education will refuse its grants to all schools where the chief aim is recreative.

SNOW-WAVES AND SNOW-DRIFTS.¹

THE primary object of a visit to Canada at the end of 1900 was to continue the investigation of terrestrial surface waves and wave-like surfaces, without, however, confining attention entirely to the study of such forms or motions of the snow as might be wave-like in character.

In Canada a geographical distribution of the kinds of snow was noticed. Near Montreal the snow was, on the whole, only moderately dry, and during December did not differ very much from what was seen in Scotland, on the Pentland Hills and near Grantown-on-Spey, during February, 1900, except that the freshly fallen flakes did not cling together to form mottling and rippling. The forms of the snow-drifts, or banks, in the neighbourhood of obstacles were not very dissimilar. The same general character of snow was observed as far west as Port Arthur, 1000 miles by rail from Montreal, the surface of the snow being generally soft. Near Winnipeg and westwards, at least as far as Medicine Hat, the appearance of the snow-banks accumulated in the neighbourhood of obstacles was strikingly different. Here the snow was almost perfectly dry and the snowfall light. The prairie was often swept quite bare of snow in the neighbourhood of the banks, and the surface of the snow on the prairie was generally hard and rough. But for its whiteness, the landscape resembled a desert with low isolated sand-hills more than a snow-scene in England. Much of this snow was granular, like sand, as the result of processes which it had undergone since its deposition.

On reaching the Rockies, the snow was seen to resemble more that of eastern Canada, but afterwards it became, apparently, still more moist, so that, in the next range, the

¹ Abridged from a paper by Dr. Vaughan Cornish, read before the Geographical Society on May 12 and published in the August number of the *Geographical Journal*.

Selkirks, perfect examples of the forms which gravity imparts to moist snow were met with.



FIG. 1.—A Snow-mushroom nine feet in diameter.

At Glacier House a tree stump 2 feet in diameter had a cap of snow 9 feet across, the eaves projecting 3 feet 6 inches all round the pedestal. A broken tree with diameter of 4 feet had a snow-cap 12 feet across, the eaves projecting 4 feet beyond the pedestal (Fig. 1). Some of these snow-mushrooms must have weighed a ton.

That the "snow-mushroom" is, on the whole, so remarkably preserved from ruin by overloading may be attributed to bending of the strata under the action of gravity, their inclination to the horizon increasing with the distance from the pedestal.

Waves of drifting snow are only formed in dry snow at a low temperature. They are not so steep as the corresponding sand-waves.

Even when the surface is all covered with fresh snow, an extensive horizontal plain appears to be the best field for the growth of snow-waves, for the liability to local *surcharge* increases with the extent of the field of drifting. The more unlevel is the country, and the more numerous the places of shelter, the shorter is the time during which the wind can drift the snow in waves, and the smaller is the extension of the individual groups of waves.

Snow-fences are commonly erected in Canada to check the rate of snow-drifting. After the first snowfall, a snow bank or drift is produced, having a moderately gentle slope to windward and a cliff or cornice on the lee side. The form resembles that of a sand-dune or any other wave of a drifted powder, which at first

suggests that the form proper to a drift caused by the fence is similar to that of freely drifting snow. This, however, is not the case, for the structure is as yet incomplete, owing to insufficient supply of the material. Succeeding snowfalls build out the drift with a diminishing cliff, until we have at last, perhaps not until nearly the end of winter, the completed form in which there is no lee cliff, but a long, gently tapering slope on the lee side, the weather face retaining its original form and *relatively* steep slope.

When we have to do with large bluffs or cliffs, the whole of the winter's snow is not sufficient to fill in the area of eddies on the sheltered side so as to reduce the surface to "easy lines." Thus the largest drifts are never of completed form, but have always a steep face to leeward. Completed drifts, having no shadow-throwing cliffs, are also much less conspicuous relatively to their size. Thus circumstances combine to prevent the casual observer from discovering what is the profile really proper to a snow-drift.

From an examination of the snow-drifts in Canada, the conclusion was reached that a curve of the character shown in Fig.



FIG. 2.—The fundamental Curve of Snow-drifts.

2, with the blunt end towards the wind, was the fundamental element of their form.

This, which may be termed the *ichthyoid curve*, is the profile of completed drifts in the neighbourhood of obstructions on the prairie.

Inverted, it is the profile of the holes round trees, as observed in the woods near Montreal.

Viewed in plan, it is the curve cut out in the snow round the end of a wall.

Viewed in plan together with its image, it is a boundary curve enclosing the horseshoe-shaped banks round houses near Winnipeg, and equally the hollows round trees or stones.

This doubled curve has the generalised form of a fish,¹ or if it be spun round so as to give the outline of a solid body, we have the modern Whitehead torpedo with the blunter head now preferred to the older sharp-nosed form.

The analogy to the fish-form is still more striking if fishes are looked at from above instead of viewing them in profile.

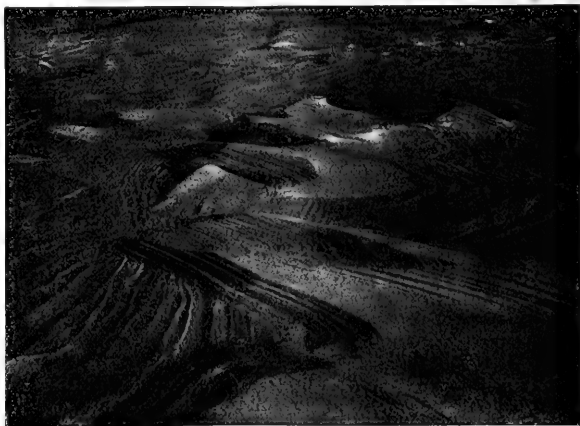

FIG. 3.—Stratification of Snow revealed by Wind Erosion.

The completed snow-drift in the neighbourhood of an obstruction. The profile of the snow-drift resembles the profile of a sole or other flat fish.

tion may be regarded as a filling in of the eddy space in such a way as to provide easy lines for the flow of the wind.

In waves into which freely drifting powders fall, the steep side is on the leeward instead of upon the windward, and this signifies that the eddy-space is *never* filled up. The whole eddy-space is, in fact, free to move forward, and does so when the snow is drifting, and this progression is the wave motion.

The relation between the profile of the snow-drift and that of the waves of drifting snow and sand may be further illustrated by drawing the profile of the wave, not in the usual way, from trough to trough, but from crest to crest. It is then seen that the unfilled space between the two ridges has the blunt nose and fine tail profile; that it is the profile of the hollows in snow round trees and of the fulges of sandy deserts, the form proper to an eddy space.

The powder, when drifting in waves, has the "fine nose and blunt tail form," which is that of greater eddy-making resistance (the nose being that part turned towards the wind), and the powder, when in its complete accumulation near fixed obstructions, assumes the "blunt nose and fine tail" form, which is that of less eddy-making resistance. Both forms are simultaneously produced on a snow-field, and both are compatible with the removal by the wind of the maximum quantity of snow in the course of the winter. Thus, on the one hand, the maintenance of strong eddies in the drifting waves evidently increases the power of the wind to drive the snow before it; and the hindrance offered by a fixed obstruction is best minimised by filling in its eddy-space with a structure which shall thereafter absorb as little energy from the wind as possible.

Sometimes the freely drifting snow is accumulated in isolated hillocks, which have been called *barchans* or *medaños*. Sometimes their development from patches of drift snow can be observed. These patches have in ground plan a fine nose towards the wind and a blunt tail or lee end—a sort of delta shape, but with curved sides. The same thing may be seen in sand. This is in accordance with the habit of the freely drifting snow to adopt a fine nose and blunt tail arrangement in vertical profile.

Freely moving barchans of less or greater elongation probably fill in less or more of the narrow end of the ichtyoid curve. The crest of the cliff will be lower than the summit of the barchan if the former be beyond the broadest part of the curve. The erosion forms produced by wind when acting upon consolidated snow were also studied. Fig. 3 shows how the minute stratification of the snow is revealed by the action of the wind.

UNIVERSITY AND EDUCATIONAL INTELLIGENCE.

The following list of candidates successful in this year's competition for the Whitworth scholarships and exhibitions has been issued by the Board of Education, South Kensington:—Scholarships, 125*l.* a year each (tenable for three years):—William M. Selvey, London; Leonard Bairstow, Halifax; Isaac V. Robinson, West Hartlepool; Arthur Baker, Gosport, Hants. Exhibitions, 50*l.* (tenable for one year):—Charles Cook, Landport, Portsmouth; John S. Mitchell, Uddingston, near Glasgow; Charles J. Stewart, Fratton, Portsmouth; Arnold H. Gibson, Sowerby Bridge, Manchester; William E. W. Millington, Hollinwood, Oldham; Neil J. Maclean, Kelvinside, Glasgow; Henry J. Jones, Southsea; Harold Rawstron, Oldham; George H. Childs, Portsmouth; Norman L. Ablett, London; William E. F. Curror, Ilford, Essex; Walter L. Port, Brighton; John Alexander, Glasgow; Louis D. Stansfeld, London; Robert J. A. Pearson, Sheffield; William L. Perry, Plymouth; Arthur S. Angwin, London; Francis G. Steed, Devonport; Henry A. Bagg, London; Frederick J. Crabbe, Southsea; Arthur Garrard, Forest Gate, E.; Benjamin J. Thomas, Devonport; Maurice B. Dalby, Gateshead; Thomas Wadhams, Wolverton; Oliver S. Spokes, Crewe; James Crone, Charlton, Kent; Alexander B. Sower, Glasgow; Fred Sykes, Huddersfield; Frederick E. Rebbeck, Belfast; Frank W. Harris, Swindon.

The metropolitan and most of the provincial medical schools will be opened at the beginning of October. Among the addresses to be delivered, the following are announced:—*Charing Cross Hospital*. The fourth biennial Huxley

lecture on "Recent Advances in Science and their Bearing on Medicine and Surgery," by Prof. W. H. Welch, of the Johns Hopkins University, Baltimore. *St. George's Hospital*. Address by Dr. T. T. Whipham. *St. Mary's Hospital*. Address by Sir A. W. Rucker, F.R.S. *Middlesex Hospital*. Mr. Stephen Paget will give an address. *University College*. Address by Mr. Percy Flemming. *London (Royal Free Hospital) School of Medicine for Women*. Address by Mr. Charles Burt. *School of Pharmacy*. Address by Dr. W. Palmer Wynne, F.R.S. *Royal Veterinary College*. Address by Prof. Bottomley. *Yorkshire College, Leeds*. Address by Mr. A. W. Mayo Kobson. *University College, Sheffield*. Address by Sir H. G. Howse. *Owens College, Manchester*. Address by Sir Dyce Duckworth. *University College of South Wales and Monmouthshire, Cardiff*. Address by Dr. Berry Hart.

A SUMMARY of the more important recommendations contained in the report of the Indian Universities Commission, which has now been published in India, is given in the *Pioneer Mail* of August 8. Among other points, it is recommended that in addition to holding examinations, all universities should be recognised as teaching universities, and that there should be no more than five faculties, viz. arts, science, law, medicine and engineering. One regulation is certainly a tribute to the power of memorising possessed by the oriental mind; it is prescribed that "text-books to be read should be so long as to exclude the possibility of all of them being committed to memory"; another lays it down that "students should not be required to pass in science before entering on the University course. Instruction should include practical experimental work, and in examinations for the B.Sc., the practical examinations should be passed independently of the written examinations, and should have a separate minimum of marks. . . . The degree of D.Sc. should require original research." The improvement of the equipment of medical colleges is urged, as well as the establishment of a diploma of sanitary science. The universities are not recommended to undertake instruction in engineering, but are advised to encourage agricultural and commercial studies. We agree with the concluding remark of the commissioners, that "it is better for India that a comparatively small number of young men should receive a sound and liberal education than that a large number should be passed through an inadequate course of instruction leading to a depreciated degree."

SCIENTIFIC SERIALS.

Bulletin of the American Mathematical Society, (2) vol. viii. No. 10 (July).—E. J. Wilczynski, account of the first meeting of the San Francisco section, with abstracts of the papers read.—Mary M. Newson, a translation of Hilbert's lecture on mathematical problems (delivered at the Paris Congress, 1900).

American Journal of Mathematics, vol. xxiv. No. 3 (July).—S. Kantor, types of linear complexes of elliptic curves in space of γ dimensions.—R. E. Moritz, generalisation of the differentiation process.—H. D. Thompson, simple pairs of parallel *W*-surfaces.

SOCIETIES AND ACADEMIES.

LONDON.

Royal Society, April 24.—"On Skin Currents. Part iii. The Human Skin." By Augustus D. Waller, M.D., F.R.S. (from the Physiological Laboratory of the University of London).

In freshly removed healthy skin, the normal current is always ingoing and the response to electrical excitation by the induction coil is always outgoing. This response, called by Dr. Waller the "blaze," is a sign of its vitality, is independent of the normal current and amounts to from 0.0100 to 0.0400 volt, if tested, within forty-eight hours after removal, by tetanising currents of alternating direction in both pairs of direction.

Moribund skin and skin from post-mortem room give small reactions of variable direction amounting to not more than ten-thousandths of a volt.

In all cases, the electrodes were carefully tested and the skin subsequently killed by boiling, tested and found to give negative results.

The following observation is illustrative. A piece of skin of breast one-and-a-half hours after removal gave 0.0180 and 0.0230 volt in response to single shocks of both directions. On the third day the reactions were 0.0050 and 0.0175, on the fourth day 0.0025 and 0.0035. In all cases, this was abolished by boiling.

A remarkable feature was the great diminution of resistance of living skin caused by tetanisation. The resistance of dead skin is far below that of living skin and is unaltered by tetanisation. Fatigue is exhibited more in human skin than in frog's skin.

As regards the locality of the reaction, Dr. Waller finds that the blaze currents arise exclusively from the malpighian layer of the epithelium, not from the superficial keratinised cells, or from the subcutaneous tissue and the corium; he demonstrates this by means of a three-way key leading off from three electrodes, of which one, A, is on the external surface, B on the internal opposed surface, C on an external indifferent part. Excitation is made through A B and the result is led off from A C and from B C; there is response from A C, but not from B C, showing that the under surface B gives no reaction. The blaze reaction is quite local and is not propagated to any distance from the excited spot, and adjacent portions exhibit different degrees of vitality.

The apparent duration of vitality is surprising, lasting as long as ten days after excision.

The remarkable augmentation of conductivity by tetanisation may be due to, first, a "Karaophoric" migration of water, second, to a dissociation of electrolytes. Dr. Waller is inclined towards the second alternative.

Alterations of temperature produce alterations of resistance as in any moist conductor. In the case of living skin, Dr. Waller has witnessed at the moment of congelation (-4° to -6° of the cooling chamber) a sudden electromotive discharge of 0.0080 volt attributable to the sudden excitation of living matter in the act of congelation. On return of the frozen skin to the original temperature, the resistance was found to be much reduced and the response to excitation was abolished.

PARIS.

Academy of Sciences, August 23.—M. Bouquet de la Grye in the chair.—Short period solar and meteorological variations, by Sir Norman Lockyer, K.C.B., and Dr. William Lockyer. A comparison of the curves, for a period of from fifteen to thirty years, of sun-spots, prominences, atmospheric pressure and rainfall in India. By comparing the solar data with the terrestrial atmospheric pressure, the conclusion is reached that the eruptions of prominences, coinciding with the variations of latitude shown by the spots about every three and a half years, are the true causes of a variation of air pressure on the earth.—The relation between the solar protuberances and terrestrial magnetism, by Sir Norman Lockyer, K.C.B. An examination of Italian observations made during the last thirty years has shown that the epochs of the solar storms classed as great by Ellis are identical with those of the greatest chromospheric activity near the poles of the sun, whilst the general curve of terrestrial magnetic activity is very nearly the same as that of the prominences observed near the solar equator.—The theoretical study of resistance to compression of mortar, by M. Considère.—On the methods of concentrating liquids used for food, and especially wine, by M. F. Garrigou. By distilling wine in a vacuum, it has been found possible to reduce the wine to one-fourth of its original bulk, without losing any of its aroma or alcohol.—Mechanical treatment in the milk industry, by MM. F. Bordes and Sig. de Raczowski. The number of bacteria in a cubic centimetre of milk capable of forming colonies under plate cultivation was determined in the milk as it left the udder, in the mass of milk 24 and 36 hours after milking, in the one case where it had not been touched by hand, and in the other after the usual amount of handling. In some cases, special antiseptic precautions were taken. The results show that there is no difficulty in keeping the various pipes and taps used in connection with the mechanical treatment sterile, and at the same time there is greater safeguard against accidental contamination.—The structure of the suprarenal bodies of the Plagiostoma, by M. E. Grynfelt.

NEW SOUTH WALES.

Royal Society, July 2.—Prof. Warren, president, in the chair.—Notes on two chemical constituents from the Eucalypts, by Mr. Henry G. Smith.—In this paper, the author records the

results of continued investigations on the ester (geranyl-acetate) contained in the oil of *Eucalyptus Macarthurii*, and also on the oil itself. These data show that the ester does not fall, at any time of the year, below 60 per cent., and that the amount of free alcohol, considered as geraniol, diminishes in amount as the ester increases. The greatest amount of naturally formed ester occurring at any time of the year was 74.9 per cent. in September, but the free alcohol was only 6 per cent., at that time. It has been found from numerous determinations that when the oil is acetylated the ester content will be but little removed from 80 per cent. The oil does not contain phellandrene at any time of the year, and eucalyptol appears to be always absent. Eudesmol is always present, but as it varies in amount the specific gravity of the oil varies also. The crude oil appears to be always slightly dextrorotatory. From the results of investigation of the oil obtained from more than 100 distinct species of Eucalypts, this is the only one found to contain this valuable oil.—The aboriginal languages of Victoria, by Mr. R. H. Mathews.—The parks of Sydney; some of the problems of control and management, by Mr. J. H. Maiden.

CONTENTS.

PAGE

Dangerous Trades. By Dr. T. E. Thorpe, C.B., F.R.S.	433
The New International Catalogue. By Prof. Herbert McLeod, F.R.S.	436
Another Theory of Sex. By J. A. T.	437
Röntgen Rays in Medicine and Surgery	438
Our Book Shelf:—	
Fletcher: "Elementary Geometry"	438
Church: "Diagrams of Mean Velocity of Uniform Motion of Water in open Channels, based on the Formula of Ganguillet and Kutter."—R. G. B.	439
Leonard: "A First Course of Chemistry (Heuristic)."—A. S.	439
Jackson and Jackson: "An Elementary Book on Electricity and Magnetism and their Applications." S. S.	439
Ovenden: "The Face of Nature"	439
Kassner: "Gold Seeking in South Africa: a Handbook of Hints for intending Explorers, Prospectors and Settlers. With a Chapter on the Agricultural Prospects of South Africa"	440
Hollenan: "A Text-Book of Inorganic Chemistry"	440
Hasler: "The Berne Oberland"	440
Letters to the Editor:—	
Archæological Remains on the Summit of the Nevado de Chañi.—Dr. Erlend Nordenskiöld, F.R.S.	440
Radiant Point of the Perseids.—Prof. Alexander Graham Bell	440
Earth Surface Vibrations.—F. C. Constable; J. M. Larva Stage of <i>Helicopsis Isidis</i> .—Fred. Fletcher	441
The Lava-Lake of Kilauca. (Illustrated.) By S. E. Bishop	441
The Influence of Education upon Trade and Industry. By Dr. F. Mollwo Perkin	442
Bird-Photography in the Garden. (Illustrated.) By R. L.	444
A New Theory of the Tides of Terrestrial Oceans. by Prof. G. H. Darwin, F.R.S.	444
Notes	445
Our Astronomical Column	
Catalogue of New Double Stars	450
Hypothesis on the Nature of Solar Prominences	450
Visit of the English Arboricultural Society to Compiegne. (Illustrated.) By Prof. W. R. Fisher	450
Palæolithic Frescoes and Mural Engravings. (Illustrated.) By A. C. H.	452
Sea Temperature Variations on the British Coasts. (Illustrated.)	452
Recent Educational Reports	453
Snow-Waves and Snow-Drifts. (Illustrated.) By Dr. Vaughan Cornish	453
University and Educational Intelligence	455
Scientific Serials	455
Societies and Academies	455

THURSDAY, SEPTEMBER 11, 1902.

TRIANGULATION OF SOUTH AFRICA.

Geodetic Survey of South Africa. Vol. ii. Report on a Rediscovery of Bailey's and Fourcade's Surveys and their Reduction to the System of the Geodetic Survey. By Sir David Gill, K.C.B., LL.D., F.R.S., &c., H.M. Astronomer at the Cape. Pp. xx + 257. (Cape Town, 1901.)

THE Geodetic Survey of Cape Colony and Natal was carried out in the years 1883-92 by Colonel Morris, C.B., C.M.G., R.E., under the direction of Sir David Gill, and the results were published in the report issued in 1896.

The present volume is entitled vol. ii. of the Geodetic Survey, although, as Sir David Gill points out, its contents are not strictly of a geodetic character. As, however, many of the points are connected with stations of the Geodetic Survey, "with all the accuracy required for astronomical geodetic stations, it has been considered convenient to preserve the results in the same series of publications."

This vol. ii., then, is a discussion of the secondary triangulation carried out by Captain Bailey, R.E., in the years 1859-62, and of that executed by Mr. Fourcade, of the Forestry Department (in 1893?). These triangulations extend along the southern coast of South Africa from Cape Town to East London, a distance of about 75 miles, and have an average width of about 75 miles, covering an area of some 40,000 square miles. The probable error of an observed angle of Bailey's triangulation is about $\pm 2''$; of Fourcade's, $\pm 0''\cdot 85$. The number of points fixed is 133.

The history of the computation of Bailey's work is somewhat curious. In 1862 the Survey party embarked at Algoa Bay for England in a coasting steamer. The vessel struck upon the rocks off Struy's Point and became a total wreck. The original observation books were all lost. Fortunately, copies of abstracts of angles had been supplied to the Admiralty Surveyor, then at work on the Coast Survey, and other abstracts with a diagram had been sent to the Surveyor-General, to the Government of British Kaffraria, and to private individuals and surveyors, and from these a report was compiled by Captain Bailey and presented to the Cape Parliament in 1863. On the completion of the Geodetic Survey, however, it became obviously necessary to harmonise Bailey's work with the geodetic triangulation.

Throughout the length of the secondary work there are many sides which are common to it and the geodetic triangulation. The secondary triangulation has therefore been broken up into a number of small manageable figures. In these figures the number of equations of condition averages about ten, and in the reduction the geodetic triangulation is considered errorless, and its sides and angles enter as fixed quantities.

The net result is an important addition to the triangulation of South Africa. The volume is all the more valuable for the fact that the results of the Geodetic

Survey (the report of which is now out of print) have been reprinted in the present report, which contains the whole of the accurate trigonometrical data in the Cape Colony and Natal which had been completed up to the year 1901. It may be hoped that the day is not far distant when this work will be used as the basis of the much-needed, long-delayed topographical survey.

Sir David Gill ends his preface with a remark which several national surveys might take to heart with advantage:—

"It is also of supreme importance that regular inspection of the Survey beacons should be instituted, and steps taken to provide for their repair and maintenance . . . it is most necessary in the public interest that these invaluable land-marks, which have cost so much in labour, skill and care to establish, should in future be more carefully preserved."

It may be noted that this is a duty which in India has long been recognised and carried out by the Government.
C. F. CLOSE.

VITALITY.

Religio Medici, &c. By a Student of Science and Medicine. Pp. viii + 216. (London: Good and Co., 1902.)

THE reader of this book is at first sight beset by two prejudices; the title, as printed on the back of it, "*Religio Medici*," is one which a great writer has made his own, a writer whose weight and intensity stand in contrast with the diffuseness and repetition of the present author; and secondly, the type is so small and defective that the labour of perusal is out of all proportion, so the reviewer is apt to think, to the value of the contents. A distant imitation of Sir Thomas Browne's conciseness would have halved these contents, at least; and thus reduced the cost of production by means better than inferior print. At the hundredth page our eyes gave out; but, after a glance at the remainder, we think in the first moiety one may read the whole.

The main purpose of the author is, by an argument which is similar to that of Dr. Lionel Beale, is not identical with it, to assert that "vitality" or "life power" belongs to the spiritual as opposed to the physical or material category, the realm of life being separate from the realm of matter. The end or purpose of this argument is not, of course, to be flouted because it cuts at the root of modern conceptions from which such entities have been dismissed; nay, even if the author regards force as something acting upon matter, as a bellows upon sand, it does not become us to throw his book aside because we have outgrown or parted company with such opinions. Evidently the author is not only an earnest and high-minded thinker, but also an accomplished scientific observer. His skill in the use of the microscope and its methods is probably considerable. But, while our minds are open and our respect for the writer is great, before we occupy our space with so vast a discussion we must have reasonable expectation of getting close to the points of issue. Of this approximation we see little hope. In the first place, it is inconceivable that modern conceptions will ever be put on the shelf that older opinions may be taken up again in their former

shape. Modern conceptions will, we trust, give way to others larger and better; in this author and reviewer are at one: yet their supersession will be by no such repentance, but by a wider and richer synthesis in which, no doubt, earlier and later opinions will find their reconciliation. To throw new ideas aside just to pick up certain old ones which, in substantially the same form, have prevailed and then lost their ascendancy, is what in the history of ideas has never happened, and, it is safe to say, never will happen. Secondly, to remodel our conceptions of life the thinker must not only be equipped, as no doubt the author is equipped, with skill in certain processes of research, but he must be equipped also with a philosophic grasp and penetration of which we see little evidence here. Besides the diffuse, reiterating and even rambling way of dealing with the subject on which we have animadverted, the author has neither rigidly defined his terms (such as "physical," "mechanical," &c.) nor repeated them even in approximately identical senses. Slovenly argument and confusion of language can only lead into the desert.

The author deprecates rash speculation; no speculation can be more ambitious than his, and it is none the less so for being elderly and familiar. The doctrines of the survival of the fittest may be "ingenious and fanciful," but his own are no less audacious and stand on supports at least as fragile.

In conclusion, we must content ourselves with pointing out that vital phenomena depend upon causes either of like nature to those which are in action in heat, light, chemical affinity and so forth, or they depend upon some intrusive entity of alien origin. The author holds the latter opinion. We must invite those who hold this opinion to explain whether in their hypothesis those which we will call the natural forces are superseded by the transcendental or not? So far as our knowledge goes, they are converted, but neither superseded nor curtailed; yet in this case how are we to conceive of them as entering into any sort of combination with agents with which they have no affinity whatsoever?

OUR BOOK SHELF.

Elements of Physics. By C. Henderson, Ph.D., and John F. Woodhull, Ph.D. Pp. x + 388; with illustrations and portraits.

Physical Experiments. By John F. Woodhull, Ph.D., and M. B. van Arsdale. Pp. iv + 112. (London: Hirschfeld Bros., Ltd., 1902.) Price 5s. net bound together.

It is to be feared that the former of these books (which are bound together) must be condemned if only for the astounding way in which optical images are considered. The image in a concave mirror is taken as being at the same distance behind the mirror as the object is in front, "because this seemed to be as reasonable as any other conclusion and it is a convenient measurement." This rule makes the image curved, and thus its distortion is explained. Even the usual inverted image is placed and its magnitude determined in accordance with the above rule. Extraordinary statements such as these in the chapter on light make it impossible to recommend that the book be placed in the hands of school children, for whom it is intended. The other portions are not affected with such general misconceptions, although they are not wholly free from serious error. Thus on p. 262 it is

stated that a 32 c.p. lamp requires twice the current of a 16 c.p. lamp, and that this may be obtained either by doubling the voltage or halving the resistance. "In any case the heat and light will be proportional to the amount of current which passes." On p. 205, in connection with latent heat, "Farmers understand this and put tubs of water in their vegetable cellars on a cold night so that if the temperature falls below 32° F. the freezing of the water will give out such quantities of heat as shall prevent the temperature from falling far below 32°."

These mistakes are to be regretted the more because the authors appear to have striven to give, and in many cases have succeeded in giving, a lucid introductory account of the many phenomena dealt with.

The experimental book contains a very good selection of experiments for school use. The description given is too brief except as a general guide to the teacher.

A. W. P.

Types of British Plants. By C. S. Colman. Pp. xii + 238. (London: Sands and Co., 1902.) Price 6s.

THIS is a volume which is intended to attract and teach the young naturalist. It presents a short general introduction, systematic and anatomical; it then traces out a developmental course, which begins with the simple unicellular alga, works up through the more complex cryptogams and finally passes in review the principal phanerogamic orders. In addition, a few chapters are given up to special features, notably trees, parasites and insectivorous plants. Apart from the fact that no worse system could be adopted than that of placing before a beginner a number of facts loosely strung together, this book has the further disadvantage of starting with the lower plants, which are more difficult of comprehension and less suited to practical examination. The descriptions, too, of the lower plants, besides being so scrappy as to be valueless, are couched in ridiculous language. Why talk of "father pits" and "mother pits" in *Fucus*, or of a "nursery" in *Vaucheria*, or of "cheerful conviction" as applied to *Phallus*. A facetious mode of expression, which implies that plants possess the attribute of consciousness, runs through the book. Unfortunately, too many writers think that loose or facetious phraseology is necessary to make a book popular; it certainly detracts from the value of any scientific work.

Water-Supply. By Prof. William P. Mason. Third Edition, Rewritten. Pp. vii + 448. (New York; John Wiley and Sons; London: Chapman and Hall, Ltd., 1902.)

THIS is the third edition of a work which has met with much appreciation both in this country and in America, for the writer is a recognised authority upon the subject with which he deals. Those who were familiar with the first two editions will note that in the present volume a considerable amount of new material has been added, and that the original chapters on "The Chemical and Bacteriological Examination of Water" have not been included—for the reason that they have been separately published.

There is nothing connected with water-supply—save engineering details of construction of water-works, &c.—on which this volume may not be consulted with value. The writer has an intimate knowledge of his subject, which has been gained by a wide experience. His information and experience is not limited to America, and the work is additionally acceptable to British readers from this circumstance—which is a somewhat exceptional one among American writers of works dealing with sanitation.

The book is well printed and bound, and is very rich in excellent illustrations and diagrams.

LETTERS TO THE EDITOR.

[The Editor does not hold himself responsible for opinions expressed by his correspondents. Neither can he undertake to return, or to correspond with the writers of, rejected manuscripts intended for this or any other part of NATURE. No notice is taken of anonymous communications.]

Science in the Public Schools.

IN NATURE, vol. lxxvi. p. 320, I directed attention to the insignificant place which science still holds in comparison with languages in our secondary education, as indicated by the results of the last matriculation examination at the University of London, the term "science" being limited to the sciences of experiment and observation, as distinguished from mathematical science. It was recognised at the time that the majority of the great public schools of England were only slightly represented in that examination. We have now, however, the results recently published of the examination for higher certificates conducted by the Oxford and Cambridge Schools Examination Board, which is a far better index of the real position of science in schools of the class mentioned. An examination of these lists is not found to be very reassuring. Eton College, for example, with its thousand boys, gains forty-five certificates, yet I cannot find a single name of an Eton boy who has passed in any scientific subject. The following list (with results) contains six of the largest and most representative of such schools:—

Eton ...	45	certificates	...	0	passes in science.
Winchester ...	48	"	...	4	" "
Rugby ...	58	"	...	6	" "
Cheltenham					
College ...	32	"	...	7	" "
Clifton College	23	"	...	8	" "
Marlborough	18	"	...	4	" "

The case of Rugby is the more remarkable, since in the '70's we looked upon that school as a pioneer, the importance of science teaching having been recognised by its great head-master, Dr. Temple, now Primate of All England. It is only fair to state that several of the great public schools, such as Harrow, Wellington and Charterhouse, are not represented.

If we turn now to the published analysis of the results of the whole examination for all the schools concerned, we find 2844 passes in the four languages Latin, Greek, French and German, with 160 (or 5.6 per cent.) first classes; while for the five branches of science allowed by the Board we find only 422 passes, with 98 (or 23.2 per cent.) first classes. These figures again tell us of the great preponderance of language teaching estimated numerically; on the other hand, a comparison of the percentages of first classes is highly complementary to the science-teaching, where it is allowed free quarter.

Speaking generally, the figures quoted may be fairly taken as representing the general attitude towards science of those who have charge of the education of the majority of the boys drawn from the best blood of England. They suggest (1) that the superstition that science forms no part of the education of a gentleman still holds the field; and (2) that the real study of science involves too much trouble in places where the interest in games dominates the whole school-life. There is not a doubt that the state of things disclosed would suit to a large extent remedied if the Universities would insist upon an elementary knowledge of some one branch of science for a pass degree and the Army entrance examinations were so adjusted as to require every candidate to take up at least one science subject in the competitive examinations. The present movement in a circle leads us nowhere, with the supineness of the governing bodies of the public schools. The published results of the Army competitions do not enable us to extend the above investigation to them, since they do not tell us from what schools the several successful candidates come; but it is to be feared that even at Woolwich there is still truth in what was said to me a few years ago by one who knew, that science is looked upon as something "less than the fifth wheel of the coach"; while in the entrance examination for the Staff College, science has still, I believe, no place at all. Thus we go on dreaming, while Germany, America and other countries are wide awake, and the first rule with our leading statesmen seems to be to "shift responsibility," as they cast about them in their feeble attempts at

educational legislation for "light and leading." The universities and the War Office have the power, if only they had the will, to act in the way here suggested; and it can scarcely be doubted that a speedy reform in our secondary education would come about simply through the transfer (in the magisterial mind) of science from the category of things to be tolerated to the category of educational essentials.

An experience of public-school work extending over more than a quarter of a century entitles me, I think, to venture to express strong views on this matter, which is one of national and imperial concern. Surely, those of our scientific giants who have places on the governing bodies of our public schools might wake up to their responsibilities, look into things more closely, and do something to strengthen the hands of those who, as science masters, often labour under grave disadvantages in the stress of the conflict of interests, which must be found in every corporate society such as a great public school. There are, however, to my knowledge cases of enlightened head-masters struggling to move their governing bodies to the necessary expenditure, though insufficiently supported by the pressure of public opinion from the outside. As things are in this country, it seems hopeless to look to the "Conference of Head-Masters" (a sort of educational Vatican Council) for a broad and fair-minded dealing with this question.

This letter is not written in any spirit of hostility to classical and literary studies, the culture derived from which is too often lacking among men of science, but under the conviction that, with a keener spirit of work in the public schools and a better correlation and graduation of studies, science might lift up its head more than it does at present.

A. IRVING.
Bishop's Stortford, September 3.

Animal Intelligence.

ALTHOUGH the terms "ass" and, at any rate in Germany, "ox" (*Ochs*) are very generally applied to stupid persons, those who have observed the bovine and asinine genera know that this is an injustice to those animals; and the following instances of particular intelligence displayed by two of the thus maligned beasts seem worth recording.

A donkey that was kept here learnt to open, not only the gate of its own field, but other gates. One day, having left its own abode, accompanied by two ponies, it went to another field half a mile off, opening three gates on the way, liberated the occupants of this field, a mare and her foal, and a yearling, old friends of the donkey's, as they used to live together, and the whole party, which had been joined by a mastiff, proceeded to wander through the world. About two miles from here the horses were recognised and secured, and the donkey eventually returned with the mastiff; but after this exploit it was thought advisable to get rid of the donkey, as being too zealously devoted to the cause of emancipation.

A Scotch bullock, which had been in the park here for about two years, was sold to a butcher at Derby Market (fourteen miles south of this place) and taken by train to Darley (nine miles north of here). A day or two afterwards the bullock found its way back here, having escaped from its would-be slaughterer, but had, alas! to be sent back to him. It is incredible that the animal can have observed the road from the railway, and the only explanation is that it was brought along the road from Darley when driven here originally from Scotland; but in any case this is a striking instance of tenacious memory and strong attachment to home or comrades.

L. C. HURT.
Alderwasley, Matlock, Derbyshire, September 4.

Variation of Common Copper Butterfly.

IN August, I took a rather large specimen of *Polymastus phloeas* (the common copper butterfly), which has a row of four faint silver-blue spots inside the copper band on the posterior margin of the upper surface of the hind wings.

I should be very glad if any of your readers could tell me if this variation is common, as I can find no mention of it in the book I use, and have never seen another case, though I have examined many of the same species.

With apologies for troubling you.
P. H. T.
September 4.

SOME SCIENTIFIC CENTRES.

V.—THE CHEMICAL LABORATORY OF THE ROYAL INSTITUTION.

THE record of the chemical laboratory of the Royal Institution is such as to give it an unique position among laboratories. The Royal Institution was established in Albemarle Street, London, in 1800, and had its origin in the work Count Rumford did for the poor at Munich—in fact, it first came into existence, in 1799, as the Rumford Institution. We are told that "its primary objects were models, workshops, and useful knowledge to benefit the poor; and that lectures, researches and scientific experiments to amuse and interest the rich, and to advance science, were comparatively the secondary intention of its founder"—and yet the advancement of science has always been its chief function, and it is safe to say that no other single institution has so brilliant a record of successes. But we have only to think of Davy's invention of the safety lamp and of Faraday's electrical researches—of which the modern dynamo and electric traction are an outcome—to realise that, as a matter of fact, the researches carried out in the laboratory of the Institution have served, in the most direct manner possible, to benefit the poor and to carry out Rumford's true purpose, and this, too, in a manner and with a completeness which he could never have contemplated as in the least degree possible. It has proved to be, not merely "a public institution for diffusing the knowledge and facilitating the general introduction of useful mechanical inventions and improvements"—but the birthplace of discoveries which have given rise to them.

Writing from the Royal Institution to his daughter in March, 1801, Rumford said:—"We have found a nice able man for this place as lecturer [on chemistry], Humphrey Davy." A few years later he was able to speak of Davy as the man "who by his eloquence and genius saved the Rumford Institution from an early death." Davy did far more than lecture—from the outset he gave to the Institution its policy, by making it the home of research, and set an example of which it is impossible to exaggerate the importance. Davy was appointed in February, 1801. Volta had just made his great discovery; as Davy phrases it, "the voltaic battery was an alarm bell to experimenters in every part of Europe." Nicholson and Carlisle made the discovery of the decomposition of water by the pile on April 30, 1800. Davy was at once attracted to the study of galvanism, and he treated of galvanic phenomena in his first course of lectures. The closing paragraph of the series of extracts from this course, published in vol. i. of the *Journal* of the Royal Institution under the date, September 1, 1801, is a happy forecast of the victories to be won by himself and others in the field of galvanism:—

"But independent of the immediate applications of this science, much is to be hoped from the elucidations which it may bestow upon the kindred sciences. And a discovery so important as to excite our astonishment cannot fail of becoming at some period useful to society. All the different branches of human knowledge are intimately connected together, and theoretical improvements cannot well be made in them without being accompanied by practical advantages."

Davy's initial triumph in this field was won in 1806, when he delivered the Bakerian lecture, "On some Chemical Agencies of Electricity." The fact that the Institute of France awarded him for this the prize founded by Napoleon for the most important discovery in galvanism, at a time when England and France were at war, is clear proof of the importance attached to his work by the scientific opinion of the time. In the following year came the great discovery of the alkali metals which immortalised his name. It is fair to say that previous

workers had made but chance discoveries, but that Davy's work was clearly based on theory; in fact, that it laid the first theoretical foundations of electrochemical science. Davy laid great stress on the interdependence of chemical and electrical phenomena. Faraday, his successor, fully established by his researches their quantitative interrelationship, and formulated the laws which to the present day serve to guide us. The importance of these researches to chemical theory was dwelt on by Helmholtz, in 1881, in the Faraday memorial lecture which he delivered to the fellows of the Chemical Society in the theatre of the Royal Institution. The conception of valency as consequent on atomic charges of electricity deduced from Faraday's researches, to which Helmholtz directed attention, has yet to be fully appreciated. The closing years of the century, we know, witnessed a remarkable development of electrochemical theory at the hands of Arrhenius and Van 't Hoff; whether the hypothesis applied by these two philosophers be essentially true or not matters little—it is sufficient that it has made the mathematical discussion of chemical phenomena possible, with a degree of accuracy and to an extent altogether remarkable. Modern electrochemical theory, however, is largely based on the discoveries made in the chemical laboratory of the Royal Institution, and this may well be regarded as the original home of both pure and applied electrochemical science.

Davy was both professor of chemistry and director of the laboratory; when Brande followed him as professor, Faraday became director of the laboratory and later on Fullerian professor of chemistry. Faraday's chemical work has never been sufficiently appreciated, his electrical researches having overshadowed it. The skill displayed in his organic researches would do credit to a well-trained chemist at the present day—and yet he was self-trained in such work and there were no precedents to guide him. From this point of view, on account of its completeness, the memoir in which the discovery of benzene was described by him in 1825 is altogether remarkable. The modern chemist thinks only of Kekulé in connection with benzene, but if the hexagon be the appropriate symbol to put on the shield of Kekulé's memory, its shadow should at least hover in the atmosphere of the Royal Institution laboratory—especially as the present occupant of the Fullerian chair has won the right to have it put on his hachment with nitrogen substituted for carbon at one of the angles. In discovering benzene, Faraday laid the foundation-stone of the coal-tar colour industry. A second most important contribution to this industry was made by him in 1826 by the discovery of sulphonaphthalic acid. We rarely think of him as the father of sulphonic acids, or as the progenitor of the naphthols and the madder colours. No one would have rejoiced more than Faraday over a wondrous story such as can now be told of benzene—) the manner in which a large part of organic chemistry centres around it, and of the way in which with its aid the colour-producing power of Nature has been altogether outdone.

Faraday's work on the condensation of the gases will always stand unrivalled on account of the originality and simplicity of his methods and of its completeness; its influence, we know, has been world-wide.

At the beginning of his career at the Royal Institution, Davy turned his attention to agricultural chemistry. He was in consequence engaged by the Board of Agriculture, in 1802, to deliver a course of lectures to its members on the connection of chemistry with vegetable physiology. This he continued to do for ten years, and he thus laid the foundation of agricultural science in this country. Had so wise a proceeding been continued, agriculture might well have been in a far better position than it now is.

Faraday also had technical proclivities, as shown by

his researches on the alloys of steel and on the manufacture of optical glass. Had the example he set in the Royal Institution laboratory been followed, we should scarcely now be making the armour plates for our iron clads under license from Krupp, or be obliged to resort to Jena for improved qualities of glass.

Brande, who occupied the chair in succession to Davy, from 1813 to 1852, did little in the way of research work. Faraday's star was brightest throughout most of these years, and it would indeed have been remarkable had there been a second chemical luminary. It was during Brande's time that the attempt was made to establish a school of chemistry at the Institution which the late

received the consideration they deserve. In extension of this inquiry, he was led to investigate the influence of pressure on the emission of light; among the important results he obtained was the observation that a considerable luminous effect was obtained by burning hydrogen in oxygen under pressure.

Prof. Dewar was appointed Fullerman professor in 1877. Those who have followed his career may recall the two Friday evening lectures he gave prior to his appointment, describing work which he and Prof. McKendrick had done on the effect of light on the retina and optic nerve; the latter of these especially was a remarkable *tour de force*, exhibiting the facility of



Prof. James Dewar, F.R.S.

Sir F. Abel referred to in the Hofmann memorial lecture as the movement which culminated in the foundation of the Royal College of Chemistry.

Frankland, who held the professorship of chemistry from 1863 to 1868, did some of his best work in the Institution laboratory, notably the research (in conjunction with Duppa) on the action of sodium (followed by that of methyl or ethyl iodide) on acetic ether, which has since proved to be one of the most fruitful of synthetic methods. In the course of lectures on coal gas which he delivered in 1867—fully reported at the time in the *Journal of Gas Lighting*, but not otherwise published—he advanced novel views on the origin of flame which have not yet

methods of liquefying the more permanent gases that it shall become possible to deal with large quantities of liquid, and to use such liquids as instruments of research in extending our knowledge of the general behaviour of substances at very low temperatures. In this he has already been highly successful. Not only has he succeeded in preparing large quantities of liquid oxygen, but he has been able by the device of vacuum-jacketed vessels to store this liquid under atmospheric pressure during long intervals, and thus to use it as a cooling agent." The vacuum vessels here referred to were introduced into use by Prof. Dewar in 1892, and have contributed in an extraordinary degree to the advancement of research

at low temperatures. Without them, the crowning achievement of obtaining hydrogen in the liquid state (May, 1898) would scarcely have been possible. Prof. Dewar is shown handling one of these vessels in the picture on p. 461.

The researches carried out under the transcendental conditions now available at the Royal Institution have led to many surprises: notably is this true of the investigations carried out by Profs. Dewar and Fleming on the electrical conductivity of metals, and on specific inductive capacity. The fact that almost all substances may be rendered phosphorescent by insolation when cooled to low temperatures is another discovery made by Prof. Dewar which promises to be of special importance in the light of recent researches on radio-activity.

But to understand Prof. Dewar fully, it is necessary to know him in the upper as well as in the lower regions of the Royal Institution; not only the wealth of his powers of imagination and his scientific acumen then become apparent, but it is realised that he is a man of extraordinarily sympathetic nature, penetrated with artistic feeling and emotions. Unfortunately, he is also gifted with a reticence rare among artists, which is particularly manifest when the time comes to commit his thoughts to paper; the world has lost much in not being made fully acquainted with his discoveries, and if his reflections were more frequently uttered outside his private circle, it would be to the advantage of scientific progress. We may hope that there is much time left to him in which to repair minor faults such as these.

A laboratory in which so many remarkable and important discoveries have been made may certainly be said to have justified the hopes of its founder, and it is surprising that its successes have not won for it a larger measure of public support—that as yet it has had no imitators.

But there is one respect in which Count Rumford might well deplore failure. However much the lectures delivered in the Institution may have interested and even amused the rich, they have failed to lead them to appreciate in any proper measure the value of scientific research to the nation, a subject on which Davy dwelt much in his lectures; for had they done so, an industry such as the coal-tar colour industry, so closely connected in its origin with the Institution, which was first established and for a time flourished in this country, would not have been allowed to pass almost entirely into other hands; the attempt made by Davy to raise agriculture to a science would have been persevered in at the public cost; electrochemistry would have been steadily developed; and pioneer work such as Faraday did on iron and glass would not have been allowed to stand in splendid isolation. A century of the highest example has had little effect in making the knowledge of scientific method a public possession.

THE BELFAST MEETING OF THE BRITISH ASSOCIATION.

IN previous issues of NATURE, particulars have been given as to the local arrangements which have been made for the comfort of those attending this meeting, and the titles of the papers which may be expected to be read in the various sections have been published; not much remains, therefore, to be said by us on this occasion. It may, however, be stated that the illustrated handbook or guide issued by the Association and prepared under the auspices of the Belfast Naturalists' Field Club appears to have been very carefully compiled. It deals with the subjects respectively of Belfast, geology, botany, zoology and antiquities, and is the work of many writers. So far as can be seen as we go to press, the meeting will be a successful one, it being estimated that in point of numbers attending it

will equal the gathering of 1874, at which the total attendance was 1951. Given fine weather, the meeting should be no less enjoyable and interesting than many of its predecessors. It had been hoped that the *Scotia*, of the Scottish Antarctic Expedition, would have been able to visit the harbour and be open for inspection by the members of the Association; this hope, however, seems likely to be disappointed. The address of the President, Prof. Dewar, was delivered as we went to press yesterday, and the various sections began their proceedings this morning. In this issue we print the Presidential Address and that of the President of Section A. Other addresses and accounts of the papers and reports brought before the sections will duly appear in subsequent numbers.

INAUGURAL ADDRESS BY PROF. JAMES DEWAR, M.A., LL.D., D.S.C., F.R.S., PRESIDENT OF THE ASSOCIATION.

THE members of an Association whose studies involve perpetual contemplation of settled law and ordered evolution, whose objects are to seek patiently for the truth of things and to extend the dominion of man over the forces of nature, are even more deeply pledged than other men to loyalty to the Crown and the Constitution which procure for them the essential conditions of calm security and social stability. I am confident that I express the sentiments of all now before me when I say that to our loyal respect for his high office we add a warmer feeling of loyalty and attachment to the person of our Gracious Sovereign. It is the peculiar felicity of the British Association that, since its foundation seventy-one years ago, it has always been easy and natural to cherish both these sentiments, which indeed can never be dissociated without peril. At this, our second meeting held under the present reign, these sentiments are realised all the more vividly, because, in common with the whole empire, we have recently passed through a period of acute apprehension, followed by the uplifting of a national deliverance. The splendid and imposing coronation ceremony which took place just a month ago was rendered doubly impressive both for the King and his people by the universal consciousness that it was also a service of thanksgiving for escape from imminent peril. In offering to His Majesty our most hearty congratulations upon his singularly rapid recovery from a dangerous illness, we rejoice to think that the nation has received gratifying evidence of the vigour of his constitution, and may, with confidence more assured than before, pray that he may have length of happy and prosperous days. No one in his wide dominions is more competent than the King to realise how much he owes, not only to the skill of his surgeons, but also to the equipment which has been placed in their hands as the combined result of scientific investigation in many and diverse directions. He has already displayed a profound and sagacious interest in the discovery of methods for dealing with some of the most intractable maladies that still baffle scientific penetration; nor can we doubt that this interest extends to other forms of scientific investigation, more directly connected with the amelioration of the lot of the healthy than with the relief of the sick. Hereditarily imposes obligations and also confers aptitude for their discharge. If His Majesty's royal mother throughout her long and beneficent reign set him a splendid example of devotion to the burdensome labours of State which must necessarily absorb the chief part of his energies, his father no less clearly indicated the great part he may play in the encouragement of science. Intelligent appreciation of scientific work and needs is not less but more necessary in the highest quarters to-day than it was forty-three years ago, when His Royal Highness the Prince Consort brought the matter before this Association in the following memorable passage in his Presidential Address: "We may be justified, however, in hoping that by the gradual diffusion of science and its increasing recognition as a principal part of our national education, the public in general, no less than the legislature and the State, will more and more recognise the claims of science to their attention; so that it may no longer require the begging box, but speak to the State like a favoured child to its parent, sure of its paternal solicitude for its welfare; that the State will recognise in science one of its elements of strength and prosperity, to protect which the clearest dictates of self-interest demand." Had this advice been seriously taken to heart and acted upon by the rulers of the nation at the time, what splendid

results would have accrued to this country! We should not now be painfully groping in the dark after a system of national education. We should not be wasting money, and time more valuable than money, in building imitations of foreign educational superstructures before having put in solid foundations. We should not be hurriedly and distractedly casting about for a system of tactics after confrontation with the disciplined and co-ordinated forces of industry and science led and directed by the rulers of powerful States. Forty-three years ago we should have started fair had the Prince Consort's views prevailed. As it is, we have lost ground which it will tax even this nation's splendid reserves of individual initiative to recover. Although in this country the king rules, but does not govern, the Constitution and the structure of English society assure to him a very potent and far-reaching influence upon those who do govern. It is hardly possible to overrate the benefits that may accrue from his intelligent and continuous interest in the great problem of transforming his people into a scientifically educated nation. From this point of view we may congratulate ourselves that the heir to the Crown, following his family traditions, has already deduced from his own observations in different parts of the empire some very sound and valuable conclusions as to the national needs at the present day.

Griffith—Gilbert—Cornu.

The saddest yet the most sacred duty falling to us on such an occasion as the present is to pay our tribute to the memory of old comrades and fellow-workers whom we shall meet no more. We miss to-day a figure that has been familiar, conspicuous, and always congenial at the meetings of the British Association during the last forty years. Throughout the greater part of that period Mr. George Griffith discharged the onerous and often delicate duties of the assistant general secretary, not only with conscientious thoroughness and great ability, but also with urbanity, tact and courtesy that endeared him to all. His years sat lightly upon him, and his undiminished alertness and vigour caused his sudden death to come upon us all with a shock of surprise as well as of pain and grief. The British Association owes him a debt of gratitude which must be so fully realised by every regular attendee of our meetings that no poor words of mine are needed to quicken your sense of loss, or to add to the poignancy of your regret.

The British Association has to deplore the loss from among us of Sir Joseph Gilbert, a veteran who continued to the end of a long life to pursue his important and beneficent researches with untiring energy. The length of his services in the cause of science cannot be better indicated than by recalling the fact that he was one of the six past Presidents boasting fifty years' membership whose jubilee was celebrated by the Chemical Society in 1898. He was in fact an active member of that Society for over sixty years. Early in his career he devoted himself to a most important but at that time little cultivated field of research. He strove with conspicuous success to place the oldest of industries on a scientific basis, and to submit the complex conditions of agriculture to a systematic analysis. He studied the physiology of plant life in the open air, not with the object of penetrating the secrets of structure, but with the more directly utilitarian aim of establishing the conditions of successful and profitable cultivation. By a long series of experiments, alike well conceived and laboriously carried out, he determined the effects of variation in soil, and its chemical treatment—in short, in all the unknown factors with which the farmer previously had to deal according to empirical and local rules, roughly deduced from undigested experience by uncritical and rudimentary processes of inference. Gilbert had the faith, the insight and the courage to devote his life to an investigation so difficult, so unpromising, and so unlikely to bring the rich rewards attainable by equal diligence in other directions, as to offer no attraction to the majority of men. The tabulated results of the Rothamsted experiments remain as a benefaction to mankind and a monument of indomitable and disinterested perseverance.

It is impossible for me in this place to offer more than the barest indication of the great place in contemporary science that has been vacated by the lamented death of Prof. Alfred Cornu, who so worthily upheld the best traditions of scientific France. He was gifted in a high degree with the intellectual lucidity, the mastery of form and the perspicuous method which characterise the best exponents of French thought in all departments of study. After a brilliant career as a student, he was chosen at

the early age of twenty-six to fill one of the enviable positions more numerous in Paris than in London, the Professorship of Physics at the Ecole Polytechnique. In that post, which he occupied to the end of his life, he found what is probably the ideal combination for a man of science—leisure and material equipment for original research, together with that close and stimulating contact with practical affairs afforded by his duties as teacher in a great school, almost ranking as a department of State. Cornu was admirable alike in the use he made of his opportunities and in his manner of discharging his duties. He was at once a great investigator and a great teacher. I shall not even attempt a summary, which at the best must be very imperfect, of his brilliant achievements in optics, the study of his predilection, in electricity, in acoustics and in the field of physics generally. As a proof of the great estimation in which he was held, it is sufficient to remind you that he had filled the highest presidential offices in French scientific societies, and that he was a foreign member of our Royal Society and a recipient of its Rumford medal. In this country he had many friends, attracted no less by his personal and social qualities than by his commanding abilities. Some of those here present may remember his appearance a few years ago at the Royal Institution, and more recently his delivery of the Rede Lecture at Cambridge, when the University conferred upon him the honorary degree of Doctor of Science. His death has inflicted a heavy blow upon our generation, upon France and upon the world.

The Progress of Belfast.

A great man has observed that the "intelligent anticipation of events before they occur" is a factor of some importance in human affairs. One may suppose that intelligent anticipation had something to do with the choice of Belfast as the meeting-place of the British Association this year. Or, if it had not, then it must be admitted that circumstances have conspired, as they occasionally do, to render the actual selection peculiarly felicitous. Belfast has perennial claims, of a kind that cannot easily be surpassed, to be the scene of a great scientific gathering—claims founded upon its scientific traditions and upon the conspicuous energy and success with which its citizens have prosecuted in various directions the application of science to the purposes of life. It is but the other day that the whole nation deplored at the grave of Lord Dufferin the loss of one of the most distinguished and most versatile public servants of the age. That great statesman and near neighbour of Belfast was a typical expression of the qualities and the spirit which have made Belfast what it is, and have enabled Ireland, in spite of all drawbacks, to play a great part in the Empire. I look round on your thriving and progressive city giving evidence of an enormous aggregate of industrial efforts intelligently organised and directed for the building up of a sound social fabric. I find that your great industries are interlinked and interwoven with the whole economic framework of the Empire, and that you are silently and irresistibly compelled to harmonious cooperation by practical considerations acting upon the whole community. It is here that I look for the real Ireland, the Ireland of the future. We cannot trace with precision the laws that govern the appearance of eminent men, but we may at least learn from history that they do not spring from every soil. They do not appear among decadent races or in ages of retrogression. They are the fine flower of the practical intellect of the nation working studiously and patiently in accordance with the great laws of conduct. In the manifold activities of Belfast we have a splendid manifestation of individual energy working necessarily, even if not altogether consciously, for the national good. In great Irishmen like Lord Dufferin and Lord Roberts, giving their best energies for the defence of the nation by diplomacy or by war, we have complementary evidence enough to reassure the most timid concerning the real direction of Irish energies and the vital nature of Irish solidarity with the rest of the Empire.

Belfast has played a prominent part in a transaction of a somewhat special and significant kind, which has proved not a little confusing and startling to the easy-going public. The significance of the shipping combination lies in the light it throws on the conditions and tendencies which make such things possible, if not even inevitable. It is an event forcibly illustrating the declaration of His Royal Highness the Prince of Wales, that the nation must "wake up" if it hopes to face its growing responsibilities. Belfast may plead with some justice that it, at least, has never gone to sleep. In various directions an immense advance has been effected during the

twenty-eight years that have elapsed since the last visit of the British Association. Belfast has become first a city and then a county, and now ranks as one of the eight largest cities in the United Kingdom. Its municipal area has been considerably extended, and its population has increased by something like 75 per cent. It has not only been extended, but improved and beautified in a manner which very few places can match, and which probably none can surpass. Fine new thoroughfares, adorned with admirable public institutions, have been run through areas once covered with crowded and squalid buildings. Compared with the early fifties, when iron shipbuilding was begun on a very modest scale, the customs collected at the port have increased tenfold. Since the introduction of the power-loom, about 1850, Belfast has distanced all rivals in the linen industry, which continues to flourish notwithstanding the fact that most of the raw material is now imported, instead of being produced, as in former times, in Ulster. Extensive improvements have been carried out in the port at a cost of several millions, and have been fully justified by a very great expansion of trade. These few bare facts suffice to indicate broadly the immense strides taken by Belfast in the last two decades. For an Association that exists for the advancement of science it is stimulating and encouraging to find itself in the midst of a vigorous community, successfully applying knowledge to the ultimate purpose of all human effort, the amelioration of the common lot by an ever-increasing mastery of the powers and resources of Nature.

Tyndall and Evolution.

The Presidential Address delivered by Tyndall in this city twenty-eight years ago will always rank as an epoch-making deliverance. Of all the men of the time, Tyndall was one of the best equipped for the presentation of a vast and complicated scientific subject to the mass of his fellow-men. Gifted with the powers of a many-sided original investigator, he had at the same time devoted much of his time to an earnest study of philosophy, and his literary and oratorical powers, coupled with a fine poetic instinct, were qualifications which placed him in the front rank of the scientific representatives of the later Victorian epoch, and constituted him an exceptionally endowed exponent of scientific thought. In the Belfast discourse Tyndall dealt with the changing aspects of the long unsettled horizon of human thought, at last illuminated by the sunrise of the doctrine of evolution. The consummate art with which he marshalled his scientific forces for the purpose of effecting conviction of the general truth of the doctrine has rarely been surpassed. The courage, the lucidity, the grasp of principles, the moral enthusiasm with which he treated his great theme have powerfully aided in effecting a great intellectual conquest, and the victory assuredly ought to engender no regrets.

Tyndall's views as a strenuous supporter and believer in the theory of evolution were naturally essentially optimistic. He had no sympathy with the lugubrious pessimistic philosophy whose disciples are for ever intent on administering rebuke to scientific workers by reminding them that, however much knowledge man may have acquired, it is as nothing compared with the immensity of his ignorance. That truth is indeed never adequately realised except by the man of science, to whom it is brought home by repeated experience of the fact that his most promising excursions into the unknown are invariably terminated by barriers which, for the time at least, are insurmountable. He who has never made such excursions with patient labour may indeed prattle about the vastness of the unknown, but he does so without real sincerity or intimate conviction. His tacit, if not his avowed, contention is, that since we can never know all it is not worth while to seek to know more; and that in the profundity of his ignorance he has the right to people the unexplored spaces with the phantoms of his vain imagining. The man of science, on the contrary, finds in the extent of his ignorance a perpetual incentive to further exertion, and in the mysteries that surround him a continual invitation, nay, more, an inexorable mandate. Tyndall's writings abundantly prove that he had faced the great problems of man's existence with that calm intellectual courage the lack of which goes very far to explain the nervous dogmatism of nescience. Just because he had done this, because he had, as it were, mapped out the boundaries between what is knowable though not yet known and what must remain for ever unknowable to man, he did not hesitate to place implicit reliance on the progress of which man is capable, through the exercise of patient and persistent research.

In Tyndall's scheme of thought the chief dicta were the strict division of the world of knowledge from that of emotion, and the lifting of life by throwing overboard the malign residuum of dogmatism, fanaticism, and intolerance, thereby stimulating and nourishing a plastic vigour of intellect. His cry was "Common to before stagnation, the leap of the torrent before the stillness of the swamp."

His successors have no longer any need to repeat those significant words, "We claim and we shall wrest from theology the entire domain of cosmological theory." The claim has been practically, though often unconsciously, conceded. Tyndall's dictum, "Every system must be plastic to the extent that the growth of knowledge demands," struck a note that was too often absent from the heated discussions of days that now seem so strangely remote. His honourable admission that, after all that had been achieved by the developmental theory, "the whole process of evolution is the manifestation of a power absolutely inscrutable to the intellect of man," shows how willingly he acknowledged the necessary limits of scientific inquiry. This reservation did not prevent him from expressing the conviction forced upon him by the pressure of intellectual necessity, after exhaustive consideration of the known relations of living things, that matter in itself must be regarded as containing the promise and potency of all terrestrial life. Bacon in his day said very much the same thing: "He that will know the properties and proceedings of matter should comprehend in his understanding the sum of all things, which have been, which are, and which shall be, although no knowledge can extend so far as to singular and individual beings." Tyndall's conclusion was at the time thought to be based on a too insecure projection into the unknown, and some even regarded such an expansion of the crude properties of matter as totally unwarranted. Yet Tyndall was certainly no materialist in the ordinary acceptance of the term. It is true his arguments, like all arguments, were capable of being distorted, especially when taken out of their context, and the address became in this way an easy prey for hostile criticism. The glowing rhetoric that gave charm to his discourse and the poetic similes that clothed the dry bones of his close-woven logic were attacked by a veritable brood of critical artillery. At the present day these would be considered as only appropriate artistic embellishments, so great is the unconscious change wrought in our surroundings. It must be remembered that, while Tyndall discussed the evolutionary problem from many points of view, he took up the position of a practical disciple of Nature dealing with the known experimental and observational realities of physical inquiry. Thus he accepted as fundamental concepts the atomic theory, together with the capacity of the atom to be the vehicle or repository of energy, and the grand generalisation of the conservation of energy. Without the former, Tyndall doubted whether it would be possible to frame a theory of the material universe; and as to the latter he recognised its radical significance in that the ultimate philosophical issues therein involved were as yet but dimly seen. That such generalisations are provisionally accepted does not mean that science is not alive to the possibility that what may now be regarded as fundamental may in future be superseded or absorbed by a wider generalisation. It is only the poverty of language and the necessity for compendious expression that oblige the man of science to resort to metaphor and to speak of the Laws of Nature. In reality, he does not pretend to formulate any laws for Nature, since to do so would be to assume a knowledge of the inscrutable cause from which alone such laws could emanate. When he speaks of a "law of Nature" he simply indicates a sequence of events which, so far as his experience goes, is invariable, and which therefore enables him to predict, to a certain extent, what will happen in given circumstances. But, however seemingly bold may be the speculation in which he permits himself to indulge, he does not claim for his best hypothesis more than provisional validity. He does not forget that to-morrow may bring a new experience compelling him to recast the hypothesis of to-day. This plasticity of scientific thought, depending upon reverent recognition of the vastness of the unknown, is oddly made a matter of reproach by the very people who harp upon the limitations of human knowledge. Yet the essential condition of progress is that we should generalise to the best of our ability from the experience at command, treat our theory as provisionally true, endeavour to the best of our power to reconcile with it all the new facts we discover, and abandon or modify it when it ceases to afford a coherent explanation of new experience. That procedure is far

as are the poles asunder from the presumptuous attempt to travel beyond the study of secondary causes. Any discussion as to whether matter or energy was the true reality would have appeared to Tyndall as a futile metaphysical disputation which, being completely dissociated from verified experience, would lead to nothing. No explanation was attempted by him of the origin of the bodies we call elements, nor how some of such bodies came to be compounded into complex groupings and built up into special structures with which, so far as we know, the phenomena characteristic of life are invariably associated. The evolutionary doctrine leads us to the conclusion that life, such as we know it, has only been possible during a short period of the world's history, and seems equally destined to disappear in the remote future; but it postulates the existence of a material universe endowed with an infinity of powers and properties, the origin of which it does not pretend to account for. The enigma at both ends of the scale Tyndall admitted, and the futility of attempting to answer such questions he fully recognised. Nevertheless, Tyndall did not mean that the man of science should be debarred from speculating as to the possible nature of the simplest forms of matter or the mode in which life may have originated on this planet. Lord Kelvin, in his Presidential Address, put the position admirably when he said "Science is bound by the everlasting law of honour to face fearlessly every problem that can fairly be presented to it. If a probable solution consistent with the ordinary course of Nature can be found, we must not invoke an abnormal act of Creative Power"; and in illustration he forthwith proceeded to express his conviction that from time immemorial many worlds of life besides our own have existed, and that "it is not an unscientific hypothesis that life originated on this earth through the moss-grown fragments from the ruins of another world." In spite of the great progress made in science, it is curious to notice the occasional recrudescence of metaphysical dogma. For instance, there is a school which does not hesitate to revive ancient mystifications in order to show that matter and energy can be shattered by philosophical arguments, and have no objective reality. Science is at once more humble and more reverent. She confesses her ignorance of the ultimate nature of matter, of the ultimate nature of energy, and still more of the origin and ultimate synthesis of the two. She is content with her patient investigation of secondary causes, and glad to know that since Tyndall spoke in Belfast she has made great additions to the knowledge of general molecular mechanism, and especially of synthetic artifice in the domain of organic chemistry, though the more exhaustive acquaintance gained only forces us the more to acquiesce in acknowledging the inscrutable mystery of matter. Our conception of the power and potency of matter has grown in little more than a quarter of a century to much more imposing dimensions, and the outlook for the future assuredly suggests the increasing acceleration of our rate of progress. For the impetus he gave to scientific work and thought, and for his fine series of researches chiefly directed to what Newton called the more secret and noble works of Nature within the corpuscles, the world owes Tyndall a debt of gratitude. It is well that his memory should be held in perennial respect, especially in the land of his birth.

The Endowment of Education.

These are days of munificent benefactions to science and education, which, however, are greater and more numerous in other countries than in our own. Splendid as they are, it may be doubted, if we take into account the change in the value of money, the enormous increase of population and the utility of science to the builders of colossal fortunes, whether they bear comparison with the efforts of earlier days. But the habit of endowing science was so long in practical abeyance that every evidence of its resumption is matter for sincere congratulation. Mr. Cecil Rhodes has dedicated a very large sum of money to the advancement of education, though the means he has chosen are perhaps not the most effective. It must be remembered that his aims were political as much as educational. He had the noble and worthy ambition to promote enduring friendship between the great English-speaking communities of the world, and knowing the strength of college ties he conceived that this end might be greatly furthered by bringing together at an English university the men who would presumably have much to do in later life with the influencing of opinion, or even with the direction of policy. It has been held by some a striking tribute to Oxford that a man but

little given to academic pursuits or modes of thought should think it a matter of high importance to bring men from our colonies or even from Germany, to submit to the formative influences of that ancient seat of learning. But this is perhaps reading Mr. Rhodes backwards. He showed his affectionate recollection of his college days by his gift to Oxid. But, apart from the main idea of fostering good relations between those who will presumably be influential in England, in the colonies, and in the United States, Mr. Rhodes was probably influenced also by the hope that the influx of strangers would help to broaden Oxford notions and to procure revision of conventional arrangements.

Dr. Andrew Carnegie's endowment of Scottish universities, as modified by him in deference to expert advice, is a more direct benefit to the higher education. For while Mr. Rhodes has only enabled young men to get what Oxford has to give, Dr. Carnegie has also enabled his trustees powerfully to augment and improve the teaching equipment of the universities themselves. At the same time, he has provided as far as possible for the enduring usefulness of his money. His trustees form a permanent body external to the universities, which, while possessing no power of direct control, must always, as holder of the purse-strings, be in a position to offer independent and weighty criticisms. More recently Dr. Carnegie has devoted an equal sum of ten million dollars to the foundation of a Carnegie Institution in Washington. Here again he has been guided by the same ideas. He has neither founded a university nor handed over the money to any existing university. He has created a permanent trust charged with the duty of watching educational efforts and helping them from the outside according to the best judgment that can be formed in the circumstances of the moment. Its aims are to be—to promote original research; to discover the exceptional man in every department of study, whether inside or outside of the schools, and to enable him to make his special study his life-work; to increase facilities for higher education; to aid and stimulate the universities and other educational institutions; to assist students who may prefer to study at Washington; and to ensure prompt publication of scientific discoveries. The general purpose of the founder is to secure, if possible, for the United States leadership in the domain of discovery and the utilisation of new forces for the benefit of man. Nothing will more powerfully further this end than attention to the injunction to lay hold of the exceptional man whenever and wherever he may be found, and, having got him, to enable him to carry on the work for which he seems specially designed. That means, I imagine, a scouring of the old world, as well as of the new, for the best men in every department of study—in fact, an assiduous collecting of brains similar to the collecting of rare books and works of art which Americans are now carrying on in so lavish a manner. As in diplomacy and war, so in science, we owe our reputation, and no small part of our prosperity, to exceptional men; and that we do not enjoy these things in fuller measure we owe to our lack of an army of well-trained ordinary men capable of utilising their ideas. Our exceptional men have too often worked in obscurity, without recognition from a public too imperfectly instructed to guess at their greatness, without assistance from a State governed largely by dilettantes, and without help from academic authorities hidebound by the pedantries of medieval scholasticism. For such men we have to wait upon the will of Heaven. Even Dr. Carnegie will not always find them when they are wanted. But what can be done in that direction will be done by institutions like Dr. Carnegie's, and for the benefit of the nation that possesses them in greatest abundance and uses them most intelligently. When contemplating these splendid endowments of learning, it occurred to me that it would be interesting to find out exactly what some definite quantity of scientific achievement has cost in hard cash. In an article by Carl Snyder in the January number of the *North American Review*, entitled "America's Inferior Place in the Scientific World," I found the statement that "it would be hardly too much to say that during the hundred years of its existence the Royal Institution alone has done more for English science than all of the English universities put together. This is certainly true with regard to British industry, for it was here that the discoveries of Faraday were made." I was emboldened by this estimate from a distant and impartial observer to do, what otherwise I might have shrunk from doing, and to take the Royal Institution—after all, the foundation of an American citizen, Count Rumford—as the basis of my inquiry. The work done

at the Royal Institution during the past hundred years is a fairly definite quantity in the mind of every man really conversant with scientific affairs. I have obtained from the books accurate statistics of the total expenditure on experimental inquiry and public demonstrations for the whole of the nineteenth century. The items are:—

	£
Professors' Salaries—Physics and Chemistry	54,600
Laboratory Expenditure	24,430
Assistants' Salaries	21,390
Total for one hundred years	£100,620

In addition, the members and friends of the Institution have contributed to a fund for exceptional expenditure for Experimental Research the sum of 95*so*l. It should also be mentioned that a Civil List Pension of 300*l.* was granted to Faraday in 1853, and was continued during twenty-seven years of active work and five years of retirement. Thirty-two years in all, at 300*l.* a year, make a sum of 9600*l.*, representing the national donation, which, added to the amount of expenditure just stated, brings up the total cost of a century of scientific work in the laboratories of the Royal Institution, together with public demonstrations, to 119,800*l.*, or an average of 1200*l.* per annum. I think if you recall the names and achievements of Young, Davy, Faraday, and Tyndall, you will come to the conclusion that the exceptional man is about the cheapest of natural products. It is a popular fallacy that the Royal Institution is handsomely endowed. On the contrary, it has often been in financial straits; and since its foundation by Count Rumford its only considerable bequests have been one from Thomas G. Hodgkins, an American citizen, for Experimental Research, and that of John Fuller for endowing with 95*l.* a year the chairs of Chemistry and Physiology. In this connection the Davy-Faraday Laboratory, founded by the liberality of Dr. Ludwig Mond, will naturally occur to many minds. But though alluded to the Royal Institution, with, I hope, reciprocal indirect advantages, that Laboratory is financially independent and its endowments are devoted to its own special purpose, which is to provide opportunity to prosecute independent research for worthy and approved applicants of all nationalities. The main reliance of the Royal Institution has always been, and still remains, upon the contributions of its members, and upon corresponding sacrifices in the form of time and labour by its professors. It may be doubted whether we can reasonably count upon a succession of scientific men able and willing to make sacrifices which the conditions of modern life tend to render increasingly burdensome. Modern science is in fact in something of a dilemma. Devotion to abstract research upon small means is becoming always harder to maintain, while at the same time the number of wealthy independent searchers after truth and patrons of science of the style of Joule, Spottiswoode, and De la Rue is apparently becoming smaller. The installations required by the refinements of modern science are continually becoming more costly, so that upon all grounds it would appear that without endowments of the kind provided by Dr. Carnegie the outlook for disinterested research is rather dark. On the other hand, these endowments, unless carefully administered, might obviously tend to impair the single-minded devotion to the search after truth for its own sake to which science has owed almost every memorable advance made in the past. The Carnegie Institute will dispose in a year of as much money as the members of the Royal Institution have expended in a century upon its purely scientific work. It will at least be interesting to note how far the output of high-class scientific work corresponds to the hundredfold application of money to its production. Nor will it be of less interest to the people of this country to observe the results obtained from that moiety of Dr. Carnegie's gift to Scotland which is to be applied to the promotion of scientific research.

Applied Chemistry, English and Foreign.

The Diplomatic and Consular reports published from time to time by the Foreign Office are usually too belated to be of much use to business men, but they sometimes contain information concerning what is done in foreign countries which affords food for reflection. One of these reports, issued a year ago, gives a very good account of the German arrangements and provisions for scientific training, and of the enormous commercial demand for the services of men who have passed suc-

cessfully through the universities and Technical High Schools, as well as of the wealth that has accrued to Germany through the systematic application of scientific proficiency to the ordinary business of life.

Taking these points in their order, I have thought it a matter of great interest to obtain a comparative view of chemical equipment in this country and in Germany, and I am indebted to Prof. Henderson of Glasgow, who last year became the secretary of a committee of this Association, of which Prof. Armstrong is chairman, for statistics referring to this country, which enable a comparison to be broadly made. The author of the Consular report estimates that in 1901 there were 4500 trained chemists employed in German works, the number having risen to this point from 1700 employed twenty-five years earlier. It is difficult to give perfectly accurate figures for this country, but a liberal estimate places the number of works chemists at 1500, while at the very outside it cannot be put higher than somewhere between 1500 and 2000. In other words, we cannot show in the United Kingdom, notwithstanding the immense range of the chemical industries in which we once stood prominent, more than one-third of the professional staff employed in Germany. It may perhaps be thought or hoped that we make up in quality for our defect in quantity, but unfortunately this is not the case. On the contrary, the German chemists are, on the average, as superior in technical training and acquirements as they are numerically. Details are given in the report of the training of 633 chemists employed in German works. Of these, 69 per cent. hold the degree of Ph.D., about 10 per cent. hold the diploma of a Technical High School, and about 5 per cent. hold both qualifications. That is to say, 84 per cent. have received a thoroughly systematic and complete chemical training, and 74 per cent. of these add the advantages of a university career. Compare with this the information furnished by 500 chemists in British works. Of these only 21 per cent. are graduates, while about 10 per cent. hold the diploma of a college. Putting the case as high as we can, and ignoring the more practical and thorough training of the German universities, which give their degrees for work done, and not for questions asked and answered on paper, we have only 31 per cent. of systematically trained chemists against 84 per cent. in German works. It ought to be mentioned that about 21 per cent. of the 500 are Fellows or Associates of the Institute of Chemistry, whatever that may amount to in practice, but of these a very large number have already been accounted for under the heads of graduates and holders of diplomas. These figures, which I suspect are much too favourable on the British side, unmistakably point to the prevalence among employers in this country of the antiquated adherence to rule of thumb, which is at the root of much of the backwardness we have to deplore. It hardly needs to be pointed out to such an audience as the present that chemists who are neither graduates of a university, nor holders of a diploma from a technical college, may be competent to carry on existing processes according to traditional methods, but are very unlikely to effect substantial improvements, or to invent new and more efficient processes. I am very far from denying that here and there an individual may be found whose exceptional ability enables him to triumph over all defects of training. But in all educational matters it is the average man whom we have to consider, and the average ability which we have to develop. Now, to take the second point—the actual money value of the industries carried on in Germany by an army of workers both quantitatively and qualitatively so superior to our own. The Consular report estimates the whole value of German chemical industries at not less than fifty millions sterling per annum. These industries have sprung up within the last seventy years, and have received enormous expansion during the last thirty. They are, moreover, very largely founded upon basic discoveries made by English chemists, but never properly appreciated or scientifically developed in the land of their birth. I will place before you some figures showing the growth of a single firm engaged in a single one of these industries—the utilisation of coal tar for the production of drugs, perfumes, and colouring-matters of every conceivable shade. The firm of Friedrich Bayer & Co. employed in 1875, 119 workmen. The number has more than doubled itself every five years, and in May of this year that firm employed 5000 workmen, 160 chemists, 260 engineers and mechanics, and 680 clerks. For many years past it has regularly paid 18 per cent. on the ordinary shares, which this year has risen to 20 per cent.; and in addition, in common

with other and even larger concerns in the same industry, has added up profits for immense extensions usually charged to capital account. There is one of these factories the works and plant of which stand in the books at 1,500,000*l.*, while the money actually sunk in them approaches to 5,000,000*l.* In other words, the practical monopoly enjoyed by the German manufacturers enables them to exact huge profits from the rest of the world, and to establish a position which, financially as well as scientifically, is almost unassailable. I must repeat that the fundamental discoveries upon which this gigantic industry is built were made in this country, and were practically developed to a certain extent by their authors. But in spite of the abundance and cheapness of the raw material, and in spite of the evidence that it could be most remuneratively worked up, these men founded no school and had practically no successors. The colours they made were driven out of the field by newer and better colours made from their stuff by the development of their ideas, but these improved colours were made in Germany and not in England. Now what is the explanation of this extraordinary and disastrous phenomenon? I give it in a word—want of education. We had the material in abundance when other nations had comparatively little. We had the capital, and we had the brains, for we originated the whole thing. But we did not possess the diffused education without which the ideas of men of genius cannot fructify beyond the limited scope of an individual. I am aware that our patent laws are sometimes held responsible. Well, they are a contributory cause; but it must be remembered that other nations with patent laws as protective as could be desired have not developed the colour industry. The patent laws have only contributed in a secondary degree, and if the patent laws have been bad, the reason for their badness is again want of education. Make them as bad as you choose, and you only prove that the men who made them, and the public whom these men try to please, were misled by theories instead of being conversant with fact and logic. But the root of the mischief is not in the patent laws or in any legislation whatever. It is in the want of education among our so-called educated classes, and secondarily among the workmen on whom these depend. It is in the abundance of men of ordinary plodding ability, thoroughly trained and methodically directed, that Germany at present has so commanding an advantage. It is the failure of our schools to turn out, and of our manufacturers to demand, men of this kind, which explains our loss of some valuable industries and our precarious hold upon others. Let no one imagine for a moment that this deficiency can be remedied by any amount of that technical training which is now the fashionable nostrum. It is an excellent thing, no doubt, but it must rest upon a foundation of general training. Mental habits are formed for good or evil long before men go to the technical schools. We have to begin at the beginning: we have to train the population from the first to think correctly and logically, to deal at first hand with facts, and to evolve, each one for himself, the solution of a problem put before him, instead of learning by rote the solution given by somebody else. There are plenty of chemists turned out, even by our Universities, who would be of no use to Bayer and Co. They are chock full of formulæ, they can recite theories, and they know text-books by heart; but put them to solve a new problem, freshly arisen in the laboratory, and you will find that their learning is all dead. It has not become a vital part of their mental equipment, and they are floored by the first emergence of the unexpected. The men who escape this mental barrenness are men who were somehow or other taught to think long before they went to the university. To my mind, the really appalling thing is not that the Germans have seized this or the other industry, or even that they may have seized upon a dozen industries. It is that the German population has reached a point of general training and specialised equipment which it will take us two generations of hard and intelligently directed educational work to attain. It is that Germany possesses a national weapon of precision which must give her an enormous initial advantage in any and every contest depending upon disciplined and methodised intellect.

History of Cold and the Absolute Zero.

It was Tyndall's good fortune to appear before you at a moment when a fruitful and comprehensive idea was vivifying the whole domain of scientific thought. At the present time no such broad generalisation presents itself for discussion, while on the other hand the number of specialised studies has enor-

mously increased. Science is advancing in so broad a front by the efforts of so great an army of workers that it would be idle to attempt within the limits of an address to the most indulgent of audiences anything like a survey of chemistry alone. But I have thought it might be instructive, and perhaps not uninteresting, to trace briefly in broad outline the development of that branch of study with which my own labours have been recently more intimately connected—a study which I trust I am not too partial in thinking is as full of philosophical interest as of experimental difficulty. The nature of heat and cold must have engaged thinking men from the very earliest dawn of speculation upon the external world; but it will suffice for the present purpose if, disregarding ancient philosophers and even medieval alchemists, we take up the subject where it stood after the great revival of learning, and as it was regarded by the father of the inductive method. That this was an especially attractive subject to Bacon is evident from the frequency with which he recurs to it in his different works, always with lamentation over the inadequacy of the means at disposal for obtaining a considerable degree of cold. Thus in the chapter in the *Natural History*, "*Sylva Sylvarum*," entitled "Experiments in consort touching the production of cold," he says, "The production of cold is a thing very worthy of the inquisition both for the use and the disclosure of causes. For heat and cold are nature's two hands whereby she chiefly worketh, and heat we have in readiness in respect of the fire, but for cold we must stay till it cometh or seek it in deep caves or high mountains, and when all is done we cannot obtain it in any great degree, for furnaces of fire are far hotter than a summer sun, but vaults and hills are not much colder than a winter's frost." The great Robert Boyle was the first experimentalist who followed up Bacon's suggestions. In 1682 Boyle read a paper to the Royal Society on "New Experiments and Observations touching Cold, or an Experimental History of Cold," published two years later in a separate work. This is really a most complete history of everything known about cold up to that date, but its great merit is the inclusion of numerous experiments made by Boyle himself on frigorific mixtures, and the general effects of such upon matter. The agency chiefly used by Boyle in the conduct of his experiments was the glaciating mixture of snow or ice and salt. In the course of his experiments he made many important observations. Thus he observed that the salts which did not help the snow or ice to dissolve faster gave no effective freezing. He showed that water in becoming ice expands by about one-ninth of its volume, and bursts gun-barrels. He attempted to counteract the expansion and prevent freezing by completely filling a strong iron ball with water before cooling; anticipating that it might burst the bottle by the stupendous force of expansion, or that if it did not, then the ice produced might under the circumstances be heavier than water. He speculated in an ingenious way on the change of water into ice. Thus he says, "If cold be but a privation of heat through the recess of that ethereal substance which agitated the little eel-like particles of the water and thereby made them compose a fluid body, it may easily be conceived that they should remain rigid in the postures in which the ethereal substance quitted them, and thereby compose an unfluid body like ice; yet how these little eels should by that recess acquire as strong an endeavour outwards as if they were so many little springs and expand themselves with so stupendous a force, is that which does not so readily appear." The greatest degree of adventitious cold Boyle was able to produce did not make air exposed to its action lose a full tenth of its own volume, so that, in his own words, the cold does not "weaken the spring by anything near so considerable as one would expect." After making this remarkable observation and commenting upon its unexpected nature, it is strange Boyle did not follow it up. He questions the existence of a body of its own nature supremely cold, by participating in which all other bodies obtain that quality, although the doctrine of a *primum frigidum* had been accepted by many sects of philosophers; for, as he says, "if a body being cold signify no more than its not having its sensible parts so much agitated as those of our sensorium, it suffices that the sun or the fire or some other agent, whatever it were, that agitated more vehemently its parts before, does either now cease to agitate them or agitates them but very remissly, so that till it be determined whether cold be a positive quality or but a privative it will be needless to contend what particular body ought to be esteemed the *primum frigidum*." The whole elaborate investigation cost Boyle immense labour, and he confesses that he "never handled any part of natural

philosophy that was so troublesome and full of hardships." He looked upon his results but as a "beginning" in this field of inquiry, and for all the trouble and patience expended he consoled himself with the thought of "men being oftentimes obliged to suffer as much wet and cold and dive as deep to fetch up sponges as to fetch up pearls." After the masterly essay of Boyle, the attention of investigators was chiefly directed to improving thermometrical instruments. The old air thermometer of Galileo being inconvenient to use, the introduction of fluid thermometers greatly aided the inquiry into the action of heat and cold. For a time great difficulty was encountered in selecting proper fixed points on the scales of such instruments, and this stimulated men like Huygens, Newton, Hooke and Amontons to suggest remedies and to conduct experiments. By the beginning of the eighteenth century the freezing-point and the boiling-point of water were agreed upon as fixed points, and the only apparent difficulties to be overcome were the selection of the fluid, accurate calibration of the capillary tube of the thermometer, and a general understanding as to scale divisions. It must be confessed that great confusion and inaccuracy in temperature observations arose from the variety and crudeness of the instruments. This led Amontons in 1702-3 to contribute two papers to the French Academy which reveal great originality in the handling of the subject, and which, strange to say, are not generally known. The first discourse deals with some new properties of the air and the means of accurately ascertaining the temperature in any climate. He regarded heat as due to a movement of the particles of bodies, though he did not in any way specify the nature of the motion involved; and as the general cause of all terrestrial motion, so that in its absence the earth would be without movement in its smallest parts. The new facts he records are observations on the spring or pressure of air brought about by the action of heat. He shows that different masses of air measured at the same initial spring or pressure, when heated to the boiling-point of water, acquire equal increments of spring or pressure, provided the volume of the gas be kept at its initial value. Further, he proves that if the pressure of the gas before heating be doubled or tripled, then the additional spring or pressure resulting from heating to the boiling-point of water is equally doubled or tripled. In other words, the ratio of the total spring of air at two definite and steady temperatures and at constant volume is a constant, independent of the mass or the initial pressure of the air in the thermometer. These results led to the increased perfection of the air thermometer as a standard instrument, Amontons' idea being to express the temperature at any locality in fractions of the degree of heat of boiling water. The great novelty of the instrument is that temperature is defined by the measurement of the length of a column of mercury. In passing, he remarks that we do not know the extreme of heat and cold, but that he has given the results of experiments which establish correspondences for those who wish to consider the subject. In the following year Amontons contributed to the Academy a further paper extending the scope of the inquiry. He there pointed out more explicitly that as the degrees of heat in his thermometer are registered by the height of a column of mercury, which the heat is able to sustain by the spring of the air, it follows that the extreme cold of the thermometer will be that which reduces the air to have no power of spring. This, he says, will be a much greater cold than what we call "very cold," because experiments have shown that if the spring of the air at boiling-point is 73 inches, the degree of heat which remains in the air when brought to the freezing-point of water is still very great, for it can still maintain the spring of 51½ inches. The greatest climatic cold on the scale of units adopted by Amontons is marked 50, and the greatest summer heat 58, the value for boiling water being 73, and the zero being 52 units below the freezing-point. Thus Amontons was the first to recognise that the use of air as a thermometric substance led to the inference of the existence of a zero of temperature, and his scale is nothing else than the absolute one we are now so familiar with. It results from Amontons' experiments that the air would have no spring left if it were cooled below the freezing-point of water to about 2½ times the temperature range which separates the boiling-point and the freezing-point. In other words, if we adopt the usual centennial difference between these two points of temperature as 100 degrees, then the zero of Amontons' air thermometer is *minus* 240 degrees. This is a remarkable approximation to our modern value for the same point of *minus* 273 degrees. It has to be confessed that Amontons' valuable

contributions to knowledge met with that fate which has so often for a time overtaken the work of too-advanced discoverers; in other words, it was simply ignored, or in any case not appreciated by the scientific world either of that time or half a century later. It is not till Lambert, in his work on "Pyrometrie," published in 1779, repeated Amontons' experiments and endorsed his results that we find any further reference to the absolute scale or the zero of temperature. Lambert's observations were made with the greatest care and refinement, and resulted in correcting the value of the zero of the air scale to *minus* 270 degrees as compared with Amontons' *minus* 240 degrees. Lambert points out that the degree of temperature which is equal to zero is what one may call absolute cold, and that at this temperature the volume of the air would be practically nothing. In other words, the particles of the air would fall together and touch each other and become dense like water; and from this it may be inferred that the gaseous condition is caused by heat. Lambert says that Amontons' discoveries had found few adherents because they were too beautiful and advanced for the time in which he lived.

About this time a remarkable observation was made by Prof. Braun at Moscow, who, during the severe winter of 1759, succeeded in freezing mercury by the use of a mixture of snow and nitric acid. When we remember that mercury was regarded as quite a peculiar substance possessed of the essential quality of fluidity, we can easily understand the universal interest created by the experiment of Braun. This was accentuated by the observations he made on the temperature given by the mercury thermometer, which appeared to record a temperature as low as *minus* 200° C. The experiments were soon repeated by Hutchins at Hudson's Bay, who conducted his work with the aid of suggestions given him by Cavendish and Black. The result of the new observations was to show that the freezing-point of mercury is only *minus* 40° C., the errors in former experiments having been due to the great contraction of the mercury in the thermometer in passing into the solid state. From this it followed that the enormous natural and artificial colds which had generally been believed in had no proved existence. Still the possible existence of a zero of temperature very different from that deduced from gas thermometry had the support of such distinguished names as those of Laplace and Lavoisier. In their great memoir on "Heat," after making what they consider reasonable hypotheses as to the relation between specific heat and total heat, they calculate values for the zero which range from 1500° to 3000° below melting ice. On the whole, they regard the absolute zero as being in any case 600° below the freezing-point. Lavoisier, in his "Elements of Chemistry" published in 1792, goes further in the direction of indefinitely lowering the zero of temperature when he says, "We are still very far from being able to produce the degree of absolute cold, or total deprivation of heat, being unacquainted with any degree of coldness which we cannot suppose capable of still further augmentation; hence it follows we are incapable of causing the ultimate particles of bodies to approach each other as near as possible, and thus these particles do not touch each other in any state hitherto known." Even as late as the beginning of the nineteenth century we find Dalton, in his new system of "Chemical Philosophy," giving ten calculations of this value, and adopting finally as the natural zero of temperature *minus* 3000° C.

In Black's lectures we find that he takes a very cautious view with regard to the zero of temperature, but as usual is admirably clear with regard to its exposition. Thus he says, "We are ignorant of the lowest possible degree or beginning of heat. Some ingenious attempts have been made to estimate what it may be, but they have not proved satisfactory. Our knowledge of the degrees of heat may be compared to what we should have of a chain the two ends of which were hidden from us and the middle only exposed to our view. We might put distinct marks on some of the links, and number the rest according as they are nearest to or further removed from the principal links; but not knowing the distance of any links from the end of the chain we could not compare them together with respect to their distance, or say that one link was twice as far from the end of the chain as another." It is interesting to observe, however, that Black was evidently well acquainted with the work of Amontons, and strongly supports his inference as to the nature of air. Thus, in discussing the general cause of vaporisation, Black says that some philoso-

phers have adopted the view "that every palpable elastic fluid in nature is produced and preserved in this form by the action of heat. Mr. Amontons, an ingenious member of the late Royal Academy of Sciences, at Paris, was the first who proposed this idea with respect to the atmosphere. He supposed that it might be deprived of the whole of its elasticity and condensed and even frozen into a solid matter were it in our power to apply to it a sufficient cold; that it is a substance that differs from others by being incomparably more volatile, and which is therefore converted into vapour and preserved in that form by a weaker heat than any that ever happened or can obtain in this globe, and which therefore cannot appear under any other form than the one it now wears, so long as the constitution of the world remains the same as at present." The views that Black attributes to Amontons have been generally associated with the name of Lavoisier, who practically admitted similar possibilities as to the nature of air; but it is not likely that in such matters Black would commit any mistake as to the real author of a particular idea, especially in his own department of knowledge. Black's own special contribution to low-temperature studies was his explanation of the interaction of mixtures of ice with salts and acids by applying the doctrine of the latent heat of fluidity of ice to account for the frigorific effect. In a similar way, Black explained the origin of the cold produced in Cullen's remarkable experiment of the evaporation of ether under the receiver of an air-pump by pointing out that the latent heat of vapourisation in this case necessitated such a result. Thus, by applying his own discoveries of latent heat, Black gave an intelligent explanation of the cause of all the low-temperature phenomena known in his day.

After the gaseous laws had been definitely formulated by Gay-Lussac and Dalton, the question of the absolute zero of temperature, as deduced from the properties of gases, was revived by Clement and Desormes. These distinguished investigators presented a paper on the subject to the French Academy in 1812, which, it appears, was rejected by that body. The authors subsequently elected to publish it in 1819. Relying on what we know now to have been a faulty hypothesis, they deduced from observations on the heating of air rushing into a vacuum the temperature of *minus* 267 degrees as that of the absolute zero. They further endeavoured to show, by extending to lower temperatures the volume or the pressure coefficients of gases given by Gay-Lussac, that at the same temperature of *minus* 267 degrees the gases would contract so as to possess no appreciable volume, or, alternatively, if the pressure was under consideration, it would become so small as to be non-existent. Although full reference is given to previous work bearing on the same subject, yet, curiously enough, no mention is made of the name of Amontons. It certainly gave remarkable support to Amontons' notion of the zero to find that simple gases like hydrogen and compound gases like ammonia, hydrochloric, carbonic and sulphurous acids should all point to substantially the same value for this temperature. But the most curious fact about this research of Clement and Desormes is that Gay-Lussac was a bitter opponent of the validity of the inferences they drew either from his work or their own. The mode in which Gay-Lussac regarded the subject may be succinctly put as follows: A quick compression of air to one-fifth volume raises its temperature to 300 degrees, and if this could be made much greater and instantaneous the temperature might rise to 1000 or 2000 degrees. Conversely, if air under five atmospheres were suddenly dilated, it would absorb as much heat as it had evolved during compression, and its temperature would be lowered by 300 degrees. Therefore, if air were taken and compressed to fifty atmospheres or more, the cold produced by its sudden expansion would have no limit. In order to meet this position, Clement and Desormes adopted the following reasoning: They pointed out that it had not been proved that Gay-Lussac was correct in his hypothesis, but that in any case it tacitly involves the assumption that a limited quantity of matter possesses an unlimited supply of heat. If this were the case, then heat would be unlike any other measurable thing or quality. It is, therefore, more consistent with the course of nature to suppose that the amount of heat in a body is like the quantity of elastic fluid filling a vessel, which, while definite in original amount, one may make less and less by getting nearer to a complete exhaustion. Further, to realise the absolute zero in the one case is just as impossible as to realise the absolute vacuum in the other; and as we do not doubt a zero of pressure, although it is unattain-

able, for the same reason we ought to accept the reality of the absolute zero. We know now that Gay-Lussac was wrong in supposing the increment of temperature arising from a given gaseous compression would produce a corresponding decrement from an identical expansion. After this time the zero of temperature was generally recognised as a fixed ideal point, but in order to show that it was hypothetical a distinction was drawn between the use of the expressions, zero of absolute temperature and the absolute zero.

The whole question took an entirely new form when Lord Kelvin, in 1848, after the mechanical equivalent of heat had been determined by Joule, drew attention to the great principles underlying Carnot's work on the "Motive Power of Heat," and applied them to an absolute method of temperature measurement, which is completely independent of the properties of any particular substance. The principle was that for a difference of one degree on this scale, between the temperatures of the source and refrigerator, a perfect engine should give the same amount of work in every part of the scale. Taking the same fixed points as for the Centigrade scale, and making 100 of the new degrees cover that range, it was found that the degrees not only within that range, but as far beyond as experimental data supplied the means of comparison, differed by only minute quantities from those of Regnault's air thermometer. The zero of the new scale had to be determined by the consideration that when the refrigerator was at the zero of temperature the perfect engine should give an amount of work equal to the full mechanical equivalent of the heat taken up. This led to a zero of 273 degrees below the temperature of freezing water, substantially the same as that deduced from a study of the gaseous state. It was a great advance to demonstrate by the application of the laws of thermodynamics not only that the zero of temperature is a reality, but that it must be located at 273 degrees below the freezing-point of water. As no one has attempted to impugn the solid foundation of theory and experiment on which Lord Kelvin based his thermodynamic scale, the existence of a definite zero of temperature must be acknowledged as a fundamental scientific fact.

Liquefaction of Gases and Continuity of State.

In these speculations, however, chemists were dealing theoretically with temperatures to which they could not make any but the most distant experimental approach. Cullen, the teacher of Black, had indeed shown how to lower temperature by the evaporation of volatile bodies, such as ether, by the aid of the air-pump, and the later experiments of Leslie and Wollaston extended the same principle. Davy and Faraday made the most of the means at command in liquefying the more condensable gases, while at the same time Davy pointed out that they in turn might be utilised to procure greater cold by their rapid reversion into the aëriform state. Still the chemist was sorely hampered by the want of some powerful and accessible agent for the production of temperatures much lower than had ever been attained. That want was supplied by Thilorier, who in 1835 produced liquid carbonic acid in large quantities, and further made the fortunate discovery that the liquid could be frozen into a snow by its own evaporation. Faraday was prompt to take advantage of this new and potent agent. Under exhaustion he lowered its boiling-point from *minus* 78° C. to *minus* 110° C., and by combining this low temperature with pressure all the gases were liquefied by the year 1844, with the exception of the three elementary gases—hydrogen, nitrogen, and oxygen, and three compound gases—carbonic oxide, marsh gas, and nitric oxide; Andrews some twenty-five years after the work of Faraday attempted to induce change of state in the uncondensed gases by using much higher pressures than Faraday employed. Combining the temperature of a solid carbonic acid bath with pressures of 300 atmospheres, Andrews found that none of these gases exhibited any appearance of liquefaction in such high states of condensation; but so far as change of volume by high compression went, Andrews confirmed the earlier work of Natterer by showing that the gases become proportionately less compressible with growing pressure. While such investigations were proceeding, Regnault and Magnus had completed their refined investigations on the laws of Boyle and Gay-Lussac. A very important series of experiments was made by Joule and Kelvin "On the Thermal Effects of Fluids in Motion" about 1862, in which the thermometrical effects of passing gases under compression through porous plugs furnished important data for the study of the mutual action of the gas

molecules. No one, however, had attempted to make a complete study of a liquefiable gas throughout wide ranges of temperature. This was accomplished by Andrews in 1869, and his Bakerian Lecture "On the Continuity of the Gaseous and Liquid States of Matter" will always be regarded as an epoch-making investigation. During the course of this research Andrews observed that liquid carbonic acid raised to a temperature of 31° C. lost the sharp concave surface of demarcation between the liquid and the gas, the space being now occupied by a homogeneous fluid which exhibited, when the pressure was suddenly diminished or the temperature slightly lowered, a peculiar appearance of moving or flickering striae, due to great local alterations of density. At temperatures above 31° C. the separation into two distinct kinds of matter could not be effected even when the pressure reached 400 atmospheres. This limiting temperature of the change of state from gas to liquid Andrews called the critical temperature. He showed that this temperature is constant, and differs with each substance, and that it is always associated with a definite pressure peculiar to each body. Thus the two constants, critical temperature and pressure, which have been of the greatest importance in subsequent investigations, came to be defined, and a complete experimental proof was given that "the gaseous and liquid states are only two distinct stages of the same condition of matter and are capable of passing into one another by a process of continuous change."

In 1873 an essay "On the Continuity of the Gaseous and Liquid State," full of new and suggestive ideas, was published by van der Waals, who, recognising the value of Clausius' new conception of the Virial in Dynamics, for a long-continued series of motions, either oscillatory or changing exceedingly slowly with time, applied it to the consideration of the molecular movements of the particles of the gaseous substance, and after much refined investigation, and the fullest experimental calculation available at the time, devised his well-known Equation of Continuity. Its paramount merit is that it is based entirely on a mechanical foundation, and is in no sense empiric; we may therefore look upon it as having a secure foundation in fact, but as being capable of extension and improvement. James Thomson, realising that the straight-line breach of continuous curvature in the Andrews isothermals was untenable to the physical mind, propounded his emendation of the Andrews curves—namely, that they were continuous and of S form. We also owe to James Thomson the conception and execution of a three-dimensional model of Andrews' results, which has been of the greatest service in exhibiting the three variables by means of a specific surface afterwards greatly extended and developed by Prof. Willard Gibbs. The suggestive work of James Thomson undoubtedly was a valuable aid to van der Waals, for as soon as he reached the point where his equation had to show the continuity of the two states this was the first difficulty he had to encounter, and he succeeded in giving the explanation. He also gave a satisfactory reason for the existence of a minimum value of the product of volume and pressure in the Regnault isothermals. His isothermals, with James Thomson's completion of them, were now shown to be the results of the laws of dynamics. Andrews applied the new equation to the consideration of the coefficients of expansion with temperature and of pressure with temperature, showing that although they were nearly equal, nevertheless they were almost independent quantities. His investigation of the capillarity constant was masterly, and he added further to our knowledge of the magnitudes of the molecules of gases and of their mean free paths. Following up the experiments of Joule and Kelvin, he showed how their cooling coefficients could be deduced, and proved that they vanished at a temperature in each case which is a constant multiple of the specific critical temperature. The equation of continuity developed by van der Waals involved the use of three constants instead of one, as in the old law of Boyle and Charles, the latter being only utilised to express the relation of temperature, pressure, and volume, when the gas is far removed from its point of liquefaction. Of the two new constants one represents the molecular pressure arising from the attraction between the molecules, the other four times the volume of the molecules. Given these constants of a gas, van der Waals showed that his equation not only fitted into the general characters of the isothermals, but also gave the values of the critical temperature, the critical pressure and the critical volume. In the case of carbonic acid the theoretical results were found to be in remarkable agreement with the experimental values of Andrews. This gave chemists the means of ascertain-

ing the critical constants, provided sufficiently accurate data derived from the study of a few properly distributed isothermals of the gaseous substance were available. Such important data came into the possession of chemists when Amagat published his valuable paper on "The Isothermals of Hydrogen, Nitrogen, Oxygen, Ethylene, &c.," in the year 1880. It now became possible to calculate the critical data with comparative accuracy for the so-called permanent gases oxygen and nitrogen, and this was done by Sarrau in 1882. In the meantime a great impulse had been given to a further attack upon the so-called permanent gases by the suggestive experiments made by Pictet and Cailletet. The static liquefaction of oxygen was effected by Wroblewski in 1883, and thereby the theoretical conclusions derived from van der Waals' equation were substantially confirmed. The liquefaction of oxygen and air was achieved through the use of liquid ethylene as a cooling agent, which enabled a temperature of *minus* 140 degrees to be maintained by its steady evaporation *in vacuo*. From this time liquid oxygen and air came to be regarded as the potential cooling agents for future research, commanding as they did a temperature of 200 degrees below melting ice. The theoretical side of the question received at the hands of van der Waals a second contribution, which was even more important than his original essay, and that was his novel and ingenious development of what he calls "The Theory of Corresponding States." He defined the corresponding states of two substances as those in which the ratios of the temperature, pressure and volume to the critical temperature, pressure and volume respectively were the same for the two substances, and in corresponding states he showed that the three pairs of ratios all coincided. From this a series of remarkable propositions was developed, some new, some proving previous laws that were hitherto only empiric, and some completing and correcting faultily though approximate laws. As examples, he succeeded in calculating the boiling-point of carbonic acid from observations on ether vapour, proved Kopp's law of molecular volumes, and showed that at corresponding temperatures the molecular latent heats of vaporisation are proportional to the absolute critical temperature, and that under the same conditions the coefficients of liquid expansion are inversely proportional to the absolute critical temperature, and that the coefficients of liquid compressibility are inversely proportional to the critical pressure. All these propositions and deductions are in the main correct, though further experimental investigation has shown minor discrepancies requiring explanation. Various proposals have been made to supplement van der Waals' equation so as to bring it into line with experiments, some being entirely empiric, others theoretical. Clausius, Sarrau, Wroblewski, Batteli, and others attacked the question empirically, and in the main preserved the co-volume (depending on the total volume of the molecules) unaltered while trying to modify the constant of molecular attraction. Their success depended entirely on the fact that, instead of limiting the number of constants to three, some of them have increased them to as many as ten. On the other hand, a series of very remarkable theoretical investigations has been made by van der Waals himself, by Kammerlingh Onnes, Korteweg, Jaeger, Boltzmann, Dieterici, and Kiengann, and others, all directed in the main towards an admitted variation in the value of the co-volume while preserving the molecular attraction constant. The theoretical reductions of Tait lead to the conclusion that a substance below its critical point ought to have two different equations of the van der Waals type, one referring to the liquid and the other to the gaseous phase. One important fact was soon elicited—namely, that the law of correspondence demanded only that the equation should contain not more than three constants for each body. The simplest extension is that made by Reinganum, in which he increased the pressure for a given mean kinetic energy of the particles inversely in the ratio of the diminution of free volume, due to the molecules possessing linear extension. Berthelot has shown how a "reduced" isothermal may be got by taking two other prominent points as units of measurement instead of the critical coordinates. The most suggestive advance in the improvement of the van der Waals equation has been made by a lady, Mme. Christine Meyer. The idea at the base of this new development may be understood from the following general statement: van der Waals brings the van der Waals surfaces for all substances into coincidence at the point where volume, pressure and temperature are nothing, and then stretches or compresses all the surfaces parallel to the three axes of volume,

pressure and temperature until their critical points coincide. But on this plan the surfaces do not quite coincide, because the points where the three variables are respectively nothing are not corresponding points. Mme. Meyer's plan is to bring all the critical points first into coincidence, and then to compress or extend all the representative surfaces parallel to the three axes of volume, pressure and temperature until the surfaces coincide. In this way, taking twenty-nine different substances, she completely verifies from experiment van der Waals' law of correspondence. The theory of van der Waals has been one of the greatest importance in directing experimental investigation and in attacking the difficult problems of the liquefaction of the most permanent gases. One of its greatest triumphs has been the proof that the critical constants and the boiling-point of hydrogen theoretically deduced by Wroblewski from a study of the isothermals of the gas taken far above the temperature of liquefaction are remarkably near the experimental values. We may safely infer, therefore, that if hereafter a gas be discovered in small quantity even four times more volatile than liquid hydrogen, yet by a study of its isothermals at low temperature we shall succeed in finding its most important liquid constants, although the isolation of the real liquid may for the time be impossible. It is perhaps not too much to say that, as a prolific source of knowledge in the department dealing with the continuity of state in matter, it would be necessary to go back to Carnot's cycle to find a proposition of greater importance than the theory of van der Waals and his development of the law of corresponding states.

It will be apparent from what has just been said that, thanks to the labours of Andrews, van der Waals, and others, theory had again far outrun experiment. We could calculate the constants and predict some of the simple physical characteristics of liquid oxygen, hydrogen or nitrogen with a high degree of confidence long before any one of the three had been obtained in the static liquid condition permitting of the experimental verification of the theory. This was the more tantalizing, because, with whatever confidence the chemist may anticipate the substantial corroboration of his theory, he also anticipates with almost equal conviction that, as he approaches more and more nearly to the zero of absolute temperature, he will encounter phenomena compelling modification, revision and refinement of formulas which fairly covered the facts previously known. Just as nearly seventy years ago chemists were waiting for some means of getting a temperature of 100 degrees below melting ice, so ten years ago they were casting about for the means of going 100 degrees lower still. The difficulty, it need hardly be said, increases in a geometrical rather than in an arithmetical ratio. Its magnitude may be estimated from the fact that to produce liquid air in the atmosphere of an ordinary laboratory is a feat analogous to the production of liquid water starting from steam at a white heat, and working with all the implements and surroundings at the same high temperature. The problem was not so much how to produce intense cold as how to save it when produced from being immediately levelled up by the relatively superheated surroundings. Ordinary non-conducting packings were inadmissible because they are both cumbersome and opaque, while in working near the limits of our resources it is essential that the product should be visible and readily handled. It was while puzzling over this mechanical and manipulative difficulty in 1892 that it occurred to me that the principle of an arrangement used nearly twenty years before in some calorimetric experiments, which was based upon the work of Dulong and Petit on radiation, might be employed with advantage as well to protect old substances from heat as hot ones from rapid cooling. I therefore tried the effect of keeping liquefied gases in vessels having a double wall, the annular space between being very highly exhausted. Experiments showed that liquid air evaporated at only one-fifth of the rate prevailing when it was placed in a similar unexhausted vessel, owing to the convective transference of heat by the gas particles being enormously reduced by the high vacuum. But, in addition, these vessels lend themselves to an arrangement by which radiant heat can also be cut off. It was found that when the inner walls were coated with a bright deposit of silver the influx of heat was diminished to one-sixth the amount entering without the metallic coating. The total effect of the high vacuum and the silvering is to reduce the ingoing heat to about 3 per cent. The efficiency of such vessels depends upon getting as high a vacuum as possible, and cold is one of the best means of effecting the desired exhaustion.

All that is necessary is to fill completely the space that has to be exhausted with an easily condensable vapour, and then to freeze it out in a receptacle attached to the primary vessel that can be sealed off. The advantage of this method is that no air-pump is required, and that theoretically there is no limit to the degree of exhaustion that can be obtained. The action is rapid, provided liquid air is the cooling agent, and vapours like mercury, water or benzol are employed. It is obvious that when we have to deal with such an exceptionally volatile liquid as hydrogen, the vapour filling may be omitted because air itself is now an easily condensable vapour. In other words, liquid hydrogen, collected in such vessels with the annular space full of air, immediately solidifies the air and thereby surrounds itself with a high vacuum. In the same way, when it shall be possible to collect a liquid boiling on the absolute scale at about 5 degrees, as compared with the 20 degrees of hydrogen, then you might have the annular space filled with the latter gas to begin with, and yet get directly a very high vacuum, owing to the solidification of the hydrogen. Many combinations of vacuum vessels can be arranged, and the lower the temperature at which we have to operate the more useful they become. Vessels of this kind are now in general use, and in them liquid air has crossed the American continent. Of the various forms, that variety is of special importance which has a spiral tube joining the bottom part of the walls, so that any liquid gas may be drawn off from the interior of such a vessel. In the working of regenerative coils such a device becomes all-important, and such special vessels cannot be dispensed with for the liquefaction of hydrogen.

In the early experiments of Pictet and Cailletet, cooling was produced by the sudden expansion of the highly compressed gas preferably at a low temperature, the former using a jet that lasted for some time, the latter an instantaneous adiabatic expansion in a strong glass tube. Neither process was practicable as a mode of producing liquid gases, but both gave valuable indications of partial change into the liquid state by the production of a temporary mist. Linde, however, saw that the continuous use of a jet of highly compressed gas, combined with regenerative cooling, must lead to liquefaction on account of what is called the Kelvin-Joule effect; and he succeeded in making a machine, based on this principle, capable of producing liquid air for industrial purposes. These experimenters had proved that, owing to molecular attraction, compressed gases passing through a porous plug or small aperture were lowered in temperature by an amount depending on the difference of pressure, and inversely as the square of the absolute temperature. This means that for a steady difference of pressure the cooling is greater the lower the temperature. The only gas that did not show cooling under such conditions was hydrogen. Instead of being cooled it became actually hotter. The reason for this apparent anomaly in the Kelvin-Joule effect is that every gas has a thermometric point of inversion above which it is heated and below which it is cooled. This inversion point, according to van der Waals, is six and three-quarter times the critical point. The efficiency of the Linde process depends on working with highly compressed gas well below the inversion temperature, and in this respect this point may be said to take the place of the critical one, when in the ordinary way direct liquefaction is being effected by the use of specific liquid cooling agents. The success of both processes depends upon working within a certain temperature range, only the Linde method gives us a much wider range of temperature within which liquefaction can be effected. This is not the case if, instead of depending on getting cooling by the internal work done by the attraction of the gas molecules, we force the compressed gas to do external work as in the well-known air machines of Kirk and Coleman. Both these inventors have pointed out that there is no limit of temperature, short of liquefaction of the gas in use in the circuit, that such machines are not capable of giving. While it is theoretically clear that such machines ought to be capable of maintaining the lowest temperatures, and that with the least expenditure of power, it is a very different matter to overcome the practical difficulties of working such machines under the conditions. Coleman kept a machine delivering air at *minus* 83 degrees for hours, but he did not carry his experiments any further. Recently Monsieur Claude, of Paris, has, however, succeeded in working a machine of this type so efficiently that he has managed to produce one litre of liquid air per horse power expended per hour in the running of the engine. This output is twice as good as that given by the Linde machine,

and there is no reason to doubt that the yield will be still further improved. It is clear, therefore, that in the immediate future the production of liquid air and hydrogen will be effected most economically by the use of machines producing cold by the expenditure of mechanical work.

Liquid Hydrogen and Helium.

To the physicist the copious production of liquid air by the methods described was of peculiar interest and value as affording the means of attacking the far more difficult problem of the liquefaction of hydrogen, and even as encouraging the hope that liquid hydrogen might in time be employed for the liquefaction of yet more volatile elements, apart from the importance which its liquefaction must hold in the process of the steady advance towards the absolute zero. Hydrogen is an element of especial interest, because the study of its properties and chemical relations led great chemists like Faraday, Dumas, Daniel, Graham and Andrews to entertain the view that if it could ever be brought into the state of liquid or solid it would reveal metallic characters. Looking to the special chemical relations of the combined hydrogen in water, alkaline oxides, acids and salts, together with the behaviour of these substances on electrolysis, we are forced to conclude that hydrogen behaves as the analogue of a metal. After the beautiful discovery of Graham that palladium can absorb some hundreds of times its own volume of hydrogen and still retain its lustre and general metallic character, the impression that hydrogen was probably a member of the metallic group became very general. The only chemist who adopted another view was my distinguished predecessor, Prof. Odling. In his "Manual of Chemistry," published in 1861, he pointed out that hydrogen has chlorous as well as basic relations, and that they are as decided, important, and frequent as its other relations. From such considerations he arrived at the conclusion that hydrogen is essentially a neutral or intermediate body, and therefore we should not expect to find liquid or solid hydrogen possess the appearance of a metal. This extraordinary prevision, so characteristic of Odling, was proved to be correct some thirty-seven years after it was made. Another curious anticipation was made by Dumas in a letter addressed to Pictet, in which he says that the metal most analogous to hydrogen is magnesium and that probably both elements have the same atomic volume, so that the density of hydrogen, for this reason, would be about the value elicited by subsequent experiments. Later on, in 1872, when Newlands began to arrange the elements in periodic groups, he regarded hydrogen as the lowest member of the chlorine family; but Mendeleeff in his later classification placed hydrogen in the group of the alkaline metals; on the other hand, Dr. Johnstone Stoney classes hydrogen with the alkaline earth metals and magnesium. From this speculative divergency it is clear no definite conclusion could be reached regarding the physical properties of liquid or solid hydrogen, and the only way to arrive at the truth was to prosecute low-temperature research until success attended the efforts to produce its liquefaction. This result I definitely obtained in 1898. The case of liquid hydrogen is, in fact, an excellent illustration of the truth already referred to, that no theoretical forecast, however apparently justified by analogy, can be finally accepted as true until confirmed by actual experiment. Liquid hydrogen is a colourless, transparent body of extraordinary intrinsic interest. It has a clearly defined surface, is easily seen, drops well, in spite of the fact that its surface tension is only the thirty-fifth part of that of water, or about one-fifth that of liquid air, and can be poured easily from vessel to vessel. The liquid does not conduct electricity, and, if anything, is slightly diamagnetic. Compared with an equal volume of liquid air, it requires only one-fifth the quantity of heat for vaporisation; on the other hand, its specific heat is ten times that of liquid air or five times that of water. The coefficient of expansion of the fluid is remarkable, being about ten times that of gas; it is by far the lightest liquid known to exist, its density being only one-fourteenth that of water; the lightest liquid previously known was liquid marsh gas, which is six times heavier. The only solid which has so small density as to float upon its surface is a piece of pith wood. It is by far the coldest liquid known. At ordinary atmospheric pressure it boils at *minus* 252.5 degrees or 20.5 degrees absolute. The critical point of the liquid is about 29 degrees absolute and the critical pressure not more than fifteen atmospheres. The vapour of the hydrogen arising from the liquid has nearly the density of air—that is, it is fourteen

times that of the gas at the ordinary temperature. Reduction of the pressure by an air-pump brings down the temperature to *minus* 258 degrees, when the liquid becomes a solid resembling frozen foam, and this by further exhaustion is cooled to *minus* 260 degrees, or 13 degrees absolute, which is the lowest steady temperature that has been reached. The solid may also be got in the form of a clear, transparent ice, melting at about 15 degrees absolute, under a pressure of 55 mm., possessing the unique density of one-eleventh that of water. Such cold involves the solidification of every gaseous substance but one that is at present definitely known to the chemist, and so liquid hydrogen introduces the investigator to a world of solid bodies. The contrast between this refrigerating substance and liquid air is most remarkable. On the removal of the loose plug of cotton-wool used to cover the mouth of the vacuum vessel in which it is stored, the action is followed by a miniature snow-storm of solid air, formed by the freezing of the atmosphere at the point where it comes into contact with the cold vapour rising from the liquid. This solid air falls into the vessel and accumulates as a white snow at the bottom of the liquid hydrogen. When the outside of an ordinary test-tube is cooled by immersion in the liquid, it is soon observed to fill up with solid air, and if the tube be now lifted out a double effect is visible, for liquid air is produced both in the inside and on the outside of the tube—in the one case by the melting of the solid, and in the other by condensation from the atmosphere. A tuft of cotton-wool soaked in the liquid and then held near the pole of a strong magnet is attracted, and it might be inferred therefrom that liquid hydrogen is a magnetic body. This, however, is not the case: the attraction is due neither to the cotton-wool nor to the hydrogen—which indeed evaporates almost as soon as the tuft is taken out of the liquid—but to the oxygen of the air, which is well known to be a magnetic body, frozen in the wool by the extreme cold.

The strong condensing powers of liquid hydrogen afford a simple means of producing vacua of very high tenacity. When one end of a sealed tube containing ordinary air is placed for a short time in the liquid, the contained air accumulates as a solid at the bottom, while the higher part is almost entirely deprived of particles of gas. So perfect is the vacuum thus formed, that the electric discharge can be made to pass only with the greatest difficulty. Another important application of liquid air, liquid hydrogen, &c., is as analytic agents. Thus, if a gaseous mixture be cooled by means of liquid oxygen, only those constituents will be left in the gaseous state which are less condensable than oxygen. Similarly, if this gaseous residue be in its turn cooled in liquid hydrogen, a still further separation will be effected, everything that is less volatile than hydrogen being condensed to a liquid or solid. By proceeding in this fashion it has been found possible to isolate helium from a mixture in which it is present to the extent of only one part in one thousand. By the evaporation of solid hydrogen under the air-pump we can reach within 13 or 14 degrees of the zero, but there or thereabouts our progress is barred. This gap of 13 degrees might seem at first sight insignificant in comparison with the hundreds that have already been conquered. But to win one degree low down the scale is quite a different matter from doing so at higher temperatures; in fact, to annihilate these few remaining degrees would be a far greater achievement than any so far accomplished in low-temperature research. For the difficulty is twofold, having to do partly with process and partly with material. The application of the methods used in the liquefaction of gases becomes continually harder and more troublesome as the working temperature is reduced; thus, to pass from liquid air to liquid hydrogen—a difference of 60 degrees—is, from a thermodynamic point of view, as difficult as to bridge the gap of 150 degrees that separates liquid chlorine and liquid air. By the use of a new liquid gas exceeding hydrogen in volatility to the same extent as hydrogen does nitrogen, the investigator might get to within five degrees of the zero; but even a second hypothetical substance, again exceeding the first one in volatility to an equal extent, would not suffice to bring him quite to the point of his ambition. That the zero will ever be reached by man is extremely improbable. A thermometer introduced into regions outside the uttermost confines of the earth's atmosphere might approach the absolute zero, provided that its parts were highly transparent to all kinds of radiation, otherwise it would be affected by the radiation of the sun, and would therefore become heated. But supposing all difficulties to be overcome,

and the experimenter to be able to reach within a few degrees of the zero, it is by no means certain that he would find the near approach of the death of matter sometimes pictured. Any forecast of the phenomena that would be seen must be based on the assumption that there is continuity between the processes studied at attainable temperatures and those which take place at still lower ones. Is such an assumption justified? It is true that many changes in the properties of substances have been found to vary steadily with the degree of cold to which they are exposed. But it would be rash to take for granted that the changes which have been traced in explored regions continue to the same extent and in the same direction in those which are as yet unexplored. Of such a breakdown low-temperature research has already yielded a direct proof at least in one case. A series of experiments with pure metals showed that their electrical resistance gradually decreases as they are cooled to lower and lower temperatures, in such ratio that it appeared probable that at the zero of absolute temperature they would have no resistance at all and would become perfect conductors of electricity. This was the inference that seemed justifiable by observations taken at depths of cold which can be obtained by means of liquid air and less powerful refrigerants. But with the advent of the more powerful refrigerant liquid hydrogen it became necessary to revise that conclusion. A discrepancy was first observed when a platinum resistance thermometer was used to ascertain the temperature of that liquid boiling under atmospheric and reduced pressure. All known liquids, when forced to evaporate quickly by being placed in the exhausted receiver of an air-pump, undergo a reduction in temperature, but when hydrogen was treated in this way it appeared to be an exception. The resistance thermometer showed no reduction as was expected, and it became a question whether it was the hydrogen or the thermometer that was behaving abnormally. Ultimately, by the adoption of other thermometrical appliances, the temperature of the hydrogen was proved to be lowered by exhaustion as theory indicated. Hence it was the platinum thermometer which had broken down; in other words, the electrical resistance of the metal employed in its construction was not, at temperatures about *minus* 250° C., decreased by cold in the same proportion as at temperatures about *minus* 200°. This being the case, there is no longer any reason to suppose that at the absolute zero platinum would become a perfect conductor of electricity; and in view of the similarity between the behaviour of platinum and that of other pure metals in respect of temperature and conductivity, the presumption is that the same is true of them also. At any rate, the knowledge that in the case of at least one property of matter we have succeeded in attaining a depth of cold sufficient to bring about unexpected change in the law expressing the variation of that property with temperature, is sufficient to show the necessity for extreme caution in extending our inferences regarding the properties of matter near the zero of temperature. Lord Kelvin evidently anticipates the possibility of more remarkable electrical properties being met with in the metals near the zero. A theoretical investigation on the relation of "electrons" and atoms has led him to suggest a hypothetical metal having the following remarkable properties: below 1 degree absolute it is a perfect insulator of electricity, at 2 degrees it shows noticeable conductivity, and at 6 degrees it possesses high conductivity. It may safely be predicted that liquid hydrogen will be the means by which many obscure problems of physics and chemistry will ultimately be solved, so that the liquefaction of the last of the old permanent gases is as pregnant now with future consequences of great scientific moment as was the liquefaction of chlorine in the early years of the last century.

The next step towards the absolute zero is to find another gas more volatile than hydrogen, and that we possess in the gas occurring in cleveite, identified by Ramsay as helium, a gas which is widely distributed, like hydrogen, in the sun, stars and nebulae. A specimen of this gas was subjected by Olszewski to liquid air temperatures, combined with compression and subsequent expansion, following the Cailliet method, and resulted in his being unable to discover any appearance of liquefaction, even in the form of mist. His experiments led him to infer that the boiling-point of the substance is probably below 9 degrees absolute. After Lord Rayleigh had found a new source of helium in the gases which are derived from the Bath springs, and liquid hydrogen became available as a cooling agent, a

specimen of helium cooled in liquid hydrogen showed the formation of fluid, but this turned out to be owing to the presence of an unknown admixture of other gases. As a matter of fact, a year before the date of this experiment I had recorded indications of the presence of unknown gases in the spectrum of helium derived from this source. When subsequently such condensable constituents were removed, the purified helium showed no signs of liquefaction, even when compressed to 80 atmospheres, while the tube containing it was surrounded with solid hydrogen. Further, on suddenly expanding, no instantaneous mist appeared. Thus helium was definitely proved to be a much more volatile substance than hydrogen in either the liquid or solid condition. The inference to be drawn from the adiabatic expansion effected under the circumstances is that helium must have touched a temperature of from 9 to 10 degrees for a short time without showing any signs of liquefaction, and consequently that the critical point must be still lower. This would force us to anticipate that the boiling-point of the liquid will be about 5 degrees absolute, or liquid helium will be four times more volatile than liquid hydrogen, just as liquid hydrogen is four times more volatile than liquid air. Although the liquefaction of the gas is a problem for the future, this does not prevent us from safely anticipating some of the properties of the fluid body. It would be twice as dense as liquid hydrogen, with a critical pressure of only 4 or 5 atmospheres. The liquid would possess a very feeble surface-tension, and its compressibility and expansibility would be about four times that of liquid hydrogen, while the heat required to vaporise the molecule would be about one-fourth that of liquid hydrogen. Heating the liquid 1 degree above its boiling-point would raise the pressure by 1½ atmospheres, which is more than four times the increment for liquid hydrogen. The liquid would be only seventeen times denser than its vapour, whereas liquid hydrogen is sixty-five times denser than the gas it gives off. Only some 3 or 4 degrees would separate the critical temperature from the boiling-point and the melting-point, whereas in liquid hydrogen the separation is respectively 10 and 15 degrees. As the liquid refractivities for oxygen, nitrogen and hydrogen are closely proportional to the gaseous values, and as Lord Rayleigh has shown that helium has only one-fourth the refractivity of hydrogen, although it is twice as dense, we must infer that the refractivity of liquid helium would also be about one-fourth that of liquid hydrogen. Now hydrogen has the smallest refractivity of any known liquid, and yet liquid helium will have only about one-fourth of this value—comparable, in fact, with liquid hydrogen just below its critical point. This means that the liquid will be quite exceptional in its optical properties, and very difficult to see. This may be the explanation of why no mist has been seen on its adiabatic expansion from the lowest temperatures. Taking all these remarkable properties of the liquid into consideration, one is afraid to predict that we are at present able to cope with the difficulties involved in its production and collection. Provided the critical point is, however, not below 8 degrees absolute, then from the knowledge of the conditions that are successful in producing a change of state in hydrogen through the use of liquid air, we may safely predict that helium can be liquefied by following similar methods. If, however, the critical point is as low as 6 degrees absolute, then it would be almost hopeless to anticipate success by adopting the process that works so well with hydrogen. The present anticipation is that the gas will succumb after being subjected to this process, only, instead of liquid air under exhaustion being used as the primary cooling agent, liquid hydrogen evaporating under similar circumstances must be employed. In this case, the resulting liquid would require to be collected in a vacuum vessel the outer walls of which are immersed in liquid hydrogen. The practical difficulties and the cost of the operation will be very great; but, on the other hand, the descent to a temperature within 5 degrees of the zero would open out new vistas of scientific inquiry, which would add immensely to our knowledge of the properties of matter. To command in our laboratories a temperature which would be equivalent to that which a comet might reach at an infinite distance from the sun would indeed be a great triumph for science. If the present Royal Institution attack on helium should fail, then we must ultimately succeed by adopting a process based on the mechanical production of cold through the performance of external work. When a turbine can be worked by compressed helium, the whole of the mechanism and circuits being kept surrounded with liquid hydrogen, then we need hardly doubt that the liquefaction will be effected. In

all probability gases other than helium will be discovered of greater volatility than hydrogen. It was at the British Association Meeting in 1896 that I made the first suggestion of the probable existence of an unknown element which would be found to fill up the gap between argon and helium, and this anticipation was soon taken up by others and ultimately confirmed. Later, in the Bakerian Lecture for 1901, I was led to infer that another member of the helium group might exist having the atomic weight about 2, and this would give us a gas still more volatile, with which the absolute zero might be still more nearly approached. It is to be hoped that some such element or elements may yet be isolated and identified as coronium or nebium. If amongst the unknown gases possessing a very low critical point some have a high critical pressure instead of a low one, which ordinary experience would lead us to anticipate, then such difficultly liquefiable gases would produce fluids having different physical properties from any of those with which we are acquainted. Again, gases may exist having smaller atomic weights and densities than hydrogen, yet all such gases must, according to our present views of the gaseous state, be capable of liquefaction before the zero of temperature is reached. The chemists of the future will find ample scope for investigation within the apparently limited range of temperature which separates solid hydrogen from the zero. Indeed, great as is the sentimental interest attached to the liquefaction of these refractory gases, the importance of the achievement lies rather in the fact that it opens out new fields of research and enormously widens the horizon of physical science, enabling the natural philosopher to study the properties and behaviour of matter under entirely novel conditions. This department of inquiry is as yet only in its infancy, but speedy and extensive developments may be looked for, since within recent years several special cryogenic laboratories have been established for the prosecution of such researches, and a liquid-air plant is becoming a common adjunct to the equipment of the ordinary laboratory.

The Upper Air and Auroras.

The present liquid ocean, neglecting everything for the moment but the water, was at a previous period of the earth's history part of the atmosphere, and its condensation has been brought about by the gradual cooling of the earth's surface. This resulting ocean is subjected to the pressure of the remaining uncondensed gases, and as these are slightly soluble they dissolve to some extent in the fluid. The gases in solution can be taken out by distillation or by exhausting the water, and if we compare their volume with the volume of water as steam, we should find about 1 volume of air in 60,000 volumes of steam. This would then be about the rough proportion of the relatively permanent gas to condensable gas which existed in the case of the vaporised ocean. Now let us assume the surface of the earth gradually cooled to some 200 degrees below the freezing-point; then, after all the present ocean was frozen, and the climate became three times more intense than any Arctic frost, a new ocean of liquid air would appear, covering the entire surface of the frozen globe about thirty-five feet deep. We may now apply the same reasoning to the liquid air ocean that we formerly did to the water one, and this would lead us to anticipate that it might contain in solution some gases that may be far less condensable than the chief constituents of the fluid. In order to separate them we must imitate the method of taking the gases out of water. Assume a sample of liquid air cooled to the low temperature that can be reached by its own evaporation, connected by a pipe to a condenser cooled in liquid hydrogen; then any volatile gases present in solution will distil over with the first portions of the air, and can be pumped off, being uncondensable at the temperature of the condenser. In this way, a gas mixture, containing, of the known gases, free hydrogen, helium and neon, has been separated from liquid air. It is interesting to note in passing that the relative volatilities of water and oxygen are in the same ratio as those of liquid air and hydrogen, so that the analogy between the ocean of water and that of liquid air has another suggestive parallel. The total uncondensable gas separated in this way amounts to about one fifty-thousandth of the volume of the air, which is about the same proportion as the air dissolved in water. That free hydrogen exists in air in small amount is conclusively proved, but the actual proportion found by the process is very much smaller than Gautier has estimated by the combustion method. The recent experiments of Lord Rayleigh show that Gautier, who estimated the hydrogen present as one five-thousandth,

has in some way produced more hydrogen than he can manage to extract from pure air by a repetition of the same process. The spectroscopic examination of these gases throws new light upon the question of the aurora and the nature of the upper air. On passing electric discharges through the tubes containing the most volatile of the atmospheric gases, they glow with a bright orange light, which is especially marked at the negative pole. The spectroscopic shows that this light consists, in the visible part of the spectrum, chiefly of a succession of strong rays in the red, orange and yellow, attributed to hydrogen, helium and neon. Besides these, a vast number of rays, generally less brilliant, are distributed through the whole length of the visible spectrum. The greater part of these rays are of, as yet, unknown origin. The violet and ultra-violet part of the spectrum rivals in strength that of the red and yellow rays. As these gases probably include some of the gases that pervade interplanetary space, search was made for the prominent nebular, coronal and auroral lines. No definite lines agreeing with the nebular spectrum could be found, but many lines occurred closely coincident with the coronal and auroral spectrum. But before discussing the spectroscopic problem it will be necessary to consider the nature and condition of the upper air.

According to the old law of Dalton, supported by the modern dynamical theory of gases, each constituent of the atmosphere while acted upon by the force of gravity forms a separate atmosphere, completely independent, except as to temperature, of the others, and the relations between the common temperature and the pressure and altitude for each specific atmosphere can be definitely expressed. If we assume the altitude and temperature known, then the pressure can be ascertained for the same height in the case of each of the gaseous constituents, and in this way the percentage composition of the atmosphere at that place may be deduced. Suppose we start with a surface atmosphere having the composition of our air, only containing two ten-thousandths of hydrogen, then at thirty-seven miles, if a sample could be procured for analysis, we believe that it would be found to contain 12 per cent. of hydrogen and only 10 per cent. of oxygen. The carbonic acid practically disappears; and by the time we reach forty-seven miles, where the temperature is minus 132 degrees, assuming a gradient of 3.2 degrees per mile, the nitrogen and oxygen have so thinned out that the only constituent of the upper air which is left is hydrogen. If the gradient of temperature were doubled, the elimination of the nitrogen and oxygen would take place by the time thirty-seven miles was reached, with a temperature of minus 220 degrees. The permanence of the composition of the air at the highest altitudes, as deduced from the basis of the dynamical theory of gases, has been discussed by Stoney, Bryan, and others. It would appear that there is a consensus of opinion that the rate at which gases like hydrogen and helium could escape from the earth's atmosphere would be excessively slow. Considering that to compensate any such loss the same gases are being supplied by actions taking place in the crust of the earth, we may safely regard them as necessarily permanent constituents of the upper air. The temperature at the elevations we have been discussing would not be sufficient to cause any liquefaction of the nitrogen and oxygen, the pressure being so low. If we assume the mean temperature as about the boiling-point of oxygen at atmospheric pressure, then a considerable amount of the carbonic acid must solidify as a mist, if the air from a lower level be cooled to this temperature; and the same result might take place with other gases of relatively small volatility which occur in air. This would explain the clouds that have been seen at an elevation of fifty miles, without assuming the possibility of water vapour being carried up so high. The temperature of the upper air must be above that on the vapour pressure curve corresponding to the barometric pressure at the locality, otherwise liquid condensation must take place. In other words, the temperature must be above the dew-point of air at that place. At higher elevations, on any reasonable assumption of temperature distribution, we inevitably reach a temperature where the air would condense, just as Fourier and Poisson supposed it would, unless the temperature is arrested in some way from approaching the zero. Both ultra-violet absorption and the prevalence of electric storms may have something to do with the maintenance of a higher mean temperature. The whole mass of the air above forty miles is not more than one seven-hundredth part of the total mass of the atmosphere, so that any rain or snow of liquid

or solid air, if it did occur, would necessarily be of a very tenuous description. In any case, the dense gases tend to accumulate in the lower strata, and the lighter ones to predominate at the higher altitudes, always assuming that a steady state of equilibrium has been reached. It must be observed, however, that a sample of air taken at an elevation of nine miles has shown no difference in composition from that at the ground, whereas, according to our hypothesis, the oxygen ought to have been diminished to 17 per cent., and the carbonic acid should also have become much less. This can only be explained by assuming that a large intermixture of different layers of the atmosphere is still taking place at this elevation. This is confirmed by a study of the motions of clouds about six miles high, which reveals an average velocity of the air currents of some seventy miles an hour; such violent winds must be the means of causing the intermingling of different atmospheric strata. Some clouds, however, during hot and thundery weather, have been seen to reach an elevation of seventeen miles, so that we have direct proof that on occasion the lower layers of atmosphere are carried to a great elevation. The existence of an atmosphere at more than a hundred miles above the surface of the earth is revealed to us by the appearance of meteors and fireballs, and when we can take photographs of the spectrum of such apparitions we shall learn a great deal about the composition of the upper air. In the meantime Pickering's solitary spectrum of a meteor reveals an atmosphere of hydrogen and helium, and so far this is corroborative of the doctrine we have been discussing. It has long been recognised that the aurora is the result of electric discharges within the limits of the earth's atmosphere, but it was difficult to understand why its spectrum should be so entirely different from anything which could be produced artificially by electric discharges through rarefied air at the surface of the earth. Writing in 1879, Rand Capron, after collecting all the recorded observations, was able to enumerate no more than nine auroral rays, of which but one could with any probability be identified with rays emitted by atmospheric air under an electric discharge. Vogel attributed this want of agreement between nature and experiment, in a vague way, to difference of temperature and pressure; and Zollner thought the auroral spectrum to be one of a different order, in the sense in which the line and band spectra of nitrogen are said to be of different orders. Such statements were merely confessions of ignorance. But since that time observations of the spectra of auroras have been greatly multiplied, chiefly through the Swedish and Danish Polar Expeditions; and the length of spectrum recorded on the ultra-violet side has been greatly extended by the use of photography, so that, in a recent discussion of the results, M. Henri Stassano is able to enumerate upwards of one hundred auroral rays, of which the wave-length is more or less approximately known, some of them far in the ultra-violet. Of this large number of rays he is able to identify, within the probable limits of errors of observation, about two-thirds as rays, which Prof. Liveing and myself have observed to be emitted by the most volatile gases of atmospheric air unliquefiable at the temperature of liquid hydrogen. Most of the remainder he ascribes to argon, and some he might, with more probability, have identified with krypton or xenon rays, if he had been aware of the publication of wave-lengths of the spectra of those gases, and the identification of one of the highest rays of krypton with that most characteristic of auroras. The rosy tint often seen in auroras, particularly in the streamers, appears to be due mainly to neon, of which the spectrum is remarkably rich in red and orange rays. One or two neon rays are amongst those most frequently observed, while the red ray of hydrogen and one red ray of krypton have been noticed only once. The predominance of neon is not surprising, seeing that from its relatively greater proportion in air and its low density it must tend to concentrate at higher elevations. So large a number of probable identifications warrants the belief that we may yet be able to reproduce in our laboratories the auroral spectrum in its entirety. It is true that we have still to account for the appearance of some, and the absence of other, rays of the newly discovered gases, which in the way in which we stimulate them appear to be equally brilliant, and for the absence, with one doubtful exception, of all the rays of nitrogen. If we cannot give the reason of this, it is because we do not know the mechanism of luminescence—nor even whether the particles which carry the electricity are themselves luminous, or whether they only produce stresses causing other particles which

encounter them to vibrate; yet we are certain that an electric discharge in a highly rarefied mixture of gases lights one element and not another, in a way which, to our ignorance, seems capricious. The Swedish North Polar Expedition concluded from a great number of trigonometrical measurements that the average above the ground of the base of the aurora was fifty kilo-heights (thirty-four miles) at Cape Thorsden, Spitzbergen; at this height the pressure of the nitrogen of the atmosphere would be only about one-tenth of a millimetre, and Moissan and Deslandres have found that in atmospheric air at pressures less than one millimetre the rays of nitrogen and oxygen fade and are replaced by those of argon and by five new rays which Stassano identifies with rays of the more volatile gases measured by us. Also Collie and Ramsay's observations on the distance to which electrical discharges of equal potential traverse different gases explosively throw much light on the question; for they find that, while for helium and neon this distance is from 250 to 300 mm., for argon it is 45 $\frac{1}{2}$ mm., for hydrogen it is 39 mm., and for air and oxygen still less. This indicates that a good deal depends on the very constitution of the gases themselves, and certainly helps us to understand why neon and argon, which exist in the atmosphere in larger proportions than helium, krypton or xenon, should make their appearance in the spectrum of auroras almost to the exclusion of nitrogen and oxygen. How much depends, not only on the constitution and it may be temperature of the gases, but also on the character of the electric discharge, is evident from the difference between the spectra at the cathode and anode in different gases, notably in nitrogen and argon, and not less remarkably in the more volatile compounds of the atmosphere. Paulsen thinks the auroral spectrum wholly due to cathodic rays. Without stopping to discuss that question, it is certain that changes in the character of the electric discharge produce definite changes in the spectra excited by them. It has long been known that in many spectra the rays which are inconspicuous with an uncondensed electric discharge become very pronounced when a Leyden jar is in the circuit. This used to be ascribed to a higher temperature in this condensed spark, though measurements of that temperature have not borne out the explanation. Schuster and Hemsalech have shown that these changes of spectra are in part due to the oscillatory character of the condenser discharge which may be enhanced by self-induction, and the corresponding change of spectrum thereby made more pronounced. Lightning we should expect to resemble condensed discharge much more than aurora, but this is not borne out by the spectrum. Pickering's recent analysis of the spectrum of a flash obtained by photography shows, out of nineteen lines measured by him, only two which can be assigned with probability to nitrogen and oxygen, while three hydrogen rays most likely due to water are very conspicuous, and eleven may be reasonably ascribed to argon, krypton and xenon, one to more volatile gas of the neon class, and the brightest ray of all is but a very little less refrangible than the characteristic auroral ray, and coincides with a strong ray of calcium, but also lies between, and close to, an argon and a neon ray, neither of them weak rays. There may be some doubt about the identification of the spectral rays of auroras because of the wide limits of the probable errors in measuring wave-lengths so faint as most of them are, but there is no such doubt about the wave-lengths of the rays in solar protuberances measured by Deslandres and Hale. Stassano found that these rays, forty-four in number, lying between the Fraunhofer line F and 3148 in the ultra-violet, agree very closely with rays which Prof. Liveing and myself measured in the spectra of the most volatile atmospheric gases. It will be remembered that one of the earliest suggestions as to the nature of solar prominences was that they were solar auroras. This supposition helped to explain the marvellous rapidity of their changes, and the apparent suspension of brilliant self-luminous clouds at enormous heights above the sun's surface. Now the identification of the rays of their spectra with those of the most volatile gases, which also furnish many of the auroral rays, certainly supports that suggestion. A stronger support, however, seems to be given to it by the results obtained at the total eclipse of May, 1901, by the American expedition to Sumatra. In the *Astrophysical Journal* for June last is a list of 339 lines in the spectrum of the corona photographed by Humphreys, during totality, with a very large concave grating. Of these no fewer than 209 do not differ from lines we have measured in the most volatile gases of the atmo-

sphere, or in krypton or xenon, by more than one unit of wave-length on Angström's scale, a quantity within the limit of probable error. Of the remainder, a good many agree to a like degree with argon lines, a very few with oxygen lines and still fewer with nitrogen lines; the characteristic green auroral ray, which is not in the range of Humphreys' photographs, also agrees within a small fraction of a unit of wave-length with one of the rays emitted by the most volatile atmospheric gas. Taking into account the Fraunhofer lines H, K and G, usually ascribed to calcium, there remain only fifty-five lines of the 339 unaccounted for to the degree of probability indicated. Of these considerably more than half are very weak lines which have not depicted themselves on more than one of the six films exposed, and extend but a very short distance into the sun's atmosphere. There are, however, seven which are stronger lines, and reach to a considerable height above the sun's rim, and all have depicted themselves on at least four of the six films. If there be no considerable error in the wave-lengths assigned (and such is not likely to be the case), these lines may perhaps be due to some volatile element which may yet be discovered in our atmosphere. However that may be, the very great number of close coincidences between the auroral rays and those which are emitted under electric excitement by gases of our atmosphere almost constrains us to believe, what is indeed most probable on other grounds, that the sun's coronal atmosphere is composed of the same substances as the earth's, and that it is rendered luminous in the same way—namely, by electric discharges. This conclusion has plainly an important bearing on the explanation which should be given of the outburst of new stars and of the extraordinary and rapid changes in their spectra. Moreover, leaving on one side the question whether gases ever become luminous by the direct action of heat, apart from such transfers of energy as occur in chemical change and electric disturbance, it demands a revision of the theories which attribute more permanent differences between the spectra of different stars to differences of temperature, and a fuller consideration of the question whether they cannot with better reason be explained by differences in the electric conditions which prevail in the stellar atmosphere.

If we turn to the question what is the cause of the electric discharges which are generally believed to occasion auroras, but of which little more has hitherto been known than that they are connected with sun-spots and solar eruptions, recent studies of electric discharges in high vacua, with which the names of Crookes, Röntgen, Lenard, and J. J. Thomson will always be associated, have opened the way for Arrhenius to suggest a definite and rational answer. He points out that the frequent disturbances which we know to occur in the sun must cause electric discharges in the sun's atmosphere far exceeding any that occur in that of the earth. These will be attended with an ionisation of the gases, and the negative ions will stream away through the outer atmosphere of the sun into the interplanetary space, becoming, as Wilson has shown, nuclei of aggregation of condensable vapours and cosmic dust. The liquid and solid particles thus formed will be of various sizes; the larger will gravitate back to the sun, while those with diameters less than one and a half thousandths of a millimetre, but nevertheless greater than a wave-length of light, will, in accordance with Clerk-Maxwell's electromagnetic theory, be driven away from the sun by the incidence of the solar rays upon them, with velocities which may become enormous, until they meet other celestial bodies, or increase their dimensions by picking up more cosmic dust or diminish them by evaporation. The earth will catch its share of such particles on the side which is turned towards the sun, and its upper atmosphere will thereby become negatively electrified until the potential of the charge reaches such a point that a discharge occurs, which will be repeated as more charged particles reach the earth. This theory not only accounts for the auroral discharges, and the coincidence of their times of greatest frequency with those of the maxima of sunspots, but also for the minor maxima and minima. The vernal and autumnal maxima occur when the line through the earth and sun has its greatest inclination to the solar equator, so that the earth is more directly exposed to the region of maximum of sunspots, while the twenty-six days period corresponds closely with the period of rotation of that part of the solar surface where faculae are most abundant. J. J. Thomson has pointed out, as a consequence of the Richardson observations, that negative ions will be constantly

streaming from the sun merely regarded as a hot body, but this is not inconsistent with the supposition that there will be an excess of this emission in eruptions, and from the regions of faculae. Arrhenius' theory accounts also, in a way which seems the most satisfactory hitherto enunciated, for the appearances presented by comets. The solid parts of these objects absorb the sun's rays, and as they approach the sun become heated on the side turned towards him until the volatile substances frozen in or upon them are evaporated and diffused in the gaseous state in surrounding space, where they get cooled to the temperature of liquefaction and aggregated in drops about the negative ions. The larger of these drops gravitate towards the sun and form clouds of the coma about the head, while the smaller are driven by the incidence of the sun's light upon them away from the sun and form the tail. The curvature of the tail depends, as Bredichin has shown, on the rate at which the particles are driven, which in turn depends on the size and specific gravity of the particles, and these will vary with the density of the vapour from which they are formed and the frequency of the negative ions which collect them. In any case Arrhenius' theory is a most suggestive one, not only with reference to auroras and comets, and the solar corona and chromosphere, but also as to the constitution of the photosphere itself.

Various Low-Temperature Researches.

We may now summarise some of the results which have already been attained by low-temperature studies. In the first place, the great majority of chemical interactions are entirely suspended, but an element of such exceptional powers of combination as fluorine is still active at the temperature of liquid air. Whether solid fluorine and liquid hydrogen would interact no one can at present say. Bodies naturally become denser, but even a highly expansive substance like ice does not appear to reach the density of water at the lowest temperature. This is confirmatory of the view that the particles of matter under such conditions are not packed in the closest possible way. The force of cohesion is greatly increased at low temperatures, as is shown by the additional stress required to rupture metallic wires. This fact is of interest in connection with two conflicting theories of matter. Lord Kelvin's view is that the forces that hold together the particles of bodies may be accounted for without assuming any other agency than gravitation or any other law than the Newtonian. An opposite view is that the phenomena of the aggregation of molecules depend upon the molecular vibration as a physical cause. Hence, at the zero of absolute temperature, this vibrating energy being in complete abeyance, the phenomena of cohesion should cease to exist, and matter generally be reduced to an incoherent heap of cosmic dust. This second view receives no support from experiment.

The photographic action of light is diminished at the temperature of liquid air to about 20 per cent. of its ordinary efficiency, and at the still lower temperature of liquid hydrogen only about 10 per cent. of the original sensitivity remains. At the temperature of liquid air or liquid hydrogen a large range of organic bodies and many inorganic ones acquire under exposure to violet light the property of phosphorescence. Such bodies glow faintly so long as they are kept cold, but become exceedingly brilliant during the period when the temperature is rising. Even solid air is a phosphorescent body. All the alkaline earth sulphides which phosphoresce brilliantly at the ordinary temperature lose this property when cooled, to be revived on heating; but such bodies in the first instance may be stimulated through the absorption of light at the lowest temperatures. Radio-active bodies, on the other hand, like radium, which are naturally self-luminous, maintain this luminosity unimpaired at the very lowest temperatures, and are still capable of inducing phosphorescence in bodies like the platino-cyanides. Some crystals become for a time self-luminous when cooled in liquid air or hydrogen, owing to the induced electric stimulation causing discharges between the crystal molecules. This phenomenon is very pronounced with nitrate of uranium and some platino-cyanides.

In conjunction with Prof. Fleming a long series of experiments was made on the electric and magnetic properties of bodies at low temperatures. The subjects that have been under investigation may be classified as follows: The Thermo-Electric Powers of Pure Metals; the Magnetic Properties of Iron and Steel; Dielectric Constants; the Magnetic and Electric Constants of Liquid Oxygen; Magnetic Susceptibility.

The investigations have shown that electric conductivity in pure metals varies almost inversely as the absolute temperature down to *minus* 200 degrees, but that this law is greatly affected by the presence of the most minute amount of impurity. Hence the results amount to a proof that electric resistance in pure metals is closely dependent upon the molecular or atomic motion which gives rise to temperature, and that the process by which the energy constituting what is called an electric current is dissipated essentially depends upon non-homogeneity of structure and upon the absolute temperature of the material. It might be inferred that at the zero of absolute temperature resistance would vanish altogether, and all pure metals become perfect conductors of electricity. This conclusion, however, has been rendered very doubtful by subsequent observations made at still lower temperatures, which appear to point to an ultimate finite resistance. Thus the temperature at which copper was assumed to have no resistance was *minus* 223 degrees, but that metal has been cooled to *minus* 253 degrees without getting rid of all resistance. The reduction in resistance of some of the metals at the boiling-point of hydrogen is very remarkable. Thus copper has only 1 per cent, gold and platinum 3 per cent., and silver 4 per cent. of the resistance they possessed at zero C., but iron still retains 12 per cent. of its initial resistance. In the case of alloys and impure metals, cold brings about a much smaller decrease in resistivity, and in the case of carbon and insulators like gutta-percha, glass, ebonite, &c., their resistivity steadily increases. The enormous increase in resistance of bismuth when transversely magnetised and cooled was also discovered in the course of these experiments. The study of dielectric constants at low temperatures has resulted in the discovery of some interesting facts. A fundamental deduction from Maxwell's theory is that the square of the refractive index of a body should be the same number as its dielectric constant. So far, however, from this being the case generally, the exceptions are far more numerous than the coincidences. It has been shown in the case of many substances, such as ice and glass, that an increase in the frequency of the alternating electromotive force results in a reduction of the dielectric constant to a value more consistent with Maxwell's law. By experiments upon many substances it is shown that even a moderate increase of frequency brings the large dielectric constant to values quite near to that required by Maxwell's law. It was thus shown that low temperature has the same effect as high frequency in annulling the abnormal dielectric values. The exact measurement of the dielectric constant of liquid oxygen as well as its magnetic permeability, combined with the optical determination of the refractive index, showed that liquid oxygen strictly obeys Maxwell's electro-optic law even at very low electric frequencies. In magnetic work the result of greatest value is the proof that magnetic susceptibility varies inversely as the absolute temperature. This shows that the magnetisation of paramagnetic bodies is an affair of orientation of molecules, and it suggests that at the absolute zero all the feebly paramagnetic bodies will be strongly magnetic. The diamagnetism of bismuth was found to be increased at low temperatures. The magnetic moment of a steel magnet is temporarily increased by cooling in liquid air, but the increase seems to have reached a limit, because on further cooling to the temperature of liquid hydrogen hardly any further change was observed. The study of the thermo-electric relations of the metals at low temperatures resulted in a great extension of the well-known Tait Thermo-Electric Diagram. Tait found that the thermo-electric power of the metals could be expressed by a linear function of the absolute temperature, but at the extreme range of temperature now under consideration this law was found not to hold generally; and further, it appeared that many abrupt electric changes take place, which originate probably from specific molecular changes occurring in the metal. The thermo-electric neutral points of certain metals, such as lead and gold, which are located about or below the boiling-point of hydrogen, have been found to be a convenient means of defining specific temperatures in this exceptional part of the scale.

The effect of cold upon the life of living organisms is a matter of great intrinsic interest, as well as of wide theoretical importance. Experiment indicates that moderately high temperatures are much more fatal, at least to the lower forms of life, than are exceedingly low ones. Prof. McKendrick froze for an hour at a temperature of 182° C. samples of meat, milk, &c., in

sealed tubes; when these were opened after being kept at blood heat for a few days, their contents were found to be quite putrid. More recently some more elaborate tests were carried out at the Jenner Institute of Preventive Medicine on a series of typical bacteria. These were exposed to the temperature of liquid air for twenty hours, but their vitality was not affected, their functional activities remained unimpaired, and the cultures which they yielded were normal in every respect. The same result was obtained when liquid hydrogen was substituted for air. A similar persistence of life in seeds has been demonstrated even at the lowest temperatures; they were frozen for over a hundred hours in liquid air, at the instance of Messrs. Brown and Escombe, with no other result than to affect their protoplasm with a certain inertness, from which it recovered with warmth. Subsequently commercial samples of barley, pea, vegetable-marrows and mustard seeds were literally steeped for six hours in liquid hydrogen at the Royal Institution, yet when they were sown by Sir W. T. Thiselton-Dyer at Kew in the ordinary way, the proportion in which germination occurred was no less than in the other batches of the same seeds which had suffered no abnormal treatment. Bacteria are minute vegetable cells, the standard of measurement for which is the "mikron." Yet it has been found possible to completely triturate these microscopic cells, when the operation is carried out at the temperature of liquid air, the cells then being frozen into hard, breakable masses. The typhoid organism has been treated in this way, and the cell plasma obtained for the purpose of studying its toxic and immunising properties. It would hardly have been anticipated that liquid air should find such immediate application in biological research. A research by Prof. Macfadyen, just concluded, has shown that many varieties of micro-organisms can be exposed to the temperature of liquid air for a period of six months without any appreciable loss of vitality, although at such a temperature the ordinary chemical processes of the cell must cease. At such a temperature the cells cannot be said to be either alive or dead, in the ordinary acceptance of these words. It is a new and hitherto unobtainable condition of living matter—a third state. A final instance of the application of the above methods may be given. Certain species of bacteria during the course of their vital processes are capable of emitting light. If, however, the cells be broken up at the temperature of liquid air, and the crushed contents brought to the ordinary temperature, the luminosity function is found to have disappeared. This points to the luminosity not being due to the action of a ferment—a "Luciferase"—but as being essentially bound up with the vital processes of the cells, and dependent for its production on the intact organisation of the cell. These attempts to study by frigorific methods the physiology of the cell have already yielded valuable and encouraging results, and it is to be hoped that this line of investigation will continue to be vigorously prosecuted at the Jenner Institute.

And now, to conclude an address which must have sorely taxed your patience, I may remind you that I commenced by referring to the plaint of Elizabethan science, that cold was not a natural available product. In the course of a long struggle with nature, man, by the application of intelligent and steady industry, has acquired a control over this agency which enables him to produce it at will, and with almost any degree of intensity, short of a limit defined by the very nature of things. But the success in working what appears, at first sight, to be a quarry of research that would soon suffer exhaustion, has only brought him to the threshold of new labyrinths, the entanglements of which frustrate, with a seemingly invulnerable complexity, the hopes of further progress. In a legitimate sense all genuine scientific workers feel that they are "the inheritors of unfulfilled renown." The battlefields of science are the centres of a perpetual warfare, in which there is no hope of final victory, although partial conquest is ever triumphantly encouraging the continuance of the disciplined and strenuous attack on the seemingly impregnable fortress of Nature. To serve in the scientific army, to have shown some initiative, and to be rewarded by the consciousness that in the eyes of his comrades he bears the accredited accolade of successful endeavour, is enough to satisfy the legitimate ambition of every earnest student of Nature. The real warranty that the march of progress in the future will be as glorious as in the past lies in the perpetual reinforcement of the scientific ranks by recruits animated by such a spirit, and proud to obtain such a reward.

SECTION A.

MATHEMATICS AND PHYSICS.

OPENING ADDRESS BY PROF. JOHN PURSER, M.A., LL.D.,
M.R.I.A., PRESIDENT OF THE SECTION.

IN opening our proceedings to-day allow me at the outset to express my deep sense of the honour the Association has conferred upon me in asking me to preside over this Section.

My predecessors in this Chair have usually given you a survey of some department of Mathematics or Physics, tracing what had been already accomplished in that department and indicating the nature of the problems which still awaited solution.

May I crave your indulgence if I deviate from this course and, following the suggestion of some of my friends, take the opportunity of the Association meeting on Irish soil to give you a slight historical sketch of our Irish School of Mathematics and Physics?

In attempting such a review, for the sake of brevity as well as for other reasons, I shall confine it to the work of those who are no longer with us, and I would not carry it further back than the beginning of last century. This seems a natural starting point, as there was at that time a very marked revival of the study of science in the University of Dublin, a revival largely due to the influence of Provost Bartholomew Lloyd.

Lloyd won his Fellowship in Trinity College a few years before the century opened, and subsequently filled in succession the Chairs of Mathematics and Natural Philosophy. In both departments he imported a radical change into the methods of teaching. By his treatises on Analytical Geometry and on Mechanical Philosophy he introduced the study of what was then called the French Mathematics, in other words the more advanced Analytic Methods, which were in use on the Continent. In 1831 he was appointed Provost of the College, and his tenure of the office, though brief, was signalled by many important improvements and new developments effected in the University teaching.

Dr. Bartholomew Lloyd was President of one of the earliest Meetings of this Association, that held in Dublin in 1835.

His son, Dr. Humphrey Lloyd, had a course which was a singularly close parallel to his father's.

He won his Fellowship in 1824, and succeeded his father in the Chair of Natural Philosophy. He also was afterwards appointed Provost, and he too presided over another Dublin Meeting of this Association, that held in 1857. He also, in this again following in his father's steps, wrote important works on different branches of Physics; "Light and Vision," a systematic treatise on plane as distinct from physical optics, "Lectures on the Wave Theory of Light," and lastly a treatise on "Magnetism."

It is, perhaps, in connection with this latter subject that his most important work was done. He made in association with Sabine an elaborate series of observations on terrestrial magnetism in twenty-four stations in various parts of Ireland, and when subsequently, at the instance of your Association and of the Royal Society, the Government established magnetic observatories in different parts of the world, it was Lloyd who was entrusted with the task of drawing up the manual of instructions for the observers and of receiving their reports.

In the interval between the two Lloyds another name claims attention. Dr. Romney Robinson occupied during an exceptionally long life a much honoured and influential position amongst men of science. It was in this city he received his early education, for when young Robinson was only nine years of age his father had occasion to move to Belfast, and he placed his son under Dr. Bruce, a well-known schoolmaster of those days. Robinson was afterwards sent to Trinity College, and after a distinguished course was elected to a Fellowship in 1814. For some years he lectured in college as Deputy Professor of Natural Philosophy. He relinquished his Fellowship on obtaining a College living, and a few years later was appointed Astronomer in charge of the Armagh Observatory. The results of his observations were considered so valuable as to be used by the German astronomer Argelander in determining the proper motions of stars. The range, however, of his published papers was by no means confined to Astronomy, but extended to the most varied subjects, Heat, Electricity, Magnetism, Turbines, Air-pumps, Fog-signals, and others. He is best known to the general public as the inventor of the Cup Anemometer. He was chosen to preside over the Birmingham Meeting of this Association in 1849.

Robinson was intimately associated with Lord Rosse and keenly interested in the experiments which culminated in the construction of the great reflector in Parsonstown. This naturally leads us to speak of Lord Rosse himself. Few scientific achievements took a greater hold upon the public mind than the successful completion of his great telescope. Only those who have read in Lord Rosse's own papers the description of the many difficulties he had to contend with in forging and polishing that wonderful speculum, harder than steel yet more brittle than glass, can adequately appreciate the patience and resource with which those difficulties were successively overcome.

Of the results obtained with this instrument the most notable were in the observation of the Nebule, a department where its unsurpassed power of light-concentration came fully into play. No doubt at the time public attention was most excited by the resolution of a number of hitherto supposed nebule into star clusters, leading to the premature conclusion in the minds of those less instructed that all the nebule might ultimately be so resolved. To us, however, a far greater interest attaches to the observation of the structure of what we now know to be genuine nebule, especially the great discovery that these had in many cases a peculiar spiral form. All previous telescopes had failed to detect this spiral character; but the drawings taken by Lord Rosse and his assistants put this feature beyond question, and these have been fully confirmed in recent years, when more accurate delineations were obtained by photography. I need not dwell upon the significance of this form, indicating, as it does, a rotatory movement in these mighty masses and fitting in with, if not actually confirming, Laplace's Nebular Hypothesis.

Sir William Rowan Hamilton was undoubtedly the most striking figure in the annals of the Dublin School of Mathematics. *In limine* we must make good our right to call him an Irishman, for his greatest admirer and disciple, Prof. Tait, has claimed him for a countryman of his own, asserting that Hamilton's grandfather was a Scotchman who emigrated to Dublin with his two young sons. That this was a complete misconception has been abundantly proved by the careful investigations of his friend and biographer, Dr. R. P. Graves, who shows conclusively that the only known strain of Scotch blood in Hamilton came through his grandmother, who was the daughter of a minister of the Scottish Kirk.

It is interesting to find how early Hamilton's remarkable mental powers began to show themselves. Dr. Graves has given us a letter from his mother in which she writes to her sister of the marvellous precocity of her little four-year-old boy, telling how "he reads Latin, Greek, and Hebrew."

His mental development did not belie these early indications, for at the age of thirteen, thanks to the teaching and care of his uncle, who was a most extraordinary linguist, he had not only acquired a considerable knowledge of the classics and the modern European languages, but also attained some proficiency in Arabic, Sanscrit and Persian. His mathematical studies, on the other hand, appear to have been carried on without help from anyone, and it is noteworthy that he does not seem to have used common text-books, but to have gone direct to the great original authors; e.g., he read his algebra in Newton's "Arithmetica Universalis"; while at the age of fifteen he set himself to read the "Principia," and two years later began a systematic study of Laplace's "Mécanique Céleste." His own estimate of his powers may be gathered from a characteristic letter to his sister written just after he had entered Trinity College:—

"One thing only have I to regret in the direction of my studies, that they should be diverted—or rather rudely forced—by the College course from their natural bent and favourite channel. That bent, you know, is science—science in its most exalted heights, in its most secret recesses. It has so captivated me, so seized on, I may say, my affections that my attention to classical studies is an effort and an irksome one; and I own that, before I entered College, I did not hope that in them I would rise above mediocrity. My success surprised me, but it has also given me a spur by holding out a prospect that even in the less agreeable part of my business I may hope still to succeed."

This letter is interesting as indicating on Hamilton's part a consciousness wherein lay his real strength and vocation. Not that his interest in literature ever abated. To the last he loved to try his hand at poetical composition, frequently inserting in his letters to his friends sonnets of his own.

He knew Wordsworth intimately, and the poet, to whom he sent some of his productions, gives him the following candid advice:—

"It would be insincere not to say that something of a style more terse and a harmony more accurately balanced must be acquired before the bodily form of your verses will be quite worthy of their living souls. You are perfectly aware of this, though perhaps not in an equal degree with myself; nor is it desirable you should be, for it might tempt you to labour which would divert you from subjects of infinitely greater importance."

Hamilton was first in his College classes in every subject and at every examination, and it was fully expected that he would carry off both the medals in Mathematics and Classics at his Degree when the following circumstances suddenly changed all his plans. Dr. Brinkley, the Professor of Astronomy in the University, was appointed to be Bishopric, and Hamilton, though still an undergraduate, was invited to offer himself for the vacant Chair. Sir George Airy and more than one of the Fellows of Trinity were also candidates, but Hamilton was unanimously elected.

His career as an original author dates from this time, for immediately after his appointment he communicated to the Royal Irish Academy the first of three remarkable papers on "Systems of Rays."

Two striking features may be observed in these papers, as indeed in all his scientific memoirs: the generality and comprehensiveness with which he states his object at the outset and the confidence with which he follows the bold and original lines of treatment which he lays down for himself, and closely connected with this, the determination not to be baffled by any laboriousness of calculations which the application of his method may involve him in. In his first paper he begins by examining what happens to a system of rays of light emanating from a point and subjected to any number of reflections at curved surfaces. He establishes the theorem that such a system will be cut orthogonally by a system of surfaces, the length of the path measured from the original source to any of these surfaces being the same for all the rays. The proof he gives of this theorem is so simple that it now seems almost axiomatic; but it is curious that Malus, who had made the laws of Light his special study, though he suspected that the theorem ought to hold, yet found himself unable to establish it.

Hamilton, now considering the length of the path to any point as a function of the coordinates of that point, and denoting this function by V , proves that V satisfies a simple partial differential equation of the first order and proceeds to show the important part the function V plays in the theory.

He goes on to prove generally that if we are dealing, not with right lines, that is, with paths, for which as between any two points $\int ds$ is a minimum, but with curved paths

for which $\int \mu ds$ is a minimum (where μ is a function of the coordinates), and a system of such paths be drawn through a given point, O , the system of surfaces $V = \text{const.}$ will still cut all the paths at right angles. If we adopt the emission theory of Light, and we take for μ the velocity of Light, V becomes "the Action," and the minimum property which the paths satisfy is the principle of "Least Action." If, on the other hand, we adopt the undulatory theory, and we take for μ the reciprocal of the velocity, the minimum property becomes the principle of "Least Time." Thus Hamilton shows that, by altering the significance of μ , his method applies to either theory.

Introducing the further conception that μ depends, not only on the coordinates of the point, but also on the direction-angles of the ray, he is able to apply his reasoning to rays passing through a crystal. He gives by his method a new and interesting proof of the equation of Fresnel's wave-surface, and arrives at the conclusion, hitherto unnoticed by mathematicians, that this wave-surface possesses four conical cusps and also four special tangent planes, each of which touches the surface, not in one point only, but in an infinite system of points lying in a circle. The physical significance of these theorems is what is known as Conical Refraction.

Having drawn this inference from his mathematical analysis, Hamilton wrote to his friend Dr. Lloyd and asked him to verify it by actual observation, and accordingly Hamilton's paper in the *Transactions of the Academy* is accompanied by another

from Lloyd, describing the beautiful arrangements by which he had succeeded in verifying this remarkable phenomenon in both its varieties.

This striking instance of scientific prediction naturally made a great sensation at the time, appealing, as it did, to a much larger public than the few select mathematicians who were capable of mastering the elaborate treatise on "Systems of Rays."

The experimental skill that was required to obtain these results may be realised from the circumstance that as I have been told the French physicists found themselves unable to repeat the experiment till Lloyd himself went over to Paris with his instruments and showed them the way.

Hamilton was so well satisfied with the success of his new method in dealing with the problems presented by the propagation of Light that full of enthusiasm he proceeded to apply a generalised form of the same method in the investigations of the motion of any material system, and a paper of his was read before the Royal Society in 1834 with the following title: "On a general method in Dynamics by which the Study of the Motions of all free systems of attracting or repelling points is reduced to the Search and Differentiation of one Central Relation, or Characteristic Function."

To show the importance attached by the most competent judges to Hamilton's work in this field of Theoretical Dynamics, we cannot do better than quote the words of his great German contemporary Jacobi, who afterwards himself added to the new theory such valuable developments.

Jacobi writes as follows:—"If a free system of material points is acted on by no other forces than such as arise from their mutual attraction or repulsion, the differential equations of their motion can be represented in a simple manner by means of the partial differential coefficients of a single function of the co-ordinates. Lagrange, who first made this important observation, at the same time showed that this form of the differential equations possesses great importance for Analytical Mechanics. The marked attention, therefore, of mathematicians could not fail to be aroused when Herr Hamilton, Professor of Astronomy in Dublin, indicated in the *Philosophical Transactions* that in the Mechanical problem referred to all the integral equations of motion might be represented in just as simple a manner by means of the Partial Differential Coefficients of a single function. This is undoubtedly the most considerable extension which Analytical Mechanics has received since Lagrange."

It will be of interest to the Section to recall the fact that Hamilton and Jacobi met each other for the first and I fancy the only time at a meeting of this Association, held in Manchester in 1842, at which meeting Jacobi, addressing this Section, called Hamilton "le Lagrange de votre pays."

The last third of Hamilton's life was mainly devoted to the development of his Quaternion Calculus. As early as 1828 his Class Fellow, J. T. Graves, who had been working at the theory of the use of imaginary quantities in Mathematics, wrote an essay on Imaginary Logarithms which he wished to get printed by the Royal Society. There appears to have been some hesitation amongst the leading mathematicians in the Society, notably, Herschel and Peacock, about publishing Graves' paper, as they felt dubious about the accuracy of his reasoning. Hamilton heard of this and wrote earnestly to Herschel defending his friend's conclusions, and it seems as if his generous desire to help his friend first set his own mind working in this direction.

For years his busy brain in the midst of all his other work kept pondering over this question of the interpretation of the imaginary, and he has left us in his "Lectures on Quaternions" an elaborate account of the many systems he devised.

It was only in 1843, fifteen years later, that he first invented the celebrated laws of combination of the quadrantal versors of the Quaternion Calculus. Argand, Cauchy, and others had proposed for space of two dimensions the theory now known as that of the Complex Variable. For them $x + iy$ meant the vector to the point xy , and the product of two vectors meant a new vector of the same form, the only law required being that i operating upon i was always equivalent to -1 .

Many attempts had been made to form on similar lines a Calculus which should apply to space of three dimensions; but so far all such attempts had proved unsuccessful, the laws by which the new symbols acted upon one another leading to results hopelessly involved. It was here that Hamilton's wonderful faculty of scientific imagination came into play. He proposed that

vector should be denoted by $ix + jy + kz$. As in the theory of the complex variable in two dimensions the result of any number of successive operations always preserved the fundamental type $a + ib$, so it was desirable that the result of the successive operations of his vectors should issue in an equally simple fundamental type. This end he found he could attain if he discarded the commutative principle which hitherto had barred his own progress and that of others, yet preserving the distributive and associative principles, and finally one happy evening he arrived at the beautifully simple laws by which the symbols of this Calculus act upon each other; that not only $i^2 = j^2 = k^2 = -1$, but also that $ij = -ji = k$, $jk = -kj = i$, $ki = -ik = j$.

Though it was thus—as the product, that is, of two vectors—that the Quaternion first presented itself to Hamilton, he of course saw that it immediately followed that it might be regarded as the ratio of two vectors, in other words the operation which turned one vector into another. In fact in the more synthetic exposition which is contained in "The Elements" he makes this latter the starting definition of the Quaternion.

It is noteworthy that this, the more complete and systematic presentation of the subject by its illustrious author, may be said to owe its origin to the keen interest my predecessor, Prof. Tait, took in the new Calculus, of which, as you know, he ever afterwards remained the most ardent champion. This interest led him to seek from Dr. Andrews an introduction to Hamilton, and the encouragement came to Hamilton at an opportune moment, for he wrote:—

"It was useful to me to have my attention recalled to the whole subject of the Quaternions, which I had been almost trying to forget, partly under the impression that nobody cared or would soon care about them. The result seems likely to be that I shall go on to write some such 'Manual,' but necessarily a very short one."

The "Manual" thus foreshadowed became the voluminous treatise "The Elements of Quaternions."

Those interested in the future of Quaternions will have welcomed the new edition of this work brought out by the present occupant of Hamilton's Chair, Prof. Charles Joly, who has himself also added some remarkable developments to one branch of the subject, the Theory of the Linear Vector Equation.

Hamilton's Quaternions may be viewed in two lights, as a development of the logic and philosophy of symbols in their relation to space of three dimensions and also as an instrument of research in Geometry and Physics. In the former aspect, the Quaternions will ever remain a splendid monument of the imagination and genius of its inventor. In the latter point of view, that is, when we come to regard it as a working calculus, it would be premature as yet to fix the place it will ultimately occupy.

A few years after Hamilton had entered upon his scientific career, James MacCullagh won his Fellowship in Trinity College. After an interval of three years he was appointed Professor of Mathematics, and eight years later succeeded Dr. Lloyd in the Chair of Natural Philosophy. It would be difficult to overestimate the stimulating effect of MacCullagh's lectures as Professor upon the Mathematical School. Many of those whose names stand out afterwards—such men as Jellett, Michael and William Roberts, Haughton, Townsend and our present honoured Provost—were MacCullagh's pupils. To the present day the tradition still lingers in Trinity College of the impression MacCullagh made upon the minds of those with whom he came in contact.

When, passing from his influence as a teacher, we come to examine his own original work, we find that this naturally divides itself into two departments, the first embracing Geometry and that part of the field of Mathematical Physics which most resembles Geometry, that in which the fundamental principles are entirely agreed upon; the second his work in Physical Optics, where he has to imagine new principles which, mathematically developed, should correlate the empirical laws hitherto obtained and be capable of verification by experiment.

Of the first class we have his studies in "Surfaces of the Second Degree." The most striking result he here obtained was the discovery of the modular generation of the quadric, thus extending to surfaces the focus-and-directrix property of the conic in plane. We are also indebted to him for some very elegant theorems in the theory of confocal quadrics, a subject to which he devoted much attention. He likewise gave a course of lectures containing a masterly discussion and geometrical pre-

sentment of the motion of a rigid body round a fixed point not acted on by external forces.

At the very outset of his career as an original author he seems to have been attracted by the theory of Light. To understand the ardour with which MacCullagh and his contemporaries devoted their mathematical powers to Physical Optics, we must endeavour to recall the circumstances of the time. The celebrated memoirs of Fresnel had recently appeared. In these he had proved, following Young, that the ethereal vibrations which constitute Light must be in the plane of the wave-front; that a beam of polarised light was simply a system of parallel waves in which these transverse vibrations were all in one direction. He had applied the theory of the ellipsoid to prove that there were three directions in a crystal in which the restitution-force coincided with the direction of the vibrations; that in the plane of every wave there are two directions along which, if a particle vibrate, the component of the restitution-force resolved in the plane of the wave will be along the direction of displacement. He had also from these principles deduced the equation of his famous wave-surface.

How much the work of Fresnel filled the imagination of scientific men in those days may be seen from the enthusiastic language which the sober-minded Dr. Humphrey Lloyd allows himself to use about him in his valuable report on Physical Optics, which he wrote for this Association in 1834.

In passing I would say that the name of Fresnel reminds us of the loss Science, and especially this Section, has sustained since we last met in the death of that illustrious French physicist who devoted his life with such ardour and success to the same field of research—Alfred Cornu. Those of us who had the privilege of being present will recall with a sad pleasure the beautiful address he gave us in Cambridge on the Wave Theory of Light on the occasion of Sir George Stokes' jubilee.

Fresnel in his analysis had assumed that when the molecules of the ether are disturbed by the passage of a wave the force of restitution acting upon a molecule depends upon that molecule's absolute displacement. Cauchy and Neumann and, in England, Green, improved on Fresnel's reasoning, making this force depend, not on the absolute, but on the relative displacement; all these physicists, however, worked on the lines of endeavouring to form an explanation of the propagation of the waves of Light, by treating them as the waves in an elastic medium, akin in its properties to a solid medium in which the stresses depend on the deformation of the elements.

MacCullagh agreed with these others in making the forces of restitution depend on the relative displacements as expressed through a certain function V , which represented the potential energy of the medium. In the further development of the theory he, however, diverges from them and adopts a line of his own. Struck by the significance of the fact, to which he seems to have been the first to direct attention, that the vector whose components are

$$\left(\frac{1}{2} \frac{dv}{dz} - \frac{dw}{dy} \right), \left(\frac{1}{2} \frac{dw}{dx} - \frac{du}{dz} \right), \left(\frac{1}{2} \frac{du}{dy} - \frac{dv}{dx} \right),$$

which we now, of course, know as the vector of molecular rotational displacement, was, so to speak, a physical vector, independent of the choice of our axes of coordinates, he was led to the idea of choosing for the form of V that of a homogeneous quadric in these three components. It must be admitted that the reasoning by which he attempts to prove the necessity of this assumption is eminently unsatisfactory, and that the assumption itself lay open to an apparently fatal objection urged later by Stokes, that of neglecting to secure the equilibrium of the element of the medium quad moments.

Having, however, adopted this form of V , MacCullagh proceeds (making the assumption that while the elasticity of the medium varied the density was everywhere the same), by processes of remarkable elegance and simplicity, to develop the laws of wave propagation in a crystal, thus verifying the wave-surface of Fresnel, while at the same time he found himself able to satisfy completely the requirements at the limits. He could also point to experience, e.g., the experiments of Brewster and Seebeck, as justifying the simple and beautiful laws which he had succeeded in obtaining.

Nevertheless the force of Stokes' objection was felt to be so strong that one who reviewed the subject, say thirty years ago, would have regarded MacCullagh's work in Optics as presenting indeed opportunities for beautiful mathematical developments, but lacking sound physical basis.

The publication, however, of the epoch-making treatise of Maxwell on Electricity and Magnetism entirely changed the aspect of the question, and in particular threw a new light on MacCullagh's assumption. FitzGerald, in 1879, pointed out that the Potential Energy, which in Maxwell's theory was equivalent to the electrostatic energy, really was a quadratic function of three variables, which answered to the components of MacCullagh's molecular rotation, and accordingly led to the same differential equations of the motion as MacCullagh had deduced.

Subsequently Larmor, in his remarkable investigation of the Dynamical Theory of the Electric and Luminiferous Ether, deliberately reconsiders MacCullagh's position, finds in fact in his equations the starting point of his own theory. He points out the real significance of MacCullagh's function V ; that it corresponds to a stress-strain system, but one of a very novel type; one in which the stresses depend entirely on the rotational displacements of the molecules, and are otherwise absolutely unaffected by the ordinary deformation-strains. He further shows that the difficulty under which MacCullagh's theory laboured, that it did not provide for the rotary equilibrium of the element, could be removed if we allowed ourselves to assume the existence of a hidden torque acting on each element.

As I understand the advocates of this theory, they maintain that an important step has been made, even though in the present state of our knowledge we may not be able to account for the existence of this hidden torque. They point out, however, that such a torque is at least not inconceivable, whether its explanation be sought in concealed kinetic phenomena, as in Lord Kelvin's material gyrostatically constituted medium, or in quasi-magnetic forces supposed to reside in the ethereal elements.

Should this theory of a rotationally elastic ether obtain final acceptance, it will of course be a matter of congratulation to MacCullagh's countrymen to find that his labours, in this, perhaps the most important field of his researches, have not been thrown away; that they represent no mere play of elegant mathematical analysis, but a real step in the progress of physical science.

A few years after MacCullagh, two other well-known men, whose names for half a century were associated with the Mathematical School in Dublin, were elected Fellows—Andrew Searle Hart, afterwards Sir Andrew Hart, and Charles Graves, subsequently Bishop of Limerick. They won their Fellowships in two successive years, and both lived to an advanced age.

Hart had a great reputation as a geometer. His examination papers were specially noted for the number of original problems they contained. As specimens of his work we may instance the following. Extending Feuerbach's theorem for the nine-point circle, Hart showed that the circles which touch three given circles can be distributed into sets of four all touched by the same circle. He also showed that Poncelet's beautiful porism for coaxial circles in plano held for the surface of an ellipsoid, if we replace the rectilinear polygons by geodesic polygons and the coaxial circles by lines of curvature.

Graves became Professor of Mathematics on MacCullagh's resigning the Chair in 1843. He was largely influenced by the writings of Chasles, of whose two memoirs on Cones and Spherical Conics he published a translation. In this were incorporated valuable original additions of his own, amongst others the remarkable theorem that if two spherical ellipses are confocal the sum of the tangents drawn to the inner from any point of the outer exceeds the intercepted arc between the points of contact by a constant length, a theorem which of course includes the corresponding proposition for conicals in plano. Graves was one of the first to apply the method of the Separation of Symbols to Differential Equations, and gave an elegant demonstration by this method of Jacobi's celebrated test for distinguishing between maxima and minima in the Calculus of Variations.

On the death of MacCullagh it was determined to strengthen the Natural Philosophy department by the establishment of a second Professorship in that subject, and Jellett, one of the ablest of MacCullagh's pupils, was appointed to the new Chair.

His first published work was his "Calculus of Variations," which at the time it was written constituted the only systematic English treatise on the subject. It is marked by that peculiar acuteness and power of fastening on essential points, whether for criticism or exposition, which was the author's leading characteristic. Apart from the excellent account he gives of the

researches of Continental mathematicians, I would notice especially his most interesting chapters on the conditions of integrability and many valuable geometrical theorems on surfaces hence resulting. In discussing his more properly original work we may arrange it in three divisions: 1st, his papers on Elasticity; 2nd, that on the properties of Inextensible Surfaces; 3rd, those on the application of polarised light to the new subject of Chemical Equilibrium.

In taking up the problem of an elastic medium and the propagation of waves in such medium, Jellett follows the example of MacCullagh, who had made this subject one of special interest to the Dublin school. In these memoirs he draws attention to a remarkable difference in the mode of regarding the molecular constitution of the medium, a difference corresponding to what is now known as the distinction between the Kari-constant and Multi-constant theories. We may, Jellett points out, regard the action between two molecules as only conditioned by the relative position of these molecules, or as dependent also on the position of the neighbouring molecules. The first is termed by Jellett the hypothesis of independent action, and this he shows to lie at the basis of Cauchy's theory, whereas the theory of Green, the English elastician, essentially involves the second hypothesis which Jellett calls "modified action." He established in the same papers the important theorem that if a Work function exists the three directions of vibration, corresponding to a plane-wave, are rectangular, and *vice versa*.

In his memoir on Inextensible Surfaces various interesting questions are discussed. He proves that in the case of a synclastic surface if a closed curve on the surface be held fixed, the entire surface will be immovable; that on the other hand on an anticlastic surface it is possible to draw a curve which may be held fixed without involving the immovability of the surface, the conditions being that the curve will be that formed by the successive elements of the inflectional tangents. The mathematical theory of such curves had been already studied, but Jellett seems to have been the first to signalise their importance in the theory of deformation, and, on account of the property referred to, he proposed to call them Curves of Flexure. It is interesting to remark that Maxwell was attracted by the same subject of Inextensible Surfaces, and in one of his earliest papers confirms by an entirely different method several of Jellett's conclusions.

At the close of Jellett's paper a remarkable proposition is laid down, apparently for the first time, that a closed oval surface cannot be inextensibly deformed; in other words, that if such a surface be perfectly inextensible it is also perfectly rigid. I think we must admit that the proof of this striking theorem offered by Jellett is by no means satisfactory. Subsequent attempts by others to establish this proposition can hardly be said to be more successful. But the fact that it can be rigorously proved true for a sphere or more generally for any ellipsoid seems to indicate that we have here to do with a real and important theorem, but one which needs, as is so often the case, to have the limits of its application more clearly defined.

Many experimental physicists will know Jellett best by the beautiful and delicate instrument he invented, "The Double-plane Analyser," an instrument which he devised in order to secure the more exact determination of the rotation of the plane of polarisation than could be obtained by the polariscopes hitherto in use. Jellett was actuated here by the consideration that he saw in this phenomenon of the rotation of the plane of polarisation a means of attacking the interesting problem of chemical equilibrium. Chemical equilibrium he defines thus: "Two or more substances may be said to be in chemical equilibrium, if they can be brought into chemical presence of each other (as in a solution) without the formation of any new compound or change in the amount of any of the former compounds which have thus been brought together." In a mixed solution of sundry bases and acids where all the possible salts are soluble, what are the proportions in which the acids are distributed amongst the bases? Such was Jellett's question, and in answering it he arrives by a remarkable train of quasi-mathematical reasoning at certain laws governing this distribution, and proceeds to establish the truth of these laws by observation with his new polariscope.

He also discusses in the same papers two alternative theories which we can hold of chemical combination, the "static" and the "dynamical," and shows from the consideration of the number of equations which subsist that the "dynamical theory" is alone admissible.

When the Association met in Belfast twenty-eight years ago Dr. Jellett occupied this Chair, and at the close of his Address, in which he took for his subject certain fresh applications of Mathematical Analysis to Physical Science, he touched upon these very researches in which he was at the time engaged.

All old Trinity men would think this enumeration incomplete if it did not refer to the wonderfully active animating presence of Samuel Haughton. He also directed his energies in the first instance to the subject of Elasticity, on which he wrote several important memoirs, endeavouring to formulate a system of laws by which he might be able to explain the propagation of Light. But apparently discouraged by the extreme difficulty of the problem his versatile brain turned soon to quite other branches of science—to Physical Geology, then to Physiology and Medical Science, and in fact in his later work he passes out of the cognisance of Section A.

Of the pure mathematicians trained under MacCullagh two of the most eminent were the twin brothers Michael and William Roberts. Strikingly alike in their personal appearance they were in my student days two of the best known figures in the Courts of Trinity.

In his geometrical work Michael Roberts pursued the fruitful lines of research started by Chasles and followed up by MacCullagh in the study of quadric surfaces, and it fell to his lot to discover some most remarkable theorems on the relations of the geodesics on the surface to the lines of curvature; theorems indeed to which the author would have been justified in applying words which Gauss used of a great theorem of his own:

“Theoremata que ni fallimur ad elegantissima referenda esse videntur.”

Joachimsthal had shown that the first integral of the equation of the geodesics on an ellipsoid could be thrown into the well-known form $PD = \text{constant}$. Michael Roberts now showed that the geodesics, which issue in all directions from an umbilic, pass through the opposite umbilic where they meet again by paths of equal length; that the lines of curvature considered with respect to two interior umbilics possess properties closely analogous to those of the plane conic with respect to its foci; that if such umbilics A and B be joined by geodesics to any point P on a given line of curvature they make equal angles with such line, and consequently that as P moves along the line of curvature, either $PA + PB$ or $PA - PB$ remains constant, so that if the ends of a string be fastened at the two umbilics and a style move over the surface of the ellipsoid, keeping the string stretched, the style will describe a line of curvature. Another remarkable analogue he proved was the following: that as in a plane conic if a point P on the curve be joined to the foci A and B,

$$\tan \frac{1}{2}(PAB) \tan \frac{1}{2}(PBA) = \text{const.}$$

$$\text{or } \tan \frac{1}{2}(PAB)/\tan \frac{1}{2}(PBA) = \text{const.}$$

so precisely the same relation holds for a line of curvature on the quadric, replacing the foci by the umbilics and the right lines by geodesics.

Sir Andrew Hart made a valuable contribution to the subject by investigating the relation between the angles which an umbilic geodesic makes with the principal plane when it leaves the umbilic and when it returns to it again after going the circuit of the surface. He proved that if ω and ω' be these angles, $\tan \frac{1}{2}\omega'$ can be expressed by means of complete elliptic integrals independent of ω . This is interesting, as it shows that such a geodesic is not a finite closed curve, but that it crosses itself over and over again at the umbilics, the successive values of $\tan \frac{1}{2}\omega$ forming a geometric series.

To Michael Roberts is also due much important work in the department of pure analysis—notably, in modern Algebra his method of deriving Covariants, and the investigation of their relations by means of their sources, and in the theory of Abelian integrals his construction (following the method of Jacobi) of a Trigonometry of the hyperelliptic functions.

His brother William Roberts is perhaps best known for some of the investigations he carried out by means of elliptic coordinates. For example, he applied them to Fresnel's wave-surface, and showed that the two sheets of the surface can be expressed in the simple forms

$$\lambda^2 + \nu^2 = a^2 + \beta^2 - c^2 \quad \text{and} \quad \lambda^2 + \mu^2 = a^2 + \beta^2 - c^2.$$

By following the same method he succeeded also in adding an interesting new triple system of orthogonal surfaces to those already known.

Richard Townsend was another of the Fellows of Trinity of MacCullagh's school. He was known to us in College in my day as the great expositor of the new geometry of Anharmonics and Involution. He wrote many valuable original papers, but it was as a lecturer he was most remarkable. I never met a teacher so enthusiastic or one who seemed to enjoy teaching more thoroughly.

He inspired his pupils with much of his own ardour, and it is greatly owing to Townsend's influence that the old name Trinity had for the study of Geometry was so well kept up in his day.

He published in the latter part of his life an extensive treatise on Modern Geometry, which did good service in presenting the subject in the light of an organised system and not as a collection of isolated problems.

In this connection I must not omit to mention one of our most original Irish geometers of recent days, Dr. John Casey. Where Casey learnt his Mathematics is indeed a marvel. Up to middle life he was engaged in the engrossing labour of a schoolmaster in Kilkenny under the National Board of Education. It was not till he was nearly forty that by the advice of Townsend, to whom he used to send up some of his ingenious geometrical solutions, he moved up to Dublin and entered Trinity College. Of his original papers his best known are those on Bicircular Quartics and Cyclides.

In elementary Geometry we owe to him a very elegant extension of Ptolemy's famous theorem that for four points, ABCD, on a circle $AC \cdot BD = AB \cdot CD + AD \cdot BC$. Casey shows that the same equation is true if we replace the four points by four circles touching a common circle and the lines joining the points by the common tangents to the circles. He acquired so high a repute both as a teacher and as a writer that he was offered and accepted the post of Professor of Mathematics in the Catholic University.

It is not yet two years since George FitzGerald was taken from us. The many loving tributes to his memory which appeared in the scientific journals after his death reveal to us how deep and widespread his loss was felt to be, but it is in Ireland this loss is most serious. As long as he lived and worked, our country could claim to own one of the foremost members of that select band who are endeavouring to wrest from Nature her inmost secrets.

You know how sedulous an attendant he was of the meetings of this Section, and Trinity College never sent you a representative of whom she had more reason to be proud, for he has done more than any of her sons for many years to maintain the reputation of her scientific school. This he has brought about, not by his writings only, able and original as these were, but also by the encouragement and stimulus he gave the younger men he gathered round him, and the self-forgetful readiness with which he gave all the help he could to those who in any measure shared his own genuine love for science.

You will all rejoice that we are now in possession of a volume containing a complete collection of FitzGerald's scientific papers. I am sure he himself could not have wished for a better chronicler of his life and labour than his intimate friend Dr. Larmor, more especially as Dr. Larmor's own far-reaching speculations on the great mystery of the ether qualify him in a very peculiar manner to appreciate the work of his fellow-physicist. The admirable analysis of that work in the opening pages of this volume renders any further account of it on my part completely unnecessary.

A few months before FitzGerald's death there passed away one of his most distinguished pupils, Thomas Preston. Though cut off so young he had already done much work, and of a quality which raised high expectations of his future. His treatises on Light and on Heat are to be noted, not merely for the excellent account they give of the recent additions to the subjects treated, but for the thoughtful and philosophic spirit in which the whole is presented. It was, however, his experimental researches which most excited attention, more particularly those on the action on Light of a strong electro-magnetic field and the fine experiments in which he extended beyond any observations hitherto made the analysis of the Zeeman effect.

Of two others I have yet to speak, and these were emphatically representatives of this city and of the College in whose Halls we are meeting to-day—Thomas Andrews and James Thomson. It would be difficult to describe adequately all the phases of so manifold an activity as that of Dr. Andrews. As one long associated with him as a colleague I would bear testimony to one side of his life-work—the potent influence he

exercised in this College in its earlier years as a skilful pilot guiding the ship till it was well out of port. His high ideal of the function it should discharge in the education of the country and the practical zeal and ability which he ever brought to bear on the administration of our affairs contributed in no small measure to place the College in the assured position it occupies to-day.

On his great physical and chemical investigations it is happily the less necessary for me to touch, as they have been so fully brought before you by our President in his opening Address; and as regards the most important of these researches, those on the continuity of the Liquid and Gaseous states, no one assuredly could have more fitly expounded them than one who has himself pressed forward with such splendid success in the paths which Andrews opened up.

I have always considered that Andrews, through the long course of these later researches, was most fortunate in having near at hand such a friend as James Thomson; not that he was a collaborator—Andrews did all this work unaided—but that Thomson gave him throughout that best of all encouragement which consists in enlightened appreciation of the importance of the results he was obtaining and of their inner meaning and significance.

Of Thomson himself what shall I say? Of all the scientific men I have come across he perhaps most fulfilled the idea of a philosopher, his ever-working brain ever seeking out causes, ever pondering on the why and the wherefore of the unexplained.

One of his earliest investigations is perhaps the best known, that in which, basing his reasoning on Carnot's principle, he demonstrates the effect of pressure in lowering the freezing-point of water, and in which he gave at the same time a numerical estimate to this effect.

This discovery was of great practical import, for, small as the effect was, it enabled him to explain fully the rationale of the plasticity of ice.

Forbes had already shown that the motion of glaciers depended on a plastic or viscous quality in the ice. It remained for Thomson, by the aid of his newly discovered principle, to go a step further and account for this plasticity.

It is interesting to note that the questions which led to some of his most valuable investigations seem to have been started by the filial task he took upon himself of re-editing his father's educational text-books. It was, for example, the revision of a chapter in his father's Geography which I believe led him to examine more thoroughly into Hadley's theory of the Trade winds, and to make the following important addition to that theory. He showed that while in the tropical latitudes, say of our northern hemisphere, two currents would satisfy all the conditions, *i.e.*, the Trade wind blowing from N.E. to S.W. in the lower regions of the atmosphere, and the return current in the upper regions, on the other hand that in the temperate latitudes there must be three currents at different elevations; that the uppermost and the lowest of these have a movement towards the Pole, but in the middle regions of the atmosphere between these there must be a large return current from the Pole, and that the prevailing motions of all three currents would be from west to east.

Thomson was particularly successful in his treatment of this and other questions of fluid motion. He was not familiar with the technique of the higher mathematics, and on this very account was not tempted, as so many mathematical experts are, to assume impossible conditions in order to bring the problems within reach of their algebraic analysis; but for all that his mind was eminently of a mathematical cast. He is never vague or loose in his reasoning, and he had a wonderfully tenacious grasp of physical principles. The result was that he has succeeded in finding out the key to some of the most curious phenomena in the motions of fluids.

I may give as a typical instance of his line of reasoning his beautiful explanation of the action of the water of a river flowing round a bend. He saw clearly that from true dynamical principles the flow of the water must be most rapid near the inner bank, and the question which presented itself to his mind was why then the inner bank was not worn away. The answer he showed to consist in the friction of the bed checking the velocity of the lowest stratum of the water. The effect of this he proves to be that an under-current is produced in this stratum across the bed of the river from the outer towards the inner bank, a current which does two things: it carries sand and

detritus and deposits the silt on the inner bank; and, since the water in this current has to rise vertically to the surface when it reaches this bank, it thus protects it from the scour.

In a review of Thomson's work we should emphasise his constant endeavour, whether in Mathematics or Physics, to attain clear conceptions of fundamental principles. This showed itself in the various innovations in nomenclature he introduced. Many of the new words he coined, "radian," "numeric," "torque," "interface," "cinure," "posure," &c., are great helps both in thinking and teaching.

The same determination at any cost of hard thinking to arrive at clearness in regard to fundamental principles is strikingly evidenced by one of his later papers, that on the "Law of Inertia and the Principle of Chronometry," which is a most searching discussion of the true significance of Newton's first and second laws of motion.

I must now close this review. I shall be glad if I have succeeded, however imperfectly, in giving you some impression of our Irish schools of Mathematics and Physics, of the workers and of the sources from which they drew their inspiration. There surely never was a time when the problems presented to the mathematician by Physical Science were more interesting; never a time when Science for its onward progress stood more in need of those gifted ones who combine clearness of thought with imagination and hopeful courage. Let us hope that amongst these in this new century, others of our countrymen may be found not unworthy to have their names inscribed in the roll which contains those of Hamilton and MacCullagh, of Andrews and Thomson.

NOTES.

WE record, with very deep regret, the death of Prof. Virchow, on September 5, in his eighty-first year. The State funeral accorded to Prof. Virchow took place in Berlin on Tuesday. Amongst those present were the Prussian Ministers of Education and Finance, the Foreign Secretary, the Chief Burgomaster of Berlin, and numerous representatives of Berlin and other universities, and of learned and scientific societies—both German and foreign. After the funeral service, orations were delivered, in which Prof. Virchow was considered as man of science, politician and municipal reformer. At the meeting of the Paris Academy of Sciences on Monday, a eulogy on Prof. Virchow was delivered by M. Bouchard.

WE have also to announce the death of Sir Frederic Abel, on September 6, in his seventy-sixth year.

THE next meeting of the Australasian Association is to be held in Dunedin, New Zealand, in January, 1904, and the following have been appointed presidents of sections:—B—Chemistry: J. Brownlie Henderson, Brisbane. C—Geology and mineralogy: W. H. Twelvetrees, Hobart. D—Biology: Colonel W. V. Legge, R.A., Hobart. E—Geography: Prof. J. W. Gregory, Melbourne. F—Anthropology and philology: A. W. Howitt, Melbourne. G—Economics, subsection 2, agriculture: J. D. Towar, Roseworthy, South Australia. H—Architecture, engineering and mining: H. Deane, Sydney. I—Sanitary science and hygiene: Dr. Frank Tidswell, Sydney. J—Mental science and education: John Shirley, Brisbane.

THE annual congress of the Sanitary Institute was opened at Manchester on Tuesday last, when some two thousand delegates were present from all parts of the country.

IN connection with the celebration of the 100th anniversary of the birth of Niels Henrik Abel, now in progress at Christiania, twenty-nine foreign men of science on Saturday last received the degree of Doctor, *Honoris Causa*; among the number were Lord Kelvin, Lord Rayleigh, Sir George Stokes, Prof. G. H. Darwin, Prof. Forsyth, and the Rev. George Salmon, Provost of Trinity College, Dublin.

THE Punjab Government has, according to the special Indian correspondents of the *Lancet* and the *British Medical Journal*,

submitted a great project to the Government of India and the Secretary of State for sanction in order to grapple with the expected outbreak of plague during the coming winter. The disease has rapidly grown in intensity in the province. Commencing in 1899-1900 with two districts and one native State affected and 530 deaths, followed by the next year with seven districts and two native States affected and 6399 deaths, it had last year no less than twenty-three districts and nine native States attacked and more than 200,000 deaths. Experience has shown that segregation of the sick is out of the question, that evacuation of dwellings even in villages can only be partial, and that disinfection is practically useless. This being so, the Punjab Government now proposes to offer universal voluntary inoculation. Arrangements are to be made to perform six and a half million inoculations between now and January next. The scheme is expected to cost more than Rs. 8 lakhs.

INFORMATION has been received through Reuter's Agency concerning the progress which has been made by the commission sent out to inquire into the mysterious "sleeping sickness" of Uganda. The three members of the commission—Drs. Low, Christy and Castellani—arrived in Uganda on July 10. Drs. Castellani and Low proceeded direct to the Government headquarters at Entebbe, where they arrived on July 12, but Dr. Christy, at the request of the Sub-Commissioner, made a detour in order to proceed by land through Busoga, where the disease is very severe. Dr. Christy arrived at Entebbe on July 27, and intended leaving in a few days for Buddu, on the west shore of the lake. Everything is being done by the authorities to assist the doctors in their investigations, and the Commissioner has ordered the erection of a laboratory at Entebbe. All the scientific apparatus has reached Uganda in good condition. A complete "sleeping sickness" hospital has been prepared, and on July 29 there were ten cases under close study, three *post mortem* examinations having also been obtained. Dr. Castellani had then got all his *media* prepared and the laboratory in order for complete bacteriological examination. Dr. Low has examined the blood of about 600 individuals, with interesting results.

AN International Fishery Exhibition, the first ever held in Austria, was opened on Saturday last in Vienna by the Archduke Franz Ferdinand. The exhibitors are mainly Germans, but France, Italy, Norway and Roumania are represented. England is taking no part in the exhibition.

ACCORDING to the *Athenaeum*, the committee of the fund which was formed in honour of the eightieth birthday of Prof. Virchow has now ended its work, and reports that it has collected 53,652 marks. This, added to the subscriptions to the fund from other sources, will put the Virchow Stiftung in the possession of a sum of nearly 150,000 marks. The yearly interest of the fund was to have been expended on scientific objects specially indicated by Prof. Virchow.

MR. SANTOS DUMONT'S new balloon, the construction of which has been begun, will be 25 metres long by 11 metres in diameter, and will carry two aeronauts and eight passengers.

A REUTER telegram from Budapest states that the electric railway, about 100 kilometres in length, along the shore of Lake Como was opened on September 4. The electrical power, amounting to 20,000 volts, is obtained from the Falls of the Adda. At the stations, the current is reduced to 3000 volts and transmitted through overhead contact wires. The power derived from this source will also be applied shortly to working the motors and electric carriages on the Lecco-Colico line. The new work, which is supplied with a full high-tension electrical system, has been carried out in accordance with the Kando system.

MR. GREGG WILSON has been appointed by the President of the Board of Trade an inspector of fisheries in England and Wales, in succession to Mr. Henry Noel Malan.

A DESPATCH from Carupano, Venezuela, to the *Figaro* states that violent detonations were heard there between ten o'clock on the night of September 3 and four o'clock on the following morning. They came from the north and were identical in character with those which were heard on the night of August 30 during the eruption of Mont Pelée. A message from the St. Thomas correspondent of the *Times*, sent on September 7, states that a slight eruption of the St. Vincent Soufrière took place at noon on September 3, and the inhabitants left Georgetown and Château Belair. At ten o'clock at night there were loud thundering noises and electrical discharges from the volcano, while from one o'clock until four o'clock in the morning there was a continuous roar. Afterwards there were murmurings for two hours. On the morning of September 4 the sky was obscured by dust and smoke, and the scene is described as terrible. Pebbles and dust fell at Barrouallie, and at Château Belair there was a heavy fall of sand. A telegram from Paris on September 7 states that the French Colonial Office has directed M. Lacroix, the head of the scientific mission which was sent to Martinique, to organise the permanent station of operations which is to be established there, and M. Lacroix will start as soon as he has collected the necessary apparatus.

AN earthquake of six seconds' duration was experienced at Pau (Pyrenees) at 2.30 on the morning of September 8.

THE Athens correspondent of the *Times* has called attention to some very destructive forest fires which have recently taken place in Greece, due mainly, it is said, to human agency. In some cases the woods are deliberately set on fire by the peasants for the purpose of making clearances for arable land, or by the shepherds in order to increase the extent of pasturage; in other cases, conflicts between neighbouring communes over the right of cutting timber have led to wanton acts of incendiarism, while lighted matches or cigarettes thrown carelessly into the thickets or sparks from the fires in the shepherds' cantonments are often productive of widespread destruction. As our contemporary remarks, these calamities demand the serious attention of the Greek Government, the loss to the country being very great. Although in recent years the matter has attracted some notice, not much has been done to remedy the evil. True, a society for the reforestation of the country has been formed, but it is doubtful whether any great success will be attained by voluntary agencies. The matter of the protection of the national forests rests with the Greek Government, which does not appear to be fully alive to the serious condition of things.

THE August issue of the *Elektrochemische Zeitschrift* contains an article by Th. Gross which seems to suggest that silicon is not an element. The author has been investigating the behaviour of silica when exposed to long-continued electrolysis, and in his opinion has proved that some second element is present in the resulting fused mixture. Starting with 15 grams of pure silica, and using 30 grams of pure caustic potash as solvent, an electric current was led through the molten mass for some hours, and the unaltered silica was then removed from the product by the usual chemical methods. The experiment was carried out in a silver crucible. The silica recovered showed a deficiency on the original weight, and the balance was found in 2.8 grams of a substance possessing different physical and chemical properties. This substance was easily soluble in hydrochloric acid. When heated in a porcelain crucible, it melted and yielded a brown mass, which, on treatment with

hydrogen-gas, left a grey residue possessing metallic characteristics resembling those of selenium. The experiments, however, require confirmation before the conclusion can be accepted.

THE last number of the *Journal* of the Institution of Electrical Engineers contains chiefly papers read before the various local sections. These show that the policy of the Institution in establishing these sections was a very wise one, the papers being quite equal in merit, if not superior, to those read in London. Mr. Osborne's paper on the lighting and driving of textile mills by electricity, read at Dublin, will be read, we feel sure, with great interest; it shows that the electrical engineer has still a great deal to study with reference to the best kind of light, and its proper distribution, for special purposes. Another paper dealing with a subject of great importance at the present time is that by Mr. Clothier on switch-gears, which is to be specially commended for its very beautiful illustrations. The Institution's *Journal* has shown a very marked improvement in this respect during the past few years; the illustrations published two or three years ago are not to be compared with those which now appear in it.

ACCORDING to the *Scientific American*, the new Marconi Transatlantic signalling station at Cape Breton is nearly completed, and will be ready for commercial working in the course of a few weeks. We reproduce an illustration showing the



FIG. 1.—The New Marconi Wireless Telegraph Station at Glace Bay, Cape Breton.

general appearance of the station, with its low buildings containing the signalling plant and its four wooden towers for supporting the aerial conductor. These towers are more than 200 feet high (their tops being about 300 feet above sea-level), and are placed at the corners of a 200-foot square. From the top platform of each tower to that of its neighbour is strung a horizontal cable from which the vertical conductors depend; these, 150 in number, are all joined together in the centre of the square, thus forming an inverted pyramid from the apex of which a single cable runs into the apparatus room. The wooden towers are of special design and are well stayed with wire ropes to prevent them from being blown down in a gale. The machinery installed is stated to be more powerful than is necessary for merely signalling to Europe, and hopes are entertained of transmitting messages to Cape Town. As a receiver, the coherer has been discarded and a more trustworthy instrument substituted; this is in all probability the magnetic receiver recently described by Mr. Marconi before the Royal Society.

In the *Century* for September, Mr. R. T. Hill and Prof. I. C. Russell contribute articles on the West Indian volcanic eruptions, both of which are excellently illustrated with pictures, many of which are published for the first time. Although the text of these articles to a great extent describes observations

similar to those with which we are already familiar, here and there, as, for example, in Mr. Hill's description of one of Pelée's eruptions which he witnessed, we find materials well worth the attention of students of volcanic phenomena. Since the articles were written, on the night of August 30, Mont Pelée and the Soufrière in St. Vincent have broken out again, and this time with exceptional intensity. Morne Rouge has disappeared, and there is "not a single creature left to tell the tale." More than a thousand persons are reported to have lost their lives. Carbet was invaded by a sea wave, a portion of the island sinking in the sea; at Fort de France the sea penetrated 40 feet inland, and the water line at that place has risen 5 to 6 feet. These disturbances in the ocean may result from a movement in its bed, which, considering the number of cables which have been interrupted, appears likely, or they may be directly due to the hurricane-like blasts from the mountain. In this last eruption, we again appear to have evidence of a connection between seismic and volcanic activities. The hour at which Mont Pelée and the Soufrière renewed their violence is not known, but on August 30, at 9.59 p.m. (5.54 p.m. St. Vincent's time), an earthquake occurred at a distance of about 62° from the Isle of Wight, which probably disturbed the whole of our globe. If this can be identified with a violent earthquake which at 9 p.m. disturbed Venezuela on that date, we again have a repetition of a history common to all the known West Indian eruptions. The gratuitous prophecies that Martinique is to sink beneath the ocean again appearing in papers are only increasing alarm, depreciating the value of property and giving trouble, not only to the authorities in Martinique, but to the governors in adjacent islands. Although the inhabitants of districts which are threatened are being moved to places of safety, the alarm at the possibility of further devastation is intense. Let this be increased by sensational announcements and there may be panic, the results of which can only intensify calamity.

We have received from M. Henri Desmarest a copy of his article on "La Houille blanche," which appeared in the *Revue Universelle*. The paper describes in a popular manner the utilisation of water power for industrial purposes, and the author points out that France, having at command a large supply of waterfalls, may hope, by making the most of its advantages, to take a leading place amongst the nations. A table shows that more than 500,000 h.p. is already utilised, but this is only one-twentieth of the power available. The article is copiously illustrated by photographs of waterfalls and turbines, and diagrams showing the general construction of water-power installations; there is also an interesting little map of France, shaded to show the amount of power existing in the different departments. One of the photographs shows the motor erected at Santa Cruz for using the power of the sea waves; this consists of two wells sunk near the sea front, in one of which is a float which is raised and lowered by the waves; the float is connected to, and works, a pump in the second well, which forces the sea-water into a reservoir, from which it can be drawn when required.

A NOTE on the use of Fourier's series in the problem of the transverse vibrations of stretched strings is contributed by Dr. H. S. Carslaw to the current number of the *Proceedings* of the Edinburgh Mathematical Society. Dr. Carslaw proves that where the initial form of the string involves discontinuity in the slope of the curve, the n th term of the series for the displacement is at most of order $1/n^2$, and the series cannot, therefore, be differentiated twice term by term, as would be necessary if the series is to be proved to satisfy the differential equation of vibration. Where, however, no discontinuity occurs in the slope of the string, the n th term of the series is of order $1/n^3$, and the second differentiation term by term is possible. But then, as

Dr. Carslaw remarks, the equation of vibration of a stretched string is obtained on the assumption that no such discontinuities occur; if sharp corners exist, dynamical difficulties are introduced.

THE French Physical Society has undertaken the publication of a collection of elementary physical experiments. This book will describe class experiments, and also simple experiments of a suitable character for class exercises. The first part, dealing with geometry, mechanics, gravity, hydrostatics and heat, is now in preparation.

SOME statistics as to the use of alcohol as an illuminant are given by M. L. Denayrouze in the *Bulletin* of the French Physical Society, No. 185. This use of alcohol, first proposed in Germany a few years ago, has recently been rendered practicable from a commercial point of view by the introduction into France of methylated spirits, and also by an increase in the efficiency of the Denayrouze lamp. Taking 1.08 grams of pure alcohol or 0.64 gram of carburetted alcohol (alcohol carburé) per candle hour as the consumption of this lamp, the cost is estimated at 0.00478 and 0.00298 of a penny per candle hour for these two alcohols, as against 0.01428 of a penny for petroleum. The lamp consists essentially of a wick, conducting the liquid by capillarity into a chamber where it is vaporised, the necessary heat being produced by a copper bar which derives its heat from the lamp itself. The vapour passes through a small channel into a kind of Bunsen burner, above which the mantle is fixed. The series of operations is entirely automatic.

THE *Ceylon Independent* of August 11 contains Prof. Herdman's report on the pearl fisheries in the Gulf of Manaar. The objects of the professor's investigations were fourfold. Firstly, to inspect the oyster banks; secondly, to find out the conditions under which the molluscs live; thirdly, to take into consideration the marine zoology of the other Singalese waters in connection with trawling; and, lastly, to select a spot for a marine laboratory. As the result of the survey, it was found that in the main the oysters were healthy and free from epidemic, and, indeed, from much disease of any description. Parasites were present in considerable numbers, but were not considered to be doing much damage. "Spat" were found in abundance in certain localities, and enormous quantities of young oysters in others. A large percentage of these appeared, however, never to reach maturity, either from being destroyed by enemies, choked in sand or overcrowded. The remedy for this is thinning out and transplanting. It is concluded that "there is no reason for despondency in regard to the future of the pearl-oyster fisheries, if they are treated scientifically."

TWO papers of considerable interest on fossil mammals are to hand. In the one—issued by the Cairo Survey Department—Messrs. Andrews and Beadnell describe remains of new forms from the Eocene of Egypt, among which the lower jaw on which the genus *Phiomia* is based is perhaps the most interesting and remarkable. The other—published in the *Journal* of the College of Science of Tokio—relates to part of a skull from the Tertiary of Japan believed by its describers, Messrs. Yoshiwara and Iwasaki, to indicate a new type of proboscidean.

IN vol. ii. pt. 10 of the *Annals* of the South African Museum, Sir George Hammon continues his valuable catalogue of the moths of South Africa, describing many new genera and species.

THE Museums Association has issued the first volume of its *Journal*, edited by Mr. E. Howarth, and containing an excellent portrait of Sir William Turner. The volume will be welcome to all interested in museum improvement, whether from the general education standpoint or on more strictly scientific grounds.

THREE memoirs of the Geological Survey of England and Wales have recently been issued in explanation of the one-inch maps. That on Ringwood, by Mr. Clement Reid, is accompanied by a colour-printed map which has been admirably executed by the Ordnance Survey. The area described is a part of the Hampshire Basin, and attention is drawn to the evidence of an old river course, which probably in Newer Pliocene times connected the Salisbury rivers with Southampton, before they were captured and diverted along the course of the subsequent Lower Avon. The geology of Southampton, also by Mr. Reid, with contributions by Mr. Whitaker, gives a concise account of the Chalk and Tertiary strata, and of the Pleistocene deposits some of which yield Palaeolithic implements. Several new inliers of London Clay have been recognised, and these indicate an extension to the westward of the Portsdown anticline. The geology of the country around Exeter is by Mr. W. A. E. Ussher, and it gives a fairly full account of the Culm-measures, the various divisions of the New Red Sandstone series, and the superficial deposits. Much interest attaches to the volcanic rocks, which are probably of Permian age, and the field-observations are supplemented by petrological notes by Mr. Teall.

A THIRD report on the soils of Dorset, by Mr. D. A. Gilchrist and Mr. C. M. Luxmoore, has been issued by University College, Reading (1902). Attention is directed to the amount of carbonate of lime in the fine earth of various soils, and it is noteworthy that some soils on calcareous formations contain very little carbonate of lime, while the soil on Kimeridge Clay contains in places more than 2 per cent., an amount which decreases in the subsoil. An interim report is given on the general results of the investigations with regard to West Dorset, and many suggestions are made on the capabilities of the land and on the improvements which might be made in the cultivation of it.

THE *Chemical News* for September 5 is a "Students' Number," and contains much useful information respecting the leading schools of chemistry in the country.

THE additions to the Zoological Society's Gardens during the past week include a Campbell's Monkey (*Cercopithecus campbelli*) from the West Coast of Africa; a Bosman's Potto (*Perodicticus potto*) from West Africa, presented by Mr. G. Robertson; a Rhesus Monkey (*Macacus rhesus*) from India, presented by Dr. Bates; a Green Monkey (*Cercopithecus callictrichus*) from West Africa, a Two-spotted Paradoxure (*Nandavia binotata*), a Dorsal Hyrax (*Hyrax dorsalis*) from the Gold Coast, presented by Mr. A. W. Morris; two Suricates (*Suricata tetradactyla*) from South Africa, presented by Capt. C. F. Wanhill, R.A.M.C.; a Suricate (*Suricata tetradactyla*) from South Africa, presented by Colonel J. S. Ewart; two Naked-footed Owlets (*Athene roctna*) European, presented by Mr. A. J. Challis; fourteen Wall Lizards (*Lacerta muralis*) European, presented by Dr. Lewis H. Gough; two Madras Entellus Monkeys (*Semnopithecus priamus*), new to collection, from Southern India; a Pale Genet (*Genetta senegalensis*) from the White Nile; four Blue Lizards (*Gerrhonotus coerulesus*) from Western North America, deposited.

OUR ASTRONOMICAL COLUMN.

OBSERVATIONS OF VARIABLE STARS OF LONG PERIOD.—Writing in the *Observatory* for September, Prof. Pickering gives an abstract of an earlier paper on the really valuable work that might be done by willing observers who only possess small instruments. He states that the number of telescopes of small size (i.e. 10 to 30 cm. aperture) now in use, is out of all proportion to the meagre results obtained by their aid, and suggests that observations of long-period variables by Argelander's method would, if systematically made, prove of real value in furthering our knowledge of these objects.

Prof. Pickering suggests the use of the charts of the Bonn Durchmusterung for this work—and their recent republication renders them accessible to all—but he adds that the star images are too small to use at the telescope; in order to overcome this difficulty, photographic enlargements, on a scale $1' = 0.1 \text{ cm.}$, of the regions for $3'$ around sixty-nine of these variables, have been prepared, and will be forwarded free of cost to experienced observers who are willing to cooperate in this work (*Circular No. 53, H.C.O.*).

To render these observations really valuable, they must be made systematically and each object must be observed once a month, or better still, once a week, by someone amongst the cooperated observers. Then again, the observations must be recorded on a uniform system of magnitudes, and for this purpose it is suggested that the combined observations of the Lick, Yerkes, McCormick and Harvard observatories for the past twenty-five years should be used. When finally reduced and brought together, it is expected that these will embrace all stars, down to the sixteenth or seventeenth magnitude, for the whole of the sky. To facilitate matters further, the whole of the magnitudes on Hagen's charts are being reduced to the photometric scale, so that all that will then be necessary will be to select a star slightly fainter and one slightly brighter than the variable, and record the catalogue numbers, with the date. Further improvement may be made in the observations if the magnitude intervals, and the minute and second of the observation, are also recorded, although the latter are not essential in the cases of long-period variables. Prof. Pickering concludes with the assurance that "if such observations, for which no apparatus but an ordinary telescope is required, are made systematically, results of great value will be obtained."

THE LICK PHOTOGRAPHS.—In *Bulletin No. 20* of the Lick Observatory, Prof. Pickering announces that, as so many legitimate requests have been made for the Lick photographs of the moon, comets, nebulae, &c., it will be possible in the future to purchase lantern slides, copies and prints of these objects on application to the director of the Lick Observatory. The prices and details of these objects may be obtained by teachers, lecturers, &c., on application.

THE DARK SPOT ON JUPITER.—In a letter to the *Observatory*, Herr Leo Brenner refutes the idea that the dark spot which Messrs. Phillips and Denning observed in the neighbourhood of the Great Red Spot on June 23, is the same spot that he recorded, and named the "pyramid-spot" during the opposition of 1901. He states that the movement of the pyramid-spot during last year was $45''$ in 85 days, therefore it is impossible for it to have moved the same distance in eight days this year, as it must have done if it is the same spot that was recorded as being under $19''$ on June 28.

THE IRON AND STEEL INSTITUTE.

THE autumn meeting of the Iron and Steel Institute was held at Düsseldorf on September 3 and following days, and was attended by an unusually large number of members. Mr. William Whitwell, the president, was in the chair, and he was supported by Sir Lowthian Bell, F.R.S., Sir James Kitson, M.P., Mr. Snelus, F.R.S., Sir J. J. Jenkins, M.P., Mr. J. Walton, M.P., Mr. E. Parkes, M.P., and numerous other prominent members from various parts of the world. Addresses of welcome were delivered by Mr. von Hulleuffer, the governor of the Düsseldorf district, on behalf of the Prussian Government, by the Mayor of Düsseldorf on behalf of the city, and by Mr. H. Lueg on behalf of the exhibition authorities and the local reception committee. Nine papers were then dealt with. Mr. W. Brüggemann read the first paper, which gave an exhaustive account of the progress in the manufacture of pig iron in Germany since the Institute last met in Düsseldorf in 1880. A similar paper dealing with the progress in the manufacture of steel was read by Mr. R. M. Daelen, and Prof. H. Wedding read a paper on iron and steel at the Düsseldorf exhibition. Prof. Heyn, of Berlin, then read an elaborate paper of great scientific and practical interest on the overheating of mild steel. The principal conclusions drawn from the author's researches were as follows:—

When low-carbon mild steel is annealed at temperatures above 1000°C. , there is an increase in the degree of brittleness if the annealing period is sufficiently long. This increase is more considerable, and manifests itself the sooner, the higher the temperature of annealing.

Prolonged annealing, say uninterrupted for fourteen days, at temperatures between 700° and 890° , produces no increase in the brittleness. In such cases where the brittleness of the material in its initial state was not yet at the lowest degree possible, by this treatment the lowest degree of brittleness will be attained. Between 1100° and 900° there exists a temperature limit, above which, if annealing is carried on for a longer period and at an increasing temperature, the degree of brittleness increases. Below this limit, however, this is not the case. Overheating does not only occur at most extreme white heat, but manifests itself at considerably lower temperatures, which must, however, exceed the temperature limit just referred to. By suitable annealing, the brittleness of overheated low-carbon mild steel can be eliminated. If annealing is carried out at above 900°C. , a short period of about half-an-hour is sufficient. Longer annealing must be the more carefully avoided, the more the temperature limit between 1100° and 900° is exceeded, otherwise the signs of overheating reappear. Below 800° an annealing of even five hours is not sufficient to eliminate the brittleness in overheated low-carbon mild steel, but by annealing of several days' duration, at temperatures between 700° and 850° , this object can be attained. If low-carbon mild steel, which has been annealed for a longer period at a high enough temperature, so that after undisturbed cooling it would show extreme brittleness, is rolled or forged during cooling to bright red-heat, it will exhibit no brittleness when cold. The fracture of overheated low-carbon mild steel generally shows a coarse grain, although this is not necessarily always the case. The single crystal grains of which the structure of the iron is built up, which can be detected under the microscope by suitable etching, are often of considerable dimensions when in the state of overheating. Nevertheless, this is not to be considered as proof positive that overheating has taken place, since the method of cooling also exercises a great influence on the size of the ferrite grains. Rapid cooling from the temperature causing overheating produces fine ferrite grains, without reducing the brittleness appreciably. Moreover, it is possible, by heating low-carbon mild steel for days together at between 700° and 890°C. , to bring the material into such a condition that it will show exceedingly coarse ferrite grains, and yet not exhibit brittleness.

An interesting discussion followed the reading of this paper. Mr. J. E. Stead took exception to some of the conclusions. Prof. Tschernoff, of St. Petersburg, described his early researches on the same subject. Mr. Saniter and Mr. Lange supported Mr. Stead.

The first paper dealt with on September 4 was on the compression of steel during solidification in the ingot mould, by Mr. A. Harmet, of Saint-Etienne. This paper, which covers 64 pages, was read in abstract by the secretary, Mr. Bennett H. Brough. Compression with a static pressure acting on the top of the ingot is the principle involved in the Whitworth process. In the Harmet process the upper portion of the ingot is left exposed, and pressure is applied to the base, causing the steel to rise in the conical mould as though being forced through a draw-plate. The process has been introduced with great success and economy at the Saint-Etienne steelworks. In the discussion, favourable opinions of the invention were expressed by Mr. Beardmore, Mr. Windsor Richards, Mr. Snelus, Prof. Howe, of New York, Mr. Vaughan Hughes, Mr. Saniter and Prof. Tschernoff.

Mr. D. Selby-Bigge next read a paper on the application of electric power in the iron and steel industries, and Mr. F. Kylberg, of Benrath, near Düsseldorf, read a paper describing some developments of the use of electricity in ironworks based on American experience and adapted to European requirements. An interesting discussion followed in which Sir Lowthian Bell, Mr. W. H. Massey and several leading continental electrical engineers took part.

Prof. E. D. Campbell and Mr. M. B. Kennedy, of the University of Michigan, communicated a paper on the probable existence of a new carbide of iron, Fe_3C ; and Mr. L. F. Giers and Mr. J. H. Harrison gave a report of the results obtained in equalising the temperature of hot blast. The proceedings concluded with the usual votes of thanks to the local reception committee and to its hon. secretary, Mr. E. Schrödter, who had planned a most attractive programme of visits and excursions. The works visited included the Krupp establishment at Essen, the Union, Hoerde and Hoesch steelworks at Dortmund, the Phenix works and the Rheinische Stahlwerke at Ruhrort, the

Gutehoffnungshütte at Oberhausen, and the Vulcan steelworks at Duisburg. In each case the members were received with great cordiality and with lavish hospitality. Visits to the exhibition under expert guidance were also organised, and numerous works in Düsseldorf were thrown open to members. The social functions in connection with the meeting included a conversation given by the Mayor and Corporation on September 3, a banquet on September 4, at which seven hundred ladies and gentlemen were present, a firework display in honour of the Institute at the exhibition on September 5, and an excursion on September 6 to the Kaiser bridge at Muingsten and to the hanging railway at Elberfeld. For the ladies accompanying the members a programme of excursions was organised by a committee of Düsseldorf ladies. At the conclusion of the meeting there were supplementary excursions to the Peine and Ilseid ironworks, and to the steelworks near Saarbrücken and Luxemburg. Altogether the meeting was one of the most attractive and successful recorded in the history of the Institute. It was announced that the next president of the Institute will be Mr. Andrew Carnegie, vice-president, who will come into office in May next.

UNIVERSITY AND EDUCATIONAL INTELLIGENCE.

ATTENTION has already been directed in these columns (vol. lxx. No. 1679, p. 216) to the statistics collected by the council of the Association of Technical Institutions comparing the number of day students of fifteen years of age and upwards who are taking complete day technological courses of not less than twenty hours a week in Great Britain and Ireland, with the number of students of a similar kind in the German technical high schools. The German Ambassador has since supplied the council of the Association of Technical Institutions with additional statistics in regard to technical high schools in the German Empire. The conditions of entry to the German schools are such that they very rarely contain any students under eighteen years of age. The additional information now available shows that the number of matriculated students in German technical high schools, of the age and status described, in each of the following branches of technology is:—Agriculture, 42; architecture, 1440; civil engineering, 2257; mechanical and electrical engineering, 5503; naval architecture and marine engineering, 318; chemistry and metallurgy, 1180; general knowledge, 280; and forestry, 12. These numbers do not include 1390 students in the above subjects attending institutions at Brunswick and Stuttgart. The figures give a total of 12,422 students, and if in addition non-matriculated students are counted, the total reaches 15,442. It is especially noteworthy that 935 of the matriculated students enumerated have each attended for more than four years. When referring to this subject on the previous occasion, it was pointed out that the total number of students in Great Britain and Ireland above fifteen years of age taking complete day technological courses of not less than twenty hours a week is 3873, and only 113 of these have attended more than three full years.

We have received a syllabus of the courses on electrochemistry and electrometallurgy to be held at Owens College, Manchester, during the coming session. In addition to the general theoretical and practical courses, Mr. R. S. Hutton will give a series of six lectures on electrometallurgy on Saturday afternoons, and also a special electrochemical course on Monday evenings. The electrochemical laboratory, which is part of the new physical laboratories opened two years ago, is very well equipped with power and apparatus for all kinds of electrochemical and electrometallurgical work, possessing two 600-ampere furnaces of the Moissan type. Probably no other technical college in the country can boast of such facilities, and Manchester is to be congratulated on moving with the times and making adequate provision for the study of a much-neglected but highly important branch of science.

SOCIETIES AND ACADEMIES.

LONDON.

Royal Society, June 19.—"On Two Methods for the Limitation and Regulation of Chloroform when administered as an Anæsthetic." By A. Vernon Harcourt, M.A.

"The Seed-fungus of *Lilium tenuitatum*, L., the Darnel." By E. M. Freeman, M.S.

PARIS.

Academy of Sciences, September 1.—M. Bouquet de la Grye in the chair.—On the eruption of Martinique, by MM. A. Lacroix, Rollet de l'Isle and Giraud. A short summary of the results obtained by the commission sent out by the Academy to study the effects of the eruption. A single measurement of the height of Mont Pelée showed that its height had not appreciably changed, so that the summit of the mountain has not been completely blown away, as was at first conjectured. No new crater appears to have been formed, although numerous fissures have opened. Volcanic eruptions are usually characterised by two classes of phenomena, the explosive evolution of gases with solid or fused siliceous materials, carried to a very high temperature, and the outflow of similar fused siliceous materials in mass. The present eruption is characterised by the total absence of this latter phenomenon, the so-called lava streams described by eye-witnesses consisting in reality of torrents of boiling mud, with large masses of moving rock. No actual flames have been observed by the members of the commission, the only certain fact about the constitution of the gases evolved being the presence of steam and sulphur dioxide, the latter being in great abundance as indicated by its suffocating odour. Fumerolles are very abundant, and it is owing to the presence of these that the rivers undergo violent fluctuations of temperature. Observations were also made of the topographical changes, variations in the depth of the sea near the coast line, together with electrical, magnetic and meteorological observations.—On entire and quasi-entire functions and differential equations, by M. Edmond Mailet.—On differential equations of the second order with fixed critical points, by M. R. Liouville.—The electrolysis of mixtures of salts, by M. Anatole Leduc. The presence of metallic impurities such as are likely to be present in commercial silver has no practical effect upon the electrochemical equivalent of silver.—The classification of binary accords. Specific consonances and dissonances, by M. A. Guillemin.—The action of soluble ferments and of high yeast upon gentiobiose. Remarks on the constitution of gentiobiose, by MM. Ed. Bourquelot and H. Hérissey.—On the proteolytic action of snake venom, by M. L. Launo.—On the difficulty of isolating the *Bacterium coli* in colonial dysentery, by M. Lesage.—The preventive treatment of scab, and on the use of an anti-scab serum, by M. F. J. Bosc.—The physical, chemical and practical results of the concentration of wine, by M. F. Garrigou.

CONTENTS. PAGE

Triangulation of South Africa. By Major C. F. Close	457
Vitality	457
Our Book Shelf:—	
Henderson and Woodhull: "Elements of Physics"; Woodhull and van Arsdale: "Physical Experiments."—A. W. P.	458
Colman: "Types of British Plants"	458
Mason: "Water-Supply"	458
Letters to the Editor:—	
Science in the Public Schools.—Rev. Dr. A. Irving	459
Animal Intelligence.—L. C. Hurt	459
Variation of Common Copper Butterfly.—Ph. T.	459
Some Scientific Centres. V.—The Chemical Laboratory of the Royal Institution. (Illustrated.)	460
The Belfast Meeting of the British Association.	462
Inaugural Address by Prof. James Dewar, M.A., LL.D., D.Sc., F.R.S., President of the Association.	462
Section A.—Mathematics and Physics.—Opening Address by Prof. John Purser, M.A., LL.D., M.R.I.A., President of the Section	478
Notes. (Illustrated.)	483
Our Astronomical Column:—	
Observations of Variable Stars of Long Period	486
The Lick Photographs	487
The Dark Spot on Jupiter	487
The Iron and Steel Institute	487
University and Educational Intelligence	488
Societies and Academies	488

THURSDAY, SEPTEMBER 18, 1902.

PROF. LORENTZ ON THE SCOPE OF
PHYSICS.

Sichtbare und Unsichtbare Bewegungen. Vorträge gehalten von H. A. Lorentz. German Translation by G. Siebert. Pp. 123. (Brunswick: Vieweg und Sohn, 1902.) Price Mk. 3.

THESE lectures, published under the title of "Motions Visible and Invisible," were delivered at Leyden last year to what would, perhaps, be called in this country a philosophical society. The object was to present to a general audience an outline of the picture of the external world which modern physics is constructing within its own province, without going so far into detail as to lose the general outlook in the interests or difficulties of special departments of knowledge. The keynote of the book, as the title implies, is that all physical explanation rests ultimately on dynamics; and accordingly the first three out of seven lectures are devoted to an exposition of the gist of the dynamics of rectilinear, curved and vibratory motions. Not much originality is to be expected in such well-worn topics, but the freshness of some of the illustrations reveals the calibre of the author. Such, for instance, is the estimation, from Hertz's analytical theory, of the intensity of the pressures set up in the ordinary impact of small balls; when a ball of 800 grammes falls on another such from a height of 12 cm., the total pressure between them mounts up to the order of 600 kilogrammes. The results developed are applied to a brief review of the cardinal phenomena of sound and light, and to the explanation of gaseous pressure and temperature on the kinetic theory. Of personal interest is the remark, on the basis of Michelson's having found that the breadth of a spectral line of a gas approaches a definite limit as the gas is rarefied, that, according to the writer's belief, we have here as direct evidence for the motion of the gas-molecules as spectral displacements give for the motions of the heavenly bodies. We naturally turn to the sixth lecture, on electrical phenomena, in the elucidation of which the author occupies so prominent a position. At the very beginning, the conception is introduced that the ultimate atoms of matter involve positive and negative electrons, which interact through the connection between them that is afforded by the æther, and thus originate all electric phenomena. In the terms of this theory, the main electric phenomena are described, including such as cathode rays, though not much attempt is made to indicate the links of the chain of deduction that bind together the various departments of electrodynamics; finally, a rather more detailed sketch of the significance of the Zeeman effect is given. Thus one is led to see how it comes about that it is now a main effort of physicists to ascribe to these electrons a function in many types of phenomena, and to realise that there is much evidence for the view that they form a very prominent element in the constitution of matter. So far as is known, they are the sole links between ponderable matter and the æther. On them, too, a hope entertained by many is largely based, that gravitation and molecular forces will also turn out to be processes in that medium. The last lecture is an

NO. 1716, VOL. 66.]

exposition of the principle of energy. The writer expresses his opinion that nothing short of careful experimental investigation can assure us of the impossibility of the *perpetuum mobile*, which forms the foundation of the doctrine of energy. The ramifications of that principle are illustrated from the action of a dynamo. The principle thus forms a clue that connects the most varied phenomena, even when we are ignorant of the mechanisms which produce them; we find it an unfailing guide in tracing relations, with a certainty to which no electron-theory or other special theory can pretend. But it is of limited scope; the independence e.g. of gaseous viscosity and density, or the effect of motion on spectra, can only be elucidated by penetrating beneath the surface of things and resolving the phenomena into their elements.

To some people, the other side of the question above referred to as to the nature of the negation of the *perpetuum mobile* will doubtless appeal more strongly. A fundamental principle in nature of simple and universal type can hardly be based exclusively on the empirical ground of experimental verification; indeed, this very principle is constantly being applied without any hesitation to considerations so delicate as to be beyond the reach of present experimental confirmation except as regards their remote results. Not the least interesting and promising topic in abstract physical science is the origin and scope of the great natural laws which transcend all distinctions between different kinds of material, and form the frame into which the science is gradually built.

The sketch here given will show that Prof. Lorentz's little book forms a welcome addition to the expositions, popular yet exact, which we possess of the current progress of physical science, even in this country which produces more than its share of such concrete and illustrative presentations; all the more so as the trend of scientific method abroad now seems to seek greater security in the purely abstract exposition of relations, between entities which appear only as pure unknowns by means of mathematical symbols, from the fear that any full-bodied analogy traced between them and other things better known may, by reason of its limitations, encourage views that may ultimately prove false.

J. L.

CELTIC MYTHOLOGY.

Cuchulain of Muirtheinne: the Story of the Men of the Red Branch of Ulster. Arranged and put into English by Lady Gregory. With a Preface by W. B. Yeats. Pp. xvii + 360. (London: John Murray, 1902.) Price 6s.

EVEN before the appearance of this attractive volume the general reader had no valid excuse for not knowing something of the story of Cuchulain and the other heroes of Ulster; henceforward he will be still more inexcusable if he persists in ignorance. No one who cares at all for early literatures can fail to enjoy this version of these old Irish tales, so unique of their kind and so full of varied interest. The serious student, no doubt, will prefer to go direct to the originals, or to close translations like those collected in Miss Hull's "Cuchullin Saga"; but Lady Gregory's work is so different in aim from Miss Hull's that there is ample room for both. She

Y

has been chiefly attracted to the tales by their literary merits, and has sought with no little success to make these the prominent feature in her renderings. This at times involves the omission of details that are not without interest, but, after all, there is enough left to give a fair impression of what can be learned from the old literature of Ireland. This mass of legend, for the most part taking its final form about the twelfth century, but demonstrably far older in origin, is, in fact, a perfect mine of primitive custom and belief, and as such is full of interest for the anthropologist. Where the ordinary reader will only see something fanciful or unintelligible, the specialist will often discern an interesting survival or a striking parallel, even if it is hard at times to draw the line between Irish tradition and Irish imagination.

The peculiar character of these tales is due to a double tendency in Irish literature. On the one hand there is an exuberant imagination which recklessly transcends all limits of time and space; on the other there is a love of minute detail which constantly brings in the smallest features of everyday life and work. To the latter tendency we owe the minute descriptions of the appearance and dress of the heroes, of their horses and chariots, their arms and modes of fighting, their palaces and forts, and so on. It is a kind of Homeric life and culture that meets us here, yet with a greater admixture of primitive types, civilisation and barbarism being strangely intermingled. Nor does the Homeric Olympus lack its counterpart, for behind the real world of mortal heroes lies the realm of the Sidhe and the Tuatha De Danann, constantly reminiscent of the old Celtic mythology which Christianity has displaced. With a real and an imaginary world to move between, there is nothing that the Irish story teller will not dare to say; nothing is either too mean or too marvellous for him. Man and animal are interchangeable beings. Cuchulain himself is a reincarnation of Lugh (one of the old gods), who takes the shape of an insect and is swallowed by the sister of Conchubar. Curóí makes his fort whirl round like a millstone all night, so that no one can enter it after sunset. The bridge in Scotland which Cuchulain has to cross can alter its own shape and size at pleasure. Conchubar's shield moans when he is in danger, "and all the shields of Ulster would moan in answer to it." Wells and streams have a faculty of bursting out and overflowing whole tracts of country, and it is out of two lakes that Cuchulain gets his famous pair of horses, the Grey and the Black. Charms and spells are as potent as in Africa, and satire may be so deadly as to kill its victim. Fingán the physician "could tell what a person's sickness was by looking at the smoke of the house he was in." It is three champions of the Sidhe who have to be killed three times before they are done with; but even mortal heroes have an almost feline tenacity of life. It is well for them that this is so, for their chief happiness consists in fighting; in cases of single combat the chariot-driver usually looks on and encourages his master, or goads him on to do his best by means of bitter taunts. Feats of strength and skill are naturally common, but some of those mentioned are not easy to understand. Still stranger are the distortions of Cuchulain when in a rage, for which Lady Gregory has substituted the very euphemistic statement that he assumed the appearance of a god;

the direct opposite would not overstate the case. Contentment and jealousy are rampant among the heroes, and each unblushingly sounds his own praises and states his claims to the "Champion's Portion," which after all is only a certain quantity of food and drink. Yet the spirit of chivalry is not wanting, and an adventurous quest is greatly to their minds. But while they are ready to face most dangers without shrinking, the power of *geasa* or taboo lies heavy on them. Before Conaire, meets his death, he has succeeded in doing everything which he ought not to have done. Historically these *geasa* are known from the "Book of Rights," and form a curious study. Of great interest, too, is the periodic weakness of the men of Ulster, which has been the subject of much discussion among scholars.

As to the central figures in the cycle, Conchubar and Cuchulain, many difficult problems present themselves. It is possible that they take the place of older mythological personages, especially as Conchubar is actually called a god in one text and Cuchulain is the representative of Lugh. Those who are interested in this feature of early Irish literature may be referred to Prof. Rhys's Hibbert lectures, where the solar explanation of Celtic myths receives full consideration, and to Mr. Nutt's study of the "Celtic Doctrine of Rebirth" in "The Voyage of Bran." It is precisely because these Irish tales can provide materials for serious works of this kind that their perusal will be found, not only interesting, but profitable; and this new version of the Cuchulain cycle may do good service in spreading a knowledge of Celtic legend outside the small circle of scholars who have made it a subject of special study.

OUR BOOK SHELF.

Flora Arctica. Part i. By C. H. Ostenfeld. Pp. xi + 136. (Copenhagen: Det Nordiske Forlag, 1902.)

THE records of plants collected in the Arctic regions are for the most part scattered through numerous papers and written in various languages. At the request of Prof. Warming, Mr. O. Gelert in 1898 undertook to work up, revise and combine the accumulated data, basing his investigations on the collections belonging to the Copenhagen Museum. The work promised to be so extensive that he requested Mr. C. H. Ostenfeld to cooperate with him. This cooperation was cut short in 1899 by Mr. Gelert's premature death, and since that time Mr. Ostenfeld has continued the work alone. The limits of the Arctic territory as here interpreted coincide fairly nearly with the limits of the wood-boundary. This has its anomalies, for, as shown by the map provided, all Greenland is included almost to the 60th parallel, while Iceland in longitude 65° N. and Norway which extends higher than the 70th parallel are excluded. This first volume contains the Pteridophyta, Gymnosperms and Monocotyledons. The Pteridophytes are very few in number, the large group of Flics being limited to ten species. The Gymnosperms included are but three, this being the result of the boundary adopted. Amongst the Monocotyledons the most extensive orders are the Gramineæ, with twenty-four genera and sixty-one species, and the Cyperaceæ, including six genera, of which *Carex*, the most important, is subdivided into fifty-four species. In dealing with this genus the author has had the benefit of Mr. C. B. Clarke's valuable assistance. The Gramineæ were undertaken by Mr. Gelert, and the arrangement given is that left by him. The larger proportion of the illustrations refer to the Carices;

the figures) of the general appearance are good, but the sketches of details, as, for instance, the utricles, are too small to help much in determination of species. They would be more satisfactory if they were drawn natural size or larger. The book is written in English.

An Arithmetic for Schools. By J. P. Kirkman, M.A., and A. E. Field, M.A. Pp. lxvi + 492. (London: Edward Arnold, n.d.) Price 3s. 6d.

THE distinguishing characteristics of this book are simplicity and great clearness of exposition. The first two chapters deal mainly with our terrible English system of weights and measures, and in this lawless region no skill on the part of an author can be of service to the beginner. Once this tangled wilderness is passed, however, the skill of the authors in exposition comes into play. The treatment of common measures and multiples and the various rules for ascertaining rapidly whether a given number is or is not divisible by specified numbers are very clearly and successfully explained. The philosophy of the rules for the division and multiplication of vulgar fractions is very plainly set forth, and the rules for the contracted multiplication and division of decimals are well explained and illustrated near the end of the book. We have also an account of the metric system, followed by numerous examples of "practice." After this we have the calculation of areas and volumes, and an adequate exposition of the method of extracting square and cube roots. This is followed by the treatment of interest, stocks, and the various branches of the subject which are found in all arithmetical treatises, and then comes an enormous collection of examples. An appendix explaining and illustrating the use of squared paper for the comparison of scales and other kinds of calculation forms a useful and interesting conclusion.

The work is one which can be very confidently recommended to all teachers and students of arithmetic.

A First Step in Arithmetic. By J. G. Bradshaw, B.A. Pp. vi + 166. (London: Macmillan and Co., Ltd., 1902.) Price 2s.

ONLY the first four rules, simple and compound, are covered by this book, but the exercises upon them have been so carefully selected and arranged that children who receive instruction through them will acquire an intelligent and working knowledge of simple arithmetic. The exercises are arranged for both oral and paper work, and there is no doubt that the combination of the two methods of teaching the subject gives the best educational result. In most text-books of arithmetic, the pupils are discouraged at the outset by exercises and problems beyond their comprehension, but Mr. Bradshaw deals with amounts which beginners will have no difficulty in grasping and will work out successfully. An essay containing hints on methods of presenting the early rules of arithmetic, which occupies the first twenty-nine pages, contains some notes of service to inexperienced teachers of children; but they are out of place in a pupil's book, and belong rather to a volume on the practice of teaching.

The Real Origin of Religion. By Jabelon. Pp. 48. (London: Simpkin, Marshall and Co., Ltd., 1902.)

THE object of this pamphlet is to establish the not very novel or fortunate hypothesis of the phallic origin of all religious symbolism. The proofs offered are of three kinds, none of which possesses any real cogency. Certain savage tribes attach great importance to circumcision and other mutilations of the sexual organs, the reason for which is unknown. Therefore, the author argues, all primitive ceremonialism must be of sexual significance. This conclusion is supported by a number of etymologies, all unscientific and demonstrably false, and by an obscurely worded attempt to interpret the vision of Ezekiel as an account of the anatomical structure of the brain. The scientific value of the farrago is precisely *nil*.

LETTERS TO THE EDITOR.

[The Editor does not hold himself responsible for opinions expressed by his correspondents. Neither can he undertake to return, or to correspond with the writers of, rejected manuscripts intended for this or any other part of NATURE. No notice is taken of anonymous communications.]

Re Vegetable Electricity.

I AM reluctantly obliged to traverse a statement made by Prof. J. C. Bose (in the *Journal* of the Linnean Society of July 21, p. 304, footnote) to the effect that "Dr. Waller has subsequently been able to confirm the results which he (Dr. W.) heard me describe on the occasions referred to (Royal Institution, May 10, 1901; Royal Society, June 6, 1901).

I am compelled to state that Prof. Bose, previously to these dates, visited my laboratory on several occasions, received every facility that I was able to afford him as regards the methods by which I was and am investigating the physiological properties of animal and vegetable protoplasm, and *inter alia* heard from me, and has doubtless forgotten, the statement that the electrical response of plants is a general property of vegetable protoplasm, and not confined to such plants (dionaea, mimosa, &c.) as exhibit obvious movements.

Prof. Bose obtained (with my full approval) from my laboratory-mechanic the principal instruments used by me in such investigations, has imitated some of my experiments, and has gradually adopted their guiding theory. He is not entitled to make the statement quoted above.

AUGUSTUS D. WALLER.

P.S.—In connection with this subject of vegetable electricity I may take this opportunity of commenting upon two series of observations that have been made in Germany in contradiction of some of my principal conclusions.

Prof. Adami, of Hof, quotes from the German translation of 1899 of my "Lectures on Animal Electricity," published in 1898, the following passage:—"Verbindet man zwei Punkte A und B der unverletzten Kartoffel mit dem Galvanometer, so lässt sich kein merklicher Strom nachweisen; sobald aber die Kartoffel an einem Punkte B durch einen Messerschnitt verletzt wird, schlägt der Lichtfleck nach rechts aus, infolge der chemischen Thätigkeit und elektromotorischen Kraft, die durch den Schnitt erregt worden sind. Man beachte, dass dieser Versuch, im strengsten Sinne des Wortes, eine Vivisektion ist. Für unseren Zweck muss die Kartoffel lebendig sein. Die Wirkung bleibt vollständig aus, wenn die Kartoffel durch kochen getötet worden ist."¹

He then proceeds to give an account of a considerable number of experiments contradictory of the above statement. Prof. Adami, of Hof, did not use unpolarisable electrodes, but copper pins. It is not surprising that he should have failed to observe any signs of vegetable electricity.

Dr. Arthur Tompa, working in the Botanical and Physiological Institutes of the University of Halle, under the direction of Prof. Bernstein and Prof. Klebs, and with the advantage of the knowledge and experience of Dr. Tschermak, quotes on p. 100² the ten headings of my communication at the Turin Congress on Vegetable Electricity, and quite correctly selects for reinvestigation as being the general and most important topic, paragraph 5, "The Electrical Response as a Measure of 'Vitality.'" He devotes much time and care to this reinvestigation, and somewhat reluctantly comes to the conclusion that Waller's blaze reaction is a fallacy arising from the fact that Waller has followed erroneously the direction of current. He devotes a diagram and a page of description, p. 104,³ to his hypothesis in explanation of this imaginary blunder. I do not think that I have mistaken the direction of current, or that Dr. Tompa could have supposed that I was liable to do this if he had been at the pains to look at any of the diagrams in any of the papers of mine that he quotes.

Dr. Tompa should also have noticed in any of these papers that I have always spoken of excitation by induction currents and by condenser discharges. He has used the direct current of one or more Daniell cells. I have never done this for the reason that such currents give predominant polarisation counter-currents on living and on dead tissues alike. The blaze

¹ Sonderabdruck aus dem II. Bericht des nordoberfränkischen Vereins für Natur-Geschichte- und Landeskunde.

² A. Tompa, Beiträge zur Pflanzlichen Elektrizität ("Botanisch. Beiheften," original arbeiten).

³ Idem *ibid.*

reaction, whether unequivocal (homodrome) or equivocal (anti-drome) requires short strong currents for its manifestation. I have therefore always used induction shocks and condenser discharges, as stated even in the extremely brief Turin abstract quoted by Dr. Tompa.

I shall be surprised if Dr. Tompa does not repeat the experiments, and from the courteous tone of his account of the matter I think it probable that he will withdraw his stricture on my work when he has witnessed for himself the clear and indubitable results of the experiments.

Can Carbon Dioxide be "Vitalised"?

THERE has long been present in my mind an idea to which I have hitherto hardly dared give expression. The query forming the above heading amounts to the raising of the question whether the carbon dioxide which is exhaled as a product of animal or vegetable vital processes differs in any way from the carbon dioxide of "inorganic" origin formed, let us say, from carbon by combustion in oxygen. The answer will probably be in the negative, since, on theoretical (stereochemical) grounds, an asymmetric structure is not possible in the case of this molecule. Nevertheless, it might be worth while to cross-examine nature on this point. It is, in fact, possible that the experiment may have been already tried with negative results, and that is why I venture into print, since I have been unable to find any record. Two ways occur to me for submitting the question to the test of experiment. Calling the carbon dioxide from the two sources "inorganic" and "organic" respectively for the sake of brevity, the "organic" gas might be obtained either from the brewer's vat or from a carbonate formed from the carbon dioxide of animal respiration. The rate of absorption of this gas might be carefully compared with the rate of absorption of a specimen of "inorganic" gas by a growing plant. This is a method which appeals to vegetable physiologists. The other method, which is more purely chemical, depends upon our being able to obtain some optically active compound sufficiently basic to absorb carbon dioxide. I cannot call to mind any such compound at the present moment, and from where I am writing I have no access to the usual sources of information. Given, however, an optically active base capable of forming a carbonate, would the gases from the two sources be absorbed at equal rates? Perhaps some of your readers may be able to dispose of these queries offhand.

R. MELDOLA.

Easton Park Cottage, Dunmow, September 13.

Effect of a Lightning Flash.

DURING the storm on Wednesday, September 10, a house opposite my rooms in Fulham was struck by lightning at 4.40 p.m. Curiously enough, at the moment of the occurrence I was looking at the exact spot, and it may be of interest to record what occurred. A stack of brickwork about ten feet high capped with two red-pot chimneys about three feet high was struck, and a hole was made in the slates of the roof on the south side of the stack. One chimney was shattered. The flash was extremely brilliant and left a perfectly straight line of light on the retina; the length of the flash appeared to be twenty feet, but its upper part was lost in the diffused daylight. The flash was of several seconds' duration and was followed by a thin column of smoke; both these facts are due in my opinion to the fusion of the soot in the chimney. The flash itself was a mere line, otherwise the appearance of the whole strongly reminded me of a cordite discharge from a big gun. There was a loud report, and the circumstances left little doubt in my mind that the electrical discharge was upwards in direction.

C. DAVIES SHERRORN.

Bipedal Locomotion of a Ceylonese Lizard.

I HAVE frequently observed with interest the erect attitude assumed by the small Agamid lizard *Otocryptis bivittata*, Wieg., when running rapidly, and have long suspected that the short front legs were not used at such times. But the rapidity with which the animal runs, and the nature of the ground which it usually frequents, have prevented very close observation. I have, however, recently fully satisfied myself that its action is truly bipedal. The lizard happens to be common in the Botanic Gardens here, and on several occasions one of them has crossed a smooth sanded road immediately in

front of me. I have thus been able to see clearly that the anterior limbs are carried quite free from the ground, progress being effected solely by the long hind limbs.

It seems possible that the closely allied and similarly built lizard *Sitana potticerrana*, Cuv., may have the same habit. But the Indian species of *Otocryptis* (*O. beddomii*) progress in the same fashion?

At present the habit has been recorded only of one or more Australian lizards, notably the "filled lizard" (*Chlamydosaurus kingi*), which has been very cleverly photographed in the erect attitude by Mr. Saville Kent.

E. ERNEST GREEN.

Peradeniya, Ceylon, August.

A Series Related to Bernoulli's Numbers.

The following seems to be a useful and interesting series—

$$\frac{r}{r+1} = \frac{D_1}{r+1} + \frac{D_2}{2} + \frac{rD_3}{3} + \frac{r(r-1)D_4}{4} + \dots + \frac{r(r-1) \dots (r-\rho+3)D_\rho}{\rho} + \dots + \frac{r(r-1)D_{r-2}}{4} + \frac{rD_{r-1}}{3} + \frac{D_r}{2},$$

where

$$\begin{aligned} D_r &= r; \\ D_{r-1} &= \frac{1}{2} = 3B_1; \\ D_{r-2} &= -\frac{1}{6} = 5B_2; \\ D_{r-3} &= \frac{1}{6} = 7B_3; \text{ \&c.} \end{aligned}$$

and generally for all odd values of $\rho > 1$,

$$D_{r-\rho} = - \left\{ (-1)^{\frac{\rho-1}{2}} \right\} (\rho+2) B_{\frac{\rho+3}{2}},$$

B_1, B_2, \dots being the numbers of Bernoulli.

Also

$$D_{r-2} = D_{r-4} = D_{r-6} = \dots = 0.$$

I have been trying since last year, without success, to ascertain whether this is a known series previously published. If it is, perhaps some of your readers will be good enough to supply a reference.

J. R. SUTTON.

Kenilworth, Kimberley, August 7.

FREDERICK AUGUSTUS ABEL.

THE death of Sir Frederick Abel on Saturday, September 6, at the age of seventy-five, removes a conspicuous figure from the world of science and technology and brings to a close a long and useful public career. For some years he had been in failing health, but his sudden death, which came painlessly from cardiac failure following one of those attacks of shivering and rigor to which he had long been subject, was quite unexpected.

Frederick Augustus Abel was born in 1827, being the son of Mr. J. L. Abel, of Woolwich. The family, which appears to have been of Swedish origin, had already produced men notable in science, music and painting. Abel has given in the Hofmann memorial lecture, which he delivered to the Chemical Society in 1893, an amusing account of his unsuccessful attempts in the early 'forties to learn chemistry at the Polytechnic Institution of those days; and these recollections perhaps impelled him in the efforts he subsequently made to improve the quality of technical education in this country. In 1845, he entered the Royal College of Chemistry as one of Hofmann's first pupils, and was soon promoted to be an assistant, which he remained until 1851, when he was appointed professor of chemistry at the Royal Military Academy at Woolwich, succeeding Faraday in this position. In 1854, he became chemist to the War Office, a post which he held until 1888, when he retired under the regulations of the Civil Service. It was during this period of thirty-four years that he made his

most important contributions to chemistry in its applications to explosives and to metallurgy. Foremost among these are his researches into the preparation and uses of gun-cotton as an explosive, which were summarised in a paper printed in the *Philosophical Transactions* of 1866 and in the Bakerian lecture which appeared in the *Philosophical Transactions* of the following year. Gun-cotton was already known at that time, but it was generally regarded, at any rate in this country, as a dangerous and probably inefficient substitute for gunpowder. Abel showed, as the result of a long series of carefully chosen and elaborate experiments, how the material may be safely prepared of constant composition, how it should be stored, and also indicated its value as an explosive agent. These papers are eminently characteristic of the practical bent of Abel's mind. Though interested in the progress of pure science, his own inclinations were in the direction of its applications. With the exception of a few of his early papers, written whilst he was Hofmann's assistant, nearly all his contributions have been to the applications of chemical science, and have been made with the express purpose of solving practical problems.

In connection with his other work on explosives, the researches, carried on in conjunction with Sir Andrew Noble, on the chemical changes resulting from firing gunpowder under various conditions and those on the detonation of explosives may be specially mentioned. In 1888, Abel was appointed chairman of the Government Committee on Explosives, and as a result of a series of experiments conducted under its auspices, the smokeless explosive known as "cordite," containing both gun-cotton and nitroglycerine, was patented by Abel and Dewar, and became the standard explosive of this country.

The influence of composition on the properties of steel and its analysis and the testing of petroleum also engaged his attention. The apparatus known by his name which he devised in connection with the Petroleum Act of 1868 and 1879 for determining the temperature at which petroleum gives off inflammable vapour is still in general use, and he became a recognised authority on petroleum and its employment as an illuminating agent.

As a member of the Royal Commission on Accidents in Mines, he investigated the cause of the explosion at the Seaham Colliery in 1881, and its connection with the presence of coal dust in the air.

No account of Abel's career can be complete without some reference to what he regarded as the most important work of his life. From the first he took a leading and responsible part in the movement which led to the foundation of the Imperial Institute. He was the secretary to the first organising committee, and in a lecture delivered at the Royal Institution in 1887 he gave an account of the work which the Institute proposed to accomplish. It is noteworthy that the need for further provision in this country for scientific research in connection with art and manufactures was one of the principal points in this lecture. On the opening of the Imperial Institute in 1893, Abel was appointed its secretary and director, a post which he held, latterly in an honorary capacity, until his death. Although already far advanced in life, Abel threw himself with great courage and determination into the difficult task of organising the operations of the Institute, and continued to do so even in the face of steadily declining health. In relation to the history of the Imperial Institute, it need only be noticed here that in 1894 a laboratory was equipped on a small scale for the chemical examination of Indian and Colonial products. In 1896, a scientific and technical department, including extensive laboratories, was established with Prof. Dunstan as director, but the necessary funds were supplied by the Royal Commissioners of the 1851 exhibition, all the available funds of the Institute having been allocated to other purposes. Although it was Abel's intention to

retire from official connection with the Imperial Institute on its transfer to the Board of Trade at the end of the present year, he characteristically expressed his intention of continuing to take an active part in its proceedings as a member of the advisory committee.

Abel was an influential member of many scientific societies. He was elected a Fellow of the Royal Society in 1860, and was awarded a Royal medal in 1887 for his researches on explosives. He became at an early age a Fellow of the Chemical Society, and filled several offices in the Society, in which he was always deeply interested; at the time of his death he was one of the oldest of its past presidents. Abel took a leading part in the foundation of the Institute of Chemistry, of the Society of Chemical Industry and of the Institution of Electrical Engineers, of all of which he became president. He was also president of the British Association in 1890 and of the Iron and Steel Institute in 1891. He had filled the offices of vice-president and chairman of the council of the Society of Arts, which awarded him the Albert medal in 1884. Abel took an important part in the foundation of the City and Guilds of London Institute, and was at the time of his death chairman of its executive committee. He was an influential member of the court of the Goldsmiths' Company, of which he became prime warden in 1895. Abel's distinctions were numerous and varied. He was a D.C.L. of Oxford and a D.Sc. of Cambridge. He was made a C.B. in 1877 and was knighted six years later. The K.C.B. was conferred in 1891, and he was created a baronet on the occasion of the opening of the Imperial Institute in 1893. The last honour, that of the G.C.V.O., was conferred by the King soon after his accession, in recognition of Abel's personal services to the Royal Family.

Highly endowed with a practical mind, great common sense and a prodigious power of work, Abel was invaluable as a member of committees. His large experience in drafting official papers made him an excellent critic, and it may be safely asserted that few of the many documents submitted to him, by the institutions he was connected with, left his hands without substantial improvement. As time went on, routine work became a confirmed habit and the idea of a holiday positively repugnant to him, so much so that he found himself unable at the last to take rest and change, the necessity for which his friends and medical advisers so repeatedly urged on him.

W. R. D.

AN INSTRUMENT FOR AIMING GUNS UNDER COVER.

THE advantage of cover in military operations has been shown over and over again during the recent war in South Africa. But even when cover is available, the head of the soldier is exposed, while in the act of aiming, to the fire of an enemy. By means of the hyposcope the marksman is able to aim with considerable accuracy, while protected by a cover of earthwork or stones. Apparatus for sighting ordnance by means of mirrors has been employed by the war departments of several nations.¹ But the inventor of the hyposcope, Mr. W. Louten, has dealt with the problem of furnishing any existing rifle with a system of mirrors, whereby the act of aiming may be performed from a point several inches below the trigger-guard. The hyposcope is shown in Fig. 1 attached to the service rifle, which is placed in position over the edge of a rough mass of stones used as cover. The marksman aims the rifle by looking into the mirror at the lower end of the vertical tube, his head being protected by cover. In this form of instrument, four mirrors are employed; on looking into the instrument, the sights of the rifle are

¹ 'Treatise on Service Ordnance.' (London, 1893).

seen nearly as clearly as under ordinary conditions, the system of mirrors merely translating the line of sight along the rifle, parallel to itself, to the distance of about eight or nine inches below the axis of the barrel of the rifle.

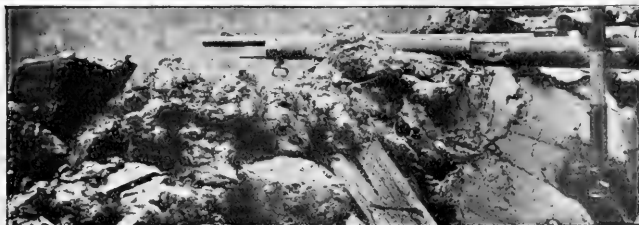

FIG. 1.

In another form of hyposcope, used to sight a Maxim gun, Fig. 2, two mirrors only are employed to translate the line of sight downwards, and but little light is lost. The tube which carries the mirrors is graduated, and the correct elevation is obtained by means of two easily made movements of the apparatus.

The National Rifle Association, recognising the importance of shooting while protected by cover, awarded prizes at the Bisley meeting this year for shooting with the hyposcope sighting. The range was 200 yards, the bullseye seven inches; each man of the thirteen who shot had seven shots. The highest possible score was 35 per man, and the average score per man was 32.15. The apparatus and the method of holding the rifle were new to nearly everyone who shot. In actual warfare, an enemy may approach a trench or cover from any direc-

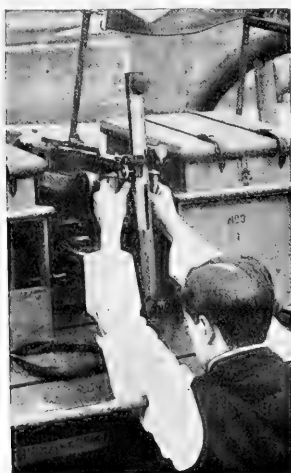

FIG. 2.

tion, and his approach must be seen, before the rifle is brought to bear on him. Probably the observation of the movements of the enemy might be found approximately by using a separate hyposcope, not attached to a

rifle in the usual way, so as to bring into view each portion of the foreground in succession. Such an instrument would only require two mirrors, and would enable an outlook to be kept with a minimum of danger to the observer. The instruments are strongly made, and with reasonable care they should efficiently answer their purpose.

THE BRITISH ASSOCIATION AT BELFAST.

IN point of numbers, the meeting of the British Association at Belfast has not been a very large one, but it has certainly been a decided success and has been full of interest. About sixteen hundred members and associates have attended, and in addition

many people have been present at the meetings who have not registered their names. The local committee has facilitated the work of the secretaries in every possible way, and the excursions have been a means of pleasure and profit to all who have been able to take advantage of them. No meetings were held on Saturday, so that members should be free to avail themselves of the opportunity of taking part in the interesting excursions arranged for that day.

At the first meeting of the General Committee, the report of the Council was read. Reference to the severe loss the Association has sustained by the death of Mr. Griffith, the late assistant general secretary, was made in the first paragraph of the report, and it was announced that Dr. J. G. Garson had been nominated to succeed him in this important office. Sir William Roberts-Austen, K.C.B., having informed the Council that he did not intend to offer himself for re-election as general secretary, Major P. A. MacMahon, F.R.S., was appointed as his successor, and Prof. D. J. Cunningham, F.R.S., was elected to fill the vacancy thus caused among the members of the Council. In addition to Prof. Cunningham, the following members have been elected on the Council, the new names in the list being in italics:—*Sir W. Abney, K.C.B., F.R.S.*; Prof. H. E. Armstrong, F.R.S.; Dr. J. Bonar; Prof. F. O. Bower, F.R.S.; Prof. H. L. Callendar, F.R.S.; Captain E. W. Creak, R.N., F.R.S.; Major L. Darwin; the Hon. Sir C. W. Fremantle, K.C.B.; Prof. F. Gotch, F.R.S.; *Prof. A. C. Haddon, F.R.S.*; Prof. W. D. Halliburton, F.R.S.; *Mr. C. Hawksley, Prof. G. B. Horvoss, F.R.S.*; Dr. J. Scott Keltie; Sir Oliver Lodge, F.R.S.; Prof. A. Macalister; Prof. W. H. Perkin, F.R.S.; Prof. John Perry, F.R.S.; Mr. L. L. Price; Mr. A. C. Seward, F.R.S.; Prof. W. J. Sollas, F.R.S.; Prof. W. A. Tilden, F.R.S.; *Prof. W. W. Watts*; Sir John Wolfe-Barry, K.C.B., F.R.S. Prof. H. Elster and J. Geitel have been elected corresponding members of the Association.

At the second meeting of the General Committee, Sir Norman Lockyer, K.C.B., F.R.S., was elected president of the Association next year. The meeting will be held at Southport, and will commence on September 9, 1903. It was resolved to hold the meeting of 1904 at Cambridge, and in all probability the meeting of the following year will be held at Cape Town. The invitation to visit South Africa has been backed up by the promise of substantial pecuniary support, so that a large and representative number of members of the Association may be enabled to accept it.

The following grants of money for scientific purposes were recommended by the General Committee at the meeting on Monday:—

Mathematics and Physics.

Rayleigh, Lord.—Electrical Standards	£35
Judd, Prof. J. W.—Seismological Observations	40
Shaw, Dr. W. N.—Investigation of the Upper Atmosphere	75
Preece, Sir W. H.—Magnetic Observations	40

Chemistry.

Divers, Prof. E.—Study of Hydroaromatic Substances	20
Roscoe, Sir H. E.—Wave-length Tables of Spectra	5

Geology.

Herdman, Prof.—Fauna and Flora of British Trias	5
Marr, Mr. J. E.—Erratic Blocks	10
Scharff, Dr. R. E.—To Explore Irish Caves	40
Watts, Prof. W. W.—Underground Waters of North-West Yorkshire	40
Marr, Mr. J. E.—Life-zones in British Carboniferous Rocks	5
Geikie, Prof. J.—Geological Photographs	10

Zoology.

Herdman, Prof. W. A.—Table at the Zoological Station at Naples	100
Woodward, Dr. H.—Index Animalium	100

Geography.

Keltie, Dr. J. S.—Tidal Bore, Sea Waves and Beaches	15
Holdich, Sir T.—Scottish National Antarctic Expedition	50

Economic Science and Statistics.

Brabrook, Mr. E. W.—Economic Effect of Woman's Labour	25
--	----

Mechanical Science.

Preece, Sir W. H.—Screw Gauges	5
Binnie, Sir A.—Resistance of Road Vehicles to Traction	90

Anthropology.

Evans, Sir J.—Researches in Crete	100
Read, Mr. C. H.—Exploration of Stone Circles	5
Cleland, Prof. J.—Anthropometric Investigation	5
Ridgeway, Prof.—Anthropology of the Todas and Tribes of Southern India	50
Read, Mr. C. H.—Anthropological Photographs (balance in hand)	—

Physiology.

Halliburton, Prof. W. D.—The State of Solution of Proteids	20
---	----

Botany.

Miall, Prof. L. C.—Registration of Botanical Photographs	3
Farmer, Prof. J. B.—Investigation of the Cyanophyceae	25
Ward, Prof. Marshall.—Respiration of Plants	12

Educational Science.

Sherrington, Prof.—Conditions of Health essential for School Instruction	10
---	----

Corresponding Societies.

Whitaker, Mr. W.—Preparing Report, &c.	20
---	----

SECTION B.

CHEMISTRY.

OPENING ADDRESS BY EDWARD DIVERS, M.D., D.Sc., F.R.S., V.P.C.S., EMERITUS PROFESSOR OF CHEMISTRY IN THE IMPERIAL UNIVERSITY OF TOKYO, JAPAN, PRESIDENT OF THE SECTION.

The Atomic Theory without Hypothesis.

In opening the Chemical Section of the British Association in this city and in the halls of the Queen's College, my first words must be those of reverence for the memory of Thomas Andrews, for so many years the Professor of Chemistry in this College, whose investigations into the properties of gases—above all those which resulted in the recognition and determination of the critical pressure and temperature of carbonic anhydride—have

become a part of the foundation of the Kinetic Theory of Gases. At the Meeting of the British Association here in 1852, Andrews was President of this Section, and again at the Meeting in Edinburgh in 1871.

Since the Meeting last year another distinguished chemist, formerly professor in one of the Queen's Colleges, Maxwell Simpson, has also passed away. He, too, acted as President of this Section, namely, at the Meeting in Dublin in 1878. The work by which Simpson's name will ever be recalled is more especially that upon the synthesis of polybasic organic acids.

One other name must not be left unmentioned in this Address: it is that of a long-time Fellow of the Chemical Society who has been intimately connected with the British Association—I mean that of George Griffith, the genial and most effective Assistant General Secretary of the Association for so many years, who died four months ago. He had visited Belfast in the spring and made the preliminary arrangements with the Local Committee for this Meeting. He joined the Chemical Society in 1859—just one year before I did—and remained a Fellow until his death.

It is now almost a century ago since John Dalton made known to the world his theory of the nature of chemical combination by the publication of a table of atomic weights. He had been occupying himself for some years with the study of the physical properties and atomic constitution of gases before he was led to extend the notion of the atom to chemical phenomena, and thus to form that conception which was to become celebrated as the atomic theory. In his laboratory note-books, preserved from 1802 onwards, the publication and analysis of which we owe to Sir Henry Roscoe and Dr. Harden, no reference is made to the theory till 1803, but we may well believe with Henry that it was already in Dalton's mind just a hundred years ago. But however that may have been, it seems fitting in a year so closely approaching the centennial of its publication as the present that the occupier of this Chair should address his audience on a subject of such general interest and importance as the atomic theory, if indeed there remains anything to be said on a subject which has so long and so fully engaged attention.

I dare not assert that I have found anything actually novel to bring before you with regard to the atomic theory, but I may say that there has certainly long seemed to me to exist the need to treat it as being a true theory instead of as an hypothesis, and to teach it and discuss it accordingly.

In thus setting forth what appears to me to be the proper form of the atomic theory, I shall have, at the risk of overtaxing your patience, to restate and examine most of the fundamental and familiar principles of our science in order to illustrate and justify the view I take. Not only this, but in order as directly and briefly as possible to meet the objection that whatever the atomic theory may be it cannot be introduced to the student of chemical philosophy in another form than that now in use, I shall sometimes have to adopt, in order to show what can be done, a didactic method which, in most other circumstances, would be quite inexcusable before so distinguished an assembly.

The atomic theory of chemistry stands unsurpassed for the way in which it has fulfilled the purpose of every great theory, that of giving intellectual mastery of the phenomena of which it treats. But in the form in which it was enunciated, and still is universally expressed and accepted, it has the defect of resting upon a metaphysical basis, namely, upon the ancient hypothesis that bodies are not continuous in texture, but consist of discrete, ultra-minute particles whose properties, if known, would account for those of the bodies themselves. Hence it has happened that, despite the light it throws upon the relations of chemical phenomena and the simple means it affords of expressing these relations, this theory has always been regarded with misgiving, and failed to achieve that explicit recognition which its abounding merit calls for. Indeed, the desire has been expressed to see the time when something on a more solid foundation shall have taken its place.

Now, it is not my intention to discuss the merits or demerits of the atomic hypothesis, which can indeed no longer be treated as a merely metaphysical speculation. What I would do to-day is to impress upon you that, in spite of all that has been said and written about the atomic hypothesis in connection with chemistry, the atomic theory propounded by Dalton and adopted, implicitly at least, by all chemists, is not founded upon the metaphysical conception of material discontinuity, and is not explained or illuminated by it. For if that should be the case there will no longer exist any grounds for hesitation in accepting

the theory quite explicitly, and then the anomalous condition of things will be removed of a theory being in universal use without its truth being freely and openly admitted. For the sake of clearness, it is convenient to restrict the term "atomic hypothesis" to the old metaphysical view of the discontinuity of matter whilst applying the term "atomic theory" to the current elaborated form of the Daltonian theory; this distinction is adhered to in the present Address.

In the peroration to his admirable discourse upon atomic weights or masses delivered before the Chemical Society in 1892 as the Stas Memorial Lecture, Prof. Mallet, F.R.S., said: "By the chemist at his balance the arm of reason is directed into those regions of almost inconceivable minuteness, which lie as far beyond the reach of the most powerful microscope as that carries us beyond the reach of the naked eye, quite as impressively as that same arm is stretched forth by the astronomer at his divided circle to reach and to weigh the mighty planets that shine in the remotest regions of our solar system." On two occasions I have heard the same comparison between the chemist and the astronomer made by Lord Kelvin when he was in the company of chemists; and undoubtedly both these high authorities have only then expressed the general view as to the nature of the domain of the chemist. Yet I venture to question whether there is anything in the ways and work of the chemist to support such a view and give point to Mallet and Kelvin's comparison. If, indeed, chemistry is a science which rests upon the atomic hypothesis and, therefore, would cease to exist in the form into which it has developed should matter prove to be continuous and not discrete, nothing can be said against the view that it is a science of the minute. But I am sure there can be no one ready to maintain that, if the hypothesis of the atomic constitution of substances were an unfounded one, the atomic theory would have been a discovery of no great importance; and Dalton himself, instead of being the founder of the chemistry of to-day, have been little more than the discoverer of the law of multiple proportions. If that cannot be maintained, what, then, becomes of this conception of chemistry as dealing with the minute? So far as comparison can be made between the operations of the astronomer and the chemist, it is the former and not the latter who, as a matter of fact, deals with the almost infinitely minute. For if, indeed, the chemist often works upon comparatively small amounts of substances, and, consequently, with very sensitive balances, that is, as we all know, only for reasons of economy of time, materials and apparatus; otherwise he works on the largest possible scale, with the object of attaining to the highest degree of accuracy and perfection. The astronomer, on the other hand, has, perforce, to deal with the smallest visible things in nature, the nearest approach there is to geometrical points, those fixed points of light in the heavens which are only known through scientific investigation to be other than what they seem to be. It is, therefore, only as interpreted by the atomic hypothesis that chemistry can be said to deal with the minute.

When the atomic theory is expounded in the usual way it is commonly and correctly stated that, on the assumption that substances consist of minute indivisible particles having weights or masses bearing the ratios of the combining numbers assigned to them, the laws of chemical combination by weight necessarily follow, and are thereby explained. But then the converse is not true—that because chemical combination obeys the well-known laws, substances consist of discrete particles. Nor does the assumption of the truth of the atomic hypothesis afford any real explanation of the facts expressed by the laws of chemical combination, or more comprehensively by the atomic theory, when that theory is given in non-hypothetical terms. It is just as difficult to see why the atoms should possess the weights on chemical grounds assigned to them as to see why substances interact in the proportions that they do; that they do so is, in either case, an ultimate fact, for which no explanation has presented itself. The atomic hypothesis masks this ignorance and deadens inquisitiveness. Notwithstanding all this, which is incontrovertible, it is certainly a common opinion that in chemistry we investigate the minute and intimate constitution of things.

But if, after all, chemistry does not deal with the minute, or, rather, if it has no concern with the magnitude of single bodies or their molecules; if the atomic hypothesis is not the foundation of, or necessary to, the atomic theory, then it is certainly most desirable and important that the theory of chemistry, which, with all its modern developments, I take to be indisputably the

atomic theory of Dalton, should be held and expounded without any reference to the physical constitution of matter, in so far as that remains unknown. The opinion that chemical theory should be developed without reference to the atomic hypothesis has indeed all along been held by many eminent chemists; but then the dilemma appears to have presented itself to them, that either the atomic hypothesis must be granted or the atomic theory must be dispensed with, since it falls with the hypothesis. That dilemma I do not recognise, and the practice of chemists shows beyond doubt that it is always ignored. Investigators use the theory whether they admit it or not; teachers of the science find it indispensable to their task, however much they may deprecate, and rightly so, unreserved acceptance of the atomic hypothesis as true.

Refusing to commit themselves to belief in the hypothesis, chemists have thought from the first to escape the adoption of the atomic theory by putting Dalton's discovery into something like these words: Numbers, called proportional or combining numbers, can be assigned to the chemical elements—one to each—which will express all the ratios of the weights or masses in which substances interact and combine together. Perhaps the atomic theory is here successfully set aside by expressing what is an actuality as an unaccounted-for possibility. But then those who use any such mode of expressing the facts, without reference to the theory, never fail also to adopt the doctrine of equivalents, and thus, by this double act, implicitly give in their adherence to the theory.

Divested of all reference to the physical constitution of matter, the atomic theory is that the quantities of substances which interact in single chemical changes are equal to one another—as truly equal in one way as equal masses are in another—and, therefore, that chemical interaction is a measure of quantity of unlike substances, distinct from and independent of dynamical or mass measurement.

Dalton, indeed, did not express himself in any such terms, his mind being fully possessed with the ancient and current belief upon which he framed his theory that substances are made up of minute, discrete particles. But it is clear enough that his theory was that of the existence of another order of equality between substances than that of weight. Up to his time, the weight or mass of every ultimate particle of any substance whatever appears to have been assumed to be the same, the atoms being alike in every way. That assumption is still made by many thinkers, chemists among them; we meet it, for example, in the different forms of the hypothesis that the elements are all, in some way, physically compounded of a universal and only true element, as in Prout's hypothesis. Dalton saw things differently, and recognised that, on the assumption of substances being constituted of particles which never subdivide, weight or mass cannot be the same for every such particle, except in the case of those of any one simple substance. Therefore, having given some numbers showing what he believed to be the respective weights of the atoms of several simple substances, taking that of hydrogen as of unit-weight, he proceeded at once to invent symbols for these atoms to indicate, not only their distinctness in kind, but above all things their indivisibility and their equality, properties which the use of their atomic numbers would have inadvertently concealed or even apparently denied, and could never have expressed or connoted.

It was only in this immediate invention and use of chemical symbols that Dalton's conception found clear expression; and again it is by the universal adoption of such symbols that chemists have shown their real acceptance of the atomic theory, even while displaying, not infrequently, their scepticism as to its truth. The replacement by Berzelius of Dalton's marked circles for atomic symbols by letters which should recall the names of the substances was in a way a great improvement, but it has had the serious consequence of causing chemical symbols to be usually first brought under notice merely as serviceable abbreviations for the names of the elements, and only then described as representing their atomic quantities. Now, evidently, what the character used as symbol shall be is, theoretically considered, but a petty detail; the vital point is what the character symbolises, and that is the atom. It does not symbolise the name; it only indicates that and recalls it. It may be said, indeed, to represent the atomic number, since it stands in place of it; but it is made to do so only in order that we may for the time forget this number and have in mind the integral character of the atom. It is not the 4006 parts of sodium hydroxide and 8097 parts of hydrobromic acid, or approximately twice as much of the latter

as of the former; it is not these gravimetrically expressed interacting quantities that we are to think of when the formulæ NaOH and HBr are before us, as we too often strive to do; it is not these, from a chemical point of view, meaningless numbers of parts, but quantities which are equal in the sense of chemistry, that are expressed as such by these symbolic formulæ. The real purpose of chemical formulation is not to abbreviate or replace language, but to facilitate, if not ensure, abstraction from and non-contemplation of gravimetric numbers.

I have just passed from atomic symbols to the formulæ of molecules; but this was not without warrant. In the form in which I have enunciated the atomic theory, it relates to the chemical interaction of substances, whether compound or simple, and the equality of the quantities concerned is the equality of molecules, since these are the quantities of substances entering into or coming out from single chemical interactions. Were it not, therefore, for fear of confounding it with the mechanical theory of that name, the atomic theory should be called the molecular theory of chemistry. It might, indeed, have happened to be so called by its author, for Dalton has told us that he had in mind both atom and molecule as names for his chemically ultimate particles, and chose the former because it carried with it the notion of indivisibility. He extended, also, as we do, the use of the term "atom" to chemically compound substances, since their combining quantities are chemically indivisible.

Next, I would point out that in the atomic theory the notions of indivisibility and equality are inseparably involved. The indivisibility of atom and molecule is not absolute or ultimate, and Dalton distinctly guarded himself against being understood to claim for the atom more than chemical indivisibility, and chemists of to-day assert no more than this. This indivisibility being conditioned by the equality of molecules, the importance of emphasising it rests only upon the danger, when it is overlooked, of losing sight also of the chemical equality through the gravimetric inequality receiving numerical expression, and thereby conveying the notion of divisibility, though only gravimetrically. The idea of indivisibility in connection with the atom or molecule is intrinsically quite subordinate to that of equality; for equality, being unity or oneness brought into relation with itself, the conception of it carries with it and includes that of indivisibility. Any rational hypothesis as to substances consisting of ultimate particles will include the notion of their being indivisible particles; and the import of the hypothesis in chemical theory must lie, therefore, not in this indivisibility, but in the nature of the equality of the particles. By his atomic theory Dalton asserted that where the substances are different this equality is chemical instead of gravimetric.

Molecules are equal in the sense that they are quantities of their substances which are interdependent and coordinate in any and every single chemical change in which they take part together. It is a form of equality for which no close parallel can be found; but as to that it should be remembered that this equality relates to the phenomena of the transformations of substances into each other, which, though they form so large a part of the phenomena of the universe, are fundamentally distinct in nature from the rest of the behaviour of bodies throughout which the substance remains what it was. In some agreement with it there is that of mechanical pressures when these balance or neutralise each other, and therefore are opposite and mutually destructive though equal. But such pressures when exerted in the same direction are also equal in their effect on any body in their path, whereas in chemical interactions the effects of molecules or equal quantities of two unlike substances are only equal in the sense that each is that quantity which interacts with the same quantity of some third substance, which itself proves to be also a chemically equal quantity to them. For the products of the interaction in the one case are in part at least not the same as those in the other, though all prove chemically equal in further interactions.

To give an example: the molecule of ammonia is equal to that of aldehyde in that it combines with it and with it disappears, or ceases to exist as such. For the same reason it is equal to the molecule of hydrocyanic acid, and molecules of aldehyde and hydrocyanic acid equal to each other, because they, too, combine and disappear as such in doing so. But the molecule of ammonia again equals that of aldehyde in effecting transformation of hydrocyanic acid and its own self into something else. And lastly, chemically equal or molecular are the products of these combinations; aldehyde ammonia, ammonium cyanide and

aldehyde-cyanhydrine, not only among themselves, but also with the quantities of ammonia, aldehyde and hydrocyanic acid from which they come and into which they return in other chemical changes. But with all this quantitative equality in transforming power, the substances produced are unlike and, each to each, peculiar to one of the three acts of chemical combination; and on this account exception may be taken to the treatment of molecules as equal chemical quantities. Yet the equality of molecules here asserted is but an extension of what is meant by the equivalence of certain atoms and radicals, since the atom and the radical are, nowadays, conceptions entirely dependent upon and derived from that of the molecule (apart, of course, from the atomic hypothesis); and this universally allowed equivalence admittedly does not extend to the identity of the products of the replacing activity of the atoms and radicals.

Quantitative equality and equivalency, it is true, have not the same meaning, equivalence being used to denote qualified equality, equality in certain specified ways, of quantities not equal in all other ways and possibly in no other. Quantities of different substances cannot, strictly speaking, ever be equal, and can only be styled so in the sense of being equivalent; for were they equal in every way the substances would obviously be the same. But this fact, if it ever strikes one, is ignored by universal custom, and quantities of substances, however unlike—feathers, air, water, salt, and what not—are taken to be all equal, even by chemists as by the world at large, if only they have the same weight, notwithstanding the incongruities of the substances. I proceed now to show the baselessness of this conviction, but only to bring out more strongly the claim of chemical activity to equal rights with weight or mass in determining what are equal quantities of substances, for I am aware that here I have nothing to tell you that you do not already know. Weight being only the gravitational measure of mass, which itself is independent of it, quantities of substances are held to be equal when their masses are equal. Now, mass is quantity of matter. But what then is meant by matter? The answer must be either that it is a general term for any and all substances, or else that it is the common basis of all substances, which presents itself in all the different forms which are known to us as such, by virtue of a corresponding variety in its instestinal motions. I gladly pass over the latter answer without discussing it, on the ground that it introduces the subject of the intimate constitution of substances, which it is my set purpose to keep independent of in this discourse. I will only say of it that it would probably be the answer of many physicists and chemists, and yet that it gives such a limitation to the nature of matter as makes the common expression "constitution of matter" devoid of all meaning. That expression means, and can only mean, the constitution of substances in common; and this brings me to the first answer, that matter is the term standing for all substances in common. Now, one thing which all substances possess in common is the property of resisting pressures; pressures not only of moving bodies, but of the motions of the ether and electrons. Measured or quantified, resistance becomes mass, all that can be signified by this term being the quantity of the resistance or inertia a substance exhibits when tested. It is the measure of a property of the substance, that is all; and there is no other way of quantifying a substance than through some one of its properties. No quantities of different substances can, as such, be commensurable throughout; and when compared and measured through some common property, such as the possession of mass, the equivalence or pseudo-equality found by this means is not the same as that found when some other common property is taken as the means of measurement. But experience has shown that though there are several rational and comprehensive ways of instituting, through some common property, comparisons between quantities of different substances, they all, with the exception of that of weighing, agree more or less exactly in pointing to the same order of equivalence, that of chemical activity; for with this are colligated those of gaseous volume and the other well-known physical activities, which give nearly the same quantities as it gives of different substances as being molecularly equivalent. There are, therefore, essentially only two measures of quantitative equivalency or pseudo-equality between substances, the dynamical and the chemical or molecular, the one wholly independent of and the other wholly dependent upon the particular nature of the substances compared. The former is the measure of dynamical phenomena, those of changes of bodies, due to their impacts and pressures, which may lead to their deformation and disruption, but do not involve transformations of the

substances of the bodies into others; the latter is the measure of chemical phenomena, those of changes of bodies induced by such of their interactions as do involve transformations of the substances of the interacting bodies into other substances. Since it is already settled for us by custom that quantities of different substances are to be called equal when or because they are equivalent gravimetrically, and as it is not to be supposed that we shall ever give up calling 16 kilos. of oxygen, of salt, of chalk, and of every other substance, however unlike, equal quantities of them from the gravimetric point of view, we have no choice but also to call molecular quantities of these substances equal from the chemical point of view, if the claim to coordination in equality of chemical with gravimetric equivalency is to be asserted and maintained.

The contention that chemical equality must be regarded as of as clearly defined a nature as gravimetric equality becomes the more weighty when it is reflected that our very definite views concerning gravimetric equality are due solely to the law of conservation of mass, the evidence for and against which, I may remind you, is just now to be discussed by Lord Rayleigh before the Physical Section. The mass of one pound of sodium remains unchanged when the metal is converted into salt, washing soda, or borax; if this were not the case, gravimetric equality would be just as definite as it is now, but physicists would have to argue for its general recognition in much the same way as I am doing now for the recognition of chemical equality.

In further justification of this claim of chemical equality to coordinate rank with dynamical equality in the quantification of substances, it may be well to take the fact into consideration that the determination of the former is independent of that of the latter. Overlooking the difficulties of the task, let there be at hand or always procurable unlimited numbers of parcels of the different substances to be experimented upon, each of which, by other means than weighing, such as spatial measurement, can be known to be equal to, or greater or less than, other parcels of the same substances. Suppose, now, that after many trials, one of a number of equal portions of sodium hydroxide has been found to be the quantity just necessary to interact with one of a number of portions of hydrochloric acid also equal among themselves. The products of the interaction will be some water and some salt. We can now have placed before us a parcel of sodium hydroxide equal to that previously used, another of hydrochloric acid also equal to that used, and the water and the salt obtained, and then have before us chemically equal quantities of four substances. Let now, by spatial measurement, a number of parcels of water be portioned out, all equal to that of the water obtained, and a number of parcels of salt equal to that of the salt obtained. By a series of trials we find a quantity of silver nitrate just sufficient to interact with the sodium chloride, and having, by supposition, taken this quantity of silver nitrate from a lot of other parcels equal to it, we find that one of these is just sufficient to interact with one of the portions of hydrochloric acid equal to that used in producing one of the portions of salt. Further, we find that the salt and the hydrochloric acid each produce a substance which is the same, namely, silver chloride, and in the same quantity as the other. Along with it in the case of the salt is sodium nitrate, and in the case of the hydrochloric acid, nitric acid. We can then find that this quantity of nitric acid is just enough to interact with one of those of sodium hydroxide, and thereby produce quantities of sodium nitrate and water, respectively equal to those obtained in the other interactions. If now we conjoin with these experiments others in which hydrogen, sodium and silver are each caused to combine with chlorine, and others in which hydrochloric acid, silver chloride and sodium chloride are electrolysed into these elementary substances, evidence is obtained of such facts of chemical composition and decomposition and of double decomposition (or what happens when compounds interact) as those upon which the science of chemistry is framed.

In teaching chemistry the point is kept too much in the background, if not altogether out of sight, that the chemical equality of quantities of different substances is independent of all other relations of equality between them, and that, therefore, its validity is not affected by the fact of its terms agreeing with some and not with other terms of equalities determined in other ways. Instead of bringing out this point the molecule of water is given out as being, primarily and prominently, that quantity which has eighteen units of mass and which measures two unit volumes. Both statements happen in the nature of things to be

true, but neither of them describes the molecule. Let it be clearly understood from illustrative examples what is meant by "chemically equal," and there is hardly more to be said as to what constitutes a molecule of water than that it is the quantity of it chemically equal to that of some other substance presenting itself for comparison. "Molecule" is a term of relation; it stands for an equal quantity, not for any particular quantity; but as such it is as easy to understand and as indefinable as an equal volume or an equal weight of a substance.

It is then only as colligated equalities, established by experiment, that gaseous volumes, osmotic pressures and other properties of substances come into consideration, first as enforcing the truth of the conception of the indicated quantities as equal, and then as the means of molecular measurement without resort to chemical change. But of the purposes served by the colligative properties, that of giving molecular measurements without recourse to the evidence afforded by chemical change is well known to be of the very widest application. To determine chemically the molecular equalities of substances, single chemical changes of suitable character, changes which are cases of double decomposition, have to be looked for; and to know these with the desirable degree of certainty calls for a much larger acquaintance with the chemical behaviour of the substances than can usually be gained at the early stage of work when the knowledge of the molecule is of the utmost assistance in the further investigation of the nature of the substances. Consequently, it is nearly always through recourse to physical methods that the molecule is first ascertained, and then through the molecule the certainty acquired that some particular interaction is a single one, thus reversing the normal order of things, which undoubtedly is that the molecule in chemistry, however it may have been first determined, is recognised as such by being what it is in chemical change.

I shall have been wholly misunderstood by you if you suppose that I would make light of the importance of the balance in chemical operations, or of the value of its indications in chemical investigations. Once the weights of molecular or atomic quantities have been ascertained the balance becomes the most accurate and generally the most easily applied instrument for apportioning substances in these quantities. Chemical interaction, to be employed in this way and without the aid of the balance, is practically useless, for the reason that it involves the destruction of the quantities it measures. Out of this dependence on the balance arises the exceeding importance of accurate tables of atomic weights, from which molecular weights are derived by addition; but the place for these tables is not on the walls of the lecture-theatre, but in the laboratory pocket-book, and, perhaps, in the balance-room. Besides the use of the balance and of atomic weight tables for getting and calculating out molecules of different substances at pleasure, there is the indispensable service they perform in enabling chemical analysis to be carried out and applied to the solution of the problems offered by chemical change. The primary problem of every science is to find some element of sameness in the diversity of its phenomena, in order that they may be compared, a problem which was solved for chemistry to a large extent by Dalton, and ceased to exist when the distinction had been made between molecule and atom. But this having been solved, there comes the other problem, namely, to find definite, that is, quantitative differences in the midst of the uniformities, and these for the chemist are differences of mass or weight. Through that redistribution of mass which attends chemical interactions, it has been possible to trace out to some extent the nature of the transformation of substances and develop the science on the lines of chemical composition and chemical constitution. Thus, then, the balance has become and will continue to be the necessary instrument of chemical research; but again I would remind you that it records its facts in units which are not ours, and of which we avail ourselves only as the means to an end. Sodium chloride is chemically composed, not of 35.5 equal parts of chlorine with 23.05 of the same equal parts of sodium, but of equal quantities of these simple substances.

The theory of chemical molecules or equalities and their relations to the equalities between the weights and gaseous volumes of different substances were brought to light, not by Richter's law of chemical combining proportions, and not by Avogadro's hypothesis as to there being equal numbers of particles in the same volume of different gases, but in the first place by Dalton's atomic theory and Gay-Lussac's law of simply related gaseous volumes in chemical change; and then, much

more fully in the middle of the last century, through the brilliant work of Gerhardt, Williamson, Laurent, Odling, Wurtz, and others, in the purely chemical field. Dalton gave us the conception of the molecule, though confused with that of the atom, as the unit of measure of chemical activity in place of the gravimetric unit; the work of the chemists of the last mid-century gave us a fuller conception of the molecule, along with the notion of chemical change as being substitution in the molecule effected by what became known as double decomposition. Up to that time chemistry had been treated only as the science of compounding and decomposing or reducing. Sodium added to oxygen gives soda, sulphur added to oxygen gives sulphur anhydride, soda added to the anhydride gives sodium sulphate, ethylene added to chlorine gives dichlorethane, water subtracted from alcohol leaves ether, and so forth. All this is strictly true in a limited way, but then it is not chemistry; and the addition precedes and does not constitute the chemical union. In the sodium sulphate we perceive no soda, no anhydride, no sodium, sulphur or oxygen. That is to say, there is evidence of the addition and subtraction of mass and some other such evidence; but, for the rest, evidence of addition there is none. Were it otherwise there could be no chemistry. It is true that one of the great things accomplished by chemistry has been that of establishing the law of the conservation of mass, without which to rely upon the chemist would be unable to carry on his experimental investigations. But that is only because, like the steady point to the seismologist, it is there unchangeable when all else is changing. Since it is the law of no change, it cannot serve to explain what is change. Far from being the science of the composition of substances, chemistry might be defined as being the science of the non-composition of substances where that composition might have been looked for from the antecedents. If salt is verily a compound of sodium and chlorine, and can be broken up into these, why have the fragments not the marks on them of that whole of which they formed a part? It is true that 5850 parts of salt become 3545 parts of chlorine and 2305 parts of sodium, nothing being gained or lost in weight; but to account for that there is no need of chemistry, a science which takes cognisance of the phenomena of change, and not of those of unchanged properties. The use of the word "composition" in chemistry cannot be discarded now, and all that is necessary to make it unobjectionable is to see that the term is always qualified by the prefix "chemical" when there is a possibility of mistake about its significance, and that that significance is carefully explained, if not defined and fully illustrated, before it is given over to the beginner.

The facts of a chemical nature about common salt which cause the statement to be made that it is a chemical compound of chloride and sodium are such as these. Salt can be wholly changed into sodium and chlorine; these substances brought together change into salt and nothing else; salt and sodium, each under conditions appropriate to it, change into the same substance, called also a sodium compound, such as sodium hydroxide; salt and chlorine, each in its own way, change into the same chlorine compound, such as hydrochloric acid; neither sodium nor chlorine, one apart from the other or the other's chemical compounds, ever changes into salt; salt is, directly or indirectly, producible in the chemical interaction of a sodium compound with a chlorine compound; the properties of salt are much less like those of either sodium or chlorine than like those of some other substances; in sensible and other physical properties the chemically compound substance, salt, is as simple as or simpler than either of the chemically simple substances, sodium and chlorine; lastly, the laws of combining proportion by weight are obeyed in all the chemical changes in which salt takes part.

With exclusive reference to such facts as these, the chemical composition of a substance will, I think, be found to be satisfactorily defined, as its having the power, capacity or property of being wholly producible from and wholly convertible into, directly or indirectly, those substances of which it is said to be composed. A simple substance differs from one that is compound only in not possessing the power of being by itself convertible into two others, or of being produced alone from any two others. Simple substances are not less varied or less complex in their physical properties than compound substances, while their chemical constitution is often more problematic than that of many which are compound. The term "simple," therefore, is as misleading in the language of chemistry as "compound," unless defined and qualified in use by the word "chemically."

The ground really occupied by chemical composition in theoretical chemistry is now greatly limited; for with the full acceptance of the idea of the molecule and of the atom as a derivative of it, its place has been taken by chemical constitution to an extent hardly realised. The useful and practically necessary expression of the results of the quantitative analysis of a new substance gravimetrically is all that can strictly receive the name of its chemical composition. When the term is applied more widely it is used for what are really the simpler forms of chemical constitution. It was otherwise before the conception of the molecule had become current and the atom had become a derived function of the molecule. Chemical composition as expressed by Dalton in atoms is indeed that and nothing else. Carbonic anhydride is composed, according to him, of two atoms of oxygen to one of carbon, as against carbonic oxide, which is composed of one; marsh gas of two atoms of hydrogen to one of carbon, as against olefiant gas composed of one. But then it was only numerical necessity which led him to adopt such a mode of expressing the facts. The same necessity, it is true, affects us also in the matter of carbon dioxide, of water and of ammonia, but how little it does so is shown by the many cases in which the empirical or simple composition is expressed in multiples. The atomic chemical composition of ethylene is two of hydrogen to one of carbon, and that of benzene one of hydrogen to one of carbon. When we say, as we always do, that the one substance is "composed" of four atoms of hydrogen to two of carbon, and the other of six of hydrogen to six of carbon, we give what is information concerning the constitution of these substances. Call it the composition of the molecule as we may, it is evident that by composition we can here mean only constitution. As with polymerism, so with isomerism, and in a more marked way. Mercurous sulphate and mercuric oxy-sulphate, quite distinct salts, have yet the same composition.

In the great reformation wrought by the chemists to whom I have referred, but by Gerhardt in particular, the new light set up in chemistry was the notion of what came to be called "double decomposition" in chemical change. The phrase is not, perhaps, happily constructed, but it has the merit of needing some explanation of its meaning before it can be understood, and troubles, therefore, through a too simple apprehension of the sense of the word "composition" are hardly to be feared. Its introduction into chemistry marked the ascendancy of the idea of the molecule as the factor in chemical change whose interactions with other molecules were to be considered, instead of those additions which, as chemical phenomena, never take place. It led also to new conceptions of the nature of the atom and the compound radical as being the quantitative and qualitative expressions of the powers possessed by substances to change into others, and to the conception of the valency of atoms and radicals as expressing the nature of the connection of successive chemical changes. The zeal with which it was attempted to force all chemical changes into the form of double decomposition interfered, perhaps, with the full recognition of its importance; but the fact remains that, with hardly an exception, all that is stated concerning the nature of those chemical changes in which two or three substances become one, or one becomes two or more, is based upon notions derived from the study of double decomposition.

The fundamental value of double decomposition consists in its displaying threads running through chemical transformations which can be followed up. When two substances change into two others, and only then, there can be found, in most cases, relations of resemblance, both physical and chemical, between the before and after of a chemical change. Instead of the striking unlikenesses shown by the substances formed by quasi-addition to those from which they are formed, there are here met with the similarities of the outgoing to the interacting substances, and the similarities between the products of different interactions in which the acting substances are similar. Chemists had been for very long familiar with acids, bases, salts, without becoming deeply impressed with the significance of the resemblances which these class-names imply, and also with the facts that acids beget acids, bases bases, and salts salts, or in more general terms, that substances in interaction produce others like them, and that differences between the products and the agents in one change are distinctly repeated in a similar change in which other substances are concerned, points now given expression to by such terms as "chemical constitution," "homologous" and "analogous series," "Kopp's law," &c.

What is so important to consider in the study of double decomposition is that the fact, that the sum of the masses of the two products of the change is the sum of the masses of the two interacting substances, presents itself no longer as being merely the evidence of the massing together of substances into a compound; for there is in double decomposition to be considered that redistribution of mass which, on the one hand, is found to correspond to and be part of a general though not sharply defined redistribution of physical and chemical properties; and, on the other hand, to be obviously irreducible to that interchange of those simpler substances which in many cases are produced in the simple decomposition of the acting substances.

The physical properties of substances, or rather their sensible qualities, are of too uncertain a character for their redistribution to be safely traced. But it generally does result, amongst inorganic substances, at least, that colour is transmitted, the saline, acid, bitter, or other taste of one of the active substances will appear, with more or less distinctness, in one of the products, a relatively volatile and a relatively fixed substance together will yield a similar pair of products, a dense and a light substance will yield a dense and a light substance, and so on. The chemical properties, however, are quite definitely redistributed to a large extent, a fact sufficiently illustrated by saying that an iron salt yields an iron salt, and a sulphate yields a sulphate.

But this is not a redistribution in which simpler substances, or indeed any other substances than those interacting, play a part; as soon becomes evident on attempting to establish the contrary by an appeal to the facts. While silver acetate and silver sulphate resemble each other and also silver nitrate as silver salts, they do not resemble silver itself; and though silver nitrate resembles sodium nitrate as nitrate, there is not even a substance known which is related to these salts as silver is related to silver salts. It might be objected to this that there may yet become known such a substance, which in its ultimate decomposition would give one molecule of nitrogen to three molecules of oxygen. If instead of nitrate were given acetate or cyanide, there would be found in the substances acetic peroxide and cyanogen, it might be said, the analogues of the as yet unknown substance of the nitrate. But the point I would make is that nitrate, sulphate, &c., are names with well-defined meanings independent of the fact that the corresponding substances are not known; for it follows without argument that also the terms silver, iron, chloride, &c., should be equally independent in meaning of the existence of the substances silver, sodium, chlorine, &c. It is a familiar historical fact that caesium, helium and fluorine were chemical names long before the substances caesium, helium and fluorine became known. We might well be convinced, therefore, without going further, that constitutional names, names which convey the facts of likenesses preserved in chemical change, cannot be indicators of the presence of the substances for which they may be also used. For, that being the case, we have no grounds for assuming that silver nitrate in interaction with sodium sulphate decomposes into the substance silver, which then combines to form silver sulphate. But fuller proof than any appearance of likeness or unlikeness can give is afforded by facts which became known and appreciated in connection with the chemical molecule. Typical of them all is the fact that in none of its interactions does chloromethane yield a hydrocarbon simpler than methane or than itself. Under those conditions in which it might have been expected to give a substance which would be methyl, it produces ethane, a substance which chlorine converts into another substance, having instead of one-third only one-sixth less hydrogen in its composition. Similar results have been obtained in all cases where the point can be determined—that is, where the simpler substance looked for would still be a compound substance, and such simpler derivatives are looked for no longer. The monohydride of oxygen or sulphur, the dihydride of nitrogen or phosphorus or arsenic, the mononitride of carbon, the organic compounds, methyl, phenyl, acetyl, are not only unknown, but are held to be non-existent substances, though their chemical compounds, the hydroxides, amides, cyanides and the rest are both numerous and well defined. Whatever other view we shall have to take of the constitution of Gomberg's remarkable "triphenylmethyl," it will certainly not be that it is identical with the radical of the triphenylmethane from which it is derived, unless we are prepared to allow that carbon is sometimes trivalent. Ethylene the substance differs from ethylene the radical in having its two

carbons differently related; but it is difficult to see how to make a similar distinction in the case of Gomberg's substance.

In those other cases in which the point is not strictly determinable, only because the resulting substances are the simple substances themselves, it required but the recognition of molecular quantities to make it evident that these cases run parallel with the others. For, in all changes which can be satisfactorily followed out, the resulting or entering quantity of the simple substance is twice as great as that which can have come from, or gone to form the molecule of either of the compound substances. But if, so far as can be traced, a simple substance comes only half from one molecule of any of its compounds, none of these compounds can contain or be composed of simple substances. All simple substances, therefore, as well as all compound substances, enter into and come out from chemical changes as dual in all of them in origin and disappearance. Their colligative properties have been appealed to in order to confirm this observation, but with conflicting results, sometimes confirmatory of the chemical evidence, sometimes contradictory of it, and sometimes too complex for confident chemical interpretation.

I refer here more especially to Avogadro's proposition, which is in effect that equal volumes of gases are chemically equal or molecular. As in the case of Dalton's atomic theory, there is to be distinguished in this proposition what Avogadro really put forward as new from what he took for granted. Admitting, as was to him a matter of course, that gases have in equal volumes equal numbers of particles, he asserted that in the case of elementary substances these particles are not the atomic particles, but, as in the case of compound substances, particles compounded of these, which interact with the particles of other gases as chemically equal each to each. If now this proposition is divested of all hypothesis, all reference to the mechanical structure of gases, it becomes the law that equal volumes of gases at the same temperature and pressure, whether simple or compound, are almost exactly chemically equal quantities, and once in possession of this law we find nothing becomes clearer by assuming that equal volumes of different gases contain the same number of chemically equal particles. This law is, obviously, an advance upon Gay-Lussac's law similar to that of the chemical molecular theory upon the atomic theory of Dalton. Unfortunately, however, it does not hold good in the case of not a few simple substances, and it seems impossible from the chemical point of view, and consistently with the molecular theory, to admit that, because the gas-volume has only half the expected mass, the chemical molecule of sodium or mercury is not bipartite like that of hydrogen or oxygen, and chemically equal to either.

The dual constitution or chemically compound nature of the simple substances as thus established by the part they take in chemical interactions furnishes further evidence of the untenability of the belief that the molecule is chemically composed of two substances, or their substitutes, simpler than itself, when we consider that, were this true, there would be chemical union between two things perfectly alike, two portions of the same thing. This difficulty was, I believe, first raised by Berzelius, and has never been met. Physically, the matter is simple enough, if motion in the opposite direction is not counted as a difference between two masses. But this would be a non-elective union, whilst chemical union is elective.

The difficulty, insurmountable when made, does not arise when the fact is recognised that every chemically single substance, whether simple or compound, is, as a substance, one and without parts, and can never, therefore, be built up of or broken down into parts different from itself. One substance (as two molecules) or two substances change into two others or into two molecules of one, in an interaction which is instant, uninterrupted, and irresolvable into stages, where the interaction is single in character. But just as a body can be mentally analysed (as in the investigations of dynamics) into mass and motion, which apart are unknown, and as these again can each be conceived of as further divided, resolved, condensed, and otherwise qualified as centres of mass, compounded motions, and so forth, so the chemist is enabled mentally to find quantitatively defined this, that, and the other mark of the many chemical interactions which have or may have gone to bring it into existence, and will or may again have place in the possible forms of its dissolution into others. The two methyls in the constitution of ethane, about which we are quite certain, are not two things held together till some interaction sunders them in

the chemical dissolution of ethane, but the double mark of similarity between it and other methyl compounds in their chemical interactions. We cannot say that only one part of the ethane is methyl, or hydrogen, or carbon, but that part of its nature, of its constitution, is its behaviour as a methyl compound, or, again, as an ethyl compound; or, more comprehensively but less specifically, part of its constitution is its behaviour as a hydrocarbon, as a hydrogen and as a carbon compound. But these are different aspects of it, different relations of it, not differing parts of the one homogeneous substance.

With the laudable object of combating the prevalent notion that matter is something which is the basis or essence of a body, something acting as the medium of the manifestation of its forms of energy, a distinguished and most lucid writer on chemistry has, adequately perhaps for that object, represented a body as a compound of the various forms of energy subsisting together and cohering in certain proportions within the volume of the body. But this presentation of a subject as a cohesion or association of forms of energy is on the same footing as the presentation of ethane as consisting of two methyls bonded together, or two portions of carbon with six of hydrogen. It is compounding what cannot be had apart, what cannot be even conceived of as separate, so far as bodies are concerned. The analysis of bodies into manifestations of different properties are only mental operations. A moving body, a hot body, a green body, an explosive body, becomes by legitimate abstraction a phenomenon of motion, of heat, of colour or of light, or a chemical phenomenon as our needs require; but the body is there all the while, and its undivided and continuous existence is indispensable to the phenomenon. The body can be hotter or colder, but not that only—not that without other differences; red-hot iron is throughout a very different thing from cold iron, and ice differs widely from steam in most of its properties. A substance is no more composed of its properties or energies than it is composed of its so-called elements. It manifests its presence in a thousand and one ways more or less distinguishable; its properties are so to manifest itself. But no divisibility of itself while it remains itself can be thought of, no differentiation can be suggested, no nucleus with its superinduced properties can be traced.

It ought, therefore, to be possible to express all the particulars of chemical constitution without making any assumption as to substances having parts or structure. Of chemical constitution itself, I doubt whether there is to be found a definition which is not couched in language having reference to the minute mechanical structure of substances, notwithstanding the fact that all knowledge of their chemical constitution has come to us through observation of the properties of the substances themselves, and more particularly their relations in cases of double decomposition. Bearing in mind that all terms are relative, I think the chemical constitution of a substance may be defined as the resemblances shown by it in its chemical changes to other substances, often better known than it and taken as types, these resemblances being indicated and described usually by means of special nomenclature and notation. As this nomenclature and notation have been developed out of those designed to express chemical composition, it is well to point out that the notion of chemical constitution is independent of that of the latter, though clothed to some extent in its language and symbols.

The notions of radical and atom are so intimately related as to be often used indifferently, the one for the other. The radical ethylene is always an atom of ethylene, the radical nitrogen always an atom of nitrogen. Radical and atom are, in fact, the qualitative and quantitative aspects of the same thing. They are thus exactly parallel with substance and molecule. We can think of unquantified substance, and perhaps of unquantified radical, but in chemistry we never really want such conceptions; one of the many definitions of science is the quantification of phenomena, and in every chemical phenomenon the substances concerned are quantified as molecules. The quantification of radicals expressed by the atom is fundamentally the same in principle as that of substances, namely, that of chemical equality in interaction; but it may be better to say that it is dependent upon the quantification of substances as molecules.

In the interaction of double decomposition each substance by contact and union with the other develops and manifests a dual character by becoming distributed as the two new substances, with the consequence that each of these has certain properties the same as those of the one, and certain others the same as those of the second interacting substance. What is common in

this way to one of the interacting and one of the resulting substances is a radical of these substances, of which there are evidently four in every double decomposition. These radicals of a single interaction are defined as whatever two parts of the powers of a substance to yield the simple substances of its chemical composition are, in certain interactions, continued separately from each other in the two new substances. But the pair of radicals developed in the various double decompositions of a substance being by no means always the same, one of the radicals of one pair must include in its composition part or all of one of those of another pair. Acetic acid has for one pair of radicals methyl and carboxyl, and for another pair acetyl and hydroxyl. Of these, carboxyl includes hydroxyl and acetyl includes methyl. Again, acetic acid yields the hydrogen and acetate radicals in one interaction, and hydroxyl and acetyl in another, so that in these cases the acetate radical includes acetyl and the hydroxyl includes the radical hydrogen. Now, what is common to carboxyl and acetyl and what is common to the acetate radical and hydroxyl are also treated as radicals, the one being known as carbonyl and the other as the radical oxygen. These are examples of what may be distinguished from the others as the polyvalent radicals. They are radicals of radicals, and therefore also radicals of substances. They may be defined as the common part of two or more other radicals. A single definition of all radicals can be given, but it is not instructive. A radical is any single power or any interdependent association of the powers of a substance to produce simple substances which continue in any product or series of successive products of its chemical change.

Before I leave the subject of the radical I wish to repeat that it is only when it is interacting that a substance shows a dual character or division, as it were, into parts or radicals, and that the duality it then shows is determined as much by the nature of the other substance as by its own. A substance is neither actually nor conceptually the sum of its radicals. The very fact of the difference of these in different interactions should be proof of this; though it only leads to its being taken to be at least the sum of its ultimate or simple radicals. If, however, it is not the sum of its proximate radicals, it is hard to see how it can be imagined to be that of the ultimate ones. In relation to its radicals, a substance must be held to present itself as any one of these for the purpose of investigation, and at the standpoint from which it is considered. It is then to the mind that particular radical, though also something else; just as snow is white and cold, yet also something else, for the moment unconsidered. Nor can the two products of an interaction be looked upon as themselves the sum in properties of the interacting substances. To a limited extent, and imperfectly, we can attach to a given radical certain of the properties common to its compounds; but it needs no greater insight than we have already to recognise that a substance cannot be what it is in one way, without being in that way greatly affected by what it is in another. This is now a recognised but not sufficiently considered point, and I therefore welcome those publications of Prof. Vorlaender, of Halle (who now honours this Section with his presence), in which he has been vigorously calling attention to the extent to which the properties of a substance, acid, basic, stable, and what not, depend as much as, if not more, upon the interrelations of the radicals than upon the radicals themselves.

One other thing I have to say about the radical, which is to the spelling of the word. I plead for a return to the ending of the word radical with "al," now interdicted in the *Journal* of the Chemical Society. It seems appropriate to call the powers of a substance to behave chemically as it does, the roots or radical parts of its chemical nature, but it does not seem appropriate to call them radicles or rootlets. Americans and all other nationalities but our own use the original spelling.

I have put off too long, perhaps, all reference to the properties of very dilute aqueous solutions of salts, but I wished first to discuss the nature of the radical. The osmotic pressure and other dependent points which are particular in the behaviour of such solutions are in full accordance with the assumption that an electrolyte by dissolution in much water becomes a pair or a binary system of two interdiffused quasi-substances called "ions." These ions must differ from isolated substances in bearing equal and opposite quantities of electricity; in being each unknown apart from its fellow; and in having a composition not to be found in actual substances, though identical possibly with that which a radical would have were it a

substance. The ions can be indeed separated from each other, but not to continue as themselves, since in the act of separating they form ordinary substances, either by uniting with other ions, or by two molecules of ion becoming one molecule of substance. In the former way of separation the ions of two salts interact on mixing their solutions; in the other way, the ions become substances when their solution is placed in a galvanic circuit. In this mode of separation—by electrolysis, that is—the substances corresponding with the two ions, or else secondary products of their change, are produced, the one substance at the cathode and the other at the anode, while the solution away from the electrodes, but between them, remains for the time unaltered in composition. Along with this there occurs in many cases a phenomenon first recorded by Daniell, and afterwards investigated by Hittorf with such beautiful results. This consists in a greater fall taking place in the concentration of the salt solution close to one electrode than in the concentration of that close to the other, as though the ions were hydrate compounds, and that the one ion was a higher hydrate than the other. Until we know more of the nature of the ions themselves this phenomenon is most conveniently quantified on the hypothesis that the ions travel as molecular particles, but the discussion of this hypothesis is beside my present purpose.

The phenomena of ionisation or, in other words, the particular properties of dilute solutions of salts, belong evidently to a change unlike all other chemical changes. It is a polarised chemical change, in which the equivalent and complementary products of the interaction appear apart and at remote surfaces of the mass of decomposing salt solution. Two points which call for notice in connection with my present subject are that an ion is one of a pair of quantities commensurate with the quantity of the salt itself that is or would be in interaction; and that it is molecular in character and therefore to be regarded as a relative and wholly variable quantity.

Dalton's atoms were both the atoms and the molecules of present-day chemistry, but much more the latter than the former. Although the chemical atom can now be no more than a dependency of the molecule, it is commonly set up as the starting-point in chemical theory, and as having an independent existence as a quantity of the substance, while the molecule is represented as being a conjugation of atoms. But there cannot be two standards in reference to the same thing, and in molecular chemistry the atom must give way. As I have already had occasion to point out, the atom is of the radical, the molecule is of the substance.

The four radicals of a double decomposition are equal and chemically complementary. These chemically equal quantities of such radicals are atoms. The quantities of all other radicals are also atoms, but only those of proximate radicals, those of a single interaction, are equal. Similarly, the quantities of the four substances of a single interaction are all equal and are molecules, but the quantities of substances are not equal in other interactions. These others are treated as the simultaneous occurrence of two or more single interactions, which they can always be represented and sometimes demonstrated to be. Calcium hydroxide and hydrogen sulphide give calcium hydrosulphide and water by two single interactions together, which in this case can be easily distinguished, since the calcium hydroxide will also interact with only half as much hydrogen sulphide to form the insoluble crystalline calcium hydroxyhydrosulphide and half as much water as before; this calcium salt will then interact with as much more hydrogen sulphide as went to form it, and produce the very soluble crystalline calcium hydrosulphide. Or the calcium hydrosulphide and as much calcium hydroxide as yielded it will readily interact to form twice as much as the first-obtained quantity of calcium hydroxyhydrosulphide. Thirdly, the calcium hydrosulphide and half as much water as was formed with it from calcium hydroxide readily interact to produce calcium hydroxyhydrosulphide, and half as much hydrogen sulphide as was needed to form the hydrosulphide. Therefore, and on other grounds, we say and know that one molecule of calcium hydroxide and two molecules of hydrogen sulphide give one molecule of calcium hydrosulphide and two molecules of water. This is, of course, only the law of multiple proportions introduced into chemical interactions. The expression "two or more molecules of a substance" has a meaning only as indicating the number of simultaneous or successive single interactions which have led to the conversion of certain substances into others.

Now a similar but complementary state of things meets us in

the case of radicals. Instead of the coefficients of molecules, necessitated by having to consider many chemical changes as being cases of two or more single interactions occurring together, there are the valency coefficients of the polyvalent radicals, called out also by such a compound interaction. Thus, in the above case, whilst the single interaction between hydrogen sulphide and calcium hydroxide shows calciumhydroxyl as one of the radicals, the succeeding interaction between the calcium hydroxyhydrosulphide and more hydrogen sulphide shows the radical calcium-hydrosulphuryl, and the common part of these two radicals is the bivalent radical, calcium. It will be evident that to give the atom of the calcium radical as bivalent is a statement reciprocal or complementary to that of giving two molecules of hydrogen sulphide as interacting with one of calcium hydroxide. Chemical equality remains still the measure of the atom, but that, in complex changes, whereas the number of molecules of one substance marks the number of single interactions, the valency number of the atom marks the same thing for the radical. It is a matter of valency, and not otherwise a matter of the atom. The radical calcium is never actively bivalent in a single interaction; in other words, it is never equal to two atoms of hydrogen. As a simple radical it does not take part in such an interaction; but it does do so as a radical of radicals, such as calciumhydroxyl and calciumhydrosulphuryl, and then has the same measure as—is equal in exchange to—the atom of hydrogen, though carrying with it of necessity other radicals, a thing the hydrogen radical never does or can do. To take another example; when acetamide is formed from acetic acid, the nitrogen of the amidogen and the oxygen of the hydroxyl are equal in exchange, but because of their valencies the one carries with it two atoms and the other one atom of hydrogen. This is no matter of merely academic contention, for upon its recognition rests the doctrine of valency itself.

The quantity of the radical is the only proper and sufficient definition of the atom, whether the radical be that of a single interaction, or a radical of radicals, that is, a polyvalent radical. The atom is, therefore, the quantified power of a substance, as the compound of the radical, to produce other compounds of the radical, including its compound with itself, where that is possible. As with the molecule of a substance, so with the atom of the radical, it is of no fixed magnitude, and may weigh a kilogram just as well as only a milligram or something much less. Being a relative quantity and nothing by itself, of its indivisibility there is nothing to be said outside its definition; whilst, as to its being the smallest relative quantity interchanging in an interaction, it had only thus to be defined when there was uncertainty as to the molecule and the single interaction.

It has been impossible for me to discuss the nature of the radical and the atom without referring to valency, but it is itself a subject of such importance as to need special consideration. It does not seem right to me to say even the little I can say about valency without naming with the respect they deserve from us the distinguished chemists who laid the foundations of the doctrine and developed it: Williamson, Odling, Wurtz, Edward Frankland and Kekulé. I had the good fortune to be in the same laboratory as, and then intimate with, Kekulé when, in 1854, he was working out the bivalency of sulphur and oxygen by his investigation of thioacetic acid, some time, that is, before he had thought out the benzene ring and the valency of carbon.

Only when, as is usual, propositions are made in which a separate and independent existence, with valency as a property, is imputed to a radical does the question, as to what valency is, present any difficulty. Approaching it from the side of the molecule and of double decomposition, and therefore from the experimental side instead of from that of the radical itself, as is customary, valency presents itself as being the number of single interactions necessary in order to have a certain radical occur, first as that of one substance, and then as that of another which has no other radical in common with the first substance. That ammonia possesses one atom of the radical nitrogen and three atoms of the radical hydrogen, and that the nitrogen radical is trivalent and the hydrogen radical univalent, are statements mutually based upon facts such as the following. Potassium nitrosulphate, which contains nitrogen but no hydrogen, is converted by water in a sharply defined single interaction, into potassium hydrogen sulphate, and into potassium imidosulphate, a substance which contains all the nitrogen along now with hydrogen. This salt passes, also sharply and by a single inter-

action with water, into as much more sulphate along now with potassium amidosulphate, which latter substance contains all the nitrogen and twice as much hydrogen as belonged to the imidosulphate. Lastly, the amidosulphate interacting with water gives a third quantity of potassium sulphate, equal to the last, and also ammonia, having all the nitrogen of the nitroso-sulphate started with, three times as much hydrogen as the imidosulphate, and nothing else. That is to say, the nitrosulphate and the ammonia have no other radical than the nitrogen the same, while three single interactions have been necessary to separate in this way the nitrogen radical from the three atoms of the potassiumsulphonyl radical. Therefore the nitrogen radical is trivalent and its quantity is the atom. Again, there are three atoms of the univalent hydrogen radical in the ammonia molecule, because in each of the three interactions an equal quantity of this radical is brought in from water. Ammonia shows only one pair of radicals, behaving, so far as its own interactions go, exclusively as a compound of amidogen and hydrogen, and these radicals are referred to as united or bound together in being ammonia. It is only the interactions of its derivatives, primary, secondary and tertiary, that are indicated by treating the amidogen as ultimately nitrogen and two hydrogen radicals. But this involves the consideration of all three hydrogens as bound to the nitrogen; and it becomes, therefore, of vital importance to bear in mind that the hydrogen radical, proper to the ammonia itself, is bound to a nitrogen radical which carries also bound to it two other hydrogen radicals.

Chemical formulæ still remain to be considered. They are symbolisations of deductions from experimentally ascertained facts, and are independent of the interpretation commonly given to them as referring to the minute differentiated structure of substances. A chemical equation expresses a chemical change quantitatively by means of chemical formulæ which are molecular. In a case of double decomposition, therefore, there are four formulæ; but when two or more such interactions are expressed in one equation, because they occur together, the formulæ of transition-substances do not appear, and then numerals before formulæ tell the number of interactions in which separate molecules of the substance have taken part. A formula represents the relative interacting quantity or molecule of a substance, while the single symbols composing it stand each for an atom of the radical of a certain simple substance as possessed by the substance formulated. The connecting lines and dots, and certain collocations of the symbols, indicate the association of the simple radicals as compound radicals in different interactions.

What is symbolised by position formulæ, and indeed by the formula altogether, are the chemical activities and abilities of the substance and its derivatives, and their analogies with those of other substances. When not in interaction, a substance has no constitution and no formula. It is certainly not on any experimental grounds that it can be regarded as some spatial arrangement of unlike parts. To take the simplest case; if we start with sodium hydroxide and symbolise its molecule by some mark, such as X to begin with, the interaction of the substance with an acid leads us to replace the X by two symbols and a connecting mark. One of these will be Na for the sodium radical; let the second be Z for the other radical, and let a dot or stroke be placed between the symbols to mark them as those of a pair of radicals in interaction. In other interactions, such as that with melted potassium acetate, we find need for a new pair of symbols, one being H for the hydrogen radical, while the other may be Q. But it is easy to decompose two molecules of sodium hydroxide in one operation into molecules of sodium, hydrogen and oxygen, from which fact we learn that Z is replaceable by the double symbol O-H, and Q by O-Na. Thus, Na-Z and H-Q became equally Na-O-H, which records the ultimate radicals of sodium hydroxide, together with all its interactions, immediate and remote. But it does this with no more implication of spatially placed and tied parts than is made by expressing the measured flow of time by a straight line, or than is to be found in t^2 seconds of time, or in t^3 as the third power of a number, unless we specifically condition this symbol as stereometric. A formula is not to be read—on experimental grounds, I mean—as a symbol of parts juxtaposed and joined on, and should be regarded as an intricate but legible monogram telling the chemical nature of the substance. Every symbol in it is to call to mind a phase of the chemical activity of the substance or of its derivatives, a phase that may be for the time as the

substance itself to the investigator, just as a pigment substance becomes only a red or a white to the painter. For example, salt is often nothing more than its chlorine phase to the chemist when he wants only a soluble chloride; whether it is of potassium, sodium or ammonium, then, matters not to him.

The double linking of the carbons in ethylene is a symbolised expression of facts without reference to hypothesis. The two carbon radicals of ethane or of alcohol behave together just as does the single carbon of methane or the nitrogen of ammonia in being, but with a valency of six, continued to other compounds devoid of all the other radicals of the ethane or alcohol—that is, of the hydroxyl and the hydrogens. The quadrivalency of each carbon is made up by the interaction necessary to dissociate or to bring together the two methyls, which counts as a unit of valency to each carbon. Ethyl hydrogen sulphate decomposes into sulphuric acid and ethylene, the hydrogen-sulphate radical with a hydrogen radical becomes the acid as the one product, while the methylene radicals again pair off as the two methyls had done when ethane was formed, thus producing the non-saturated substance, ethylene. Since there is a perchlorethylene, the second linking mark falls between the two carbons; and when ethylene passes back to an ethane compound two units of valency are displayed by it without the carbons becoming dissociated.

Position formulæ of isomerides, such as those of propyl alcohol and acetone, present no difficulty, because they are interpreted as the expressions of unlike double decompositions. It is not unfrequently the case that no constitutional or structural formula can be given to a substance which shall express all the pairs of radicals possible in its interactions, of which the best-studied example is that of ethyl acetoacetate. This state of things, known as tautomerism, admits of no other interpretation than that there are really two substances existent, of which one only is known, the other or so-called "pseudoform" requiring the assumption of its existence as a transition-substance only. The notion of the shifting hydrogen radical is but the hypothetical way of viewing the intervention of the intramolecular change by which the substance becomes its "pseudoform."

The cyclic formula of benzene expresses the fact that, unlike a fatty hydrocarbon, benzene shows but one pair of interaction radicals, hydrogen and phenyl. The "ortho-" "meta-" and "para-" positions in benzene derivatives are only expressions of facts of "position" isomerism, such as those pertaining to other non-saturated compounds, but more complex to unravel and more varied and interesting. It is doubtful whether the Kekulé ring does not remain as efficient a symbol as any stereographic substitute yet proposed for it; but it itself is purely a symbol of chemical interactions, and has no spatial significance other than what may be put into it by convention. "Adjacent," "opposite" and the like have only application literally to the arrangement of the symbols; but if the symbolisation is perfect the "opposite" carbons will, as a matter of course, always indicate the same point concerning the chemical interactions.

Whether the chemical formulæ for the lactic acids are better arranged in a plane or as a tetrahedron is to be decided by the facts concerning these and other asymmetric carbon compounds, the object being to symbolise or formulate as distinct and complementary in certain physical properties, but alike in their chemical interactions, two isomeric substances, simultaneously formed in molecular quantities. Enantiomorphous arrangements of the respective formulæ of dextro- and levo-lactic acids fully meet the case, but the facts are in no way explained by these formulæ. In the enantiomorphously related hemihedral crystals of the corresponding salts of the dextro- and levo-acids, and in their opposite rotatory effect in solution upon the plane of polarised light, we recognise something like a torsioned state of the whole homogeneous substance, something to be accounted for by peculiarity of chemical origin, but not something made more intelligible by any imagined arrangement of unlike parts. It is possible to give an account of the chemical facts without making reference to mechanical structure, and then to reason about them somewhat in the following way: Given the case of a substance doubly equipped with the power to take part in a certain interaction, and considering that the exercise of the power can only be single, and that it cannot be made without affecting and transforming, or perhaps nullifying, the second equipment with power, predict what will happen. That is the prediction called for concerning any interaction which generates an asymmetric carbon compound. The result could never have been predicted; yet how natural and beautiful it is when it comes to us through

experiment enlightened by the genius of Pasteur, Le Bel and Van 't Hoff! That answer is that a twinned substance [results, one indeed in most respects and chemically, but two in certain physical properties, characterised by presenting phenomena as of equal and opposite strains, a polarised pair of substances, in fact. What I mean by the double equipment with power is, of course, the pair of identically related and self-identical radicals, or the bivalency of one radical wholly and directly associated with the carbon radical. The case of the oxygen radical of aldehyde is that of the bivalent radical; the other case is that of the two carboxyl radicals of hydroxytartronic acid, or that of the two methylene hydrogen radicals of alcohol which these carboxyls have replaced. The tetrahedral formula with its reflected form admirably symbolises the case of enantiomorphously related pairs of substances. But no light whatever is thrown upon the nature of this pairing by the tetrahedron model; its value depends upon the fact that as a symbol it so fully matches the constitution of the substances.

Here I bring my summary of chemical theory and its formulation without hypothesis to a conclusion, hoping that, to some extent, I may have impressed you with the fact that the exposition of even advanced chemistry, in its symbolic, equally as in its ordinary language and nomenclature, is independent of any hypothesis as to the mechanically and chemically differentiated structure of substances, and that chemistry can be studied and still further developed without reference to such a structure. I have asked for few or no reforms in the use of either terms or symbols, my point having been only to press for a consideration and discussion of the doctrines of chemistry and the great atomic theory itself as something concerned exclusively with experimental chemical facts.

SECTION C.

GEOLOGY.

OPENING ADDRESS BY LIEUT.-GENERAL CHARLES ALEXANDER McMAHON, F.R.S., F.G.S., PRESIDENT OF THE SECTION.

Rock Metamorphism.

I WISH to offer some observations to-day on some aspects of rock metamorphism; and as this is a complex subject, and the time at my disposal is brief, I purpose to deal with it in simple language, and to avoid as far as possible all petrological technicalities.

A short description of a granite in the Satlej Valley of the Himalayas will, I think, introduce us by a short cut to the consideration of "contact metamorphism," an important branch of the subject under consideration.

The granite I allude to is an intruder in the normal gneissose-granite of the Himalayas, and cuts through it at right angles to its foliation.

The intruder, which is some yards wide, did not rise through a simple crack or fissure, for its passage upwards was interrupted by a sheet of dark intrusive diorite, older than itself, which ran, roughly speaking, parallel to the foliation of the gneissose-granite.

This sheet of diorite offered considerable resistance to the rising granite.

The granite zigzagged backwards and forwards across the diorite and ran along its edges for fifty yards or more, converting it into a mica trap.

It then rose itself away and continued its upward course. The granite I am describing was in a molten or fluid condition at the time of its eruption, as I hope to show in my subsequent remarks.

I may pause here, however, to consider in passing what was the probable temperature reached by a granite such as that above described.

The question is one of very great difficulty, as we know so little about the plutonic conditions of igneous rocks, and can only arrive at an answer to our question by indirect evidence.

The melting point of quartz ranges from 1425° to 1450° C., but the fusion point of granite need not necessarily be as high as this, inasmuch as the presence of water at high temperature materially lowers the melting or solution point.

The fusion point of the other constituents of granite may here be mentioned: that of orthoclase ranges from 1164° to 1168°; microcline, 1169°; albite, 1172°; augite and hornblende, 1188° to 1200°; apatite, 1221°. Zircon, which is commonly found in

granites, and is one of the first minerals to separate out of the magma, is shown by Ralph Cusack to have probably a melting point of 1760°; whilst topaz, a not uncommon mineral in granite, is infusible up to the melting point of platinum, namely, 1770° C.

If we consider, therefore, the melting points of the mineral constituents of granite, we can hardly avoid the conclusion that for the magma to have attained perfect fluidity it must have reached a temperature of at least 1200° C.

Vernadsky has shown that kyanite is transformed into sillimanite, a well-known product of contact-metamorphism at a temperature of 1320° to 1380°.

If rocks in contact with granitic masses have been raised to this temperature, it follows that the granite itself must have been still more heated. Vernadsky's observations have been relied on by Mr. George Barrow in his well-known paper "On an Intrusion of Muscovite-biotite Gneiss" in the S.E. Highlands of Scotland to account for the presence of sillimanite in the inner zone of metamorphism between the kyanite schists and the granite, and he considered that the temperature attained by the "central masses of the Highland rocks" was probably higher than the figures indicated by Vernadsky.

Bearing all considerations in mind, including the influence of water and alkali in reducing, and of pressure in raising, the melting point, I think we may safely infer that granites, such as the Himalayan granite alluded to above, must have been raised at plutonic depth to a temperature midway between red and white heat, that is to say, to at least 1200° C.

To return to the granite of the Satlej Valley under consideration, I wish to draw attention to its condition just before crystallisation commenced.

A study of the mineral beryl will, it seems to me, throw light on this point.

Beryl is an important accessory mineral of the granite under description. It is clearly an original mineral, and it is material to note that it was the first mineral to crystallise out of the magma of the Satlej granite. This is shown by several circumstances.

In the first place the beryl preserved its perfect crystallographic shape, showing that its molecules during the entire period of crystallisation possessed comparative freedom of motion, and were not interfered with or molested by other solid minerals. In the second place all the essential minerals of the granite when they subsequently crystallised out of the magma were deposited on the crystals of beryl. I have specimens of the granite showing crystals of beryl enclosed in feldspar, in muscovite and in quartz.

The beryl, therefore, having been the first mineral to crystallise, the examination of thin slices of it under the microscope ought to give us a clue to the condition of the magma at the time the beryl was formed.

I have made such an examination, and I find that the beryl is crowded with liquid and gas cavities, the former containing movable bubbles and deposited crystals as well as water.

The bubbles are of substantial size relative to the area of the cavities, showing that the water suffered considerable contraction after it was sealed up in the beryl.

Scrope long ago suggested that the fluidity of lavas below the melting point was due chiefly to the water they contained, and attributed the liquidity of granite to the same cause.

Scrope, however, in ascribing the mobility of an igneous rock to the presence of water, seems to have had regard principally or wholly to its mechanical action in furnishing an elastic medium in the interstices between the crystals or grains of the rock. He observes that a lava consists "of more or less granular or crystalline matter, containing minute quantities of either red-hot water, or steam in a state of extreme condensation, and consequent tension, disseminated interstitially among the crystals or granules, so as to communicate a certain mobility to them, and an imperfect liquidity to the compound itself," and he quotes Scheerer and Delesse, both of whom assert that water exists in mechanical combination with all crystalline rocks, "its minute molecules being intercalated between the crystals."

Nowadays one would attribute the liquidity of an igneous rock not so much to the mechanical action of the water present in it as to the combination of the water with the mineral contents of the lava, producing a state of solution.

Sorby's investigations supported Scrope's observations, for he proved that the liquid contained in the inclusions in granite is

water, and showed that it was caught up during the formation of the crystals, "and was not introduced subsequent to the consolidation of the rock."

The water now contained in cavities in the beryl was probably held in solution by the constituents of that mineral at the time of its formation, and as it cooled down the water separated from the substance of the beryl and formed the cavities in which we now find it imprisoned.

If this be so, it follows that when the beryl crystallised out of the magma, the latter was in a fluid condition, and held a considerable amount of heated water in solution. The temperature of the magma must have been above that of red heat, and the potential energy of the water held in a fluid state by pressure must have been great. When therefore in the course of the earth movements which accompany or in some cases are caused by the intrusion of eruptive igneous masses, pressure was temporarily relieved by the rupture and faulting of rocks, the superheated water contained in the magma would be ready to flash into steam with almost explosive violence.

It must also be borne in mind that water under great pressure, at or above a red heat, has a powerfully solvent action on most minerals, even on so refractory a mineral as quartz. When therefore granite in the molten and fluid condition of the Satej granite was erupted along a line of faulting, fissure, or weakness, the superheated water or steam, bearing with it much mineral matter in solution, must have acted with great chemical energy on the rocks into which it was intruded.

I have spoken of water carrying mineral matter in solution, and of a magma carrying water in solution. These two conditions may rapidly succeed each other under varying conditions of temperature and pressure. To use the words of Van Hise, "under sufficient pressure and at a high temperature there are all gradations between heated waters containing mineral material in solution and a magma containing water in solution."

The condition of the beryl crystals, crowded as they are with liquid cavities, shows how high a proportion of superheated water was contained in the fluid granite magma at the time of their formation.

Sorby estimated that the fluid cavities in the quartz of granites sometimes amount to more than ten thousand millions to the cubic inch. As quartz, however, is usually the last mineral of a granite to consolidate, it may be thought that the water contained in it is a residuum left by the feldspar and muscovite on their separation from the magma; but the case of the beryl above quoted shows clearly that the amount of water diffused through the magma before the mica, feldspar and quartz began to consolidate must have been very considerable. The amount of water held in solution by a granite, during the time of its aqueo-igneous fusion, cannot be estimated by the amount of water given in the analysis of consolidated and dried hand-specimens of that rock. A considerable proportion of this liquid must necessarily have been lost during the gradual cooling of the rock, and in the course of its intrusion into neighbouring sedimentary strata as sheets, dykes and veins. Sorby, as the result of other lines of investigation, came to the conclusion that the amount of water present in granite, though limited, is considerable.

We must now turn for a few minutes to consider the important question of the porosity of minerals, and their permeability by heated water and gas at high pressure.

The fact that solid substances are built up of molecules having interstitial spaces between them hardly needs demonstration nowadays.

But have we all quite realised that the molecules of rock-forming minerals and crystals are not inert particles of matter, but that they vibrate or revolve or are endowed with other orderly movement that may be likened to the motion of the planets round the sun?

Far, far away in space the solar system would, to an eye formed like our own, in all probability present a nebulous appearance, because the eye would not be able to see the individual members of our system.

So, too, the molecules of which crystals are built up may have their appropriate motions, but we cannot see them with the eyes of sense because the molecules are beyond the highest powers of the microscope.

We can, however, I think, perceive them with the eye of the scientific imagination; and the hypothesis that the molecules of minerals are separated from each other by intermolecular spaces,

and have their modes of motion, seems essential to the comprehension of rock metamorphism.

The important experiments of Sir W. Roberts-Austen on the diffusion of gold in pure lead throw considerable light on this subject.

Disks of solid gold were held against the bases of cylinders of lead by clamps, and were kept in an upright position at the ordinary temperature for four years. At the end of this time it was found that the gold had diffused upwards in the solid lead, for a distance of 7.65 mm., in sufficient quantity to be detected by the ordinary methods adopted by assayers. Traces of gold were found still higher.

When a column of molten lead, 16 cm. high, was placed above solid gold and kept at a mean temperature of 492° C., that is to say, at 166° above the melting point of lead, but 569.7° below that of gold, the gold diffused in considerable amount to the top of the lead column, in a single day.

Sir W. Roberts-Austen's experiments, above alluded to, demonstrate that even such metals as gold, whose melting point is as high as 1061.7° C., exhibit a measurable amount of kinetic energy at the ordinary temperature and pressure. Great results may no doubt be brought about at ordinary temperatures and pressures, when time, as in the laboratory of nature, is practically unlimited; nevertheless the importance of high temperature and high pressure, in operations connected with metamorphism, can hardly be overrated.

Not only does a rise in temperature increase the energy of the chemical actions and reactions which produce the mineralogical changes embraced by the term metamorphism, but it increases the porosity of minerals and facilitates the passage of liquids and gases through their pores.

The cohesion of molecules is lessened, the amplitudes of their vibrations, rotatory or other movements, are increased, and a passage is opened for the advance of chemical materials into the heart of the crystal.

Increase of temperature thus not only throws open the doors of the mineral fortress attacked, but gives enhanced energy to the invaders. The fact that the mineral components of a rock are, under conditions of heat and pressure practically porous to heated water, laden with chemical reagents in solution, is frequently brought home to the mind of the petrologist in a very tangible way. We sometimes observe, for instance, that metamorphic changes begin at the heart of a crystal, and leave the peripheral portions of it fresh and unaltered.

In such cases the chemical agents of change have evidently passed freely through the outer parts of the crystal, and have by preference selected its internal parts for attack.

In order to explain clearly how this remarkable result takes place, in the cases referred to, it will be necessary to diverge for a few minutes to consider another branch of our subject. It is difficult, if not impossible, to lay down any hard-and-fast rule of universal application, because the conditions under which igneous rocks crystallise vary with temperature, pressure, the relative proportion of constituents and other local causes, and these variations in the conditions may materially affect the results; but I think the rule that minerals crystallise out of a molten magma in the order of their basicity is of very frequent if not of absolutely general application. This rule also governs the growth of individual crystals, especially those that exhibit what is known as zonal structure. Take, for instance, the felspars of an igneous rock. A gradual passage may frequently be traced by the petrologist from one species of feldspar at the heart of a crystal to another distinct species at its periphery. Sometimes a crystal is made up of more than two species, which shade more or less gradually into each other. In accordance with the rule laid down above, the more basic species formed first; then, as the percentage of the bases left in the magma gradually decreased, owing to the first formed crystals having taken a lion's share of the available bases, the felspars that formed later became gradually more and more acid in composition. Thus a large feldspar of slow and gradual growth may be composed of several zones, each zone being successively less basic and more acid than that upon which it crystallised, each successive zone thus possessing slightly different physical properties from the one that formed before it. These statements are capable of proof. When sections of feldspar, such as occur in thin slices of igneous rock, are examined under the microscope in polarised light, petrologists can distinguish one species from the other—when the direction in which the sections were cut is approximately known

—by measuring the angles at which they extinguish from the twinning or the pinacoidal plane.

This is not mere theory. Each species of feldspar has its own angle of extinction and its own index of refraction. The determination of these two factors enables a petrologist to prove optically the change in composition; or, in other words, the change in species which has taken place in the successive zones, during the gradual growth of a large zonal feldspar.

Another general rule must now be mentioned. I think it may safely be asserted as a broad rule that the different species of feldspars are attackable by the chemical reagents which make themselves felt in metamorphic action, in the order of their basicity; that is to say, the more basic feldspars are more easily attacked than the acid ones. When we bear in mind the facts stated above, we shall, I think, be able to see clearly how it is that the peripheral portions of large feldspars in igneous rocks sometimes escape alteration, whilst the cores of these crystals are converted into secondary minerals, such as chlorite, silvery mica, zoisite, epidote, kaolin, steatite, saussurite, calcite and scapolite.

The chemical reagents flowing in solution through the pores of the feldspars, pass by the more acid and refractory species and devote their energies to the more susceptible basic species embedded at the heart of the zonal crystals.

The point I wish to enforce most strongly is that the phenomenon above described, namely, the formation of secondary metamorphic minerals in the interior of a crystal, combined with the comparative immunity to change of the external portions, shows that the agents which brought about chemical changes at the core of the crystal flowed freely through its unaltered peripheral portions.

But some may ask whether the chemical agents referred to may not have gained access to the heart of a crystal by a crack. I answer that a crack is a coarse and tangible object that looms large under the microscope. A crack in a mineral liable to metamorphic action, through which chemical reagents have flowed, could not escape detection. The finest crack through a homogeneous mineral, such as, for instance, an olivine, can be readily seen, not only by the small canal worn by the corrosive action of the chemical agents that flowed through it, but by the alteration set up in the mineral along the whole course of the canal.

I have a thin slice from a beautifully fresh olivine contained in one of the lavas of Vesuvius collected by myself. A volcanic explosion or other cause, operating after the crystallisation of the olivine, produced a very fine crack in the mineral through which water, charged with chemical reagents, subsequently flowed. The crack, though of microscopic width, is filled with serpentine, and on both margins fibrous serpentine has been formed at the expense of the parent olivine, and constitutes a fibrous band on both sides of the crack throughout its entire length, the direction of the fibres being at right angles to the crack.

The rest of the olivine is of virgin purity and polarises in the most brilliant colours, contrasting strongly with the serpentine.

In this case it is clear that the chemical reagents, through free to flow along the crack, had commenced to extend beyond its walls, encouraged thereto by the porosity of the olivine itself.

But how different is this case from those in which the entrance of the chemical agents had not been facilitated by a crack. In the case above described, the chemical changes set up were limited to the borders of the crack, and even had they gradually extended in the course of time to the whole of the olivine, the original canal by which the chemical reagents had gained access to the crystal would have remained to tell its tale, and exhibit along its course the banks of iron oxide thrown down by the chemical navies that had excavated it.

Cracks save time as roads and canals do, but they leave behind them evidence of their former existence. In order to understand fully how rocks and minerals are so completely open to the attacks of chemical reagents, which penetrate to and produce chemical and mineralogical changes at the very hearts of minerals, we must fully realise how completely porous rocks and minerals are, to the heated liquids which carry these reagents with them in solution. Heat, as before stated, not only increases chemical energy, but destroys more or less completely the cohesion between molecules, and increases the amplitude of the vibrations, or other motions of the molecules, and consequently facilitates the entrance of liquids and gases into the pores of minerals, and their complete permeation by these powerful agents of change. Thus far we have been

chiefly concerned with some of the principles underlying the branch of our subject embraced by the term contact metamorphism, which implies operations conducted at considerable depths below the surface of the ground, under conditions of heat and pressure.

We must now consider very briefly changes produced at or near the surface by the agency of water, or, as Bischof in his well-known work termed it, metamorphism in the "wet way."

No hard-and-fast line, however, can be drawn between the two classes of operations, as the one gradually shades by fine gradations into the other. At one end of the scale we have high pressure and high temperature, and a fluid igneous magma holding water in solution, above a red heat, and giving up heated water or vapour charged with salts to the rocks in contact with it.

Passing to the other end of the scale through diminishing temperatures and pressures, we reach a condition in which the water circulating through the rocks at ordinary pressure and temperature is more abundant in amount, and holds acids and salts in solution, capable of setting up important chemical reactions in the rocks and minerals to which it gains access.

In the case of surface operations, moreover, the metamorphic agents—water, acids, salts—are being constantly renewed. Conditions differing as widely as the conditions at the extreme ends of our scale do not yield, however, precisely the same results. In both metamorphic change goes on with more or less briskness, but the products are different. Some minerals require great heat and great pressure for their production, and such minerals are never formed by any surface process of weathering. For instance, the temperature reached determines whether titanium dioxide crystallises as rutile, or in one of its other two forms, rutile requiring a temperature of more than 1000° C., and being the only form of titanium dioxide "stable at a high temperature."

Temperature also seems to determine whether the silicate of alumina crystallises as andalusite, kyanite or sillimanite, the two former being transformed into the latter, at a temperature of 1320° C. to 1380° C.

On the other hand, some minerals require little heat for their formation, and are readily produced by metamorphic changes in the "wet way."

There seems to be some correspondence between the melting point of minerals and their density; thus in the case of eleven minerals produced by contact metamorphism, whose average specific gravity ranges from 3.06 to 4.03, I find that their melting point ranges from 954° to above 1770° C., high temperature and high pressure (a concomitant of plutonic conditions) appearing to be factors in the production of high specific gravity in minerals.

The genesis of individual species of minerals is a fascinating study, but the subject is too large to enter upon here.

Water gains access to rocks in several ways. It falls as rain; it rises from hidden depths; it leaks from the sea into horizontal beds or into strata dipping away from it; and it penetrates through faults and fissures. Rain in its descent takes up from the air oxygen, nitrogen, carbonic acid, and in some cases small amounts of nitric acid.

It is thus in itself a powerful solvent and potent agent in producing chemical change.

In its passage through the surface soil it dissolves humic and other organic acids, the products of vegetable decay, which add greatly to its solvent power and enable it to break up many silicates and to dissolve even silica.

By the time the rain-water reaches the solid rocks below the surface soil, it has become a very active agent in producing chemical change in them. It is by such agents, persistently applied during long periods of time, that large areas of ultra-basic igneous rocks have been altered into serpentine.

Hot springs are a well-known instance of water rising in considerable quantity from plutonic depths. They are known to occur in the plains of India, and are especially abundant in the Himalayas. I visited two very interesting ones at Suni, in the bed of the Satlej River, west of Simla. These springs rise apparently under the very bed of the river, and come to the surface on both banks within a yard or two of the rushing water of the Satlej. When I visited the springs they had a temperature of 130° F., and contrasted strongly with the cold water of the river flowing past them, which had descended from high Himalayan glaciers and had a temperature of 49° F.

The native inhabitants of neighbouring villages told me that

the hot springs always appear at the very edge of the river, whatever may be the height of its waters during drought or flood. The statement is probably true, for I think the springs well up from below through the walls of a fault that traverses the bed of the Satlej at a high angle to its course, and the springs thus come to the surface on both its banks.

The metamorphic influence of these springs on the rocks in this locality has been very powerful. The ancient volcanic rocks there exposed have, for some distance up the river, been altered by aqueous agents almost out of recognition. The original structural characters of these lavas have been almost completely broken down and an amorphous substance substituted for the crystals and minerals of which they were originally composed.

This result shows that the crystals and minerals of these old lavas must, for all practical purposes, have been completely porous to the aqueous agents brought to bear on them.

The general transmutation of one mineral into another by the action of heated water holding mineral agents in solution, aided by heat and pressure, may take place in a variety of ways. Some of these processes are simple, but others are highly complex. Many are the results of a single operation, others of a series of changes, some of which prepare the way for those that follow.

In some cases the change may be brought about by the removal, in whole or in part, of one or more of the essential constituents of a mineral, whereby the relative proportions and mutual relations of those that remain are altered, as the following examples will show.

By loss of water limonite passes into hæmatite, and opal into crystalline quartz. Dyscrasite, by loss of antimony, passes into native silver, and pyroxene, by the removal of its lime and iron, is changed into talc. Simple oxidation or the absorption of oxygen by a mineral is responsible for another class of changes, as in the conversion of zinc blende into goslarite, and antimony into valentinite.

The loss of one or more of the ingredients, concurrently with the introduction of one or more new ones, causes many metamorphic changes, as in the conversion of marcasite into magnetite, of witherite into barite, and of azurite into malachite.

The well-known conversion of a peridotite into serpentine is a case in point. Here, part of the iron and magnesia is removed from the olivine, and water is introduced. A simple process like this, brought about by the percolation of surface waters through an igneous rock, is sufficient to transform considerable areas of rock masses into serpentine, as has been the case in parts of Cornwall.

Some metamorphic processes are more complex than those alluded to above, but Nature has unlimited time at her disposal, and is able to manufacture potent chemical reagents as her processes proceed. For instance, the sulphides of various metals of common occurrence in rocks, most of which, with the exception of those of the alkaline metals, are insoluble in water, by taking up oxygen pass into sulphates, most of which are soluble in that liquid at the ordinary temperature.

These sulphates are readily carried away in solution, and become potent factors of change in rocks through which water charged with these salts flows. Again, carbon dioxide, so abundant in percolating water, decomposes minerals containing lime or alkali, and removes them as soluble carbonates to effect powerful chemical reactions elsewhere.

I must pass over the subjects of paramorphism and pseudo-morphism, as the limited time at my disposal does not permit me to enter upon these subjects.

In the above sketch I have contented myself with a brief discussion of some of the leading principles that seem to me to underlie contact action and metamorphism in the wet way, because I venture to think that, if we really understand these two divisions of our inquiry, it will be unnecessary on the present occasion to enlarge on other branches of our subject.

Take, for instance, what is commonly called dynamic metamorphism. The main factors in this kind of metamorphism are the folding, crumpling, crushing and shearing of rocks by earth movements, especially during the upheaval of mountains.

But these dynamic forces are potent factors in the development of heat.

In the case, therefore, of dynamic metamorphism, as in contact metamorphism, pressure and heat are the main factors acting in conjunction with the water shut up in or circulating

through a rock. If we understand how these factors operate and produce the results we see in cases of contact metamorphism, we shall not fail to understand their action in a case of dynamic metamorphism.

These observations also apply to regional metamorphism; that is to say, to metamorphism produced in rocks at great depth, by being brought within the influence of the interior heat of the earth. The action of heat in increasing molecular motion and kinetic energy is well understood nowadays, and so long as we get heat it seems to me immaterial how heat is generated in rocks subject to metamorphic action.

In the above sketch I have intentionally omitted to enter into the details of chemical and mineralogical action that have brought about individual cases of metamorphic change.

Volumes would be required to do justice to so complex a subject, and the details would, in an opening Address, be out of place.

In conclusion I have, I trust, shown how important a part water plays as an agent of metamorphism, not only at and near the surface of the earth, but at plutonic depths. We have seen that the molten granite of the Satlej Valley, which was given as an illustration of a fluid igneous magma, contained a considerable proportion of water held in solution at considerably above red heat, and that the fluidity of the magma was due to its presence. We also saw that the great heat to which the magma was raised increased the potential energy of the contained water when a relief of pressure opened the way for the intrusion of the molten magma into neighbouring rocks. We also saw that this water was rendered by heat a powerful solvent, and that it carried with it into the adjoining rocks the mineral matter of the granite in solution. We also saw that heat increased the porosity of minerals, facilitated the passage of liquids laden with mineral matter through their pores, and increased the potency of chemical action.

SECTION F.

ECONOMIC SCIENCE AND STATISTICS.

OPENING ADDRESS BY EDWIN CANNAN, M.A., LL.D.,
PRESIDENT OF THE SECTION.

If it happened every year that the President of this Section undertook to justify his own existence, I am afraid the Section would become weary. But my four distinguished predecessors have all been drawn from the Civil Service, and though each of us may have doubts about particular branches of the Civil Service, we are mostly willing to allow that as a whole it is at least a necessary evil, so that we do not get apologies from the Presidents who, so to speak, represent the practice of political economy. I hope, therefore, that you will bear with me if I offer some reasons for thinking that the teaching and study of the theory of economics is not, as many people seem to suppose, a wholly unnecessary evil, but, on the contrary, a thing of very great practical utility.

I do not mean to argue that a knowledge of economic theory will enable a man to conduct his private business with success. Doubtless many of the particular subjects of study which come under the head of economics are useful in the conduct of business, but I doubt if economic theory itself is. It does not indeed in any way disable a man from successful conduct of business; I have never met a decent economist who was in a position of pecuniary embarrassment, and many good economists have died wealthy. But economic theory does not tell a man the exact moment to leave off the production of one thing and begin that of another; it does not tell him the precise moment when prices have reached the bottom or the top. It is, perhaps, rather likely to make him expect the inevitable to arrive far sooner than it actually does, and to make him underrate, not the foresight, but the want of foresight of the rest of the world.

The practical usefulness of economic theory is not in private business, but in politics, and I for one regret the disappearance of the old-name "political economy," in which that truth was recognised.

One of the commonest complaints of the time is that there is no text-book of economics which commands any really wide approval, and you may therefore, I think, fairly ask me to explain what I mean by the teaching and study of economic theory before I undertake to prove its practical usefulness in the discussion of legislative and administrative measures. I will

therefore endeavour to sketch as shortly as possible the course of instruction which the modern teacher of economic theory, if unhampered by too close adherence to traditional standards, puts before those who come to him for instruction.

The first, or almost the first, thing he will do is to try to open the eyes of his pupils to the wonderful way in which the people of the whole civilised world now cooperate in the production of wealth. He may perhaps read them Adam Smith's famous description of the making of the labourer's coat, a description which required three generations and three great writers to elaborate in the form in which we know it. Or he will ask them to consider the daily feeding of London. There are, he will point out, six millions of people in and about London, so closely packed together that they cannot grow anything for their own consumption, and yet every morning their food arrives with unflinching regularity, so that all but an infinitesimal fraction of them would be extremely surprised if they did not find their breakfast ready to hand. To prepare it they use coal which has been dug from great depths hundreds of miles away in the Midlands or Durham; in consuming it they eat and drink products which have come from Wiltshire, Jamaica, Dakota, India, or China, with no more thought than an infant consuming its mother's milk. It is clear that there is in existence some machinery, some organisation for production which, in spite of occasional failures here and there, does its work on the whole with extraordinary success. It is easy to be pessimistic, especially when the weather is damp, and we are apt to concentrate our attention, and to endeavour to make others concentrate their attention, on this or that defect, and to forget that the system is not made up of defects, but on the whole works very well. Imagine the report of a really outside observer. In all civilised planets, I have no doubt, there must be an institution more or less resembling the British Association. An economist in Mars, let us say, has been favoured with a glimpse of this island through a new mammoth telescope of sufficient power to let him see us walking about, and he is reporting to Section F what he saw. Will he say that he saw a confused scramble for the scanty natural products of the earth? That most people were obviously in a state of starvation? That few had clothes? And that scarcely any were housed? No, truly; he will be much more likely to report that he saw a wonderfully orderly population, going to and from its work with amazing regularity, without a sign of compulsion or unwillingness; that it appeared to be fed and clothed and housed in a way extraordinarily creditable on the whole to some mysterious organisation, the nature of which he could only guess at.

Having endeavoured to make his pupils recognise that we are organised, and that the organisation works, the teacher will go on to show how it works; why things that are wanted are produced in the places where they can be easiest produced and taken to the places where it is most convenient to consume them; why people go to live in large numbers in spots where it is desirable they should work, and leave great areas sparsely inhabited; why more people are brought up to follow an occupation when the desire for its products increases, and fewer when it decreases; why if the harvest is short the consumption is economised so as to spread it over the year; and so on. The answer to all these questions is of course "self-interest" or "the hope of gain." Durham coal, Wiltshire milk, Danish butter, Jamaica sugar, Dakota wheat and China tea go to London because it pays to send them there. People congregate in London or Belfast because it pays them to work there. More do not come because it would not pay them. Young people leave agriculture and go to towns to make agricultural implements or bicycles because it pays. The consumption of grain is economised and spread over the year because it pays to hold the stock. If people with one accord left off doing what paid we should all be dead in two months.

The reasons why it pays to do the right thing—to do nearly what an omniscient and omnipotent benevolent Inca would order to be done—are to be looked for in the laws of value. This used to be regarded as a somewhat arid subject, but the discussions of recent years, especially the contribution made by Jevons and the Austrian school, have fertilised it. Long ago economists pointed out how the much-abused corn-dealer who held out for a higher price saved the people from starvation; and we now, thanks to the theory of final utility, not only know that it is a fact, but also why it is a fact, that value rises with the extent and urgency of demand, so that when a thing is much wanted, much is offered to those who produce it, or are ready

to part with it, and consequently its production is stimulated or its consumption economised, as need be.

This will naturally lead to the question of distribution—the question, that is, why much of the produce falls to the share of one individual and little to that of another; why, in a word, some are rich and others poor. The teacher will here explain that the share of each person depends on the amount and value of his contribution to production, whether that contribution be labour or the use of property. He will show how this system of distribution is essential to the existing system of production, where no man is compelled to work or to allow his property to be used by others, and where every man has legal freedom to choose his own occupation and the uses to which he will put his property. He will beware of claiming for it that it is just in the sense in which justice is understood in the nurseries where jam is given when the children are good. There is, he will explain, no claim on behalf of the system that it rewards moral excellence, but only that it rewards economic service. There is no claim that economic service is meritorious. Whether a man can and does perform valuable economic service does not by any means depend entirely on his own volition. His valuable property may have come to him by bequest or inheritance; his incapacity to do any but the least valuable work may be the result of conditions over which he has had no control. The system exists, not because it is just, or to reward merit, but because it is inextricably mixed up with the system of production. It has one great evil—its inequality. Moralists and statesmen have long seen the evils of great inequality of wealth, and now, thanks to modern discoveries in economic theory, the economist is able to explain that it is wasteful, that it makes a given amount of produce less useful, because each successive increment of expenditure yields, as a rule, less enjoyment to the spender. The teacher will go on to show how this organisation of production and distribution is made possible by the order enforced by Government, and how, in various ways, Government supplements or modifies it; but I shall not enlarge upon this part of the teaching of economics, as its practical usefulness is obvious. My theme is the usefulness of the other part, the explanation of the organisation of production and distribution in so far as it depends on separate property, free labour, and the consequent action of self-interest.

In the first place, I maintain that the widespread dissemination of such teaching would help to do away with a vast amount of most disastrous obstruction of necessary and desirable changes. Take, for example, the obstruction offered to changes in international trade. Of course every conceivable argument has been used by different writers in wholly different circumstances for obstructing the cooperation of mankind in production, as soon as it oversteps a national boundary. But what is the real support of this kind of obstruction? Obviously the fact that certain producers, or owners of certain means of production, are damaged by an increase in the importation of a particular article. Their loss, their suffering, if their loss is severe enough to deserve that name, appeals to popular compassion, and their request for "protection" is easily granted, the new trade is nipped in the bud, and things are forced to remain in their accustomed channels. The same principle is not applied as between county and county or between province and province, simply because there is then visible to everyone an opposing interest, the interest of the new producers, within the hallowed pale of the national boundary. Adam Smith tells us that when the great roads into London were improved, some of the landlords in the home counties protested on the ground that the competition of the more distant counties would reduce their rent. The home counties did not get the protection they wanted, because it was obviously to the interest of the more distant counties that they should not have it. These two interests being balanced, the interest of the consumer, London, turned the scale. So it usually happens that beneficial changes in internal trade are allowed to take their course without obstruction because the votes of two sets of producers counteract each other, and the consumer's interest settles the question. But in international trade one of the two sets of producers is outside the country; it consists of hated foreigners, the fact that it will benefit is an argument against rather than for the threatened change in trade, and the consumers therefore feel it patriotic to sacrifice their own interest and vote for protection. But if they were properly instructed in economic theory they would see at once that such unanimity is entirely misplaced. They would see that it would cut away all international trade, since, if

there were no fallacy involved in it, the stoppage of each import taken separately would benefit home producers and damage foreign producers. Even if some of the imported commodities could not be produced at all at home, substitutes, more or less efficient, could be produced and give all the more employment. Having acquired some notion of the advantages of cooperation and the territorial division of labour, the consumers would regard this as a *reductio ad absurdum*, and after thinking a little further they would soon see that, after all, there is another set of producers, actual or potential, within the country who will gain—namely, the producers, present or future, who will supply the articles which are to go abroad in exchange for the new import. They will see that what they are asked to do is not to maintain the amount of national production, but merely to prevent a change in its character which will be accompanied by an increase in its amount.

Take another example of Chinese obstructiveness to desirable change. As great cities grow, it becomes convenient that their centres should be devoted to offices, warehouses and shops, and that people who work in these places, and still more their families, should live in the outskirts. I do not know that anyone has denied this. Certainly the great majority are willing to admit it. At one time it is believed that a quarter of a million people lived in the square mile comprised within the City of London; no one supposes that would be convenient now. There is no reason to suppose that further change in the same direction will not be desirable in the future. Yet, incredible as it will appear to future generations, public opinion, the House of Commons, the London County Council and some town councils think, or at any rate act as if they thought, that the process has now gone far enough and ought to be stopped; as if the state of things reached about the year 1891 was to be permanent, to last for ever and ever. Private owners are indeed still allowed to pull down dwelling-houses and erect shops and offices, but they are abused for doing so, and their liberty is at least threatened. But if a new railway or a new street is made—in all probability with the intention of increasing the accessibility of the centre from the suburbs—if even a new London Board School is built, and houses inhabited by persons who have less than a certain income are pulled down in any of these processes, it is required by law or parliamentary resolution that other houses for these people must be built in the neighbourhood. So it comes about that there are in quarters of London most unsuitable for the purpose enormous and repulsive barrack dwellings, the sites of which are devoted in *secula seculorum* to the housing of the working classes; while the immense cost of devoting them to this instead of to their proper purpose is debited to the cost of improving the facilities for locomotion or to education, and is defrayed principally by the rates on London property, which chiefly consists of houses, and to some extent by the higher charges on the railways consequent on the restriction of facilities for extension. Fifty pounds a head is the average loss involved to the rates of London on every man, woman and child for whom these dwellings are provided. Such is the wisdom of practical men uninformed by instruction in economic theory.

This palpable absurdity could never have been perpetrated if the general working of the economic organisation had been understood. In that case it would have been seen at once that the extrusion of over 200,000 inhabitants from the City of London in the past, which is admitted to have been desirable, was effected by the quiet operation of the laws of value. It would have been seen that as it became desirable to turn the City to other purposes, the ground in the City became too valuable to use as bedrooms and as living-rooms for mothers and children, and this increase of value drove out the 200,000 inhabitants. It would have been seen that the change had not come to an end, and no responsible body would have dreamt of putting themselves in opposition to it by buying sites and writing them down to 2 per cent. of their actual value in order that they might be tied up for ever and ever to be the homes of a certain number of persons with less than a certain income. If some unusually dense individual who had failed after many attempts to pass his examination in economic theory had proposed the policy which has been adopted, he would have been asked two questions: first, "What peculiar sanctity is there about the position occupied in the closing years of the nineteenth century? Why should this be stereotyped for all time? Why should not the position at the end of the seventeenth century have been maintained? Why should we not endeavour to

restore the working classes to their old home in the City, and remove the Bank of England to Tooting?" Secondly, "Whom do you imagine you will benefit by the policy you propose?"

It is difficult to conceive of any answer to the first question. To the second the reply of the dunce would of course be that he thought the policy proposed would benefit the people housed on these expensive sites. This answer would at once be condemned as unsatisfactory. To build houses on land worth 100,000*l.*, and let them to the first-comers of respectable antecedents at rents which would pay if the land were worth 2000*l.*, would be a very stupid sort of almsgiving if these respectable first-comers actually got the difference between the interest on the 100,000*l.* and the 2000*l.* But no one supposes that they do get this difference or any considerable part of it. The difference is almost entirely pure loss to the community. The chief immediate effects of the policy are, first, to retain in the centre the men, women and children who inhabit the dwellings; secondly, to retain other workers who perform various offices for these inhabitants; and thirdly, to ensure a surplus of labour for factories which would otherwise (to the advantage of everyone concerned) be driven into the country by the pressure of the high wages necessary to bring workmen to the centre or to pay their house rent if they lived there.

So much for the utility of economic theory in preventing obstruction of desirable changes. My second claim on its behalf is that it serves to hinder the adoption of specious but illusory projects. This, I think, may be illustrated by examples closely connected with those which we have already considered, under the head of obstruction.

The people who are most anxious to obstruct changes in the channels of trade which are coming about of themselves because they are profitable, are often extremely anxious to promote changes which will not come about of themselves because they are not profitable. For this end one of their most favourite devices at present is a State or municipal subsidy to locomotion or transport between particular points. So we have shipping subsidies, free grants to light railways, the construction of unprofitable telegraph lines by the Post Office, and the advocacy, at any rate, of the construction of unprofitable tramways by municipalities. The practical man, uninstructed in economic theory, feels uneasy about such projects because he does not see where he is to stop, and he feels obscurely that a universal subsidisation would mean ruin. But he does not see why he should not go a little way, and he goes sufficiently far to involve a loss quite worth considering. A knowledge of economic theory would come to his assistance by showing him that, as a rule, the most profitable enterprises are those which it is most desirable to undertake first, and that the subsidisation of the less profitable does not create new enterprises, but merely changes the order from the more desirable to the less desirable. I suppose that if in 1830 Parliament had offered a sufficient subsidy a railway might have been at once made and worked from Fort William to Fort Augustus, to the great satisfaction of the inhabitants of Fort Augustus and the intermediate places. But it is obvious that it was more desirable, in the interests of the whole community, that the railway from Fort William to Fort Augustus should wait for seventy years, and that the railway from Manchester to Liverpool, and many others, should be made first.

Then, too, we find people who are not quite so stupid as to think the working classes should always remain in the places where they were at the end of the nineteenth century, alleging that the way to cure overcrowding is for local authorities to enter the building trade in a general way, and build houses inside or outside their districts, wherever it seems most convenient. To the mind uninstructed in economic theory it seems obvious that the larger amount of housing there is the less overcrowding there will be, and that the more housing local authorities provide the more housing there will be. Economic theory, with its explanation of the general working of the organisation of production, suggests two objections. First, an addition to the housing in any locality will not be effectual in diminishing overcrowding, in so far as it attracts new inhabitants to the spot; a policy which assumes that the comparative plentifulness of houses is not a factor in the determination of the enormous and perpetual migration of people from place to place which is indicated in the tables of birthplaces and births and deaths in the census, is doomed to failure. Secondly, economic theory suggests the reflection that the mere fact of a local authority building some houses will not cause the whole number to be greater, if for

every house built by the local authority one less is built by private enterprise, and that this is very likely to happen. Houses have been built by private enterprise in the past, and in these houses nearly the whole population is at present housed. I have seen an enthusiast for municipal housing stand in the empty streets of a town late at night, when every soul in the town was evidently housed, and say, in a tone of conviction, "Private enterprise has failed." In that town four small houses had been built by municipal enterprise and more than ten thousand by private enterprise, and private enterprise was adding hundreds every year, while the housing committee of the corporation was meeting once a year to re-elect its chairman. Is it likely that private enterprise will build as much when it is completed with or supplemented by—the term does not matter—municipal enterprise? Why should it? If the municipality turned baker, would the private bakers continue to bake as much bread? Is not the attempt to stop overcrowding by inducing local authorities to build houses exactly the same thing and just as absurd as it would be to attempt to cure under-feeding by opening municipal butchers' and bakers' shops?

In the long run, I admit, experience teaches. Protection has fallen once in this country, and I have little doubt that it will fall again if it becomes considerable. The policy of obstructing the removal of dwellings from the centre of a great city already excites opposition in the London County Council, though unanimity still reigns in those last homes of extinct superstitions, the Houses of Parliament. Chancellors of the Exchequer and finance committees may be trusted to offer a stout resistance, on what they call financial grounds, to any really great development of the system of subsidies. There is hope even that the municipal building policy may be checked by the laborious inquiries which show by statistics what everyone knows, that the poor are ill-fed and ill-clothed as well as ill-housed, and therefore lead people to consider how the poor may be made more able to pay for houses, among other things, instead of simply how houses may be built in the absence of an effective demand for them. But I claim that, in matters such as these, a more widespread appreciation of economic theory, and the quickened intelligence which that would produce, would save us much painful experience, many expensive experiments, and an enormous mass of tedious investigation.

Thirdly, and at any rate on the present occasion, lastly, I claim that the teaching and study of economic theory has great practical utility in promoting peace and good will between classes and nations.

Between classes within the same nation the peacemaking influence of economic theory lies chiefly in the fact that it tends to get rid of that stupid cry for "rights" and "justice" which causes and exacerbates industrial and commercial quarrels. When demand for some commodity falls, or supply from some new quarter arises, and profits and wages fall, the workers cry out that they are being unjustly treated, because they have the unfounded belief that reward is or ought to be proportional to moral merit, and they are not conscious of any diminution of their moral merit. They demand a living wage or a minimum wage and employment for all who happen to have been hitherto employed in the trade, read the air with complaints, and get subscriptions from a compassionate but ill-informed public. We cannot, of course, expect people who suffer by them to regard even the most beneficial operations of the economic organisation with enthusiasm or even satisfaction. It would be absurd to do so. But all the same, it is true that a wider apprehension of the fact that it is only by raising and lowering the advantages offered by different employments that production is at present regulated so as to meet demand would not only diminish the dissatisfaction, but also, which is more important, diminish the actual suffering by causing transitions to be less obstinately resisted. The present fashion of deploring rapid changes of trade and dwelling-place is a most unfortunate one; the ordinary forms of labour do not, as a matter of fact, require such specialised ability that there should be much difficulty in changing from one to another; and surely it is much better for a man to work at several different things at different places in the course of his life than to stick for ever in the same place, surrounded by the same objects, going through the same monotonous round of duties. Anything which will weaken the present obstructive sentiment and lead people to regard the necessity of a change of employment or residence as a temporary inconvenience rather than a cruel injustice is to be warmly welcomed.

It is not, however, only the poor and the industrious who would be taught by a greater knowledge of economic theory not to kick against very necessary pricks. The rich, both industrious and idle, would be taught to be far more tolerant than they are of attempts to diminish inequality of wealth by reducing the wealth of the rich as well as increasing that of the poor. The economist may be a little annoyed with the workman who insists that he ought to have thirty shillings a week for producing something worth fifteen shillings, or five shillings, or nothing at all, but he can only have hearty contempt for the millionaire who holds up his hands in holy horror and murmurs "confiscation," "robbery," "eighth commandment," when it is proposed to relieve him of a fraction of a farthing in the pound in order to bring up destitute orphans to an occupation in which they may earn twenty-five shillings a week. The sanguine teacher of economic theory has hopes of making even such a man see that he has his wealth, not because Moses brought it down from Sinai, or because of his own supereminent virtue, but simply because it happens to be convenient, at any rate for the present, for society to allow him to hold it, whether he obtained it by inheritance or otherwise. In other words, that private property exists for the sake of production, not for the sake of the particular kind of distribution which it causes. Some, I know, say that the rich are so few that it does not much matter whether they acquiesce in the measure meted to them or not; but that is not the teaching of history, and I think you will agree with me that for the progress of the whole community it is, in practice, quite as important to secure the acquiescence of the rich as of the poor.

In regard to international relations, the first business of the teacher of economic theory is to tear to pieces and trample upon the misleading military metaphors which have been applied by socialists to the peaceful exchange of commodities. We hear much, for example, in these days of "England's commercial supremacy," and of other nations "challenging" it, and how it is our duty to "repel the attack," and so on. The economist asks what is "commercial supremacy"? and there is no answer. No one knows what it means, least of all those who talk most about it. Is it selling goods dear? Is it selling them cheap? Is it selling a large quantity of goods in proportion to the area or of the country? or in proportion to its population? or absolutely, without any reference to its area or population? It seems to be a wonderful muddle of all these various and often contradictory ideas rolled into one. Yet what a pile of international jealousy and ill-feeling rests on that and equally meaningless phrases! The teacher of economic theory analyses or attempts to analyse these phrases, and they disappear, and with them go the jealousies suggested by them.

When misleading metaphors and fallacies are dismissed, we are left with the facts that foreign trade—the trade of an area under one Government with areas under other Governments—is merely an incident of the division of labour, and that its magnitude and increase are no measures of the wealth and prosperity of the country, but merely of the extent to which the country finds it convenient to exchange commodities of its own growth or manufacture for commodities produced elsewhere. If the city of York were made independent, and registered its imports and exports, they would come out far larger per head of population than those of the United Kingdom or any other great country. Should we be justified in concluding York to be far richer than any great country? If means were discovered of doubling the present produce of arable land with no increase of labour, much less corn would be imported into Great Britain and less of other goods would be exported to pay for it; the foreign trade of the country would consequently be diminished, but would the people be any less prosperous? What jealousies, heart-burnings, and unfounded terrors leading to hatred would be extinguished if only these elementary facts were generally understood!

To anyone who has once grasped the main drift of economic theory, it will be plain that the economic ideal is not for the nation any more than for the family that it should buy and sell the largest possible quantity of goods. The true statesman desires for his countrymen, just as the sensible parent desires for his children, that they should do the best paid work of the world. This ideal is not to be obtained by wars of tariffs, still less by that much greater abomination, real war, with all its degrading accompaniments, but by health, strength and skill, honesty, energy and intelligence.

NOTES.

A NOTE in the *Times* states that the continuance of the meteorological work at Ben Nevis Observatory is practically assured. The staff had received notice that their services would not be required longer than October, but so satisfactory have been the offers of support that this order has been cancelled and winter stores have already been conveyed to the summit. The composition of the departmental committee of inquiry promised by Mr. Balfour will be announced shortly. So great has been the clamour against the threatened stoppage of the valuable work at the Observatory that it is confidently believed that the Treasury, guided by the advice of the committee, will enable the governing body to place the institution on a satisfactory financial footing of a permanent kind.

The thirteenth annual general meeting of the Mining Institute of Great Britain was opened on Tuesday last at Newcastle-upon-Tyne, and at the same time the jubilee meeting of the North of England Institution of Mining and Mechanical Engineers, upon the foundation of which the Mining Institute was laid, was held.

THE *Pioneer Mail*, Allahabad, states that a donation of 50,000 rupees has been made by the Government of India to the Pasteur Institute of India at Kasauli, and the Punjab Government has handed over to the central committee of the Institute as a free gift Drumbar House at Kasauli for the accommodation of the poorer class of European and Eurasian patients, while Sir Charles Rivas has given 10,000 rupees to the Institute for the years 1902-3; grants have also been made by the Governments of Burma and the United Provinces of Agra and Oudh, and the chief commissioners of the Central Provinces and Assam. It is pointed out by our contemporary that no grants have been made by the Governments of Bombay and Madras.

THE next international conference on tuberculosis will be held in Berlin from October 22 to 26, and a provisional programme of the proceedings has just been issued. The subjects suggested for debate are the position of Governments with regard to the prevention of consumption; obligation to give information to the police; organisation of dispensaries; the task of schools with regard to the prevention of consumption; precautions against the dangers of milk; tuberculosis during infancy; protection of labour and prevention of consumption; classification and different modes of accommodating consumptives. In addition to the consideration of the foregoing questions, the members of the congress will inspect various establishments for the treatment of tuberculosis, and preparations are being made for a number of social functions.

THE sixth International Congress of Hydrology, Climatology and Geology will be opened at Grenoble on Monday, September 29, and continue in session until the following Saturday.

THE ninth expedition of the Liverpool School of Tropical Medicine has just proceeded to the Suez Canal to institute preventive measures against malaria. Major Ronald Ross, F.R.S., the leader of the expedition, will be joined at Brindisi by Sir William MacGregor, the Governor of Lagos, who has expressed a desire to witness the operations at Ismailia. The work will be begun immediately on the arrival of the expedition, and extensive operations commenced against mosquitoes.

AN archaeological expedition, composed of seven Japanese, has just started for Central Asia, under the leadership of Count Otani Kozui and M. Watanabe Tetushin. The object of the expedition is to search for the Buddhistic remains in Central Asia, India and China, and to trace so far as is possible the course of Buddhism from its source northwards and eastwards to Japan.

WE have to report the death of Dr. H. von Wild at Zürich on September 5, in his sixty-ninth year. He was director of the Central Meteorological Station at Berne from 1863-5, director of the Russian Meteorological Service from 1868-1895, and president of the International Meteorological Committee from 1882-1892. He was the author of numerous works on meteorology and terrestrial magnetism, and the inventor of a wind-vane with a simple swinging wind-force plate which was much used in Switzerland. Prof. von Wild was probably best known to our readers as the editor of the Russian *Reperitorium der Meteorologie*, which contained valuable elaborate discussions of scientific subjects. His greatest work was "Temperatur-Verhältnisse des russischen Reiches," which embraced 349 pages of text and 271 plates.

THE death is announced of Prof. J. J. Hummel, principal of the dyeing department of the Yorkshire College, Leeds; also of Mr. Alexander Sutherland, registrar of the University of Melbourne, and author of, among other works, "The Origin and Growth of the Moral Instinct."

LETTERS received from Uganda give a good account of the progress of Mr. Budgett, Balfour travelling student of Cambridge, on his zoological mission to the Semliki. On July 13, he writes that he was proposing to start next day from Kampala for Lake Albert, where he would probably stay at Katyaba, near the Nile end, the *Polypterus* which he was in quest of being stated to be abundant at this spot. Afterwards his plans were to proceed southward to Fort Portal and thence to the Semliki valley, where he would make a general collection and look after the okapi in the neighbouring forest. Mr. Jackson has most kindly allowed Mr. Budgett to have the assistance of one of his trained taxidermists.

A COMMISSION will shortly leave England to settle the boundary line between the western portion of northern Rhodesia and the Portuguese territory. The commissioners selected for the purpose are Lieut.-Colonel Jackson and Lieut.-Colonel J. M. Woodward, of the Intelligence Department of the War Office, and Colonel Harding, the resident of the British South Africa Company in Barotse-land, will probably accompany the party. As the country to be traversed is very little known, it is much to be desired that a naturalist should be attached to this expedition, and we are informed that the authorities of the Natural History Museum have been consulted on the subject. The commissioners, it is said, are quite favourable to this being done, if the necessary arrangements can be made.

A DESPATCH has been received at New York from Lieutenant Peary, dated from Chateau Bay, Labrador, stating that he is homeward bound on board the *Windward* and that all is well.

AN international marine laboratory is, it is stated, to be established at Christiania under the direction of Dr. Fridtjof Nansen.

Science announces that Mr. William H. Wright, of the Lick Observatory, has been selected to take charge of the D. O. Mills expedition, which is at present being got ready for a two years' stay in Chile to make a special study of the stars of the southern hemisphere. The superintendence of the erection of the observing station and the inauguration of the work of the expedition will be undertaken by Director W. W. Campbell.

A FUNGUS foray in connection with the Yorkshire Naturalists' Union will take place in Arnelcliffe Woods and other portions of Eskdale from Saturday, September 27, to Thursday, October 2.

DURING the past week, Vesuvius has been showing a certain amount of activity and Stromboli has also been active, frequent explosions and detonations having taken place and much

black smoke having been emitted. Travellers from Alaska report that great volumes of steam are rising from the volcanoes Redoubt and Iliamna in the Augustine Mountains, while the Redoubt is also throwing up immense clouds of smoke. According to advices from Honolulu dated September 3, Mount Kalauea is active and is ejecting streams of fire. M. Lacroix, of the French Natural History Museum, left on Tuesday last to begin his work at Martinique.

ACCORDING to a Reuter telegram from Rome, the Italian postal authorities have examined a scheme submitted by an engineer, named Piscicelli, for the establishment of an electric postal service. It is proposed, by means of this system, to transmit letters in aluminium boxes, travelling along overhead wires at the rate of 400 kilometres an hour. A letter could thus be sent from Rome to Naples in twenty-five minutes and from Rome to Paris in five hours. A technical commission has been appointed to report on the system before instituting a series of experiments between Rome and Naples.

It is stated in the *British Medical Journal* that a somewhat new departure is about to be made by the North-Western Railway (U.S.), the headquarters of which are in Chicago. The plan is to equip every freight and passenger train with emergency chests containing splints, cotton bandages, antiseptics, restoratives, &c., and to open a school of instruction in first aid to the injured. The employés on all trains are to be required to attend the same and demonstrate that they comprehend the purpose of the teaching. The great purpose of the plan is to save lives, in the case of injuries, by the prompt and intelligent use of modern principles of treatment such as could be reasonably applied by an ordinary train crew, the contention being that an injured person in such circumstances will be able to reach the nearest hospital in a far better condition, and that his chances in all respects will be correspondingly heightened.

THE *Electrician* states that a patent has just been issued in America for a coin-controlled X-ray machine for public use. The external appearance of the apparatus is similar to that of the automatic cinematograph machines so commonly seen on railway platforms and other places. The observer places a coin in the slot, moves a lever, puts his hand, or whatever he wishes to examine, into a box without any sides, and looks down at it through a fluorescent screen which forms the top of the box. The coin, on being inserted, closes the primary circuit of an induction coil worked by a few dry cells, and the vacuum tube is in a position immediately below the object to be observed.

SOME four years ago, the Belgian Government offered a prize of 50,000 francs for a paste for matches which should not contain white sulphur. The commission appointed to judge the results of the competition has now reported that after careful experiment and analysis it finds that none of the products so far submitted fulfil the required conditions, being defective in inflammability, ignite on any surface, or in igniting eject inflammable matter containing some poisonous substance.

THE sum of 5000 dollars has, according to *Science*, been bequeathed to the Astronomical Society of the Pacific by Mr. John Dolbeer, of San Francisco. The money will be invested, and the interest devoted to the diffusion of astronomical knowledge.

A GOTHENBURG physician has, it is stated in the *Journal* of the Society of Arts, invented an apparatus by which milk can be brought into the form of powder similar in appearance to flour, and possessing all the qualities of milk in concentrated form, moisture excepted. It is maintained that the flour is perfectly soluble in water, and can be used for all purposes for which ordinary milk is employed. It is also claimed for it that

it does not get sour, or ferment, and in its dry state is not sensitive to changes in the weather. The cost of its production is estimated at 1s. 1d. per 100 quarts.

THE zoological station of Arcachon, under the direction of M. le Dr. F. Jolyet, professor of medicine in the University of Bordeaux, is now in full work, but we are sorry to learn that the laboratories are not fully occupied. Arcachon, with its grand "basin" always accessible, and large fishing fleet, is such a favourable spot for the marine zoologist that we are surprised that such should be the case. The report of the station for 1900-1 contains the results of several pieces of scientific work of much interest. Arcachon is a good place for the student of animal electricity, Torpedo being of common occurrence there. A new subsidiary station has recently been opened at Guethary, a small bathing-place near St. Jean de Luz, which is stated to have an excellent beach for dredging operations.

THERE are now three examples of the Grevy's zebra (*Equus grevyi*) in the Regent's Park Gardens, placed under the Zoological Society's care by the order of the King. Two of these were presented to His Majesty by the Emperor Menelik, and the third is the survivor of a pair presented by the same Emperor to Queen Victoria. Unfortunately, they are all three of the female sex. But Colonel Harrington, the British representative in Abyssinia, has most kindly presented to the Zoological Society a pair of this zebra now living in his compound at Abis Abeba, and it has been arranged to send out one of the keepers to bring them home next month, so that there is a good chance of this magnificent animal, by far the largest and finest of all the wild Equidae now in existence on the earth's surface, being permanently established in England.

THE weekly weather reports issued by the Meteorological Council up to August 30 show that in the principal wheat-producing districts, which include the eastern portions of Great Britain and the south of England, the only part where the rainfall had reached the average amount was the east of England; in the east of Scotland the deficit was 3 inches. In the principal grazing districts, which include the western portions of Great Britain, the south-west of England and the whole of Ireland, the only part where the rainfall had reached the normal amount was the north of Ireland; in the south-west of England the deficit was 5 inches. These figures will be somewhat modified by the heavy fall that accompanied the severe storm which passed along St. George's Channel and the Irish Sea on the night of September 2-3, when the amount exceeded an inch both in the north and south of Ireland; and in the counties of Wicklow and Dublin, which lay in the direct path of the centre of the storm, the fall in twenty-four hours amounted to nearly 3 inches. Nearly 2 inches fell on parts of the south coast of England during the same night.

METEOROLOGISTS are much indebted to Mr. R. C. Mossman for the publication of part iii. of his valuable papers on the meteorology of Edinburgh, which appears in a recent number of the *Transactions* of the Royal Society of Edinburgh. The present paper deals more particularly with new monthly and annual averages for the ten years 1891-1900 and the fifty years 1851-1900, and includes, *inter alia*, means of temperature and pressure, and rainfall values for periods varying from 124 to 137 years. An appendix continues the very interesting account, commenced in part ii., of remarkable atmospheric and celestial phenomena that have occurred in past years, and contains references to two events as far back as the twelfth century. The complete work undoubtedly forms the most useful and comprehensive discussion of the climatology of Edinburgh that exists.

A PAPER by Mr. Walter Wesché in the *Journal* of the Royal Microscopical Society for August bids fair to throw light on the

relations between the mouth-organs of diptera and those of other insects. Even in such dipterous genera as *Tabanus* and *Culex*, the full number of mouth parts of a typical insect is not present, the absent parts being one pair of palpi, which are commonly regarded as the labial palpi. In other families, such as the Muscidae and Syrphidae, where mandibles and even maxillae are absent, chitinous structures are visible on the dorsal side of the labium representing the aborted parts. Mr. Wesché now finds that certain members of the Muscidae are provided with a second pair of palpi in addition to those always present and which are generally regarded as maxillary. "In several species of the Anthomyia family, in the genera *Hyetodesia*, *Spilogaster* and *Hydrotea*, are to be found at the base of the labium and hypopharynx, and connected with the apodemes or levers that work those parts, two hairy processes, one on each apodeme. These are jointless, chitinous in structure, and have much the appearance of ordinary palpi." In *Hyetodesia basalis*, the organs measure about 0.003 inch (0.085 mm.) in length, while in *Spilogaster duplicata* they are the same length and about half the breadth. In other species of the same family, the rudiments are reduced to a few hairs and a minute tubercle; in the Sarcophagidae, rudiments are found in *Myiocera carinifrons*; in the Muscidae proper in *Musca corvina* and *M. domestica*, and the palpi have also been found in the families Sepsidae, Opomyzidae and Borboridae. The discovery of these rudimentary palpi, which are undoubtedly maxillary, leads to the conclusion that the palpi so conspicuous on the proboscis of many flies are not the maxillary but the labial palpi.

EIGHT years ago Prof. Omori studied the distribution in time of the after-shocks of several great Japanese earthquakes, and concluded that a strong earthquake is almost invariably followed by weaker ones, and a destructive one by hundreds or even thousands of minor shocks, which gradually diminish in frequency and strength, but may continue to be felt for several years. In a recent valuable memoir (*Boll. Soc. Sism. Ital.*, vol. viii. pp. 17-48), Dr. Cancani has investigated the distribution in intensity of the after-shocks of three hundred Italian earthquakes, all strong enough to produce at least slight damage in buildings. Such earthquakes, he finds, are never isolated, but are always preceded or followed by others generally weaker. The total duration of an earthquake-period (perhaps earthquake-series or group would be a better term) is a function of several variables, but depends especially on the depth of the seismic focus. When the depth is small, the earthquake-period is of brief duration, generally about ten days; when moderate, the after-shocks may continue for about three months, and when the depth is great they may last for several years. In 70 per cent. of the earthquake-periods, the strongest shock occurred during the initial phase or first tenth part of its total duration.

THE Report of the Botanical Exchange Club of the British Isles for 1901 has been delayed, as the distributor, the Rev. E. S. Marshall, explains, in order to obtain critical opinions on some of the specimens. The number of specimens sent in by twenty-five contributors amounts to more than 2700. Many of these are varieties or hybrids, others represent new localities. Several new species are recorded for Lancashire, notably *Helleborus viridis* and *Helleborus foetidus*, *Scirpus caricis* and *Carex terdrinuscula*. A discovery of *Euphorbia exigua* in limestone crevices on the north coast of Wales lends support to the view that it is a native of Britain. *Statice Limonium* × *rariflora* and *Salicornia lignosa*, both growing near Bosham in west Sussex, have elicited interesting criticisms, but the most important collection, *Diotis candidissima*, was made by Mr. C. P. Hurst in Wexford. There it grows in quantity on a sandy bar, as may be seen from the two illustrations given, which are reproduced from photographs taken by the finder.

A NUMBER of papers dealing with electric traction, which were read before the Association Française pour l'Avancement des Sciences last month, are summarised in *L'Éclairage électrique* for August 23. These will be found especially useful by those who are interested in accumulator traction, whether for tramways or automobiles, as the suitability of the accumulator is considered from several points of view. The general conclusions are not very favourable to the accumulator in its present commercial form, although accumulator traction was voted a perfectly practical solution of the problem of running a tramway electrically in a position in which trolley wires were inadmissible. Accumulators were not, however, regarded as so suitable for automobiles, as their weight involved difficulties in the construction of the cars and tyres which were not so important in a tramcar heavy in itself and running on a prepared track. For a public service of electric automobiles, the only system considered practical was one in which power was obtained from a trolley wire, with omnibuses or carriages running on the ordinary roadway, a system which obviously possesses some advantages over even the electric tramway.

A BRIEF account of the latest apparatus for rendering air respirable in a closed space is described by M. Desgrez in the *Bulletin* of the French Physical Society, No. 185, the apparatus having been devised by M. Desgrez in collaboration with M. Balthazard. The underlying principle is the decomposition by water of sodium peroxide, with liberation of oxygen, absorption of carbon dioxide and destruction of the toxic products of respiration. The apparatus consists of (1) a distributor which, by the action of clockwork, drops the peroxide into water at regular intervals; (2) a cubical steel box containing the water; and (3) a ventilating fan. A refrigerator is also supplied, as a general rule, to counteract the heating effects of the chemical reactions. A complete apparatus has been constructed, capable of enabling a man to work for at least three-quarters of an hour in a closed space, and weighing in all about 12 kilograms.

THE current number of the *Proceedings* of the Edinburgh Mathematical Society contains a note on decimal coinage and approximations by Mr. J. W. Butters. Apart from the advantages of a decimal system of coinage, the author calls attention to several points which cannot be too strongly emphasised. One is the common complaint as to the time wasted by learners in using long and cumbersome methods (often calculating sums of money to a fraction of a penny with a long numerator and denominator), from ignorance of the use of decimals. This evil, the author thinks, could be remedied by teaching decimals before vulgar fractions, as is often done in Germany. Another point is the use of the unit's figure instead of the decimal point as a landmark in counting places in multiplication and division. Everyone knows, or should know, that the characteristic of a logarithm is given by the number of places that its first significant figure is to the left of the unit's figure, whereas if the decimal point is taken as the landmark, we are told that the characteristic is one more or one less than something or other and confusion may arise. Mr. Butters suggests that the decimal point be called the unit's point and regarded as used for fixing the unit's place, and he shows how multiplication and division of decimals are simplified by adopting this view. The necessity for such a change is emphasised by the fact that the ordinary method of dividing decimals fails to give the correct remainder. Finally, the author points out the saving in labour in using decimals of a pound and contracted methods for ordinary calculations.

THE current number of the *Journal* of the Anthropological Institute fully maintains the great reputation which that publication has earned. There are three papers on customs and beliefs of various African tribes, one on a remarkable musical

instrument of the Bushmen and two papers on Kabyle pottery. Indian ethnography is represented by one paper and Malay ethnography by three: other papers deal with the Nicobars, Sarawak, Tasmania, Tonga and New Zealand. The range is wide alike in geography and matter, so that practically all departments of anthropology are represented, and the twenty plates are of exceptional interest and excellence.

ANTHROPOLOGY is to be congratulated in having found so able and enthusiastic a student as the Rev. J. Koscoe, of Uganda, whose paper on the manners and customs of the Baganda is of extreme interest. Amongst other important novelties, it contains an account of a typical form of totemism which was previously unrecorded among the Baganda, and even the magical aspect appears to be present. Very suggestive are the customs relating to twins and the sympathy between human beings and plants. The people appear to have but recently emerged from matriarchy into patriarchy.

ANOTHER important paper in the same *Journal* of the Anthropological Institute is that on some animistic beliefs among the Yaos of British Central Africa, by the Rev. A. Hetherwick. The Yao present us with three stages of animistic belief, (1) the *lisoka* or human shade, the agent in dreams, delirium, &c.; (2) this *lisoka* regarded as *mulungu* and an object of worship, the controller of the affairs of this life; and (3) *mulungu* as expressing the great spirit agency, the creator of the world and of all life. Between these three conceptions of the spirit nature no definite line can be drawn.

In the concluding portion of his article on "Regeneration in Plants" in the *Biologisches Centralblatt*, Prof. Goebel has an instructive chapter on the disposition of adventitious developments which follow upon injury or wounding. That it may be referred to a polarity depending upon internal, not external, factors follows from Vochting's researches. Tracing the argument back further—e.g., what does polarity mean?—Bejerinck's hypothesis of an upward current shoot forming and a downward current root forming is accepted in part, and experiments which can be explained upon this hypothesis are mentioned. Sometimes, however, this is not satisfactory, and Prof. Goebel finds that a more general and correct explanation of certain anomalous cases is obtained by a consideration of the direction of flow of the food current. Finally, Prof. Goebel regards with favour the idea of a controlling enzyme as postulated by Bejerinck.

The Geological Survey of Western Australia, in *Bulletin* No. 6 (1902), gives the results of the chemical and mineralogical research work carried out by Mr. E. S. Simpson since the laboratory was established in 1897. There are notes on native gold and its compounds with tellurium and other elements, as well as notes on various ores, on coal, peat, clays, water, and on sundry intrusive rocks.

WE have received three important papers devoted to embryology and development. Two of these, dealing respectively with amphibians and the brachiopod *Lingula*, appear in a recent issue of the *Journal* of the Tokio College of Science. The third, by Dr. J. A. Masterman, which is published in the *Transactions* of the Royal Society of Edinburgh, treats of echinoderm development.

THE August issue of the *Journal* of the Department of Agriculture of Victoria is composed of the annual reports of the officers in charge of the various branches of the Department, prefaced by a brief summary of the whole by Mr. S. Williamson Wallace, the Director of Agriculture for the colony. The reports are interesting reading, and tell of much good work done on scientific lines at a comparatively small cost.

THE *Scientific American*, New York, for August 30, contains an illustrated article, by Mr. F. Moore, upon the United States Naval Observatory.

PART 4 of the new and cheaper edition of Kerner and Oliver's "The Natural History of Plants" has reached us from Messrs. Blackie and Son, Ltd.

MR. BERNARD QUARITCH has just issued a new part, devoted to India and the Far East, of his "Catalogue of Works on Oriental History, Languages and Literature," containing particulars of many rare and valuable books.

THE additions to the Zoological Society's Gardens during the past week include two Bonnet Monkeys (*Macacus sinicus*) from India, presented by Mr. J. H. Osborne; two Diana Monkeys (*Cercopithecus diana*) from West Africa, presented by Mr. E. Skinner; a Levaillant's Cynictis (*Cynictis penicillata*) from South Africa, presented by Mr. E. C. S. Jervis; two Cape Eared Owls (*Asio capensis*) from Africa, presented by Captain Fraser; a Diana Monkey (*Cercopithecus diana*), a White-thighed Colobus (*Colobus vellerosus*), two Grey-headed Sparrows (*Passer simplex*) from West Africa, a Simpae Monkey (*Semnopithecus melalophus*) from Sumatra, a Salle's Amazon (*Chrysotis ventralis*) from St. Domingo, two Striated Tanagers (*Tanagra striata*) from Buenos Ayres, a Blue Sugar-bird (*Dacnis cayana*), an All-green Tanager (*Chlorophonia viridis*) from Brazil, deposited; two Swinhoe's Pheasants (*Euplocamus swinhoi*), an Argus Pheasant (*Argus giganteus*) bred in the Gardens.

OUR ASTRONOMICAL COLUMN.

ANOTHER NEW COMET.—From information received, through Mr. E. W. Maunder, from Mr. John Grigg (a member of the Cometary Section of the British Astronomical Association), of Thames, New Zealand, it appears that the comet discovered by Perrine, which, if this news is confirmed, has been erroneously named 1902 *b*, is not the second, but the third comet discovered this year.

Mr. Grigg says that whilst using his 3½-inch Wray equatorial, with a power of 25 on July 22d. 18h. 30m. G.M.T., he saw a nebulous object which was roughly noted as R.A. = 11h. 35m., Dec. = +7° 0', and reference to various charts and tables elicited the fact that this was not a previously recorded nebula or comet. On the following evening, the same object was doubtfully recorded as 24' further south and 7' eastward of its previous position. Feeling satisfied that this was really a new comet, Mr. Grigg acquainted Mr. Baracchi (Melbourne Observatory) and the Press Association of his supposed discovery.

Three days later, and also on August 1 and 2, the same observer again saw the suspected comet and recorded the following positions:—

d.	h. m.	R.A.	Dec.
July 23	8 G.M.T.	= 11 40	= +6 35
26	8 "	= 12 0	= +5 30
29	8 "	= 12 20	= +4 20

and from these he calculated the following elements:—

T = June 20, 1902.

$$\begin{aligned} \omega &= 292 \text{ } 43 \\ \Omega &= 217 \text{ } 48 \\ i &= 18 \text{ } 24 \\ \log q &= 9 \cdot 7241. \end{aligned}$$

The observations are all of them a little doubtful owing to persistent haze and moonlight, but Mr. Grigg gives the particulars for "what they are worth," and has sent them in this uncertain state in order to catch the outgoing mail.

The position of his observatory is:

Longitude	175 32 38 54 E.
Latitude	37 8 23 21 S.

COMET 1902 *b*.—Circular No. 51 from Kiel gives the subjoined elements and ephemeris, as calculated by Herr Elis Strömgren from the observations made at Lick on September 1, at Urania on September 2, and at Copenhagen on September 4, for the comet discovered by Perrine at Lick on September 1.

Elements.

T = 1902 Nov. 23^h 31^m 5 Berlin.

$\omega = 153 \ 53 \cdot 2$
 $\Omega = 50 \ 10 \cdot 6$ 1902^o
 $i = 157 \ 8 \cdot 2$
 $\log q = 9 \cdot 60094$.

Ephemeris.

1902.	h.	m.	s.	δ app.
Sept. 6 ...	3	11	48	+37 0'3
10 ...	3	4	26	+39 10'4
14 ...	2	52	59	+41 51'4
18 ...	2	34	47	+45 13'2
22 ...	2	4	19	+49 23'3
26 ...	1	10	1	+54 3'8

Perrine describes the comet as "slightly elongated, mean diameter 4', magnitude =9, tolerably well-defined nucleus, possesses a tail." Struve, observing at Königsberg on September 2, 10h. 41m. 2' (Königsberg), saw a sharply defined nucleus of the 11th magnitude.

NEW ALGOL VARIABLE.—Mr. A. Stanley Williams announces in the *Astronomische Nachrichten*, No. 3811, the discovery of a new Algol variable (13, 1902 Lyrae), the position of which he gives as

$\alpha = 19h. 10m. 48s. 7. \quad \delta = +32^{\circ} 10' 1'' (1855).$

This object is the most following, and normally the brightest, of the three stars forming a small triangle south of the 9^h 1 mag. star B.D. +32° 3377. On the scale used, its normal magnitude is 10.98, whilst at minimum it is only just visible with the 6.5-inch reflector, i.e. its magnitude is about 12.8.

The star remains at its normal brightness for about 3d. 6h. 22m., and the increase and decrease each occupy about 4 hours; there is no apparent interval at minimum, and the observations, so far, have not indicated the presence of any secondary minimum.

Subjoined is an extract from an ephemeris, calculated for every fifth minimum by Mr. Williams.

1902.	G.M.T.
	h. m.
Sept. 21 ...	11 28
Oct. 9 ...	11 20
Oct. 27 ...	11 12
Nov. 14 ...	11 4
Dec. 2 ...	10 56
Dec. 20 ...	10 48

Prof. E. Hartwig observed this variable from 9h. 22m. to 11h. 19m. (Bamberg M.T.) on August 16, and found that, during that period, its light decreased by 1.3 magnitudes; cloud and strong moonshine prevented the observations from being carried on throughout the minimum.

SIR DAVID GILL'S NEW THEORY OF STELLAR MOVEMENT.—Mr. Carpenter has recently been examining the measures of the stellar photographs obtained at Oxford during the last seven or eight years, in order to see if they indicate any such movement of the brighter stars as a whole, with respect to the fainter stars as a whole, as was recently suggested by Sir David Gill. Although this was too great a task for Mr. Carpenter to finish during his holiday, he got far enough to find indications which supported Gill's hypothesis.

This result was considered so important that the whole of the Oxford staff was deputed to examine the photographic measures for a belt of stars about Dec. +26°, and the result indicates that there is an apparent movement as suggested amounting to about 0s. 002 per magnitude per year. This corresponds in magnitude to the quantity found by Gill, "but its sign is opposite to that found by him." If this sign is found on further revision to be correct, then it is difficult to imagine that the movement is simply one of rotation, and further investigation must be made before any definite theory may be accepted (*The Observatory*, September, 1902).

UNIVERSITY AND EDUCATIONAL INTELLIGENCE.

DR. W. H. MILLS, Fellow of Jesus College, Cambridge, has been appointed head of the chemical department of the Northern Polytechnic Institute in succession to Mr. H. C. L. Bloxam.

MR. H. W. MALCOLM, B.Sc., has been appointed lecturer and demonstrator in physics at University College, Bristol, in the place of Mr. L. N. Tyack.

MR. W. R. KELSEY, late of the Bradford Technical College and of the South-West London Polytechnic, has been appointed principal of the Taunton Municipal Technical Institute.

THE UNIVERSITY of Nebraska has this year added a course of study in forestry to its curriculum. The course will extend over a period of four years.

THE sum of 1000*l.* has been placed by Sir Conan Doyle at the disposal of the senatus of Edinburgh University for the purpose of instituting a bursary in the faculty of medicine, available only for students from South Africa. The bursary is to be administered in detail as the University may direct.

SCIENCE for September 5 publishes for the fifth year in succession statistics of the conferment of the degree of Doctor of Philosophy by American universities. In the present year, some 214 doctorates have been conferred by twenty-seven institutions, as against 253 in 1901, 233 in 1900, 224 in 1899 and 234 in 1898. The largest numbers of degrees conferred were in the subjects of chemistry, zoology, physics and botany, the numbers being respectively 24, 16, 12 and 11.

SIR HENRY CRAIK's report for the year 1902 on secondary education in Scotland shows that there has been a large increase in the number of schools presenting candidates in science subjects at the leaving certificate examination, and also in the total number of candidates presented. In many cases there has been a distinct advance in the quality of the work done as compared with former years. It is satisfactory to know that in the examinations of Scottish secondary schools great prominence is given to oral and practical methods of testing the work, and the examinations in the case of each school are shaped by the curriculum of that school.

THE educational announcements for the session 1902-3 of the Northampton Institute, Clerkenwell, make an imposing volume of some 200 pages. Classes will be provided in a large number of technological and trade subjects, but students who require instruction in literary or commercial subjects must go to one of the other City polytechnics, for the Northampton Institute is primarily intended to teach technology. Very properly, great attention is given to subjects which directly assist the industries of the immediate neighbourhood. The courses of instruction fall into two distinct sections, the engineering day classes for students willing to give the whole of their time for one or more years to a systematic training in some branch of engineering, and the evening classes in a variety of subjects for working men engaged during the day.

THE new regulations of the University of Oxford School of Geography show that admission is not confined to members of the University, but all applicants must give satisfactory evidence of sufficient general education to profit by the teaching. A course of instruction in the subjects required for the University diploma in geography begins in October and extends over one academic year. Weekly lectures are delivered by all the members of the staff, six in number, and practical instruction is given on at least four days in each week, and includes position-finding, topographical surveying and map-projection. A scholarship of the value of 60*l.* is offered annually for competition among members of the University who have taken honours in one of the final schools of the University. During 1901-2 the lectures were attended by 205 students, of whom 163 were men from twenty-one colleges, and forty-five women from five colleges or halls.

IN urging the necessity for a more extensive and highly developed system of technical education in this country, English men of science often refer to the provisions made in the United States of America to equip American workers with a practical education of a technical kind so as to fit them to take a useful place in the industries of their country. A recent address, by Prof. V. C. Alderson, Dean of the Armour Institute of Technology at Chicago, on "Technical Education an Economic Necessity," shows some imperfections in the American system. Prof. Alderson is of opinion that up to the present the existing admirable technical institutions in the United States have concerned

themselves only with the needs of the highest grades of workers, "the commissioned officers of our industrial army," as he calls them. "The great mass of non-commissioned officers and privates are left uncared for." The region of what may with approximate correctness be called "secondary technical education" is represented in the United States, Prof. Alderson says, "by more or less feeble efforts in a few trade schools, in a limited number of private institutions aimed to help the working men and in night schools." American educational authorities are urged, later in the address, to follow the example of Switzerland, and, "recognising the dependence of national prosperity upon technical education, to set about the task of providing an education for all classes of workers suited to their callings. The technical high school, if properly equipped and put in close relationship with the trades and industries, will satisfy this national need; it will not be a copy of the European trade school, but rather an adaptation of the trade school which will be in harmony with American thought and American educational ideals."

SOCIETIES AND ACADEMIES.

PARIS.

Academy of Sciences, September 8—M. Bouquet de la Grye in the chair.—The president announced to the Academy the death of M. R. Virchow, Foreign Associate of the Academy.—Address by M. Bouchard on the occasion of the death of R. Virchow.—On the irreducibility of uniform transcendentals defined by differential equations of the second order; by M. Paul Painlevé.—The experimental study of the resistance to compression of armed mortar, by M. Considère. A study of the mechanical properties of prisms of cement having embedded in its mass metallic wires of various shapes. The results are summarised in a graphical form.—On the eruption of Martinique, by MM. A. Lacroix, Rollet de l'Isle and Giraud. In discussing the calorific and physiological effects of the eruption in the town of St. Pierre, all the observations indicate the rapid and persistent action of a source of heat at a high temperature, producing asphyxia. In a central zone the temperature was sufficiently high to determine combustion, to superficially carbonise the bodies after burning their clothes, but it was insufficient to melt thin copper wires, or below 1054° C. On the edges of this zone the phenomena of asphyxia continue, but the temperature was hardly high enough even to char the clothes. The presence of steam and ashes in the destructive cloud which overwhelmed the city is certain; the presence of combustible gases such as hydrogen sulphide, hydrocarbons or hydrogen cannot be proved with certainty, but such a supposition would explain many of the effects produced. The commission consider the complete evacuation of the entire neighbourhood of Mont Pelée is imperative, and must be maintained until the complete cessation of the volcanic disturbances.—On the secular acceleration of the mean longitude of the moon, by M. H. Andoyer.—The comet 1902 *b*, discovered on September 1 by M. Perrine and independently by M. Borrelly, September 2, at the Observatory of Marseilles. Observations made by MM. Borrelly and L. Fabry.—Observations of the comet 1902 *b*, made at the Observatory of Besançon, by M. P. Chofardet.—On certain differential equations, by M. Edmond Maillat.—On the properties of closed chambers relating to electric waves, by M. A. Turpain.—On a new acidimetric indicator, by M. L. J. Simon. By the dry distillation of tartaric acid with potassium bisulphate, a new acid isomeric with pyrotartaric acid has been obtained the ferric salt of which may be used as an indicator. It possesses the curious property of giving similar indications to a mixture of methyl-orange and phenolphthalein, and in some cases conveniently replaces such a mixture.—On the interrenal bodies of Plagiostomes, by M. Ed. Grynfeltt.—On some india-rubber plants on the west coast of Africa, by M. Aug. Chevalier.—On the duration of the germinating period in seeds exposed to sunlight, by M. Victor Jodion

NEW SOUTH WALES.

Linnean Society, July 30.—Mr. J. H. Maiden, president, in the chair.—Descriptions of some new species of plants from Western Australia, by Mr. W. V. Fitzgerald. Five additions to the flora of Western Australia referable to the genera *Mitrasacme*, *Cremnophila*, *Grevillea* and *Schenus* (two species) are described.—Descriptions of new species of (Queensland Lepidoptera, by

Dr. Thomas P. Lucas. Two genera and five species, distributed among three families (Cossidae, Pyralidae and Nylotritidae), are described as new.—A revision of the genus *Notonotus* (fam. Carabidae; subfam. Feroniini), by Mr. Thomas G. Sloane. Seventy-two species are attributed to the genus, twenty-seven being described as new.—Contributions to a knowledge of Australian Entozoa. No. ii. On a new species of Distomum from the sawfish-shark (*Pristiophorus cirratus*, Lath.), by Mr. S. J. Johnston. The worm has an extremely mobile neck in the living state. Its most characteristic features are its size, the character and position of the suckers, the folded but unbranched limbs of the intestine, the grape-like vitelline glands and the very marked development of the excretory system. It falls into Dujardin's subgenus *Brachylaimus*.—Notes on Australian Lycænidæ, by Mr. G. A. Waterhouse. *Lycæna nigra*, Misk., is referred to the genus *Megisba*, Moore. *Holochila purpurea*, Grose-Smith and Kirby, is given as a synonym of *H. cypratus*, Olliff. *Holochila androetus*, Miskin, and *H. subargentea*, Grose-Smith and Kirby, are given as synonyms of *H. helenita*, Semper. The sexes of *Ogyris oretes*, Hew., and *O. amaryllis*, Hew., are described; likewise two new species. The paper concludes with a note on *O. ianthis*, Waterh.

GÖTTINGEN.

Royal Society of Sciences.—The *Nachrichten* (physico-mathematical section), part 4 for 1902, contains the following memoirs communicated to the Society:—

November 8, 1901.—David Hilbert: On the bases of geometry.

May 3, 1902.—Ernst Richard Neumann: New integral properties of successive potentials. W. Voigt: On the absolute retardation of light-waves on reflection.

The accompanying *Proceedings* include reports on the progress of the "Mathematical Encyclopedia" and the publication of Gauss's works; obituary notices of Friedrich Leo, Adolf Erik von Nordenskiöld, Karl Hegel; and congratulatory addresses to Eduard Süss, of Vienna, and Dedekind, of Brunswick.

CONTENTS.

	PAGE
Prof. Lorentz on the Scope of Physics. By J. L.	489
Celtic Mythology	489
Our Book Shelf	
Ostenfeld: "Flora Arctica"	490
Kirkman and Field: "An Arithmetic for Schools"	491
Bradshaw: "A First Step in Arithmetic"	491
Jabelon: "The Real Origin of Religion"	491
Letters to the Editor:—	
Re Vegetable Electricity.—Dr. Augustus D. Waller, F.R.S.	491
Can Carbon Dioxide be "Vitalised"?—Prof. R. Meldola, F.R.S.	492
Effect of a Lightning Flash.—C. Davies Sherborn	492
Bipedal Locomotion of a Ceylonese Lizard.—E. Ernest Green	492
A Series Related to Bernoulli's Numbers.—J. R. Sutton	492
Frederick Augustus Abel. By W. R. D.	492
An Instrument for Aiming Guns under Cover. (<i>Illustrated</i>)	493
The British Association at Belfast	494
Section B.—Chemistry.—Opening Address by Edward Divers, M.D., D.Sc., F.R.S., V.P.C.S., Emeritus Professor of Chemistry in the Imperial University of Tokyo, Japan, President of the Section.	495
Section C.—Geology.—Opening Address by Lieut.-General Charles Alexander McMahon, F.R.S., F.G.S., President of the Section.	504
Section F.—Economic Science and Statistics.—Opening Address by Edwin Cannan, M.A., LL.D., President of the Section	507
Notes	511
Our Astronomical Column:—	
Another New Comet	514
Comet 1902 <i>b</i>	515
New Algol Variable	515
Sir David Gill's New Theory of Stellar Movement	515
University and Educational Intelligence	515
Societies and Academies	516

THURSDAY, SEPTEMBER 25, 1902.

LEGENDS OF PALESTINE AND ARABIA.

Theology and Ethics of the Hebrews. By Archibald Duff, M.A., LL.D., B.D., Professor of Old Testament Theology, Yorkshire College, Bradford. Pp. xvii+304. (London: John C. Nimmo, Ltd., 1902.)

Syria and Palestine. By Lewis Bayles Paton, Ph.D. With Five Maps. Pp. xxxvi+302. (London: John C. Nimmo, Ltd., 1902.) Both in the "Semitic Series." Each 5s. net.

THE increasing number of popular books on early Semitic history and sociology marks the ever-widening interest taken in this branch of scientific research, especially as far as the results of modern Old Testament criticism are concerned. The writer of a popular handbook undertakes a serious responsibility; it is for him to weigh carefully the arguments for and against all important theories, and to set before the general reader a fair and unbiased account of what he considers to be the certain and indubitable results of the labours of scholars. In all matters of Biblical criticism he must hold a middle course between the servile acceptance of traditional belief on the one hand, and a system of drastic and monotonous emendation on the other. Above all must he keep himself severely aloof from ephemeral hypotheses, for he is writing for the uncritical layman and not for the discriminating expert.

Dr. Duff's book on the theology and ethics of the Hebrews seems hardly to fulfil all the above requirements. The first section opens with the period of Hebrew history which begins with the fifteenth century B.C., and describes the Exodus from Egypt to Sinai. Then follows what is, to say the least of it, an unsatisfactory explanation of the episode of the Tables of the Law. According to Dr. Duff, "then or thereabouts two slabs were brought down from the heights. There were strange markings upon them, crystalline, fossil, or otherwise" (p. 9). Of the three possibilities, the last is certainly the most probable, as neither crystalline nor fossil markings are likely to be mistaken for writing, and as the mountain traditionally regarded as Sinai is of granite, it is hardly probable that fossils would be found there. However, Dr. Duff proceeds with his explanation: "There arose in time a sacred formula connected with this relic, whereby they called their god

"The Almighty Yahweh who sits
Throned upon the winged creatures."

"This seems to suggest that the seeming hieroglyphic figures on the slabs were fossils or else crystalline forms resembling winged creatures. Therefore the people called them 'Kroobs,' i.e. Griffins (Γρὶψ)." The connection of Dr. Duff's "Kroobs" (which in the traditional transliteration is *cherub*) with Γρὶψ, has been given up by the Oxford Hebrew Dictionary (Clarendon Press, 1892, p. 500). That such supposed fossil markings on granite could be mistaken for "hieroglyphic figures," or crystalline markings for "winged creatures" or "Kroobs," are

explanations harder to understand than the difficulty which they are devised to solve.

Dr. Duff inclines to the opinion that the divine name, Yahweh, is a causative incipient from the root *hawah*, i.e. the god who caused rain to fall and thereby brought life and all things into being (p. 11). This is certainly possible, and appears to be as good an explanation as the other plausible view that Yahweh is the Kal of *hawah* (= *hayah*), i.e. "He Who Is."

When Dr. Duff reaches the third part of his book, wherein he describes the teachings of the prophets, he stands on firmer ground, and appears to know his subject better. Naturally, he begins with the caustic utterances of Amos against the luxury of Israel, and his warnings of the Assyrian approach; and, with the exception of a passage of "fine writing" on the first page, his *résumé* of this prophet is a good one. In the chapter on Hosea, which follows, the author has apparently been unable to make up his mind about a theory which, if it were true, would profoundly modify our conception of early Arabian and Hebrew history. On p. 61 he says: "Events on the Upper Nile or in Arabian *muçur* (*sic*) now left a southern prince So or Sewe (Sabako?) free to turn again to plots in the Asiatic direction"; but, in spite of this leaning towards the heresies of Dr. Winckler, the author inclines to the more usual view of the relations between Israel and Egypt at this time. He is certainly to be congratulated on not having gone over entirely to what on the face of it seems a possible theory, but which in reality has less in its favour than is at first sight apparent.

Taken as a whole, Dr. Duff's book will be found useful, and though the author's style is at times somewhat tedious, his matter has been well arranged, and the idea of the analysis of the "J" and "E" portions of the Old Testament at the end is an excellent one.

In the second of the two books under review Dr. Paton has endeavoured, as he says in his introduction, to "gather up the results of the most recent explorations, and combining them with the facts already known from the Bible and from other ancient sources, to present them in a clear and popular form." His book deals with the history of Palestine and its relations with Egypt and Mesopotamia from the earliest times down to Cyrus, and to this end the author has laid under contribution a large quantity of material both from Egyptian and Assyro-Babylonian sources, though apparently he has little first-hand knowledge of the original texts. A wider understanding of the languages of the peoples with which he deals would have prevented him from falling into certain errors that are to be found in his book. For instance, he has adopted the chronological system of Lehmann, and although he accepts Assurbanipal's dating for Kudurmanhundi, who invaded Babylonia 1635 years before Assurbanipal's time (p. 30), yet, apparently only on the ground of its extreme antiquity, he rejects Nabonidus's date for Naram-Sin, who is said by the former to have reigned 3200 years before (p. x.). Again, he seems unable wholly to accept the truth about the "Chedorlaomer" texts, and sums up his review of the facts with the words, "It still remains doubtful, therefore, whether Chedorlaomer is mentioned in the

Babylonian monuments" (p. 34). Now, as the "Chedor-laomer" myth was long ago exploded by King ("Letters and Inscriptions of Hammurabi," vol. i. p. xxv.), there is no longer any question about this matter, at any rate so far as the tablets that have been discovered up to the present time show. Noticeable, also, is the translation of "Ya'aqob-el" and "Yoseph-el" as "Jacob-god" and "Joseph-god" (p. 42), which is misleading to the general reader, and almost seems to betray in the author an ignorance of the meaning of these names. Further, "Moriah" is hardly likely to be the equivalent of the Sumerian MAR.TU (p. 16).

In this book we again meet with the "Arabian-Mušri" theory, though even its supporters do not seem to be very certain as to where they intend to fix the position of their hypothetical Mušri. Even in the two maps where it is marked the position assigned to it is not the same in the one as in the other, and it has therefore apparently been given what is known mathematically as a *locus* in which its position varies, at one time shifting perilously near the borders of the southern Mušri, *i.e.* Egypt (pp. 157 and 200). Since this so-called "epoch-making" theory has now begun to be reproduced in popular works, it is but right that the arguments on which its supporters rely should be examined in detail.

In 1893¹ Dr. Winckler published a theory that in addition to the two countries called in the Assyrian inscriptions Mušri (Egypt and part of Northern Syria) there existed a third in Northern Arabia, and since then he has adduced a number of arguments in order to support this theory, both from the Assyrian and Hymyritic inscriptions. Among German scholars it has received little encouragement, but in England Dr. Winckler has been fortunate in finding an eloquent and receptive advocate in Prof. Cheyne, who has given it his sanction in the "Encyclopædia Biblica."² Since a popular handbook has absorbed and given credence to what is considered by the majority of critics to be a doubtful question, to say the least of it, it will be as well to state Dr. Winckler's arguments *seriatim*, in order that we may see how far they bear out his case. They may be briefly enumerated as follows:—

(1) Tiglath Pileser III. appointed a certain Idibi'ilu to be *kīpu* over Mušri,³ and this Idibi'ilu is mentioned elsewhere in the inscriptions of the same king,⁴ where he is called "Idibi'ilu of Arubu" (*i.e.* Arabia). Hence, Dr. Winckler says that Mušri cannot mean Egypt here, but is a country in Northern Arabia, apparently simply because Idibi'ilu was an Arab. Now there seems to be no reason for translating Mušri as anything else than Egypt, for the Assyrians at this period were pushing their dominions rapidly down through Palestine. Further, we are not told that Tiglath Pileser conquered Egypt, but only that he appointed an Arabian sheikh as *kīpu* (an officer whose duties were obviously to watch the marches), a most natural and proper person for this purpose. So the new Mušri theory receives no support from the first hypothesis.

(2) Yamani,⁵ the leader of the revolt in Ashdod, flees

before the approach of Sargon *ana ite (mātu) Mušuri ša paš (mātu) Meluḥḥa, i.e.* to the side of Mušuri which borders on Meluḥḥa.¹

If Meluḥḥa be "Sinai, Midian," as Dr. Winckler at first supposed,² there is no reason to assume that Mušuri is a country lying to the east of this district, for if Mušuri be translated "Egypt," such an identification entirely agrees with the Assyrian geographical description of the southern Mušri. Besides, the most natural route for Yamani, who was fleeing from Ashdod before the Assyrian army advancing through Palestine from the north, led straight into Egypt, and not into Arabia, directly across the enemy's line of advance.

(3) Dr. Winckler argues that the Pir'u (spelt with the determinative prefix of persons and not officials) mentioned in the Assyrian texts³ is not Pharaoh, as Schrader supposed, but the proper name of a sheikh of his North Arabian Mušri, since he is once spoken of as *maliku*. But Pir'u is certainly called *šarru* in the same inscription, so this cannot be considered of any great importance. It was about this time that the Assyrians of the later Empire were coming into actual contact with the Southern Mušri. Tiglath Pileser III., who pressed as far as its borders, mentions no king by name, but Sargon speaks of its king as Pir'u, evidently understanding it as a proper name. Now, we have an exact parallel to this in the Old Testament, where the Hebrews first speak of the King of Egypt as Pharaoh, evidently understanding it as a proper name, but later mention him either by name (Shishak), or with the addition of the royal title (Pharaoh-Necho, Pharaoh-Hophra). Further, in the last of the three texts quoted below in note³, there is surely no doubt that Haziti is Gaza, Rapiḥi is Raphia, and Sib'i is So (=Sēwe); and, these being granted, there is little to be gained by inventing an Arabian Mušuri, when "Egypt" is the obvious explanation of the name. From this third line of argument, therefore, the new theory obtains no support.

(4) In the account of Sennacherib's battle at Eltekeh,

¹ It is doubtful whether any such meaning as "included in" or "belonging to" can be safely attached here to *ša paš*. Dr. Winckler's additional examples carry no weight (footnote, AOF, i. 27); the first, "Aphek im gebiete der provinz Samaria," rests on a misreading of *Samer[na] for Samena . . .* or much less probably *Sameru . . .* This name was copied *Samena . . .* by Dr. Budge in his *Evarhaddon*, 1880, p. 119, in correction of W. A. L., iii. and TSEA, iv., but this correction is totally ignored by Winckler (*Untersuchungen*, 1890, p. 98), who repeats the old mistake *Samerina*, and apparently did not recognise it until his publication of *Mušri, Meluḥḥa, Ma'tu* (1893, p. 3). Dr. Budge's translation, "Aphek, which borders on the country of Samena," still holds good, inasmuch as no suitable identification for Samena has been suggested (Winckler's later suggestion, *Šimcon*, being doubtful). Even if it were Samaria, the translation "On the borders of Samaria" would quite agree with the geographical position of Aphek. His second example is "Pillatu ša paš Ilamti Tigl. 14 (i R 67)" (read "Pillatu ša paṣti Ilamti Tigl. 14 (ii R 67)"). As we do not know the exact locality of Pillutu, it is impossible to base any theories on the meaning of *ša paš* here, for the city in question may have been on the border of Elam.

² *Alt. Forsch.*, i. 27. We shall refer to Dr. Winckler's later theory that Meluḥḥa = Yaman further on.

³ *Mušri, Meluḥḥa, Ma'tu*, 1893, p. 2. Cf. (a) "Philistia, Judah, Edom and Moab . . . had brought presents to Pir'u, king (*šar*) of Mušri, a chief (maliku) who could not save them." (b) "Of Pir', king of Mušri, Samsi, queen of Arribi It'amra of Saba'al, kings of the side of the sea and the desert . . . their tribute I received." (c) "Hanunu, king of Haziti, with Sib'i the tartan of Mušuri to the city of Rapiḥi to battle came against me; their defeat I accomplished. Sib'i feared the clash of my weapons and fled away, and his place was no more seen. Hanunu, king of Haziti, in hand I captured. The tribute of Pir'u," &c.

¹ *Altorientalische Forschungen*, i. 24.

² *ibid.*, 316f.

³ *Annals*, l. 225, &c.; Winckler, *Alt. Forsch.*, i. 25.

⁴ *Annals*, l. 240.

⁵ Winckler, *Sargon*, Pt. I. 102; *Alt. Forsch.*, i. 27.

Dr. Winckler¹ considers the Muşur, which is here mentioned with Meluḫḫa as coming to the help of the Ekronites, to be the so-called North Arabian country, and not Egypt. But Egypt was the natural ally of Palestine, and there is no reason to suppose that the Muşur here mentioned is anything else but Egypt, especially as the scene of the battle was Eltekeh, which is either in or near Philistia.

(5) Dr. Winckler finds support for his Arabian Muşri² in a Himyaritic text (Glaser, 1155 = Halévy, 535) which mentions *Msr.*, *ʿAṣr*, *ʿabr nhrn*,³ and *Mdi*. *ʿAṣr* is mentioned elsewhere in the Himyaritic inscriptions (Glaser, 1083). The former of these inscriptions was assigned by Hartmann⁴ to the year of the conquest of Egypt by Cambyses (525 B.C.), and there is little doubt that this dating is correct. *Msr* undoubtedly refers to Egypt; *Mdi*, of which Dr. Winckler gives no explanation, is, as far as we can judge at present, Media; while the identification of *Aṣr* is as yet uncertain. Hartmann has shown that the speculations of Hommel as to the possibility of this inscription dating back to the time of the eighteenth Egyptian dynasty (c. 1500 B.C.) are without foundation, and the same may be said for the theory promulgated by Dr. Winckler, according to whom this text gives a hint of the wars of the people of Maʿin (= Meluḫḫa) and its supposed northern dependency, his imaginary Muşri, against the Assyrians in Southern Palestine in the eighth century B.C.⁵ The explanation of Hartmann is entirely sufficient; and no proof of the existence of an Arabian Muşri can be found in the Minæan inscriptions. It may be noted that Dr. Winckler does not accept the obvious meaning of the term *ʿabr nhrn*, "across the river," i.e. in the eyes of the Arabs Persia, an explanation which entirely fits in with Hartmann's chronological theory.

(6) Dr. Winckler, however, has finally brought forward evidence which, on the face of it, seems good. He maintains that the small fragment of Assyrian tablet 83-1-18, 836 (which mentions Esarhaddon) proves the existence of Muşri as distinct from Mişri, i.e. Egypt. It "wird durch seine nebeneinanderstellung von Muşri und Mişri d.h. von unserem Muşri und Ägypten," he says, "ja wol wenigstens die auseinanderhaltung beider länder von nun an bewirken," and he has attached such importance to it that he has published it in full.⁶ Unfortunately, besides one or two other bad blunders⁷ in a small text of six fragmentary lines, he has misread the one sign which was of importance to his theory.

In the fourth line Dr. Winckler reads, . . . mā[*tu* Mu-*u*-*ṣ*-*r*i u mātu Mi-*i*-*ṣ*-[*ri* . . .], thus proving to his own satisfaction that Muşri and Mişri were two distinct countries. But the *i*ṣ in Mi-*i*-*ṣ*-[*ri*] ends at the break in the clay, and even from the very slight traces that remain, it is certain that the character is not *i*ṣ. Taking into consideration the common conjunction of the country *Miluḫḫa* with Muşri, so well known to Assyriologists,

there can be no possible doubt that the sign was originally *luḫ*, and not *i*ṣ, and the slight traces that remain (the traces of the top of another vertical wedge) make this hypothesis a certainty. Thus Dr. Winckler's attempted proof of a mention in Assyrian literature of a Muşri side by side with Mişri (Egypt) falls to the ground.

Dr. Winckler has therefore furnished no proof whatever of the existence of a North Arabian Muşri, and until he does so, it is impossible to believe in the existence of a Muşri other than Egypt and the well-known country in Northern Syria.

Apart from these matters, Dr. Paton has evidently spent much time and trouble on his book, and although he has been influenced in too great a degree by the school of Hommel, his compilation will probably be found useful. Both Dr. Paton and Dr. Duff have added an excellent index to their books, and if only they had had a wider acquaintance with the languages of Assyria and Egypt, they would probably have been able to speak in less uncertain tones of the results obtained from the study of cuneiform and hieroglyphic texts.

R. C. T.

OUR BOOK SHELF.

The Elementary Principles of Chemistry. By A. V. E. Young. Pp. xiv + 252 + 106. (London: Hirschfeld Brothers, Ltd., 1902.) Price 5s. net.

THIS book, which is of American authorship, provides an elementary course of inorganic chemistry based upon the quantitative system. There is a theoretical part, an experimental part, and an appendix giving hints on manipulation. The student is to perform the experiments, make notes, and then to turn to the theoretical part for fuller information on the topic of his experiments, the teacher supervising each portion of the work.

The author expresses the hope that his book will contribute "to making practicable and serviceable that which he enthusiastically believes is both scientifically and pedagogically an improvement on the older and still largely prevailing method." An examination of the book leads to the belief that this hope will be fulfilled, for there can be no doubt that the author is imbued with real educational zeal, and that he has bestowed much care and thought upon the arrangement of an excellent sequence of experiments illustrative of the main principles of chemistry.

A. S.

P.O.P. (The Use of Silver Printing-out Papers). By A. Horsley Hinton. Pp. 134. (London: Hazell, Watson and Viney, Ltd., 1902.) Price 1s. net.

SILVER printing-out papers are now so extensively used that a small volume like this cannot fail to be useful to a large number of those who practise photography. There is nothing particularly original in it, but a practical and successful photographer like the author cannot set down a series of instructions without giving many a useful hint. Current photographic literature and manufacturers' "instructions" furnish an almost endless variety of formulæ for the treatment of printing-out papers; it will therefore be distinctly advantageous to those whose experience of such papers is not large to have a small collection of selected formulæ such as is here given. The illustrations that show the extent of over printing necessary to compensate for the loss by toning and fixing, and the kind of negative best suited for these processes, will be very welcome to the beginner. It would have been but little trouble to provide an index, the advantage of which in a book of practical instructions it is not necessary to point out.

¹ *Altor. Forsch.*, i. 27.

² *Muṣri, Meluḫḫa, Maʿin*, p. 20.

³ = ʿabr ha-nahar (Winckler) [hannahar].

⁴ *Zeits. für Assyriol.*, x., 32.

⁵ *Muṣri, Meluḫḫa, Maʿin*, 18.

⁶ *Muṣri, Meluḫḫa, Maʿin*, p. 2.

⁷ For *pa-na* read [DINGIR].ALAD (L. 3), and add a determinative prefix to the proper name in l. 5. Read *ina* *lu-ḫi* after *ṣa* in l. 3.

LETTERS TO THE EDITOR.

[The Editor does not hold himself responsible for opinions expressed by his correspondents. Neither can he undertake to return, or to correspond with the writers of, rejected manuscripts intended for this or any other part of NATURE. No notice is taken of anonymous communications.]

Symbol for Partial Differentiation.

In his first letter (p. 53), Prof. Perry very properly drew attention to the desirability of greater definiteness in the notation for partial differential coefficients in the case of functions of two variables, the essence of his remarks being that it is not enough merely to change d into ∂ , but that the variable which is for the nonce held to be constant should also be indicated. Apropos of this, and for the sake of historical interest, I quoted from a paper since published (*Proc. R.S. Edinb.* xxiv, pp. 151-194) a short paragraph regarding a passage¹ in Jacobi's writings of the year 1841, and containing a footnote with an old suggestion on the matter of notation. In his second letter (p. 271), Prof. Perry undertakes to show that this latter notation is objectionable so far as thermodynamics is concerned, and not to be compared with that which he himself uses. I regret to have to say that I was quite satisfied with his notation, and had no intention whatever of bringing the two into comparison, mine having been designed for much more complicated cases than those which occur in ordinary text-books on thermodynamics. His words are—

"I use one letter E where on Mr. Muir's suggestion I must use six distinct symbols if I have to express any differential coefficient of E , and if I have to express all the differential coefficients of v I must use other six symbols; altogether I must use thirty of these curious symbols instead of five common letters, and, furthermore, I must keep them all in my head."

This is, of course, all a mistake. Without any desire, therefore, to spare Prof. Perry's head, but merely in order to undo a misrepresentation, however unwitting, I am forced to point out that if we are to have a perfectly definite notation in this connection, we must indicate three things, viz. (1) the dependent variable E ; (2) the two independent variables, say v and ϕ ; and (3) whether the differentiation is to be performed with respect to v or ϕ . Now, in the notation of my last letter these three are all cared for, thus

$$E \frac{\partial}{\partial v, \phi};$$

or, since a vinculum contributes a "curious" look to the symbol, let it be written

$$E \frac{\partial}{\partial (v, \phi)}.$$

The notation used by Prof. Perry, viz.

$$\left(\frac{dE}{dv} \right)_{\phi}$$

is a trifle lengthier, but, as I have said, is equally definite, the main difference between the two arising from the fact that in the matter of differentiation he is a "dec-ist"; it is, however, excessively cumbersome when used in the complicated cases for which the other was designed. THOMAS MUIR.

Cape Town, South Africa, August 9.

It would have been presumption on my part to express my private opinion, which is in favour of Dr. Muir's symbol in general mathematical work, and so I referred merely to its use in thermodynamics where I think that such a use would be bad.

The form he now gives is handier, being a mnemonic for my symbol, but I submit that it is different from what he would use in other applications of mathematics. According to his general

system, $\rho \frac{\partial}{\partial (v, \phi)}$ implies that there is a function of v and ϕ called

$\rho(v, \phi)$ which is differentiated. But $\rho \frac{\partial}{\partial (t, E)}$ implies that there is a function $\rho(t, E)$, and in thermodynamics $\rho(v, \phi)$ is always

¹ Well worth reading. It begins at "Ut distingueretur," on p. 320, and ends at bottom of p. 322 of vol. xxii. of *Crelle's Journal*.

equal to $\rho(t, E)$. If ρ is a functional symbol there can be no such equality, and I still think that the forms in which I put Dr. Muir's suggestion were the only ones consistent with his instructions. The new form would give no great trouble to a good mathematician perhaps, but it would quite unsettle the ordinary student of thermodynamics.

A man who insists on "dec-ism" in those parts of higher mathematics where it is clumsy is an obstacle to progress. But if Dr. Muir had my experience in dealing with men who know only a little mathematics and who wish to use what they know, he would, I think, be a "dec-ist" in elementary work.

JOHN PERRY.

PROF. JOHN JAMES HUMMEL.

JOHN JAMES HUMMEL was born in 1850 at Clitheroe, in Lancashire. His father was a native of Switzerland and his mother English.

His scientific education was obtained at the Zurich Polytechnic, where he studied under Bolley, Stadeler, Wislicenus and Weith. On returning to England in 1870, he became chemist in the calico printworks of Messrs. Jas. Black and Co., of Alexandria, near Glasgow, and remained there six years, busily and successfully engaged with new dyeing problems incident to the introduction of artificial alizarine and other coal-tar dyes. He was subsequently connected with other printing and dyeing firms, until in 1879 he decided to gratify his taste for science and teaching by applying for the post of Instructor in the dyeing department established at the Yorkshire College by the Clothworkers' Company of London. On taking up work at the College, Hummel applied himself with the utmost assiduity to devising and developing a system of instruction in dyeing. In this difficult undertaking he relied upon his own ideas, and he will always rank as a pioneer in this branch of teaching. He was a firm believer in the value of pure science, and always protested against that superficial teaching of technology too often attempted in compliance with the wishes of self-styled practical men. The course of teaching which he devised has been adopted very widely in this country and has attracted much attention abroad. The Dyeing School at the Yorkshire College has drawn students from all parts of the world.

Hummel's original contributions to his subject have always been marked by mastery of the subject in hand and scrupulous attention to detail. The burden of teaching and administrative duties severely restricted his time for experimental investigations, but his desire to have such work in progress in his department was gratified in the most handsome way by the Clothworkers' Company, which has associated a research chemist with the professor of dyeing.

The last few years of Hummel's life were devoted to the planning and organisation of important extensions of his department, which is now in possession of extremely ample and well-appointed buildings. In this, as in all other work, Hummel did not spare himself, and the strain doubtless told upon his health.

As an expert on his subject, Hummel was in constant demand. He lectured occasionally on important developments of dyeing before the Society of Arts, the Imperial Institute and other institutions, and he was a juror at the last Paris Exhibition. As an author, he was best known by his admirable text-book of dyeing, which has had a very large circulation and has been translated into a great variety of languages.

His labours have done much for the college with which he was associated and for the important industry that he so earnestly desired to serve. Fortunately, he has left a large number of disciples who, in different parts of the world, are carrying on the work which he originated.

A. S.

THE BRITISH ASSOCIATION AT BELFAST.

THE Belfast meeting of the British Association was concluded as we went to press last week. The weather during the meeting was not all that might have been desired, but both the local committee and the visitors have reason to be thankful that the deluge which flooded Belfast a few days before the opening meeting did not occur a few days later.

The flags of the presidents were in imminent danger of destruction on account of this flood. They had been placed on a table in the Grosvenor Hall ready to be hung up for the opening address, and were saved only by the timely action of the Rev. Mr. Kerr, who divesting himself of some of his clothing, waded in to their rescue. The water afterwards rose to a height of several feet in the Hall, an occurrence never before experienced there.

With the exception of the garden party given by the local executive committee in the Botanic Gardens Park, when the rain came punctually at the hour named on the cards and departed with the guests, all the other outdoor functions went off with nothing more than a sprinkle or two.

The garden parties of the Earl and Countess of Shaftesbury and of Lord and Lady O'Neill at their picturesque residences were favoured with dry but cool afternoons, as was also that of Mr. and Mrs. J. Brown. This last included a visit to the linen factory of Mr. G. Herbert Brown, and an inspection of Mr. Brown's physical laboratory and of various applications of electric power to domestic appliances, among which an electrically driven lawn mower and the ice-making, knife-cleaning and meat-chopping machines in the kitchen offices seemed to attract most attention. The excursions arranged for Saturday were well attended, as also were those planned by the Belfast Naturalists' Field Club for the Thursday after the meeting.

General and warm approval has been expressed regarding the arrangements made by the local officials for the reception and comfort of the members, and although these were smaller in number than on the last occasion, this was not due to any falling off in those visiting Belfast, but rather to the apathy of local people, judging by the smaller number of associates' and ladies' tickets issued, as shown by the following table:—

Old Life Members	1874	...	1902
New	"	162	...	243
Old Annual Members	13	...	21
New	"	232	...	314
Associates	85	...	84
Ladies	817	...	647
Foreign Members	630	...	395
				12	...	6
				1951	...	1620

It has been questioned whether this falling off, especially in the number of ladies' tickets, may not be ascribed in a considerable degree to the educational methods of Ireland and their effect on the tastes of those brought up under their influence within the last thirty years.

The educational note struck in the admirable Presidential Address of Prof. Dewar seemed to ring through the entire proceedings, and not only in the new Section devoted to the subject, but in joint discussions, and notably in the excellent address of Prof. Perry in Section G, do we find this question prominent. New opinions seem to be growing, and among these are the ideas that the English public-school system must be relegated to the limbo of inefficiency and that the technical school of the kind made in Germany is all very well over there, but almost useless here.

From a scientific point of view, the meeting was without doubt an admirable one. Many important papers were brought before the sections.

At the concluding meeting of the Association, the following votes of thanks were unanimously adopted:—

(1) To the Lord Mayor and Corporation for their reception of the Association; to the President and Council of the Queen's College, the Presbyterian College, the Methodist College and the Elmwood Presbyterian Church for the use of rooms; and to the Harbour Commissioners for their reception. (2) To the local secretaries—Mr. John Brown, Mr. Ferguson and Prof. Fitzgerald—Dr. Kyle Knox (the local treasurer) and the local committee for the excellent arrangements made for the reception of the Association in Belfast. (3) To the noblemen, gentlemen and public bodies who have entertained the Association; to the firms who have opened their works; to the citizens who have hospitably entertained members; to the gentlemen who have contributed to the success of the excursions; to the committees of clubs, libraries and other institutions who have opened their premises to the members of the Association; to the Belfast Tramway Company; and to the Belfast Press, for their admirable reports of the proceedings.

A noteworthy event of the meeting was the speech given by Prof. C. S. Minot, President of the American Association, in which he invited members of the British Association to attend the meeting to be held early next January at Washington. Prof. Minot said he had been directed by the council of his Association to express the hope that as many members as possible of the British Association would attend the Washington meeting. A vote had been passed to the effect that all members of the British Association would be received upon presenting themselves at the meetings in America as members of the American Association without further requirement. In future, as has already been announced in these columns, the annual meetings of the American Association will begin on the first Monday after Christmas and extend throughout the week. The scientific societies affiliated with the Association have agreed to this arrangement, and the universities have consented to the establishment of this "Convocation Week," in which the meetings of scientific societies are to be held. It is expected that the first meeting to be held next January under this rule will be the most important scientific gathering ever held in America. In the course of his remarks, Prof. Minot said:—

It was the duty, he believed, which they should all perform to attend these gatherings and take part in international intercourse. Many Americans had come to the British Association, and they had always been treated with the greatest hospitality. They arrived strangers and went away friends; they brought expectations, and took back realisations and a grateful memory. He asked for one moment in which to remind them of a new historic condition never existing in the world before. It was the first time that two great nations existed with a common speech, a common past, a common history; would they not therefore so work together that they might build up a common future? And for the scientific man this duty came first. Each nation was governed, not by the Government, but by the men of learning and above all by the universities. Nowhere, he believed, in the Anglo-Saxon world had science yet taken its place in the universities. Nowhere in the Anglo-Saxon world had the full value of scientific knowledge throughout the whole range of life, from the university down to every practical affair—nowhere, he said, had the full power of the world of science been established.

Prof. Dewar, in replying on behalf of the Association, said:—

They were all delighted to hear the kind invitation which had been extended to the members of the Association by their brother workers on the other side of the Atlantic. The great blunder we in the United Kingdom were perpetrating for many years past was in remaining ignorant of what was being done on the other side of the Atlantic. He had again and again said to manufacturers and those interested in industrial progress that if they would subsidise their chief officials by a donation which would enable them to spend their short holiday by going to see what

could be seen during a three weeks' residence in the United States, to note how they economise time there, how a person could be transferred from place to place, the freedom with which one is allowed to see the great internal organisation—if they did that they would be repaid one-hundredfold. He did not know of anything that had occurred to himself personally which had affected him so much as a short visit which he had the honour of paying to America. Both in the universities and in applied industries it was a revelation to him, and he was sure it would be a personal gratification to every member of that Association, and an entirely new revelation to them, if they took advantage of the invitation offered. He hoped some of the officials of the British Association would be present on the great occasion in Washington.

In bringing the meeting to a close, Prof. Dewar referred to the work of Joseph Black, Thomas Andrews, James Thomson, Lord Kelvin and Prof. Tait, who were connected with Belfast and had given it a leading place in scientific history.

SECTION D.

ZOOLOGY.

OPENING ADDRESS BY PROF. G. B. HOWES, D.Sc., LL.D., F.R.S., PRESIDENT OF THE SECTION.

The Morphological Method and Progress.

It is now twenty-eight years since this Association last assembled in Belfast, and to those present who can recall the meeting the proceedings of Section D will be best remembered for the delivery of an address by Huxley "On the Hypothesis that Animals are Automata, and its History," one of the finest philosophic products of his mind. At that date the zoological world was about to embark on a period of marked activity. Fired by the influence of the "Origin of Species," which had survived abuse and was taking immediate effect, the zoological mind, accepting the doctrine of evolution, had become eager to determine the lines of descent of animal forms. Marine observatories were in their infancy; the *Challenger* was still at sea; the study of comparative embryology was but then becoming a science; and when, reflecting on this, we briefly survey the present field, we can but stand astonished at the enormity of the task which has been achieved.

Development has proceeded on every hand. The leavening influence, spreading with sure effect, has in due course extended to the Antipodes and the East, in each of which portions of the globe there has now arisen a band of earnest workers pledged to the investigation of their indigenous fauna, with which they are proceeding with might and main. Of the Japanese, let it be said that not only have they filled in gaps in our growing knowledge, for which they alone have the materials at hand, but that, with an acumen deserving the highest praise, they have put us right on first principles. I refer to the fact that they have shown, with respect to the embryonic membranes of the common chick, that we in the West, with our historic associations, our methods and our skill, contenting ourselves with an ever-recurring restriction to the germinal area, have, by an error of orientation, missed an all-important septum, displaced under an inequality of growth.

Those of us who have lived and worked throughout this memorable period have had a unique experience, for never has there been progress so rapid, accumulation of observations so extensive and exact. Of the 386,000 living animal species, to compute the estimate low, every one available has been lain under hand, with the result that our annual literary output now amounts to close upon 10,000 contributions, the description of new genera and subgenera, say 1700. More than one-half of this vast series refers to the Insecta alone; but notwithstanding this, the records of facts of structure and development, with which most of us are concerned, now amount to a formidable mass, calculated to awe the unlettered looker-on, to overwhelm the earnest devotee, unless by specialising he can secure relief. As an example of what may occur, it may be remarked that a recent exploration of the great African lakes has resulted in the discovery of over 130 new species.

As to the nature of this unprecedented progress, it will suffice to consider the Earthworms. In 1874 few were known to us. An advance in our knowledge, which had then commenced, had made known but few more which seemed likely to yield result. Darwin's book upon them had not appeared. Some were exotic, it is true, but no one suspected that a group so restricted in their

habits could reveal aught beyond a dull monotony of form and structure. Never was surmise more wide of the mark, for the combined investigations of a score of earnest workers in all parts of the world have in the interval recorded some 700 odd species of about 140 genera. Mainly exotic, they exhibit among themselves a structural variation of the widest possible range. Not only do we recognise littoral and branchiate forms, but others, achetous and leech-like in habit, to the extent of the discovery of a morphological overlap with the leeches, under which we are now compelled to remove them from their old association with the flat worms, and to unite them with the earthworms. And we even find these animals, as represented by the *Acanthodrilide*, coming prominently into considerations which involve the theory of a former Antarctic continent, one of the most revolutionary zoo-geographical topics of our time.

This case of the earthworm may be taken as typical of the rest, since for each and every class and order of animal forms, the progress of the period through which we have passed since last we assembled here has produced revolutionary results. Our knowledge of facts has become materially enhanced; our classifications, at best but the working expression of our ideas, have been to a large extent replaced in clearer, more comprehensive schemes; and we are to-day enabled to deduce, with an accuracy proportionate to our increased knowledge of fact, the nature of the interrelationships of the living forms which with ourselves inhabit the earth.

Satisfactory as is this result, it must be clearly borne in mind that its realisation could not have come about but for a knowledge of the animals of the past; and turning now to palæontology, it may be said that at the time of our last meeting in this city the scientific world was just becoming entranced by the promise of unexpected results in the exploration of the American Tertiary beds, then being first opened up. The Rocky Mountain district was the area under investigation, and with this, as with the progress in our knowledge of recent forms, no one living was prepared for the discoveries which shortly came to pass. To consider a concrete case, we may premise that study of the placental mammals had justified the conclusion that their ancestors must have had equal and pentadactyle limbs, a complete ulna and fibula, a complete clavicle, and a skull with forty-four teeth; must have realised, that is, the predominant term of the living Insectivora as generally understood. Who among the zoologists of our time does not recall with enthusiasm the revelation which arose from the discovery, during these early days, in the Eocene of Central North America, of the genera at first described as *Eo-* and *Helohyus*? The evidence of the existence, in the locality named, of these forty-four toothed peccaries, as they were held to be, rendered clearer the records of the later Tertiary deposits of the old world, which were those of hogs, and, in correlation with the facts then known, suggested that the Rocky Mountain area was the home of the ancestral porcine stock, and that in Early Tertiary times their descendants must have migrated, on the one hand, across the northern belt, of which the Aleutian Islands now mark the course, into the old world, to beget, by complication of their teeth, the pigs and hogs; and on the other into Central South America, to give rise, by numerical reduction of teeth and toes, to the peccaries, still extant.

Migration in opposite directions with diversity of modification was the refrain of this remarkable find, far-reaching in its morphological and zoo-geographical effects. Nor can we allude with less fervour to the still more striking case of the horses, which proved not merely a similar, though perhaps a later, migration, but a parallelism of modification in both the old and new worlds, culminating in the latter in extinction, whereby it became necessary, on the advent of civilised man, to carry back the old-world horse to its ancestral American home. No wonder that this should have provoked our Huxley to the remark that in it we have the "demonstrative evidence of the occurrence of evolution," and that the facts of palæontology came to be regarded as certainly not second to those of the fascinating but seductive department of embryology, at the time making giant strides.

I have endeavoured thus to picture that state of zoological science at the time of our last meeting here; and I wish now to confine myself to some of the broader results since achieved on the morphological side. But let us first digress, in order to be clear as to the meaning of this phrase.

We do not expect the public to be accurate in their usage of scientific terms; but it is to me an astounding fact that among trained scientific experts, devotees to branches of science other than our own, there exists a gross misunderstanding as to the

limitations of our departments. I quote from an official report in alluding to "comparative anatomists, or biologists, as they call themselves," and I but cite the words of an eminent scientific friend, in referring to biology and botany as coequal. In endeavouring to get rid of this prevailing error, let it be once more said that the term "biology" was introduced at the beginning of the nineteenth century by Treviranus and Lamarck, and that in its usage it has come to signify two totally distinct things as employed by our continental contemporaries and ourselves. By "Biologie" they understand the study of the organism in relation to its environment. We, following Huxley, include in our term biology the study of all phenomena manifested by living matter; botany and zoology; and by morphology we zoologists mean the study of structure in all its forms, of anatomy, histology and development, with paleontology—all of all; that is, which can be preferably studied in the dead state, as distinct from physiology, the study of the living in action. Comparative morphology, the study of likeness and unlikeness, is the basis of our working classifications, and it is to the consideration of the morphological method, and the more salient of its recent results, that I would now proceed, in so far as it may be said to have marked progress and given precision to our ideas within the last eight-and-twenty years. I would deal in the main with facts, with theories only where self-evident, ignoring that type of generalisation to which the exclusive study of embryology has lent itself, which characterises, but does not grace, a vast portion of our recent zoological literature.

To the earnest student of zoology, intent on current advance, the mental image of the interrelationships of the greater groups of animal forms is ever changing, kaleidoscopically it may be, but with diminishing effect in proportion as our knowledge becomes the more precise.

Returning now to American paleontology, we may at once continue our theme. In this vast field, expedition after expedition has returned with material rich and plentiful; and while, by study of it, our knowledge of every living mammalian order, to say the least, has been extended, and in some cases revolutionised, we have come to regard the Early Tertiary period as the heyday of the mammals, in the sense that the present epoch is that of the smaller birds. No wonder then that there should have been discovered group after group which has become extinct, or evidence that in matters such as tooth-structure there is reason to believe that types identical with those of to-day have been previously evolved but to disappear. To contemplate the discovery of the Titanotheria, the Amblyopoda, the Dinocerata, with their strange diminutive brain, chief among the heavier ungulate forms, is to consider the Mammalia anew; and when it is found that among late discoveries we have (1) that of a series of Rhinocerotidae, which though not yet known to extend so far back in time as the primitive tapirs and horses are complete as far as they go; (2) that among the Ruminants we have, in the Oreodontidae of the American Eocene, primitive forms with a dentition of forty-four teeth, an absence of diastemata, a pentadactyle manus, a tetradactyle pes with traces of a hallux, and, as would appear from an example of Mesoreodon, a bony clavicle, which is unknown in any later ungulate, we are aroused to a pitch of eager enthusiasm as to the outcome of labours now in hand; for, as I write, there reaches me a letter to the effect that for most of the great vertebrate groups, and not the mammals alone, collections are still coming in, each more wonderful than the last.

In the extension of our knowledge of the Ancylopoda, an order of mammals named after the Ancylotherium of Pikermi and Samos, which occur in the Early Tertiary deposits of Europe, Asia, North America and abundantly in Patagonia, we have been made aware of the existence of genera whose salient structural features combine the dentition of an ungulate with the possession of pointed claws, believed to have been retractile like those of the living cats. Conversely to these ungulate herbivores, which include genera with limbs on both the artio- and perisso-dactyle lines, there have been found, among the so-called Mesonychia, undoubted primitive carnivores, indications of a type of terminal phalanx seal-like and approximately non-ungulate; from all of which it is clear that we have in the rocks the remains of forms extinct which transpose the correlations of tooth and claw deducible from the living orders alone. Further, among the primitive pentadactyle Carnivora we meet, in the genus Patriofelis, with a reduction of the lower incisors to two, and characters of the fore-limb which, with this, suggest the seals. It is, however, probable that these characters are in

no way indicative of direct genetic relationship between the two, for, inasmuch as these animals were accustomed to seek their food in the water of the lake by which they dwelt, their seal-like characters may be but the expression of adaptation to a partially aquatic mode of life—of parallelism of modification with the seals and nothing more.

Early in the history of their inquiry, our American confrères recorded from the Pliocene the discovery of camel-like forms possessed of a full upper incisor dentition; for example, the genera *Protolabis* and *Ithygrammodon*; and now they have arrived at the conclusion that while the camels are of American origin, one of their most characteristic ruminants, the Prongbuck (*Antilocapra*), would conversely appear to be the descendant of an ancestor (*Blastomeryx*) who migrated from the old world.

Sufficient this concerning the work in mammalogy of the American paleontologists. While we return them our devout and learned admiration, we would point out that the brilliance of their discoveries has but clouded the recognition of equally important investigations going on elsewhere. In Argentina there have proceeded, side by side with the North American explorations, researches into the Pleistocene or Pampa fauna, which in result are not one whit behind, as has been proved by the recognition of a whole order of primitive ungulates, the *Toxodontia*, by that of toothed cetaceans with elongated nasals, as in the genera *Proqualodon* and *Argyrocetus*, and of sperm whales with functional premaxillary teeth, viz. *Physonod* and *Hypocetus*, to say nothing of giant armadillos and pigmy glyptodonts.

It will be remembered by some present that, from Patagonian deposits of supposed Cretaceous age, there was exhibited at our Dover meeting the skull of a horned chelonian *Mielolania*, which animal, we were informed, is barely distinguishable from the species originally discovered in Cook's Island, one of the Society group, and which, being a marsh turtle highly specialised, would seem in all probability to furnish a forcible defence for the theory of the Antarctic continent. But more than this, renewed investigation of the Argentine beds by the members of the Princeton University of North America have recently resulted in collections which, we are informed, seem likely to surpass all precedent in their bearings upon our current ideas, not the least remarkable preliminary announcement being the statement that there occurs fossil mole indistinguishable, so far as is known, from the golden mole (*Chrysochloris*) of South Africa.

Before I dismiss this fascinating subject, let me disarm the notion, which may have arisen, that the paleontological work of the old world is done. Far from it! Even our American cousins have to come to us for important fossil forms; as, for example, the genus *Pliohyax* of Samos and the Egyptian desert, while among the rodents and smaller carnivores there are large collections in our national museum waiting to be worked over afresh.

If one part of the globe more than another is just now the centre of interest concerning its vertebrate remains, it is the Egyptian desert. Here there have recently been found the bones of a huge cetacean associated, as in South America, with those of a giant snake, one of the longest known, since it must have reached a length of thirty feet. There also occur the remains of other snakes, of chelonians of remarkable adaptive type, of crocodilians, fishes and other animals. Interest, however, is greatest concerning the Mammalia, which for novelty are quite up to the American standard, as with an upper and a lower jaw of an anomalous creature, concerning which we can only at present remark that it may be a marsupial, or more probably a carnivore, which has taken on the rodent type in a manner peculiarly its own. Important beyond this, however, are a series of Eocene forms which more than fill a long-standing gap, viz., that of the ancestors of the Elephants and Mastodons, which hitherto stopped short in the Middle Miocene of both old and new worlds. As represented by the genus *Meritherium*, they have three incisors above and two below, of which the second is in each case converted into a short but massive tusk. An upper canine is present, and in both upper and lower jaws a series of six cheek-teeth, distinct and unodont in type. In the allied *Barytherium*, of which a large part of the skeleton is known, the upper incisors were presumably reduced to two, the tusks enlarged, with resemblances in detail to the Dinoceratan type.

So far as these remains are known, they appear to present in their combined characters all that the most ardent evolutionist

could desire. There are with them Mastodons which simplify our knowledge of this group; and among the last discovered remains Sirenians, which, in presenting a certain similarity to the afore-named *Mæritherium*, strengthen the belief in the proboscidean relationships of these aquatic forms. Finally, and perhaps most noticeable of all, there is the genus *Arsinoitherium*, a heavy brute with an olfactory vacuity which outrivals that of *Grypotherium* itself, and is surmounted by a monstrous fronto-nasal horn, swollen and bifid, for which the most formidable among the Titanotheres might yearn in vain. There is an occiput to match! The suggestion that this extraordinary beast has relationships with the Rhinocerotidae is absurd, since its tooth pattern alone inverts the order of this type. That it is a proboscidean may be nearer the mark, and if so it shows once more how subtle were the mammals of the past. Great as is this result, much remains to be done or done again, if only from the fact that in seeking to determine homologies our American brethren, in the opinion of some of us, have placed too much reliance on a so-called tritubercular theory of tooth genesis, of which we cannot admit the proof. How, we would ask, is it conceivable that a transversely ridged molar of Diprotodon type can be of tritubercular origin?

Sufficient for the moment of palæontological advance, except to remark that the zoologist who neglects this branch of morphology misses the one leavening influence; neglects the court on whose ruling arguments deduced from embryological data alone must either stand or fail. We may form our own conclusions from facts of the order before us; but it is when we find their influence on the master-mind prompting to action, like that of Huxley with his mighty memoir of 1880, in which he revised our subclass terms, that we appreciate them to the full.

With this consideration we pass to the living forms, and I have only time in dealing with these to comment on advance which affects our broadest conceptions and classifications of the past.

To commence with the Mammalia, we now know that the mammary gland when first it appears is in all forms tubular, and that this type is no longer distinctive of the Monotremata alone. We know, too, that the intranarial position of the epiglottis when at rest, long known for certain forms, is a distinction of the class. It explains the presence of the velum palatinum, by its association with the glottis for the restriction of the respiratory passage, the connection being lost in man alone, under specialisation of the organ of the voice.

Similarly, the doubly ossified condition of the coracoid may now be held diagnostic, for it is known that the epicoracoidal element, originally thought to characterise the monotremes alone, is always present, and that reduction to a varying degree characterises the metacoracoid, which retires, as in man, as the so-called coracoid epiphysis.

Our conceptions of the interrelationships of the Marsupialia and Placentalia have during the period we are considering been delimited beyond expectation, by the discovery of an allantoic placenta in a polyprotodont marsupial, in place of the vitelline, present in its allies. When it is remembered that in the formation of the placenta of the rabbit and a bat there is realised a provisional vitelline stage, it is tempting to suggest that the evidence for the direct relationship of the two mammalian subclasses first named overlaps (there being a placental marsupial on the one hand, a marsupial placental on the other), such as we have come to regard *Archæopteryx* as an avian reptile, the *Odontornithes* as reptilian birds. These facts, moreover, prove that the type of placenta inherited by the Placentalia must have been discoidal, and that from that all others were derived.

Equally important concerning our knowledge of the Marsupialia is the discovery, first made clear by Prof. Symington, of this College, that Owen was correct in denying them a corpus callosum. How Owen arrived at this conclusion it is difficult to conceive; but in these later days the history of discovery is largely that of method; and it is by the employment of chrome-silver, methylene-blue, and other reagents, which in differentiating the fibre-tracts enable us to delimit their course, that this conclusion has been proved. By the corpus callosum we now understand a series of neo-pallial fibres which transect the alveus and are present only in the Placentalia.

There is no department of mammalogy in which recent work has been more luminous than this which concerns the brain; and, to mention but one result, it may be said that in the renewed study of the commissures there has been found a fibre-

tract characteristic of the Diprotodontia alone, so situated as to prove that they and the Placentalia must have specialised on diverse lines from a polyprotodont stock. Interesting this, the more, since the phalangers and kangaroos are known to be polyprotodont when young. And when we add the discovery that in the detailed relationship of its commissures the brain of the Elephant Shrew, a lowly insectivore, alone among that of all Placentalia known, realises the marsupial state, as does its accessory organ of smell, we have to admit the discovery of annectant conditions just where they should occur.

The morphological method is sound!

The master hand which has given us this result has also reinvestigated the Lemurs. From an exhaustive study of the brain or its cast of all species of the order, living and extinct, there has come the proof that the distinctive characters of the lemuroid brain are intelligible only on a knowledge of the pithecoïd type; that its structural simplicity in the so-called lower lemur is due to retrogressive change, in some species proved to be ontogenetic; and that the Tarsier, recently claimed to be an insectivore, is a lemur of lemurs. It is impossible to over-estimate the importance of this conclusion, which receives confirmation in recent palæontological work; and there is demanded a re-investigation of those early described Tertiary fossil forms placed on the Ungulo-lemuroid border line, as also a reconsideration of current views on the evolution of the primates and of man.

In dismissing the Mammalia, we recall the capture during the period we review of three new genera, a fourth, the so-called *Neomylydon*, having proved by its skull to be *Grypotherium Darwinii*, already known. The African Okapi, an object of sensation beyond its deserts, has found its place at last. To have been dubbed a donkey, a zebra and a primitive hornless giraffe is distinction indeed; and we cannot refrain from contrasting the nonsensical statement that its discovery is "the most important since *Archæopteryx*" with the truth that it is a giraffe, horned for both sexes, annectant between two groups well known. As a discovery it does not compare with that of the Mole-marsupial, and it falls into insignificance beside that of the South American diprotodont *Cœlestes*, the survivor of a family which there flourished in Middle Tertiary times.

Passing to Birds and Reptiles, it will be convenient to consider them together. A knowledge of their anatomy has extended on all hands, and in respect to nothing more instructively than their organs of respiration. Surprise must be expressed at the discovery, in the chelonian, of a mode of advancing complication of the lung suggestive of that of birds. On looking into this, I find that Huxley, who rationalised our knowledge of the avian lung and its sacs, was aware of the fact that in our common Water-tortoise (*Emys orbicularis*), the lung is sharply differentiated along the bronchial line into a postero-dorsal more cellular mass, an antero-ventral more saccular, of which the posterior vesicle, in its extension and bronchial relationships, strangely simulates the so called abdominal sac of birds. He had already instituted comparison with the Crocodiles, and was clearly coming to the conclusion that the arrangement in the bird is but the result of extreme specialisation of a type common to all Sauropsida with a "cellular" lung. The respiratory process in the bird may be defined as transpulmonary, and it is an interesting coincidence that, as I write, there comes to hand a memoir, supporting Huxley's conclusion, and establishing the fact that there is a fundamental principle underlying the development and primary differentiation of all types of vertebrate lung.

The discovery of the *Odontornithes* in the American Cretaceous is so well known, that it is but necessary to remark that nine genera and some twenty species are recognised. To *Archæopteryx* I shall return. Before dismissing the Chelonian, however, it must be pointed out that palæontology has definitely clenched their supposed relationship to the Plesiosaurs. Of all recent palæontological collections there are none which, for care in collecting and skill in mounting, surpass the reptilian remains from the English Jurassic (Oxford Clay) now public in our national museum. The Plesiosaurs of this series must be seen to be appreciated, and nothing short of a merciful Providence can have interposed, to ensure the generic name *Cryptocleidus*, which one of them has received, since the hiding of the clavicle, its diagnostic character, is an accomplished fact. It is due to secondary displacement, under the approximation in the middle line of a pair of proscapular lobes, present in the Plesiosauria and Chelonian alone, and until the advent of this discovery, mis-

interpreted. Taken in conjunction with other characters of little less importance, conspicuously those of the plastron and pelvis, this decides the question of affinity, and proves the Chelonians to have had a lowly ancestry, as has generally been maintained.

Recent research has fully recorded the facts of development of the rare New Zealand reptile *Sphenodon*, and it has more than justified the conclusion that it is the sole survivor of an originally extensive and primitive group, the Rhynchocephalia, as now understood. To confine our attention to its skeleton, as that portion of its body which can alone be compared with both the living and extinct, it may be said that positive proof has been for the first time obtained that the developing vertebral body of the terrestrial vertebrata passes through a paired cartilaginous stage, and that in its details the later development of this body is most nearly identical with that of the lower Batrachia. There has long been a consensus of opinion that the forward extension of the pterygoids to meet the vomers in the middle line, known hitherto in this animal and the crocodyles alone, is for the terrestrial Vertebrata a primitive character; and proof of this has been obtained by its presence in all the Rhynchocephalia known. The same condition has also been found to exist in the Plesiosaurs, the Ichthyosaurs, the Pterodactyles, the Diconodontia, the Dinosaurs, and with modification in some Chelonians. It has, moreover, been found in living birds; a most welcome fact, since Archaeopteryx, in the possession of a plastron, carries the avian type a stage lower than the Dinosaurs. It is pertinent here to remark that, inasmuch as in those Dinosaurs (e.g. *Compsognathus*) in which the characters of the hind limbs are most nearly avian, the pelvis, in respect to its pubis, is at the antipodes of that of all known birds, and the fore-limb is shortened in excess of that of Archaeopteryx itself, the long supposed dinosaurian ancestry for birds must be held in abeyance.

Passing through the Rhynchocephalia to the Batrachia, we have to countenance progress most definite in its results. The skull, the limbs and their girdles are chiefly concerned, and this in a very remarkable way.

In the year 1881 there was made known by Prof. Friepe, of Tübingen, the discovery that the hypoglossus nerve of the embryo mammal is possessed of dorsal ganglionated roots. Again and again we heard Huxley insist on the fact that the ventral roots of this nerve are serial with the spinal set, but never did he suspect the rest. It is, however, a most intensely interesting fact that, whereas by a Huxleyan triumph the vertebral theory of the skull was overthrown, in these later Huxleyan days the proof of the incorporation of a portion of the vertebral region of the trunk into the mammalian occiput should have marked the succeeding epoch in advance. The existence of twelve pairs of cranial nerves which all the Amniota possess involves them in this change; and the fact that in all Batrachia there are but ten, enables us to draw a hard-and-fast line between batrachian and amniote series.

It may be urged, as an objection, that since we have long been familiar with a fusion of vertebrae and skull in various piscine forms, the force of this distinction is weakened. But this cannot be; since, in respect to the investing sheaths and processes of development which lie at the root of the genesis of the vertebral skeleton, the fishes stand distinct from the Batrachia and Amniota, which are agreed. So forcible is this consideration that it behoves us to express it in words, and I have elsewhere proposed to discriminate between the series of terrestrial Vertebrata as *archae-* and *syn-craniate*.

Similarly there is no proof that any batrachian, living or extinct (and in this I include the Stegocephala as a whole) possesses a costal sternum. So far as their development is known, the cartilages in these animals called "sternal" are either coracoidal or *sub-generis*. The costal sternum, like the syn-craniate skull, is distinctive of the Amniota alone. Had the Stegocephala possessed it even in cartilage, there is reason to think it might have been preserved, as it has been in the colossal Mososaur *Tylosaurus* of the American Cretaceous. When to this it is added that whereas, in the presence of a costal sternum, the mechanism of inflation of the lung involves the body-wall, in its absence it mainly involves the mouth (as in all fishes and batrachians), the hard and sharp line between the Batrachia and Amniota may be expressed by the formula that the former are *archae-craniate* and *stomatophysous*, the latter *syn-craniate* and *somatophysous*.

There are allied topics which might be considered did our

time permit; but one certain outcome of this is that there is an end to the notion of a batrachian ancestry for the Mammalia. And when, on this basis, we sum up the characters demanded of the stock from which the Mammalia have been derived, we find them to be precisely those occurring outside the Mammalia in the Anomodont Reptiles alone. Beyond the sternum and skull, the chief characters are the possession of short and equal pentadactyle limbs, with never more than three phalanges to a digit, a complete fibula and clavicle, a doubly ossified coracoid, a heterodont dentition—a combination which, wholly or in part, we now associate with the Permian genera *Procolophon*, *Paria-saurus*, and others which might be named, the discovery of which constitutes one of the morphological triumphs of our time.

Beyond this, it may be added, concerning the Batrachia, that among living pedate forms the Anura have alone retained the pentadactyle state and the complete maxillo-jugal arch, an 1 that the Eastern *Tylostotriton*, in the possession of the latter, becomes the least modified urodele extant. These facts lead to the extraordinary conclusion that the living Urodela, a whole of general lowly organisation, are one and all aberrant; and it is not the least important sequel to this that, despite their total loss of limbs, the Apoda, in the retention of the dermal armour and other features which might be stated, are the most primitive Batrachia that exist.

The batrachian phalangeal formula 22343 was until quite recently a difficulty in the determination of the precise zoological position of the class; but it has now been overcome, by the discovery of a *Keratopetion* in the Irish Carboniferous having three phalanges on the second digit of both fore- and hind-limbs, and by that in the Permian of Saxony of a most remarkable creature, *Scleurocephalus*, which, if rightly referred to the Stegocephala, had a head encased, as its name implies, in an armature like that of a fish, and the phalangeal formula of a reptile, 23454.

Passing from the Batrachia to the Fishes, we have still to admit a gap, since an interminable discussion on fingers and fins has not narrowed it in the least. In compensation for this, however, we have to record within the fish series itself progress greater, perhaps, than with the higher groups. Certainly is this the case if, as to bulk, the literature in systematics and palaeontology be alone taken into account.

Of the Dipnoi our knowledge is fast becoming complete. We know that Lepidosisiren forms a burrow; and, in consideration of a former monstrous proposal to regard this animal, with its fifty-six pairs of ribs, and Protopterus, with its thirty to thirty-five, as varieties of a species, it is the more interesting to find that the Congo has lately yielded a Protopterus (*P. Dollotii*) with the lepidosiren rib formula, viz., fifty-four pairs.

As a foremost result of American palaeontological research we have to record the occurrence, in the Devonian of Ohio, of a series of colossal fishes known as the Arthrodira, the supposed dipnoan affinities of which are still a matter of doubt.

We have evidence that the osseous skeleton in a plate-like form first appeared as a protection for the eye of a primitive shark. And coming to recent forms having special bearings on the teachings of the rocks, we have to acknowledge the capture in the Japanese seas of a couple of ancient sharks, of which one (*Cladoselachus*), since observed to have a distribution extending to the far North, is a survivor from Devonian times; the other (*Mitsukurina*) a genus whose grotesqueness leaves no doubt of its identity with the Cretaceous lamnoid *Scapanorhynchus*. In the elucidation of the Sturiones and the determination of their affinities with the ancient Palaeoniscidae a master stroke has been achieved. In the Old Red genus *Palaeospondylus* we have become familiar with an unmistakable marsipobranch, possessing, as do certain living fishes, a notochord, annulated, but not vertebrated in the strict sense of the term. The climax in Ichthyopalaeontology, however, has been reached in the discovery of Silurian forms, which, there is every reason to believe, explain in an unexpected way the hitherto anomalous Pteras- and Cephalaspidiens, by involving them in a community of ancestry with the primitive Elasmobranchs. The genera *Thelodus*, *Drepanaspis*, *Ateleaspis* and *Launkia* chief among these annectant and ancestral forms, are among the most remarkable vertebrate fossils known.

Passing to the Recent Fishes alone, the discovery which must take precedence is that of the mode of origin of the skeletogenous tissue of their vertebral column. The fishes, unlike all the higher Vertebrata, have, when young, a notochord invested in

a double sheath, there being an inner chordal sheath, an outer cuticular, which latter is alone present in all the higher groups. The skeletogenous cells, by whose activity the cartilaginous vertebral skeleton is formed, arise outside these sheaths; but whereas, when proliferating, they in one series remain outside, they in the other, by the rupture of the cuticular sheath, invade the chordal. This distinction enables us to discriminate between a *Chordal series*, which embraces the Chimeroids, Elasmobranchs and Dipnoi, and a *Perichordal*, consisting of the Teleosts, Ganoids and Cyclostomes.

In consideration of the enormity of the structural gap between the cyclostomes and the higher Vertebrata this is an extraordinary result. For be it remembered that, in addition to their well-known characters, the lampreys and hags (1) in the total absence of paired fins; (2) in the presence of branchiae, ordinarily seven in number, fourteen in *Biellostoma polytrema*, numerically variable in individuals of certain species between six and fourteen, and doubtfully asserted in the young of one to be originally thirty-five; and (3) in the carrying up of their oral hypophysis by the nasal organ, whereby it perforates the cranium from above, as contrasted with all the higher Vertebrata, in which, carried in with the mouth-sac, it perforates it from beneath, exhibit morphological characters of an extraordinary kind. And if we are to express these characters in terms, we may distinguish the Cyclostomes as *apterygial* and *epicraniate*, the higher Vertebrata as *hypocraniate*.¹ But this notwithstanding, the aforementioned subdivision of the Pisces into two series, which would associate the teleosts and ganoids with the cyclostomes, as distinct from the rest, receives support from recent study of the head-kidney by a Japanese, who seeks to show that the organ so called in the Elasmobranchs is of a late-formed type peculiar to itself; and it is also in agreement with one set of conclusions previously deduced from the study of the reproductive organs.

To deal further with the fishes is impossible in this Address, except to remark that recent discovery in the Gambia that the young of the Teleostean genera *Heterotis* and *Gymnarchus* bear filamentous external gills, renders significant beyond expectation the alleged presence of these among the loaches, and shows that adaptive organs of this type are valueless as criteria of affinity.

In paleontology, as in recent anatomy, our records of detail have increased beyond precedent, often but to show how deficient in knowledge we are, how contradictory are our theories and facts.

In dismissing the fishes, I wish to comment upon our accepted terms of orientation. To speak of the median fins as dorsal, caudal and anal, of the pelvic as ventral, and of the pectoral in its varying degrees of forward translocation as abdominal or thoracic, though a convention of the past, is to-day inaccurate and absurd. I question if the time has not come at which the terms thoracic (pulmocardiac) and abdominal are intolerable, as expressing either the subdivisions of the body-cavity or anything else, outside the Mammalia, which alone possess a diaphragm. Even in the birds, to grant the utmost, the subdivision of the coelom, if accurately described, must be into pulmonary, hyper-pulmonary and cardio-abdominal chambers; while with the reptiles the modes of subdivision are so complex that a special terminology is necessary for each of the several types extant.

In the fishes, where the pericardium is alone shut off, the retention of the mammalian terms but hampers progress. This was indeed felt by Duméril, when in 1865 he attempted a revisionary scheme. Since, however, one less fantastic than his seems desirable, I would propose that for the future the "anal" fin be termed *ventral*, the "ventral" *pelvic*; and that for the several positions of the pelvic, that immediately in front of the vent, primitive and embryonic (which is the position for the Elasmobranchs, Sturiones, Lower Siluroids and all the higher Vertebrata), be termed *proctal*, the so-called "abdominal" *pro-proctal*, the so-called "thoracic" *jugalular* (in that it denotes association with the area of the "collar-bone"), and the so-called "jugalular" *mental*. The necessity for this becomes the more desirable, now that it is known that a group of Cretaceous fishes (the Ctenothrissidae), hitherto regarded as Berycoidea, are

¹ It is an interesting circumstance, as if their "ciliated sac" is rightly homologised, that Amphioxus and the Tunicata present a corresponding dissimilarity, allowance being made for the fact that in *Botryllus*, *Goodria* and *Polycarpa* the sac overlies the ganglion. It is pertinent here to recall the ammonite-like condition of the "endostyle" in *Oikopleura hutchinsoni*.

in reality of eluopoid affinity, despite the fact that at this early geologic period they had translocated their pelvic fin into the jugular ("thoracic") position.

The sum of our knowledge acquired during the last twenty-eight years proves to us that, among the bony fishes, the structural combination which would give us a premaxillo-maxillary gap dentigerous throughout, a proctal pelvic fin, a heart with conal valves, would be the lowest and most primitive. Inasmuch as this character of the heart, so far as at present known, exists only among the Clupeoidea (pikes and herrings and their immediate allies), these must be regarded as lowly forms; wherefore it follows that the possession of but a single dorsal fin is not, as might appear, a necessary index of a highly modified state.

Before I dismiss the vertebrates, a word or two upon a recent result of morphological inquiry which concerns them as a whole. I refer to the development of the skull. Up to 1878 it was everywhere thought and taught that the cartilaginous skull was a compound of paired elements, known as the trabeculae cranii and parachordals, and that the former contributed the cranial wall. Huxley in 1874, from the study of the cranial nerves of fishes, had reiterated the suggestion he made in 1864, when dealing with the skull alone, that the trabeculae might be a pair of pre-oral visceral arches, serial with those which support the mouth and carry the gills. The next step lay with the Sturgeon, in which in 1878 it was found that the cranial wall is originally distinct. And later, when the facts were more fully studied in sharks, batrachians, reptiles and birds, it became evident that the trabeculae, though ultimately associated with the cranial wall, take no share in its formation, and that when first they appear they are disposed at right angles to the parachordals and the axis, serially with the visceral arches behind. Huxley was right; and although this consideration by no means exhausts the category of independent cartilages now known to contribute to the formation of the skull, it proves that the cartilaginous cranium, like the bony one, which in the higher vertebrate forms replaces it, is in its essence compound.

I now pass to the Invertebrata. Of the Oligocheta and Leeches I have spoken, and we may next consider the Arthropods. Of the Insecta, our knowledge has gained precision, by the conclusion that the primitive number of their Malpighian tubes is six, and by the study of development of these in the American cockroach *Doryphora*, which has rendered it probable they may be modified nephridia, carried in as are those of some oligochetes with the proctodeal invagination. An apparent cervical placenta has been discovered in the orthopteran *Hemimerus*, which would seem to suggest homology with the so-called "trophic vesicle" of the Peripatoids, as exemplified by *P. Novae-Britannica*. In this same orthopteran there have been recognised, in secondary proximity to the "lingua," reduced maxillule, which, fully developed and interposed between the mandible and first maxilla, in *Japyx*, *Machilis*, *Forficula* and the *Ephemera* larva, give us a fifth constituent for the insectan head. And when it is found that all the abdominal segments of the common cockroach, when young, are said to bear appendages, of which the cerci are the hindmost, we have a series of facts which revolutionise our ideas. Little less striking is the discovery that in the caterpillar of the bombycine genera *Lagoa* and *Chrysopyga* seven pairs of pro-legs occur.

The fuller study of the apertures of the tracheate body has resulted in the discovery that the Chilopoda are more nearly related to the Hexapoda than to the Diplopoda; wherefore it is proposed to reclassify the Tracheata, in accordance with the position of the genital orifice, into Pro- and Opistho-gonata. In a word, the "Myriapoda," if a natural group, are diplytic.

Our knowledge of the Peripatoids (*Arthropoda malacopoda*) has increased in all that concerns distribution and structure. They are now known, for example, from Africa, the West Indies, Australia and New Zealand, and for examples from the two latter localities and Tasmania the generic name *Ooperipatus* has but lately been proposed, to include three species, characterised by the possession of an ovipositor, of which two have been observed to lay eggs.

Work upon the Crustacea in our own land, notorious for the tendencies of some of its devotees in their stinking for priority, has within the last twelve years advanced beyond all expectation. Much of our literature has been systematised, and an enormous increase in our knowledge of new forms has to be admitted, thanks to memoirs such as those of the "Investigator,"

"Naples Zoological Station," and others which might be named; while in the discovery and successful monographing, in the intervals of six years' labour at other groups, of a new family of minute Copepods (the Chionostomatidae), parasitic on the Malacostraca, embracing forty-three species, difficult to find, we have an almost unique achievement. The hand which gave us this has also provided a report which embraces the description of a nauplius of exceptional type, which, by a process of reasoning by elimination, masterly in its method, has been "run to ground" as in every degree of probability the larva of Darwin's apodal barnacle *Protopleps bivenusta*, of which only the original specimen is known.

There is but one other crustacean record equal in rank with this, viz., the discovery of the genus Anaspides. Originally obtained from a fresh-water pool on Mount Wellington, Tasmania, at 4000 feet, it has since been found in two other localities. It is unique among all living forms, in combining within itself characters of at least three distinct suborders of "prawns," for with a schizopod body it combines the double epipodial lamellæ of an amphipod, the head of a decapod (pedunculated eyes and antennular statocysts) apart from characters peculiarly its own. There is reason to believe that the nearest living ally to this remarkable creature is a small eyeless species (*Bathynella natana*) obtained from a Bohemian well; and if its presumed relationships to the Palæozoic "pod-shrimps" be correct, this heterogeneous assemblage may perhaps be the representatives of a group of primitive Malacostraca, through which, by structural divergence, the establishment of the higher crustacean suborders may have come about.

It is pertinent to this to note that work upon cave-dwelling and terrestrial forms, upon "well-shrimps" and the like, has produced important results. And interesting indeed is the recent discovery of three species, living at 800-900 feet above sea-level, in Gippsland, one an amphipod, two of them isopods, which, though surface-dwellers, are all blind. While they prove to be species of genera normally eyed, they in their characters agree with well-known American forms; and the bleaching of their bodies and atrophy of their eyes proclaim them the descendants of cave-dwelling or subterranean ancestors, among whom the atrophy took place.

Huxley in 1880 rationalised our treatment of the higher Crustacea, by devising a classification by gills, expressive of the relationships of these to the limb-bases, interarticular membranes and body-wall. Hardly has his influence taken effect when, by work extending over the years 1886 to 1893, in the study of Penæus, the Phyllopods, Ostracods and other forms, evidence had been accumulating to show that the crustacean appendage, even to the mandible itself, has primarily a basal constituent (protopodite) of three segments; that the branchiæ one and all are originally appendicular in origin; and that the numerical reduction of the basal (protopoditic) segments to two, with the assumption of a non-appendicular relationship by the gills, is due to coalescence of parts, with or without suppression. The evidence for this epoch-making conclusion, which simplifies our conceptions and brings contradictory data into line, is as irresistible as it is important, and there has been nothing finer in the whole history of crustacean morphology. With it, the attempt to explain the supposed anomalous characters of the antennule by appeal to embryology goes to the wall; and, taking a deep breath, we view the Crustacea in a new light.

There remains for brief consideration one carcinological discovery second to none which bears on the significance of larval forms. It is that of the Trilobite *Triarthrus Becki*, obtained in abundance from the Lower Silurian near New York, with all its limbs preserved. In the simplicity of its segmentation and the biramous condition of its limbs it is primitive to a degree. Chief among its characters are the total absence of jaws in the strict sense of the term, and the fact that of its three anterior pairs of appendages the third is certainly and the second is apparently biramous, the first uniramous and antenniform. In this we have a combination of characters known only in the nauplius larva among all living crustacean forms; and the conclusion that the adult trilobite, like that of the Euphausiacea, Sergestidae, Penæidae, the Ostracods and Cirripedes of to-day, was derived by direct expansion of the nauplius larva can hardly be doubted. Much yet remains to be done with the study of the Triarthrus limbs; and the suggestion of a foliaceo condition by those of the pygidium, which are youngest, is a remarkable fact, the meaning of which the future must decide. We should expect the condition to be a provisional one, since while we admit the

primitive nature of the phyllopods as an Order, we cannot regard the foliation of their appendages as anything but a specialisation. Be this as it may, the structural community between the nauplius larva and the trilobite is now proved; and when we add that in the yolk-bearing higher Crustacean types (e.g. Astacus) a perceptible halt in the development may be observed at the three-limb-bearing stage; that in Mysis the vitelline membrane is shed but to make way for a nauplius cuticle; and that the median nauplius eye has long been found sessile on the adult brain of representative members of the higher crustacean groups, up to the lobster itself, our belief in the ancestral significance of the nauplius larval form is established beyond doubt.

The thought of the nauplius suggests other larval forms. The gastrula is no longer accepted without reserve; the claims of the blastula, planula, parenchymella, not to say the plakula, have all to be borne in mind. It is of the Trochophore, however, as familiar as the nauplius, that I would rather speak, as influenced by recent research. It is supposed to be primitive for the molluscs and chetopod worms at least; and various attempts have been made to bolster it up, and to show that if we allow for adaptive change, its characters, well known, are constant within the limits of its simpler forms.

It is now more than forty years ago that the late Lacaze-Duthiers described for Dentalium a larval stage, characterised by the possession of recurrently ciliated zones, which by reduction, with union and translocation forwards, give rise to the trochal lobe. It is now known that in the American pelecypod *Yoldia limatula* a similar stage is found, in which a "test," of five rows of ciliated cells, is present; and of the young of *Dondersia banyulensis* the like is true. But whereas in the *Yoldia* the ciliated sac is ultimately shed, in the Myzomenian the escape of the embryo is accompanied by rupture which liberates the anterior series of ciliated zones in a manner strongly suggestive of forward concentration, leaving the posterior cirlet with its cilia attached.

This "test" has also been seen in two species of *Nucula*, and pending fuller inquiry into the Myzomenian and a reinvestigation of Dentalium, I would suggest that this recurrently ciliated sac is representative of a larval stage antecedent to the trochophore, for which the term *protrochal* may suffice. This term has indeed been already applied to a larva of certain Polycheeta, which might well represent a modification of that for which I am arguing; and quite recently it appears to have been observed near Ceylon for a species of the genus *Marphysa*.

The discovery of this larva in *Dondersia* was accompanied by that of a later-formed series of dorsal spicular plates, which for once and for all, in realising a chitonid stage, demolish the heresy of the "Solenogastres," mischievous as suggesting an affinity with the worms. Like that of the supposed cephalopod affinities of the so-called "Pteropods," it must be ignored as an error of the past.

Returning to the protrochal stage, whatever the future may reveal concerning it, by bringing together the Lamellibranchiata, Scaphopoda and Polyplacophora, it associates in one natural series all the bilaterally symmetrical Mollusca except the cephalopods. In doing this, it deals the death-blow to the supposed Rhipidoglossan affinity of the Lamellibranchiata; and in support of this conclusion I would point out that the recently discovered eyes of the mytilids are in the position of those of the embryo Chiton, and that just as Dentalium, in the formation of its mantle, passes through a lamellibranchiate stage, so are there lamellibranchs in number in which a tubular investment is found.

This protrochal larva has an important part to play. It may very possibly explain phenomena such as the compound nature of the trochal lobe of the limpet, the presence of a post-oral ciliated band in the larva of the ship-worm, and of a pre-anal one in that of various molluscan forms. In view of it, we must hesitate before we fully accept the belief in the ancestral significance of the trochophore. And it is certain that an idea, at one time entertained, that the Rotifer (Trochosphaera) which so closely resembles it as to bear its name is its persistent representative is wrong, since this is now known to be but the female of a species having a very ordinary male.

Through the Rhipidoglossa we pass to the Gastropods, which are one and all asymmetrical, for even *Fissurella*, *Patella* and *Doris*, when young, develop a spiral shell; while Huxley in 1877 had observed that the shell of *Aplysia*, in its asymmetry, betrays its spiral source.

The notion, which until recently prevailed, that among these gastropods the non-twisted or so-called euthyneurous condition of the visceral nerve-cords, as exemplified by the Opisthobranchs, is a direct derivative of that of the Chitons has been proved to be erroneous, since the nerves in Acteon and Chilina, like those of the prosobranchs, are twisted or streptoneurous. And as to the torsion of the gastropod body, recent research, in which one of my pupils has played a part, involving the discovery of paired reno-pericardial apertures in *Haliotis*, *Patella* and *Trochus*, has resulted in proof that the dextral torsion which leads to the monocardiac condition does not uniformly affect all organs lying primitively to the left of the rectum, as we have been taught; since, concerning the renal organs, it is the primitively (pretorsional) left one which remains as the functional kidney, its ostium as the genital aperture. Nor is the primitively right kidney necessarily lost, for while its ostium remains as the renal orifice, its body, by modification and reduction, may become an appendage of the functional kidney, the so-called nephridial gland. And we now know there are cases of sinistral torsion of the visceral hump, in which the order of suppression of the organs is not reversed, the arrangement being one of adaptation of a dextral organisation to a sinistral shell.

Though thus specialised and asymmetrical as a group, the gastropods are yet plastic to an unexpected degree. Madagascar has yielded a *Physa* (*P. lamellata*) with a neomorphic gill, a character shared by species of *Planorbis* (*P. cornuus* and *P. marginatus*), and an *Ancylus* in which the lung-sac is suppressed; while St. Thomas's Island has given us a snail (*Thyrophorella Thomensis*), the perisome of whose shell is produced into a protective lid.

In paleontology, history records the fact that in 1864 Huxley observed that the genus *Belemnites* appears to have borne but six free arms; a startling discovery which lay dormant till the present year. And the recent study of the fauna of the great African lakes, in bringing to light the existence of a halolimnic molluscan series in Lake Tanganyika, has opened up new possibilities concerning the paleontological resources of enormous aqueous deposits, recently discovered in the interior, and has entirely changed our geological conceptions of the nature of Equatorial Africa.

Time prevents my dealing with other groups, and it must suffice to say that with those I have not considered substantial work has been done. From what has been said, it is natural to expect that in some direction or another so vast an accumulation of facts must have extended the Darwinian teaching; and it is now quite clear that this has been the case with the two post-Darwinian principles known as "Substitution" and "Isomorphism" or "Convergence."

The former may be exemplified by nothing better than the case of the Rays and Skates, in which, under the usurpation of the propelling function of the tail by the expanded pectoral fins, the tail, free to modify, becomes in one species a lengthy whip-lash, in another a vestigial stump, in others, by the development of powerful spines, a formidable organ of defence. In both the Rays and certain other fishes subject to the working of this law, modification goes further still, in the appearance of electric organs in remotely related genera and species, by specialisation of the muscular system of the trunk or tail, or, as in the case of *Malapterurus*, of "tegumental glands." In this we have a difficulty admitted by Darwin himself, which now becomes clear and intelligible, since there is nothing new. There has simply come about the conversion, in one case of the energy of muscular contraction, in the other of glandular secretion, into that of electrical discharge, with accompanying structural change. The blind louse (*Pachyanura fasciata*) of the New Zealand Limestone caves presents an allied case, since here, under the reduction of the eye, the antennae, elongated to a remarkable degree, have become the more efficiently tactile; and it is an interesting question whether this principle may not explain the attenuation of the limbs in the recently discovered American Proteoid (*Typhlomolga Rathbourni*) of the Texan subterranean waters.

And as to isomorphism, by which we mean the assumption of a similar structural state by members of diverse or independent groups, I would recall the case of the Eocene Creodont *Patriofelis* and the Seals, and that of the Myriapods to which I have already alluded, and would cite that of the Dinosaurs and Birds, heterodox though it may appear, for reasons I have given.

As our knowledge increases, there is every reason to believe that, in the non-appreciation of these principles in the past, not a few of our classifications are wrong. We have even had our bogies, as, for example, the so-called Phylaxaria, which deceived the very elect; and before I close I wish to deal briefly with a question of serious doubt, which these considerations suggest.

It is that of the position in the zoological series of the Limuloids, popularly termed the King Crabs. These creatures, best known from the opposite shores of the Northern Pacific, but found in the oriental seas as well as far south as Torres Strait, have been since 1829 the subject of a difference of opinion as to their zoological position and affinities. Within the last twenty years there have been three determined advances upon them, and of these the third and most recent may be first discussed. It has for its object the attempt to prove that they are intimately associated with the cephalaspidian and other shield-bearing fishes of the Devonian and Silurian epochs, and that through them they are ancestral to the Vertebrata. The latest phase of this idea is based on the supposed existence in a *Cephalaspis* of a series of twenty-five to thirty lateral appendages of arthropod type. When, however, it is found that the would-be limbs are but the edges of body-scutes misinterpreted, suspicion is aroused; and when, working back from this, an earlier attempt reveals the fact that the author, compelled to find trabeculae, in order to force a presupposed comparison between the architecture of the Cephalaspidian head-shield and the Limulus' prosomal hood, resorts to a comparison between the structure of the former in general and that of the cornu of the latter, with details which on the pi-cine side are not to date, the argument must be condemned. It violates the first principles of comparative morphology, and is revolting to common sense; and as to the fishes concerned, we know that they have nothing whatever to do with the Limuloids, for we have already seen that, with their allies the Pteraspidae, they are a lateral branch of the ancient piscine stem.

The second advance upon the king crabs has very much in common with the first. It has engrossed the attention of an eminent physiologist for the last six or seven years, and by him it was in detail set before Section I at our meeting of 1896. Suffice it to say that it specially aims at establishing a structural community between the king crabs and certain vertebrates, favourable to the conviction that the Vertebrata have had an arthropod ancestry. When we critically survey the appalling accumulation of words begotten of this task, it is sufficient to consider its opening and closing phases. At the outset, under the conclusion that the vertebrate nervous axis is the metamorphosed alimentary canal of the arthropod ancestor, the necessity for finding a digestive gland is mainly met by homologising the so-called liver of the arthropod with the cellular arachnoid of the larval lamprey, in violation of the first principles of comparative histology! At the close we find ingenious attempts to homologise nerve tracts and commissures related to the organs of sense, such as are invariably present wherever such organs occur. Sufficient this to show that the comparison, in respect to its leading features, is in the opening case strained to an unnatural degree, in the closing case no comparison at all. Finding, as we do, that the rest of the work is on a par with this, we are compelled to reject the main conclusion as unnatural and unsound; and when we seek the explanation of this remarkable course of action, we are forced to believe that it lies in the failure to understand the nature of the morphological method. For the proper pursuit of comparative morphology, it is not sufficient that any two organisms chosen here and there should be compared, with total disregard of even elementary principles. Comparison should be first close and with nearly related forms, passing later into larger groups, with the progressive elimination of those characters which are found to be least constant. And necessary is it, above all things, that in instituting comparison it should be first ascertained what it is that constitutes a crustacean a crustacean, a marsipbranch a cyclostome, and so on for the rest. We have tried to accept this theory, fascinated both by the arguments employed and by the idea itself, which for ingenuity it would be difficult to beat, but we cannot; and we dismiss it as misleading, as a fallacy, begotten of a misconception of the nature of the morphological method of research. It is of the order of events which led Owen to compare a cephalopod and a vertebrate, led Lacaze-Duthiers to regard the Tunicata and Lamelibranchs as allied; and with these and other heresies it must be denounced.

Passing to the third advance, extending over the last twenty years, it may be said to consist in the revival of a theory of 1829, which boldly asserts that *Limulus* is an Arachnid. In the development of the defence there have been two weak points but lately strengthened, viz., the insufficient consideration of the palaeontological side of the question and of the presence of tracheae among the Arachnida. Under the former there was, until recently, assumed the absence of the first pair of appendages in the Eurypterida; but it may be said that they have since been observed in *Eurypterus Fischeri* of the Russian Silurian, and *E. scoticus* from the Pentland Hills, in both of which they consist of small chelate appendages flexed and limuloid in detail, somewhat reduced perhaps, and enclosed by the bases of the succeeding limbs, which become apposed as the anterior end is reached. Since by this discovery the Limuloids, Eurypterids and Scorpionids are brought into a numerical harmony of limb-bearing parts, we may at once proceed to other points at issue. So far as the broader structural plan of *Limulus* and the Scorpion are concerned, all will agree to a general community, except for the organs of respiration; but concerning the coelom, the mobile spermatozoa and the more detailed features under which *Limulus* is held to differ from the Crustacea and to resemble the Arachnida, I would remark that while motile spermatozoa are characteristic of the Cirripedes, the rest of the argument is weakened, by the probability that the "arachnidian" characters which remain may well have been possessed by the crustacean ancestors, and that *Limulus*, though specialised, being still an ancient form, might have retained them. The difficulty does not seem to me to lie in this, or with the excretory organs, if we are justified in accepting the aforementioned argument that the so-called Malpighian tubes may be intuned nephridia, ectodermal in origin, and in knowledge of the existence of endodermal excretory diverticula in the Amphipods. These facts would seem to suggest that as our experience widens, differences of this kind will disappear.

As to the tracheal system, now adequately recognised by the upholders of the arachnid theory, the presumed origin of tracheae from lung-books, the probability that the ram's-horn organ of the Gherneidae may be tracheal, the presence of tracheae in a simple form in the Acari, and, by way of an anomaly, in a highly organised form on the tibiae of the walking legs of the harvestmen (Phalangidae), are all features to be borne in mind. While I am prepared to admit that this wide structural range and varied distribution of the tracheae lessens their importance as a criterion of affinity, I cannot accept as conclusive the evidence for the assumed homology between lung-books and gills. And here it may be remarked that a series of paired abdominal vesicles, recently found in the remarkable arachnid *Koenenia*, invaginate as a rule but in one example everted, seized upon in defence of this homology, have not been so regarded by those most competent to judge.

There remains the entosternite, an organ upon which much emphasis has been placed. Not only does a similar organ exist, apart from an endophragmal system, in *Apus*, *Cyclops*, some Ostracods and Decapods, but, regarding the question of its histology, it may be pointed out that, from all that is at present known, the structural differences between these several entosternites do not exceed those between the cartilages of the Sepia body. And when it is found that the figures and descriptions of the entosternite of *Mygale* ("Mygale sp.," "Mygalomorphous Spider," *auct.*) have been thrice presented upside down! the reliability of this portion of the argument is lessened, to say the least.

Recent observation has sought to clench the homology of the four posterior pairs of limbs of the King Crab and Scorpion, by appeal to a furrow on the fourth segment in the former, believed to denote an original division into two; but I hesitate to accept this until myological proof has been sought.

Returning, amidst so much that is problematic, to the sure ground of palaeontology, I wish to point out that when all is considered in favour of the arachnid theory there still remains another way of interpreting the facts.

In both *Limulus* and the Scorpion the first six of the eighteen segments are well known to be fused into a prosoma bearing the limbs, but while in the Scorpion the remaining twelve are free, in *Limulus* they are united into a compact opisthosomal mass. In dealing with the living arthropods, there is no character determinative of position in the scale of this or that series more trustworthy than the antero-posterior fusion of segments. It has been called the process of "cephalisation," and the degree of

its backward extension furnishes the most trustworthy standard of highness or lowness in a given assemblage of forms. In passing from the lower to the higher Crustacea, we find this fusion increasing as we ascend; and it therefore becomes necessary to compare the Scorpion with the other Arachnida, *Limulus* with the Eurypterida, in order the better to determine the position of each in its respective series, by the application of this rule.

As to the number of segments present, variation is a matter of small concern, in consideration of the mode of origin of segmentation and the wide numerical range—from seven in the Ostracods to more than sixty in *Apus*—the segments of the crustacean class present.

On the arachnidian side, in the Solifuge but the third and fourth segments are fused; the remaining four of the prosomal series with the ten which remain are free. In *Koenenia* four of the prosomal segments alone unite; the fifth and sixth with the rest are free. And when we pass to the Limuloids and the descending series of their allies, we find it distinctive of the Eurypterida that all the opisthosomal segments are free. If we can trust these comparisons, we must conclude that the Eurypterida of the past, in respect to their segmentation, simplify the Limuloid type, on lines similar to that on which the Solifuge and *Koenenia* simplify the Higher Arachnid and Scorpionid type, and that therefore, if the degree of antero-posterior fusion of segments has the significance attached to it, *Limulus* and *Scorpio* must each stand at the summit of its respective series. If this be admitted, it has next to be asked if, in comparing them, we may not be comparing culminating types, which might well be isomorphic.

The scorpions are known fossil by two genera, *Palaeophonus* and *Proscorpius*, from the Silurian of Gotland and Lanarkshire, the Pentland Hills and New York Slate; while recent research, in the discovery of the genus *Strabops*, has traced the Eurypterida back to the Cambrian, leaving the scorpions far behind. One striking feature of the limbs of the Palaeozoic Eurypterids is their constantly recurring shortness and uniformly segmented character, long known in *Silmonia*, and less conspicuously in *Pterygotus* itself, retained with development of spines in three of five known appendages of the recently described eurypterid giant *Stylonurus*. The minimum length yet observed for these appendages is that of the Silurian species *Eurypterus Fischeri*, discovered by Holm in Russia in 1898. This creature is one of the few eurypterids in which all the appendages are preserved, and it is the more strange therefore that the advocates of the arachnid theory should ignore it in their most recent account. Allowing for the specialisation of its sixth prosomal appendage for swimming, the fifth is but little elongated, the second, third and fourth are each in total length less, by far, than the transverse diameter of the prosoma, and uniformly segmented, giving the appearance of short antennae. They seem to be seven-jointed, and are just such appendages as exist in the simpler crustacean and tracheate forms; and in the fact that their structural simplicity is correlated with the independence of the whole series of opisthosomal segments they lend support to the argument for their isomorphism.

With this conclusion, we turn once more to the Scorpions, if perchance something akin to it may not be in them forthcoming. The Silurian genus *Palaeophonus*, especially as represented by the Gotland specimen, reveals the one character desired. Its body does not appear to be in any marked degree simpler than that of the living forms; but on turning to its limbs, we find the four posterior pairs, in length much shorter than those of any living species, all but uniformly segmented. In this they approximate towards the condition of the limbs of the Eurypterida just dismissed, and their condition is such that had they been found fossil in the isolated state they would have been described as the limbs of a Myriapod, and not of a scorpion at all. Indeed, their very details are what is required, since in the possession of a single terminal claw they differ from the limbs of the recent scorpions as do those of the Chilopoda from the hexapods.

With this the scorpionid type is carried back, with a structural simplification indicative of a parallelism with the other arthropod groups; and while the facts do not prove the total independence of the scorpionid and limuloid series, they bring the latter into closer harmony with the Eurypterida of the past. They prove that the Silurian Scorpions simplify the existing Scorpionid type, on precisely the lines on which the Eurypterida simplify the Limuloid; and they do so in a manner which suggests that a distinction between the *Crustacea vera* and the *Crustacea giganteostraca* (to include the Eurypterida and

Xiphosura) is the nearest expression of the truth. It becomes thereby the more regrettable that in a recent revision of the taxonomy of the Limuloids the generic name *Carcinoscorpius* should have found a place.

I foresee the objection that the antenniform condition of the shorter limbs may be secondary and due to change. There is no proof of this. Against it, it may be said that the number of the segments is normal, and that where nature effects such a change, elongation is with the multi-articulate state the only process known; as, for example, with the second leg of the Phryniidae, the so called second pariepod of the Polycarpidea and the last abdominal appendage of Apeusides.

That advances such as we have now considered should lead to new departures is a necessity of the case; and it but remains for me to remind you that within the last decade statistical and experimental methods have very properly come more prominently into vogue, in the desire to solve the problems of variation and heredity. Of the statistical method, by no means new, I have but time to recall to you the Presidential Address of 1895 by my friend and predecessor in this chair, himself a pioneer; and of the experimental method I can but cite an example, and that a most satisfactory one, justifying our confidence and support. It concerns the late Prof. Milne-Edwards, who in 1864 described, from the Paris Museum, the head of a rock lobster (*Palinurus penicillatus*), having on the left side an antenniform eye-stalk. With the perspicuity distinctive of his race, he argued in favour of the "fundamental similarity of parts susceptible to revert to their opposite states." The matter remained at this till, on the removal of the ophthalmite of certain Crustacea, it was found that in regeneration it assumes a uniramous multiarticulate form; and it is an interesting circumstance that in the common crayfish the biramous condition normal to the antennule may occur. An example this of a fact which no other method could explain.

When all is said and done, however, it is to the morphological method that I would appeal as most trustworthy and sound. And when we find (1) that in certain compound Tunicates the atrial wall, in the egg development delimited by a pair of ectoblastic invaginations, in the bud development may be formed from the parental endodermic branchial sac; (2) that regenerated organs are by no means derivative of the blastemata whence they originally arose; (3) that in the development of a familiar star-fish the inner cells of the earliest segmentation stages, by intercalation among the outer, contribute half the fully-formed blastula; (4) that there are Diptera in existence in which, while it is well-nigh impossible to discriminate between the adult forms, there is reason to believe the pupa cases are markedly and constantly distinct; it becomes only too evident that the later embryonic and adult states are those most trustworthy for all purposes of comparison, and that it is by these that our animals can best be known and judged. Caution is, however, necessary with senility and age, since certain skulls have been found to assume at this period characters and proportions strikingly abnormal, and by virtue of the most important discovery, which we owe to the Japanese, that in certain Holothurians the calcareous skeletal deposits may so change with age as to render specific diagnoses based on their presumed immutability invalid. Advance, real and progressive, is in no department of zoological inquiry better marked than comparative morphology, and it is for the preeminence of this that I would plead. Educationally, it affords a mental discipline second to none.

We live by ideas, we advance by a knowledge of facts, content to discover the meaning of phenomena, since the nature of things will be for ever beyond our grasp.

And now my task is done, except that I feel that we must not leave this place without a word of sympathy and respect for the memory of one of our sons, an earnest devotee to our cause. William Thompson, born in Belfast, 1806, became in due time known as "the father of Irish natural history." By his writings on the Irish fauna, and his numerous additions to its lists, he secured for himself a lasting fame. In his desire to benefit others, he early associated himself with the work of the Natural History Society, which still flourishes in this city. He was President of this Section in 1843, and died in London in 1852, while in the service of our Association, in his forty-seventh year, beloved by all who knew him. His memory still survives; and if, as a result of this meeting, we can inspire in the members of the Natural History and Philosophic Society of this city, as it is now termed, and of its Naturalists' Field Club an enthusiasm equal to his, we shall not have assembled in vain.

SECTION G.

ENGINEERING.

OPENING ADDRESS BY PROF. JOHN PERRY, M.E., D.SC., LL.D., F.R.S., PRESIDENT OF THE SECTION.

THIS Section has had sixty-six Presidents, all different types of engineer. As each has had perfect freedom in choosing the subject for his Address, and each has known of the rule¹ that Presidential Addresses are not subject to debate afterwards, and as, being an engineer, he has always been a man of originality, of course he has always chosen a subject outside his own work. An engineer knows that the great inventions, the great suggestions of change in any profession, come from outsiders. Lawyers seem like fish out of water when trying to act as law-makers. The radical change that some of us hope to see before we die in the construction of locomotives will certainly not come from a locomotive superintendent who cannot imagine a locomotive which is not somehow a lineal descendant of the Rocket.

Hence it is that in almost every case the President of this Section has devoted a small or large part of his Address to the subject of the education of engineers. I grant that every President has devoted his life to the education of one engineer—himself—and it is characteristic of engineers that their professional education proceeds throughout the whole of their lives. Perhaps of no other man can this be said so completely. To utilise the forces of Nature, to combat Nature, to comprehend Nature as a child comprehends its mother, this is the pleasure and the pain of the engineer.² A mere scientist man analyses Nature; takes a phenomenon, dissects it into its simpler elements, and investigates these elements separately in his laboratory. The engineer cannot do this. He must take Nature as she is, in all her exasperating complexity. He must understand one of Nature's problems as a whole. He must have all the knowledge of the scientific man, and ever so much more. He uses the methods of the scientific man, and adds to them methods of his own. The name given to these scientific methods of his own or their results is sometimes "common-sense," sometimes "character," or "individuality," or "faculty," or "business ability," or "instinct." They come to him through a very wide experience of engineering processes, of acquaintance with things and men. No school or college can do more than prepare a young man for this higher engineering education which lasts through life. Without it a man follows only rule of thumb, like a sheep following the bell-wether, or else he lets his inventiveness or love of theory act the tyrant.

When a man has become a great engineer and he is asked how it happened, what his education has been, how young engineers ought to be trained, as a rule it is a question that he is least able to answer, and yet it is a question that he is most ready to answer. He sees that he benefited greatly by overcoming certain difficulties in his life; and forgetting that every boy will have difficulties enough of his own, forgetting that although a few difficulties may be good for discipline many difficulties may be overwhelming, forgetting also that he himself is a very exceptional man, he insists upon it that those difficulties which were personal to himself ought to be thrown in the path of every boy. It often happens that he is a man who is accustomed to think that early education can only be given through ancient classics. He forgets the dullness, the weariness of his school days. Whatever pleasure he had in youth—pleasure mainly due to the fact that the average Anglo-Saxon boy invents infinite ways of escaping school drudgery—he somehow connects with the fact that he had to learn classics. Being an exceptional boy, he was not altogether stupefied and did not altogether lose his natural inclination to know something of his own language; and he is in the habit of thinking that he learnt English through Latin, and that ancient classics are the best mediums through which an English boy can study anything.³

¹ The Committees of Sections G and L have arranged a discussion on "The Education of Engineers," this Address being regarded as opening the discussion. Thus the rule is not in force this year.

² Of all the unskilled labour of the present day, surely that of the modern poet is the most grotesque. How much more powerful and powerless man seems to us now; how much more wonderful is the universe than it was to the ancients! Yet our too learned poets prefer to copy and recopy the sentiments of the ancients rather than try to see the romance which fills the lives of engineers and scientific men with joy.

³ The very people who talk so much of learning English through Latin neglect in the most curious ways those Platt-Deutsch languages, Dutch and Scandinavian, a knowledge of which is ten times more valuable in the study of what is becoming the speech of the world. And how they do scorn Lowland Scotch!

The cleverest men of our time have been brought up on the classics, and so the engineer who cannot even quote correctly a tag from the Latin grammar, who never knew anything of classical literature, insists upon it that a classical education is essential for all men. He forgets the weary hours he spent getting off Euclid and the relief it was to escape from the class-room not quite stupefied, and he advocates the study of pure mathematics and abstract dynamics as absolutely necessary for the training of the mind of every young engineer. I have known the ordinary abominable system of mathematical study to be advocated by engineers who, because they had passed through it themselves, had really got to loathe all kinds of mathematics higher than that of the grocer or housekeeper. They said that mathematics had trained their minds, but they did not need it in their profession. There is no profession which so much requires a man to have the mathematical tool always ready for use on all sorts of problems, the mathematical habit of thought the one most exercised by him; and yet these men insist upon it that they can get all their calculations done for them by mathematicians paid so much a week. If they really thought about what they were saying, it would be an expression of the greatest contempt for all engineering computation and knowledge. He was pitchforked into works with no knowledge of mathematics, or dynamics, or physics, or chemistry, and, worse still, ignorant of the methods of study which a study of these things would have produced; into works where there was no man whose duty it was to teach an apprentice; and because he, one in a thousand, has been successful, he assures us that this pitchforking process is absolutely necessary for every young engineer. He forgets that the average boy leaves an English school with no power to think for himself, with a hatred for books, with less than none of the knowledge which might help him to understand what he sees, and he has learnt what is called mathematics in such a fashion that he hates the sight of an algebraic expression all his life after.

I do not want to speak of boys in general. I want only to speak of the boy who may become an engineer, and before speaking of his training I want to mention his essential natural qualification—that he really wishes to become an engineer. I take it to be a rule to which there are no exceptions that no boy ought to enter a profession—or, rather, to continue in a profession—if he does not love it. We all know the young man who thinks of engineering things during office hours and never thinks of them outside office hours. We know how his fond mother talks of her son as an engineer who, with a little more family influence and personal favour, and if there was not so much competition in the profession, would do so well. It is true, family influence may perhaps get such a man a better position, but he will never be an engineer. He is not fit even to be a hewer of wood and drawer of water to engineers. Love for his profession keeps a man alive to its interests all his time, although, of course, it does not prevent his taking an interest in all sorts of other things as well; but it is only a professional protest that warms him through with enthusiasm. I think we may assume that there never yet was an engineer worth his salt who was not fond of engineering, and so I shall speak only of the education of the young man who is likely to be fond of engineering.

How are we to detect this fondness in a boy? I think that if the general education of all boys were of the rational kind which I shall presently describe, there would be no great difficulty; but as the present academic want of system is likely to continue for some time, it is well to consider things as they are. Mistakes must be made, and the parent who tries during the early years of his offspring to find out by crafty suggestion what line his son is likely to wish to follow will just as probably do evil by commission as the utterly careless parent is likely to do evil by omission. He is like the botanical enthusiast who digs up plants to see how they are getting on. But in my experience the Anglo-Saxon boy can stand a very great deal of mismanagement without permanent hurt, and it can do no kind of boy any very great harm to try him on engineering for a while. Even R. L. Stevenson, whose father seems to have been very persistent indeed in trying to make an engineer of him against his will, does not seem, to a Philistine like myself, to have been really hurt as a literary man through his attendance on Fleeming Jenkin's course at Edinburgh—on the contrary, indeed. It may be prejudice, but I have always felt that there is no great public person of whom I have ever read who would not have benefited by the early training which is suitable for an engineer.

I am glad to see that Mr. Wells, whose literary fame, great as it is, is still on the increase, distinguishes the salt of the earth or saviours of society from the degraded, useless, luxurious, pleasure-loving people doomed to the abyss by their having had the training of engineers and by their possessing the engineer's methods of thinking.

It may be that there are some boys of great genius to whom all physical science or application of science is hateful. I have been told that this is so, and if so I still think that only gross mismanagement of a youthful nature can have produced such detestation. For such curious persons, engineering experience is, of course, quite unsuitable. I call them "curious" because every child's education in very early years is one in the methods of the study of physical science; it is Nature's own method of training, which proceeds successfully until it is interfered with by ignorant teachers who check all power of observation and the natural desire of every boy to find out things for himself. If he asks a question, he is snubbed; if he observes Nature as a loving student, he is said to be lazy and a dunce, and is punished as being neglectful of school work. Unprovided with apparatus, he makes experiments in his own way, and he is said to be destructive and full of mischief. But however much we try to make the wild ass submit to bonds and the unicorn to abide by the crib, however bullied and beaten into the average schoolboy type, I cannot imagine any healthy boy suffering afterwards by part of a course of study suitable for engineers, for all such study must follow Nature's own system of observation and experiment. Well, whether or not a mistake has been made, I shall assume the boy to be likely to love engineering, and we have to consider how he ought to be prepared for his profession.

I want to say at the outset that I usually care only to speak of the average boy, the boy usually said to be stupid, ninety-five per cent. of all boys. Of the boy said to be exceptionally clever I need not speak much. Even if he is pitchforked into works immediately on leaving a bad school, it will not be long before he chooses his own course of study and follows it, whatever course may have been laid down for him by others. I recollect that when in 1863 I attended an evening class held in the Model School, Belfast, under the Science and Art Department, on Practical Geometry and Mechanical Drawing, there was a young man attending it who is now well known as the Right Honourable William J. Pirrie. He had found out for himself that he needed a certain kind of knowledge if he was to escape from mere rule-of-thumb methods in shipbuilding work; it could at that time be obtained nowhere in the North of Ireland except at that class, and of course he attended the class. For forty two years the Science and Art Department, which has recently doubled its already great efficiency, has been giving chances of this kind to every clever young man in the country, from long before any Physical Science was taught in any English public school.¹ The one essential thing for the exceptional boy is that he shall find within his reach chances to take advantage of; chances of learning; chances of practice; and over and above all, chances of meeting great men. It takes me off my subject a little, but I should like here to illustrate this matter from my own personal experience.

I had already been an apprentice for four years at the Lagan Foundry when I entered Queen's College for a course of Civil Engineering. I suppose that there never was on this earth a college so poorly equipped for a course of engineering study. Even the lecture room—this lecture room in which you are now sitting—was borrowed from the Physics Professor. There was a narrow passage, ironically called a "Drawing Room," and this was the only space reserved for engineering in a town whose engineering work was even then very important. There were some theodolites and levels and chains for surveying, but nothing else in the way of apparatus. But there was as Professor a man of very great individuality; he acted as President of this Section twenty-eight years ago. I can hardly express my obligations to Prof. James Thomson. It was my good fortune to be a pupil both of this great man and of his younger brother, Lord Kelvin, as well as of Dr. Andrews. It is not because these three men were born in Belfast that we here call them great. It is not because Tait, late of Edinburgh, and

¹ I once stated that my workshop at Clifton College in 1871 was the first school workshop in England. I understand that this is a mistake; there had been a work shop at Rossall for some years. But I believe I am right in saying that my physical laboratory at Clifton was the first school laboratory in England. These ideas were not mine; they were those of the Headmaster, now the Bishop of Hereford.

Purser, now the President of Section A, were professors at this College that we call them great. All the scientific men of the world are agreed to call these men very great indeed. To come in contact with any of them, even for a little while, as a student, altered for ever one's attitude to Nature. It was not that they gave us information, knowledge, facts. The syllabuses of their courses of study were nothing like so perfect as that of the smallest German polytechnic. And yet if a youth with a liking for physical science had gone to a German Gymnasium to the age of nineteen, and had become a walking encyclopædia on leaving one's polytechnic at the age of twenty-four, the course of that life-study would not have done for him as much good as was done by a month's contact with one of these men. People call it "personal magnetism" and think there is something occult about it. In truth, they revealed to the student that he himself was a man, that mere learning was unimportant, that one's own observation of some common phenomenon might lead to important results unknown to the writers of books. They made one begin to think for oneself for the first time. Let me give an example of how the thing worked.

James Thomson was known to me as the son of the author of my best mathematical books, but more particularly as the man who had first used Carnot's principle in combination with the discovery of Joule, and I often wondered why Rankine and Clausius and Kelvin got all the credit of the discovery of the second law of thermodynamics. Men think of this work of his merely as having given the first explanation of regelation of ice and the motion of glaciers. He was known to me as the inventor of the Thomson Turbine and Centrifugal Pump and Jet Pump. His name was to be found here and there in all my text-books, always in connection with some thoroughly well-worked-out investigation, as it is to be found in all good text-books now; for wherever he left a subject, there that subject has remained until this day; nobody has added to it or found a mistake in it. He was to me a very famous man, and yet he treated me as a fellow-student. One of his early lectures was about flowing water, and he told us of a lot of things he had observed, which also I had observed without much thought; and he showed how these simple observations completely destroyed the value of everything printed in every text-book on the subject of water flowing over gauge-notches, even in the otherwise very perfect Rankine. I felt how stupid I had been in not having drawn these conclusions myself, but in truth till then I had never ventured for a moment to criticise anything in a book. I have been a cautious critic of all statements in text-books ever since. If any engineer wants to read what is almost the most instructive paper that has ever been written for engineers, let him refer to the latest paper written by James Thomson on this subject.¹ The reasoning there given was given to me in lectures in this very room in 1865, and had been given to students for many years previous.

Again, soon afterwards, he let me see that although I had often looked at the whirlpool in a basin of water when the central bottom hole is open, and although I had read Edgar Allan Poe's mythical description of the Maelstrom, I had been very much too careless in my observation. Among other things, Thomson had observed that particles of sand gradually passed along the bottom towards the hole. When he found out the cause of this, it led him at once to several discoveries of great importance. Indeed, the study of this simple observation gave rise to all his work on (1) What occurs at bends of pipes and channels, and why rivers in alluvial plains bend more and more; (2) The explanation of the curious phenomena that accompany great forest fires; (3) The complete theory of the great wind circulation of the earth, published in its final form as the Bakerian Lecture of the Royal Society in 1892.

But why go on? He taught me to see that the very commonest phenomenon had still to reveal important secrets to the understanding eye and brain, and that no man is a true student unless he is a discoverer. And so it was with Kelvin and Andrews. Their names were great before the world, and yet they treated one as a fellow-student. Is any expenditure of money too large if we can obtain great men like these for our Engineering Colleges? Money is wanted for apparatus and more particularly for men, and we spend what little we have on bricks and mortar!

The memory of a man so absolutely honest as Prof. James Thomson was compels me to say here that I was in an exceptionally fit state to benefit by contact with him, for I

hungered for scientific information.¹ I do not think that there was so much benefit for the average student whose early education had almost unfitted him for engineering studies. To work quantitatively with apparatus is good for all students, but it is absolutely necessary for the average student, and, as I said before, there was no apparatus. Also the average student cannot learn from lectures merely, but needs constant tutorial teaching, and the Professor had no assistant.

Anybody who wants to know what kind of engineering school there ought to be in such a college as this can see excellent specimens (sometimes several in one town) in Glasgow, Birmingham, Liverpool, London, Manchester, Leeds, Bristol, Nottingham, Edinburgh and other great cities. There the fortunate manufacturers have given many hundreds of thousands of pounds for instruction in applied science (engineering). In America the equipment of such schools is much more thorough and there are large staffs of teachers, for fortunate Americans have contributed tens of millions of pounds for this kind of assistance to the rising generation. Germany and Switzerland compete with America in such preparation for supremacy in manufacture and engineering, and nearly every country in the world is more and more recognising its importance as they see the great inventions of Englishmen like Faraday and Perkin and Hughes and Swan developed almost altogether in those countries which believe in education. Even one hundred thousand pounds would provide Queen's College, Belfast, with the equipment of an engineering school worthy of its traditions and position, and Belfast is a city in which many large business fortunes have been made.

It is interesting to note that the present arrangements of the Royal University of Ireland, with which this College is affiliated, are such that most of the successful graduates in engineering of Queen's University would now be debarred from taking the degree. Even in London University, Latin is not a compulsory subject for degrees in science; Ireland has taken a step backwards towards the Middle Ages at the very time when other countries are stepping forward.

Well equipped schools of applied science are getting to be numerous, but I am sorry to say that only a few of the men who leave them every year are really likely to become good engineers. The most important reason for this is that the students who enter them come usually from the public schools; they cannot write English; they know nothing of English subjects; they do not care to read anything except the sporting news in the daily papers; they cannot compute; they know nothing of natural science; in fact, they are quite deficient in that kind of general education which every man ought to have.

I am not sure that such ignorant boys would not benefit more by entering works at once than by entering a great engineering school. They cannot follow the College courses of instruction at all, in spite of having passed the entrance examination by cramming. Whereas after a while they do begin to understand what goes on in a workshop; and if they have the true engineer's spirit, their workshop observation will greatly correct the faults due to stupid schoolwork.²

Perhaps I had better state plainly my views as to what general education is best for the average English boy. The public schools of England teach English through Latin, a survival of the time when only special boys were taught at all, and when there was only one language in which people wrote. Now the average boy is also taught Latin, and when he leaves school for the army or any other pursuit open

¹ Some of our most successful graduates went direct to works from the Model School, Belfast, and afterwards attended this College. No school in the British Islands could have given better the sort of general education which I recommend for all boys. English subjects were especially well taught, so that boys became fond of reading all manner of books. There were good classes in freehand and machine drawing, classes in chemistry and physics (at that time I believe that there were no such classes in any English public school), and the teaching of mathematics was good. Some of the masters started classes also under the Science and Art Department. Some of the masters had much individuality, and there was no outside examination to restrain it; there was only encouragement. Evidence has been given before a committee of the London School Board as to the excellence of the teaching at this school forty years ago. Foreign languages were not in the regular curriculum, but they could be studied by boys inclined that way; and in my opinion this is the position that all languages other than English ought to take in any British school. With such preparation a boy was eager and able to understand what went on in engineering works from his first day there.

² When I was young I remember that there were many agricultural colleges in Ireland; they have all but one been failures. Why? Because the entering pupils were not prepared by early education to understand the instruction; this had done as much as possible to unfit them.

¹ Brit. Assoc. Report, 1876, pp. 243-266.

to average boys he cannot write a letter, he cannot construct a grammatical sentence, he cannot describe anything he has seen. The public-school curriculum is always growing, and it is never subtracted from or rearranged. There is one subject which ordinary schoolmasters can teach well—Latin.¹

The other usual nine subjects have gradually been added to the curriculum for examination purposes; they are taught in watertight compartments—or, rather, they are only crammed, and not taught at all. Our school system resembles the ordinary type of old-established works, where gradual accretion has produced a higgledy-piggledy set of shops which one looks at with stupefaction, for it is impossible to get business done in them well and promptly, and yet it seems impossible to start a reform anywhere. What is wanted is an earthquake or a fire—a good fire—to destroy the whole works and enable the business to be reconstructed on a consistent and simple plan. And for much the same reason our whole public-school system ought to be "scrapped." What we want to see is that a boy of fifteen shall be freed of reading, shall be able to compute and shall have some knowledge of natural science; or, to put it in another way, that he shall have had mental training in the study of his own language, in the experimental study of mathematics and in the methods of the student of natural science. Such a boy is fit to begin any ordinary profession, and whether he is to enter the Church, or take up medicine or surgery, or become a soldier, every boy ought to have this kind of training. When I have advocated this kind of education in the past I have usually been told that I was thinking only of boys who intend to be engineers; that it was a specialised kind of instruction. But this is very untrue. Let me quote from the recommendations of the 1902 Ministry Education Committee (Report, p. 5):—

1 Only one subject—Latin—is really educational in our schools. I do not mean that the average boy reads any Latin after he leaves school, or knows any Latin at all ten years after he leaves school. I do not mean that his Latin helps him even slightly in learning any modern language, for he is always found to be judiciously ignorant of French or German, even after an elaborate course of instruction in these languages. To not mean that his Latin helps him in studying English, for he can hardly write a sentence without error. I do not mean that it makes him fond of literature, for of ancient literature or history he never has any knowledge except that Cæsar was a good looker for literature, as his mind is a blank. But I do mean that as the ordinary public-school master is really able to give a boy easy mental exercises through the study of Latin, this subject is in quite a different position from that of the others. If any proof of this statement is wanted, it will be found in the published utterances of all sorts of ordinary teachers, business men, and the like. To not mean that the boy, who, confessedly ignorant of "the tongues," get into a state of rapture over their school experiences and the efficiency of Latin as a means of education. All this comes from the fact, which schoolboys are sharp enough to observe, that English schoolmasters can teach Latin well, and they do not take much interest in teaching anything else. I do not mean that the boy, in the Middle Ages, when there really was a simple system of education. I ask for a return to simplicity of system. English (the King's English; I exclude Johnstone) is probably the richest, the most complex language, the one most worthy of philosophical study. English literature is certainly more valuable than any ancient or modern literature of any other country yet admiration for it among learned Englishmen is wonderfully mixed with patronage and even contempt. At present, in there one man who can teach English as Latin is taught by nearly every master of every school? Just imagine that English could be so taught by teachers capable of rising to the level of our literature!

I have often tried to give advice to parents. I find the average parent exceedingly ignorant of his son's character or inclinations or ability. He pays a schoolmaster handsomely for taking his son off his hands except during holidays. During the holidays, so terrible to a parent, he sees his son as little as possible. One question he is always asking is, "What is Mr. So-and-so have theoretical" instruction (which always call it by this absurd name) before or after an actual apprenticeship in works? Of course, such a question cannot be answered offhand. You tell the parent, to his great astonishment, that you must see the boy himself. When at length you see him, the chances are that you will find him to be what the schoolmasters are making of all our average boys. No part of his school work has been a pleasure to him, and, although he has had to work hard at his books, not one of the above three powers is his—power to use books and to write his own language, the language of his own mind, his mother, his mistress that is to be, his enemies and friends; the only language in which he thinks—power to compute and a liking for computation—power to understand a little of natural phenomena. Honestly I practically never find that such a boy has had any education at all except what he has obtained at home or from his school companions or from his sports. Even his sports, when he is really doing only any of them at all to cultivate his mental powers. Those old games like "Prisoners' Base," which really developed in a wonderful way not only all the muscles of the body, but also the thinking power, are scorned in the public schools. Think now how such a boy is handicapped if we pickfork him into works where it is his body's duty to teach him anything, or send him to college, where he cannot understand the lectures. Of course, if he is very eager to be an engineer he will, by hook or by crook, get to understand things. I have met some such men—clever, successful engineers in spite of all sorts of adverse circumstances—but the best of them are willing to admit that they are, and have always been, greatly hurt by the absence of the three powers which I have specified. And if this has been so in the past, when the scientific principles underlying engineering have been simple, how much more must it be so now, when every new discovery in physics is producing new branches of engineering!

"The fifth subject which may be considered as an essential part of a sound general education is experimental science; that is to say, the science of physics and chemistry treated experimentally. As a means of mental training, and also viewed as useful knowledge, this may be considered a necessary part of the intellectual equipment of every educated man, and especially so of the officer, whose profession in all its branches is daily becoming more and more dependent on science." When statements of this kind have been made by some of us in the past, nobody has paid much attention; but I beg you to observe that the headmaster of Eton and the headmaster of St. Paul's School are two of the members of the important Committee who signed this recommendation, and it is impossible to ignore it. Last year, for the first time, the President of the Royal Society made a statement of much the same kind, only stronger, in his annual address. I am glad to see that the real value of education in physical science is now appreciated; that mere knowledge of scientific facts is known to be unimportant compared with the production of certain habits of thought and action which the methods of scientific study usually produce.

As to English, the Committee say: "They have no hesitation in insisting that a knowledge of English," as tested by composition, together with an acquaintance with the main facts of the history and geography of the British Empire, ought in future to hold the first place in the examination and to be exacted from all candidates." The italics are mine. It will be noticed that they say nothing about the practical impossibility of obtaining teachers. As to mathematics, the Committee say: "It is of almost equal importance that every officer should have a thorough grounding in the elementary part of mathematics. But they think that elementary mechanics and geometrical drawing, which under the name of practical geometry is now often used as an introduction to theoretical instruction, should be added to this part of the examination, so as to ensure that at this stage of instruction the practical application of mathematics may not be left out of sight." As Sir Hugh Evans would have said, "It is a very discretion answer—the meaning is good"; but I would that the Committee had condemned abstract mathematics for these army candidates altogether.

This report agrees in good time. It would be well if Committees would sit and take evidence as to the education of men in the other professions entered by our average boys. It is likely that when an authoritative report is prepared on the want of education of clergymen, for example, exactly the same statements will be made in regard to the general education which ought to precede the technical training; but perhaps a reference may be made in the report to the importance of a study of geology and biology as well as physical science. Think of the clergyman being able to meet his scientific enemies in the gate!

Thanks mainly to the efforts of a British Association Committee, really good teaching of experimental science is now being introduced into all public schools, in spite of most persistent opposition wearing an appearance of friendliness. In consequence, too, of the appointment of a British Association Committee last year, at what might be called the psychological moment, a great reform has already begun in the teaching of mathematics.² Even in the regulations for the Oxford Locals for 1903, Euclid is repudiated. It seems probable that at the end of another five years no average boy of fifteen years of age will have been compelled to attempt any abstract reasoning about things of which he knows nothing; he will be versed in experimental mathematics, which he may or may not call mensuration; he will use logarithms, and mere multiplication and division will be a joy to him; he will have a working power with algebra and sines and cosines; he will be able to tackle at once any curious new problem which can be solved by squared

¹ This Committee recommends for the Woolwich and Sandhurst candidates a reform that has already been carried out by London University. No dead language is to be compulsory, but unfortunately some language other than English is still to be compulsory. Those boys of whom there are so many, who dislike and cannot learn another language are still to be labelled "undisciplined." Must there, then, be national defeat and captivity before our chosen race gives up its false academic gods? We think of education in the most slovenly fashion. The very men who say that *utility* is of no importance are the men who insist on the usefulness of a knowledge of French or German. They say that a man is illiterate if he knows only English, although he may be familiar with all English literature and with other literatures through translations. The man who has passed certain examinations in his youth and never cares to read anything is said to be educated. The men of the city of the Violet Crown, were they not educated? And did they know any other than their own language?

² Discussion last year and report of Committee, published by Macmillan.

paper; and he will have no fear of the symbols of the infinitesimal calculus. When I insist that a boy ought to be able to compute, this is the sort of computation that I mean. Five years hence it will be called "elementary mathematics." Four years ago it was an unorthodox subject called "practical mathematics," but it is establishing itself in every polytechnic and technical college and evening or day science school in the country. Several times I have been informed that on starting an evening class, when plans have been made for a possible attendance of ten or twenty students, the actual attendance has been 200 to 300. Pupils may come for one or two nights to a class on academic mathematics, but then stay away for ever; a class in practical mathematics maintains its large numbers to the end of the winter.¹

Hitherto the average boy has been taught mathematics and mechanics as if he were going to be a Newton or a Laplace; he learnt nothing and became stupid. I am sorry to say that the teaching of mechanics and mechanical engineering through experiment is comparatively unknown. Cambridge writers and other writers of books on experimental mechanics are unfortunately ignorant of engineering. University courses on engineering—with one splendid exception, under Prof. Ewing at Cambridge—assume that undergraduates are taught their mechanics as a logical development of one or two axioms; whereas in many technical schools under the Science and Art Department, apprentices go through a wonderfully good laboratory course in mechanical engineering. We really want to give only a few fundamental ideas about momentum and the transformations of energy and the properties of materials, and to give them from so many points of view that they become part of a student's mental machinery, so that he uses them continually. Instead of giving a hundred labour-saving rules which must be forgotten, we ought to give the one or two ideas which a man's common-sense will enable him to apply to any problem whatsoever and which cannot be forgotten. A boy of good mathematical attainments may build on this experimental knowledge afterwards a superstructure more elaborate than Rankine or Kelvin or Maxwell ever dreamt of as being possible. Every boy will build some superstructure of his own.

I must not dwell any longer on the three essential parts of a good general education which lead to the three powers which all boys of fifteen ought to possess; power to use books and to enjoy reading; power to use mathematics and to enjoy its use; power to study Nature sympathetically. English Board School boys who go to evening classes in many technical schools after they become apprentices are really obtaining this kind of education. The Scotch Education Board is trying to give it to all boys in primary and secondary schools. It will, I fear, be some time before the sons of well-to-do parents in England have a chance of obtaining it.

When a boy or man of any age or any kind of experience enters an engineering college and wishes to learn the scientific principles underlying a trade or profession, how ought we to teach him? Here is the reasonable general principle which Prof. Ayrton and Armstrong and I have acted upon, and which has so far led us to much success. Whether he comes from a bad or a good school, whether he is an old or young boy or man, approach his intelligence through the knowledge and experience he already possesses. This principle involves that we shall compel the teacher to take the pupil's point of view² rather than the pupil the teacher's; give the student a choice of many directions in which he may study; let lectures be rather to instruct the student how to teach himself than to teach him; show the student how to learn through experiment and how to use books, and, except for suggestion and help when asked for, leave him greatly to himself. If a teacher understands the principle he will have no difficulty in carrying it out with any class of students. I myself prefer to have students of very different qualifications and experience in one class because of the education that each gives to the others. Usually, however, except in evening classes, one has a set of boys coming from much the

¹ To many men it will seem absurd that a real working knowledge of what is usually called higher mathematics, accompanied by mental training, can be given to the average boy. In the same way it seemed absurd 500 years ago that power to read and write and cipher could be given to everybody. These general beliefs of ours are very wonderful.

² Usually it is assumed that there is only one line of study. In mathematics it is assumed that a boy has the knowledge and power and past experience and leisure of an Alexandrian philosopher. In mechanics we assume the boy to be fond of abstract reasoning, that he is a good geometrical who can do the most complex things in geometrical conics, but cannot possibly take in the simplest idea of the calculus.

same kind of school, and, although perhaps differing considerably as to the places they might take in an ordinary examination, really all of much the same average intelligence. Perhaps I had better describe how the principle is carried out in one case—the sons of well-to-do parents such as now leave English schools at about fifteen years of age.

It was for such boys that the courses of instruction at the Finsbury Technical College (the City and Guilds of London Institute) were arranged twenty-two years ago. It was attempted to supply that kind of training which ought already to have been given at school, together with so much technical training as might enable a boy at the end of a two years' course to enter any kind of factory where applied science was important, with an observing eye, an understanding brain and a fairly skilful hand. The system, in so far as it applies to various kinds of mechanical engineering, will be found described in one of a small collection of essays called "England's Neglect of Science," pp. 57-67.³ I am sure that any engineer who reads that description will feel satisfied that it was the very best course imaginable for the average boy of the present time. A boy was taught how he must teach himself after he entered works. If after two or three years in the works he cared to go for a year or so to one of the greater colleges, or did not care, it was assumed that he had had such a training as would enable him to choose the course which was really the best for him.

Old Finsbury students are to be found everywhere in important posts. The experiment has proved so successful that every London Polytechnic, every Municipal Technical School in the country has adopted the system, and in the present state of our schools I feel sure that all important colleges ought to adopt the Finsbury system. It hardly seems appropriate to apply the word "system" to what was so plastic and uncrystallised and had nothing to do with any kind of ritual.

The Professors were given a free hand at Finsbury, and there were no outside examiners. I need not dwell upon the courses in Chemistry and Physics; some critics might call the subjects *Rational Chemistry* and *Applied Physics*; they were as different from all other courses of study in these subjects as the courses on Rational Mathematics and Mechanics differed from all courses elsewhere. The course on Mechanics was really one on Mechanical Engineering. There were workshops in wood and iron, not to teach trades, but rather to teach boys the properties of materials. There were a steam-engine and a gas-engine, and shafting and gearing of many kinds, and dynamos which advanced students in turn were allowed to look after under competent men. There was no machine which might not be experimented with occasionally. Elementary and advanced courses of lectures were given; there was an elaborate system of tutorial classes, where numerical and squared paper exercise work was done; there were classes in experimental plane and solid geometry, including much graphical calculation; boys were taught to make drawing-office drawings in pencil only, and tracings and blue prints, such as would be respected in the workshop, and not the ordinary drawing-class drawings, which cannot be respected anywhere; but the most important part of the training was in the Laboratory, in which every student worked, making quantitative experiments. An offer of a 100-ton testing-machine for that laboratory was made, but refused; the advanced students usually had one opportunity given them of testing with a large machine, but not in their own laboratory. I consider that there is very little educational value in such a machine; the student thinks of the great machine,⁴ and not of

¹ The ideas in this Address have been put forward many times by Prof. Ayrton and myself. See the following, among other publications:—"England's Neglect of Science" (Fisher Unwin); "Practical Mechanics," 188 (Cassell); "Applied Mechanics," 1897 (Cassell); "The Steam Engine," 1898 (Macmillan); "The Calculus for Engineers," 1897 (Arnold); Recent Syllabuses and Examination Papers of the Science and Art Department in Subjects I., VII., Vp. and XXII.; Summary of Lectures on Practical Mathematics (Board of Education); "The Work of the City and Guilds Central Technical College" (*Journal of the Society of Arts*, July 9, 1897); Inaugural Lecture at Finsbury, 1879; Address at the Coventry Technical Institute, February, 1893; "Education of an Electrical Engineer" (*Journal of the Society of Telegraph Engineers and of Electricians*, September, 1893); Presidential Address, Institution of Electrical Engineers, January, 1899; "The Best Education for an Engineer" (*NATURE*), October 12, 1899; Address at a Drawing-room Meeting, March, 1887.

² These great testing-machines, so common in the larger colleges, seem to have destroyed all idea of scientific experiment. There is so much that the engineer wants to know, and yet laboratory people are persistently and lazily repeating old work suggested and begun by engineers of sixty years ago. For example, men like Fairbairn and Robert Napier would long ago have found out the behaviour of materials under combined stresses. We do not even know the condition of strength of iron or steel in a twisted shaft which is also a beam. The theory of strength of a gun or thick tube under

the tiny specimen. Junior students loaded wires and beams, or twisted things with very visible wires, and saw exactly what was happening, or they studied vibrating bodies. Many hours were devoted to experiments on a battered, rusty old screw-jack, or some other lifting-machine, its efficiency under many kinds of load being determined, and students studied their observations using squared paper, as intently as if nobody had ever made such experiments before. There was one piece of apparatus, an old fly-wheel bought at a rag and-bone shop, to which kinetic energy was given by a falling weight, which, I remember, occupied the attention of four white-headed directors of Electric Companies in 1882 (evening students) for many weeks. A casual first measurement led on to corrections for friction and stiffness of a cord, and much else of a most interesting kind. At the end of six weeks these gentlemen had gained a most thorough computational acquaintance with every important principle of mechanics, a knowledge never to be forgotten. They had also had a revelation such as comes to the true experimenter—but that is too deep a subject.

Perhaps teachers in the greater colleges will smile in a superior way when they hear of this kind of experimental mechanics being called engineering laboratory work. True it was elementary mechanics; but is not every principle which every engineer constantly needs called a mere elementary principle of mechanics by superior persons? I find that these elementary principles are very much unknown to men who have passed through elaborate mathematical studies of mechanics. Students found out in that laboratory the worth of formulæ; they gained courage in making calculations from formulæ, for they had found out the extent of their own ignorance and knowledge.

I have never approved of elaborate steam-engines got up for students' laboratory exercise-work. A professor who had devoted much thought for a year to the construction of such a four-cylinder engine showed a friend how any one or any two or any three or all four cylinders, with or without jacketing, could be used in all sorts of ways. The friend ventured to say: "This engine will be used just once and never after." The professor was angry, but his friend proved to be right. The professor made experiments with it once himself with a few good students. Unfortunately, it was not a sufficiently elaborate investigation for publication. Afterwards he never had time personally to superintend such work; his assistants were busy at other things; his students could not be trusted with the engine by themselves, and to this day it stands in the laboratory a beautiful but useless piece of apparatus. At Finsbury there was an excellent one-cylinder engine with vapourising condenser. It drove the workshops and electric generators. On a field-day it drove an electric generator only, and perhaps thirty students made measurements. Each of them had already acted as stoker and engine-driver, as oiler and tester of the machinery, lighting fires, taking indicator diagrams, weighing coals, opening and closing cocks from seven in the morning to ten at night, so that everything was well known to him. They maintained three different steady loads for trials of three hours each. They divided into groups, one from each group ceasing to take a particular kind of observation every ten minutes and removing to another job. All watches were made to agree, and each student noted the time of each observation. These observations were:—Taking indicator diagrams, checking the speed indicator, taking temperature of feed-water, quantity of feed by meter (the meter had been carefully checked by gauge-notch, and every other instrument used by us had been tested weeks before), taking the actual horse-power passing through a dynamometer coupling on the shaft, taking boiler and valve-chest pressures and vacuum pressures on the roof and in the engine-room, weighing coals (the calorific value had already been tested), taking the horse-power given out by the dynamo, counting the electric lamps in use, and so on. Each student was well prepared beforehand. During the next week he reduced his own observations, and some of the results were

hydraulic pressure is no clearer now than it was fifty years ago. The engineer asks for actual information derived from actual trial, and we offer him the "could-kill-but-again" stuff falsely called "theoretical," which is found in all the text-books (my own among others). These great colleges of university rank ought to recognise that it is their duty to increase knowledge through the work of their advanced students. The duty is not neglected in the electrical departments of some of the colleges. Perhaps the most instructive reference is to the work done at the Central Technical College of the City and Guilds Institute at South Kensington, as described by Prof. Ayrton in some of the papers already referred to. I cannot imagine a better development of the Finsbury idea in the work of the highest kind of Engineering College.

gathered on one great table. One lesson that this taught could never be forgotten—how the energy of one pound of coal was disposed of. So much up the chimney or by radiation from boiler or steam-jacket and pipes; in condensation in the cylinder; to the condenser; in engine friction; in shaft friction, &c. I cannot imagine a more important lesson to a young engineer than this one taught through a common working engine. The students had the same sort of experience with a gas-engine. I need hardly say how important it was that the Professor himself should take charge of the whole work leading up to, during, and after such a field-day.

The difficulty about all laboratory exercise work worth the name is that of finding demonstrators and assistants who are wise and energetic. Through foolishness and laziness the most beautiful system becomes an unmeaning routine, and the more smoothly it works the less educational it is. In England just now the curse of all education is the small amount of money available for the wages of teachers—just enough to attract mediocre men. I have been told, and I can easily imagine, that such men have one talent over-developed, the talent for making their job softer and softer, until at length they just sit at a table, maintaining discipline merely by their presence, answering the questions of such students as are earnest enough to come and worry them. In such cases it is absolutely necessary to periodically upset their clockwork arrangements. After such an artificial earthquake one might be reminded of what occurred at the pool of Bethesda, whose waters had their healing property restored when the angel came down and troubled them. But for a permanently good arrangement there ought to be very much higher wages all round in the teaching profession.

No kind of engineering has developed so rapidly as the electrical. Why, it was at the meeting here in Belfast twenty-eight years ago (I remember, for I was a Secretary of Section A that year, and took the machine to pieces afterwards in Lord Kelvin's laboratory) that there was exhibited for the first time in these islands a small Gramme machine. This handmaid of all kinds of engineering is now so important that every young engineer may be called uneducated who has not had a training in that kind of mechanical engineering which is called electrical engineering. Prof. Ayrton's laboratory at Finsbury is the model copied by every other electrical engineering laboratory in the world. He and I had the same notions; we had both been students of Lord Kelvin; we had worked together in Japan since 1875; but whereas I was trying to make my system of teaching mechanical engineering replace an existing system, or want of system, there was no existing system for his to replace. Thus it will be found that in every electrical engineering laboratory the elementary principles are made part of a pupil's mental machinery by many quantitative experiments, and nobody suggests that it is mere elementary physics which is being taught—a suggestion often enough made about the work in my mechanical laboratory. When students know these elementary principles well, they can apply their mathematics to the subject. As they advance in knowledge they are allowed to find out by their own experiments how their simple theories must be made more complex in real machines. Their study may be very complete, but, however much mathematics and graphical calculation may come in, their designs of electrical machinery are really based upon the knowledge acquired by them in the electrical and mechanical laboratories.

The electrical engineer has an enormous advantage over other engineers; everything lends itself to exact calculation, and a completed machine or any of its parts may be submitted to the most searching electrical and magnetic tests, since these tests, unlike those applied by other engineers, do not destroy the body tested. But for this very reason, as a finished product, the electrical engineer cannot have that training in the exercise of his judgment in actual practical work after he leaves a college that some other engineers must have. In tunnelling, earth-work and building, in making railways and canals, the engineer is supremely dependent on the natural conditions provided for him, and these conditions are never twice the same. There are no simple laws known to us about the way in which sea and river currents will act upon sand and gravel, and engineers who have had to do with such problems are continually appealing to Nature, continually making observations and bringing to bear upon their work all the knowledge and habits of thought that all their past experience has given them. I do not know that there is any job which a good teacher would have greater

pleasure in undertaking than the arrangement of a laboratory in which students might study for themselves such problems as come before railway, canal, river, harbour and coast-protection engineers; there is no such laboratory in existence at the present time, and in any case it could only be of use in the way of mere suggestion to an engineer who had already a good knowledge of his profession.

It was a curious illustration of mental inertia that the usual engineering visitor, even if he was a professor of engineering, always seemed to suppose that the work done at Finsbury was the same as that done in all the great engineering colleges. As a matter of fact, no subject was taught there in the same manner as it was taught elsewhere.¹

Most of the students were preparing for electrical or mechanical engineering, and therefore we thought it important that nearly every professor or demonstrator or teacher should be an engineer. I know of nothing worse than that an engineering student should be taught mathematics or physics or chemistry by men who are ignorant of engineering, and yet nothing is more common in colleges of applied science.² The usual courses are only suitable for men who are preparing to be mere mathematicians, or mere physicists, or mere chemists. Each subject is taken up in a stereotyped way, and it is thought quite natural that in one year a student shall have only a most elementary knowledge of what is to the teacher such a great subject. The young engineer never reaches the advanced parts which might be of use to him; he is not sufficiently grounded in general principles; his whole course is only a preliminary course to a more advanced one which there is no intention of allowing him to pursue, and not being quite a fool, he soon sees how useless the thing is to him. The Professor of Chemistry ought to know that until a young engineer can calculate exactly by means of a principle, that principle is really unknown to him. For example, take the equation supposed to be known so well,

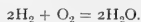

It is never understood by the ordinary elementary chemical student who writes it down so readily. Every one of the six cunning ways in which that equation conveys information ought to be as familiar to the young engineer as they are, or ought to be, to the most specialised chemist. Without this he cannot compute in connection with combustion in gas and oil engines and in furnaces. But I have no time to dwell on the importance of this kind of exact knowledge in the education of an engineer.

Mathematics and physics and chemistry are usually taught in watertight compartments, as if they had no connection with one another. In an engineering college this is particularly bad. Every subject ought to be taught through illustrations from the professional work in which a student is to be engaged. An engineer has been wasting his time if he is able to answer the questions of an ordinary examination paper in chemistry or pure mathematics. The usual mathematical teacher thinks most of those very parts of mathematics which to an ordinary man who wants to use mathematics are quite valueless, and those parts which would be altogether useful and easy enough to understand he never reaches; and, as I have said, so it is also in chemistry. Luckily, the physics professor has usually some small knowledge of engineering; at all events he respects it. When the pure mathematician is compelled to leave the logical sequence which he loves to teach mechanics, he is apt scornfully to do what gives him least trouble; namely, to give as "mechanics" that disguised pure mathematics which forms ninety per cent. of the pretence of theory to be found in so many French and German books on machinery. As pure mathematical exercise work it is even meaner than the stupid exercises in school algebras; as pretended engineering it does much harm because a student does not find out its futility until after he has gone through it, and his enthusiasm for mathematics applied to engineering problems is permanently hurt. But how is a poor mathematical professor who dislikes engineering, feeling like Pegasus harnessed to a common wagon—how is he to distinguish good from evil? He fails to see how worthless are some of the books on "Theoretical Mechanics"

written by mathematical coaches to enable students to pass examinations. An engineer teaching mathematics would avoid all futilities; he would base his reasoning on that experimental knowledge already possessed by a student; he would know that the finished engineer cannot hope to remember anything except a few general principles, but that he ought to be able to apply these, clumsily or not, to the solution of any problem whatsoever. Of course he would encourage some of his pupils to take up Thomson and Tait, or Kayleigh's "Sound," or some other classical treatise as an advanced study.¹

Not only do I think that every teacher in an engineering college ought to have some acquaintance with engineering, but it seems to me equally important to allow a professor of engineering, who ought, above all things, to be a practical engineer, to keep in touch with his profession. A man who is not competing with other engineers in practical work very quickly becomes antiquated in his knowledge: the designing work in his drawing-office is altogether out of date; he lectures about old difficulties which are troubles no longer; his pupils have no enthusiasm in their work because it is merely academic and lifeless; even when he is a man distinguished for important work in the past his students have that kind of disrespect for his teaching which makes it useless to them. If there is fear that too much well-paid professional work will prevent efficiency in teaching, there is no great difficulty in applying a remedy.

One most important fact to be borne in mind is that efficient teachers cannot be obtained at such poor salaries as are now given. An efficient labourer is worthy of his hire; an inefficient labourer is not worthy of any hire, however small. Again, there is a necessity for three times as many teachers as are usually provided in England. The average man is in future to be really educated. This means very much more personal attention, and from thoughtful teachers. Is England prepared to face the problem of technical education in the only way which can lead to success, prepared to pay a proper price for the real article? If not, she must be prepared to see the average man remaining uneducated.

Advocacy of teaching of the kind that was given at Finsbury is often met by the opposition, not only of pure mathematicians and academic teachers, but I am sorry to say also of engineers. The average engineer not merely looks askance at, he is really opposed to the college training of engineers, and I think, on the whole, that he has much justification for his views. University degrees in engineering science are often conferred upon students who follow an academic course, in which they learn little except how to pass examinations. The graduate of to-day, even, does not often possess the three powers to which I have referred. He is not fond of reading, and therefore he has no imagination, and the idea of an engineer without imagination is as absurd as Teufelsdröckh's notion of a cast-iron king. He cannot really compute, in spite of all his mathematics, and he is absurdly innocent of the methods of the true student of Nature. This kind of labelled scientific engineer is being manufactured now in bulk because there is a money value attached to a degree. He is not an engineer in any sense of the word, and does not care for engineering, but he sometimes gets employment in technical colleges. He is said to teach when he is really only impressing upon deluded pupils the importance of formulae and that whatever is printed in books must be true. The real young engineer, caught in this eddy, will no doubt find his way out of it, for the healthy experience of the workshop will bring back his common-sense. For the average pupil of such graduates there is no help. If he enters works, he knows but little more than if he had gone direct from school. He is still without the three qualifications which are absolutely necessary for a young engineer. He is fairly certain to be a nuisance in the works and to try another profession at the end of his pupillage. But if it is his father's business he can make

¹ One sometimes finds a good mathematician brought up on academic lines taking to engineering problems. But he is usually *stiff* and unwilling to go thoroughly into these practical matters, and what he publishes is particularly harmful, because it has such an honest appearance. When we do get, once in forty years, a mathematician (Osborne Reynolds or Dr. Hopkinson) who has common-sense notions about engineering things, or a fairly good engineer (Rankine or James Thomson) who has a common-sense command of mathematics, we have men who receive the greatest admiration from the engineering profession, and yet it seems to me that quite half of all the students leaving our technical colleges ought to be able to exercise these combined powers in mathematics, were sensibly taught in school and college. We certainly have had enough of good mathematicians meddling with engineering theory and of engineers with no mathematics wasting their time in trying to add to knowledge.

² It is really ludicrous to see how all preachers on technical education are supported by not thinking people to hold the same doctrine. The people asking for reform in education differ from one another more than Erasmus and Luther, and John of Leyden and Knipperding.

³ At the most important colleges the usual professor or tutor is often ignorant of all subjects except his own, and he generally seems rather proud of this; but surely in such a case a man cannot be said to know even his own subject.

a show of knowing something about it, and he is usually called an engineer.

Standardisation in an industry usually means easier and cheaper and better manufacture, and a certain amount of it must be good even in engineering, but when we see a great deal of it we know that in that industry the true engineer is disliked. I consider that in the scholastic industry there has been far too much standardisation. Gymnasien and polytechnic systems are standardised in Germany, and there is a tendency to import them into England; but in my opinion we are very far indeed from knowing any system which deserves to be standardised, and the worst we can copy is what we find now in Germany and Switzerland. What we must strive for is the discovery of a British system suiting the British boy and man. The English boy may be called stupid so often that he actually believes himself to be stupid; but of one thing we may be sure, he will find in some way or other an escape from the stupefying kind of school work to which the German boy submits. And if it were possible to make the average English boy of nineteen pass such a silly school-leaving examination as the German boy,¹ and to pass through a polytechnic, I am quite sure that there would be little employment among common-sense English engineers for such a manufactured article. But is it possible that British boys could be manufactured into such obedient academic machines, without initiative or invention or individuality, by teachers who are none of them engineers? No, we must have a British system of education. We cannot go on much longer as we have done in the past without engineering education, and, furthermore, it must be such as to commend itself to employers. Of my Finsbury students I think I may say that not one failed to get into works on a two or three years' engagement, receiving some very small wage from the beginning, and without paying a premium. To obtain such employment was obviously one test of fitness to be an engineer, because experienced men thought it impossible. One test of the system was the greater ease with which new men obtained employment in shops which had already taken some of our students. It is certainly very difficult to convince an employer that a college man will not be a nuisance in the shops. In Germany and France, and to a less extent in America, there is among employers a belief in the value of technical education. In England there is still complete unbelief. I have known the subscribers of money to a large technical college in England (the members of its governing board) to laugh, all of them, at the idea that the college could be of any possible benefit to the industries of the town. They subscribed because just then there was a craze for technical education due to a recent panic. They were ignorant masters of works (sons of men who had created the works), ignorant administrators of the college affairs and ignorant critics of their mismanaged college. I feel sure that if the true meaning of technical education were understood, it would commend itself to Englishmen. Technical education is an education in the scientific and artistic principles which govern the ordinary operations in any industry. It is neither a science nor an art, nor the teaching of a handicraft. It is that without which a master is an unskilled master; a foreman an unskilled foreman; a workman an unskilled workman; and a clerk or farmer an unskilled clerk or farmer. The cry for technical education is simply a protest against the existence of unskilled labour of all kinds.²

¹ The following is, I understand, a stock question at certain gymnasien: "Write out all the trigonometrical formulæ you know." I asked my young informant, "Well, how many did you write?" "Sixty-two," was the answer. This young man informed me that a boy could not pass this examination unless he knew "all algebra and all trigonometry and all science." Strasbourg geese used to be fed in France; now they are fed in Germany. German education seems to be like smothering a fire with too much fuel or wet slack which has the appearance of fuel.

² I have pointed out how natural it is that business men should feel somewhat antagonistic to college training. Poorly paid, unpractical teachers, with no ideas of their own, have in the past taught in the very stupidest way. They have called themselves "scientific" and "theoretical" till these words stink in the nostrils of an engineer. When I was an apprentice, and no doubt it is much the same now, if an apprentice was a poor workman with his hands he often took to some kind of study which he called the science of his trade. And in this way a pawkiness for science got to be the sign of a bad workman. But if workmen were so taught at school that they all really knew a little physical science, it would no longer be laughed at. When a civil or electrical engineer is unpractical because he has no business habits, he takes to calculation and the reading of so-called scientific books, because it is very easy to get up a reputation for science. The man is a bad engineer in spite of his science, but people get to think that he is an unpractical man because of his scientific knowledge. I do believe that the unbelief in technical education so very general has this kind of illegal foundation. Four hundred years ago, if a layman could read or write he was

To have any good general system the employers must cooperate. Much of the training is workshop practice, and it cannot be too often said that this is not to be given in any college. The workshop in a college serves a quite different purpose. Now how may the practice best be given? I must say that I like the Finsbury plan very much indeed, but there are others. When I attended this college in winter I was allowed to work in the Lagan Foundry in summer. In Japan the advanced students did the same thing; they had their winter courses at the college, and the summer was spent in the large Government workshops; the system worked very well indeed.³ In Germany recently the great unions of manufacturers made facilities for giving a year of real factory work to the polytechnic students, but it seems to me that these men are much too old for entrance to works, and, besides, a year is too short a time if the finished product is to call itself a real engineer. Possibly the British solution may be quite different from any of these. A boy may enter works at fourteen on leaving a primary school or not later than sixteen on leaving a secondary school. In either case he must have the three powers to which I have already referred so often. It will be recognised as the duty of the owners of works to provide, either in one large works or near several works, in a well-equipped school following the Finsbury principle, all the training in the principles underlying the trade or profession which is necessary for the engineer.

No right-thinking engineer has been scared by the newspaper writers who tell us of our loss of supremacy in manufacture, but I think that every engineer sees the necessity for reform in many of our ways, and especially in this of education. People talk of the good done to our workmen's ideas by the strike of two years ago; it is to be hoped that the employers' ideas were also expanded by their having been forced to travel and to see that their shops were quite out of date.⁴ In fact, we have all got to see that there is far too much unskilled labour among workmen and foremen and managers, and especially among owners. There may be some kinds of manufacture so standardised that everything goes like a wound-up clock and no thought is needed anywhere; but certainly it is not in any branch of engineering. Many engineering things may be standardised, but not the engineer himself. Millions of money may build up trusts, but they will be wasted if the unskilled labour of mere clerks is expected to take the place of the thoughtful skilled labour of owners and managers. I go further, and say that no perfection in labour-saving tools will enable you to do without the skilled, educated, thoughtful, honest, faithful workman with brains. I laugh at the idea that any country has better workmen than ours, and I consider education of our workmen⁵ to be the corner-stone of prosperity in all engineering manufacture. It is from the workman in countless ways that all hints leading to great inventions come. New countries like America and Germany have their chance just now; they are starting, without having to "scrap" any old machinery or old ideas, with the latest machinery and the latest ideas. For them also the time will come when their machines will be getting out-of-date and the cost of "scrapping" will loom large in their eyes. In the meantime they have taught us lessons, and these greatest of all lessons—that unless we look ahead with much judgment, unless we take reasonable precautions, unless we pay some regard to the fact that the cleverest people in several nations are hungry for our trade and jealous of our supremacy, we may for a time lose a little of that supremacy. In the last

probably a useless person who, because he could not do well otherwise, took to learning. What a man learnt was clumsily learnt; usually he learnt little with great labour and made no use of it; therefore reading and writing seemed useless. Now that everybody is compelled to read and write, it is not a usual thing to say that it hurts a man to have these powers.

¹ It was the idea of Principal Henry Dyer.

² Not only is there an enormous improvement in the use of limit gauges and checking and tools, and the careful calculation of rates of doing work by various tools and general shop arrangement, but attention is being paid to the comfort of workmen. There are basins and towels, and hot and cold water for them to wash in. In the old days it would have been called faddy philanthropy. Now, owners of works who scorn all softness of heart provide perfect water-closets for their men; their workshops are kept at a uniform temperature; the evil effect of a bad draught in producing colds, or a bad light in hurting the eyes, is carefully considered. In some of these works it is actually possible for a workman or a member of his family to get a luxurious hot bath for a penny. Will this really pay? Some clever, hard-headed men of my acquaintance say they already say that it does pay very well indeed.

³ The old apprenticeship system of training men has broken down, and this is the cause of most of our industrial troubles. An apprenticeship system suited to modern conditions is described fully on pp. 68-68 of "England's Neglect of Science."

twenty-three years I have written a good deal about the harm done to England by the general dislike that there is among all classes for any kind of education. I do not say that this dislike is greater than it used to be in England; I complain that it is about as great. But I have never spoken of the decadence of England. It is only that we have been too confident that those manufactures and that commerce and that skill in engineering, for which Napoleon sneered at us, would remain with us for ever. Many writers have long been pointing out the consequences of neglecting education; prophesying those very losses of trade, that very failure of engineers to keep their houses in order, which now alarms all newspaper writers. Panics are ridiculous, but there is nothing ridiculous in showing that we can take a hint. We have had a very strong hint given us that we cannot for ever go on with absolutely no education in the scientific principles which underlie all engineering. There is another important thing to remember. Should foreigners get the notion that we are decaying, we shall no longer have our industries kept up by an influx of clever Uitlanders, and we are much too much in the habit of forgetting what we owe to foreigners, Fleming and German, Hollander, Huguenot and Hebrew, for the development of our natural resources. Think of how much we sometimes owe to one foreigner like the late Sir William Siemens.

But I am going too far; there is after all not so very much of the foolishness of Ishbosheth among us, and I cannot help but feel hopeful as I think lovingly of what British engineers have done in the past. We who meet here have lived through the pioneering time of mechanical and electrical and various other kinds of engineering. Our days and nights have been delightful because we have had the feeling that we also were helping in the creation of a quite new thing never before known. It may be that our successors will have a better time, will see a more rapid development of some other applications of science. Who knows? In every laboratory of the world men are discovering more and more of Nature's secrets. The laboratory experiment of to-day gives rise to the engineering achievement of to-morrow. But I do say that, however great may be the growth of engineering, there can never be a time in the future history of the world, as there has never before been a time, when men will have more satisfaction in the growth of their profession than engineers have had during the reign of Queen Victoria.

And now I want to call your attention to a new phenomenon. Over and over again has attention been called to the fact that the engineer has created what is called "modern civilisation," has given luxuries of all kinds to the poorest people, has provided engines to do all the slave labour of the world, has given leisure and freedom from drudgery, and chances of refinement and high thought and high emotion to thousands instead of units. But it is doing things more striking still. Probably the most important of all things is that the yoke of superstitions of all kinds on the souls of men should be lifted. The study of natural science is alone able to do this, but education through natural science for the great mass of the people, even for the select few called the distinguished men of the country, has been quite impossible till recently. I say that it is to engineers that the world owes the possibility of this new study becoming general. In our country nearly all discoveries come from below. The leaders of science, the inventors, receive from a thousand obscure sources the germs of their great discoveries and inventions. When every unit of the population is familiar with scientific ideas, our leaders will not only be more numerous, but they will be individually greater. And it is we, and not the schoolmasters, who are familiarising the people with a better knowledge of Nature. When men can hardly take a step without seeing steam-engines and electro-motors and telegraphs and telephones and steamships, with drainage and water works, with railways and electric tramways and motor-cars; when every shop-window is filled with the products of engineering enterprise, it is getting rather difficult for people to have any belief in evil spirits and witchcraft.

All the heart-breaking preaching of enthusiasts in education would produce very little effect upon an old society like that of England if it were not for the engineer. He has produced peace. He is turning the brown desert lands of the earth into green pastures. He is producing that intense competition among nations which compels education. If England has always been the last to begin reform, she has always been the most thorough and steadfast of the nations on any reform when

once she has started on it. Education, pedagogy, is a progressive science; and who am I that I should say that the system of education advocated by me is that which will be found best for England? In the school education of the average boy or man England has as yet had practically no experience, for she has given no real thought to it. Yet when she does, I feel that although the Finsbury scheme for engineers may need great improvement, it contains the germ of that system which must be adopted by a race which has always learnt through trial and error, which has been led less by abstract principles or abstract methods of reasoning than any race known in history.

NOTES.

WE learn from the *Times* that the work at the Ben Nevis Observatory is to be continued for another year without change in its character. The Meteorological Council in London has agreed to continue its grant of 250*l.* to the low-level observatory at Fort William and the grant of 100*l.* to the high-level observatory. The proceeds derived from furnishing newspapers with meteorological reports and from other sources will amount, it is hoped, to about 150*l.*, the sum hitherto yielded. The balance of the cost of maintenance, amounting to about 1000*l.*, has been readily subscribed by the public. This satisfactory arrangement will enable the staff to prosecute its work without interruption until the Parliamentary Committee inquiry has reported.

REUTER telegrams state that both craters of the Soufrière have been active since September 11, that communication by wireless telegraphy is to be established between Martinique and Guadaloupe, and that a shock of earthquake was felt in many of the northern towns of South Australia on Friday morning last. A severe shock was also experienced in Adelaide in the evening of the same day.

THE medals and prizes will be distributed to the students of the Royal College of Science, South Kensington, in the theatre of the Victoria and Albert Museum at 2.30 p.m. on Thursday next. The opening address of the new session will be delivered by Prof. John Perry, F.R.S., and Sir Arthur Kücker, F.R.S., will also speak.

THE death is announced in the *Athenaeum* of Theodor v. Heldreich, director of the Botanic Gardens at Athens. The deceased botanist, who was in his eighty-first year, devoted his attention mainly to the flora of Greece, and was the author of numerous works.

AMONG the deaths of foreign men of science we notice the following:—M. Damour—a member of the Paris Academy of Sciences—at the age of 94, and Prof. O. G. Nordenström, of the Stockholm School of Mines. The former was well known for his chemical analyses of rare minerals, and the latter was an authority on mining and the author of numerous technical memoirs.

THE suggestion that a public subscription should be opened for the purpose of purchasing the house in which Pasteur was born and presenting it to the town of Dôle was brought before the French Association at its recent session.

A SCHEME has been proposed to the Italian Minister of Posts and Telegraphs by Mr. Marconi for the creation of a radio-telegraphic station communicating with the stations established or to be established by the Marconi companies in London and in America. The scheme, which is still under consideration, would, if carried out, cost about 70,000 lire. It was announced at a dinner given in Mr. Marconi's honour that the King of Italy had bestowed the Cross of a Grand Officer of the Italian Order of the Crown upon the inventor.

A PRELIMINARY report on the subject of the wireless telegraphy experiments conducted by a board of naval officers

has, according to the *Western Electrician*, been submitted to the U.S. Navy Department. The board reported that it had tried the Rochefort system with some success, messages having been received and sent with accuracy, and that it was now proposed to test in turn a French and two German systems.

On Friday afternoon last, Mr. Stanley Spencer, the aeronaut, sailed from the Crystal Palace in the airship he has constructed. A successful voyage over London was made, and the vessel descended at Eastcote, near Pinner.

THE *British Medical Journal* states that arrangements are nearly completed for the formation of a new society to be known as the Therapeutical Society, which shall concern itself with the medicinal properties of every kind of natural product of value in practical medicine. As new countries are opened up, plants hitherto unknown are brought to this country, and, as our contemporary remarks, the society may fulfil a most useful function if it undertakes to study the chemical, pharmacological and therapeutical qualities of such plants, especially those which are believed by the natives of the countries from which they come to possess valuable medicinal properties. The first president will be Sir W. T. Thiselton-Dyer, K.C.M.G., F.R.S., and the first hon. secretary Dr. T. E. B. Brown, master of the Society of Apothecaries. The meetings are to be held in the house of the Society of Apothecaries, and the first will take place shortly to make the necessary preliminary arrangements for the first year's work.

PART of an expedition for the survey of the Gold Coast set sail from Liverpool on Saturday last. The remaining members of the expedition, numbering between thirty and forty, and consisting of trained surveyors from the Ordnance Survey and surveyors from Queensland and New Zealand, will leave for West Africa on October 4.

AN inquiry into the earthquakes in Guatemala and Martinique has been undertaken by Prof. Sapper, of Tübingen, who has obtained leave of absence for the purpose from the Württemberg Government.

AN international exhibition of photography is to be held in Moscow in the spring of next year. It will be divided into the following sections:—(1) Scientific photography; (2) artistic photography; (3) photography applied to printing; (4) works on photography; (5) technical applications of photography; (6) photography considered as a special industry.

THE following rewards are offered by the Government of South Australia for the discovery and working within the State of a deposit or deposits of marketable mineral manure—500*l.* if found on Crown lands; 250*l.* if found on freehold lands. It is stipulated (1) that the deposit is easily accessible and within a reasonable distance of a railway or seaport, and not within twenty-five miles of any discovery on account of which any bonus has been paid; (2) that the deposit is sufficiently abundant and is available at a price which will allow of it being remuneratively used for agricultural purposes; (3) that the product is of a good marketable quality, averaging not less than 40 per cent. of phosphate of lime. In the event of a phosphate of a lower average composition being discovered, it may be recommended that a portion of the reward be paid. Applications must reach the Minister for Agriculture, Adelaide, not later than December 31.

It was found from the examination of 55,000 children in some thirty-six public schools in New York that no fewer than 12 per cent. suffered from contagious diseases of the eyes.

To prevent such children from attending the institutions, a routine examination of the eyes is in future to be made at regular intervals, and for this purpose ophthalmic surgeons have been appointed.

JUDGING from the reports issued by the teachers in the various West Indian islands, the experiment of introducing the subject of agriculture into the elementary schools, which was due to a suggestion made by the Commissioner of the Imperial Department of Agriculture, has already begun to yield satisfactory results. The best accounts come from Jamaica, where the training college at Kingston provides a suitable centre for imparting instruction to teachers in training and special classes; here, too, good practical work has been accomplished. School gardens are being instituted, notably in Jamaica, Trinidad and Tobago, but in some of the islands they have not proved so successful owing to predial larceny. A full account of the agricultural conference appears in the last number of the *West Indian Bulletin*, when besides these reports several papers of an economic nature were read. The Hon. Sydney Olivier pointed out the necessity for careful sorting and good packing of exported fruit if West Indian growers hoped to establish a market in England and America. He suggested that an inspector should be appointed to report on the condition of the fruit as it arrived at its destination. The Hon. W. Fawcett read a paper on the banana industry in Jamaica, which gave general information on the habits of the plant and its method of cultivation. Statistics show that at present the exports to England are small in proportion to those shipped to America. Mr. A. Howard brought forward evidence to show that epiphytes do harm to cacao trees mainly by blocking up the lenticles. He advised spraying with copper sulphate or rosin compound to kill off the smaller plants. Other papers were, "Insect Pests," by Mr. H. Maxwell-Lefroy; "Barbados Aloes," by Mr. W. G. Freeman; and "Essential Oils," by Mr. J. H. Hart.

THE issue of the *Elektrochemische Zeitschrift* for August contains a useful reference article by Dr. H. Lienau on bauxite. This mineral is the chief source of the commercial aluminium produced by the electrolytic processes, and although many attempts have been made, and are still being made, to replace it by some cheaper raw material, these attempts hitherto have been unsuccessful. Natural deposits of bauxite occur in France, Germany, Ireland and the United States, those of the department Var in southern France being at present the most extensively worked. In 1896 this district produced 29,620 tons and in 1901 65,000 tons, of which total 55,000 tons were exported to other countries. After a reference to the geological formation in which bauxite occurs and to the varying composition of the deposits, the author describes the various processes which have been worked at one time or another for extracting aluminium or its compounds from this source. The first patented process dates from 1858, and had for its object the extraction of aluminium hydrate from red bauxite. The demand by paper and colour manufacturers for a cheaper source of aluminium sulphate than the alums turned attention to the direct production of aluminium sulphate from bauxite, but the efforts to produce this salt, free from iron, from red bauxite have not been completely successful. The utilisation of bauxite for the electrometallurgical production of aluminium is a comparatively recent development, but very large quantities of the mineral are now being used in aluminium reduction works. The author surmises from this fact that bauxite is being employed directly in the electrolytic baths, and that the troublesome and costly process by which alumina was first extracted from the raw bauxite is now being dispensed with.

MR. F. KROHN sends from Funchal, Madeira, some notes on sunset glows observed by him during June, July and August, in continuation of those previously described by him (p. 199). On a number of occasions, even when the sky above and to the west was overcast at sunset, a pink glow could be seen on the eastern horizon just before sunset, and then just immediately after or at the time of sunset a pink glow would suffuse the cloud screen above. Mr. Krohn was under the impression that the phenomenon was rather more marked about July 6-7, 12-16 and 26-27, but these dates, especially the last two, are uncertain. Since the end of July, clear weather has prevailed, and during August 1-3 a well-marked maximum was observable, the phenomenon being particularly well marked on August 2, when both sunrise and sunset displays were very fine, the sky at the time being quite clear. The latter sunsets, however, were very far from equalling the displays of June 10-11. The rays or spokes in the pink haze, mentioned in Prof. A. S. Herschel's letter of July 10 (NATURE of July 24), have been observed by Mr. Krohn four or five times. From the observations it is concluded that the volcanic dust and moisture cloud is travelling at an average rate of about thirty miles an hour in the latitude of Funchal. This does not seem an improbable rate if Prof. Herschel's estimate of the height of the present cloud is correct, for the rate at which the Krakatoa cloud travelled was about seventy-two miles an hour; but this cloud was travelling at a much greater height.

WHEN well marked, the phenomena observed by Mr. Krohn at sunset followed the course described by Prof. Herschel. In Mr. Krohn's words, "A pink glow appears in the east in the form of a broad band above a broad greenish-grey band down on the horizon. The pink band gradually extends upwards and disappears as the glow begins to form a pink arc in the western horizon, which until then shows a white hazy area above the sun's point of setting. Gradually the white area contracts and assumes a more golden hue. The pink arc also contracts and assumes a more intense colour; at the outer edge it is more purple where the pink mixes with the blue of the sky. A dirty greenish-grey haze now begins to spread upwards from the eastern horizon and finally replaces the pink halo in the west as a purplish-grey arc around a whitish halo. This faint purplish halo or arc is visible for some time after dusk has set in. At sunrise the phenomena are practically the same, but the order is reversed and the colours near the horizon seem to be purer."

THE director of the Philippine Weather Bureau, the Rev. Fr. José Alcúe, S. J., has issued the first part of a report containing an account of the climate of Baguio (Benguet), as gathered from a complete year's observations. The report is very thoroughly made and is the first of its kind, and one of its main objects is to draw attention to climatological conditions of certain regions of the archipelago which might be advantageously chosen as health resorts. In the case of each of the meteorological elements here discussed, a comparison of the facts is made with the data already recorded at and published by the Manila Observatory. The meteorological station at Baguio is of quite recent date, having been in operation since August, 1900, and its equipment was made more complete after the establishment of the Philippine Weather Bureau in May, 1901. The present report contains the observations of pressure, temperature, relative humidity, fog, clouds, rainfall, wind, and in most cases curves of the daily and yearly variations are given. The concluding chapter is devoted to a comparison of the climate of this station with those of other tropical stations at similar altitudes.

THE trustees of the British Museum at Bloomsbury have issued a capital "Guide to the Antiquities of the Stone Age in the Department of British and Medieval Antiquities," which is

accompanied by ten plates and 142 other illustrations. It has been prepared by Mr. Charles H. Read, who observes that his work is to some extent rendered incomplete owing to the fact that many objects essential to a full understanding of the Stone Age are at the Natural History Branch in Cromwell Road, while some localities and some classes of implements are not so well represented as they should be in the national collection. Although he groups the antiquities under those of Palaeolithic and Neolithic ages, he figures and describes certain Eolithic implements, recognising that the existence of an earlier and ruder type is in itself not improbable. His reference to the occurrence of "early Palaeolithic" implements in beds older than the chalky boulder clay, though based on a statement in a Geological Survey memoir, requires qualification, as the evidence is far from satisfactory. The text is, however, so full of information and the illustrations are so excellent, exhibiting the chipped and polished stone-implements from all parts of the world, as well as engraved stones, bones and horns, and pile-dwellings, that the work will be highly appreciated by all who take an interest in the antiquity of man.

MR. T. MELLARD READE has given an account of the Glacial and post-Glacial features of the River Lune and its estuary (*Proc. Liverpool Geol. Soc.*, vol. ix. 1902). The lower part of the valley is a pre-Glacial excavation that was filled with Boulder-clay and other glacial drift, and since to a large extent removed by river denudation, the various stages being recorded by terraces cut in the drift. The later deposits include thick sands and clayey sands rich in foraminifera, of which lists have been furnished by Mr. Joseph Wright.

A FULL account of a recent peat and forest bed at Westbury-on-Severn has been contributed by Mr. Mellard Reade, Mr. A. S. Kennard and others to the *Proceedings of the Cotteswold Naturalists' Field Club* (vol. xiv. part 1). The deposits include blue clays containing foraminifera, an intermediate peat bed with branches and roots of trees, and an overlying mass of tidal alluvium. The foraminifera appear to have lived in the locality and probably in brackish water. The peat bed has yielded many land and fresh-water molluscs, which with other remains indicate climatic conditions similar to those of the present day. The deposits are recent, and the indications they furnish of changes of level prior to the Roman occupation are briefly discussed.

A PAPER by E. Guyou, entitled "La Méthode des Distances Lunaires, le Présent, le Passé, l'Avenir," has reached us. The author considers that the publication of lunar distances of certain stars in the national ephemerides has had a bad effect in that it has concentrated observation upon those stars all of which at the moment of observation are possibly too far from the moon for accurate observation, and that therefore repeated failure to obtain accurate results has led to the abandonment of the method. The author expects now to see the method revived, observers being no longer biased in their choice and taking the most convenient star. We think he is too sanguine.

THE chemical composition of tubercle bacilli derived from various sources, especially in regard to the amount of ash and of phosphoric anhydride, and of the alcoholic, ether and chloroform extracts, has been investigated by De Schweinitz and Dorset. There is a distinct difference in the composition of the various bacilli; the alcoholic extract of avian bacilli is very much greater than that of any other variety, but the chloroform extract of bovine and of human virulent bacilli is almost the same. There is also a greater difference between the virulent and non-virulent human bacilli than between the virulent human, bovine and equine bacilli. (*Amer. Med.*, July 19, p. 93.)

In the August number of the *American Chemical Journal* is an interesting paper by Messrs. Franklin and Stafford on reactions between acid and basic amides in liquid ammonia. Solutions of these amides in liquid ammonia are conductors of electricity, a fact presumably due to electrolytic dissociation of the dissolved substances. It would appear that these amides indeed bear a relation to liquid ammonia which in many respects is very similar to that borne by ordinary acids and bases to water. Complete or partial neutralisation of the dissolved amides takes place with the formation of one or more molecules of the solvent ammonia in which the reaction takes place. By bringing together liquid ammonia solutions of different acid and basic amides, the authors have prepared a large number of metallo-substituted acid amides; for example, monopotassium acetamidic acid, mono- and di-potassium benzamide, mono- and di-potassium sulphamide, mono- and di-potassium urea, magnesium acetamidic acid, &c.

In a *Bulletin* of the Bussey Institution, vol. iii. No. 2, Prof. F. H. Storer describes the results of tests for mannose carried out on a large number of vegetable species. From these it would appear that mannan is fairly widely distributed in plant life. The amount of mannan in the trunk-wood of sugar-maple trees felled during the period of hibernation is considerably greater than that in maple trees felled at the beginning or end of May, that is, during or just after the formation of new leaves upon the trees. The author comes to the conclusion that mannan as well as starch is stored as reserve food in the wood of the sugar maple.

The sixteenth number of the *Revue générale des Sciences*, issued on August 30, contains a short article, by Mr. P. Lemout, on the new synthesis of indigo patented by Sandmeyer. The author points out that the Sandmeyer synthesis possesses several advantages, from a chemical point of view, over the two processes which are now used on the large scale for the artificial production of indigo. An estimate of the cost of production by the new process indicates that the indigo obtained should compete successfully on the market with the natural product and that of the older synthetic methods.

In vol. xvii. of the *Journal* of the College of Science, Imperial University, Tokyo, Messrs. Divers and Ogawa show that it is possible to prepare sulphamide from ammonium amidosulphate with a 10 per cent. yield, whereas the older method of obtaining it from sulphuryl chloride and ammonia only gives 1 to 2 per cent. of the theoretical amount.

To the September number of the *Zoologist*, Mr. R. C. J. Swinhoe contributes some important notes on prehistoric man in Burma. It will be remembered that in 1894 Dr. F. Noetling announced in the *Records* of the Geological Survey of India the discovery in a bed of ferruginous conglomerate at the oil-fields of Yenangyoung of worked flints in association with the remains of *Hipparion antilopinus* and *Rhinoceros beringensis*, thus carrying back the existence of man in that country to the older Pliocene or upper Miocene. A year later, Mr. R. D. Oldham expressed the opinion that, in the first place, the flints are not confined to the ferruginous conglomerate and, secondly, that they are not chipped by man. As the result of a recent visit to the locality, Mr. Swinhoe confirms Dr. Noetling's view that the chipped flints, and likewise certain faceted bones, are the works of men's hands; but, on the other hand, he regards them as of Palæolithic age, the place where they were found being apparently a workshop of that period.

The September issue of the *Quarterly Journal of Microscopical Science* contains four articles of a highly technical nature, for the most part interesting only to specialists. In the first of the four, Dr. T. H. Bryce treats of the maturation of the

egg in the common sea-urchin; he is followed by Mr. R. I. Pocock, who discusses the "entosternite" of spiders and scorpions. The third article, by Dr. S. F. Harmer, is devoted to the morphology of polyps allied to the common sea-mat, while in the fourth, Mr. L. Doncaster describes the development and anatomy of the annelid sagitta.

Nos. 1275 and 1276 of the *Proceedings* of the U.S. Museum are respectively devoted to a list of the beetles of the Columbia district, by Mr. H. Ulke, and to the description of some new South American birds, by Mr. H. C. Oberholser.

THE additions to the Zoological Society's Gardens during the past week include a Vervet Monkey (*Cercopithecus lalandii*) from South Africa, presented by Mrs. O'Connor; a Rhesus Monkey (*Macacus rhesus*) from India, presented by Miss Faulkner; a Lesser White-nosed Monkey (*Cercopithecus petaurista*) from West Africa, presented by Mr. C. W. Woodhouse; a Black-headed Lemur (*Lemur brunneus*) from Madagascar, presented by Dr. H. C. Hilliard; a Grey Parrot (*Psittacus erithacus*) from West Africa, presented by Captain Paget J. Bourke; a Carrion Crow (*Corvus corone*) British, presented by Miss N. Simmons; a Great Barbet (*Megaloea virens*) from the Himalayas, presented by Mr. R. Phillips; eighteen Green Tree Frogs (*Hyla arborea*) European, presented by Dr. E. L. Gough; a Common Marmoset (*Haple jacchus*), an All-green Tanager (*Chlorophonia viridis*), a Blue Sugar-bird (*Dacnis cayana*) from Brazil, a Suricate (*Suricata tetradactyla*) from South Africa, a Prairie Marmot (*Cynomys ludovicianus*) from North America, a Crab-eating Opossum (*Didelphys cancrivorus*) from Tropical America, a Levaillant's Amazon (*Chrysolis levaillanti*) from Mexico, three Asiatic Quails (*Perdix asiatica*) from India, deposited; an Axis Deer (*Cervus axis*) born in the Gardens.

OUR ASTRONOMICAL COLUMN.

ASTRONOMICAL OCCURRENCES IN OCTOBER:—

- Oct. 10. 0h. 41m. to 5h. 34m. Transit of Jupiter's Sat. IV.
- 12. 2h. 7m. to 5h. 49m. Transit of Jupiter's Sat. III.
- 13. 11h. 24m. Minimum of Algol (β Persei).
- 15. Venus. Illuminated portion of disc = 0.981, of Mars = 0.930.
- 16. 8h. 13m. Minimum of Algol (β Persei).
- 16. 10h. 17m. to 11h. 18m. Moon occults ζ^1 Piscium (mag. 4.2).
- 16. 16h. 17m. to 19h. 50m. Total eclipse of the moon partly visible at Greenwich. The moon sets at 18h. 32m. when totally eclipsed.
- 19. 5h. 58m. to 9h. 40m. Transit of Jupiter's Sat. III.
- 19. 17h. 8m. to 18h. 13m. Moon occults δ^1 Tauri (mag. 4.0).
- 19. 17h. 43m. to 18h. 43m. Moon occults δ^2 Tauri (mag. 4.7).
- 19-21. Epoch of Orionid meteoric shower. Radiant $91^\circ + 15^\circ$.
- 22. 12h. 53m. to 13h. 44m. Moon occults λ Geminorum (mag. 3.6).
- 23. 9h. Mercury in conjunction with Venus. Mercury, $1^\circ 20' S$.
- 26. 9h. 54m. to 13h. 36m. Transit of Jupiter's Sat. III.
- 30. 6h. Venus in conjunction with moon. Venus, $0^\circ 54' N$.
- 30. Partial eclipse of the sun slightly visible at Greenwich. The eclipse ends at 19h. 1m., or 8 minutes after sunrise at Greenwich on the morning of Oct. 31.

REPORT OF THE MELBOURNE OBSERVATORY FOR 1901.—New buildings are being added at a cost of 1500*l.*, and, with the repairs that have already been done, this will add considerably to the efficiency of the Observatory.

The third Melbourne catalogue for the epoch 1890 has been in the printer's hands since last December. 336 plates have been exposed in connection with the astrophotographic chart, and of these, 320 have been passed as satisfactory.

6327 stars have been selected from the catalogue plates, and roughly reduced for observation with the Melbourne transit circle, to serve as standard stars for the reduction of the Melbourne regions, and of these 3944 have already been completely observed with the meridian circle three times or more.

There are now 760 meteorological stations in communication with the Observatory, and all the records for the last forty years are, at present, being completely rearranged and classified in convenient forms for easy reference. The terrestrial-magnesium work has been carried on as hitherto, and the special observations in connection with the Antarctic expeditions are being made at the required intervals. In the reduction of the magnetograph curves for the past thirty years, 21,877 curves had been measured up to March 31.

NEW MINOR PLANETS.—The following five minor planets, with their positions, are recorded by Prof. Max Wolf in No. 3815 of the *Astronomische Nachrichten*:—

1902. Sept. 3d. 12h. 55m. '8 (Heid).	Sept. 7d. 10h. 38m. '9 (Heid).				
α	δ	α	δ	Mag.	
1902 J.O. 23h. 54m. '7	-0° 13'	23h. 51m. '7	-0° 44'	13	
1902 J.P. 23h. 56m. '7	+1° 14'	23h. 54m. '5	+0° 47'	12	
1902 J.Q. oh. 13m. '4	+1° 20'	oh. 11m. '3	+0° 44'	12.5	
1902 J.R. oh. 9m. '2	-1° 21'	oh. 6m. '6	-1° 36'	12	
1902 J.S.		oh. 10m. '3	-0° 13'	13	

THE RETURN OF THE ARCTIC EXPEDITIONS.

SINCE we went to press with our last issue, the Arctic expeditions of Lieut. Peary and Captain Sverdrup have returned, and accounts of their work, as well as of that of the Baldwin-Ziegler expedition, have appeared in the daily papers. The following brief account of the scientific results obtained by the three expeditions is obtained from telegrams received through Reuter's Agency, and from the personal narrative of Captain Sverdrup which is to be found in the *Times* of Monday last.

Lieut. Peary reached Payer Harbour on September 16, 1901, and within a week the Eskimos with the expedition began to sicken, and not one escaped illness. Of the number, six adults and a child died. Further sickness among the Eskimos occurred in the following January.

An advance party, in charge of Hensen, started for Conger on March 3. On March 6, the main party started, leaving Peary in charge at Payer Harbour. Conger was reached in twelve marches, shortly after the advance party had arrived there. The Eskimos supporting the expedition went back on reaching Conger. Eight marches more took the expedition to Cape Hecla, at the north end of Robinson Channel, which was all open across to Greenland, while there were lakes of water extending northward as far as could be seen, from Black Cape to Cape Ransome. On April 1, Lieut. Peary started northward over the Polar Sea with Hensen, four Eskimos and six sledges. The old floes were covered deeply with snow and intersected by rubble ridges, and lanes of young ice were encountered.

The travelling, except for the lanes of young ice, was similar in character to that experienced by the English expedition of 1876. After a number of difficult marches, which became more and more perilous, the pack, in latitude 84° 17', to the north-west of Cape Hecla, became impracticable, and further efforts to advance had to be abandoned. New leads and the pressure ridges, with fogs, made the return in some respects more trying than the advance. Cape Hecla was regained on April 29 and Cape Sabine on May 15. The ice broke up earlier than in 1901, and Payer Harbour was blockaded almost continuously. The *Windward* bored through, entered the harbour on August 8, and left the same afternoon.

The leader of the expedition states that he has a deep-rooted conviction that it is possible to reach the North Pole. In all his attempts during the last four years, he points out, he has not had a suitable starting-point, but he believed that the Pole can be reached on sledges by an adequately equipped expedition which makes latitude 83 its winter quarters. If he had means of his own to continue the work, he would certainly not give it up, but he must now bow to circumstances. It has been demonstrated to his satisfaction, he declares, that there is no open ocean in the voyage to the Far North. On the other hand, there is no foundation for the idea that there is an eternally frozen sea, though the waters are practically always

covered with ice. He has shown, he thinks, that Greenland's shore is the most northerly land of the earth's surface, and that all beyond it on the other side is ocean.

Lieut. Peary made a close study of the Eskimos living on Whale Sound, the most northerly people in the world. Their complete isolation has differentiated them from every other race. They are a small tribe, not exceeding 200 in number, and are being rapidly destroyed by an unknown disease, apparently a malignant slow fever. He collected specimens of everything pertaining to their habits, knew every man, woman and child personally, learned their characters and capacities, and taught them to work.

The first intimation of the return of Capt. Sverdrup in the *Fram* came in the shape of the following telegram (dated Stavanger, September 19) from Captain Sverdrup to the secretary of the Royal Geographical Society:—

"Arrived here to-day with the *Fram*. Our exploring work consists in the southern and the western shores of Ellesmere Land and other unknown fields to the westward. Brakerud died autumn 1899, otherwise all well."

The *Fram*, it will be remembered, left Christiania in June, 1898, its principal geographical object being to ascertain the extension of Greenland towards the north, to determine the yet unknown configuration of the mainland, and, if possible, to discover whether this great Arctic land finally breaks up into groups of islands in the north. It was also understood that, if circumstances were favourable, Captain Sverdrup, like Lieut. Peary, would make an attempt to reach the North Pole.

The personal narrative of the leader of the expedition, already referred to, gives an interesting account of the work accomplished and the way in which the great difficulties which presented themselves were overcome. As so much care and attention had been paid to the scientific equipment of the expedition, valuable scientific results may be expected to accrue from it, particulars of which will be eagerly awaited. The narrative, however, gives information as to some of the work done in the interests of science. Hayes Sound was completely mapped. The unknown west coast of Ellesmere Land was explored. Between Ellesmere and North Kent, a large bay was seen to extend eastward and to be about 100 miles broad. On the northern side of the same, some large, complicated fjords were found. The land extended about fifty miles westward from these, after which it ran in a north and north-westerly direction. Part of the land which was traversed was very hilly and intersected by large fjords, several of which were from fifteen to twenty miles broad at the mouth.

Much other new land was explored and the numerous fjords investigated. All the members of the expedition appear to have worked heartily and harmoniously together, and returned safely to Stavanger on Friday last, with the exception of the surgeon, who was to have taken charge of the meteorological observations and who died in the course of the expedition.

Mr. Baldwin, in the course of an interview, claimed to have accomplished, in the course of nearly a year and a half's incessant work, more than the unfavourable conditions which surrounded his expedition really warranted, and to have brought back data which ought materially to assist subsequent explorers. For the first time in the history of North Polar exploration, a photographic record had been secured of the ice and snow conditions of the Arctic and of the animal life of those regions. The kinematograph had been for the first time successfully employed in the far North, and as a result there were more than 1000 perfect photographic representations of their work, and in addition more than 200 drawings and paintings had been made.

The main object of the expedition was to plant the American flag at the North Pole, and the result being what it was, the explorer is naturally somewhat disappointed. He maintains, however, his belief that his objective can be reached in accordance with his original plan. He attributes his non-success to the condition of the ice in the Franz Josef Land Archipelago in the autumn of 1901, which prevented the navigation of the *America* far enough north to be of practical advantage in establishing headquarters so as to facilitate sledge-work in the winter and spring of the present year, and to the sickening and death of many of the dogs from internal parasites, which ultimately proved fatal to more than half the pack.

A hut was found by the party, and in it a small brass cylinder

3 inches in length containing a record of Dr. Nansen's work, dated May 19, 1896, the hut proving to be that in which Nansen had stayed. In the place of the document, Mr. Baldwin left a record by himself of his own work and visit.

During the period spent by the expedition in the far north, some fifteen balloons were released containing messages, addressed to the nearest American Consul, respecting both air and sea currents.

After an adventurous and trying journey, the expedition, on July 17, reached a place of safety to the southward of Cape Flora, and eventually home. In Mr. Baldwin's opinion, the old idea of an open Polar sea is baseless. "We know," he says, "that land extends as far as the 82nd degree on the Franz Josef Land side, and it is from here that I believe the Pole will be reached. I quite agree with Lieutenant Peary that the most practical way of attaining the Pole is by sledging from this point."

CONVENTION OF WEATHER BUREAU OFFICIALS.

ON August 27, 28 and 29 of last year, the second Convention of Weather Bureau Officials took place at Milwaukee, Wisconsin, and we have recently received the report of the proceedings, which has been published by the U.S. Department of Agriculture (*Bulletin No. 31*), being edited by Messrs. James Berry and W. F. R. Phillips under the direction of the chief of the Weather Bureau, Prof. Willis L. Moore. The report, which covers no less than 246 pages, will be found most interesting

Amongst other papers of particular interest are those referring to "the forecaster and the newspaper," by Mr. Harvey Maitland Watts, who points out the great value newspapers can be in publishing popular and accurate meteorological information and timely warnings to their readers. Dr. Oliver Fassig gives the results of a study of the diurnal variations of the barometer, and demonstrates the westward movement of the daily barometric wave, portraying it excellently by means of a series of charts which accompany the paper. In the subsequent discussion, Prof. Moore refers to the paper as "quite unique and entitled to great consideration." "Lightning Recorders and their Utility in Forecasting Thunderstorms," "Meteorology in Colleges," &c., are among other subjects touched upon, and the volume concludes with a good index and a capital photograph of a group of the members present at this Convention. There seems no doubt that such gatherings are most useful and valuable, and Prof. Moore tells us that these two conventions have demonstrated their usefulness by affording exceptional opportunity for exchange of views and discussion of methods and means for advancing the work of the Weather Bureau.

UNIVERSITY AND EDUCATIONAL INTELLIGENCE.

THE technical schools and colleges throughout London are now beginning their winter's work. An examination of a batch of prospectuses which has reached us shows that year by year there is an increasing amount of attention paid to the varied wants of students engaged throughout the day in different

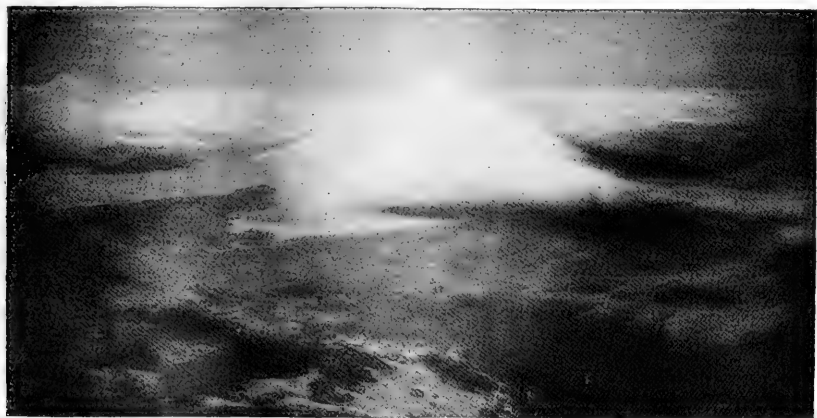

FIG. 1.—Fog Pyramid. This photograph was taken by Prof. Alex. McAdie on July 30, 1900, at 7.15 p.m. The conditions were normal so far as temperature, humidity and wind are concerned at Mount Tamalpais. The view in the foreground is the town of Mill Valley. The apex of the fog pyramid was (it is estimated) about five miles from the camera. The fog in the background overlies the Golden Gate and the Bay of San Francisco. The formation is peculiar, and it should be noted that the land under the fog pyramid is level, and the uplifting of the fog is not due to the existence of foothills at this point.

reading to meteorologists, for the numerous papers included in the seven sections of the volume refer to widely varied branches of work. To enter into anything like detail in this note is out of the question, but brief references may be made to a few of the papers read at this Convention.

Prof. Moore in his presidential address gave a brief survey of the weather service since its inception in 1870, showing its rapid growth and pointing out its increasing efficiency. "Fog Studies" was the subject of Prof. Alex. McAdie's paper, the author emphasizing the point that fog "may be considered as a problem in *air drainage*, just as frost may be so considered." We reproduce one of the numerous excellent reproductions in the report with which he illustrated his remarks. Mr. E. J. Glass describes and illustrates the "chinook" winds so well known to those who live near the Rocky Mountains and which serve the useful purpose of storing the snow that supplies the water to the rivers during the summer season.

At the Battersea Polytechnic, for example, we notice that in addition to the lectures and laboratory work in inorganic, organic and physical chemistry, classes have been arranged in gas manufacture, in the manufacture of oils, fats, soaps and candles, in iron and steel analysis, in paper making and testing, and in the chemistry of the kitchen and laundry. The same thoroughness is shown in the departments concerned with the building, engineering and other trades. The prospectus of the Chelsea Polytechnic, over which Prof. Tomlinson, F.R.S., presides, is published in four volumes dealing respectively with the day colleges for men and women, the day school for boys and girls, and the evening classes. It would be difficult to name a subject, commercial or technical, in which no class is provided at Chelsea. Moreover, every stage is looked after; there are classes suitable for the apprentice, and yet arrangements have been made by which advanced students may engage in research work under the supervision of the principal.

The Sir John Cass Technical Institute at Aldgate is just entering upon its first full session. Intending students will find that complete chemical, metallurgical and physical courses of instruction have been provided, as well as classes in commercial and domestic subjects. Considerable attention appears to have been given to the preparation of candidates for examinations in connection with the University of London.

THE Report for the year 1901 on the museums, colleges and institutions under the administration of the Board of Education has been issued. Among other interesting items, it may be mentioned that the year was marked by a large falling off in the number of visitors to the western galleries of the Victoria and Albert Museum who received special assistance or facilities for the examination of the collections for scientific instruction and research. There was also a diminution in the total number of visitors to the Museum, the total in 1901 being 836,848 as compared with 1,017,314 in 1897, since which year there has been a steady decrease. The most important events in the history of the Royal College of Science during the year reported upon were the retirement of Sir Norman Lockyer after forty-four years' total service, and of Sir Arthur Rucker after fifteen years' service. Similarly the report of the Geological Survey is exceptional, since it records the retirement of Sir Archibald Geikie after a service of more than forty-five years. The Solar Physics Observatory was very busy during the fifteen months with which its report deals, viz. from October, 1900, to December, 1901. Bad weather entirely prevented observations of sun spots on 127 days throughout this period, and 171 nights during the same time were wholly bad for observing purposes, leaving 201 nights available, on which occasions the observers attended.

THE Report of the Board of Education for the year 1901-2 contains much interesting information concerning the amount and quality of the science teaching in schools working under the regulations of the South Kensington authorities. During the session 1900-1, the total number of students receiving instruction in science and art in such schools was 332,329, and the total number of such schools or institutions was 2288. The grants paid in respect of the instruction given, or of the examinations held at its close, amounted to 286,251*l.*, of which it is interesting to note 268*l.* only was paid on the results of the annual examinations, by far the greater part being awarded upon attendances or in the form of capitation grants in "schools of science." The new regulations, under which fees became payable by candidates for examination in the elementary stage of science subjects, appear to have had a beneficial effect. The percentage of these papers which reached the first class rose from 27 in 1900 to 31 in 1901 under the new regulations, and of those which reached the second class from 32 to 37, the percentage of failures thus falling from 41 to 32. Up to the end of 1901, 78 schools in England and 65 in Wales applied for recognition under the new regulations, which offer grants to secondary day schools taking an approved scheme of instruction for a three or four years' course in science. Of the English schools, 58 were endowed schools, 6 were county or municipal schools, 9 were established by articles of association and 5 by religious bodies. As these regulations only came into force in August, 1901, none of the schools had, at the time of drawing up the report, completed the first year's course, so that no account of the way in which the new arrangements work is yet available.

SOCIETIES AND ACADEMIES.

PARIS.

Academy of Sciences, September 15.—M. Bouquet de la Grye in the chair.—The cultivation of the yellow lupin (*Lupinus luteus*), by MM. P. P. Dehérain and E. Demoussy. The poor yield of this plant on calcareous soil appears to be due to the effect of the lime in preventing the assimilation of phosphoric acid, since if considerable quantities of phosphate are added, the plant will grow in soils containing a fair proportion of lime. The tubercles containing bacteria capable of fixing atmospheric nitrogen do not, however, appear under these conditions, not even when the yellow lupins are inoculated from the tubercles of white lupins. The growth is best in non-calcareous soils.—On the principal focal surface of the objective of the photographic equatorial of the Observatory of Toulouse, by

MM. B. Baillaud and Montangerand.—On the rocks thrown out by the actual eruption of Mont Pelée, by M. A. Lacroix. From the external appearances, three classes of rocks can be distinguished, compact vitreous blocks of a greyish-black colour, rocks of a clearer colour than these, and angular blocks of white pumice, sometimes as large as a cubic metre. All these have proved to be of the same petrographical type; they consist of hypersthene andesites rich in phenocrysts, the latter consisting of plagioclases of the andesine and bytownite series. The principal coloured element is hypersthene, accompanied by titanomagnetite and small quantities of augite, hornblende and olivine. The products of the eruption have the same general character as the rock mass of Mont Pelée formed in the course of previous eruptions.—On the differences of contact potential, by M. Pierre Boley. A study of the electromotive forces of the cell constructed of the saturated amalgams of two metals, with two electrolytes.—On the electrical resistance of slightly conducting bodies at very low temperatures, by M. Edmond van Aubel. The electrical resistance of iron pyrites was measured for a temperature range of from 60° C. to -181° C. The resistance increases considerably as the temperature is lowered, but there is still an appreciable conductivity at the temperature of liquid air. The curve showing the variation of the electrical resistance of iron pyrites with temperature shows that $\frac{AR}{\Delta T}$ increases as the temperature approaches the absolute zero. Experiments on other metallic sulphides are being carried out.—On a note of M. Th. Tommasina, on the mode of formation of kathode and Röntgen rays, by M. Jules Semenov.—On the formation of liquid drops and the laws of Tate, by MM. Ph. A. Guye and F. Louis Perrot. With other conditions fixed, the weight of a drop falling from the end of a tube is a function of the time of formation of the drop. It follows that any attempt to verify Tate's law, in which the time of formation is not taken into account, is wanting in precision. It is essential that the conditions of experiment should be so arranged that the weight of the drop should be independent of the time of formation. In view of these facts, the authors consider that the experiments of MM. Leduc and Sacerdoté do not furnish even an approximate proof of the law in question.—On the production of india-rubber in the forests of the French Congo, by M. Aug. Chevalier. Observations on *Landolphia Klainii*, the chief india-rubber-producing tree in the French Congo.

CONTENTS.

	PAGE
Legends of Palestine and Arabia. By R. C. T.	517
Our Book Shelf:—	
Young: "The Elementary Principles of Chemistry." —A. S.	519
Hinton: "P.O.P. (The Use of Silver Printing-out Papers)."	519
Letters to the Editor:—	
Symbol for Partial Differentiation.—Dr. Thomas Muir, C.M.G., F.R.S.; Prof. John Perry, F.R.S.	520
Prof. John James Hummel. By A. S.	520
The British Association at Belfast	521
Section D.—Zoology.—Opening Address by Prof. G. B. Howes, D.Sc., LL.D., F.R.S., President of the Section	522
Section G.—Engineering.—Opening Address by Prof. John Perry, M.E., D.Sc., LL.D., F.R.S., President of the Section	530
Notes	538
Our Astronomical Column:—	
Astronomical Occurrences in October	541
Report of the Melbourne Observatory for 1901	541
New Minor Planets	542
The Return of the Arctic Expeditions	542
Convention of Weather Bureau Officials. (Illustrated.)	543
University and Educational Intelligence	543
Societies and Academies	544

THURSDAY, OCTOBER 2, 1902.

FUSILS DE CHASSE.

Tir des Fusils de Chasse. Par Journée, Lieut.-Colonel du 69^e Régiment d'Infanterie. Deux : Edition. Pp. ii + 387. (Paris : Gauthier-Villars et Fils, 1902.) Price fr. 12.

THIS volume on guns, rifles and explosives is divided into eight chapters. The first is devoted to general information about guns and ammunition; for example, the writer states that the *calibre* which we call 16 signifies that sixteen spherical lead balls of the calibre of the gun weigh one pound. The nominal calibres are then shown in a tabulated form reduced to millimetres, also some of the qualities of different powders and shot are described.

In chapter ii. the pressures of powder gases are considered, and a large amount of solid work on this subject has been collected together in section vii. of this chapter. The pressures due to Amberite, Coopal and Valsrode are shown in a tabulated form.

The action of the gas of explosion was measured by the method of Sébert, by which the successive velocities and accelerations of recoil of a gun are measured during the passage of the shot through the barrel. When the writer comes to the subject of crusher gauges, for determining the pressure of powder gases, he quotes from the *Field*, in which the results obtained by M. Polain, of Liège, were published; the author might have cited with advantage the excellent work on this subject to be found in the *Proceedings and Transactions* of the Royal Society of London, vols. lii. and clxv. respectively. In chapter iii. the question of the velocity of the projectile is treated, and the author writes :—

“ Mais le plus souvent, on déduit la vitesse initiale de la vitesse restante à une-petite distance de la bouche, vitesse qui a été mesurée avec un chronographe électrique, dont le modèle le plus usité est le chronographe de Boulengé.”

The Boulengé chronograph, now rather antiquated instrument, has gained a far-reaching popularity from the fact that nearly anyone can read the results, but the instrument is not at all suitable for determining high velocities over short ranges, and in the case of a shot gun the range for finding the velocity is very short indeed.

The method of dealing with the question by MM. Billardon and Don is far better and exact; it consists of a moving target and a fixed one. The form of this instrument, referred to by the author, has been constructed by Mr. R. Griffith, the manager of the Schultze Powder Co. The moving target consists of a disc 12 feet in diameter, from which a central disc of 4 feet diameter has been removed, leaving a band carried on spokes, 4 feet wide. This is so rotated by a steam engine that the velocity of a point on its edge is 200 feet per second. The edge is marked with divisions, each representing 1/400 sec. From each division lines are drawn to the centre. The band is also ruled with fifteen concentric circles. Thus the whole surface of the band is divided into sections, which can be numbered for reference. In front of the target, and close to it, is a

fixed screen covering the lower half of the circular target, except where it is perforated with a circular opening 4 feet in diameter, so placed as to coincide with the width of the band moving behind it. Across this opening a sheet of very thin paper is strained; this receives the stationary pattern of the discharged pellets, while the revolving band receives the pattern made by the pellets striking it in succession. Observations made with the instrument show the relative velocity of the pellets, so that from the observations a diagram may be constructed showing the actual position of the pellets at a given time.

In chapter iv. the recoil of guns is discussed, the velocities of recoil being measured by the method of Sébert; but the instrument employed was far more simple than that of Sébert, and gave results the limit of which is shown by the following quotation from the writer :—“ Il permet d'obtenir la vitesse du recul à 1/5000 près.” None of the modern methods of working experiments on recoil, such as the pneumatic and electrical methods of firing, are mentioned. Chapter v. is a long one of eighty-one pages, the subject being the dispersion of shot. The author has illuminated this portion of his book with one of the excellent spark photographs of Prof. C. V. Boys, F.R.S., in which the relative position of the pellets is clearly shown. Information on the subject of “choke bore” has been carefully collected, and exhibited in tabular form. The author devotes six pages to the vibration of the gun, and on p. 254 the supposed form of vibration is shown. The excellent and new work of Cranz and Koch on the vibration of gun-barrels does not appear to have been consulted, neither is the method employed in obtaining the results described.

In chapter vi. a large amount of matter respecting the form and nature of bullets has been collected. On p. 269 the name of the celebrated inventor W. E. Metford is wrongly spelt, “d” being written for “t.” Alloys used in the manufacture of bullets, both of the heavy and light classes, are described. With respect to the latter, the author writes :—

“ Les balles faites en aluminium pur se champignonnent trop facilement sur les os offrant quelque résistance.”

Alloys are also mentioned, such as that of aluminium and tungsten, called partinium, and aluminium and magnesium, called magnalium. The latter alloy is becoming popular amongst Continental instrument makers on account of its lightness and tenacity. Bullets made of these alloys would be of great service as man-stoppers at close quarters because of the spread of the bullet.

The chapter concludes with a description of the method of applying the abacus for finding the remaining velocities of projectiles at different ranges, when the initial velocity is given. The abacus now used in calculations connected with technical matters in France is well described in “Le Calcul Simplifié,” by Maurice d'Ocagne. By means of the abacus, solutions of many problems may be easily and rapidly found, when the law of the formula employed has been plotted in the form of a graph. The work concludes with a chapter on aiming the gun in sport, and the influence of the nervous condition of the sportsman and the skill of different individuals. The author has collected together a great mass of

valuable matter on the subject he has taken in hand, and he puts it before the reader with clearness and precision. Should another edition be called for, some of the valuable results obtained by Dr. Bashforth and the more modern work in ballistics, which has been carried on in the United States of America, in Germany and in England, might be introduced with advantage. F. J. S.

THE COMPLETION OF ROSCOE AND SCHORLEMMER'S ORGANIC CHEMISTRY.

Roscoe-Schorlemmer's Lehrbuch der Organischen Chemie. By Jul. Wilh. Brühl, Professor in the University of Heidelberg. Seventh Part, in conjunction with Eduard Hjett and Ossian Aschan, Professors in the University of Helsingfors; O. Cohnheim, O. Emmerling and E. Vahlen, Privatdocenten in the Universities of Heidelberg, Berlin and Halle. Pp. xxiii + 527. (Brunswick: F. Vieweg und Sohn, 1901.)

THE seventh part of the above text-book, which forms the ninth volume of the entire work, brings to a close the publication of that standard treatise of which two of the earlier volumes were reviewed in these columns on a former occasion (November 14, 1901, Supp. iii.). Beyond an indication of the contents of the present volume, there is not much to add in the way of general remarks to the statements already made. The whole work of translating and editing the early volumes and of writing the later ones has cost Dr. Brühl and his coadjutors five years' labour. As one result of the task which the editor first took in hand in 1896, chemical literature has been enriched by a series of valuable monographs written by specialists, these monographs, some of which were noticed in NATURE at the time of their appearance, being separate issues of certain sections of the present and former volumes. Chemists are no doubt familiar with the works on five- and six-membered heterocyclic systems (1898 and 1899), on vegetable alkaloids (1900) and on albuminoid substances (1900), all of which have originated in the manner indicated.

This concluding volume of the great treatise which first saw light in this country is one which appeals most particularly to physiologists. The four groups of compounds with which it deals are all, strictly speaking, and in the narrow sense, "organic," *i.e.* of vital origin. Dr. Cohnheim's contribution, "Die Eiweisskörper," is already known in its separate form; it occupies more than 300 pages of the volume. The same author contributes a section of some twenty pages on the compounds found in animal gall secretion. The third section, of more than 100 pages, comprises Dr. Emmerling's monograph on enzymes, and the concluding section, which is by Dr. Vahlen, deals with the ptomaines and toxins. It must be stated also that the present volume, in addition to its own subject-matter, contains a general synopsis of the contents and a general index for the whole seven volumes of the treatise on organic chemistry.

As regards the treatment of the subjects dealt with in this concluding instalment of the work, it need only be repeated that the names of the writers are vouchers for their completeness and accuracy. As compared with

this and the volumes formerly noticed in these columns, the earlier volumes are, of course, now much behind our actual state of knowledge. But as standards fixed by the dates on the title-pages, these seven volumes represent the most complete and coherent descriptive treatise on the chemistry of the carbon compounds as yet offered to the scientific world. We shall be curious to see how our German colleagues will grapple with the literary difficulty of keeping a work of this exhaustive character *au courant* of the rapid progress which is being made in this department of science. As the editor reminds us in the preface, organic chemistry as a distinct branch of our science was born and has grown to its present magnitude during the nineteenth century. In congratulating Dr. Brühl and his collaborators on the completion of their task, we can assure him that there is every prospect of his wish that organic chemistry should develop as much during the twentieth as it has during the preceding century being fulfilled. We may further assure him that his hope that the work which he has been instrumental in giving to chemists may contribute towards this future development is amply justified. Of the original authors, one is happily still with us; to the memory of the other, this treatise will serve as an enduring monument. R. MELDOLA.

JAPANESE MYTHOLOGY.

Japanische Mythologie. Nihongi "Zeitalter der Götter." Von Dr. Karl Florenz. Pp. ix + 341; mit Illustrationen. (Tokyo, 1901.)

DR. FLORENZ is well known as a writer on Japan, and in his present work he adds one more volume to the many which he has published on that interesting subject. Some years ago he gave to the world the translation of a part of the "Nihongi," one of the earliest productions of Japanese literature, and in his present volume he takes the mythological portion of that work and by the aid of notes helps to throw considerable light on the very dark places of Japanese mythology.

The "Nihongi" yields in antiquity to only two other works, *viz.* the "Kijiki," which was compiled in A.D. 620, and the "Kojiki," which was completed in 712. Eight years later the "Nihongi" was laid before the Empress Gemmō as a complete work. The "Nihongi," or the "Records of Japan," is said to have been written by Shōtoku Daishi, and it is certain that only an author as well versed in Buddhist lore and Chinese classical literature as he was could possibly have written it.

To both of these wells of learning constant references are made, and throughout its pages the influence of Chinese thought is everywhere apparent. The opening sentence in the book contains the Chinese philosophical terms *Yin* and *Yang*, the male and female principles of Nature, which form a strange introduction to the mythology of a foreign land. The Chinese metaphor for the State, the temples of "The Earth and of Grain," also find frequent mention in its pages, and even a long dying speech originally uttered by the Chinese Emperor Kaotsu is put into the mouth of the Japanese sovereign Yūriaku. As Dr. Florenz says:—

"The little which European inquiry has hitherto been able to teach us of the real condition of Japan in the ancient times shows that the historical representation of this period in the 'Kojiki' and 'Nihongi' (upon which rest all the later statements of the Japanese) is most profoundly penetrated by false principles. The newer relations, partly developed from later material, partly influenced by Chinese culture, are reflected back upon the oldest without due distinction, and the result is a confused picture in which the critical inquirer can, it is true, frequently separate what is original from subsequent additions, but must often let fall his hands in despair."

The earliest part of the "Nihongi" consists of myths, pure and simple, and while it is necessary to sift the mass of legendary tales which it recounts for the grains of truth which it contains—and the grains are there—its value is enhanced by the poems of undoubted antiquity which are constantly introduced. This mythological period extends to the fifth century, and it is upon this portion of the history, with extracts from the "Kojiki," that Dr. Florenz has based his present work.

Japan is a land of myth. Of a more imaginative race than the Chinese, and enriched with the stores of legend gathered from the Malay Peninsula and the northern mainland of Asia, the Japanese have through all history revelled in the weird conceptions of the imagination, and even at the present day, unchecked by the veneer of civilisation which they have adopted, they see elves and fairies on every hill and in every valley, and recognise elfin foxes in moments of heightened fancy.

According to the "Nihongi," the creation of the world was after this wise, and here again we trace the influence of Chinese thought. In the beginning the universe was in a state of chaos, out of which by a process of disintegration the lighter and finer portions separated themselves from their surroundings and rising upwards formed the skies, while the more substantial constituents resolved themselves into the world. These two elements formed the male and female principles of Nature and begat certain deities, two of whom, Izanaki and Izanami, were the first to divide the land from the waters. We are told that these deities

"stood on the floating bridge of heaven and held counsel together, saying 'Is there not a country beneath?' Thereupon they thrust down the jewel spear of heaven and groping about therewith found the ocean. The brine which dripped from the point of the spear coagulated and became an island, which received the name of Onogoro," *i.e.* self-curdled.

This legend is interesting as reminding us of the Greek myth of Dêlos, *i.e.* Manifest, which was so called from its suddenly emerging from the sea. Dêlos was, as will be remembered, the centre or hub of the Cyclades, which derived their name, ἀπὸ κύκλου, from the wheel. Another and a still more striking parallel is furnished by the account which relates that "Poseidon with one blow of his trident made the island surge from the bottom of the ocean." In other lands besides Greece we recognise this legend under varying forms, and, indeed, on almost every page of Dr. Florenz's work we find traces of world-wide myths. One of the most widely spread of these is that of St. George and the Dragon. Sosa no wo no Mikoto in this case represents the Christian St. George and

Kushi-nada-hime is the lovely maiden whom he rescues from the fangs of the serpent or dragon.

To the comparative mythologist Prof. Florenz's work will be invaluable. But, as it professes to be, it is essentially a book for the student of folk-lore. By such it will be found full of suggestive matter, while it is much to be feared that to the ordinary reader it will be but a weariness to the flesh.

OUR BOOK SHELF.

An Introduction to Chemistry. By D. S. Macnair, Ph.D., B.Sc. Pp. xii + 187. (London: George Bell and Sons, 1902.) Price 2s.

WHATEVER may be thought of the use of text-books in teaching elementary science, there can be no doubt as to the improvement which has taken place in the character of such books in recent years. The change is particularly noticeable in volumes dealing with the rudiments of chemistry and physics. Instead of the descriptive style formerly in vogue, we have now courses of practical work connected with a few explanatory paragraphs, and the whole constructed upon a plan which aims at making the pupil do things for himself and so far as possible arrive at his own conclusions.

Dr. Macnair's book is based upon this method, and as a representative of a good type it deserves a welcome from teachers of science. Beginning with simple observations and experiments on solubility, the author paves the way to the study of the rusting of iron, the atmosphere, water, chalk and a few other common bodies, following in a general way the course suggested by Prof. Armstrong, which is now followed in many schools, with results encouraging both to teachers and pupils.

As to the educational value of work of the kind described by Dr. Macnair, no one who has tried it with young pupils desires to go back to the old method of teaching chemistry by test-tubing in the laboratory and startling experiments in the lecture room. Quantitative work which was formerly postponed until pupils were able to make an analysis of a simple salt is now taken up at the beginning of a course, and early use is made of squared paper for plotting results. Dr. Macnair, for instance, shows on his twelfth page how solubility curves should be constructed from results of experiments.

To anyone familiar with the excellent work now being done in schools, by the practical study of common properties of matter, the book adds little that is new, and many of the experiments will be recognised. But this does not make the book any the less useful as a practical manual containing a course of work suitable for introducing pupils to methods of scientific study.

A Tentative List of the Flowering Plants and Ferns for the County of Cornwall, including the Scilly Isles. By F. H. Davey. Pp. xvi + 276. (Penryn: F. Cheg-widden, 1902.)

THE spirit in which Mr. F. H. Davey has taken up the task of preparing a "Flora of Cornwall," which shall rank with Druce's "Flora of Berkshire" and other similar handbooks bodes well for success. In two years and a half this tentative list has been formulated, and as one looks through the list of species and records there is ample proof of excellent work. The principle of the book is to give the first record for each species, besides a complete list of localities for species and varieties. Also it is sought to amplify the published list of plants found in Devon, but wanting in Cornwall, and to obtain details of local peculiarities of growth, as well as local names or any plant lore which can be unearthed. In the book

before us these features are not treated, but presumably in the "Flora" they will be incorporated. Also it would add to the interest of the book if a summary of the principal ecological features were presented. It is evident from the published list of contributors that Mr. Davey has been successful in enlisting the services of many well-known systematists; but more workers are required, especially residents in the districts just north and east of Truro, also in Camborne and the country lying south. To these and to botanists visiting the county Mr. Davey will gladly supply copies of "the tentative list," which is interleaved for notes, so that their records may be returned to him in November, 1903, when the accumulated data will be worked up.

Outer Isles. By A. Goodrich-Freer. Pp. xv + 448. (Westminster: Constable and Co., Ltd., 1902.) Price 12s. 6d. net.

THIS book contains much valuable information about the Outer Hebrides and their people, and it is good service to have it put on record in accessible and readable form. Specially good are the accounts of the *Celtidh*, or custom of "assembling together during the long winter nights to pass them off in happiness and mirth," and of the process of "fuling" or dressing the Harris cloth. But the work as a whole is blemished by a want of perspective. The natives of the Outer Isles are, after all, not without faults, and even vices, and some of their virtues are shared by inhabitants of the "adjacent islands of Great Britain and Ireland." There is something to be said on the side of the landlord, the Free Kirk, and even the sporting Sassenach, and the reiteration of their enormities on all possible occasions becomes very tiresome. It is not true that the people of the Outer Hebrides are "practically less known to the average Englishman than the inhabitants of New Zealand or of Central Africa," or that "those who penetrate to their islands, so far at least as they are represented by comfortable inns in easily accessible places, come back knowing nothing of the life of the people, and only ready to condemn them as half-savage, extortionate, and above all, idle."

The Fauna of British India, including Ceylon and Burma. Published under the authority of the Secretary of State for India in Council. Edited by W. T. Blanford. Rhynchota, vol. i. (Heteroptera). By W. L. Distant. Pp. xxxviii + 438. (London: Taylor and Francis, 1902.)

THIS important work continues to make steady progress, and we have now the pleasure to notice the appearance of another volume devoted to entomology, in addition to those already published by Sir G. Hampson on "Moths," Col. C. T. Bingham on "Hymenoptera," and Mr. R. I. Pocock on "Spiders." Mr. W. L. Distant is so well known as a close student of Rhynchota, and also for his careful and accurate work, that we have no doubt that specialists will find the present volume to be one of the most complete and satisfactory that has yet appeared on the subject; and it should give a great impetus to the study of Rhynchota, especially in India and in the adjacent countries.

Following Severin, Mr. Distant accepts fifteen families, eleven of which are represented in India, the first volume including descriptions of the Pentatomide, Coccide and Berytidae. We may point out that Dr. D. Sharp's estimate of about 18,000 species of Rhynchota, quoted by Mr. Distant on p. xxxv, is obviously much too low, the number given by Mr. W. F. Kirby as long ago as 1892, in the second edition of his "Elementary Text-book of Entomology" (p. 14), being already 18,300. The volume is illustrated by 249 excellent text illustrations by Mr. H. Knight, including a series of very clear illustrations of structure in the introduction.

NO. 1718, VOL. 66]

LETTERS TO THE EDITOR.

[The Editor does not hold himself responsible for opinions expressed by his correspondents. Neither can he undertake to return, or to correspond with the writers of, rejected manuscripts intended for this or any other part of NATURE. No notice is taken of anonymous communications.]

The Carnegie Institution of Washington, D.C.

SIR,—It gives me great pleasure to answer in writing some of the questions which you, and others who are interested in scientific research, have asked in respect to the scope of the institution lately founded in Washington by Mr. Andrew Carnegie.

To begin with, it may be well to recapitulate the facts already made known. The amount of his gift is ten million dollars (2,000,000*l.*), so invested that the annual income is five hundred thousand dollars (100,000*l.*). The control of this fund is invested in a board of twenty-seven trustees, selected from widely separated parts of the United States, and including many men who have won distinction and confidence by the service they have rendered in public life. It is not a board made up of specialists, but rather (if I may be allowed the expression) of generals—that is to say, of men accustomed to the administration of large affairs, political, financial, philanthropic and educational. Absolute power is given to this board to devise such methods and form such plans as may seem to them wise in order to carry out the purposes of Mr. Carnegie. These purposes he has clearly defined in the deed of trust and, with less formality, in the remarks which he addressed to the trustees when they first came together on January 29, 1902, under the chairmanship of the Hon. John Hay, Secretary of State, and recently the Ambassador of the United States in London.

In one general phrase, which reads as follows, Mr. Carnegie thus lays down the principle which has guided him:—"It is proposed to found in the city of Washington an institution which, with the co-operation of institutions now or hereafter established there or elsewhere, shall in the broadest and most liberal manner encourage investigation, research and discovery, show the application of knowledge to the improvement of mankind, provide such buildings, laboratories, books and apparatus as may be needed, and afford instruction in an advanced character to students properly qualified to profit thereby."

There are six points upon which the munificent donor then proceeds to lay emphasis, and these are, namely, the promotion of original research; the discovery and encouragement of exceptional men; the increase of facilities for higher education; the assistance of those now engaged in research; and the bringing to Washington of students qualified to profit by the work carried on in the several departments of the Government; and finally, the publication of scientific memoirs.

So far all was clear. Mr. Carnegie's part was performed. Now began the perplexities and responsibilities. The trustees, many men of many minds, must take the subsequent steps. Fortunately, there was no occasion for hasty action; at the outset no buildings were to be constructed, no faculty was to be brought together. Such considerations could be postponed indefinitely. The trustees decided to take time for reflection and for conference with the leaders of science at home and abroad, before the adoption of a programme. Letters were addressed to many persons who could not be reached in person. Confidential interviews were secured with those who could be seen in Europe and the United States. The experience of existing institutions was studied, such as the Royal Society, the Royal Institution, the Academies of Science in Berlin, Munich, Vienna, Paris and other cities. Attention was given to the conditions which have helped or retarded the progress of eminent men during the last generation

—Darwin, Pasteur, Helmholtz, Abel and Virchow for example, in Europe—Henry, Agassiz, Dana and Rowland in America—and also the encouragements and discouragements which are encountered by the men of to-day. Time will be required for the digestion of this material in order to discover the methods which are most efficacious in the advancement of knowledge.

Meanwhile, much co-operative counsel will be given by experts in various branches of learning. As soon as the general purposes of Mr. Carnegie's foundation were made known, hundreds of applications for assistance were received—the number of self-discovered "exceptional men" was large. The number of trivial applications for help in the prosecution of researches was surprising; but, on the other hand, the number of well-considered, important, fundamental inquiries suggested by men of the highest rank among the promoters of knowledge indicated that the entire income would all be absorbed at no distant day. Discrimination, therefore, became the paramount virtue—discrimination which should meet the approval and, if possible, the concurrence of the world's wisest men.

For this discrimination, the aid of specialists was indispensable. The astronomer was not the man to judge of biological claims, nor the chemist of economic problems. No board of "generals" could wisely act without the aid of a strong advisory staff of "adjutants." Accordingly, the authorities of the Carnegie Institution proceeded to select and enlist a number of advisory committees. Three, four, or five well-known authorities were chosen in each of the principal branches of science. All their expenses for travel and for clerical assistance were generously paid by the fund, but their services, like those of the trustees, were cheerfully given to the public without remuneration, and often at the sacrifice of time and convenience. Their hearty co-operation is a fresh illustration of the public spirit of men of science in our day, and their readiness to appreciate and help on the most deserving claims, irrespective of local or personal preference, augurs well for the efficiency of the Carnegie Fund and for the wisdom of the plans that will presently be adopted.

More specific announcements cannot be made until the trustees come together for their second meeting at the close of November next.

A careful perusal of Mr. Carnegie's language will bring out several points, to some of which I will venture to call attention. Here we have that special "endowment for research," which has been during the last thirty years and more the desire of so many men in England and America. This endowment is independent of any existing academy, university or school of technology; but it may co-operate with any that now exist or that may be established. It does not establish a university in Washington, which so many have advocated and so many have disapproved. Mr. Carnegie on this point is explicit and decided. The efficiency of the new institution is not restricted by any local, political or ecclesiastical fetters. Nor is there any attempt to decide what science includes. None of the progressive organised and systematic branches of knowledge are excluded. Economic, historical and archeological inquiries may be aided as well as those which are more obvious to the public—physical, chemical, biological, geological and astronomical researches. Education may be encouraged, but it must be by the personal development of uncommon talents,—the advanced student, the young professor, "the exceptional man." To the last clause of his deed of trust, Mr. Carnegie attaches the highest importance. It corresponds with a clause in his gift to the Scotch universities. The trustees by a majority of two-thirds "may modify the conditions and regulations under which the funds may be dispensed"—if time, experience and changed conditions call for new arrangements.

I cannot close this letter without reference to the great interest which this gift has aroused in all scientific circles at home and abroad. During the past summer, spent upon the Continent and in Great Britain, I have had the honour of talking with many men of eminence, everywhere known as investigators, and their counsel, suggestions and co-operation are not only an indication of the international character of science, but they give an assurance that the most enlightened experience of the world can be enlisted in the plans of this new foundation. At home, "it goes without saying," that there is the heartiest response to Mr. Carnegie's generosity.

With a grateful appreciation of the work of NATURE in the persistent advocacy of research. DANIEL C. GILMAN,
London, September 9. President of the Carnegie Institution.

Re Vegetable Electricity.

WITH reference to Dr. Waller's letter in NATURE, September 18, I confine my reply, in the limited space courteously offered me, to the main issue, *i.e.* the priority of research on the electric response of ordinary plants under mechanical stimulus. My footnote to my Linnean Society paper gave the published dates which must determine, as usual, such a question. It would only obscure the issue were I to take up here assertions resting solely on Dr. Waller's personal affirmation.

My statement which Dr. Waller wishes to traverse is definite enough, and may be answered in a definite manner. "He has not done this." I stated that five months before the communication of his paper to the Physiological Society (November 9, 1901), Dr. Waller *heard* me describe my results on the electric response of ordinary plants under mechanical stimulus. My paper on the "Electric Response of Inorganic Substances: Preliminary Notice," was communicated to the Royal Society on May 7, 1901 (*i.e.* six months before Dr. Waller's communication to the Physiological Society). I read it before the Society on June 6. From the concluding portion of this paper I quote the short summary of the results obtained with plants.

"An interesting link between the response given by inorganic substances and the animal tissues is that given by plant tissues. By methods somewhat resembling that described above, I have obtained from plants a strong electric response to mechanical stimulus. The response is not confined to sensitive plants like *mimosa*, but is universally present. I have, for example, obtained such response from the roots, stems, and leaves of, amongst others, horse-chestnut, vine, white lily, rhubarb and horse-radish. The current of injury is, generally speaking, from the injured to the uninjured part. A negative variation is also produced. I obtained both the single electric twitches and tetanus. (Two response curves given to exhibit this.) Very interesting also are the effects of fatigue, of temperature, of stimulants and of poison. Definite areas killed by poison exhibit no response, whereas neighbouring unaffected portions show the normal response."

Dr. Waller not only heard me describe these results, but took part in the subsequent discussion of my paper. It is indeed very strange that he should on that occasion have said absolutely nothing about his being engaged in this particular investigation. An eminent physiologist declared during the discussion that the electric response of ordinary plants under mechanical stimulus was an impossibility. Dr. Waller, who immediately followed him, it is again remarkable to note, had not one word to say for the possibility of such a phenomenon! These facts are as significant as the fact that Dr. Waller communicated his paper five months after he had discussed mine at the Royal Society.

The above will dispose of the question of priority. My Linnean Society paper and Dr. Waller's paper read before the Physiological Society are now before the public. From these, anyone interested in the subject will be able to determine the scope of the two investigations, the novelty of the appliances and methods employed, and the accuracy of the results obtained.

JAGADIS CHUNDER BOSE.

THE claim for priority comes from Prof. Bose—implicitly by the note to his paper at the Linnean Society, to which I had to demur—explicitly in his present reply. Prof. Bose bases his claim on the final paragraph of a paper of June 6, 1901, now in

the Archives of the Royal Society. If this be regarded as a valid document and date of departure, I shall have something more to say about Prof. Bose's methods. If this date and document be not valid, his claim rests upon a paper at the Linnean Society of July 21, 1902, which seems to me to be a very interesting instance of scientific mimicry. Anyone interested in the study of such phenomena will find it instructive to compare the papers mentioned by Prof. Bose, of November 9, 1901, and July 21, 1902, to the Physiological and Linnean Societies respectively. I think he should also, as regards the general method, consult my Lectures on Animal Electricity of 1897 at the Royal Institution, which have been adopted by Prof. Bose as his point of departure.

A. D. WALLER.

British Association Meetings.

THE gradual decrease in the number of those attending the recent meetings of the British Association might suggest that the popularity or the usefulness of these scientific gatherings is on the wane. The opportunity for an instructive comparison exists in the fact that on the last three occasions on which the Association has met, it has repeated its visits to well-known centres, widely distributed. It might have been anticipated that, owing to the growth of material prosperity and of the population of these towns, a continually increasing number would have availed themselves of the advantages of these meetings. The following figures show, however, that the contrary is the case:—

Year.	Place of Meeting.	Number attending.	Year of pre-attending.	Number attending.
1900	Bradford	1915	1873	1983
1901	Glasgow	1912	1876	2774
1902	Belfast	1620	1874	1951

Naturally the amount of grants for scientific purposes shows a similar decline:—

Bradford,	107 <i>l.</i>	against	165 <i>l.</i>	in 1873
Glasgow,	94 <i>l.</i>	„	109 <i>l.</i>	„ 1876
Belfast,	96 <i>l.</i>	„	115 <i>l.</i>	„ 1874

The usefulness of the Association in one direction is apparently lessened, since it has distributed about 1000*l.* less in the three years, but it may be that there is not the same necessity for assistance as was the case a quarter of a century ago, and that consequently the amount applied for by the different sections has not been as large as on previous occasions. But this does not put aside the fact that there is a distinct falling off in the interest exhibited, as tested by the numbers attending.

Supposing there is any decrease in the popular favour, and the smaller figures are not due to temporary causes, it seems worth while to ask whether any portion of the decline is traceable to reasons connected with the Association itself. This is a question which can be answered only by those who are intimately connected with the management, but there was a feeling among some of the members that the business was unduly protracted, and it was asked, with some apparent show of reason, why the meeting must always begin on a Wednesday. If the President's address, it was urged, was given on Monday evening, it would allow four clear, uninterrupted days for the business of the sections, which in most cases would be found sufficient, and then the Saturday could be employed in the manner it now is, or in winding up the unfinished sections. There may, of course, be an insurmountable objection to altering the arrangements which have existed for so many years, but which scarcely seem to meet the conditions of modern life, and it is with the view of hearing from some authoritative source the object of maintaining the old order of things that I have ventured to trouble you with this note.

W. E. P.

September 19.

Helmholtz on the Value of the Study of Philosophy.

THE opinions of Helmholtz, even as expressed in his popular scientific lectures, have such permanent weight that you may consider the following correction of sufficient general interest to publish it in your journal.

On p. 234 of Dr. Atkinson's "Popular Lectures on Scientific Subjects by H. von Helmholtz" (second series, new edition, Longmans, Green and Co., 1893), lines 7 to 11, we read:—

"And the physician, the statesman, the jurist, the clergyman, and the teacher, ought to be able to build upon a know-

ledge of physical processes if they wish to acquire a true scientific basis for their practical activity." (The italics are mine.)

What may have been Helmholtz's opinion of the value of a knowledge of physical science to the groups of specialists above named may be gathered from other parts of his writings, but in view of the surely unjust discredit into which the study of genuine philosophy (such as Helmholtz defines it) appears to have fallen in the eyes of the followers of the "Naturwissenschaften," it would appear just to quote the original passage, whereby it will be seen that what was perhaps a printer's error in the translation has altered the whole gist of the passage:—

"Und auf die Kenntniss der Gesetze der psychischen Vorgänge müsste der Arzt, der Staatsmann, der Jurist, der Geistliche und Lehrer bauen können, wenn sie eine wahrhaft wissenschaftliche Begründung ihrer praktischen Thätigkeit gewinnen wollten" (Helmholtz, "Vorträge und Reden," p. 180, fourth edition, second vol., Braunschweig, 1896). (The italics are mine.) That "psychischen" is not a printer's error for "physischen" in the original is evidenced by the context, which is so interesting that I venture to quote it.

After a brief comparison of the relation of philosophy to metaphysics with that of astronomy to astrology, Helmholtz says:— "Ebenso bleibt der Philosophie, wenn sie die Metaphysik aufgibt, noch ein grosses und wichtiges Feld, die Kenntniss der Geistigen und seelischen Vorgänge und deren Gesetze. Wie der Anatom, wenn er an die Grenzen des mikroskopischen Sehvermögens kommt, sich Einsicht in die Wirkung seines optischen Instrumentes zu verschaffen suchen muss, so wird jeder wissenschaftliche Forscher auch das Hauptinstrument, mit dem er arbeitet, das menschliche Denken, nach seiner Leistungsfähigkeit genau studieren müssen. Zeugnis für die Schädlichkeit irrtümlicher Ansichten in dieser Beziehung ist unter Anderem das zweitausendjährige Herumtappen der medicinischen Schulen."

I have not access to earlier editions of the original German than 1896; relatively to my object, such reference seems unnecessary.

B. BRANFORD.

The Technical College, Sunderland, September 23.

Trade Statistics.

DR. MOLLWO PERKIN repeats in NATURE, p. 443, Mr. Levinstein's statement that in foreign trade "we went back during the ten years 1891-1900" (*Journ. Soc. Chemical Industry*, pp. 893-4). The evidence given is that "in the year 1890 our total exports amounted to 328 millions sterling," whereas "the average amount during the decade 1891-1900 was only 300 millions." But why should 1890 be taken as the standard year? It happens that the exports in that year were unusually high—higher, indeed, than in any other year from 1880 to 1898. Had Mr. Levinstein been in a hopeful frame of mind, he might have chosen 1888 or 1892 as his normal year, or, much more rationally, he might have taken the average of five years, 1886-1890 (299 millions), or the average of ten years, 1881-1890 (297 millions). Any of these methods would have brought out the more pleasing conclusion that our foreign trade is advancing. My object is not to decide whether it is or not, but to protest against Mr. Levinstein's method of proof. Can we imagine a meteorologist contrasting the average rainfall of a series of years with the rainfall of a single preceding year and on that basis announcing a change in the climate?

The facts (often exaggerated and misunderstood) as to the more rapid advance of German exports are fully and clearly stated in "Comparative Statistics of Population, Industry and Commerce," recently issued by the Board of Trade at the price of 5*l.* It is not clear why Mr. Levinstein makes use of the British "total" exports, including all the transit trade, while for Germany he takes the "special" exports, from which the transit trade is, as far as possible, excluded. This swells all the British amounts by something like 25 per cent. beyond what they would stand at if they represented native produce only. It does not, however, much affect comparisons of rates of progress. But it confuses abstractors—in Dr. Perkin's abstract the distinction is overlooked.

F. EVERSHED.

Kenley, Surrey, September 9.

It is quite true, as Mr. Evershed points out, that the exports for 1890 were unusually high, but those of 1899 and 1900 were also exceptional, owing largely to war exports; this, however, hardly alters Mr. Levinstein's contention—that the trade of the country shows a decline as compared to the trade of

Germany and the United States. But if, instead of using Mr. Levinstein's figures, we take the annual exports per head of population, which is after all the truest test, we find that in the period 1870-74 they were 71. 75. 34. per head, but in 1895-99 they had fallen to 54. 19. 54. In Germany during the same periods they were 21. 16. 74. and 34. 75. 24. respectively, while in the United States they rose from 21. 92. 114. to 21. 18. 47. These figures show that although per head of population we export more than either of these nations, yet during the last forty years they have been increasing their exports per head, but those of the United Kingdom have been declining. The figures are much more striking if at the same time we examine the increase of population which has taken place in the three lands during the same period. From 1871 to 1901, the population of the United Kingdom increased by 31.7 per cent., while that of Germany increased 37.3 per cent. and that of America 96.1 per cent.¹

I will now take another comparison—the five years' averages of the annual exports at the beginning and end of the period 1880-1900. Here it will be seen that the increase of exports of the United Kingdom only amounted to 6.4 per cent. (234 to 249 millions), but that Germany showed an increase of 23.1 per cent. (156 to 192 millions) and the United States 42.8 per cent. (166 to 237 millions).

Again, we are unable to show such large increases in the quantity of pig iron produced as are Germany and America. In the years 1870-74, the United Kingdom was far and away ahead of all other nations, producing 6.4 million tons against 1.8 million tons by Germany and 2.2 million tons by America. But in 1896-1900, the amounts were for the United Kingdom 8.9, Germany 7.4, and America 11.5 million tons.

Mr. Evershed objects to Mr. Levinstein taking a "fat year" as the starting point for his statistics, but, as I have already pointed out, the years 1899 and 1900, which come within Mr. Levinstein's decade, were also exceptionally good years and thus help to bring up the average. But I think that although Mr. Evershed has taken exception to the use of the year 1890, he will agree with all scientific and broad-minded men in being glad that a man of Mr. Levinstein's experience should have the courage to speak out and try to wake the nation up to a sense of its responsibilities. F. MOLLWO PERKIN.

Bipedal Locomotion of Lizards.

I KEPT for many years in a glass case some specimens of *Lacerta viridis*, and often observed them after a feed playing in the sunlight in a peculiar manner, first drinking water, which they lapped up with their wide forked tongues. The play was a sort of dance. The lizard stands on his hindlegs and, raising the fore part of his body, executes a rapid, playful waving of the forelegs. When both forelegs are used, they move in unison; sometimes, however, only one is employed. This action seemed to be meant as an attraction, the motions being performed facing another lizard, who often responded with answering waves of the forelegs; at times during the pastime, the pair would lick each other. I observed the females indulged oftener in this coquetish dance, though the males would go through the same performance, strange to say, as often with each other as with a female for a partner to set to.

One female I kept for five years always, when excited, took a perpendicular position, progressing on her hindlegs with the fore part of the body lifted, and would play, running at my hand and biting, always in that erect pose.

The blue lizards of Capri, which I have kept for years in confinement, move along upright under excitement, also using bipedal action.

ROSE HAIG THOMAS.

September 23.

RUDOLPH LUDWIG KARL VIRCHOW.

"All that lives must die,
Passing through nature to eternity."

THE great master and founder of modern pathology, Rudolph Virchow, has passed away, full of years and full of honours, mourned, not only by his fellow countrymen, but by the whole scientific world. A fall early in January last resulting in a fractured thigh was the ultimate cause of his death, which occurred on September 5.

¹ In Germany and America, the census returns are for 1900.

Born at Schivelbein in Pomerania in 1821, Virchow attended the public school of his native town until his thirteenth year, when he entered the gymnasium of Cöslin and early distinguished himself by his linguistic attainments. In 1839, he entered the Friedrich-Wilhelm Institut, a training college for army medical officers, having among his teachers Müller and Caspar and among his fellow students Helmholtz, and in 1843 proceeded to take his degree. He had already shown such promise that he was released from service with the army and was attached to the Charité Hospital as prosector of anatomy, acting as assistant to Froriep, whom he succeeded in 1846. About this time he founded, in collaboration with Reinhardt, the famous *Archiv*, and after the death of the latter continued to edit it himself. In 1848, he carried out an investigation into an epidemic of relapsing fever in Silesia, and so uncompromising were his strictures on the authorities, together with his alliance to the ultra-Radical party, that he was compelled to resign his appointment at the Charité. Already, however, his reputation as a pathologist was made, and he was immediately offered and accepted the chair of pathology at Würzburg, where for the next seven years he devoted himself to pathological research. In 1856, on the death of Hemsbach, the Faculty of the University of Berlin petitioned for his recall, and, in spite of bitter opposition, was successful in its application, and Virchow returned to his old University for the remainder of his life, founding the Pathological Institute and the Museum of Morbid Anatomy.

Virchow's life was a strenuous one, and being blessed with a wonderful constitution he was able to devote himself to, and to become a master in, many pursuits, any one of which is usually sufficient to fill the life of ordinary mortals. In addition to his pathological chair, the duties of which he fulfilled up to the time of his accident, he was ethnologist and anthropologist, archæologist and Egyptologist, politician, a member of the Berlin Municipal Council for forty years, a member of the Prussian Chamber from 1862 to 1878, where he was the recognised leader of the Radical party and for fifteen years chairman of the Finance Committee. In 1880, he was elected a member of the Imperial Reichstag, but took little active part in its debates. One of his most important public works was concerned with the introduction of a system of drainage and with the installation of sewage farms, whereby Berlin has become one of the healthiest cities of Europe.

Of the man it may be said that he was beloved by his family and by his intimates. Short of stature and spare of figure, with grizzled hair and piercing grey eyes covered with spectacles, his was not a striking personality. Nor was he an orator, having a somewhat thin and weak voice and impassive delivery, but what he said was always to the point and clothed in simple but logical language, and he compelled a hearing by his very earnestness and simplicity. His political views and his uncompromising manner of stating them unquestionably prevented a full measure of State recognition of his genius.

As a teacher he attracted students from all parts of the world. Until his time, autopsies had been performed in a very perfunctory manner, the supposed seat of disease alone being examined. Virchow, however, submitted all the organs and tissues to a careful scrutiny, thereby in course of time as data accumulated proving the interdependence of one condition upon another and showing how widespread might be the effects of a limited lesion. At his demonstrations, the specimens were subjected to a rapid description and criticism, rough sections were cut and placed under the microscope, which was mounted upon a trolley running on rails, and so could be submitted without disturbance to the scrutiny of each member of the class. Drawings of the specimens

were made upon the blackboard and the salient features indicated, and in the course of a demonstration six or eight specimens might thus be started on the tour of inspection.

Of his pathological work, the earliest was upon vascular disorders. He was the first to elucidate the true nature of phlebitis, thrombosis and embolism, to recognise the essential features of leucæmia and to distinguish this condition from pyæmia, so laying the foundation for the brilliant work of Ehrlich and others upon hæmatology. In 1858, his "Cellular Pathology" appeared, in which the theory that every cell arises from a pre-existing cell was enunciated and the cellular derivation of the connective tissues, bone and cartilage recognised. Up to this time, the humoral theory had dominated medicine, but these considerations revolutionised pathology by introducing the new conception that all pathological cell-formations must arise from pre-existing normal cells. He says in his lectures, "The question is whether the general types which we have established for the physiological tissues will also be found to hold good for the pathological ones. To this I unreservedly reply, yes; and however much I herein differ from many of my living contemporaries, however positively the peculiar (specific) nature of many pathological tissues has been insisted upon during the last few years, I will nevertheless endeavour to furnish you with proofs that every pathological structure has a physiological prototype and that no form of morbid growth arises which cannot in its elements be traced back to some model which had previously maintained an independent existence in the economy."

Harvey had enunciated the celebrated proposition *Omne vivum ex ovo*, subsequently found to be too narrow to apply to all living forms; to Virchow pathology and physiology are indebted for the not less striking dictum, *Omnis cellula e cellula*. By this his name will live through the ages. Another great work of his was that on tumours, unfortunately never completed. He showed that cartilaginous tumours of bone might start from islands of cartilage which had remained untransformed during the general ossifying process, and thus gave some support to Cohnheim's theory of the origin of tumours from embryonic remains. He further made contributions on tuberculosis and leprosy, trichiniasis, hydatid tumours of the liver, lardaceous disease, cholera and diphtheria, and animal pigments; in fact, it is no exaggeration to say that there is hardly any subject in pathology that has not been illumined by some important contribution of his. He was a pathological anatomist and histologist rather than an experimental pathologist, and pathological bacteriology was of too recent development for him to contribute to it extensively. It is true that he made mistakes—he was but mortal; for example, his theory of the dependence of chlorosis upon anatomical defects in the circulatory organs has been found untenable—but he was the first to recognise them, and as often as not himself destroyed the fabric he had previously erected.

Virchow's fame was world-wide, and honours of all kinds were showered upon him. In 1874, he became a member of the Royal Academy of Science of Berlin; at the centenary of the Institute of France he was made a Commander of the Legion of Honour, and the following year Foreign Associate of the French Academy of Sciences. A foreign member of our Royal Society, he was Copley medallist in 1892 (an honour he highly appreciated) and Croonian lecturer in 1893. The subject of his discourse, delivered in English, on this occasion was "The Position of Pathology among the Biological Sciences" (*NATURE*, vol. xlvii. p. 487). In 1898, his last visit to us, he delivered the Huxley lecture at Charing Cross Medical School, and he was afterwards entertained at a banquet, at which Lord Lister presided. The title of the Huxley lecture was "Recent Advances in Science and their Bearing on Medicine and Surgery," and to the

last he retained his marvellous vitality of mind and kept abreast of the most recent advances in pathology. Last year, on the occasion of his eightieth birthday, he was the recipient of congratulatory addresses from all parts of the world, Lord Lister representing the Royal Society and other learned bodies of Great Britain and Ireland, and his reply, which occupied nearly two hours in delivery and was brimful of dates and facts, was given without a note.

His countrymen rightly accorded him a public funeral, and representatives of the State, the city, the university and of the learned societies accompanied his remains to their last resting place.

Space forbids anything but this brief sketch of Virchow's life, but as a writer in the *Lancet* well says, "His active work ceased only with his death, the world's appreciation of his worth remains." R. T. H.

THE ABEL FESTIVAL IN CHRISTIANIA.

THE centenary of the birth of the famous Norwegian mathematician Henrik Niels Abel was celebrated in Christiania by a festival, or rather a series of festivals, which lasted from September 4 to 7, to which delegates from all the more important scientific societies and universities of the world were invited. The festival aroused the interest of the people of Christiania in a very unusual degree and, indeed, appeared to be regarded in the light of an important national event; the presence of the King of Sweden and Norway, who made a special journey from Stockholm for the purpose, contributed in a high degree to emphasise the importance attached to the festivities by the whole population of the Norwegian capital. The festival was inaugurated by an informal reception of the delegates at a supper-party given on the evening of September 4 at St. Haushangen, a place of popular resort on the outskirts of Christiania. The company was received by the famous Arctic explorer, Dr. Nansen, president of the reception committee, by the Foreign Minister Lagerheim, the Ministers of State Blehr and Ovam, the president of the Storting, and Prof. Mohn, president of the Christiania Academy of Science. In a bright and genial speech delivered in English, Dr. Nansen welcomed the foreign delegates and expressed the feeling of pride on the part of his own small nation in having through Abel made an important contribution to the essentially international work of the development of science and of civilisation. The formal part of the festival commenced at noon on September 5 in the Hall of the Municipality; the King and his son Prince Eugen arrived shortly after noon, and were received by a guard of honour, consisting of students of the University of both sexes. The ceremony consisted of the performance of a cantata written by the celebrated author Björnson, and of speeches which were made between the first and second parts of the cantata. Speeches were delivered by the Minister of State Blehr in French, by Prof. W. C. Brogger in German, and on behalf of the delegates by Prof. H. Weber, of Strassburg, and Prof. Volterra, of Rome. A detailed appreciation of Abel's work was given by Prof. L. Sylow. In the evening, the delegates had the honour of being invited by the King to a reception and supper at the Castle, when a large and distinguished company was present; many of the delegates were presented to the King, who conversed freely with them in their own languages. The second part of the festival was held on September 6, at noon, in the Hall of the University, the King and Prince Eugen being again present. The proceedings commenced with an address in French by Prof. Mohn. Speeches were then delivered by Prof. Forsyth on behalf of the English-speaking delegates; by Prof. Gravé on behalf of the Slav nations; by Prof. Picard, Prof. Schwarz, Prof. Zeuthen, Prof. Henzel

and Prof. Mittag-Leffler. The eloquent speech of Prof. Forsyth met with the special approval of the audience and of the Christiania Press. The addresses from the various universities and learned societies were then delivered by the delegates; these were so numerous that with a few exceptions the delegates handed them in with a simple statement of the name of the society or university from which they came.

The last stage of the proceedings consisted of the conferring of honorary degrees upon twenty-nine distinguished men of science, of whom ten were present as delegates. It was explained that the University of Christiania had hitherto not possessed the power of granting honorary degrees, but that by a special Act of the Storting the power had been granted to the University with a view to the present occasion. Among the twenty-nine mathematicians who were created *Doctores Mathematicae*, there were six British subjects—Lord Kelvin, Lord Rayleigh, Dr. Salmon (provost of Trinity College, Dublin), Sir George Gabriel Stokes, Prof. G. H. Darwin and Prof. A. R. Forsyth. In the evening, the delegates and a large number of other guests were entertained at dinner by the Municipality of Christiania; after the dinner there was a torch-light procession of many hundreds of students, which produced a most imposing effect. The students were addressed from an open window by Dr. Nansen in an enthusiastic speech. The festival concluded with a special representation of Ibsen's *Peer Gynt* at the National Theatre on the evening of September 7, the King and a distinguished company being present. The University of Oxford was represented by Prof. A. E. H. Love, F.R.S., the University of Cambridge by Prof. A. R. Forsyth, F.R.S., the University of Dublin by Prof. Joly, the University of Durham by Prof. Sampson, the University of London by Prof. A. G. Greenhill, F.R.S., the University of Glasgow by Prof. Jack, the London Mathematical Society and the Cambridge Philosophical Society by Dr. Hobson, F.R.S.

MR. F. W. RUDLER AND THE MUSEUM OF PRACTICAL GEOLOGY.

MR. F. W. RUDLER retired under the age regulations at the end of last month from the post of curator and librarian of the Museum of Practical Geology. He entered the public service in 1866 as assistant to Trenham Reeks, who was then curator of the Museum and registrar of the School of Mines. For fifteen years Mr. Rudler was actively engaged in the Museum, acquiring an intimate knowledge of mineralogy and applied geology, and an expert knowledge of British pottery. He practically re-wrote the third and fourth editions of the "Descriptive Guide to the Museum," which was originally drawn up by Robert Hunt; and he almost wholly prepared the second and third editions of the "Catalogue of Specimens of British Pottery and Porcelain."

In 1876, Mr. Rudler was chosen professor of natural science in the newly-established University College of Wales at Aberystwyth. Here he was successfully occupied for three years, until on the death of Mr. Reeks he was besought by the late Sir Andrew Ramsay to apply for the post rendered vacant in the Museum of Practical Geology. Mr. Rudler's appointment was cordially assented to, and from 1879 onwards he has held office with increasing advantage to the Institution and to the many individuals who have constantly sought his advice. It is not too much to say that one might search the world over and fail to find anyone with a fuller knowledge of the subjects that have been connected with the Library and Museum of Practical Geology, or one who was more ready at all times to give to others the benefit of varied and accurate information.

NOTES.

A COMMITTEE has been formed, under the chairmanship of Prof. Waldeyer, for the erection in Berlin of a public memorial of the late Prof. Virchow.

DR. DAVID FERRIER, F.R.S., will deliver the Harveian oration before the Royal College of Physicians, London, on October 18.

WE are sorry to have to record the death, at the age of sixty-eight, of Mr. J. W. Powell, director, since 1879, of the United States Bureau of Ethnology, and from 1880 to 1894 director of the United States Geological Survey. Mr. Powell's death occurred on September 23.

THE death, at the age of eighty-six, is reported of M. Vincent Leche Chesnevieux, the French traveller and geologist; also of Signor Adolfo Targioni-Tozzetti, emeritus professor of comparative anatomy and the zoology of the invertebrates in the Medical School at Florence. Prof. Targioni-Tozzetti was in his eightieth year.

THE *Pioneer* (Allahabad) learns from its correspondent at Kashgar that a severe earthquake occurred at that place at 8 a.m. on August 22, resulting in the loss of 1000 lives and great damage to property. A pronounced rise in the temperature immediately followed the shock. This rise continued for a week, during which period there were repeated slight shocks. A Reuter telegram from Simla, dated September 26, gives the number of people killed as 667, and states that more than 1000 persons were injured.

REUTER'S agent at Mobile, telegraphing on September 30, states that information has been received by steamer that an earthquake of a serious character occurred in Guatemala and British Honduras on September 23. The shocks occurred simultaneously along the coast and lasted three minutes. It is believed that Guatemala City was the centre of the disturbances. The telegraph wires are down between Guatemala City and the coast.

A REUTER telegram from New York, dated September 24, states that the *New York Herald* has published the following telegram from Lima:—"Mount Chullapata, which is situated 18 miles from Celendin, has been throwing up dust and smoke for a fortnight. Loud noises have been audible at a distance of 30 miles from the mountain. There is no record that Mount Chullapata was ever believed to be a volcano."

A SEVERE cyclone visited the eastern Sicilian coast on Friday last from Taormina to Catania, and resulted in a heavy loss of life and very great damage to property. At Modica, two mountain torrents burst their banks and submerged the lower portion of the town as high as the second floor of the houses. The disaster was at first attributed to a waterspout, but subsequent accounts declared that it was due to torrential rains following on the prolonged drought. Throughout the day, Mount Etna sent up a thick column of steam from the vicinity of the scene of the eruption of 1892.

A SEVERE typhoon occurred at Yokohama on September 29, and a great wave broke over the adjacent district of Odawara, causing, it is feared, the loss of 200 lives; much shipping was also damaged.

AN Institute of Colonial Medicine has, says the *British Medical Journal*, recently been established in Paris. The scheme of instruction comprises courses on bacteriological and hematological technique, parasitology, tropical surgery, tropical ophthalmology, tropical pathology and hygiene, and tropical skin diseases. The Institute is open to foreign as well as to French medical practitioners.

THE official programme of the fourteenth International Medical Congress, to be held at Madrid from April 23 to April 30 next, has now been issued. The congress will be divided into the following sections:—Anatomy (including anthropology, comparative anatomy, embryology, descriptive anatomy, normal histology and teratology), physiology, general pathology, therapeutics, pathology, nervous diseases, children's diseases, dermatology and syphilis, general surgery, ophthalmology, oto-rhinolaryngology, obstetrics and gynaecology, military-naval medicine and hygiene, hygiene and epidemiology, and forensic medicine and toxicology.

AT the annual meeting of the Indian Association for the Cultivation of Science, held in Calcutta last month, it was decided to found a medal, to be known as the Temple medal, to perpetuate the memory of the late Sir Richard Temple for the invaluable services he rendered in the establishment of the Association.

A COURSE of four lectures is to be given at Gresham College, Basinghall Street, by Dr. E. Symes Thompson on "Food." The lectures will be delivered on October 7, 8, 9 and 10 at 6 o'clock; no charge is made for admission.

IN connection with the Universal Exposition which is to take place at St. Louis, Mo., U.S.A., in 1904, there is to be an aeronautical competition and exhibition, the rules and regulations governing which have just reached us. From them we learn that the sum of one hundred thousand dollars is offered as a grand prize, and that fifty thousand dollars are to be appropriated for minor and subsidiary prizes for competition between airships, balloons, air-ship motors, kites, &c. Information concerning the competitions is obtainable from the Chief of the Department of Transportation Exhibits, Louisiana Purchase Exposition, St. Louis, Mo., U.S.A.

ACCORDING to the *American Electrician*, a commission was recently appointed by the New York State Legislature for the purpose of determining the advisability of establishing a State electrical laboratory to provide independent authoritative information on questions of electrical science and official standardisation of electrical measuring instruments, apparatus and standards. The commission is to report to the Legislature at the opening of its session in 1903, and if in its judgment the establishment of a laboratory is necessary, detailed plans and specifications for the construction and equipment of such a laboratory are to be prepared and submitted in connection with the commission's report.

ACCORDING to the Berlin correspondent of the *Times*, the German Government is afraid that the policy pursued by the Marconi Company, and the arrangements concluded between it and Lloyds, threaten an absolute monopoly which would be objectionable for both commercial and political reasons. Germany has therefore invited England, France, Russia, Italy, Austria-Hungary and the United States to make arrangements for a meeting of delegates to prepare a programme for an international conference to consider the subject. It is said that this suggestion has been favourably received by the States addressed, and that, as soon as a programme has been arranged, the co-operation of all maritime States will be sought in drawing up an international convention to settle the conditions under which the establishment of stations for wireless telegraphy shall be allowed. The *Electrician* suggests that the conference should take place at the International Telegraphic Conference to be held in London next year. It is to be hoped that the conference will be held soon and will be successful. We have already pointed out in these columns the growing necessity for some consolidation of the competing systems.

A NOVEL table, designed by Prof. E. C. Pickering, has been placed in the north building of the Harvard College Observatory. It is in two revolving sections, and takes the place of six separate tables which have hitherto been in use. In the upper section of the table, the annals of the observatory, magnifying glasses and reference books are kept, and the lower section is used for the storing of letters and files.

ACCORDING to the *Aeronautical World*, a new American periodical, Prof. Graham Bell has nearly completed his flying machine. It is being constructed under Prof. Bell's personal supervision, and is stated to be radically different from M. Santos-Dumont's machine. The machine will, it is reported, be 20 feet in length and composed of twenty-five distinct parts, and the principle of the kite will be utilised to a considerable extent.

THE *Athenaeum* learns that steps are being taken by the Department of Prisons, New South Wales, to establish a new system of criminal identification on the lines of the combined Bertillon and Francis Galton methods, modified to suit local conditions. A comprehensive criminal register is now in course of compilation, and already the anthropometrical measurements of a large number of prisoners have been taken, together with finger impressions and other distinguishing records. The work has been entrusted to Mr. M'Cauley, Deputy Controller and Inspector of Prisons, who has recently personally investigated the systems of identification pursued in the prisons of France and of the United Kingdom.

WRITING from Yokohama on August 24, Captain H. J. Snow says:—"I have never known such a cool summer since 1869. Constant rain has been the rule in this part of the country, and I think it has been similar all over Japan. Floods everywhere. The neighbourhood of the Philippines has sent us along a string of storms of small area, not one of which has come along the Pacific side of Japan. They have all either gone through the Korean Straits or across the south-western part of Japan and the Japan Sea. They have followed each other so often that the whole weather of the country has been kept in an unsettled state. Winds from north to east have prevailed nearly all the summer so far. We certainly have not had six days of southerly winds all told. The thermometer has ranged between 62° and 75° F. nearly all the time. On four or five days only it reached 84° to 86°."

THE eruption of Mont Pelée appears to have been heard as far away as Maracaibo, Venezuela, a distance of about 830 miles. In a report abstracted in the last number of the *Monthly Weather Review*, Mr. E. H. Plumacher, United States Consul at Maracaibo, writes:—"On the morning of the great calamity that has fallen upon the island of Martinique, strong rumbling sounds were heard here, as well as in the other parts of this State. At many places during the day before the catastrophe, noises of heavy cannonading were heard at La Ceiba, Cabimas, Perija and Quisiro. At Sinamaica the people thought that a great battle with heavy artillery was in progress near Maracaibo. . . . Early in the morning of the catastrophe, I found that my servant had saddled my horse; when I asked him if somebody was sick and needed a doctor, he answered that he thought I needed my horse to go to the city, as a big battle must be going on, judging from the sounds of the heavy firing of guns. Observing the same sounds, I knew at once that it could not be heavy artillery, for if all of the cannons of Venezuela were fired together, they could not produce such sounds. It was not like cannonading with heavy siege guns; it was neither thunder nor the strange, unpleasant subterranean sounds of convulsions of the earth; it was as if immense explosives were fired high up in the clouds. . . . Last night

(May 12) after eleven o'clock we had a slight horizontal trembling movement from a south-westerly direction."

An aerial luggage transmitter has been erected recently by the L. and S.W. Railway Company at their junction at Woking, and is, we understand, in the nature of an experiment, being, it is believed, the first appliance of its kind used by any railway company in the kingdom. In briefly describing it, *Engineering* states that on the up and down platforms are erected iron towers, each 32 feet 6 inches in height, and set in blocks of concrete. Suspended from tower to tower are four spans of wire cable. The topmost cable, on which the transmitter runs to and fro, is exceptionally strong, and is capable of bearing a strain equal to at least 20 tons. The second cable keeps the transmitter in position, and the third and fourth cables, which are much thinner and are in one length, are for "paying out" and "returning." Each span is 110 feet long, and the height of the transmitter above the railway is 22 feet 6 inches. Attached to the transmitter is an iron cage capable of holding half a ton at one time. The whole is worked by hydraulic power, the engine being on the down side. Above it is a small box in which are the levers working the apparatus. The transmitter is very rapid in its working, taking only 30 seconds to deposit 10 cwt. of luggage from one platform to the other. All the experimental trials have been, it is said, most satisfactory, and the transmitter is now ready for use.

ATTENTION has recently been called to the possibilities of the balata fields on the Amazon. A gutta-percha merchant in the Guianas, examining this region about a year ago, found the balata tree growing in abundance near Para, and on the Amazon and its tributaries for thousands of miles. The Brazilians had no knowledge of its gum-producing qualities, and were found cutting down the trees for firewood and building material. A concession was bought, and the practical work of producing gutta-percha for the market begun. As in the case of rubber, there is practically no limit to the supply of gutta-percha on the Amazon, and, as it can be produced at a fraction of the cost of rubber, it offers a much higher percentage of profit. The method of bleeding the balata tree is entirely different from that used to extract the gum of the rubber tree, and only experienced and expert bleeders can be employed. But, on the other hand, these trees yield many times as much sap as the rubber trees, and one man can, it is said, easily produce as many kilograms of gutta-percha in a day as twenty men can extract of rubber. Each tree will average $3\frac{1}{2}$ lb. of gutta-percha and a competent bleeder can prepare 40 to 50 lb. per day. The gum is first fermented and then dried in the sun, after which it is ready for shipment.

We have received several communications on the variation of the small copper but terfly (*Chrysophanus Phlaeas*, Linn.) with reference to the letter of a correspondent in our issue of September 11. The insect is very variable, and the row of blue spots inside the dark border of the hind wing, which has been specially referred to, is not uncommon, and according to Rühl ("Paläarktischen Grossschmetterlinge," i. p. 217) is only met with in the female. The insect extends throughout the whole northern hemisphere, and exhibits local variation in many parts of its range. In the south of Europe and Asia, a larger and darker variety, with rudimentary tails (var. *Eleus*, Fabricius), is not uncommon. The species is also very prone to albinism, specimens with the usual copper colour of the wings replaced by white, leaving only the black markings dark, being occasionally met with (var. *Schmidti*, Gerhard). We are not aware that it ever hybridises with "blues," as one of our correspondents has suggested. We may refer readers who require further information to the following works:—Barrett's "Lepidoptera of the British Islands," vol. i. pp. 62-65, plate 2, Figs. 2, 2a to 2j (Fig. 2a

represents the white form); Tutt's "British Butterflies," pp. 152-155; Mosley's "Illustrations of Varieties of British Lepidoptera," part 10 ("Polymmatous Phlaeas"), plates 1 and 2 (twelve varieties figured, some very remarkable, including not only copper and black and white forms, but a dark greyish brown specimen, slightly suffused with copper and marked with a few large black spots); Rühl's "Paläarktischen Grossschmetterlinge," Band 1, pp. 217, 218, 746, 747 (this work gives full information respecting the foreign range and variation of the insect); Staudinger and Rebel, "Catalog der Lepidopteren des Paläarktischen Faunengebietes," p. 74. Mr. F. Merrifield has also called our attention to his paper on "The Coloration of *Chrysophanus Phlaeas* as affected by Temperature," in the *Entomologist* for November, 1893 (vol. xxvi. pp. 333-337).

THE report on "British Rainfall for the Year 1901," compiled by Mr. H. S. Wallis and Dr. H. R. Mill (60 + 252 pp. large 8vo), contains, as usual, most valuable and trustworthy data, showing the annual distribution of rain over the British Isles, as observed at about 3500 stations, together with the number of days on which 0.01 inch or more fell. This most useful organisation is so well known that it seems scarcely necessary to refer to the articles which regularly appear upon various branches of rainfall work. The notes on the meteorology of the year and on the principal phenomena, arranged according to months, are exceedingly interesting and valuable for reference, as are also the tables showing the heavy falls in short periods and the monthly rainfall at 232 stations. The comparison of the rainfall of the year with a thirty years' average is very instructive, and shows at a glance that, on the whole, there has been a great deficiency in the total amount. In the eastern counties the deficiency reached 30 or 35 per cent. of the normal value.

In the *Transactions of the South African Philosophical Society* of June last, Mr. J. R. Sutton contributes an elaborate paper on the "Pressure and Temperature Results for the Great Plateau of South Africa," accompanied by useful daily and monthly means for the years 1888-97. The discussion exhibits a systematic comparison between the temperatures and pressures of the air over a plateau and corresponding coast station, as represented by observations at Kimberley and Durban, similarly to comparisons between the summit and base of a mountain.

THE United States Weather Bureau has published a valuable memoir on West Indian hurricanes (*Bulletin* No. 32), prepared by Mr. W. H. Alexander from all available sources. Part of the information has been published in a previous *Bulletin*, but the present paper includes additional observations on those of St. Kitts and Porto Rico in particular, with brief historical notes of the most remarkable storms that have occurred from the earliest times.

THE *Journal of the College of Science of Tokio* (vol. xvi. article 7) contains an interesting paper entitled "Studies in Atmospheric Electricity," by Prof. Y. Homma. The facts discussed have been obtained chiefly from observations and documents belonging to the Central Meteorological Observatory of Japan. The principal conclusions are:—(1) The negative potential observed during strong wind is entirely due to the negative electrification of the dust in the atmosphere by friction with terrestrial objects; (2) similarly the high potential observed during fog or haze is due to the positive electrification of the water particles composing it; (3) when a mass of cold air comes in contact with a mass of warm air, the former becomes positively electrified with respect to the latter; (4) the high potentials about sunrise are probably owing to the air near the surface having a lower temperature than the air above it, and becoming, in consequence, positively electrified; (5) when two masses of air at different temperatures happen to be mixed suddenly, the

electric field is violently disturbed. Various types of potential are illustrated by reproductions of photographic curves of a self-recording electrometer.

It is often necessary in experimental work to maintain a condenser continuously charged at a constant high potential for a considerable length of time, and various methods, none of them altogether satisfactory, have been proposed. An "electrostatic relay" suitable for this purpose is described by M. V. Crémieu in the *Journal de Physique* for September. The form hitherto found most satisfactory depends essentially on the action of an electrostatic balance, which essentially makes or breaks contact in an electric circuit when the potential passes a certain value, thereby connecting or disconnecting the condenser to be charged and an electrostatic machine. The objection to this arrangement arises from the fact that a certain force is necessary either to make or break the contact, and hence the potential of the condenser may fluctuate as much as 22 per cent. The arrangement which M. Crémieu now proposes obviates this difficulty. In one of the contacts there is no adhesion of the terminals and no sparking, because when the contact is made only a very small quantity of electricity flows through it, and when it is broken the terminals are both at the same potential. In the only contact in which adhesion may occur, the terminals are separated by a force which can by adjustment of the apparatus be made as large as desired. It results that the present arrangement is capable of regulating the potential of a condenser of 1 kilometre capacity, charged up to 5000 volts, to within $\frac{1}{2}$ per cent.

MR. J. L. WORTMAN contributes part i. of "Studies of Eocene Mammalia in the Marsh Collection, Peabody Museum" (*Amer. Journ. Science*, ser. 4, vols. xl-xiv., 1901-1902). In this work the Carnivora are dealt with, the ancestral relations and progressive modifications of the several families are considered, some new genera and species are described, others are freshly defined, and some, like *Triacodon*, *Ziphaecodon* and *Harpalodon*, are not regarded as valid genera. The author also discusses the general organisation of the Carnivora and the relationship of its more primitive members to the metatherian marsupials.

IN an exhaustive memoir relative to the Mexican meteorites which was published in the *Mineralogical Magazine* in 1890 (vol. ix. pp. 91-178), Mr. Fletcher called attention to the fact that a large mass of meteoric iron, found in 1867 in an ancient grave at Casas Grandes de Malintzin, Chihuahua, Mexico, and thus of much archaeological interest, had not been heard of since 1873, in which year it was said to be about to be transported from Casas Grandes to the United States consulate at El Paso. Mr. Fletcher suggested that the missing mass was possibly identical with one which had been shown in the Mexican mineral exhibit at the United States International Exhibition of 1876 and had been afterwards transferred to the Smithsonian Institution. On investigation, the Washington authorities were convinced that the suggestion was well founded. Mr. Wirt Tassin has now published (*Proceedings of the United States National Museum*, 1902, vol. xxv. p. 69) a description of the mineralogical and chemical characters of the mass. Very sharply defined Widmanstätten figures are developed by the etching of a polished face. The percentage of nickel (and cobalt) varies in different parts from 4.5 to 5.3. The chemical composition of one of the alloys (tenite) corresponds to the formula Fe_3Ni . As is usual in meteoric irons, both troilite (ferrous sulphide) and schreibersite (phosphide of iron and nickel) are present; both minerals were isolated and analysed. Cliftonite, the cubic form of graphitic carbon, was carefully sought for, but only massive graphitic carbon was found.

IN the course of an interesting paper on the crustacean fauna of the Mammoth Cave, Kentucky, and its neighbourhood, forming No. 1285 of the *Proceedings of the U.S. Museum*, Mr. W. P. Hays describes a new form of blind shrimp discovered by himself in one of the streams passing through the cave. This shrimp, which belongs to a family previously unknown from the North American Continent, is referred to a new genus, although it appears to come very close to *Xiphocaris*, of which one representative is found in the West Indies, a second in New Zealand and a third in the Indo-Malay region. The author is of opinion that the group is a very ancient one and that the cave-forms have survived in districts whence their relatives have migrated south.

THE Report of the Director of the Botanical Survey for the year 1901-1902 has been received, and includes the independent reports of the directors of the three botanical departments. The chief items of interest are the failure of attempts to introduce the plant *Paspalum dilatatum*, which has a considerable reputation in America and Australia as a drought-resisting fodder grass, hybridisation experiments with wheat, and various sugar-cane pests and diseases.

WE have received a subject list of works on domestic economy, foods and beverages, including the culture of cacao, coffee, barley, hops, sugar, tea and the grape, in the library of the Patent Office. The list comprises 1270 works.

THE September issue of the *Agricultural Journal of the Cape of Good Hope* contains a powerful plea for the use of the metric system in South Africa from the pen of Mr. D. E. Hutchins, conservator of forests, western districts of Cape Colony. The number also contains the communications on the "Misuse of Coal" by Prof. John Perry, F.R.S., and Mr. Hutchins which appeared in our columns on March 20 and July 10 respectively.

THE same number of the journal has a note upon some French experiments which have been made respecting the use of salt in the dietary of sheep. Three lots of sheep were fed identically, excepting that one lot had no salt, another lot had half an ounce every day and the remainder three-quarters of an ounce daily. Those receiving half an ounce gained 4.5 pounds each more than those which had no salt and 1.25 pounds more than those which had more than half an ounce. The salted sheep had 1.75 pounds more wool and a better fleece than those which had no salt.

THE current issue of *Engineering* contains a description of the proposed scheme for the transmission of letters, newspapers and parcels by an aerial electric railway which is at present under the consideration of the Italian Minister of Posts and Telegraphs, to which we briefly referred in our columns of September 18.

THE *Times* of Thursday last contains an interesting account, by Mr. J. Y. Buchanan, F.R.S., of the recently completed fourth annual scientific cruise of the Prince of Monaco's steam yacht *Princesse Alice*.

A NEW edition, the sixth, of Lord Avebury's "The Origin of Civilisation and the Primitive Condition of Man" has just been issued by Messrs. Longmans and Co. The author, in his preface, states that he sees no reason to change in any essential respects the opinions originally expressed by him in the first edition of the book thirty years ago. The present issue of the work contains, however, numerous additions here and there.

THE Report of the proceedings and abstracts of the papers read at the International Engineering Congress held in Glasgow in 1901 has been issued in volume form by Mr. W. Asher, of Glasgow.

MESSRS. Philip Harris and Co., Ltd., Birmingham, have sent us a handy little pocket diary giving, besides space for notes, addresses, &c., particulars and dates of the various science examinations which are to take place during the session 1902-3.

THREE catalogues which should be of interest to our readers have reached us, viz., a "Subject List of Works on the Textile Industries and Wearing Apparel, including the Culture and Chemical Technology of Textile Fibres, in the Library of the Patent Office" (issued by the Patent Office); "Catalogue of Geological Books and Papers," on sale by Dulau and Co.; and a "Catalogue of Miscellaneous Books in Literature, Science and Art," offered by Sotheran and Co.

THE additions to the Zoological Society's Gardens during the past week include a White-throated Capuchin (*Cebus hypoleucus*) from Central America, presented by Dr. O. Inchley; an African Civet Cat (*Viverra civetta*) from Sierra Leone, presented by Mr. Reginald Espeut; a Ring-tailed Coati (*Nasua rufa*) from South America, presented by Mr. Alfred Stockman; a Sparrow Hawk (*Accipiter nisus*), British, presented by Mr. M. T. England; a Nilotic Crocodile (*Crocodius niloticus*) from Africa, presented by Mr. L. C. Ditton; a Common Boa (*Boa constrictor*) from Trinidad, presented by Mr. W. J. Sanger Tucker; a Macaque Monkey (*Macacus cynomolgus*) from India, a Vervet Monkey (*Cercopithecus landuldi*) from South Africa, four Lesser Egyptian Gerbilles (*Gerbillus aegyptius*) from North Africa, a Great Anteater (*Myrmecophaga jubata*) from South America, a Spix's Macaw (*Cyanopsittacus spixi*), ten Cope's Terrapins (*Hydromedusa tectifera*) from Brazil, a Limbless Lizard (*Pygopus lepidopus*) from Australia, deposited.

OUR ASTRONOMICAL COLUMN.

EPHEMERIS FOR THE SEARCH OF THE COMET TEMPEL, SWIFT.—M. F. Bossert contributes to No. 3811 of the *Astronomische Nachrichten* an ephemeris for the search for this comet. An extract is given herewith:—

1902.		h. m. s.		log r.		log Δ.	
Oct. 1	...	19	3 28	...	0.2518	...	0.1335
" 6	...	18	5 1	...	0.2421	...	0.1385
" 11	...	18	4 3	...	0.2321	...	0.1432
" 16	...	18	5 1	...	0.2220	...	0.1471
" 21	...	18	3 0	...	0.2117	...	0.1507
" 26	...	17	38 8	...	0.2013	...	0.1535
" 31	...	17	12 0	...	0.1909	...	0.1563
Nov. 5	...	16	41 3	...	0.1803	...	0.1582

GRIGG'S COMET.—The comet which was announced by Mr. John Grigg has been named 1902 c, and the following ephemeris has been calculated for it by Herr M. Ebell, taking T=June 20^o Berlin M. T., from the elements previously published:—

1902.		h. m. s.		log r.		log Δ.		Bright-ness.	
May 20	...	4	13 7	...	0.9407	...	0.2706	...	0.35
June 21	...	7	28 1	...	0.7245	...	0.0937	...	2.29
July 23	...	11	28 5	...	0.9567	...	0.0416	...	1.00
Aug. 24	...	14	21 2	...	0.1565	...	0.1896	...	0.20
Sept. 25	...	15	57 5	...	0.2855	...	0.3536	...	0.05
Oct. 27	...	17	4 0	...	0.3785	...	0.4773	...	0.02

Unit of brightness on July 23. (*Astronomische Nachrichten*, 3816.)

REAPPEARANCE OF EROS.—This planet was visually rediscovered by Dr. Charles J. Ling, using the 20-inch refractor of the Chamberlain Observatory, at 3.15 a.m. on August 2. On August 7, Dr. Ling made an accurate determination of the planet's position and magnitude, and this showed the right ascension to be 15 seconds less than the computed R.A. obtained from Miss M. C. Traylor's ephemeris; the declination only shows a variation of less than 1 minute from the position given by the ephemeris. Dr. Ling estimated the magnitude to

be 1m. 0 brighter than one would expect from the observations published in No. 61 of the Harvard College *Circular*, and he has confirmed his estimate on several later occasions. As these estimations were made when the planet was low down in the east and just before dawn, it is not likely that he has overestimated the brightness; photometric measures should therefore be made as soon as possible by those observatories which are equipped for this work.

EROS is now moving eastward nearly as fast as the sun, and will move southwards for several months, so that it will not be very favourably situated for observers in the northern hemisphere. Its position on August 11 at 15h. 25m. 19s. (University Park M. T.) was:—

R.A. 5h. 36m. 35s. 03
Dec. + 31° 56' 17" 7
(*Popular Astronomy*, No. 97.)

A REMARKABLE METEOR.—A meteor of extraordinary brightness was observed at Earlsfield, Surrey, on the evening of September 29.

Two observers, Mr. Archibald McDougall, of Earlsfield, and Mr. W. E. Rolston, of the Solar Physics Observatory, were, at the moment of the meteor's appearance, looking at that part of the sky in which it was first visible, and both were very much surprised by the brightness and beauty of the appearance. They recorded the following data regarding the phenomenon:—

At 10.16 p.m. the meteor appeared as a faint greenish trailing light, having a phosphorescent appearance, in the S.S.W., and very deliberately travelled in a south-eastern direction. Its altitude at the commencement of its flight was about 25° to 30°, and its bursting point was 10° to 15° above the horizon. The head gradually swelled out into an elongated pear-shaped mass, and the light emitted by it on bursting was of a yellowish red tinge, which afterwards became rose-coloured. The whole phenomenon occupied about 4 to 5 seconds, but the faint greenish trail disappeared, closing up from its starting point, in about 1½ seconds; this trail was about 10' long. The meteor was appreciably brighter than Jupiter; it first appeared about halfway between α and γ Aquarii and then travelled in the direction of Cetus.

Several other bright meteors were seen by Mr. Rolston on the same evening.

METEOR RADIANTS.—In a list of radiants observed at the Observatory of Athens during 1900 and 1901, M. Eginitis records in the *Astronomische Nachrichten* (No. 3815) two new radiants, and three which he says are "probably new."

During 1900 and 1901, the maximum of the Perseid shower was recorded as occurring on August 11, the principal radiant being situated near to γ Persei, whilst the principal point from which the Leonids seemed to radiate was recorded as being situated near to Regulus. M. Eginitis remarks on the number of different radiants from which each shower appears to proceed.

INSTRUCTIONS ON THE OBSERVATION OF THE SUN.—Under this heading, "La Commission Solaire" publish, in the September *Bulletin de la Société Astronomique de France*, an introduction to the "Instructions for Solar Observations," of which they propose to send a copy to all members of the Société Astronomique who intend taking part in the solar observations the preparation and collection of which form the *raison d'être* of the commission recently appointed.

The introduction first points out the vital importance of an earnest and continuous study of solar physics, and then proceeds to state under twenty-one subheadings the details of these studies, the necessity for each, and the necessity for the continuous gathering together and the reduction of the whole work. M. Deslandres, who is the writer of the introduction, especially insists upon the absolute necessity of the co-operation of many observers in this work.

CORRECTIONS TO THE RIGHT ASCENSIONS OF THE PRINCIPAL STARS OF THE BERLINER JAHRBUCH.—Nos. 3813 and 3814 of the *Astronomische Nachrichten* are devoted to an account, by Senor Campos Rodrigues, of the methods pursued, and the results obtained thereby, in determining the corrections obtained at Lisbon to the right ascensions of 384 of the principal stars given in the Berliner Jahrbuch.

Senor Rodrigues describes the meridian circle and the instrumental aids which he has used in this work, and then sets out in tabular form the results he has obtained since he commenced the work in 1887.

OBSERVATIONS OF PERRINE'S COMET, 1902 b.

THIS comet was discovered by Perrine, using the 12-inch refractor of the Lick Observatory, on the morning of September 1, and the discovery was published by the following telegram, of that date, from Prof. Pickering to the Kiel Centralstelle:—"A comet was discovered by Perrine August 31, 16h. Sm. 16s. Lick, a app. 3h. 17m. 49s. 4, δ app. +34° 38' 47", slightly elongated, mean diameter 4', magnitude 9, tolerably well-defined nucleus, tail." This object was also discovered, independently of Perrine, by M. Borely, of the Marseilles Observatory, on September 2, 9h. 50m. 4, and the observation was forwarded to Kiel in a telegram from M. Loewy, which stated that the comet's position, at the time of its discovery, was $\alpha = 49^{\circ} 9'$, N.P.D. = $54^{\circ} 48'$, its daily movement -15' and -26' respectively, and that it possessed a nucleus and a tail.

Further observations were made by Perrine, and the following parabolic elements, ephemeris and details have been obtained therefrom:—

Elements of Comet 1902 b.

T = 1902 November 23 472 G.M.T.

$$\begin{aligned} \omega &= 153^{\circ} 25' 46'' \\ \Omega &= 49^{\circ} 56' 10'' \\ i &= 156^{\circ} 54' 22'' \\ \log q &= 9.60424. \end{aligned}$$

Ephemeris for 12h. G.M.T. (Perrine).

1902.	True α , h. m. s.	True δ .	log. Δ .	Bright- ness.
Oct. 5 5	20 55 49	+50 28	9.566	27.1
22 5	17 43 15	+3 53	9.812	16.1
Nov. 8 5	16 57 23	-11 0	0.040	13.9
23 5	16 13 8	-18 13	0.139	17.2

The brightness given for each day is the value obtained on comparison with the brightness at the time of discovery, calling the latter unity. Perrine adds that, when discovered, the comet had a magnitude of 9, with a well-defined, but not stellar, nucleus of magnitude 10.5 or 11.0; the diameter of the coma was 4' to 5', whilst the short, bushy tail could be traced to the south-west for a distance of 8' to 10'. As a correction to the telegram dispatched to the various observatories on September 2, he mentions that the calculated time of perihelion passage is November 23.47, and not November 24.47 as was stated in that telegram.

The above elements and ephemeris agree fairly closely with those calculated by Herr Elis Strömgen, of Kiel, from observations made at Lick (September 1.05), Urania (September 2.58) and Copenhagen (September 4.61), and he has calculated an ephemeris for every day from September 6 to October 16. Part of this ephemeris is given below, and from it has been prepared the accompanying chart, which shows the comet's approximate daily positions with regard to the neighbouring stars.

Ephemeris for 12h. M.T. (Berlin). (Strömgen.)

1902.	α app. h. m. s.	δ app.	Brightness. ¹
Oct. 2	22 28 46	+56 15.9	
3	21 55 30	54 56.5	
4	21 23 23	52 58.3	26.0
5	20 53 36	50 25.1	
6	20 46	47 22.8	
7	20 3 5	43 59.4	
8	19 42 28	40 23.5	29.4
9	21 41	36 42.9	
10	19 9 20	33 4.5	
11	18 50 4	29 32.9	
12	44 33	26 11.5	26.6
13	34 31	23 2.3	
14	25 42	20 6.2	
15	17 54	17 23.3	
16	18 10 58	14 53.3	21.8

¹ Brightness at time of discovery = 1.

MM. Borely and Fabry, of the Marseilles Observatory, have observed the comet on several occasions since its discovery by the former, and they report that it is fairly brilliant, has an elongated nucleus and a tail 10' to 12' long. On September 2, at 14h. (Marseilles M.T.), the nucleus appeared to become double and thus form two small, globular nuclei; on September 3 it had much the same aspect, but on September 5 the nucleus was more diffuse and the light of the comet appeared to sensibly diminish.

It may be seen from the above ephemerides that the comet will attain its maximum brightness about October 8 and that it



FIG. 1.

passed its maximum declination on September 30, so that by November 30 it will be comparatively faint, and so far south that it will be a difficult object for observers in the northern hemisphere, except on very fine nights and in clear atmospheres; at present (September 27) it is an easy object to find with an ordinary opera-glass, and, given good meteorological conditions, it should soon become obviously visible to the naked eye.

FORTHCOMING BOOKS OF SCIENCE.

THE announcements of Messrs. Baillière, Tindall and Cox contain—"Manual of Operative Surgery," by H. W. Allingham; "Manual of Medicine for Students and Practitioners," by Dr. T. K. Monro; "Refraction of the Eye," by E. Clarke; "Drugs: their Production, Preparation and Properties," by H. W. Gadd; "Anesthetics," by Dr. J. Blumfeld; "Aids to the Analysis and Assay of Metals, Ores and Fuels," by J. J. Morgan; "Suggested Standards of Purity for Food and Drugs," by C. G. Moor; "Selected Papers on Operative Surgery," by Sir William Stokes; "The Dental Annual, and Year-Book of Dental Surgery"; "Artistic Poses," by Dr. R. Colenso, illustrated; "The Common Colics of the Horse," by T. C. Reekes; "Pulmonary Consumption," by Dr. A. C. Latham (winner of the King's prize of 500l.); and new editions of Politzer's "Text-Book of the Diseases of the Ear and Adjacent Organs," translated by Drs. C. L. Heller and M. J. Ballin; Cross and Cole's "Modern Microscopy"; Fleming's "Veterinary Surgery," edited by Prof. Macquoen, vol. i.; Allan's "Aids to Sanitary Science"; Rose and Carler's "Manual of Surgery"; Gresswell's "Veterinary Pharmacopoeia"; Courtenay's "Veterinary Medicine," edited by Prof. Hobday; Murrell's "Aids to Forensic Medicine and Toxicology"; Gubb's "Aids to Gynaecology."

Messrs. A. and C. Black give notice of:—"Problems in Astrophysics," by Agnes M. Clerke, illustrated; "Descriptive Geographies from Original Sources," edited by Dr. A. J. Herbertson and F. D. Herbertson:—Africa, Asia and Europe, illustrated; "Geography Readers," by L. W. Lyde:—British Empire, illustrated; Africa.

Messrs. Blackie and Son, Ltd., promise "The Coal-Fields of Scotland," by Robert W. Dron.

Messrs. Wm. Blackwood and Sons announce:—"An Introductory Text-Book of Logic," by Dr. S. H. Mellone; "The Psychology of Ethics," by Prof. D. Irons.

The announcements of the Cambridge University Press include:—"The Geography of Disease," by Dr. Frank G. Clemow; "A Treatise on Spherical Astronomy," by Prof. Sir Robert S. Ball, F.R.S.; "Dr. William Turner's Treatise 'De Avibus,' Cologne, 1544, translated and edited by A. H. Evans; "The Fauna and Geography of the Maldivic and Laccadive Archipelagoes: being the Account of the Work carried on and of the Collections made by an Expedition during the years 1899 and 1900 under the Leadership of J. Stanley Gardiner," vol. i. part

iii., illustrated; "The Algebra of Invariants," by J. H. Grace and A. Young; "Reports of the Anthropological Expedition to Torres Straits by the Members of the Expedition," edited by Dr. A. C. Haddon, F.R.S.; "Solutions of the Examples in the Elements of Hydrostatics," by S. L. Loney; "Immunity in Infectious Diseases," by Prof. Élie Metchnikoff, authorised English translation by F. G. Binnie, illustrated; "Scientific Papers," by John William Strutt, Baron Rayleigh, F.R.S., vol. iv.; "The Principles of Mathematics," vol. i., by Bertrand Russell; "The Sub-mechanics of the Universe," by Prof. Osborne Reynolds, F.R.S.; "On an Inversion of Ideas as to the Structure of the Universe: being the Rede Lecture for 1902," by Prof. O. Reynolds, F.R.S.; "A Treatise on Determinants," by R. F. Scott, F.R.S., a new edition by G. B. Mathews, F.R.S.; "Index Nominum Animalium," compiled by C. Davies Sherborn, under the supervision of a committee appointed by the British Association and with the support of the British Association, the Royal Society and the Zoological Society, vol. i. (1758-1800); "The Electrical Properties of Gases," by Prof. J. J. Thomson, F.R.S.; "A Course of Modern Analysis: an Introduction to the General Theory of Infinite Series and of Analytic Functions, with an Account of the principal Transcendental Functions," by E. T. Whittaker; "A Systematic Account of the Seed-Plants," by Dr. A. B. Rendle, vol. i.—Introduction, Gymnosperms, Monocotyledons; "Fossil Plants: a Manual for Students of Botany and Geology," by A. C. Seward, F.R.S., vol. ii.; "A Primer of Botany," by F. F. Blackman; "A Primer of Geology," by J. E. Marr, F.R.S.; "A Brief History of Geographical Discovery since 1400," by Dr. F. H. H. Guillemaud; "An Introduction to Physiography," by Dr. W. N. Shaw, F.R.S.; and a new edition of "Solution and Electrolysis," by W. C. D. Whetham.

Messrs. Cassell and Co., Ltd., promise:—"The Dominion of the Air: the Story of Aerial Navigation," by the Rev. J. M. Bacon, illustrated; "White's Natural History of Selborne," with notes by R. Kearton, illustrated.

Messrs. W. and R. Chambers, Ltd., will issue a new edition of "Organic Chemistry," by Prof. W. H. Perkin, jun., F.R.S., and F. Stanley Kipping, F.R.S., part i.

Messrs. J. and A. Churchill announce:—"A Manual of Hygiene," by Dr. Hamer; "Pathological Anatomy and Histology," by Dr. Lazarus-Barlow; "A Handbook of Clinical Medicine," by Dr. T. D. Savill; "Cancer of the Stomach," by Dr. Fenwick and Dr. W. Soltau Fenwick; "Obstinate Hiccough," by Dr. Knuthsen; "Electric Lighting," edited by W. J. Dibdin (being the fourth volume of Groves and Thorp's "Chemical Technology"); and new editions of Morris's "Treatise on Anatomy"; Starling's "Elements of Human Physiology"; Heath's "Practical Anatomy," revised by J. Ernest Lane; Coles's "The Blood"; Haig's "Diet and Food"; Bloxam's "Chemistry: Inorganic and Organic."

Messrs. T. and T. Clark promise:—"The Religion of the Ancient Egyptians and Babylonians, being the Gifford Lectures on the Conception of the Divine in Egypt and Babylonia," by Prof. A. H. Sayce; "Explorations in Bible Lands during the Nineteenth Century," edited by Prof. Herman V. Hilprecht; "Euclid, his Life, and System," by Dr. T. Smith; "Hegel and Hegelianism," by Prof. R. Mackintosh.

Mr. W. B. Clive gives notice of:—"Matriculation Advanced Algebra and Geometry," edited by Dr. Wm. Briggs; "The New Matriculation Chemistry, being the 'Tutorial Chemistry,' Part I., with Matriculation Supplements on Metals and their Compounds and the Chemistry of Daily Life," by Dr. G. H. Bailey; "The New Matriculation Botany," by Dr. A. J. Ewart; "Matriculation Geography, Physical and General, both for the London Matriculation Examination (Revised Regulation)"; "Practical Plane and Solid Geometry, First Stage," by G. F. Burn; "Applied Mechanics, First Stage"; "Organic Chemistry (Theoretical), First Stage," by R. A. Lyster; "Mining, First Stage"; "Steam, First Stage"; "Advanced Hygiene," by Alfred E. Ikin and Robert A. Lyster.

Messrs. Archibald Constable and Co., Ltd., call attention to:—"The Prevention of Disease, Prophylaxis in Surgery Operations, the Treatment of Fractures and Dislocation, Wounds, Deformities and Tumours, Medicine and Insanity," translated from the German, edited with introduction by H. Timbrell Bulstrode; An English Garner:—Geographical; iv.-v.; "Voyages and Travels, mainly of the Seventeenth Century," edited by C. Raymond Beazley.

Messrs. R. A. Everett announce:—"The Horse, from Birth to Old Age," by S. Buckman-Linard, illustrated; "Age and Old Age: a Handbook on Health and Disease," by Dr. David Walsh.

The following are among the announcements of Messrs. Charles Griffin and Co., Ltd.:—"Physico-chemical Tables for the Use of Analysts, Physicists, Chemical Manufacturers and Scientific Chemists," by John Castell-Evans, vol. ii. —Chemical Physics, Pure and Analytical Chemistry; "Electrical Engineering in Colliery Practice," by D. Burns, illustrated; "The Metallurgy of Steel," by F. W. Harbord, illustrated; "The Elements of Metallurgical Chemistry: an Introduction to Chemistry for Students of Science Classes," by John H. Stansbie, illustrated; "Emery Grinding Machines: a Text-Book of Workshop Practice in General Tool Grinding, and the Design, Construction and Application of the Machines Employed," by R. B. Hodgson, illustrated; "Modern Electric Tramway Traction: a Text-Book of Present-Day Practice for the Use of Electrical Engineering Students and those interested in Electric Transmission of Power," by Prof. Andrew Jamieson, illustrated; "Open-Air Studies in Bird-Life: Sketches of British Birds in their Haunts," by Charles Dixon, illustrated; "Official Year-Book of Scientific and Learned Societies of Great Britain and Ireland," nineteenth annual issue; "The Chemistry of India Rubber: a Treatise on the Nature of India Rubber, its Chemical and Physical Examination, and the Determination and Valuation of India Rubber Substitutes, including the Outlines of a Theory on Vulcanisation," by Dr. Carl Otto Weber, illustrated; "Technical Mycology: the Utilisation of Micro-Organisms in the Arts and Manufactures, a Practical Handbook on Fermentation and Fermentative Processes for the Use of Brewers and Distillers, Analysts, Technical and Agricultural Chemists, and all interested in the Industries dependent on Fermentation," by Prof. Franz Lafar, translated by Charles T. C. Salter, vol. ii. part i., illustrated; "The Work of the Digestive Glands," by Prof. Pawlow, translated by Prof. W. H. Thompson (the Nobel prize researches in physiology, 1901, sole authorised edition for England and America); "Hygiene and Public Health," by Dr. H. W. G. Macleod, illustrated.

Mr. Heinemann promises:—"Mutual Aid, a Factor of Evolution," by Prince Kropotkin; "The Care of the Teeth," by Dr. Samuel A. Hopkins; "The Regions of the World," edited by H. J. Mackinder, vol. iii., "Central Europe," by Dr. Joseph Pertsch; "Through the Heart of Patagonia," by Hesketh Prichard, illustrated.

Mr. H. K. Lewis announces:—"Handbook of the Pathology of the Skin, being an Introduction to the Histology, Pathology and Bacteriology of the Skin, with special reference to Technique," by J. M. H. MacLeod, and new editions of "Diseases of the Skin, their Description, Pathology, Diagnosis and Treatment," by H. Radcliffe-Crocker; "Hygiene and Public Health," by Drs. Louis C. Parkes and H. R. Kenwood; "Ophthalmic Practice," by Charles Higgins, revised with the assistance of A. W. Ormond.

Messrs. Crosby Lockwood and Son announce:—"Surveying as practised by Civil Engineers and Surveyors," by John Whitelaw, jun.; "Electricity as applied to Mining," by Arnold Lupton, G. D. Aspinall Parr and Herbert Perkin; "A Short Text-Book of Oil Analysis," by A. C. Wright; "The Care and Management of Stationary Steam Engines," by Charles Hurst; "The Electro-Plating and Electro-Refining of Metals," being a new edition of Alex. Watts's "Electro-Deposition," rewritten by Arnold Philip; and new editions of E. H. Davies's "Machinery for Metalliferous Mines"; "Factory Accounts," by E. Garcke and J. M. Fells; "The Cyanide Process of Gold Extraction," by M. Eissler; Clement Mackrow's "Naval Architect and Shipbuilder's Pocket-Book"; A. C. Wannan's "Marine Engineer's Guide."

Messrs. Longmans and Co.'s list includes:—"The Practitioner's Guide," by Dr. J. Walter Carr, T. Pickering Pick, Alban H. G. Doran and Dr. Andrew Duncan, illustrated; "An Introduction to Bacteriology" (specially designed for Indian medical students), by Dr. M. L. Dhingra; "Fermentation Organisms," by Dr. Klöcker, translated by G. E. Allan and J. H. Millar; "Bacteria in Daily Life," by Mrs. Percy Frankland; "The Great Mountains and Forests of South America," by Paul Fountain, illustrated; "Light Railway Construction," by Richard Marion Parkinson, illustrated; "The Teaching of Chemistry and Physics in the Secondary School," by Profs. Alexander Smith and Edwin H. Hall, illustrated; "Biology

(Nature Study, Botany and Zoology),” by Prof. Francis E. Lloyd and Maurice A. Bigelow; “The Mycology of the Mouth: a Text-Book of Oral Bacteria,” by Kenneth W. Goadby, illustrated; “Mechanics: Theoretical, Applied and Experimental,” by W. W. F. Pullen, illustrated; “Elementary Biology, Descriptive and Experimental,” by John Thornton, illustrated; “British Museum Publications: a Guide to the Antiquities of the Stone Age in the Department of British and Medieval Antiquities,” illustrated; “The Beginnings of Trigonometry: for Use on the Modern Side of Schools,” by Dr. A. Clement Jones; and a new edition of “Materia Medica, Pharmacology and Therapeutics: Inorganic Substances,” by Dr. Charles D. F. Phillips.

Messrs. Sampson Low and Co., Ltd., announce:—“A Manual of Indian Timbers: an Account of the Growth, Distribution and Uses of Indian Trees and Shrubs, with Descriptions of their Wood Structure,” by J. S. Gamble, F.R.S., illustrated; “Modern Workshop Hints,” by R. Grimshaw, illustrated; “Thallner’s Tool-Steel: a concise Handbook on Tool-Steel in General,” translated from the German by W. T. Brannit, illustrated.

In the announcements of Messrs. Macmillan and Co., Ltd., we notice:—“Across Coveted Lands: or, a Journey from Flushing to Calcutta Overland,” by A. H. Savage Landor, 2 vols., illustrated; “Tribes of the Malay Peninsula,” by W. W. Skeat, illustrated; “Life in Mind and Conduct: Studies of Organic Human Nature,” by Dr. Henry Maudsley; “What is Meaning?” by Victoria, Lady Welby; “Mineralogy, an Introduction to the Scientific Study of Minerals,” by Prof. Henry A. Miers, F.R.S., illustrated; “Text-Book of Palæontology,” by Prof. Karl A. von Zittel, translated and edited by Dr. Charles R. Eastman, English edition revised and enlarged by the author and editor and others, vol. ii., illustrated; “A Manual of Medicine,” edited by Dr. W. H. Allechin, vol. iv.:—Diseases of the Respiratory System and of the Circulatory System; vol. v.:—Diseases of the Digestive System and of the Kidneys; “Wild Fowl,” by Leonard C. Sanford and T. S. Van Dyke, illustrated; “Big Game Fish,” by Charles F. Holder, illustrated; “Gun and Rifle,” by A. W. Money, W. E. Carlin and A. L. A. Himmelweight, illustrated; “First Lessons in Agriculture,” by Prof. L. H. Bailey; “The Principles of Stock Breeding: the Application of Biological Laws to the Breeding of Domestic Animals (including Poultry), whether for Fancy or Profit,” by Prof. W. H. Brewer; “The Care of Stock,” by Prof. N. S. Mayo; “An Introduction to Celestial Mechanics,” by Dr. F. Kay Moulton, illustrated; “Climatology,” by Prof. Julius Hann, translated by R. De Courcy Ward; “The Diamond Mines of South Africa: some Account of their Rise and Development,” by Gardner F. Williams, illustrated; “Outlines of Psychology,” by Prof. J. Royce; “Dictionary of Philosophy and Psychology,” edited by Prof. J. Mark Baldwin, vols. ii. and iii.; “Experimental Psychology: a Manual of Elementary Laboratory Practice,” by Prof. E. B. Titchener, vol. ii.:—Quantitative Experiments; and new editions of “A Text-Book of Geology,” by Sir Archibald Geikie, F.R.S., illustrated; “A Text-Book of Botany,” by Dr. E. Strasburger and others, translated by Dr. H. C. Porter, revised by Dr. W. Lang; “Elementary Applied Mechanics,” by Profs. T. Alexander and A. W. Thomson.

Mr. John Murray gives notice of:—“Volcanic Studies,” by Dr. Tempest Anderson, illustrated; “In the Andamans and Nicobars: the Narrative of a Cruise in the schooner *Terrapin*, with Notices of the Islands, their Fauna, Ethnology, &c.,” by C. Boden Kloss, illustrated; “A Naturalist in Indian Seas, or Four Years with the Royal Indian Marine Survey Ship *Investigator*,” by Dr. A. Alcock, F.R.S., illustrated; “The Progressive Science Series:—“Visivication,” by Stephen Paget, and “Heredity,” by Prof. J. Arthur Thomson, illustrated; “The Soil,” by A. D. Hall; “Elements of Political Economy,” by Dr. James Bonar; “Botany,” by William Cross; “Introduction to Philosophy,” by Dr. S. Rappoport; “Introduction to the Study of Animal Life,” by Prof. W. B. Bottomley; “Plant Life,” by Prof. W. B. Bottomley; “Telegraphs and Telephones,” by Sir W. H. Preece, K.C.B., F.R.S.; “The Calculus for Artisans,” by Prof. O. Henri, F.R.S.; “Algebra,” Part ii., by E. M. Langley and S. K. N. Bradley; “Geometry, an Elementary Treatise on Euclid and Geometrical Drawing,” by S. O. Andrew; “The Book of Sir Marco Polo, the Venetian, concerning the Kingdoms and the Marvels of the East,” translated and edited by the late Colonel Sir Henry Yule,

K.C.S.I., revised throughout in the light of recent discoveries by Henri Cordier, with a Memoir of Henry Yule; “Animism: a Treatise on the Natural History of Religion, based on the Gifford Lectures delivered in Aberdeen in 1889-90 and 1890-91,” by Prof. Edward Burnett Tylor, F.R.S., illustrated.

Messrs. T. Nelson and Sons will publish:—“In Flora’s Realm: a Story of Flowers, Fruit and Leaves,” by E. Step, illustrated. Messrs. George Newnes, Ltd., announce:—“Gardens, Old and New,” vol. ii., illustrated; “The Twentieth Century Citizen’s Atlas,” by J. G. Bartholomew; “A Book of Birds and Beasts,” by James Bolton, the famous photographer of wild animals, illustrated; Library of Useful Stories:—“The Story of Alchemy, or the Beginning of Chemistry,” by M. M. Pattison Muir.

The Oxford University Press announces:—“A Text-Book on the Theory and Practice of Histology,” by Gustav Mann; Schimper’s “Geography of Plants,” English edition, by Profs. Percy Groom and W. R. Fisher, illustrated; Goebel’s “Organography of Plants,” authorised English edition, by Prof. I. Bayley Balfour, F.R.S., part ii.

Messrs. C. Arthur Pearson, Ltd., call attention to:—“The Eldorado of the Ancients: Travels in Central Africa,” by Dr. Carl Peters, illustrated; “Among Swamps and Giants in Equatorial Africa,” by Major H. H. Austin, illustrated.

Messrs. G. P. Putnam’s Sons announce:—“Spiritism or Telepathy, Results of Psychological Research,” by Minot J. Savage; “Field Book of American Wild Flowers, with a short Description of their Character and Habits, a concise Definition of their Colours, and References to the Insects which Assist in their Fertilisation,” by F. Schuyler Mathews, illustrated; “The Romance of the Colorado River: a Complete Account of the first Discovery and of the Explorations from 1540 to the Present Time, with Particular Reference to the two Voyages of Powell through the Line of the Great Canyons,” by Frederick S. Dellenbaugh, illustrated; “The Home Life of the Wild Birds,” by Francis H. Herrick, illustrated.

Mr. Grant Richards announces:—“Scientific Phenology: a Practical Handbook,” by Bernard Hollander, illustrated.

Among Messrs. F. E. Robinson and Co.’s announcements we observe:—“The Zoological Gardens of Europe, their History and chief Features,” by C. V. A. Peel, illustrated.

Messrs. Smith, Elder and Co. will issue:—“The Lighthouse Work of Sir James Timmins Chance,” by J. F. Chance, with two portraits.

Messrs. Swan Sonnenschein and Co., Ltd., announce:—“Aristotle’s Psychology: a Treatise on the Principles of Life (*De anima* and *Parva Naturalia*),” translated and edited by Prof. William Hammond; “A History of Contemporary Philosophy,” by Prof. Max Heinze, translated by Prof. William Hammond; “The Mind of Man: a text-book of Psychology,” by Gustav Spiller; “The Basis of Morality,” by Arthur Schopenhauer, translated by Arthur Brodric Bullock; “Contemporary Psychology,” by Prof. Guido Villa, translated from the Italian by Harold Manacorda; “The Student’s Text-book of Zoology,” by Adam Sedgwick, F.R.S., vol. ii., illustrated; “Avenues to Health,” by Eustace H. Miles; “British Moths,” by Alfred H. Bastin, illustrated; “Specimens of Bushman Folklore,” by Dr. W. H. J. Bleek and Miss L. C. Lloyd; “West African Folk Tales: as taken from the Mouths of the Temne Tribesmen,” illustrated; “Fatigue,” by Dr. Mosso, translated by W. B. Drummond; “Elementary Geometry: being a new Treatment of the Subject-Matter of Euclid (Books I. to IV.), specially Adapted for Use in Schools,” by J. Elliott, and new editions of “Harlyn Bay and the Discoveries of its Prehistoric Remains,” by the Rev. R. Ashington Bullen, illustrated; “School Hygiene: the Laws of Health in Relation to School Life,” by Drs. Arthur Newsholme and Walter C. C. Pakes, illustrated; “Practical Pocket-book of Photography,” by Dr. E. Vogel, translated and edited by E. C. Conrad, illustrated; “The Dynamo: How Made and How Used,” by S. R. Botnone; “The Home Doctor,” by Dr. F. R. Walters, illustrated; “Crustaceans and Spiders,” by F. A. A. Skuse.

Mr. Fisher Unwin promises:—“Sand-Buried Ruins or Khotan,” by M. Aurel Stein, illustrated; “Motor Cars and the Application of Mechanical Power to Road Vehicles,” by Rhys Jenkins, illustrated.

Messrs. F. Warne and Co. announce:—“Rand Gold Mining” by John Stuart, illustrated; “The Little Folks’ Picture Natural History: First Glimpses of the Animal World,” by Edward Step.

Messrs. Whittaker and Co.'s announcements are:—"Experiments with Vacuum Tubes," by Sir David Salomons; "Hints to Automobilitists," translated from the French of Baudry de Saunier by C. V. Biggs; "Practical Chemistry on the Heuristic Method," by Dr. W. C. Harris; "Elementary Practical Optics," by T. H. Blakesley; "Electric Traction," by J. H. Rider; "Electrical Engineers' Pocket-book," by Kenelm Edgcombe; "Electric Lighting and Power Distribution," by W. Perren Maycock, vol. ii.; "Mechanical Refrigeration," by H. Williams; "Telephone Lines and Methods of constructing Them," by W. C. Owen; "Friction and its Reduction by Means of Oils, Bearings and Lubrication," by G. U. Wheeler.

THE BRITISH ASSOCIATION AT BELFAST.

SECTION H.

ANTHROPOLOGY.

OPENING ADDRESS BY A. C. HADDON, M.A., Sc.D., F.R.S., M.R.I.A., PRESIDENT OF THE SECTION.

So much has been written of late on totemism that I feel some diffidence in burdening still further the literature of the subject. But I may plead a slight claim on your attention, as I happen to be an unworthy member of the Crocodile kin of the Western tribe of Torres Straits, and I have been recognised as such in another island than the one where I changed names with Maino, the chief of Tutu, and thereby became a member of his kin.

I do not intend to discuss the many theories about totemism, as this would occupy too much time; nor can I profess to be able to throw much light upon the problems connected with it; but I chiefly desire to place before you the main issues in as clear a manner as may be, and I venture to offer for your consideration one way in and some ways out of totemism.

A few years ago M. Marillier wrote ("Rev. de l'Hist. des Religions," xxxvi. 1897, pp. 368, 369) that "totemism is one of the rare forms of culture: it is incapable of evolution and transformation, and is intelligible only in its relations with certain types of social organisation. When these disappear it also disappears. Totemism in its complete development is antagonistic alike to transformation or progress." In due course I shall describe how one people at least is emerging from totemism. At the outset I wish it to be distinctly understood that I do not regard this as the only way out; doubtless there have been several transformations, but a record of what appears to be taking place appeals more to most students than a guess as to what may have happened.

What is most needed at the present time is fresh investigation in the field. Those who are familiar with the literature of the subject are only too well aware of the imperfection of the available records. There are several reasons which account for this. Some of the customs and beliefs associated with totemism have a sacred significance, and the average savage is too reverent to speak lightly of what touches him so deeply. Natives cannot explain their mysteries any more than the adherents of more civilised religions can fully explain theirs. Further, they particularly dislike the unsympathetic attitude of most inquirers, and nothing shuts up a native more effectually than the fear of ridicule.

Language is another difficulty. Even supposing the white man has acquired the language, the vocabulary of the native is not sufficiently full or precise to explain those distinctions which appeal to us, but which are immaterial to him.

Granting the willingness of the native to communicate his ideas, and that the hindrance of language has been overcome, there remains the difficulty of the native understanding what it is the white man wishes to learn. If there is a practically insuperable difficulty in the investigator putting himself into the mental attitude of the savage, there is also the reciprocal source of error.

"Oh, East is East, and West is West,
And never the twain shall meet."

If Kipling is right for the civilised Oriental, how about those of lower stages of culture and more primitive modes of thought?

We must not overlook the fact that the majority of white men who mix with primitive folk are either untrained observers or their training is such that it renders them yet more unsympathetic—one might say antagonistic—to the native point of view. The

ignorance and prejudice of the white man are great hindrances to the understanding of native thought.

When students at home sit, tabulate and compare the available records they get a wider view of the problems concerned than the investigator in the field is apt to attain. Generalisations and suggestions crystallise out which may or may not be true, but which require further evidence to test them. So the student asks for fresh observations and sends the investigator back to his field.

The term "totemic" has been used to cover so many customs and beliefs that it is necessary to define the connotation which is here employed.

It appears from Major J. W. Powell's recent account of totemism (*Man*, 1902, No. 75) that the Algonkin use of the term "totem" is so wide as to include the representation of the animal that is honoured (but he does not state that the animal itself is called a totem), the clay with which the person was painted, the name of the clan,¹ and that of the gens,² the tribal name, the names of shamanistic societies, the new name assumed at puberty, as well as the name of the object from which the individual named. He distinctly states, "We use the term 'totemism' to signify the system and doctrine of naming." I must confess to feeling a little bewildered by this terminology, and I venture to think it will not prove of much service in advancing our knowledge. It looks as if there had been some misunderstanding, or that the Algonkins employed the word "totem" to cover several different ideas because they had not definite terms with which to express them. Major Powell's definitions practically exclude those cults which are practised in various parts of the world, and which by the common consent of other writers are described as totemic.

Prof. E. B. Tylor has given (*Man*, 1902, No. 1; cf. *Journ. Anthropol. Inst.*, xxviii. 1898, p. 138) the following clear exposition of his interpretation of the American evidence: "It is a pity that the word 'totem' came over to Europe from the Ojibwas through an English interpreter who was so ignorant as to confuse it with the Indian hunter's patron genius, his *manitu*, or 'medicine.' The one is no more like the other than a coat of arms is like a saint's picture. Those who knew the Algonkin tribes better made it clear that totems were the animal signs, or, as it were, crests, distinguishing exogamous clans; that is, clans bound to marry out of, not into, their own clan. But the original sin of the mistake of Long the interpreter has held on ever since, bringing the intelligible institution of the totem clan into such confusion that it has become possible to write about 'sex totems' and 'individual totems,' each of which terms is a self-contradiction. . . . Totems are the signs of intermarrying clans."

A reviewer in "L'Année Sociologique," ii. 1899, says (p. 202): "One must avoid giving to a genus the name of a species. It will be said these are merely verbal quibbles; but does not the progress of a science consist in the improvement of its nomenclature and in the classification of its concepts?"

Totemism, as Dr. Frazer and as I understand it, in its fully developed condition implies the division of a people into several totem kins (or, as they are usually termed, totem clans), each of which has one, or sometimes more than one, totem. The totem is usually a species of animal, sometimes a species of plant, occasionally a natural object or phenomenon, very rarely a manufactured object. Totemism also involves the rule of exogamy, forbidding marriage within the kin, and necessitating intermarriage between the kins. It is essentially connected with the patriarchal stage of culture (mother-right), though it passes over into the patriarchal stage (father-right). The totems are regarded as kinsfolk and protectors or benefactors of the kinsmen, who respect them and abstain from killing and eating them. There is thus a recognition of mutual rights and obligations between the members of the kin and their totem. The totem is the crest, or symbol of the kin.

Sometimes all the kins are classified into two or more groups; for example, in Mabuig, in Torres Straits, there is a dual grouping of the kins, the totems of which are respectively land and water animals; and in speaking of the latter group my informant volunteered the remark, "They all belong to the water; they are all friends." On the mainland of New Guinea also I found that one group of the totems "stop ashore," while the other "stop in water." When no member of a group of kins in a community can marry another member of that same

¹ A group that reckons descent only through the mother.

² A group that reckons descent only through the father.

group, that group is termed a phratry. An Australian tribe is generally divided into two exogamous phratries.

North America is the home of the term "totem," and though typical totemism does occur there, it is often modified by other customs. In Australia we find true totemism rampant, and it occurs in Africa, where also it is subject to much modification. Quite recently the Rev. J. Roscoe has published an important paper (*Journ. Anthropol. Inst.*, xxvii, 1902, p. 25) on the Baganda, in which he describes a perfectly typical case of totemism. Among the Baganda there are a number of kins each of which has a totem, *muciro*. The kin, *kika*, is called after its totem; no member of a kin may kill or eat his totem, though one of another kin may do so with impunity. No one mentions his totem. Old people affirm their fathers found some things injurious to them either as food or to their personal safety, and made their children promise not to kill or eat that particular thing. No man may marry into his mother's kin, because all the members of it are looked upon as sisters of his mother; nor may he marry into his father's kin except in the case of two very large kins. In Uganda, royalty follows the totem of the mother, whilst the common people follow the paternal totem. Each kin has its own special part of the country where the dead are always buried. For sympathy or assistance the member of a kin always turns to his particular kin. From what Mr. Roscoe says about the married women of the Green Locust kin, it is evident that the magical aspect of totemism is present as it is in Australia and Torres Straits. The Baganda are thus a true totemic people who are in an interesting transitional condition between matriarchy and patriarchy. Totemic practices also occur in various parts of Asia.

To put the matter briefly, totemism consists of the following five elements:—

(1) Social organisation with totem kinsmen and totem symbols.

(2) Reciprocal responsibilities between the kin and the totem.

(3) Magical increase¹ or repression of the totem by the kinsmen.

(4) Social duties of the kinsmen.

(5) Myths of explanation.

Totemism is only one of several animal cults, and it is now necessary to consider certain cults that have been termed totemic before I proceed with the main object of this Address.

Manitu (Guardian Spirit).

Very widely spread in North America was the belief in guardian spirits which appeared to young men in visions after prayer and fasting. It then became the duty of the youth to seek until he should find the animal he had seen in his trance; when found he must slay and preserve some part of it. In cases when the vision had been of no concrete form, a symbol was taken to represent it: this memento was ever after to be the sign of his vision, the most sacred thing he could ever possess, for by it his natural powers were so to be reinforced as to give him success as a hunter, victory as a warrior, and even power to see into the future.

The guardian spirit was obtained in various ways by different American tribes, but the dream apparition was the most widely spread. Dr. Frazer ("Totemism," 1887, pp. 2, 53) calls it "individual totem"; Miss Fletcher speaks of the object dreamed of (the *wahube* of the Omaha) as the "personal totem" or simply as the "totem"; it is termed by the Algonkin *manitu*, by the Huron *okki*, by the Salish Indians *sulia*, and *nagual* in Mexico. Perhaps it would be best to adopt either *wahube* or *manitu* to express the guardian spirit.

Miss Alice C. Fletcher finds that among the Omaha ("The Import of the Totem," Amer. Assoc. Adv. Sci., Detroit Meeting, August, 1897) those who have received similar visions, that is, those who have the same *wahube*, formed brotherhoods which gradually developed a classified membership with initiatory rites and other rituals. These religious societies acquired great power; still later, according to this observer, an artificial social structure, the "gens," was organised on the lines of the earlier religious societies. Each "gens" had its particular

name, which referred directly or symbolically to its totem, and its members practised exogamy and traced their descent only through the father. "As totems could be obtained in but one way—through the rite of vision—the totem of a gens' must have come into existence in that manner, and must have represented the manifestation of an ancestor's vision, that of a man whose ability and opportunity served to make him the founder of a family." Mr. C. Hill-Tout (*Trans. Roy. Soc. Canada*, 2nd ser., vii., sect. 2, 1901, p. 6), in discussing the origin of the totemism of the aborigines of British Columbia, states: "There is little room for doubt that our clan totems are a development of the personal or individual totem or tutelary spirit, as this is in turn a development of an earlier fetishism."

Dr. F. Boas points out ("Report U.S. Nat. Mus.," 1895 (1897), pp. 322, 323, 334) that the tribes of the northern portion of the North Pacific group of peoples, such as the Tlingit, Haida and Tsimshian, have a maternal organisation with animal totems; the clans bear the names of their respective totems and are exogamous. The central tribes, particularly the Kwakiutl, show a peculiar transitional stage. The southern tribes have a purely paternal organisation, and their groups are simple village communities which are often exogamic.

Dr. Boas distinctly asserts (*l.c.*, p. 323) that "the natives do not consider themselves descendants of the totems; all endeavours to obtain information regarding the supposed origin of the relation between man and animal invariably led to the telling of a myth in which it is stated how a certain ancestor of the clan in question obtained his totem. . . . It is evident that legends of this character correspond almost exactly to the tales of the acquisition of manitous among the eastern Indians, and they are evidence that the totem of this group of tribes is in the main the hereditary manitou of a family.¹ This analogy becomes still clearer when we consider that each man among these tribes acquires a guardian spirit, but that he can acquire only such as belong to his clan. Thus a person may have the general crest of his clan, and besides use as his personal crest such guardian spirits as he has acquired. This accounts partly for the great multiplicity of combinations of crests on the carvings of these people."

Throughout a considerable portion of North America there appears to be a mixture of variously developed cults of the totem and of the *manitu*. It is not perhaps possible at present to dogmatise as to the relative chronology of these two cults. Personally I am in favour of the superior antiquity of the totem cult, as the conception of an individual spirit-helper appears to me to be of a higher grade than the ideas generally expressed by purely totemic peoples, or what may be gathered by implication from a study of their ceremonies.

The social organisation appears to be very weak in some Californian tribes; our knowledge of the Seri in this respect is very meagre, but Dr. Dixon definitely denies (*Bull. Amer. Mus. Nat. Hist.*, xvii., pt. 2, 1902, p. 35) the existence of totemic grouping among the Maidu.

Accepting then for the present the priority of the totem cult, we find a substratum of totemism underlying many of the social organisations in North America. Religious societies are a noticeable feature of the social life of North-west America; those societies have the guardian spirit (*manitu*) as their central idea, but it appears as if the organisation is rooted in a clan (matriarchal totemic kin) system which has been smothered and virtually destroyed by the parasitic growth. The problems to be solved in North-west America are very complicated, and we must await with patience further researches. It is perfectly evident from the researches of Boas, Nelson, Hill-Tout and others that comparatively recent great changes have taken place. Dr. Boas indeed states that "the present system of tribes and clans (of the Kwakiutl) is of recent growth and has undergone considerable changes" (*l.c.*, p. 333). An interesting illustration of this is found in the alteration in the organisation of the Kwakiutl tribe during the season of the winter ceremonial. "During this period the place of the clans is taken by a number of societies, namely, the groups of all those individuals upon whom the same or almost the same power or secret has been bestowed by one of the spirits" (*l.c.*, p. 418). The characteristic North

¹ But Mr. E. S. Hartland points out ("Folk-lore," xi 1900, p. 61) that we have clear evidence from the legends of the descent at all events of some of the clans from non-human ancestors; and Mr. Hill-Tout says: "Among the Salish tribes it is uniformly believed that in the early days, before the time of the tribal heroes or great transformers, the beings who then inhabited the world partook of the character of both men and animals, assuming the form of either apparently at will."

¹ The first intimation of this aspect of totemism is entirely due to the researches of Messrs Spencer and Gillen ("The Native Tribes of Central Australia," 1899). Dr. J. G. Frazer, appreciating the value of these observations, extended the conception to totemism generally, *Journ. Anthropol. Inst.*, xviii, 1899, p. 283, read December 14, 1902; the *Fortnightly Review*, April, 1900, pp. 164, 165; cf. also "Israel and Totemism," by S. A. Cook, *Jewish Quart. Review*, April, 1902, pp. 25, 26 of reprint.

American idea of the acquisition of the *manitu* was evidently also fundamental among the Kwakiutl, as all their tales refer to it and the whole winter ceremonial is based on it.

I agree in the main with Mr. Hartland ("Folk-lore," xi. p. 68) in thinking that, "whether or no totemism was anciently a part of the tribal organisation, the *manitu* conception is of modern date. It is part of the individualism which is tending, not among these tribes only, to obscure the older communistic traditions."

Nyarong.

Allied to the *manitu* of North America is the *nyarong*, or spirit-helper, of the Iban (Sea Dayaks) of Sarawak. The Iban believe that the spirit of some ancestor or dead relative may come to them in a dream, and this *nyarong* becomes the special protector of the individual. An Iban youth will often retire to some lonely spot or mountain-top and live for days on a very restricted diet in his anxiety to obtain a vision. This custom is called *manjok*. On the following day the dreamer searches for the outward and visible form of the *nyarong*, which may be anything from a curious natural object to some one animal. In such cases the *nyarong* hardly differs from a fetish. In other cases, as the man is unable to distinguish the particular animal which he believes to be animated by his *nyarong*, he extends his regard and gratitude to the whole species. In some instances all the members of a man's family and all his immediate descendants, and if he be a chief all the members of the community over which he rules, may come to share the benefits conferred by the *nyarong* and pay respect to the species of animal in one individual of which it is supposed to reside. "In such cases," Drs. Hosi and McDougall remark (*Journ. Anthropol. Inst.*, xxxi. 1901, p. 210), "the species approaches very closely the clan totem in some of its varieties." Here we have a parallel to the North American custom, but the later stages are not carried as far.

Personally I concur in the opinion expressed by Drs. Hosi and McDougall that there is no proof that the peculiar regard paid in Sarawak to animals, the sacrifice of animals to gods or spirits, the ceremonial use of the blood of these sacrificed animals are survivals of a fully developed system of totem worship now fallen into decay. It is very significant that the magical and social aspects of totemism are entirely lacking.

Those who have read Miss Alice Fletcher's sympathetic account of "The Import of the Totem" (*Amer. Assoc. Adv. Sci.*, Section Anthropology, Detroit Meeting, August, 1897) can scarcely fail to recognise that the moral support due to a belief in the guidance and protection of a *wakube* ("personal totem") is of great importance to the individual, and would nerve him in difficulty and danger, and thus proving a very present help in time of need it would surely justify its existence in a most practical manner and consequently be of real utility in the struggle for existence—a struggle which in man has a physical as well as a material aspect.

The advantages of totemism are many, but most of them are social and benefit the special groups or the community at large. The hold that the *manitu* has on the individual consists in its personal relation; the man feels that he himself is helped, and I suspect this is the main reason why it supplants totemism. I believe Mr. Lang some years ago suggested the term *manituism* for this cult. If this name be not accepted I venture to propose the revival of the word "daimon" (*δαίμων*) to include the *manitu*, *nyarong* and similar spirit-helpers, and "daimonism" as the name of the cult.

Theriomorphic Ancestor Worship.

Dr. Frazer calls attention (*Man*, 1901, No. 3) to a publication by Dr. G. McCall Theal ("Records of South-eastern Africa," vii. 1901) in which he describes the tribal veneration for certain animals, *siboko*. The Bantu believed that the spirits of the dead visited their friends and descendants in the form of animals. Each tribe regarded some particular animal as the one selected by the ghost of its kindred, and therefore looked upon it as sacred. Dr. Frazer says: "Thus the totemism of the Bantu tribes of South Africa resolves itself into a particular species of the worship of the dead; the totem animals are revered as incarnations of the souls of dead ancestors. This entirely agrees with the general theory of totemism suggested by the late S. G. A. Wilken and recently advocated by Prof. E. B. Taylor" (*Journ. Anthropol. Inst.*, xxviii. p. 146). But is this totemism? The *siboko* are the residences of the ancestral spirits of the tribe, not of a clan; there is no mention of *siboko*

exogamy. Is this anything more than theriomorphic ancestor worship? There can, however, be little doubt that true totemism did occur, and probably universally so, among the Bantu people; but some of the tribes appear to be in a transitional state, and others have doubtless passed beyond typical totemism. The decay of the Bantu totemism in South Africa appears to have been mainly due to a patriarchal organisation combined with a pastoral life.¹

In describing Dr. Wilken's theory that the doctrine of the transmigration of souls affords the link which connects totemism with ancestor worship, Prof. Tylor concludes as follows: "By thus finding in the world-wide doctrine of soul-transference an actual cause producing the two collateral lines of man and beast which constitute the necessary framework of totemism, we seem to reach at least something analogous to its real cause." I have already expressed my belief that the animal cults of the Malay Archipelago, so far as they are known at present, cannot be logically described as totemism, and the majority of the peoples of this area have so long passed out of savagery that we are hardly likely to find here an unequivocal clue to the actual origin of totemism.

The reverence paid to particular animals or plants by certain groups of people in Fiji may, as Mr. Lorimer Fison says, ("Ann. Rep. Brit. New Guinea," 1897-98, p. 136) "look like reminiscences" of totemism, but he has "no direct evidence." It surely belongs to the same category as the Samoan custom of which Dr. George Brown writes (*ibid.*, p. 137), "In Samoa every principal family had some animal which they did not eat, and I have always regarded this as meaning, not that they thought the animal divine, or an object of worship, but that it was the 'shrine' in which their ancestral god had dwelt, or which was associated with some fact in their past history which had led them to adopt it as their totem." An opinion which Prof. Tylor has independently expressed (*Journ. Anthropol. Inst.*, xxviii. p. 142), but he naturally dissents from the incarnate god being termed a "totem."

I agree with Dr. Coddington ("The Melanesians," 1891, p. 32) in doubting whether the evidence warrants a belief in totemism as an existing institution in the Southern Solomon Islands. I suspect that totemism has been destroyed over a considerable portion of Melanesia by the growth of secret societies as well as by theriomorphic ancestor worship. Herr R. Parkinson (*Abh. Ber. k. Zool. Anth. Eth. Mus. Dresden*, vii. 1899, Nr. 6), however, proves true totemism in the Northern Solomon Islands as the Rev. B. Danks had previously done (*Journ. Anthropol. Inst.*, xviii. 1889, p. 281) for New Britain, Duke of York Island and New Ireland.

The more one looks into the evidence the more difficult is it to find cases of typical totemism; almost everywhere considerable modification has taken place, often so much so that the communities cannot logically be called totemistic. The magical increase of the totem by the clansmen does not appear to be common, but that may be due to its having been overlooked; on the other hand, magic may be performed against the totems to prevent them from injuring the crops, as in the case of the "Reptile people" of the Omaha (J. O. Dorsey, "Ann. Rep. Bureau Ethnol.," 1881-82 (1884), p. 248).

Animal Brethren.

Throughout South-eastern Australia and probably elsewhere in that continent, there is a peculiar association of a species of animal, unusually a bird, with each sex. To take two examples given by Mr. A. W. Howitt (*Journ. Anthropol. Inst.*, xv. 1886, p. 416), "the bird totems of the Kurnai are the Emu, Wren and the Superb Warbler, which are respectively the 'man's brother' and 'woman's sister.' . . . When we turn to the Kulin, we find both the Kurnai totems in just the same position. In addition there are also a second male and female totem, namely, the Bat and the small Night Jar." Mr. Howitt is careful to point out, "They are not true totems in the sense that these represent subdivisions of the primary classes; yet they are true totems in so far that they are regarded as being the 'brothers' and 'sisters' of the human beings who bear their names." Mr. A. L. P. Cameron (*ibid.*, xiv. 1885, p. 350) also states that these are "something different from ordinary totems." Later Mr. Howitt (*ibid.*, xviii. 1888, pp. 57, 59) says: "Among the Wotjobaluk tribe which have a true totemic

¹ E. Durkheim, "L'Année Sociologique," v. 1902, p. 330; cf. also F. B. Jevons, "Introduction to the History of Religion," 1902, pp. 155, 158.

system these were real totems although of a peculiar kind. They were called *yaur*, or 'flesh,' or *ngirabil*, or *nir*, just as were the totems proper. The only difference was that the Bat was the brother of all the men, while any one totem was the brother only of the men who bore it as their totem. . . . It is evident that the institution of the 'man's brother' and the 'woman's sister' as totems is very widespread throughout Australia. I have traced it over an extent of about a thousand miles and in tribes having marked differences in language and in social organisation. It seems to be very persistent and enduring, for it remained among the Kurnai in full force after the ordinary social organisation in class divisions and totems had become extinct." Mr. Howitt speaks of these as "abnormal totems," and Dr. Frazer ("Totemism," p. 51; "The Golden Bough," iii, p. 416) calls them "sex totems." As it appears most desirable to distinguish between this cult, which is confined to Australia, and true totemism, I propose, in default of a distinctive native term, to call these revered animals "animal brethren." Although the natives do not appear to distinguish nominally between these animal brethren and ordinary totems, it does not follow they are to be considered as the same. I am calling attention to an analogous confusion of terms in the totemism of Torres Straits.

I must now pass on to a further consideration of true totemism as understood by Tylor, Frazer, Lang, Hartland, Jevons, Durkheim and others, as it is impossible within the limits of an Address to give an account of all the varieties of pseudo-totemism.

A Suggestion concerning the Origin of Totemism.

I take this opportunity to hazard a suggestion for a possible origin of one aspect of totemism. Primitive human groups, judging from analogy, could never have been large, and the individuals comprising each group must have been closely related. In favourable areas each group would have a tendency to occupy a restricted range owing to the disagreeable results which arose from encroaching on the territory over which another group wandered. Thus it would inevitably come about that a certain animal or plant, or group of animals or plants, would be more abundant in the territory of one group than in that of another. To take a clear example, the shore-folk and the river-folk would live mainly on different food from each other and both would have other specialities than fell to the lot of the jungle-folk. The groups that lived on the seashore would doubtless have some natural vegetable products to supplement their animal diet, but the supply would probably be limited alike in quantity and variety. Even they would scarcely have unlimited range of a shore line, and there would be one group of shore-folk that had a speciality in crabs, another would have shell-beds, while a third would own sandy shores which were frequented by turtle. A similar natural grouping would occur among the jungle-folk; sago flourishes in swampy land, certain animals frequent grassy plains, others inhabit the dense scrub, bamboos grow in one locality, various kinds of fruit trees thrive best in different soils; the coastal plains, the foot hills, the mountains, each has its characteristic flora and fauna. There is thus no difficulty in accounting for numerous small human groups each of which would be largely dependent upon a distinctive food supply the superfluity of which could be bartered for the superfluities of other groups. These specialities were not confined to food alone; for example, the shore-folk would exchange the shells they collected for the feathers obtained from the jungle-folk.

It may be objected that in the great prairies and steppes of America, Eurasia and Australia the natural products are very uniform; but these areas are not thickly populated, and in most cases they probably were only inhabited when the pressure of population in the localities with more varied features forced migration into the open. Certainly these were never the primitive homes of man.

In a recent paper read before the Folklore Society, Mr. Andrew Lang put forward the hypothesis that while each primitive human group called itself "the men," they named the surrounding groups from the names of animals or plants, and hence arose totemism. The idea that there was an intimate connection between the group and the object from which they were nicknamed would soon be developed, and myths of origin would spring up to ac-

¹ It may be objected that the idea of barter is by no means primitive; but as I believe that sociability was a fundamental characteristic of primitive man I can see no reason why it should not have occurred quite early in a rudimentary sort of way.

count for the name. Mr. Lang's theory, still unpublished, regards totem names as given from without for a variety of reasons, amongst which, I understand, he includes my own suggestion. His conjecture is based on the similar names, or sobriquets, of villages in the folklore, or *blason populaire*, of France and England, which, again, is almost identical with the extant names of Red Indian totem kindred now counting descent in the male line. Similar phenomena occur in Melanesia with female kin. Mr. Lang is rather indifferent to the causes of the name-giving so long as the name-giving comes from without and applies to groups, not to individuals.

To return to my suggestion. Among the shore-folk the group that lived mainly on crabs and occasionally traded in crabs might well be spoken of as the "crab-men" by all the groups with whom they came in direct or indirect contact. The same would hold good for the group that dealt in clams or in turtle, and reciprocally there might be sago-men, bamboo-men, and so forth. It is obvious that men who persistently collected or hunted a particular group of animals would understand the habits of those animals better than other people, and a personal regard for these animals would naturally arise. Thus from the very beginning there would be a distinct relationship between a group of individuals and a group of animals or plants, a relationship that primitively was based, not on even the most elementary of psychic concepts, but on the most deeply seated and urgent of human claims, hunger.

There is scarcely any need to point out that the association of human groups with fearsome animals would arise by analogy very early. Hence tiger-men and crocodile-men would restrain the ravages of those beasts (Dr. Frazer, *Fortnightly Review*, 1899, p. 835, describes this as the negative or remedial side of totemic magic); but I take it this was not as primitive as the nutritive alliances. The relation between groups of men and the elements has a purely economic basis; for example, rain is rarely required for itself, but as a means for the increase of vegetable food; similarly the fisherman wants a wind to enable him to get to and from his fishing grounds.

The next phase is reached when man arrived at elementary metaphysical conceptions and endeavoured by sympathetic or symbolic magic to increase his food supply. Naturally the food or product that each group would endeavour to multiply would be the speciality or specialities of that group, and for this practice we now have demonstrative evidence. Though this may be an early phase of totemism, I do not consider it the earliest; it can scarcely be the origin of totemism, but it doubtless helped to establish and organise the system.

The essential difference between the view advocated by Dr. Frazer (*loc. cit.*, 1899, p. 835) and that here suggested is that according to him totemism "is primarily an organised and cooperative system of magic designed to secure for the members of the community, on the one hand, a plentiful supply of all the commodities of which they stand in need, and, on the other hand, immunity from all the perils and dangers to which man is exposed in his struggle with nature. Each totem group, on this theory, was charged with the superintending and control of some department of nature from which it took its name, and with which it sought, as far as possible, to identify itself." Whereas I suggest that the association between a group of men and a species of animals or plants was the natural result of local causes, and that departments of nature were not "assigned to a particular group" of men. I think it is scarcely probable "that in very ancient times communities of men should have organised themselves more or less deliberately for the purpose of attaining objects so natural by means that seemed to them so simple and easy." I suspect that if there was any deliberate organisation it was in order to regulate already existing practices.

To us it might appear that these magical practices could be undertaken by anyone, but this does not seem to have been an early conception. As far as we can penetrate the mind of existing backward man, there is a definite acknowledgment of the limit of his own powers. The members of one group can perform a certain number of actions; there are others that they cannot undertake. One group of men, for example, may ensure the abundance of a certain kind of animal, but another will have power over the rain. An interesting example of this limitation is afforded at Port Moresby, in British New Guinea, where the Motu immigrants have to buy fine weather for their trading voyages from the sorcerers of the indigenous agricultural Koitapu (J. Chalmers, "Pioneering in New Guinea," 1887, p. 14).

The remarkable researches of Messrs. Spencer and Gillen in Central Australia prove that it is the function of the kinsmen of a particular totem to perform what are known as *intichiuma* ceremonies, the object of which is to cause the abundance of the species of animal or plant which is the totem of that kin. The descriptions of these ceremonies are well known to students.¹ I have adduced further evidence of a like nature,² and from what Mr. Roscoe has found in Uganda we may expect other examples from Africa.

It may be that in some, possibly in all, of the instances of sympathetic and symbolic magic there is a belief that wind or sun, animal or plant, or whatever the objects may be, are animated by spirits akin to those of humankind; but even so, as Dr. Frazer³ points out, the action of the magician is a direct one; it does not imply the assistance of other powers who can control the body or spirit of those objects. The data from Australia and Torres Straits point to the conclusion that there is a magical aspect of totemism, which is of great economic importance, and there is no evidence that the officiators at these ceremonies acknowledge the assistance of spiritual powers resident either within the objects themselves or in the form of independent, more or less supreme beings. The existing data do not deny their existence, they simply ignore them in the ceremonies, and so far they are practically non-existent.

According to the suggestion I have ventured to make, the primitive totemic groups ate their associated animals or plants; indeed, these were their chief articles of diet. Messrs. Spencer and Gillen point out⁴ that while amongst most Australian tribes a man may not eat his totem, amongst the Arunta and other tribes in the centre of the continent there is no restriction according to which a man is altogether forbidden to eat his totem. On the other hand, though he may, only under ordinary circumstances, eat very sparingly of it, there are certain special occasions on which he is obliged by custom to eat a small portion of it, or otherwise the supply would fail. The Arunta are a peculiar people, while they may be primitive in some respects; in others they are not so, as also has been pointed out by Durkheim ("L'Année Sociologique," v. 1902). According to the strict definition of the term, they are not even a totemic people. Judging from the evidence of the legends of the Alcheringa time and the traces of group marriage and mother right, Mr. Hartland ("Folk-lore," xi. 1900, pp. 73-75) is of opinion that the present disregard by the Arunta of the totem in marriage is a stage in the sloughing of totemism altogether, whereas the *engwaura*, or final initiation ceremonies, indicate that "the organisation is undergoing a slow transformation into something more like the so-called secret societies of the British Columbian tribes."

The eating of what are evidently the totem animals by the Arunta may possibly be a persistence from an earlier phase, but, without doubt, the totem taboo is characteristic of totemism in full sway.⁵ We have evidence to show that under certain conditions the totem taboo may break down, but this is a later transformation, and indicates a breaking up of the rigid observance of totemism.

Mr. Lang ("Magic and Religion," 1901, pp. 264, 265) has made a simple suggestion to account for the origin of the totem taboo. He says: "These men therefore would work the magic for propagating their kindred in the animal and vegetable world. But the existence of this connection would also suggest that, in common decency, a man should not kill and eat his animal or vegetable relations. In most parts of the world he abstains from this uncouthly behaviour; among the Arunta he may eat sparingly of his totem, and must do so at the end of the close-time or beginning of the season. He thus, as a near relation of the actual kangaroo or grubs, declares the season is open, now his neighbours may begin to eat grubs or kangaroos; the taboo is off." Dr. Frazer puts forth two suggestions (*Fortnightly Review*, 1899, pp. 838-40): the one is that as animals do not eat their own kind, so man thought it inconsistent to eat his totem kin; the other is a hypothetical idea of conciliation.

¹ Baldwin Spencer and F. J. Gillen, "The Native Tribes of Central Australia," 1899; cf. also J. G. Frazer, *Fortnightly Review*, 1899, pp. 643, 835.

² "Folk-lore," xii. 1901, p. 230, and "Report Camb. Anthrop. Expedition to Torres Straits," vol. v. (in the press).

³ *Loc. cit.*, 1899, p. 657.

⁴ *Loc. cit.*, pp. 73, 187.

⁵ I am fully aware that this appears to cut the ground from under my suggestion; but the latter deals with incipient totemism, and I do not see why the totem taboo should not have arisen from several causes.

I have barely touched upon the relation of social organisation, with its marriage taboo, to totemism. It is by no means certain that the social regulations and customs, which are so much in evidence in a fully developed totemic society, were primitively connected with totemism. So far as the Arunta are concerned, Messrs. Spencer and Gillen believe (*Journal Anthropol. Inst.*, xxviii. 1899, pp. 277, 278) the "totemism appears to be a primary, and exogamy a secondary, feature . . . and that exogamic groups were deliberately introduced so as to regulate marital relations." But is this primitive?

If one admits that mankind was originally distributed in small groups, which must have consisted of near kin, it does not seem difficult to imagine that marriage would more likely take place between members of contiguous groups rather than within the groups themselves. The attraction for novelty must always have operated, and in the struggle for existence there was always one advantage to be gained by alliances between neighbouring groups, not only from a commissariat point of view, but for offensive and defensive purposes. There is, of course, the converse of this, as wife-stealing would lead to feuds; perhaps daughter-abduction was more frequent, and this probably was not regarded as an offence so serious that a mild scrimmage would not set matters right. It would not take long for wont to crystallise into rigid custom, and custom is always supported by public opinion.

Social regulations must be later than social conditions, and I suspect that the privileges and taboos which run through the social aspect of totemism first arose when totemic groups were in process of aggregation into more complex communities, and afterwards gradually became fixed into a system.

Hero-cults.

The facts to which I have hitherto directed your attention fall well within the sphere of totemism, but I wish now to indicate two interesting departures from typical totemism, both of which occur among the Western tribe of Torres Straits.

I have alluded to the dual grouping of the totem kins at Mabuig, and an analogous arrangement occurred in the other islands; I propose to speak of each group of kins as a phratry. Strictly speaking, a phratry is a group of exogamic kins within a community; that is, no member of a group of kins (or phratry) could marry another person belonging to the same phratry. The evidence that this is or was the case in the Western tribe of Torres Straits is strong, but it is not absolutely proven.

In Yam, as in the other islands, there is at least one *kwod*, or taboo ground, where sacred ceremonies were held. In the principal *kwod* in Yam there was formerly a low fence surrounding a space about thirty-five feet square in which were the shrines of the two great totems of the island. All that now remains is several heaps of great Fusus shells.

Two of the heaps are about twenty-five feet in length. Formerly at the southerly end of each long row of shells was a large turtle-shell (tortoise-shell) mask representing respectively a crocodile and a hammer-headed shark. These were decorated in various ways, and under each was a stone in which the life of the totem resided; stretching from the front end of each mask was a cord to which numerous human lower jaw-bones were fastened, and its other end was attached to a human skull, which rested on a stone. Beside the shrine of the hammer-headed shark was a small heap of shells which was the shrine of a sea-snake, which was supposed to have originated from the shark. These shrines were formerly covered over by long low huts, which like the fence were decorated with large Fusus shells.

Outside the fence were two heaps of shells which had a mystical connection with the shrine; they were called the "navels of the totems."

I have referred to the *intichiuma* ceremonies of the Arunta tribe of Central Australia as being magical rites undertaken by certain kinsmen for the multiplication of the totems. In some cases, apparently, the ceremonies may take place wherever the men happen to be camping; in other cases there are definite localities where they must be performed, as there are in these places certain stones, rocks or trees which are intimately connected with the magical rites. These spots may be spoken of as shrines. In the island of Mabuig the magical ceremony for the alluring of the dugong was performed by the men of that kin in their own *kwod*, which was a fixed spot; and doubtless this was the case in the other islands of Torres Straits, for even

in the small islands there was a tendency to a territorial grouping of the kins. This localisation of a totem cult has proceeded one step further in Yam Island. Here we have a dual synthesis. The chief totem of each group of kins is practically alone recognised; in other words, the various lesser totems are being absorbed by two more important totems. Each totem has a distinct shrine, and the totem itself, instead of being a whole species, is visualised in the form of a representation of an individual animal, and this image was spoken of as the totem (*augud*). Indeed, the tendency to concretism had gone so far that the life of the *augud* was supposed to reside in the stone that lay beneath the image,¹ and certain heaps of shells were the navels of the totems, a further linkage of the totem to that spot of ground.

A suggestion as to the significance of this transformation is not lacking. There are various folk-tales concerning a family of brothers who wandered from west to east across Torres Straits. Some of them were, in a mysterious way, sharks as well as men. The two brothers who went to Yam were called Sigai and Maiau, and each became associated, in his animal form, with one of the two phratries. The shrines in the *kwod* were so sacred that no women might visit them, nor did the women know what the totems were like. They were aware of Sigai and Maiau, but they did not know that the former was the hammer-headed shark and the latter was the crocodile; this mystery was too sacred to be imparted to the uninitiated. When the totems were addressed it was always by their hero names, and not by their animal or totem names.

Malu, another of these brothers, introduced the cult that bears his name to the Murray Islanders, who form part of the Eastern tribe. He also was identified with a hammer-headed shark. Totemism, as such, had practically disappeared from Murray Island before the advent of the white man, and the great ceremonies at the initiation of the lads into the Malu fraternity were a main feature of the religion of these people.

In Yam totemism was merging into a hero cult; in Murray Island the transformation was accomplished; the one had replaced the other.

In Mabuigi, one of the Western Islands, there was a local hero named Kwoiam whose deeds are narrated in a prose epic. Kwoiam made two crescentic ornaments of turtle-shell, which blazed with light when he wore them at night-time, and which he nourished with the savour of cooked fish. These ornaments were called totems (*augud*)—presumably because the natives did not know by what other sacred name to call them—and they became the insignia of the two groups of kins of Mabuigi. The crescent which was worn above Kwoiam's mouth was regarded as the more important, and those kins which had land animals for their totems were called from it "the children of the great totem," but the water group was called "the children of the little totem." There is reason to believe that the dual grouping of the kins is ancient. The erecting Kwoiam's emblems as the head totems of the two groups of kins must be comparatively recent. Here, again, the primitive association of a group of men with a group of natural objects obtains in the small groups or totem-kins, but in the larger synthesis a manufactured object replaces a group of animals, and this object possesses definite magical powers. There were two navel-shrines connected with the cult of Kwoiam, which were constructed to show that the two *augud* were born there. When it was deemed necessary to fortify the *augud*—that is, the emblems—they were placed on their respective navel-shrines. Further, in Muralug and the adjacent islands Kwoiam himself was a totem (*augud*). Thus in the westernmost islands of the Western tribe the transition from totemism to hero-worship was in process of evolution till it was arrested by the coming of the white man.

To what was this transformation due? It is not very easy to answer this question. We have evidence that in comparatively recent times a change took place in the social organisation of the people, and that the former matriarchal conditions had been replaced by patriarchal. Although superficially the marriage system of the Western tribe appears to be regulated by totemism, Dr. Rivers has found² that it is really a relationship system, and that descent, rather than totemism, is the regulating factor. The Eastern tribe, as represented by the Murray Islanders, had pro-

¹ For the keeping of a soul in an external receptacle, and for Dr. Frazer's views on its bearing on totemism, cf. *Fortnightly Review*, May, 1899, p. 84; "The Golden Bough," iii, 1900, pp. 418-422; and S. A. Cook, *Jewish Quart. Review*, 1902, p. 34 of reprint.

² "Reports Camb. Anthropol. Expedition to Torres Straits," v. "Kinship" (in the press).

gressed further along this road than had the Western tribe. Such a change as this could not fail to have a disturbing effect upon other old customs.

The folk-tales that I collected clearly indicate a migration of culture from New Guinea to the Western tribe, and from the Western tribe to the Eastern tribe. I believe I can demonstrate the migration from New Guinea of a somewhat broad-headed people that spread over the Western Islands but barely reached Murray Island. It is conceivable that the culture myths have reference to this migration, and that the gradual substitution of a hero cult for totemism may be part of the same movement; but, on the other hand, this social and religious change is most thorough in Murray Island, where, I imagine, the racial movement has been least felt. The isolation of Murray Island from outside disturbing factors is very complete, and, being but a small island, a change once started might take place both rapidly and effectively.

It is interesting to note that the totem heroes of the Western tribe were invoked when their votaries were preparing to go to war. I obtained the following prayer in Yam Island:—"O *Augud* Sigai and O *Augud* Maiau, both of you close the eyes of those men so that they cannot see us," which had for its intent the slaughtering of the enemy without their being able to make a defence. I was informed that when the Yam warriors were fighting they would also call on the name of Kwoiam, who belonged to another group of islands, and on Yadezub, a local warrior. Yadezub was always described as a "man," whereas Kwoiam and Sigai were relegated to a "long time" back. From the folk-tales it is evident that Sigai and Maiau are more mythical or mysterious than Kwoiam. We thus have an instructive series: Yadezub, the local famous man; Kwoiam, the hero, who was also a totem to other people; and Sigai and Maiau, the local totem heroes whose cult was visualised in turtle-shell images, and the life of each of whom resided in a particular stone. Perhaps it would be more correct to speak of this as the grafting of a new cult on totemism rather than to describe it as an evolution of totemism. A transformation has certainly occurred, but it does not appear to me to be a gradual growth—a metamorphosis in the natural history sense of the term—so much as the pouring of new wine into old bottles.

I hope on another occasion to deal with the question of religious and secret societies, as the growth of these has invariably disintegrated whatever antecedent totemism there may have been.

It is highly probable that something like what was taking place in Torres Straits has occurred elsewhere, but I cannot now enter into a comparative study of the rise of hero cults.

Local or Village Exogamy.

I have more than once ("Folk-lore," xii, 1901, p. 233; "Head-hunters, Black, White, and Brown," 1901, p. 258) called attention to the fact that among some Papuans marriage restrictions are territorial and not totemic. Dr. Rivers (*Journ. Anthropol. Inst.*, xxx, 1900, p. 78) has shown that in Murray Island, Eastern tribe of Torres Straits, marriages are regulated by the places to which natives belong. A man cannot marry a woman of his own village or of certain other villages. The totemic system which probably at one time existed in this island appears to have been replaced by what may be called a territorial system. A similar custom occurs in the Mekeo-district of British New Guinea, and it is probably still more widely distributed.

I was informed by a member of the Yaraikanna tribe of Cape York, North Queensland, that children must take the "land" or "country" of their mother; all who belong to the same place are brothers and sisters, a wife must be taken from another "country" ("Brit. Assoc. Report," Dover, 1899, p. 585); thus it appears their marriage restrictions are territorial and not totemic. The same is found amongst the Kurnai and the Coast Murring tribe in New South Wales (Frazer, "Totemism," p. 90).

At Kiwai, in the delta of the Fly River, B.N.G., all the members of a totemic group live together in a long house which is confined to that group. I have also collected evidence which proves there was a territorial grouping of totemic clans among the Western tribe of Torres Straits ("Reports Camb. Anthropol. Expedition to Torres Straits," v. in the press).

Within a comparatively small area we have the following conditions:—

(1) A typical totemic community with totem-kin houses (Kiwai).

(2) A typical totemic community with territorial grouping of the kins. Although there is totem exogamy, the marriage restrictions are regulated by relationship. The former mother-right has comparatively recently been replaced by father-right, but there are many survivals from matriarchy (Western tribe, Torres Straits).

(3) A community in which totemism has practically lapsed, with village exogamy and marriage restrictions regulated by relationship, patriarchy with survivals from matriarchy (Eastern tribe, Torres Straits).

(4) Total absence of totemism (?), village exogamy (Mekeo). I do not assert this is a natural sequence, but it looks like one, and it appears to indicate another of the ways out of totemism. It is suggestive that this order also indicates the application of the several peoples to agriculture: the people of Kiwai are semi-nomadic, those of the Mekeo district are firmly attached to the land. This constraint of the soil must have operated in a similar manner elsewhere (*cf.* "L'Année Sociologique," v. 1902, pp. 330, 333). The territorial exogamy occasionally found in Australia cannot be explained as being due to agriculture; a rigid limitation of hunting grounds may here have had a similar effect.

In offering these remarks to-day I desire, above all, to impress on you the need there is for more work in the field. When one surveys the fairly extensive literature of totemism one is struck with the very general insufficiency of the evidence; as a matter of fact, full and precise information is lamentably lacking. The foundations upon which students at home have to build their superstructures of generalisation and theory are usually of too slight a character to support these erections with much chance of their permanence. There is only one remedy for this, and that is more extensive and more thorough field work. The problems connected with totemism bear upon many of the most important phases in the social and religious evolution of man, the solution of which can only be obtained within the space of a few years. The delay of each year in the investigation of primitive peoples means that so much less information is possible to be obtained. There is no exaggeration in this. Those who have a practical experience of backward man and who have travelled in out-of-the-way places can testify as to the surprising rapidity with which the old order changeth. In sober earnestness I appeal to all those who are interested in the history and character of man, whether they be theologians, historians, sociologists, psychologists or anthropologists, to face the plain fact that the only available data for the solution of many problems of the highest interest are daily slipping away beyond recovery.

SECTION I.

PHYSIOLOGY.

OPENING ADDRESS BY W. D. HALLIBURTON, M.D., F.R.S.,
PROFESSOR OF PHYSIOLOGY IN KING'S COLLEGE, LONDON,
PRESIDENT OF THE SECTION.

The Present Position of Chemical Physiology.

An engineer who desires to thoroughly understand how a machine works must necessarily know its construction. If the machine becomes erratic in its action, and he wishes to put it into proper working order, a preliminary acquaintance with its normal structure and function is an obvious necessity.

If we apply this to the more delicate machinery of the animal body, we at once see how a knowledge of function (physiology and pathology) is impossible without a preliminary acquaintance with structure or anatomy.

It is therefore not surprising, it is indeed in the nature of things, that physiology originated with the great anatomists of the past. It was not until Vesalius and Harvey by tedious dissections laid bare the broad facts of structure that any theorising concerning the uses of the constituent organs of the body had any firm foundation.

Important and essential as the knowledge is that can be revealed by the scalpel, the introduction and use of the microscope furnished physiologists with a still more valuable instrument. By it much that was before unseen came into view, and microscopic anatomy and physiology grew in stature and knowledge simultaneously.

The weapons in the armoury of the modern physiologist are multitudinous in number and complex in construction, and enable him in the experimental investigation of his subject to accurately measure and record the workings of the different parts of the machinery he has to study. But preeminent among these instruments stands the test-tube and the chemical operations typified by that simple piece of glass.

Herein one sees at once a striking distinction between the mechanism of a living animal and that of a machine like a steam engine or a watch. It is quite possible to be an excellent watchmaker or to drive a steam engine intelligently without any chemical knowledge of the various metals that enter into its composition. In order to set the mechanism right if it goes wrong, all the preliminary knowledge which is necessary is of an anatomical nature. The parts of which an engine is composed are stable; the oil that lubricates it and the fuel that feeds it never become integral parts of the machinery. But with the living engine all this is different. The parts of which it is made take up the nutriment or fuel and assimilate it, thus building up new living substance to replace that which is destroyed in the wear and tear associated with activity. This condition of unstable chemical equilibrium is usually designated metabolism, and metabolism is the great and essential attribute of a living as compared with a non-living thing.

It seems childish at the present day, and before such an audience as this, to point out how essential it is to know the chemical structure as well as the anatomical structure of the component parts of the body. But the early anatomists to whom I have alluded had no conception of the connection of the two sciences. Speaking of Vesalius, Sir Michael Foster says: "The great anatomist would no doubt have made use of his bitterest sarcasms had someone assured him that the fantastic school which was busy with occult secrets and had hopes of turning dross into gold would one day join hands in the investigation of the problems of life with the exact and clear anatomy so dear to him." Nor did Harvey, any more than Vesalius, pay heed to chemical learning. The scientific men of his time ignored and despised the beginning of that chemical knowledge which in later years was to become one of the foundations of physiology and the mainstay of the art of medicine.

The earliest to recognise this important connection was one whose name is usually associated more with charity than with truth, namely, Paracelsus, and fifty years after the death of that remarkable and curious personality his doctrines were extended and developed by van Helmont. In spite, however, of van Helmont's remarkable insight into the processes of digestion and fermentation, his work was marred by the mysticism of the day, which called in the aid of supernatural agencies to explain what could not otherwise be fully comprehended.

In the two hundred and fifty years that have intervened between the death of van Helmont and the present day, alchemy became a more and more exact science and changed its name to chemistry, and a few striking names stand out of men who were able to take the new facts of chemistry and apply them to physiological uses. Of these one may mention Mayow, Lower, Boerhaave, Réaumur, Borelli, Spallanzani and Lavoisier. Mulder in Holland and Liebig in Germany bring us almost to the present time, and I think they may be said to share the honour of being regarded as the fathers of modern chemical physiology. This branch of science was first placed on a firm basis by Wöhler when he showed that organic compounds can be built out of their elements in the laboratory, and his first successful experiments in connection with the comparatively simple substance urea have been followed by numberless others, which have made organic chemistry the vast subject it is to-day.

Sir Michael Foster's book on the History of Physiology, from which I have already quoted, treats of the older workers who laid the foundations of our science, and whose names I have not done much more than barely mention. Those interested in the giants of the past should consult it. But what I propose to take up this morning is the work of those who have during more recent days been engaged in the later stages of the building. The edifice is far from completion even now. It is one of the charms of physiological endeavour that, as the older areas yield their secrets to the explorers, new ones are opened out which require equally careful investigation.

If even a superficial survey of modern physiological literature is taken, one is at once struck with the great preponderance of papers and books which have a chemical bearing. In this the

physiological journals of to-day contrast very markedly with those of thirty, twenty, or even ten years ago. The sister science of chemical pathology is making similar rapid strides. In some universities the importance of biological chemistry is recognised by the foundation of chairs which deal with that subject alone; and though in the United Kingdom, owing mainly to lack of funds, this aspect of the advance of science is not very evident, there are signs that the date cannot be far distant when every well-equipped university or university college will follow the example set us at many seats of learning on the Continent and at Liverpool.

With these introductory remarks let me now proceed to describe what appear to me to be the main features of chemical physiology at the present time.

The first point to which I shall direct your attention is the rapid way in which chemical physiology is becoming an exact science. Though it is less than twenty years since I began to teach physiology, I can remember perfectly well a time when those who devoted their work to the chemical side of the science might almost be counted on the fingers of one hand, and when chemists looked with scarcely veiled contempt on what was at that time called physiological chemistry; they stated that physiologists dealt with messes or impure materials, and therefore anything in the nature of correct knowledge was not possible. There was a good deal of truth in these statements, and if physiologists to-day cannot quite say that they have changed all that, they can at any rate assert with truth that they are changing it. This is due to a growing *rapprochement* between chemists and physiologists. Many of our younger physiologists now go through a thorough preliminary chemical training; and on the other hand there is a growing number of chemists—of whom Emil Fischer may be taken as a type—who are beginning to recognise the importance of a systematic study of substances of physiological interest. A very striking instance of this is seen in the progress of our knowledge of the carbohydrates, which has culminated in the actual synthesis of several members of the sugar group. Another instance is seen in the accurate information we now possess of the constitution of uric acid. When Miescher began his work on the chemical composition of the nuclei of cells, and separated from them the material he called nuclein, he little foresaw the wide practical application of his work. We now know that it is in the metabolism of cell-nuclei that we have to look for the oxidative formation of uric acid and other substances of the purine family. Already the chemical relationships of uric acid and nuclein have taught practical physicians some of the secrets that underlie the occurrence of gout and allied disorders.

With the time at my disposal, it would be impossible to discuss all the chemo-vital problems which the physiologists of the present day are attempting to solve, but there is one subject at which many of them are labouring which seems to me to be of supreme importance—I mean the chemical constitution of proteid or albuminous substances. Proteids are produced only in the living laboratory of plants and animals; proteid metabolism is the main chemical attribute of a living thing; proteid matter is the all-important material present in protoplasm. But in spite of the overwhelming importance of the subject, chemists and physiologists alike have far too long fought shy of attempting to unravel the constitution of the proteid molecule. This molecule is the most complex that is known; it always contains five, and often six, or even seven elements. The task of thoroughly understanding its composition is necessarily vast, and advance slow. But little by little the puzzle is being solved, and this final conquest of organic chemistry, when it does arrive, will furnish physiologists with new light on many of the dark places of physiological science.

The revival of the vitalistic conception in physiological work appears to me a retrograde step. To explain anything we are not fully able to understand in the light of physics and chemistry by labelling it as vital or something we can never hope to understand is a confession of ignorance, and, what is still more harmful, a bar to progress. It may be that there is a special force in living things that distinguishes them from the inorganic world. If this is so, the laws that regulate this force must be discovered and measured, and I have no doubt that those laws when discovered will be found to be as immutable and regular as the force of gravitation. I am, however, hopeful that the scientific workers of the future will discover that this so-called vital force is due to certain physical or chemical properties of living matter which have not yet been brought into line with the known chemical and physical laws that operate in the

inorganic world, but which as our knowledge of chemistry and physics increases will ultimately be found to be subservient to such laws.

Let me take as an example the subject of osmosis. The laws which regulate this phenomenon through dead membranes are fairly well known and can be experimentally verified; but in the living body there is some other manifestation of force which operates in such a way as to neutralise the known force of osmosis. Is it necessary to suppose that this force is a new one? May it not rather be that our much vaunted knowledge of osmosis is not yet complete? It is quite easy to understand why a dead and a living membrane should behave differently in relation to substances that are passing through them. The molecules of the dead membrane are, comparatively speaking, passive and stable; the molecules in a membrane made of living cells are in a constant state of chemical integration and disintegration; they are the most unstable molecules we know. Is it to be expected that such molecules would allow water, or substances dissolved in water, to pass between them and remain entirely inactive? The probability appears to me to be all the other way; the substances passing, or attempting to pass, between the molecules will be called upon to participate in the chemical activities of the molecules themselves, and in the building up and breaking down of the compounds so formed there will be a transformation of chemical energy and a liberation of what looks like a new force. Before a physicist decides that his knowledge of osmosis is final, let him attempt to make a membrane of some material which is in a state of unstable chemical equilibrium, a state in some way comparable to what is called metabolism in living protoplasm. I cannot conceive that such a task is insuperable, and when accomplished, and the behaviour of such a membrane in an osmometer or dialyser is studied, I am convinced that we shall find that the laws of osmosis as formulated for such dead substances as we have hitherto used will be found to require revision.

Such an attitude in reference to vital problems appears to be infinitely preferable to that which too many adopt of passive content, saying the phenomenon is vital and there is an end of it.

When a scientific man says this or that vital phenomenon cannot be explained by the laws of chemistry and physics, and therefore must be regulated by laws of some other nature, he most unjustifiably assumes that the laws of chemistry and physics have all been discovered. He forgets, for instance, that such an important detail as the constitution of the proteid molecule has still to be made out.

The recent history of science gives an emphatic denial to such a supposition. All my listeners have within the last few years seen the discovery of the Röntgen rays and the modern development of wireless telegraphy. On the chemical side we have witnessed the discovery of new elements in the atmosphere and the introduction of an entirely new branch of chemistry called physical chemistry. With such examples ready to our hands, who can say what further discoveries will not shortly be made, even in such well-worked fields as chemistry and physics?

The mention of physical chemistry brings me to what I may term the second head of my discourse, the second striking characteristic of modern chemical physiology; this is the increasing importance which physiologists recognise in a study of inorganic chemistry. The materials of which our bodies are composed are mainly organic compounds, among which the proteids stand out as preeminently important; but everyone knows there are many substances of the mineral or inorganic kingdom present in addition. I need hardly mention the importance of water, of the oxygen of the air, and of salts like sodium chloride and calcium phosphate.

The new branch of inorganic chemistry called physical chemistry has given us entirely new ideas of the nature of solutions, and the fact that electrolytes in solution are broken up into their constituent ions is one of fundamental importance. One of the many physiological aspects of this subject is seen in a study of the action of mineral salts in solution on living organisms and parts of organisms. Many years ago Dr. Ringer showed that contractile tissues (heart, cilia, &c.) continue to manifest their activity in certain saline solutions. Howell goes so far as to say, and probably correctly say, that the cause of the rhythmical action of the heart is the presence of these inorganic substances in the blood or lymph which usually bathes it. The subject has more recently been taken up by Loeb and his colleagues at Chicago; they confirm Ringer's original statements, but interpret them now as ionic action. Contractile

tissues will not contract in pure solutions of non-electrolytes like sugar or albumin. But different contractile tissues differ in the nature of the ions which are their most favourable stimuli. An optimum salt solution is one in which stimulating ions, like those of sodium, are mixed with a certain small amount of those which like calcium restrain activity. Loeb considers that the ions act because they affect either the physical condition of the colloidal substances (protein, &c.) in protoplasm or the rapidity of chemical processes.

Ameboid movement, ciliary movement, the contraction of muscle, cell division and karyokinesis all fall into the same category as being mainly dependent on the stimulating action of ions.

Loeb has even gone so far as to consider that the process of fertilisation is mainly ionic action; he denies that the nucleus of the male cell is essential, but asserts that all it does is to act as the stimulus in the due adjustment of the proportions of the surrounding ions, and supports this view by numerous experiments on ova in which without the presence of spermatozoa he has produced larvae by merely altering the saline constituents and so the osmotic pressure of the fluid that surrounds them. Whether such a sweeping and almost revolutionary notion will stand the test of further verification must be left to the future; so also must the equally important idea that nervous impulses are to be mainly explained on an electrolytic basis. But whether or not all the details of such work will stand the test of time, the experiments I have briefly alluded to are sufficient to show the importance of physical chemistry to the physiologist, and they also form a useful commentary on what I was saying just now about vitalism. Such eminently vital phenomena as movement and fertilisation are to be explained in whole or in part as due to the physical action of inorganic substances. Are not such suggestions indications of the undesirability of postulating the existence of any special mystic vital force?

I have spoken up to this point of physical chemistry as a branch of inorganic chemistry; there are already indications of its importance also in relation to organic chemistry. Many eminent chemists consider that the future advance of organic chemistry will be on the new physical lines. It is impossible to forecast where this will lead us; suffice it to say that not only physiology, but also pathology, pharmacology and even therapeutics will receive new accessions to knowledge the importance of which will be enormous.

I have now briefly sketched what appear to me to be the two main features of the chemical physiology of to-day, and the two lines, organic and inorganic, along which I believe it will progress in the future.

Let me now press upon you the importance in physiology, as in all experimental sciences, of the necessity first of bold experimentation, and secondly of bold theorising from experimental data. Without experiment all theorising is futile; the discovery of gravitation would never have seen the light if laborious years of work had not convinced Newton that it could be deduced from his observations. The Darwinian theory was similarly based upon data and experiments which occupied the greater part of its author's lifetime to collect and perform. Pasteur in France and Virchow in Germany supply other instances of the same devotion to work which was followed by the promulgation of wide-sweeping generalisations.

And after all it is the general law which is the main object of research; isolated facts may be interesting and are often of value, but it is not until facts are correlated and the discoverers ascertain their inter-relationships that anything of epoch-making importance is given to the world.

It is, however, frequently the case that a thinker with keen insight can see the general law even before the facts upon which it rests are fully worked out. Often such bold theorists are right, but even if they ultimately turn out to be wrong, or only partly right, they have given to their fellows some general idea on which to work; if the general idea is incorrect, it is important to prove it to be so in order to discover what is right later on. No one has ever seen an atom or a molecule, yet who can doubt that the atomic theory is the sheet anchor of chemistry? Mendeléeff formulated his periodic law before many of the elements were discovered; yet the accuracy of this great generalisation has been such that it has actually led to the discovery of some of the missing elements.

I purpose to illustrate these general remarks by a brief allusion to two typical sets of researches carried out during recent years in the region of chemical physiology. I do not pretend that

either of them has the same overwhelming importance as the great discoveries I have alluded to, but I am inclined to think that one of them comes very near to that standard. The investigations in question are those of Ehrlich and of Pawlow. The work of Ehrlich mainly illustrates the useful part played by bold theorising, the work of Pawlow that played by the introduction of new and bold methods of experiment.

I will take Pawlow first. This energetic and original Russian physiologist has by his new methods succeeded in throwing an entirely new light on the processes of digestion. Ingeniously devised surgical operations have enabled him to obtain the various digestive juices in a state of absolute purity and in large quantity. Their composition and their actions on the various foodstuffs have thus been ascertained in a manner never before accomplished; and an apparently unfulfilling resourcefulness in devising and adapting experimental methods has enabled him and his fellow workers to discover the paths of the various nerve impulses by which secretion in the alimentary canal is regulated and controlled. The importance of the psychological element in the process of digestion has been experimentally verified. If I were asked to point out what I considered to be the most important outcome of all this painstaking work, I should begin my answer by a number of negatives, and would say, no: the discovery of the secretory nerves of the stomach or pancreas; not the correct analysis of the gastric juice, nor the fact that the intestinal juice has most useful digestive functions; all of these are discoveries of which anyone might have been rightly proud; but after all they are more or less isolated facts. The main thing that Pawlow has shown is that digestion is not a succession of isolated acts, but each one is related to its predecessor and to that which follows it; the process of digestion is thus a continuous whole; for example, the acidity of the gastric juice provides for a delivery of pancreatic juice in proper quantity into the intestine; the intestinal juice acts upon the pancreatic, and so enables the latter to perform its powerful actions. I am afraid this example, as I have tersely stated it, presents the subject rather inadequately, but it will serve to show what I mean. Further, the composition of the various juices is admirably adjusted to the needs of the organism; when there is much proteid to be digested, the proteolytic activity of the juices secreted is correspondingly high, and the same is true for the other constituents of the food. It is such general conclusions as these, the correlation of isolated facts leading to the formulation of the law that the digestive process is continuous in the sense I have indicated, and adapted to the needs of the work to be done, that constitute the great value of the work from the Russian laboratory. Work of this sort is sure to stimulate others to fill in the gaps and complete the picture, and already has borne fruit in this direction. It has, for instance, in Starling's hands led to the discovery of a chemical stimulus to pancreatic secretion. This is formed in the intestine as the result of the action of the gastric acid, and taken by the blood-stream to the pancreas. Whether this *secretin* as it is called may be one of a group of similar chemical stimuli which operate in other parts of the body has still to be found out.

The other series of researches to which I referred are those of Ehrlich and his colleagues and followers on the subject of immunity. This subject is one of such importance to every one of us that I am inclined to place the discovery on a level with those great discoveries of natural laws to which I alluded at the outset of this portion of my Address. I hesitate to do so yet because many of the details of the theory still await verification. But up to the present all is working in that direction, and Ehrlich's ideas illustrate the value of bold theorising in the hands of clear-sighted and far-seeing individuals.

But when I say that the doctrine is bold, I do not mean to infer that the experimental facts are scanty; they are just the reverse. But in the same way that a chemist has never seen an atom, and yet he believes atoms exist, so no one has yet ever seen a toxin or antitoxin in a state of purity, and yet we know they exist, and this knowledge promises to be of incalculable benefit to suffering humanity.

It may not be uninteresting to state briefly, for the benefit of those to whom the subject is new, the main facts and an outline of the theory which is based upon them.

We are all aware that one attack of many infective maladies protects us against another attack of the same disease. The person is said to be *immune* either partially or completely against that disease. Vaccination produces in a patient an

attack of cow-pox or vaccinia. This disease is related to small-pox, and some still hold that it is small-pox modified and rendered less malignant by passing through the body of a calf. At any rate, an attack of vaccinia renders a person immune to small-pox, or variola, for a certain number of years. Vaccination is an instance of what is called *protective inoculation*, which is now practised with more or less success in reference to other diseases like plague and typhoid fever. The study of immunity has also rendered possible what may be called *curative inoculation*, or the injection of antitoxic material as a cure for diphtheria, tetanus, snake poisoning, &c.

The power the blood possesses of slaying bacteria was first discovered when the effort was made to grow various kinds of bacteria in it; it was looked upon as probable that blood would prove a suitable soil or medium for this purpose. It was found in some instances to have exactly the opposite effect. The chemical characters of the substances which kill the bacteria are not fully known; indeed, the same is true for most of the substances we have to speak of in this connection. Absence of knowledge on this particular point has not, however, prevented important discoveries from being made.

So far as is known at present, the substances in question are proteid in nature. The bactericidal powers of blood are destroyed by heating it for an hour to 56° C. Whether the substances are enzymes is a disputed point. So also is the question whether they are derived from the leucocytes; the balance of evidence appears to me to be in favour of this view in many cases at any rate, and phagocytosis becomes more intelligible if this view is accepted. The substances, whatever be their source or their chemical nature, are sometimes called alexins, but the more usual name now applied to them is that of *bacteriolytins*.

Closely allied to the bactericidal power of blood, or blood-serum, is its globulicidal power. By this one means that the blood-serum of one animal has the power of dissolving the red blood-corpuscles of another species. If the serum of one animal is injected into the blood-stream of an animal of another species, the result is a destruction of its red corpuscles, which may be so excessive as to lead to the passing of the liberated hemoglobin into the urine (hemoglobinuria). The substance or substances in the serum that possess this property are called *haemolysins*, and though there is some doubt whether bacteriolytins and hemolysins are absolutely identical, there is no doubt that they are closely related substances.

Another interesting chemical point in this connection is the fact that the bactericidal power of the blood is closely related to its alkalinity. Increase of alkalinity means increase of bactericidal power. Venous blood contains more diffusible alkali than arterial blood and is more bactericidal; dropsical effusions are more alkaline than normal lymph and kill bacteria more easily. In a condition like diabetes, when the blood is less alkaline than it should be, the susceptibility to infectious diseases is increased. Alkalinity is probably beneficial because it favours those oxidative processes in the cells of the body which are so essential for the maintenance of healthy life.

Normal blood possesses a certain amount of substances which are inimical to the life of our bacterial foes. But suppose a person gets run down; everyone knows he is then liable to "catch anything." This coincides with a diminution in the bactericidal power of his blood. But even a perfectly healthy person has not an unlimited supply of bacteriolytins, and if the bacteria are sufficiently numerous he will fall a victim to the disease they produce. Here, however, comes in the remarkable part of the defence. In the struggle he will produce more and more bacteriolytins, and if he gets well it means that the bacteria are finally vanquished, and his blood remains rich in the particular bacteriolytins he has produced, and so will render him immune to further attacks from that particular species of bacterium. Every bacterium seems to cause the development of a specific bacteriolytin.

Immunity can more conveniently be produced gradually in animals, and this applies, not only to the bacteria, but also to the toxins they form. If, for instance, the bacilli which produce diphtheria are grown in a suitable medium, they produce the diphtheria poison, or toxin, much in the same way that yeast-cells will produce alcohol when grown in a solution of sugar. Diphtheria toxin is associated with a proteose, as is also the case with the poison of snake venom. If a certain small dose called a "lethal dose" is injected into a guinea-pig, the result is death. But if the guinea-pig receives a smaller dose it

will recover; a few days after it will stand a rather larger dose; and this may be continued until after many successive gradually increasing doses it will finally stand an amount equal to many lethal doses without any ill effects. The gradual introduction of the toxin has called forth the production of an antitoxin. If this is done in the horse instead of the guinea-pig the production of antitoxin is still more marked, and the serum obtained from the blood of an immunised horse may be used for injecting into human beings suffering from diphtheria, and rapidly cures the disease. The two actions of the blood, antitoxic and antibacterial, are frequently associated, but may be entirely distinct.

The antitoxin is also a proteid probably of the nature of a globulin; at any rate, it is a proteid of larger molecular weight than a proteose. This suggests a practical point. In the case of snake-bite the poison gets into the blood rapidly owing to the comparative ease with which it diffuses, and so it is quickly carried all over the body. In treatment with the antitoxin or antivenin, speed is everything if life is to be saved; injection of this material under the skin is not much good, for the diffusion into the blood is too slow. It should be injected straight away into a blood-vessel.

There is no doubt that in these cases the antitoxin neutralises the toxin much in the same way that an acid neutralises an alkali. If the toxin and antitoxin are mixed in a test-tube and time allowed for the interaction to occur, the result is an innocuous mixture. The toxin, however, is merely neutralised, not destroyed; for if the mixture in the test-tube is heated to 68° C. the antitoxin is coagulated and destroyed and the toxin remains as poisonous as ever.

Immunity is distinguished into *active* and *passive*. Active immunity is produced by the development of protective substances in the body; passive immunity by the injection of a protective serum. Of the two the former is the more permanent.

Ricin, the poisonous proteid of castor-oil seeds, and *abrin*, that of the Jequirity bean, also produce when gradually given to animals an immunity, due to the production of antiricin and antiabrin respectively.

Ehrlich's hypothesis to explain such facts is usually spoken of as the *side-chain theory* of immunity. He considers that the toxins are capable of uniting with the protoplasm of living cells by possessing groups of atoms like those by which nutritive proteids are united to cells during normal assimilation. He terms these *haptophor* groups, and the groups to which these are attached in the cells he terms *receptor* groups. The introduction of a toxin stimulates an excessive production of receptors, which are finally thrown out into the circulation, and the free circulating receptors constitute the antitoxin. The comparison of the process to assimilation is justified by the fact that non-toxic substances like milk introduced gradually by successive doses into the blood-stream cause the formation of anti-substances capable of coagulating them.

Up to this point I have spoken only of the blood, but month by month workers are bringing forward evidence to show that other cells of the body may by similar measures be rendered capable of producing a corresponding protective mechanism.

One further development of the theory I must mention. At least two different substances are necessary to render a serum bactericidal or globulicidal. The bacteriolytic or hemolysin consists of these two substances. One of these is called the *immune body*, the other the *complement*. We may illustrate the use of these terms by an example. The repeated injection of the blood of one animal (e.g. the goat) into the blood of another animal (e.g. a sheep) after a time renders the latter animal immune to further injections, and at the same time causes the production of a serum which dissolves readily the red blood-corpuscles of the first animal. The sheep's serum is thus hemolytic towards goat's blood-corpuscles. This power is destroyed by heating to 56° C. for half an hour, but returns when fresh goat's serum is added. The specific immunising substance formed in the sheep is called the immune body; the ferment-like substance destroyed by heat is the complement. The latter is not specific, since it is furnished by the blood of non-immunised animals, but it is nevertheless essential for hemolysis. Ehrlich believes that the immune body has two side groups—one which connects with the receptor of the red corpuscles and one which unites with the haptophor group of the complement, and thus renders possible the ferment-like action of the complement on the red corpuscles. Various antibacterial serums which have not been

the success in treating disease they were expected to be are probably too poor in complement, though they may contain plenty of the immune body.

Quite distinct from the bactericidal, globulicidal and antitoxic properties of blood is its agglutinating action. This is another result of infection with many kinds of bacteria or their toxins. The blood acquires the property of rendering immobile and clumping together the specific bacteria used in the infection. The test applied to the blood in cases of typhoid fever, and generally called Widal's reaction, depends on this fact.

The substances that produce this effect are called *agglutinins*. They also are probably proteid-like in nature, but are more resistant to heat than the lysins. Prolonged heating to over 60° C. is necessary to destroy their activity.

Lastly, we come to a question which more directly appeals to the physiologist than the preceding, because experiments in relation to immunity have furnished us with what has hitherto been lacking, a means of distinguishing human blood from the blood of other animals.

The discovery was made by Tschistovich (1899), and his original experiment was as follows:—Rabbits, dogs, goats and guinea-pigs were inoculated with eel-serum, which is toxic; he thereby obtained from these animals an antitoxic serum. But the serum was not only antitoxic, but produced a precipitate when added to eel-serum, but not when added to the serum of any other animal. In other words, not only has a specific antitoxin been produced, but also a specific *precipitin*. Numerous observers have since found that this is a general rule throughout the animal kingdom, including man. If, for instance, a rabbit is treated with human blood, the serum ultimately obtained from the rabbit contains a specific precipitin for human blood; that is to say, a precipitate is formed on adding such a rabbit's serum to human blood, but not when added to the blood of any other animal.¹ The great value of the test is its delicacy; it will detect the specific blood when it is greatly diluted, after it has been dried for weeks, or even when it is mixed with the blood of other animals.

I have entered into this subject at some length, because it so admirably illustrates the kind of research which is now in progress; it is also of interest to others than mere physiologists. I have not by any means exhausted the subject, but for fear I may exhaust my audience let me hasten to a conclusion. I began by eulogising the progress of the branch of science on which I have elected to speak to you. Let me conclude with a word of warning on the danger of over-specialisation. The ultra-specialist is apt to become narrow, to confine himself so closely to his own groove that he forgets to notice what is occurring in the parallel and intercrossing grooves of others. But those who devote themselves to the chemical side of physiology run but little danger of this evil. The subject cannot be studied apart from other branches of physiology, so closely are both branches and roots intertwined. As an illustration of this, may I be permitted to speak of some of my own work? During the past few years the energies of my laboratory have been devoted to investigations on the chemical side of nervous activity, and I have had the advantage of cooperating to this end with a number of investigators, of whom I may particularly mention Dr. Mott and Dr. T. G. Brodie. But we soon found that any narrow investigation of the chemical properties of nervous matter and the changes this undergoes during life and after death was impossible. Our work extended in a pathological direction so as to investigate the matter in the brains of those suffering from nervous disease; it extended in a histological direction so as to determine the chemical meaning of various staining reactions presented by normal and abnormal structures in the brain and spinal cord; it extended in an experimental direction in the elucidation of the phenomena of fatigue, and to ascertain whether there was any difference in medullated and non-medullated nerve fibres in this respect; it extended into what one may call a pharmacological direction in the investigation of the action of the poisonous products of the breakdown of nervous tissues. I think I have said enough to show you how intimate are the connections of the chemical with the other aspects of physiology, and although I have given you but one instance, that which is freshest to my mind, the same could be said for almost any other well-planned piece of research work of a bio-chemical nature.

¹ There may be a slight reaction with the blood of allied animals; for instance, with monkey's blood in the case of man.

We have now before us the real work of the Section, the reading, hearing and seeing the researches which will be brought forward by members of the Association, and I must, in thanking you for your attention, apologise for the length of time I have kept you from these more important matters.

UNIVERSITY AND EDUCATIONAL INTELLIGENCE.

It is recommended by Mr. Herbert Welsh, of Philadelphia, who was largely instrumental in raising the Wilson endowment fund, value 100,000 dollars, of the Washington and Lee University, that a fund of 500,000 dollars be raised to endow a scientific and technical school for the University.

The papers read at the conference of science teachers held at the Hartley University College, Southampton, to which attention was directed in our issue of June 19, 1902, have now been published in book form. The title of the little volume is "Science Teaching and Nature Study." Copies may be obtained from Mr. H. M. Gilbert, Above Bar, Southampton, price 6s. each.

The following courses of lectures on advanced physiology are announced for delivery in the physiological laboratory at the buildings of the University of London during the coming term:—(a) "On the Sources of Animal Energy," by Prof. E. H. Starling, on Tuesdays, October 14, 21, 28, November 4, 11, 18, 25, December 2, at 5 p.m.; (b) "On Animal Heat and Respiration," by Dr. M. S. Pembrey, on Wednesdays, October 15, 22, 29, November 5, 12, 19, 26, December 3, at 5 p.m. The lectures, admission to which is free, are addressed to advanced students, and are arranged to meet the requirements of candidates for honours in physiology at the University. Cards of admission may be obtained on application to the Academic Registrar, at the University Buildings, South Kensington, S.W.

SCIENTIFIC SERIALS.

Journal of Botany, September.—Under the title of "Alabastra diversa," Mr. Spencer le M. Moore continues his account of new plants. *Amphoranthus spinosus*, from Damara-land, furnishes a new genus of the suborder Casalpiniæ, approximating to the existing genus *Cordyla*. Five new species are added to the Acanthaceæ. A note by the same writer refers to the plant which, under the name of *Haemacanthus coccineus*, was described in a previous number of the *Journal* as a new genus; there is some possibility of this proving to be identical with the plant named *Satanocrater coccineus* by Dr. Lindau.—Dr. Rendle describes two new varieties of orchids from China, and a new species of Burmannia from the same country. The latter is figured along with *Amphoranthus*.—Two papers deal with the genus *Hieracium*; in the first, Mr. H. J. Riddelsdell gives a list of Welsh *Hieracia*; in the second, Mr. F. N. Williams, in the course of his remarks on the "Salient Features in *Hieracium*," alludes to the difference between the characters emphasised by Scandinavian and Continental botanists, and points out the importance of the hairs, the structure of the receptacle and the stem branching as distinguishing morphological features.—Messrs. R. E. and F. Cundall contribute a list of Glamorgan-shire plants which furnishes a supplement to that published recently by Messrs. Marshall and Shoobred.—The article entitled "Botany in England a Century Ago" gives the impressions of Dr. H. A. Noehden formed during his visit to this country in the year 1799.

The American Journal of Science, September.—The relationships of some American and Old World birches, by M. L. Fernald.—On the fertile fronds of *Crossotheca* and *Myriotheca*, and on the spores of other Carboniferous ferns from Mazon Creek, Illinois, by E. H. Sellards.—On the validity of *Idiophyllum rotundiflorum*, Lesquerens, a fossil plant from the Coal-measures of Mazon Creek, Illinois, by E. H. Sellards. It

is shown that the species *Idiophyllum rotundiflorum* is a synonym of *Neuropteris varinervis*, and that the genus *Idiophyllum* has no status in fossil botany.—The precipitation of ammonium vanadate by ammonium chloride, by F. A. Gooch and R. D. Gilbert. Previous work on the separation of vanadium as ammonium metavanadate by means of ammonium chloride having led to contradictory results, the method has been exhaustively re-examined, with the result that under suitable conditions, easily realised experimentally, the determination by Gibbs's method is accurate.—Some additions to the alunite-jarosite group of minerals, by W. F. Hillebrand and S. L. Penfield.—The Niagara limestones of Hamilton County, Indiana, by Edward M. Kindle.—On the velocity and the structure of the nucleus, by C. Barus.—Note on corundum and a graphitic essonite from Barkhamstead, Connecticut, by B. K. Emerson.

SOCIETIES AND ACADEMIES.

PARIS.

Academy of Sciences, September 22.—M. Bouquet de la Grye in the chair.—The president announced to the Academy the loss it had sustained by the death of M. Damour.—The extension of Fermat's principle on the economy of time to the relative movement of light in a transparent homogeneous body subject to a rapid translation, by M. J. Bousinesq. It is shown that the principle of least time as enunciated by Fermat applies to the case of a body subjected to a rapid translatory motion. Polarisation is also unaffected.—The enclosures in the andesites from Mont Pelée, by M. A. Lacroix. The enclosures contain a greenish or yellowish-grey rock of a microlitic character; the mineralogical composition is always the same qualitatively, but the proportion of the elements varies considerably. The most complete type contains plagioclases, hypersthene, augite, titanomagnetite, hornblende and olivine. These enclosures are not fragments of solid rock torn off from the depths of the volcano, there being abundant evidence that they have been formed in place. They greatly resemble certain nodules of hypersthene-andesite from the last eruption of Santorin.—Spectral researches on the rotation of the planet Uranus, by M. H. Deslandres. The first researches on the rotation of the planets have been made by simply measuring the movement of 'certain' well-defined points; if the image is uniform and without detail, this method fails. On account of the small apparent diameter and feeble lustre of Neptune and Uranus, their time of rotation has hitherto remained undetermined. A new mode of attacking this problem is by applying the Doppler-Fizeau principle. This was first applied successfully to the Sun in 1889, to Jupiter and Saturn in 1895, and to Venus in 1900. The same method in a modified form has now been applied to Uranus, with the result that it is very probable that this planet turns in a retrograde sense, like its satellites. To obtain more definite measurements, further researches must be carried out in observatories nearer the equator, with more powerful instruments and in a very calm atmosphere, and for a period of twenty-one years. Encouraging results have also been obtained by the application of the same method to the planet Neptune.—On the combinations of silicon with cobalt, and on a new silicide of this metal, by M. P. Lebeau. When cobalt is heated in the presence of an excess of fused silicon, or when a mixture of silicide of copper, cobalt and silicon is submitted to the temperature of the electric furnace, a well-crystallised cobalt silicide of the composition Si_2Co is formed, the physical properties and chemical reactions of which are given in detail. Cobalt thus forms three definite crystalline compounds with silicon, having the formulae SiCo_2 , SiCo and Si_2Co ; these compounds forming a series in all respects comparable with the silicides of iron.—On the calorific power of coal, by M. Goutal. By an examination of 600 specimens of coal of different kinds, the calorific value (P) is found to be given, with an approximation of 1 per cent, by the formula $P = 82 C + a V$, in which C is the percentage of ash-free coke, V the volatile matter, and a a coefficient, a curve for the determination of which is given in the paper. The error may amount to 2 per cent. of the calorific value in the case of anthracite and some lignites.—On the existence of stable yeast

forms in some moulds, by M. G. Odin.—On a modification produced in *Scoparia carnolica* following its grafting on the tomato, by M. Lucien Daniel.

NEW SOUTH WALES.

Royal Society, August 6.—Prof. Warren, president, in the chair.—On the mitigation of floods in the Hunter River, by Mr. J. H. Maiden. The paper discusses the subject from the point of view of the forester.

CONTENTS.

	PAGE
Fusils de Chasse. By F. J.-S.	545
The Completion of Roscoe and Schorlemmer's Organic Chemistry. By Prof. R. Meldola, F.R.S.	546
Japanese Mythology	546
Our Book Shelf:—	
Macnair: "An Introduction to Chemistry"	547
Davey: "A Tentative List of the Flowering Plants and Ferns for the County of Cornwall, including the Scilly Isles"	547
Goodrich-Freer: "Outer Isles"	548
"The Fauna of British India, including Ceylon and Burma"	548
Letters to the Editor:—	
The Carnegie Institution of Washington, D.C.—Dr. Daniel C. Gilman	548
Re Vegetable Electricity.—Prof. Jagadis Chunder Bose; Dr. A. D. Waller, F.R.S.	549
British Association Meetings.—W. E. P.	550
Helmholtz on the Value of the Study of Philosophy. B. Branford	550
Trade Statistics.—F. Evershed; Dr. F. Mollwo Perkin	550
Bipedal Locomotion of Lizards.—Rose Haig Thomas	551
Rudolph Ludwig Karl Virchow. By R. T. H.	551
The Abel Festival in Christiania	552
Mr. F. W. Rudler and the Museum of Practical Geology	553
Notes	553
Our Astronomical Column:—	
Ephemeris for the Search of the Comet Tempel-Swift	557
Grigg's Comet	557
Reappearance of Eros	557
A Remarkable Meteor	557
Meteor Radiants	557
Instructions on the Observation of the Sun	557
Corrections to the Right Ascensions of the Principal Stars of the Berliner Jahrbuch	557
Observations of Perrine's Comet, 1902 <i>b</i> . (<i>Illustrated</i>)	558
Forthcoming Books of Science	558
The British Association at Belfast:—	
Section II.—Anthropology.—Opening Address by A. C. Haddon, M.A., Sc.D., F.R.S., M.R.I.A., President of the Section	561
Section I.—Physiology.—Opening Address by W. D. Halliburton, M.D., F.R.S., Professor of Physiology in King's College, London, President of the Section	567
University and Educational Intelligence	571
Scientific Serials	571
Societies and Academies	572

THURSDAY, OCTOBER 9, 1902.

MENDEL'S THEORY OF HEREDITY.

Mendel's Principles of Heredity: a Defence. By W. Bateson, M.A., F.R.S. With a Translation of Mendel's Original Papers on Hybridisation. Pp. xiv + 212. (Cambridge: University Press, 1902.) Price 4s. net.

Reports to the Evolution Committee of the Royal Society. Report I. Experiments undertaken by W. Bateson, F.R.S., and Miss E. R. Saunders. Pp. 160. (London: Harrison, 1902.) Price 10s.

THESE can be no question of the importance, in reference to evolutionary theory, of a proper comprehension of the principles of heredity. Many attempts towards a solution of the problem have been made, but to none of them has it been possible hitherto to give more than a provisional approval. While the nature of this process remains unknown, the fabric of evolution cannot be regarded as in any sense complete. It seems certain that at present the question may be most hopefully approached from the statistical side, and to the labours of Galton and of Pearson we owe the enunciation of a law which gives quantitative expression to many of the observed facts. But about two years ago the discovery was made that Gregor Mendel, sometime Abbot of Brunn, had long since, in the seclusion of his cloister, devised and carried through a very remarkable series of experiments in cross-fertilisation; and had on them based a theory which bids fair, if its truth can be established, to put the whole subject of heredity on an entirely new footing.

After more than thirty years of neglect, the Mendelian theory has found an energetic champion in Mr. Bateson, to whose lucid and exhaustive exposition of the doctrine in the two volumes before us students of the problem will naturally turn. Here we can only state in very briefest outline some of the main conclusions to which Mendel was led. In the instances (of pea-plants) selected by him for experiment, it was found that when two plants, differing in a given feature, were crossed, the hybrid offspring invariably exhibited one of the parental characters (called by Mendel the "dominant") to the entire or partial exclusion of the other (called "recessive"). After self-fertilisation, each hybrid produced offspring in which the two antagonistic parental characters (Bateson's "allelomorphs"), dominant and recessive, appeared in a ratio closely approximating on an average to 3:1. Further experiment showed that while the recessive minority henceforth bred true, the other class consisted of one-third genuine dominants also breeding true, and two-thirds "cross-breds" (Bateson's "heterozygotes"), which latter on self-fertilisation again gave the old ratio of 3:1, and so on. When plants differing in several characters instead of one only were taken, *mutatis mutandis* the same law was found to hold good. From these and other experiments, ingeniously devised and giving wonderfully accordant results, Mendel was led to formulate the hypothesis of the numerical equality in kinds, and purity in respect of given characters, of the gametes produced by any zygote, whatever the composition of the latter. The

consequences of the acceptance of this view would undoubtedly be far-reaching, and Mr. Bateson does well, in reprinting a translation of Mendel's original papers and also in recording the illustrative experiments made by himself and Miss E. R. Saunders, to trace out in considerable detail the main lines of speculation thus laid open.

The chief issue between the Mendelian and Galtonian conceptions is the question of "ancestral" heredity; and in disallowing the latter Mr. Bateson is pitting himself against a formidable triumvirate. Prof. Weldon has discussed Mendel's results from this point of view in a critical, but, as it seems to us, not unfriendly spirit. Much may be conceded to the zeal of an advocate, but we regret certain personalities in Mr. Bateson's "Defence." An impartial judge, after hearing the able statements of counsel, would probably desire to adjourn the case for the production of further evidence.

On p. 71 of the first-named work, *Abab* should read *Ab+ab*, and similarly *aBab* should be *aB+ab*. Giltay's name appears in the bibliography as "Gitay."

F. A. D.

LIGHTNING ARRESTORS IN ELECTRICAL ENGINEERING.

Die Schutzvorrichtungen der Starkstromtechnik gegen atmosphärische Entladungen. By Dr. Gustav Benischke. (Brunswick: Friedr. Vieweg und Sohn.)

IT is customary in Germany to divide electrical engineering into two parts, the "Starkstrom" and "Schwachstrom"—the "strong" and "weak" current branches. This book is the first issue of a series, edited by Dr. Benischke, each issue to be complete in itself and to deal with some application of the industry. The first issue treats of the means adopted in the "strong current" branch, *i.e.* electric lighting and power, for protection against atmospheric electrical discharges. With overhead lines, especially overhead power-transmission lines, this subject is one of great importance, and is also one upon which very little is known with certainty. It is interesting to find that the author, on the first page, gives it as his opinion that it is impossible to protect a line against the effects of being directly struck by lightning. In such a case a destruction of the insulation is bound to take place. It is well that electrical engineers should understand this, and be clear in their own minds that the so-called lightning arrestors at present on the market afford no protection here. Fortunately, such cases are very rare. Protection is afforded, according to Dr. Benischke, by lightning arrestors against the weaker side discharges which accompany the main lightning flash, also against spark discharges due to the static charges which the overhead conductors assume as the result of dust, snow, &c., and against induced discharges caused by atmospheric electrical disturbances in the neighbourhood.

The book contains a very clear and concise description of the various forms of lightning arrestors at present in use. Nearly all of them consist of spark gaps placed with one side of the gap connected to the conductor and the other side to earth. Should, therefore, at any time the conductor become charged to a high potential, a

spark is formed across the gap and the charge is thus conducted to earth. As now the electromotive force required to maintain an arc is much less than that required to start it across a gap, the arc is maintained by the ordinary voltage of the system, and has to be put out by some other means. Upon the methods adopted to do this Dr. Benischke bases his classification of the various arrestors as follows:—(1) An arc is not allowed to form by reason of the dividing up and cooling of the spark; (2) arc broken mechanically; (3) arc broken by a magnetic blow out; (4) arc broken by its own magnetic and thermal action; and (5) arrangements containing a large resistance in the earth connection.

This classification is all very well, but in our opinion does not give one a proper standpoint from which to judge of the value of the protection afforded.

Recent investigations have shown that the formation of an arc in the circuit of an underground cable is, in certain circumstances, attended with very grave danger. An arc in such a circuit, between horns, as, e.g., in the Siemens or the Allgemeine Elektrizitäts Gesellschaft's arrestors, whether it is blown out by a magnet or by its own action on itself or other means, is very liable to produce those very rises in potential which it is the object of the arrestors to obviate. This very important consideration is not mentioned by the author. That, however, it is true is borne out by the fact that, in many English alternating-current high-tension stations, originally fitted up with spark-gap arrestors, their use has been attended with such bad results that they have been given up. Even if such so-called arrestors are scientifically good, it is very questionable if they can be made of practical service for high-tension systems by reason of their inherent want of sensitiveness. In support of this contention it may be mentioned that on p. 32 the author gives as an example of great sensitiveness the adjustment of the gap so that it will go across at double the working voltage. We are very certain, however, that there are very few high-tension underground cable systems which have such a large factor of safety. In, for example, a 5000- or 6000-volt system which has been running for some time, a rise of but 2000 or 3000 volts above the working pressure is generally sufficient to break the insulation down somewhere. In purely overhead lines the case is somewhat different, as it is very much easier here to make the insulation with a much larger safety factor.

In our opinion the proper arrestor for high-potential lines has yet to be designed. It must be so adaptable to the circuit on which it is placed that by its action no danger of rises of potential due to it can occur. By proper adjustment of its dimensions to the electrical constants of the circuit this can, perhaps, be arranged.

The arrestors classified by the author under No. 5 are, in our opinion, the most hopeful. In places like South Africa, where static charges are of constant occurrence, this form is the only one that has given any good result, on, of course, low-tension circuits. Their development for high tension is, however, a thing of the future, and has to cope with many difficulties, some of which are indicated in the book by the author.

Dr. Benischke's book is to be welcomed as a valuable contribution to a subject to which as yet so little attention has been paid.

C. C. G.

OUR BOOK SHELF.

Catalogue of Scientific Papers (1800-1883), Supplementary Volume. Compiled by the Royal Society of London. Vol. xii. Pp. xxxii + 807. (London: C. J. Clay and Sons, 1902.)

THE readers of NATURE must be so familiar with the "Royal Society Catalogue" that it is needless to give any description of it; suffice it to say that when the work for the decade 1874-1883, printed in vols. ix. to xi., was in progress, it was found that a considerable number of periodicals had been omitted, many of which contained valuable papers. As stated in the preface to vol. ix., the President and Council contemplated the publication of a supplementary volume which should contain the most important papers that appeared between 1800 and 1883 in periodicals not hitherto catalogued.

A preliminary list of the omitted serials was made, and after a careful sifting it was found that 355 remained to be dealt with, the titles and abbreviations of which occupy twenty-six pages of the volume. These were catalogued in the same way as the previous portion of the work, but when the matter was prepared for the press it was evident that the amount to be printed was much greater than had been anticipated; the committee therefore decided that references to abstracts of papers that had appeared in previous volumes should be excluded, that all references to abstracts should be excluded except in the cases of papers in some other language than English, French, German, Italian or Latin, abstracts of which had been published in one of these languages, and in such a case reference was to be made to only one abstract. The effect of this curtailment was to reduce the work to about 800 pages.

The papers of each author are numbered as in the previous volumes; it must be noticed, however, that these numbers no longer represent the chronological order of publication.

Great care has been taken to ensure accuracy in the references, and many corrections of errors discovered in previous volumes have been made. Much credit is due to Miss Chambers and Miss Bremner and the ladies working under them, and also to the late Mr. George Griffith, who acted as editor.

The Early Life of the Young Cuckoo. By W. P. Westell. Pp. 26; illustrated. (London: Burleigh, 1902.) Price 1s. net.

IN this little volume the author gives an account of the observations made by Mr. J. Craig, of Ayrshire, during the summer of 1899, as to the manner in which young cuckoos eject the other occupants of the nest in which they happen to have been hatched. Two of the photographs illustrating the work have appeared previously in the *Amateur Photographer* of November 28, 1901, in connection with a lecture by Mr. J. P. Millar; and it would perhaps have been better if the author had definitely informed his readers of this fact instead of merely stating that Mr. Craig's "photographs and observations have by this time been heard of throughout the ornithological world."

Since Mr. Craig's observations have not been previously referred to in NATURE, they may be briefly noticed on the present occasion. At the commencement of June, 1899, Mr. Craig found a titlark's or meadow-pipit's nest containing five eggs, two of which were those of cuckoos. One of the titlark's eggs was broken in order to ascertain how long it had been brooded. In due course two young cuckoos were hatched out, one of the titlark's eggs being by this time broken and the other missing. One cuckoo soon succeeded in ejecting its fellow by carrying it on its back to the edge of the nest and tilting it over in the manner shown in the illustrations. The same process

was repeated when the ejected cuckoo, together with a young tillark, was returned to the nest. Other experiments of a similar nature were made subsequently with nestling buntings. The volume closes with a few general, and by no means original, notes on the life-history of the cuckoo. We are afraid that we cannot congratulate either Mr. Craig or the author on the theory advanced to account for the peculiar breeding-habits of the cuckoo. It is argued that if the bird laid a clutch of eggs in the usual manner the offspring would quarrel among themselves owing to their aggressive habits, the author of this theory forgetting that the disposition in question in the young is doubtless correlated with the present laying habit of the parent.

R. L.

Physics: a Text-book for Secondary Schools. By Prof. Frederick Slate. Pp. xxi + 414. (New York: the Macmillan Company; London: Macmillan and Co., Ltd., 1902.) Price 6s.

THIS book is intended for young people from sixteen to eighteen years of age, and consequently deals with physics of an elementary standard. It is for use in the classroom rather than in the laboratory, and details of practical work have been omitted; whilst considerable stress is laid on ample illustration by means of lecture experiments. There are some diagrams, but no pictures of apparatus or phenomena; these the student is to draw for himself from what he sees. Much of the text is written in a spirit of suggestion or question, with the view of making the student think and reason for himself. In the first section of the book there is very little about kinetics, and ideas concerning force are gained from weight. Newton's laws are not stated formally, and work is not discussed until late in the section on heat.

Altogether we think the standard is very elementary, and it is an open question whether students of the ages seventeen to eighteen would not profit more by a rather deeper study of one or two branches of physics in place of this wide review of the whole subject. This, however, must be left to the individual teacher; some will certainly be delighted with this book, others, we feel sure, will prefer to treat the subject quite differently.

S. S.

L'Électricité (déditée de l'Expérience et ramené au Principe des Travaux virtuels). By M. E. Carvallo. Pp. 91. (Paris: C. Naud.) Price 2 francs.

Les Phénomènes électriques chez les Êtres vivants. By M. Mendelsohn. Pp. 99. (Paris: C. Naud.) Price 2 francs.

BOTH these volumes belong to the valuable "Scientia" series of short monographs upon important scientific topics.

M. Carvallo's book contains a concise mathematical treatment of electrical principles based upon the theories of Helmholtz and Maxwell and the principles of virtual work.

The second book contains a complete discussion of electrical phenomena observed in the muscles, nerves, skin, glands, nerve-centres and sense-organs. Separate chapters are also devoted to electrical fish, to the phenomena observed in certain forms of vegetation and to a historical review of the entire subject.

Elementary Chemical Analysis. Distinguishing Tables and Tests. By Prof. P. Carmody. Pp. v + 35. (Trinidad: D. Adamson and Co., 1902.) Price 2s. 6d.

IN those laboratories where a course of qualitative analysis is the plan adopted to give a knowledge of practical chemistry, these tables may prove useful. The reactions for the metals and acids are arranged in a tabular form, and by means of the tables the student learns, not only the ordinary methods of separation for the metals, but also their other distinctive tests.

NO. 1719, VOL. 66]

LETTERS TO THE EDITOR.

[The Editor does not hold himself responsible for opinions expressed by his correspondents. Neither can he undertake to return, or to correspond with the writers of, rejected manuscripts intended for this or any other part of NATURE. No notice is taken of anonymous communications.]

"The Primrose and Darwinism."

I DESIRE to make a short reply in answer to two or three of your reviewer's criticisms on "The Primrose and Darwinism," and on its author, which appeared in your issue of August 28. "We do not propose," to adopt the words of your reviewer, "to go through the whole review, but to discuss one or two points and to leave your readers to judge of the remainder."

My first and chiefest point is in reference to the charge which the reviewer makes in the following statement (p. 411) — "The only point which is worthy of notice" (relative to the cleistogamic flowers) "is a quotation (Prim. and Dar., p. 191) from Darwin's 'Form of Flowers,' which has several copyist's mistakes, and, moreover, contains interpolated words which do not occur in the original, the whole being within inverted commas. It is this sort of treatment of Darwin's text that makes it almost impossible to read the 'Field Naturalist.'"

I give here an exact copy of Darwin's paragraph from "Form of Flowers," p. 323, and an exact copy both of words and inverted commas of my own comments on Darwin's statement. It will be evident to every reader that Darwin's own observations are always marked off by inverted commas, and that my own comments are not included within the commas. Your reviewer seems to have read my comment with exceeding carelessness.

Darwin's Text.

"The most singular fact about the present species is that long-styled cleistogamic flowers are produced by the long-styled plants, and mid-styled as well as short-styled cleistogamic flowers by the other two forms; so that there are three kinds of cleistogamic and three kinds of perfect flowers produced by this one species! Most of the hetero-styled species of *Oxalis* are more or less sterile, many absolutely so, it illegitimately fertilised with their own form pollen. It is therefore probable that the pollen of the cleistogamic flowers has been modified in power, so as to act on their own stigmas, for they yield an abundance of seeds" (p. 323 of last edition, 1892).

My own comment.

But in *Oxalis Sensitiva* "the long-styled cleistogamic flowers are produced by long-styled plants; the mid-styled as well as short-styled cleistogamic flowers are produced respectively by the other two forms; so that there are three kinds of cleistogamic and three kinds of perfect flowers produced by this one species" (F. Fl., p. 323). Now, as Darwin, from his *net experiments*, concluded that "most of the hetero-styled species of *Oxalis* are more or less sterile, many absolutely so, if illegitimately fertilised with their own form pollen" (F. Fl., p. 323), he had in some way to account for this extreme contradiction in results between the naturally abundant fertility of these cleistogamic flowers, and his own results, which we have given above. *Lythrum Salicaria*, under the unnatural method of experimenting with his net. Under this difficulty, Darwin suggests, "it is probable that the pollen of the cleistogamic flowers has been modified in power, so as to act on their stigmas, for they yield an abundance of seed" (F. Fl., p. 323. The italics are ours). (Prim. and Dar., p. 191.)

Again the reviewer states that the "Field Naturalist's" sentence (p. 11) :—"To attribute the capacity for fertilisation in the unprotected flowers to the bees is perfectly gratuitous, as the flowers under the net (when bees were excluded) 'when they touched the net and the wind blew' produced seeds without any cross-fertilisation"—contains, in the words 'when they touched the net and the wind blew,' an "incorrect quotation" (p. 409).

Darwin's words are:—

"*Salvia tenori*. Quite sterile; but two or three flowers on the summits of three of the spikes, which touched the net when the wind blew, produced a few seeds" (Cr. and S.F., p. 362).

My quotation.

Salvia tenori under the net, Darwin tells us, "was quite sterile"; but two or three flowers on the summits of the spikes, which touched the net when the wind blew, produced a few seeds" (Cr. and S.F., p. 362. The italics are ours). (Prim. and Dar., p. 11.)

The quotation is word for word from Darwin in the italicised words; yet the reviewer takes no notice of this, but produces a merely shortened form a few lines below, and which though shortened conveys exactly the same sense, and calls it "an incorrect quotation"!

One more charge of this kind of your reviewer scarcely needs being noticed. But I notice it in order to avoid any misinterpretation if I passed it over. The charge is one in reference to *Sarothamnus scoparius*. Darwin states concerning it (Cr. and S.F., p. 360) :—"Extremely sterile when the flowers are neither

visited by bees, nor disturbed by being beaten by the wind against the surrounding net." The reviewer says:—"The *Field Naturalist* quotes the passage incorrectly, omitting 'when the flowers are neither visited by bees.'" In my chapter headed "The Sterilising Influence of Darwin's Net," where the quotation occurs, the bees in this reference—as they were excluded by the net—had nothing whatever to do with the subject, and so reference to them was omitted; the effect of the net and of the net alone on fertilisation was there being discussed.

Such are the passages which the reviewer cites as misquoted or interpolated. I should have esteemed it a deep dishonour if I had knowingly misquoted any statement of Darwin, or had interpolated any words in quotations from Darwin, and should not lightly have excused myself even had it been done carelessly or unwittingly. To avoid all such charges like those of the reviewer, I distinctly state in the preface:—"We have carefully given the references to all the passages quoted, or referred to, in the following pages." This was done that every reader might find without trouble, if he desired, the original passages and could compare the quotation with them.

At p. 409, the reviewer cites from "The Primrose and Darwinism":—"In calm weather the net would prevent the free access of the wind and would prevent it from shaking, and so from freely disturbing and distributing the pollen" (p. 8), and states "not a particle of evidence is given from his point of view." The evidence in this case is supplied by Darwin himself:—"In all cases the flowers were protected from the wind" (Cr. and S.F., p. 23); and again, as quoted in Prim. and Dar., "The wind does hardly anything in the way of conveying pollen from plant to plant when insects are excluded" (F. of Fl., p. 93).

The reviewer says, "When the author ventures on suggesting a function we are liable to come across such a theory, as the orifice in the carina of Lotus is to serve for the ventilation of the pollen stored within the carina." As I spent three and a half to four years of my life in the uninterrupted study of physiology and its sister sciences, there still remains a sufficient residuum of its flavour in the cask that I can venture to assert that if your reviewer will only consult a competent physiologist about a piston surrounded with packed pollen in a closed carina, like Fig. 13, p. 132 (Sowerby's "English Botany," v. iii.), of the Lotus, he will tell the reviewer that such ventilation of a cone, if not absolutely necessary in every season, yet would be absolutely necessary in some seasons, and would be very conducive in all seasons to the healthy fertilisation and fructification of the pod.

Finally, the reviewer states, "the author makes the astonishing statement that Darwin's predecessors are to be commended for strictly subordinating theory to natural facts. They thus happily avoided the error into which Darwin, in this instance at least, most assuredly and most conspicuously fell." The reference here is to the dimorphism of the primrose and to Darwin's statement in reference to such a state—"One form of *Primula* must unite with the other form in order to produce full fertility" ("Form of Flowers," pp. 49, 56). And again, "heterostyled flowers stand in the reciprocal relation of different sexes to each other" ("Form of Flowers," pp. 2, 28, 245).

The late Professor J. S. Henslow was acquainted with the heterostylism of the primrose as stated (and quoted) by me in the preface to the book, but Darwin alone fell into the error that "the two forms stood in the reciprocal relation of different sexes to each other." I will leave to the judgment of botanists who are also acquainted with the long-tongued *Hymenoptera aculeata* and Lepidoptera to decide the question in the spring by observing the flowers from the middle of March to the end of April, whether the short-styled primrose, though fully productive, is cross-fertilised by insects.

In the same way we will leave to all observers or naturalists, by their observing the flowers in the month of May, the question whether the *Arion* is not, with possibly some very accidental exceptions, "a purely self-fertilised flower." We know of no English plant which gives plainer and more easily observable evidence to the fact of self-fertilisation. This is our decided opinion after having examined more than 500 specimens of opened spathes and found in them no evidence to the contrary.

After examining these cases the reviewer will not, I think, "find it hard to tell why this book was written." But lest he should still after that find a difficulty, I will tell him myself. It was, and is, to show that artificial experiments conducted under a close-meshed net was an unnatural and very defective method to discover the operations of Nature in flowers when

exposed to the unlimited influence of sun, wind, dew and other atmospheric agencies; and to show that Nature must be interpreted under the atmospheric conditions which she herself provides, and not under those conditions minimised and in some cases almost absolutely intercepted.

AUTHOR OF "PRIMROSE AND DARWINISM."

September 2.

In my review of "The Primrose and Darwinism," I thought it necessary to call attention to the inaccuracy of the author in the matter of quotation, but I had not the least intention of accusing him of anything more than carelessness. For instance, in the case of *Sarothamnus*, to which he refers in his letter, I was quite ready to believe that the omission of words within inverted commas was an oversight. But in his letter he tells us that they were omitted because "the bees in this reference—as they were excluded by the net—had nothing whatever to do with the subject." He stands self-convicted of knowingly altering what he quotes, but I readily believe that he is guilty of nothing worse than ignorance of the usage of literary work.

The *Field Naturalist* objects to my statement that there are "several copyist's mistakes" as well as "interpolated words" on p. 191 of his book. I therefore give the passage in his book to which I referred, followed by the corrections needed to make it agree with "Forms of Flowers," ed. ii. p. 323¹.

But in *Oxalis sensitiva* "the long-styled cleistogamic flowers are produced by long-styled plants; the mid-styled as well as the short-styled cleistogamic flowers are produced respectively by the other two forms."

The mistakes are:—

For "the long-styled read the "long-styled.

For produced by long-styled read produced by the long-styled.

For the mid-styled read and mid-styled.

For the short-styled read short-styled.

Dele, produced respectively.

If the *Field Naturalist* really considers this a justifiable sample of the art of citation I shall be surprised.

With regard to *Salvia tenori*, the *Field Naturalist* complains that I describe (p. 409) the words, "when they touched the net and the wind blew" ("The Primrose," &c., p. 11) as an incorrect quotation. When I read the phrase in question I was so much surprised to find these words attributed to Mr. Darwin that I turned to his book, where I found, "which touched the net when the wind blew." I still think that the *Field Naturalist* is not justified in placing within inverted commas a passage which does not occur in the original; nor can I agree with him that the correct and incorrect versions convey "exactly the same sense." This was the only inaccuracy in regard to *Salvia tenori* to which I called attention in my review; but I now learn, from the parallel passages given in the *Field Naturalist's* letter, that he quotes incorrectly the words "two or three flowers on the summits of three of the spikes," changing them by a not unimportant omission to "two or three flowers on the summits of the spikes."

Lastly, the *Field Naturalist* complains of my saying that he has not a "particle of evidence" for his point of view in regard to the supposed injurious effect of the net in keeping the wind from the experimental plants. He goes on: "The evidence in this case is supplied by Darwin himself. 'In all cases the flowers were protected from the wind.'" What we want is not evidence of protection from wind, but evidence that such protection has any hurtful effect on the reproductive organs of the plants.

The rest of the *Field Naturalist's* remarks do not seem to me to call for reply.

THE WRITER OF THE REVIEW.

A Method of Treating Parallels.

In your issue of July 3, just to hand, Dr. Richardson suggests a method of treating parallels which differs from the orthodox Euclidean method. Improvements of a kind similar to that suggested by him will go far towards rendering the teaching of geometry more effective than it is at present. I differ from him to a slight degree in this particular instance, in that I consider it preferable to take the more general case of equal inclination of parallels to any straight line which cuts them as expressing the clearest and most useful conception of parallelism. By constituting sameness of direction the criterion of parallels—direction being purely relative, this sameness is determined by

¹ The passage is the same in edit. i.

reference to any other direction—the other theorems, common perpendicularity, equality of alternate angles, &c., are easily deduced.

I was pleased to read Dr. Richardson's letter, as it showed that others were working in the same direction as myself. Part of my time is devoted to teaching mathematics at the School of Mines in this town. This technical institution is attended in the evening by students who during the day are serving their apprenticeship in mechanical workshops. Although geometry is a subject which readily appeals to them, I have learnt the utility of presenting it to them under the garb of Euclid. Even if they had the courage to face the schoolboy's drilling in Euclid, I could not conscientiously ask them to devote their energies to a labour so unremunerative. I, for one, hope that Prof. Perry's efforts to harmonise the teaching of geometry and other branches of mathematics with the needs of engineering students will bear fruit, and that before the lapse of any considerable time.

W. R. JAMIESON.

Gawler, South Australia, August 27.

Symbol for Partial Differentiation.

DR. MUIR'S symbols (p. 520) may be very suitable for manuscripts or the blackboard, but the expense of printing them would be prohibitive. No book in which such symbols were used to any extent could possibly pay. On the other hand, the symbol $(dE/dx)_y$ can always be introduced into a paragraph of letterpress without using a justification or a vinculum; and this very much lessens the expense of printing.

A. B. BASSET.

Fledborough Hall, Holyport, Berks, September 26.

Bipedal Locomotion in Lizards.

I HAVE recently observed bipedal locomotion (p. 551) in the case of *Calotes versicolor* in similar circumstances to those noted by Mr. Ernest Green, and have reason to believe that it also occurs in the case of several other Agamid lizards that I have watched in the Malay Peninsula, though their movements are too rapid to admit of certainty. *Liolepis bellii*, however, certainly uses all four legs when in rapid motion, holding its tail in the air.

N. ANNANDALE.

Lochbuie, Isle of Mull, N.B., September 25.

A Possible Meteor Shower on October 4.

ON Saturday last, October 4, at 7.45 p.m., I noticed the following phenomenon:—The sky was clouded entirely, when, happening to look to the west-north-west, I saw a well-defined streak of light, starting on a level with some trees in a small wood and moving roughly horizontally towards the south for an angular distance of about 30°. This was followed at about 3-second intervals by another and another, until I counted 43 of them. After this the interval became greater, and about 8 o'clock the phenomenon ceased. It appeared to be like a meteor shower partially hidden by a thickness of cloud. Assuming this to be true, I am afraid the radiant point was hidden by the trees before mentioned. The elevation would be about 15°. Perhaps some of your readers more favourably situated may be able to throw further light on the matter.

G. PERCY BAILEY.

Stonyhurst College, Blackburn, October 6.

✓ FALL OF A METEORIC STONE NEAR CRUMLIN (CO. ANTRIM) SEPTEMBER 13.

THE writer of this note visited the scene of the fall of this meteorite yesterday evening, September 20, and learned that it occurred at about 10.30 a.m. (local time) on the date in question. The body is almost 10 lb. in weight and of a more or less irregular outline, and of the usual meteoric appearance. It bears strong evidence of fusion, shines with a metallic lustre on one side and is apparently truncated, a fragment—say about a third—having fractured off in its descent through the atmosphere. There is also a well-marked line or two of fracture still visible. The evidence at present is that it fell quite perpendicularly, there being no trace of slope or inclination in the hole, about 13–15 inches deep,

which it made on striking the soil. Mr. Walker, of Cross-hill, on whose holding it fell, says it was quite hot at first, and felt warm for almost an hour afterwards. Of course, a good deal of interest and local curiosity is naturally aroused, the usual query being "Where did it come from?" Possibly the data given above may help to furnish an answer to this question, although hardly yet sufficient to enable an orbit or trajectory to be computed for this—the third meteorite which has fallen in the British Isles within recent years. The occurrence was accompanied by the usual rumblings or detonations, but the estimations of the duration are here, as is usual in other similar instances, untrustworthy.

Crumlin is almost due west from Belfast, distance about 10 miles, lat. 54° 36' N., long. 6° 12' W.,

W. H. MILLIGAN.

26 Cooke Street, Belfast, September 21.

[The delay in the publication of Mr. Milligan's letter has resulted from our sending it to Mr. L. Fletcher, F.R.S., who has furnished the following interesting notes upon the meteorite.—Editor, NATURE.]

During the past fortnight it has been stated in various Irish and English newspapers that a meteoric stone had been seen to reach the earth near the village of Crumlin, a few miles distant from Belfast, on Saturday, September 13, when the meeting of the British Association in that city was in mid course.

Such reports of meteoritic falls are by no means infrequent and are almost always based on mere misapprehension of fact; indeed, it is very seldom that a stone believed to be a meteorite is found on critical examination to have any valid claim to a celestial origin. As lately as last week, for instance, a supposed meteorite was sent to the Natural History Museum from Shropshire for inspection, and yet was undoubtedly a product of our own earth.

As twenty-one years had passed away since the fall of a meteoric stone in the British Isles and thirty-seven years since the fall of a meteoric stone in Ireland, to a person in London it seemed more likely that the Crumlin fall was mythical than that a heavenly body should have fallen after so long an interval near to the very city where so many men of science were gathered together; and it seemed in any case to be a matter of certainty that before the news of the fall had reached London the stone must already have passed into the possession of a private, perhaps foreign, collector.

Last week, impressed by the circumstantial character of the reports (especially that sent by Mr. Milligan, of Belfast, for publication in NATURE), and desiring further information, I telegraphed from South Kensington to Mr. Andrew Walker, on whose farm the stone was said to have fallen; in reply he stated that the stone was still in his possession and that it had not been examined by anyone who had made a special study of meteorites. Though in doubt as to the advisability of so long a journey on the basis of such evidence as was at the moment available, I left at once for Crumlin, and was relieved on arrival to find that the journey had not been made in vain; the stone was undoubtedly a true meteorite. That a high degree of excitement had been aroused in the district by the reports of a meteoritic fall will be manifest from the circumstance that during the interview with Mr. Walker no fewer than four different sets of visitors, some in carriages, some on foot, called to see the stone and the place where it had struck the earth; each visitor was allowed to handle the specimen and feel its weight. It was being stated in the village, but Mr. Walker said it was an exaggeration, that as many as 300 people had been to the farm in the course of a single day. Although Mr. Walker had been told by some of his visitors that it would be unlucky for him to part with a gift sent to him direct from heaven, he perceived that the stone would be best preserved elsewhere

than in a farmhouse; a change of ownership was accordingly effected, and on the following day the stone was safely deposited on the premises of the Natural History Museum, South Kensington.

The particulars of the fall, as given orally to me by Mr. and Mrs. Walker, are as follows:—

At 10.30 a.m. on Saturday, September 13, which was a cloudy morning, W. John Adams, who is in the employment of Mr. Walker at Crosshill farm, was gathering apples from a tree on the edge of the cornfield and near the house; he was startled by a noise of such a character that he thought it was due to the bursting of the boiler at the mill, which is a mile to the south and is situated near to Crumlin railway-station. Another loud noise, like that of escaping steam, was followed by the sound as of an object striking the ground near by, and a cloud of dust immediately arose above the standing corn at a spot only twenty yards away from where he was at work. Adams ran through the corn towards the cloud of dust and found a hole in the soil; thereupon he hurried to the farmyard for a spade, and within a quarter of an hour of the fall had extracted a black, dense stone, which had penetrated the soil to a depth of $1\frac{1}{2}$ feet and had then been stopped by impact against a much larger terrestrial

certain information as to the direction of the line of flight of the meteorite.

As for the stone itself, it weighs 9 lb. $5\frac{1}{2}$ oz.; it is $7\frac{1}{2}$ inches long, $6\frac{1}{2}$ inches wide and $3\frac{1}{2}$ inches thick. Its form is irregular and distinctly fragmental; there are nine or ten faces, each of them slightly concave or convex; the edges are rounded. Five of the faces are similar to each other in character, and, except for minute pittings and projecting points, are smooth; they show those large concavities which are common on meteoric stones, and have been likened in shape to "thumb-marks"; the remaining faces are different in aspect and have a low ridge-and-furrow development; they are doubtless due to fractures during the passage of the stone through the earth's atmosphere, possibly to the break-up at the moment of detonation. A crack going nearly half-way through the meteorite at a distance of an inch from an outer face was probably caused by impact on the larger stone met with in the soil.

The meteorite is virtually completely covered with the characteristic crust which is formed during the passage of such bodies through the air; the crust is in parts black, in parts brown perhaps owing to the influence of the soil. On the smoother faces already referred to the

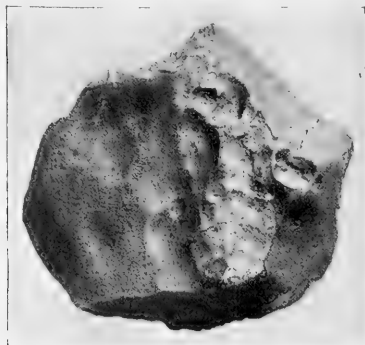

FIG. 1.—The Crumlin meteorite (reduced to one-third the natural size). View showing the smoother faces, the concavities, and the crack probably caused when the meteorite struck a still larger terrestrial stone buried in the soil.



FIG. 2.—The Crumlin meteorite (reduced to one-third the natural size). View showing the two dominant kinds of surface. The face on the right was probably produced by the breakage of the meteorite at an early part of the journey through the earth's atmosphere.

stone. The black stone was hot and, according to Mr. Walker, was still warm to the touch even an hour later. There was a sulphurous odour. Two other men were working at a haystack twenty yards further away from the hole made by the stone and also heard the sounds. Mr. Walker, who is seventy-two years of age, had himself just gone into the house, which is close by, and heard nothing of the explosion. Mrs. Walker told me that she was in the lane on the far side of the house and heard a sound comparable for character with that made by a swarm of bees, though much more intense, or with the rattling noise made by a reaping machine; she said that others who had heard it had likened the same sound to that of a reaping machine which had run away. It may be mentioned that the sound of a reaping machine is at present very familiar to the observers, for the harvest is in progress. Mr. Walker had heard that the detonation was remarked at Antrim, five miles to the north of Crosshill; at Legoniel, nine miles to the east; at Lisburn, eleven miles to the south-east; and also at Lurgan, thirteen miles south-south-west by south. Mrs. Walker said that some of the hearers had taken the sound to herald the arrival of the Day of Judgment. As yet there is no

crust is thicker than, and different in aspect from, that on the remaining faces. From this it is inferred that the meteorite broke up in the earth's atmosphere at an early part of its course, when the speed was still so enormous that the heat produced by compression of the air in front of the quickly moving stone was sufficient to scorch the newly broken surface, for a fresh fracture of the stone is quite light in colour. In one part the crust is iridescent in purple, blue and pink colours. Here and there bright particles of a metallic alloy of iron and nickel interrupt the continuity of the dark crust. On one of the smaller surfaces of latest fracture there is visible a section of a large flat nodule of the bronze-coloured protosulphide of iron, trolite, which is a characteristic mineral constituent of meteorites and is not found as a native terrestrial product. Owing to the presence of particles of nickel-iron dispersed through the stony matter, the meteorite affects the magnetic needle, though not to a great extent.

A mould of the meteorite has been made from which models will be prepared; a detailed mineralogical and chemical examination of the material of the stone will be at once begun.

Crosshill is a mile to the north of Crumlin, a small village on the line of railway between Lisburn and Antrim; it is twelve miles west of Belfast and 3½ miles east of Lough Neagh, a sheet of water thirteen miles long and seven miles wide; it is thus possible that the remaining fragments of the mass which entered the earth's atmosphere may have fallen into the water. The distance of separation of stones belonging to a single meteoritic fall has not yet been observed to exceed sixteen miles; it has on several occasions been found to reach ten miles.

The Crumlin meteorite is the largest stone which has been seen to fall from the sky to the British Isles for eighty-nine years, and is larger than any which has fallen in England itself since the year 1795.

L. FLETCHER.

OPENING ADDRESSES AT THE MEDICAL SCHOOLS.

THE first week of October has again brought round the opening of the medical schools, and with it a series of addresses by distinguished members of the profession, in which the first year's man is told something of the calling in which he has elected to earn his livelihood. These addresses are this year perhaps more varied and interesting than usual; at any rate, even the cursory reader cannot help but be struck with the quantity and the quality of the advice of which the future practitioner has been during the last few days the recipient.

At Owens College, Manchester, the introductory address was delivered by Sir Dyce Duckworth. In it some points of great importance both to teachers, students and the profession at large were considered. In the present state of medical education in London, especially with regard to the development of the medical faculty of the University of London, the remarks of the lecturer under the heading of the standard of general education for medical students cannot escape the observation of those interested in this subject. It is well known that a supposed grievance of the London medical student, which has certainly been well aired, is that although he spends as much money, time and intellect on his medical curriculum as his fellow student at the Scottish universities, he obtains merely a license to practise, whereas the Scottish student receives what is certainly of more value in the eyes of the public, viz. a degree in medicine. Into this question Sir Dyce Duckworth did not enter, but his view seems to be that licenses should not be made more difficult or university degrees easier; in other words, that the distinction between the two should remain, and that the degree should be regarded as an indication of distinctly higher attainments conferred upon those already holding diplomas. Those interested in the obtaining of an efficient medical staff for the public services are strongly recommended to take to heart the somewhat ominous words of this experienced teacher.

At University College, Sheffield, the opening address was given by Sir Henry Howse, the president of the College of Surgeons. After some remarks pregnant with interest and suggestion upon the scientific training, viz. the biological, chemical and physical training, of the medical student, the lecturer passed on to the part of the curriculum devoted to practical training. Under this latter head, Sir Henry Howse emphasised the most important fact that no disease must be regarded as a text-book entity, but that each as it occurred in each individual patient possessed individual characteristics, and that successful treatment could only be attained by observing and allowing for these characteristics. The great effect of apparently small causes was aptly illus-

trated by the lecturer by showing the difference between a little excess of alkali or acid in the preparation of the liquor ammonia acetatis of the pharmacopoeia.

At the Yorkshire College, Leeds, the opening address was delivered by Mr. Mayo Robson, who took for his subject the advance of surgery during the last thirty years. At the end of the lecture, the author referred to the advances made in medicine and predicted that the progress in the next century would be chiefly medical.

At Guy's Hospital, the opening of the winter session was celebrated on October 1 by a distribution of prizes and medals to the students who were successful last session by the Lord Mayor of London. The Dean read the report of the medical and dental schools and referred to the position of Guy's as a medical school in the reconstituted University of London, expressing a hope that the altered regulations for the matriculation examination would enable a larger number of London students to obtain the doctor of medicine degree.

The London Hospital Medical College opened its 118th session with an old students' dinner on October 1. In a long speech, the chairman of the hospital referred to the great size and enormous work the hospital was doing both in relieving the sufferings of humanity and in the cause of medical education.

A most interesting address was delivered at the opening of the sixty-first session of the London School of Pharmacy, on October 1, by Prof. W. Palmer Wynne, F.R.S. The subject was the changes which have taken place on what may be called the scientific side of pharmacy during recent years, and especially those in which progress in chemistry has played a part. Prof. Wynne discussed the connection between chemical composition and physiological action, and emphasised the extreme difficulty of reducing the results obtained in this connection to anything approaching law, at the same time admitting the great progress which had been made in this direction.

F. W. T.

NOTES.

WE much regret to see the announcement of the sudden death of Dr. J. H. Gladstone, F.R.S., in his seventy-sixth year.

MR. J. ALLEN HOWE has been appointed curator and librarian of the Museum of Practical Geology in succession to Mr. F. W. Rudler, who, as mentioned in our last number, has retired.

THE zoological, botanical and geological collections of Dr. Sven Hedin have, it is stated, been presented by the explorer to the University of Stockholm.

THE death is announced, at the age of sixty-one, of Dr. Julius Ziegler, who for nearly thirty years was at the head of the meteorological department of the Frankfort Physikalische Verein.

THE next annual congress of the Royal Institute of Public Health is to take place in Liverpool, probably, the third week of July next.

AT the Royal Microscopical Society on October 15, a demonstration on "Rock Changes in Nature's Laboratory" will be given by Prof. T. G. Bonney, F.R.S.

REPORTS of the following earthquakes have appeared in the *Times* during the past few days:—Advices from Guam state that 180 shocks of earthquake were felt in that island on September 25. The marine barracks and other buildings at Agana were destroyed.—Three violent earthquake shocks were felt at Tifis at 2.30 a.m. on Saturday last, October 4.—A severe earthquake, lasting two minutes, was felt at New Marghilan, Ferghana, on Monday afternoon, October 6.

A TELEGRAM from the Governor of Martinique states that Mont Pelée is again emitting clouds and that rumblings are being heard. There has been an overflow of hot water from the crater in the region of Basse-Pointe, and slight earthquake shocks have been felt at Bourg Sainte Marie and at Bourg Trinité. A telegram from Kingstown, St. Vincent, reports that a slight eruption of the Soufrière occurred on the evening of October 1 after a week's tranquillity. The volcano was quiet on October 2.

AT the opening ceremony of the new session of the Royal College of Science, held in the lecture theatre of the Victoria and Albert Museum on October 2, the Huxley gold medal was for the first time awarded to Mr. J. E. S. Moore, associate of the College, in recognition of work which he has already carried through and is still continuing in the Huxley Research Laboratory, in connection with his investigations into the African lake fauna and his studies in cytology and nuclear metamorphosis, commenced at the Naples Zoological Station. The medal is intended as an award for research carried out in the Huxley Laboratory in some branch of natural science in which Huxley was distinguished. The recipient has the option of a silver-gilt medal, and the award is in either case accompanied by the balance of the interest on the capital sum invested for the purchase of books, instruments or as an aid to research.

THE Official Reports of the Belgian Antarctic Expedition have been presented by the Belgian Government to the Scottish Antarctic Expedition, which is shortly to take its departure. Mr. W. S. Bruce, the leader of the expedition, has also received a telegram from Lieut. G. Lecoq, of the recent Belgian expedition, wishing him success.

CAPTAIN SVERDRUP and the other members of his recent expedition were entertained by the Geographical Society at Christiania last week. It was announced at the gathering that the Grand Cross of the Order of St. Olaf had been conferred upon Captain Sverdrup, that the Fram medal in gold was to be bestowed upon Peter Henriksen, and that the other members of the expedition were to receive the same in silver.

AT a meeting of the local Society for the Prevention of Consumption held in Newcastle-upon-Tyne on Thursday last under the chairmanship of Mr. Watson Armstrong, it was decided to build a sanatorium for fifty patients at a cost of 50,000*l.*, towards which the sum of 8000*l.* was subscribed at the meeting. Of this amount the chairman contributed 4000*l.*

ARRANGEMENTS are already in progress for the next meeting of the Australasian Medical Congress, which is to be held at Adelaide in 1905 under the presidency of Prof. E. C. Stirling, F.R.S. The business is to be conducted in seven sections, as follows:—Medicine; surgery; gynaecology; diseases of eye, ear and throat; anatomy, physiology, pathology and pharmacology; public health; State medicine and medical ethics.

DR. LOGAN TAYLOR set sail last week in charge of an expedition which has been sent by the Liverpool School of Tropical Medicine to inquire into the health conditions of the Gold Coast, reports having from time to time during the past year reached this country as to the ill-health which has been prevalent in the colony. The expedition will not be occupied so much with research work as with practical operations against the unhealthy conditions of the principal towns, and it will, so far as possible, work in conjunction with the medical staff of the colony.

In continuation of the announcement made a few weeks ago (September 4, p. 446), we learn from the *Times* that a resolution has been published stating that the Government of India has come to the conclusion that central authority is needed to ensure that the work of scientific research in India is distributed

to the best advantage, that each investigator confines his researches to the subject with which he is most capable of dealing, and that energy is not wasted by the useless duplication of inquiries or misdirected by lack of cooperation amongst the various departments. Hence a board of scientific advice is to be formed, comprising the heads of the Meteorological, Geological, Botanical, Forest, Survey, Agricultural and Veterinary departments, and other scientific officers of special attainments. This board is to prepare every year a general programme of research and a report describing what has been done. The main object of the scheme is to promote the economic development of the country. The resolution mentions the various scientific officers appointed in recent years, and says that the development of machinery in the different departments has rendered more essential than ever the coordination of scientific inquiry. The special Indian correspondent of the *Lancet* points out that to complete the scheme of the Government another advisory board, similarly constituted to that already referred to, is required for the original investigation of human diseases. There are many complaints, he says, towards the understanding of which clinical observation has done little, and more scientific research upon them is wanted.

We learn from the *Isle of Man Times* that on Saturday last the Isle of Man Natural History and Antiquarian Society paid a visit to the new buildings at Port Erin utilised by the Insular Government and the Liverpool Marine Biology Committee for the purposes of a biological laboratory and museum, and also as a fish hatchery. An interesting address was given by Prof. Herdman, director of the biological station, who explained the purpose the laboratory was intended to serve in the way of education and scientific research, and referred to the advantage of bringing students into contact with the living animals as they were enabled to do in an institution of this character. He thought the principal work of the fish hatchery would be the breeding and rearing of lobsters and flat fish. Mr. P. M. C. Kernode, the hon. sec. of the Society, unveiled a bust of Edward Forbes, which he has presented to the new institution, and gave a brief address on the life and work of this illustrious biologist, who was born in the Isle of Man and accomplished considerable work in Manx natural history. Mr. Isaac Thompson also spoke in receiving the bust on behalf of the Liverpool Marine Biology Committee, and made an appeal for scientific publications for the station library; and Sir James Gell (the acting governor) alluded to the part which the Tynwald Court had taken in providing the new building and the support given to the project by Deemster Kneen. The proceedings terminated with an inspection of the tanks in the aquarium, the microscopic specimens in the gallery and the local type collection in the museum gallery, all arranged by Mr. H. C. Chadwick, the resident curator of the institution. In the afternoon the Society paid a visit to the Neolithic Stone Circle on the Meayll hill.

The New South Wales Government has recently made an experiment with the object of introducing European flat-fishes to the colony. At the time of arrival of the consignment of fishes, there were alive 560 plaice, twenty English soles, three Mediterranean soles and one female lobster. The experiment is reported to have quite come up to the expectations of the fisheries commissioners, as, although some of the fish dispatched died on the voyage out, they were looked upon only as of secondary importance in the experiment, all the special arrangements having been made to suit the plaice.

It is stated in the *Scientific American* that Prof. R. Fessenden, whose system of wireless telegraphy is at present receiving the attention of the United States Government, has announced his intention of resigning his position in the

Weather Bureau, and that stations equipped with his instruments are shortly to be located along the Pacific coast, for use in the dissemination of the weather reports throughout that part of the country.

At the festivities held in Bologna on the occasion of Mr. Marconi's return to his native town, Prof. Augusto Righi, in congratulating his former pupil on his successes, spoke to the following effect:—Perhaps no one can appreciate better than I his exceptional inventive power and his unusual intellectual gifts. I remember with great pleasure his visits when quite a young man, for asking my advice, for explaining his experiments, made with simple apparatus ingeniously put together, and for keeping me informed of his new projects, in which his passion for applied science always stood out. Even then I predicted that he would sooner or later attain fame. The system of wireless telegraphy which he derived from Hertz's classical experiments . . . is the most pleasing transference to the field of practical industry of those instruments and principles which might have seemed to be relegated to the domain of natural philosophy. Science always contains the germs of every unexpected marvel, and never has a seed fallen in ground that is more fertile or more suitable for causing it to germinate and transform into a fine and healthy plant. It is to the credit of Marconi that he has once more proved how much those are in error who regard with disdainful or indifferent eyes the work carried on continuously in the silence of the laboratory by the modest and disinterested scientific students, and who only appreciate science in proportion to the immediate uses that can be obtained from it. They do not know that even from the most abstruse result, a sympathetic mind may unexpectedly derive one of those applications which accelerate the advance of humanity on the path of progress and social welfare.

It is suggested by Mr. R. Hedger Wallace in the October number of *Nature Notes* that Gilbert White's house, which, as has already been stated in these columns, is offered for sale, should be purchased and used as a school of nature-study. "What," says Mr. Wallace, "could well be housed at Selborne, and would assist the nature-study movement, is a library—say the 'Gilbert White Memorial Library'—which would illustrate what has been and is the influence of his teaching over the wide world—especially the English-speaking world. The number of such books is by no means small, and when once the library is formed, if it be kept up to date, it would be of very great service indeed to all interested in nature-lore and nature-studies."

At the suggestion of the Astronomer Royal for the Cape, Mr. R. T. A. Innes, of the Royal Observatory, Cape of Good Hope, has made special observations in order to decide whether the stars marked γ in the Cape Photographic Durchmusterung really exist or not. Using a 7-inch refractor, Mr. Innes has found that all these stars except seventeen do exist.

The application of the stereoscope to lantern projections has proved a fruitful field for the ingenuity of inventors. M. J. Macé de Lépinay now describes a very simple method of producing the desired effects. He projects two pictures side by side on the screen, and provides each observer with a pair of prisms the angle of which depends on the distance of that observer from the screen. Taking the two images at a distance of one metre apart, the angles of the prisms used are 12° , 10° , 8° and 6° for distances of 4.5, 5.4, 6.8 and 9 metres, the accommodatory power of the eye enabling intermediate distances to be used without further multiplication of prisms. One of the advantages of the system is the convenient and portable character of the prisms when mounted in the form of spectacles for observing the projections.

NO. 1719, VOL. 66]

PROF. RINALDO FERRINI contributes to the Lombardy *Rendiconti* a short note on the calorimetric determination of high temperatures. A mass of platinum or nickel being heated to the temperature to be measured and then plunged into a water calorimeter, the rise of temperature determines the number of units of heat given out by the metal, and it is only necessary to know the specific heat of the metal at different temperatures in order to determine the initial temperature. Taking an approximate algebraic formula for the relation between specific heat and temperature, Prof. Ferrini deduces a linear equation for the temperature calculated with the use of nickel, and a quadratic equation for the temperature calculated by the use of platinum, within the limits considered in his investigation.

MESSRS. WITHERBY AND CO., the publishers of *Knowledge*, announce for early publication in book form the series of articles by Mr. E. W. Maunder entitled "Astronomy without a Telescope," which has been recently running through *Knowledge*.

WE are glad to notice that a new and cheaper edition of Prof. L. C. Miall's admirable book "Round the Year" has been issued by Messrs. Macmillan and Co., Ltd. In this popular form the book will doubtless be much in favour in schools where nature-study is encouraged.

THE secretary of the National Home Reading Union informs us that the new syllabus of subjects for the coming session—the fourteenth—of the Union is now ready for distribution. We notice that among the subjects included in the special courses are geology, Egyptian archeology, physiology and the laws of health. Information as to fees, text-books, &c., can be obtained from the secretary of the Union, Surrey House, Victoria Embankment, W.C.

THE October issue of *Climata*, the interesting and useful organ of the Livingstone College at Leyton, contains many items relating to health and travel which should be of service to travellers, e.g. among its contents are to be found illustrated interviews with Sir Harry Johnston, respecting "An African Equipment," and Dr. H. White, concerning "Life and Travel in Persia"; there are also, among other things, notes on "Kashmir from a Climatic Standpoint" and the progress of the virulent campaigns against malaria.

MR. J. C. NIMMO promises, "Fragments in Philosophy and Science," by Prof. J. Mark Baldwin; "History of the Babylonians and Assyrians," by Dr. H. Winckler; and new editions of Rev. F. O. Morris's "A History of British Birds," six volumes (illustrated), and "Natural History of British Moths," four volumes (illustrated).

IN Messrs. Hutchinson and Co.'s new list of announcements we notice:—"British Fresh-water Fishes," by Sir Herbert Maxwell, Bart., F.R.S.; "Fishes of our Seas," by F. G. Afalo, W. Senior and F. B. Marston; "British Birds," by Aubyn Trevor-Battye; "British Butterflies and Moths," by F. Edward Hulme; and "British Mammals," by Sir Harry Johnston, G.C.M.G., K.C.B., all in the Woburn Library, and each illustrated; "The Polar Star in the Arctic Seas," by H.R.H. the Duke of the Abruzzi, in two volumes (illustrated); "Lord Lilford on Birds," a collection of unpublished writings by the late Lord Lilford, with contributed chapters on falconry and other hunting, his favourite sports, edited by Aubyn Trevor-Battye, in parts (illustrated); "Our Poultry and all about Them," by Harrison Weir" (illustrated); "Hillside, Rock and Dale," bird life pictured with pen and camera by Oliver G. Pike; "Lizards, Living and Extinct," by T. Saville-Kent (illustrated); "The Insect Book of North America," by Dr. L. O. Howard (illustrated); "The Butterfly Book of North America," by W. J. Holland (illustrated).

THE additions to the Zoological Society's Gardens during the past week include a Vervet Monkey (*Cercopithecus lalandii*) from South Africa, presented by Mrs. E. L. Francis; a Chacma Baboon (*Cynocephalus porcellus*) from South Africa, presented by the 4th Co. Army Service Corps; an Anubis Baboon (*Cynocephalus anubis*) from West Africa, presented by Mr. R. D. Whigham; a Formosan Deer (*Cervus taivanus*?) from China, presented by Captain Percy Scott, H.M.S. *Terrible*; three Herring Gulls (*Larus argentatus*), European, presented by Mr. F. W. Hutton; a Land Rail (*Crex pratensis*), British, presented by Miss Elsie E. Hutton; a Schmidt's Monkey (*Cercopithecus schmidti*) from East Africa, a Black-cheeked Monkey (*Cercopithecus melanogenys*) from West Africa, two Rhesus Monkeys (*Macacus rhesus*), an Indian Python (*Python molurus*) from India, a Brown Macaque (*Macacus arctoides*) from Burmah, an Amphinua (*Amphinua means*) from North America, a Lion Marmoset (*Midas rosalia*) from South-east Brazil, two Eyraas (*Felis eyra*) from South America, deposited.

THE SCIENTIFIC AND TECHNICAL EXHIBITS AT THE ROYAL PHOTOGRAPHIC SOCIETY'S EXHIBITION.

THIS section of the Royal Photographic Society's exhibition appears to be rather smaller than on the two previous occasions, that is, since the larger accommodation of the New Gallery made it possible to represent adequately this side of photographic work. We hope that this is not an indication that the section is receiving less attention and is likely to suffer extinction, the fate that we regret to observe has overtaken the apparatus section, except, indeed, so far as concerns the trade stalls and a few exhibits that appear to be out of place in any of the existing departments.

The most striking novelty in the Gallery is a "parallax stereogram" shown by Mr. F. E. Ives. No details are furnished, but we believe that the photograph is taken by means of a lens of large diameter obscured except for two apertures, one on each side, so that it acts in a similar way to the two lenses of the ordinary stereoscope camera, but that the two images are superimposed. In front of the sensitive plate there is placed a screen with vertical lines on it, alternately opaque and transparent, at such a distance that each image will impinge upon the plate in narrow, vertical strips and in the shadows of the opaque lines cast by the light transmitted by the other opening in the lens. The two images are thus received on the plate in narrow, alternating strips. For viewing, the eyes take the place of the openings in the lens, the lined screen remaining in position to keep the two images separate. The correct position for the eyes is indicated by two holes in a board, no other apparatus being necessary. The effect is perfect.

The only example of colour photography by the Lippmann process is a photograph of the spectrum of the arc light by Mr. Edgar Senior. This is an improvement on Mr. Senior's previous noteworthy results, being taken with a narrower slit, but still the colours shown are not quite the same as those which one sees in the direct spectrum. It seems not unlikely that the differences are inherent in the process. Of other prints in colour, Mr. Brewerton contributes some in which the blue print is in Prussian blue, and the red and yellow superposed carbon prints, and Miss Acland some copies of miniatures by a modification of the Sanger Shepherd three-film process. These results are admirable, but they are not convincing. It would be better if an object were used less valuable than a precious miniature and more convenient than a landscape, so that the object and the copy could be exhibited side by side. It is well known that very good results can be obtained; we want now to see how near they are to perfection.

Mr. Hort Player exhibits some splendid examples of his method of copying engravings by superposition. The ordinary relative positions of the engraving and the sensitive paper are reversed, the light passing through the sensitive paper before it illuminates the engraving. A yellow screen is used, and potassium iodide is added to the developer. The whiteness of the

ground, the blackness of the lines and the sharpness of the detail are excellent.

Photomicrography is well represented. The most notable examples are a series of photomicrographs taken in connection with the bacterial treatment of sewage, exhibited by Dr. Clowes. The enlargements vary from about natural size up to three thousand diameters. These fifty or more photographs may well be accepted as a model of what this kind of technical work should be. Mr. Ives has twelve photomicrographs made with a small and simple apparatus that is not described. The results would do credit to any apparatus, and show what may be done by care and skill without elaborate conveniences. Among the other work of this class that deserves commendation is a series of microphotographs of etched alloys by Mr. Ernest A. Lewis.

Astronomical and spectroscopic photography is well represented by very fine work from Sir Norman Lockyer, Captain Hills, the Greenwich Observatory and others. Some of the spectra have no wave-length scale attached, or any other indication of the part of the spectrum represented, and others bear no indication of the facts sought in their preparation or of the facts that the spectra demonstrate. If a little information of this kind were invited by the Society's officers and incorporated in the catalogue, the exhibits would gain vastly in interest. This want of information is also manifest in the "multiple lightning flash," fourfold, by Mr. J. Howden Wilkie, presumably taken with a swinging camera, and in other cases.

There are many other exhibits that deserve more than a passing mention. Snow formations, huge "caps" and "mushrooms" are illustrated by Mr. Vaughan Cornish (see p. 453 of this volume). Balloon photographs, Röntgen-ray work, the photography of animals and meteorological photography are represented by collections of good and in some cases unique examples.

THE BRITISH ASSOCIATION AT BELFAST. SECTION K.

BOTANY.

OPENING ADDRESS BY PROF. J. REYNOLDS GREEN, M.A.,
SC.D., F.R.S., PRESIDENT OF THE SECTION.

THE visits of the British Association to a particular city recur with a certain irregular frequency and bring with them a temptation to the President of a Section to dwell in his opening Address on the progress made in the science associated with that Section during the interval between such consecutive visits. This course possesses a certain fascination of its own, for it enables us to realise how far the patient investigations of years have ultimately led to definite advances in knowledge and to appreciate the difficulties that have involved disappointments, and that still have to be surmounted. We like to look back upon the struggles, to record the triumphs, to deplore the failures and to brace ourselves for new efforts. The opportunity afforded hereby for criticism of methods, for reconsideration of what have been held to be fundamental principles, for the laying down of new lines of work based upon longer experience, shows us how desirable such a periodical retrospect may be.

Standing as we do almost at the threshold of a new century, it seems particularly advisable that we shall occupy our thoughts with some such considerations to-day. I do not wish, however, so much to dwell upon the past and to lead my hearers to rest in any way satisfied with the achievements of the last century, phenomenal as they have been, as to direct attention to the future and to place before you some of those problems which at the opening of the twentieth century we find awaiting investigation, if not solution.

I can only attempt to deal with a small portion of the botanical field. These are the days of specialisation, and when anyone is said to be a botanist, the question which arises at once is, Which particular section of botany is he associated with? The same principle of subdivision which cut up the old subject of Natural History into Zoology, Botany and Geology has now gone further as knowledge has increased, and three or perhaps four departments of botany must be recognised, each demanding as much study as the whole subject seemed to only fifty years ago. I shall therefore confine my remarks to-day to the field of vegetable physiology.

I should like at the outset to recommend this section of botanical work to those of the younger school of botanists who

are contemplating original research. To my mind the possibilities of the living organism as such present a fascination which is not afforded by the dry bones of morphology or histology; valuable as researches into the latter are, they seem to me to derive their importance very largely from the past, from the possibility of indicating or ascertaining the line of descent of living forms and the relation of the latter to their remote ancestors. The interest thus excited seems to me to be rather of an academic character when compared with the actual problems of present-day life, its struggles, triumphs and defeats in the conflict for existence waged to-day by every living organism. The importance of the study of physiology as bearing upon the problems of the morphologists has, I need hardly say, been fully recognised by the workers in that field. I may quote here a sentence or two from the Address of one of my distinguished predecessors, who said at Liverpool, "There is a close relation between these two branches of biology, at any rate to those who maintain the Darwinian position, for from that point of view we see that all the characters which the morphologist has to compare are, or have been, adaptive. Hence it is impossible for the morphologist to ignore the functions of those organs of which he is studying the homologues. To those who accept the origin of species by variation and natural selection there are no such things as morphological characters pure and simple. There are not two distinct categories of characters—a morphological and a physiological category—for all characters alike are physiological."

But apart from the considerations of the claims of vegetable physiology based upon its own intrinsic scientific value and the interest which its problems possess for the worker himself, and upon the place accorded to it as its relationship to morphology, it must, I think, be recognised as being of fundamental economic importance, especially in these times of agricultural depression. For many years now it has been recognised that agriculture is based upon science; that it involves indeed properly the application of scientific principles to the cultivation of the soil. But when we look back upon what has passed for agricultural science since the alliance between the two has been admitted, we cannot but recognise how lamentably deficient in breadth it has been. The chemical composition of the soil and subsoil has been investigated with some thoroughness in many districts of the country. The effect of its various constituents on the weight and quality of the crops cultivated in it has been exhaustively inquired into, and a considerable amount of information as to what minerals are advantageously applied to the soil in which particular plants are to be sown has been acquired. A kind of empirical knowledge is thus in our possession, in some respects a very detailed one, quantitative as well as qualitative records being available to the inquirer. But elaborate as have been the researches in these directions, and costly and troublesome as the investigations have been, they have been hardly, if at all, more than empirical. Till quite recently the physiological idiosyncrasies of the plants round which all these inquiries centred were almost entirely ignored. No serious attempt was made to ascertain the way in which a plant benefited by or suffered from the presence of a particular constituent of the soil. What influence, for instance, has potassium or any of its compounds upon the general metabolism of the plant? Does it affect all its normal nutritive processes, or does it specially associate itself with some particular one? If so which one, and how does the plant respond to its presence or absence by modifying its behaviour? So with phosphorus again; hardly any investigation can be made into the nutritive processes of a plant without this element becoming more or less prominent. In some cases the empirical results already referred to show an enormous influence on the crop exerted by soluble phosphates in the soil or the manure applied to it. But what can yet be said as to the rôle played by phosphorus or by phosphates in the metabolic processes in the plant? Further, how do different plants show different peculiarities in their reactions to these various constituents of the soil? For the advance of agriculture the study of the plant itself must now be added to the study of the soil. The fact that it is a living organism possessing a certain variable and delicate constitution, responding in particular ways to differences of environment, capable of adapting itself to a certain extent to its conditions of life, dealing in particular ways with different nutritive substances, must not only be recognised, but must be the basis for the researches of the future, which will thus supplement and enlarge the conclusions derived

from those of the past, in some respects correcting them, in others establishing them on a firmer basis.

In pressing upon the younger school of botanists the importance of this line of research, I do not wish to minimise the difficulties that accompany it. Difficulties of method assume considerable magnitude, for we have here no question of section cutting and microscopic examination. Vegetable physiology is allied very closely to other sciences, and research into its mysteries involves more than a preliminary acquaintance with them. Especially must one point out the importance, indeed the necessity, of acquaintance with a certain range of organic chemistry and with chemical methods of work. In certain directions, too, physics are as much involved as chemistry in others. The bearing of these sciences in particular directions will be referred to later.

I fear another obstacle stands at the threshold of research which looks sufficiently formidable. The so-called fundamental facts of vegetable physiology have been laid down with sufficient dogmatism in text-books by many writers whose names carry with them such weight that it appears almost heresy to question their statements. We have been content to accept many things on the authority of the great workers of the past, with the result that the advance of knowledge has been hindered by such acceptance of what were deemed facts, but were really inaccuracies. We may refer, for instance, to the statement made by Boussingault, and accepted by most botanists ever since his time, that the absorption of carbon dioxide from the air takes place by means of solution in the cuticle of the epidermal cells of plants and thence passes by diffusion to the seats of photosynthesis. Only comparatively recently has this been shown to be erroneous. If, however, it is once recognised that authority is fallible, this apparent obstacle becomes the opposite. The more evident questions have not yet been solved, leaving only the more difficult ones for the present-day worker.

Recognising the importance of work in this field, and realising that with the advent of a new century new departures must be taken, I have thought I might venture to direct the thoughts of my hearers, many of whom I may call my colleagues, to the present position of certain problems which have long been the subjects of speculation and which offer the prospect, if not of complete solution, at any rate of considerable advance if investigated by modern methods.

I turn first to a few questions connected with the nutritive problems of plants in general.

There are several theories abroad as to the progress of events during photosynthesis, none of which can be regarded as entirely satisfactory. For many reasons it seems desirable that this question shall be thoroughly investigated in the light of the present condition of both chemical and physical science. I may perhaps venture to recall to you the principal hypotheses of carbohydrate formation which have been advanced, so that its present position may be properly appreciated.

The view that has met with the widest acceptance is that of Baeyer. On his hypothesis the carbon dioxide absorbed is decomposed under normal conditions to yield carbon monoxide and oxygen; a corresponding and coincident decomposition of water leads to the production of free hydrogen and oxygen. The oxygen from both sources is exhaled, while the carbon monoxide and hydrogen combine to form formaldehyde. The formaldehyde gives rise by a process of polymerisation to some form of sugar.

A modification of this hypothesis has been advanced, which suggests that the preliminary decomposition of the carbon dioxide and the water may not take place, but that by a rather less violent reaction between them the formaldehyde may be formed and the oxygen liberated.

Erlenmeyer has suggested a somewhat different course of reaction, yielding substantially the same results. He thinks it possible that the first interaction of carbon dioxide and water leads to the formation of formic acid and hydrogen peroxide, and that these subsequently interact with each other, yielding formaldehyde and water and giving off oxygen.

Many years after the views of Baeyer appeared, a hypothesis of a different nature was proposed by Crato. He suggests that the carbon dioxide after absorption becomes ortho-carbonic acid, and that this remains in solution in the cell sap. This acid has the structure of a closed benzene ring in which six molecules are linked together. This becomes decomposed, liberating six molecules of water and six molecules of oxygen,

and forming a hexavalent phenol which subsequently undergoes a molecular rearrangement and becomes glucose.

Yet another suggestion was made by Bach in 1893. He points out that when sulphurous acid is exposed to light it becomes transformed to sulphuric acid, sulphur and water being split off, and he argues that a process analogous with this may take place in a leaf. The carbon dioxide uniting with water would form carbonic acid, and this might then split up in the same way as the sulphurous acid. The carbon and the water thus split off are on this hypothesis not set free separately, but in combination as formaldehyde. The higher carbon acid, to which Bach ascribes the formula H_2CO_4 , splits up into carbon dioxide and hydrogen peroxide, and the latter is decomposed into water and free oxygen.

Lieben has still more recently put forward the view that formic acid and not formaldehyde is formed by the first decompositions. He has found that leaves of grasses and various trees yield formic acid among other products when mixed with their own weight of water containing a trace of sulphuric acid and distilled with steam. Moreover, when carbon dioxide is acted upon by nascent hydrogen the only product is formic acid.

These speculations afford many points which might be well made the starting places of research. The views of Baeyer have met with most acceptance, though but little success has attended the few efforts that have been made to establish them by experiment.

They involve several definite stages of action, of which the most important seem the production of carbon monoxide and hydrogen, the formation of formaldehyde and the construction of a sugar. The last two questions arise also in connection with the hypothesis of Bach.

If we examine the work that has been published bearing on the probability of the formation of carbon monoxide in the plant we find little that is satisfactory. The statements that have been made are opposed to the idea that carbon monoxide is of value in nutrition; it is said that when supplied to a plant instead of carbon dioxide it does not lead to the formation of carbohydrates. It is further advanced that this gas is of a very deleterious nature, and if formed would result in the speedy death of the protoplasm of the cell in which it originates. This idea is, of course, specious; but it does not appear to be well founded. The deadly character of carbon monoxide when inhaled by a human being depends upon a peculiar interference which it causes with the oxygen-carrying power of the red blood corpuscles. The pigment hæmoglobin to which these little bodies owe their usefulness forms a loose chemical combination with oxygen, the compound being formed in the blood vessels of the lungs and being decomposed with the liberation of the oxygen in those of the tissues of the body. It is evident, therefore, that the value of the corpuscles as oxygen-carriers depends upon their hæmoglobin. When this pigment is exposed to carbon monoxide it combines with it in the same way as it does with oxygen, forming, however, a more stable compound. The affinity for this gas which the pigment manifests is very considerable. Hence the poisonous nature of carbon monoxide. It is easily seen that the latter is a poison because it throws out of gear and temporarily paralyses a most essential part of the mechanism of respiration, effectually preventing oxygen from reaching the tissues of the body. There is no evidence here that it exerts even a deleterious influence upon the living substance itself. The only poisonous effect it would be able to exert on the plant would necessarily be of the latter character, for there is no oxygen-carrying mechanism that could be interfered with. We cannot lay any stress, therefore, on the objection to Baeyer's view, based upon the action of carbon monoxide upon the human organism.

Another possibility may, however, be mentioned. As we shall see later, there are certain resemblances between hæmoglobin and chlorophyll, the vegetable pigment concerned in photosynthesis. May not carbon monoxide enter into some relationship with the latter, and thereby indirectly hinder its activity? Of that, however, there is no trustworthy evidence, the facts known to us rather pointing in the opposite direction.

The idea of the poisonous nature of this gas may easily be subjected to experimental examination. It would appear easy to expose a plant to an artificial atmosphere made up of different partial pressures of carbon monoxide, to expose it in such atmospheres to various conditions of warmth and illumination and to note the effect produced. It would seem possible to examine

a great variety of plants in that way, to try both aerial and aquatic forms, and indeed to test the matter exhaustively. It must be borne in mind, however, that the solubility of carbon monoxide in water is extremely small, and that there may be a great difficulty in getting it brought within the scope of the influence of the living substance on that account. It must necessarily be in solution in the cell sap before it can affect the activity of the chloroplast. Even the relations of solubility are not, however, outside the range of experiment, and it may be that the slightly acid cell sap has not the same peculiarities as water as a solvent for the gas.

It is important, again, to take into account in such work the factor of sunlight, on which the power of photosynthesis depends. Should carbon monoxide prove capable of serving as a basis for the formation of carbohydrates, the question would arise, Is the activity of the chlorophyll in sunlight confined to the preliminary formation of carbon monoxide from the dioxide, or is the energy derived from the light brought to bear upon the subsequent constructive processes? We have little or no accurate information as to the way in which the energy is utilised after absorption by the chlorophyll.

This opens up a very important but very difficult line of work, which brings home to us the intimate dependence of vegetable physiology upon physics. The absorption of energy from without, in the form of the radiant energy of the solar rays, is certainly a fact, and to a certain extent we can picture to ourselves the way in which it is secured. The spectrum of chlorophyll shows us a number of absorption bands whose position corresponds with the position in the spectrum of the places where oxygen is liberated in photosynthesis. But the transformation and applications of energy in the body of the vegetable organism need much closer examination. The intimate relationship between the different manifestations or forms of energy and the ways in which they can be transformed into one another have been very minutely scrutinised in recent times. What then should hinder us from learning something much more definite than we at present know about these transformations in the rôle of vegetable life? The electrical phenomena connected with the movements of the leaves of the Venus's fly-trap (*Dionaea muscipula*) have been examined with considerable completeness by Burdon Sanderson, and we have learned that the vegetable and animal organisms show considerable similarities in this respect. Recently, again, Bosc has made important contributions to the subject of the electrical responses to stimulation that can be observed under particular conditions. A promising beginning has thus been made, but only a beginning. The electrical condition of the normal plant under different conditions of rest and activity has still to be investigated. If we return to the subject of photosynthesis and the work done by the chloroplast, may we not hope to discover something about the transformation and utilisation of the radiant energy associated somehow with this structure? Considering the relations between the manifestations of energy which we appreciate respectively as light and electricity, it does not seem wildly improbable to imagine that the energy absorbed as the former may lead to a possible electrolysis of carbonic acid under the influence of the chloroplast, with the formation of carbon monoxide and oxygen. Pfeffer has suggested that perhaps the decomposition of the gas is not due to the light rays at all, and that they may exercise only a stimulating influence upon the chloroplast, the energy concerned being derived from heat rays directly absorbed, or heat vibrations derived from the more rapidly vibrating light rays. In this case is the decomposition brought about directly by the heat vibrations, or have we a transmutation into some other form of energy? The whole subject seems at all events a promising subject for inquiry.

Another problem connected with the action of chlorophyll is associated with the absorption of radiant energy by the different regions of the spectrum. Bands of considerable intensity are noticeable in the blue and violet, though the deepest absorption takes place in the red. Yet Engelmann's classic bacterium method shows us that very little evolution of oxygen takes place in the position of these bands in the blue and violet. The fact that absorption of radiant energy and photosynthetic activity show no quantitative relationship is of course not new, but the reason remains still to be discovered. Van Tieghem has suggested an explanation which recalls to us the hypothesis advanced by Pfeffer, just alluded to. This explanation is that there are two factors concerned in the action of chlorophyll, the elective absorption of light, shown by the occurrence of the

absorption bands in the spectrum, and the calorific energy of the absorbed radiations. The failure of the rays of the blue and violet to effect photosynthesis, in spite of their absorption, would on this view be attributable to their possessing but little calorific energy. The latter is associated much more strongly with the deep band in the red, which is the seat of the maximum evolution of oxygen when the spectrum is thrown upon a collection of active chloroplasts. The heating rays alone are ineffectual, as shown by the fact that there is no liberation of oxygen in the region of the infra-red, due no doubt to the fact that chlorophyll does not absorb these rays.

Timiriazeff, in his classical researches on the liberation of oxygen by the leaves of the bamboo when exposed in tubes of small calibre to a large spectrum, found that the amount of carbon dioxide decomposed by leaves is proportional to the distribution of effective calorific energy in the spectrum.

Van Tieghem's hypothesis that this is a matter of calorific energy may prove to be erroneous, and yet his views may rest on some sound basis. It may be a matter in which electrical rather than calorific energy may be concerned.

Returning now to the chemical steps demanded by Baeyer's hypothesis, there are certain considerations which may be urged in favour of the view that carbon monoxide really occurs in photosynthesis. It has been ascertained by Norman Collie that when a mixture of gases containing a large proportion of carbon dioxide is exposed at low pressures in a vacuum tube to the action of an electric discharge from an induction coil, there is a very large formation of the monoxide, together with oxygen, in some cases as much as 70 per cent. of the gas undergoing decomposition.

Appealing to the experience of various observers, there seems on the whole to be a balance of evidence in favour of the power of plants to live and prosper in an atmosphere containing a very considerable percentage of carbon monoxide.

The question of the possibility of the latter replacing the dioxide, as the theory appears to require, is complicated very seriously by the differences of solubility between them. Carbon dioxide dissolves very readily in water and in cell sap; carbon monoxide is almost insoluble in either. As the amount of a gas taken up by a solvent depends, not only on its solubility, but upon its partial pressure, it is very evident that we cannot compare the two gases by admitting the same quantity of both to plants under simultaneous comparison. It is only necessary to supply the dioxide in the proportion of four parts in 10,000; but the almost insoluble nature of the monoxide makes it inevitable that from 2 to 5 per cent. shall be experimented with. The same question of solubility makes it almost out of the question to experiment with an aquatic plant.

It would be of considerable interest from this point of view also to inquire whether if carbon monoxide is liberated at the outset of the photosynthetic processes its combination with other groupings can take place apart from the action of chlorophyll. If so, the fungi should be capable of carbohydrate construction, if supplied under proper conditions with the monoxide and with hydrogen. The proper conditions, however, might be extremely difficult to establish.

The next stage in the constructive process affords still ample room for investigation. The presence of formaldehyde is not the hypothesis of Baeyer alone, but is demanded according to Bach's views, though the stages of its hypothetical construction are not the same. We have therefore to ask whether formaldehyde can be detected in plants, and if so whether the conditions under which it may exist admit of its being considered an up-grade product in photosynthesis. Objections to the theory of its formation may be advanced, based upon its undoubtedly poisonous nature. Of all the antiseptics now available to the bacteriologists it is perhaps the most potent, even traces being fatal to the form of vegetable protoplasm which is found in bacteria. We may argue that it must be equally deleterious in the cell containing chlorophyll and to the chloroplast itself, as we have no reason to suppose that any difference in vitality exists between the protoplasm of different plants. At first sight this appears an almost insuperable difficulty in the way of the theory. Formaldehyde has, however, the properties of aldehydes in general, one of which is the power of condensation or polymerisation. It passes with extreme readiness into a much more inert form, para-formaldehyde, a body in which three molecules of the formaldehyde are grouped together. It is therefore possible that it may be prevented from exercising its deleterious properties by a transformation at once into this

comparatively harmless modification. This will slowly decompose under proper conditions, giving off the free aldehyde.

Pollacci has stated that it is possible to extract formaldehyde from leaves. In his experiments he took such as had been exposed to light for a very considerable period and then macerated them in water. After a sufficient extraction he distilled the leaves, together with the water in which they had been steeped. The first portions of the distillate yielded reactions indicative of the presence of formaldehyde. His experiments do not enable us to say that free formaldehyde was there, for the more stable para-form would be likely to decompose during the distillation, so that the reactions would be explained without demanding the presence of the free aldehyde in the leaves.

But little success has attended hitherto the attempt to show that formaldehyde, in the presence of chlorophyll, or preferably, we may say, of chloroplasts, can give rise to carbohydrates. We have nothing more satisfactory than Bokorny's experiments, in which, after failing to set up photosynthesis in a filament of Spirogyra fed with formaldehyde, he succeeded when he supplied the alga with its compound with sodium-hydrogen-sulphite. Experiments on a more comprehensive scale, conducted on a variety of plants of different habits, are needed before we can regard the process as satisfactorily established.

We have further to pursue the problem by an inquiry as to the nature of the sugar first formed. Certain considerations lead to the view that it is probable that a sugar of the aldose type must be accompanied in the plant by a ketose. The hypothesis as stated by Baeyer, and so far accepted until quite recently, took no account of the latter. The aldose *grape sugar* was the one always suggested, and from this all others met with have been held to be constructed. The first appearance of a ketose, *levulose*, or *fruit sugar*, has been associated with the hydrolytic decomposition of *cane sugar*, itself constructed presumably from the *grape sugar*. I fear sufficient attention has not been paid to probability or to the normal course of chemical action in framing our hypotheses, for it is rather difficult to see how some of the transformations somewhat dogmatically affirmed can possibly take place. I may refer in passing to the statement that in the digestion of fat or oil during germination part of it is converted into starch or sugar.

But to return to the construction of sugar. The condensation of formaldehyde, which can be brought about by the action of basic lead carbonate, leads to the formation of several sugars, each yielding its characteristic osazone. How far the condensation in the plant follows this is still uncertain. It is quite possible that stages intervene between formaldehyde and sugar of any kind. It has been suggested that formaldehyde in the presence of water may under the conditions obtaining in the leaf give rise to glycolaldehyde, a body which forms sugar very readily indeed. The formation of sugar directly from formaldehyde is a much longer process and is attended with greater difficulty.

I may call your attention here to the views of Brown and Morris traversing the theory of the primary carbohydrate being *grape sugar*. In their classical paper on the chemistry and physiology of foliage leaves, they have adduced strong evidence, based upon analyses of the sugar-content of leaves of *Tropaeolum majus*, that in this plant at any rate the first sugar to be formed is *cane sugar*. Whether or no this is the case in plants generally cannot at present be said, though it appears from many considerations probable.

The part played by chlorophyll in photosynthesis has already been touched upon. Remarkably little is known about chlorophyll itself. It has so far been found impossible to extract it from the chloroplast without causing its decomposition, and hence our ideas of its constitution, such as they are, are based upon the examination of something differing in some not well-ascertained particulars from the pigment itself. A remarkable relationship is known to exist between the latter and iron, for unless this metal is supplied to a plant its chloroplasts do not become green. But the condition of the iron in the plant is uncertain; it seems probable that it does not enter into the molecule of the pigment at all. A remarkable series of resemblances between derivatives of chlorophyll and derivatives of hematin, the colouring matter of hemoglobin, has been brought to light by the researches of Schunck and Marchlewski, which is very suggestive. The same leaning towards iron is found in the two pigments, but in the case of hematin our knowledge is further advanced than in that of chlorophyll. The iron is known to be part of its molecule. It can by appropriate treatment be

removed, and a body known as *haematoporphyrin* is then formed, which presents a most striking similarity to a derivative of chlorophyll which has been named *phylloporphyrin*. The two pigments are almost identical in their percentage composition, the haematoporphyrin containing a little more oxygen than the other. Both seem to be derivatives of pyrrol. The most striking similarity between them is their absorption spectra, their ethereal solutions both showing nine bands of identical width and depth, those of haematoporphyrin being a little more towards the red end of the spectrum. Their solutions in alcohol and ether show the same colour and the same fluorescence. Though they differ in certain other respects, notably the facility with which they form crystals, it is impossible to deny that a close relationship seems probable. If this is established, we may by analogy perhaps learn something about the part played by iron in the action of the chloroplast, which so far has proved as obscure as the relation of the metal to the pigment. It is very suggestive to recall the resemblances between the two pigments, the one playing so prominent a part in animal, the other in vegetable life. Both are associated with a stroma of protoid, or possibly protoplasmic, nature, in which a solution of the pigment is retained, apparently after the fashion of a sponge. Both are concerned in metabolic processes in which gaseous interchanges play a prominent part. Both are in some way dependent on the presence of iron for their individuality, even if iron is not actually present in the molecule of both. The iron being removed, the derivatives which are found are almost identical. Further researches may throw a light on this curious relationship, perhaps showing that chlorophyll may enter into a combination with carbon dioxide as haematin does with oxygen. Such a combination might well be the precursor of the decomposition of the carbon dioxide which has been already spoken of.

We meet with another pigment in many plants the physiological significance of which has in recent years begun to attract some attention. This is the red colouring matter, *anthocyan*, apparently related to the tannins, which is developed especially in the young leaves of shade-loving plants when they become exposed to illumination exceeding the intensity which they normally encounter. The formation of this pigment is greatest in tropical plants, where it is found usually in the epidermis of the young leaves, though in some cases it extends to the mesophyll as well. The pigment seems in some way to be supplementary to chlorophyll, for its absorption spectrum shows that it allows all the rays useful in photosynthesis to pass through it. It is unlikely that it takes any share in photosynthesis. Several theories have been advanced to explain its presence; it may be simply to protect the delicate cells from the destructive action of too intense light, or to avert the evil of overheating from the solar rays. It has been suggested that certain rays hinder the translocation of starch, and that the pigment shields the cells from the incidence of such rays. Again, the view has been advanced that the red colour is important in accelerating the development of diastase from its antecedent zymogen, which has been found to take place under the influence of the rays of a certain region of the spectrum. While all these views have been advanced, however, there is little positive information bearing upon either the formation or the function of the pigment.

Very little progress has been made with the problem of the construction of proteid matter in the plant, which still confronts us. The question of its relation to the mechanism of photosynthesis has received some attention without leading to any satisfactory conclusion. Winogradski's success in cultivating the nitrate bacteria upon purely inorganic matter reveals an unexpected constructive power in some forms of vegetable protoplasm. The question of the energy made use of in proteid construction is in an equally unsatisfactory condition. Laurent, Marchal and Carpioux have stated that the rays of the violet and ultra-violet region of the spectrum are absorbed and devoted principally to the construction of nitrogen compounds from the nitrates, or the compounds of ammonia, which are absorbed by the plant, while the intervention of the chlorophyll apparatus is unnecessary for this purpose. The experiments which they give in considerable detail upon this absorption carry much weight and appear conclusive. Unfortunately, other observers have failed to confirm them, so that at present the matter must be left open.

Among the problems connected with the nutrition of the plant, the part played by alcohol has recently come into promi-

ence. Alcohol was originally associated only with the lower fungi, and especially with the yeast plant. Biological problems of grave importance arose in connection with the Saccharomyces, apart from what seemed at first the larger question, viz. the nature of fermentation. A prolonged study of the latter phenomenon led Pasteur to the view that alcoholic fermentation is only the expression of the partial asphyxiation of the yeast, and its efforts to obtain oxygen by the decomposition of the sugar. It is hardly necessary here to remind you of the controversies that centred about the question of fermentation and the theories held and abandoned as to its cause. The biological phenomena have, however, a claim now upon our attention in the light of some very remarkable researches that are calling for our attention and criticism to-day. Pasteur's explanation of the behaviour of the yeast was, as we have seen, such as to connect it with the respiration of the plant. When oxygen was withheld from active yeast, 60-80 parts of sugar disappeared for one part of yeast formed. When oxygen was present, not more than ten parts of sugar were decomposed for the same amount of yeast production. Undoubtedly the stimulus of asphyxiation materially stimulated the yeast metabolism.

But certain observations did not agree with Pasteur's explanation. An energetic fermentation takes place in the presence of oxygen, the plant multiplies extremely quickly, and its metabolism appears very active. Schützenberger argued against Pasteur's explanation with some force, emphasising these points of disagreement between his hypothesis and the facts, and claimed that the matter rather concerned nutrition than respiration. He based his view on experiments carried out to ascertain how respiration was affected under changed conditions.

The results he obtained were briefly the following:—

(1) In a watery liquid without sugar, but containing oxygen in solution, the quantity of oxygen absorbed in unit time by a gramme of yeast is constant, whatever proportion of oxygen is present.

(2) In a saccharine liquid containing albuminous matter as well as sugar, and with oxygen in solution, the same result is obtained, except that the quantity absorbed in unit time is greater.

(3) In two digestions carried on side by side for some time, one being supplied continuously with oxygen and the other deprived of it, the former produced most alcohol.

If the decomposition of the sugar had been the result of the respiratory activity of the yeast cells at the expense of the combined oxygen of the sugar, it would seem that fermentation should either not have taken place at all in the presence of free oxygen or that it should have been much less than in the other case, whereas the reverse is what is found. Hence Schützenberger advocated the view that the sugar is alimentary and not respiratory.

Certain facts more recently discovered support strongly the view that the nutrition of the yeast is the chief object of the process normally, though we cannot deny that when partial asphyxiation sets in, fermentation is resorted to by the plant in its difficulty, that it may obtain the energy normally supplied by the respiratory processes. The mode of decomposition of the sugar, however, the formation of alcohol and carbon dioxide, raises a question as to the exact form in which the nutritive material is supplied to the protoplasm.

Of these more recent discoveries, the work of Devaux on the trunks of trees may be mentioned first, as it seems to point to a similar problem to the one connected with yeast. Devaux examined the composition of the air in the interior of woody stems growing under normal conditions, and found that the proportion of oxygen it contains often sinks as low as 10 per cent., while in a few cases, in the most internal part of the tree, he found this gas to be entirely absent. The disappearance of oxygen becomes easier with every increase of temperature. The partial asphyxiation is attended by the formation of alcohol in the struggling tissue, the spirit being detected by cutting up the branches of the trees and distilling them with a large excess of water. Devaux's experiments were made upon a considerable variety of trees, among which may be noted *Castanea vulgaris*, *Pyrus domestica*, *Abies glutinosa*, *Ulmus campestris*, *Sambucus nigra* and *Ficus Carica*.

Similar results have been obtained by Mazé in some researches on seeds. When a number of these are submerged in water, micro-organisms being properly guarded against, they do not readily germinate, but their weight nevertheless somewhat rapidly diminishes. In some of Mazé's experiments with peas, he

ascertained that this diminution was attended by a considerable formation of alcohol. Three parcels of forty peas were examined, weighing respectively 10, 17 and 27 grammes, and the experiments lasted six, twelve and twenty-seven days. He found the proportion of alcohol to the original weight of the peas was 2.34, 4.63 and 6.56 per cent. As the peas were submerged, and so kept out of contact with air, it seems possible to suppose we have here again an effect of asphyxiation. Other experiments, however, make this view unsatisfactory. He germinated twenty peas at 22° C. for seven days under normal conditions, till their axes were about 1½ inches long. He then covered them with water, in some cases leaving the terminal bud exposed to air. The development of the submerged plants stopped at once, and at the end of five days the liquid contained 130 milligrammes of alcohol. The seedlings whose terminal buds were exposed to the air continued to grow without showing any disturbance. Mazé concludes that the alcohol produced was utilised by them in their growth, and suggests that it is a normal and necessary product of the digestion of carbohydrate material in seeds in course of development.

He goes on to show that alcohol can be demonstrated to be present in plantlets that have germinated for forty-eight hours at 23° C. under normal conditions.

Another worker of great eminence who has found similar conditions to exist in normal vegetation is Berthelot. He put blades of wheat and leaves of the hazel in flasks, displaced the air by hydrogen, and distilled. In the case of the wheat he heated the flask to 94° C., in that of hazel he conducted the distillation by passing steam through the flask. In both he found the distillate contained alcohol. The quantity was not large, but still measurable; from 10 kilos. of leaves he obtained 10 grammes of alcohol.

Mazé claims to have found alcohol under normal conditions in the stems and leaves of the vine.

Mazé finds, further, that the weight of a seedling of maize approximates at any moment during the early stages of germination to half that lost by the reserve store in the endosperm.

From his experiments, and those of the other authors alluded to, he concludes that alcohol is formed in the living cells of seeds at the expense of grape sugar by virtue of a normal diastasic process, which makes them approach yeast cells more closely than has been suggested by any of the experiments hitherto published. We may inquire further how far the evidence points to the probability that the molecule of sugar is split up in that way into alcohol and carbon dioxide, and that the alcohol is the nutritive part of the sugar molecule. Certainly Mazé's experiments on the submerged seeds with the plumule exposed above the water are not inconsistent with that view. Duclaux has spoken more definitely still on this point, and has said that the alcohol formed becomes a true reserve material to be used for nutrition.

We have, however, further evidence that to some plants, at all events, alcohol is a food. Laborde has published some researches conducted upon a fungus, *Eurotiopsis Gayoni*, which point unmistakably to this conclusion. He cultivated it in a solution containing only the mineral constituents of Rawlin's fluid and a certain percentage of alcohol, usually from 4 to 5 per cent. The plant grew well, forming little circular patches of mycelium, which enlarged radially as the growth progressed. The mycelium became very dense in the centre of the patches, and the fungus evidently thrived well. As it grew the alcohol slowly disappeared, the rate being about equal to that of sugar in a similar culture in which this substance replaced the alcohol. The mycelium in some experiments was cultivated quite from the spores. *Eurotiopsis* is a fungus which has the power of setting up alcoholic fermentation in saccharine solutions. When cultivated in these, alcohol is accordingly produced, and subsequently used, but the growth of the mould is not so easy under these conditions as when the alcohol is supplied to it at the outset.

Duclaux has shown that in the case of another fungus, the well-known *Aspergillus niger*, though alcohol kills it while it is in course of germination from the spore, it can utilise for nutrition 6.8 per cent. when it becomes adult, continuing to grow, and putting out aerial hyphæ. *Eurotiopsis* is more pronounced in its liking for alcohol, for it thrives in a mixture containing 10 per cent.; even if submerged entirely it continues to grow and flourish in an 8 per cent. solution.

The peculiarity relates only to ethyl alcohol; methyl alcohol will serve as a nutritive medium for only a little time, sufficient

only for the commencing development of the spores into a mycelium and disappearing very slowly from the culture fluid. The higher alcohols, propyl, butyl and amyl, not only give no nourishment, but are poisonous to spores. A very small trace of any of them can be used by the adult mould.

Laborde claims to have established as the result of his investigations that *Eurotiopsis* normally makes alcohol from the sugar to nourish itself with it, just as yeast makes invert sugar from cane sugar because it is the nutritive material it likes best. The enzyme zymase is present in the fungus and plays the part of an alimentary enzyme. Its consumption lasts twice as long as that of a corresponding weight of glucose; it can serve twice as long for the nutrition of the same weight of plant.

These remarkable results lead us to the consideration of the mode in which the carbohydrates, and particularly the sugars, are assimilated by the plant. We have held the view that the sugar molecule is capable of entering with little if any alteration into that of protoplasm. We have found no direct evidence bearing upon its fate. It is possible to detect sugar in the axis of a plant till quite near its growing point. Then the reaction ceases to be obtainable, and we know that assimilation is taking place. But we have still to investigate the steps, no very easy problem to undertake. May it possibly be that it is the alcohol moiety of the sugar which the protoplasm takes up, part of the carbon dioxide evolved by the growing organ being an expression, not of respiration, but of a fermentation preliminary to assimilation?

But I feel I have dealt at sufficient length with this question. I pass, therefore, to consider briefly another nutrition problem of a rather different kind. The germination of seeds is a question that might be thought to have been fairly settled by the investigations of the latter half of the last century. We have come to the conception of the seed as fundamentally a young embryo lying quiescent within its testa, and provided with a store of nourishment deposited either within its own substance or lying round it in the tissues vaguely named endosperm or perisperm. The nourishment has been held to be practically ready for its use, needing only a certain amount of enzyme action to be applied to it to convert the food store from the reserve to the nutritive condition. We have recognised here starch, proteids and glucosides, and have ascertained that the embryo can furnish the appropriate enzymes for their digestion. Each reserve store has apparently been quite independent of the rest, and the embryo has had control of the whole.

Certain considerations, however, lead us to the view that for albuminous seeds at any rate this mode of looking at the matter is no longer satisfactory. We may first ask how far the embryo is the controlling factor in the digestion. Putting the matter in another form, is the influence of the parent plant lost when a stable store of food has been provided for the offspring, and does it leave its utilisation entirely to the latter? Is the gametophyte prothallus merely to become a dead or inactive structure as soon as it has developed its young sporophyte, or may its influence extend for the longer period of germination? There are many reasons for thinking this is the case. Indeed, the view has been put forward by some observers at intervals for some years. Gris claimed to have shown it in 1864; but it was opposed by Sachs, who said that the enzymes which cause decompositions in the reserve materials are always formed in the young plant or embryo and are excreted by the latter into the endosperm. Some careful experiments on the point were conducted by Van Tieghem and were published by him in 1877. His work was carried out on the seeds of the castor-oil plant. He deprived the seeds of their embryos and exposed them for some weeks on damp moss to a temperature of 25–30° C. After several days of this exposure, he found the isolated endosperms were growing considerably, and at the end of a month they had doubled their dimensions. In the interior of the cells he found the aleurone grains to be gradually dissolving, and the oily matter to be diminishing, though slowly. The dissolution extended throughout the mass of the endosperm, and was not especially prominent in the side that had been nearest to the cotyledons. He noted, too, that though starch did not normally appear in the germinating endosperm, under the condition of non-removal of the products of the decomposition, it did appear in the cells in the form of small grains, though not till after several days had elapsed. Van Tieghem also observed that the progress of the decompositions could be arrested and the endosperms made to reassume a quiescent condition, and that then the aleurone grains again became formed, though in less quantity than before.

In some experiments on *Kicinus* which I carried out in 1889, I found much the same sequence of events as Van Tieghem had described. The endosperm unquestionably became the seat of a renewed metabolism, in the course of which many interactions between the various reserve materials became noticeable. It was remarkable that the activity of this metabolism was much more pronounced when the embryo or parts of it were left in contact with the endosperms.

An observation of a similar character has been made by Haberlandt and by Brown and Morris in the case of the seeds of grasses. The conversion of the reserve cellulose of barley grains has been shown by these observers to be the result of the action of an enzyme *lyase*, which is secreted largely by the so-called aleurone layer, which is found surrounding the endosperm, immediately underneath the testa.

Recently my own work has been bearing on this question, particularly as regards the behaviour of the seeds of *Kicinus* during germination. The reserves of this seed are mainly composed of oil and aleurone grains, hardly a trace of carbohydrates being present. At the onset of germination there is a remarkable appearance of both cane sugar and glucose, which increase as the oil diminishes. The old view advanced to explain this fact has been the transformation of the oil directly into the sugars or one of them, a theory which it was difficult to reconcile with the chemical possibilities of oil. I have found that side by side with the appearance of the sugar we have also the formation of a considerable quantity of lecithin, a fatty body containing nitrogen and phosphorus. The seed contains a comparatively large amount of phosphorus in the form of the well-known globoids of the aleurone grain, a double phosphate of calcium and magnesium. The occurrence of this body points to a considerable interaction of various substances existing in the seeds, the phosphorus apparently coming from the globoids and the nitrogen from the proteids. Instead, therefore, of the fat being transformed into sugar, it seems certain that a very considerable metabolism is set up, in which the very constituents of the endosperm interact very freely together. I am informed by Mr. Biffin, who has investigated the histological changes accompanying the germination, that the protoplasm of the endosperm cells appears to increase in amount very greatly during the early stages. The observations suggest a very vigorous resumption of metabolic activity by the cells of the endosperm, in the course of which the various reserves are brought into relation with the living substance of the cells and a number of new products are formed to minister to the nutrition of the growing embryo. The formation of the sugars may more probably be referred to the renewed activity of the protoplasm of the parent gametophyte than to a direct transformation of the fat under the influence of the embryo. Further researches upon a large variety of seeds appear necessary to give us a true idea of the chemical processes of germination. What now appears probable in the case of fatty seeds may prove to be true also in the case of those which have other varieties of reserve material.

I have already alluded to the problems concerning the electrical phenomena presented by the plant at rest and during activity. Very little work has so far been done in this direction, and our knowledge of the subject is materially less than that concerning similar phenomena in muscle and nerve. Still a beginning has been made, and we have observations on record due to Waller and to Bose which are of the greatest interest, not only because they show a great correspondence in behaviour between animal and vegetable structures, but on account of their possible importance in determining the character of many of the metabolic processes and the forces at work in the tissues.

Some very striking results were only a few months ago published by Bose on the electric response in ordinary plants to mechanical stimulation. He arranged a piece of vegetable substance, such as the petiole of the horse-chestnut, or the root of a carrot or a radish, so that it was connected with a galvanometer by two non-polarisable electrodes. The uninjured tissue gave little or no evidence of the existence of electrical currents; but if a small area of its surface was killed by a burn or the application of a few drops of strong potash, a current was observed to flow in the stalk from the injured to the uninjured area, just as is the case in animal tissue. The potential difference in a typical experiment amounted to 0.12 volt. The tissue was then stimulated, either by tapping or by a torsion through a certain angle, and at once a negative variation or current of action was indicated, the potential difference being decreased by 0.020 volt. Very soon after the cessation of the stimulus, the

tissue recovered and the current of rest flowed as before. Bose's investigations extended considerably beyond this point, and established a very close similarity in behaviour between the vegetable substance and the nerves of animals. Summation effects were observed, and fatigue effects demonstrated, while it was definitely shown that the responses were physiological. They ceased entirely as soon as the piece of tissue was killed by heating.

This remarkable demonstration of similar electrical properties to those possessed by nerve strengthens very greatly the view of the conduction of stimuli in the plant by means of the protoplasmic threads which have been demonstrated by Gardiner and others to exist throughout the plant, uniting cell to cell into one coherent whole.

Much remains to be done in this field; indeed, not more than a beginning has been made. The electrical accompaniments to response to stimuli have been investigated by Burdon Sanderson in the case of *Dionaea*, but many other instances are still awaiting examination. The peculiar phenomena of electrotonus and their relation to stimulus have so far only been observed in animals.

These observations strengthen considerably the view of the identical nature of animal and vegetable protoplasm which has in recent years come into prominence, and which is receiving more and more support in all directions.

These electrical currents, following mechanical action, which no doubt is accompanied by chemical change, make us ask whether electrical phenomena do not in all probability accompany the slow chemical actions which we call metabolism. The view that electrical energy is concerned in the processes of photosynthesis, suggested in an earlier part of this Address, is certainly not weakened by a consideration of these phenomena.

The probability of the transmission of stimuli through vegetable tissue along the protoplasmic threads, extending from cell to cell, has been supported during the last year or two by some remarkable observations claimed to have been made by Nemeč on certain roots and other organs. He says he has succeeded in demonstrating a continuous fibrillar structure in the protoplasm of the cells, fibrils passing along it in a longitudinal direction and apparently connecting the protoplasm of a longitudinal series of cells into a conducting chain. These conducting strands extend between the sensitive region—e.g. the tip of the root—and the region which is growing, and which is caused by the stimulus to curve. Nemeč says that these conducting strands can be made evident by the use of appropriate staining reagents. They vary in number and position, but appear to be confined to sensitive and motile organs.

It is clear that the matter cannot rest where it is. The statements made by Nemeč call for investigation by both histological and physiological methods. It is possible that appropriate reagents may lead to the recognition of structure in what has been hitherto regarded as undifferentiated protoplasm.

Before concluding this Address I may call attention to the vast field opening up in connection with the pathology of plants. The work done by our predecessors has been more largely work on the morphological peculiarities of various fungi than upon the physiological changes which constitute pathology, properly so called. It is only recently that attention has been given to the broad questions of disease in plants. Even now, however, certain advances have been made, and the direction of research is taking shape. In the science of pathology, little in recent years has been so fascinating as the question of immunity against the attacks of certain diseases, either hereditary or acquired. It has been bound up with the very large question of toxins and their attenuation, their opposites, the antitoxins and matters of a similar nature.

Great results have been obtained in human pathology, with which it is not for me to deal. I mention them here because we are face to face with the possibility of treating some of the diseases of plants in a similar way, and perhaps on the threshold of very far-reaching discoveries.

I may call attention to the discoveries of Ray and of Beauverie upon the general question of plant infection and especially upon a disease set up by a fungus known as *Botrytis cinerea*, which attacks grapes, begonias and other plants. The fungus exists in three forms, one of which is a harmless saprophyte, another a destructive parasite and a third intermediate between the two. The first is a very common fungus, developing on decaying plants and bearing ordinary conidia or spores. The second is completely filamentous and bears no reproductive

organs. It is produced when the air is heavily charged with moisture and the temperature high, conditions of common occurrence in forcing houses. The third is an attenuated form intermediate between the other two. It bears gonidia like those of the first, and in addition others which germinate without falling off the parent plant and elongate into long threads. Many plants can bear the invasion of this plant without suffering greatly, though it cannot be called harmless. It occurs chiefly when a high temperature is associated with a considerable amount of moisture in the air.

It is not difficult to cultivate this attenuated form of the *Botrytis* in sterilised soil. Beauverie describes one experiment made with it which is very striking. Damp earth was sterilised in a Petri dish of large surface, sown with spores of the *Botrytis* and kept at a temperature of about 16° C. After three days, the surface of the dish was covered with a loose mycelium, which bore numerous gonidiophores. The fungus was allowed to grow for some time under these conditions, and the infected earth was then transferred to fresh pots in which were placed cuttings of begonias. The plants grew well and were not sensibly affected by the presence of the fungus in the substratum or in its surface. Placed subsequently in conditions which were eminently suitable to the development of the parasitic form, they resisted its action perfectly, though control plants which had not been cultivated in the ground infected by the attenuated form were killed very quickly. From their experiments the authors claim to have shown that the form of *Botrytis cinerea* intermediate between the gonidial and the sterile form can make plants immune to the attacks of the latter.

Researches of a somewhat kindred nature dealing with the infection of particular plants by specific fungi have been communicated recently to this Section by Prof. Marshall Ward in his paper read last year on the Bromes and their brown rust. They brought to light many very important facts connected with the question of adaptive parasitism and immunity. Few questions in vegetable physiology can compare in economic importance with these when we think of their possible development in relation to agriculture.

I have now somewhat hurriedly surveyed certain parts of the field of vegetable physiology. It has been impossible in an Address like this to do more than indicate what seem to me some of the more important problems awaiting investigation. May we hope that all such work will be vigorously conducted, but that the conclusions reached will be scrutinised with the greatest care and subjected to repeated examination? Great hindrances to the advance of the science resulted from dogmatic assertions made by eminent men in the past, their personal influence having led to their conclusions, not altogether accurate, being nevertheless almost universally accepted. Many years subsequently these conclusions have needed re-examination, the result being the destruction of a whole fabric that had been reared upon this unworthy foundation. I may close, as I began, by an appeal to the younger school of botanists to take some of this work in hand, and by assiduous and critical experiment and observation to contribute to the solution of the problems pressing upon us in this field.

SECTION L.

EDUCATIONAL SCIENCE.

OPENING ADDRESS BY PROF. HENRY E. ARMSTRONG, LL.D., PH.D., V.F.R.S., PRESIDENT OF THE SECTION.

The last meeting of the British Association at Belfast was presided over by Prof. Tyndall, one of whose most memorable discourses was that delivered at Liverpool in 1870 on "The Scientific Use of the Imagination." In the course of his Address, the President could point out that "science had already to some extent leavened the world," and abundant proof has since been given that he was right in claiming that "it will leaven it more and more." Nevertheless, if we consider the leavening effect which science has had on the public mind, it is impossible to deny that progress is being made in this direction at a woefully slow rate, in no way proportionate to the growth of knowledge or to the recognised usefulness of the many discoveries which are the outcome of scientific investigation. Science is still treated by society as a rich *parvenu* all the world over, and is at most invited to its feasts, but not incorporated, as it should be, with the domestic life of the people.

Complaint has long been rife that the British are indifferent as a people even to things which are of manifest importance, and which as a nation of business men they might be expected to value. It would certainly seem that we are all too forgetful of Tyndall's warning that "every system which would escape the fate of an organism too rigid to adjust itself to its environment must be plastic to the extent that the growth of knowledge demands." As our President said a full quarter of a century ago, "when this truth has been thoroughly taken in, rigidity will be relaxed, things not deemed essential will be dropped, and elements now rejected will be assimilated. The lifting of the life is the essential point, and as long as dogmatism, fanaticism and intolerance are kept out, various modes of leverage may be employed to raise life to a higher level."

But how are we to become plastic to the extent that the growth of knowledge demands, in order that rigidity may be relaxed, that conservatism may give way to a wise spirit of advance? Probably there is no more important question the nation can ask at the present time; for that we are wanting in plasticity is proved to demonstration. Does not the shade of our former President stand before us and solemnly give answer: "By the cultivation and exercise of imaginative power—by the scientific use of the imagination"; for in these days are we not indeed a people "of little faith"? There would seem, in fact, to be clear evidence, if not of destruction, at least of impairment, of imaginative power under modern conditions—that the tendency of education is to kill rather than to develop the very power on which the progress of the world depends. A death of imaginative power is strikingly apparent in art, in literature, in music, in science; in public taste generally, the prevailing tendency being to imitate rather than to originate and individualise. Commentators and critics of sorts abound, but these rarely display any catholicity of judgment. Leaders are few and far to seek. The prevailing policy is that of the party in power, and more often than not of a caucus behind it—not the policy which on broad general grounds is the most desirable; in fact, little attempt is made to discover in any scientific manner what would be the really wise policy to pursue. Nothing could illustrate this better than the state of chaos into which affairs educational are plunged at the present time. Those who dare to differ or offer advice are looked at askance, and always with jealous eyes; and too often everything is done to block the way of the reformer, not from any base motive, but as a rule from sheer inability to appreciate what is proposed—from sheer lack of imaginative power. Necessarily, as the conditions of civilisation become more complex, the tendency to accept and follow must become greater, and self-satisfaction more and more complete and general; but unless effective means be taken to counteract such a tendency, decay is inevitable.

The phrase "creatures of habit" is familiar to us all; few will deny that we are seldom otherwise than creatures of habit and that plasticity of mind is a rare attitude. But the growth of knowledge is taking place at such a compound interest rate that a high degree of plasticity is essential if we are to avail ourselves thereof. We were formerly accounted a nation of shopkeepers—of clever shopkeepers—but now the title is passing from us to the Germans and Americans, because they are more alive than we are to the fact that in these days it is necessary both to organise and to be alive to every opportunity. If we would put money in our purse in future, it will be necessary to put imagination into our affairs, so that we may be far more ready to act than we have been of late years.

And not only is knowledge increasing, but our responsibilities are daily becoming heavier and heavier. In the minds of thinking men at the present time, the burden of empire our nation bears is of appalling magnitude; the men who have imaginative power are agast at the flippant unconsciousness of responsibility manifest in the public at large, and even in the majority of our statesmen and politicians. It is widely felt that a deeper sense of responsibility must be induced among us if we are to maintain our heritage intact—if we are to remain worthy to play the great part for which by an inscrutable ordinance we find ourselves cast at the very commencement of a new century. Nothing is so sure as that if we cannot show ourselves to be worthy we shall not long be allowed to play the part: jealousy confronts us on all sides, and we have learnt that the struggle for existence is Nature's first law, against which philanthropy is powerless so long as it is not universal—a contingency which is not even remotely possible. It is little short of remarkable that we should be able to go so far as we

do in securing the services of able men to conduct our affairs generally; but we cannot be too mindful of the duty incumbent upon us of developing the store of ability latent in the nation, and above all of maintaining intact our heritage of individuality.

The call to organise the forces of our empire is imperative, but we do not heed it in any proper manner. For many years past we have rarely refused to treat with utmost consideration the representations of those who have dwelt on the importance of our Navy. One of the most highly respected men in the country at the present day is our gifted American cousin, Captain Mahan, on account of the way in which he has exercised his powers of imaginative insight and taught us to understand our achievements at sea, to appreciate the true meaning and value of sea power. We need a Mahan to discuss the larger issues of national defence through education, to teach the nation the true meaning and value of education. The Ship of State is of vastly greater consequence than the mere Navy, and yet those who direct attention to the insufficient character of its armament are scarce identified; not the slightest effort is made to secure for it a scientifically adjusted and organically complete machinery for the effective administration and working of all its departments; the drill of its crew is woefully incomplete; what is worse, there is a terrible absence of organisation and discipline, a terrible absence of willingness, little, if any, desire among those who are charged with its care to cooperate, and the consequences of neglect are not immediately obvious. In war we appreciate the effects suddenly: a long list of killed and wounded brings its meaning home to us at once; and we know that we must pay the penalty of defeat forthwith. The indemnity exacted can be expressed as a lump sum. The battle of life is waged in a less obtrusive way, the killed and maimed are not scheduled in any regular manner, and so it escapes our notice that in reality the carnage is awful, that few, if any, escape without severe wounds, that defeat is constant and yet often dealt so silently and imperceptibly that it excites little comment. But we know that vastly more than is done might be done to alleviate if not to prevent suffering, and even to give charm to life where at present there is but pain, if only our efforts could be organised. If we reflect on the bareness of the life lived by the majority, on the debasing conditions under which very many are placed, on the terrible evils consequent on indulgence in drink, surely we must agree with Tyndall that the essential point is to raise life to a higher level, to elevate the general tone of thought, and that it is our duty to consider more seriously than we have done hitherto what use can be made of the forces at our disposal for the purpose.

If we will but picture to ourselves how most of our difficulties, and especially our slow advance, are consequences of lack of imaginative power, or perhaps rather of failure to exert the power which, though latent in most of us, is not sufficiently called into being by practice; if we will but consider how much of our success has been due to the exercise of imaginative power, we may be led to propound a fruitful theory of education, a theoretical basis on which a sound educational structure may be reared. It has been well said by Carlyle "that all that man does and brings to pass is the vesture of a thought." In fact, the illustrations which may be given of the value of theoretical conceptions, of imaginative power, are innumerable. Taking recent events, if we consider the success achieved by the late Mr. Rhodes, the narrow-sighted will say he was a practical man; a man who did things and led others to do. Those with broader views recognise that at heart Mr. Rhodes was a theorist, an idealist, a man of imagination, and hence his success. And men such as Lord Roberts and Lord Kitchener, whose immense services to the nation have been so universally admitted of late, are not merely practical soldiers of experience, but men gifted with powers of insight and imagination; men able to apply theory to practice. Some of those who were unsuccessful in the late campaign are currently reported to have gone out to South Africa openly deriding science, and it will be well if the lesson taught by their failure be not disregarded by their colleagues. The importance of the part played by theory in science cannot be exaggerated. We have only to think of the influence exercised by the Newtonian theory of Gravitation, by the Daltonian theory of Atoms, by Faraday's conception of Lines of Force, by the Wave theory in its varied applications, by the Darwinian theory of Evolution; we have only to think of the way in which the reflections of one weak man indited at his study-table in a secluded Kentish village have changed the tone of thought of the civilised world. Such theories are the

very foundations of science; whilst facts are the building stones, theories furnish the design, and it is the interpretation of facts in the light of theory and the considered application of theory to practice that constitute true science. The marvellous development of scientific activity during the past century has been consequent on the establishment of fruitful theories. If teachers generally would pay more attention to theory their teaching would doubtless be more fruitful of results; facts they know in plenty, but they lack training in the considered use of facts. False prophets among us have long taught the narrow doctrine that practice is superior to theory, and we pretend to believe in it. That the belief is founded on misconception may safely be contended, however; the two go together and are inseparable. It is true that we have enjoyed the reputation of being a practical people, and have been accustomed to take no little pride in the circumstances, and to scoff somewhat at theory, but behind our practice in the past there was a large measure of imaginative power, of theoretical insight; in fact, we were successful because we were innately possessed of considerable power of overseeing difficulties, of grasping an issue, of brushing aside unessential details and going straight to the point; in other words, of being practical. We are ceasing to be practical because modern practice is based on a larger measure of theory, and our schools are paying no proper attention to the development of imaginative power or to giving training in the use of theory as the interpreter of facts; didactic and dogmatic teaching are producing the result which infallibly follows in their wake—sterility of intellect.

Mr. Francis Darwin, in his *Reminiscences of his father*, tells us that "he often said that no one could be a good observer unless he was an active theoriser." And he goes on to say: "This brings me back to what I said about his instinct for arresting exceptions: it was though he were charged with theorising power ready to flow into any channel on the slightest disturbance, so that no fact, however small, could avoid releasing a stream of theory, and thus the fact became magnified into importance. In this way it naturally happened that many untenable theories occurred to him; but fortunately his richness of imagination was equalled by his power of judging and condensing the thoughts that occurred to him. He was just to his theories and did not condemn them unheard; and so it happened that he was willing to test what would seem to most people not at all worth testing."

In his *Autobiography*, Darwin remarks:—"I have steadily endeavoured to keep my mind free so as to give up any hypothesis, however much beloved (and I cannot resist forming one on every subject), as soon as facts are shown to be opposed to it." The italics in these passages are mine.

Our system of education has no proper theoretical basis. Educators have ceased to be practical because they have failed to keep pace with the march of discovery, the theoretical basis underlying their profession having been enlarged so rapidly and to such an extent that it is beyond their power to grasp its problems. The priesthood of the craft are, in fact, possessed by the spirit of narrow parochialism, and upholders of an all too rigid creed, being lineal descendants of a privileged class—"the knowledge caste," to use Thring's expression—whose functions were far more limited than are those which must now be discharged by teachers if teaching is to be given which will serve as an efficient preparation for life under modern conditions. They enlarge *ad nauseam* on the superiority of literary and especially of classical training, forgetting that their preference for classics is but the survival of a practice and that their arguments in defence of a literary system are but preconceived opinions. Being incapable of appreciating the arguments used on the other side, it is unlikely that they will ever be able to admit their force.

So long as the forces of Nature were not tamed to the service of man, they could be neglected; sanitary sins were alone found out and punished with unsparring severity. But now it is otherwise. To succeed in competition with others we must be able to avail ourselves of every opportunity; and wide understanding is demanded of us. Moreover, the growth of knowledge has induced severe mental hunger, and the feeling that the dainty dishes provided by Nature should be in no selfish manner restricted to the few is a growing one; altruism is a growing force. We feel that we are called upon to counteract the evils arising from the growth of our cities; from the concentration of workers in large bodies; from the minute subdivision of labour; from the depressing conditions under which the masses daily

toil. To provide relief and healthy occupation for leisure hours, and to secure that vacuity of mind and pettiness of motive shall no longer be the sore affliction they now are, we must take all the requirements into consideration and define with utmost minuteness the task in hand; broader and higher ideals than those now prevailing must be established and practical requirements must be met. To secure the right attitude of mind for this task will not be easy. Few realise, few know, how signal is our failure to appreciate our power, how deplorably we neglect our opportunities. The bareness of the fare we provide is nothing less than shameful in view of the rich possibilities which lie ready to hand.

In saying that
A primrose by a river's brim,
A yellow primrose was to him
And it was nothing more,

the poet has well pictured our average attitude towards our surroundings. To the majority, indeed, a primrose is scarcely a primrose; it is unseen. It is little short of impossible to account for our callous disregard of the wondrous beauty of the multitudinous objects displayed in Nature's realm, our willingness to remain ignorant of the meaning of the mysterious changes which are ever happening before our eyes. That familiarity should breed such contempt is passing strange; but how great the guilt in these days of those who allow the contempt to grow up, knowing as they must that the ignorance is easy to dispel, knowing also that those versed in the mysteries have ever sought to lay bare all that is within their ken. The failure on the part of those who have the charge of education to make a scientific use of the imagination is nothing short of complete; there is nothing to show that the imagination is ever called into play.

Surely it were time to make some real effort to imbue all with a proper understanding of their surroundings, to create in all minds a higher and reverent interest in life.

It is a sad reflection and a grievous blot on our civilisation that our spiritual advisers are mostly so little regardful, so destitute of understanding, of the works of that Omnipotent Power which all must recognise and humbly submit to, whether or no allegiance be acknowledged in doctrinal terms; they before all others should be prepared to consider their inmost meaning and to direct attention to their wondrous mechanism. We indeed need to send forth a new mission charged with the holy duty of enabling man to appreciate and acknowledge the beauty of the universe, as well as of preparing him to be a thoroughly effective worker, thus fitting him for the true, unselfish and reverent enjoyment of life. To use the apt words of the Master, quoted by the Poet at the Breakfast-table: "If for the Fall of man, science comes to substitute the Rise of man, it means the utter disintegration of all the spiritual pessimisms which have been like a spasm in the heart and a cramp in the intellect of men for so many centuries."

If we can but make sweet use of our present adversity, though we may not be exempt from public haunt but live even in crowded cities, we shall unquestionably soon find

... tongues in trees, books in the babbling brooks,
Sermons in stones and good in every thing.

The wonderful presence of our great poet is nowhere more clearly displayed than in these lines, and it is more than surprising that although generations have been charmed by the music of the words, so little has been done to realise their meaning or to give them a meaning in the minds of the majority.

It is but a question of attitude, for, as Carlyle somewhere says, "so soon as men get to discern the importance of a thing they do infallibly set about arranging it, facilitating it, forwarding it, and rest not till in some approximate degree they have accomplished that."

Unfortunately, there are all too many things of which we fail, through our faulty education, to discern the importance, but which a little understanding, the exercise of some slight imaginative power, would enable us to appreciate. I will take the word *Energy* as an example. No word in the English language carries more meaning to those versed in the principles of physical science, and yet how narrow its connotation in the minds of the uninstructed majority. As a guide of practical conduct, no word is of greater significance, and if its true implication fully seized us the word would ever rankle in our ears and serve to remind us of the maxim "Waste not, want not." In Great Britain we are using up our coal stores at the rate of over two hundred millions of tons per annum. Used at such a rate, the supply cannot last many generations; whence will our

children derive their supplies of energy? Energy cannot be created. When we have squandered the wealth funded on our earth by the sun in eons past, we must fall back on the modicum we can snatch from the daily allowance the glowing orb dispenses, for his largess will for the most part be wasted and will be very difficult to garner in our country, sun mills, wind mills and falling water being but irregular and ill-disciplined servants, trees growing but slowly. In all civilised countries the same criminal waste of fuel—of energy—is going on; but although we recognise that individual men have no right to live beyond their means and have little pity for bankrupts, no corresponding feeling exists on the subject of collective squandering. The spendthrift is regarded with equanimity, because he but distributes his gold among the many—so that the many gain while he alone is the loser—but the energy of fuel is spent irrecoverably, and all waste is not merely apparent, but real. To waste fuel is to court criminal bankruptcy; but to how many does it occur that we are all parties to such a crime? Does any schoolmaster or schoolmistress call attention to the fact? How many heads of schools could even write a respectable essay on such a topic? When I have suggested "A piece of coal" as the subject for a scholarship examination essay, I have actually been told by literary critics that you have no right to ask for knowledge of facts in a schoolboy's essay, the object being but to find out to what extent he can "gas" in flowing periods! A scuttle full of coal excites no emotions in the literary mind; it should be one to call up harrowing visions, as well as a vista of memories extending far back into the ages of time, for in no other stone can we find a more wonderful sermon.

To descend to the ordinary level, how many householders ever take into consideration the wicked waste of fuel which goes on in their establishments? how many are really thrifty in the use of fuel? I never see a "Kitchener," or hear it roar, but I shudder. The prevention of smoke is of no consequence in comparison with the prevention of the waste of fuel. Even when every care is taken the waste is very great—simply because our means of utilising the energy of fuel are so imperfect. The best steam engine can recover for us but very few per cent. of the energy stored up in the coal which is burnt in its boiler fire. If we could succeed in burning fuel electrically—in directly converting the latent energy into electricity—it is conceivable that the engine might be of nearly theoretical efficiency. But what imaginative power must be exercised to secure such a result! Cannot we in some measure hasten the time of such discovery? Prof. Perry not long ago had the temerity to direct attention anew to the subject in *NATURE*, and made what many practical people will consider the impossible suggestion of a wildly imaginative, irresponsible Irishman—that a round million or so should be devoted to systematic experiments, with the object of discovering means of increasing the efficiency of our engines. If we consider what is the cost of a modern battleship; if we consider what has been spent on the war in South Africa; if we consider the extent to which the value of the fuel at our disposal would be increased if we could only double the efficiency of our engines and of our stoves, Prof. Perry's proposal cannot be regarded as otherwise than modest and sensible. But what is of real importance is the implied suggestion that the subject should be seriously inquired into at national expense. It must, and at no distant date, be admitted that our fuel stores are national assets over which there should be some national control.

I may take Food as another subject of which we fail to discern the importance, and which is outside the schoolmaster's ken, although teachers have stomachs as well as other men, and boys in particular are believed to take some interest in the existence of that organ. It is but a variant on that of energy, as the food we take is mainly of value as the source of the energy we expend—as fuel, comparatively little being required for the construction and repair of the bodily machinery.

... God has made
This world a strife of atoms and of spheres;
With every breath I sigh myself away
And take my tribute from the wandering wind
To fan the flame of life's consuming fire.

Oliver Wendell Holmes.

How many will appreciate this pregnant passage; in how many schools is instruction given which would make it possible to recognise its beauty and completeness as a statement of the philosophy of the respiratory process? Our ignorance of ourselves and of the functions of food is indeed phenomenal. Life involves the unceasing occurrence of a series of changes for the

most part chemical. If the proper study of man be man—as the highest dignitary of our Church some time ago asserted it was—the ordinary person would be prone to assume that those in charge of education would so direct studies as to give man some interest in his own wonderful mechanism; instead they almost uniformly direct that true “culture” consists in knowing what he has thought and written of himself in classic tongues, in ages gone by before the slightest vestige of understanding of the phenomena of life had been obtained. And we moderns calmly suffer this, and at the same time wonder at the way in which primitive peoples allow their medicine men and wizards to dominate them. Taking into account what is known, ours perhaps is relatively a deeper savagery than is that of most un-tutored races; our educational priesthood are for the most part never trained to a knowledge of the mysteries and deny admission through ignorance rather than willfully.

From food to the preparation of food is an easy step—in point of fact, the knowledge how to prepare food properly is of far more importance than any knowledge of what food is and does, as on it depends much of the happiness and health of mankind. Cooking is a branch of applied chemistry. We live in a scientific age—an age of knowings. We might therefore expect that our girls at least would be so trained at school that with little effort they could become knowing cooks. I am not aware that the authorities who lay down the regulations for University Locals or similar examinations have allowed any such vulgar considerations to guide them in drafting their examination schemes: niceties of grammatical construction, recondite problems in Geography and History, the views of an ancient philosopher who gave himself up to angle worship, are alone thought of on such occasions; and yet there are times, it is said, when these august persons deign to take some notice of culinary efforts, and they cannot be unaware that cookery is a subject of some importance, which might well at least be led up to at school. To justify my reference to the subject, let me read a passage from “An Address on Education,” delivered, not by a narrow-minded Goth who is so lost to reason as to doubt the sufficiency of an exclusively literary training as a preparation for life, but by a classic, the Headmaster of a great public school, Thring of Uppingham, in speaking of the Higher Education of Women at St. Albans in 1886.

“We English are proud of our homes. We sing songs about them, we write on them; in fact, we are very justly proud of our homes. Has it ever entered your minds that home to the great majority in a very large degree, and to all in some degree, is but a lotlier name for cookery? In a cottage good cookery means economy, luxury, health, comfort, love. . . . Cookery to the vast majority of mankind means home, and when the weary worker comes back from work wanting to refit, cookery alone can turn him out fit for work again. From this point of view home is cookery.”

Cookery is certainly a subject of which those in charge of education have not yet in any way discerned the importance. Our cooks are inferior and wasteful simply because they fail to exercise sufficient imaginative power. If we wish to make good cooks of our girls, we must teach them to think for themselves and to be imaginative—to make a scientific use of their imagination; they will then come to see that the subject is a vastly interesting one, full of opportunity for research. The kitchen, of all places, is the one, in fact, in which the heuristic method should most flourish.

Could we find tongues in trees we should doubtless find them eloquent on the subject of food supply, and far more delicate in their tastes than any mortals. But how many of us, looking at a green leaf, can in any way call to mind the wonderful mechanism which enables the plant to secure the main bulk of its solid substance from the fleeting stores in the circumambient atmosphere; or the manner in which it is dependent on light; or its mineral needs; or its great need of water and its wonderful transpiratory activity? And yet the chief industry of the world is agriculture—the feeding and tending of plants. At least those who lead a rural life should have their imagination excited on such subjects at school; it is even possible that much of the asserted dullness of a country life might pass away if an interest in plant activity were properly cultivated. And schoolmasters might even find comfort in the reflection that, as Messrs. Brown and Escombe have recently shown, the translocation of the material first formed in the leaves, metabolism and growth are become so intimately correlated that the perfect working of the entire plant is only possible in an atmosphere containing the

normal amount of three parts of carbon dioxide per ten thousand; they might recognise in the plant an organism after their own heart, with ripened conservative instincts, and unwilling to accept any other than the limited diet long favoured by the craft.

In these days, not only the obvious, but also the microscopic forms of life claim attention, and it is imperative that all should be at least aware of their existence and mindful of the deadly power that some of them exercise. All should be able to read with intelligence the wonderful story of the beneficent labours of the great Pasteur—a true saviour of mankind—and appreciate their value. The lessons of sanitary science will never be properly brought home to us and heeded in daily life until a more direct intimacy with micro-organisms is encouraged at school.

And whether or no there be “good in everything,” children must at least be encouraged to seek it; to use their eyes always, and to reflect on what they see. A proper use will be made of leisure and of holidays when they are so trained, and even “Days in the Country” will be days of enjoyment and peace for all, never of mere vacuous wanderings, let alone of wanton destruction, and will leave no memories of broken glass and waste paper behind them. And in the end the national drink bill may be considerably diminished if Shakespeare’s words come to have some slight meaning for all.

Let us consider what we can do to further this most desirable end. Section L is in advance of the times, being concerned with a non-existent science—the Science of Education. The science will come into existence only when a rational theory of education is developed and applied; but it is clearly on the very eve of coming into existence, otherwise the section could not have been established; and we may contribute much to its development.

Surely, the primary article of our creed will be that—as Thring has said—“the whole human being is the teacher’s care,” for all must admit that the faculties generally should be cultivated and educated. At present we make the fundamental mistake of disregarding this truth, but there is evidence that sounder views are beginning to prevail. It is very noteworthy, for example, that in the recent report of the Committee on Military Education it is laid down that five subjects are to be regarded as necessary elements of a sound general education, viz. English, Mathematics, a Modern language, Latin and Experimental Science. Moreover, it is recognised that each of these subjects has a peculiar educational value of its own. Such a conclusion takes the breath away; indeed, it is almost beyond belief that Headmasters of Public Schools could commit their brethren by attaching their names to a report containing such a paragraph as the following:—

“The fifth subject, which may be considered as an essential part of a sound general education, is Experimental Science, that is to say, the Science of Physics and Chemistry treated experimentally. As a means of mental training, and also viewed as useful knowledge, this may be considered a necessary part of the intellectual equipment of every educated man, and especially so of the officer, whose profession in all its branches is daily becoming more and more dependent on Science.”

Just consider what this recommendation means; that it is now publicly admitted by high authority that all boys should have the opportunity given to them at school of gaining knowledge by experience—by actually doing things themselves, not merely by reading about them or being told about them, because this, and nothing short of this, is what is aimed at by all who advocate the introduction of Experimental Science as a necessary part of school training. The reign of the cleric as absolute monarch of the school kingdom will be at an end if such doctrine be accepted and acted upon, and there will be some chance of our regaining the reputation of being a practical people. Members of the British Association will be carried back in a dream some thirty odd years, to 1867, when a report from a Committee, consisting of the General Officers of the Association, the Trustees, the Rev. F. W. Farrar, the Rev. T. N. Hutchinson, Prof. Huxley, Mr. Joseph Payne, Prof. Tyndall and Mr. J. M. Wilson, specially appointed to consider the best method of extending Scientific Education in schools, was presented by the Council to the General Committee, and it was resolved: “That the President of the Association be requested to communicate the Report to the President of the Privy Council,” &c. One among the reasons then given why general education in schools ought to include some training in science was, “as providing the best discipline in observation and collection of facts,

in the combination of inductive with deductive reasoning, and in accuracy both of thought and language." History does not record what the Privy Council did with the memorial. Had the Council been mindful of its duty to the country and paid serious attention to so weighty a representation, our present position might have been a very different one; the German and American bogies would have assumed less portentous dimensions in our eyes, and we might have found ourselves far better prepared than we were to cope with the conditions in South Africa. Accuracy of thought and language, according to the evidence given before the Committee on Military Education, are qualities in which military candidates are particularly lacking, notwithstanding the asserted value of Latin—the chief subject of study in the Public Schools—as mental discipline.

Unless we are prepared to disregard, not only all the lessons of the recent war, but also the lessons we have been receiving during years past in the wider war of commercial competition; unless we are prepared to disregard the still wider consideration that education must be an effective preparation for life and not merely for business, the findings of the Committee on Military Education must be embodied in our practice. Undoubtedly the real issue decided by the Committee was the question whether the *antecedent*, and not the technical, training of military candidates was properly conducted. In other words, *our Public School system was on its trial*. Although not referred to in so many words, this system is most effectively condemned in spirit in every line of the Report, and far more between the lines. But the Committee have merely recognised what has been known for years and years; not a single novel point is brought out—not a single novel issue is raised in their report. By making definite recommendations, however, they have lifted the subject on to a higher plane, and it is these recommendations which require the most careful consideration and revision; for it carried out, as they stand, there will be little improvement in our condition. The Committee have certainly done more than they were asked to do, but not more than they were bound to do. By the terms of reference they were to consider and report what changes, if any, are desirable in the system of training candidates for the Army at the Public Schools. Instead they have recognised that education at secondary schools has in a great measure conformed to the course generally prescribed by public professional examinations originally designed to secure the selection of candidates who had availed themselves of the advantages of a good general education; and that the State has been careful in the matter of examinations that they should be so framed as not to disqualify or hinder the unsuccessful candidate from entrance into other professions; or, in other words, that neither more nor less is to be exacted from candidates for entrance into the Army than from candidates for other professions. Consequently the requirements to be laid down for Army candidates are such as can be met from a sound general education, and in no way special. The Committee have, in fact, pronounced judgment on the subject of all others which is of greatest consequence to the nation at the moment. But they were not actually appointed for such a purpose, although they should have been, as it was to be foreseen that the major issue must be tried if the minor were to be settled. The modern spirit in education was not sufficiently represented on the Committee. Of the witnesses examined, too few had any practical acquaintance with the work of education, although a great many who could judge of its effects gave evidence; and the practical side of education was scarcely considered. Only one witness was examined on behalf of "Science," and Mathematics was unrepresented. Such being the case, it is surprising that the Committee should have gone so far in their recommendations, and a proof how overwhelming the case must be in favour of change.

Among the signs of the time showing that liberal views are coming into vogue, I may refer to the provision made in the new buildings designed by Mr. Aston Webb and Mr. Ingress Bell for Christ's Hospital School, which was removed from London in May last. The new home of this ancient foundation is situated in the county of Sussex, about four miles south-west of Horsham, and comprises an area of 1300 acres of land—meadow, arable and woodland. Nearly 600,000⁰⁰⁰ have been expended on the new school up to date. Provision is made for 800 boys, and together with the necessary staff, these will form a colony of some thousand persons. The school provides its own water supply, disposes of its sewage by the bacterial system on its own premises, and is lit entirely by electricity generated

on the spot. Only food and clothing are derived from the outside. If senior boys, in the future, are allowed to gain some insight into the interior management and economy of such an institution, what wonderful opportunities they will enjoy! And I hope the day is not far distant when boys will learn to understand everything connected with the school in which they pass so many years of their lives. A school should be the last to deny to boys every opportunity of gaining such invaluable experience. Fortunately, Christ's Hospital School is conducted on the hostel system; the masters are therefore not charged with household cares, and have no temptation to withdraw their thoughts from the work of education. The school has no taint of commercialism about it. It will be a happy day for our country when this is true of all our schools.

The school buildings are placed nearly in the centre of the site and cover an area of about eleven acres. They are disposed along a slightly convex line facing southwards, the extremities curving gently towards the east and west respectively. The main range has a frontage of 2200 feet. At the eastern end, detached from the main range and somewhat retired, are the Infirmary and Sanatorium, which has a frontage of 500 feet. There are extensive playing fields and also a Gymnasium and Swimming Bath.

The scholastic buildings are grouped in the centre around a "Quad," 300 feet by 240 feet.

The Dining Hall, 154 feet by 56 feet, behind which are the Kitchens and subsidiary offices, is placed on the north side of the Quad. The Chapel has sole possession of the western side. The School Hall, 130 by 50 feet, is at the centre of the southern side, class rooms being provided in two buildings parallel to it, but separated by intervals of 40 feet.

The Science School faces the Chapel, filling the eastern side. The Art School and Library are arranged at right angles to it, somewhat in the background. The Science School consists of four main "laboratories," with subsidiary smaller rooms attached to each. No lecture rooms are provided, as Science is to be studied at the work bench; but each of the laboratories has a space arranged so that demonstrations may be conducted within it. The laboratories are fitted up as workshops, as well as in the ordinary way, so that boys may use tools as well as test-tubes, and the effort has been made to keep the fittings as simple as possible. Workshops for specific manual instruction will be provided in addition to the Science Schools. Experimental Science will be taught throughout the school. It will be obvious that body, mind and soul have all been cared for. Whilst due provision has been made for the intake of that energy which is so indispensable to the indulgence in mental effort as well as to the maintenance of the vital machinery, science has received recognition at the hands of the designers of the Buildings, of the Governing Body and of the Head Master in a manner heretofore unusual; it has actually been placed on an equality even with religion and with literary study, and it may be hoped that the reverent regard of the beauties and wonders of Nature gained in the Science workshops and in the surrounding country will but deepen the feelings of devotion proper to the Chapel and greatly help in lifting the life of the school to a high level. May the example not be without effect.

It has been my privilege to act as the nominee of the Royal Society of London on the Governing Body of the School during several years past, and I may be permitted to bear witness to the manner in which one and all have been mindful of the needs of the times in arranging the new buildings. I believe few Governing Bodies of Schools will do otherwise than promote advance, if properly advised. Resistance to progress comes from within the schools. The public must force the schools to reform.

Let me now return to the recommendations of the Committee on Military Education. It is to be noted that they clearly involve the recognition of two sides to education—a *literary and a practical*. I use the term practical advisedly, because it would be wrong to draw a distinction between a literary and a scientific side, as the whole of education should be scientific, and science—true knowledge—and scientific method—true method—should pervade and dominate the whole of our teaching, whatever the subject-matter; and as the object of introducing experimental science into the school is to give the scholars an opportunity of gaining their knowledge at first hand—by practical heuristic methods, as distinguished from literary didactic methods—the introduction of such discipline may be properly said to involve the recognition of a practical side.

The term practical must not be understood as the antithesis of theoretical. Practice is inseparable from theory in all true teaching, the advance from one practical step to the next being always over a bridge of theory. But if it be granted that education necessarily has two sides, it follows that the Committee on Military Education are illogical in their recommendation that Latin and Experimental Science may be treated as alternative subjects; they are but complementary, not alternative, subjects. The only possible alternative to Latin would be a subject in the literary branch—another language, in fact.

But the recommendations of the Committee are also far from satisfactory on the subject of languages. "The study of languages," they say, "forms a third main feature of a sound general education. Of these the most important, from an educational point of view, is Latin. Modern languages, though much inferior to Latin as a means of mental discipline (at least as generally taught), must none the less be regarded as an important part of a sound general education." In face of this conclusion it would have been logical to make a modern language rather than Latin the alternative to Experimental Science, but obviously the Committee dared not omit the modern language. It is true the recognition of Experimental Science and Latin as possible alternatives may be regarded as a high compliment to the latter, but it was never intended to be such; in truth it marks the recognition of the inevitable; that Latin will ere long be deposed from its high estate and intellectual freedom granted to our schools, greatly to the advantage of Latin, I believe. There is no doubt that the relative value of Latin as an educational subject is grossly exaggerated; those who dwell on its merits are rarely conversant with other subjects to a sufficient extent to be able to appreciate the effects these would produce if equally well taught. As a matter of fact, in the case of Latin the most capable teachers have been chosen to teach the most capable boys, and the results obtained have been unfairly quoted in proof of the superior value of the subject. We have yet to discover the highest value of other subjects, their depth of power as disciplinary agents having been most imperfectly sounded. And if we consider results, do not they afford proof that the belief in Latin (as taught) is misplaced? It has been the staple subject of education and has been supposed to afford the most valuable training possible in composition.¹ Nevertheless the complaint is general, and not only here but also in Germany—where Latin is far more taught and believed in—that composition is the one subject of all others which the schools do not teach. The fact is, Latin is a subject which appeals to the minority of scholars, and the time of the majority is wasted in studying it. I would give to all an opportunity of proving their aptitude in Latin and Greek, or at least some opportunity of appreciating the construction of these languages; but I am inclined to favour the proposal—made by high authority, I believe—that such studies should follow that of modern languages rather than precede it. The true study of classical languages should be reserved for the University. In any case, it is beyond question that a very large proportion of those who would make magnificent officers are incapable of learning Latin to advantage; such will in future enjoy the inestimable advantage of studying Experimental Science; but if those who take up Latin are in consequence to lose all opportunity of acquiring some power of reading the secrets of Nature and of thereby developing thought-power and mental alertness—and such must be the effect of the adoption of the recommendations of the Committee—they will prove to be of little value to the army in comparison with their colleagues whose eyes have been trained as well as their "intellect." In the course of the evidence given to the Committee, Dr. Warré expressed the view that Science would kill Latin eventually. Nothing could be more unfortunate, but the course adopted by the Committee is that most calculated to bring about such a result, as Latin is thereby put in competition with a subject which must ere long be regarded as a necessary subject of school

instruction under all conditions. Latin should be made one of the optional subjects along with Greek.

In their scheme of marks for the examination, the Committee put Latin, French or German and Experimental Science on an equality by assigning 2000 marks to each; but English and Mathematics are rated at a higher value, each receiving 3000 marks. It would have been better to have assigned equal values to the several group-subjects regarded as essential to a sound general education. It should scarcely be necessary to put a premium on the proper study of a man's own language; the subject has naturally a great advantage over others. As to Mathematics, there is no doubt that this also is a subject of which the relative value as mental training has been greatly over-valued, and that the methods adopted in teaching it have been very faulty; consequently much time has been wasted and its true value has not been appreciated, as it has been made to appear unnecessarily difficult and forbidding. The evidence before the Committee against Mathematics being carried too far was very strong. Thus Captain Lee, in examining Major-General Sir C. Grove (speaking of the training at Woolwich), said (Q. 604): "There was an immense amount of pure mathematics and so forth, which one never has occasion to utilise afterwards, unless one becomes an Instructor of Cadets at Woolwich, where you teach them the same useless things you have learned yourself." This elicited from General Grove the reply: "Well, there is a strange tendency in Mathematics—I do not know why—that wherever you introduce them they encroach horribly. I am always struggling to cut down advanced mathematics." And more to the same effect. Again, Lieutenant-Colonel S. Moores, when asked whether he considered the syllabus for the entrance examinations at Woolwich and Sandhurst to be reasonable (Q. 2353), said (Q. 2353): "No, sir; Mathematics are, in my opinion, very much over-valued as a subject for Army examinations, excepting for the Royal Engineers."

After all, if reasonable standards were adopted both in Mathematics and Latin, these subjects would not create the difficulty they do in examinations at present by absorbing so much of the time in school that no proper attention can be given to subjects in reality at least of equal importance. It should be insisted that fundamentals be thoroughly taught, and by practical methods, so that the knowledge acquired may be real and usable; it is astonishing how far students may be carried in Mathematics, and how real and interesting the subject becomes, when they grasp the fact that it has a practical bearing.

While dealing with Mathematics, I cannot refrain from quoting a statement made by Captain Lee (Q. 4209), with regard to the relative values of this subject and science to military men, as the opinion he expressed is of very general application. "I think it is quite true," said Captain Lee, "that a great number of Artillery officers do go through their service without using Science, but I think they feel that any science they know proves of much more practical use to them in their profession than the Mathematics they have learned. As far as I know, in the most scientific branch of the Artillery, the Garrison Artillery, there are practically no occasions where a knowledge of Mathematics is required beyond the Mathematics necessary to solve a simple formula, whereas the lack of knowledge of Electricity, Steam and Hydraulics is often a serious handicap to the officer." I will venture to enlarge on this and say that, assuming Latin, Mathematics and Experimental Science were taught equally well, by equally sound methods, and that they proved to be of equal value as forms of mental training (though of course, developing somewhat different faculties), the training gained through Experimental Science would be far the most valuable because the recipients would be brought thereby most intimately into contact with the world and most fitted to help themselves by having their thought-power developed. Of course this is but an opinion, but one which, I venture to think, many share with me; and yet I make no superior claim for the subject, and ask only that it should rank equally with literary and mathematical training among the necessary subjects of education.

It still remains to consider the specific recommendations of the Committee with regard to Experimental Science, as these are most unsatisfactory. Nothing could be more satisfactory than the manner in which the subject is dealt with by the Committee in their general report, paragraph 20, already quoted (p. 592). But on turning to the scheme of the proposed

¹ Dr. Warré was continually harping on this point in his questions to witnesses examined by the Committee. Thus (Q. 3122): "I want to put Geography and History into English, and your composition would be tested in that way. We think, for instance, that Composition is admirably taught by translation from Latin or Greek. (To the witness:?) Would you agree with that, that translation from another language is teaching English Composition?"

Again (Q. 3129): "When officers have talked to us of the uselessness of Greek and Latin, they have neglected the fact that Greek and Latin are the great instructors in English." Witness (the Rev. A. Robertson): "I quite concur in that."

examination (Appendix A), it appears that not one Experimental Science, but two Experimental Sciences are contemplated, viz. Physics and Chemistry, either of which may be taken in preference to Latin and together with English, Mathematics, and French or German. A most important issue is involved in this recommendation, and it cannot be too strongly opposed.

It is very strange, and a proof of how little we are accustomed to act consistently or to organise, that having found a good thing we rarely make use of it. In the early days of scientific teaching, the elementary parts of chemistry and physics were taught as one subject; but gradually, as the individual sciences developed, this healthy practice fell into abeyance. Then time brought its revenge; it was seen that a very one-sided creature was being trained up; that the subjects were in reality interdependent. Moreover, a revolt had been setting in against the formal stereotyped manner in which chemistry was being taught in the schools; this came to a head about 1887, and a better policy was inaugurated by the Reports and scheme presented to Section B of this Association in 1889 and 1890, which condemned "test-tubing" in favour of problem work and led to the introduction of the quantitative exercises which are now generally admitted to be of the first importance. Although the scheme dealt primarily with chemistry, being the work of the Chemical Section, it yet had a physical basis; physical measurement, in fact, was its life blood, and all the earlier exercises prescribed in it were in essence physical exercises; moreover, the importance of paying some attention to bio-chemical and bio-physical phenomena was not overlooked. As teachers have gained experience of the educational value of the heuristic methods advocated in the British Association scheme, they have been led to apply them more and more widely, and the teaching of Elementary Science has in consequence been regarded with growing favour of late years; more and more has been done to give it the necessary breadth so as to constitute it an effective system of "Nature Study."

The University of London—not the reconstituted body of the present day, but the much-abused examining body of the past—after careful inquiry a few years ago advisably substituted the subject of General Elementary Science for the specific sciences previously prescribed for the Matriculation Examination, and by so doing took a forward step which has generally been admitted by those who can really appreciate the issue to be one of the most important possible from an educational point of view. But the syllabus was imperfectly drawn up—although it had many good points—and the examination was entrusted to men who, besides having little sympathy with the subject, had scant knowledge of school requirements and possibilities. Consequently, the examination was a failure, as everyone foresaw it would be if conducted without proper consideration. The new University has taken the *most unwise* step of reverting to single subjects. It has done far worse than this, however, in making "Science" an alternative subject. Such a reversal of the policy so long pursued by its forerunner can only be described as a *National disaster*. I make this statement with the utmost consideration, and trust that the fact that it is so pronounced from the Chair of this Section may give increased force to my opinion.

It may be claimed that the action taken by the Committee on Military Education is in harmony with that approved of by the Senate of the University of London. The only comfort left open to us is that afforded by the proverb that two wrongs do not make a right. Let us hope that wiser counsels will ere long prevail. The consequences of perseverance in so narrow a policy must be very serious. Consider the effect even from a limited professional point of view. It is widely felt that, owing to the growth of knowledge, it is necessary to specialise if we are to do effective work; but this does not mean that we should be uncultured. We know that the very contrary is the case, and that there was never a time when general knowledge was of greater value than it is at the present day. Yet how little this is recognised. The physicist is already unable to understand the chemist. And although the biologist is attempting to unravel almost transcendental problems in chemistry, he has but the most rudimentary knowledge of the subject. What intellectual pigmies we shall be if we pursue so short-sighted a policy; how ineffective must be our treatment of borderland problems. How little right men of science will have to reproach those who have received only a classical and literary

training with lack of general culture if we remain so narrow within our own domain. And from a general point of view the outlook is still more serious. The object of introducing Experimental Science into schools is to give training in knowledge of the world and to cultivate appreciation of its beauties and mysteries. To do this involves resort in some measure to all the sciences. Chemistry and physics are put first merely because they are of fundamental importance, chemical and physical changes being at the root of all natural phenomena.

As to the value of "Science" to military men, it is easy to understand that they should have little conception what it may do for them; having never received proper training hitherto, they cannot have had the opportunity of testing its usefulness or of appreciating its merits. But making all allowances, it is difficult to understand an answer such as that given by Lieutenant-Colonel Murray (Q. 4806) to the Committee on Military Education, viz. that "Science is a narrowing study for the young mind, and we want to widen and open the mind as much as possible; let them learn their science afterwards" (that is, after the entrance examination). The contention of the advocates of "Science" has always been that of all subjects it tends most to widen and open the mind. Why attention should be specially called to this answer by the Committee in their report is a riddle; I hope it was because they desired to show they could rise superior to the occasion. But the idea that science "can be learnt afterwards" is a very common one, and one of the most pernicious abroad. Learning from books and teachers is a lazy method of learning, and the average scholar is corrupted at an early age by exclusive resort to such methods. Much of the mental inertness of the day is acquired at school by over-indulgence in book study. But apart from this, early youth is the period when the mind is most alert and the desire to acquire and experiment greatest; it is the time when the powers of observing and of reasoning can be most easily developed into fixed habits; in fact, if they are not then developed, it is only in exceptional cases that the omission can be rectified in after life. It is too cruel that Mr. Shemstone, the one witness on the subject heard by the Committee on Military Education, should have given expression to the ill-considered opinion that the beginning of the study of Science necessarily comes somewhat later than that of Latin. The statement shows how prone we are to draw false conclusions, how little we think before we speak. The study of Science begins when the infant opens its eyes; every step it takes when it toddles is an attempt to apply the methods of experimental science; some training in scientific method is given in well-conducted Kindergarten schools; but when school is entered, the curtain is suddenly drawn upon all such rational study; if it be the fate of the child to enter a Preparatory school prior to entering a Public school, he is at once referred back to the times of the Romans and Greeks, his teachers being oblivious to the real lesson to be learnt from the study of the scholastic methods of classical times—that the training given to the youth should be such as to fit him to do his work as a man. How can our officers, how can any of us, be otherwise than ill prepared to do our duty in the world when we are so treated as youths?

Of course all such narrow views, all such narrow actions, as those I have referred to are but consequences of the lack of imaginative power—of our failure to make any scientific use of our imagination. Surely it were time we recognised this, and that we sought to do our duty towards our children. An Arnold who could introduce morality into school method, not merely into school manners, would be a precious gift to the world in these days. Steeped as we are in medievalism, we need some cataclysm—some outburst of glowing sand and steam such as the world has recently witnessed in the islands of Martinique and St. Vincent—which would sweep away preconceived opinions and give clearness to the atmosphere. American industry is distinguished by the readiness with which manufacturers scrap their machinery and refit. Why cannot we agree to scrap our scholastic and academic ideals, if not our schools and schoolmasters, and refit on scientific lines? If we are to weld our Empire into a coherent whole and maintain it intact, we must do so. Unless we recognise prophets—if progress be allowed to depend on the multitude—we shall perish. And time presses; we cannot with safety much longer remain a "nation of amateurs." An appeal must ere long be made to the masses to enforce the provision of leaders; it must be urged upon

the men that they see to it that their masters are educated; for however democratic we may be in our ideals, history teaches, in a manner which admits of no denial, that leaders are the salt of the earth, and in these days leaders need a deal of training to be effective.

Unfortunately, it too often happens that those placed in authority are the very last to attempt to march with the times. Bodies such as our Universities, the Education Department and the Civil Service Commissioners might have been expected to lead the way, to keep the most watchful eye on all that was happening, and to note and apply all improvements. The very contrary has been the case. As a rule, they have advanced only under severe pressure from outside, and scarcely a change can be credited to their initiative. It does not seem to have occurred to them that an Intelligence Department would be a desirable appendage. All suffer from the fatal blot that discretion and authority are vested only in a few heads of departments; the younger and more active spirits have no opportunity granted them while their minds are plastic, full of courage and instinct with advance; so when the time comes that they can act they have lost the desire through inaction. This is the terrible disease from which all our public offices and many industries suffer. It is right to accord experience its proper value, but it is wrong to put aside youthful energy and inventiveness. Our American cousins owe their advance largely to the recognition of these facts.

At bottom the spirit of commercialism is the cause of much of the contorted action we complain of. Neither Cambridge nor Oxford will take the step which has long been pressed upon them—and never more eloquently than by the Bishop of Hereford in his paper read before this Section last year—to make their entrance examination one which would be in accordance with our knowledge and the recognised needs of the times, and one which would have the effect of leading schools generally to impart the rudiments of a sound general education. They cannot act together and are afraid to act singly, each fearing that it would prejudice its entry if it took a step in advance and in any way sought to influence the Schools. The Colleges vie with each other in securing the best scholars in the hope of scoring in the general competition. And the Schools have discovered that successes gained in examinations are the most effective means of advertising, and are therefore being turned more and more into establishments resembling those engaged in the manufacture of *pâté de foie gras*, in which the most crammable are tutored without the least consideration of the manner in which lifelong mental biliousness is engendered by the treatment. Parents, with strange perversity, worship the success achieved by Tom and Dick, Mary and Jane, and think they are doing their duty by their children in allowing them to be made use of—for private ends. The worst feature of the system is the narrow spirit of trades unionism which it has engendered, which leads to the worship for ever afterwards of those who have gained the prizes, instead of regarding them but as victors for the moment and requiring them at each step to give fresh proof of power. Nothing is more unwise than the way in which we overrate the pretensions of the "first class" man; we too often make a prig of him by so doing. Those who succeed in examinations are too frequently not those most fitted for the work of the world. A long experience has convinced me that the boys a few places down a class are, as a rule, the best material. Those at the top may have acquisitive power, but more often than not they lack individuality and the power of exercising initiative. We must base our judgment in the future on evidence of training and of general conduct, not on isolated examinations. If any sincerity of purpose be left in us, if any sense of the value of true training—of what constitutes true training—can be rescued from the scholastic wreck on which we find ourselves at present embarked, we must institute some form of leaving examination which will give the requisite freedom to the schools and every opportunity for the development of individuality, and at the same time necessitate thoroughness of training and patient regard of every grade of intelligence; leaders will show themselves and will not need to be examined for. Examinations as commercial enterprises must suffer an enforced bankruptcy.

Racing studs must be regarded as luxuries in schools and kept apart from the ordinary stables, these being regarded as the first charge upon the establishment, as the serious work of the world will fall upon their occupants. In other words, special provision must be made for scholars, and they must

not be allowed to monopolise attention and set the pace to the detriment of the majority. When Carlyle made the statement that we had in our islands a population of so many millions, mostly fools, he stated what is only a half truth. He failed to realise that the foolishness is very largely begotten of neglect and want of opportunity, not innate. Our schools mostly fail to find out the intelligence latent in the great majority of their pupils, and give it little chance of developing by offering them a varied diet from which to select. During a long experience as a teacher, I have over and over again seen weaklings develop in course of time into strong men when they have been properly encouraged and an opportunity at last found for the exercise of their "talents." The Briton is in this respect a most mysterious creature; you never know when it is safe to call him a fool. All are agreed that the mistakes in the recent war were not due to lack of intelligence, but to lack of training. There can be no doubt of that. All who have taught in our colleges will, I am sure, agree with me that the material sent up from the schools is in substance magnificent, but too often hopelessly unfit to benefit from higher teaching. The things said of those who enter for the military profession are as nothing in comparison with what could be said of those who enter for the professions generally. If our young people fail to show intelligence in later life, it is, as a rule, because the conditions under which we place them in earlier life are such as not only to leave their intelligence undeveloped, but, what is far worse, such as to mar their ability. The best return we can make to those who did such magnificent service in the late war will be to take to heart the real lessons taught by the mistakes, and to see to it that their children and successors generally are trained in a happier school than that in which they were placed.

Examining bodies at the present time do not appear to realise the full measure of their responsibility. To examine well is at all times a difficult task, far more difficult than to teach well. The examiner wields a large measure of authority, and it is imperative that he should exercise this wisely. Examiners should therefore be chosen with extreme care and with due regard to their fitness for the work; but this too rarely happens; the choice falls too frequently on specialists, with little knowledge of educational requirements and possibilities. The examination of boys and girls is far too often put into the hands of those who have no real knowledge of the species and little sympathy with its ways.

There are three courses open to examining bodies—to lead, to maintain themselves just abreast of the times, to stagnate. As a matter of fact, the last is that almost invariably chosen—a syllabus, when once adopted, remaining in force year after year. Consequently, examinations tend to retard rather than to favour the introduction of improved methods of teaching. It is impossible to justify a policy which has such results. The evil effect of examinations would be less if the syllabus were abolished and the limits of examinations very broadly indicated; this is done in some cases, and might be in all. The incompetent examiner and teacher are not in the least helped by the conventional curt syllabus, but the liberty of action of the competent examiner and teacher, and their desire to effect improvements, are materially limited by it. The competent examiner should know what is a fair demand to make of a particular class of students, and should be in a position to take count of the advances that are being made; and the competent teacher should be able to do all in his power to make the teaching effective, and be secure in feeling that his efforts could not fail to be appreciated. To take my own subject, the chemistry syllabus recently laid down for the London Matriculation examination is quite unsuited to its purpose and most hopelessly behind the times. The scheme put forward in the report of the Committee on Military Education is but a bag of dry bones. In the case of several subjects, the South Kensington schemes are full of the gravest faults, their hoary antiquity being their least objectionable feature. Surely a national institution, dispensing public funds, should be the last to hold back the nation; it should be provided with machinery which would enable it to march with the times. In making this criticism I should like to recognise the great work done by Sir William Abney in instituting reforms; but one swallow does not make a summer; a self-acting, governing mechanism is needed which would at all times maintain the balance of practice with progress.

If we consider the process by which decisions on such matters are arrived at, even in the bodies representative of very large interests it is a curiously imperfect one. Usually very few

individuals are concerned. We are all still imbued with primitive instincts. In some way two parties arise, and the question is, which shall conquer? More often than not the true inwardness of the issue presented is left out of account—the considered opinion of the day is scarcely asked for, or if opinions are collected they are not weighted. Therefore calm reason is rarely the arbiter. The conditions of modern civilisation require that some better method shall be devised, which will really enable us to do that which would be of the greatest good to the greatest number. We do not sufficiently remember that while we are tilting, the enemy at our gates is contemplating our failure to maintain and strengthen our fortifications, and quietly advancing his forces to the attack. Speaking of the Navy in the House of Commons not long ago, Mr. Arnold Forster said: "There was a need for some reinforcement of the intellectual equipment which directed, or ought to direct, the enormous forces of our Empire." Surely we may take these words as true generally.

At the present time, when the responsibility of controlling all grades of education is about to be cast upon the community and the actual call to arms is imminent, it is imperative that a sound public policy should be framed and that nothing should be allowed to stand in the way of the public good. It cannot be denied that School Boards have done most admirable service; but there are many who are convinced that in not a few respects they have been disastrous failures and that we need a wider organisation, penetrated with sounder and especially with more practical views. The one essential condition of success is that the public itself treat the matter seriously, realising that their own immediate interests are at stake and that they will be the first to suffer if those who are chosen by them to formulate the new policy and to supervise the work of education are unqualified and, to emphasise my meaning, let me add, unpractical. If the State is to retain any measure of authority, it too must be prepared to exercise that authority wisely. The blame to be put upon School Boards in England for having allowed an unpractical system of education in the schools is as nothing compared with the blame to be put upon the Education Department for having allowed such a system to grow up by the adoption of academic ideals and academic machinery. Until recently, it was a disqualification for an inspector to have teaching experience. A good degree, if not political influence, was the one qualification. Consequently men were chosen whose practical instincts had never been developed, who knew nothing of practical life and of common-place requirements, and nothing of children and their ways; with rare exceptions, the inspectors could look at education only through literary blinkers. To intensify the evil, the wicked system of payment by results was introduced. An inspector such as I have described, working under such a system, could not do otherwise than destroy teaching.¹

The first necessary step to take will be to reorganise the Education Department, root and branch; to imbue it throughout with sound ideals and lead it to understand its great importance as the head centre of the Educational system; for disestablish as we may, and however much we may favour local self-government, a head centre there must be to correlate the efforts made throughout the country and to distribute wisdom; but its functions will be those of an exchange and inquiry office rather than directive and assertive. At least, such is my reading of the tendency of the *Zeitgeist*. Such a Department will have an Intelligence Board, whose members are partly official, partly unofficial, so that it may maintain itself in constant touch with outside opinion and effort. One function of this Board will be to preside at a monthly bonfire of red tape and official forms; for in future, even if no other subject of Government concern be kept in a lively and living state, education must infallibly be. The whole staff of the office, including the inspectorate, will be required to avail itself of that most valuable institution, the sabbatical year, *i.e.* to spend every seventh year in some other employment, so that they may not forget that the world has ways sometimes different from those pictured within the office and which it is advisable to take note of in education. Refreshed and invigorated, they will return to work, prepared to sacrifice all sorts of traditions and to recognise the existence of short cuts across fields which had before appeared to be of interminable dimensions; and as it

¹ The inspector destroys teaching, because he is bound by law and necessity to examine according to a given pattern; and the perfection of teaching is that it does not work by a given pattern (Thring).

will be required that they spend a certain proportion of their close time in the company of children—if they have none of their own—they will learn that a child has ways and views of its own, none the less interesting and worthy of consideration because they are somewhat different from those of grown-up people.

It is fortunate that the Technical Education Movement has been coincident in England with the development of the School Board system. Those engaged in it have worked untrammelled by official requirements, and much original thought has been enlisted in its service. In essence it has always been a revolt against the academic ideals permeating University education and the schools generally; the faults of the schools, in fact, are the more obvious in the light of experience gained in technical education, which will now come to our aid in correcting them.

The really serious tasks before those who direct the work of education in the immediate future will be the choice of a programme and the provision of capable teachers. If they enter on these tasks with a light heart, God help our nation; they will thereby give proof that they have no true conception of the great responsibility attaching to the position they occupy. Let no man offer himself for the work unless he feels certain that he is in some degree qualified.

As to the programme, it may be said that that is for the teachers to settle; and so it should be. But it cannot be denied that, by long-continued neglect to read the writing on the wall, they have lost the claim to legislate; they have shown that they do not know how to legislate. The public must lay down the programme in its broad outlines; teachers must fill in the details. The task imposed upon the schools will be to develop the faculties generally—not in the lop-sided manner customary heretofore—and especially to develop thought-power in all its forms and the due application of thought-power.

I believe that gradually a complete revolution must take place in school procedure, and that the school building of the future will be altogether different from the conventional building of to-day, which is but an expansion of the monkish cell and the cloister. Instead of being a place fitted only for the rearing of what I have elsewhere termed desk-ridden emaculates, the school will be for the most part modelled on the workshop, giving to this term the most varied meaning possible, and a great part of the time will be spent at the work-bench, tool in hand. Nature's workshop will, of course, be constantly utilised, and the necessary provision will be made for outdoor exercise and physical training. Scientific method will underlie the whole of education.

It will be recognised that education has two sides, a literary and a practical; that the mind can work through fingers; in fact, through all the senses; that it is not embodied only in the so-called intellect, a narrow creation of the schools. The practical training will therefore be regarded as at least equal in importance to the literary. Heads of schools will not only be potential bishops, but almost all careers will be open to them. In fact, I trust the system will be in operation which I have already advocated should be applied to the Education Department, and that the members of the school staff will be forced out into the world at stated intervals, so that they may not degenerate into pedants capable only of applying set rules much after the manner of that delightful creation Beckmesser in Wagner's opera "Die Meistersinger."

The class system will be largely abandoned. Children's school time will not be chopped up into regulated periods in a manner which finds no analogy in the work-a-day world, but they will have certain tasks confided to them to do and will be allowed considerable latitude in carrying them to completion. In fact, they will be treated as rational beings, and their individuality and self-respect developed from the outset. The Boer War will have taught us to adopt open-order teaching as well as open-order firing. Schools will glory in turning out individuals, not machines. The success of the Americans is largely due to the way in which Republican doctrines are applied to the up-bringing of children in America. We must follow their example, and set our children free and encourage them to be free at an early age. The human animal develops at a sufficiently slow rate in all conscience, and there is little need for man to retard his own development. School, with its checks upon freedom and individuality, should be quitted at seventeen at latest, I believe, and all subsequent systematic training should take place at college. Boys are kept at school after seventeen mainly for the purposes of the school. It is claimed that by

requiring they gain most valuable experience by acting as monitors and prefects; but this experience is enjoyed only by the few, and might be obtained at an earlier age. Then it is said that seventeen is too early an age to enter Oxford or Cambridge, but this has only been the case since schools have retained boys to prepare them for examinations and in order that they might assist in the management. I believe that the attempts which have been made in these latter days to do college work at schools and to establish engineering sides in order to find work for senior boys have had a most detrimental effect. It is said that the training given in technical schools is too far removed from practice; but how much more must this be true of technical work done under school conditions? The excessive devotion to literary methods favoured by schools and the older Universities tends to develop unpractical habits which unfit many to face the rough-and-tumble life of the world, and is productive of a disinclination for practical avocations. By leaving school at a properly early period this danger is somewhat lessened; moreover, it is necessary in many walks of life that school should be left early in order that the school of practice may be entered sufficiently soon to secure the indispensable manual dexterity and habits. For a long time past we have been drifting away from the practical, and those who are acquainted with the work of the schools, especially the elementary schools, are aghast at the influence they are exercising in hindering the development of practical ability. We must in some way counteract this tendency. On the other hand, we have to meet the views of those who very properly urge that it is cruel to withdraw children from school even at the age we do. The two views must in some way be reconciled. The only way will be to so improve the teaching in schools that school becomes a palace of delight and the continuation school a necessity. The habits formed at school should be such that study would never be intermitted on leaving school. At present school so nauseates the majority that on quitting it they have neither desire nor aptitude to study left in them; the work done in it is so impossible to translate into ordinary practice, so foreign to outside requirements.

The problem can only be solved by the scientific use of the imagination. The solution I would venture to offer is that an honest attempt be made to teach, not only the three R's, but also a fourth, Reasoning—the use of thought-power—and that a properly wide meaning be given to all the R's.

Of all powers that can be acquired at school, that of reading is of first importance. Let teachers read what Carlyle says in the "Hero as Man of Letters," correcting his exaggerations by reading into his words some of the lessons taught by experimental science. Reading is not taught in schools in these days; if it were, people would not waste their time on the rubbish which now figures as literature and for which a rational substitute *must be found*. A well-read man is worshipped at the Universities and is held up to all comers as a pattern. Why should not children be encouraged to be "well read"? Let us admit this and sow books in their path. Thing, in giving utterance to his "Practical Thoughts on Education after Thirty Years' Work," speaks strongly on this point. "Great interest will make up for want of time. Create great interest," he says; and these are noteworthy words. "As soon as children can read, throw away all lesson books for a time. Let them read—let them read aloud—really read, not tumble through the pages. Give them to read poetry, the lives of good men, narratives of noble deeds, historical stories and historical novels, books of travel, and all the fascinating literature of discovery and adventure. The person who has once learnt to read well is tempted to go on. And such books, selected by a carefully graduated scheme, would supply endless knowledge whilst kindling the mind, without any waste of time from drudgery and disgust. Geography, history and power of speech are all comprised in such books if properly used."

Thing here advocates what I would advocate—the *incidental* method of teaching. Why should there be any set lesson in subjects such as history and geography? Nothing is worse, more stereotyped, more cramping to the intellect than the set lesson of so many lines or pages, of a sort of Liebig's Essence of information, with the attendant obligation of committing the facts recorded in them to memory. The child, like the restive, high-mettled young steed, wants to be off and away—not to be held severely in hand. Why should not the method by which we get up a subject in later life be followed in schools? At least it should be properly tried. Let us give freedom to children,

and at least during early years lead them to read hard and wisely; they will do so gladly; and give them pictures innumerable in illustration of their reading. And children must not only be taught to read books; they must learn also to regard and use them as sources of information; the habit of flying for information to books must be cultivated. They must be constantly referred to dictionaries and works of reference generally; they must be set to hunt up all sorts of stories. Of course the scholastic Beckmesser will object that such a system is impossible, that there would be an end to all discipline; but to say this is to show a want of understanding of children and of faith in them, and is proof of failure to recognise their power of accepting responsibility when it is properly put upon them. The secret of success lies in beginning sufficiently early; once let them appreciate what they are doing and the majority will work eagerly and spontaneously.

But when the full meaning is given to the first of the R's, it will be held to cover, not only the reading of printed or written character, but also the reading of some of Nature's signs, to the end that sermons *may be* discovered in stones and good in everything. That is to say, at the same time that they are acquiring the true art of reading, they must be learning the true art of experimenting—to find out things by putting questions of their own and obtaining direct answers. The teaching of the elements of experimental science must therefore accompany the teaching of reading. And great care must be exercised that the palate for experimenting, for results, is not spoiled by reading. The use of text-books must be most carefully avoided at this stage in order that that which should be elicited by experiment is not previously known and merely demonstrated—a most inferior method from any true educational point of view, and of little value as a means of developing thought-power. I regard Huxley's "Physiography," for example, as a type of the book to be avoided until method has been fully mastered. The great difficulty in the way of teaching the art of reading arises from the comparative paucity of readable books for young people. Text-books are not readable, and in fact tend to spoil reading; and the majority of books are written for grown-up people having considerable experience of the world. The mistake is too commonly made of expecting children to master "classics." On the other hand, we need not fear allowing advanced books to fall into the hands of children; they are the first to despise the namby pamby stuff that is too frequently offered to them. A new literature must be created, if education is to be put on a sound basis; something beyond mere word-painting is required. Books are wanted, written in a bright, attractive and simple style, full of accurate information, which would carry us over the world and give clear pictures of all that is to be seen, as well as of the character and customs of its inhabitants; and books are wanted which, in like manner, would carry us back in time and sketch the history of the peoples of the earth. The various branches of science all need their popular exponents; our books are for the most part too technical, and whilst much has been done to advocate the introduction of "Science" into general education, little has been done to make this possible. Unfortunately, those who attempt to write readable books are too frequently not those who are possessed of sound knowledge, and it is time that it were realised by those who could write well and accurately that there is a duty incumbent upon them; on the other hand, something should be done to stem the torrent of text-books which is now flooding the field of education with the destroying force of a deluge and making proper reading impossible.

The true use of books has yet to be found and admitted; we do not sufficiently recognise their value as stores of information and savers of brain waste. Why should long trains of facts be committed to memory but to be forgotten? It is impossible to believe that such a process is mental training; it must involve loss of energy and mental degradation. In future we must give the training at less cost and teach the art of going to books for minute details whenever they are wanted. Nearly every subject is taught in an eminently selfish manner at the present time, the expert declaring that the learner must become acquainted with all the main facts of the subject, instead of recognising that it is far more important to acquire knowledge of first principles together with the power of acquiring the knowledge of facts whenever these become necessary.

The second R may be held to cover, not only mere writing, but also composition. Why is the art of composition taught so badly? Because it is impossible even for children to make

bricks without straw; they have little to write about under ordinary school conditions. The subject is also one, I believe, which must be taught incidentally, at least during the earlier years, and chiefly in connection with the experimental work; in fact, to make this last the training it should be an absolute record of all that is done, must be properly written out, and while the work is being done too. Many teachers, I know, shy at this, and say that it is their business to teach "Science," and not literary style; but they are wrong, and must inevitably accept the burden if they are to succeed in teaching "Science" at all. An experiment, like an act, "hath three branches"—to conceive, to do, to utilise; a clearly defined motive must underlie it; it must be properly executed; the result must be interpreted and applied. It is only when the motive is clearly written out that it is clearly understood—that the meaning or intention of the experiment is clearly grasped; and this is equally true of the result. Of course, it is necessary to proceed slowly and not to demand too much from beginners; but it is surprising how the power grows. Drawing, of course, must be included under the second R; but this also may with advantage be taught incidentally, and only receive individual attention at a later stage, when those who show aptitude in the incidental work have been selected out for higher instruction.

The third R must be held to cover, not merely the simple rules of arithmetic and all that is necessary of formal mathematics, but also measurement work. Mathematics claims to be an exact subject, and therefore must be treated exactly and made the means of inculcating training in exactness, and not on paper merely, but in fact. Moreover, physical science reposes on a basis of exact measurement, so that the introduction of experimental work into schools involves the introduction of measurement work as a matter of course.

The fourth R—Reasoning—will necessarily be taught in connection with every subject of instruction, not specifically. It is introduced as marking the absolute need of developing thought-power; and, in point of fact, should be put before all others in importance.

Under such a system as I suggest, the time of study would be spent in two ways—in reading and experimenting. But whatever we do, let us be thorough; the danger lies in attempting too much, too many things. Each step must be taken slowly and warily, and a secure position established before going further.

Ireland is fortunate at the present time in that far-reaching changes are being introduced into its educational system. A body of men are engaged in this work who are, I believe, in every way specially qualified to promote reforms and earnestly desirous of developing a sound policy. The Irish race have rich powers of imagination such as no other section of the nation possesses, and it is only necessary that these powers be trained to considered and balanced action to make the Irish capable of deeds before which the splendid achievements of the past will appear as nothing. Of course, the development of a true policy must come about slowly, and we must not be too impatient of results, but give every encouragement and all possible support to those engaged in the work. It is before all things necessary to remember that the school is a preparation for life, not for the inspector's visit; in the future, the inspector will act more as adviser and friend, let us hope, than as mentor.

Turning to my own subject, the programmes laid down for primary and intermediate schools appear to me to be well thought out and full of promise; the only fault that I might be inclined to find being that perhaps they are somewhat too ambitious. But very able men are directing the work, and they should be able to see that thoroughness is aimed at before all things. Nothing could be more gratifying than Mr. Heller's statement in the Report for 1900, "that the Irish teachers as a whole seem to possess a great natural taste and aptitude for science and the method of experimental inquiry." May they seek to set the example which is sorely needed to teachers in other parts of the kingdom. I fear there has been a good deal of hand-to-mouth teaching in the past; to avoid this, the teacher should not only have a carefully drawn-up scheme of work, but should keep a diary in which the work accomplished each week is carefully recorded. In this way the weaker teachers will check any tendency they may have to relax their efforts, and inspectors will be in the position to understand at once what progress is being made. Education, unfortunately, is subject to booms as the money market is; just now the "Nature-study" boom is on. We must be very careful not to

let this carry us away; whatever is done must be by way of real Nature-study, and must have very simple beginnings. In most of the work that is being boomed, the presence of the eternal book is only too evident, and such teaching must be worthless. Let the teachers remember that the great object in view is to acquire the art of experimenting and observing with a clearly defined and logical purpose. If they once learn to experiment properly, all else will follow. The inspectors must give constructive help to the work; they too must be students and labourers in the cause of progress, not mere commentators. And there will be a great opportunity for experts to assist who can be helpful to schools. Every school should be provided with a workshop, simply equipped with flat-topped tables, in which all the subjects which are taught practically can be taken. Elaborately fitted laboratories are not only unnecessary, but undesirable; the work should be done under conditions such as obtain in ordinary life. A due proportion of the school time must be devoted to experimental studies; no difficulty will arise when it is seen that so much else is taught incidentally; and that this is the case must be carefully borne in mind in arranging the curriculum—otherwise there will be much overlapping and waste of time. Lastly, every effort must be made to keep down the size of the classes. I trust that in Ireland the girls will receive as much attention as the boys. Experimental teaching is of even greater value to them than to boys, as boys have more opportunities of doing work which is akin to it in the world. The work done by girls should of course bear directly on their domestic occupations.

If we are to improve our schools, the teachers must be trained to teach properly—or rather, let me say, must be put in the right way to teach, because practice and experience alone can give proficiency. This is the most difficult of all the problems to be faced in providing for the future. It is the one of all others to be thought out with the greatest care, and in solving it the help of all who can help must be secured. No amount of didactic teaching will make teachers; the training must be practical. To graft on the ordinary training a course of lectures on the theory and practice of teaching plus a certain amount of practice in a school is not enough. How can we attempt to teach the theory and practice of teaching when we are agreed that we do not know how to teach most subjects? How can a master of method instruct us how to teach subjects of which he has only heard? It cannot be done; in point of fact, we are talking about the thing—beating about the bush—instead of treating the problem as one which can only be solved by experiment. To teach method, you must know your subject; one man cannot know many subjects. Of course there are quite a number of good general rules to be learnt, but the application of these must rest with the specialist; and the only proper way of giving training in method is to teach the subject in the way it seems desirable that it should be taught. The end result of training should be the development of a spirit of absolute humility—of the feeling that no task is so difficult as that of teaching properly, no career in which finality is more impossible to attain to, no career which offers greater opportunity for perpetual self-improvement. The effect of the narrow and unimaginative system in vogue to-day is to send forth a set of young persons who arrogantly consider that they are "trained"; if they would only think of the amount of preparation involved in training for athletic competitions, or in training race-horses even, they would entertain more modest views and be aware that they have everything to learn when they commence their work. The Beckmessers reign supreme in our training colleges of to-day; they must be got rid of, and true modest experts introduced in their place. The test of efficiency must be a real one, not that of a mere final examination. The inspectors must see to it that the instruction is given always with a view to the fact that the students are to become teachers, which at present seems to be the last consideration borne in mind. Every effort must be made to secure a higher class of student for the training colleges; a fair secondary training must be insisted on. A narrow spirit of trade unionism pervades the primary school system at the present time, and School Boards and managers of Pupil Teachers' Centres make no effort to secure the assistance of secondary teachers.

My receipt for a training college would be: Develop thought-power and individuality; develop imagination. Teach whatever will do this most effectively, and let special subjects be studied in the way that may best be followed in teaching them subsequently.

It is to the lasting shame of our State organisation and of our School Boards that so little has been done to provide competent teachers.

The future rests with the Universities; but to save the nation the Universities must be practical, and broader conceptions must prevail in them. A course of training which will give true culture must be insisted on. The Universities have recently shown a disposition—to use a vulgarism—to throw themselves at the heads of the military authorities and to make special provision for the training of military students. It is much more their office to train teachers. Why should not the example to hand in the engineering school at Cambridge be followed? Why should not a special Tripos be established for teachers in training? I believe this to be the true solution of the problem.

The desire now manifest in several of our large towns to establish new Universities comes most opportunely, and should receive every possible encouragement from all who have the interests of our country at heart. I believe the objections to be altogether fanciful and the outcome of academic views. It is said that the value of the degree will go down like that of Consols. But in what does the value of a degree consist? Simply and solely in the evidence it affords of training. We regard the Oxford and Cambridge degrees as of value because they are proof that their possessors have lived for some time under certain conditions which are recognised to be productive of good. The degrees of other Universities must soon come to be regarded as proof of sound and healthy training. It must become impossible to obtain degrees such as the University of London has been in the habit of awarding, which have been the result of mere garret-study; proof of training will be required of all candidates for degrees.

But I must now bring this Address to a conclusion. The only apology that I can offer for its length is that having had over thirty years' experience as a teacher, and being profoundly impressed by the serious character of the outlook, the opportunity being given me, I felt that, as the walrus said to the carpenter,

"The time has come, . . .
To talk of many things:
Of shoes, and ships, and sealing-wax,
Of cabbages, and kings,
And why the sea is boiling hot,
And whether pigs have wings."
(*"Alice through the Looking-glass."*)

This list of subjects is no more varied and disconnected—the problems set no deeper—than those to which we must give our attention in dealing with education; and the sooner the fate of the oysters is that of our present educational "system" the better. Having shown by this quotation that I am not an absolute modern, but have some knowledge of the classics, let me finally say, in the words of another poet—of him who on various occasions gave utterance to much wisdom at the breakfast table, that "I don't want you to believe anything I say, I only want you to try to see what makes me believe it."

Something more than an apology for an Education Act such as the powers are now engaged in shaping for us must be framed at no distant date, and a determinate policy arrived at. That policy may perhaps be found in the words put into Hamlet's mouth:—

Hamlet. To what base uses we may return, Horatio! Why may not imagination trace the noble dust of Alexander, till he find it stopping a bung-hole?

Horatio. 'Twere to consider too curiously, to consider so.

Hamlet. No, faith, not a jot; but to follow him thither with modesty enough, and likelihood to lead it, as thus: Alexander died, Alexander was buried, Alexander returneth into dust; the dust is earth; of earth we make loam; and why of that loam, whereto he was converted, might they not stop a beer barrel?

Imperious Caesar, dead and turned to clay,
Might stop a hole to keep the wind away;
O, that that earth, which kept the world in awe,
Should patch a wall to expel the winter's flaw!

Shakespeare thus taught the use of the imagination before Tyndall! The fact that we can now carry our imagination far further afield and contemplate the survival of atoms once embodied in imperious Caesar in the flowers and fruit which deck the fair face of Nature—a higher end than that Hamlet paints—may serve to justify the adoption of a method he advocated. Modern progress is based on research—the application of imagination. Surely then there is every reason to make the spirit of research the dominant force in education!

UNIVERSITY AND EDUCATIONAL INTELLIGENCE.

PROF. C. F. MYERS WARD, of the University College, Sheffield, has been appointed lecturer in physiology at the Charing Cross Hospital Medical School, vice Mr. Benjamin Moore, who was recently elected to the newly established chair of Biological Chemistry at the University College, Liverpool.

THE jubilee of Sydney University was celebrated on October 1, when addresses of congratulation were presented from British, colonial and foreign universities. The Australian universities were represented in an address by Prof. Tucker, and Prof. Baldwin Spencer, F.R.S., spoke for the English universities.

REFERRING to the Education Bill, in a letter in Monday's *Times*, Sir Henry Koscoe favours the view first stated in NATURE, namely, that the part of the Bill dealing with secondary education should be dealt with separately and passed before taking that concerned with primary instruction. Since this suggestion was made in these columns, excitement over the religious difficulty involved in the representation clause of the Bill has greatly increased, and there seems little hope that a compromise will be effected between the contending clerics. It is now clear that the Government would have been well advised to have divided the Bill into two and settled secondary education apart from primary education. As Sir Henry Koscoe remarks, "To the mind of the nation at large, the question as to whether children are to be taught the Catechism or not looms small in comparison with that as to whether the next generation can be better prepared than our own to sustain and improve the industrial and commercial position of the Empire." Whatever may be thought about religious instruction in primary schools, it is unreasonable to delay the coordination of secondary education until the various parties have settled their differences, more particularly as public opinion is in favour of placing secondary education on a sound basis as soon as possible.

CONTENTS.

	PAGE
Mendel's Theory of Heredity. By F. A. D.	573
Lightning Arrestors in Electrical Engineering. By C. C. G.	573
Our Book Shelf:—	
"Catalogue of Scientific Papers (1880-1883), Supplementary Volume"	574
Westall: "The Early Life of the Young Cuckoo."—R. L.	574
Slate: "Physics: a Text-book for Secondary Schools." S. S.	575
Carvalho: "L'Electricité (déduite de l'Expérience et ramenée au Principe des Travaux virtuels)"; Mendelsohn: "Les Phénomènes électriques chez les Etres vivants"	575
Carmody: "Elementary Chemical Analysis. Distinguishing Tables and Tests"	575
Letters to the Editor:—	
"The Primrose and Darwinism."—Author of "Primrose and Darwinism"; The Writer of the Review	575
A Method of Treating Parallels.—W. R. Jamieson	576
Symbol for Partial Differentiation.—A. B. Basset, F.R.S.	577
Bipedal Locomotion in Lizards.—N. Annandale	577
A Possible Meteor Shower on October 4.—G. Percy Bailey	577
Fall of a Meteoric Stone near Crumlin (Co. Antrim) on September 13. (<i>Illustrated</i>). By W. H. Milligan; Dr. L. Fletcher, F.R.S.	577
Opening Addresses at the Medical Schools. By F. W. T.	579
Notes	579
The Scientific and Technical Exhibits at the Royal Photographic Society's Exhibition	582
The British Association at Belfast:—	
Section K.—Botany.—Opening Address by Prof. J. Reynolds Green, M.A., Sc.D., F.R.S., President of the Section	582
Section L.—Educational Science.—Opening Address by Prof. Henry E. Armstrong, LL.D., Ph.D., V.P.R.S., President of the Section	589
University and Educational Intelligence	600

THURSDAY, OCTOBER 16, 1902.

THE END OF THE WORLD.

Der Untergang der Erde und die kosmischen Katastrophen. Von Dr. M. W. Meyer. Pp. viii + 38. (Berlin: Allgemeiner Verein für deutsche Litteratur, 1902.)

AT various times and by authorities of very varied reputation, but at tolerably frequent intervals, we are invited to consider the problems that are connected with the origin or the decay of the cosmos. It is doubtful in which category the present volume should be placed; the author, indeed, writes decay on his cover, but his pages have more to do with formation and development. The main thought running through the book is to declare the existence of a cycle of events, which may be accompanied with catastrophes of greater or less severity, but tending always to recovery and restoration. This is no new thought, and until some epoch-making discovery such as that of the spectroscope or the principle of the conservation of force widens and directs the issues of scientific investigation, it is difficult to understand how anything new can be written on the cosmogony as a whole. Dr. Meyer presumably thinks differently, and, with the pen of a ready writer, he is willing to rearrange, in a very pleasant manner, the few facts that have been collected, and to repeat the views of the original thinkers and workers on this fascinating subject. Occasionally, Dr. Meyer wanders slightly from recognised lines, and is then, as we think, neither so accurate nor so interesting as when he keeps on the well-trodden paths that his predecessors have followed. If, however, this rearrangement had been nicely managed, we could have forgiven the author much. If he had unfolded before us a panoramic view, in which the development of the cosmos could be traced continuously and uniformly, or had pictured for us the gradual cessation of the phenomena with which we are familiar, we could have welcomed his book as a contribution to popular scientific literature. But in this respect we do not think Dr. Meyer has done himself justice. The successive chapters of his book have too much resemblance to articles in a popular magazine, and may possibly have done duty in that capacity. Each chapter may read pleasantly enough, but the author has not nicely welded his material and dovetailed his story together. As evidence of the traces of magazine writing, we may quote the following passage (p. 201):—

„ . . . brennt nicht die Wohnstätten der Männer nieder, die für die Freiheit ihres Landes kämpfen, das sie mit schwieriger Hand der Wildnis abgetrotzt haben, drängt anderen nicht euer Christentum auf, bevor ihr es nicht übt an euren eigenen Brüdern. . . .“

Such interpolations have very little to do with the outbreak of the new star in Perseus, in the description of which this occurs, but the passage is reminiscent of a style which we will hope has passed. It certainly would have been in better taste to have omitted it from a scientific treatise.

It is a little uncertain how far we may regard this book as the reflection of German thought and the ex-

pression of views currently held in astronomical circles in that country. Dr. Meyer has, however, filled positions of some scientific importance, and may to that extent be regarded as an authority. It should therefore have some interest to compare in detail the views he holds on the construction of the universe with those that obtain in this country, more especially on points which we are inclined to regard as having passed beyond controversy and to be generally accepted. Obviously, however, only a few such points can be selected, and the history of the moon is the most conspicuous instance, because it has been made the subject of an elaborate inquiry, in which it has been shown that the obliquity of the ecliptic, the eccentricity and inclination of the lunar orbit, the period of revolution of the moon and the rotation of the earth are coordinated together on the hypothesis that the moon originally existed near the present surface of the earth, and with small differential motion with respect to it. Further, that the discussion of the moment of momentum amongst the several planetary systems shows that the condition, obtaining on the terrestrial, differs widely from that of other planets, pointing to the necessity of unique treatment. But the references to Prof. G. H. Darwin's work are so scanty that we should doubt if Dr. Meyer has read it, or whether any popular account of the investigation exists in Germany.

To explain the origin of the planets and satellites, the author starts with a collision, and finds the materials for the construction of a new universe in the debris of previously existing, but now shattered, suns. This material will consist of gas, molten particles of every conceivable size, and solid fragments. These particles, in the form of dust, meteors, even gleaming suns, are originally gifted with rectilinear motion, but by a process the author does not fully explain, this motion is converted into spiral movement and finally becomes elliptic, characterised by considerable eccentricity, which diminishes with time until an approximately circular form is reached. At least, this process is followed by the more solid portions which are destined to become suns and planets; some portions have their velocities increased by collision, and are carried away to form wandering suns. The actual formation of a sun or planet by the process of conglomeration—a feature common to all cosmogonies—is very difficult of explanation, and the author can follow what train of reasoning he pleases without much fear of hostile criticism, though the necessity of passing through the stage of a double nebula is not very apparent.

With his centres of condensation and space charged with dust and meteors, Dr. Meyer apparently follows the suggestions of the late M. Faye, and assumes that many meteors moving in eccentric orbits strike against the nucleus and are absorbed by it, maintaining an elevated temperature in the central body by impact. Our moon and the satellites of other planets seem to have come into being simultaneously with the primaries, being formed from secondary rings, the separate existence and stability of which are not explained. But as condensation proceeds on the secondary rings, the bodies so formed necessarily cool more quickly than the larger planetary masses, and the precipitated meteoric matter, which is absorbed by the glowing and fluid planets without any difficulty, leaves holes in the thin crust of the satellite,

which is not yet sufficiently rigid to resist. The result is that phenomena resembling lunar craters are produced. These craters, therefore, are not the result of ejections resembling volcanic eruptions from within, but are the results of action from without. Further than this, the matter carried into the body of the moon will in its turn be melted in the heated interior; consequently the thin crust will no longer be able to support the internal pressure, and rents or fissures of the hardened exterior will take place, and this is the cause of the bright streaks or radiations which can readily be seen on the most superficial examination of the moon. It might be urged in opposition to this view that the molten matter ejected from the interior must soon cool, and not only destroy the traces of the meteoric bombardment, but would also thicken the crust and tend to prevent the penetration of fresh meteors. If one asks why the earth or Mars does not show similar signs of precipitated matter, Dr. Meyer is ready with his answer. By the time that the greater mass of a planet had sufficiently cooled, all the larger debris, the results of the original collision, had been absorbed, and the smaller masses either fell upon the stiffening crust without penetrating it, or were volatilised by friction with the atmosphere, which in those days, it is suggested, was more dense than at present. And if anyone, still unconvinced, asks how it is that Jupiter, for example, can drink up all the matter in a cosmical ring extending into indefinite space, and yet refuses to swallow the small mouthful which in the form of the fifth satellite tantalisingly tempts its capacious appetite, the answer is, wait. All the satellites will eventually be drawn in and form an integral portion of their respective primaries, just as these in their turn will be absorbed in the sun, to be followed again at immense intervals of time by the crashing together of defunct suns producing a larger set of planets with a larger and hotter sun, a solar system on a vaster scale than that in which we play our little part. And so growing in grandeur but diminishing in number, the final catastrophe will come, when there are no more suns to produce collisions, and one huge body cooled to the zero of space, void of available energy, will mark the final outcome of cosmical motion.

This, if we understand our author, is the final state of rest, but there are qualifications introduced which may modify this conclusion. We have endeavoured to draw the conclusion without entering into the limitations which depend, more or less, "in unsern unvollendeten Geist." The only objection one might urge is to the insistence on the lowering of the temperature of the mass to that of the absolute zero. It is only necessary for a uniform temperature, however great, to exist throughout the whole, when a practically useless state of kinetic energy would result, and no work would be possible.

On this world, however formed, it is necessary to introduce life, and, if possible, without a definite creative act implying a breach of continuity. Dr. Meyer follows, but without acknowledgment so far as we have seen, the hypothesis of Helmholtz or of Kelvin. We imagine that the author regards life as old as matter itself, and that its transition from a defunct world to a new one is effected by means of germs, borne through space on fragments; or so-called meteors, and whenever such germs meet with

a favourable environment the processes of life are continued. In a collision, heat would be generated only in proportion as motion is destroyed, so that, as the author is careful to point out, fragments could escape without any great development of heat or necessary destruction of all forms of life. But we do not understand so clearly his theory of the method by which the meteoric fragment, carrying life to a new world, finds itself deposited there. But this is of little consequence, since meteors do come here, and if their surface is heated by friction, the interior can be of lower temperature. Or it can very well happen that germs lying on the surface would be blown away in the highest and most attenuated strata of the earth's atmosphere before the fragment reached the denser parts of the gaseous mass, where the compression becomes great enough to generate considerable heat. The author, however, seems to think it necessary to give to the meteor the same velocity as that of the earth, so that it is quietly and gently deposited on the surface without any arrest of motion and therefore without any increase of temperature. Indeed, he seems to think that meteors, bringing with them enormous masses of water, can accompany the earth for some days in its journey round the sun, giving rise to severe local storms, and marvels that meteorologists have not entertained such explanations as legitimate and worthy of consideration. It is true that the author does not say that these meteors are moving in a circular orbit, but he allows this to be inferred, since parabolic velocities do not seem to be considered. We gather from an account that the author gives of a controversy with Dr. Palisa that that astronomer has had some difficulty in following Dr. Meyer's views, and, so far as we can follow the account from the description of one of the disputants, we would respectfully associate ourselves with the opinion of Dr. Palisa.

We have dwelt, perhaps, at too great length on the points of difference that separate us from the author, and have no space to enter on other matters, which we would do the more willingly since no note of disapprobation need accompany our remarks. In many respects, the book is very interesting, and many chapters can be read with equal pleasure and profit, though the connection with terrestrial catastrophes is not very apparent. Dr. Meyer has selected a subject of great interest, but one on which diverse views can be maintained more or less legitimately. He can write pleasantly and clearly, and while his book may be instructive to the general reader, for he studiously avoids all technical expressions, it should not be offensive to the most orthodox theologian.

ARTIFICIAL MINERAL WATERS.

The Evolution of Artificial Mineral Waters. By William Kirkby, F.L.S. Pp. x + 155. (Manchester: Jewsbury and Brown, 1902.) Price 3s. 6d.

THIS little book has been written with the object of showing the origin and development of the mineral water industry, an industry the commercial importance of which may be to some extent gauged by the author's statement that our annual exports amount to more than

one million dozens and that, directly or indirectly, it gives employment to no less than 25,000 persons in London alone.

In his historical sketch of the evolution of artificial mineral waters as we know them to-day, the author shows that progress has been made along two main lines. The existence of these popular beverages undoubtedly had its origin in the desire of the earlier physicians to prepare by artificial means saline solutions which should have the same therapeutic and curative effects as the waters obtained from well-known natural springs such as those of Epsom, Seidlitz or Bath. This necessarily involved some knowledge of the chemical nature of their constituents, and it was not, therefore, until Boyle had given birth to analytical chemistry, and Bergman had brought his genius and industry to bear upon the chemical examination of the waters from many of the mineral springs, that such imitation became possible. At the same time, much speculation was being indulged in as to the exact nature of that wonderful "principle" which gave to many of the natural waters their sparkling character and piquant flavour; and the numerous researches which were being made in this direction culminated in the great discovery by Black of the chemical identity and true nature of carbonic acid gas. Along both these lines the author traces the gradual development of the mineral water industry, showing in true perspective and with due attention to their relative importance the various discoveries or steps by which its present position has been reached. In this connection, we think that the author has attached rather too much importance to Brownrigg's share in the discovery of the true nature of carbonic acid gas, and has perhaps given too little prominence to the masterly researches and brilliant deductions of Black. In the main, however, the chapters dealing with the work of the earlier discoverers are accurately and clearly written, and the book should certainly be read by all who are desirous of acquiring an intelligent knowledge of the beginnings and development of this now important industry.

There are, unfortunately, a few blemishes which ought scarcely to have escaped the author's notice. Thus we are told on p. 3 that the latter half of the eighteenth century witnessed the birth of chemistry, while on p. 13 that honour is assigned to the seventeenth. Whether we are to consider the former, the latter, or, indeed, either of these statements correct will naturally depend upon the precise meaning we are to give to the word "birth," but we presume that the author had in his mind the eighteenth century, which witnessed the labours of Black, Cavendish, Priestley, Scheele and Lavoisier, to mention only some of the giants who laid the foundation on which the wonderful superstructure of modern chemistry has been reared.

The statement on p. 34 that "it is possible to-day to obtain by mechanical and other means water of as great chemical and bacterial purity as any natural water from the deep springs" presumably refers to filtration, but is not by any means clear. On p. 67 we are told that Macquer purified carbonic acid by passing it through a vessel "containing lime and water," but are not told how much of the gas passed through. In connection with

the use of sodium bicarbonate for the preparation of carbonic acid gas, the author makes, on p. 120, the truly astonishing statement that precautions have to be taken to prevent any ammonia present as an impurity from passing over with the gas into the gas holders. We should have thought, as a matter of fact, that the presence of the acid used for its decomposition would have constituted a sufficient "precaution." In one or two places, the language is a little involved, and there are several misprints and slips, such as Becheri for Becher on p. 42, Thilorria for Thilorier on p. 60, and *unabsorbed* would have been better than *unattached* on p. 120. The chapter on the syphon and its development is well written, and like the rest of the book is clearly illustrated by means of well-executed drawings. The author states in his prefatory remarks that he does not intend this to be a manufacturer's handbook, and that therefore he has given no formulæ for the preparation of the various waters. For the same reason, presumably, the description of manufacturing processes and machinery is contained within the limits necessary to render the book acceptable to the general reader. It contains a good index and a well-compiled bibliographical table, and we can, in conclusion, heartily commend it "to all whom it may concern." We cannot, however, help feeling that the author would have done well to have given his book a more independent character by dwelling with rather less emphasis on the excellence of the plant and manufactured products of a particular firm. A. C. C.

DEVELOPMENT OF THE HUMAN EMBRYO
Human Embryology and Morphology. By Dr. A. Keith. Pp. viii+324. (London: Edward Arnold, 1902.) Price 12s. 6d. net.

DR. KEITH is an accomplished anatomist, and in this morphological study of the development of the human embryo he has given us a valuable account, the result of wide and exact personal observation, of all the later phases of organogeny.

The descriptions of the changes that occur during the formation of the face and neck, the alimentary tract, the central nervous system, the heart and blood-vessels, the history of the development of the skeleton and musculature of the head and trunk; are evidently the work of one who is thoroughly familiar with the anatomy, not merely of the human subject, but of the apes and other mammals as well; and in what we may term the "anatomical embryology" here set before us there is much which will be of permanent scientific worth, apart from what is of practical importance for the ordinary surgeon.

From the other aspects, however, we regret that this treatise is less satisfactory. The earnest student who expects to find here a critical exposition of the thorny problems of modern embryology, or even a sufficiently accurate statement of the facts, will be sadly disappointed.

The account of the formation of the germinal layers and of the early changes in the mammalian blastocyst is not only inadequate, it is erroneous; we are told, for instance (p. 89), that "in lower vertebrates the mesoblast is entirely produced from the hypoblast," and (p. 243)

that it is "highly probable that the cœlom was originally a series of segmental diverticula derived from inflections of the hypoblast," while no attempt at all is made to discuss the difficult question of the significance of germinal layers. The chapter on the placenta might perhaps have passed muster ten or fifteen years ago.

The epiblastic origin of the pronephric duct is treated as an established fact, and the vertebrate kidney tubule compared to the nephridium of the annelids.

The writer appears to have quite misunderstood the results of recent work on the segmentation of the vertebrate head. On p. 221, for example, it is said that the motor nerve of the fourth cranial segment, comparable, therefore, to the nerves which supply the muscles of the eyeball, is the seventh, and the chorda tympani its sensory root; while the last-mentioned is spoken of here, and in the diagram on p. 35, as pre-spiracular in position, a statement which, however true it may be for some reptiles, is certainly at variance with Broman's careful account of its development in the human embryo.

Again, it would be gathered from the wording on p. 238 that the interventricular septum in Sauropsida is homologous with the similar structure in the mammals; and in chapter xiv. the author has been completely led away by a very dubious theory, to say the least, of the origin of the rods and cones of the retina.

Minor inaccuracies are the ascription of only one dentition to the marsupials (p. 67), the omission of any reference to the possible paired origin of the pineal eye, or to the paraphysis, the derivation of the Eustachian valve from the right valvula venosa alone, and the statement that in fishes the "mesial element" of the diaphragm is alone developed.

Such work as this can hardly be taken as a serious contribution towards the solution of those problems which beset the vertebrate embryologist, and it would have been wiser for Dr. Keith, who appears to intend his book preeminently as a *vade mecum* in the hospital wards, to have resisted the temptation to deal with questions which are beyond the scope and cannot be answered by the methods of mere surgical anatomy. Still, as a practical handbook we hope that this treatise may be a success, especially when, in a future edition, certain orthographical slips—"epiphyseal," "fasiculi," "anatomatic," "systematic" (for "systemic"), "embryoes," "Turcica" (for "Turcica"), "hypopophysis"—are duly amended.

AN EDUCATIONAL COMPARISON.

The Making of Citizens. A Study of Comparative Education. By R. E. Hughes, M.A., B.Sc. Pp. viii + 405. (London and Newcastle: The Walter Scott Publishing Co., Ltd., 1902.) Price 6s.

THE educationist anxious to keep pace with all that has been written on the very wide subject with which he is concerned has had an almost impossible task during recent years. The annual reports of the Commissioner of Education, Washington, are so bulky—the last, that for 1899-1900, runs to 2348 pages—and the special reports of our own Board of Education are

published so frequently, that one is tempted to give up in despair the effort to master their contents. In addition to these official publications there are the books written by private persons who have studied foreign methods of education on the spot. Mr. Hughes has, in the book before us, endeavoured to meet this difficulty, and to provide students with "a complete and accurate account of the present position of education in the four principal countries of the world," by which he means England, France, Germany and the United States of America. In the compilation of the volume, free use has been made of the official reports mentioned, and numerous quotations from many writers show that the author has a good knowledge of recent educational literature.

The plan of the book is very simple. After some preliminary pages, separate chapters are devoted to the primary school systems of each of the countries under comparison; after this a general view of the working of primary schools is followed by an account of higher elementary schools. The secondary schools of the four countries are allotted a chapter each, and the book is completed by a *résumé* of the provisions made for the education of girls and for the training of defective children.

With the wealth of material he had from which to select, it was not to be expected that Mr. Hughes would please everybody; naturally the same subjects do not appear of equal importance to all authorities. For instance, in our opinion too little attention is paid to the question of the science teaching in the schools described. The prominence given both in England and America to the need for rational methods in the teaching of science, and to the desirability of the inclusion of some instruction in the methods of science in schools of every grade, is scarcely mentioned by Mr. Hughes. We are told that the science side and master of the best English secondary schools are only tolerated (p. 307), and that chemistry is the favourite and first science taken up (p. 320), though it does not seem to be mentioned that this preference for chemistry as the initial science study is less marked year by year. It is pointed out that the German teacher relies upon the lecture rather than upon the laboratory method (p. 253), that the heuristic method is becoming the accepted way of teaching science in American high schools, and that in them it is usual to begin with the study of physics (p. 280); but these odd paragraphs exhaust all that is said on this important subject.

In view of the influence which science has exerted upon manufacture, commerce and thought generally, a careful comparison of the place which science teaching takes in schools of every grade in the four countries concerned would have been most valuable. The book is intended, however, for the ordinary person with a general interest in education, and this may explain why Mr. Hughes has given more prominence to administrative matters than to questions of curriculum. It only remains to be said that the author's personal acquaintance with English education and his wide experience of schools have enabled him to bring together in convenient compass very much of interest and importance about American, French and German systems of education.

OUR BOOK SHELF.

Animal Forms: a Second Book of Zoology. By David S. Jordan, M.S., M.D., Ph.D., LL.D., President of Leland Stanford Junior University, and Prof. Harold Heath, Ph.D. Pp. vi + 258: 140 figs. and frontispiece. (London: Hirschfeld Bros., Ltd., 1902.) Price 6s. net.

THIS attractive volume, distinguished by the freshness and excellence of its illustrations, is designed as "a second book of zoology," "to meet the needs of the beginning student of zoology." The opening chapters deal, somewhat lightly, with the characteristics of living things and of animals in particular, and with the cell and its protoplasm. They are clear and straightforward, but they lack both distinction and distinctiveness. If this sort of introduction is desirable it should be less easy-going.

The bulk of the book consists of a description of the classes of animals, with particular reference to representative types, considered mainly in their structural aspects, but with considerable attention to functions, habits and life-history—always in a simple, elementary fashion. Here and there throughout the chapters the student is judiciously pulled up for a moment before one or other of the deeper problems of biology, e.g. the plasticity of form in sponges, regeneration in worms, and the origin of species. Apart from the relative prominence given to "ecology," the absence of anything suggestive of a cramming synopsis and the really fine illustrations, the survey does not differ markedly from that to be found in a crowd of other books.

It is very important that a simple work of this kind should not give the student any impressions which he will afterwards have to discard; therefore we doubt the wisdom of speaking of the "skull" of cuttlefishes, the "external" skeleton of echinoderms, the "gills" of the lancelet, the air-bladder as "a modified or degenerate lung." With such a graphic illustration of the viscera of the starfish, it seems a pity that a "twentieth century" text-book should retain the absurd terms "cardiac" and "pyloric" for the two main regions of the gut. As we should expect from the authors, such blemishes are very rare. We have to lament, however, that the desirable prominence given to "ecology" seems to have practically excluded the good old-fashioned lessons on homology, which we believe to be very useful to "the beginning student," and might also expect in a book entitled "Animal Forms." Another defect seems to us to be the relative absence of the definite suggestion of problems for the student to think over.

The half-tone illustrations, many from photographs, deserve great praise. We may notice, in particular, the mures on the frontispiece, the piddocks in their holes, the long-eared sunfish, the rattlesnake, the raccoon and the baby orang-utan. J. A. T.

Das botanische Practicum. Von Dr. Eduard Strasburger. Vierte umgearbeitete Auflage. Pp. I + 771. (Jena: Gustav Fischer, 1902.) Price Mark 20.

THE third edition of this well-known book has been so favourably received that a fourth edition has now been published. The alterations and additions in this new issue are not so extensive as in the previous one, but they are nevertheless considerable, and the whole book has been subjected to careful revision. The scope of the book has certainly advanced beyond the author's original intention as conveyed by the title, "Introduction to the Personal Study of Microscopic Botany," for there are references to several important facts which are highly interesting, but the experiments connected with them one would not think of undertaking unless they formed part of an original investigation; parthenogenesis in *Marsipia*

and the problem of intramortal or intravital staining are notable instances. As the facts are stated without critical opinions being offered, a simple reference to the publications would have been as valuable, and would have made a reduction even though slight in the size of the book. However, the greater number of the additional paragraphs are of considerable practical value, and not the least so are the directions or hints which emanate from Prof. Strasburger himself or from workers in his laboratory, as, for instance, the method of examining the root of *Vicia Faba*, the directions for embedding small algae and the instructions for demonstrating protoplasmic threads (Plasmodesmen). Other notable additions include new tests for starch, fats, callus and cork, and the use of neutral violet as a reagent for pectic compounds. Darwin's device of using hornshavings as a hygrometer to determine the number of stomata and Buscalioni's colloid method for the same purpose are mentioned, and some account is given of Brown and Escombe's work on the diffusion of gases through small apertures. It will be found that this edition differs mainly by the insertion of new paragraphs, and practically the only chapter which is rewritten is the last, dealing principally with cell problems.

Principles of Sanitary Science and the Public Health. By Prof. William T. Sedgwick, Ph.D. Pp. xix + 368. (New York: The Macmillan Company; London: Macmillan and Co., Ltd., 1902.) Price 12s. 6d. net.

A FEW sentences of the preface to this work serve admirably to indicate its scope and, it may be added, its attainment. "This volume deals with the principles, rather than the arts, of sanitation," the author writes. "It is intended to be no more than an elementary treatise on the subject; and while it is believed that it contains some new material, and some old material treated from new points of view, no special claim is made for originality either in substance or in method of presentation." The author has, therefore, chiefly sought to bring together and to present in a simple and logical form those fundamental scientific principles on which the great practical arts of modern sanitation securely rest.

If the chapter on disinfection is taken, that will serve well to illustrate the scope and limitations of the work. There the necessity for disinfection and the object of disinfection are dealt with, but no directions are given as to how principles are applied in actual practice.

It is a most readable work, in which every principle of sanitation that is enunciated is lucidly explained and convincingly advocated, and in which the history of the facts on which the principles of sanitation are based is brought right up to date. It is a good book for everyone to read, and there is certainly no better book for the student to master before he commences the study of the practical and administrative side to public health work.

The author is very sound in his opinions. It is necessary to aim at high ideals when one advocates preventive measures in the interest of the public health, for those measures which are generally thought to be extreme are frequently the only ones which attain their object; but the author's ideal of a city, the water-supply of which is derived from surface-water, owning the entire watershed and keeping it clean and uninhabited, is an impossible one. Even in America it must be rare indeed that a city can secure for its water-supply a totally uninhabited watershed; but everyone will agree that a systematic and frequent inspection should always be maintained to guard the purity of the water collected on such gathering grounds. It is one of the great reproaches upon the sanitary administration of this country that so little is done in this direction. Frequently one sees men employed to patrol river banks to guard the interests of those who have the sole right to the fishing, while no systematic inspection is carried out to guard against

dangerous pollution of the water in the higher interests of the public health.

The work is a welcome addition to public health literature, and it is sure to meet with general appreciation. It should appeal to a wide circle of readers, for it is written in a manner which presents a most important subject in a clear and intelligible light to everyone.

Nature Study: Realistic Geography. Model based on the 6-inch Ordnance Survey. Designed by G. Herbert Morrell, M.A. (London: Edward Stanford.) Price 3s.

THIS is a model of the country round Streatley-on-Thames, constructed by cutting out pieces of cardboard according to the contour lines and placing them one above another in the positions shown by the map. Spare pieces of cardboard, on which the contour lines are printed, ready for cutting out to make a second model, are enclosed in a portfolio along with the first. The construction of models of this kind has been carried out for some years in a number of schools, both in this country and abroad, but the general experience seems to be that, like the trigonometrical survey of the school playground, and other similar devices, the time necessary to carry them out is too much for the value of the results obtained. The use of Mr. Morrell's model undoubtedly saves some time, inasmuch as the contour lines are already traced, but we suspect that the tracing of the contour lines is really the most important part of the exercise. But anything which assists in familiarising British school children with the ideas of contour lines and surfaces is to be welcomed; it is astonishing how many children who are familiarly acquainted with isobars, isothermals and "iso-" lines of all sorts have scarcely heard of contour lines, and it is not too much to state that the failure to present the conception of a contour or "iso-" line as the intersection of a surface with the surface of the earth is almost the fundamental defect in our teaching of advanced physical geography. Apart from its application to the purpose for which it is immediately intended, Mr. Morrell's model should be of value to teachers for demonstration.

A Junior Chemistry. By E. A. Tyler, B.A. Pp. viii + 228. (London: Methuen and Co., 1902.) Price 2s. 6d.

THE author's primary object seems to be to enable boys to present themselves successfully for the examinations in chemistry held in connection with the Oxford and Cambridge locals and similar examinations. He recognises the existence of a better way of teaching his subject than the one he adopts, and urges in extenuation of his procedure the inadequate provision made for practical science in most secondary schools and the small amount of time devoted to science in them. Mr. Tyler expresses the hope that the book he has written will enable boys in ordinary schools "to acquire, as far as possible, a scientific knowledge of chemistry," but he does not seem to understand that science is not properly included in the curriculum because of the information its study imparts, but rather as a means of developing a habit of mind. Unless chemistry is studied experimentally, and is made to train the pupil to observe and to reason from his observations, it has no right to a place on the school time-table. Before the pupil has been set to study the preparation and properties of a few simple substances, and from his own deductions taught to discover the laws of chemical combination, Mr. Tyler tries to explain to him the atomic theory, Avogadro's law, compound radicals, and other theoretical considerations. Though the author understands well enough all the chemistry a boy need learn at school, he does not quite appreciate why men of science desire such subjects as chemistry to be introduced into school work.

NO. 1720, VOL. 66]

LETTERS TO THE EDITOR.

[The Editor does not hold himself responsible for opinions expressed by his correspondents. Neither can he undertake to return, or to correspond with the writers of, rejected manuscripts intended for this or any other part of NATURE. No notice is taken of anonymous communications.]

Finger Print Evidence.

By the courtesy of authorities in Scotland Yard, I have just received duplicates of two enlarged photographs (on slightly different scales). These photographs were lately submitted in a court of law to prove the identity of *a*, the mark left on the window frame of a house after a burglary had been committed, with *b*, the impression of the left thumb of H. J., a criminal then released and at large, whose finger prints are preserved and classified in Scotland Yard. I wished to show the resemblance between *a* and *b* by the method described in my "Decipherment of Blurred Finger Prints," believing that to be the readiest way of explaining to a judge and jury the nature of the evidence about to be submitted to them. I send the results. The questions of the best mode of submitting evidence and of the amount of it that is reasonably required to carry conviction deserve early consideration, for we may have a great deal of it before long. It is as a contribution towards arriving at a conclusion that I send the enclosed. I should say that in the above-mentioned book, each pair of impressions was printed in triplicate and on a still larger scale than these. One of the three was untouched, the second had lines drawn like those in the figure, down the axes of the ridges, the third had the lines and numbers and nothing else, just as in the figure. The attention

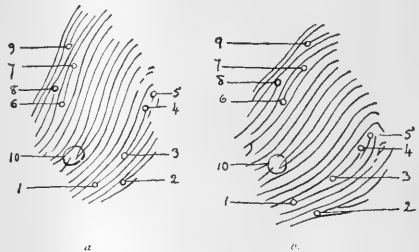

of the judge and jury could be easily directed by counsel to whatever pair of corresponding points he might desire, by reference to their common number on the chart. Without some such guidance it would be extremely difficult to do so, for persons unaccustomed to finger prints are bewildered by the maze of their lineations.

Certain more or less faint lines run across *a* that seem to have been made with the brush when painting the window frame. They seriously interfere with the lineations just above No. 5 and to the right of it. No. 5 is itself so far affected by them that I do not attach full weight to it as a point of reference. But accurate comparison is possible at nine other points, all of which are marked, and a close agreement will be found between every pair of them as well as in the number of intervening ridges.

FRANCIS GALTON.

[The prints have been too much reduced from the tracings I sent, to be quite clear. Thus unless a lens be used, No. 2 in *b* will probably be misinterpreted.]

Remarkable Fossil Oysters from Syria.

In examining a series of more than one hundred specimens of *Ostrea (Exogyra) flabellata*, Goldfuss, from the Middle Cretaceous of Lebanon, I was struck with the marked reproduction in the free upper valves of the figures of other shells to which the lower valves have been attached. These specimens were all collected in the same place, a hill near Bhamdin, Mount Lebanon, Syria. They have been freed by weathering from a soft marly rock exceedingly rich in fossils. Specimens of *Ostrea*, *Plicatula*, *Pecten* and *Anomia* have the shell well preserved. Many others, including species of *Cardium*, *Trigonia*, *Corbula*, *Isocardia*, *Cytherea*, *Leda*, *Nucula*, *Cerithium*, *Alaria*, *Melo*, *Pterocera*, *Turritella*, *Natica* and others are preserved only as casts. Consequently the shell to

which the oyster was attached has usually disappeared, except in those cases in which it was attached to one of its own species. More than half of the specimens have the two valves united and free from adhesions, so that they are capable of exhibiting the phenomenon referred to. More than nine-tenths of these show more or less clearly in the upper valve the figure impressed upon the lower valve by the shell to which the latter adhered.

In most cases this is the figure of a part of the outer surface of a bivalve shell. In a few it is the inner surface of a bivalve shell. In one oyster the figure of part of a specimen of *Cerithium magni-ostatum*, Conrad, is clearly shown above and below; in another, *Cerithium libanoticum*, Fraas, with a much better outer lip than is usually found in specimens of the original shell. In two cases the internal cast of a small *Cerithium*, together with some of the matrix, still adheres to the lower valve of the oyster, while its external form, lost below, is beautifully reproduced upon the upper valve.

In two very striking instances, the lower valve of the oyster shows the impression of a bivalve shell with spiny ribs, while a reproduction of these same spiny ribs appears in high relief upon the upper valve. These reproductions in the upper valve of figures impressed upon the lower valve might be supposed to result from the close contact of two valves when both valves were thin and small, and might be expected to be confined to the region of the umbo in well-grown specimens; but in all cases in which the oyster has been attached by a large portion or all of the lower valve, the impression is reproduced upon a correspondingly large portion of the upper valve. In view of the fact that in most specimens the shell is from 1.5 to 2 cm. thick, and, further, that internal surfaces when exposed show no traces of these external markings, it is noteworthy that the markings should extend over so much of the upper surface instead of being confined to the umbonal region.

ALFRED ELY DAY.

Syrian Protestant College, Beirut, Syria, September 22.

THE peculiar phenomenon referred to in the above letter is well known to occur among Secondary fossils, and has been fully explained by Prof. J. W. Judd in the *Geological Magazine* for 1871, p. 385, where several figures of Oolitic forms are given in illustration. The same peculiarity is also seen in certain oysters from the Lias. The thin growing edge of the shell adapts itself to the inequalities of the surface upon which it grows; the upper valve, being also thin, reproduces the form of the lower valve. The shell becomes thickened by additional layers on the inside, which thus gradually loses the markings that are retained upon the outer surfaces.

E. T. N.

Refractivities of the Inert Gases.

A RELATION appears to exist between the refractivities ($\mu-1$) of the inert gases of the atmosphere and that of hydrogen, which, so far as I am aware, has hitherto escaped attention. The following figures show that, taking the refractivity of hydrogen as 1, the refractivities of the other gases are very nearly in the proportion of $\frac{1}{2}$, $\frac{2}{3}$, 2, 3 and 5.

By far the largest divergence is in the case of helium. This gas, as I am informed, is difficult to purify from the admixture of the heavier gases, so that a perfectly pure specimen would probably give a better result. Even if the relation to hydrogen is fortuitous, the ratios of the refractivities of the other five gases to one another are sufficiently interesting.

Refractivities ¹ observed (Air=1).	Ratio to H.	Calculated from H=0.4733.	Error per cent.
Helium	$\frac{1}{2}$	0.1183	-4.4
Neon	$\frac{2}{3}$	0.2366	+0.9
Hydrogen	1	0.4733	
Argon	2	0.9466	-2.2
Krypton	3	1.420	-2.0
Xenon	5	2.367	+0.1

CLIVE CUTHBERTSON.

9 York Terrace, Regent's Park, N.W., October 10.

¹ Ramsay and Travers, *Phil. Trans.*, vol. cxvii. A, 1901, p. 47.

Trade Statistics.

In his reply to my letter (October 2, p. 550), Dr. Mollwo Perkin brings forward fresh figures, apparently proving an enormous decline in British industry since 1870-74. This, however, is but to repeat Mr. Levinstein's mistake in an aggravated form. The Franco-Prussian war in 1870 checked manufacturing abroad for a twelvemonth, and in 1870-74 there was a heavy demand for British iron and coal at excessively high prices. That period, as is well known, is useless for comparisons of British and German export trade.

It is true, as Dr. Perkin points out, that the general rate of increase of exports (*i.e.* of their total values irrespective of the number of producers) has, in the last twenty years, been very slow in this country, rather rapid in Germany and very rapid in the United States.

But if we reckon per head of population, we get the following (from the Board of Trade "Memorandum," "Cd. 1199") :—

Annual Exports ("Special") per head of Population.

Average of period.	United Kingdom.	France.	Germany.	United States.
1875-79	£ 6.00	£ 3.75	£ 3.15	£ 2.81
1880-84	6.66	3.67	3.43	3.30
1885-89	6.18	3.46	3.27	2.59
1890-94	6.15	3.57	3.14	2.95
1895-99	5.97	3.73	3.36	2.92

These figures are distinctly reassuring. They must not be used as an excuse for laxity in education or the application of science to manufacture, but they ought to allay unreasonable pessimism.

The slight decline per head in the British exports (as measured in money, not in commodities) would be a rather unsatisfactory feature if the export trade were our chief trade and chief source of income. Dr. Perkin perhaps thinks that it is, for he translates Mr. Levinstein's "foreign trade" into "trade." But the gross value of the export trade (280 or 300 millions per annum), large as it is, is small compared with the total national income, recently estimated by Sir Robert Giffen at 1500 millions sterling, while the income-tax assessments indicate that it is increasing faster than the population (*Times*, May 23, 1901). This enormous income is, of course, chiefly made up of the value of goods produced and consumed within the country, constituting the internal trade as distinguished from the foreign trade. From this point of view a close scrutiny of export statistics appears to be unnecessary, and may easily be misleading.

Unfortunately, we have no adequate statistics of total production. The figures for pig iron which Dr. Perkin gives are to the point, and the progress of our two great rivals is here very striking. But the pig-iron manufacture accounts for less than 3 per cent. of our national earnings.

F. EVERSHED.

Kenley, Surrey, October 10.

Material for Natural Selection.

*Verbena exauriculata*¹ is an evil-scented but handsome herbaceous plant with broad orange rays, very abundant in the town of Las Vegas, New Mexico. My class in biology has been making a study of the variations in the number of rays in the heads of this plant, and in so doing we took occasion to compare two sets, from the eastern and western parts of the town respectively. The result was as follows, calling these sets A and B respectively :—

Number of Rays.	(7)	(8)	(9)	(10)	(11)	(12)	(13)	(14)	(15)	(16)	(17)	(18)	(19)	(20)	(21)
Number of heads, set A.	—	7	7	31	63	95	39	19	13	7	9	7	3	2	—
Number of heads, set B.	1	6	10	19	32	73	24	25	12	5	2	1	—	1	—

¹ *Verbena encelioides exauriculata*, Robinson and Greenman, *Proc. Amer. Acad.*, May, 1890, p. 544. Notwithstanding the name of this northern type, the petals of the upper leaves are commonly strongly auriculate.

It will be seen that the mode is the same in each case, but the means are very different. To ordinary observation, the two sets of flowers looked exactly alike, and the demonstration of a difference in the average, while not at all extraordinary, is interesting. No doubt such differences exist in all organisms and all characters, and one can easily see how, under certain circumstances, they may have an important bearing upon the question of survival. The great variability no doubt indicates that the number of rays is not at present of much importance to the *Verbesina*; and no doubt those organs which have become variable for this reason, but suddenly become of importance through changed conditions, afford the best material for selection. In other words, evolution will proceed fastest when there are changes in the survival-value of organs. While examining the *Verbesina*, I found on the undersides of the leaves a new species of spinning mite (*Tetranychus verbesinae*); a little creature about half a millimetre long, pale yellowish, with two scarlet spots on the anterior part of the body, and irregular black spots (pertaining to the soft parts) arranged somewhat in the form of a crescent. The first pair of legs is somewhat more than half the length of the animal; mandibular plate with the sides as in *T. gloveri*, but the end rounded; hairs of body moderate, on very small tubercles. Further particulars will be given elsewhere.

T. D. A. COCKERELL.

East Las Vegas, New Mexico, U.S.A., September 17.

THE INTERNATIONAL METEOROLOGICAL COMMITTEE.

IF we come to consider the work of the International Meteorological Committee and its predecessor, the Permanent Committee of the Vienna Congress, it will be impossible to deal with the subject without taking notice of all the meetings, whether Congresses or Conferences, from which the committees above named took their rise.

It may here be explained that Congresses are convened through diplomatic channels; Conferences are brought together by private invitation to meteorologists of repute.

The first attempt to convene an international meeting was in 1845, when a Conference was held at Cambridge on the occasion of the meeting of the British Association in that year. This was attended by Dove, Kupffer, von Lamont, Adolph Erman and some other foreigners, and of course by the leading meteorologists of England. The difficulties in introducing uniformity in land observations were found to be too serious for definite arrangements to result.

This was followed, in 1853, by the Brussels Conference, which was instigated by Maury. It dealt with the Meteorology of the Sea, and its action met with general acceptance among maritime nations. It may be said that our own Meteorological Office was an outcome of this Conference.

In 1863 Dove endeavoured to convene a Conference on Land Meteorology. At the meeting of the Swiss Naturforscher Verein, he invited the meteorologists of Austria, France, Italy and Spain, but the invitation was not generally accepted.

Nothing definite, however, was done for Land Meteorology until Weather Telegraphy took its rise, about the year 1860, when the demand from each nation for regular intelligence from adjacent countries rendered it impossible for any Government to ignore the subject absolutely. Still, however, every country continued to deal with its Climatology as seemed right in its own eyes.

This was the state of affairs when, in 1872, Prof. Bruhns (Leipzig), Jelinek (Vienna) and Wild (St. Petersburg) issued a general invitation to a Conference, to be held at Leipzig coincidentally with the meeting of the German Naturforscher Verein. This Conference was a signal success. It was attended by 52 members, and from it all subsequent meetings took their rise.

There have been in all seventeen of these meetings.

1872. Leipzig, Conference.	1882. Copenhagen, meeting of I.M.C.
1873. Vienna, Congress.	1885. Paris, meeting of I.M.C.
Do. First meeting of Permanent Committee.	1888. Zurich, meeting of I.M.C.
1874. London, Maritime Conference.	1891. Munich, Conference.
Utrecht, meeting of P.C.	1894. Upsala, meeting of I.M.C.
1876. London, meeting of P.C.	1896. Paris, Conference.
1878. Utrecht, meeting of P.C.	1899. St. Petersburg, meeting of I.M.C.
1879. Rome, Congress.	1901. Paris, meeting of I.M.C.
1880. Berne, meeting of Int. Met. Committee.	

An elaborate *résumé* of the resolutions at all the meetings, down to the Munich Conference, was printed by the late Prof. Wild in vol. xvi. of his "Repertorium für Meteorologie."

In dealing with the action taken at these several gatherings, it is found that many of the resolutions passed at early meetings were materially modified on subsequent consideration, and this is especially the case with reference to instruments and their observation. It is therefore proposed to mention only the final outcome.

The Barometer.—The use of aneroids as independent instruments was condemned, and it was decided that all standard barometers, at Central Offices, should be compared with the standard barometers of the Bureau International des Poids et Mesures at Paris.

As regards barometer corrections, the readings in climatological tables are to be given unreduced to sea level. It is desirable to apply the Gravity correction, and at all events it is to be stated in the tables if this correction has been applied or not, and what is its amount.

The Thermometer.—In this case to the standards at Central Offices are to be compared with the standard air thermometer of the Bureau International.

No recommendation has been made on the subject of thermometer exposure, owing to the impracticability of meeting the requirements of all climates. Meteorologists are referred to the published papers on the subject by Wild and others.

The desirability of devising a really good maximum thermometer was expressed. As regards minimum thermometers, the use of amyl alcohol instead of ordinary spirit was recommended.

Maximum and minimum thermometers are to be read at the latest observing hour of the day.

Humidity.—This subject was treated at considerable length, and the employment of ventilation with the wet bulb was urgently insisted on. At the meeting of St. Petersburg, Prof. Pernier proposed to abandon the use of the dry- and wet-bulb hygrometer, and to revert to the use of the hair hygrometer, but the proposal was not adopted.

Wind.—No general form of anemometer was recommended, nor was any action taken as to uniformity of installation or of altitude. As to wind direction, the English letters N. E. S. W. were adopted owing to the misunderstandings caused by the use of "O" for "Ost" in German and for "Ouest" in French.

Clouds.—At the Munich Conference, the international scheme of Cloud Observations, Direction and Velocity, for one year, was adopted, and the results of this work have appeared. At the same meeting, the Classification of Clouds proposed by Abercromby and Hildebrandson was adopted, and from that has come the "International Cloud Atlas."

Rain.—It was decided to place rain gauges in such positions as should preclude their being buried in snow or exposed to splashing from the ground. It was recommended to mark especially the days of precipitation which did not reach the limit of 1 mm. and to ignore falls below 0.1 mm. Two columns are to be given

for Snow, one for amount, and the other for depth on the ground.

Unusual Occurrences.—The well-known international symbols were adopted at the Vienna Congress.

Glaciers.—A general recommendation was made to institute measurements of the motion of Glaciers.

Earth Movements.—The statements of Monsieur de Rossi, at Rome, as to what he terms "la météorologie endogène" were received with much interest.

As regards other matters, various combinations of hours for observing were suggested.

The simultaneous observations, proposed at Vienna, by the Chief Signal Office of the United States, were strongly supported.

As regards Weather Telegraphy, an international code for the messages was adopted and various details were settled.

The International Forms for the publication of climatological data (stations of the Second Order) were all arranged and have been very generally adopted.

Among the most lasting and valuable results of these gatherings has been the volume of International Tables, published by Gauthier Villars in 1890.

At several meetings endeavours were made to organise an International Office for directing international work, and this resulted in a proposal for an International Directing Bureau. This scheme, however, failed to secure approval. Various resolutions were framed as to international investigations.

The whole scheme of International Balloon Ascents, superintended by Prof. Hergesell, of Strassburg, took its origin at the Paris Conference of 1896.

The Circumpolar Observations of 1882-3, on the scheme of the late Lieutenant Weyrecht, also took a definite shape at the Roman Congress.

Terrestrial Magnetism.—This subject was first discussed at the Munich Conference in 1891, and at the Paris Conference of 1896 a special committee *ad hoc* was appointed, under the presidency of Sir A. Rücker, and in the report of that conference its action can be seen.

R. H. S.

JOHN HALL GLADSTONE.

THE scientific world has lost an indefatigable worker by the sudden death of Dr. Gladstone, which occurred on Monday, October 6. Few men had a larger circle of friends, for the beauty of his character and the kindness of his nature endeared him to all those who had the good fortune to know him.

Dr. Gladstone was born in London in 1827, and was educated at University College, London, and Giessen University. He was twice married, first, in 1852, to May, daughter of the late Charles Tilt; and secondly, to Margaret, daughter of the late Rev. D. King and niece of Lord Kelvin. So early as 1850 he became lecturer on chemistry at St. Thomas's Hospital, and three years later (in 1853) he was elected a Fellow of the Royal Society. He served on its Council in the years 1863-1864 and again in 1866-1868, and a few years ago received the Davy medal. The Royal Society list of papers credits him with more than a hundred contributions to scientific literature, apart from those in collaboration with other writers. He held the Fullerian professorship of chemistry at the Royal Institution from 1874 to 1877, was first president of the Physical Society from 1874 to 1876, and was president of the Chemical Society from 1877 to 1879.

There can be no question, as an eminent English physicist has recently pointed out, that Dr. Gladstone was "one of the founders of physical chemistry, a fact which is fully recognised abroad, where his rightful position is accorded him." It is, however, only neces-

sary to show how highly his work was appreciated in England to quote the reference to it which was made in 1898, on the occasion of a banquet to past presidents of the Chemical Society who had been Fellows of the Society for half a century, of whom Dr. Gladstone was one. Prof. Dewar then said, "Gladstone has worked out his long and brilliant scientific career as a labour of patient love. Furthermore, he has created an entirely new department—that which is in modern times regarded as physical chemistry. For half a century he has worked on this side of chemistry, for his early investigation of the spectrum of the atmosphere was one of marvellous suggestiveness. He found that the spectrum of Fraunhofer varied at sunset and at sunrise from that at midday, and showed that a large number of those absorption lines must originate in the earth's atmosphere. That discovery stimulated further inquiry as to the substance that could produce these lines so characteristic of the solar atmosphere; and later experimenters have found it in the vapour of water and in oxygen. Gladstone's greatest merit, however, lies undoubtedly in his optical researches on the atomic refractions and dispersions of the elements. He has determined the optical constants of hundreds of bodies, and has thus stimulated inquiry in that borderland between physics and chemistry which is so much cultivated in the present day, and the pursuit of which has added so much to our knowledge. He has also contributed largely to miscellaneous inquiries, especially those connected with various voltaic batteries, and other questions conducive to the study of both organic and inorganic chemistry."

His work was remarkable for its very varied nature. The title of his first paper was "Contributions to the Chemical History of Gun-cotton and Nxyloidine," and, true to this early promise, he served as a member on the Gun-cotton Committee of the War Office from 1864 to 1868, having previously served as a member of the Royal Commission on Lights, Buoys and Beacons (1858-1861). Among his less known work, his investigations in connection with early metallurgical history well deserve mention. For instance, he showed that the use of bronze in Egypt went back as far as 3700 B.C., and that not only was bronze used, but that it was of a type common to much later periods, the ratio of copper to tin being as 9 to 1.

It is as an educational reformer that many of Dr. Gladstone's friends will best remember him, for he worked hard for twenty-one years, beginning in 1873, as a member of the London School Board, upon which body he represented the Chelsea division, and was for three years its vice-chairman. He was unwearied in his insistence upon the necessity for teaching science in elementary schools, keeping steadily in view its influence upon the nation as a whole. His attitude may best be gathered from the concluding sentence of his presidential address delivered before the members of the Chemical Section of the British Association in 1872. It ran as follows:—"While the rudiments of science are being infused into our primary education, now happily becoming national, while physical science is gradually gaining a footing in our secondary and our large public schools, and while it is winning for itself an honoured place at our universities, it is to be hoped that many new investigators will arise and that British chemists will not fall behind in the upward march of discovery, but will continue hand in hand with their continental brethren, thus to serve their own and future generations."

The prevailing ignorance of science and scientific methods is constantly rebuked by modern educational writers, but a sentence such as the following, which also occurs in Gladstone's presidential address in 1872, was unusually plain speaking for twenty years ago. He says "the so-called educated classes in England are not only supremely ignorant of science, they have scarcely

yet arrived at the first stage of improvement—the knowledge of their own ignorance.”

Among the glowing tributes to Gladstone's memory which have been offered since his death, none are more significant than the following words from one who is singularly well qualified to form an opinion as to the value of his educational work. “It is twenty years,” the writer says, “since I first made his acquaintance as a co-worker on my election to the London School Board, and the respect which I felt at first for his activity and devotion in the cause of London education soon ripened into a real personal affection and warm admiration for his unselfish and kindly nature and for his insight into the needs of children intended for industrial life. He was almost the first to see that elementary education must be widened to include the training of all the faculties if it is to be effective, and he did more than any to bring this knowledge to a practical result. It would be well for the country if more men existed of the same noble character.”

He has left many witnesses to his power of influencing young scientific workers, to many of whom his memory will be very precious, for but few men have been so faithful throughout a long life to high ideals, and have at the same time so effectively promoted the welfare of humanity.

W. C. R. A.

NOTES.

THE subject of the address of the retiring president (Dr. E. W. Hobson, F.R.S.) of the London Mathematical Society at the annual general meeting on Thursday, November 13, at 5.30, will be “The Infinite and the Infinitesimal in Mathematical Analysis.” There are few people better qualified than Dr. Hobson, both on the mathematical and the philosophical side, to expound the change of view that has been gradually spreading over the field of advanced pure mathematical thought during the last half-century; and many persons interested in the subject will doubtless take advantage of his explanations who would not have time to make headway with the extensive literature, mainly foreign, to which these modern philosophical developments have given rise. At the same meeting, the triennial De Morgan medal will be presented to Prof. A. G. Greenhill, F.R.S., for his contributions to mathematical analysis and its application to mechanical problems.

WHILE attempting to navigate the air with a new steerable balloon, M. de Bradsy and his assistant, M. Morin, were killed at Stains, near Paris, on October 13. The balloon was so constructed that the weight of the gas and all its parts was about equal to the weight of air displaced, so that it remained at rest until the propelling screw was started. The screw was driven by a 16 horse-power motor and was behind a steel car, seventeen metres long, suspended by steel wires attached to a light wooden scaffolding. After the balloon had started, it was evident to the spectators that the motor power was insufficient to enable it to be steered. When at an altitude of about one hundred metres, the car broke away from the balloon and was dashed to the ground, causing the death of the two occupants—M. de Bradsy and M. Morin. The disaster appears to have been caused either by the fracture of the steel wires by which the car was suspended from the envelope, or by the whole framework slipping away from the balloon.

ON Friday, November 7, Lord Kelvin will reopen the ancient Cloth-hall at Newbury, which has been restored as a memorial to Queen Victoria and will in future be utilised as a local museum and art gallery.

THE committee of the Huxley Memorial at Ealing has had a memorial tablet placed in the Free Library, Walpole Park, and it will be unveiled by the Mayor of Ealing, on behalf of the Borough Council, on October 23 at 4 p.m.

THE annual “Fungus Foray” of the Essex Field Club will be held on Friday and Saturday, October 17 and 18—in the country near North Weald and Foot Hill on the Friday, and on the Saturday in Epping Forest. Botanists desirous of attending should communicate with the hon. secretary, Mr. W. Cole, Buckhurst Hill, Essex.

WE learn from the *Times* that an interesting antiquarian discovery has just been made in the neighbourhood of High Wycombe in connection with the construction of the new main line of the Great Western and Great Central Railway Companies. In the course of excavating a hill an ancient flint mine has been unearthed, together with an interesting specimen of a pick made of the antler of a stag with its points worn smooth. Many of the disintegrated blocks bear the marks made by the picks used by prehistoric workmen.

THE council of the Institution of Civil Engineers has, in addition to the medals and prizes given for communications discussed at the meetings of the Institution in the last session, made the following awards in respect of other papers dealt with in 1901-1902:—A Telford gold medal to Mr. J. Macfarlane Gray; a George Stephenson gold medal to Mr. R. Price-Williams; a Watt gold medal to Dr. W. Bell Dawson; Telford premiums to Mr. W. R. Cooper, Mr. E. M. De Burgh, Dr. George Wilson, Mr. Frank Oswell and Dr. A. W. Brightmore; a Crampton prize to Mr. C. D. H. Braine; the Manby premium to Mr. B. W. Ritsco. For students' papers the awards are:—A Miller scholarship (tenable for three years) and the James Forrest medal to Mr. H. F. Lloyd; Miller prizes to Messrs. J. C. Collett, W. H. C. Clay, H. C. M. Austen, A. M. Arter, Robert Bruce, L. F. Wells and W. H. McLean.

PROF. ROBERT WALLACE is preparing for publication the “Reminiscences” of the late Miss E. A. Ormerod, to the preparation of which she devoted the leisure of her later days. The autobiography was not completed, and much additional material of an interesting character must be in existence. Prof. Wallace would be glad to receive such letters from Miss Ormerod as her correspondents may consider of sufficient importance, together with any other information which they think will be of interest to the general public. His address is the University Edinburgh.

THE remarkable successes achieved by the Marconi system in transmitting messages from Cornwall, across the continent, to the *Carlo Alberto*, moored off the coast of Italy, are well known; some further details of the experiments were published in the *Times* of October 14, from the official report upon them. It appears from this report that the magnetic detector, recently described by Mr. Marconi before the Royal Society, proved in every way superior to the coherer. It was much more accurate in its working and required no regulation. Moreover, it was less sensitive to atmospheric disturbances, giving fairly clear signals under conditions which put the coherer *hors de combat*. The experience on board the *Carlo Alberto* also served to confirm the observation that signalling was more difficult during the day than the night, but this only necessitates increasing the power at the transmitting station in order to carry on long-distance work continuously; there seems to be a practical limit to the sensitiveness of the receiver in that it must not be made too easily affected by atmospheric influences.

THE subject of this year's essay competition for the prizes of 10*l.* and 5*l.* annually offered by the Society for the Protection of Birds (3 Hanover Square, W.) is “Birds in the Field and Garden: their Economic Value to Man.” The Society's object is to collect facts and opinions respecting the utility of birds as insect and weed destroyers, a matter which has in recent years compelled attention in various parts of the world, but is still

only very imperfectly understood and appreciated. Full particulars may be obtained from the hon. secretary.

THE Huxley Memorial lecture was delivered on October 1 at the opening of the Charing Cross Hospital Medical School by Prof. Welch, of the Johns Hopkins University, whose discourse was entitled "Recent Studies of Immunity with Special Reference to their Bearing on Pathology." After a tribute to the memory of Huxley and of Virchow, Prof. Welch proceeded to discuss the specific properties of the cells and fluids of the body in health and disease in their relation to immunity, referring to the various antitoxic, bacteriolytic, hemolytic and cytolytic functions exerted under certain conditions. He pointed out that whereas the tetanus and diphtheria bacilli elaborate toxins which can be separated from the organisms that produce them, such is not the case with other pathogenic bacteria, notably the typhoid bacillus, the toxin of which is believed to be intracellular and intimately associated with the bacterial cells. On this conception, the disease symptoms present in typhoid fever are assumed to be due, not to the living and vigorous organisms, but to typhoid bacilli which have died and in consequence have set free their protoplasmic poisons. Prof. Welch doubts whether this theory affords a complete explanation of the toxic phenomena in typhoid and other similar infections, and advances an ingenious alternative hypothesis. The injection of bacterial cells stimulates certain cells of the host to generate one component of the toxin, the intermediary body, which although itself not poisonous, becomes so by bringing about the union between a pre-existing toxophorous substance, the complement and the foreign cell which started the reaction. Similarly, Prof. Welch suggests that certain substances derived from the host may stimulate the invading organism and cause it to produce intermediary bodies which might have the power to link complements to cellular constituents of the host and thereby to poison the latter. That is to say, just as the cells of the organism react towards the invading bacterium, so Prof. Welch suggests does the bacterium react towards the cells of the host, a possible factor hitherto overlooked. Finally, it was pointed out that such researches as these can be carried out only by the experimental method, and that to impose unnecessary restrictions with regard to experiments upon animals is nothing short of a crusade against humanity.

WE have received a valuable series of meteorological results made at Truro for the Royal Institution of that town. The tables are divided into two sets, (1) the monthly values for the separate years 1882-1900, and (2) the average monthly values for fifty-one years, 1850-1900, compiled by Mr. G. Penrose, curator of the Truro Museum. The establishment of the observatory was mainly due to the late Dr. Barham, who prepared the summary for the years 1850-1881. The mean of the daily maximum temperature is $58^{\circ}5$ and of the daily minimum $44^{\circ}7$, the extremes being 92° in June, 1893, and 8° in January, 1867. The mean annual rainfall is high, $40\frac{1}{2}$ inches. It is noteworthy that the Cornwall Institution possesses several long series of observations, dating from those of Dr. Borlase, of Ludgvan, 1754-1772; Mr. James, at Redruth, 1787-1806; Mr. E. C. Giddy, at Penzance, 1807-1827. These are closely followed by Mr. Moyle's, at Helston, and others.

A REDETERMINATION of the density and coefficient of cubical expansion of ice at 0°C . is given by Mr. J. H. Vincent in the *Physical Review*. The author, after comparing previous results, obtains a value agreeing closely with that found by Nichols for the density, but considers that the coefficient of cubical expansion is from 4 to 5 per cent. less than the mean of the previous determinations.

MR. S. J. BARNETT contributes to the *Physical Review* a note on Gauss's theory, considered mainly with respect to electro-

statics. It is pointed out that the ordinary demonstrations apply only to the case of a single homogeneous isotropic medium, and that the theorem is usually implicitly assumed to hold good in all cases. Mr. Barnett now attempts to deduce the generality of the theorem in a logical manner. But in order to extend the validity to a region containing any number of homogeneous dielectrics, or to a medium of varying permittivity, the author has to assume that in a condenser containing two dielectrics, one in contact with one face and the other in contact with the other, the charges on the two faces are equal and opposite. The theorem is thus seen to be based on experimental evidence and not to be capable of proof by deductive methods alone.

FROM the Report of the Survey of India for 1900-1, we notice that surveyors were engaged during the season in the determination of astronomical latitudes in Karachi, while another party was employed with satisfactory results on experimental work connected with the Jaderin base line apparatus. Tidal observations were continued as usual. Preparations for the commencement of a magnetic survey were continued during the year, and arrangements were made for the establishment of base stations at Bombay, Kodaikanal, Dehra Dun, Calcutta and Rangoon, at which magnetic observatories are to be built and self-recording instruments installed. The recent introduction of electric tramways in Calcutta and their impending construction in Bombay have rendered it necessary to arrange for the construction of the new observatories far enough away from the two cities to be beyond the effects of the electric current.

THE Bremer arc lamp, in which the arc is maintained between a pair of inclined carbons saturated with certain mineral salts (see NATURE, this volume, p. 272), has recently been subjected to careful photometric tests by two independent observers, M. Laporte in Paris and Prof. Wedding in Charlottenburg. A full discussion of the two sets of experiments is given in *L'Éclairage Électrique* for October 4. The results are not in very close agreement, though both bring out the superiority of the Bremer lamp over ordinary arc lamps. This is especially noticeable if one only considers the mean hemispherical candle power for the lower hemisphere, since the construction of the Bremer lamp is such that, when used without a globe, practically all the light is thrown downwards. The distribution of light in this direction is also particularly good, being nearly uniform throughout an angle of 50° on either side of the vertical. The consumption of power in a 400-watt lamp comes out at about 0.6 watt per spherical candle and 0.4 watt per hemispherical candle for the Bremer lamp with a globe, as against 1.1 and 0.65 for an ordinary lamp under similar conditions.

WE referred in these columns a short time ago to the fact that an American company had been formed to work a process for the fixation of atmospheric nitrogen. Some further particulars of the apparatus used by the inventors, Messrs. Bradley and Lovejoy, are given in the *Electrical World and Engineer* (N.Y.) for August 2 last. A cylindrical metal box is provided on its inner surface with six upright rows of fixed contacts, there being twenty-three contacts in each row. Each contact is connected through an inductance to the positive pole of a dynamo generating direct current at a pressure of 10,000 volts. A similar set of contacts is mounted on an inner rotating cylinder connected to the negative pole of the generator. As the inner cylinder rotates, the negative contacts come up to the positive and an arc strikes across; this is gradually drawn out and finally extinguished as the negative contact moves past, and away from, the positive. The action may be likened to the rotation of the cylinder in a musical box. Air circulates amongst the arcs, and is drawn off containing about $2\frac{1}{2}$ per cent.

of oxides of nitrogen and led to absorbing towers. The air is circulated at the rate of about 5 cubic feet per contact per hour, and the inner cylinder rotates at the rate of 500 revolutions per minute, thus forming more than 400,000 arcs per minute. Sufficient data are not given to enable a calculation of the efficiency of the arrangement to be made. It will be remembered, however, that the result of Lord Rayleigh's experiment showed that, given cheap power, nitrates could be made by this process at less than the present cost.

THE geology of western Rajputana forms the subject of an essay by Mr. Tom D. La Touche (*Mém. Geol. Survey India*, vol. xxxv. pt. i. 1902). The country is for the most part a very sandy plain diversified only by sand hills and by isolated knolls and groups of hills composed almost wholly of crystalline rocks. Except when rain is falling, no running water is to be seen, and the principal agents of erosion are the intense heat of the sun, or rather the great alternations of temperature that act on the superficial layers of rock, and the violent winds aided by the sand they bear with them. Deflation, or the action of sand-laden wind, is illustrated in many curious features, notably in certain scarped outliers of horizontal beds of sandstone which appear like pyramids in the plain. Some of these known as *zeugen* or "witnesses" are figured. The crystalline rocks exposed comprise schists and quartzite, granites, rhyolites and basic dykes. The sedimentary rocks include the Vindhyan, Talchir boulder-beds, Cretaceous (?) Sandstone, Nummulitic Limestone, and recent accumulations.

In a recent issue of the *Journal of the Asiatic Society of Bengal*, Major J. Manners-Smith records the existence of hybrids between the common wolf and domesticated dogs in the Gilgit district.

In the October number of the *Entomologist's Monthly Magazine*, Mr. Charles Rothschild describes two new British species of fleas, the one infesting the moorhen and the other various small mammals.

MR. W. L. DISTANT, in a recent issue of the *Annals of the South African Museum* (vol. ii. pt. ix. art. xii.), publishes a series of notes on the bugs of the country, with descriptions of new species.

In a paper on the fishes of Mexico, published by the Field Columbian Museum (zool. series, vol. iii. No. 6), Mr. S. E. Meek figures a female of a viviparous species of *Goodea* in which the ovary is absolutely crammed with young.

A RECENT supplement to the *Tropical Agriculturist* (Colombo) contains the text of a preliminary report by Prof. Herdman, F.R.S., on the pearl fisheries of Ceylon. The report may, we understand, be seen by those interested at the Commercial Intelligence Branch of the Board of Trade, 50 Parliament Street, S.W.

In the *Proceedings of the U.S. Museum*, Messrs. Jordan and Fowler continue their survey of the fishes of Japan, the latest fasciculus dealing with the trigger-fishes, file-fishes and trunk-fishes. Excellent figures are given of some of these strange fishes, one of which is made the type of a new species and genus.

THE effect of wind on the migration of birds, as exemplified by the case of hawks, forms the subject of an interesting article by Mr. C. C. Trowbridge in the September issue of the *American Naturalist*. It is inferred that the migratory movements of hawks are very largely affected by wind, an adverse wind retarding, if not completely arresting them. Several other conditions of the atmosphere which affect the migration are mentioned by the author.

In the October number of the *Journal of Conchology*, Mr. R. Welch describes and figures a number of "sports" of the common black-lipped snail (*Helix nemoralis*), showing the spiral more or less elongated above the normal. It appears that enormous numbers of these snails are collected by the peasant women in a certain district of Donegal for the purpose of making necklaces of the shells. Among this number a small percentage of reversed specimens and others with abnormally tall spires are met with and picked out for special sale. In one of the figured specimens the spiral is so elongated as to recall a Scalara.

In the August issue of the *Biological Bulletin*, Mr. H. F. Perkins describes a remarkable degeneration-process observed in larval coelenterates of the genus *Gonionema*. After mentioning the manner in which the larvae disintegrate, the author observes that "the repeated fission of the individuals resulted in such diminution of the size of the pieces which came from the original individuals that after a time it was impossible to distinguish the bits of living matter from the other particles lying about on the bottom. But during the entire time in which it was possible to recognise the pieces of disintegrating larvae, the sum total of this substance did not seem to be at all diminishing. It is impossible to assign any satisfactory explanation to the phenomena, but it is not unlikely that the condition of the water in this particular aquarium was peculiar."

THE affinities of that remarkable group of worm-like creatures known as Solenogastræ and their relationship to the Mollusca form the subject of a long article by Herr J. Thiele in the *Zeitschrift für wissenschaftliche Zoologie* (vol. lxxii. pts. ii. and iii). There are two families of these organisms, the one typified by *Neomenia* and the other by *Chaetoderma*. Very generally the group is classed among the molluscs with the chitons; the author is, however, of opinion that the Solenogastræ are really worms allied to the thread-worms (as represented by the Gordiidae) and annelids, but, in the relation of the heart to the uterus, as well as in the possession of a rudimentary tongue, or radula, approximating to the molluscs, and more especially to the chitons. If this view be correct, the Mollusca are descended from worms, the chitons representing the transitional type.

As the result of a considerable number of experiments, Dr. Margaret C. Ferguson finds that the most effectual plan for starting the germination of spores of *Agaricus campestris* is to include in the culture either some of the mycelium of this plant or else some spores which have already been induced to germinate. An account of the various methods devised to bring about the germination of spores of this and various basidiomycetous fungi is published as a *Bulletin* of the U.S.A. Department of Agriculture. An extremely useful historical summary of similar experiments is given at the end of the paper.

THE latest parts of Engler's "Botanisches Jahrbuch" contain a monograph of the Berberidaceæ and Podophyllaceæ, in which the writer, Dr. G. Tischer, proposes a separate order for Podophyllium and Diphyllia. Herr Bieyer finds that a comparative study of certain of the Anonaceæ bears out the latest division of that order by Engler and Diels into two suborders only, the Uvarioideæ and the Eupomatoidæ. An article, "Der Wind als pflanzengeographischer Factor," by Dr. Warming, is mainly a polemic against Prof. Hansen's book dealing with the East Friesian Islands. Another proposal to deal with the present confused terminology of phytogeography originates from America, and a system of nomenclature is suggested by Mr. F. E. Clements, of Nebraska.

MATTHEW ARNOLD'S well-known work on "Literature and Dogma," which, as its subtitle explains, is "An Essay towards a better Apprehension of the Bible," has been issued for the

Rationalist Press Association, Ltd., in paper covers at sixpence, by Messrs. Watts and Co.

A NEW medical and scientific circulating library has been opened by Mr. T. H. Prince, who was for many years with Mr. H. K. Lewis, and has just started as a medical and scientific bookseller at Prae I Street, Paddington. It is promised that all standard works in the various branches of science will be available to subscribers.

WE have received the concluding part of the *Boletim Mensal* of the Observatory of Rio de Janeiro for the year 1901. In addition to the meteorological observations taken eight times daily at that observatory, the *Bulletin* contains monthly and yearly results for various parts of Brazil, and a valuable summary for twenty years (ending March, 1901) for Bahia, from observations made by Dr. Guimarães.

SEVERAL new forms of apparatus for the physical laboratory have lately been produced by Messrs. W. G. Pye and Co., Cambridge. Among the instruments are a table cathetometer and a reading microscope, constructed on the geometric slide principle, an improved pattern storage cell, five hundred of which have been in use at the Cavendish Laboratory for several months and have proved "very convenient and thoroughly satisfactory," and sets of patent resistance coils, in which the coils themselves take the place of the usual plugs and can be easily removed to show the wire and method of construction.

A NOTEWORTHY paper on the decomposition of urea is contributed by Mr. C. E. Fawsitt to the fifth number of the *Zeitschrift für physikalische Chemie*, vol. xli. When a pure aqueous solution of urea is heated at 100° C. for a considerable time, the urea is completely transformed into ammonium carbonate. This decomposition takes place also under the influence of acids and bases, the velocity under these circumstances being much greater. If strongly alkaline solutions are excepted, the decomposition takes place in all cases according to the simple equation for a unimolecular reaction, a result which does not accord with the ordinary method of representing the reaction. The author finds that the facts can only be satisfactorily explained by assuming that the urea is in the first place transformed into ammonium cyanate and that a state of equilibrium is set up between these two substances. The cyanate, however, is gradually decomposed with the formation of ammonium carbonate, the equilibrium being thus disturbed, and a further quantity of urea undergoes transformation into the cyanate. This decomposition of ammonium cyanate into ammonium carbonate takes place very quickly under the influence of acids. A large amount of experimental evidence is found to support the theory advanced, and the author concludes that urea is not directly attacked either by water, acids or moderately concentrated alkalis. Concentrated solutions of the alkalis have probably however a direct saponifying action upon the urea, in addition to the indirect action described.

AN investigation of the rate of bromination of carbon compounds by L. Bruner, which will be of considerable interest to organic chemists, is published in the current number of the *Zeitschrift für physikalische Chemie*. The catalytic action of iodine on the bromination of benzene has been carefully studied in a quantitative manner, and it is shown that this action is very probably due to the formation of iodine monobromide, which by its dissociation gives rise to free bromine atoms. These free bromine atoms are the active agents in the bromination process, and the catalytic influence of the iodine is due to the much greater dissociation of the iodine bromide as compared with that of bromine itself. The author shows that the substitution

of bromine is a quadrimolecular reaction taking place according to the equation



The action of other carriers has also been investigated, the most active in the case of the bromination of benzene and bromobenzene being aluminium bromide. This compound has, however, no influence on the bromination of nitrobenzene. From the concentrated nitrobenzene solution, a compound of the formula $AlBr_3 \cdot 2C_6H_5NO_2$ has been crystallised out, a fact of some interest in view of Gustavson's theory of the mode of action of $AlBr_3$ in the bromination of benzene, toluene and other compounds. The author has finally investigated the relative velocities of some so-called instantaneous reactions. It is found that the bromination of aniline takes place more rapidly than that of phenol, and that the velocity of the latter reaction is about one-fifth of that at which iodine is separated by bromine from potassium iodide solution.

THE additions to the Zoological Society's Gardens during the past week include a Vervet Monkey (*Cercopithecus lalandii*) from South Africa, presented by Mrs. Chas. Lisle Hackett; two Mozambique Monkeys (*Cercopithecus pygerythrus*) from East Africa, presented respectively by Mr. J. M. Creasey and Mrs. G. Ord; a Common Marmoset (*Hapale jacchus*) from South-east Brazil, presented by Mrs. Murray Simpson; a Gannet (*Sula bassana*) from Scotland, presented by Lord Ribblesdale; six Carolina Anolis (*Anolis carolinensis*) from Florida, two Tarantula Spiders, from Arizona, presented by Miss Ilda Orme; two Entellus Monkeys (*Semnopithecus entellus*), two Sambur Deer (*Cervus aristoëlis*), two Nylghais (*Boselaphus tragocamelus*), two Tigers (*Felis tigris*), two Gadwells (*Chaulestasmus streperus*), an Indian Adjutant (*Leptoptilus argala*) from India, two Nutmeg Fruit Pigeons (*Myristicivora bicolor*) from Melucces, received in exchange; eight Saddle-backed Tortoises (*Testudo ephippium*), two Thin-shelled Tortoises (*Testudo microphaps*), twenty-four South Albemarle Tortoises (*Testudo vicina*), one — Tortoise (*Testudo* —), seven — Iguanas (*Conolophus subcristatus*) from the Galapagos, four Indian Porphyries (*Porphyrio calvus*) from Eastern Asia, a Brindian Gnu (*Connochætes taurina*) from South Africa, deposited.

OUR ASTRONOMICAL COLUMN.

A NEW TRANSITING DEVICE.—An article by Mr. M. B. Snyder, of the Philadelphia Observatory, in *Popular Astronomy*, No. 97, discusses a new device for transiting stars, in which the micrometer thread is moved, with a regular speed, across the field by means of an electric motor.

The fundamental idea of getting rid of the personal equation in transit observations by using mechanical transmitters was first suggested by Braun in 1865 and since then has been persistently developed by Repsold. After discussing the various methods suggested by these and other inventors, Mr. Snyder gives some details of his own device, although full details are withheld for a future communication when circumstances have permitted of more time being spent on the subject.

In Mr. Snyder's instrument, the micrometer screw, and thereby the micrometer thread, is driven across the field of the instrument by an electric motor, at a speed depending on the declination of the object observed, whilst at the same time the observer, by using a secondary adjustment, keeps the star image accurately bisected, and the various positions of the thread are automatically recorded, by means of an ordinary chronograph, at the end of each revolution of the screw. Then at the moment of meridian passage an automatic electrical arrangement records the instant of transit. The micrometer in its fundamentals is of the ordinary type, and is at present attached to the 4-inch meridian circle of the Philadelphia Observatory; it is so arranged that, with the motor driving regularly, visual observations may be made, and recorded by any one of the usual methods, synchronously, thus forming a ready means of determining the personal equations existing between the various individuals of any group of observers.

THE SEARCH FOR A PLANET BEYOND NEPTUNE.—Herr T. Grigull, of Münster, Germany, describes in the October number of the *Bulletin de la Société Astronomique de France* his new contribution to the research which has for its object the discovery of another planet, beyond the orbit of Neptune.

In a previous paper (*Bulletin*, January, 1902, p. 31), Herr Grigull explained the hypothesis on which his calculations are based, and the elements of the hypothetical planet as deduced from the observations of the aphelia of three comets. In the present contribution, the elements given below have been calculated from the observed aphelia of twenty comets which appeared, and were observed and recorded, between the years 1490 and 1898. After giving due weight to the various cometary observations, the author has calculated these elements for the possibly existing planet:—

Epoch 1902.

$$\lambda = 357^{\circ} 54 \pm 1^{\circ} 867$$

$$\text{Dist. from sun} = 50.61 \text{ R.}$$

$$\text{Time of revolution} = 360 \text{ years.}$$

$$\Omega = 90^{\circ} (\text{???}).$$

$$i = ?.$$

A NEW MINOR PLANET.—In No. 3819 of the *Astronomische Nachrichten*, Prof. Max Wolf announces, along with other minor planetary observations, the discovery of another new minor planet, 1902 T.

COMET 1902 b.—A number of observations of this comet have been made.

A photograph taken on September 27 by Prof. Kononowitsch, Odessa, with three hours' exposure, shows a straight double tail extending in a southerly direction to a distance of 3'.

Prof. Nijland has published, in the *Astronomische Nachrichten* (No. 3817), a further ephemeris, from which the following extract is taken:—

1902.	app. a.			app. δ .	Brightness.
	h.	m.	s.		
Oct. 16	...	18 16 24	...	+ 16 30 5	
17	...	9 55	...	14 9 1	
18	...	4 7	...	11 58 9	...
19	...	17 58 52	...	9 59 1	13.0
20	...	54 6	...	8 8 9	
21	...	49 43	...	6 27 3	
22	...	45 41	...	4 53 6	...
23	...	17 41 56	...	+ 3 26 9	10.9

The brightness of the comet on September 6 is taken as unity, and it was then estimated at 7.5m.

THE BRITISH ASSOCIATION AT BELFAST. SECTION A.

SUBSECTION OF ASTRONOMY AND COSMICAL PHYSICS.

OPENING ADDRESS BY ARTHUR SCHUSTER, F.R.S.,
F.R.A.S., CHAIRMAN OF SUBSECTION.

OUR proceedings to-day constitute an innovation and require a few words of explanation. When, a few years ago, some astronomers felt that our Association bestowed an insufficient share of attention on their subject, an easy remedy suggested itself in the formation of a special subsection devoted to that subject. Such a subsection was accordingly organised at Bradford and Glasgow, but for reasons, which are perhaps not altogether to be regretted, the experiment was only partially successful. In the meantime the work of Section A became heavier and heavier, and, as it seemed necessary to find some way of relieving its meetings, it was decided to hand over to the already established subsection of Astronomy other subjects, such as Meteorology, Terrestrial Magnetism, Seismology, and, in fact, anything that the majority of physicists is only too glad to ignore.

When the Council of the British Association asked me to act as President of such an enlarged subsection, I was very doubtful whether I ought to accept the honour. In the first place, I felt incompetent, owing to my almost complete ignorance of most branches of astronomy, and in the second place I do not approve of the formation of subsections dealing with important branches of Physics. If I eventually consented, it was partly because I lacked the strength of mind to refuse an honour of

this kind, but partly because I was glad to have an opportunity of raising the whole question of the organisation of our meetings. The ground for such a discussion has, however, to a great extent disappeared, because, when the Organising Committee of Section A met in the spring, there appeared amongst those present a sudden revival of interest in the subjects assigned to the subsection and it was decided that the main section should not meet at all to-day so as to allow its members to help us in our discussions. The parent section has, therefore, voluntarily submitted itself to absorption by its neglected offspring, which now has to show that Cosmical Physics obeys the laws of Terrestrial Physics and that good absorbers are also good radiators.

Gratifying as this reunion must be to us, it fails to realise one of the original objects for which we have been called into existence, because instead of lightening your work it has added to it by imposing upon you the burden of having to listen to a second Presidential Address. I will try to make this additional burden as light as possible by concentrating my general remarks into a few sentences and then introducing the business of the section by means of a contribution to its scientific work, which I otherwise should have made in the ordinary course of the meeting.

To make our meeting as fruitful as possible, we should make the fullest use of the opportunities it gives us of personal contact and interchange of ideas. This is not accomplished by dividing into separate camps as soon as we have come together, but rather by finding some common ground for our debates. We should not try to minister to the separate needs of the specialist in electricity, or in meteorology or in astronomy, but should impress upon each of these specialists that they must bring before us the results of their investigations in so far as they bear on the more general questions in which we all are, or ought to be, interested. If it is necessary to lighten the work of the section this should be done by excluding all papers which are of interest only to specialists, or by establishing subsections for such papers. Let us divide—if I divide we must—according to the character of the contribution, rather than according to the subject it happens to deal with. The difficult and, perhaps, unpopular censorship which such a course would involve would probably be temporary only, as the character of the papers which are desired for the main section would soon become known, and the increased attraction and usefulness of our discussions would, I am convinced, in a few years compensate for the initial trouble. We all require, occasionally, to be reminded that the detail work which is necessary, and on which most of us are engaged, is only of importance or interest if it helps us forward towards the solution of the great problems of Nature.

Addressing myself more particularly to Astronomers, I should like to say that we shall always welcome them as members of Section A, and that the benefit we shall derive from their contributions will be great in proportion as they will consider themselves to be citizens of the general empire of that section rather than inhabitants of an independently governed State.

There is one minor reform, or perhaps I ought to call it a protest against one of the traditions of the Association, which I feel called upon to urge on you. Discussion is our principal aim, and we are always trying to find suitable subjects for discussion; yet we are prevented by the rules of the Association from discussing the Presidential address and the reports of Committees. Those who framed such a rule must have had some unfortunate idea that the dignity of the chair might be endangered if some criticism happened to be expressed in the discussion of the Chairman's address, or that the value of the report of a Committee might be endangered by some adverse comment coming from outside. But it seems to me that a scientific society or association, and especially one framed on a democratic constitution, ought not to take such a narrow and unscientific view. I can remember several Presidential addresses which might, and probably would, have given rise to most instructive debates had the rule not existed. Reports of Committees if not suitable for discussion should not be read at all; but if read they should be open to discussion.

I hope that to-day you will not feel yourself bound by ancient custom, but in order that, at any rate, the more scientific portion of my contribution to our proceedings should not be stained by the suspicion of immaculate conception, I will now ask the duly-constituted President of our section to take his proper place.

The question I wish to bring to your notice to-day is an old one: if two events happen simultaneously or one follows the

other at a short interval of time, does this give us any reason to suppose that these two events are connected with each other, both being due to the same cause, or one being the cause of the other? Everyone admits that the simple concurrence of events proves nothing, but if the same combination recurs sufficiently often we may reasonably conclude that there is a real connection. The question to be decided in each case is what is "sufficient" and what is "reasonable." Here we must draw a distinction between experiment and observation. We often think it sufficient to repeat an experiment three or four times to establish a certain fact, and with meteorological observations the case is different, and it would, e.g., prove very little if on four successive full moons the rainfall had been exceptionally high or exceptionally low. The cause of the difference lies in the fact that in an experiment we can control to a great extent all the circumstances on which the result depends, and we are generally right in assuming that an experiment which gives a certain result on three successive days will do so always. But even this sometimes depends on the fact that the apparatus is not disturbed, and that the housemaid has not come in to dust the room. Here lies the difference. What is possible in a laboratory, though perhaps difficult, is not possible in the upper regions of the atmosphere, where some unseen hand has not made a clean sweep of some important condition.

When we cannot control accessory circumstances we must eliminate them by properly combining the observations and increasing their number. The advantage does not lie altogether on the side of experiment, because the very identity of condition under which the experiment is performed gives rise to systematic errors, which Nature eliminates for us in the observational sciences. In the latter also the great variety in the combinations which offer themselves allow us to apply the calculus of probability, so that in any conclusion we draw we can form an idea of the chance that we are wrong. Astronomers are in the habit of giving the value the "probable error" in the publication of their observations. Meteorologists have not adopted this custom, and yet their science lends itself more readily than any other to the evaluation of the deviations from the mean result, on which the determination of the probable error depends. We look forward to the time when weather forecasts will be accompanied by a statement of the odds that the prediction will be fulfilled.

The calculation of the probability that any relationship we may trace in different phenomena indicates a real connection seems to me to be vital to the true progress of Meteorology, and although I have on previous occasions (*Cambridge Phil. Trans.*, vol. xviii. p. 107) already drawn attention to this matter I should like once more to lay stress on it.

The particular case I wish to discuss (though the methods are not restricted to this case) is that in which one of the two series of events between which relationship is to be established has a definite period, and it is desired to investigate the evidence of an equal period in the other series.

Connections between the moon and earthquakes, or between sunspots and rainfall if proved to exist, would form examples of such relationships. The question to be decided in these cases would be, is there a lunar period of earthquakes, or an eleven years' sunspot period of rainfall.

Everyone familiar with Fourier's analysis knows that there is a lunar or sunspot, or any other period in any set of events from volcanic eruptions down to the birth-rate of mice; what we want to find out is whether the periodicity indicates a real connection or not. Let us put the problem into its simplest form. Take n balls, and by some mechanism allow them to drop so that each falls into one of m compartments. If finally they are equally distributed each compartment would hold n/m balls. If this is not the case we may wish to find out whether the observed inequality is sufficient to indicate any preference for one compartment or how far it is compatible with equality of chance for each. If we were able to repeat the experiment as often as we like we should have no difficulty in deciding between the two cases, because in the long run the average number received by each compartment would indicate more and more closely the extent of bias which the dropping mechanism might possess. But we are supposed to be confined to a single trial, and draw out conclusions as far as we can from it.

It would be easy to calculate the probability that the number of balls in any one compartment should exceed a given number, but in order to make this investigation applicable to the general problem of periodicities we must proceed in a different manner.

If the compartments are numbered, it does not matter in which order, and a curve be drawn in the usual manner representing the connection between the compartments and the number of balls in each, we may, by Fourier's analysis, express the result by means of periodic functions. The amplitude of each period can be shown on the average to be $\frac{1}{m} \sqrt{n}$. It is often more

convenient to take the square of the amplitude—call it the intensity—as a test, and we may then say that the "expectancy" of the intensity is $4n/m^2$. The probability that the intensity of any period should be k times its average or expectancy is e^{-k} . We may apply this test to test the reality of a number of coincidences in periods which have been suspected. A lunar effect on earthquakes is in itself not improbable, as we may imagine the final catastrophe to be started by some tidal deformation of the earth's crust. The occurrence of more than 7000 earthquakes in Japan has been carefully tabulated by Mr. Knott according to lunar hours, who found the Fourier coefficient for the lunar day and its three first sub-multiples to be 10.3, 17.9, 10.9, 3.97; the expectancy on the hypothesis of chance distribution for these coefficients I find to be 19.3, 15.7, 10.6, 5.02. The comparison of their numbers disproves the supposed connection; on the other hand, the investigations of Mr. Davison on solar influence have led to a result much in favour of such influence, the amplitude found being in one series of observations equal to five times, and in the other to fifteen times the expectancy. The probability that so large an amplitude is due to accident in the first case is one in 300 millions, and in the second the probability of chance coincidence would be represented by a fraction, which would contain a number of over 70 figures in the denominator. We may, therefore, take it to be established that the frequency of earthquakes depends on the time of year, being greater in winter than in summer. With not quite the same amount of certainty, but still with considerable probability, it has also been shown that earthquake shocks show a preference for the hours between 9 a.m. and noon.

A great advantage of the scientific treatment of periodical occurrences lies in the fact that we may determine *a priori* how many events it is necessary to take into account in order to prove an effect of given magnitude. Let us agree, for instance, that we are satisfied with a probability of a million to one as giving us reasonable security against a chance coincidence. Let there be a periodic effect of such a nature that the ratio of the occurrence at the time of maximum to that at the time of minimum shall on the average be $1+\lambda$ to $1-\lambda$, then the number of observations necessary to establish such an effect is given by the equation $N = 200/\lambda^2$. If there are 2 per cent. more occurrences at the time of maximum than at the time of minimum $\lambda = .01$, and N is equal to two million. If the effect is 5 per cent., the number of events required to establish it is 80,000.

To illustrate these results further, I take as a second example a suggested connection between the occurrence of thunderstorms and the relative position of sun and moon. Among the various statistical investigations which have been made on this point, that of Mr. MacDowall lends itself most easily to treatment by the theory of probability. One hundred and eighty-two thunderstorms observed at Greenwich during a period of fourteen years have been plotted by Mr. MacDowall as distributed through the different phases of the moon, and seem to show a striking connection. I have calculated the principal Fourier coefficient from the data supplied, and find that it indicates a lunar periodicity giving for the ratio of the number of thunderstorms near new moon to that near full moon the fraction 8/17 to 4/83.

This apparently indicates a very strong effect, but the inequality is only twice as great as that which we should expect if thunderstorms were distributed quite at random over the month, and the probability of a true connection is only about 20 to 1. No decisive conclusions can be founded on this, the number of thunderstorms taken into account being far too small. We might dismiss as equally inconclusive most of the other researches published on the subject were it not for a remarkable agreement among them, that a larger number of storms occur near new moon than near full moon.

I have put together in the following table the results of all investigations that are known to me; following the example of Koeppen, I have placed in parallel columns the number of thunderstorms which have occurred during the fortnight including new moon, and the first quarter and the fortnight including the other two phases.

Place of observation and author.	Time of observations.	Percentage of thunderstorms during the fortnight including	
		New moon and first quarter.	Full moon and last quarter.
Karlsruhe (Eisenlohr) ...	1801-31	50.8	49.2
Gotha (Luedicke) ...	1867-75	72.5	27.5
Vjgevano (Schiaparelli) ...	1827-64	46	54
Germany (Köppen) ...	1879-83	56	44
Glatz (Richter) ...	1877-84	62	38
United States (Hazen) ...	1884	56.5	43.5
Prag (Grüss) ...	1840-59	51	49
" " " " " "	1860-79	52.5	47.5
Göttingen (Meyer) ...	1857-80	54	46
Kremsmunster (Wagner) ...	1862-87	53.8	46.2
Aix la Chapelle (Polis) ...	1833-92	54.4	45.6
Sweden (Eckholm) ...	1880-95	53.8	46.2
Batavia (v.d. Stock) ...	1887-95	51.9	48.1
Greenwich (McDowall) ...	1888-91	54	46
Average ...	—	54.9	45.1

It will be seen that out of fourteen comparisons, thirteen show higher numbers in the first column, there being also, except in two cases, a general agreement as regards the magnitude of the effect. Two of the stations given in the table, Göttingen and Gotha, are perhaps geographically too near together to be treated as independent stations, and we may, therefore, say that there are thirteen cases of agreement, against which there is only one published investigation (Schiaparelli) in which the maximum effect is near full moon.

The probability that out of thirteen cases in which there are two alternatives, selected at random, twelve should agree and one disagree is one in twelve hundred. If the details of the investigations summarised in the above table are examined, considerable differences are found, the maximum taking place sometimes before new moon and sometimes a week later. There is, however, evidently sufficient *prima facie* evidence to render an exhaustive investigation desirable. The most remarkable of all coincidences between thunderstorms and the position of the moon remains to be quoted. A. Richter has arranged the thunderstorms observed at Glatz, in Silesia, according to lunar hours, and finds that in each of seven successive years the maximum takes place within the four hours beginning with upper culmination. If this coincidence is a freak of chance, the probability of its recurrence is only one in three hundred thousand. The seven years which were subjected to calculation ended in 1884. What has happened since? Eighteen years have now elapsed, and a further discussion with increased material would have definitely settled the question, but nothing has been done, or, at any rate, published. To me it seems quite unintelligible how a matter of this kind can be left in this unsatisfactory state. Meteorological observations have been allowed to accumulate for years, one might be tempted to say for centuries, yet when a question of extraordinary interest arises we are obliged to remain satisfied with partial discussion of insufficient data.

The cases I have so far discussed were confined to periodical recurrences of single detached and independent events, the condition, under which the mathematical results hold true, being that every event is entirely independent of every other one. But many phenomena, which it is desirable to examine for periodic regularities, are not of this nature. The barometric pressure, for instance, varies from day to day in such a manner that the deviations from the mean on successive days are not independent. If the barometer on any particular day stands half an inch above its average it is much more likely that on the following day it should deviate from the mean by the same amount in the same direction than that it should stand half an inch below its mean value. This renders it necessary to modify the method of reduction, but the theory of probability is still capable of supplying a safe and certain test of the reality of any supposed periodic influence. I can only briefly indicate the mathematical theorem on which the test is founded. The calculation of Fourier's coefficients depends on the calculation

of a certain time integral. This time integral will for truly homogeneous periodicities oscillate about a mean value, which increases proportionately to the interval, while for variations showing no preference for any given period, the increase is only proportional to the square root of the time.

Investigations of periodicities are much facilitated by a certain preliminary treatment of the observations suggested by an optical analogy. The curve, which marks the changes of such variables as the barometric pressure, presents characteristics similar to those marking the curve of disturbance along a ray of white light. The exact outline of the luminous disturbance is unknown to us, but we obtain valuable information from its prismatic analysis, which enables us to draw curves connecting the period and intensity of vibration. For luminous solids we thus get a curve of zero intensity for infinitely short or infinitely long radiations, but having a maximum for a period depending on temperature. Gases, which show preference for more or less homogeneous vibrations, will give a serrated outline of the intensity curve.

I believe meteorologists would find it useful to draw similar curves connecting intensity and period for all variations which vary round a mean value such as barometric, thermometric or magnetic variations. These curves will, I believe, in all cases add much to our knowledge; but they are absolutely essential if systematic searches are to be made for homogeneous periods. The absence of any knowledge of the intensity of periodic variation renders it, e.g., impossible to judge of the reality of the lunar effect which Eckholm and Arrhenius believe to have traced in the variations of electric potential on the surface of the earth. The problem of separating any homogeneous variation, such as might be due to lunar or sunspot effects, is identical with the problem of separating the bright lines of the chromosphere from the continuous overlapping spectrum of the sun. This separation is accomplished by applying spectroscopes of great resolving powers. In the Fourier analysis, resolving power corresponds to the interval of time which is taken into account, hence to discover periodicities of small amplitude we must extend the time interval of the observations.

I believe that the curve which connects the intensity with the period will play an important rôle in meteorology. It is a curve which ought to have a name, and for want of a better one I have suggested that of periodograph. To take once more barometric variations as an example, it is easy to see that just as in the case of white light the periodograph would be zero for very short, and probably also for very long, periods. There must be some period for which intensity of variation is a maximum. Where is that maximum? And does it vary according to locality? The answer to these questions might give us valuable information on the difference of climate. Once the periodograph has been obtained, the question of testing the reality of any special periodicity is an extremely simple one. If h be the height of the periodograph, the probability that, during the time interval chosen, the square of the Fourier coefficient should exceed kh is e^{-k} . If we wish this quantity to be less than a million, k must be about 11; so that in order to be reasonably certain that any periodicity indicates the existence of a truly homogeneous variation, the square of the Fourier coefficient found should not be less than 11 times the corresponding ordinate of a periodograph.

I have calculated in detail the periodograph of the changes of magnetic declination at Greenwich, taking as basis the observations published for the 25 years 1871-95. It was not, perhaps, a very good example to choose, on account of the complications introduced by the secular variation, but my object was to test the very persistent assertions that have been made as to the reality of periodic changes of 26 days or thereabouts. The first suggestion of such a period came from Hornstein, of Prague, who ascribed the cause of the period to the time of revolution of the sun round its axis. He only discussed the records for one year's observations, but the evidence he offered was sufficient to impress Clerk Maxwell with its genuineness. Since Hornstein's first attempts, a great many rough and some very elaborate efforts have been made by himself and others to prove a similar period in various meteorological variations. The period found by different computers differed, but there is a good deal of latitude allowed if the rotation of the sun really has an effect on terrestrial phenomena, because the angular velocity of the visible solar surface varies with the latitude. Hornstein himself and some of his followers deduced a period

not differing much from 26 days, while Prof. Frank Bigelow, using a large quantity of material, finds 26.68 days, and Eckholm and Arrhenius return to 26 days, or, as they put it more accurately, to 25.929 days. The two latter investigators do not, however, adopt the idea that this periodicity is due to the rotation of the sun. None of these periods can stand the test of accurate investigation.

As the result of my calculations, I can definitely state that the magnetic declination at Greenwich shows no period between 25.5 and 27.5 days having an amplitude as great as 6" of arc. The influence of solar rotation on magnetic variation may therefore be considered to be definitely disproved.

The intensity of the periodograph increases rapidly with the period, and minute variations are, therefore, more easily detected in short than in longer periods. Six seconds of arc forms about the limit of amplitude, which can be detected in 25 years of observations, when the period is about 26 days; and from what has been said above, the amplitude which can be detected will be seen to vary inversely with the square root of the time interval. For periods of about 14 days, an amplitude of 3" of arc is still distinguishable with the material I have used; and such an amplitude is actually found for a period which has half the synodic month as its time. The chance that this apparent variation is due to an accidental coincidence is one in two thousand; and I cannot, therefore, assert its definite existence beyond all possibility of cavil. But it is surely significant that of all the periods possible between 12.5 and 13.7 days, that gives the highest amplitude which coincides with half the synodic revolution of the moon. That it is at all possible to detect variations of 3" of arc in the observations which are taken to 6", with a probability of error of only one in two thousand, is, I think, a proof of the value of the method and the carefulness of the observations. The periodograph has another valuable use. It not only gives us the time necessary to establish true periodicities of given amplitude, but it also gives us an outside limit of the time beyond which an accumulation of material is of no further advantage. That limit is reached when the time is sufficient to discover the smallest amplitude which the instruments, owing to their imperfections, allow us to detect.

I am only concerned to-day with a purely statistical inquiry, and not with the explanation of any suggested relationship. To prevent misunderstandings, however, I may state that I consider the possibility of a direct magnetic or electric action of the moon excluded; as regards the latter, the diurnal variations of electric potential would be so much affected by a lunar electrification sufficiently strong to influence the outbreak of thunderstorms that it could not have escaped discovery. We must not, however, be dogmatic in asserting the impossibility of indirect action. The unexpected discovery of radio-activity has opened out an entirely new field, and we cannot dismiss without renewed careful inquiry the evidence of lunar action which I have given. Its reality can be decided by observation only. No—not by observation only—but by observation supplemented by intelligent discussion; and this brings me to my concluding appeal, which I wish to urge upon you with all the legitimate weight of strong conviction and all the illegitimate influence of presidential infallibility.

The subjects with which our subsection is concerned deal with facts which are revealed to us by observation more frequently than by experiment. There is in consequence a very real danger that the importance of observation misleads us into mistaking the means for the end, as if observation alone could add anything to our knowledge. Observation is like the food supplied to the brain, and knowledge only comes through the digestion of the food. An observation made for its own sake and not for some definite scientific object is a useless observation. Science is not a museum for the storage of disconnected facts and the amusement of the collecting enthusiast. I dislike the name "observatory" for the astronomical workshop, for the same reason that I should dislike my body to be called a food receptacle. Your observing dome would be useless without your computing room and your study. What you want is an Astronomical Laboratory, a Meteorological or Magnetic Laboratory, attaching to the word "laboratory" its true meaning, which is a workshop in which eyes and hands and brains unite in producing a combined result.

The problems which confront the astronomer being more definite than those of Meteorology, Astronomy has grown under the stimulus of a healthy tradition. Hence it is generally recognised, at any rate in the principal observatories, that the

advance of knowledge is the chief function of the observer. Nevertheless, the President of the Astronomical Department of Section A last year (Prof. H. H. Turner) has found it necessary, in his admirable address, to warn against the danger there is that the astronomer should allow himself to be swallowed up in a routine work and mere drudgery. The descent is easy: You begin by being a scientific man, you become an observer, then a machine, and finally—if all goes well—you design a new eyepiece.

If such a danger exists in Astronomy, what shall we say about Meteorology? That science is bred on routine, and drudgery is often its highest ambition. The heavens may fall in, but the wet bulb must be read. Observations are essential, but though you may never be able to observe enough, I think you can observe too much. I do not forget the advances which Meteorology has made in recent years, but if you look at these advances, I think you will find that most of them do not depend on the accumulation of a vast quantity of material. The progress in some cases has come through theory, as in the applications of Thermodynamics or through special experiments as by kite and balloon observations, and when it has come through the ordinary channels of observation, only a comparatively short period of time has been utilised. It would not be a great exaggeration to say that Meteorology has advanced in spite of the observations and not because of them.

What can we do to mend matters? If we wish to prepare the way for the gradual substitution of a better system, we should have some one responsible for the continuation of the present one. For this purpose it should be recognised that the head of the Meteorological Office is something more than a Secretary to a Board of Directors; also that he is appointed to conduct Meteorological research and not to sign weather forecasts. The endowment of Meteorology should mean a good deal more than the endowment of the Telegraph Office which transmits the observations. Terrestrial Magnetism and Atmospheric Electricity are looked after at present by institutions already overworked in other directions and should be handed over to an enlarged Department of Meteorology. Seismology in this country now depends on the private enterprise and enthusiasm of a single man, and as long as Prof. Milne is willing to continue his work, we cannot do better than leave it to him, but some permanent provision will ultimately have to be made.

An improved organisation such as I have sketched out would do good, but could only very slowly overcome the accumulated inertia of ages. I should prefer a more radical treatment. Organisation is good, but sometimes disorganisation is better.

Most earnestly do I believe that the subjects of meteorology and terrestrial magnetism, and possibly also of atmospheric electricity, could be most quickly advanced at the present moment if all observations were stopped for five years, and all the energy of all observers and computers concentrated on the discussion of the results obtained and the preparation of an improved scheme of observation for the future. When we have made up our minds what to do with the observations, when we have actually done it; when we know where our present instruments require refining or supplementing, and especially when we have found out whether we have not spent much time and trouble on unnecessary detail, then the time will have arrived for us to draw up an economical, sufficient and efficient scheme of observations. At present we are disinclined to discontinue observations, though recognised as useless, for fear of causing a break. We make ourselves slaves to so-called "continuity," which is important, but, may be, and I believe is being, too clearly purchased.

There are no doubt some, though probably not very many, observations which it is necessary to carry on continuously over long periods of time. But at present we are groping in the dark, and go on observing everything, and always in the hope that some time the observations might prove useful. Our whole point of view in this respect wants altering. We should fix on our problem first and then provide the observations which are necessary for the solution of the problem. Let us restrict, in the first instance, the secular observations to the smallest number, and concentrate our attention, for short periods of time, on some special question. Let us have, for instance, two or three years of thunderstorm observations, all countries joining in concentrating their energies to the elucidation of all the various features of their phenomena. When that is accomplished, it will probably be found that thunderstorms may be left to shift for themselves for a while, and attention might be

directed to some other matter. The whole question of lunar influence on meteorological phenomena might be settled in a comparatively short space of time if the civilised countries of the world could agree to record all observations during a few years according to lunar instead of solar coordinates. Other problems will readily suggest themselves to you, and several might possibly be dealt with simultaneously.

The great reform I have in view is this:—Before you observe, make sure that your observations will be useful and will help to answer a definite question.

I hope that, though my frankly outspoken criticisms may not command universal assent, you will agree that there is some foundation for them, and, if so, the time is obviously not well chosen when observational science can be separated from its mathematical and experimental sisters. We hope that cosmical physics may remain an integral portion of Section A, and, though we acknowledge our weaknesses, we claim to have also something to teach.

I hope that our proceedings this week may show that we can put aside observational detail and throw some light on the great and important problems with which our science is concerned.

MATHEMATICS AND PHYSICS AT THE BRITISH ASSOCIATION.

ALTHOUGH the number of communications made to the Section at Belfast was less than at Glasgow last year, there was no decrease in the interest of the meetings. The inclusion of cosmical physics in the subjects dealt with by the department for astronomy materially increased the attendance at the meetings of that department.

In the mathematical department, Miss Hardcastle described the ground covered by the second part of her report on the present state of the theory of point groups, and stated that a further communication would be necessary to bring the report up to the present time. In the absence of the author, Prof. Forsyth gave a short account of Mr. E. T. Whittaker's solutions of the partial differential equations of mathematical physics. Mr. Whittaker finds that an expression of the type

$$\int_0^{2\pi} f(z + ix \cos u + iy \sin u, u) du$$

is the most general solution of the potential equation of Laplace, where f is an arbitrary function of the arguments

$$z + ix \cos u + iy \sin u \text{ and } u, \text{ and } i = \sqrt{-1}.$$

It follows that Legendre's, Bessel's and other well-known solutions of the equation are special forms of Mr. Whittaker's. In the same way, the general solution of the equation of wave motion is of the type

$$\int_0^{2\pi} \int_0^{\pi} f(x \sin u \cos v + y \sin u \sin v + z \cos u + \frac{t}{R}, u, v) du dv,$$

where f is an arbitrary function. Mr. Whittaker points out that this solution may be analysed into plane waves, and therefore supports the conclusion arrived at by Dr. Johnstone Stoney in 1897, that all disturbances in the ether can be resolved into trains of plane waves.

In the department of physics, Lord Rayleigh brought forward the question of the accurate conservation of weight in chemical reactions. He considered the discrepancies found by experimenters too large to allow the law of conservation to be accepted as proved, and hoped that the experiments at present being carried out by Landolt and Heydeweller would soon lead to a definite conclusion. Prof. Morton described the experiments he and Mr. Hawthorne had carried out on the motion of a detached thread of liquid in a capillary tube. He concludes from them that there is some force of the nature of an attraction between the liquid and the material of the tube, which must be taken into account to explain completely the phenomena observed. He further detailed how he had, in conjunction with Mr. Vinycomb, repeated and extended the work of Kaps on the mode of vibration of stretched strings, and investigated the effect of the rigidity of the support on the motion of the string.

Dr. Barnes, of Montreal, on continuing his experiments on the critical velocity of flow of water through tubes, has found

that the velocity varies with temperature in the way anticipated from the viscosity term in the expression given by Prof. Osborne Reynolds in his classical paper on critical velocity. By applying in the case of mercury the method most used in determining the specific heat of water, he has also found that the specific heat of mercury decreases at a rate which itself decreases slightly with increase of temperature. Lord Kelvin sent a short communication in which he suggested that the temperature of an animal surrounded by a saturated atmosphere hotter than itself was kept down by evaporation within the lungs.

Dr. J. Larmor, in a paper on the application of the method of entropy to radiant energy, showed that by defining the entropy of a given space containing radiant energy distributed in any arbitrary way, as the logarithm of the probability of the existence of that particular distribution, the law of distribution of the energy with wave-length, which was recently deduced by Planck by considering a space filled with electrical resonators, could equally well be established. According to it, the amount of energy between wave-lengths λ and $\lambda + d\lambda$ radiated by a perfectly black body at absolute temperature t is proportional to

$$\frac{I}{\lambda^5} \frac{I}{e^{\frac{h}{\lambda t}} - 1}$$

where a is a constant.

Mr. Petavel gave an account of the work he had done towards the production of a standard of light. He considered that the incandescent surface of a metal of the platinum group heated electrically furnished the best source, and proposed to fix the temperature of that source by the equality of the radiation transmitted by suitable thicknesses of two media, the absorption of one of which (water) increased, and of the other (black fluor-spar) decreased, with increase of temperature of the source. Dr. C. S. Myers called attention to a variation of pitch of Galton and other high-frequency whistles when the wind pressure was changed, which he had not been able to explain.

Lord Rayleigh prefaced a description of his own experiments to determine whether double refraction was produced in isotropic transparent bodies by their motion through the ether, by an account of those of Michelson and Morley. The latter led to the conclusion that light travelled with the same velocity, whether the direction of transmission was coincident with, across or opposed to that of the motion of the body. Lord Rayleigh's arrangement would have enabled a change of velocity of 10^{-10} of the velocity of light to be detected, but no change was observed when the light was transmitted through water or carbon bisulphide. The experiments on solids are not yet concluded.

Dr. Johnstone Stoney forwarded a note in which he showed that by substituting for Huyghen's wave surface, a wave film of finite thickness, within which the phases of the disturbances were given proper values, the disturbance propagated to a point outside the wave surface could be accurately calculated. In a second note, Dr. Stoney showed how his method of resolving the light traversing any isotropic medium into trains of plane waves might be applied to explain several optical phenomena which have not hitherto yielded to other methods.

Prof. E. Wilson described his experiments on the use of a magnetic detector in space telegraphy. His detector consists of an iron ring magnetised to instability by a current through a coil wound on the ring. The electric waves falling on the ring slightly disturb its magnetic state, and the disturbance is indicated by the sound produced in a telephone in series with a second coil wound on the ring. He finds such a detector very convenient and satisfactory in working.

Prof. Minchin has found that a coherer consisting of a carbon rod lightly supported in aluminium stirrups in an evacuated glass tube decoheres better than any other form he has tried, and is now engaged in applying the arrangement to long-distance transmission.

Dr. Marchant showed that the graphical method of determining the discharge of a condenser through a variable inductance gave results which agreed very closely with the calculated discharge in those cases in which the calculation could be carried out.

Mr. Butler-Burke gave a short account of his work on the phosphorescence produced in partially exhausted tubes by the passage of an alternating current round them. He concludes that it is due to the formation of groups consisting of a large number of molecules of gas within the tube.

In the department of astronomy and cosmical physics, Dr. W. E. Wilson exhibited a bolometer arranged to record solar radiation. It consists of two blackened coiled platinum wires, on one of which the light of the sun is allowed to fall through an opening in the metal box in which both are enclosed. The Rev. A. L. Cortie has examined in detail the Greenwich records of sun-spots and facule, and the diurnal ranges of the declination magnet, for the years 1899-1901, and finds that there is not sufficient accordance to support the statement sometimes made that sun-spots cause magnetic storms. He considers the two are correlated effects of some common cause still to be found.

The committee for investigating the upper atmosphere by means of kites gave a report of flights made from their station near Oban during July and August. The average height reached was about 3500 feet, and the average rate of decrease of temperature upwards about $3\frac{1}{2}$ ° F. per 1000 feet.

Dr. Shaw, in his communication on radiation in meteorology, pointed out that radiation or absorption of heat by a cloud would result in motion of the cloud downwards or upwards. This motion would produce in its turn a heating or cooling of the cloud opposed to the initial change, and a much more careful and extended study of the radiation from clouds than had hitherto been attempted was necessary before several of the problems connected with cloud motion could be solved. He suggested several ways in which observers with simple instruments could help toward the solution of these problems.

Prof. Milne, in presenting the report of the Seismological Committee, stated that each of the recent West Indian eruptions had been preceded by sudden readjustments of the strata in the neighbourhood, which left their traces on the earthquake-recording instruments. This may, after further investigation, lead to a method of predicting eruptions.

Dr. Roberts exhibited photographs of nebulae illustrating the nebular theory of the evolution of star systems, from cloudy nebulae, through the spiral stage, to star clusters.

Mr. Hinks opened a discussion on the nebula surrounding Nova Persei by showing that some of the phenomena exhibited by the nebula might be due to its being ring-shaped. Photographs exhibited by Dr. Roberts did not, however, appear to support this view, and there seems little hope of coming to any definite conclusion as to the nature of the nebula until more information as to its appearance is available. C. H. LEES.

GEOLOGY AT THE BRITISH ASSOCIATION.

THE total number of communications brought before Section C at Belfast was thirty-five. None of them can be said to have been of really great importance, but they were for the most part records of good work. The Committee on Life-zones in the Carboniferous Rocks sent in an admirable report of careful and systematic fossil-collecting. The Committees on the Underground Waters of N.W. Yorkshire and on Erratic Blocks were also able to show excellent work, and Prof. W. W. Watts, as usual, brought a good series of photographs which had been collected by his committee during the past year. Proceedings opened on Thursday, September 11, with the president's address, which has already been printed in our columns. It was followed by a lecture on the geology of the country around Belfast by Prof. Grenville A. J. Cole. On the morning of Sept. 15 Prof. Cole gave a second lecture, on the geological structure of Ireland; both lectures were illustrated by lantern slides and were listened to with close attention by large audiences. A considerable number of the papers naturally dealt with the geology of Ireland, and it may be convenient to notice them first and then to mention some of the other communications in geographical order. A proof-sheet of the Drift edition of the geological map of Ireland was exhibited by Mr. Teall, the director of the Survey. He explained that it was printed in colour instead of being hand-coloured, and was consequently clearer and would cost much less than the hand-coloured maps now issued by the Survey.

The post-Glacial deposits of the Belfast district were described in a most interesting paper by Mr. R. Lloyd Praeger. A peat bed, representing an old land surface, is found 20 feet below low water at Belfast, but between tides at other places in the district. In it remains of the Irish elk have been found, and a little above it there is some 12 feet of blue clay, the upper part of which contains *Thracia convexa* and other shells, indicating a warmer climate than the fauna now living in the Irish Sea and

a depth of five to ten fathoms, whilst in the lower part of the clay, *Scrobicularia piperata* and fossils of a shore type are found.

Mr. P. F. Kendall read a paper by Madame Christen giving an account of the recent work of the Belfast Field Club. The members have made a careful study of the drifts of the district. They have, for example, proved the transport of the Khyolite of Tardree to the north as well as in other directions. Attention was also drawn to the wide dispersal through the district of blocks from Ailsa Craig, and it was stated that these blocks are practically always found associated with marine shells. The committee appointed to explore Irish caves was able to show excellent work in the caves of Keishocoran Mountain, a mass of Carboniferous Limestone fifteen miles south of Sligo. In the Coffey Cave, bones of the Arctic lemming had been found in considerable numbers. This, the report states, is the first record of its existence as a former inhabitant of Ireland. Excavations in an extensive series of caves at Edenvale, county Clare, were described. Remains of bear and of the Irish elk were recorded, as well as human implements, ornaments, &c., and Mr. R. J. Ussher, who read the report, said that he hoped for important evidence of the state of prehistoric Ireland from further exploration.

Mr. Joseph Wright announced his discovery of large numbers of marine Foraminifera in Boulder-clay from various places in Ireland and also from England, Wales, Scotland, the Isle of Man and Canada. He more especially dealt with the Boulder-clay of Knock Glen, near Belfast. From it he had obtained seventy-nine species, and he suggested a considerable depression of the area at the time of its deposition. This led to an animated discussion, Prof. Boyd Dawkins supporting the author's view and Messrs. Lamplugh and Kendall contending for a transport of the clay to its present position by land ice.

A paper by Mr. R. Clark dealt with the Silurians of north-east Ireland. The author described some new fossil localities and gave lists of the species found.

Mr. G. Barrow read a paper on the prolongation of the Highland Border rocks into county Tyrone. The author referred to the Jasper and green-rock series, which he had found between Blairgowrie and Stonehaven (*Q.J.G.S.* vol. lvii. p. 328), and explained that he believed it to correspond with a series found by Mr. Peach near Omagh. He thought these rocks were intermediate in age between the Highland rocks, which he looked upon as Archaean, and a newer series, the Pomroy rocks, of Silurian age.

An interesting discussion followed the reading of this paper.

Mr. McHenry agreed that in Ireland there are three series:—(1) An old series, which he thought was probably metamorphosed Llandeilo and Bala; (2) the green rocks; and (3) the Pomroy rocks, which are mapped Lower Silurian, but contain Devonian and Wenlock fossils with a few survivors of Bala type. The conglomerates of this third series contain pebbles of the green rocks. He agreed that the line between the green rocks and the older series was a great thrust which in his opinion affected the Old Red Sandstone. He had followed it south-west to Castlebar and Clew Bay into Clare Island.

Mr. Teall agreed that this line of disturbance in Ireland should be classed with that which the author had worked out in Forfarshire, but he thought further evidence was required as to the age of the rocks. Dr. Matley, Prof. Cole, Prof. J. F. Blake and Mr. Cunningham-Craig also spoke. In reply, the author said he was sure of the order of succession, but not of the precise age of the rocks.

A list of 113 minerals known to occur in Ireland was contributed by Mr. H. J. Seymour. He explained that it was but of a preliminary character and that he had only included species which he was satisfied really have been found in the country.

Passing to Scottish geology, a paper of very great interest was sent in by Mr. Kynaston and was read by Mr. Teall. The author described a series of volcanic rocks in the district extending from Glen Coe to the Black Mount. The lower part consists of some 1500 feet of basic andesites with sandstone, shale and conglomerate at the base. Above these andesites are agglomerates and breccias capped by some 700 feet of hornblende andesite. Messrs. Peach and Tait have discovered plant remains in a bed of black shale associated with these lavas which enable the author to fix their age as Lower Old Red Sandstone; that is, they are of the same date as the great volcanic series of Lorn.

The author then showed that the granite of Ben Cruachan

s newer than these volcanic series, thus solving a question of considerable interest. From this it follows that the boulders of granite found in the basement conglomerate of the volcanic series are not derived from the granite of the district, but must have come from some other area.

Two papers were sent in by Dr. W. Mackie. The first dealt with the conditions under which manganese dioxide has been precipitated in the Elgin sandstone. The second gave the results of a series of determinations of the soluble chlorides and sulphates in the same sandstone, made with a view to test the theory that from such an examination it is possible to determine the character of the waters of the basin of deposit of sedimentary rocks. The result was of a negative character, and the author believes it is not safe to infer that the soluble salts of a deposit represent the salts of the original waters of the basin of deposition.

English geology occupied a very small part of the time of the Section. Mr. Horace B. Woodward sent an interesting note relating to the Eocene. A section on a new railway between Axminster and Lyme Regis shows a good example of Bagshot strata near Combe Pyne Hill which serves to connect the beds of that age at Bournemouth with the deposit at Bovey Tracey in Devon. This last is now admitted to be of Bagshot age. It used to be called Miocene, but Mr. Starkie Gardner has long contended that it is equivalent to the Bournemouth Series.

A paper on the fossil flora of the Cumberland Coalfield was read by Mr. E. A. Newell Arber, who described plants from both the Whitehaven sandstone and the Coal-measures.

Mr. P. F. Kendall dealt with the Vale of Eden. He believed that he could show from the relative position of the Permian breccias or Brockrams that a movement of the Pennine faults had taken place in Permian times.

There was one paper relating to Wales. It was by Mr. W. G. Fernside, who described some new faunas which he had obtained at Pen Morfa, near Tremadoc. He described a zone with species of high Lingula Flag type 30 feet below the Lower Tremadoc. Some 30 feet above the horizon of Ramsay's Lower Tremadoc fossils, he had found a continuous zone of Dictyonema, and had mapped its outcrop for more than five miles. Finally, some 400 feet above the Dictyonema, he had found a Shineton fauna with a number of Swedish forms and some new species.

Passing now to papers dealing with localities outside the British Isles, we may mention a paper by Dr. R. H. Traquir on fishes of the Lower Devonian roofing slate of Gemünden in Germany. They belong to the class with mailed bodies and are there associated with a fauna thoroughly marine in character, a point of considerable interest. The author showed some beautiful photographs of the fishes and of starfishes, crinoids, trilobites, corals, &c., from the slates.

Indian geology was dealt with in an interesting note by Prof. H. G. Seeley. He said that hitherto there has been no evidence of Cretaceous strata in the Salt Range of the north of India, but he was now able to bring forward an account of a series of species found by Mr. E. G. Fraser on the shoulder of Sekasar. They are of the type or age of the Upper Greensand.

Two papers dealt with Victoria, Australia. Mr. James Stirling gave some notes on a new geological map of the colony, and Dr. Smith Woodward sent an account of some observations on a new Lower Carboniferous fish-fauna from the Broken River. Attention was first drawn to these Broken River fossils some twelve years ago, and the late Sir Frederick McCoy described them as a mixture of Devonian and Carboniferous forms. This Dr. Woodward now shows to have been a mistake; he considers them typically and essentially Carboniferous. Dr. Traquir said that he had seen the collection and could corroborate all the statements in the paper. Paleontologists might now congratulate themselves that the myth which alleged the existence of fishes of Lower and Upper Devonian and Lower Carboniferous types in the same bed had been exploded.

With regard to America, the only contribution was a paper by Dr. H. Woodward on the Middle Cambrian Trilobites of Mount Stephen, British Columbia.

Most of the Paleontological papers have already been noticed, but an interesting note on the tusks and skull of *Mastodon angustidens*, by Dr. C. W. Andrews, deserves mention.

Prof. J. Joly brought forward a suggestive paper on the viscous fusion of rock-forming minerals, which gave rise to an

interesting discussion in which Mr. Teall, Prof. Grenville Cole and Dr. Johnston-Lavis took part.

Prof. J. F. Blake read a paper on the original form of sedimentary deposits. He observed that during the continuance of constant physical conditions, the seaward boundary of river-brought deposits will be a marked line. Such a line has been called an escarpment and the edge of the continental plateau, but the author believed it to be the limit of terrigenous deposits in bulk. He also considered that limestones are most likely to form deposits of lenticular shape with the long axis parallel to the shore, and when they are found to give place to shales we should infer that we are approaching a river or other source of sediment.

In conclusion, we may mention that a series of excursions to places of geological interest was arranged by Messrs. G. W. Lamplugh, J. St. J. Phillips and H. J. Seymour, and were much appreciated by the geologists present at the meeting.

CARBON AND PLANTS.¹

IN a paper recently laid before the Royal Society, dealing with the physical processes which regulate the entry of atmospheric carbon dioxide into the leaves of plants,² the author incidentally described a series of experiments relating to the rate of absorption of dilute gaseous carbon dioxide by surfaces of solutions of caustic alkali, when air containing definite small amounts of this gas is drawn over the liquid. Contrary to what might be expected from the perfect absorbing nature of the solution, and the known laws of gaseous diffusion, the amount of CO₂ absorbed by unit area of the liquid surface in unit time ceases sensibly to increase when a comparatively low velocity of the moving air current has been reached. This, however, only holds good when the proportion of CO₂ in the air stream is maintained quite constant, any slight variation in the amount at once affecting the rate of absorption. On investigation, it was found that for dilutions of carbon dioxide lying between 0.6 part and 6 parts per 10,000 of air, the rate of absorption of the carbon dioxide is strictly proportional to its partial pressure.

In determining the rates of gaseous diffusion of atmospheric carbon dioxide through multiperforate diaphragms extended over chambers containing perfect absorbents, the same relations between partial pressure of the gas and its absorption were found to hold good; under these conditions the amount of carbon dioxide passing through the diaphragm in a given time is also directly proportional to the density of that gas in the moving stream of air which flows over the outer surface of the diaphragm.

But this latter case exactly defines the physical conditions under which atmospheric carbon dioxide enters the tissue of a living leaf, the multiperforate diaphragm being represented by the cuticle and epidermis, pierced with numerous stomata, and the inner absorbing chamber by the intercellular spaces of the parenchyma, bounded by the chlorophyll-containing cells in which the process of photosynthesis goes on (*loc. cit.*).

The authors have now found, by enclosing the living leaves in glass cases through which air containing known proportions of CO₂ is passed, that a living leaf is really able, within certain limits, to respond to increased amounts of carbon dioxide in the air surrounding it, in such a manner as to indicate an approximate proportionality between the photosynthetic work it can accomplish and the partial pressure the gas exercises in the air bathing the leaf surface.

The following experiment may be selected from several, in illustration:—

Experiment I.—In this case, comparative experiments were made on two successive days in August, 1898, with two similar leaves, A and B of *Helianthus annuus* whilst still attached to the plant. These were exposed to the strong diffused light of a clear northern sky under as nearly as possible identical conditions, with the exception of the composition of the air drawn through the cases.

Over leaf A was drawn normal air containing 2.8 parts per 10,000 of CO₂, whilst the air passing over leaf B contained 25.53 parts CO₂ per 10,000.

¹ Adapted from a paper on "The Influence of Varying Amounts of Carbon Dioxide in the Air on the Photosynthetic Process of Leaves and on the Mode of Growth of Plants," by Dr. Horace T. Brown, F.R.S., and Mr. F. Escombe. Read before the Royal Society on May 29.

² *Phil. Trans.*, B, 1900, vol. cxciii, p. 278.

<i>Leaf A.</i>	
Area of leaf	743'1 sq. cm.
Volume of air passed per hour, reduced to normal temperature and pressure... ..	159'03 litres.
CO ₂ content of air entering case ...	2'80 parts per 10,000.
" " leaving case	1'64 " "
Mean CO ₂ content of air in contact with leaf during experiment	2'22 " "
CO ₂ absorbed by leaf per hour	18'44 c.c.
" " per sq. metre per hour	248'2 c.c.
<i>Leaf B.</i>	
Area of leaf	863'75 sq. cm.
Volume of air passed per hour, reduced to normal temperature and pressure... ..	72'7 litres.
CO ₂ content of air entering case ...	25'30 parts per 1000
" " leaving case	4'12 " "
Mean CO ₂ content of air in contact with leaf during experiment	14'82 " "
CO ₂ absorbed by leaf per hour	155'7 c.c.
" " per sq. metre per hour	1802'8 c.c.

It is manifest that if we wish to determine the relation of the partial pressures of carbon dioxide to the rate of intake of that gas into the leaf, we must employ the values representing the mean carbon dioxide content of the air in contact with the leaf during the experiment, which may be taken as the arithmetical mean of the composition of the entering and emergent air. In the above experiment, we obtain the following relations:—

Ratio of partial pressures of CO₂ in A and B, 2'22 : 14'82 or 1 : 6'6.

Ratio of CO₂ absorbed per sq. metre of leaf A and B in one hour, 248'2 : 1802'8 = 1 : 7'2.

Thus by increasing the amount of CO₂ in the air passing over the leaf about sevenfold, we have, under similar conditions of illumination, increased the photosynthetic power of the leaf by a little more than the same amount.

Experiments of this nature are necessarily limited to comparatively short periods, and give no information as to how far the plant, as a whole, will respond to such changes in its atmospheric environment. When first drawing attention to these facts in 1899 (Presidential Address, British Association, Section B, Dover), it was pointed out that we were not justified, without direct experiment, in concluding that the plant would be able to avail itself indefinitely of the increased amount of plastic carbohydrate material formed in its leaves under these artificial conditions, and that translocation, metabolism and growth may have become so intimately correlated that the perfect working of the entire plant may only be possible in an atmosphere containing the normal amount of three parts of CO₂ per 10,000.

Experiments were started to test how far slightly increased amounts of CO₂ in the air would affect the dry weight of plants grown in such atmospheres, and they indicate that the plants were certainly not stimulated to increased growth by somewhat increasing the amount of CO₂ in the surrounding air. The evidence, in fact, points in the other direction, i.e. towards a slight diminution in the increment of dry weight, and to a less development of foliar area. There were also indications of certain morphological differences, which assumed some importance in the light of subsequent experiments. The plants grown in air slightly enriched with CO₂ had not only smaller leaves than the controls, but these leaves were of a distinctly darker green, and the internodes of the plants were decidedly shorter.

The results obtained with these preliminary experiments now induced the authors to extend their observations to a larger number of species, and arrangements were consequently made to carry out a series of experiments on a large scale. This was done in a greenhouse divided in two by a glazed partition. In one half the plants, gourds, balsams, fuchsias, begonias, &c., were exposed to the CO₂-laden atmosphere; in the other, control plants were in ordinary air. The original paper must be consulted for experimental details and precautions.

A careful record was made of the differences in appearance of the two sets of plants on June 10, June 29 and July 13, that is to say, at 28, 47 and 61 days from the commencement of the experiment. The results are given in detail in the appendix to this paper, and may be summarised as follows:—

The effect of an increased amount of CO₂ in the air, becomes

in most cases apparent within a week or ten days from the commencement of the experiment, and rapidly increases as time goes on. There is a marked difference induced in the habit and general appearance of most of the plants owing to a stimulation of all axial growth, accompanied by a more or less pronounced shortening and thickening of the internodes. Usually, but not in all cases, there is an increased number of the internodes, so that the height of the two contrasted sets remains much about the same, but the chief difference of general habit is brought about by the development throughout the plant of secondary axes in the axils of the leaves, thus giving the plants grown under the influence of increased CO₂ a denser and more bushy appearance. This was particularly noticeable in the fuchsias, especially the dark-leaved variety, in which every axil bore a shoot and frequently extra axillary ones. Adventitious shoots were also developed rather freely at the base of the plants.

The leaf area of the plants under the influence of increased CO₂ was generally found to be much reduced, not so much by the formation of a smaller number of leaves as by the reduction in area of the individual leaves. This was found to be extreme in the case of the dark-leaved fuchsias, and it was also very marked in the second crop of the leaves of Impatiens. There was also produced in many of the plants a marked inward curling of the leaves, the extremes in this direction being found in the begonias and fuchsias. In the dark-leaved variety of fuchsia, the leaves were curled inwards like a watch-spring, which would doubtless tend to reduce excessive photosynthesis by preventing the normal amount of light from reaching the chloroplasts. This change of habit may, in fact, be regarded as an attempt on the part of the plant to adapt itself to its abnormal atmospheric surroundings.

The extra CO₂ in several cases induced a deeper green colour in the leaf, and in all other parts of the plant where chlorophyll was present. This was particularly noticeable in the second crop of leaves developed on the Impatiens, in the begonias and in the darker-leaved fuchsias.

On July 19, the Sachs test for starch was applied to the leaves of the two varieties of fuchsia, *Cucurbita Pepo* and *Impatiens platyptala*. In all cases, the leaves taken from the plants grown with increased CO₂ in the air showed a much larger accumulation of starch than did the leaves of the control plants. These differences were the most strongly marked in the leaves of Impatiens, which became quite black with the test.

It was, however, in the development of the reproductive organs of the two sets of plants that the most striking and important differences were found. Whilst the control plants in ordinary air flowered, and in some cases fruited luxuriantly, in the corresponding plants submitted to air containing 11'4 parts per 10,000 of CO₂, inflorescence was almost totally inhibited. With the exception of one or two sickly-looking flowers on the begonias, not a single flower-bud opened on any of the plants of this set. The plants of Impatiens, Kalanchoe and of the darker-leaved fuchsias did not even produce a flower-bud, whilst in the Nicotiana, Cucurbitas and lighter-leaved fuchsias, the small flower-buds which commenced to form were completely shed long before the time of opening.

In another series of experiments, carried out on similar lines, the air of compartment B was enriched with carbon dioxide to the extent of 6 per cent., that is to say, up to about 200 times the normal amount. The experiment extended from June 3 to August 26, and the general results both in the direction and amount of change of habit induced in the plants were so very similar to those induced in the plants with only three-and-a-half times the normal amount of CO₂ as to require no further special description. The results are, however, valuable as indicating that the observed differences cannot be due to any direct poisonous influence of the carbon dioxide, otherwise we should certainly expect a marked difference to be produced by increasing the amount of CO₂ from 11'4 parts per 10,000 to 600 parts per 10,000, i.e. more than fiftyfold, which was not the case to any appreciable extent.

The direction in which we must search for the true explanation of the effect is probably indicated by the experiments on leaves described in the early part of the paper, where it was shown that the amount of photosynthesis in the leaf lamina is, within certain ill-defined limits, a function of the partial pressure of the CO₂ in the surrounding air.

In the first series of experiments in the greenhouse, where this partial pressure was maintained at about three-and-a-half times the normal, the plants for a certain limited period must

have been manufacturing carbohydrate material within their chloroplasts at least three-and-a-half times faster than those in normal air, and, although this rate of photosynthesis would perhaps not be maintained for very long, yet there would always be a general tendency for the carbohydrate supply in the leaves to be kept up to a higher point than in the controls grown in ordinary air, a fact which was shown by the leaves of set B always being gorged with starch.

Since it is quite certain that this increased photosynthesis does not to any material extent contribute to the increase of dry weight of the plants, we can only conclude that the transformation, translocation and general metabolism of the leaf-reserves under these conditions cannot keep pace with the increased tendency to produce an extra amount of plastic material from the atmosphere. Moreover, it is clear that the whole mechanism of the plant on which normal nutrition depends has its parts so completely and accurately correlated that any slight increase in the composition of the surrounding air which favours increased photosynthesis destroys the adjustment of the various parts and results in a more or less abnormal development of the plant. That any such disturbance of the economy of the plant should profoundly modify the reproductive functions might perhaps have been expected.

It is somewhat remarkable to find that all the species of flowering plants, without exception, which have been the subject of experiment appear to be accurately "tuned" to an atmospheric environment of 3 parts of CO₂ per 10,000, and that the response which they make to slight increases in this

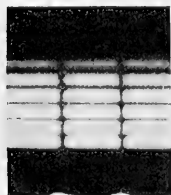

FIG. 1.

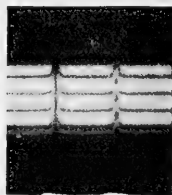

FIG. 2.

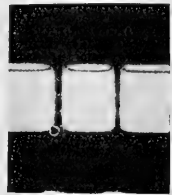

FIG. 3.

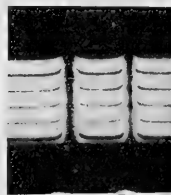

FIG. 4.

amount are in a direction altogether unfavourable to their growth and reproduction. It is not too much to say that a comparatively sudden increase of carbon dioxide in the air to an extent of about two or three times the present amount would result in the speedy destruction of nearly all our flowering plants.

To a certain extent, we may regard the facts recorded in this paper as indicating that the composition of our atmosphere as regards its carbon dioxide has remained constant, or practically constant, for a long period of time, but the authors leave altogether untouched the question of any variations of a secular kind. All we are justified in concluding is that if such atmospheric variations have occurred since the advent of flowering plants, they must have taken place so slowly as never to outrun the possible adaptation of the plants to their changing conditions.

MAGNETO-OPTICAL ROTATION IN THE INTERIOR OF ABSORPTION BANDS.

AN interesting confirmation of Voigt's theory of absorption has been afforded by an experiment by Prof. Zeeman, described in the *Proceedings of the Amsterdam Academy of Sciences of June 25*. In Voigt's theory, the separation of a spectral line by the action of a magnetic field is found as the separation of an absorption line, and the theory requires a negative rotation of the plane of polarisation in the interior of the absorption band. Now in previous experiments, such as those of Corbino, the only observed result has been a very small positive rotation. The new experiment described by Prof. Zeeman is interesting, not only as showing the existence of a negative rotation in the interior of an absorption band, but also as being in perfect quantitative agreement with Voigt's theory.

By means of a system of quartz prisms such as have been used by Fresnel in his experiment on the division of a plane polarised ray into two circularly polarised rays, a number of interference fringes were formed at right angles to the bands of a spectrum,

and when light from a bright source was allowed to pass through sodium vapour and analysed with a Nicol's prism, the effect produced by the sodium absorption lines and the interference lines combined was as shown in Fig. 1. If, however, the sodium vapour was subjected to the action of a powerful magnetic field, of from fifteen to twenty thousand units, the effects shown in Fig. 2 were observed. It will be noticed that the fringes moved upwards along the components of the doublets, whereas the parts of the fringes *between* the components became disconnected from the exterior parts and *moved downwards*. As the density of the sodium was increased, the interior portions slid downwards with increasing velocity, and at a certain stage those in the interior, more particularly of the D₁ line, resembled inverted arrows. At last with increasing proportions of sodium these arrows entirely disappeared, and it was observed that this disappearance was more rapid with the D₂ lines than with the D₁ lines. Among subsidiary features it was noticed that the slope of the interior interference fringes is greater towards the side of the greater wave-lengths than towards the violet. The interior fringes also show a slight asymmetry, so that, e.g., the points of the arrows in Fig. 2 ought to be asymmetrical.

Using very much denser vapours, however, results were obtained agreeing more with the experiments of Macaluso and Corbino. Figs. 3 and 4 show the effects with field intensities of about 4500 and 10,700 units respectively, and the absorption bands appear to contain horizontal parts of an interference fringe which have undergone a very small displacement *upwards*

by the action of the field. These horizontal parts are, however, broader and more ill defined than the markings in the circumstances previously described. It is possible that the conditions assumed in these later experiments are different from those required by the theory, and that some explanation of the difference in the two kinds of phenomena may be found.

In a paper communicated to the Reale Accademia dei Lincei of Rome, also on May 31, Prof. W. Voigt discusses the same phenomenon on a theoretical basis, and quotes the formula

$$n\chi = KP \frac{(\Delta^2 - P^2 - 1)}{(\Delta^2 + P^2 + 1)^2 - 4\Delta^2 P^2}$$

where χ denotes the angular rotation of the plane of polarisation, n the geometrical mean of the indices of refraction of the two waves propagated in the vapour, P is proportional to the magnetic field, and Δ is proportional to the number of wave-lengths in the distance of the point considered from the primitive position of the absorption band. From this formula are obtained the curves shown in Fig. 5, which correspond to the

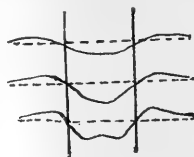

FIG. 5.

values $P=0.5$, $P=1.5$, $P=3.0$, and the resemblance between these curves and Prof. Zeeman's photographs will be readily noticed.

UNIVERSITY AND EDUCATIONAL INTELLIGENCE.

CAMBRIDGE.—The following is the letter of congratulation, written by the Public Orator, Dr. Sandys, on behalf of the University of Cambridge, and presented to the University of Christiania by Prof. A. R. Forsyth, F.R.S., the delegate appointed to represent the University of Cambridge on the occasion of the recent commemoration of the centenary of the birth of Niels Henrik Abel:—"Litterae vestrae, viri doctissimi, ad nos nuper perlate sunt, in quibus certiores facti sumus, annum centesimum ex eo quo natus est alumnus vester insignis, Nicolaus Henricus Abel, Universitatem vestram Nonis Septembris esse celebraturum. Alumnus ille vester, ut studiorum mathematicorum inter peritos ubique constat, inter scientiae illius ipsos principes merito iam dudum numeratus est, neque in sua tantum vita, intra annorum septem et viginti spatium angustum, nomen immortale est adeptus, sed etiam saeculo in eodem inter Europae gentes scientiae analyticae cultoribus plurimis novos stimulos indidit, et studiorum suorum ad regiones novas explorandas excitavit; e quibus unus, non secus atque alumnus ille vester, provinciae suae pulchritudine singulari commotus, existimavit 'functiones ellipticas non aliis adnumerari debere transcendentibus, sed speciem quandam his inesse perfecti et absoluti.' Iuvat vitae illius annales ab uno e professoribus vestris summa cum scientia, summa cum humanitate, conscriptos evolvere; iuvat inter socios illius exteros, unum audire suis laudibus, suis laboribus omnibus illum maiorem esse dicentem; alterum, ab illo temporis exiguu intra terminos 'monumentum aere perennius' esse exactum, quod indicaret quantum ex ingenio eius sperare licuisset, 'ni fata obstitissent'; iuvat nos quoque inter praecipuos nostros nonnullos numerare, qui ad vitam vestri vestigii insisterunt, alium vestri famam indies latius extendunt. Unum ex eis, etiam in Scandinavia horum studiorum cultoribus non ignotum, nuntium et legatum ad vos honoris causa mitimus, qui nostrum omnium vota optima ad vos perferat, et nostrum omnium nomine viri tanti memoriae celebrandas laetus intersit. Valet."

Mr. R. P. Gregory, St. John's, has been appointed a demonstrator in botany.

The following have been elected to fellowships at Trinity College:—A. E. A. Watt Smyth, P. V. Bevan, O. W. Richardson, F. J. Pollock.

Dr. D. MacAlister has been appointed assessor to the regius professor of physics; Prof. Thomson, F.R.S., an elector to the Isaac Newton studentship in physical astronomy; Mr. J. B. Peace, Emmanuel, demonstrator of mechanism and applied mechanics; and (Mr. R. C. Punnett, Caius, demonstrator of comparative anatomy. Mr. Punnett has also been elected to a fellowship at his college.

It is stated in the *British Medical Journal* that Prof. Johannes Orth, of Göttingen, has been invited to succeed Prof. Virchow in the chair of pathology at Berlin.

The following appointments have been made at the Hartley University College, Southampton:—Assistant lecturer in physics, Mr. O. W. Griffith; assistant lecturer in electrical engineering, Mr. E. H. Dixon; assistant lecturer in civil engineering, Mr. R. Baldwin Wiseman.

As already announced, the Manchester School of Technology is to be opened by Mr. Balfour as we go to press with this number. The school has occupied about seven years in building, and represents an endowment of nearly 300,000*l.*, largely, but not entirely, of municipal origin. A sum of no less than 25,000*l.* has been expended upon the plant of the department of mechanical engineering alone, and the other departments have been equipped in the same liberal spirit. The city of Manchester thus possesses a technical school which should become an important factor of national progress.

We have received the calendar of the Bristol Merchant Venturers' Technical College, which contains many illustrations of the workshops and laboratories in that institution. The College provides full courses of training in mechanical, electrical and sanitary engineering, and also prepares students for the B.Sc. examinations of the University of London in the faculties of science, engineering and economics. There are courses of training in the various branches of applied chemistry, including metallurgy, and special classes for persons intending to become architects, builders or surveyors. There is also a navigation department, a school for boys, and numerous evening classes.

THE Clothworkers' scholarship of 60*l.* a year for three years, awarded on the results of the matriculation or entrance examination of the Central Technical College of the City and Guilds of London Institute, has been awarded to W. H. Grinstead, from Horsham Grammar School, who obtained first place at the examination. Free studentships have been awarded by the Institute to W. M. Hooton, from King's Lynn Municipal Technical School, L. G. Morse, from Marlborough College, and H. K. E. Reed, from the South-Western Polytechnic, who came next in order of merit.

AN address on the reorganised University of London was given by Sir Arthur Rucker, F.R.S., at the opening of the winter session of St. Mary's Hospital Medical School on October 3. Referring to the educational equipment of London, he remarked that "it was and is in many respects inferior to what is provided, not only in Germany and America, but in our own provinces. There is not a single laboratory in the metropolis devoted to pure chemistry and physics which will compare in magnitude or in the perfection of its details with some of those which exist elsewhere." The hope was expressed that the teaching of the sciences connected with medicine would be combined with research; so that the University should contribute directly to the advancement of knowledge, and graduates of foreign and colonial universities might be attracted to London to study in research laboratories like those of the recently established physiological department of the University.

THE proceedings at Oxford on October 8 and 9 in connection with the Bodleian tercentenary were marked both by their enthusiasm and by their picturesqueness. Among the multitude of distinguished guests were representatives of the universities, libraries and learned societies in every part of the world. On the evening of October 8, a reception by the Provost of Oriel, in his capacity of Vice-Chancellor of the University, took place in the Ashmolean Museum, where Mr. A. J. Evans exhibited a number of drawings, photographs, plans and casts illustrating the excavations at Knossos, in Crete. On the following morning, a congregation, presided over by the Vice-Chancellor, was held for the purpose of conferring degrees upon certain of the eminent persons present as guests of the University, for receiving congratulatory addresses on the tercentenary of Sir Thomas Bodley's library, and for welcoming the visitors by the Public Orator, Dr. Merry. Among the honorary degrees, that of doctor of science conferred upon Prof. C. S. Minot, professor of histology and human embryology at Harvard University, may be mentioned as indicating that the claims of science were not forgotten. The congratulatory addresses, handed to the Vice-Chancellor by the delegates appointed for the purpose by the university or learned society they represented, were numerous, the list of universities and learned bodies presenting addresses included the following names:—Universities of Cambridge, Dublin, London, Birmingham, Durham, Wales, Edinburgh, Aberdeen, Glasgow, Toronto, Montreal (McGill), Sydney, Allahabad, Cape Town, Paris, Caen, Lille, Nancy, Breslau, Giessen, Göttingen, Leipzig, Kiel, Brussels, Ghent, Louvain, Cracow, Graz, Copenhagen, Lund, Stockholm, Upsala, Geneva, Lausanne, Harvard, Cornell, Yale, Princeton, Columbia, Pennsylvania, Ireland (Royal), St. Andrews and Victoria, Royal Society, Royal College of Physicians, Royal College of Surgeons, Royal Geographical Society, Royal Irish Academy, Asiatic Society of Bengal, Royal Society of Sciences, Göttingen, Accademia dei Lincei, Rome, and Academy of Sciences, Vienna. After the congregation came the formal visit to the Bodleian Library. No preparations had been made, and the visitors found the Library wearing its every-day aspect. The celebrations were brought to a close by a dinner at Christ Church.

SOCIETIES AND ACADEMIES.

PARIS.

Academy of Sciences, September 29.—M. Bouquet de la Grye in the chair.—New experiments on the limit of intensity of current from a battery which corresponds to external electrolytic work apparent in a voltameter, by M. Berthelot. In a circuit consisting of one or more Daniell cells and a voltameter, the external resistance was increased until the gas resulting from the electrolysis was barely perceptible, and the limiting value determined. From these and earlier experiments on the same

subject, the conclusion is drawn that in electrolysis chemical energy is always necessary to commence the action, but not to maintain it. The preparation and properties of a new silicide of vanadium, by MM. H. Moissan and Holt. On heating silicon with an excess of vanadium trioxide in the electric furnace for some time, the silicide VSi_2 , previously described, is obtained, which is stable in the presence of an excess of silicon. Another silicide, of the composition V_2Si_3 , has been obtained in three ways—by the interaction of vanadium trioxide (120-grains) and silicon (14 grams), of silicon and vanadium chloride, or of the trioxide, silicon and copper, in all cases in the electric furnace. The new silicide is more infusible than the silicide VSi_2 , from which it can also be distinguished by its colour, density, action with hydrochloric acid and easy decomposition on fusion with silicon.—On double fertilisation in the Crucifere, by M. L. Guignard. The phenomenon of double fertilisation can be followed completely in *Lepidium sativum* and *Capsella Bursa pastoris*, a detailed description of the stages being given.—Observations of the Perrine-Borrelly comet (1902 *b*), made with the Brunner equatorial at the Observatory of Lyons, by M. J. Guillaume.—The organisation of automatic spectrographs at the Observatory of Meudon, registering the radial movements and the thickness of the solar chromosphere, by M. H. Deslandres. The apparatus briefly described produces on the same plate ninety small spectra giving the radial velocity and thickness at 180 points on the sun's edge. These points are united on a circle of 95 mm. diameter. So far, it has not been possible to make continuous records on account of the expense; similar equipments at different parts of the world are also necessary for complete results.—On the continuous deformation of surfaces, by M. G. Teitzéica.—On nitro-pyromucic acid and its ethyl ester, and on dinitrofurfuran, by M. R. Marquis. A mixture of nitric acid and acetic anhydride has been found especially serviceable in nitrating in the furfuran series. With ethyl pyromucate a mononitro derivative is readily obtained.—On the saponification of nitric esters, by MM. Leo Vignon and I. Bay. The results of experiments on the hydrolysis of various nitrates by sulphuric acid and by soda. The reaction is complex, nitrous acid and occasionally ammonia being produced.—On the utilisation of mineral substances by grafted plants, by MM. Lucien Daniel and V. Thomas. Transpiration is greater in the host than in the grafted plants, the total quantity of mineral material absorbed being considerably modified as a result of the grafting. It was also found that one effect of grafting was to profoundly modify the phenomenon of chlorosis.—On the caoutchouc-producing *Landolphia* of the French Congo, by M. Auguste Chevalier.—The earthquake at Salonica, by M. Christomanos. The earthquake of July 5, the epicentre of which was between Salonica and Gouvesno, was not of volcanic origin. Its effects were felt at great distances and for several days, hence it is probable that the seismic focus was at a great depth.—October 6.—M. Bouquet de la Grye in the chair.—Remarks by M. Appell on the third volume of his "Traité de Mécanique rationnelle."—Observations on the sun made at the Observatory of Lyons with the 16 cm. equatorial during the first quarter of 1902, by M. J. Guillaume. The number of observations is smaller than usual owing to the unfavourable atmospheric conditions. Tables are given showing the number of spots, their distribution in latitude and the distribution of the facule in latitude.—Comparison of the tables of Vesta with the meridional observations made between 1890 and 1900, by M. Gustave Leveau.—Remarks on a problem of Clebsch on the movement of a solid body in an indefinite liquid, and on the problem of M. de Brun.—On a theorem of M. Frobenius, by M. de Séguier.—On a derivative of hydrogen peroxide, by M. R. Fosse. The reactions of dinaphthopyranol towards zinc dust, alcohol, pyragallol and potassium iodide show that it behaves rather as a derivative of hydrogen peroxide than as an alcohol.—The synthesis of some tertiary alcohols; diphenylcarbinols, by M. H. Masson. The results of the action of magnesium phenyl-bromide upon a series of esters is given in summary, with a list of the alcohols and hydrocarbons obtained and their boiling points.—Anhydrous copper-ammonium sulphates, by M. Bouzat. A thermochemical paper.—On the examination and estimation of extract of chestnut wood mixed with oak extract, by M. Ferdinand Jean. The method is based on the fact that extract of chestnut sets free iodine from iodic acid, whilst extract of oak bark has not this property.—On the pectic fermentation, by M. Goyaud. Pectic forms pectic acid at the expense of the pectin. The phenomenon is not qualitatively influenced by the

presence or absence of calcium salts.—The elaboration of venom and of venom in the parotid gland of *Vipera Aspis*, by M. L. Launoy. The snake poison is formed in the cells of the parotid gland of *Vipera Aspis* in two phases—the nuclear phase, with formation of grains of venom, and the cytoplasmic phase, in which the venom is transformed into the venom.—Paleontological researches in Patagonia, by M. André Tournouer.—On an enormous carnivorous mammal found in the plastic clay of Vaugirard, near Paris, by M. Marcellin Boule.

DIARY OF SOCIETIES.

FRIDAY, OCTOBER 17.

INSTITUTION OF MECHANICAL ENGINEERS, at 8.—Oil Motor Cars of 1902: Captain C. C. Longridge.

TUESDAY, OCTOBER 21.

ANTHROPOLOGICAL INSTITUTE (Lecture Theatre, Burlington House), at 5.30.—Huxley Memorial Lecture. Right-handedness and Left-handedness: Prof. D. J. Cunningham, F.R.S.

CONTENTS.

	PAGE
The End of the World	601
Artificial Mineral Waters. By A. C. C.	602
Development of the Human Embryo	603
An Educational Comparison	604
Our Book Shelf:—	
Jordan and Heath: "Animal Forms: a Second Book of Zoology."—J. A. T.	605
Strasburger: "Das botanische Practicum"	605
Sedgwick: "Principles of Sanitary Science and the Public Health"	605
Morrell: "Nature Study: Realistic Geography. Model based on the 6-inch Ordnance Survey"	606
Tyler: "A Junior Chemistry"	606
Letters to the Editor:—	
Finger Print Evidence. (Illustrated.) Dr. Francis Galton, F.R.S.	606
Remarkable Fossil Oysters from Syria.—Alfred Ely Day; E. T. N.	606
Refractivities of the Inert Gases.—Clive Cuthbertson	607
Trade Statistics.—F. Evershed	607
Material for Natural Selection.—Prof. T. D. A. Cockerell	607
The International Meteorological Committee. By R. H. S.	608
John Hall Gladstone. By W. C. R.-A.	609
Notes	610
Our Astronomical Column:—	
A New Transiting Device	613
The Search for a Planet beyond Neptune	614
A New Minor Planet	614
Comet 1902 <i>b</i>	614
The British Association at Belfast:—	
Section A.—Subsection of Astronomy and Cosmic Physics.—Opening Address by Prof. Arthur Schuster, F.R.S., Chairman of Subsection	614
Mathematics and Physics at the British Association. By Dr. C. H. Lees	618
Geology at the British Association	619
Carbon and Plants	620
Magneto-Optical Rotation in the Interior of Absorption Bands. (Illustrated.)	622
University and Educational Intelligence	623
Societies and Academies	623
Diary of Societies	624

THURSDAY, OCTOBER 23, 1902.

THE ENCYCLOPÆDIA BRITANNICA.

The *Encyclopædia Britannica*, vols. xxviii. and xxix. Being the Fourth and Fifth of the New Volumes. Ele-Gla. Pp. xix + 742. Gla-Jut. Pp. xx + 763. (London: A. and C. Black, and the *Times*, 1902.)

THE prefatory essay to vol. xxviii. is by Sir Leslie Stephen upon the subject of "The Growth of Tolerance." It is pointed out that one dominant factor in the development which has taken place has been the growth of the natural sciences; and reference is made to the influence exerted by scientific investigation upon traditional beliefs and dogmas. Mr. Benjamin Kidd contributes to vol. xxix. a prefatory essay on "The Application of the Doctrine of Evolution to Sociological Theory and Problems."

There are many scientific articles in the two volumes, several being of great importance. Among the articles to which attention must be directed are the following:—Vol. xxviii.: Electricity and electricity supply, by Prof. J. A. Fleming, Mr. W. C. D. Whetham, Prof. J. J. Thomson, Dr. L. Duncan and Mr. E. Garcke; electrochemistry, Mr. W. G. McMillan; electromagnets, Prof. J. A. Fleming; embryology, Mr. Adam Sedgwick and Dr. A. E. Driesch; energetics, Dr. J. Larmor; engines, Prof. J. A. Ewing; England and Wales (geography), Dr. H. R. Mill; Entomostraca, Rev. T. R. R. Stebbing; evolution, Dr. Chalmers Mitchell; fisheries, Mr. W. Garstang; and forestry, Prof. W. Schlich and Mr. G. Pinchot (United States); Fourier's series, Dr. E. W. Hobson; analytic functions, Mr. H. F. Baker; functions of real variables, Prof. A. E. H. Love; fungi, Prof. Marshall Ward; fusion, Prof. H. L. Callendar; gas and gas lighting, Prof. V. B. Lewes; gaseous fuel, Prof. G. Lunge; artificial gems, Sir William Crookes; geography, Dr. H. R. Mill; geology, Sir Archibald Geikie; geometrical continuity, Rev. Charles Taylor; line geometry, Mr. J. H. Grace, and non-Euclidean geometry, the Hon. A. A. W. Russell. Vol. xxix.: Theory of groups, Prof. W. Burnside; gunnery, and gyroscope, Prof. A. G. Greenhill; gymnosperms, Mr. A. C. Seward; halos, the late Prof. P. G. Tait; Helmholtz, Prof. J. G. McKendrick; hemichorda, and hydrozoa, Dr. G. H. Fowler; heredity, and hybridism, Dr. P. Chalmers Mitchell; Huxley, Sir W. T. Thiselton-Dyer; hygiene, Colonel J. Lane Nottter; ichthyology, Dr. A. Günther; insects, Dr. D. Sharp; iron and steel, Prof. H. M. Howe; irrigation, Sir Colin Campbell Scott-Moncrieff.

It is impossible to describe the whole of these articles in a notice of limited length, but from this group of scientific contributions to the "Encyclopædia" we select a few for brief notice.

So large a part, nearly one-sixth, of vol. xxviii. is devoted to electrical subjects that we cannot, with the space at our disposal, do much more than enumerate the branches treated. Under the heading "Electricity," Prof. Fleming writes on electric conduction, current and units; Prof. J. J. Thomson on discharge through gases and electric waves; and Mr. Whetham on electrolytic conduction. These articles cover the greater part of

electrical theory; the practical applications are dealt with in separate contributions. Mr. Whetham's discussion of electrolytic conduction gives a full and favourable account of the dissociation theory; the student has therefore an opportunity, from this article and from that by Prof. Armstrong on "Chemistry," of considering both sides of the question. The electrochemist is indeed particularly well catered for in the new volumes, since, in addition to the articles already mentioned, Mr. McMillan contributes two articles to the present volume on "Electrochemistry" and "Electrometallurgy." These deal with the industrial applications, the first with refining of metals, electrotyping and plating, and alkali and chlorate manufacture; and the second with furnace processes, such as the production of aluminium and calcium carbide. A contribution on "Electromagnet," written by Prof. Fleming, discusses magnetic flux, permeability and hysteresis. A long article on "Electricity Supply" deals with the principle of lighting by arc and incandescent lamps, with electric traction, and with the commercial aspects of the industrial development of electricity. The treatment of electric traction is hardly adequate if this is all that is to be given in the "Encyclopædia"; for one thing, the article is entirely without illustration, a great disadvantage to the general reader. It is also to be noticed that there is a certain amount of repetition which might have been avoided; thus, the theory of the arc is discussed at some length by both Prof. Fleming and Prof. J. J. Thomson.

"Energetics" is a name commonly associated with a philosophy which proposes to abolish Newton's laws of motion and to deduce all the equations of dynamics from the single equation of energy. Dr. Larmor's article deals with a much more useful field of study, including Carnot's principle, the general thermodynamical equations, free and available energy, and Gibbs's important work on the equilibrium of chemical systems. It forms an excellent introduction to the study of thermochemistry.

Pure mathematics is well represented in the present volumes. In an article on the "Error Law," Mr. Edgworth gives an account of the various proofs of the common law of error and of Prof. Weldon's experimental verification, corrections for cases in which the number of elements is finite, normal and abnormal correlation, and applications to various problems in statistics. In the account of Fourier's series, Dr. Hobson divides the historical development of the theory of the representation of functions by trigonometric series into three periods, the first period opening with the work of D'Alembert, Bernoulli and others in connection with vibrations of strings, the second with Fourier's memoir of 1807 on the "Theory of Heat," and the modern period being inaugurated by Riemann's memoir of 1867. The article on "Analytic Functions" contains a good general account of Weierstrass's methods; that on "Functions of Real Variables" deals largely with the *continuum* of real numbers, the domain of a variable, the doctrine of continuity, and the questions of differentiability and integrability of functions. Under "Line Geometry," we have a discussion of the properties of linear and non-linear complexes, congruences and ruled surfaces. In the article on "Non-Euclidean Geometry," Mr. Russell traces the genesis of this important branch of pure

mathematics out of the attempts of mathematicians to improve the theory of parallels. A historical account is given of the development of the new geometry by Gauss, Lobatchewsky, Bolyai, Riemann and Beltrami. Considerable attention is given to the three prevailing misconceptions which have retarded the development of the subject, namely, the introduction of a fourth dimension in connection with the notion of curvature of space, the projective definitions of distance and angle, and the necessity for introducing rigid bodies in geometry.

The writer of the article on evolution has had a difficult task, with which, on the whole, he has grappled successfully. We miss, however, any clear presentment of the crucial point on which the controversies that at present divide evolutionists indisputably turn—viz. that of the transmission or otherwise of modifications due to individual plasticity. It seems inadequate to say, without explanation, that "the weakness of the neo-Lamarckian view lies in its interpretation of heredity," when, as a matter of fact, the whole neo-Lamarckian fabric must fall unless the reality of such transmission can be established. The summaries given of several modern developments of evolutionary theory are scarcely full enough to be of much value to the specialist, while the unskilled but intelligent reader in search of information, whose requirements should always be kept in view in a work like the present, will, we fear, find their language often too technical to give him what he wants. The writer tells us that

"multiradial apocentricities lie at the root of many of the phenomena that have been grouped under the designation of *Convergence*."

We should say rather that the first phrase merely repeats the idea of the second in a more cumbersome form. Moreover, we doubt whether anyone not an expert would grasp the meaning of either expression, or that of "homogeneous homoplasies," without illustration. The account given of the recent departure in biometrics is good so far as it goes, and the position of its exponents is not unfairly stated; justice, however, is hardly done to the fact that the quantitative stage is inevitable in any inquiry the material of which admits of measurement. Workers in this department are fully alive to the danger pointed out by Dr. Mitchell, and analysis of composite characters is making progress under the stimulus supplied by the rediscovery of Mendel.

The article dealing with forests and forestry is in two parts, the general part by Dr. Schlich, C.I.E., F.R.S., and that referring to the United States of America by Mr. Gifford Pinchot, Forester of the U.S. Department of Agriculture.

Dr. Schlich first deals with the general distribution of forests throughout the world, and this might with advantage be more detailed. His account of the utility of forests based on their indirect and direct advantages is admirable, the former being chiefly the prevention of the denudation of hill-sides and of the consequent flooding of low-land and the silting-up of river-beds. The direct utility of forests increases steadily with the population of civilised countries, and it is a remarkable proof of the effects of economic progress that whereas in 1880 Germany produced as much timber as she required, in 1899

she imported 4,600,000 tons, valued at 14,000,000*l.* and this in spite of the increasing yield-capacity of her State forests. The latter comprise about one-third of her forest area, but as continental communal forests are chiefly managed by the State, it is a pity that they are not separated from private forests in the table of areas, for continental private forests are frequently no better managed than our own. Eighty-seven per cent. of the timber we import yearly, worth about 22,000,000*l.*, is coniferous, and it is chiefly on Canada, with 1,250,000 square miles of forests, that the world will have to depend for the future. Curiously, the table showing movements of timber within the British Empire entirely omits Canada.

Dr. Schlich appeals to the landowners of Britain to afforest 3,000,000 of our 24,000,000 acres of lands either waste or used for light hill grazing, and for more attention to forestry by our colonies, most of which are no better than Canada in this respect. He gives an interesting account of forest management in India, the managed State forests of which, comprising, in 1900, 95,000 square miles, 10 per cent. of the area of British India, yielded (1890-95) an average net revenue, which is steadily increasing, of 73,70,000 rupees. Progress in forestry is also being made in South Africa and Ceylon.

Mr. Pinchot gives a good summary and a map of the distribution of forests in the United States, the chief causes of destruction of which are over-lumbering and fires. He gives a map of the present State reserved forests, which, although amounting in area to 72,500 square miles, look inconspicuous on the huge territory of 3,500,000 square miles. He has also drawn up a useful history of the State protection of forests, which was greatly assisted by the large reservations carried out by President Cleveland and the forest law passed in 1897, the general purport of which he explains and praises.

Forest education has progressed in America, forestry being taught at several universities and other institutions. Mr. Pinchot states, however, that European forestry is not yet applicable to America, but that the production of a net revenue and the perpetuation of the forest are the chief objects of the private forest owner, who is the principal timber producer in the States. There is an account given of the lumber trade, and the ominous note occurs that numbers of the eastern white pine lumber- and mill-men have removed to the southern States and Pacific Coast, driven away by the exhaustion of their supplies. From Dr. Schlich we learn that already the United States imports from Canada nearly as much timber as it exports.

The article "Geology" is written happily by the same authority, Sir Archibald Geikie, who contributed the elaborate essay in vol. x. of the ninth edition. He divides his subject as before into sections, and reviews in the same lucid manner the general progress made during the interval. In its cosmical aspects, the record is not, however, one wholly of progress, as Croll's astronomical theory is no longer considered to afford a solution of the problem of the Ice age. Many have dealt with the question of the earth's age, notably Sir A. Geikie, and we cannot wonder that he repeats his protest against the time-restrictions of physicists and mathematicians. No evidence of progressive diminution of activity, whether of

the sea or of volcanoes, is preserved among the rocks; their record, indeed, is one of singular uniformity, despite the catastrophes of Krakatoa in Sunda Strait and of Bandai-san in Japan, to which attention is directed. Much has also been learnt about fissure-eruptions. Here we are in touch with the author's special subject, and he devotes a considerable space to the volcanic history of the British Isles. To petrography, which no doubt is dealt with in a special article, but brief reference is made.

A glance at the article on geography shows how intimately it has become linked with geology during the past quarter of a century, thanks to the labours of Suess, Penck, Lapworth and W. M. Davis. The fact that the surface of the sea preserves no uniformity, and that it may locally rise and fall to a considerable extent without change in the lithosphere, would seem to revolutionise our ideas about raised beaches and submerged forests; but the author points to certain regions where there is definite evidence of slow upheaval or depression of land. The indications of changes of level derived from a study of coral-reefs are also discussed.

Structural geology naturally occupies some space, and special reference is made to the great flexures and overthrusts that have been determined in many regions. Palæontological zones receive attention, for on this subject great progress has been made, and although we miss reference to the brilliant researches of Dr. A. W. Rowe, the importance of the subject is fully admitted. We agree with the author that there is much yet to be solved in the problem of life-zones. Special mention might have been made of observations on radiolarian chert, but in so complex and many-sided a subject as geology we feel that the author has done all that could well be done to illustrate its progress in a limited space.

Prof. Greenhill's two contributions on ballistics and the gyroscope and gyrostat are full of material of interest to students of dynamics. In a short essay Sir W. T. Thiselton-Dyer summarises the chief points of Huxley's life and work, and contrives to express the essential characters of each in a few pages. Dr. Günther has brought the article on fishes up to date. In 1870 the number of known species of living fishes was stated as 8525, but since then it has been nearly doubled. Knowledge of the distribution, organisation and development of fishes has also made substantial progress, and Dr. Günther gives a survey of the most important advances.

The article on insects is by Dr. David Sharp, whose general knowledge of the subject is probably more extensive than that of any other living entomologist. Nevertheless, it is obvious that the space at his disposal was utterly inadequate to permit of his attempting more than a mere glance at a few of the more interesting matters connected with entomology that have been discussed in recent years. Among these are the number of species of insects; antiquity; duration of life (inadequately discussed; but the fact of a water-beetle living five and a half years in captivity was new to us, though some of Lord Avebury's Queen ants have attained a much greater age); economic entomology (with special reference to Coccidae, and to insects and malaria); luminosity (concerning which Dr. Sharp remarks, "The light given by insects has been shown to be highly economical, and if a similar illuminating agent can be produced artificially it will be a great boon.")

Granted; but then there is the immense initial difficulty of producing or imitating organic chemical substances artificially); galls; anatomy and morphology (with special reference to the structure of the segments of the head); metamorphosis; classification (twenty-two orders are now recognised, the sequence of which differs considerably from that followed in the author's "Cambridge Natural History," published in 1899) and ethology (referring to intelligence and to social insects). The article concludes with a paragraph of "authorities," including references to a few recently published books and papers on insects; but the list is necessarily so short and incomplete that we think it might almost as well have been omitted altogether.

Though limitations of space have prevented some of the writers from doing full justice to their subjects, the volumes are rich in matter of interest to the student of science, and furnish substantial evidence of progress in many branches of natural knowledge.

THE STUDY OF THE PROTISTA.

Archiv für Protistenkunde. Herausgegeben von Dr. Fritz Schaudinn, Band i. Heft 1. Pp. 192; 5 plates. (Jena: Gustav Fischer, 1902.) Price Mk. 24.

OF late years very rapid progress has been made in our knowledge of that vast assemblage of organisms for which Haeckel set up a special "kingdom" or *Reich* with the name Protista, comprising the simplest living creatures amongst which the distinction of plant and animal is of quite secondary importance. In no branch of biology do works become so quickly out of date as in that which deals with the lowest forms of life. The attention which the Protista have received has been stimulated from two sources. From a purely scientific and theoretical point of view, it is evident that many elementary problems, or fundamental phenomena, of life can be studied in their simplest form, divested of unessential complications, in these lowly organisms. This is especially true of the facts of cytology relating to the structure and activities of cells. The discoveries of the last decade of the nineteenth century have revealed a remarkable uniformity, underlying the greatest variety in form and detail, in the cell-processes of the higher animals and plants, which cannot be considered as satisfactorily understood until the steps are made clear by which they have been evolved from the usually simpler, but in any case far more diversified, types of structure or development which are found to occur in unicellular organisms. It is only necessary to refer to the problems of cell-division and fertilisation in support of this proposition. Quite apart, however, from their claims on the attention of scientific biologists, the Protista are becoming continually more important as objects of study from the practical point of view. Some, as, for instance, the organisms of fermentation, are indispensable for human arts and manufactures; others have a claim to consideration which, if more melancholy, is not less great, on account of the injuries or disease which they inflict as parasites or pathogenic agents upon man, beast, or plant. The importance of the lower organisms from the practical standpoint has already been the cause of specialisation in their study. An instance of this is seen in the rise

and rapid growth of the science of bacteriology, and the special study of yeasts and fermentation has been dignified by the name of zymotechnology. By "Protistenkunde" or protistology is denoted a wider field of study, embracing all Protista as its objects, and of which bacteriology and kindred sciences are but subordinate branches.

It is not surprising, therefore, that a journal has appeared which is to be devoted entirely to protistology. The *Archiv für Protistenkunde* will be welcomed by a wide circle of naturalists, and will find a place in every biological library. Edited by Dr. Fritz Schaudinn, who has himself pursued the study of Protozoa with such remarkable success, its high standard of excellence is practically guaranteed. The contents of the first number do not disappoint our expectations, while they show at the same time that the aim of the journal is to be scientific rather than practical. With contributions headed by names so well known as Hertwig, Bütschli, Brandt and others, the new journal makes a good start.

The first article is contributed by Prof. R. Hertwig, and is a very interesting discussion on Protozoa in relation to the cell-theory. To show the scope of his dissertation, it must suffice to quote his principal conclusions. He attempts "to develop a uniform conception of the cell, applicable alike to Protozoa and Metazoa," recognising that any such attempt does not rest at present on a very firm basis, but thinking it nevertheless more useful to formulate precise conclusions, which can be criticised, than to rest content with vague indications.

"Three kinds of substances, characterised by the part they play in cell-life, must be assumed: (1) the achromatic substance; (2) the chromatin; (3) the nucleolar substance. These three substances show the following distribution in the cell of the Metazoa, and probably also in that of multicellular plants. The protoplasmic framework—leaving out of consideration the material filling the meshes or alveoli (Bütschli)—represents an intimate union of achromatic framework and chromatin, of which the latter is only separated out under special circumstances in small quantities, and then induces a heightened staining-capacity of the cell body. . . . The linin-framework of the nucleus consists only of achromatic substance, in which is deposited the chromatin, bound up with nucleolar substance and thereby organised. In this way arises the chromatic nuclear framework of authors. An excess of nucleolar substance forms the true nucleoli, which in the majority of cases are subsequently used up in the formation of chromosomes in karyokinesis, in the Metazoa just as in *Actinosphaerium*."

The first number contains five other articles besides that of Hertwig, amongst which may be noticed one by Bütschli on the structure of the Cyanophyceae and Bacteriaceae, a monograph of the Coccolithophoridae by Lohmann, and a discussion by Doflein of the outlines of classification of the Protozoa. The last-named author divides the Protozoa into two main divisions: first the Plasmodroma, characterised by possessing organelles for locomotion

"which can be easily recognised as protruded portions of the body-protoplasm, and which, moreover, in many cases can be extruded and withdrawn as required";

secondly the Ciliophora, in which the organs of locomotion, when present, are cilia. The Plasmodroma comprise the three classes Rhizopoda, Mastigophora and

Sporozoa; the Ciliophora comprise the Ciliata and Suctorioa.

In conclusion, it is only necessary to add that the various memoirs are illustrated, where necessary, by lithographed plates of the degree of excellence to which one is accustomed in German zoological periodicals.

E. A. M.

AN ASSAYER'S HANDBOOK.

Assaying and Metallurgical Analysis for the use of Students, Chemists and Assayers. By E. L. Rhead and Prof. A. Humboldt Sexton, F.I.C., F.C.S. Pp. x + 431. (London: Longmans, Green and Co.) Price 10s. 6d. net.

THE differences between assaying and chemical analysis in the ordinary usage of the terms are perhaps not very precise. An effort was made some years back in America to apply the word "assaying" only to the estimation of some or all of the elements in a substance by means of dry reagents and heat, and the word "analysis" to all estimations by the use of reagents in aqueous solution. These definitions, however, have not met with much favour, and have little to recommend them. It would be better to limit "assaying" to the estimation of the valuable constituent or constituents of an ore or other substance, and to use "analysis" for the estimation of the other constituents and for all qualitative determinations. According to this view, a gold ore would be assayed for gold and silver, and the sulphur, copper, iron, &c., would be determined by analysis, while a copper ore would be assayed for copper, the sulphur in iron pyrites would be determined by assay, and so on. Messrs. Rhead and Sexton have in general followed this method, but there are difficulties in its adoption, and in any case an authoritative definition is required.

There are already many books on the subject, and although some of them are out of date, the need of a new one which does not follow any strikingly original and advantageous plan does not seem pressing. It may be presumed that the authors of the book under review have found difficulties in teaching their students with the aid of the older books, and after supplying their own wants have decided to offer their system to other teachers. The result is by no means displeasing. The plan of the book is excellent. The student or assayer can find what he wants without delay, and the description of the required process is always terse, usually accurate and in many instances sufficiently complete. The accuracy, however, is unfortunately by no means without exception, but the chief fault of the book is that in the effort to reduce its size terseness has been pushed to an extreme, and the working directions are often insufficient to enable the process in course of description to be properly carried out even by an assayer of some experience unless he has been previously taught what to do.

An example of the lack of accuracy occurs in the description of the iodide method of estimating copper, in the course of which on p. 79 the student is informed that

"Cupric salts liberate iodine from potassium iodide. The liberated iodine may be estimated by means of a solution of potassium thiosulphate of known strength, sodium iodide and sodium tetrathionate being produced."

If he is puzzled by the production of sodium salts from potassium thiosulphate, and turns to the fuller account on p. 85 for elucidation, he is confronted by the equation

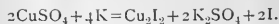

In the subsequent directions, moreover, no attempt is made to shorten calculation by the use of a normal standard solution or of one that will enable the percentage of copper to be read off from the burette. The student is told to "Dissolve [0.5 grm. copper] in 5 c.c. nitric acid and boil till all nitrous fumes are expelled," a dangerous piece of advice, and one that contains no hint of the practice now often preferred of getting rid of the nitric acid by means of sulphuric acid and so removing all chance of the disconcerting return of the blue colour. The dangers of terseness are also shown in the account of the estimation of lead as lead sulphate, on p. 64, where the directions are as follows:—

"The solution is evaporated with sulphuric acid till the fumes of the acid are given off. The solution is diluted with water, allowed to settle, filtered, washed by decantation with water acidulated with sulphuric acid, and finally on the filter with dilute alcohol or water," and so forth.

These directions are inadequate, and it may be doubted whether either Prof. Rhoad's or Prof. Sexton's students have ever been set to work without a fuller and more careful account of the precautions to be observed.

Among other blemishes, the omission of all reference to Mulder's neutral point in the Gay-Lussac method of estimating silver may be mentioned, and the importance of check assays in this method is not sufficiently insisted on.

However, all these faults do not prevent the book from being useful both as a supplement to oral laboratory teaching and as a book of reference to experienced assayers. It is divided into three parts, part i. being devoted to a brief description of laboratory appliances and general processes, part ii. to the assay of the more important metals as well as chlorine and sulphur, and part iii. to a short account of certain analyses which have to be made in practice in metallurgical works. Of these, part iii. is perhaps less satisfactory than the others, but, although it is far from complete, there is much useful information in it, and speaking generally, analytical chemists and assayers will not regret the addition of the volume to their bookshelves.

T. K. R.

OUR BOOK SHELF.

The Climates and Baths of Great Britain. Vol. ii. Pp. xvi + 628. (London: Macmillan and Co., Ltd., 1902.) Price 12s. 6d. net.

THIS volume completes the work undertaken by the committee of the Royal Medical and Chirurgical Society of London in 1889. The general arrangement of the subject-matter is on the same plan as in vol. i., and in order to maintain this uniformity the meteorology of the same series of years (namely, 1880-1890) has been investigated.

The volume deals with London and Middlesex, the east coast, the midland counties, Lancashire, the lake district, Northumberland, North and South Wales, Ireland—including its mineral springs; and the whole of the work has been placed in the hands of contributors

whose names are well known in the medical world. It should be added that seven excellent maps, showing areas, elevations, rainfalls and isothermals, are also incorporated.

The local information contained in this and in the former volume was mainly collected by means of circular letters sent to medical men practising at the various health resorts and bath-places, in which they were asked their opinion as to the prevalence of certain diseases; the influence of the climate upon patients sent there for the treatment of different diseases; the common causes of death and frequency of old age among residents; the system of drainage; the water supply; and the local climatological data. Where medicinal baths exist, inquiry was made as to what morbid conditions are treated with advantage by these baths, the ways in which the waters are employed, the diseased conditions contraindicating their use, and the time of the year advised for their application.

The chapter dealing with London and Middlesex is certainly one of the best. The writer, Dr. William Ewart, remarks that in London "everything is artificial," from the "made ground" upon which it is built to its water courses, some of which are turned away from their natural beds, and to the composition of its air, so much altered by smoke, London fogs and mists, that the meteorology of London is one *sui generis*. Dr. Ewart asks, why should life in London be, on the test of mortality, so much safer than in many other districts? This he considers to be partly explained by the relative dryness and warmth prevailing in the streets; and he concludes that, with all its faults, its climate is a protective one, with less exposure, greater warmth and less humidity than is the case in many other districts.

The work is undoubtedly a valuable one, and well repays the large amount of time and labour which must have been devoted to its compilation. It will be found alike serviceable for reference to medical practitioners and their patients, and also to medical officers of health and local sanitary authorities, who are so largely interested in the health of the communities under their charge. The only respect in which this useful work leaves something to be desired is that the information should be of a more definite character than that furnished with reference to the prevalence of disease in some of the localities dealt with.

Electric Wiring: a Primer for the Use of Wiremen and Students. By W. C. Clinton, B.Sc. Pp. viii + 179. (London: John Murray, 1902.) Price 1s. 6d.

ELECTRIC wiring is not a very suitable subject on which to write a primer. From the wireman's point of view it is a subject to be studied only by practical apprenticeship; from the engineer's it is a special branch of electrical work to be taken up at a time when primers are things of the past. Nor do we quite see the right of such a book to a place in Mr. Murray's "Home and School Library," which is intended (as an advertisement sets forth) for the general reader as well as for school use. The general reader does not want to know how to make joints, and the schoolboy would be far better employed learning the first principles of electricity instead of the elementary details of one of its practical applications. Apart from considerations such as these, it must be admitted that Mr. Clinton has done his work well and written an interesting little book. He deals with wiring for both electric light and electric bells, and as these between them involve the principles of electricity, magnetism and electrochemistry, he has said a few words about the theory of all three subjects, and has strengthened these by the addition of some worked examples of an elementary character. The theoretical parts are necessarily brief, the bulk of the book being devoted to descriptions of the practical

work which are clearly written and well illustrated. A little more space might have been given to the construction of bell indicators and to the maintenance and peculiarities of batteries, both of more importance to the wireman than the details of the manufacture of electric incandescent lamps. Also the distribution of lamps to give the best illumination, the use of globes and shades, and the ageing of incandescent lamps are all subjects on which wiremen would be wise to be informed, which are dealt with either inadequately or not at all. There is a question we should like to ask: Is Mr. Clinton correct in saying that the B.C. holder is known as the "bottom contact"? We had always thought that the letters stood for "bayonet cap," and certainly "bayonet holder" is much the more general phrase.

Finally, we may add that the book should be useful to the wireman entering for the City and Guilds examination in this subject; he will find it a valuable travelling companion as he proceeds to the examination room.

M. S.

The Common Spiders of the United States. By James H. Emerton. Pp. xviii + 225. (Boston, U.S.A., and London: Ginn and Company, 1902.) Price 6s. 6d. net.

THE study of spiders is probably less neglected in the United States than in Britain, for writers on general entomology like Packard and Comstock have included them in their works, and there are several valuable books on the subject. Still, spiders are less popular than butterflies or beetles, and Mr. Emerton has brought out the work before us, illustrated with no less than 501 illustrations in the text, in which he has given a very useful account of the commoner American spiders, classed under ten families. Mr. Emerton informs us that there are at least 300 or 400 species of spiders to be found in the neighbourhood of any city in the United States. The introductory matter is very good, dealing with structure, habits, collecting, &c., and the diagrams on p. ix, showing the undersurface of a spider and the front of the head, are particularly clear. So many families, genera, and occasionally even species of spiders are common to the United States and Europe that a student beginning to collect British spiders could not do better than use this book in conjunction with Miss Staveley's "British Spiders," before passing on to the more elaborate works of Blackwall and Pickard Cambridge.

Trees in Prose and Poetry. Compiled by Gertrude L. Stone and M. Grace Fickett, Instructors in State Normal School, Gorham, Maine. Pp. xi + 184; illustrated. (Boston, U.S.A., and London: Ginn and Company, 1902.) Price 2s.

THERE are many methods of nature-study in America, and in some more attention is given to the æsthetic and emotional sides of education than to the scientific. This little book is a collection of extracts from good writers showing that trees have often been the source of literary inspiration. It is good that children should become familiar with the best literature their country provides, and when at the same time they have their attention directed to the study of nature, the lesson becomes of increased value.

Chart of the Metric System. Constructed by Prof. C. Bopp. With a pamphlet of "Notes." Pp. 15. (London: Williams and Norgate.)

THIS diagram of the metric units of length, area and volume is printed on a sheet of paper about 3 feet 6 inches by 2 feet 6 inches. The various measures are shown full size. To be of the greatest use in class teaching, the chart should be used in conjunction with models, and fortunately these are to be obtained. With the aid of the "Notes," teachers should have no difficulty in making the idea of the decimal system easy of comprehension to their pupils.

LETTERS TO THE EDITOR.

[The Editor does not hold himself responsible for opinions expressed by his correspondents. Neither can he undertake to return, or to correspond with the writers of, rejected manuscripts intended for this or any other part of NATURE. No notice is taken of anonymous communications.]

Vortex Spirals.

It appears that a reference to Dr. W. M. Hicks's memoir on the properties of spiral fluid vortices (*Phil. Trans.*, 1898), inserted in the recent reprint of FitzGerald's Helmholtz lecture of January, 1896 ("Collected Scientific Writings," p. 353), has suggested the misconception that the idea of spiral vortices originated with FitzGerald and was subsequently developed by Hicks.

It is beyond doubt, from the context, that FitzGerald derived his knowledge of the possible existence and the properties of vortex spirals from the detailed discussion of vortex theories of matter and their difficulties, contained in Dr. Hicks's presidential address to Section A of the British Association in September, 1895; in this address, and in papers communicated to Section A, that striking extension of vortex theory was explained in illustration of the structure of optically rotational atoms. This is the more certain as Dr. Hicks's observations (*loc. cit.*) as to the possibility of the mutual absorption of a pair of Hill's spherical vortices (M. J. M. Hill, *Phil. Trans.*, 1894) were mentioned by FitzGerald in the same context.

J. LARMOR.

October 13.

Bipedal Locomotion in Lizards.

THE accounts of bipedal locomotion among lizards contributed by Mr. E. A. Green and Miss R. Haig Thomas are of high interest. This peculiar method of progression has been recorded by me of the Australian lizards *Physignathus Lescuri* and *Amphibolurus muricatus*, in addition to the frilled species *Chlamydosaurus Kingi*, all belonging to the Agamidae. More recently I have found by experiment that a member of the American greaved lizards, *Tupinambis nigropunctatus*, possesses a like bipedal habit, and have been informed by a correspondent, Mr. H. Preston, that the same locomotive peculiarity is commonly manifested by the allied form *Aniœta Surinamensis* and also by sundry species of the typical iguanas. Another correspondent has informed me that that singular iguanoid the basilisk is likewise bipedal, not only on *terra firma*, but that it will also run rapidly over the surface of water in an erect position. As is the case with the long-toed aquatic birds the jacanas, the feet of the running lizard are most probably in this case supported in transit by a more or less substantial substratum of water plants.

The bipedal progression attributed to *Lacerta viridis* and an allied form is, as compared with that of the above-named species, relatively incomplete; the tail is not raised clear from the ground during locomotion, and neither is the erect attitude sustained for any duration of time. The conspicuously greater length of the hind limbs that characterises all those species of which sustained bipedal locomotion has been recorded is a prominent feature in many other types which will probably be found to possess the same habit. Among these, members of the agamid genera *Goniocephalus*, *Otocryptis*, *Japalura* and *Calotes*?; some of the Anoliids, *Uraniscodon* and others among the Iguanidae, and *Cnemidophorus* belonging to the Teiidae, may be indicated as likely to yield affirmative evidence in this direction.

W. SAVILLE-KENT.

Milford-on-Sea, October 9.

Theories of Heredity.

IS there not room for some provisional hypothesis which shall include both Galton's and Mendel's ideas, which are not necessarily antagonistic, but may turn out to be simultaneously true as the laws of Boyle and Charles, so that the final results may be of the nature of a product or resultant? I mean that instead of drawing a hard-and-fast line between "recessive" and "dominant" characters we may suppose that these differ like heat and cold, in degree but not in kind. So that "dominance" may be measured on some scale from 0 upwards, the measure of dominance being perhaps a function of the number of generations for which a character has been established.

I since writing this letter, a confirmation of my anticipation in the case of this genus has been recorded in NATURE for October 9 by Mr. N. Annandale.—W. S. K.

To take an instance. Last year (1901) I carefully hybridised two varieties of the sweet pea, using lens, paint brush and muslin nets. One variety used was "Gorgeous," of a salmon-orange colour. It is described in Burpee's catalogue as an improved "Meteor," and "Meteor" was brought out by Eckford about 1893. The other variety was a new cream white, Eckford's "Mrs. Kenyon," novelty of 1901.

The seeds formed were some pale and some dark, the colour following that of the mother parent. None of the flowers of the offspring have been cream-coloured; the seeds borne on "Mrs. Kenyon" by pollen from "Gorgeous" have all yielded purple flowers unlike either immediate parents, but probably taking their colour from the known remote purple ancestor of our sweet peas. Of seeds borne on "Gorgeous" by pollen from "Mrs. Kenyon," eight plants yielded flowers like "Gorgeous," but ten of the plants yielded purple flowers.

Here the dominant purple appears to be due to the previous long ancestry; the salmon variety of ten years' standing has several representatives, but not one single cream flower stands for the 1901 novelty.

HUGH RICHARDSON.

Bootham School, York.

The Fertilisation of Linum.

In the *Proceedings* of the Academy of Natural Sciences of Philadelphia for 1902, pp. 33-36, is a very interesting paper by the late Mr. Thomas Meehan, treating of some points in the life-history of certain plants. On p. 36, Mr. Meehan says:—"Mr. Darwin once stated that one might as well use organic dust as to endeavour to get seeds of *Linum perenne* by the aid of its own pollen. I found *Linum perenne* of our Rocky Mountains abundantly fertile with own-pollen, and said so in one of my papers." As some anti-Darwinian will probably make much of this statement, it is as well to say that the Rocky Mountain plant is a distinct species, *Linum lewisii*, Pursh.

In the same paper, Mr. Meehan has some very interesting remarks on the fertilisation of *Lobelia*, and shows that the Bartram Oak, *Quercus heterophylla*, Michaux, is not a hybrid, but a mutation (quite of the DeVriesian sort) of the pin oak. It will therefore be called *Quercus palustris heterophylla*. Mr. Meehan attributes such variations to "varying degrees of vital energy," and supports this view by calling attention to the fact that in the ivy, for instance, the leaves may at first be more or less lobed, but become wholly entire later on, in the same individual plant. One also recalls the great difference between the early and late leaves of many Malvaceae, and of species of *Eucalyptus*. It is to be remarked, however, that these differences occur in a regular manner, and their order cannot be reversed.

T. D. A. COCKERELL.

East Las Vegas, New Mexico, U.S.A., October 7.

Retention of Leaves by Deciduous Trees.

HAVING followed the interesting discussion relating to the deferred shedding of their leaves by young beeches, it seems to me that something yet remains to be said, though, as I take it, P. T. (NATURE, May 15) has come very close to the solution. The phenomenon is common here also, and much more of the same kind can be seen. The maturing of leaves appears to be retarded by two causes. In older trees the lower branches with their leaves come late to maturity by reason of the tendency of the energy of growth to expend itself toward the higher branches. With young trees, and especially such as are cultivated late in the season, maturity of the fresh growth is slow by reason of excess of vegetative activity. In both there is failure to mature the abscission layer of cork at the base of the petiole and consequent retention of the leaves. In seasons of early autumnal frosts, the late-growing and imperfectly lignified parts of trees are the first to suffer.

D. T. SMITH.

Loufville, September 25.

THE SCOTTISH ANTARCTIC EXPEDITION.

THE Antarctic summer of 1902-3 will see the unprecedented number of five exploring steamers at work on the edge of the southern ice, and three of these under the British flag. The fifth expedition is on the point of departure, and it promises to be by no means the least important, its equipment for some branches of research being remarkably complete. An objection may

perhaps be taken to the name given to this expedition—the Scottish National—for, so far as we are aware, no public body or learned society in Scotland has been asked to accept any responsibility and none has claimed any credit in the matter; we fear, too, that the number of subscribers is not great enough to indicate any widespread interest amongst the people of Scotland. To Mr. W. S. Bruce is due the whole credit of planning the expedition, arranging all details of equipment and organisation, and beating up subscriptions with a pertinacity which has deserved and commanded success. He now goes out as leader of the expedition, his enthusiasm in all branches of science and his unequalled experience of work in the ice of both Polar zones justifying hopes of good results. In a very full measure it is Mr. Bruce's expedition. Next to him, honour is due to the small number of munificent subscribers, all, we believe, Scotsmen, whose generosity has made the enterprise possible. The expedition is in truth Scottish throughout, but without the formal recognition and support of the leading learned societies it cannot rightly be considered national.

In a paper read to the British Association at the recent meeting in Belfast, Mr. Bruce gave details of his plans and equipment, and on this authoritative statement we base the following remarks.

While the British national expedition on the *Discovery* and the German national expedition on the *Gauss* are devoting attention in the first place to magnetism, for the study of which the ships were specially designed, and the Swedish expedition in the *Antarctic* is in large measure geological, the Scottish expedition will be mainly devoted to oceanography and meteorology. Other branches of science will, of course, be attended to in each case, and Mr. Bruce has made ample provision for turning all opportunities to account.

The ship for the expedition was an old Norwegian whaler, the *Hekla*, which might possibly have made a Polar voyage in her original state; but, on examination, it was found desirable practically to reconstruct her so as to render her absolutely safe in any circumstances that can be foreseen. She was accordingly stripped of her outer skins and resheathed, fitted with new masts and spars, and her whole internal arrangements and deck-plan remodelled, from the designs of Mr. G. L. Watson, by the Ailsa Shipbuilding Company at Troon. Her name suffered a similar sea-change, and she is now the *Scottia*. A vessel of about 400 tons, she is 140 feet long with 29 feet beam, and draws 15 feet of water. She has graceful lines, is barque-rigged, and is fitted with a new engine and boiler which have proved able to propel her at the rate of eight knots, while she is confidently expected to prove a fast sailer.

The leader, captain and scientific staff will occupy an after deckhouse, the officers will be berthed amidships and the crew forward. A large deckhouse has been built amidships containing the galley and also a large, well-lighted laboratory, where most of the scientific work will be carried on. It communicates with a zoological laboratory on the deck below, adjoining which there is a photographic dark-room. This lower deck contains two great drums each carrying 6000 fathoms of cable (presumably of steel wire, as each drum weighs six tons), which is led up to a 40-horse-power steam winch on the upper deck, and is to be used for trawling and trapping in the deep sea. Ample sounding wire is also carried. On the after deck, a special petrol engine is employed for working the winch for winding in the great meteorological kite specially designed and constructed by Mr. John Anderson, of Edinburgh, but of which no description has yet, so far as we are aware, been published. A full equipment of meteorological and oceanographical instruments of the best patterns has been provided.

The expedition has been fortunate in securing the services of Mr. Thomas Robertson, of Peterhead, as

captain of the *Scotia*. Captain Robertson has been engaged in Arctic whaling for twenty years, and has made some interesting geographical surveys on the coast of Greenland. In 1892, he took part with the Dundee whaling fleet in an Antarctic voyage, and he is not likely to neglect any opportunity of exploration in the far south. While the captain is in command of the ship, the command of the expedition is in the hands of Mr. Bruce alone, and he is responsible for the plan, which he is free to vary as circumstances may require or suggest, and for the direction of all the scientific work. Mr. Bruce will be supported by a scientific staff of six, including Mr. R. N. Rudmose Brown (son of the late Mr. Robert Brown), as botanist and observer of plankton; Mr. R. C. Mossman, as meteorologist, a choice which ensures the highest efficiency in that department; and Dr. J. H. H. Pirie, as medical officer and geologist. Dr. Pirie has studied oceanic deposits with Sir John Murray and has also had experience of field-work in geology. The zoological work will be shared between Mr. Bruce himself and Mr. Wilton, an old companion on the Jackson-Harmsworth expedition. Two younger men will also go as assistants.

The plan of the expedition is stated to be as follows:—The *Scotia* is to proceed direct to the South Atlantic Ocean, and in the coming Antarctic summer she will go "as far south as is compatible with the attainment of the best results to science." The Scottish station is marked on the map accompanying Mr. Bruce's Belfast paper as in 82° S., 30° W.; but it is explicitly stated that the ship will, if possible, be kept clear of the ice and will not winter in the far south unless that course cannot be avoided. Hence we doubt whether a latitude within many degrees of that designated can be reached. The Antarctic winter of 1903 is to be spent in oceanographical work to the north of the ice-pack, an arduous programme, but one likely to secure very interesting results if the sea is not too rough for working the instruments. If funds permit, a second trip into high latitudes will be made in the following summer. We consider it is extremely important that this should be done. After providing one of the finest Polar ships afloat at great expense and bringing together a singularly competent staff of specialists, it would be most unfortunate not to utilise the opportunity for securing two years' work. In the interests of science we would appeal to those who are generously bearing the cost of this expedition to do a little more, to free Mr. Bruce absolutely from any further anxiety as to expense and leave him no excuse for not reaping fully the harvest of scientific results which lies awaiting him in the field he has succeeded at last in entering.

THE NATURAL HISTORY OF THE THAMES VALLEY.¹

IN a series of pleasantly written and beautifully illustrated articles, a large proportion of which have previously appeared in various serials, such as the *Spectator*, *Country Life*, and the *Badminton Magazine*, Mr. Cornish introduces his readers to a number of interesting facts connected more or less intimately with the valley of the Thames and its tributaries. Indeed, if we may judge by a statement made in the preface, and the evidence afforded by the text itself, few Englishmen can be better acquainted, both from the natural history and the sporting point of view, with the basin of the Thames than the author. In the first chapter we are introduced to the Thames at Sinodun Hill, in the next the manner in which the great river receives its supply of water is discussed, while the shells, plants and insects of the Thames form the subject of the next three chapters.

Perhaps the author is a little too much dominated with the idea of the great antiquity of fresh water and all its belongings, but this is a small point; and his notes on the variation of colour presented by the Thames Neritina, and the remarkable manner in which these empty shells collect in vast quantities in certain parts of the river-beds are of considerable interest. Indeed, it would be well worth while for some investigator to turn his attention to the manner in which these accumulations of shells are brought together. Several chapters are devoted to fish and fishing, the chub coming in for a special share of attention, and eel-traps being fully described. The two chapters on Wittenham Wood are specially interesting, as showing the numbers of wild mammals to be met with a few years ago in the Thames valley. From the former of these chapters we select, as a sample of the illustrations of the volume, the exquisite photograph of a pair of otters herewith reproduced.

The migratory and resident birds of the district are treated of in a couple of chapters, in the first of which the author states that, as the result of several years' observation, the river serves as the migration route of several species of birds besides swallows. "Sand-martins," he writes, "when beginning the migration, travel down the Thames in small flocks, and sleep each night in different osier-beds. How many stages they make when 'going easy' down the river no one knows. But I have seen the flocks come along just before dusk, straight down stream, and then dropping into an osier-bed." A third chapter describes the birds to be seen on the reservoirs in the valley.

The plants of the Thames valley, other than those of the river itself, receive attention in two chapters, the one treating of various poisonous kinds, while the other describes the flowering species to be met with in the meadows. Nor are economic and agricultural considerations by any means neglected. In one article, for instance, the author gives notes on the different breeds of sheep to be met with in the Thames watershed, while in a second he discourses on watercress and osier-growing. Sporting readers will find much to interest them in the account of netting red deer in Richmond Park, while the lover of picturesque scenery will be delighted alike by the author's descriptions and the photographs by which they are illustrated.

In discursive and chatty writings of this description Mr. Cornish is indeed thoroughly at home, and his book ought to command a large circle of readers who delight in our chief river and its neighbourhood. But in not a few of his chapters the author attempts more ambitious subjects, where in several places he gets sadly out of his depth. For instance, on the very first page we find it gravely stated that "there are in Lake Tanganyika or the rivers of Japan exactly the same kinds of shells as in the Thames." We may take it, charitably, that by the somewhat vague term "kinds" the author means genera and not species. But even then the reference to the molluscan fauna of Tanganyika is a most astounding and unpardonable error. Has the author, we may well ask, never heard of Mr. J. E. S. Moore's famous expedition to that lake, and the shoals of papers that have been written with regard to its so-called "halolimnic" molluscan fauna? It is perfectly true, indeed, that Tanganyika, like other African lakes, contains several widespread genera, such as *Planorbis* and *Paludina* common to the Thames and other freshwaters of Europe and Asia, but in addition to these it is the home of quite a number of peculiar generic, if not family, types of molluscs unknown at the present day anywhere else in the world. And we are told that its shells are exactly the same as those of the Thames!

In describing the freshwater "limpet" (*Ancylus fluviatilis*), the author alludes to it as "shaped like a Phrygian cap." On referring to the plate of "Thames

¹ "The Naturalist on the Thames." By C. J. Cornish. Pp. viii + 260; illustrated. (London: Seeley and Co., Ltd., 1902.) Price 7s. 6d.

Shells," facing p. 14, it will be seen that in place of this species the author has actually had figured the marine shell commonly known as *Pileopsis hungaricus*! Nor is this all, for in the same plate an Ampullaria does duty for Paludina (or Vivipara); while instead of the freshwater Thames Neritina we have the marine West Indian *Neritina radiata* depicted. Comment is superfluous!

Neither is Mr. Cornish less unfortunate when, in the chapter on "London's Buried Elephants," he essays to enlighten his readers on the fauna of the Thames valley in Pleistocene times. Passing over his misuse of the term "Prehistoric" as equivalent to "Pleistocene," which in a work of this nature may be regarded as a venial sin, we find on p. 234, in connection with the discovery of mammalian remains during the excavations for the foundations of the Victoria and Albert Museum at South Kensington, the following sentence:—

"So on the London 'veldt' there were lions, wild horses (perhaps striped like zebras), three kinds of

astounding statement is the one relating to the occurrence of the Cape wild, or hunting, dog in the Thames valley deposits. It is true, indeed, that the present writer has ventured to refer, provisionally, a single lower jaw from a cave in Glamorgan to the same *genus* as the animal in question, but that appears to be the only evidence of the former existence in Britain of any representative of the genus *Lycaon*; and we are informed by Mr. Cornish that the Cape *species* once lived in London!

But this is not all, for on p. 235 we find it stated that among the London Pleistocene fauna are included "the pika, a little steppe hare, and an extremely odd antelope now found in Tibet. This is a singularly ugly beast with a high Roman nose, and a wool almost as thick as that of a sheep when the winter coat is on. It must have been quite common in these parts, for I have had two of their horns brought to me during the last few years."

From the second sentence in this quotation it is quite clear that by the "extremely odd antelope" the author means the saiga. That animal, however, is not an inhabitant of Tibet, where it is represented by its distant cousin the chiru, with which it has evidently been confounded by the author. With reference to the statement that it was formerly common in the Thames valley, we venture to differ from the author. A frontlet has been obtained at Twickenham, and we believe one or two other specimens are known from British deposits, but these are all that have come under the observation of persons competent to decide the affinities of animals represented by fossil bones.

If the two chapters we have been compelled to criticise thus severely have been before the public previously, the repetition of such absurd mis-statements is the more unpardonable.

In his proper sphere Mr. Cornish is an entertaining and pleasant writer, and it is therefore the greater pity that he is so ill-advised as to attempt subjects of which he has no practical knowledge. R. L.



FIG. 1.—Otters.

rhinoceroses—two of which were just like the common black rhinoceros of Africa, though one had a woolly coat—elephants, hyænas, hippopotami, and that most typical African animal, the Cape wild dog!¹⁹

The author may well place a note of admiration at the end of this sentence, for it is in truth a most remarkable one. To begin with, Mr. Cornish is apparently unaware that the domesticated horse, with which the Pleistocene race agrees in every particular as regards its skeleton, differs remarkably from the asses and zebras in regard to the proportionate size of the front and hind hoofs; and from this essential difference we are entitled to argue that even in Pleistocene times it was most certainly not striped, such striping as occurs on the legs of certain domesticated horses being probably due to a cross. A certain degree of obscurity veils the part of the sentence referring to the Thames rhinoceroses, but it may be confidently stated that neither was *exactly like* the living African *black* species, while the woolly-coated kind was a relative of the living *white* rhinoceros! But the most

count of the successful efforts made by the Technical Instruction Committee of the City Council, the School Board and other educational authorities to educate Manchester citizens was given in an article published in our issue for January 31, 1901. One cause among many of the high state of development of education in Manchester is the broad view of its duties taken by the Technical Instruction Committee. On several occasions the Committee has arranged for the present principal of the school, Mr. J. H. Reynolds, to visit foreign countries to study other systems of technical instruction. In this way the Manchester educational authorities have become practically acquainted with German and American methods of education, and though they have not slavishly followed these ideas in organising their new school, they have not hesitated to adopt ideas they consider suitable for the peculiar needs of their own district. For the following extracts from Mr. Balfour's speech at the opening of the new school we are indebted to the *Times*.

MR. BALFOUR ON TECHNICAL EDUCATION AT MANCHESTER

AS announced in these columns last week, the Prime Minister opened the new Manchester School of Technology on Wednesday, October 15. For many years past, the provisions for technical education in the city of Manchester have been remarkable for their excellence, and an account of the successful efforts made by the Technical Instruction Committee of the City Council, the School Board and other educational authorities to educate Manchester citizens was given in an article published in our issue for January 31, 1901. One cause among many of the high state of development of education in Manchester is the broad view of its duties taken by the Technical Instruction Committee. On several occasions the Committee has arranged for the present principal of the school, Mr. J. H. Reynolds, to visit foreign countries to study other systems of technical instruction. In this way the Manchester educational authorities have become practically acquainted with German and American methods of education, and though they have not slavishly followed these ideas in organising their new school, they have not hesitated to adopt ideas they consider suitable for the peculiar needs of their own district. For the following extracts from Mr. Balfour's speech at the opening of the new school we are indebted to the *Times*.

Mr. Balfour said he counted it a most happy and fortunate circumstance that he had been able to take any part whatsoever in an occasion which was interesting, not merely to Manchester or merely to Lancashire, but to the whole of a country which depended in an ever-increasing degree upon its power to preserve its position as a great manufacturing centre. The building was perhaps the greatest fruit of that kind of municipal enterprise in this country, and though he would be presumptuous in saying that the brief visit he had been able to pay to it had given him any adequate or sufficient idea of all that it was capable of doing for the industries of Lancashire, still nobody could go over the building, observe its equipment, study even in the most cursory manner the care which had been devoted to it, without feeling that the corporation had set a great example worthy of the place it held in Lancashire and in Great Britain.

The great building in which they were assembled was an outward and visible sign of that awakening which had come over our people in view of the ever-changing conditions of intellectual industry. There was a time when we could flatter ourselves without any undue egotism or vanity that not only were we the first of the industrial nations, but that the rest were nowhere. That time had passed never to return again, and he was far from uttering selfish complaints at that change in the condition of the world which was absolutely inevitable, and from which they ought not to be, and in his judgment would not be, the ultimate losers. It was a profound mistake to suppose that the fact that other nations were now great producing centres was an injury pure and simple to this country. It was nothing of the kind. The growth of the wealth of the world must be a benefit to every part of the world, and all that we had to do was to see that we bore our full share in the great industrial development.

But not only was there the change in the industrial condition of the world to which he had adverted, but another change had occurred more closely connected, perhaps, with the necessity for institutions of this character. It was the change from the pre-scientific to the scientific stage of industry. When England or Great Britain first obtained its great manufacturing monopoly, it was not too much to say that the relation between science and industry was of the feeblest character. There was always, of course, the closest connection between mechanical ingenuity and invention and the great growth of our industries, but the intimate correlation between the discoveries of the laboratory and the processes of the workshop was not in existence, and it was because we had been a little slow to discover in this country how intimately speculative research is connected with manufacturing progress that we were, in some branches of our work at all events, behind our neighbours, who in this respect, although not in many others, had proved themselves more ready and more apt to learn that lesson than we had ourselves. And if anybody wanted a proof of the truth of the proposition he was laying down they had only to recall the kind of meaning which the average man attached only a few years ago to the phrase "technical instruction." In the phrase "technical instruction" there was, in the minds of the people of whom he spoke, no scientific tinge or flavour whatever, but some kind of knowledge of manual dexterity, some opportunity for learning the uses of machinery, and so forth. But the fact on which he was venturing to insist, and on which the very existence and justification of an institution like that at Manchester depended, was that henceforth and evermore there would be a closer and closer connection between the most remote and abstract scientific study of the chemist, of the physicist, of the electrician in his laboratory, and the great industries of the community of which he was a member. He wished he could be quite sure that even now, and even in the more cultivated part of the community, there was a more perfect appreciation of two capital facts which he would like to impress upon all who heard him. One was that education was, and must be, an organic whole, and that it was perfectly vain to spend vast sums upon buildings and equipments unless the student who went to those places went adequately prepared to learn the lesson they could teach. He had not the slightest intention of over-exalting or over-praising foreign nations at the expense of our own, but it must be admitted that they had grasped much more fully and much more firmly the great truth on which he was insisting—namely, that a man really to profit by the scientific training which he could get in these institutions and to be able himself to turn the learning he acquired to the purpose of original discovery, it may be of original research of his own, had to go there, not a raw product,

but at all events a half-prepared human product. He should go there, not only anxious to learn, but ready to learn.

Another great truth was that, after all, the persons who were responsible for the manufactures of the country were the manufacturers. It was perfectly vain and useless to turn out highly-trained and capable servants if there were not to be employers for them when they were turned out. He did not in the least know whether in Germany, for instance, they might not have overdone the matter; he had not sufficient evidence on the point, but he was quite sure something must be very wrong when he saw the extraordinary difference in the practice of the great German and in some, at all events, of the English firms. He was speaking on a subject which he only knew at second hand to people who knew the whole thing at first hand; but, unless his information greatly erred, they would find, if they went to Germany, at all events a few years ago, and studied the equipment of one of the great German industrial concerns, electrical, chemical, optical or what not, a proportion of scientifically trained students in the German manufactory enormously in excess of anything commonly thought necessary in this country. There was not the least use in the Manchester Corporation turning out competent students if those students were not to find employment when they were turned out. With the naturally conservative instincts of our nation, the tradition of the great manufacturing establishments would rather tend to make people say that the best, the only place in which to learn was not in the lecture-room, but in the shop, not at the feet of skilled professors, but actually among the artisans who were carrying on the industry, and he did not deny there was a great deal of truth in that, and that probably we gained a great deal by our extreme anxiety to make industrial training a practical training. But he felt confident that they drove that truth too far, and that, however sound the instinct might be which lay at the bottom of it, they were working it too hard at the present time, and that, if they really did mean to turn the brains, and the muscles, and the enterprise, and the energy, and the inventive skill of their countrymen to its best purpose, it was absolutely necessary to place among the directors of industry those who had not merely that admirable and necessary practical knowledge which consisted in seeing things done from day to day by the people who had to sell the article when it was finished, but, in addition, they must give that complete scientific training which had become more the basis of our whole industrial fabric.

He did not deny that there might be dangers in that course. Every policy they adopted required watching; every policy they adopted would petrify into some stupid and pedantic rules unless they kept close to the ever-varying realities of life, and if anybody said there might be a certain danger that they would have a quasi-scientific and industrial orthodoxy which would stand in the way of quick development in every new discovery in mechanics or in science, he did not deny that the danger might possibly exist. The way to meet it was to remember that true theory and true practice could never be divorced without loss to both, and that the ideal for which they had to strive was not that of simply imitating the processes of those who went before, but imitating their energy, their anxiety to take the best the world had to give—the world both of practice and of theory—in the changed and ever-changing conditions of our time. Let them imitate this great quality of their forefathers, and then institutions like that school would bear all the fruit of which they were capable. They would see the marriage of science and industry far more fertile and far more productive of good, and those who had called, and not called in vain, on Manchester for this great effort of municipal liberality might feel that their labours had not been thrown away, but that they had done great things for the growth, the maintenance and the expansion of those industries on which the health and existence of the community depended.

NOTES.

The office of Meteorological Reporter to the Government of India will become vacant about a year by the retirement of Mr. J. Eliot, F.R.S., who has administered the office with great success for a long series of years. The selection of suitable names for consideration, with a view to the filling of the prospective vacancy after a preliminary period of training in Europe and in India, is now occupying the attention of an

advisory committee of the Royal Society, nominated at the request of the Government of India. The problem of the future administration and scientific development of the department is also under consideration by the committee, in conjunction with Mr. Eliot, who is now in England for that purpose.

A BUREAU of Government Laboratories has been established in the Philippine Islands, and arrangements are being made for erecting a large building and equipping it with modern appliances for scientific work. Investigations will be made, not only of the resources of the island, but also of tropical diseases. The laboratories will provide exceptional opportunities for scientific study in the tropics.

AT a meeting of the Cold Storage and Ice Association, to be held at the Institution of Mechanical Engineers on Wednesday, November 5, at 8 p.m., Dr. Carl Linde, of Munich, will read a paper on "The Technical Application of Liquid Air."

THE new session of the Hampstead Scientific Society will be inaugurated by a conversation, to be held on Wednesday, October 29. Prof. Boyd Dawkins, F.R.S., will give an address on "The Forest Primeval of the Coal-measures."

THE meeting of the Geologists' Association on Friday, November 7, will be devoted to a conversation at University College, Gower Street, W.C. Exhibits of specimens and photographs of geological interest will be on view during the evening.

AN Egyptian Medical Congress will be held at Cairo on December 19-23 under the presidency of Dr. Ibrahim Pacha Hassan. The principal object of the Congress is the study and discussion of diseases occurring in warm climates. The secretary of the English committee is Dr. W. Page May, 9 Manchester Square, London, W.

THE death is announced of Mr. Peter Brotherhood, whose invention of a new type of steam engine in 1872 made his name well known among mechanical engineers. In this type of engine, three cylinders are set at angles of 120° round a central chamber, and all three connecting rods operate upon one crank within the central chamber. Mr. Brotherhood introduced important improvements in the pumps for compressing air on board ship for use in torpedoes, and thus assisted the development of the automobile torpedo. He was also the inventor of a vertical direct-acting engine.

WITH reference to the movement which has been set on foot in Berlin to raise a fund to defray the cost of erecting a statue to the late Prof. Virchow in that city, the *British Medical Journal* states that Prof. Waldeyer, who has taken the lead in the matter, summoned a meeting for October 15. At an early date a committee will be formed in this country, with Lord Lister as chairman, to afford the friends and admirers of Virchow in the United Kingdom the opportunity of contributing to the memorial. The Berlin Medicinische Gesellschaft will hold a special memorial meeting for Virchow on October 29, and the Berlin Verein für innere Medizin has already held a special meeting in memory of Virchow and Gerhardt, when a memorial oration was delivered by Prof. von Leyden.

THE Soufrière of St. Vincent was again in eruption on October 16. The following records are abridged from reports published in the *Times*:—*Kingstown, St. Vincent*.—The eruption has caused even greater distress in the colony than that which prevailed before. Large areas of tillage lands which were hitherto considered to be outside the volcanic zone are now buried in hot sand. The roads in the Windward district are the only regular means of communication between Georgetown and

Kingstown, a distance of twenty miles, and travel is extremely difficult. *Barbados*.—Between 2 and 3 a.m. on October 16, loud reports heard from St. Vincent; at 7 a.m. inky blackness in direction of St. Vincent, air quite still; at 9.30 a.m., volcanic dust commenced falling, with very strong smell of sulphur. Dust continued to fall for several days, producing a deposit about one-eighth of an inch thick. *Windward Islands*.—Soufrière in full eruption October 16, between midnight and 5 a.m. No loss of life reported, but heavy fall of sand and stones, principally on Windward side as far as Union; slight fall Kingstown and Leeward coast. A layer of volcanic material eight inches deep was deposited in the Carib country. *Guadeloupe*.—Loud detonations were heard, and a glimmering light was seen in the direction of Martinique in the early morning.

WE have received from Mr. P. Baracchi, Government Astronomer, the results of observations in meteorology and terrestrial magnetism made at the Melbourne Observatory and other localities in the State of Victoria for the last half of the year 1901. These periodical results form a valuable contribution to the climatology of that part of Australia, showing in a concise form the monthly means and extremes at a considerable number of stations of the second and third orders, and the monthly and yearly rainfall of all the numerous stations in the State, together with the average rainfall computed from the results of as many years as are available for the purpose. In some cases the series exceeds forty years' duration.

WE learn from the *Auto-velo* that Captain Ferber, of Nice, has recently made some highly successful experiments in aerial gliding. His first attempts were made with a machine of the Lilienthal type, with which several glides were effected, but this machine was destroyed by a sudden gust of wind, and Captain Ferber has now adopted a form of aeroplane similar to the two-surface machine of Mr. Wilber Wright and his brother, in which the operator assumes a horizontal position and steers by means of a rudder placed in front. The newspaper states that the captain is enchanted with his apparatus and hopes to beat the record of Mr. Wright of 150 metres. He finds the machine remarkably stable and easy of manipulation, and by careful management of the rudder he is able to land without any shock.

A SECOND edition of Dr. S. P. Langley's memoir containing the results of his "Experiments in Aerodynamics" has been published [by the Smithsonian Institution. The work originally appeared eleven years ago, and the principles and experiments described in it have since been used in the construction of aerodromes or flying machines. At the end of his memoir, Dr. Langley refers to the position and promise of aerial navigation in the following words:—"Since the preceding lines were written, the writer has demonstrated that mechanical flight is possible by actually performing it with steel flying machines nearly a thousand times heavier than the air, driven by steam, and employing as a rule curved sustaining surfaces. These machines, which were built by the writer, weighed from thirty to forty pounds, and they have arisen and descended in safety, their flight being limited to distances of from half a mile to three-quarters of a mile, at speeds varying from twenty to thirty miles an hour (see NATURE, vol. liv. p. 80, May 28, 1896). The 'inchoate art' of aerodynamics has since made a corresponding progress, and while leaving a great deal to be done, it is believed by the writer that the time is now very near when human beings will be transported at high velocities, though perhaps at first under exceptional conditions such as are demanded in the arts of war rather than of peace."

VERY little ice has been reported from the north-western quarter of the North Atlantic this year. The Meteorological Office pilot chart for November shows that since the beginning

of September a few large bergs have been passed on the steamer route between Belle Isle and the 50th meridian, but the strait of Belle Isle appears to have been quite free since about August 20, while no ice has been met with on the banks of Newfoundland for a long time past. For the month of September, 4300 observations of North Atlantic sea-surface temperatures were discussed, the results showing that nearly the whole of the area northward of the 48th parallel was warmer than the average, while between 30° and 48° N. there was a deficiency. In the immediate vicinity of the British coasts there was a slight defect, the air temperature over the land having been from 1° to 3° below the average. Further information relating to the West Indian volcanic eruptions is given, based on reports from captains of ships and on the preliminary report to the Royal Society by Drs. Anderson and Flett. At 2.30 a.m. on May 8, volcanic ash was falling on board the barque *Jupiter*, at a distance of 930 miles east-south-east (to windward) of St. Vincent, about twenty-four hours after the violent outburst from the Soufrière, so that the upper counter current had an average velocity of about forty miles an hour. Off Martinique, at 1.15 p.m. on August 21, the s.s. *Dahomé* was enveloped in a dust cloud from Mont Pelée, the darkness being more intense than that of night, while steam was rising from the sea in localities where the hot mud from the volcano fell into the water. Captain Leutken heard no noise or rumblings.

WE have received from Messrs. Crompton and Co., Ltd., a pamphlet describing the latest pattern of Crompton potentiometer. The advantages possessed by this instrument for accurate measurements in direct-current work are well known. It can be used to measure either P.D., current, resistance or power; the actual measurement being in all cases made by balancing two potential differences. The instrument can be at any distance from the circuit under test, the lead wires introducing no error, since, when balance is obtained, no current flows through them. The form of instrument designed by Messrs. Crompton is very compact and convenient, and enables a measurement of any kind to be made with very little trouble. The shunts and volt-boxes made to accompany the potentiometer give it a very wide range, and in its latest form provision is made for easily testing its accuracy by comparing the resistance coils with the slide wire. With this instrument, a standard cell and a galvanometer, the electrical engineer has practically all he requires for accurate testing work.

AN important memoir, by Sir George King, on the flora of the Malay Peninsula, is in course of publication in the *Journal of the Asiatic Society of Bengal*, the last fasciculus received in this country dealing with the begonias and allied groups.

THE latest issue of Gegenbaur's *Morphologisches Jahrbuch* (vol. xxx. pts. i. and ii.) contains two papers on the anatomy of mammals. In the one, Herr G. Ruge continues his account of the variations of form in the liver of the Primates, dealing in this instance with the American monkeys; in the second, Herr J. Tandler discusses the development of the cranial arteries.

THE Indian Forest Department has just issued the first fasciculus of a series of tracts dealing with insects affecting the forestry of the country under the title of "Departmental Notes." The part before us is by Mr. E. P. Stebbing, the lecturer to the school of the Department at Dehra Dun, and it is proposed in later numbers to give information with regard to both injurious and beneficial species. By this means it is hoped that the officers of the Department and others interested in forestry may be able to keep abreast of modern researches connected with the subject. Several of the insects referred to in this part are new to science. For the benefit of non-entomological readers, the descriptions might, we think, have been made a little less technical.

AMONG recent papers in the *Proceedings of the Washington Academy* is one by Prof. C. H. Eigenmann on the degenerate eyes of the blind, burrowing amphiblenian lizard *Rhineura floridana*. The case is especially interesting on account of the occurrence of a fossil representative of the same genus in the Miocene of Dakota. Unfortunately, nothing is known with regard to the eyes of the extinct form, but from the fact that all the living members of the group are blind, it seems practically certain that the degeneration of the eyes took place before the differentiation of the existing genera, in other words, at least as early as the lower Miocene. In the existing form, not only is the eye invisible externally, but there is no indication of the aperture by which it formerly opened on the surface.

DR. W. BORCHERS AND MR. L. STOCKEM describe an apparatus for the electrolytic separation of calcium from the fused chloride in the *Zeitschrift für Elektrochemie* for October 2. The separation of the alkali earth metals is one of the most difficult of electrometallurgical problems, on account of the conflicting character of some of the necessary conditions. The form of furnace used in the present experiments consists of a circular carbon box serving as anode, which is supported on, but insulated from, a cooling arrangement; a thin iron rod in the centre of the box is used as cathode, and this is connected to the cooler. The floor of the box is covered with fluor-spar, on the top of which is the layer of molten calcium chloride. This arrangement allows the temperature to be so regulated that it is above the melting point of calcium chloride, but below that of calcium. The calcium separates in spongy form and can be removed by suitable tongs; if it is pressed together before it is taken out, so as to get rid of some of the chloride, a white metallic mass containing about 90 per cent. calcium can be obtained. A somewhat similar arrangement is described for the separation of strontium. The apparatus, the authors state, is suitable for lecture experiments and also for the preparation of the metal in large quantities.

THE so-called foul brood of bees was first described under that name by Schirach in 1769, but it is supposed that so far back as Aristotle it was a recognised disease and that the remarks about it made by this writer undoubtedly refer to this particular malady. It was in 1885 that Messrs. Watson-Cheyne and Cheshire, with Koch's new bacteriological methods at their disposal, submitted this destructive disease to an elaborate scientific investigation, and shortly after presented to the scientific world a certain *Bacillus atvei* which was accepted as the *foes et origo* of the foul brood of bees. The subject has occupied much attention, not only of apiarists, but also of scientific men, and in 1900 Mr. Francis Harrison, of Ontario, published an important memoir dealing with methods of effectually combating the disease. The latest contribution to the scientific work on the subject emanates from the University of Liège, and the funds for carrying it on were provided by the Belgian Government. Dr. Lambotte, as the result of his extended researches, affirms that the *Bacillus atvei* of Cheyne and Cheshire is identical with the well-known and widely distributed *Bacillus mesentericus vulgaris*, and must be placed in the same category with, for example, the ubiquitous *B. coli communis*, which, although a normal and harmless inhabitant of the intestine, may under given conditions become pathogenic and give rise to disease. The endowment of harmless micro-organisms by suitable means with pathogenic properties is, of course, a well-recognised achievement, and Dr. Lambotte has shown experimentally how the familiar so-called potato-bacillus may artificially become invested with disease-producing powers and can engender foul-brood disease in bees.

THE Department of Revenue and Agriculture of the Government of India has recently published the seventeenth issue of

"Agricultural Statistics of India for the years 1896-97 to 1900-01." The numerical data have been compiled under the supervision of the Director-General of Statistics and are issued in two parts, the first dealing with British India and the second with native States. The information is tabulated under fourteen headings, including, among others, tables showing the total area of districts; the amount of cultivated and culturable land; the gross cultivated area under each crop; agricultural stock; the principal varieties of tenure held direct from the Government; the progress made in the production of tea and of coffee; and the average yield per acre of the principal crops. The tables are accompanied by numerous short, explanatory notes which are often of an interesting nature. The following statistics referring to the cultivation and production of indigo in British India during the past few years show that a remarkable decline has occurred, doubtless in consequence of the competition of the artificial product:—

Year.	Acres under cultivation.	Production in cwts.
1897-1898.....	1,339,099	166,812
1898-1899.....	1,010,318	139,320
1899-1900.....	1,026,900	111,890
1900-1901.....	990,375	148,029
1901-1902.....	803,697	121,475

An important addition to the literature of the Myxomycetes will be found in the "Monograph of the Acrasieæ," by Mr. E. W. Olive. The paper, which is published in the *Proceedings* of the Boston Society of Natural History, provides a critical summary of the data furnished by previous writers and the results of the author's investigations. Mr. Olive follows Zopf in uniting the groups of the Labyrinthulæ and Acrasieæ under the title of the Sorophoreæ; which are related to, but more primitive than, the true Myxomycetes.

A NEW edition of the first volume of Mr. William Scott Taggart's "Cotton Spinning" has been published by Messrs. Macmillan and Co., Ltd. The book deals with all processes in cotton spinning up to the end of carding.

THE lecture arrangements at the London Institution, Finsbury Circus, for the session 1902-3, have now been announced. The list includes lectures by Lord Avebury, on "The Scenery of England and the Causes to which it is Due"; by Sir Robert Ball, F.R.S., on "The Earth's Beginning"; by Dr. A. Smith Woodward, F.R.S., on "Some newly discovered Extinct Animals"; by Prof. S. P. Thompson, F.R.S., on "The Magic Mirror"; by the Rev. W. H. Dallinger, F.R.S., on "Recent Studies in the Lives of Spiders"; and by Dr. W. Hampson, on "Liquid Air." The lectures are held on Monday evenings at 5 o'clock and on Thursday evenings at 6 o'clock.

MESSRS. MACMILLAN AND CO., LTD., have published a small collection of mathematical tables for ready reference compiled by Mr. Frank Castle and printed on stout paper. The booklet costs 2s., and contains useful numbers and formulæ, tables of logarithms and anti-logarithms, as in similar tables published by the Board of Education, together with tables of natural sines and tangents for every five minutes of arc. In view of the encouragement now being increasingly given to the use of logarithmic and trigonometric tables at an early stage of mathematical instruction in schools and colleges, the collection should prove of use to teachers and students alike.

AN elaborate catalogue of balances and weights, containing more than one hundred pages and two hundred illustrations, has been published by Messrs. F. E. Becker and Co., of Hatten Wall, London. Balances and weights suitable for scientific work of every kind are described in the catalogue, and the prices at which they can be obtained are remarkably low in comparison with those of a few years ago. The quantitative

work now carried on in the physical and chemical laboratories of schools has greatly increased the demand for students' balances sensitive to a milligramme or two, no less than six thousand of such balances having been introduced lately into Irish elementary schools. It is impossible to over-estimate the educational value of practice in the use of accurate balances, and by producing such instruments at reasonable prices firms like Messrs. Becker and Co. have done much to facilitate the introduction of such work into the school course.

THE existence of a pentafluoride of iodine was indicated by Gore and by MacIvor thirty years ago. On account of its bearing on the question of the valency of iodine, a further examination of the behaviour of this fluoride seemed desirable, and in the current number of the *Comptes rendus* M. Henri Moissan gives an account of its preparation and properties. The compound is obtained without difficulty in a perfectly pure state by the action of fluorine upon solid iodine, and forms a colourless liquid, solidifying at 8° C. and boiling without change at 97° C. Analyses show that the fluoride has undoubtedly the composition IF_5 , and it is noteworthy that it can be distilled in a current of hydrogen without any reaction taking place. This fluoride possesses very great chemical activity; most elementary bodies decompose it, and it produces with compound bodies a large number of double decompositions. Iodine pentafluoride is decomposed at about 500° C., iodine being formed, and possibly a new fluoride of iodine.

IN the current number of the *Zeitschrift für physikalische Chemie* is an interesting paper by Mr. A. A. Banchard on the decomposition of ammonium nitrite in aqueous solution by which reaction nitrogen is liberated. It is found that this decomposition only takes place with sufficient rapidity to enable the velocity to be determined under the influence of hydrogen ions or free nitrous acid. In these circumstances, the velocity with which nitrogen is evolved is proportional to the concentration of the ammonium ions and of the nitrite ions, being increased by the presence of other ammonium salts or nitrites, and the hydrogen ions have an accelerating effect on the reaction.

IT has been known for some time that the compounds which the albuminoids form with acids and bases are of true salt-like character. The aqueous solutions of these compounds are conductors of electricity, and presumably, therefore, contain electrically charged ions. In the current number of the *Zeitschrift für physikalische Chemie*, Dr. Sackur gives an account of experiments which he has made on aqueous solutions of casein sodium. From the variation of the conductivity with the dilution, the author concludes that casein is a tetrabasic acid with a molecular weight equal to 4540. Experiments on the diffusibility of casein sodium indicate that, although an electrolyte, it is incapable of passing through parchment paper, and in this respect therefore behaves as a colloid.

IN the *Journal* of the Chemical Society, Messrs. Chapman and Lidbury give an account of some interesting experiments on the decomposition of water vapour by the electric spark. A series of electric sparks was allowed to pass between two platinum wires sealed into a glass tube through which a current of water vapour was drawn. The gases from the anode and cathode sections of the tube were collected separately. As a result of the examination of the gases thus collected, the authors conclude that the separation of the constituent elements of water from water vapour is not entirely due to a process of electrolysis. If it were, hydrogen should appear at one electrode and oxygen at the other, whereas hydrogen collects at both electrodes. The quantities of the separated gases should, moreover, not exceed those of the oxygen and hydrogen, which collect in a voltameter

placed in the same electrical circuit, whereas the experiments show that under certain conditions the quantity of hydrogen from the water vapour which collects at the kathode is five or six times as large as that which separates in the voltameter.

THE additions to the Zoological Society's Gardens during the past week include a Chacma Baboon (*Cynocephalus porciarius*) from South Africa, presented by Captain R. Bolton; a Campbell's Monkey (*Cercopithecus campbelli*) from West Africa, presented by Mr. F. G. Lloyd; a Goutian Ground Squirrel (*Xerus setulosus*) from Morocco, presented by Mr. Arthur Gill; a Cape Hyrax (*Hyrax capensis*) from South Africa, presented by Mr. A. C. Boddam Whetham; two Egyptian Jerboas (*Dipus oegyptius*) from North Africa, presented by Mr. G. Swales; a Spotted Eagle Owl (*Bubo maculosus*) from Africa, presented by Mr. C. H. Turner; a Horned Capuchin (*Cebus apella*), a Tayra (*Galictis bicolor*), a Larger Racket-tailed Drongo (*Dissemurus paradiseus*), two White-throated Ground Thrushes (*Geocichla cyanonotis*), an Indian Pitta (*Pitta brachyura*), an Indian Dial-bird (*Copsychus saularis*) from India, a Common Rat Kangaroo (*Potorus tridactylus*) from Australia, a Common Water-Buck (*Cobus ellipsiprymnus*) from South Africa, four Flat-backed Tortoises (*Testudo platynota*), a Phayre's Trionyx (*Trionyx phayrei*) from Burma, two Eroded Cinyx (*Cinyx erosa*) from West Africa, two Bell's Cinyx (*Cinyx belliana*) from Tropical Africa, three Pennsylvanian Mud Terrapins (*Cinosternum pennsylvanicum*) from North America, deposited; an Amherst's Pheasant (*Thaumalea amherstiae*) from China, purchased.

OUR ASTRONOMICAL COLUMN.

COMET δ , 1902 (PERRINE).—The photograph of this comet which accompanies this note was secured by Dr. Isaac Roberts on the evening of October 10. It was taken with his 20-inch reflector and received less than one hour's exposure, namely, 52 minutes. A great amount of detail is shown on the original positive from which this reproduction has been made, and it



will be noticed that the comet has a multiple tail, two of comparatively large dimensions and several smaller streamers.

The rapidity with which the comet is travelling relatively to the stars can be gathered from the length of the star trails on the plate, the observer correcting the telescope for the comet's motion at short intervals.

NO. 1721, VOL. 06]

A BRIGHT METEOR.—Mr. W. Lascelles-Scott, of Little Ilford, Essex, states in the *Times* that at about 7:52 p.m. on October 15 he observed a bright meteor and noted the following particulars as to its path:—“General course and direction of the meteor, N.W. by N. towards S.W.; general angle of course to S.W. on horizontal plane, 30°; general length of course to S.W. about 105°; general shape of course, like an inclined and attenuated letter S; apparent diameter of meteor at maximum, about 1-25th of that of the moon, or 4:100; apparent brightness at maximum, about 1/4th that of the moon, or 12:100; colour variations, from faint yellow, through blue to purplish at finish; apparent duration, about 3/8 sec. (nearly 4 sec.); coruscation, faint tripartite at finish.”

OBSERVATIONS OF FIFTY-EIGHT LONG-PERIOD VARIABLES.—Part ii. of vol. xxvii. of the *Annals of the Harvard College Observatory* is devoted to the observations of fifty-eight long-period variables. The methods employed in making these observations were explained in part i. of this volume in reference to a similar research with regard to circumpolar long-period variables. Most of the stars are brighter than tenth magnitude, and these have been observed with the meridian photometer; those between the tenth and thirteenth magnitudes have been observed with the photometer attached to the 15-inch equatorial.

By taking a series of comparison stars in the immediate neighbourhood, observing their magnitudes in order of brightness and their differences in magnitude, and then plotting a smooth curve having for its abscissa these approximate brightnesses, and its ordinate the photometric magnitude, a very trustworthy value has been obtained for the magnitude of each variable.

A NEW ALGOL VARIABLE.—In No. 3820 of the *Astronomische Nachrichten*, Mr. A. Stanley Williams announces the discovery that the star B.D. + 41° 504 is a variable of the Algol type. The position of this star is R.A. = 2h. 30m. 50s., Dec. = 41° 34' 3" (1855), and its normal magnitude 9.4. At minimum the star's brightness decreases to nearly twelfth magnitude.

Owing to the various observations being interrupted by clouds and by daylight, the instant of minimum has not been finally determined, but from the observations which have been made, the following elements and ephemeris have been found:—

Minimum of 14 1902 Persei = 1902 Sept. 16, 16h. 38m. G.M.T.
+ 3d. 1h. 21m. 32s. 23 E.
= J.D. 2416009.6934 + 3d. 056623 E.

Ephemeris for every fifth minimum.

E.	Date.	G.M.T.	E.	Date.	G.M.T.
		h. m.			h. m.
207 ...	1902 Oct. 17 ...	6 14 ..	247 ...	1903 Feb. 16 ..	12 35
212 ...	Nov. 1 ...	13 1 ...	252 ...	Mar. 3 ...	19 23
217 ...	“ 16 ...	19 49 ...	257 ...	“ 19 ...	2 11
222 ...	“ Dec. 2 ...	2 37 ...	262 ...	“ Apr. 3 ...	8 58
227 ...	“ 17 ...	9 25 ...	267 ...	“ 18 ...	15 46
232 ...	1903 Jan. 1 ...	16 12 ...	272 ...	“ May 3 ...	22 34
237 ...	“ 16 ...	23 0 ...	277 ...	“ 19 ...	5 21
242 ...	“ Feb. 1 ...	5 48			

NOTES ON THE RECENT ERUPTIONS OF MONT PELÉE.

Dominica, September 24.

August 17.—A steamer passing five miles to the west of Mont Pelée met a heavy ash cloud, which rendered the day as dark as night whilst the vessel passed through it. The deck was covered with ash.

August 18 and 19.—News reached here of further eruptions of Mont Pelée.

August 25.—Detonations heard during the day.

August 26.—Loud detonations and sounds like growlings were heard in the afternoon and evening. To the south-west of the island there were very heavy black ash clouds like a wall with a level top. The sun set behind this cloud as though a solid mass, all rays of light being cut off. During the whole day the upper atmosphere was charged with dust, but very little fell on this island.

August 28.—In the evening there was a magnificent display of lightning from Mont Pelée, and the sky in the direction of the volcano glowed with a pinkish light. At 11 p.m., lightning

shot out from the mountain in all directions, zigzagging and flickering flashes alternating with, or being accompanied by, reddish globes, which ascended and exploded, and shot out stars and long rays. Away towards the south-west was another large focus of electric energy, which appeared to me to have a distinct relation to the volcanic electric discharges from Mont Pelée. This spot was, I reckoned, at least forty miles from the volcano, from which it bore almost west two points north. This latter electrical display was similar, but less extensive than that from Mont Pelée, and it was accompanied by curious glowing globes, which burst and shot out tongues of lightning. The most curious part of the magnificent sight, however, was that occasionally long rays of light, very like to the rays of a searchlight, shot out from the direction of Mont Pelée downwards to the secondary and distant electrical display, and on this broad ray reaching the western focus, the lightning there became more vivid, intense and extensive.

The West Indian volcanic explosions are undoubtedly due to the irruption of water into the reservoirs feeding the volcanoes. There are no large rivers or lakes that could supply water in sufficient quantity to produce the phenomena observed. Clearly, then, the sea has got in by some fissure or dislocation, and it has occurred to me that the electrical display to the west of Pelée observed on the night of August 28 was caused by a fissure in the sea bottom permitting an irruption of water into the reservoir from whence the volcano has obtained the material for its solid ejecta. Anyhow, the disastrous eruption of Pelée on the 30th—that is, two days afterwards—was accompanied by an enormous discharge of steam and hot water, much greater, indeed, than in the case in the earlier eruptions.

In the neighbourhood of the volcanoes there has been much alteration of the bottom of the Caribbean Sea. The cable-repairing ships report the depth in places to have increased by half a mile. On September 19, a telegram from the West Indian and Panama Telegraph Company stated that:—

"Unprecedented difficulties have been encountered in the endeavour to repair the interrupted cables between St. Lucia and St. Vincent and St. Lucia and Grenada. The cables appear to be buried under a layer of volcanic mud, and this, combined with the great depth of water, which can only be attributed to the alteration of the sea-bed due to the late eruptions, has rendered it difficult to raise the cable to the surface in consequence of the enormous strain. The repair of the St. Lucia—St. Vincent section, which was effected on the 16th instant after several weeks' operation, has been a very costly one, necessitating an expenditure of over thirty miles of new cable, and the fresh interruption which occurred in this section during the night of the 17th is in this new cable put down only the day before, and was evidently caused by some submarine disturbance."

Since the loss of the *Grappler* during the destruction of St. Pierre, no attempt has been made to repair the cable between Dominica and Martinique, so there is no recent authentic information concerning the disturbance of the sea bottom near to Mont Pelée; but Captain McKay, the Superintendent of the Quebec Steam Ship Co., who went south in the s.s. *Korona* on August 29, reported that "the sea between Dominica and Martinique was of a light green colour, which makes one think there was shoal water." This colour was due, doubtless, to the suspended ash which has fallen into this portion of the sea in enormous quantities from time to time, and it is to be expected that there has been a subsidence instead of an upheaval of the sea bottom to the west of Martinique.

August 30.—There were detonations in the afternoon, with slight vibrations of the earth; and at 7 p.m. there were exceedingly loud detonations and growlings, which continued at intervals until 2 a.m. on August 31. Volcanic ash began to fall at 5.30 p.m., and, as the night wore on, the fall was so great that the darkness became intense. The ash came from the east, so that evidently it was shot high into the upper strata of the atmosphere and carried to the north-east before it began to fall into the lower regions swept by the "trades." Later on, news came that the fall of ash in Guadeloupe was very heavy. In Montserrat the fall was lighter, and in Antigua it was lighter still.

August 31.—The fall of ash in Roseau (at the south-western end of the island) covered the surface to the depth of a quarter of an inch; the dust penetrated everywhere, closed drawers and presses being insufficient to keep out the finer particles.

September 1.—The atmosphere is still dust-laden, and the sun

was obscured all day; it could be seen only towards the evening, when it set like a dull greenish disc. In the afternoon heavy ash clouds were drifting to the west through the Martinique Channel.

September 2.—Mr. A. Robinson, the Government Officer at the eastern side of the island, reports to me that the ash fell there on the night of August 30 to the depth of from an inch to two inches, that small trees and branches of large ones were broken down by the weight of the dust, which clung tenaciously to the leaves, branches and stems, and that the cattle were suffering from hunger, as the grass was covered and grazing was impossible.

September 3.—The mail steamer came in to-day from the south, and brought some refugees from Morne Rouge, which was destroyed by the eruption of Mont Pelée on the night of August 30. There was a French priest on board who was an eye-witness of the disaster. The following statement he made was kindly written down for me by Mr. C. A. Seignoret, the Quarantine Officer:—

"The phenomena were entirely new, and hot water and red-hot dust were the principal elements of destruction amongst the inhabitants of Morne Rouge and Carbet. Several houses were completely destroyed, while others sustained no damage."

Mr. Seignoret has also kindly interviewed one of the intelligent refugees for me, and he has furnished me with the following statement made by her:—

"Miss Carra, a respectable resident at Morne Rouge, who was an eye-witness to the eruption of Mont Pelée which occurred on August 30 last, informed me that rumbling noises were heard from the crater all day, with detonations and frequent flashes of electricity, and towards evening the mountain appeared to be a mass of flame, emitting alternately jets of hot water and red-hot ashes, which ascended into the air in the form of rockets, and as the ashes fell upon the wooden house-tops, the buildings at once caught fire. A great many lives were destroyed by hot ashes and water, for numbers of persons rushed from their houses into the streets to escape from the flames, and as the ashes fell upon their faces and other exposed portions of their bodies, the skin at once became red as scarlet and peeled off, causing the parts to swell to an enormous size. In most cases, portions of the legs, arms and chest were burnt, while the clothes were intact. White persons got completely charred in the face, causing them to appear like coal-black negroes. Some of the gendarmes were found dead in fixed positions with their clothing quite sound, while others were burnt in various parts of their bodies. Water! Water! was the only cry from the wounded and dying, and in many instances death ensued immediately after their thirst was quenched."

This interesting account indicates that there was an ejection of much larger quantities of steam and hot water than occurred in the earlier eruptions. Persons who shut themselves close in their houses were nearly all saved, the hot blast passing quickly, but from other accounts I have received it appears that the heat was fearful for a brief period and that the rapid evaporation of moisture from the tissues caused a thirst that was agonising until assuaged.

About 1500 persons were killed and, according to the statements of *L'Opinion*, of Fort-de-France, a greater number have suffered injuries.

H. A. ALFORD NICHOLLS.

ASTRONOMY AND COSMICAL PHYSICS AT THE BRITISH ASSOCIATION.

AT the Bradford meeting, in 1900, a department of astronomy was established as a subsection of Section A, in deference to a wish that had been expressed that astronomy should be better represented at the British Association. After two years' experience, it was felt that the astronomical papers that were received were scarcely enough to justify this division of Section A, and this year the subsection was strengthened by the addition of cosmical physics. On the Friday the whole section was given up to cosmical physics; on the Monday and Tuesday the subsection met separately. On all three days the room was well filled, and it was apparent that the enlarged subsection was in some ways a success. But towards the end of the meeting there was a strong expression of opinion that it is not to the advantage of the section as a whole that it should be so much subdivided, and the whole matter will have to be carefully considered before next year. Perhaps a solution of the difficulty

might be found in the division of all papers for Section A into two classes—papers that are generally intelligible and papers that are not—and in relegating the latter class only to sub-sectional meetings. It is not impossible that this might have beneficial results in more ways than one.

The address of the chairman, Prof. Schuster, has already been printed in full. His criticisms of mere routine observation raised an interesting discussion, in which the meteorologists reserved their defence.

Among the papers submitted to the subsection were several of general interest. Major S. G. Burrard, R.E., described the difficulties which are caused in the Geodetic Survey of India by the attraction of the mass of the Himalayas and the Thibet plateau, and by the existence of an underground chain of excessive density which runs across India. Contrary to the opinion that was held until a few years ago, it now seems certain that the plumb-line is deviated over the whole of India, and that all astronomical latitudes may be in error by a number of seconds of arc. The Government of India and the staff of the Survey must be congratulated on their good fortune in being confronted with problems of such interest and importance. Prof. Turner described an attempt made at Oxford to verify the suggestion put forward by Sir David Gill that the bright stars, as a whole, are rotating relatively to the fainter stars. From the Oxford astrophysical catalogue plates he finds distinct evidence of such an effect, but with a sign opposite to that found by Gill in the southern hemisphere.

The feature of the meeting on September 16 was an exhibition of photographs from the Yerkes Observatory. Mr. Ritchey has made a most interesting set of pairs of photographs of star clusters, made respectively with a 2-foot reflector and with the 40-inch visual refractor fitted with a colour screen used in contact with isochromatic plates. With the latter, the densest parts of the clusters are beautifully resolved and measurable. The photographs of nebulae made with the 2-foot are unsurpassed; and it is remarkable how, though nearly all the detail which they show can be found on the photographs taken at Crowborough and Daranona and Greenwich, the general effect is in some cases quite different. Mr. Percival Lowell sent three papers, one describing a scheme for sending expeditions in search of good "seeing." Mr. S. A. Saunderson discussed the possibility of changes in the surface of the moon, and urged the need of cooperation in the work of describing minute detail. Mr. W. E. Wilson reported failure in his search for Forbes's hypothetical extra-Neptunian planet, and showed a bolometer mounted equatorially for measuring solar radiation.

Other papers read at the meetings of the subsection have already been mentioned in NATURE in the notes of mathematical and physical papers.

A. R. H.

ZOOLOGY AT THE BRITISH ASSOCIATION.

ON September 11, in addition to the reports of committees, a short series of fisheries papers was taken:—

(1) Prof. McIntosh, who was prevented from being present, sent a detailed paper discussing British fisheries investigations and the international scheme, which was read in abstract to the meeting by Mr. W. S. Green, Chief Inspector of Fisheries for Ireland. He showed the necessity for improved statistics and for a careful survey of the off-shore and in-shore fishing grounds. He considered that hydrographical work occupied too prominent a position in the international scheme and that other more important points in connection with the distribution of fish have been omitted. (2) Mr. W. Garstang then read a statement as to the proposed programme for the international investigation of the North Sea, as passed at the recent meeting of delegates at Copenhagen. He stated that in his opinion all the investigations thought desirable by Prof. McIntosh and other critics were included in the Christiania scheme, and that that scheme was going to be carried out practically unchanged. He explained that the Government had had to adopt hydrography as a part of the proposed programme, although its importance in connection with English fishery interests might be doubtful. Finally, he urged the advantages of international cooperation. (3) Dr. Noel Paton, who was prevented from being present, sent a paper criticising the methods proposed in the international scheme, and throwing doubt upon the accuracy and value of results based upon such methods. Dr. Masterman, Dr. Mill and others spoke in the

discussion which followed. (4) Mr. J. Stuart Thomson had a paper on the scales of fishes as an index of age.

The following were the reports of committees submitted to the Section:—

(1) "Migration of Birds," mainly the work of Mr. W. Eagle Clarke on the fieldfare and the lapwing. (2) "Naples Zoological Station," containing reports on work by Mr. E. S. Goodrich, Mr. N. Maclaren, Miss A. Vickers and Dr. R. N. Wollenden, in addition to the usual statistics from the station. (3) "Plymouth Marine Laboratory," with a short report from Mr. H. M. Woodcock. (4) "Index Animalium." Vol. i. of this work, by Mr. Sherborn, will be issued in October. (5) "Plankton Investigation." (6) "Zoology of Sandwich Islands." (7) "Millport Marine Zoological Station." And (8) "Coral Reefs of the Indian Region." Mr. Stanley Gardiner reports considerable progress with the publication of his results.

The forenoon of September 12 was devoted to a series of papers, by Prof. Herdman and those who are helping him to work out his results, on the fauna and flora associated with the pearl oyster banks in the Gulf of Manaar. First, Prof. Herdman gave a general account, illustrated by the lantern, of his recent expedition to Ceylon, with a description of the pearl fisheries. Then followed:—Mr. A. O. Walker, on the Amphipoda, Mr. I. C. Thompson, on Indian Ocean Copepoda, Mr. W. E. Hoyle, on the cuttlefishes, and Mr. J. Lomas, on the marine deposits dredged by Prof. Herdman. Prof. Dendy, Mr. Stanley Gardiner and others took part in the discussion that followed. The remaining papers before the Section that day were:—(1) Prof. Cleland, on a hitherto unrecorded element in the occipital bone of seals. (2) Prof. Poulton, on the habits of the predeaceous flies of the family Asilidae, with exhibition of specimens. (3) Prof. E. W. MacBride read a paper on some new points in the development of *Echinus esculentus*. He stated that in order to obtain successful cultures of the larvae it was necessary to use perfectly ripe parents and to supply the growing larvae with an abundance of sea water, frequently changed. He pointed out that many cultures on which important conclusions were based were made under insanitary conditions. The cavity of the blastula was at first filled with a thick proteid solution which became thinner as development advanced, and this thinning was possibly connected with the infolding processes in the wall, by means of which the organs of the larva were built up. The larva showed its relationship to Tornaria by the three-fold division of the body cavity on each side and by a larval brain, which was situated at the front end and was independent of the ciliated band. The development of the nerve-ring of the Echinus from the floor of an ectodermic pit was described. A false floor formed over this by the meeting of interradial ridges gave rise to the buccal membrane of the adult. The masticatory apparatus was derived from five pocket-like outgrowths of the left posterior body cavity. Finally, the blood system was a remnant of the proteid contents of the blastocoel added to by exudation from the cells of the alimentary canal. (4) Dr. A. T. Masterman exhibited a series of wax models illustrating the transition from larva to adult in *Cribrella oculata*. The main points brought out were the complete bilaterality of the larva, the sinistral asymmetry followed by axial symmetry converting the larva into adult, and the absence of any true metamorphosis. The changes in the body cavities were shown to agree with the results of Goto for *Asteria* and *Asterias*, and to differ from those of MacBride. (5) Dr. J. Ilume Patterson gave an important communication, on the causes of salmon disease—a bacteriological investigation, in which he showed that if a sound salmon is placed in water with *Saprolegnia* there is no result, and that the fungus is effectual only after a preliminary softening of the skin by the action of a bacillus which he had succeeded in isolating and cultivating.

On Monday, September 15, the following papers, &c., were taken:—

(1) Prof. Howes exhibited, on behalf of Mr. J. P. Hill, of Sydney, photographs of the first segmentation stages of the zygote of the native cat (*Dasyurus*) up to the period of first formation of the endoderm. A 16-celled stage was described, at which the embryo-cells are arranged in a couple of annuli, and later a stage suggestive of over growth of a yolk by the ectoderm. Selenka's blastopore stage was shown to be conspicuous, and in one example the endoderm appeared to arise from a single cell at the point of closure of the blastopore, after the manner of that of *Didelphys*. Mr. Hill has succeeded in obtaining microscopic

sections of the earlier stages by affixation of the egg to the embryonic membrane of the pig. (2) Prof. J. C. Ewart gave an account, illustrated by the lantern, of some recent intercrossing experiments with dogs, and pointed out that unless one of the parents was highly prepotent, the first crosses were not as a rule uniform, and that when the members of the cross-bred litters were interbred, some of the offspring very closely resembled the pure-bred grandparents. (3) Mr. Nelson Annandale had a paper on flower-like insects from the Malay Peninsula, and Mr. H. C. Robinson, who had been on the same expedition, gave notes on protective resemblance—both subjects being illustrated by lantern slides. (4) Prof. Poulton then gave lantern exhibitions (1) of British insects in their natural attitudes, and (2) of three-colour slides showing mimicry, protective resemblance, seasonal forms of butterflies, &c. (5) Mr. Thos. Steel exhibited an interesting collection illustrative of Australian zoology, such as the different species of *Peripatus*, including forms of *Ooeripatus* which lay fertile eggs having a lengthy period before hatching; also a fine series of land Planarians, also marsupial embryos, the blind marsupial mole, *Notoryctes typhlops*, and the honey ant, *Camponotus inflatus*, both from the Central Australian desert. (6) Prof. R. J. Anderson gave two notes—one on a specimen of the pilot whale of a white colour, with twenty-eight teeth and a large foramen of Winslow in the abdomen; and the second on the relations of the parietal bone in Primates. He showed that the orang is in a variable condition, having sometimes, but not always, a parieto-phenoidal suture. Other variations were discussed. (7) Mr. A. T. Watson gave a most interesting account, illustrated by the lantern, of the errant habitus of the Onuphidae (Polychæta), and described a defensive mechanism which he had discovered in the tubes. The onuphid worms drag their tubes over the sea-bottom, and protect the open ends by constructing membranous valves, like those of the veins, and so arranged that on retreat of the worm the inrush of sea water causes the valves to close automatically. (8) Mr. R. T. Leiper, on an acceleus Turbellarian inhabiting the common heart urchin. The worm was found in the accessory canal of about 5 per cent. of the *Echinocardium cordatum* at Millport. It is white, leaf-like, and 2.5 mm. in length. There is no spermatheca or vagina. A similar absence of female accessoria obtains in Haplo-discus, from which this Turbellarian differs in the following respects:—(1) shape; (2) parasitic habit; (3) mouth in anterior fourth; (4) paired lateral testes; (5) no defined vas deferens; (6) penis with chitinous knob-like armature; (7) large digestive vacuole. In discussing the classification of the Acoela, the author suggests that the family Proporidae, comprising all *Acoela* with one genital opening, be subdivided to form two subfamilies:—(1) Proporinae, to include the genera (a) *Proporus*, (b) *Monoporus*, (c) *Böhmgia*, *i.e.* those with a common genital pore; (2) *Avagininae*, consisting of (a) *Haplo-discus* and (b) the genus now recorded, *i.e.* those having a male pore only. The name *Avagina* is proposed for this new form.

On the Tuesday, Dr. Henry Woodward gave a note on a diagram of the skull of *Mastodon angustidens*. Dr. R. F. Scharff had an interesting paper on the Atlantis problem, in which he collected a number of facts in the distribution of animals bearing upon the possible land connection between Europe and America by way of the Atlantic islands. His investigations tended to show that Madeira and the Azores are the remains of an ancient Tertiary area of land which was joined to Europe, and that it probably became disconnected in Miocene times. As to a land bridge across the Atlantic, many reasons can be given in its favour. Uniting North Africa with Brazil and Guiana in early Tertiary times, it probably subsided during the Miocene period, leaving only a few isolated peaks as islands.

Mr. R. J. Ussher gave an interesting address, illustrated by lantern photographs taken by Mr. R. W. Welch, on the avifauna of Ireland as affected by its geography. He shows that as a result of the position and features of the country, some species breed more numerous and extensively than in England. The buzzard, bittern and capercaillie have been exterminated, and certain other British birds have never established a footing in Ireland. Winter and occasional visitants were discussed, also the list of North American species taken in Ireland. The raven, harriers and eagles are approaching extinction. The bones of the great auk found in kitchen middens in Antrim show that it was used as food.

Mr. E. J. Bles gave two communications, one on the development of *Xenopus*, and the other on experiments on the *Axolotl*, showing adaptations to life in an alkaline medium. Dr. H. W. Maret Tims had a paper on the structure of the scales in the cod. Prof. C. S. Minot, of Boston, U.S., gave an address on the significance of the embryonic cell, in which he gave the results of his observations on cellular development in guinea-pigs, mice and rabbits. Mr. J. Stanley Gardiner had a paper on the breaking up of coral rock by organisms in the tropics. First the boring algae and sponges penetrate the living corals, extending into every septum and spine. They weaken the coral and so riddle it that it is then easy for boring Polychæta such as *Polydora* and *Eunice* to enter. Following these come various Sipunculids, the bivalve *Lithodomus* and the cirripede *Lithotrypa*. Then a wave breaks off the coral mass, leaving a bare surface, which more boring animals at once take advantage of. The fallen coral mass is finally broken down into smaller and smaller fragments by the boring animals. Then the sand-feeders come into action and grind up the coral fragments into sand. Chief among these may be mentioned the sea-slugs, *Holothuria atra* and *Stichopus chloronotus*, which appear to retain within their guts the coarser fragments in the sand for long periods of time, while the finer particles are swept out along the ciliated grooves. Other sand-feeding forms are Sipunculids, *Echinus* and *Ptychodera*, the mound-like casts of the latter of which form most conspicuous features of the landscape at low tide. Much of the finer material must pass into suspension in the water and be swept out by the tidal and oceanic currents, while the smaller sand grains the greater the area they present for solution. It will thus be clear what an important bearing the sand-feeding and boring animals have on the formation of the lagoons of atolls.

Mr. J. Graham Kerr communicated a paper, illustrated by microscopic preparations, on the early development of muscles and motor nerves in *Lepidosiren*. He described a stage in which the inner wall of the myotome consisted of a layer of large neuromyoeplithelial cells, the cell substance of each of which was continued into a tail-like process, which was in turn continuous with the nerve rudiment. The outer wall of the myotome was shown to contribute largely to the formation of the myomere. Mr. Kerr's preparations showed that the connection between spinal cord and myotome existed at a very early period—while the two structures were still in contact—and that these primitive connections—the rudiments of the motor nerve-trunks—became gradually drawn out and lengthened as the myotome receded from the spinal cord with the interposition of mesenchyme. The motor nerve-trunk, at first naked, became later on surrounded by a sheath of mesenchymatous protoplasm.

Mr. G. H. Carpenter, of the Dublin Museum, read a paper on the insect fauna of some Irish caves, dealing especially with *Collembola* discovered in Michelstown Cave, co. Tipperary, and in Dunmore Cave, near Kilkenny. With the exception of *Heteromurus marginatus*, Wankel, which has now been found to inhabit caves in Ireland, France and southern Austria, all the blind species enumerated occur in above-ground localities (albeit with a discontinuous range) as well as in various caves in continental Europe. These facts point to the conclusion that such insects may be regarded as the survivors of ancient races with wide distribution whose ancestors were destitute of eyes; now almost exterminated in the upper world by the competition of eyed forms, they still survive in the caves. This conclusion does not, of course, contradict the generally accepted view that a large proportion of the blind cave fauna of continental Europe and North America (probably including *H. marginatus* mentioned above) must be descended from eyed ancestors.

On Wednesday forenoon there was an interesting discussion on natural selection in relation to protective resemblance and mimicry in animals, arising out of the communications made to the section by Prof. Poulton and by Messrs. N. Annandale and H. C. Robinson. Prof. Poulton, in opening the discussion, expressed his conviction that natural selection was the key to the puzzle, although it was not always possible to say how it should be applied. He gave examples of some mistakes that had been made in the past, and since rectified in attributing utility to characters. He alluded to the results he had obtained from the destruction of chrysalides in different environments, and he finally accepted natural selection as a working theory. Mr. Annandale and Mr. Robinson both brought up various cases observed by them in Siam and Malaya where the

explanation by natural selection seemed very difficult. Mr. G. H. Carpenter pointed out how some of these cases might be explained. Miss M. Newbigin and others also brought up further difficulties, and some speakers discussed natural selection as a form of isolation and as being of less importance than other forms. In his reply, Prof. Poulton dealt with many of the cases cited, and showed how they could be brought under the operation of natural selection.

Finally, a paper by Mr. C. Shearer, on the early development of the head kidney in *Polygordius* and *Eupomatus*, and the usual votes of thanks to the president and officers brought a very successful meeting of Section D to a close.

GEOGRAPHY AT THE BRITISH ASSOCIATION.

THE changed spirit that is coming over geography was in evidence at Belfast. Accounts of explorations proposed or executed were limited in number, and half of them related to the unknown Polar lands. On the other hand, papers dealing with the morphology of limited areas and with applications of geographical knowledge to economic problems, branches of geography which are rapidly growing in importance, this year outnumbered the accounts of pioneer travels.

The president, Sir Thomas Holdich, in his address on the progress of geographical knowledge, emphasised the fact that the area for pioneer work was rapidly diminishing, and that the exploration required was of a more exact and comprehensive character, which necessitated a more restricted scene of operations. He very properly insisted on the need for an exact knowledge of the previous work done in any region before attempting to carry out new investigations in it, and that the investigators should be thoroughly trained men. In much of the world, a topographical knowledge is wanted intermediate between that given by pioneer surveys and that of elaborate national surveys such as our ordnance survey, *i.e.* a knowledge sufficient to show on a fair scale the salient features, and capable of being adjusted to the triangulation of a geodetic survey. Following a recent American authority, Sir Thomas Holdich called this a geographical as opposed to a topographical survey. As geographical survey means a survey of the distribution of all phenomena within a selected area, and not merely of its topographical features, it would be well to find another term. Topography and geography are too often considered synonymous, and it does not help to an appreciation of the true significance of geography to identify it with a topography. Why not simply say large- and small-scale topographical surveys? The president of Section E is the last man to limit geography to topography, as many paragraphs in his address showed, although as a surveyor of long and special experience he naturally dwelt most fully on map making.

The travel papers were of a high standard. The audience had to listen, not to uninteresting extracts from diaries, but to well-digested summaries of results. Major Molesworth Sykes discussed the geography of southern Persia, in a paper which might equally well be classed among those applying geographical knowledge to practical needs. He pointed out the influence of the dry, barren conditions of southern Persia and Baluchistan, bounded by an inaccessible coast and so escaping invasion from the sea, in determining a hardy, warlike race, which has held in subjection the plains of Mesopotamia and even of India. He traced the influence of physical features on trade routes and the new telegraph line. Part of his paper was a contribution to physical geography, for it dealt with the changes of the bed of the Helmand River. He remarked that the desert of Lut is traditionally associated with Abraham's nephew, and condemned our maps for distinguishing between it and the Dasht-i-Kavir, as Kavir is the name of Arabic origin applied to all saline portions of Dasht-i-Lut, the general name for the whole desert area. A very serviceable paper was communicated by Captain Ryder on Hilly Yunnan, in which the possibility of the much-discussed railway line from Burma was not denied, though its utility or financial success was. The natural route was by the Red River through Tongking, and a railway would soon be ready through the French territory. Mr. Hawes, an energetic young Cambridge graduate, told us how he could find out so little about Sakhalin that he visited it to discover for himself what it was like. It is almost as long as from the Shetland to Land's End, rises to about 5000 feet as Great Britain does, has two

ivers each about 300 miles in length, and is covered with the forest primeval, wherein bear, wolf, fox, sable, reindeer and other animals wander. The climate is one of extremes, but popular ideas about a perpetual fog enshrouding it must be abandoned. The natives are the Ainus, Gilaks, Orochons, Yakuts and Tunguses, but the majority of the inhabitants are Russian exiles, few of whom are political prisoners. The Rev. W. S. Green brought us to a little island nearer home and showed views of Rockall. Prof. Libbey, of Princeton University, described his recent visit to Petra and showed magnificent views of its impressive rock temples, tombs and still older "high places" of Moab, and of the gorges through which this depression is reached.

Prof. Libbey read a prophetic note from Sir Clements Markham on the Sverdrup North Polar Expedition, and subsequently gave a graphic account of the expedition to renew Peary's supplies two years ago, in which he took part. Both communications expressed belief in the safety of these explorers, and were verified within a few days. Interest, however, was concentrated on the South rather than on the North Polar regions. Dr. Mill gave one of his admirably lucid expositions, in which he traced the sequence of ideas about a great southern continent and the various phases of Antarctic exploration. A crowded audience listened to Mr. Bruce's account of the plans of the Scottish National Antarctic Expedition, which will concern itself mainly with oceanographical and meteorological investigations, for which it is exceptionally well equipped. Much is hoped from the kite flying by the meteorologists, for which elaborate apparatus has been provided. The audience sympathised greatly with Mr. Bruce, who has unhappily found himself compelled practically to rebuild his ship, the *Scotia*, at the cost of transforming an estimated surplus of 2000*l.* collected above the sum required for the expenses of one year's work into a deficit of 4000*l.* A grant of 50*l.* was voted by the Association to the expedition.

Of physical papers, that which attracted most attention was Prof. J. Milne's account of world-shaking earthquakes, with special reference to the recent volcanic eruptions in the West Indies, of which 93 per cent. are submarine. He associated periods of volcanic activity with periods of upheaval, and those Antillean eruptions of which we possess records with huge readjustments of the Hispaniola-Jamaica fold or of neighbouring folds on the American continent. A report was read by the Committee on Terrestrial Surface Waves and Wave-Like Surfaces, which was drawn up by Dr. Vaughan Cornish, whose well-known recent work was outlined in it.

Prof. Libbey discussed the evolution of the Jordan Valley, the origin of which he traced to a rift at the close of the Cretaceous period. It was subsequently widened and deepened by ice action to the Sea of Galilee, if not throughout its whole length; then submerged nearly as far north as the Sea of Galilee and covered with 4000 feet of sedimentary deposits, which were afterwards gradually elevated, the stream cutting its bed through them the while. Some 3000 feet of this sedimentary rock were removed when conditions altered, and probably the glacier disappeared or the water supply failed, or the rate of elevation increased, or all three took place and connection with the ocean was blocked. After 1000 feet of rise, the present conditions were obtained. Mr. Herbertson read a note on the windings of the Evenlode, and suggested that we must look some 150 feet above the present level, where the river flowed over Oxford Clay, for their initiation. Mr. Porter traced the origin of the valleys of county Cork, which change abruptly from one strath to another, to glacial interference, and explained the meridional character of many tributary glens as the outcome of faulting plus the rapid flow of pre-Glacial streams. Prof. W. W. Watts described the features of Charnwood Forest, where old mountains rise above Triassic deposits which cover their lower slopes, these slopes being here and there exposed in the river valleys. He compared the Triassic landscape in Charnwood Forest with that of the Great Basin of North America at the present day.

A report was read from Dr. T. N. Johnston on the Scottish Lakes Survey, in which the seiches which have been recently observed were described and illustrated by curves. (See NATURE, June 12.)

The only paper on biological geography was that by Mr. Lloyd Praeger on geographical plant groups in the Irish flora. A careful analysis of the distribution of plants in Ireland reveals the existence of several fairly well-defined types. There is a marked tendency to a "central" or "marginal" distribution, the result of the configuration of the country, the central group

being largely composed of lowland, calcicole, and aquatic or paludal species; the marginal of calcifuge, upland and dry-soil plants. Well-marked northern and southern, eastern and western groups also exist, the boundaries between them consisting of lines running not exactly east and west or north and south, but rather north-north-eastward from Cork to Londonderry and east-north-eastward from Galway Bay to Dundalk Bay. For these six types of distribution the author proposes the names Central, Marginal, Ultonian, Munonian, Lagenian, Connacian, the last four being taken from the old names of the four provinces of Ireland, in each of which one of the groups attains its maximum. The characters of each plant-group, and its relations to the climatological and physiographic features of the country, were pointed out.

Two papers of economic importance were read. Prof. Johnston showed the distribution of peat bogs in Ireland by means of a new map prepared by the Intelligence and Statistical Branch of the Irish Agricultural and Technical Instruction Department. They cover 1861 square miles, chiefly in counties Donegal, Mayo and Galway, and have an average depth of 25 feet. An account was given of the character of the different layers of a bog as seen in a vertical section, and an explanation suggested of the origin of a bog-slide. Specimens of the bog-flora, of the different kinds of peat and of the economic products derivable from turf or peat, lent from the botanical collections of the National Museum in Dublin, were exhibited. The second paper, by Mr. R. B. Buckley, on colonisation and irrigation in Uganda and the British East African Protectorate, began with a clear picture of the existing physical and economic conditions of these dependencies, and enunciated comprehensive and judicious views as to their development in the future. The question of irrigation was exhaustively treated, and the author concluded that the prospects of great transformations taking place through its aid are not very hopeful.

A. J. H.

ENGINEERING AT THE BRITISH ASSOCIATION.

ON Thursday, September 11, after the president's address, a paper by Mr. H. A. Humphrey on recent progress in large gas engines was read. This paper, which was illustrated by lantern slides, gave an account of the extraordinary development of large gas engines which has taken place during the past few years, and which has, as the author said, had but few parallels in the history of engineering enterprise. In the Paris Exhibition of 1900, a 600 h.p. Cockerill gas engine was, from its size, the object of much interest. The same makers are now building engines of 2500 h.p., and they are prepared to undertake one to develop 5000 h.p. In this country it is only as recently as 1900 that engines above 400 h.p. have been made, the first two being constructed for Messrs. Brunner, Mond and Co.'s works at Winnington, yet when the paper was written (August) the two chief manufactories in Great Britain had under contract or had already delivered no less than fifty-one gas engines ranging in size between 200 and 1000 h.p. But it is on the Continent and in America that the most remarkable advance has been made. The author gave in a very complete table particulars of all engines of more than 200 h.p. capacity which have been built abroad or are under construction, the total amounting to 327 engines, developing 181,605 h.p. Slides shown by the author illustrated the various uses to which these large gas engines have been put so far, such as dynamo driving, air compression for blast-furnace work, and other similar uses. Perhaps the most interesting detail in connection with this increase in the size of gas engines has been the use of blast-furnace gas for working them. The author in the latter part of his paper explained in some detail the improvements in construction and governing which have made these large engines possible, in particular the changes which have been necessary in the old "hit and miss" governor mechanism, where, as in dynamo driving, perfect uniformity of speed is necessary. As several large engineering firms in this country have now acquired the rights for manufacturing some of the most successful foreign types of these engines, there is little doubt that we are on the eve of important developments in this country in the gas-engine industry, especially in the utilisation of producer and of blast-furnace gases.

In the afternoon of September 11, the Section made a special visit to the harbour works, under the guidance of the engineers

to the Belfast Harbour Commissioners, in order that members might see for themselves some of the remarkable developments which have taken place in Belfast Harbour and have been brought about by constant increase in the size of ocean steamships.

On Friday, September 12, the first paper was a brief communication by the Hon. C. A. Parsons on steam turbines, in which figures were given to show the rapid increase in the use of the compound turbine since 1884. Up to 1890, though a number of compound turbines had already been constructed for driving dynamos, the largest size had not exceeded 120 h.p., the total h.p. at that date being 5000; by 1896 the total h.p. had increased to 40,000 and the largest individual plant to 600 h.p., and now the largest unit has increased to 3,000 h.p. and the aggregate h.p. sold in Great Britain to 200,000. On the Continent, also, their use has been rapidly extending, and the total aggregate of horse-power at home and abroad for driving dynamos up to the present time is not far short of 300,000. As a proof of the remarkable economy obtained in the very large machines, the author stated that a steam consumption of 17.3 lb. per kilowatt hour had been recorded during a test of a 1000 kilowatt continuous-current machine belonging to the Newcastle and District Electric Light Company; this would be equivalent to about 10.2 lb. of steam per i.h.p. hour, a very remarkable figure, and he anticipates still greater economy in the future in turbines of large size when using superheated steam. Many engineers had feared that these machines would fall off notably in their economy after they had been running for some time, but the author stated that careful tests had now been made with several plants to determine the steam consumption after the machinery had been in use for several years, and no appreciable increase had been found. The second half of the paper was devoted to an account of the application of the steam turbine to marine work; seven vessels have so far been fitted with turbine engines, including the two unfortunate destroyers—the *Cobra* and the *Viper*—and the two well-known Clyde passenger boats—the *King Edward* and the *Queen Alexandra*. In addition to these, a third-class cruiser, the *Amethyst*, would shortly be completed, and orders have recently been placed on the Clyde with Messrs. Denny Bros. for the construction of two cross-channel boats which are to have turbine engines of about 8000 h.p.; this means a total of about 85,000 h.p. in use or in construction. Mr. Parsons stated that if the coal consumption of the *Duchess of Hamilton* (fitted with ordinary reciprocating compound engines) was compared with that of the *King Edward*, and if various allowances for the difference in speed of the two boats and for various other factors were made, then the turbine boat showed a saving of 20 per cent.; he again, as at the Dover meeting, prophesied the eventual use of turbine engines for Atlantic liners, cruisers and battleships. In his reply to a brief discussion, in which several points were raised with regard to the use of superheated steam in the turbines, the author stated that he estimated a gain of efficiency due to superheating of about 1 per cent. for every 10° of superheat.

The next matter dealt with by the Section was the report of the Committee on the Resistance of Road Vehicles to Traction, the first eleven sections of which were devoted to a complete *résumé* of the experimental work which has already been carried out on this subject, and to a summary of the opinions which have so far been expressed (based on these experiments) of the effects on traction on the level of the three independent elements of road resistance, namely, axial friction, rolling resistance and grade resistance. The last two sections of the report were devoted to a brief description of the special apparatus which has been designed and made by the Committee; the first series of experiments undertaken will be confined to measurements of the resistance of single wheels. The tractive force will be transmitted through a system of levers to a small ram which presses upon a rubber diaphragm enclosing a space filled with water or other liquid; the pressure exerted by the levers on the ram will vary with the tractive force, and the consequent varying fluid pressure will be registered by a recording pressure gauge of the Bourdon tube type, and since the drum of the instrument carrying the recording paper will be rotated in strict accordance with the movements of the car, a diagram will be drawn giving the tractive force at all points on the journey. The instrument has been so designed that the leverage on the ram can be altered to ensure diagrams of a reasonable size even when the tractive force is very small, and a revolution counter will be used for obtaining independently the revolutions of the experimenta-

wheel. Several preliminary experiments have already been carried out, but the main work of the Committee will be undertaken during the forthcoming year. It should be mentioned here that although another grant was given to the Committee by the Association, still its work will be terribly hampered, and in fact will be almost impossible, unless additional funds are forthcoming from other sources; the Committee is doing work of such great importance to the country that it is to be hoped public bodies and all those who are interested in the question of the construction and upkeep of public streets and roads and the best means of road traction will respond liberally to the appeal which the Committee has issued for financial help.

Two other important papers read on this day dealt respectively with the rainfall and water-power available in Ireland. Dr. Mill exhibited a map of Ireland coloured to show the distribution of rainfall, as ascertained from the records of the ten years 1890-1899, and pointed out that practically the whole country west of the Foyle and the Shannon, and west and south of a line drawn from Limerick to Clonmel, had a rainfall exceeding 40 inches in the year. He also gave some interesting statistics as to the number of rainfall stations in Ireland and the increase since the Belfast meeting in 1874; he calculated that 185 additional observers would be required to secure as many rain-gauge observations per 1000 of population as were now made in England. Perhaps as a result of this meeting we may again find an increase of interest taken in this important question.

Mr. Dick, in his paper on the water-power available in Ireland, considered only the cases of the Shannon, the Erne and the Bann, perhaps the most important rivers, however, from a power point of view. The dry-weather minimum flow of these rivers is the vital factor in calculations of available power, and the problem is rendered exceptionally difficult owing to the conditions which have been laid down in reference to this minimum flow in Acts of Parliament which have been passed in connection with the fishing industry in these rivers. Mr. Dick stated that very careful measurements had been made of the amount of water available under the above conditions, and he calculated that as a result the continuous water-power available on the lower Shannon would be nil, on the lower Erne 400 and on the lower Bann 800. He then dealt with the possibility of increasing this small horse-power by storage of flood waters, and came to the conclusion that this was out of the question when regard was paid to the enormous amount of money which had already been spent for the purpose of keeping these rivers at or near their summer level in connection with the requirements of arterial drainage and navigation. It will be seen that the author's figures correct the serious misconceptions that have prevailed in regard to the amount of water-power likely to be available in Ireland; no doubt these too favourable views have arisen from the erroneous figures given by Sir Robert Kane in his book on the "Industrial Resources of Ireland," since that author estimated that the available water-power on the Shannon alone between Killaloe and Limerick was 34,000. Several of those who took part in the discussion were of opinion that the author had taken a too pessimistic view of the situation, and that in several cases, at any rate if useless navigation rights were abandoned, considerable power would be rendered available.

The meeting on Monday, September 15, was, as usual, devoted to electrical papers, and the first paper dealt with was a suggestive one by Mr. J. E. Kingsbury on the future of the telephone in the United Kingdom. The author gave a short history of the various telephone companies which have been at work in this country from the date of the famous action brought against the Edison Telephone Company by the Post Office in 1880, and then went on to show that competing services which had been started in one or two towns, as for example, Dundee, Sheffield and Manchester, had not benefited the community; in fact, the people of those towns had actually derived an advantage from the amalgamation of the local competing companies with the National Telephone Company, a view, we may point out, quite opposed to the popular ideas upon that subject. Mr. Kingsbury was of opinion that competing services had ceased in the past because the absurdity of such a situation was obvious as soon as it was put into practice. Parliament, by the Act of 1899, determined to foster once more, by the help of the ratepayers, this system of competition, although when tried before under private enterprise it had proved unsatisfactory. Both in Glasgow and in Tunbridge Wells, where municipal

telephone systems had been started, the author was of opinion that money had been uselessly spent simply to create a system of duplicate subscribers and duplicate subscriptions. In London, on the other hand, an admirable arrangement had been concluded by the Postmaster General by which every subscriber to the Post Office system was in connection with the existing 45,000 subscribers to the old system. In conclusion, he stated that as corporations could borrow money easily and cheaply, it would be spent on competitive systems which were wasteful, and gave the maximum of inconvenience and the minimum of public benefit. Several of those who took part in the discussion were opposed to the position taken up by the author on the question of municipal telephone systems, but Sir William Preece appeared to uphold the idea that a general telephone system could be much better worked by the Post Office than by separate municipalities. One of the speakers declared, as the result of careful inquiry, that the Glasgow telephone system, instead of being a failure as the author had stated, was a great success.

Prof. E. Wilson then read a paper on the electrical conductivity of certain aluminium alloys as affected by exposure to London atmosphere. A number of specimens of various light aluminium alloys had been placed on the roof of King's College, London, in order to investigate the effect of exposure to the atmosphere. The specimens were wires about $\frac{1}{8}$ inch in diameter, carried on a wooden frame, and had been exposed for about thirteen months. A table was presented by the author giving the results of the experiments, and as chemical analyses had been made in every case, the author was able to show the effect upon the specific resistance of each alloy of the different elements in combination with the aluminium; as a result of his work, he concluded that for exposed light aluminium alloys copper alone should not be used; on the other hand, the presence of equal amounts of nickel and copper, about 1 per cent. of each, though it slightly reduced conductivity, produced a marked improvement in power to resist corrosion. Dr. Glazebrook, in the discussion, mentioned how difficult it was in such experiments to determine accurately the specific resistance owing to the pittings and cracks which were produced on the surface by the action of the weather.

Another paper of much interest was one by Mr. W. Taylor on the science of the workshop. He said that the subject would divide itself naturally into three parts—the materials used in the workshop, the processes for their treatment, and tools; and in the section on materials he pointed out truly enough that much of the work which had hitherto been carried on in technical schools and also by original investigators had been confined to the study of the physical properties of materials from the point of view of the designer, whose chief interest is that his machine structures shall not be strained beyond the elastic limit, rather than from the point of view of the mechanic, whose business it is to shape the materials, generally by straining them beyond the elastic limit. He hoped for considerable advance in our knowledge from this latter point of view, from the photomicrographic study of the structure of materials and from such researches as those which have been carried out by the Alloys Research Committee of the Institution of Mechanical Engineers.

The last paper on the programme for the day was one by Mr. J. R. Wigham on a new flashing lighthouse light without intervals of darkness. One of these lights was placed on the top of the tower of Queen's College and was shown in operation each night during the meeting. The author stated that the cost of the new light, which was practically a continuous one, was not greater than that of any other of the first-class lights with revolving annular lenses, and that any common illuminant might be used.

The afternoon of Monday was devoted to a joint discussion with Section L on the training of engineers. The discussion was opened by the president of the Section, Prof. Perry; it was, in fact, a discussion of his presidential address to Section G. One of the points mentioned by the president was the necessity that engineers and manufacturers should interest themselves in the question of the education of the young engineer, and that until they do so engineering teachers cannot hope to meet with success. We feel sure that this want of interest is at the bottom of much of the trouble the directors of engineering schools now experience in inducing parents and guardians to consider that the profession of an engineer is one which requires in the present day as lengthy and complete a preparation as medicine or law. Several speakers

raised the question as to whether it was advisable to adopt what has been called the half-time course, that is to say, the system under which students attend the university or technical college classes during the winter and work in the shops or drawing offices during the summer. We may mention that this plan has been carried out in several towns, but as a rule employers are somewhat opposed to it. Sir William Preece declared—and it is a statement which cannot be too often made—that it is at the top and not at the bottom that we require radical changes in our technical education for engineers.

On Tuesday, September 16, a number of general papers were dealt with. The first paper, by Mr. W. H. Booth, treated of the smokeless combustion of bituminous fuel, and the author contended that as a rule boiler furnaces were badly designed in respect of the prevention of smoke. Furnaces must be arranged in such a way that all the gaseous products of the furnace are swept together with the admitted air, and are not cooled down until sufficiently burnt to admit of their being used for heating purposes; and he was of opinion that there was nothing in smoke prevention to justify the assertion that it was economically impossible. Mr. J. S. Kaworth, in connection with this subject, described a system for the prevention of smoke known as the "Wilson smokeless process." A small quantity of nitrate of soda in solution is injected into the furnace with sufficient air to give perfect combustion, the cost being about 3d. to 4d. per ton of coal burnt; this system has been installed in a tobacco factory in Belfast, smoke has been abolished, and the output and efficiency of the boilers improved.

Prof. G. Forbes then gave an interesting account of his experiences in the late South African war with the infantry range-finder, which he described at the Glasgow meeting last September. Both officers and men who had served at the front were unanimous in their opinion that the great want which had so often nullified the strategy of our leaders and endurance of our men was a quick, handy, trustworthy one-man range-finder. In actual service this range-finder had proved that its accuracy was all that could be desired, and it was much quicker in action than the mekometer. During a trek of 300 miles in eleven days, he had been constantly called upon to give distances, and it never took longer than one minute to dismount from his horse, set up the range-finder and give the first range, other ranges being given in a few seconds. He was in action for two days, and was able to give the ranges quickly and accurately without any unnecessary exposure. With his own eyesight, which was not particularly good, he was able to get an accuracy of 2 per cent. in 3000 yards, but many of the men had been able to get a very much greater degree of accuracy than this.

Several other short communications were read, but we have not space to deal with them.

T. H. B.

SCIENCE AND LITERATURE.¹

ON what subject ought one to speak at the beginning of the session of a College of Science which is also a School of Applied Science, speaking, not only to one's colleagues, but to new and old students who differ from one another in character, training, social position and attainments more than the students of any other college probably in the world? This college has three functions. It gives the highest possible instruction in mathematics and natural philosophy and in all the natural sciences. It gives technical instruction to mining, metallurgical and mechanical engineers. It gives pedagogic training to teachers of all subjects taught at the college. The presence of Sir Arthur Rücker, Principal of London University, reminds me of a fourth function which has recently been added—namely, the preparation of students to pass university examinations.

I am strongly of opinion that every engineer—that is, every man whose business it is to apply any of the physical sciences—ought to have a more or less thorough training as a mechanical and electrical engineer. In the address which I had the honour to deliver three weeks ago as president of the Engineering Section of the British Association, I tried to show that only a very exceptional student can obtain such training unless he spends much time in mechanical or electrical engineering labo-

ratories such as I there described. For many years, from long before I came to Kensington, the mechanics course here has been one in mechanical engineering as well as in mechanical philosophy. My anxiety to own a laboratory has met with the utmost sympathy from the higher authorities and the council of the college. I may say that we are all as anxious that students should work with electric generators and motors and other electric-power plant as with steam and gas engines, with water turbines and pumps. I know that some of you blame me because I can give none of this necessary instruction, and sometimes, perhaps, I blame others for not affording me facilities. The curriculum at this college was arranged a great many years ago, when people aimed only at the training of the exceptionally clever student, and, indeed, before any electrical appliance was used by miners or metallurgists; before the time when a mine became filled with mechanical contrivances. Every mining or metallurgical or other technical school now established in any part of the world gives this sort of training to the students which we are unable to give. The authorities of this College are in sympathy with you and with me, and would help us to this necessary laboratory work and greater space and other facilities for instruction in my division if they possibly could. Parenthetically, I may observe that, in so far as applied mechanics and engineering theory are concerned, the courses of study here will enable any willing student to obtain the highest engineering degree of the University of London.

Some of you are extremely well read in scientific text-books, having passed most severe examinations in pure and applied science. And not mere text-books, but real scientific books have been studied by many of you; for I know that some of you have dipped into Larmor's book on the ether, and have read Thomson and Tait and Maxwell and Rayleigh. Not only have you this wonderful knowledge in science, but you have been earning your own living and you have developed an instinct for taking advantage of chances, of fending for yourselves, of making other people do what you ask, that is perfectly marvellous. Some of you remind me of great fir-trees that I saw in Norway this summer, spreading their roots over a rocky soil, gaining sustenance where no other kind of tree could exist. One power more developed than another is that of passing examinations. Nobody who is without the experience of an examiner of candidates from the evening science classes can comprehend your power of getting marks from a careless examiner for answers to questions on subjects about which your knowledge is limited. There is hardly any town in the British Islands from which our scholars—I suppose that quite a hundred scholars are here—have not come, each picked from many hundreds or thousands, each the recipient of great honour and a valuable scholarship, and your townspeople and your old companions are keeping their eyes on you, wondering whether or not it is a great man of the future that has been sent up to us. And now for the other side. You know much of what has been done, but have you the power to discover, to add to the world's knowledge? Your knowledge has been derived from books and lectures; you have now to learn that a week in the laboratory, during which you seem to rack, during which for examination purposes you do less than in reading ten lines of a text-book, is really of more value to your scientific education than a month's hard reading. This is almost unbelievable to you who are such adepts in passing examinations; yet it is quite true. Lectures and lessons have spoon-fed you until now; lectures and lessons will in future teach you to feed yourselves.

Again, many of you think it is not only a waste of time, but a positive sin, to read novels and poetry and general literature, to cultivate in any way the imagination, to take an interest in painting or sculpture or music. You have yet to learn that although parrots and other imitative animals can get on without imagination, there is no such thing in existence as an unimaginative scientific man. That you have some imagination and individuality is evidenced by your differentiation from all other students of science classes; but have you these well developed, and have you those other qualities which are absolutely necessary for the success of a scientific worker? Imagination is far and away the most important; but there are also judgment and common sense, and the love of truth and the power of self-sacrifice, which seem always to accompany the pursuit of science. Are you fond of reading? Do you know how to use books? Can you explain with decent sketches what you observe and know? Mere learning is a poor thing, but fondness for reading leads to the greatest possible development of all one's

¹ Abridged from the inaugural address delivered at the Royal College of Science (with which is incorporated the Royal School of Mines), London, by Prof. John Perry, M.E., D.Sc., LL.D., F.R.S., Professor of Mechanics and Mathematics, on October 2.

intellectual and emotional faculties. Fondness for reading will come to you if your companions are fond of reading. English and English subjects are badly taught in schools; hardly anybody anywhere seems able to teach them; one's own reading and discussion with friends are far better for one's education than any course of lectures. However limited your past education may have been, whatever defects some hypercritical learned man may see in the school system under which you have been brought up, starting from your present conditions, if you are fond of reading and have common sense, there is nothing to prevent your becoming men of the finest kind of liberal education. But you must exert your common sense and try to distinguish clearly what is essential from what is unessential in education. English literature is equal to, if not greater than, any literature of any people that exists now or has ever been. The language of our great Empire is enough for any man who is not specially fond of language study. If you love to study foreign or dead languages, do so; but if you are not so inclined you will be acting foolishly to waste your time over them.

The average man cannot be much hurt intellectually by anything he does, but the higher intellect is, I think, easily hurt, and I know of several men who had genius, real genius, whose intellects have been permanently dwarfed by a six months' course of classics pursued with the base object—degrading to classics and to themselves—of becoming able to pass an examination. There are some kinds of moral degradation which are final; and the holy of holies has been desecrated once for all. My language about this matter will not probably be understood by more than a few of my hearers, but if there is even one who understands, my message is very important. If such a one is here I would warn him that there are certain prices too large to pay for examination success. I object very much to those examination systems in which certain things are compulsory. Of course, we cannot get rid of all compulsory things. English and English subjects must be compulsory on English students. But I do say that the list of compulsory things should be made as small as possible. I am told that a knowledge of the German language must be made compulsory for chemists and biologists. I am sorry to think that this may be so. But inasmuch as the men who tell me this say that it is the case also for physicists and mathematicians and engineers, I venture to doubt the necessity for compulsion in any case whatsoever. I am perfectly certain that in these days of much publication of translations and abstracts of foreign scientific papers, no kind of physicist or engineer needs French or German or any foreign language so much that it is *imperative* on him to make a study of it. The men who insist on the study of a language other than English do not seem to know how difficult such a study is for some students. Time will not allow me to do it here, but I hope some time to have a chance of pricking this compulsory foreign language bubble which everybody is cherishing at the present time without really thinking about its intrinsic value. How often have I heard common men say that they abhor translations; that the style and real flavour of an author are only to be had in the original. I notice that such men read very little. I doubt if the average educated man ever does get that kind of appreciation of a foreign author which the author's educated countrymen get so easily. I have met all sorts of men in my life, and I have never seen reason to alter the opinion of my young days that a lover of reading can get immense satisfaction from a translation—whether it is from Greek or Latin, French or German, Spanish or Italian, Russian, Scandinavian or Hebrew; whether it is Omar Khayyám or the Rig Veda, the Talmud or the Koran, or the Bible. To the lover of English all literature is open. The man who insists on reading "the original" seems to me like a tethered cow, such as we see in Jersey; it costs the grass very closely, but surely it must sometimes sigh for a little more freedom and a more extensive range of grazing! If you had finished your course here I would say to you that we are all getting far too learned in natural science. We read far too many of the latest papers. Some of the greatest scientific workers of our times—men who are constantly advancing the boundaries of knowledge—read almost nothing of what other men do. I wish I had time to give you some interesting, and indeed absurd, examples of this. The average scientific man merely casts his eyes over the twenty or thirty scientific periodicals that every man buys every month; he does not even read that valuable periodical "Science Abstracts," or those

abstracts of chemical papers published so voluminously, for he has no time. The men who read everything that is written in scientific journals, not merely in England and America, but also in Germany and France, seem to me to have no time to do anything else; they have no time for scientific work of their own. Indeed, they know so much that a simple investigation such as they might bring upon their own account seems insignificant to them and quite unworthy of the time that they would have to spend upon it. I ask only that in matters like this of foreign languages and so much reading of scientific papers you should really judge for yourselves. In these days you can recognise the manufactured men of science by their taking up a notion without thinking about it, by their inclination to follow a leader as a flock of sheep follows the bell-wether, a phenomenon studied by a famous philosopher named Sydney Otteris.

When the Prince Consort tried to impress upon this nation those ideas of training in science and art which, if they had been attended to, would have kept us in the front of industrial progress, there was one of his ideas which took root, and which has given rise to the work of the Science and Art Department. I know the faults of the department as well as anybody, but all my life I have been pointing out its enormous services to the country. No other country in the world has anything to compare with it. When I think of our industrial supremacy before 1870, and how during thirty years some of us have been vainly warning a careless people that the combination of wisdom and knowledge which we call science, neglected in the education of all well-to-do people, would lead other nations to the capture of our industries; when I think of the utter failure of our higher educational authorities to recognise facts, I bless the Science and Art Department. For more than forty years, in towns remote from universities, it has been possible for the poorest apprentice or workman to get instruction in natural science. These science and art classes were open to the very poorest. Until lately there were no other classes open to rich, clever students. It is astonishing to me that men should be ignorant of the fact that it is the Science and Art Department which has so far saved our industries. I can speak with knowledge of the engineering industries. Of the many hundreds of thousands of pupils who have successfully passed our examinations, a very large proportion, by the combination of their scientific knowledge or scientific habits of thought with practical workshop knowledge and through their energy, became foremen and managers, and in many cases owners, of works. I need not dwell on the fact that every year since 1869 many Whitworth scholars have been sent out into the industrial world, and I affirm of my own knowledge that these men have become such captains of industry as no other country in the world has at its command.

If only our capitalists had even the most elementary technical training such as is suitable for capitalists, the men educated by the Science and Art Department would alone have enabled them to retain that industrial supremacy the loss of which is being bewailed day by day in the newspapers. Many of our best men are making bricks without straw. They discover, they invent, they project improvements. But if the owner of the works, the son or grandson of the creator of an industry, if all the directors of a company, with however scientific a manager, are quite ignorant of those natural science principles on which the industry is based, if they cannot distinguish between good and evil, there is nothing for the industry except to go upon lines that get more and more old-fashioned until the works stop through inanition. And yet I have heard of cases in which old science students, in spite of heart-breaking failures to interest their superiors, have by dogged persistence maintained works as paying concerns, in spite of competition from American and German and Swiss strategists of the best polytechnic training.

Many of the most successful students hide the source to which they owe their scientific training, because the science class fees are small; the classes are open to the poorest students, and in this country caste feeling so predominates that no man likes to have it thought that he comes of poor parents or that he ever attended a class to which poor students were admitted. If all the successful old Science and Art students comprehended how much harm is being done just now by their careful concealment of the fact that the Science and Art Department used to be, and in many places still is, the only agency through which a scientific training could be given in this

country; if they knew of the development which has been going on for some years in the functions of this department; if they knew the importance to the country of a general recognition of the services of the department, they would, I am sure, refrain from hiding their enormous obligations to it. No Government department has had so much intelligent criticism, because the only people who know about it are its own students, and they have by it been brought up in an atmosphere of scientific criticism.

And here are you students—about half of you—the picked men of these science classes, caught in our net, the net that Huxley spoke of, selected from thousands of students who are themselves select, selected that we may train most of you to be leaders of scientific thought or great appliers of science, or great teachers of science! There is the idea that for the good of the country our net has caught in one of you the young man most likely to repay cultivation, and I cannot too often repeat that it is not for your sake that this is done. If one of you happens to be a potential Faraday, however poor he may be, and so far as I can see he is just as likely to be poor as to be rich, it is our duty to try to discover him and give him chances of development. We are supposed to give you enough money to live upon; we ask no fees from you; we set you as men whom the King delighteth to honour, side by side with the most promising fee-paying students—men from our public schools, men taught to admire what you have done in the past, encouraged to think you men of promise—and we ask you to develop those exceptional faculties which to you are your own, but which we believe to be national assets.

I will conclude this address by bringing another and much more important problem before your consideration. The matriculation examination of a teaching university has this meaning only—that it is inadvisable to admit men who are obviously unfit to benefit by the instruction given in the university. When in medieval Europe all university lectures were given in the one universal language, Latin; when men from all nations came to hear the same lectures, it was evident that no man ought to be admitted who had not enough Latin to be able to comprehend the lectures. As present in Glasgow it is assumed that everybody has had the usual school training, and the only matriculation is in signing one's name in a book. Hitherto at this college men who have passed certain examinations in elementary natural science are thought to be fit and proper students, and of course you scholars who have all passed rather difficult examinations in natural science are admitted without question. I am glad to think that every student admitted to this college does always seem capable of benefiting by our instruction; but if you consider what our object is, the education of true scientific men, you will see that there is something much higher than is attempted elsewhere.

Merely to be able to benefit by the instruction, that is a small thing. Men who come here with valuable scholarships are expected, not merely to benefit, but to benefit in a very exceptional way. They are supposed to develop to the very utmost their obvious scientific ability. To test for this likelihood of development in even the roughest way is evidently difficult. Even to apply any test outside the old limits seems difficult, because of the peculiar circumstances under which you are selected for scholarships. In more than half your cases you are not aware beforehand that you have a chance of being selected. You joined science classes merely to obtain a kind of knowledge which would be useful in your daily work. Your prospects were those of a workshop with a slow rise to foremanship. Your spare time was meagre; it was stolen at enormous sacrifice from family duty and from those pursuits which make a man popular with his fellow workers; the study of language and literature was comparatively unimportant to you, and you were suddenly told that your scientific talents were such that you were selected for the higher life, the life of the seeker after truth; of the man of brains rather than muscle. In seven cases out of ten, it was quite impossible for you to prepare yourselves for any examination in language or literature in the two months before entering this college. I wish I saw clearly what ought to be done. You are valuable material, and if you come here without that training in your own language, that love of reading which leads to the power to use books and the knowledge of all subjects derivable from books, I am quite sure that you are greatly wasted. I have a solution of this problem, but I am not sure that it is the best solution, and therefore I leave the problem for you yourselves to consider.

UNIVERSITY AND EDUCATIONAL INTELLIGENCE.

PARLIAMENT reassembled on Thursday, October 16, for the resumed debate on the Committee stage of the Education Bill. In moving a resolution to give Government business precedence of all other matters during the remainder of the session, the Prime Minister took the opportunity to point out that the main object of the autumn sitting was to pass the Education Bill. The Committee has since its reassembly been engaged upon Clause 8 of the Bill, which defines the powers and duties of local education authorities and the managers of schools. The part of the clause passed reads as follows:—"The local education authority shall maintain and keep efficient all public elementary schools within their area which are necessary, and have the control of all expenditure required for that purpose other than expenditure for which, under this Act, provision is to be made by the managers." As we go to press the subsections of this clause are under consideration.

An appendix to the calendar for the session 1902-3 of the University College of North Wales provides a very complete account of the agricultural department, which has been much developed since its inauguration in 1888. In addition to the ordinary entrance scholarships and exhibitions open to all students entering the College, there are five scholarships for which students proposing to take the agricultural course may alone compete. The College offers a diploma in agriculture, and students may enter for the degree of bachelor of science, in the group of agriculture and rural economy, in connection with the University of Wales. In cooperation with five county councils, a complete scheme of "out-college" work in agriculture has been organised.

THE many good results which will eventually follow the re-constitution of the University of London are heralded by the new departures in the work of University College, London, all of them explained fully in the calendar for the session 1902-3. Complete university courses of study in the various faculties included in the work of the College have now been established. Among other developments are the institution of a full sessional, instead of a terminal, course in the psychological laboratory; the endowment of the department of pure mathematics by Mr. Astor; the reorganisation of the department of chemistry and the appointment of Prof. Collie to the chair of organic chemistry; the institution of a new matriculation examination for engineering students and the reorganisation of the curriculum preparatory for the diploma in engineering.

THE University of Birmingham *Engineering Magazine* (a well-edited little paper published by the University Engineering Society) contains in its October number an article on continental methods of training engineers, from the pen of Dr. D. K. Morris. The author considers that the chief differences in the courses of study are due to the high quality of the preliminary training and to the number of students. The latter enables special courses to be held; a student can in consequence take, in a subject not actually his own, a course which is specially suited to him, and has not to rest content with taking part of the general course for students of that subject. The electrical laboratories, it is said, have outdistanced those for civil and mechanical engineering, and a special feature in some of the technical high schools is a loan collection of the latest types of machinery provided by the leading manufacturers. Certainly a striking feature of technical education abroad seems to be the cooperation of the manufacturers and the teachers.

THE calendar of the Bristol University College for the session 1902-3 reveals the existence of very satisfactory cooperation between the college and the manufacturers and other employers of labour in the district. In addition to a college engineering scholarship competed for annually, many of the local engineering firms have recently consented to give entrance scholarships to their works. The students nominated will obtain the combined college and works' education for about 50% a year, whereas the ordinary premium paid by non-collegiate students in works is in general 100% annually. The college council has consented to allow any firm offering these concessions to send one deserving apprentice to the college to attend the day lectures at half fees. A large number of local civil engineers, manufacturing engineers and architects have expressed approval of the courses of instruction arranged for students entering upon any of the careers they respectively represent.

In his introductory article to the recent volumes of special reports dealing with American education and issued by the Board of Education, Sir Joshua Fitch very wisely insists that "the progress of mankind is to be secured, not by uniformity or by exact imitation even of the best models, but by differentiation, and by the evolution from time to time of new varieties of type both in principle and practice. Each nation must work out its own problems, in view of its special circumstances, its environment, its past history and its own national aspirations." It is well that English administrators of education should acquaint themselves with the work of the schools and colleges throughout the world, but there must be no attempt to transplant bodily any foreign system of instruction, for the national circumstances and genius are here different from those of other countries. Attention is directed to the fact that American educational reformers look with most confidence for help and guidance to "eminent teachers and professors rather than politicians or official personages." This, at least, is a practice which could be followed with advantage in this country.

❖ SOCIETIES AND ACADEMIES.

MANCHESTER. ❖

Literary and Philosophical Society, October 7.—Mr. Charles Bailey, president, in the chair.—A paper was read by Mr. R. L. Taylor on the reaction of iodine with mercuric oxide in presence of water. In a former paper he had shown that, when aqueous iodine is shaken up with precipitated mercuric oxide and rapidly filtered, the filtrate contained 80 to 90 per cent. of the possible amount of hypiodous acid. Messrs. Orton and Blackman have stated, in a paper read before the Chemical Society, that the solutions obtained from iodine and mercuric oxide contain only a small quantity of hypiodite, the iodine existing mainly as iodic acid. Mr. Taylor concludes from the description of these experiments that the authors overlooked the extremely unstable nature of hypiodous acid. They used ordinary powdered iodine, which is not sufficiently finely divided, and they took a great deal too long over their experiments. Using precipitated iodine and performing the experiments as rapidly as possible, Mr. Taylor finds that with from ten to twenty-five times as much iodine in proportion to the water as he formerly used, the solution contains from 44 to 52 per cent. of the possible amount of hypiodous acid and very little iodic acid.

PARIS.

Academy of Sciences, October 13.—M. Bouquet de la Grye in the chair.—On the laboratory registers of Lavoisier, by M. Berthelot. A *résumé* is given of the second volume of laboratory notes of Lavoisier: the contents are not so valuable as those of the first and third volumes. The most important experiments described are those dealing with the calcination of lead and tin in closed vessels.—On some peculiarities of the theory of shooting stars, by M. O. Callandrea.—A general demonstration of the construction of light rays by curved wave surfaces, by M. J. Boussinesq.—Study of iodine pentafluoride, by M. Henri Moissan (see p. 637).—On the hematoma in marine fishes, by MM. A. Laveran and F. Mesnil.—Carbonic acid as an agent of choice in experimental parthenogenesis, by M. Yves Delage.—The fourteen large laboratory registers of Lavoisier. The register stated to be lost and which has been recently found, by M. H. Brocard. An account of the discovery in the library of Perpignan of the volume of laboratory notes referred to by M. Berthelot above.—On the reduction of the linear element of a surface to a specified form, by M. M. Servant.—The magnetic and electric deviation of the Becquerel rays, and on the electromagnetic mass of the electrons, by M. W. Kaufmann. The results of the experiments quoted are completely in accord with the theory of M. Max Abraham, and it may be regarded as proved that the mass of the electron is entirely electromagnetic, that is to say, the electron is nothing but an electric charge distributed over a volume or surface of minute dimensions, not exceeding 1 cm. $\times 10^{-14}$.—On a consequence of the kinetic theory of diffusion, by M. J. Thoveret. The motion of a diffusing material being considered as proportional to the mean velocity of the molecule, the application of the kinetic theory to

substances dissolved in a given solvent leads to the prediction that, at constant temperature, the product MD^2 should be constant, M being the molecular weight and D the constant of diffusion. By a method described in a previous paper, the diffusion constants of about twenty non-electrolytes have been determined in aqueous solution, and it has been found that the theoretical conclusions are fairly well borne out by experiment, the constant MD^2 varying between 55 and 67. The author suggests the practical application of the method for the determination of molecular weights.—The methyl ester of methylanthranilic acid in the vegetable organism, by M. Eugene Charabot. The essential oil from the leaf of *Citrus sudanensis*, obtained by distillation with steam, contains about 50 per cent. of methyl methylanthranilate.—On cedar wood essence from *Cedrus Atlantica*, by M. Emilien Grimal. A sesquiterpene, cadinene and a ketone have been isolated from the oil.—On a new reaction of formal, serving for its detection in foods, by MM. Manget and Marion. Use is made of the colour reaction with amido-phenol.—Stimulants and nerve poisons, by M. N. E. Wedensky.—On the nerve centres in the Acepahale, by M. Louis Boutan.—Excretion in the higher Crustacea, by M. L. Bruntz.—On the composition of some reserve hydrocarbons in the albumen of some palms, by M. E. Liénard. The albumen of the palm contains a small quantity of a reducing sugar, a little cane sugar, several condensed mannans and a galactane.—On the geological constitution of the neighbourhood of Alexandria, Egypt, by MM. R. Fourtau and D. E. Pachoudaki. The rocky bar which forms the Alexandrine coast, and which protects the Nile delta against the sea at high water, belongs to the Quaternary epoch, and rests upon the limestones of the Upper Pliocene.—On the general causes of seismic instability in India, by M. F. de Montessus de Ballore.—On a new method designed to facilitate writing and calculation in the blind, by M. Dussaud.

CONTENTS.

	PAGE
The Encyclopædia Britannica	625
The Study of the Protista. By E. A. M.	627
An Assayer's Handbook. By T. K. R.	628
Our Book Shelf:—	
"The Climates and Baths of Great Britain"	629
Clinton: "Electric Wiring: a Primer for the Use of Wiremen and Students."—M. S.	629
Emerton: "The Common Spiders of the United States"	630
Stone and Fickett: "Trees in Prose and Poetry"	630
Bopp: "Chart of the Metric System"	630
Letters to the Editor:—	
Vortex Spirals.—Dr. J. Larmor, F.R.S.	630
Bipedal Locomotion in Lizards.—W. Saville-Kent	630
Theories of Heredity.—Hugh Richardson	630
The Fertilisation of Linum.—Prof. T. D. A. Cockerell	631
Retention of Leaves by Deciduous Trees.—Dr. D. T. Smith	631
The Scottish Antarctic Expedition	631
The Natural History of the Thames Valley. (<i>Illustrated</i> .) By R. L.	632
Mr. Balfour on Technical Education at Manchester	633
Notes	634
Our Astronomical Column:—	
Comet δ , 1902 (Perrine). (<i>Illustrated</i> .)	638
A Bright Meteor	638
Observations of Fifty-eight Long-Period Variables	638
A New Algol Variable	638
Notes on the Recent Eruptions of Mont Pelée. By Dr. H. A. Alford Nicholls, C.M.G.	638
Astronomy and Cosmical Physics at the British Association. By A. K. H.	639
Zoology at the British Association	640
Geography at the British Association. By A. J. H.	642
Engineering at the British Association. By T. H. B.	643
Science and Literature. By Prof. John Perry, F.R.S.	643
University and Educational Intelligence	647
Societies and Academies	648

THURSDAY, OCTOBER 30, 1902.

MODERN SCIENTIFIC GEOGRAPHY.

The Nearer East. By D. G. Hogarth, M.A. (The Regions of the World. Edited by H. J. Mackinder, M.A.) Pp. xvi+296. (London: Heinemann, 1902.)

IT has long been a reproach to the British nation that it, the greatest, if not the only real, colonising nation of the West, undoubtedly also the most travelled nation of the world, devotes less time and trouble to the study of geography than any other people. The manner in which geography is taught, or rather is not taught, in our great public schools is indeed more than a reproach to England, it is a disgrace. Great geographers we have had and have; our disgrace lies in the fact that geographical instruction is well-nigh omitted from the curriculum of the schools which our upper classes are accustomed to patronise, our reproach in the fact that the average English "classical" schoolmaster would probably prove ill-fitted to impart such instruction were he given the opportunity and the means of doing so. What average "educated" Briton could answer a series of simple questions on the geography, commerce and politics of the Persian Gulf? Yet a German observer would probably consider it remarkable that the citizen who may have ere long to cast his vote this way or that as to whether Russia is to be peacefully allowed to extend her sway by Teheran to Bushire and Bandar Abbas, or is to be forcibly prevented from doing so by war, should know practically nothing of a matter which may have an outcome most vitally affecting his empire and himself!

Of late, however, we seem to be trying to improve ourselves a little in this matter of general geographical knowledge. The University of Oxford has created a Readership in Geography, and it could have found no better man to fill the post of Reader than Mr. Mackinder, whose energetic geographical propaganda is deserving of the highest praise. The series of handy and useful books entitled "The Regions of the World," of which he is editor, does indeed "supply a long-felt want," for it is calculated to supply, not only valuable books of reference to the merchant and the politician, and interesting manuals for *Selbstunterricht* to the don and the schoolmaster, but also readable and informing volumes which will reach the average patron of Mudie's Select Library, which is exactly what one wants.

The preparation of the volume which deals with the "Nearer East" has been confided by Mr. Mackinder to hands in all respects fitted to deal with it. Few know the lands of the Levant better than Mr. Hogarth, and though he may not have seen the Arabian waste or the wall of Elburz with his own eyes, yet no reader of his book can doubt his capacity to use the eyes of others to the best advantage, and it can certainly be said that the portions of his work which deal with Arabia and with Persia suffer in no way from the fact that he himself has not yet visited those countries. They emphatically give the lie to the pretension that no man may write a book about a country unless he has been there himself.

As to the limits of the "Nearer East" opinions may

differ. Mr. Hogarth rules out the whole north coast of Africa west of Egypt; yet Cyrenaica and Tripoli are of the Nearer East, and, though we may consent to omit Algeria because Algiers is a French city, surely Morocco is of the East Eastern. But Mr. Hogarth sets his frontier in the Libyan Desert, and, all things considered, we have no fault to find with him for having done so.

The boundary-line of his territory runs eastward from the northernmost limits of Albania across the "Balkan Peninsula" to the Black Sea coast of Eastern Rumelia; thence to the Caucasus and the Caspian, and then south-eastward across the desert which divides Khorasan from Kerman and Irak to the limit of Baluchistan on the Indian Ocean; thence round Arabia and up the Red Sea to a point on a line with Aswân; then along the historical southern boundary of Egypt proper to the Western Desert, and so northwards west of the Oases up to and across the Mediterranean and up the Adriatic to his starting point.

The author deals with the various lands comprised within this boundary in this order: first, "The Balkan Belts," then "The Asian Ascent," then "The Central Upland," then "The South-western Plains," lastly "Egypt." In the "First Part" of the volume these lands are thus generally described; then follow three chapters on their geological structure, their climates and their "Physical Circumstance." In the "Second Part" the human inhabitants of the Nearer East first appear upon the scene, in chapters dealing with their distribution and grouping, the products of their lands, their communications, and their life under the varying conditions which obtain in the various regions described. A chapter on "World Relation" finishes the book. Maps are frequent and, on the whole, good.

This is a modern scientific geography book, systematic in plan, clear and picturesque in description, and, above all, "giving to think."

Upon the excellence of the general plan of the work we need enlarge no further. So far as description is concerned, what could be better than the following impression of the great island which fences in the Hellenic world to the south with its mighty mountain barrier:—

"A serrated and shaggy wall, rising from a wind-tormented, inhospitable sea, and interrupted by three main depressions, of which two are low; little locked pans and long verdant valleys, hidden inland behind spurs; spontaneous vegetation wherever the north wind is shut away—such is the impression left by Crete" (p. 123)?

Or take this, of the Egyptian desert (p. 142):—

"The Egyptian wastes are of limestone formation from the sea to Silsileh. . . . Accordingly, except between Silsileh and Aswan, the traveller will expect to find in the desert all varieties of contour, hill and cliff, valley and gorge, beds of streams and of tributary rivulets; yet neither verdure nor water, but a skeleton of earth, such a landscape as may be imagined in the moon. . . . And here and there in the hollows and wadis will be even such tussocky vegetation as camels love, drawing its life from a hidden humidity. . . ."

Space forbids our giving the whole of the description which follows of the prospect which greets the desert traveller on his arrival on the brink of the Nile valley; we must therefore content ourselves with the following:—

"Small clumps of palms mark the villages, and now and again, but rarely, lengthen or widen out into larger plantations. What other trees there are, sycamores, tamarisks, or thorns, stand for the most part singly near the desert edge. The squat mud cabins, dominated often by the white 'Italianate' house of a *sheikh*, are raised a little on their own débris. The long line of a curving dyke, carrying beside a canal a cultivation road or a railway, cuts the horizon. The angles of white sails or a smoky funnel indicate the river; the chimney of a sugar factory is a landmark for miles. The rest is one flat stretch of varying hues, brown, green, red or yellow, according to the season, or is for two months a burnished sheet of inundation, now wider, now narrower, now defined by high cliffs, now melting into an easy gradient of desert, now more to east, than more to west of the central stream. . . . Serious change in the landscape occurs only far south and far north. Above Silsileh the green belt narrows to a thread. Golden ruin of the sandstone slides on the west almost to the margin of Nile, and low cliffs rise steeply to east with little interval of plain; and presently, with the intrusion of plutonic rocks, the scenery loses all amenity and the river flows with obstructed current between beetling crags which only recede to admit the naked waste within a few yards of the stream. Far northward again the deep lands grow ever more salt and sodden, till reedy marsh supervenes and passes insensibly into permanent inundation; and shallow and slimy meres with few intervals stretch all the length of the Delta base, washing their wavelets on the low sand hills and bars of stony beach, which scarcely keep out the discoloured sea."

Mr. Hogarth does not say much of the peculiar beauties of Egypt, beauties of distance and of light: the Arabian wall above Girga seen from the Libyan cultivation-border, nine or ten miles away, through and over a noonday haze; the bastions of Kasr es-Sayad or the three peaks of Gebel el-Geir at sunset, salients aglow with richest rose, recesses blue with deepest indigo; Luxor approached across the western sands towards evening, when even that abominable castellated villa-residence which flies the Dutch flag cannot spoil the marvellous effect; things not only not to be forgotten, but to be seen again, for no country excites in the minds of most such a *Schmucht* as Egypt. Greece does not; were it not for her historical associations she would be of no more interest to the average man than is Albania; she possesses naturally no such fascination as Egypt, beautiful as she is.

"The natural beauties of Greece," says Mr. Hogarth (p. 122), "are those of distance, beauties of outline on a large scale, beauties of white snows and grey rocks in juxtaposition to an ever present sea of deepest blue, beauties of opalescent lights cast by oblique rays shining through suspended dust raised by the daily winds."

Beauties of detail there are few; all is so patchy and scrubby. Yet what can be more delightful than the view as one descends to Marathon from above Araphén, looking over the broad Gulf of Petali to where Ocha raises its mighty snow-clad mass into the sky? Of the views of Greece from Lykabetos or from the splendid Frankish castle which crowns the Lárissa of Argos we need not speak; the first at least, or its smaller edition from the terrace of Niké Apteros, is almost too well known, especially at sunset; but the second enables one to realise very well the small geographical extent of continental Hellas, for from the keep of the Lárissa the

eye can range from Parnon to Parnassus, roughly then from Sparta to Delphi.

Greece plays impudence to Egypt's dignity. Monotonous this dignity may be, yet this very monotony only serves to make it the more impressive. Such beauty as Greece has Egypt does not possess, beauty of sea and snow-mountain; yet nothing in Greece can so subdue the beholder to its fascination as can those interminable bastioned hills with the sand-billows washing half-way up their sides, those curving, branching wadis behind them where on the sand the once water-worn boulders lie blackened by ages of exposure to an un pitying sun, or that monotonous fen which with its palm-clumps, its strings of laden donkeys or camels winding their dusty way along the raised *gisys* or causeways, its innumerable *sakiyas* each with its boy (in charge of the motive power, a pair of oxen or buffaloes), chanting his monotonous song in duet with the groaning of his machine as he is carried round and round, stretches away to where in the hazy distance a shimmering line of cliff marks the opposite limit of Egypt. Greece always interests and often charms; Egypt *imponirt*.

We have said that Mr. Hogarth's book gives the reader much to think about. Naturally this is very much the case when he touches on political matters. His touch is light, as befits a book of this kind; his intention is simply to draw the reader's attention to matters with regard to which it is necessary that he should form some opinion for himself. The Persian Gulf, for one example, the future of Arabia for another. Is the Power which holds Aden and Cairo and dominates Muscat and Kowét eventually to hold sway at Er-Riadh and Hayil either as she now rules at Ajmír or as she controls Bikanír or Baluchistan? This is a question which will have to be faced in the future.

Mr. Hogarth's appreciations of the peoples who inhabit the region which he describes are interesting; his note on the modern Greek character (p. 241) is worth quoting:—

"Unprejudiced appreciations of the character of South Balkan peoples are very rare. The Greek character, especially, is seldom treated justly by a northern observer, apt to remember the ancient Hellene too much or too little. The Oriental element does not give endurance and dignity to Latin decadence in Greece as in Spain, because it is not due to the intrusion of a strong Oriental race. To be fair, the Briton must overcome his strong aversion to ideas without works. . . . In published accounts of the Greeks one has usually to do with social, religious, or scholarly idealists with little knowledge of the realities. To their views a course of Byron's letters from Greece and Finlay's final volume supplies a salutary corrective."

Strictly speaking, we might cavil at Mr. Hogarth's attribution of modern Greek want of stedfastness and want of dignity to the intrusion of an Oriental race not so strong as that which has intruded into Spain. Dignity Spain has, but grit she has no more than Greece; surely also the Turk is, as an Oriental, really stronger than, if not so dignified as, the Arab.

An editorial note at the beginning of the book tells us that

"Owing to Mr. Hogarth's absence in Crete at the time when it was necessary that this book should go to press,

a few errors have unfortunately remained uncorrected. These he has noted on p. xvi."

One or two have still escaped the author's notice. Muscat is ordinarily spelt by him "Maskat," but once "Mascat" appears; and no regular rule is followed with regard to the hyphening of Arabic compound names; thus we have "Roba-el-Khali" (p. 73), but "Wadi er Rumma" (p. 71), which is spelt "Wadi-er-Rumma" in the index. So in other cases. The correct form, of course, is Roba el-Khali, Wadi er-Rumma; only one hyphen is necessary.

We are at one with Mr. Hogarth as to the undesirableness of too pedantically accurate a transcription of Oriental names, but it seems to us that "Hadramut" and "Riad" would be better replaced by Hadhramut and Riadh, which we can pronounce even if the Germans cannot. And though Mr. Hogarth defies the pedant with his "Bedawins," we are unable to back him up in his defiance; "Bedouins" or "Beduins" may be all very well, but not "Bedawins"; either "Beduins" or "Bedawin," one or the other.

In the maps there are one or two mistakes which need correction; for instance, in Fig. 36, "Yidda." In Fig. 16 the railway is made to cross the Nile immediately south of Siut, which is itself placed much too far south. In reality the railway crosses further south than in the map, at the Nag' Hamadi bend. South of Aswan, spelt here and in other maps "Assuan," the railway gets wrong again. There is no line between Shellal and Wadi Halfa, and there is a line along the Nile bank south of Wadi Halfa, which runs as far as the Third Cataract, to Kerma. In Fig. 49 the Athens-Kephisia-Lavriion line is not inserted at all, nor is the new Athenian "underground" from the Theseion *via* Monasteraki to the Omonoias. It is true that these are only sketch-maps, but if the railways are inserted in them at all, they should be inserted correctly. In the fine ethnographical map opposite p. 176, we do not quite like the unhesitating colouring of Egypt with the Semitic yellow; there should be some brown or other coloured stripes across it. Nor do we think that pure brown should begin with the Wadi Hammamat; Nuba is not spoken north of Daraw, south of the 25th parallel, so the line should run north-eastward from Daraw to Kusér. Should there not also be some Magyar, Szekler and Teutonic stripes and spots in the portion of Hungary and Siebenbürgen which comes into the upper left-hand corner of this map and is entirely coloured with Rumanian purple? It is true that the book does not deal with these parts at all, but if they are coloured in the map, the coloration should be correct.

For these cartographical slips Mr. Hogarth, of course, cannot be held entirely responsible. We point them out merely that they may be corrected in the second edition. They in no way detract from the value of the maps as a whole.

One thing we regret, the absence of photographs. A few pictures of salient features of the land—a Greek isle, a desert wadi, a Cilician gorge—would have added greatly to the interest of the book.

We welcome Mr. Hogarth's work, then, not only as a notable contribution to geographical literature, but as a book which will—as is the idea of the series—appeal to a

larger public than the members of scientific societies, and will probably not only cause its general readers to take an unwonted interest in geography, but will also direct their attention to threatening political questions for which sooner or later they will be called upon to help to devise a solution.

H. H.

CHEMISTRY AND LIFE.

Das Eisen als das thätige Prinzip der Enzyme und der lebendigen Substanz. Von N. Sacharoff. Pp. 83. (Jena: G. Fischer, 1902.) Price M. 2.50.

THIS philosophical treatise, originally written in Russian, is presented to us in a translation by Dr. Rechtsamer. Without going so far as to say it is of the first importance, it may be safely affirmed that it will be welcomed by physiologists as a contribution to the discussion of the more obscure chemical processes connected with the life of the protoplasm. The author at the outset reviews the different hypotheses that have been advanced as to the intimate constitution of living matter, and finds them all unsatisfactory. He holds that the behaviour of protoplasm cannot be attributed to either its organisation, or its chemical composition or structure, and suggests that all the vital processes must be regarded as arising from a decomposition or splitting of the living substance in consequence of the access of oxygen, followed by a series of recombinations. Hence he turns to a study of the nature of this auto-decomposition with a view to determining its cause.

Proceeding to the action of oxygen in the animal and vegetable cell, and seeking for something universally present therein which is capable of easy oxidation, and of yielding compounds which can be reduced again or further decomposed with comparative ease, he considers he has found it in minute traces of iron. He puts forward accordingly a hypothesis of his own, to the effect that the various vital phenomena of protoplasm are set up by the oxidation of a minute trace of iron contained in the living substance, with subsequent or concurrent hydrolysis.

This theory is examined at some considerable length in the subsequent chapters, attention being given first to enzyme action, which he takes as one of the most remarkable of the metabolic processes. His views on this point will not commend themselves to all physiologists, but he argues in favour of them with some skill. After reviewing the theories of enzyme action advanced by Liebig, Nägeli, Berzelius, Würtz and more recent writers, and quoting published experimental evidence of the action of several of these bodies, he suggests that the active principle of enzymes is a substance which is capable of auto-oxidation and auto-reduction, and that the working which they exhibit depends upon alternate oxidation and reduction of this active principle. An experiment of his own with papain may be quoted in illustration of his view. He prepared a solution containing 2 per cent. of papain and heated it to boiling. Taking another solution of the same enzyme, containing 10 per cent., he prepared three tubes. No. 1 contained two drops of this active extract and 10 c.c. of the boiled extract; No. 2 two drops of the active extract with 10 c.c. of water; No. 3 10 c.c. of the boiled extract alone. He added to each a

measured amount of gelatin, on which papain works. No. 1 digested the gelatin much more rapidly than No. 2, while No. 3 was inactive. As both Nos. 1 and 2 contained the same amount of active enzyme, he considers it certain that the boiled solution contained some constituent necessary for the action of the papain. The solvent action of papain on gelatin thus requires the presence of two substances, the enzyme itself, which is split up and destroyed by heating, and another substance which is contained in the heated enzyme.

He considers subsequently at some length the group of oxidases, possessing in such a great degree the power of taking up oxygen and communicating it to the bodies which they attack.

The conclusion is that there exists in all enzymes the substance already alluded to, and that this is an iron-containing nuclein. He gives the name *bionuclein* to this hypothetical body.

It would be too long a task to follow the author through all the developments of his theory. They may be gathered from the statement he makes in his third chapter, that since the chemistry of all vital phenomena must be fundamentally the same, the processes which are the foundation of enzyme action must be also the foundation of all vital phenomena, and all must alike depend upon the oxidation of bionuclein. In his later chapters he deals with the behaviour of the cell substance, the fusion of sexual cells, the phenomena of karyokinesis, the phenomena presented by muscle and nerve and by the central nervous system.

The treatise is one which is deserving of careful consideration, though it is doubtful how far many of the author's conclusions will be held deserving of support.

TWO ASPECTS OF THE THEORY OF PROBABILITY.

Probabilités et Moyennes géométriques. By Emmanuel Czuber. Translated into French by Herman Schuermans, with a preface by Charles Lagrange. Pp. xii + 244. (Paris: A. Hermann, 1902.) Price Fr. 8.50.

Philosophical Essay on Probabilities. By Pierre Simon Marquis de Laplace. Translated from the sixth French Edition by Frederick Wilson Truscott, Ph.D., and Frederick Lincoln Emory, M.E. Pp. iv + 196. (New York: John Wiley and Sons; London: Chapman and Hall, Ltd., 1902.)

WE have here two books dealing with widely different aspects and applications of the theory of probability.

Prof. Czuber's treatise is a collection of problems relating to probabilities in which the number of cases of success and failure, instead of being finite or at any rate discrete, is continuously infinite. The cases considered relate to points chosen arbitrarily on a line, in a plane or in space, to lines drawn arbitrarily in a plane or in space, to surfaces taken arbitrarily in space, and to mean values depending on such random constructions. Such problems have a great interest for the pure mathematician, and they lead to a number of apparent paradoxes depending chiefly on what is meant by "taken at random," and many of these have been the subject of much con-

trovery. No better preparation for the study of such paradoxes can be suggested than a comparison of the results of choosing a point so that all values of its Cartesian coordinates are equally probable with the corresponding results when all values of the polar coordinates are equally probable. The author has made an extended study of the problems proposed by various English writers in the *Educational Times*, of the writings of French mathematicians, and in particular of the important memoir of 1868 by Crofton. The result of this study has been the insertion of a number of historic notes and remarks, including a brief but full discussion of the famous "needle problem" of Buffon, *i.e.* the problem of calculating the probability that a needle dropped at random on a sheet of ruled paper should cross one of the ruled lines when the needle is too short ever to cross two lines. The author quotes Dr. Wolf's experimental tests, which gave a result falling well within the limits of probable error.

The second book is a translation of the famous philosophical essay by Laplace, which was originally based on a course of lectures given by him in 1795 at the *École Normale* when he was appointed professor of mathematics with Lagrange as a colleague. It is purely philosophical, and deals with general questions arising out of probabilities and hope, their applications to natural philosophy, to prediction of the decisions of juries and other assemblies, to problems of life insurance and to the dispersion of superstitions. In regard to the latter use, Laplace's words may well be quoted:—

"All these prejudices and the terrors which they inspire are connected with physiological causes which continue sometimes to operate strongly after reason has disabused us of them. But the repetition of acts contrary to these prejudices can always destroy them."

There are few illusions arising from a failure to appreciate the calculus of probabilities which have done so much harm in the world as that which has given rise to the confirmed gambler or speculator. The very definite mental impression produced by a valuable prize and the difficulty to form a tangible conception of the probability factor which reduces the expectation to one of loss have proved fruitful sources of revenue to organisers of lotteries. But there is another cause which prevents a study of the theory of probability from saving the gambler from ruin. If in a game of even chances red turns up twenty times in succession, it is still an even chance whether red or black turns up on the twenty-first time; but no amount of mathematical reasoning will enable the confirmed gambler to realise that a previous run of bad luck gives no grounds for the expectation of recovering his losses by a run of good luck in the future.

OUR BOOK SHELF.

Upland Game-Birds. By E. Sandys and T. S. Van Dyke. Pp. ix + 429; illustrated. (New York: the Macmillan Company; London: Macmillan and Co., Ltd., 1902.) Price 8s. 6d. net.

THIS is the first of a series of ten volumes on American game and fish, published under the title of the "American Sportsman's Library," which has come under our notice; and if its companions are anything near so good as the

one before us, the series ought to command a large sale among both sportsmen and naturalists. Indeed, the mere fact that all the volumes are to be issued under the editorial supervision of Mr. Whitney, the well-known editor of *Outing*, ought of itself to be a sufficient guarantee that they will be all such works should be. The greater part of the volume under consideration is by the first of the two authors whose names appear on the title-page, Mr. Van Dyke merely contributing a small section—considerably less than 100 pages—on the game-birds of the Pacific coast.

Throughout the work, the authors appear to have hit the happy mean between a strictly scientific treatise and a purely sporting manual, each species being carefully described in accurate and, at the same time, popular language, while the rest of the space devoted to each is a pleasantly blended mixture of sport and natural history, enlivened by a number of racy anecdotes. Mr. Sandys evidently loves his subject, and, being himself an enthusiastic sportsman with a strong bias towards natural history and a delightful style of writing, it is little wonder that he has succeeded in producing a most interesting book. The volume commences with the "bob-white," the so-called American quail, and embraces all the species and varieties which can be classed as game-birds up to, and inclusive of, such a magnificent bird as the wild turkey, which the author calls the king of wild birds. The scientific nomenclature is thoroughly up-to-date—perhaps, indeed, almost too much so, as Mr. Sandys follows those authorities who consider it necessary to separate the American woodcock generically from its European relative. A notable instance of the extreme degree of refinement to which modern American zoology is carried occurs in the case of the plumed partridge, which is stated to differ from the typical *Oreortyx pictus* chiefly by its predilection for a mountain habitat.

As an example of Mr. Sandys's powers of accurate observation and induction, we may refer to his account, p. 223, of the resemblance of the ptarmigan in winter dress to its surroundings. After mentioning that every projection above clean snow is apt to cast a more or less decided shadow and thus cause a darker spot, he observes that the black tail of the crouching ptarmigan so closely imitates this effect that the intelligent observer cannot fail to detect Nature's purpose in the one peculiar mark. In such a brief notice as our space allows, we cannot quote further, and can only say that the authors and the artists have combined to produce a most attractive and interesting little volume. R. L.

Wild Fruits of the Country Side. Figured and described by F. Edward Hulme, F.L.S., F.S.A. Pp. viii + 259; with thirty-six coloured plates by the author. (London: Hutchinson and Co., 1902.) Price 12s. 6d. net.

THIS work forms one of the "Woburn Series of Natural History," published under the auspices of the Duke of Bedford, and intended, as His Grace's preface shows, to supply to those who, from various circumstances, cannot devote themselves to the scientific study of natural history, some knowledge of the processes and products of Nature in a form at once easily assimilated and scientifically accurate.

The author himself amplifies this statement of his editor, and declares "Our purpose to be a very simple one, to deal with the principal typical forms that one may reasonably expect to meet with during a country sojourn, and to deal with them in the simplest way—caring but little to send our readers to the dictionary in a wild quest for six-syllabled words of weird appearance, but caring much if the result of the perusal of our pages be to so far interest them as to send them to seek for themselves in the great Book of Nature."

The class of people for whom this book is intended is

further defined as including those who need to be told that "a privet berry and an acorn are distinguishable one from the other, that a beech nut and a blackberry are not so identical in form and colour but that practice and observation will enable us to tell which is which."

A much less pretentious book would surely have answered the purpose as well as this handsome volume. The nature of the text may be inferred from what has been said—it contains much pleasant gossip, but little information, and no pains have been taken to correlate or classify what there is.

The illustrations are pretty and well executed, but scrappy and wanting in detail; for instance, a fragment of the common yew and a similar morsel of the dogwood (*Cornus*) are placed together on the same plate without any particular reason and with no details. We can only suppose this has been done for the benefit of those who cannot distinguish a beech nut from a blackberry. The table of contents of the three chapters into which the book is divided is very full, but very unsystematic. The index is copious, but displays the same absence of method; for instance, the first entry runs thus, "Abnormal Chestnut Cluster, 128," but there is no corresponding reference under Chestnut or under Cluster, both more important words for the user of the index than that chosen to direct his research. In fine, we can but regret the expenditure of so much time, labour and money which might with so much greater profit have been bestowed on a work of a different character.

A word of praise is due to the printer and publisher, for paper, typography and illustrations (so far as they go) are all good.

Einführung in die Theorie der Doppelbrechung. By Heinrich Greinacher. Pp. 64; numerous figures. (Leipzig: Von Veit and Co., 1902.) Price M. 1.20.

THIS is a simple account of some of the leading phenomena of double refraction considered by the help of geometric methods. These are of the simplest type, no attempt being made to give rigorous proofs where any difficulty would be encountered. The booklet can, therefore, only be recommended to those who are unable to grasp the theory as usually given, but desire some explanation of the phenomena which they have met with experimentally. They are presumably acquainted with such phenomena, as no diagrams of the effects described are provided; these might be added with great advantage. The description is lucid, but meagre. If the attack were concentrated on the ellipsoid of elasticity and the wave surface instead of spread out over four surfaces, greater success would be achieved. A. W. P.

Physical Geography. By Margery A. Reid, B.Sc. With maps and illustrations by Bertha Reid. Pp. iv + 148. (London: Allman and Son, Ltd.) Price 2s. 6d.

THOUGH this little book contains so few pages, it is divided into twenty-four chapters, in each of which new subjects are introduced. The reader is thus hurried from one subject to another without explanation enough to make the work intelligible. Rivers and glaciers are described in a little more than two pages. Rain receives scarcely any attention and the rain-gauge is not described at all. When the author seriously attempts an explanation she is successful, but the limited space has prevented her from doing justice to herself or her subject. Especially in the descriptions of experiments is the guidance insufficient. For instance, we read on p. 35, "Submerge a shoot of watercress in water. Bubbles of gas collect on it; if some of these be tested as they ascend through the water, they are found to be oxygen." How to catch one of these bubbles and test it under water would puzzle older students than those for whom the book is intended.

LETTERS TO THE EDITOR.

[The Editor does not hold himself responsible for opinions expressed by his correspondents. Neither can he undertake to return, or to correspond with the writers of, rejected manuscripts intended for this or any other part of NATURE. No notice is taken of anonymous communications.]

The Hydrography of the Faeroe-Shetland Channel.

IN that portion of the programme of international investigation of the North Sea (as finally drawn up by the conference at Copenhagen last July) which provides for a coordinated series of hydrographic cruises at intervals of three months, it falls to Scotland to investigate the Faeroe-Shetland Channel and adjacent waters. It was important that the work should be begun as soon as possible, and especially so in order that the sea-temperatures, &c., should not go unrecorded in this abnormal season; but it would have been impossible to begin at so short notice had not Dr. Hjort, the director of the Norwegian investigation, helped by the loan of apparatus and by permitting his hydrographic assistant, Mr. Helland-Hansen, to come over and inaugurate the work. The Admiralty gave the use of H.M.S. *Jackal*; Lieutenant and Commander Sharpe and Mr. Helland-Hansen were conjointly responsible for the observations, and the report will be drawn up by Mr. Helland-Hansen, who has sent me the preliminary account which follows. The *Jackal's* course lay from the Moray Firth to Lerwick, thence in a north-easterly direction nearly to the Norwegian coast, then west to the Faeroes, thence to Fair Isle and out into the North Sea again; and it was so planned as to give, over each of the more important areas, double and approximately parallel lines of observations. Between August 25 and September 1, hydrographic observations were taken at twenty-six stations, and in addition surface-temperatures were taken every hour. A small number of plankton samples was collected also, but not to the extent that will be done on future cruises.

D'ARCY W. THOMPSON.

The Cruise of H.M.S. "Jackal," August, 1902.

The following short account is only a preliminary one and is given with some reservation, as the time has not yet permitted to draw the final results. In some weeks, however, we shall know the results of the investigations of the Norwegian fishery steamer *Michael Sars* from the neighbouring seas during the same period, and then we shall be able to work out the material from the *Jackal* very completely.

The best result from the *Jackal* expedition is, perhaps, that for the time in question we shall be able partially to solve the problem, equally important to hydrographers and biologists, of the quantity of Atlantic water entering the North Sea and the Norwegian Sea. Many years ago, and by different investigators, it was demonstrated that a large quantity of Atlantic water moved to the north between the Faeroes and Shetland (the Gulf Stream), and also that Atlantic water to the north and north-east of Scotland flowed in a south-westerly direction into the North Sea. Now we have undoubtedly found some unknown details of great importance.

(1) The Gulf Stream is in the Faeroe-Shetland Channel divided from beneath by a deep wedge of cold and less salt water coming from the north. The influence of this cold water is traced even to the surface. Thus we have really two parallel branches of the Gulf Stream from the Faeroe-Shetland Channel to the north. This fact may be shown by the following table. Station xii. (61° 2' N., 1° 10' W.) is situated near Shetland, and station xvi. (61° 47' N., 6° 4' W.) near the Faeroes. The temperatures and salinities at, for instance, 300 metres depths—stations xiii. (61° 12' N., 2° 5' W.), xiv. (61° 25', 3° 24' W.) and xv. (61° 35' N., 4° 39' W.)—are very typical.

Stations.

Depth in metres.	xii.		xiii.		xiv.		xv.		xvi.	
	Tem. °C.	Salin. ‰	Tem. °C.	Salin. ‰	Tem. °C.	Salin. ‰	Tem. °C.	Salin. ‰	Tem. °C.	Salin. ‰
0	11.3	35.33	11.2	35.31	9.5	34.96	8.9	34.98	9.2	35.19
40	10.8	35.32	10.7	35.31	10.0	35.07	8.4	35.11	8.7	35.17
100	9.4	35.32	9.4	35.31	6.4	35.14	8.2	35.20	8.5	35.19
200	Bottom		8.9	35.32	6.3	35.10	7.7	35.20	Bottom	
300			8.5	35.32	3.6	34.97	6.9	35.14		
400							6.4	35.09		
500			6.6	35.17	7.2	34.95				

As the cold water from the north and the warm water from the south have very different influences upon organic life, the discovery of such a division of the Gulf Stream will probably be of importance in understanding the distribution of the organisms.

(2) In August comparatively little Atlantic water enters the North Sea in the surface between Scotland and Shetland. The influx of Atlantic water chiefly takes place close to the coast of Scotland, at a distance of about twenty to forty nautical miles away from the coast. [Further away, at about eighty miles' distance, the surface-water seems to move in a northerly direction. This cannot be certainly decided, however, until a minute examination of the hydrodynamic conditions has taken place.]

(3) Another branch of Gulf Stream-water enters the North Sea between Shetland and Norway.

(4) In the north-western part of the North Sea we find at the bottom (below thirty to forty fathoms from the surface) a layer of remarkably cold and salt water; it is much saltier than the surface-water. It is too salt to be Arctic water and too cold to be summer water from the Atlantic Ocean. I think it probable that this bottom layer consists of Atlantic water that has been at the surface in winter time. Our hydrographical observations, then, seem to indicate that the influx of Atlantic water into the North Sea in winter time takes place to a much greater extent than in summer time. To find the laws of the variations of this influx, however, we must have autumn and winter observations.

The regions where the *Jackal* collected her material this year were previously incompletely explored. I have only now had an opportunity to compare our observations with those found in Mr. H. N. Dickson's excellent paper on "The Circulation of the Surface-Waters of the North Atlantic Ocean" (published 1901). Unfortunately, Mr. Dickson's observations are limited to the surface. It seems as if the influx of the cold water from the north and the east Icelandic Polar current this year were much stronger than in, e.g., 1896. In the western part of the channel, the surface-temperatures this year were about 1°-1½° C. lower than in 1896, and the Gulf Stream seems to have been narrower. This may probably be connected with the unusually cold weather of this year.

B. HELLAND-HANSEN.

Matriculation Requirements in Scottish Universities.

IN reference to a remark made in my address published in NATURE last week, Prof. A. Gray tells me that matriculation in the Scottish universities is no longer the simple matter it was in my time. Before entering on his qualifying course of study, every candidate for a degree in arts or science must now pass a preliminary examination.

JOHN FERRY.

Royal College of Science, London, October 27.

The Neglect of Anthropology in British Universities.

THE recent publication in NATURE (August 28, p. 430) of an abstract of Prof. Haddon's presidential address to the Anthropological Institute, affords an opportunity of bringing before the scientific public, by way of contrast, a concise statement of what is being at present done in Britain to forward anthropological science.

Of all the universities in Britain, two only attempt systematic teaching in this subject, viz. Oxford and Cambridge, while in a third, viz. Aberdeen, there has existed since 1899 a society having for its object the promotion of anatomical and anthropological research. In Oxford there is a poorly paid professorship of anthropology, but in Cambridge even this scanty recognition is not vouchsafed to the subject, for in that University there are two lectureships of but 50% a year each, established in 1899 and 1900 respectively for five years. One of these lectureships is devoted to physical anthropology and is attached to the School of Human Anatomy. The other, held by Prof. Haddon himself, is for ethnology, and covers the wide field of all relating to the industries, customs and beliefs of primitive peoples, but in many cases approaching extinction, and the loss by disinterestedness of their primitive customs and unwritten records. It cannot be expected that any real advance in these branches of science can be made in Britain while, they are so plentifully starved, and while the men holding mere precarious appointments are not deemed worthy of their hire.

Now that the war is over, cannot some appeal be made to remedy this state of things? Is it too much to hope that a chair for ethnology might be endowed by private benefaction for the new teaching University of London, or at least that subscriptions might be secured sufficient to place the existing lectureships in Cambridge on a sounder and more satisfactory basis?

ANTHROPOTAMIST.

Phosphorus versus Lime in Plant Ash.

THAT in the mineral constituents of leaves a strong proportion of lime is an obstacle to the presence of a considerable quantity of potash has been recognised as a feature of calcifugous species of plants. It has been sought, indeed, to explain, apparently on this ground alone, the existence of special plants which shun lime soils, or at least to account for the difference between their habitat and that of calcicolous species. A certain proportion of lime in the soil, say about 12 per cent. carbonate, is sufficient for the needs of a certain number of calcicolous species and banishes the calcifugous species from it. If, however, we carefully examine the ash constituents of the leaves of herbs growing and seeding in a soil (such as here in this valley) with only about 1 per cent. lime (CaO) in its finer particles, we recognise a large ratio both of potash and of lime, as the annexed table will attest.

Leaves of	Date.	Per-centage of Ash.	Constituents of the Ash.		
			Soluble Salts.	CaO.	P ₂ O ₅ .
Hawkweed	July 15	12·6	24·7	28·4	4·3
Figwort	" 24	8·9	31·7	24·7	8·35
Bracken (stem)	" 24	—	63·8	41	3·04
Cranesbill (lamina) ...	" 27	7·5	38·3	24·9	9·5
Hazel	" 29	6·3	18	30·4	7·7
Rowan	" 31	6	38·5	23	5·6
Dock	Aug. 1	11·7	43·4	20	6·3
Water Flag	" 5	8·7	42·2	29·7	6
Sycamore	" 5	10·5	33·6	25	4·7
Great Knapweed	" 12	10	37·1	29·4	3·6
Ragwort	" 19	12·2	44·5	23·6	5·15
Foxglove	" 21	9·1	40·7	23·3	5
Heather (whole plant)...	Sept. 19	2·2	25	16·3	7·3
Sycamore fruit	" 24	5·5	37	25·7	8

These figures are taken from my own analyses, the percentages being calculated on the crude ash minus charcoal. The sphere of experimental observation is, perhaps, too narrow or restricted, but a suspicion is awakened by the results that the need for phosphorus is a direct or indirect agent operative in the case. That is to say, a strong proportion of lime in the ash seems rather an auxiliary or accompaniment than an obstacle to a strong proportion of potash (as computed by the soluble salts). On the other hand, we see a rough approximation to an inverse ratio between the lime and the phosphorus, *i.e.* roughly 28 or 29 per cent. of lime with 3 or 4 P₂O₅, and 23 or 24 lime with 8 or 9 P₂O₅; and where this does not prevail, the whole percentage of ash is below the average (as in water flag and the woody plants). That a poor yield of certain plants on calcareous soils appears to be due to the effect of the lime in preventing the assimilation of phosphorus is a result of the experiments of MM. Dehérain and Demoussy. Moreover, it is known that the ash of seeds, which is invariably very rich in phosphorus, contains also a comparatively very small proportion of lime. It would seem, therefore, to be legitimate to conclude that a certain proportion of lime in the soil (say 3 or 4 per cent.) is inimical to the life of certain plants which require a definite amount of phosphoric acid for the healthy performance of their physiological functions. The fact that some plants will grow, but not flourish or propagate, in certain localities or habitats is a pretty certain indication that a sufficient amount of phosphorus is not available to the seed for purposes of germination and development. The analyses would seem to indicate that a too liberal supply of lime is the preventative agent in the case.

P. Q. KEEGAN.

Patterdale, Westmorland.

NO. 1722, VOL. 66]

ALUMINIUM AND ITS ALLOYS.

THE electrolytic process for the extraction of aluminium, which was patented in 1887 by Héroult in Europe and by Hall in America, has resulted in such a great diminution in the cost of production that the price of the metal has fallen from about twenty shillings to one shilling a pound. It is not surprising that, in the early days of the electrolytic industry, this circumstance, combined with the many very valuable properties of aluminium, caused extravagant hopes for its future to be raised.

The experience that has been gained in the past five or ten years has enabled us to form a truer estimate of the value of the metal, though it would be difficult to say even now to how great an industrial importance it may ultimately develop. A very good idea of the present position and prospects of the industry may be obtained from two papers recently published in the *Journal* of the Institution of Electrical Engineers.¹ The first of these, by Prof. E. Wilson, gives the results of an elaborate series of tests of the physical properties of a number of aluminium alloys; we shall have occasion to refer to this paper later. The second paper is by Mr. W. Murray Morrison, and contains a description of the British Aluminium Company's works at Foyers and an account of the applications of the metal, its use as an electrical conductor being considered at some length. We are enabled by the courtesy of the British Aluminium Company to give an illustration showing the turbo-generators in the power-house at Foyers.

The Hall and Héroult processes for the electrolytic extraction of aluminium are practically identical and are too well known to need lengthy description. The aluminium is obtained as the result of the electrolysis of alumina dissolved in melted cryolite (6NaF·Al₂F₆). The electrolysis is carried out in a carbon-lined crucible, at the bottom of which the separated metal collects, the liberated oxygen combining with the carbon of the anode and passing off ultimately as carbon dioxide. It is interesting to note that, whereas the specific gravity of solid aluminium is less than that of solid cryolite, in the fused condition this order is reversed; but for this the process in its present form would be unworkable. Some figures showing the cost of production by the Héroult process are given by Mr. Blount in his "Practical Electrochemistry," as follows:—

Cost of power ...	2·2 pence per lb. of aluminium.
Cost of alumina ...	4·0 " " "
Cost of electrodes ...	2·0 " " "
Cost of labour, &c. ...	2·0 " " "
Total cost ...	10·2 " " "

It is probable that this estimate is somewhat high, but it is sufficient to show that the cost of power is a very important item, which explains the necessity for the use of water-power. The cost of power per lb. is higher than in any other electrolytic manufacture; it forms, it will be seen, about one-fifth of the total cost; in the manufacture of calcium carbide, another electrochemical industry requiring cheap power, the ratio of cost of power to total cost is about 1 to 7·5.

The product of the electrolytic furnace is very pure. According to Mr. Morrison, commercial aluminium is 99·5 to 99·6 per cent. pure, the impurities being iron (about 0·25 per cent.) and silicon (about 0·17 per cent.). A sample of pure commercial aluminium analysed by Prof. Wilson contained 0·31 per cent. Fe and 0·14 per cent. Si, which agrees pretty closely with Mr. Morrison's figures.

¹ "The Physical Properties of certain Aluminium Alloys, and some Notes on Aluminium Conductors," by Prof. E. Wilson. (*Journal* I.E.E., vol. xxxi, p. 321.) "Aluminium: Notes on its Production, Properties and Use," by W. Murray Morrison. (*Ibid.* p. 400.)

This standard of purity has only been gradually attained, and we may hope for further improvement. The purity is a matter of importance, as it affects the value of the metal as an electrical conductor in two ways, for impurities not only lower the conductivity, but also increase the liability to atmospheric corrosion. The evidence as to the power of aluminium to withstand atmospheric influences, especially in towns or places where the air is bad, is somewhat conflicting, but on the whole it seems that the metal is fairly satisfactory in this respect. The thin film of oxide which immediately forms on the surface of the metal in air acts as a protective coating. Mr. Morrison quotes an interesting illus-

per ton, of aluminium is found greatly to improve the finished casting; the aluminium, by combining with the occluded gases, reduces the blowholes and renders the metal being cast more fluid and ultimately more homogeneous. Though the actual quantity used in this way is but a small percentage of the metal to which it is added, the total consumption of aluminium for this purpose is very large. A second use for aluminium depending on the same principle has been devised by Dr. Goldschmidt for producing high temperatures, and has been applied to the welding of iron rails, pipes and so forth. A mixture of iron oxide and finely divided aluminium is used, and is ignited by means of a magnesium ribbon; a very high temperature is immediately reached by the oxidation of the aluminium at the expense of the oxygen of the iron oxide. This process, having been only lately introduced, has not yet become of much commercial importance, but is full of promise.

The extremely low specific gravity (2.6) of aluminium has naturally resulted in its use in cases in which weight is a drawback. Thus in naval and military equipments, in motor-car construction and like applications, the metal already finds considerable and increasing employment. For cooking utensils the use of aluminium is steadily increasing; the metal is eminently suited for this purpose, as, apart from its lightness, it is a good conductor of heat, is not liable to deteriorate in use and gives rise, if dissolved, to perfectly harmless compounds. Applications of this kind may seem small individually, but in the aggregate they constitute no mean field for the metal to capture.

The chief drawback to aluminium is its low tensile strength, which, for the cast metal, is only from five to eight tons per square inch; but for this weakness its utility would be enormously increased. A certain amount of improvement can be effected by alloying a small quantity, generally less than 10 per cent., of some other metal, such as nickel or copper, with the aluminium. The specific gravity of these alloys is only slightly higher than that of the metal itself, but the tensile strength may be made two or three times as great. Exceedingly valuable data relating to a number of these light alloys are contained in the paper by Prof. Wilson to which reference has been made above. It is impossible to enter at all fully into the results obtained by Prof. Wilson, as the paper is itself so condensed as to be little more than a summary, but a few of the more interesting conclusions may be briefly tabulated. In the accompanying table is shown approximately the effect of alloying different metals on the conductivity, specific gravity and strength of aluminium.

Aluminium is now finding considerable employment as a substitute for copper as an electrical conductor, especially in America, where it is used to a large extent in connection with the transmission of power over long distances. One of the most important of these installations is the transmission of 12,000 h.p. from the Snoqualmie Falls to Seattle and Tacoma, a distance of more than forty miles. In this scheme an alloy of aluminium with $1\frac{1}{2}$ per cent. of copper has been used, the lightness



FIG. 1.—The British Aluminium Company's Power-house at Foyers.

tration of the tenacity of this oxide film; if the metal is cast into a mould and allowed to overflow, the film of oxide adhering to the molten metal that has run over acts as a syphon tube, and will syphon out a considerable quantity of the aluminium.

The two most marked characteristics of aluminium, on which its principal applications depend, are its high affinity for oxygen and its low specific gravity. The former of these properties causes aluminium to play a part of considerable importance in the metallurgy of other metals. Thus in the casting of steel, iron, brass, &c., the addition of a small quantity, two to five pounds

Aluminium.	Principal Impurity.	Other impurities.	Specific Gravity.	Conductivity.	Limit of Elasticity: lb. per sq. in.	Breaking Load: lb. per sq. in.
99.5 per cent.	Commercial aluminium	Fe (0.31), Si (0.14)	2.715	61.5	19,376	28,200
98-97 "	Copper, 1.6-2.6 per cent.	Fe (0.4), Si (0.4)	2.75	51	33,000	41,000
98-97 "	Zinc, 1.2-2.4 "	Fe (0.4), Si (0.43), Cu (0.2)	2.74	56	20,500	28,000
98-96 "	Nickel, 1.2-2.2 "	Fe (0.6), Si (0.35), Cu (0.1)	2.745	52.5	22,000	36,000
98.3 "	Iron, 1.2 "	Si (0.4), Cu (0.1)	2.73	57.1	20,300	31,300
97 "	{ Copper, 1.1 Nickel, 1.3 }	Fe (0.43), Si (0.37)	2.75	49.7	36,600	45,900
Hard drawn copper	8.9	98	28,000	64,000

and strength of this alloy enabling spans of 150 feet to be made with safety. A great saving in the number of poles is thus effected, which is one of the principal advantages gained. Numerous other important transmission schemes might be quoted in which aluminium is used, or in which it has been decided to use it. As has been just pointed out, the use of aluminium effects a great saving in the number of poles required; it also involves dealing with a much smaller weight of conductor, and is, finally, cheaper than copper. In round numbers, for equal conductivity, the section of an aluminium cable is one and a half times that of a copper one, the weight is half and the tensile strength three-quarters. It is the decreased weight which, in spite of the smaller tensile strength, allows longer spans to be used, and this effect can be made more marked by the use of a suitable alloy possessing increased strength without much diminished conductivity or much higher specific gravity. Mr. Morrison gives an interesting table showing the variation, according to the price of copper, in the price per lb. that can be paid for aluminium for equal conductivity and equal cost. From this it appears that with copper at its present price of about tenpence per lb., twenty-one pence per lb. could be paid for aluminium, which is two or three pence above its market price, showing that aluminium conductors are cheaper.

It is to be noted that the above remarks apply only to bare conductors. Where insulated cables are needed for low-tension work the increased diameter of an aluminium conductor involves increased cost in insulating material; moreover, with lead-covered cables the increased weight of the lead would almost, if not quite, cancel the decrease in weight gained by substituting aluminium for copper. For high-tension cables it is possible that aluminium may in some cases be cheaper than copper. Thus in a paper by Mr. M. O'Gorman¹ it is shown that increasing the diameter of the conductor may produce such a diminution in the depth of insulation necessary as to lessen the total price; in such circumstances a tubular copper conductor, or an aluminium conductor, could be used with advantage. There seems, therefore, a possibility that aluminium may some day successfully invade the field of insulated cables, hitherto regarded as peculiarly the property of copper. M. S.

RECENT WORKS ON SYSTEMATIC BOTANY IN GERMANY.

IT was in the year 1887 that, following on the publisher's announcement, the first parts of "Die natürlichen Pflanzenfamilien" appeared under the joint editorship of Drs. Engler and Prantl. The announcement does not seem to have attracted much attention, as there was no mention of it in many botanical journals until several numbers following each other rapidly came under notice. Strange as it may seem, De Bary's name does not appear as one of the collaborators, nor did he have any share in

the work. His remarks, therefore, as set forth in *Die Botanische Zeitung* in October, 1887, besides providing a criticism of the general scheme, also enable one to form an idea of the attitude displayed towards the undertaking.

He says, "the object is to present by means of illustrations and descriptions a corporate picture of the plant world which shall be strictly scientific and at the same time generally intelligible. Under each family, and for each genus of that family, mention will be made of any points that call for description or that have a practical bearing."

That there was some uncertainty as to its successful completion may be gathered from what he says later, after congratulating editor and publisher:—

"If the book is only carried through as it has been started, then it will have no equal . . . since it gives information shortly and objectively, not in the abstruse and learned manner of Bentham and Hooker, nor yet in the form of the subjectively learned monograph touched up with popular varnish which characterises the otherwise life-like history of plants by Baillon." Undoubtedly the terse and vigorous descriptions, the careful choice of matter, and the wealth of illustration which elicited favourable comment for the earlier numbers have, on the whole, been consistently maintained. Now that the work is almost completed, and as one looks back on the enormous labour entailed, congratulations may again be offered to Dr. Engler, who has been the sole editor since Dr. Prantl died in 1893.

The responsibility of such a vast undertaking might well be sufficient, but in the year 1900 Dr. Engler announced the publication of a new work, "Das Pflanzenreich"—adopting the title suggested by De Bary—which will amplify the information given in "Die natürlichen Pflanzenfamilien." As Dr. Engler announces in his introduction, "Das Pflanzenreich" is not a revised edition of "Die natürlichen Pflanzenfamilien," for appendices to the latter will continue to appear from time to time, and whereas "Die Pflanzenfamilien" gives a complete account of the orders and genera, but only enumerates a few species, "Das Pflanzenreich" will furnish a full and comparative account of all authenticated species.

Eleven parts have already been issued—"Musaceae," by K. Schumann; "Typhaceae and Sparganiaceae," by P. Graebner; "Pandanaceae," by O. Warburg; "Monimiaceae," by J. Perkins and E. Gilg; "Rafflesiaceae and Hydnoraceae," by H. Graf zu Solms Laubach; "Symplocaraceae," by A. Brand; "Naïadaceae," by A. B. Rendle; "Aceraceae," by F. Pax; "Myrsinaceae," by C. Mez; "Tropealaceae," by Fr. Buchenau; and "Marantaceae," by K. Schumann.

As regards the general arrangement, the citation of important literature and the review of the main characters of the order are similar to the method adopted in "Die Pflanzenfamilien," and, together with a certain number of illustrations, will be more or less the same. But, apart from new facts which may be added, it will be observed that the orders are not necessarily taken up by the same authors in the two works. English botanists may be

¹ "Insulation on Cables," by Mervyn O'Gorman. (*Journal of the Institution of Electrical Engineers*, vol. xxv. p. 608.)

allowed to express their satisfaction with the inclusion of one of our ablest systematic workers.

The key and description for each species are given in Latin, in order that, as the author remarks, they may be available to the botanists of all nations. The parts will not be issued in any particular sequence, the only proviso being that no order will be forthcoming until at least twelve years have elapsed since it was treated either in "Die Pflanzenfamilien" or in De Candolle's "Suites au Prodromus." Each part dealing with one order will be complete in itself and will contain an index.

Apart from the memoirs incorporated in these two works, many of the studies in systematic botany, the results of which have been published in Germany within recent years, have been controlled more or less by Dr. Engler in his position as director of the Botanical Museum in Berlin. The "Flora of Africa," which has reached the twenty-third instalment, represents mainly the investigations of workers in the Berlin Museum. One of the assistants, Dr. L. Diels, has written an able memoir on the "Flora von Central-China." It is especially noticeable how distant and comparatively unknown are many of the countries in which the herbaria have been formed which are finding their way to the museums in Germany. The same spirit of unflagging energy which has made famous the names of many German collectors, whose object has been to acquire fame by sending home flowers previously unknown, may here be found, but the incentive is merely scientific enthusiasm.

NOTES.

THE Huxley Memorial Tablet represented in the accompanying illustration was unveiled at the Ealing Public Library on Thursday last by the Mayor of Ealing, Alderman H. C. Green. The inscription upon the tablet is, "The Right Honourable Thomas Henry Huxley. Born at Ealing, 4th May, 1825. Died at Eastbourne, 29th June, 1895." Try to learn something about



everything, and everything about something." The whole memorial was designed by Mr. Frank Bowcher, with the assistance of Prof. G. B. Howes, F.R.S. The background of the tablet is "Dove" marble; the frame, top row of lettering, wreaths and medallion are bronze; the rest of the inscription is in incised gilt letters. The movement to establish this memorial originated with Mr. B. B. Woodward, who brought it before the Ealing Natural Science Society, and a committee was formed with him as hon. secretary. Altogether about eighty subscriptions were received, mainly from Ealing residents, hence the tablet shows that the memory of Huxley is cherished at his birthplace. Among those present at Thursday's ceremony, in addition to the Mayor, were Prof. G. Henslow, Mrs. T. H.

Huxley, Mr. and Mrs. Leonard Huxley, Mr. L. Fletcher, F.R.S., Mr. B. B. Woodward, and Mr. F. E. Beddard, F.R.S. (representing the Zoological Society of London). Letters regretting inability to attend were read from Prof. Howes and Lord George Hamilton. Prof. Henslow gave a short address, in the course of which he related some personal reminiscences of Huxley; and the Mayor of Ealing afterwards unveiled the tablet. The accompanying photograph having been taken before the tablet was erected, an error of the masons, undetected at the time, but since corrected, gives the date of Huxley's death as the 25th instead of the 29th of June, 1895.

WE regret to see the announcement of the death of the Rev. Dr. Wiltshire, formerly professor of geology and mineralogy at King's College, London.

THE opening meeting of the Institution of Electrical Engineers is fixed for Thursday, November 13, when the premiums awarded for papers read or published during the session 1901-1902 will be presented, and the president, Mr. James Swinburne, will deliver his inaugural address.

AT the recent conference of Colonial Premiers, a resolution in favour of the metric system of weights and measures was adopted. Referring to this action, Mr. Chamberlain has informed a correspondent that he fully recognises the importance of the matter, and is in correspondence with the Colonial Governments and the Board of Trade on the subject.

IN reply to a question in the House of Commons on Thursday last, Mr. Austen Chamberlain said:—A new cable has been laid to Belgium, and telephonic communication between London and Brussels will be opened as soon as the necessary arrangements can be completed. The establishment of communication between London and Berlin is not at present feasible.

ENERGETIC measures are being adopted at Odessa to prevent the spread of plague from the cases which have occurred there.

The outbreak of the disease in May of this year is attributed to the presence of rats, which have carried the means of infection since the last case of plague was treated in Odessa in November, 1901. Systematic efforts are therefore being made to destroy the colonies of rats and carry out strict sanitary regulations.

THE chief members of the Scottish Antarctic Expedition about to start for the South Polar regions were entertained to dinner in Edinburgh on Thursday last by the president of the Royal Scottish Geographical Society, Sir John Murray. Replying to the toast proposing success to the expedition, Mr. W. S. Bruce, the leader, remarked that the work undertaken would be supplementary to that of the three expeditions already in the Antarctic, and would be largely oceanographical. The Scottish area of activity would be around that part of the Antarctic where Sir James Ross, sixty years ago, took one sounding, attaining a depth of 4000 fathoms without reaching bottom.

THE Home Secretary has appointed a committee to inquire into the use of electricity in mines and the dangers attending it, and to report what measures should be adopted in the interests of safety by the establishment of special rules or otherwise. The committee consists of Mr. H. H. S. Cunynghame, C.B. (chairman), Mr. Charles Fenwick, M.P., Mr. Archibald Hood, past president of the Mining Association of Great Britain, Mr. James Swinburne, president of the Institution of Electrical

Engineers, and Mr. W. N. Atkinson and Mr. A. H. Stokes, H.M. Inspectors of Mines." The secretary of the committee is Captain A. Desborough, H.M. Inspector of Explosives.

THE Berlin correspondent of the *Standard* announces that the International Conference on Wireless Telegraphy will be held in Berlin about the end of March or the beginning of April next. England, the United States, France, Austria-Hungary, Italy and Russia have all responded to the invitation from Germany, and have intimated that they will accept an invitation to a conference in Berlin on condition that the programme is fixed beforehand and sent with the invitation. It is hoped to draw up a programme shortly, if possible before the end of February.

THE Paris correspondent of the *Times* reports that investigations by the Lacroix expedition to Martinique have shown that the immense opening on the south-west side of the crest of Mont Pelée has grown to formidable dimensions, and the White River is choked near its source. The dangerous portion of the mountain is the south-west slope.

MR. A. W. CLAYDEN writes to direct attention to the close resemblance between recent sunset effects and those which followed the eruption of Krakatoa in 1883. At Exeter, on Friday last, he observed very high cirrus clouds which passed through the various shades of yellow and red to grey, and then changed to brown, golden yellow and vivid crimson. The double series was as pronounced as in any of the sunsets of 1883. On Sunday evening, faint cirro-stratus became visible just before sunset, exactly resembling those seen at sunrise and sunset in 1883. The afterglow on Tuesday was richer in tone than any Mr. Clayden remembers since the Krakatoa effects. It will be remembered that similar observations of remarkable sunsets since the West Indian eruptions of May last have been made elsewhere and recorded in these columns (see pp. 199, 221, 294, 390 and 540).

THE third annual Huxley memorial lecture was delivered at the Anthropological Institute on October 21 by Prof. D. J. Cunningham, F.R.S. The subject was "Right-handedness and Left-brainedness," and Prof. Cunningham referred to the general interest which it presents to all students of anthropology. So far as available evidence goes, it seems probable that right-handedness was a characteristic of man at a very early period in his evolution. It is an inherited quality in the same sense that the potential power of articulate speech in man, and of song in the bird, are inherited possessions. Investigation shows that right-handedness is due to a transmitted functional pre-eminence of the left brain, and this factor prevents an oscillation of the condition from one side to the other in those curious cases in which the right and left sides of the body are reversed and the thoracic and abdominal viscera transposed. The greater part, if not the whole, of the motor incitations which lead to articulate speech go out from the speech centre which resides in the left cerebral hemisphere. In left-handed people, the predominance of the right cerebral hemisphere is accentuated by the transference to it of the active speech centre. Left-handed people, therefore, speak from the right brain. Prof. Cunningham concluded by pointing out that before definite conclusions could be arrived at upon many aspects of the subject, it is necessary that detailed observations should be made of the development and growth-changes of the cerebral cortex of the ape and man.

THE International Conference on Tuberculosis was held in Berlin on October 22-26, about four hundred members being present at the opening ceremony. At the final meeting, the following officers were elected for the international union against tuberculosis:—President, Prof. Brouardel, Paris; vice-presi-

dents, Prof. Andword, Christiania; Sir William Broadbent, London; Dr. Dewez, Mons; Prof. Espina y Cayo, Madrid; Prof. von Leyden, Berlin; Prof. Linroth, Stockholm; Prof. Margliano, Genoa; Prof. Schirwinsky, Moscow; and Prof. von Schrötter, Vienna. The executive committee consists of Dr. Althoff (president); Prof. Fraenkel, Berlin; Dr. Calmette, Lille; Dr. Chyzer, Budapest; Dr. Noerdam, Copenhagen; and Dr. Raw, Liverpool; with Dr. Pannwitz, Berlin, as secretary.

FROM a note in the *Times* we learn that a resolution of the Government of India on the report of the Imperial Bacteriologist for the past official year describes the chief work of the department for the year as the testing and production of the rinderpest serum. The experiments were directed to improving its protective quality and perfecting the process of manufacture. The results obtained at Jacobabad, Madras and Rangoon showed that the initial protective value of sera is materially diminished by exposure to high temperatures. Experiments relating to anthrax are said to have been brought to a successful issue by the discovery of a protective serum, and researches have been prosecuted into other animal diseases. A scheme recently sanctioned for enlarging the laboratory will, it is hoped, lead to the production of 100,000 doses of the serum per annum, while the plan for training veterinary assistants at the laboratory in the inoculation of cattle against rinderpest has been successful. It has been decided to discontinue the issue of fungus tubes for exterminating locusts, the results not having been successful in any of the provinces; meanwhile, investigations and experiments on the subject will be conducted in the agricultural department as well as by the bacteriologist.

A LIST of the earthquakes and volcanic eruptions recorded from April 10 to September 23 of this year has been compiled by the *New York Times* and is reprinted in the *Scientific American* of October 11. Serious disturbances of the earth's crust have occurred on the following dates in various parts of the world:—April 10, 18; May 3, 7, 8, 12, 13, 15, 18, 20, 21, 24, 28, 30, 31; June 2, 4, 6, 8, 9, 14, 15, 19, 20, 21, 22, 24; July 1, 7, 8, 9, 10, 11, 12, 17, 27; August 13, 14, 15, 25, 27, 30; September 1, 6, 8, 9, 16, 17, 22, 23. Reports have since been received of disturbances on September 25, October 4, 6 and 16-25. With reference to the last of these records, when both Mont Pelée and the Soufrière of St. Vincent were in eruption, it is perhaps worth remark that a postcard posted at Greussen was received from Herr Nobbe on October 16 predicting that disturbances would occur on October 17 and 18, not only at Martinique and St. Vincent, but also in Europe and America.

THE Odessa correspondent of the *Standard* quotes from the *Turkestan Gazette* some further details with regard to the Kashgar earthquake of August 22. It appears that the earthquake was far more disastrous than was supposed from the first accounts. The populous settlement of Nijni-Artish, lying to the north-east of Kashgar, was practically razed, with the whole of its inhabitants, in number about 550. The total loss of life is estimated at a little above 3000. Undulations of the surface, like sea-waves, were observed in the Chatar-Kula Hills; and the wooded banks of the Scharikhanskaia at Sultan-Abada are riven into immense chasms.

IN a paper read before the Institution of Mining and Metallurgy on October 16, Messrs. T. H. Leggett and F. H. Hatch collate the facts on which estimates can be based of the gold.

production and life of the Main Reef Series, Witwatersrand, down to 6000 feet, and then deduce what, in the circumstances, they consider to be a fair estimate. They conclude that it must be assumed that the annual production will increase for a few years to a maximum, will be maintained for a second period, and that then there will be a third period of decline. For the three years preceding the war, the average increase of production was at the rate of 4,000,000% per annum, the production for 1899 having a value of about 19,000,000%. Allowing eighteen months from January 1, 1902, for the industry to be restored to the conditions existing in August, 1899, a similar increase of production will bring the output to at least 30,000,000% per annum by June 30, 1906, and if this rate of production were to be maintained from then on, the total production of 1,233,560,709% would give a life from January 1, 1902, of 42½ years. But as the production will decline gradually instead of coming to a sudden stop, this length of life will be increased, unless the annual output should for any considerable period exceed 30,000,000%, when the increase in length of life due to declining output would be neutralised.

MR. C. J. WOODWARD, Municipal Technical School, Birmingham, sends us a photograph, from which the accompanying



illustration has been reproduced, showing Indians in the art of producing fire by means of the fire drill. The photograph is a copy of one in the possession of Mr. Henri d'Este, and was taken in the Orinoco region of South America.

IN a recent number of the *Sitzungsberichte* of the Vienna Academy of Sciences, Dr. J. Hann contributes an important paper on the meteorology of the equator, based on observations taken by Dr. E. Goeldi, director of the museum at Pará. Very few stations exist near the equator, and especially equatorial South America; the observations now in question extend from August, 1895, to August, 1901, and, although they are still continued, Dr. Hann considers them to be of such exceptional value that he has preferred to submit them to an elaborate discussion rather than to wait for later materials. In this note we shall refer only to temperature and rainfall. The results show that the temperature is extremely uniform throughout the year; the annual variation amounts only to 1°·4 C., while the mean daily variation is 8°·8. The lowest temperature occurs in the beginning of the year, and the highest at the end of the year; from May to September the mean temperature is almost constant. The yearly mean is 25°·7 C. The rainfall is characterised by a

wet season, January to April, and a relatively dry period, from May to December, although rain is somewhat frequent during the dry season. The falls occur almost exclusively in the afternoon and evening, during thunderstorm weather. The mean annual rainfall is about 102 inches.

A SURVEY of the principal changes that have occurred in the birth and death rates in Italy during the last forty years has been given by Prof. Giuseppe Sorman in the *Lombardy Rendiconti*, xxxv. 16. The principal conclusions are as follows:—The birth rate fluctuated between the limits 39·34 per 1000 in 1876 and 33·49 in 1898, while the corresponding limits of the death rate were 34·39 in 1867 and 21·87 in 1899. The fluctuations are thus seen to be less marked in the birth rate than in the death rate, but both show a downward tendency, which occurs to a great extent concurrently with the introduction of improved sanitary conditions. Still, the birth rate has in every year exceeded the death rate, the excess varying from 2·40 in 1867 to 12·80 in 1897. During the period 1862–1899, the population increased by 10,000,000. In connection with the decreased death rate, the author estimates an annual saving of eight lives per thousand in the period 1897–99 as compared with the period 1862–75. Taking account of the influence of the diminished birth rate, and assuming that the reduction of the death rate is due to progress in checking the spread of infectious diseases, it is considered that at least 200,000 people have been effectively saved from death, and that the number of those saved from illness must be at least twenty times as great.

IN "Notes on the Geology of the Eastern Desert of Egypt," by Mr. T. Barron and Dr. W. F. Hume (Dulau and Co., 1902), there are some interesting remarks on the later physical changes which the country has undergone. Attention is drawn to certain "igneous gravels" which in reality are gravels containing in places fragments of granite, gneiss and other stones derived from the Red Sea hills. They are probably Pleistocene and of earlier date than the Nile, as its bed has been cut through them and its alluvium overlies them, so that this river could not have begun to flow until late Pleistocene times. A study of the raised beaches and coral reefs affords evidence of important movements which ushered in the present conditions. During the Pliocene period, minor fault-valleys were formed, and likewise great rifts such as the Red Sea (with the invasion of the fauna of the southern seas), the Gulf of Suez and other features. Miocene strata afford evidence of the former extension southwards of the Mediterranean; Eocene strata have not been recognised; while the earlier Eocene strata, preserved here and there from destruction by faults, point to the Eocene sea having covered the entire area examined. These Eocene strata are Londonian in age, but they comprise two series, an upper, mainly composed of limestones with nummulites, and a lower, of shales and marls. The lower series rests unconformably on Upper Cretaceous limestones, which are characterised by abundant oysters and well-marked bone-beds. Certain gypseous deposits near the Red Sea have resulted from the chemical alteration of Cretaceous and Eocene limestones. The Nubian Sandstone, which underlies the Cretaceous limestones, is also regarded as of Cretaceous (Santonian) age, and it rests on smoothed surfaces of Plutonic, volcanic and metamorphic rocks, planed down by marine erosion.

WE have received a copy of a paper by Dr. J. Beard, from the *Zoologischer Jahrbuch*, entitled "The Determination of Sex in Animal Development."

THE *Revue générale des Sciences* of October 15 contains an admirably illustrated account of a discourse on "extinct monsters" recently delivered by M. Marcellin Boule in the

Paris Museum. Among the illustrations, especial interest attaches to a reproduction of a photograph of the skeleton of *Mastodon angustidens* lately acquired by the museum, showing the remarkable downward flexure of the upper tusks and the great length of the symphysis of the lower jaw in which the lower pair are implanted. It seems certain that this species could not have been provided with a long trunk.

AMONG a batch of articles from the *Proceedings* of the U. S. Museum, attention may be directed to one by Major E. A. Mearns on the ocelot cats, of which five distinguishable forms (regarded as species) are recognised. In a second fasciculus (No. 1292), Mr. W. P. Hay describes the crustaceans inhabiting "Nickajack" Cave, Tennessee. In other parts (Nos. 1293 and 1296), Messrs. Jordan, Snyder and Fowler continue their description of Japanese fishes, treating in the former fasciculus of the blennies, and in the latter of the gorgeously coloured chaetodonts and their allies.

WHEN discussing the extent to which the posterior vertebral segments of the body have been suppressed and transmuted during the evolution of man and the higher apes, Dr. A. Keith (*Journal of Anatomy and Physiology*, vol. xxx. p. 18) calls attention to the fact that naturalists are wrong in describing the larger apes as quadrupedal. They are so only when on the ground, which is not their proper habitat. When at home among the trees they carry the body upright, and may thus be called *orthograde*, in contradistinction to the lower Primates, which are *pronograde*.

THE third part of the first volume of Mr. J. S. Gardiner's "Fauna and Geography of the Maldive and Laccadive Archipelagoes" contains articles by five contributors, in addition to a continuation of the editor's general description of these islands and the coral-reefs of the Indian Ocean generally. In the first article, Prof. F. J. Bell discusses certain groups of echinoderms; in the second, Mr. M. Burr describes the orthopterous insects; while the third, by Mr. L. A. Borradaile, treats of certain crabs. The fishes of the Maldives fall to the lot of Mr. C. T. Regan, and for the identification of the turbellarian worms Mr. F. F. Laidlaw is responsible. A full notice of the work is reserved until its completion.

To the October number of the *Zoologist* Mr. Graham Renshaw contributes an interesting series of notes on various zoological gardens. A plate, from photographs, illustrates the remarkable difference between the summer and winter coats of the addax antelope. Attention is called to the fact that the attitude generally given to the South American maned wolf in museums and figures is incorrect, the creature carrying its head very low.

IN Gegenbaur's *Morphologisches Jahrbuch*, vol. xxx. part iii., Herr L. Tobler points out that the so-called axillary bands (Achselbogen) of the human subject are vestiges of the panniculus carnosus (skin-muscle) of the lower mammals.

THREE reprints from the *Yearbook* of the Department of Agriculture, and *Bulletin* No. 32 from the Bureau of Forestry in the same Department, all dealing with forestry questions, have been received. The work, mainly of supervision or providing expert advice, which is carried on by the Department is here emphasised on three distinct lines. Two of the pamphlets give working plans for forests, the one in Arkansas drawn up by Mr. F. E. Olmsted for a lumber company, and the other arranging for economic lumbering of land belonging to the University of Tennessee, on a system suggested by Mr. J. Foley. In Arkansas, 85 per cent. of the company's holding consists of pine lands, where about 50 per cent. of the trees are pines, of the varieties short-leaf and loblolly (*Pinus echinata*,

Pinus taeda), but both furnishing timber known as yellow pine. The remaining 50 per cent. are hard woods, commercially less valuable, and it is recommended to increase the pines by leaving trees to furnish seed and to decrease the number of hard-wood trees. The cutting limit recommended for pines is 14 inches on the stump, and for hard-wood 20 inches. Mr. W. L. Hall deals with the "Timber Resources of Nebraska," and points out that not only is the amount of planted timber satisfactory, but that the natural timber is increasing both in area and density. The gain in area represents the encroachment of the forest on the prairie, particularly along the creeks and in the ravines, and may in places amount to as much as 100 acres during a period of fifty years. Pine again forms the staple product, except near water, where oak, elm and walnut thrive. "Grazing in Forest Reserves" is the title of the report by Mr. F. Roth, and this furnishes an account of the existing arrangements under which farmers may graze sheep, cattle or horses on the Government forest reserves. The success of this regulated grazing seems to be due to the simple though fairly stringent rules drawn up, combined with the level-headedness of the average American. All the reports call attention to the great damage wrought by fires, and grazers are compelled by their agreement to aid in extinguishing fires, though Mr. Roth combats the prevalent idea that many fires are to be laid to the charge of the shepherds, because fires are quite as frequent where grazing is not allowed.

AMONG the lectures to be delivered at the Royal Victoria Hall, Waterloo Road, S.E., during the next few weeks, the following:—November 4, Mr. Herbert Rix on "To Palestine and Back"; November 18, Mr. Rudler on "Volcanoes."

MESSRS. SANDERS AND CROWHURST, Shaftesbury Avenue, have sent us five lantern slides reproduced from the remarkable photographs of young cuckoos in nests, mentioned in *NATURE* of October 9 (p. 574). These and other lantern slides of birds and plants photographed direct from nature provide a pleasant means of creating interest in natural history.

THE first two of the three volumes of "The Elements of Physics," by Profs. Edward L. Nichols and William S. Franklin, have been revised and published as a second edition by the Macmillan Company of New York (London: Messrs. Macmillan and Co., Ltd.). The first volume deals with "Mechanics and Heat" and the second with "Electricity and Magnetism."

THE Zoological Society has just issued a new (fifth) edition of the catalogue of the Society's library in Hanover Square, prepared by Mr. F. II. Waterhouse, the librarian. The volume contains the titles of about 11,000 different works, exclusive of periodicals. The whole library contains about 25,500 different volumes. The Zoological Society is also issuing an index-volume to the *Proceedings* of their scientific meetings for the last decennial period 1891-1900, in correspondence with similar indexes for former decennial periods.

THE additions to the Zoological Society's Gardens during the past week include a Vervet Monkey (*Cercopithecus lalandii*) from South Africa, presented by Mr. J. D. Tannahill; a ——— Monkey (*Cercopithecus*, sp. inc.) from West Africa, presented by Mr. A. J. Lytleton Turner; a Spotted Ichneumon (*Herpestes auro-punctatus*) from Nepal, presented by Mrs. F. Cameron; a Collie's Squirrel (*Sciurus collii*) from Mexico, a Rufed Lemur (*Lemur varius*, var. *ruber*), a Fringed Gecko (*Uroplatus fimbriatus*) from Madagascar, a Gould's Monitor (*Varanus gouldi*), three Limbless Lizards (*Pygopus lepidopus*) from Australia, deposited; a Golden Eagle (*Aquila chrysaetos*) from Scotland, presented by Mr. J. Baxendale.

OUR ASTRONOMICAL COLUMN.

ASTRONOMICAL OCCURRENCES IN NOVEMBER:—

- Nov. 2. 13h. 6m. Minimum of Algol (β Persei).
 4. 1h. 0m. Mercury at greatest western elongation ($18^{\circ} 50'$).
 5. 9h. 55m. Minimum of Algol (β Persei).
 6. 5h. 0m. Saturn in conjunction with the moon. Saturn $5^{\circ} 33' S$.
 9. Predicted perihelion passage of Swift's comet (1895 II.).
 14-15. Epoch of Leonid meteoric shower.
 15. Venus. Illuminated portion of disc = 0.998, of Mars = 0.914.
 20. 12h. 6m. to 13h. 7m. Moon occults δ Cancri (mag. 5.7).
 20. 15h. 42m. to 19h. 51m. Moon occults κ Cancri (mag. 5.0).
 23. Epoch of Andromedid meteoric shower.
 23. Perihelion passage of Perrine's comet (1902 b).
 23. 14h. 14m. to 15h. 0m. Moon occults ν Leonis (mag. 4.5).
 24. 2h. 21m. to 6h. 4m. Transit of Jupiter's Sat. III. (Ganymede).
 25. 11h. 37m. Minimum of Algol (β Persei).
 28. 8h. 26m. Minimum of Algol (β Persei).
 28. 14h. 0m. Venus in superior conjunction with the sun.
 29. 7h. 43m. to 12h. 37m. Transit of Jupiter's Sat. IV. (Callisto).

THE LEONID SHOWER.—Two articles in *Popular Astronomy*, No. 98, by Prof. Pickering and Mr. R. B. Taber respectively, deal with the reports of different observers of the Leonids during the shower of 1901, which, although not seen in this country, appears to have been a brilliant one as seen by the observers in the United States on the morning of November 15. Prof. Pickering records the following six observations:—

Station.	Latitude.	Longitude.	No. of meteors per hour.
Trinidad, W.I. ...	10	63	290
Steamer <i>Admiral Dewey</i> ...	26	73	420+
Tuape, Sonora, Mex. ...	30	110	countless
Tucson, Arizona ...	32	111	225
Claremont, California ...	34	118	800
Mount Lowe Observatory ...	34	118	300

The position of the radiant point seems unchanged. The Harvard report giving it as R.A. = 10h. 6m., Dec. = $22^{\circ} 16'$. Mr. Upton, of Providence, estimated it to be R.A. = 10h. 2m. S., Dec. = $21^{\circ} 19'$, whilst M. Eginitis, director of the Athens Observatory, suggests "a sensible displacement in right ascension." Mr. Upton thinks that "the radiant is probably a point, rather than a spot $2''$ or more in diameter."

OBSERVATIONS OF ζ GEMINORUM.—During the period March 10 to May 23 of this year, forty-two observations of the variable star ζ Geminorum were made, by Argelander's method, at the Princeton University Observatory by Mr. F. P. McDermott, the junior.

The observations indicate that there is a secondary maximum about 3.0d. before the principal maximum, and that the object attains a brightness of 3.8m.; a secondary minimum, when the object has a magnitude of about 3.93, is also indicated 1.6d. before the principal maximum.

THE FIFTH SATELLITE OF JUPITER.—Writing to *Popular Astronomy* (No. 98) on September 9, Prof. Barnard recalls the fact that it is exactly ten years since Jupiter's fifth satellite was discovered.

From the spring of 1899 until the spring of this year, Prof. Barnard was unable to see this object, but several good elongations have been observed this year; the satellite can, however, only be seen under very good observing conditions and with large instruments.

SEARCH FOR AN INTRA-MERCURIAL PLANET DURING THE TOTAL SOLAR ECLIPSE OF 1901.—In *Bulletin* No. 24 of the Lick Observatory, Prof. Perrine describes the photographic search for the intra-Mercurial planet which, according to Leverrier and others, might be the disturbing influence that

causes the considerable motion observed in the line of apsides of the orbit of Mercury.

Reduction of the negatives obtained during the 1901 eclipse has led to a negative result. There is just a possibility that at the time of the eclipse the hypothetical planet may have been in a direct line with the bright corona, and so have escaped notice; but, as the corona only covered 1/200th of the area photographed, this is not very probable.

A planetary body 34 miles in diameter would have appeared as having a magnitude of 7 $\frac{1}{2}$ in the existing circumstances, and, as it would need seven hundred thousand such bodies, each having the same density as Mercury, to produce the observed movement in the orbit of the latter, it seems highly improbable that these changes are due to the interference of an intra-Mercurial planet. Prof. Perrine suggests that perhaps the finely divided matter which produces the zodiacal light may, when considered in the aggregate, be sufficient to cause the perturbations in the orbit of Mercury.

CHEMISTRY AT THE BRITISH ASSOCIATION.

IN a paper on experiments to ascertain the amount of carbonic anhydride absorbed from sea water, Prof. E. A. Letts and Mr. W. Caldwell stated that they are experimentally testing the validity of Schloesing's theory that the ocean serves as the regulator of atmospheric carbonic anhydride, with the aid of a specially devised piece of apparatus. Prof. E. A. Letts also read a paper on the corrosion of copper by sea water and on the detection of traces of impurity in the commercial metal, in which it was suggested that rapid corrosion of copper by sea water may be due to electrolytic action between particles of a copper-arsenic alloy embedded in the copper plates and the copper itself. Prof. F. Clowes, in a paper on the action of distilled water upon lead, showed that dissolved oxygen first acts upon the lead, and the oxidation product is subsequently converted into a hydroxycarbonate by carbonic acid. Dr. C. E. Fawsitt gave a paper on the decomposition of urea, showing that on heating urea in aqueous acid or alkaline solution at 99°, the decomposition does not proceed in accordance with a bi- or tri-molecular reaction as would be expected theoretically, but in accordance with the formula of a monomolecular reaction. The apparent anomaly is explained by the formation of ammonium cyanate as an intermediate product; on heating with water, urea first undergoes isomeric transformation into ammonium cyanate, and this then decomposes into ammonia and carbonic anhydride. In a paper on the telluric distribution of the elements in relation to their atomic weights, Mr. W. Ackroyd explains the purchasing power of a given sum as an indication of the abundance or rarity of the different elements; he shows that in each of the natural groups the rarity of the element increases with the atomic weight. In a paper on the proposed standardisation of methods of chemical analysis, Mr. B. Blount protested against the growing tendency to apply the principle of standardisation to analytical methods for the determination of chemical entities, such, for instance, as the constituents of steel; at the same time, he agreed that arbitrary methods, such as those applied to the examination of waters, oils, milks, &c., should be standardised. Prof. T. Purdie, F.R.S., and Dr. J. C. Irvine, in a paper on the alkylation of sugars, described a method for alkylating hydroxyl groups in methylglucosides. On boiling methylglucoside in methyl alcohol with methyl iodide and dry silver oxide, the trimethyl ether of methylglucoside,

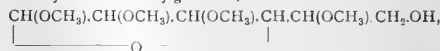

is produced; on further heating with methyl iodide and silver oxide, it is converted into a tetramethyl ether. Under similar treatment, acetone-rhamnoside yields a dimethyl ether. In dealing with the synthetic action of enzymes, Dr. E. F. Armstrong showed that the enzyme lactase is capable of converting glucose into a disaccharide, to which the name isolactose was given. The same author gave a paper on recent synthetic researches in the glucoside group; the pentacetylglucosides are converted into aceto-halogen-glucosides by anhydrous hydrogen chloride or bromide, the acetyl group attached to the aldehyde group being replaced by halogen. These substances are converted into alkylglucosides by treatment with alcohols. A report of the committee appointed to collect

statistics concerning the training of chemists employed in English chemical industries, of which Prof. G. G. Henderson is secretary, was read; information concerning their course of training had been received from 502 managers and chemists employed in English chemical industries, 111 of whom are fellows or associates of the Institute of Chemistry. The following figures give more detailed information:—

Number of graduates of a British University	59
Number of graduates of both a British and a foreign University	16
Number of graduates of a foreign University.....	32 ¹
	107
Number of non-graduates trained in a British University or University College	137 ²
Number of non-graduates trained in a British Technical College	165
Number of non-graduates trained in a foreign University or Technical College	8
Number of non-graduates trained in Evening Classes, analysts' laboratories, works' laboratories, or otherwise	85
	395

The committee on isomorphous sulphonic derivatives of benzene, of which Prof. H. E. Armstrong, F.R.S., is secretary, reported that Dr. Jee has completed the crystalllogical study of the 1:3-dichloro-, chlorobromo- and dibromo-benzene 5-sulphonic chlorides and bromides, and finds that this group of compounds constitutes an isotetramorphous group. In discussing the colour of iodine-containing compounds, Miss Ida Smedley called attention to the fact that two classes of such compounds are known, namely, colourless and coloured. In a paper on colloids of zirconium compared with those of other metals of the fourth group, Dr. J. H. Gladstone, F.R.S., and Mr. W. Hibbert stated that zirconium gives a colloid of well-marked properties resembling those of silicon, tin, titanium and thorium; Dr. J. H. Gladstone also gave a paper on fluorescent and phosphorescent diamonds. The following papers were also read:—Note on a fourth methylmorphimethine, by Mr. J. Hawthorne; on the absorption of ammonia from water by algae, by Prof. E. A. Letts and Mr. J. S. Tottont; on determinations of atmospheric carbonic anhydride made on board the *Discovery* on the voyage to the Cape and thence to New Zealand, by Prof. E. A. Letts; a new method of causing isomerisation, by Prof. R. Meldola; acid-esters of methylsuccinic acids, by Prof. J. J. Sudborough and Mr. W. A. Bone; compounds of trinitrobenzenes and alkylated naphthylamines, by Mr. H. Hibbert and Prof. J. J. Sudborough; action of alkalis on cinnamic acid dibromide and its esters, by Prof. J. J. Sudborough and Mr. K. J. Thomson. An interesting feature of the proceedings of Section B was the reading and discussion of two important monographs, one on our present knowledge of diazo-compounds, by Dr. G. T. Morgan, and the other on hydro-aromatic compounds with single nucleus, by Dr. A. W. Crossley.

ANTHROPOLOGY AT THE BRITISH ASSOCIATION.

THE papers read before the Section covered, as will be seen, a considerable portion of the field that is usually embraced by anthropology.

Archæology.—Mr. W. J. Knowles exhibited some Irish flints mostly with a dark brown patina and "the fashion of chipping the flint perpendicularly through the thickness," some of which came from "interglacial gravels." Two questions were asked: (1) What useful object could the perpendicular chipping serve to man? (2) If not artificial, what force in nature can dress so many objects alike with chipping that has all the appearance of being artificial in character? Miss Nina F. Layard described and exhibited a number of variously shaped Palæolithic implements from a small pit in the plateau gravels of Ipswich, and Messrs. W. and W. A. Cunnington

¹ Thirteen of whom studied also in a British University or Technical College.

² Twenty of whom studied also in a foreign University or Technical College.

gave an account of the recent discovery of Palæolithic implements from Knowle, Wiltshire; these implements and the ordinary flints of the gravel pit are remarkable for the very high polish that many exhibit, and some are marked with peculiar striae. There are two views to account for the polishing, (1) a deposit of silica, which was favoured by the authors, and (2) sand action, which was emphatically advocated by Prof. Boyd Dawkins; as a matter of fact, the sand of this quarry is exceptionally fine and entirely siliceous. Mr. S. B. Dixon also exhibited some of these polished implements. No satisfactory explanation was given of the striae. Mr. W. J. Knowles described some important stone-axe factories that he had discovered near Cusendall, co. Antrim; axes in all stages of manufacture and innumerable chips were found where boulders of a certain rock occurred in the drift. The conditions were somewhat similar to those Mr. W. H. Holmes has described in the United States. Mr. Knowles also exhibited leaf-shaped stone blades from co. Antrim, which were probably a stage in the manufacture of spear- and arrow-heads, like the stone blades from America.

A remarkable series of underground, tunnel-like dwellings (souterrains) in Ulster was shown in lantern slides by Mr. W. J. Fennell, and similar remains from various parts of the British Isles were copiously illustrated by Mr. D. MacRitchie. Mr. G. Clinch also described the subterranean dwellings recently discovered at Waddon, near Croydon.

The report on the excavations at Arbor Low Stone Circle in Derbyshire was read by Mr. H. Balfour. The evidence as to its age was not decisive, but it pointed to the monument having been erected at the close of the Neolithic period, or at the beginning of the Bronze age. A Belfast antiquary endeavoured to prove that the Irish elk survived into the Bronze age, but the bones exhibited belonged to oxen, not to deer.

A note from Mr. R. A. S. Macalister, on a prehistoric cemetery-cave in Palestine recorded the first discovery yet made of the pre-Israelite inhabitants of Palestine who burnt their dead; above these were found unburnt remains of the earliest Semitic stock. The recent Cretan excavations at Knossos by Mr. A. Evans and those at Palæokastro by Mr. R. C. Bosanquet were illustrated by lantern slides; at the latter site there is an exceptional opportunity for a craniological study of Mycenaean and recent Cretans.

The Hon. John Abercromby read a very important paper on the oldest Bronze age earthenware vessel, which is usually called a "drinking-cup" and for which he proposed the term of "beaker." By the aid of numerous photographs, he demonstrated that it came into Britain from the Rhine and in all probability had its origin in Central Europe. Bronze objects of the Hallstatt culture phase have been recognised in Ireland, but it was not until Mr. G. Coffey drew the attention of the Section to the fact that the abundance of them was realised. This he did in a very convincing manner, drawing his examples mainly from the wonderful collection of the Royal Irish Academy in Dublin. Iron was probably known before the close of the Hallstatt period in Ireland. Mr. Coffey also exhibited lantern slides of some remarkably fine carved Irish monuments belonging to the La Tène, or so-called Late Celtic, period. These stone monuments, which are ornamented with the "trumpet" design, are unique. Reports were read on excavations in the Roman fort at Gellygær, near Cardiff, and in the Roman city of Silchester. The survival of certain Pagan sepulchral symbols on early Christian monuments in Ireland was abundantly illustrated by lantern slides by Mr. P. J. O'Reilly. The significance of these symbols is, however, unknown. A note was presented by Mr. F. P. Mennell on the Khami ruins twelve miles from Balawayo, Rhodesia. It is satisfactory to find that these monuments are being investigated and the specimens preserved in the Rhodesia Museum.

Anthropology, or Physical Anthropology.—A new departure was made at this meeting in the formation of a subsection to discuss matters relating to this branch, and a demonstration was made by Prof. Symington in the anatomical museum of the College. Mr. J. F. Tocher read his report on the pigmentation survey of Scottish school children. Preparations are now being made for an exhaustive inquiry into the distribution of the hair and eye colour of Scottish children analogous to that made by Virchow for German children. Mr. Tocher also presented a note on some measurements of Eskimo. Mr. J. Gray gave measurements of the Indian Coronation contingent, and drew therefrom some interesting conclusions. Dr. C. S.

Myers presented his report on the very numerous anthropometric investigations he has made among the native troops of the Egyptian army, and at the same time described a method of radial craniometry. The skeleton of Cornelius Magrath, the Irish giant, was exhibited, and the subject of gigantism was lucidly explained, by Prof. J. D. Cunningham; Prof. A. F. Dixon also exhibited a skull modified by acromegaly. Prof. J. Symington exhibited some ancient Irish crania collected by the late John Grattan, of Belfast, and described the methods of cranial investigation adopted by that gentleman; the president also alluded in eulogistic terms to the acumen of Mr. Grattan, who, though he was engaged in business and had not received a scientific training, yet was in his time in advance of every European craniologist so far as methods were concerned.

Psychology.—Miss A. Amy Bulley read a paper on the psychology of primitive man; while primitive man had no absolute mental deficiency, he "sensed" objects singly and without anything more than a hazy perception of their relation to one another. The results of this deficiency were:—(1) Inability to generalise; (2) no distinction recognised between essential and non-essential characteristics; (3) imperfect understanding of cause and effect. These imperfections were employed as tests for certain religious ideas that have been attributed to primitive man, such as one supreme God, phallic worship, the ghost theory and the theory of the *continuum* in religion. Dr. W. Graham's paper on the mental and moral characteristics of the people of Ulster led to a very lively debate which was fortunately free from excess, although the author referred to the increase of insanity due to religious excitement in the north of Ireland. The main valid criticism was the pointing out that the author fell into the common mistake of calling the non-Teutonic element in Ireland "Celtic," thereby entirely ignoring the vastly preponderating Mediterranean strain.

Ethnography.—There were several papers, illustrated with lantern slides, which described certain peoples who had been studied by the lecturers. Dr. W. H. Furness gave an entertaining and instructive discourse on the Nagas, whom he visited with the special purpose of investigating whether they had a connection with any of the interior tribes of Borneo; he came to the conclusion that there was no positive proof for this view. The Lolos and other tribes of western China were dealt with by Mr. A. Henry. A comparison of the Lolo and Miao-tze speech with the Chinese suggests that the tonal monosyllabic languages form a distinct primitive group and are not the result of linguistic degradation; the peculiar script of the Lolos may be due to early Nestorian missionaries; the surnames of the Lolos always signify the name of a tree or animal, which may not be touched. Messrs. Nelson Annandale and H. C. Robinson described the wild and civilised tribes of Malay Peninsula. No distinction could be drawn between the Malays and Siamese of the district between Singora and Jambu; there is evidence of an admixture of aboriginal blood; the savage tribes are the Semangs, Sakais and Orang Laut Kappir of Trang. The report on the ethnological survey of Canada was presented. The Canadian Committee itself has not yet got beyond the "resolution" stage; the long report of more than ninety pages is solely the work of the secretary, Mr. C. Hill-Tout, who has investigated, mainly linguistically, the Lower Fraser Indians of British Columbia. The Royal Society of Canada has at last undertaken to prosecute with vigour the important and pressing objects of this committee.

Comparative Religion.—The human souls and ghosts of the Malays of Patani were described by Mr. N. Annandale, as well as the ghosts of inspired magicians, the giving in marriage of the son of such a ghost, and the marriage procession (a cyclone); the evolution was traced of a local god from such a ghost. Two papers by the Rev. J. H. Holmes were read by the president. The first described the sacred initiation ceremonies undergone by the lads of the Papuan Gulf. The boy is isolated in the "eravo," or club house, until his hair has grown to its full length. His body must not be exposed to the sun, and he is subject to several taboos. The bull-roarer is shown and explained, and masks play a great part in the more important ceremonies. The second paper dealt with the religious ideas of the Elema tribe of the Papuan Gulf. From certain customs and taboos, it is evident the natives were totemic people, but they appear to have partially passed beyond this phase. There are four classes of ghosts—those who have died a natural death, who have been killed in a fight, who have been murdered, and who have been killed by a crocodile. Every family of living things, from man downwards, has its special god or guardian

spirit, for whom there is a feeling of respect; for example, the barana has two gods. The Toaripi or Elema recognise a good and an evil supreme god and a number of subsidiary ones. Mr. F. T. Elworthy exhibited a number of perforated stone amulets from Lincolnshire, Dorset, Somerset, co. Antrim, and southern Italy which are used as prophylactic agents against witchcraft in houses, cattle byres, or in gardens. An important paper on the Lia Fail of Tara and election of kings by augury was communicated by Mr. E. S. Hartland. The famous Lia Fail, or Stone of Destiny, often, but erroneously, identified with the Coronation Stone, was a stone on which were enchantments, for it used to roar under the person who had the best right to obtain the sovereignty of Ireland at the time the men of Ireland were in assembly at Tara to choose a king over them. It was thus an oracle, and the choice of king was made by the augury which it gave. Kingship was something more than human; it was thus necessary to ascertain the will of the gods. Other examples from diverse times and places were given as proofs of the widespread character of these customs.

Survivals.—Mr. E. Lovett discoursed in an interesting manner on tallies; these are records kept by cutting notches in sticks of wood, and are a survival of probably the earliest appliance of a commercial nature made by man. There are two varieties: (1) the contract tally, formed by a stick split through the notches, and (2) the simple or memorandum tally, a single notched slip of wood. The simple or folk tally has survived the complex form as elaborated in the banker's and exchequer tallies. Numerous modern examples were exhibited. Mr. Hartland exhibited two wooden "swords" formerly worn as professional emblems by medical practitioners in Japan; one represented a bean pod, and the other was a rough piece of wood.

Museums.—On the last morning, a very interesting discussion on the classification and arrangement of exhibits in anthropological museums was started by the reading, by the recorder, of a very suggestive paper by Dr. W. H. Holmes, of the U.S. National Museum. The chief methods of arrangement are the ethnographical on a geographical basis, and the evolutionary and distributionary. It was generally agreed that no hard and fast rule could be laid down, but that it was desirable that every museum should develop along its own lines, subject to a controlling idea along one of these chief directions. It was held essential that museums should be liberally labelled, and rendered at the same time instructive and interesting; more attention should be paid to these points, as the success of a museum depends upon the interest that it awakens.

Classification.—The business of the Section terminated with a discussion of the classification of the subject-matter of anthropology; this was opened by Mr. E. N. Fallaize with a suggested scheme which was offered for future consideration.

A popular feature of the Section was the interesting museum mainly of local archaeology and ethnographic survivals which, thanks to the courtesy of Prof. Symington, were exhibited in the dissecting room and anatomical museum. Mr. R. Welch exhibited numerous photographs and other objects, notably a series of remarkable primitive vehicles from co. Antrim, which illustrated several stages in the evolution of the Irish jaunting car. Many of the papers read at the meeting will be published in full by the Anthropological Institute either in their *Journal* or in *Man*.

PHYSIOLOGY AT THE BRITISH ASSOCIATION.

PROF. HALLIBURTON, president of the Section, read a paper on the regeneration of nerves, contributed by Dr. Moit and himself. Two opinions existed in regard to the regeneration of nerve-fibres. One set of observers concluded that the new nerve-fibres sprout out from the central stump of the divided nerve-trunk. This was the opinion of by far the larger number of workers. The other opinion was that the new nerve-fibres were of peripheral origin. Those who held the latter view relied almost entirely upon histological evidence. But a strand of cells that looked like a nerve-fibre to the microscope might nevertheless be not physiologically a nerve-fibre, inasmuch as it might be quite unable to be excited as a true nerve-fibre is or to conduct nerve impulses as a nerve-fibre can. These functional performances were the true criteria for nerve-fibres. Among recent

observers, Howell and Huber, who had used both histological and experimental methods, had arrived at the conclusion that the axis cylinder, the essential portion of a nerve-fibre, had an exclusively central origin; they admitted that the peripheral tissues in which it was embedded were active in preparing and generating a nutritive scaffolding for it. With Dr. Mott he had come to experimental results which, so far as they at present went, confirmed those by Howell and Huber. One experiment they had performed was to divide a large nerve and suture the ends together. After a sufficient length of time had passed, restoration of function occurred, and this was taken as a sign that regeneration had successfully ensued. Then they exposed the nerve-trunk anew. The union of the two ends was then found to have been accomplished, and on testing the nerve it was found to be excitable by faradisation when the stimulus was applied either below or above the point of reunion of the divided trunk. A piece of the nerve-trunk was then excised some little distance below the point of reunion; on microscopical examination of this, new nerve-fibres were discovered within it. Subsequent to this second operation, the wound was closed up and the animal was finally sacrificed ten days later. When the animal was finally then examined, the nerve both above and below the second section was once more tested for response to electric stimulation. The peripheral piece was then found to have become once more inexcitable. Degeneration had also set in within the fibres of the peripheral piece of the nerve-trunk. Prof. Halliburton urged that this showed that the degenerative process which followed the direction of growth had occurred in a peripheral direction only and had not started at the periphery. Observations were also mentioned indicating that normal functional activity exercised an important influence on the speed and perfection of the process of nerve repair. Paralysis was induced in the arm of the monkey by section of a number of the cervico-brachial afferent spinal roots. By this device, the motor cells of the cord in that region, namely, the cells whence originate the motor nerve-fibres of the limb, are cut off from the influence of all impulses coming to them reflexly from the sensory nerves of the limb itself. A large nerve-trunk in the arm is then divided and the corresponding nerve-trunk of the opposite non-paralysed limb is likewise cut, the latter as a control experiment. Union of the ends of the divided nerves occurred on both sides, but on the side on which the afferent roots had been cut the union was much slower and less perfect, as shown both by histological and by electrical examination of the nerve.

Prof. Schäfer communicated the results of a series of experiments executed with the object of analysing further the mechanism connecting the muscular apparatus with the centres for willed movement having their seat within the brain. He compared the relative effects of transection of the pyramidal tracts and of the ventral columns of the spinal cord. The observations had been made on monkeys. Section of the ventral columns of the spinal cord produced paralysis of voluntary movement in the parts of the body lying behind the segmental level of the lesion. The descending fibres of the ventral columns of the cord were in the main derived from the cells of the nucleus of Deiters in the bulb, a group of fibres that were, on the other hand, related to the impulses entering the brain from the labyrinth organ, namely, the semicircular canals and the otolith organ. It had been proved by Ewald and others that the destruction of the labyrinth organ entailed diminution and impairment of the "tonus" of the voluntary muscles of the body. Prof. Schäfer proposed to account for the paralysis ensuant upon transection of the ventral spinal columns by the removal of the bracing influence of Deiters' nucleus from the ventral horn cells of the spinal cord, the tonus of muscles being certainly primarily a tonus of the ventral horn cells of the cord. The paralysis produced by section of the ventral columns of the cord would on this explanation be comparable with that described by Sherrington and Mott in the monkey consequent on section of the afferent roots, which seems to take effect by producing loss of tonus in the motor nerve-cells.

A paper on some new features in the intimate structure of the human cerebral cortex was read by Dr. John Turner. His specimens showed (1) a beaded network enveloping the pyramidal cells of the cortex and their dendrites; (2) an intercellular plexus of nerve-fibrils not previously demonstrated to exist. The preparations demonstrating these points had been made by placing pieces of the brain tissue directly on removal

from the body, and without previous hardening or fixing, into a staining solution containing methylene blue and hydrogen peroxide. From this mixture, after a sufficient time had elapsed, the tissue was transferred to a solution of molybdate of ammonia. The tissue was then after this fixation dehydrated, embedded in paraffin and cut into sections. The beaded network is a network, not of neuroglial fibres, but of processes of true nerve-cells. This network loosely invests the pyramidal cells and their dendrites. The network is made up of the finer ramifications of stouter fibres which can be traced from certain pyriform dark cells in the cerebral cortex; these cells are generally small, and no signs of any network can be seen around them. There seem, in fact, in the cortex of the cerebrum to be at least two systems of nerve-cells present, the pyramidal variety, which are pale under the method of examination here employed, and the smaller darkly stained pyriform nerve-cells. These latter possess branches which ramify and form by a fusion a network enveloping the pyramidal cells. Since the network is a true network formed by actual anastomosis, the system of dark cells constitutes a *continuum*. Dr. Turner urged that in all probability collaterals arising from the axons of the pyramidal cells also joined on to the network. If that were so, all the nerve-cells of the cortex would be practically in organic continuity. He suggested that the differences observed in staining, shape, arrangement, &c., of the two varieties of cells indicated a difference in function. There was good ground for associating the pyramidal cells with motor functions; he was therefore inclined to ascribe to the dark pyriform cells sensory functions. They were in all likelihood, he urged, the bearers and distributors of afferent impulses. This method might therefore afford a means of showing where ingoing currents ended and where outgoing currents started. On this view, however, the impulses must flow in a centrifugal direction in the dendrites of the dark cells and in a centripetal direction in the axons of those cells; this was against the views generally in acceptance which regard the axon as always a cellulifugal conductor and the dendrites as always conducting in a direction toward the perikaryon.

Prof. Schäfer corroborated the description of the microscopical structures described and discovered by Dr. Turner. He suggested, however, that the course of conduction was not cellulifugal in the dendrites of the dark cells. He argued that it was more probable that the nervous pericellular network took up impulses brought by the afferent fibres coming to the cortex in such large numbers from the optic thalamus; that these impulses in part were carried through the pyramid cells and in part through the dendrites of the dark cells to the perikarya and axons of these latter.

Dr. Page May communicated a paper upon the movements and innervation of the stomach. His investigation had been an experimental one, and the animals employed had been cats, dogs and monkeys. A short time after taking food, movements of a rhythmic character arise in the muscle of the wall of the organ. These movements are waves of contraction, each of which commences near the œsophageal end of the stomach. The waves succeed each other at a rate of about three times per minute, and they slowly increase in strength as they pass toward the pylorics. The contractions have their origin in the wall of the organ itself, because they will continue for half an hour or more after removal of the viscus from the body and its preservation in a bath of warm saline solution. The small ganglia in the wall of the stomach probably coordinate the contractions. Although the gastric contractions are of autochthonous origin, they are subject to control of the central nervous system by means of the vagus nerve, especially of the left vagus nerve. On stimulating the peripheral end of the vagus nerve, the tone of the gastric muscle is usually at once much diminished. Any gastric contractions are usually then abolished. Shortly after this, on the contrary, renewed movements set in, often very vigorous in character, and usually about four times as powerful as the contractions during ordinary digestive activity. Thus the first effect of stimulation of the vagus is inhibition of the gastric tone, the second is increase of tone and augmentation of movement. Stimulation of the central end of the vagus produces a slight inhibitory effect upon the stomach if the other vagus nerve is intact. The splanchnic nerve was not found to exert any influence upon the musculature of the stomach, either in the direction of augmentation or of inhibition. Occasionally some inhibition of gastric movement is excited by the stimulation of the splanchnic, but this not usually; such occasional results are due probably to the vaso-constriction produced by the splanchnic

stimulation. Anæmia of the stomach experimentally produced by blocking the thoracic aorta cuts short the normal contractions of the organ. The cerebral centres for the gastric movements and tone, which have been described by many observers, notably by Bechterew and Opendowsky, were not found, although diligently searched for. No definite result upon the movements of the stomach seemed to result from any cerebral stimulation.

Prof. Schäfer contributed a communication on the diuretic action of pituitary extracts, based on recent researches by Dr. Magnus, of Heidelberg, and himself. He showed a series of tracings exhibiting by the graphic method the effect that intravenous injection of extract of pituitary body has upon the activity of the kidneys. The epithelial part of the pituitary body yields an extract which causes a marked increase in urinary secretion. This part of the gland had always previously been supposed inert. The diuretic action now proven to be exerted by the gland had, Prof. Schäfer urged, a direct bearing upon the disease called acromegaly, in which the pituitary body was enlarged and diuresis was present.

Prof. Gotch brought forward an experiment upon fatigue and nerve. It had long been held that repeated or excessive activity caused fatigue of nerve-endings, but had no effect upon the fibres which conduct the nervous impulses. Herzen had recently questioned the truth of the above generally adopted view. Herzen stated that after a nerve-trunk had been subjected to repeated stimuli, the subsequent response of the nerve shows signs of impairment when examined by electrical tests. This impairment it had been the object of the present observations to examine, and they showed that the impairment was a change which was confined in its situation to the neighbourhood of the place of the electrodes by which the electric currents used for fatiguing the nerve were applied to the nerve. Were the effect a true fatigue effect, its locus should not be confined to the electrode region, but should be distributed throughout the nerve, because the process of conduction of nerve-impulses occupying the whole length of the nerve, the true fatigue which arose as their after effect must have a similar distribution. The changes which were confined to the immediate neighbourhood of the electrodes by which the long series of "fatigue"-producing currents were introduced were those to which much attention has long been devoted as *electrotomæ*. Probably the process involved was one of electrolysis, and certainly its relation to fatigue in the true sense was at most extremely remote. For the experiments the capillary electrometer had been employed; the electric differences studied had been given by the nervous impulse in response to a single induction current.

Dr. Edridge-Green brought forward evidence regarding the distribution in the retina of the photo-sensitive pigment, the visual purple. This pigment belongs to the "rods" only, and is not present in the "cones." Nevertheless, Dr. Edridge-Green finds that it is present in the central region of the retina, a region in which there are cones only and no rods. On examining the retina of the monkey, when that animal had, in order to increase the amount of visual purple, been kept in the dark for twenty-four hours, the central region of vision, the yellow spot, instead of being free from visual purple was the most purple part of the whole retina. The purple was, however, seen by microscopic examination to be around and not actually in the cones. He advanced the theory that the cones were only sensitive to changes in the visual purple, not to light itself.

Dr. Osborne communicated the results of researches on glycogen carried out in conjunction with Dr. Zobel. Glycogen when hydrolysed by a diastatic ferment gives rise to bodies very similar to those derived from starch. Amongst these is the so-called isomaltose, shown by Brown and Morris to be a mixture of maltose and a dextrin-like body. When acted on by saliva, glycogen gives dextrins, dextrose and maltose.

Dr. C. S. Myers referred to observations on the smallest perceptible musical tone-difference as examined in the people of Scotland and of the Torres Straits. The investigations had been conducted by means of tuning-forks. The least perceptible tone-difference among the children of Murray Island was not widely different from those of the children of Aberdeenshire. But with practice the Aberdeenshire children improved more readily and uniformly. The adult Murray Islanders for the most part failed to detect a semi-tone interval. The average difference of vibration-frequency just distinguishable by the

Adult Murray Islanders was fifteen vibrations per second, whereas for the adult Scotch examined it was nine vibrations.

Dr. Page May gave an excellent demonstration of sections of the brain and of the spinal cord of the camel.

Mr. Barcroft described work dealing with a series of observations on the quantitative estimation of urea.

MAGNETIC WORK OF THE UNITED STATES COAST AND GEODETIC SURVEY, OULINED FOR JULY 1, 1902—JUNE 30, 1903.

(a) *LAND Magnetic Survey Work.*—The determination of the three magnetic elements at 400-500 stations distributed principally in Virginia, New Jersey, Pennsylvania, Ohio, Michigan, Kansas, Nebraska, Texas, Arkansas and Florida.

(b) *Magnetic Observatory Work.*—The continuous operation of the four magnetic observatories situated at Cheltenham, Maryland; Baldwin, Kansas; Sitka, Alaska; and near Honolulu, Hawaiian Islands; also the selection of sites and preparations of plans of an observatory in Porto Rico or vicinity, and another in the extreme western part of the United States. [The International Committee on Terrestrial Magnetism and Atmospheric Electricity at the Bristol Conference in 1897 recommended Porto Rico as a suitable and favourable site. The recent magnetic disturbances experienced simultaneously with volcanic eruptions in Martinique will now make the vicinity of Porto Rico an especially important location for a fully equipped magnetic observatory.]

(c) *Ocean Magnetic Survey Work.*—The inauguration of magnetic work on board ship in connection with regular trips of vessels engaged in coast survey work. [In this connection it is also proposed during the coming winter to make some trial investigations of the distribution of the magnetic elements over the frozen portions of Lakes Michigan, Superior and Huron in the vicinity of the Straits of Mackinac. The necessary observations at shore stations and on islands will be made in the fall and spring.]

(d) *Special investigations* conducted at the magnetic observatories and at certain educational institutions by persons available as "associate magnetic observers."

(e) *At the office at Washington* a special effort will be made to bring all computations of field work performed and investigations conducted since July 1, 1899, up to date and prepare results for publication.

THE "SUDD" OF THE WHITE NILE.

A RECENT number of the *Geographical Journal* contains a paper on the "sudd" of the White Nile, by Dr. Edward S. Crispin, explaining the method of opening up the true river bed employed by Major Mathews, who commanded the Sudd Expedition of 1901-1902. The first difficulty is to find the position of the river bed; this is done by probing, the depth suddenly increasing to 15 or 20 feet. Next the top growth, consisting mostly of papyrus, is cut down or burnt; and it was noted that when the papyrus was fired the fire frequently spread along what was afterwards found to be the true bed of the river. Men are then landed on the cleared surface and the sudd cut along the river banks with saws; next transverse cuts are made, dividing the sudd into blocks of size convenient for the steamer to tear out. The bows of the steamer are run into the block, and the loop of a steel hawser, both ends of which are made fast to the steamer, is passed over the bows and trodden into a trench cut on the surface of the block. The steamer then goes full speed astern, men standing on the hawser to keep it in position, and after a number of trials the block is torn away. The block is then towed clear and cast adrift to float down stream, when it is gradually disintegrated. We reproduce figures illustrating (a) the steamer towing out a block of sudd, showing the men standing round and holding the hawser in position, and (b) the block let go in open water and floating down stream.

The chief growths in the sudd are papyrus and tiger or elephant grass, a kind of bamboo growing to a height of 20 feet or more. Up these climbs a creeper of the convolvulus species. There is also abundance of ambatch and a long

sword-grass that cuts like a knife, known as "oom soof." The steamer could cut its own way through the latter in the presence

practical men of science and others in regard to the mitigation of the evil effects of fog in towns, and incidentally to point out what demands in this connection, desirable in themselves, must be regarded as beyond the scope even of scientific ambition.

For the sake of clearness, what I have to say is cast in the form of a parallel or analogy. The smoke in fog is the element of the problem to which special attention is directed, and the smoke is regarded as a species of domestic or industrial refuse which has to be removed somehow or other. The removal of smoke is a problem not dissimilar in its fundamental character from that of the removal of sewage, and in what I have to say I keep in view the analogy that exists between the elements of these two problems. I choose the problem of the removal of sewage for this purpose, because it is a problem in which sanitary reformers have achieved gradual but conspicuous success during the nineteenth century, and even within the memory of the present generation, to the great advantage of the whole community.

In all matters concerning the disposal of refuse, we progress by slow degrees from an individualist to a socialist point of view. Occasional illustrations of reckless indulgence of the extreme individualist view as regards the disposal of other forms of refuse might be quoted, and at this day it is no great exaggeration to say that we all act with similar recklessness with regard to our smoke; we throw it into the atmosphere and leave to beneficent chance the question whether or not it injures our neighbours.

In large towns, we have travelled very far in the path of development from the original instinct as regards the problem of the disposal of sewage-polluted water, but there has been no corresponding progress in the disposal of smoke-polluted air. In London, at a cost to the community of 211,000*l.* a year, or 1*3*/₈% in the pound on rateable value, nearly a million tons of sewage are removed day by day for about 600,000 houses—about a ton and a half on the average for each house. In the same period, viz. each day, in winter, each house throws into the atmosphere on the average perhaps ten tons of smoke-laden air, or a total quantity of five million tons of smoke-laden air for the inhabited houses of London per day, or possibly seven millions of tons per day if we include factories. The actual weight of solid soot which gives colour and body to the smoke is a very uncertain quantity; it may in the worst cases amount to nearly 3 per cent. of the coal consumed, and the houses of London probably get rid of 300 tons of solid refuse every day by throwing it up the chimney. It is mixed with much larger quantities of other more or less injurious products of the combustion of coal, complete or incomplete, but it is with the soot, which alone darkens and defiles, that I am primarily concerned.

The Initial Stages of the two Problems.

The difference of our attitude towards these two problems is very conspicuous, yet physically speaking the whole difference between the problem of the removal of sewage and that of the removal of smoke on similar lines lies in the distinction that sewage naturally goes downwards, whereas, in the first instance, smoke goes upwards. If the smoke of our fires had been in the habit of falling downwards and finding a lower level instead of rising to a higher level and making its way up the chimney, we should



FIG. 1.—Steamer towing out a block of sudd.

of a current, as it would break up and float down stream. In the absence of current it does not float away, and obstructs the



FIG. 2.—Block of sudd let go in open water.

steamer by fouling the paddle-wheel. Another source of obstruction is a very light kind of duckweed which covers some of the small open pools.

THE TREATMENT OF SMOKE: A SANITARY PARALLEL.¹

Introductory.

IN accepting the suggestion that I should take as my subject some aspect of the fog question, I have allowed the importance of the question to override the many considerations which I could adduce in opposition thereto. I propose to consider what demands sanitary reformers may fairly make upon

¹ Abstract of a lecture to the Sanitary Congress at Manchester by Dr. W. N. Shaw, F.R.S.

long ago have been driven into solving the problem of its disposal, as we have been driven to deal with the disposal of sewage, no matter how great the volume might be.

It days not so very remote, the arrangements for the disposal of smoke might be regarded as comparatively in advance. The genius who first put in practice the idea of confining smoke to a narrow flue specially built for it wrought a revolution in house-building. There are still archaeological survivals which show that before his day there were architects who were satisfied with the more simple provision of a hole in the roof, and there are even traces extant of a still earlier architectural style of inhabited dwelling in which such rudimentary provision as a special opening for smoke did not exist. I do not attempt to describe the corresponding stages in the development of the means of disposal of other kinds of refuse; they could be traced—*gardy loo* is the survival of a warning with special meaning in the Scottish capital—and examples of present-day practice might be adduced in illustration. But while the disposal of sewage has been generally though slowly progressive since the first commissioners of sewers were appointed in 1531, the invention of the chimney seems to have been so successful as to paralyse mechanical enterprise in that department until the subject was taken up in later years by cowl makers, who have devoted much ingenuity to the improvement of the terminal outlet. For domestic purposes, the simple chimney, with or without the assistance of a cowl, remains a sufficiently effective apparatus; the practice of using it to throw smoke into the atmosphere to be carried away by any currents of air that may arise is universal.

Demands beyond the range of Scientific Ambition.

One of the incidental obstacles to a scientific treatment of the smoke question is that at first sight the atmospheric currents appear to perform the duties of general scavenger with such exemplary efficiency that few people give any thought to the general success or failure of the method itself. On foggy days we become aware of the nuisance which we have created, and accordingly desire that steps should forthwith be taken to remove or prevent fogs, with the understanding that whatever does away with the fog will, at the same time, do away with the smoke nuisance. Now the prevention of fog as a meteorological phenomenon is one of the demands which I think we are not legitimately entitled to ask of practical men of science; it is beyond the ambition even of physical science. To use the parallel further, it would be just as reasonable for us to throw all our refuse into the streets and, when we found that it accumulated beyond endurance, demand of men of science that they should provide showers at suitable intervals to wash it all away. The well-known meteorological conditions for the formation of inland fog are my justification for this opinion.

Nor can we hope for the removal of fog by the actual removal of the foggy air of London. I have on several occasions seen suggestions which seemed to regard such a scheme as possible, but I have never been able to understand where the air would be sent to and by what it would be replaced. Any such proposal has always seemed to me to come perilously near to a scheme for sweeping away the Atlantic with a mop. The removal of foggy air from the streets is as hopeless a matter as the prevention of fog, and when once smoke has been allowed to be discharged into the free atmosphere, all chance of removing it is gone.

Gravity of the Smoke Nuisance.

It is not only on foggy days that the method of leaving the atmospheric currents to act as the smoke scavengers fails. In large towns, the system is generally speaking inefficient. In support of this assertion, I quote from the figures giving the average amount of sunshine recorded at a large number of stations in the British Isles during the twenty years from 1881 to 1900, a comparison between the records for London and the average of those for other places in the southern district of England. The amounts given as percentages of the possible duration of sunshine for the several months are as follows:—

	Jan.	Feb.	Mar.	Apr.	May	June	July	Aug.	Sept.	Oct.	Nov.	Dec.	
London ...	10	15	23	31	38	36	33	39	34	24	14	9	per cent. of possible duration.
Average for the southern district of England ...	21	28	38	42	46	43	46	47	44	37	24	21	do.
London loss in approximate figures	↓	↓	↓	↓	↓	↓	↓	↓	↓	↓	↓	↓	

It appears that in summer London loses one-sixth of its sunshine, and presumably also about the same fraction of its daylight, on account of its smoke, while in winter its loss amounts to one-half for a similar reason.

The contrast of the figures for summer and winter is remarkable. As regards smoke, the difference rests chiefly on the fact that there are fewer domestic fires in summer, and we may therefore legitimately conclude that the domestic smoke is the most serious item to be reckoned with in considering the smoke question. It is, in fact, two-thirds of the problem.¹ Anyone who wishes to satisfy himself as to this aspect of the question can easily do so. During the past winter, Captain Carpenter, R.N., D.S.O., who has been conducting an inquiry for the Meteorological Council into the prevalence and distribution of fogs in London, found that the Victoria Tower at Westminster and St. Paul's Cathedral—two buildings a mile and a half apart as the crow flies—are invisible the one from the other until March is well established. There is here no question of persistent fog in the meteorological sense; even on windy days, when fog is meteorologically impossible, there is no possibility of seeing a distant object in London on account of the domestic smoke from the thousands of chimneys, each using the primitive plan of pouring its refuse into the atmosphere. Not only is the magnitude of the task too great, but the manner in which the atmosphere deals with it is not by any means satisfactory. It does not consume or annihilate the smoke, or render it harmless; it carries its load a little way, longer or shorter according to the state of the weather, and then drops it regardless of consequences. The results are easily recognised. Sooty rains are not by any means an unusual phenomenon, and that is not all. A special type of heavy, dull, oppressive atmospheric condition may generally be noticed on the lee side of all great smoke centres.

That we endure the presence of all this burden of refuse in the air which we breathe, and which carries all our daylight, while we have eliminated the corresponding refuse from our streets and our drinking-water, is partly to be accounted for by the fact that ideas about the treatment of smoke are still in an almost primitive stage; partly also because the inefficiency of the atmospheric currents for renewing the air of our great cities in ordinary weather is not fully realised. It is only during persistent fog that the failure is complete and unmistakable. On foggy days when we thrust our refuse into the atmosphere, it simply descends upon our heads and into our houses. We might almost as well have no chimneys at all. The experience of Sir W. Thissell-Dyer at Kew could easily be shown to be the experience of all of us who live in large towns if we were able to make such measurements as he made in 1891, when after a week of fog he found upon the greenhouses at Kew—a comparatively favoured atmospheric position for London—a deposit of tarry matter at the rate of six tons to the square mile.

So far as I know, the only practical suggestion put forward by those interested in the abatement of the smoke nuisance is to invite householders and compel factory owners not to make smoke, or to consume it if they make it, or, in the third event, to make as little as may be, consistently with their own interests. As regards factories, very considerable improvement has followed these efforts, and I do not wish to be adversely critical when I point out, first, that the distinction drawn between the factory and the domestic establishment is unscientific if the smoke nuisance is to be really removed, and secondly, that that was not the plan adopted in the parallel case of the removal of sewage, for which the local authorities have used common funds.

Further Development of the Analogy.

In following the analogy somewhat further, I suppose it agreed that the proper course to be pursued is, not merely to

¹ The corresponding figures for Glasgow as compared with Douglas (Isle of Man), the only other station in the same meteorological district, indicate that domestic smoke is only responsible for one-half of the smoke problem in the Glasgow district, though the want of stations makes the comparison incomplete. The figures are as follows:—

	Jan.	Feb.	Mar.	Apr.	May	June	July	Aug.	Sept.	Oct.	Nov.	Dec.	
Glasgow sun-shine	10	17	24	30	33	31	28	28	26	22	11	8	per cent. of possible duration.
Douglas sun-shine	21	26	37	43	46	43	39	38	38	32	24	13	do.
Glasgow, loss in approximate figures ...	↓	↓	↓	↓	↓	↓	↓	↓	↓	↓	↓	↓	

prevent smoke by penal legislation, but to encourage the interception of smoke and the removal of the sooty particles before the air is allowed to escape, and I will subsequently call attention to the share which a local authority could fairly take in such an enterprise. I do not say that this is the only or the best mode of dealing with the question; I only consider whether it is, *prima facie*, practicable enough to justify our including inquiries with regard to it in the demands that sanitation may reasonably make upon science. I offer a few considerations in mitigation of criticism of this venturesome proceeding.

First, I am only practically recalling a suggestion made many years ago. A proposal for the treatment of smoke by the erection of municipal chimneys was made in Manchester by Mr. Peter Spence (*Proceedings Manchester Lit. and Phil. Soc.*, 1857). It is precisely in such a city as Manchester—a city of fogs and smoke, but also the city of Dalton and of Juley—where the facilities for the association of scientific experiments with real practical life have been so wonderfully developed that an enterprise of this character could be taken in hand.

Secondly, the present method of dealing with smoke is by no means final, although, as I have said, it has marked a most important stage of progress. One of the most conspicuous features of London architecture is the enormous variety of smoke cowl, in all stages of dilapidation, to be seen surmounting the roofs. Almost every chimney stack is a sort of museum of contrivances for improving the action of chimneys. The mere exhibition of so many contrivances can only mean that smoky chimneys are not by any means so rare as they might be under more favourable mechanical conditions. On that very account, if on no other, the separate chimney method of dealing with smoke is not suited to the circumstances of large towns.

Thirdly, the designer of a factory takes a further step in advance in the treatment of smoke, and provides a single smoke stack for a considerable number of independent fires. The separate opening of each chimney of the domestic house into free air is, therefore, not absolutely required for the removal of smoke. The factory builder is not always successful in using his chimney for preventing smoke, but he is successful in leading the foul air of many flues into one channel which might afford an opportunity for depriving the smoke of its soot.

Moreover, arrangements for propelling air mechanically are becoming every day more extended. Some of them as employed in various systems of ventilation are quite as elaborate as any that would be required to deal with the smoke of an ordinary house or block of houses. There is no sufficient distinction to be drawn between coal smoke and other forms of refuse that foul the air to make it necessary to use one system for the former and a different one for the others. It thus seems almost certain that if the domestic architect had sufficient encouragement to make the attempt, he would not find the plan of dealing with household smoke by the method of the factory chimney or by mechanical propulsion beyond the range of practical physics.

Some Particulars of the Smoke Problem.

For purposes of comparison, I next consider what is the amount of smoke-laden air which we have to deal. It is difficult to give any but the roughest estimate. I assume that on the average every house of the 600,000 rated for the municipal purposes of London has two fires burning, and therefore two chimneys emitting smoky air, for twelve hours each day, and that each chimney uses and defiles 10,000 cubic feet of air per hour. If these estimates are inaccurate, we can at least ask scientific men to correct them. On these assumptions, every "working chimney" delivers 4.2 tons of smoky air per day; every house, on the average, 8.4 tons. We thus obtain the estimate of five millions of tons of smoky air sent up to the household chimneys of London in one day. Allowing for the 14,500 factories of London, which are not altogether innocent in the matter of smoke, as equivalent each to thirty house chimneys, we get an additional two million tons of air fouled with smoke; that is, in the aggregate about seven million tons of air are used per day in London to carry away smoke¹ as compared with about a million tons of water to carry away

¹ A layer of air 60 feet thick over the 75,000 acres comprised within the administrative county of London would weigh about 7,000,000 tons. The calculation suggests that on a day of dense fog, when there is very little horizontal movement of air, there is a more or less complete circulation of the air through the chimneys and back again to the streets and houses during the hours when chimneys are active. Dr. W. J. Russell's analyses of air during fog lend support to this suggestion.

sewage. The cost of dealing with the sewage is about 600*l.* per day. Supposing that a ton of dirty air could be "treated" for the same cost as a ton of sewage, the cost of clearing the air of London might be set down at 4200*l.* a day, equivalent to a rate of 10*l.* in the pound.

To move air is a comparatively cheap matter. An electrically-driven fan will do the day's work of a single chimney, as regards smoky air, at a cost of about a penny, under suitable conditions. A single colliery fan has been made to deliver as much as 200,000 cubic feet of air per minute, and its output therefore amounts to about 10,000 tons a day, or sufficient to carry the smoke of more than 1000 London houses on the scale mentioned above. Five hundred of such fans would carry the household smoke of the whole of London. It would mean a huge aggregation of power, but London means the same.

These figures show that although the volume of smoky air is vastly larger than the volume of sewage, yet the cost of dealing with it for the purpose of treatment may not be of an altogether different order of magnitude from the cost of the manipulation of London sewage, and the point at which I wish to arrive is, that we are justified in asking practical men of science, as a first question, whether the treatment of smoky air, on a plan somewhat similar to the treatment of sewage, is mechanically possible within reasonable limits of original outlay and current expense.

Limitation of the Analogy.

Beyond this point it would be necessary to diverge in the treatment of smoke from the plan adopted with sewage, both as regards the special method of dealing with it and as to the part which the local authorities should take in encouraging and assisting the purification of air.

I do not suppose that it is possible to establish a few main drains for smoky air corresponding to the main sewage drains, and to use one or two cleansing stations for purifying the air from smoke; but it might be possible to achieve a similar result by a large number of systems on a correspondingly small scale, and the systems might be some of them municipal and some private. A single block of houses might have means for drawing off the smoke from all its fires into a chamber wherein the smoke could be treated,¹ before the fouled air was allowed to pass into the atmosphere, and if such a system were mechanically feasible we should then be able to put a second question to practical men of science, viz., whether it is not possible completely to deposit from the air as it passes on its way the solid particles which form the smoke. It has been shown that sooty particles coagulate under mechanical action, and some years ago Sir Oliver Lodge showed experiments on the deposition of smoke in a closed chamber by means of electricity. I should now like to ask whether it is not possible to make a further advance in this direction. I do not demand that no smoke shall be produced. I think that people may prefer to pay the cost of abstracting the smoke if they enjoy the free use of open fires, to which, in England, we are so much attached.

The Question of Cost.

If men of science give us satisfactory answers as to the physical possibilities, the question then becomes one of cost. Suppose that the cost amounts to the equivalent of a tenpenny rate. Would ratepayers be willing to expend a sum of that magnitude for the purpose of eliminating smoke from the atmosphere of London or Manchester?

In considering this aspect of the question, it should be remembered that the result, if successful, would have some economies to set down per contra.

A bad fog in London, according to the *Times*, may cost 5000*l.* a day for additional gas alone; to that we have to add the loss due to interference with traffic and other incidental items. I have seen the cost of a day's fog estimated variously at from 20,000*l.* to 50,000*l.*, and the cost per annum is set, I think by Mr. Rollo Russell, at from three to five million pounds. If any of these estimates be true, the equivalent of a tenpenny rate would obviously be a very cheap substitute for the smoke of London. Certainly, whatever may be the material damage of a day's fog, the moral and intellectual damage should be reckoned as no inconsiderable addition, and if the indirect results of the dirt of London smoke could be avoided, even an additional tenpenny rate might be found acceptable to a majority of ratepayers.

¹ The plan of using a single chimney for a building comprising a chemical laboratory and suite of offices—sixteen rooms—has been carried out at the Manchester Alum Works in pursuance of Mr. P. Spence's idea.

Incidental Advantages.

A system such as that indicated would have some incidental advantages. It would provide a persistent and calculable system of ventilation that would enable hot water or steam pipes to be used advantageously much more generally than they can be at present, and afford other facilities corresponding to those of an efficient system of drainage with a copious water supply.

Contribution of Local Authorities to the Solution of the Problem.

Hitherto the powers of local authorities have been restricted to fining conspicuous offenders, and the system of penalties for conspicuous failure is not fully effective; it might be replaced advantageously by a system of rewards for success. For the sake of definiteness, I have set down the contribution of the local authority as equivalent to a tenpenny rate, though it would not seem practicable for it to contribute in the same way as it does to the solution of the sewage question by maintaining a single municipal system. It might contribute effectively by allowing a specific reduction of rate on those properties within its area which were so arranged as not to add to the pollution of the atmosphere by smoke.

If the questions which I have mentioned are to be asked, it is essential that they should be put in such a manner that practical men of science may be encouraged to work out effective answers, and for that purpose they must make experiments. In the practical applications of science on the large scale, experiments are very expensive, and the only way of getting them performed is to take care that they are remunerative to somebody if successful. In this matter the local authorities could be of great assistance if they were willing to adjust their rating in what seems to me a reasonable manner. At present the incidence of rating is such as to discourage all experiments of this kind. If an enterprising architect were to erect a block of buildings and provide it with means of delivering its used air free of smoke at a substantial outlay, I presume the local authority would increase the rateable value of the property on account of the outlay, and thus fine the owner some considerable sum per annum for his enterprise. The owner would also be placed in the unfortunate position that whereas by avoiding smoke he had conferred as much benefit upon all his neighbours as upon himself, he would have to pay the whole fine of increased rating himself, and would still have all the disadvantages of his neighbours' smoke.

I would suggest that instead of pursuing so unreasonable a course, the local authorities might recognise public spirit of this kind by reducing the assessment of a property that, to the satisfaction of its neighbours as well as of a surveyor or inspector, produced no smoke, so that the rates upon such a property should be decreased by, say, *6d.* or *1s.* in the pound instead of being increased. This would afford direct encouragement to practical men of science to design and keep in action means for the prevention of smoke, and would lead to gradual improvement.

It would naturally appeal with the greatest force in those quarters where rateable value is high and the advantage of open fires relatively small, and in such places it would be really worth while for practical men to make a serious effort to qualify for the reduction of rate. In the City of London, for example, there must be many properties with very high rateable value the facilities of which for contributing smoky air are already limited to one hot-water furnace and a few open fires. For such establishments it would be an experiment on a very small scale to arrange matters to obviate smoke altogether and satisfy the surveyor or inspector that the property was smokeless, and thus secure the reduction of rate. There might be some difficulty at first in establishing a qualification, but it could not be greater than the difficulty of establishing a right to a parliamentary vote. In the course of time, the smoke producers would be a few exceptional persons paying exceptionally high rates, a very rational state of affairs; and when the City of London had by the gradual extension of such experiments freed itself from its own smoke, I think we might safely rely upon the citizens to take care that the indirect economies to which they would be legitimately entitled by their public spirit were not destroyed by the unrestricted smoke production of the surrounding boroughs.

I have made the system of the general collection of smoke by mechanical means for the purpose of treatment the basis of my remarks, but I have already disclaimed any desire for exclusive privileges for that particular form of experiment in the puri-

fication of smoky air. If it be feasible on the commercial scale, it has the advantage in an especial manner of making successive improvements possible. The smoky air of London is injurious, not only on account of its visible soot, but also on account of the sulphurous acid and other invisible products of combustion which accompany the soot in the first instance. If it be found possible in the first place to deposit the soot particles, attention might next be turned to some means of dealing with the noxious acid fumes, at least, in those cases where they are specially abundant.

Such a system would thus be, in the first instance, a direct encouragement to progressive experiments, and in the end would enlist the active support of all those possessing arrangements for avoiding smoke in favour of effective compulsion for those who had not.

To put the questions I have indicated to men of science in this way would be merely a matter of business, and if the questions were so put, the science of the twentieth century would probably give as satisfactory an answer to the question of the treatment of smoke as the science of the nineteenth has given to the question of the treatment of sewage.

UNIVERSITY AND EDUCATIONAL INTELLIGENCE.

CAMBRIDGE.—The Hon. C. A. Parsons, M.A., F.R.S., whose scientific work in connection with the development of the steam turbine has excited much interest, has been elected to an honorary fellowship at St. John's College, of which he was formerly a scholar.

Mr. L. Doncaster, King's, has been appointed to work at the University table in the Naples Zoological Station.

A conference on the training of teachers for secondary schools for boys will take place in Cambridge, under the presidency of the Vice-chancellor, in November.

The Gedge prize for research in physiology has been awarded to Mr. S. W. Cole, King's.

ON Wednesday, October 22, Mr. Andrew Carnegie was formally installed to the rectorship of St. Andrew's University. In his rectorial address, Mr. Carnegie dealt with the economic changes in the relative position and power of nations which either have taken place or are impending. Among honorary degrees conferred on the occasion was one bestowed on Mr. Alexander Graham Bell, the inventor of the telephone.

WHILE agricultural education is in a flourishing condition in the colleges of the United States, it is not yet doing as much for the welfare of the American farmer as is desirable. This, at least, we infer from the vigorous address delivered by the Secretary of Agriculture before the National Educational Association, which is briefly referred to in an editorial article in vol. xiv. part i. of the "U.S. Experiment Station Record." Mr. Wilson pleads not so much for technical instruction in agriculture as for the education of "half the people under our flag, who till the soil and furnish 65 per cent. of our exports." The importance of this class warrants the special adaptation of the educational system to its needs. "The four-year college course does not begin soon enough nor continue long enough to meet the requirements of our day." Study should begin in the primary school and continue through life. Teachers and the organisers of education in rural districts should understand the farmer's requirements, should themselves know something of agricultural science, and to this end Mr. Wilson recommends that teachers in primary and secondary schools should be sent to agricultural colleges at State expense to get the necessary knowledge. While much might be done to awaken the interest of the rising generation in agriculture were the teachers in elementary schools possessed of an agricultural bias, it is doubtful if any such "entirely new" system as Mr. Wilson refers to in the following sentence would be practicable or desirable. "Five thousand students attend agricultural colleges, but these colleges are feeling their way in the dark along untravelled paths. . . . They will at last forge out a system that will meet the requirements of producers and be entirely new and suitable to our conditions as a people."

In the *North British Agriculturist* of October 22, a different and more direct method of awakening the interest of the young farmer in his work is described. Under the auspices of the

Berkeley Hunt Society, a competitive examination in agriculture, and especially in the arts of hedging, thatching, judging stock, &c., is held. The examination is open to young farmers and labourers of the district, is partly written, partly practical and oral. Three valuable prizes are offered and certificates are awarded for satisfactory work. The fall in prices and the scarcity of labour have made farmers less careful in details than formerly, and as a consequence their labourers are less skilled. Any kind of competition which revives the interest of masters and men in arts so necessary to good farming is much to be commended. If country districts held more competitions of this sort, if skill in rural arts were fostered with a tenth of the energy bestowed on foxes or football, we would hear less of rural depopulation and of agricultural depression.

The last annual report of the Glasgow and West of Scotland Technical College shows that the high standard of the work accomplished in the institution is fully maintained. During the session 1901-2, the number of students in the various departments of the College reached 5651, of whom 596 were students studying in the day technological courses. Although the evening classes were attended by 4174 men and 220 women, the governors were unable to find room for some hundreds of students, who were perforce refused admission. In view of this serious want of accommodation, we are glad to learn that contracts, amounting to about 130,000*l.*, have been entered into for the erection of the first section of the proposed new buildings. The section will comprise about seventy-two per cent. of the whole structure, and fully three years will be occupied in its erection. It is anticipated that the new buildings, as planned, exclusive of equipment, will cost about 180,000*l.*, to which amount must be added 30,000*l.* for the site. The building fund, as shown by the list of donations given in an appendix to the report, now stands at 175,000*l.*, to which the Scottish Association of Master Bakers has contributed nearly 2500*l.*, the Glasgow Building Trades' Exchange about 650*l.* and the Trades' House and Incorporations of Glasgow an amount approaching 2000*l.* Nor is this the only evidence of the keen interest taken in higher education by Scottish manufacturers and merchants, for the report contains long lists of firms who have either given facilities for parties of students to visit works or have supplied the College with gifts of apparatus, specimens or laboratory material. That the claims of pure science have not been overshadowed by the pressing needs of the technological studies is shown by the gift of 5000*l.* from Mrs. John Elder for the provision of lectures on descriptive astronomy. There is evidently a great future in store for this deserving Glasgow institution.

SCIENTIFIC SERIAL.

Journal of Botany, October.—From the collection of plants made by Mr. T. Kässner chiefly along the railway from Mombasa, in British East Africa, Mr. Spencer Moore selects for description the more interesting species of the Compositæ and Acanthaceæ, and proposes seven new species.—Mr. W. E. Nicholson refers some miniature mosses gathered near Crowborough, Sussex, to *Ephemerum stellatum*, a species first recorded by Monsieur Philibert for specimens collected at Bruailles, in France.—A note on the genus *Sematophyllum* signifies Mrs. E. G. Britton's approval of the revival of that genus of mosses by Dr. Braithwaite.—Mr. G. C. Druce gives a brief account of the plant establishments on the shingle near Dungeness, and a list of Kentish plants which adds a few new localities to those recorded in Hanbury and Marshall's "Flora of Kent."—Mr. S. T. Dunn, by an inductive method of argument, deduces that only one species of the British representatives of the deadnettle, *Lamium Galabardum*, has maintained its original habitat and may be considered naturally indigenous.—A list of West Lancashire plants, by Messrs. J. A. Wheldon and A. Wilson, provides new county records and localities.

SOCIETIES AND ACADEMIES.

LONDON.

Entomological Society, October 1.—The Rev. Canon Fowler, president, in the chair.—Mr. H. St. J. Donisthorpe exhibited specimens of *Dibolia cynoglossi*, taken by him near Pevensey on August 11 last. He said that the beetle, which was figured by Curtis, had not been recorded as British since 1866.—Mr. O. E. Janson exhibited a fine hermaphrodite speci-

men of *Dryas paphia*, taken in the New Forest by Mr. Herbert Charles on July 28 and recorded in the *Entomologist*, also a melanic specimen of *Papilio demoleus* from Ceylon, in which all the usual marginal and submarginal yellow markings were absent and the discal markings much obscured; on the underside the yellow markings were entirely wanting.—Mr. C. P. Pickett exhibited a *♂ Callimorpha dominula* with the hind-wings suffused with black and an extra black spot in the centre, the white spot on the fore-wings being absent, and a very large ♀ of the same species, both bred from larvae found at Walmer at the end of March; also three aberrant specimens of *Triphaena fimbria* bred from larvae taken at Wood Street during the same month.—Mr. C. O. Waterhouse exhibited specimens of a wasp, *Zethus chalybeus*, and a neuropter, *Mantissa semihyalina*, received with a collection of Hymenoptera from Rio Janeiro, suggesting a curious case of mimicry.—Mr. F. B. Jennings exhibited specimens of *Hister meridarius*, from Broxbourne, Herts, part of a large colony of this usually scarce species found with *Hister 12-striatus* and other beetles inhabiting a heap of a chemical substance, probably gas-lime, in which also many larvae, presumably of *Hister meridarius*, and burrows were observed. The soil was warm and moist, and this, and the presence of a quantity of vegetable refuse thrown on the heap, was no doubt the attraction to the Histers to settle there.—Mr. A. J. Chitty exhibited a specimen of *Meteoecus paradoxus* with a part of the cells of a nest of *Vespa vulgaris*, in which place the beetle is invariably found. The beetle in the cell tucks in his head, only displaying on the surface the thorax, which is coloured similarly to the face of the wasp. This peculiarity suggests a case of mimicry, and Prof. Poulton said that it fitted in with the case of some other bees and wasps.—Mr. H. Rowland-Brown exhibited on behalf of Mr. G. F. Leigh, of Durban, a ♀ and ♂ specimen of a rare noctuid, *Muzgavia Leighi*, Hampson, discovered by him in Natal, and read remarks upon the life-history of the species, communicated by the captor.—Mr. Stanley W. Kemp exhibited two additions to the British list of Coleoptera, *Bembidium argentiolum*, from Lough Neagh, Armagh, and *Laomostenus complanatus*, from the neighbourhood of Dublin, taken in June.—Mr. W. J. Kaye exhibited examples of *Heliconius Lindigii*, *Heliconius antiochus* and *Morpho achilles* from British Guiana with notches taken out of the hind-wings, presumably by birds, to illustrate that these distasteful or warning-coloured species are subject to attack, this helping to show that experimental tasting as propounded by the Müllerian theory of mimicry does exist and go on.—Prof. L. C. Miall, F.R.S., communicated a paper by Mr. T. H. Taylor entitled "The Tracheal System of Simulium."—Prof. Auguste Forel communicated a paper entitled "Descriptions of some Ants from the Rocky Mountains of Canada (Alberta and British Columbia) collected by Edward Whymper."—Dr. T. A. Chapman read a paper entitled "On *Heterogynis paradoxa*."

Royal Microscopical Society, October 15.—Dr. H. Woodward, F.R.S., in the chair.—Prof. T. G. Bonney, F.R.S., gave a demonstration on rock changes in nature's laboratory.

PARIS.

Academy of Sciences, October 20.—M. Bouquet de la Grye in the chair.—Studies on earth, by M. Th. Schloesing. In a previous paper the author has shown that the distribution of the ferric oxide varies with the size of the earth particles. In the present paper a similar result is obtained for the organic matter. The earth was separated into particles of varying fineness by levigation and the amount of organic matter determined in each, the percentage varying from 0.15 in the coarsest particles to 7.8 in the finest. A hypothesis is developed to explain these results, which it is proposed to submit to experimental verification.—On the mode of action of carbonic acid in experimental parthenogenesis, by M. Yves Delage. It has been shown that the addition of carbonic acid communicates to sea water the property of developing parthenogenetically the eggs of Asterias. Its effect is now considered from the points of view of its acidity, anæsthetic action, asphyxiating power and effect on osmotic pressure, and the conclusion is drawn that parthenogenetic agents act as temporary poisons. Carbonic acid is a perfect agent because it completely poisons the eggs, but its action is absolutely temporary, and after its elimination the protoplasm is unchanged.—On some parasitic protozoa in *Damonia Reesii*, by MM. A. Laveran and F. Mesnil.—On the problem of the brachistochrone, by M. Haton de la Goupillière.—Remarks by M. R. Zeiller on his note in *Palæontologia Indica* entitled

"Observations on some Fossil Plants of the Lower Gondwanas."
—Remarks by M. Dubail on a volcanic eruption at the island of Torishima, Japan.—On the formation of liquid drops and Tate's laws, by MM. Ph. A. Guye and F. Louis Perrot. The formation of drops of water, benzene and aniline issuing from a capillary tube has been studied photographically by means of the cinematograph. The photographs were taken under two conditions, one in which the drops were formed slowly (static drops) and the other in which the rate of growth was increased (dynamical drops), and a plate is given showing a typical set of the forms observed in each case. The separation of the drop offers a great analogy with the rupture of metallic wires under traction; the rigidity of the liquid is consequently one of the elements of the problem. The authors conclude that the laws, of Tate do not correspond to the facts observed, and hence should be abandoned.—On the elastic parameters of silk fibres, by M. F. Beaulard. In spite of the frequent use of silk fibres in bifilar suspensions, the elastic properties of this substance do not appear to have been determined. In the course of the experiments it was found that silk fibre is affected by hysteresis and undergoes permanent deformations.—Thin metallic films obtained by kathode projection, by M. L. Heullevegue. Mirrors of platinum, palladium, iron, nickel, cobalt, copper and bismuth have been prepared by this method, but no trace of deposit could be obtained from carbon. A bismuth film prepared in this way and placed normally in a strong magnetic field showed no variation in its electrical resistance; from this it would appear that bismuth obtained by kathode projection is absolutely amorphous. Transparent films of iron placed normally in an electromagnetic field showed the existence of a magnetic rotatory power without difficulty.—The action of mixed organomagnesium compounds on the esters of ketonic acids, by M. V. Grignard. The interaction of CH_3MgI with isoamyl pyruvate, ethyl phenylglyoxylate, ethyl levulate and ethyl acetosuccinate has been studied, and brief descriptions of the resulting products are given.—On the derivatives of ethyl pyruvylpyruvate, by M. L. J. Simon. A substance to which the constitution of ethyl pyruvylpyruvate has been assigned is produced by the consecutive action of aniline and strong sulphuric acid upon ethyl pyruvate. In order to demonstrate clearly the ketonic nature of this substance, its interaction with phenylhydrazine has been studied. Two isomeric hydrazones are produced, the preparation and properties of which are fully described.—The germination of the spores of *Sterigmatocystis nigra* in the trachea of some birds, by M. Pierre Lesage.—Experiments on the germination of pollen grains in the presence of stigmata, by M. Pierre Paul Kicher. The pollen of a certain number of species, which do not germinate in pure water, germinate if stigmata of the same, or closely allied, species be added.

DIARY OF SOCIETIES.

FRIDAY, OCTOBER 31.

PHYSICAL SOCIETY, at 5 p.m.—On the existence of a Relationship between the Spectra of some Elements and the Squares of their Atomic Weights: Dr. W. Marshall Watts.—The Size of Atoms: H. V. Kidout.—Exhibition of "Vacuum Calorimeters." Prof. H. L. Callendar, F.R.S.

INSTITUTION OF MECHANICAL ENGINEERS, at 8 (Extra Meeting).—Discussion of the Paper on Oil Motor Cars of 1902: Captain C. C. Longridge.

MONDAY, NOVEMBER 3.

SOCIETY OF CHEMICAL INDUSTRY, at 8.—Preliminary Investigation of the Chemical Changes produced by various Reagents on Guttapercha: Sir William Ramsay, K.C.B., F.R.S.—Also, *time permitting*, The Reduction of Ammoniacal Silver Solutions by Organic Substances: Dr. G. T. Morgan.—A simple Qualitative Test for Bromides and Iodides: Dr. F. Mollwo Perkin.—The Influence of Impurities on the Specific Gravity of Sulphuric Acid: Arthur Marshall.

SOCIETY OF ENGINEERS (Royal United Service Institution), at 7.30.—Effect of Segregation on the Strength of Steel Rails: Thomas Andrews, F.R.S.

TUESDAY, NOVEMBER 4.

INSTITUTION OF CIVIL ENGINEERS, at 8.—Address by the President, and presentation of Medals and Prizes awarded by the Council.

ZOOLOGICAL SOCIETY, at 8.30.—An Account of Recent Palaeontological Discoveries in Egypt: Dr. C. W. Andrews.—On the Classification of the Fishes of the Suborder Plectognathi, with Notes and Descriptions of New Species from Specimens in the British Museum: C. Tate Regan.—On the Transformations of *Papilio dardanus* and *Phalampetus megera* and on two new Species of South-African Heterocera: Lieut.-Colonel J. Malcolm Fawcett

WEDNESDAY, NOVEMBER 5.

COLD STORAGE AND ICE ASSOCIATION (Institution of Mechanical Engineers), at 8.—The Technical Application of Liquid Air: Dr. Carl Linde.

SOCIETY OF PUBLIC ANALYSTS, at 8.—(1) The Reactions of the Alkaloids of *Ipocacua*; (2) The Analysis of Preparations containing Opium: Alfred H. Allen.—The Estimation of Salicylic Acid: Sidney Harvey.—Volatility of Aqueous Solutions of Acetic Acid: William Chatterway.

GEOLOGICAL SOCIETY, at 8.—The Fossil Flora of the Cumberland Coal-field, and the Palaeobotanical Evidence with regard to the Age of the Beds: E. A. Newell Arber.—Notes on Mr. E. A. Newell Arber's paper on the Clarke Collection of Fossil Plants from New South Wales: Dr. F. Kutz.—On a New Boring at Gaythorpe (Lincolnshire): Henry Preston.

ENTOMOLOGICAL SOCIETY, at 8.—New Indian Hymenoptera: Major C. G. Nurse.—Notes on *Driulus flavescens*, Rossi: L. R. Crawshaw.—New Species of Indian Chrysididae: Major C. G. Nurse.

THURSDAY, NOVEMBER 6.

LINNEAN SOCIETY, at 8.—Notes on a Natural History Journey to Chile: H. J. Elwes, F.R.S.

RÖNTGEN SOCIETY, at 8.30.—Address by the President, Mr. Herbert Jackson.

CHEMICAL SOCIETY, at 8.—Di-Indigotine: J. Moir.—Note on the Localisation of Phosphates in the Sugar Cane: C. H. G. Sprankling.—The Specific Heats of Gases: H. Crompton.—On the Non-existence of the Gaseous Sulphide of Carbon described by Deninger: E. J. Russell and N. Smith.—The Action of Nitric Acid on Bromophenolic Compounds: W. Robertson.—Hydroxy oxamides. Part II.: R. H. Pickard, C. Allen, W. A. Fowler and W. Carter.—3,5-Dichloro-*p*-xylene and 3,5-Dichloro-*m*-phthalic Acid: A. W. Crossley and H. R. Le Sueur.—Isomeric Anhydrous Sulphates of the Form $\text{M}^n\text{SO}_4\text{R}_2\text{SO}_4$: F. R. Mallet.—The Catalytic Racemisation of Amygdaline: J. W. Walker.—The Combination of Carbon Monoxide with Chlorine under the Influence of Light: G. Dyson and A. Harden.—The Constituents of Commercial Chrysoarobin: H. A. D. Jowett and C. E. Potter.

CONTENTS.

	PAGE
Modern Scientific Geography. By H. H.	649
Chemistry and Life	651
Two Aspects of the Theory of Probability	652
Our Book Shelf:—	
Sandys and Van Dyke: "Upland Game-Birds."—	
R. L.	652
Hulme: "Wild Fruits of the Country Side"	653
Greiner: "Einführung in die Theorie der Doppelbrechung."—A. W. P.	653
Reid: "Physical Geography"	653
Letters to the Editor:—	
The Hydrography of the Faeroe-Shetland Channel.—	
Prof. D'Arcy W. Thompson; B. Helland-Hansen	654
Matriculation Requirements in Scottish Universities.	
Prof. John Perry, F.R.S.	654
The Neglect of Anthropology in British Universities.—	
Anthropotamist	654
Phosphorus versus Lime in Plant Ash.—Dr. P. Q. Keegan	655
Aluminium and its Alloys. (<i>Illustrated</i>). By M. S.	655
Recent Works on Systematic Botany in Germany	657
Notes. (<i>Illustrated</i>).	658
Our Astronomical Column:—	
Astronomical Occurrences in November	662
The Leonid Shower	662
Observations of ζ Geminaurum	662
The Fifth Satellite of Jupiter	662
Search for an Intra-Mercurial Planet during the Total Solar Eclipse of 1901	662
Chemistry at the British Association	662
Anthropology at the British Association	663
Physiology at the British Association	664
Magnetic Work of the United States Coast and Geodetic Survey, Outlined for July 1, 1902—June 30, 1903	666
The "Sudd" of the White Nile. (<i>Illustrated</i>).	666
The Treatment of Smoke: a Sanitary Parallel. By Dr. W. N. Shaw, F.R.S.	667
University and Educational Intelligence	670
Scientific Serial	671
Societies and Academies	671
Diary of Societies	672

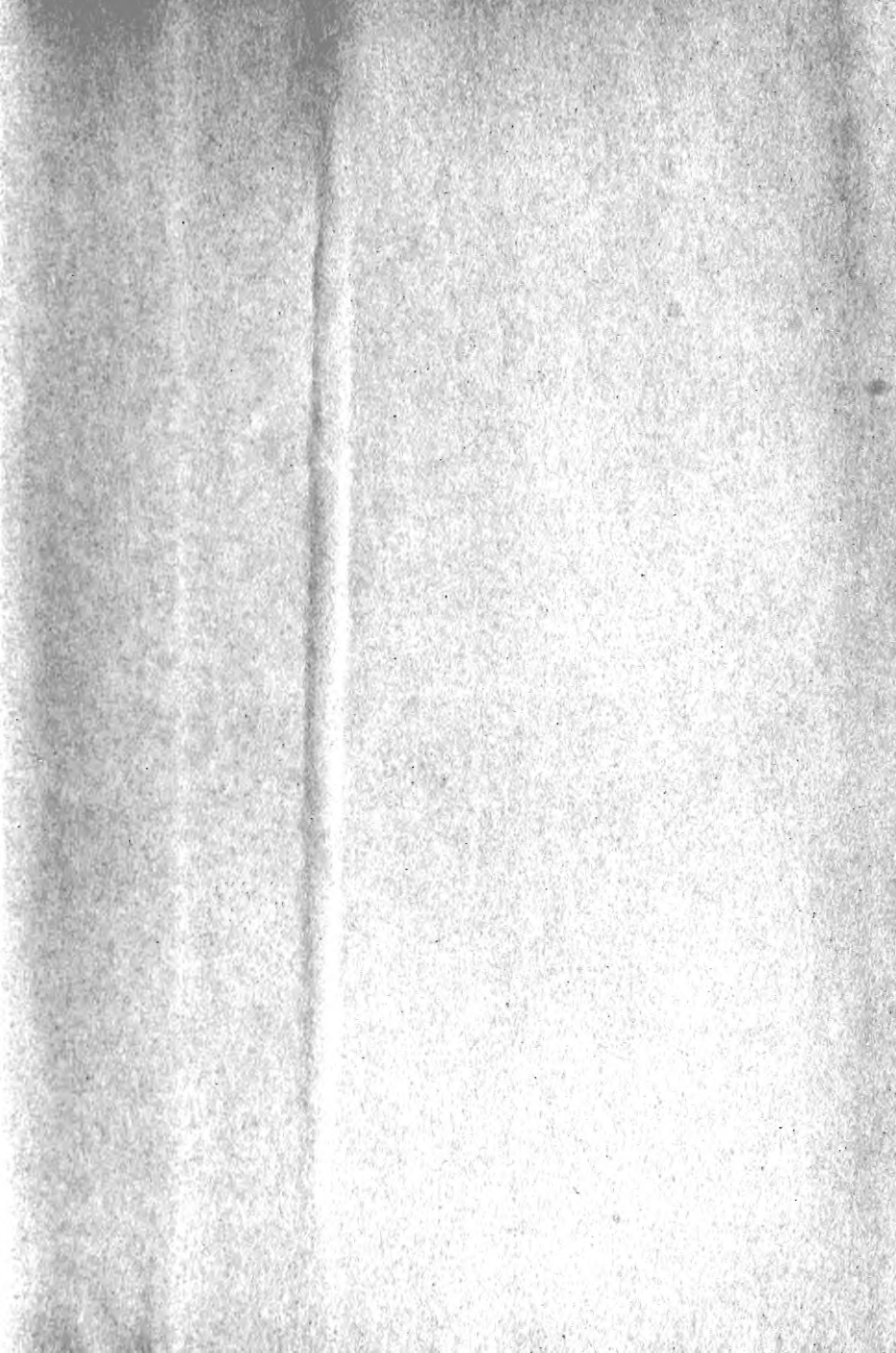





SMITHSONIAN INSTITUTION LIBRARIES



3 9088 01359 6622